

Foreword

Welcome to the growing family of new NISSAN owners. This vehicle is delivered to you with confidence. It was produced using the latest techniques and strict quality control.

This manual was prepared to help you understand the operation and maintenance of your vehicle so that you may enjoy many miles of driving pleasure. Please read through this manual before operating your vehicle.

A separate Warranty Information Booklet explains details about the warranties covering your vehicle. The NISSAN Service and Maintenance Guide explains details about maintaining and servicing your vehicle. Additionally, a separate Customer Care/Lemon Law Booklet (U.S. only) will explain how to resolve any concerns you may have with your vehicle, as well as clarify your rights under your state's lemon law.

Your NISSAN dealer knows your vehicle best. When you require any service or have any questions, they will be glad to assist you with the extensive resources available to them.

READ FIRST — THEN DRIVE SAFELY

Before driving your vehicle please read your Owner's Manual carefully. This will ensure familiarity with controls and maintenance requirements, assisting you in the safe operation of your vehicle.



WARNING

IMPORTANT SAFETY INFORMATION REMINDERS FOR SAFETY!

Follow these important driving rules to help ensure a safe and comfortable trip for you and your passengers!

- Never drive under the influence of alcohol or drugs.
- Always observe posted speed limits and never drive too fast for conditions.
- Always use your seat belts and appropriate child restraint systems. Pre-teen children should be seated in the rear seat.
- Always provide information about the proper use of vehicle safety features to all occupants of the vehicle.
- Always review this Owner's Manual for important safety information.

For descriptions specified for four wheel drive models, a **4x4** mark is placed at the beginning of the applicable sections/items.

As with other vehicles with features for offroad use, failure to operate four wheel drive models correctly may result in loss of control or an accident. For additional information, see "Driving your four wheel drive safely" in the "5. Starting and driving" section.

ON-PAVEMENT AND OFFROAD DRIVING

This vehicle will handle and maneuver differently from an ordinary passenger car because it has a higher center of gravity for offroad use. As with other vehicles with features of this type, failure to operate this vehicle correctly may result in loss of control or an accident. For additional information, see "On-pavement and offroad driving precautions" and "Avoiding collision and rollover" in the "5. Starting and driving" section.

MODIFICATION OF YOUR VEHICLE

This vehicle should not be modified. Modification could affect its performance, safety or durability, and may even violate governmental regulations. In addition, damage or performance problems resulting from modification may not be covered under NISSAN warranties.

WHEN READING THE MANUAL

This manual includes information for all options available on this model. Therefore, you may find some information that does not apply to your vehicle.

All information, specifications and illustrations in this manual are those in effect at the time of printing. NISSAN reserves the right to change specifications or design at any time without notice.

IMPORTANT INFORMATION ABOUT THIS MANUAL

You will see various symbols in this manual. They are used in the following ways:



WARNING

This is used to indicate the presence of a hazard that could cause death or serious personal injury. To avoid or reduce the risk, the procedures must be followed precisely.



CAUTION

This is used to indicate the presence of a hazard that could cause minor or moderate personal injury or damage to your vehicle. To avoid or reduce the risk, the procedures must be followed carefully.

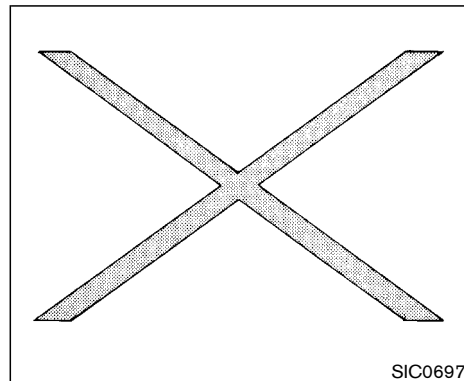

If you see this symbol, it means **Do not do this** or **Do not let this happen.**

CALIFORNIA PROPOSITION 65
WARNING



WARNING

Engine Exhaust, some of its constituents, and certain vehicle components contain or emit chemicals known to State of California to cause cancer and birth defects or other reproductive harm.

© 2002 NISSAN MOTOR CO., LTD.
TOKYO, JAPAN

All rights reserved. No part of this Owner's Manual may be reproduced or stored in a retrieval system, or transmitted in any form, or by any means, electronic, mechanical, photocopying, recording or otherwise, without the prior written permission of Nissan Motor Co., Ltd.

Welcome To The World Of NISSAN

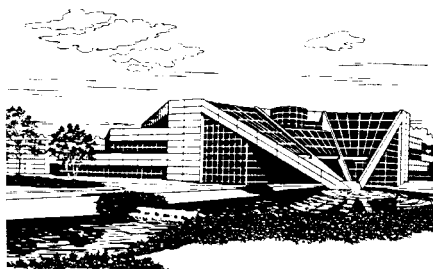

NISSAN TECHNICAL CENTER NORTH AMERICA, INC.
in Farmington Hills, Michigan

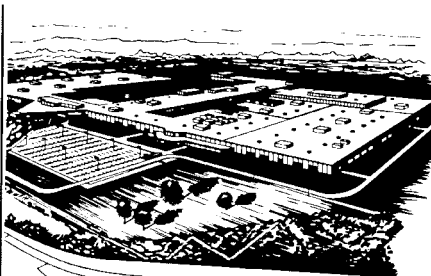

NISSAN MANUFACTURING FACILITY
in Smyrna, Tennessee

WFW0002

Your new NISSAN is the result of our dedication to produce the finest in safe, reliable and economical transportation. Your vehicle is the product of a successful worldwide company that manufactures cars and trucks in over 17 countries and distributes them in 170 nations.

NISSAN vehicles are designed and manufactured by Nissan Motor Co., Ltd. which was founded in Tokyo, Japan in 1933, and NISSAN affiliates worldwide, collectively growing to become the fifth largest automaker in the world. In addition to cars and trucks, NISSAN also makes forklift trucks, marine engines, boats and other diversified products.

NISSAN has made a substantial and growing investment in North America. NISSAN'S commitment is nearly \$4 billion dollars in capital investments in facilities across the continent. Some of

the facilities include the Nissan Manufacturing facility in Smyrna, Tennessee, vehicle styling design at Nissan Design America in San Diego, California, and engineering at Nissan Technical Center North America in Farmington Hills, Michigan. Additionally, NISSAN employs nearly 18,000 people throughout the United States, Canada, and Mexico. An additional 71,000 people work for the 1,500 NISSAN and INFINITI dealers across North America.

NISSAN is also a substantial contributor to the Canadian economy. Nissan Canada Inc., its suppliers and over 140 dealers employ approximately 4,500 people. These include company employees and the staffs of NISSAN dealers all across Canada. In addition, many Canadians work for companies that supply NISSAN and NISSAN dealers with materials and services ranging from operation of port facilities and transportation services

to the supply of lubricants, parts and accessories.

NISSAN pioneered the use of electronics and computers in automobiles, and has led the industry in improving both performance and fuel efficiency through new engine designs and the use of synthetic materials to reduce vehicle weight. The company has also developed ways to build quality into its vehicles at each stage of the production process, both through extensive use of automation and — most importantly — through an awareness that **people** are the central element in quality control.

From the time the parts arrived from our suppliers until you took delivery of your new Nissan, dozens of checks were made to ensure that only the best job was being done in producing and delivering your vehicle. NISSAN also takes great care to ensure that when you take your NISSAN to your dealer for maintenance, the service technician will perform his work according to the quality standards that have been established by the factory.

Safety has also been built into your NISSAN. As you know, seat belts are an integral part of the safety systems that will help protect you and your passengers in the event of a sudden stop or an accident. We urge you to use the seat belts every time you drive the vehicle.

The NISSAN story of growth and achievement reflects our major goal: to provide you, our customer, with a vehicle that is built with quality and craftsmanship — a product that we can be proud to build and you can be proud to own.

NISSAN CUSTOMER CARE PROGRAM

NISSAN CARES ...

Both NISSAN and your NISSAN dealer are dedicated to serving all your automotive needs. Your satisfaction with your vehicle and your NISSAN dealer are our primary concerns. Your NISSAN dealer is always available to assist you with all your automobile sales and service needs.

However, if there is something that your NISSAN dealer cannot assist you with or you would like to provide NISSAN directly with comments or questions, please contact our (NISSAN's) Consumer Affairs Department using our toll-free number:

For U.S. mainland customers
1-800-NISSAN-1 (1-800-647-7261)
For Hawaii customers
(808) 836-0888 (Oahu Number)
For Canadian customers
1-800-387-0122

The Consumer Affairs Department will ask for the following information:

- Your name, address, and telephone number
- Vehicle identification number (on dash panel)
- Date of purchase
- Current odometer reading
- Your NISSAN dealer's name
- Your comments or questions

OR

You can write to NISSAN with the information on the left at:

For U.S. mainland and Alaska customers
Nissan North America, Inc.
Consumer Affairs Department
P.O. Box 191
Gardena, California 90248-0191
For Hawaii customers
Nissan Motor Corporation in Hawaii
2880 Kilihau St.
Honolulu, Hawaii 96819
For Canada customers
Nissan Canada Inc.
5290 Orbitor Drive
Mississauga, Ontario L4W 4Z5

We appreciate your interest in NISSAN and thank you for buying a quality NISSAN vehicle.

Table of Contents

| | |
|-----------------------------------------------------------|-----------|
| Seats, restraints and supplemental air bag systems | 1 |
| Instruments and controls | 2 |
| Pre-driving checks and adjustments | 3 |
| Heater, air conditioner and audio systems | 4 |
| Starting and driving | 5 |
| In case of emergency | 6 |
| Appearance and care | 7 |
| Maintenance and do-it-yourself | 8 |
| Technical and consumer information | 9 |
| Index | 10 |

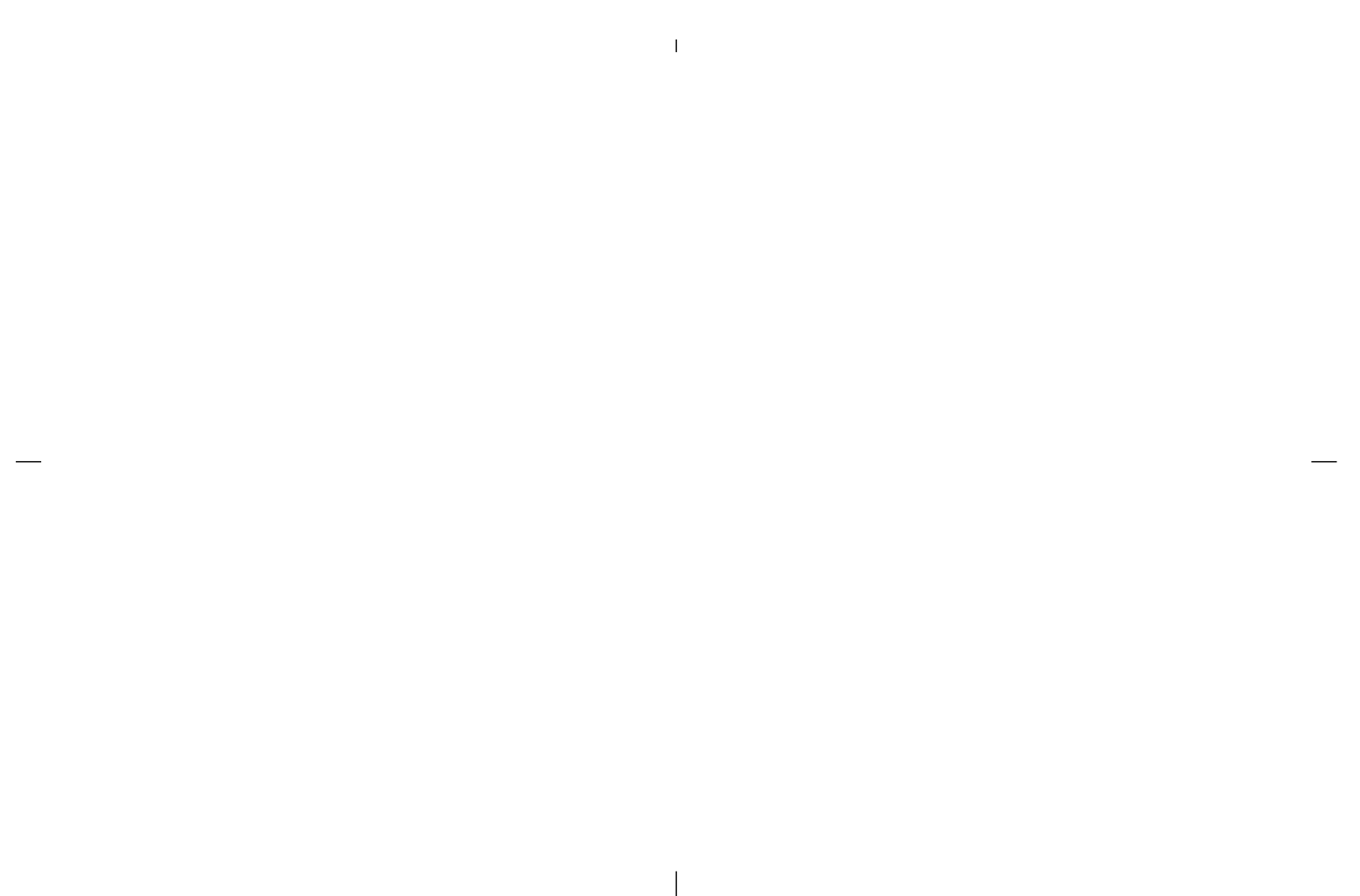

1 Seats, restraints and supplemental air bag systems

| | | | |
|----------------------------------------------------|------|----------------------------------------------------------------------------|------|
| Seats | 1-2 | Injured persons..... | 1-26 |
| Front manual seat adjustment..... | 1-2 | Three-point type seat belt with retractor..... | 1-26 |
| Front power seat adjustment | 1-4 | Two-point type seat belt without retractor (Center of rear seat)..... | 1-30 |
| Rear seat adjustment | 1-6 | Seat belt extenders..... | 1-32 |
| Head restraint adjustment..... | 1-9 | Seat belt maintenance | 1-32 |
| Armrest (if so equipped) | 1-9 | Child restraints..... | 1-32 |
| Supplemental restraint system..... | 1-10 | Precautions on child restraints..... | 1-32 |
| Precautions on supplemental restraint system | 1-10 | Installation on rear seat center position..... | 1-34 |
| Supplemental air bag warning labels | 1-21 | Installation on rear seat outboard positions | 1-37 |
| Supplemental air bag warning light..... | 1-21 | LATCH (Lower Anchor and Tether for Children) system (if so equipped) | 1-41 |
| Seat belts | 1-23 | Top tether strap child restraint..... | 1-43 |
| Precautions on seat belt usage..... | 1-24 | Installation on front passenger seat..... | 1-45 |
| Child safety | 1-25 | | |
| Pregnant women..... | 1-26 | | |

SEATS

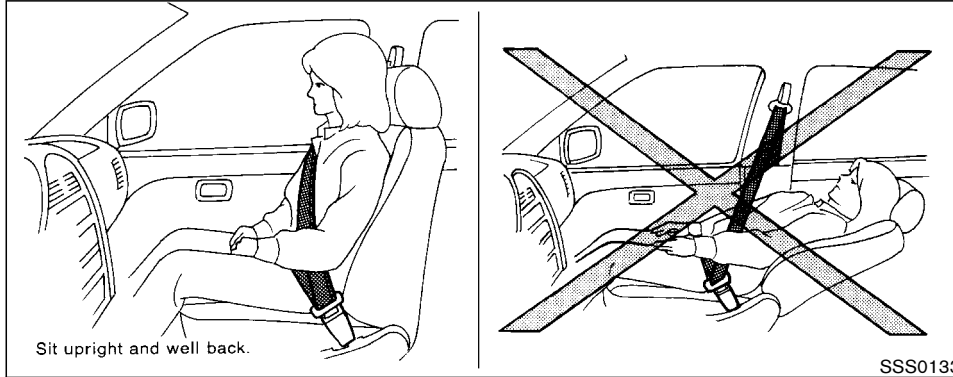

WARNING

- Do not ride in a moving vehicle when the seatback is reclined. This can be dangerous. The shoulder belt will not be against your body. In an accident you could be thrown into it and receive neck or other serious injuries. You could also slide under the lap belt and receive serious internal injuries.

- For most effective protection when the vehicle is in motion, the seat should be upright. Always sit well back in the seat and adjust the seat belt properly. See “Precautions on seat belt usage” later in this section for precautions on seat belt usage.

FRONT MANUAL SEAT ADJUSTMENT

WARNING

- Do not adjust the driver's seat while driving so full attention may be given to vehicle operation. The seat may move suddenly and could cause loss of control of the vehicle.
- After adjustment, gently rock in the seat to make sure it is securely locked.

See “Automatic seat positioner” in the “3. Pre-driving checks and adjustments” for automatic seat positioner operation.

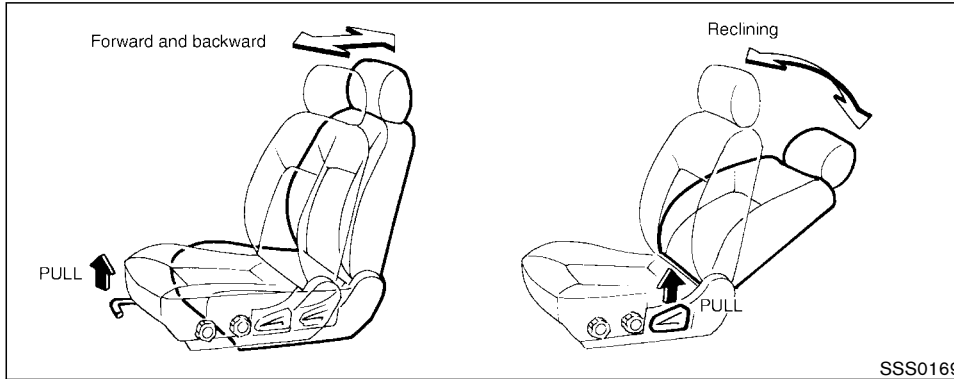

SSS0169

Forward and backward

Pull the lever up while you slide the seat forward or backward to the desired position. Release the lever to lock the seat in position.

Reclining

To recline the seatback, pull the lever up and lean back. To bring the seatback forward again, pull the lever and move your body forward. The seatback will move forward.

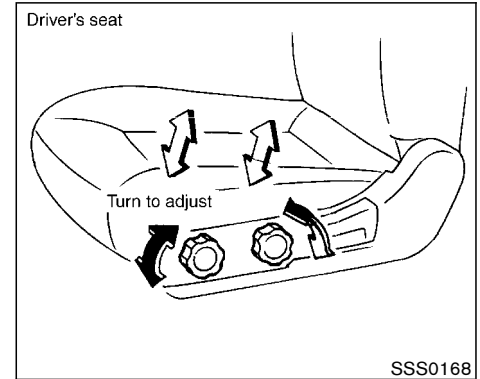

SSS0168

Seat lifter (if so equipped for driver's seat)

Turn either dial to adjust the angle and height of the seat cushion to the desired position.

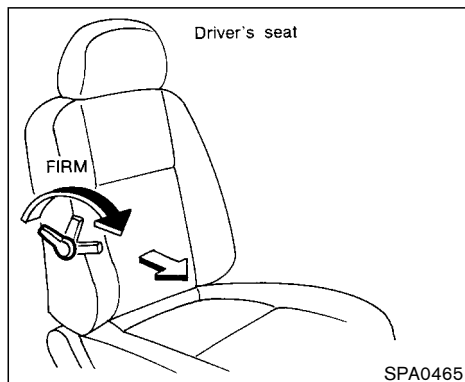

Lumbar support (if so equipped for driver's seat)

Turn the lever forward or backward to adjust the seat lumbar area.

FRONT POWER SEAT ADJUSTMENT

WARNING

- **Do not adjust the driver's seat while driving so full attention may be given to vehicle operation.**
- **Do not leave children unattended inside the vehicle. They could unknowingly activate switches or controls which could cause a serious accident.**

Operating tips

- The motor has an auto-reset overload protection circuit. If the motor stops during operation, wait 30 seconds, then reactivate the switch.
- Do not operate the power support seat for a long period of time when the engine is off. This will discharge the battery.

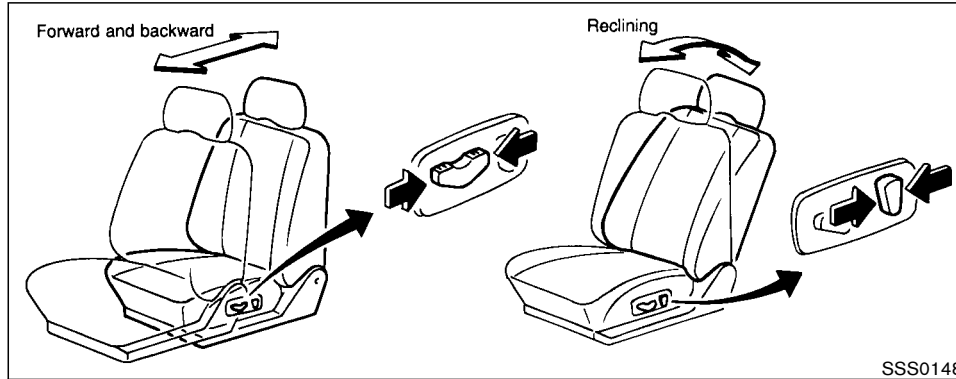

SSS0148

Forward and backward

Moving the switch forward or backward will slide the seat forward or backward to the desired position.

Reclining

Move the recline switch backward until the desired angle is obtained. To bring the seatback forward again, move the switch forward and move your body forward. The seatback will move forward.

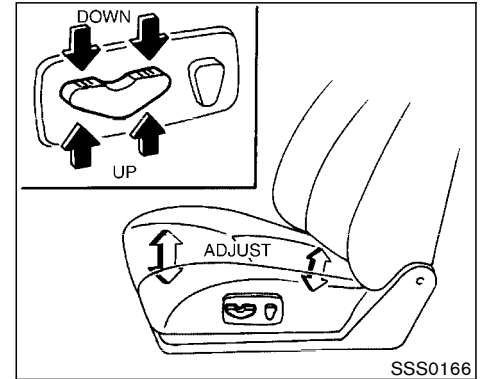

SSS0166

Seat lifter

Push the front or rear end of the switch up or down to adjust the angle and height of the seat cushion.

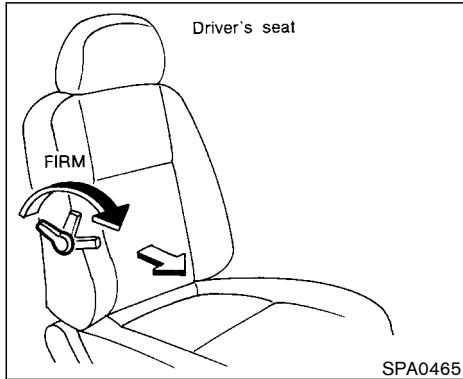

Lumbar support (if so equipped for driver's seat)

Turn the lever forward or backward to adjust the seat lumbar area.

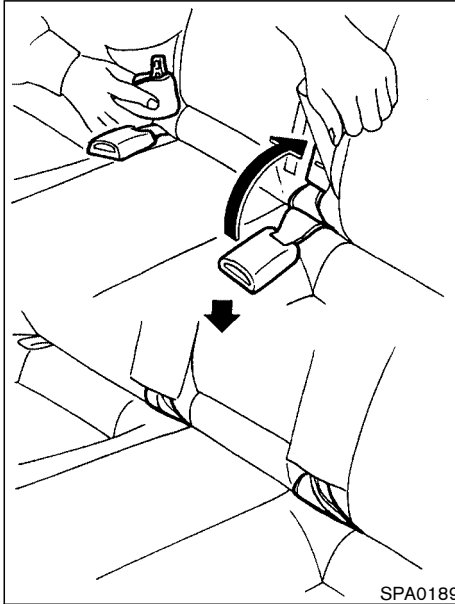

REAR SEAT ADJUSTMENT

Before folding down the seat, put the buckle in its storage area in the seatback to avoid dropping it under the seat cushion.

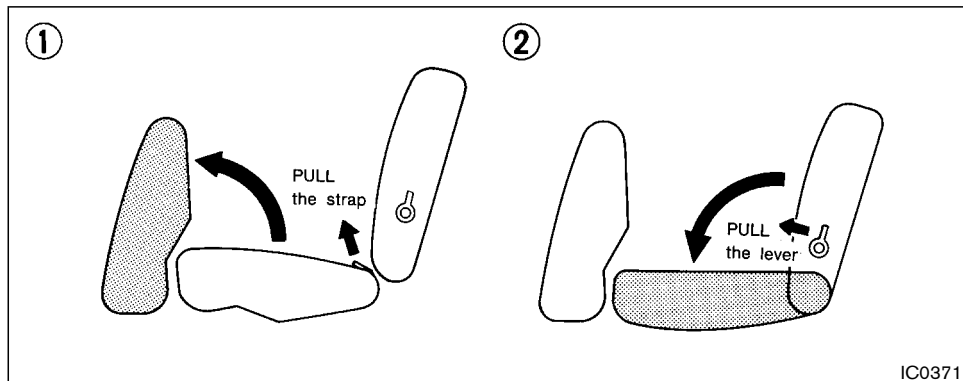

Folding

1. Remove the head restraints.
2. Pull the strap forward and fold the seat cushion up.
3. Pull the lever and pull the seatback forward to fold it down.
4. When resetting the seat, be sure to install the head restraints.



WARNING

- **Never allow anyone to ride in the cargo area or on the rear seat when it is in the fold-down position. Use of these areas by passengers without proper restraints could result in serious injury in an accident or sudden stop.**
- **It is extremely dangerous to ride in a cargo area inside of a vehicle. In a**

collision, people riding in these areas are more likely to be seriously injured or killed.

- **Do not allow people to ride in any area of your vehicle that is not equipped with seats and seat belts. Be sure everyone in your vehicle is in a seat and using a seat belt properly.**
- **Head restraints should be adjusted properly as they may provide significant protection against injury in an accident. Always replace and adjust them properly if they have been removed for any reason.**
- **If the head restraints are removed for any reason, they should be securely stored to prevent them from causing injury to passengers or damage to the vehicle in case of sudden braking or an accident.**
- **Properly secure all cargo to help prevent it from sliding or shifting. Do not place cargo higher than the seatbacks. In a sudden stop or collision,**

unsecured cargo could cause personal injury.

- When returning the seatbacks to the upright position, be certain they are completely secured in the latched position. If they are not completely secured in the right position, passengers may be injured in an accident or sudden stop.

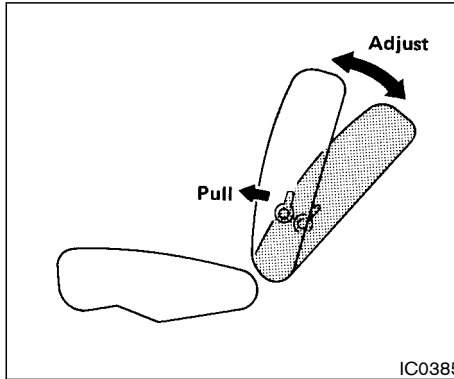

Reclining (if so equipped)

Pull the reclining lever and position the seat back at the desired angle. Release the reclining lever after positioning the seat at the desired angle.



WARNING

- Do not ride in a moving vehicle when the seatback is reclined. This can be dangerous. The shoulder belt will not be against your body. In an accident

you could be thrown into it and receive neck or other serious injuries. You could also slide under the lap belt and receive serious internal injuries.

- For most effective protection when the vehicle is in motion, the seat should be upright. Always sit well back in the seat and adjust the seat belt properly. See “Seat belts” later in this section for precautions on seat belt usage.
- After adjustment, check to be sure the seat is securely locked.

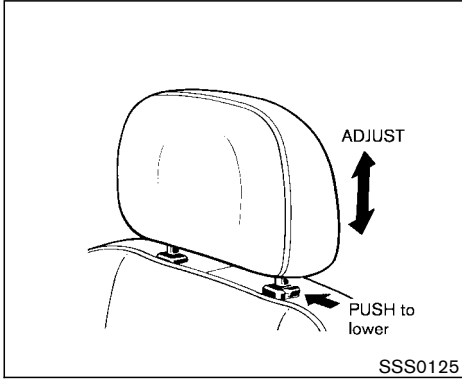

SSS0125

HEAD RESTRAINT ADJUSTMENT



WARNING

Head restraints should be adjusted properly as they may provide significant protection against injury in an accident. Do not remove them. Check the adjustment after someone else uses the seat.

To raise the head restraint, just pull it up. To lower, push the lock knob and push the head restraint down.

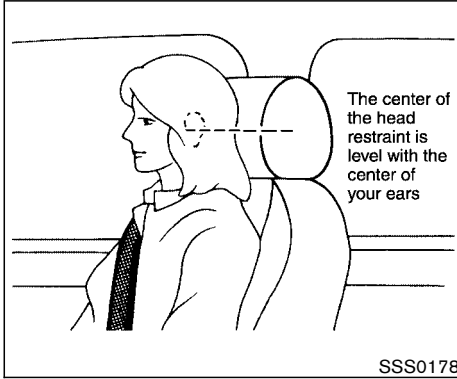

SSS0178

Adjust the head restraints so the center is level with the center of your ears.

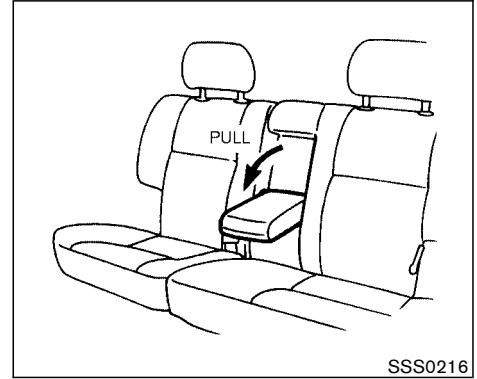

SSS0216

ARMREST (if so equipped)

Pull the armrest forward until it is horizontal.

SUPPLEMENTAL RESTRAINT SYSTEM

PRECAUTIONS ON SUPPLEMENTAL RESTRAINT SYSTEM

This Supplemental Restraint System (SRS) section contains important information concerning the driver and passenger front impact supplemental air bags, front seat side-impact supplemental air bags, curtain side-impact air bags and front seat pre-tensioner seat belts.

Supplemental front impact air bag system:

This system can help cushion the impact force to the face and chest of the driver and front passenger in certain frontal collisions.

Supplemental side-impact air bag system

(if so equipped): This system can help cushion the impact force to the chest area of the driver and front passenger in certain side impact collisions. The front seat side-impact supplemental air bags are designed to inflate on the side where the vehicle is impacted.

Supplemental curtain side-impact air bag system

(if so equipped): This system can help cushion the impact force to the head of occupants in front and rear outboard seating positions in certain side impact collisions. The curtain side-impact air bags are designed to inflate on the side where the vehicle is impacted.

These supplemental restraint systems are designed to **supplement** the crash protection

provided by the driver and passenger seat belts and are **not a substitute** for them. Seat belts should always be correctly worn and the occupant seated a suitable distance away from the steering wheel, instrument panel, door finishers and side roof rails. (See "Seat belts" later in this section for instructions and precautions on seat belt usage.)

After turning the ignition key to the ON position, the supplemental air bag warning light illuminates. The supplemental air bag warning light will turn off after about 7 seconds if the systems are operational.

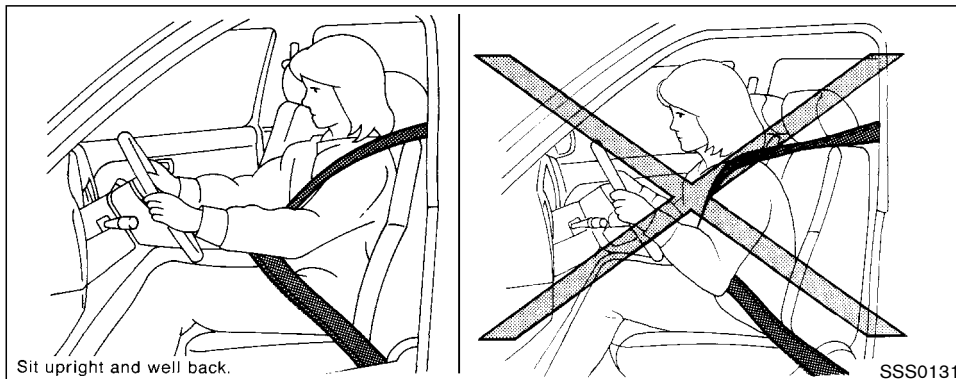

steering wheel or instrument panel.
Always use the seat belts.

- Keep hands on the outside of the steering wheel. Placing them inside the steering wheel rim could increase the risk that they are injured when the supplemental front air bag inflates.



WARNING

- The supplemental front air bags ordinarily will not inflate in the event of a side impact, rear impact, roll over, or lower severity frontal collision. Always wear your seat belts to help reduce the risk or severity of injury in various kinds of accidents.
- The seat belts and the supplemental front air bags are most effective

when you are sitting well back and upright in the seat. Front air bags inflate with great force. If you are unrestrained, leaning forward, sitting sideways or out of position in any way, you are at greater risk of injury or death in a crash. You may also receive serious or fatal injuries from the supplemental front air bag if you are up against it when it inflates. Always sit back against the seatback and as far away as practical from the

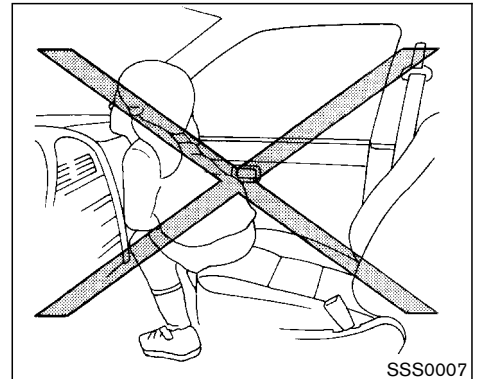
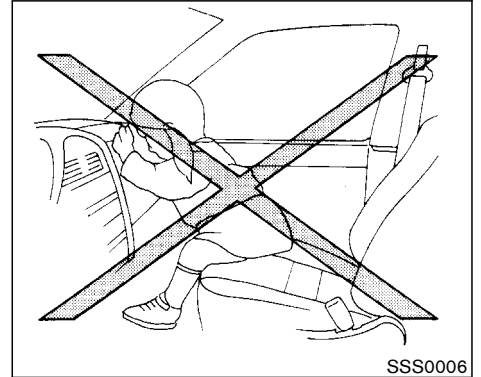
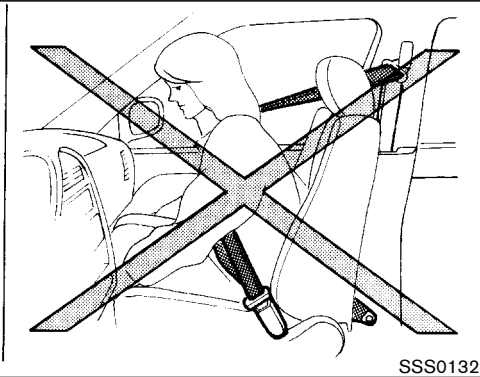

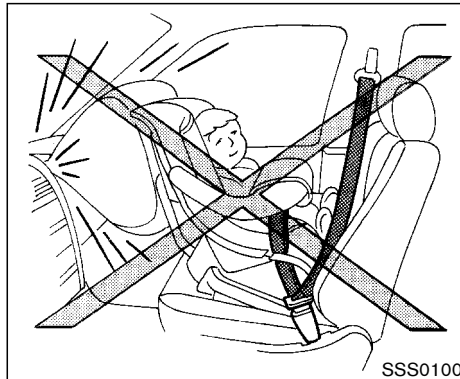
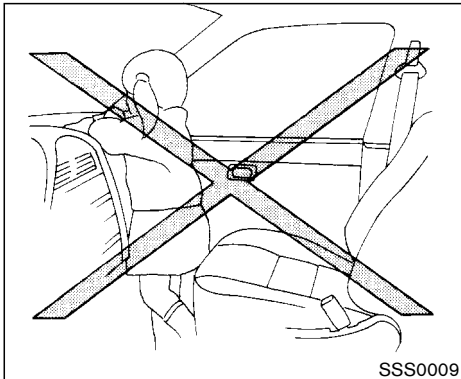
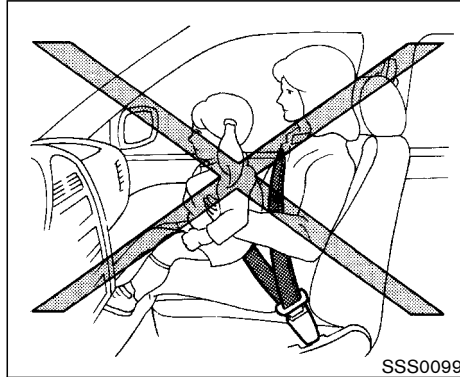
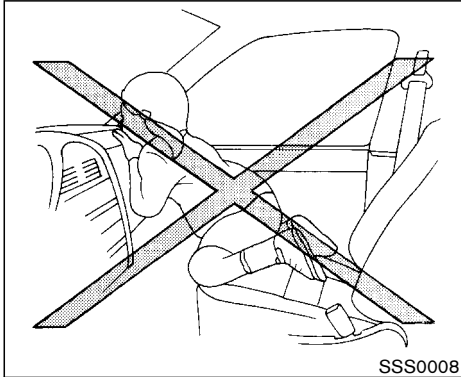

WARNING

- Never let children ride unrestrained or extend their hands or face out of the window. Do not attempt to hold them in your lap or arms. Some examples of dangerous riding positions are shown in the previous illustrations. Preteens and children should be properly restrained in the rear seat if possible.
- Children may be severely injured or killed when the supplemental front air bags, side or curtain side-impact air bags (if so equipped) inflate if they are not properly restrained. Preteens and children should be properly restrained in the rear seat if possible.
- Also never install a rear facing child restraint in the front seat. An inflating supplemental front air bag could seriously injure or kill your child. For additional information, see “Child restraints” later in this section.

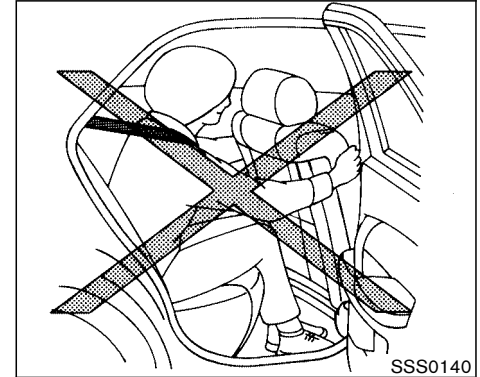
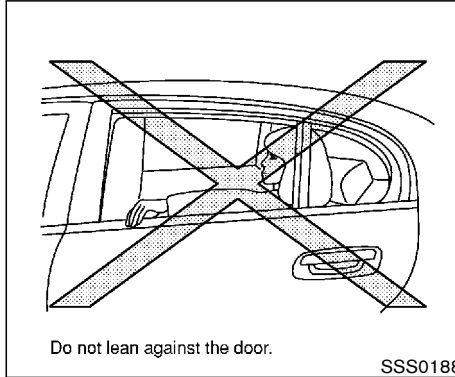
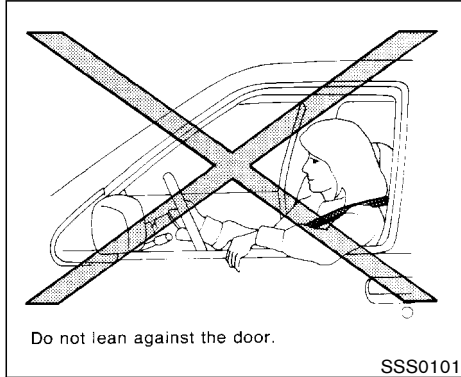

WARNING

Supplemental side air bag and curtain side-impact air bag (if so equipped):

- The supplemental side air bag and curtain side-impact air bag ordinarily will not inflate in the event of a frontal impact, rear impact, rollover or lower severity side collision. Always wear your seat belts to help reduce the risk or severity of injury in various kinds of accidents.

- The seat belts, the supplemental side air bag and curtain side-impact air bag are most effective when you are sitting well back and upright in the seat. The side air bag and curtain side-impact air bag inflate with great force. Do not allow anyone to place their hand, leg or face near the side air bag on the side of the seatback of the front seat or near the side roof rails. Do not allow anyone sitting in the front seat or rear outboard seats

to extend their hand out of the window or lean against the door. Some examples of dangerous riding positions are shown in the previous illustrations.

- When sitting in the rear seat, do not hold onto the seatback of the front seat. If the supplemental side air bag inflates, you may be seriously injured. Be especially careful with children, who should always be properly restrained.

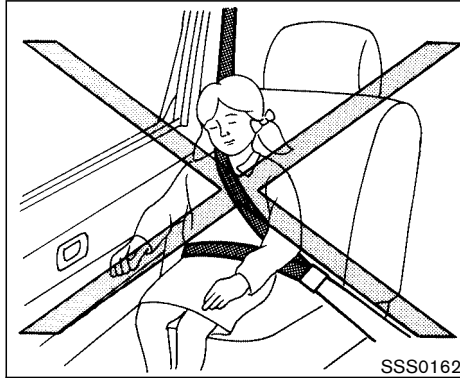
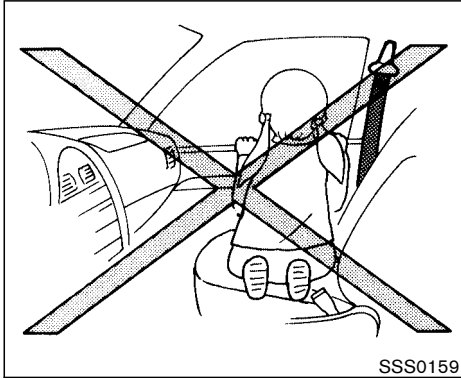

- **Do not use seat covers on the front seatbacks. They may interfere with supplemental side air bag inflation.**

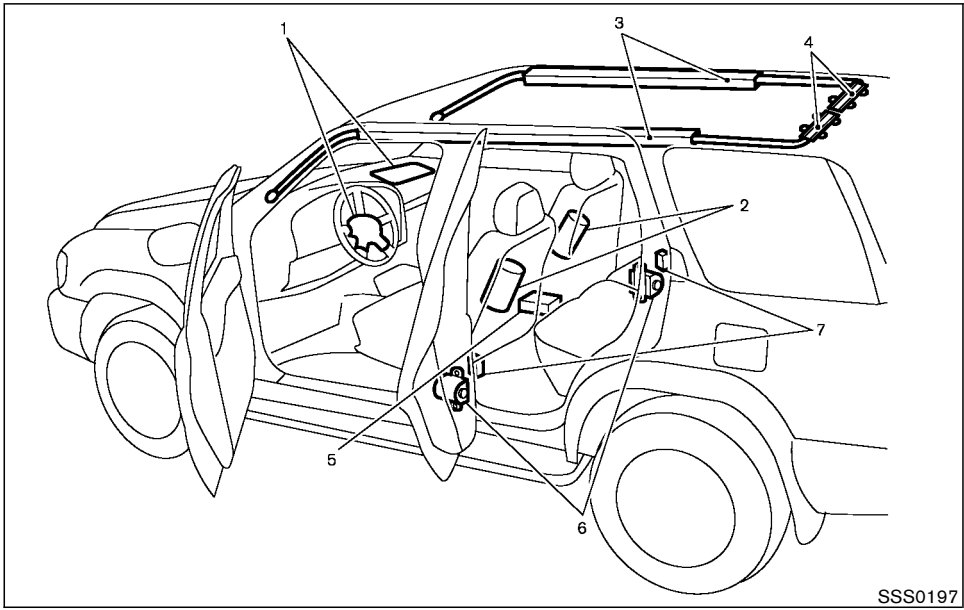

SSS0197

- 1. Supplemental front air bag modules
- 2. Supplemental side air bag modules
- 3. Supplemental curtain side-impact air bags
- 4. Supplemental curtain side-impact air bag modules
- 5. Diagnosis sensor unit
- 6. Seat belt pre-tensioner retractor
- 7. Satellite sensors

1-16 Seats, restraints and supplemental air bag systems

Supplemental front air bag system

The driver supplemental air bag is located in the center of the steering wheel; the front passenger supplemental air bag is mounted in the instrument panel above the glove box. These systems are designed to meet optional certification requirements under U.S. regulations. They are also permitted in Canada. The optional certification allows front air bags to be designed to inflate somewhat less forcefully than previously. **However, all of the information, cautions and warnings in this manual still apply and must be followed.** The front air bags are designed to inflate in higher severity frontal collisions, although they may inflate if the forces in another type of collision are similar to those of a higher severity frontal impact. They may not inflate in certain frontal collisions. Vehicle damage (or lack of it) is not always an indication of proper supplemental air bag operation.

When the supplemental front air bag inflates, a fairly loud noise may be heard, followed by release of smoke. This smoke is not harmful and does not indicate a fire. Care should be taken not to inhale it, as it may cause irritation and choking. Those with a history of a breathing condition should get fresh air promptly.

Supplemental front air bags, along with the use of seat belts, helps to cushion the impact force

on the face and chest of the front occupants. They can help save lives and reduce serious injuries. However, an inflating front air bag may cause facial abrasions or other injuries. Front air bags do not provide restraint to the lower body.

The seat belts should be correctly worn and the driver and passenger seated upright as far as practical away from the steering wheel or instrument panel. The supplemental front air bags inflate quickly in order to help protect the front occupants. Because of this, the force of the front air bag inflating can increase the risk of injury if the occupant is too close to, or is against, the air bag module during inflation. The air bag will deflate quickly after the collision is over.

After turning the ignition key to the ON position, the supplemental air bag warning light illuminates. The supplemental air bag warning light will turn off after about 7 seconds if the system is operational.



WARNING

- **Do not place any objects on the steering wheel pad or on the instrument panel. Also, do not place any objects between any occupant and the steering wheel or instrument**

panel. Such objects may become dangerous projectiles and cause injury if the supplemental front air bag inflates.

- **Right after inflation, several air bag system components will be hot. Do not touch them; you may severely burn yourself.**
- **No unauthorized changes should be made to any components or wiring of the supplemental front air bag system. This is to prevent accidental inflation of the air bag or damage to the air bag system.**
- **Do not make unauthorized changes to your vehicle's electrical system, suspension system or front end structure. This could affect proper operation of the supplemental air bag system.**
- **Tampering with the supplemental front air bag system may result in serious personal injury. Tampering includes changes to the steering wheel and the instrument panel as-**

sembly by placing material over the steering wheel pad, above the dashboard, or by installing additional trim material around the air bag system.

- **Work around and on the supplemental front air bag system should be done by a NISSAN dealer. Installation of electrical equipment should also be done by a NISSAN dealer. The yellow and orange Supplemental Restrain System (SRS) wiring and connectors should not be modified or disconnected. Unauthorized electrical test equipment and probing devices should not be used on the air bag system.**
- **A cracked windshield should be replaced immediately by a qualified repair facility. A cracked windshield could affect inflation of the supplemental air bag system.**
- **The SRS wiring harness connectors are yellow and orange for easy identification.**

When selling your vehicle, we request that you inform the buyer about the supplemental front air bag system and guide the buyer to the appropriate sections in this Owner's Manual.

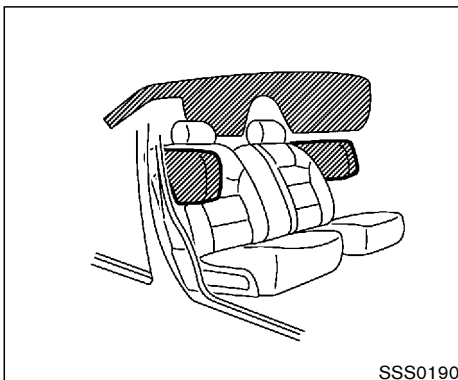

Supplemental side air bag and curtain side-impact air bag systems (if so equipped)

The supplemental side air bags are located in the outside of the seatback of the front seats. The supplemental curtain side-impact air bags are located in the side roof rails. These systems are designed to meet voluntary guidelines to help reduce the risk of injury to out-of-position occupants. **However, all of the information, cautions and warnings in this manual still apply and must be followed.** The supplemental side air bags and curtain side-impact air bags are designed to inflate in higher severity side

collisions, although they may inflate if the forces in another type of collision are similar to those of a higher severity side impact. They are designed to inflate on the side where the vehicle is impacted. They may not inflate in certain side collisions. Vehicle damage (or lack of it) is not always an indication of proper supplemental side air bag and curtain side-impact air bag operation.

When the supplemental side air bag and curtain side-impact air bag inflate, a fairly loud noise may be heard, followed by release of smoke. This smoke is not harmful and does not indicate a fire. Care should be taken not to inhale it, as it may cause irritation and choking. Those with a history of a breathing condition should get fresh air promptly.

Supplemental side air bags, along with the use of seat belts, help to cushion the impact force on the chest of the front occupants. Curtain side-impact air bags help to cushion the impact force to the head of occupants in the front and rear outboard seating positions. They can help save lives and reduce serious injuries. However, an inflating side air bag and curtain side-impact air bag may cause abrasions or other injuries. Supplemental side air bags and curtain side-impact air bags do not provide restraint to the lower body.

The seat belts should be correctly worn and the

driver and passenger seated upright as far as practical away from the side air bag. Rear seat passengers should be seated as far away as practical from the door finishers and side roof rails. The side air bags and curtain side-impact air bag inflate quickly in order to help protect the front occupants. Because of this, the force of the side air bag and curtain side-impact air bag inflating can increase the risk of injury if the occupant is too close to, or is against, these air bag modules during inflation. The side air bag and curtain side-impact air bag will deflate quickly after the collision is over.

After turning the ignition key to the ON position, the supplemental air bag warning light illuminates. The air bag warning light will turn off after about 7 seconds if the systems are operational.



WARNING

- **Do not place any objects near the seatback of the front seats. Also, do not place any objects (an umbrella, bag, etc.) between the front door finisher and the front seat. Such objects may become dangerous projectiles and cause injury if the side air bag**

inflates.

- **Right after inflation, several side air bag and curtain side-impact air bag system components will be hot. Do not touch them; you may severely burn yourself.**
- **No unauthorized changes should be made to any components or wiring of this side air bag and curtain side-impact air bag system. This is to prevent accidental inflation of the side air bag and curtain side-impact air bag or damage to the side air bag and curtain side-impact air bag system.**
- **Do not make unauthorized changes to your vehicle's electrical system, suspension system or side panel. This could affect proper operation of the supplemental side air bag and curtain side-impact air bag system.**
- **Tampering with the supplemental system may result in serious personal injury. For example, do not**

change the front seat by placing material near the seatback or by installing additional trim material, such as seat covers, around the side air bag.

- **Work around and on the side air bag and curtain side-impact air bag system should be done by a NISSAN dealer. Installation of electrical equipment should also be done by a NISSAN dealer. The SRS wiring harnesses* should not be modified or disconnected. Unauthorized electrical test equipment and probing devices should not be used on the side air bag system.**

*** The SRS wiring harnesses are covered with yellow insulation either just before the harness connectors or over the complete harness for easy identification.**

When selling your vehicle, we request that you inform the buyer about the side air bag and curtain side-impact air bag system and guide the buyer to the appropriate sections in this Owner's Manual.

Pre-tensioner seat belt system (For front seats)



WARNING

- **The pre-tensioner seat belt cannot be reused after activation. It must be replaced together with the retractor as a unit.**
- **If the vehicle becomes involved in a frontal collision but the pre-tensioner is not activated, be sure to have the pre-tensioner system checked and, if necessary, replaced by your NISSAN dealer.**
- **No unauthorized changes should be made to any components or wiring of the pre-tensioner seat belt system. This is to prevent accidental activation of the pre-tensioner seat belt or damage to the pre-tensioner seat belt operation. Tampering with the pre-tensioner seat belt system may result in serious personal injury.**
- **Work around and on the pre-**

tensioner seat belt system should be done by a NISSAN dealer. Installation of electrical equipment should also be done by a NISSAN dealer. Unauthorized electrical test equipment and probing devices should not be used on the pretensioner seat belt system.

- **If you need to dispose of the pre-tensioner or scrap the vehicle, contact a NISSAN dealer. Correct pre-tensioner disposal procedures are set forth in the appropriate NISSAN Service Manual. Incorrect disposal procedures could cause personal injury.**

The front seat pre-tensioner seat belt system activates in conjunction with the supplemental front air bag. Working with the seat belt retractor, it helps tighten the seat belt the instant the vehicle becomes involved in certain types of collisions, thereby restraining seat occupants.

The pre-tensioner is encased with the seat belt's retractor. These seat belts are used the same as conventional seat belts.

When the pre-tensioner seat belt activates, smoke is released and a loud noise may be heard. The smoke is not harmful, but care should be taken not to inhale it as it may cause irritation and choking. Those with a history of a breathing condition should get fresh air promptly.

If any abnormality occurs in the pre-tensioner seat belt system, the supplemental air bag warning light  will not come on, will flash intermittently or will turn on for 7 seconds and remain on after the ignition key has been turned to the ON or START position. In this case, the pre-tensioner seat belt may not function properly. They must be checked and repaired. Take your vehicle to the nearest NISSAN dealer.

When selling your vehicle, we request that you inform the buyer about the pre-tensioner seat belt system and guide the buyer to the appropriate sections in this Owner's Manual.

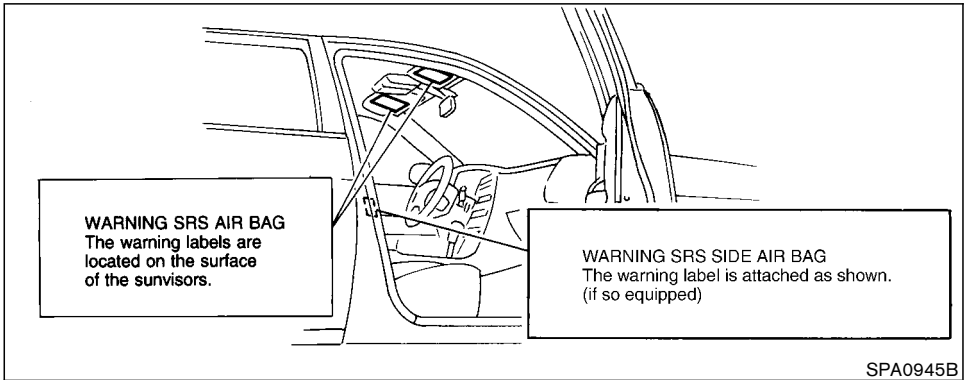

SPA0945B

SUPPLEMENTAL AIR BAG WARNING LABELS

Warning labels about the supplemental air bag system are placed in the vehicle as shown in the illustration.



SPA1097

SUPPLEMENTAL AIR BAG WARNING LIGHT

The supplemental air bag warning light, displaying  in the instrument panel, monitors the circuits of the supplemental front air bag, supplemental side air bag (if so equipped) and curtain side-impact air bag (if so equipped) systems, and pre-tensioner seat belt. The circuits monitored by the air bag warning light are the diagnosis sensor unit, satellite sensors, front air bag modules, side air bag modules, curtain side-impact air bag modules, and pre-tensioner seat belt and all related wiring.

After turning the ignition key to the ON position,

the supplemental air bag warning light illuminates. The supplemental air bag warning light will turn off after about 7 seconds if the system is operational.

If any of the following conditions occur, the supplemental front air bag, supplemental side air bag (if so equipped) and curtain side-impact air bag (if so equipped) systems, and pre-tensioner seat belt need servicing:

- The supplemental air bag warning light remains on after approximately 7 seconds.
- The supplemental air bag warning light flashes intermittently.
- The supplemental air bag warning light does not come on at all.

Under these conditions, the supplemental front air bags, supplemental side air bags, curtain side-impact air bags and/or pre-tensioner seat belt may not operate properly. They must be checked and repaired. Take your vehicle to the nearest NISSAN dealer.



WARNING

If the supplemental air bag warning light is on, it could mean that the

supplemental front air bag, supplemental side air bag, curtain side-impact air bag systems and/or pre-tensioner seat belt will not operate in an accident.

Repair and replacement procedure

The supplemental front air bags, supplemental side air bags (if so equipped), curtain side-impact air bags (if so equipped) and pre-tensioner seat belt are designed to inflate on a one-time-only basis. As a reminder, unless it is damaged, the supplemental air bag warning light will remain illuminated after inflation has occurred. Repair and replacement of these systems should be done only by a NISSAN dealer.

When maintenance work is required on the vehicle, the supplemental front air bags, side air bags, curtain side-impact air bags, related parts and pre-tensioner seat belt should be pointed out to the person conducting the maintenance. The ignition key should always be in the LOCK position when working under the hood or inside the vehicle.



WARNING

- **Once the supplemental front air bag, side air bag or curtain side-impact air bag has inflated, the air bag module will not function again and must be replaced. Additionally, if any of the supplemental air bags inflate, the pre-tensioner seat belts must also be replaced. The air bag module and pre-tensioner seat belt system should be replaced by a NISSAN dealer. The air bag modules and pre-tensioner seat belt system cannot be repaired.**
- **The supplemental front air bag and side air bag, curtain side-impact air bag systems and pre-tensioner seat belt system should be inspected by a NISSAN dealer if there is any damage to the front end or side portion of the vehicle.**
- **If you need to dispose of these supplemental systems or scrap the vehicle, contact a NISSAN dealer.**

SEAT BELTS

Correct disposal procedures are set forth in the appropriate NISSAN Service Manual. Incorrect disposal procedures could cause personal injury.

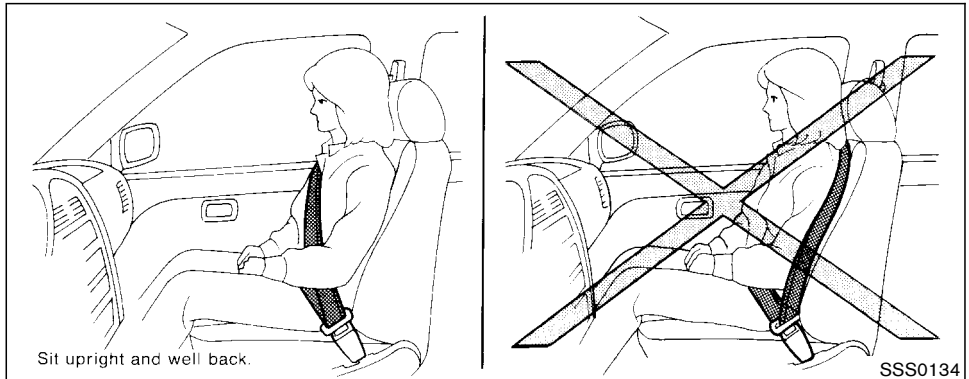
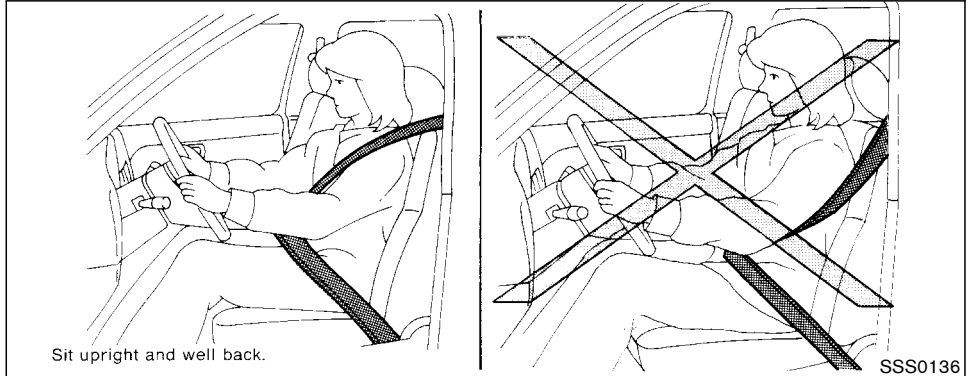

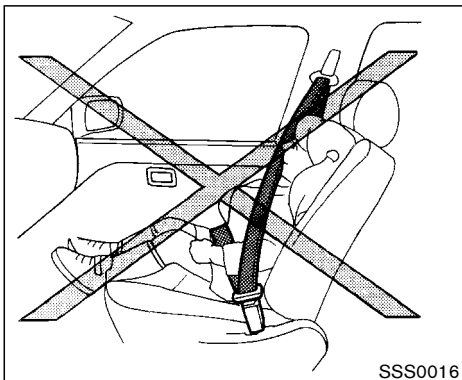

PRECAUTIONS ON SEAT BELT USAGE

Your chances of being injured or killed in an accident and/or the severity of injury may be greatly reduced if you are wearing your seat belt and it is properly adjusted. NISSAN strongly encourages you and all of your passengers to buckle up every time you drive, even if your seating position includes a supplemental air bag.

Most states, provinces or territories require that seat belts be worn at all times when a vehicle is being driven.

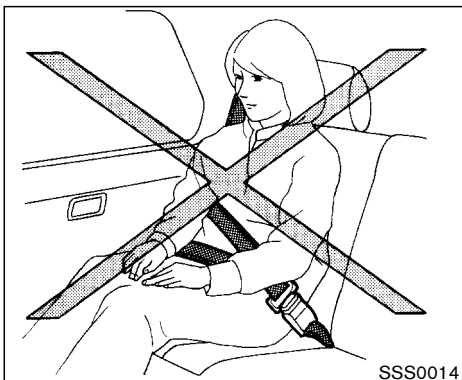

WARNING

- Every person who drives or rides in this vehicle should use a seat belt at all times. Children should be properly restrained in the rear seat and, if appropriate, in a child restraint.
- The belt should be properly adjusted to a snug fit. Failure to do so may reduce the effectiveness of the entire restraint systems and increase the chance or severity of injury in an

accident. Serious injury or death can occur if the seat belt is not worn properly.

- **Always route the shoulder belt over your shoulder and across your chest. Never run the belt behind your back, under your arm or across your neck. The belt should be away from your face and neck, but not falling off your shoulder.**
- **Position the lap belt as low and snug as possible around the hips, not the waist. A lap belt worn too high could increase the risk of internal injuries in an accident.**
- **Be sure the seat belt tongue is securely fastened to the proper buckle.**
- **Do not wear the belt inside out or twisted. Doing so may reduce its effectiveness.**
- **Do not allow more than one person to use the same belt.**
- **Never carry more people in the ve-**

hicle than there are seat belts.

- If the seat belt warning light glows continuously while the ignition is turned ON with all doors closed and all seat belts fastened, it may indicate a malfunction in the system. Have the system checked by your NISSAN dealer.
- Once the pre-tensioner seat belt has activated, it cannot be reused and must be replaced together with the retractor. See your NISSAN dealer.
- Removal and installation of the pre-tensioner seat belt system components should be done by an authorized NISSAN dealer.
- All seat belt assemblies including retractors and attaching hardware should be inspected after any collision by your NISSAN dealer. NISSAN recommends that all seat belt assemblies in use during a collision be replaced unless the collision was minor and the belts show no damage

and continue to operate properly. Seat belt assemblies not in use during a collision should also be inspected and replaced if either damage or improper operation is noted.

- All child restraints and attaching hardware should be inspected after any collision. Always follow the restraint manufacturer's inspection instructions and replacement recommendations. The child restraints should be replaced if they are damaged.

CHILD SAFETY

Children need adults to help protect them. They need to be properly restrained.

The proper restraint depends on the child's size. Generally, infants (up to about 1 year and less than 20 lb (9 kg)) should be placed in rear facing child restraints. Front facing child restraints are available for children who outgrow rear facing child restraints.



WARNING

Infants and children need special protection. The vehicle's seat belts may not fit them properly. The shoulder belt may come too close to the face or neck. The lap belt may not fit over their small hip bones. In an accident, an improperly fitting seat belt could cause serious or fatal injury. Always use appropriate child restraints.

All US states and provinces of Canada require the use of approved child restraints for infants and small children. See "Child restraints" later in this section.

In addition, there are many types of child restraints available for larger children which should be used for maximum protection.

NISSAN recommends that all preteens and children be restrained in the rear seat if possible. According to accident statistics, children are safer when properly restrained in the rear seat than in the front seat.

This is especially important because your vehicle has a Supplemental Restraint Sys-

tem (Air Bag System) for the front passenger. See “Supplemental Restraint System” earlier in this section for precaution.

Infants and small children

NISSAN recommends that infants and small children be placed in child restraints that comply with Federal Motor Vehicle Safety Standards or Canadian Motor Vehicle Safety Standards. You should choose a child restraint that fits your vehicle and always follow the manufacturer’s instructions for installation and use.

Larger children

Children who are too large for child restraints should be seated and restrained by the seat belts which are provided.

If the child’s seating position has a shoulder belt that fits close to the face or neck, the use of a booster seat (commercially available) may help overcome this. The booster seat should raise the child so that the shoulder belt is properly positioned across the top, middle portion of the shoulder and the lap belt is low on the hips. The booster seat should fit the vehicle seat and have a label certifying that it complies with Federal Motor Vehicle Safety Standards or Canadian Motor Vehicle Safety Standards. Once the child has grown so the shoulder belt is no longer on or near the face and neck, use the shoulder belt

without the booster seat.



WARNING

Never let a child stand or kneel on any seat and do not allow a child in the cargo areas while the vehicle is moving. The child could be seriously injured or killed in an accident or sudden stop.

PREGNANT WOMEN

NISSAN recommends that pregnant women use seat belts. The seat belt should be worn snug, and always position the lap belt as low as possible around the hips, not the waist. Place the shoulder belt over your shoulder and across your chest. Never run the lap/shoulder belt over your abdominal area. Contact your doctor for specific recommendations.

INJURED PERSONS

NISSAN recommends that injured persons use seat belts, depending on the injury. Check with your doctor for specific recommendations.

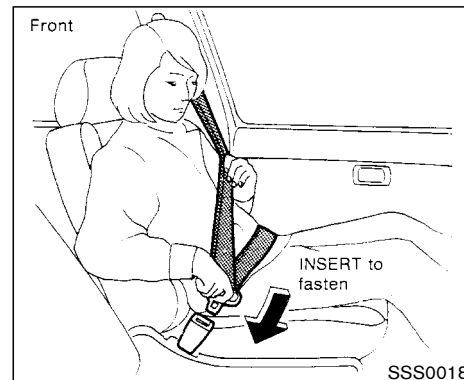

THREE-POINT TYPE SEAT BELT WITH RETRACTOR



WARNING

- **Every person who drives or rides in this vehicle should use a seat belt at all times.**
- **Do not ride in a moving vehicle when the seatback is reclined. This can be dangerous. The shoulder belt will not be against your body. In an accident**

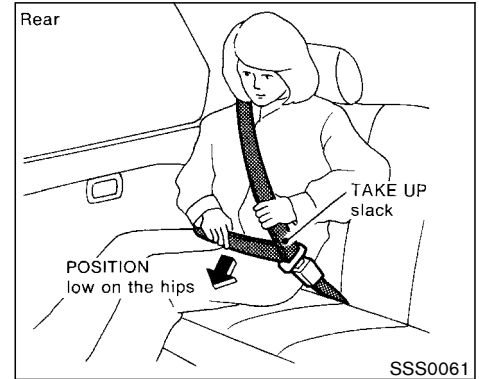
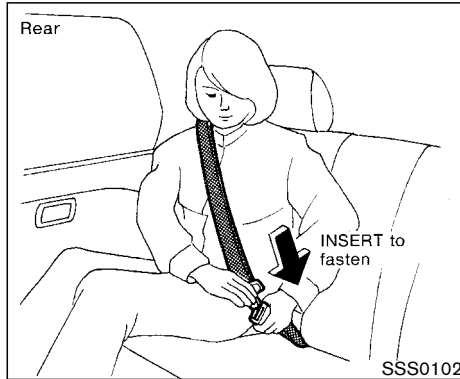
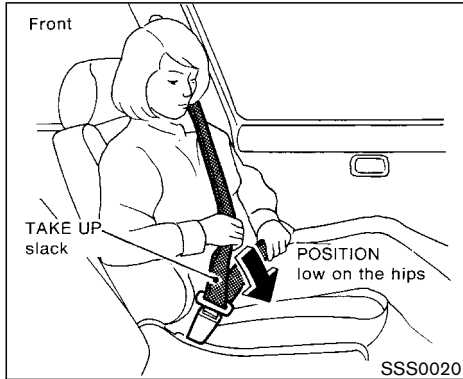

you could be thrown into it and receive neck or other serious injuries. You could also slide under the lap belt and receive serious internal injuries.

- **For most effective protection when the vehicle is in motion, the seat should be upright. Always sit well back in the seat and adjust the seat belt properly.**

Fastening the seat belts

1. Adjust the seat.

2. Slowly pull the seat belt out of the retractor and insert the tongue into the buckle until it snaps.

The retractor is designed to lock during a sudden stop or on impact. A slow pulling motion will permit the belt to move, and allow you some freedom of movement in the seat.

3. Position the lap belt portion **low and snug on the hips** as shown.
4. Pull the shoulder belt portion toward the retractor to take up extra slack.

The front seat passenger side seat belt and rear three-point seat belts have a cinching mechanism for child restraint installation. It is referred to as the automatic locking mode.

When the cinching mechanism is activated the seat belt cannot be withdrawn again until the seat belt tongue is detached from the buckle and fully retracted. For additional information, see "Child Restraints for Infants and Small Children" later in this section.

The automatic locking mode should be used only for child restraint installation.

During normal seat belt use by a passenger, the locking mode should not be acti-

vated. If it is activated it may cause uncomfortable seat belt tension.



WARNING

When fastening the seat belts, be certain that seatbacks are completely secured in the latched position. If they are not completely secured in the right position, passengers may be injured in an accident or sudden stop.

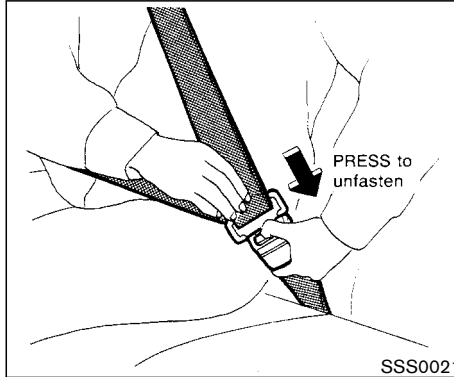

forward. The retractor should lock and restrict further belt movement.

If the retractor does not lock during this check or if you have any question about belt operation, see your NISSAN dealer.

Unfastening the seat belts

To unfasten the belt, press the button on the buckle. The seat belt will automatically retract.

Checking seat belt operation

Your seat belt retractors are designed to lock belt movement by two separate methods:

- When the belt is pulled quickly from the retractor.
- When the vehicle slows down rapidly.

You can check the operation as follows:

- Grasp the shoulder belt and pull quickly

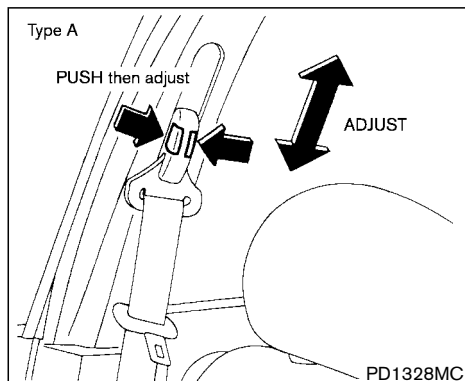

Shoulder belt height adjustment (For front seats)

The shoulder belt anchor height should be adjusted to the position best suited for you (see "Precautions on Seat Belt Usage" earlier in this section). To adjust, push (Type A)/pull (Type B) the release buttons, then move the shoulder belt anchor to the desired position so that the belt passes over the shoulder. Release the adjustment buttons to lock the shoulder belt anchor into position.

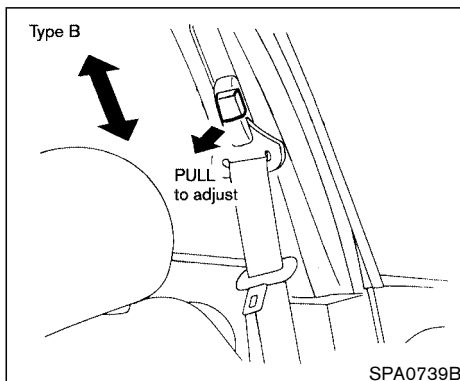

WARNING

- **After adjustment, release the adjustment button and try to move the shoulder belt anchor up and down to make sure it is securely fixed in position.**
- **The shoulder belt anchor height should be adjusted to the position best for you. Failure to do so may reduce the effectiveness of the entire**

restraint system and increase the chance or severity of injury in an accident.

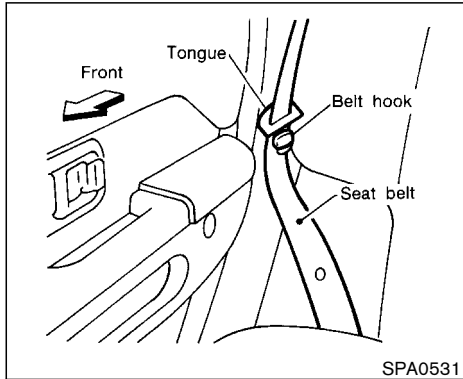

Seat belt hook

When the rear seat belt is not in use, hook it at the belt hook.

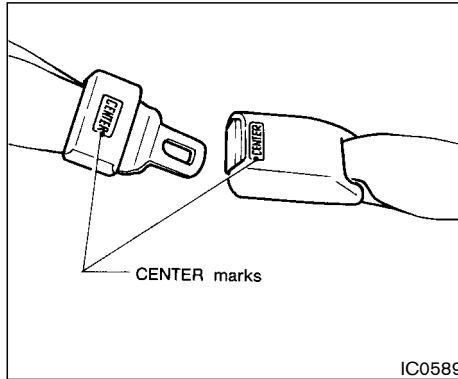

TWO-POINT TYPE SEAT BELT WITHOUT RETRACTOR (Center of rear seat)

Selecting correct set of seat belts

The center seat belt buckle and tongue are identified by the CENTER mark. The center seat belt tongue can be fastened only into the center seat belt buckle.

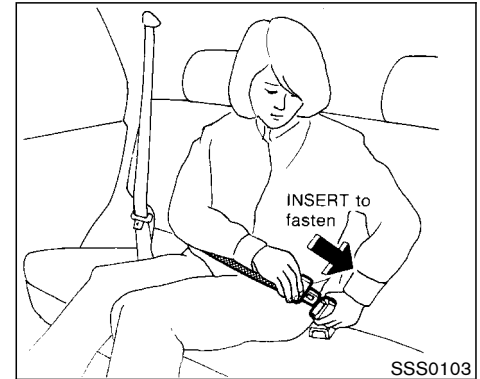

Fastening the seat belts

1. Insert the tongue into the buckle marked CENTER until it snaps.

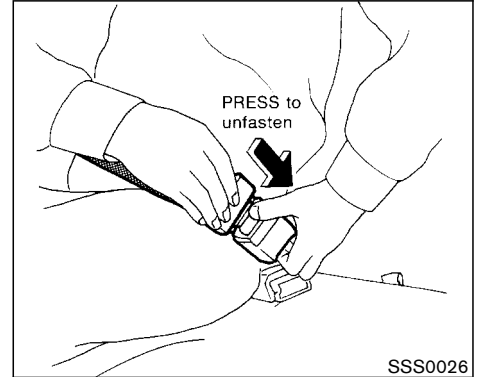
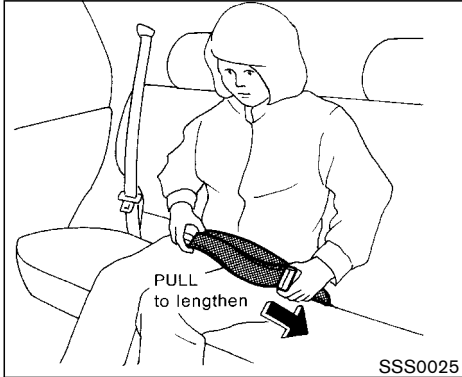
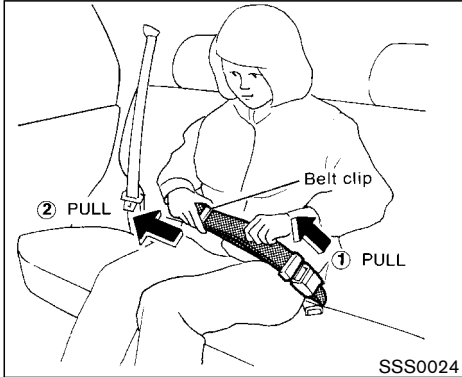

2. To lengthen, hold the tongue at a right angle to the belt and pull on the belt.
To shorten, pull the free end of the belt away from the tongue, then pull the belt clip to take up the slack.
3. Position the lap belt **low and snug on the hips** as shown.

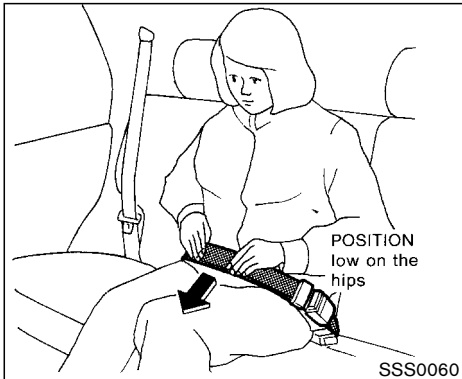

Unfastening the seat belts

To unfasten the belt, press the button on the buckle.

SEAT BELT EXTENDERS

If, because of body size or driving position, it is not possible to properly fit the lap-shoulder belt and fasten it, an extender is available which is compatible with the installed seat belts. The extender adds approximately 8 inches (200 mm) of length and may be used for either the driver or right passenger seating position. See your NISSAN dealer for assistance if the extender is required.



WARNING

- **Only NISSAN belt extenders, made by the same company which made the original equipment belts, should be used with NISSAN belts.**
- **Persons who can use the standard seat belt should not use an extender. Such unnecessary use could result in serious personal injury in the event of an accident.**
- **Never use seat belt extenders to install child restraints. If the child restraint is not secured properly, the**

child could be seriously injured in a collision or a sudden stop.

SEAT BELT MAINTENANCE

- **To clean the seat belt webbings**, apply a mild soap solution or any solution recommended for cleaning upholstery or carpets. Then brush the webbing, wipe it with a cloth and allow it to dry in the shade. Do not allow the seat belts to retract until they are completely dry.
- If dirt builds up in the shoulder belt guide of the seat belt anchors, the seat belts may retract slowly. Wipe the shoulder belt guide with a clean, dry cloth.
- **Periodically check to see that the seat belt and the metal components** such as buckles, tongues, retractors, flexible wires and anchors work properly. If loose parts, deterioration, cuts or other damage on the webbing is found, the entire belt assembly should be replaced.

CHILD RESTRAINTS

PRECAUTIONS ON CHILD RESTRAINTS



WARNING

- **Infants and small children should always be placed in an appropriate child restraint while riding in the vehicle. Failure to use a child restraint can result in serious injury or death.**
- **Infants and small children should never be carried on your lap. It is not possible for even the strongest adult to resist the forces of a severe accident. The child could be crushed between the adult and parts of the vehicle. Also, do not put the same seat belt around both your child and yourself.**
- **Never install a rear facing child restraint in the front seat. An inflating supplemental front air bag could seriously injure or kill your child. A rear facing child restraint must only be used in the rear seat.**

- **NISSAN recommends that the child restraint be installed in the rear seat. According to accident statistics, children are safer when properly restrained in the rear seat than in the front seat.**
- **An improperly installed child restraint could lead to serious injury or death in an accident.**

In general, child restraints are designed to be installed with a lap belt or the lap portion of a three point type seat belt. Child restraints for infants and children of various sizes are offered by several manufacturers. When selecting any child restraint, keep the following points in mind:

- Choose only a restraint with a label certifying that it complies with Federal Motor Vehicle Safety Standard 213 or Canadian Motor Vehicle Safety Standard 213.
- Check the child restraint in your vehicle to be sure it is compatible with the vehicle's seat and seat belt system.
- If the child restraint is compatible with your vehicle, place your child in the child restraint and check the various adjustments to be sure

the child restraint is compatible with your child. Always follow all recommended procedures.

All US states and Canadian provinces require that infants and small children be restrained in approved child restraints at all times while the vehicle is being operated.



WARNING

- **Improper use of a child restraint can result in increased injuries for both the infant or child and other occupants in the vehicle.**
- **Follow all of the child restraint manufacturer's instructions for installation and use. When purchasing a child restraint, be sure to select one which will fit your child and vehicle. It may not be possible to properly install some types of child restraints in your vehicle.**
- **If the child restraint is not anchored properly, the risk of a child being**

injured in a collision or a sudden stop greatly increases.

- **Adjustable seatbacks should be positioned to fit the child restraint, but as upright as possible.**
- **After attaching the child restraint, test it before you place the child in it. Tilt it from side to side. Try to tug it forward and check to see if the belt holds the restraint in place. If the restraint is not secure, tighten the belt as necessary, or put the restraint in another seat and test it again.**
- **For a front facing child restraint, if the seat position where it is installed has a three-point type lap/shoulder belt, check to make sure the shoulder belt does not go in front of the child's face or neck. If it does, put the shoulder belt behind the child restraint. If you must install a front facing child restraint in the front seat, see later in "Child restraints" for installation on front passenger seat.**
- **When your child restraint is not in**

use, store it in the trunk or keep it secured with a seat belt to prevent it from being thrown around in case of a sudden stop or accident.

CAUTION

Remember that a child restraint left in a closed vehicle can become very hot. Check the seating surface and buckles before placing your child in the child restraint.

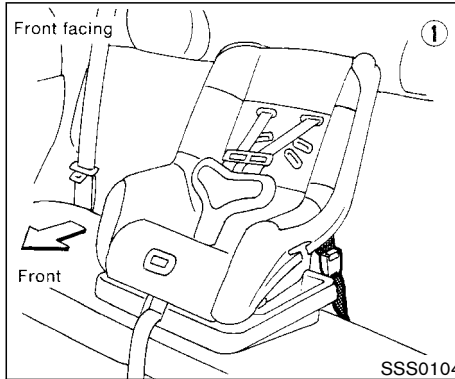

INSTALLATION ON REAR SEAT CENTER POSITION

Front facing

When you install a child restraint in a rear center seat, follow these steps:

1. Position the child restraint on the seat as illustrated. The direction of the child restraint depends on the type of the child restraint and the size of the child. Always follow the restraint manufacturer's instructions.

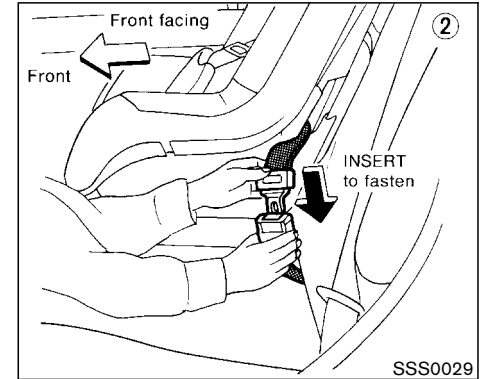

2. Route the seat belt tongue through the child restraint and insert it into the buckle until you hear and feel the latch engage. Be sure to follow the child restraint manufacturer's instructions for belt routing.

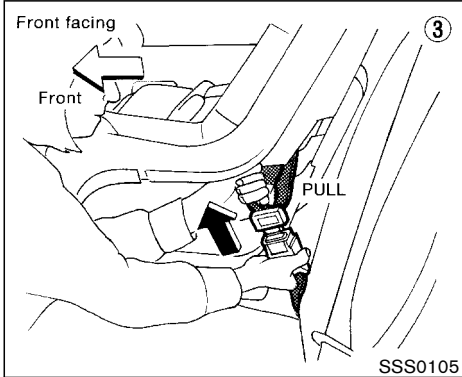

3. Remove all slack in the lap belt for a very tight fit by pulling forcefully on the lap belt adjustment.

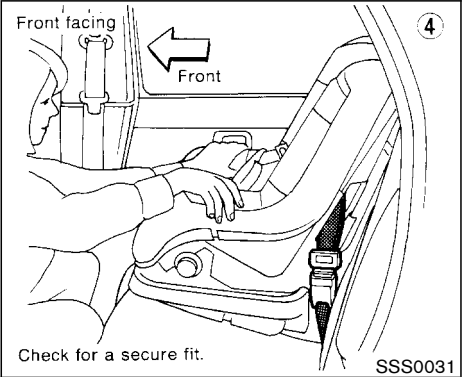

4. Before placing the child in the child restraint, use force to tilt the child restraint from side to side, and tug it forward to make sure that it is securely held in place.

5. If it is not secure, try to tighten the belt again, or put the restraint in another seat.

6. Check to make sure the child restraint is properly secured prior to each use.

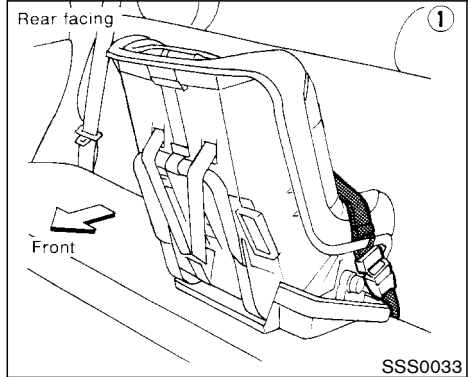

Rear facing

When you install a child restraint in a rear center seat, follow these steps:

1. Position the child restraint on the seat as illustrated. The direction of the child restraint depends on the type of the child restraint and the size of the child. Always follow the restraint manufacturer's instructions.

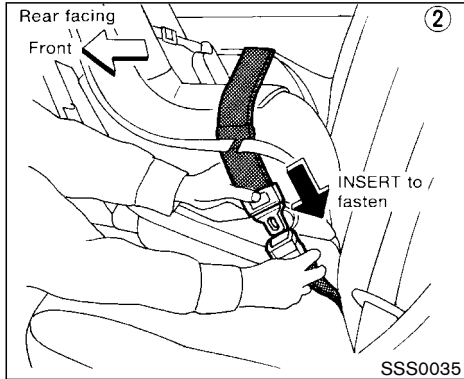

2. Route the seat belt tongue through the child restraint and insert it into the buckle until you hear and feel the latch engage. Be sure to follow the child restraint manufacturer's instructions for belt routing.

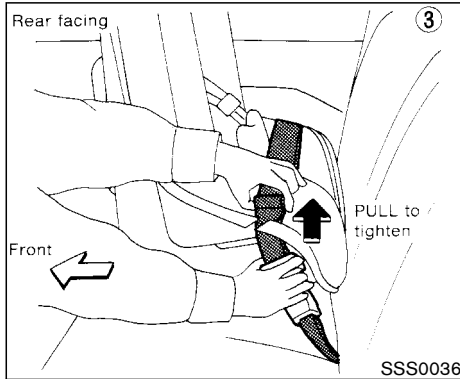

3. Remove all slack in the lap belt for a very tight fit by pulling forcefully on the lap belt adjustment.

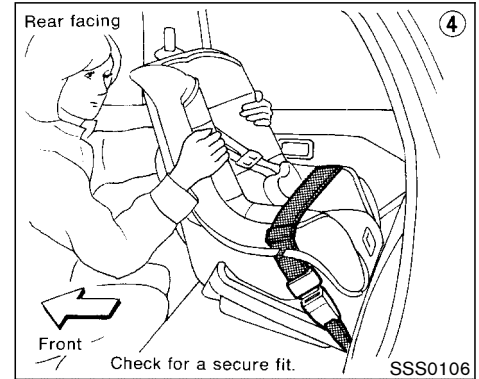

4. Before placing the child in the child restraint, use force to tilt the child restraint from side to side, and tug it forward to make sure that it is securely held in place.

5. If it is not secure, try to tighten the belt again, or put the restraint in another seat.

6. Check to make sure the child restraint is properly secured prior to each use.

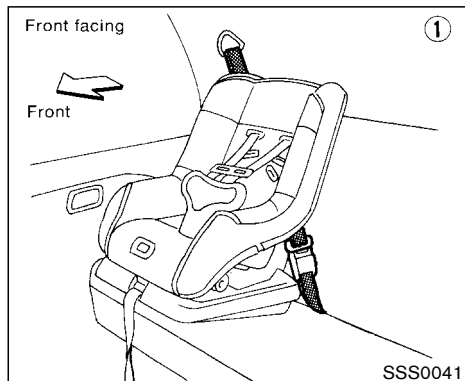

INSTALLATION ON REAR SEAT OUTBOARD POSITIONS

Front facing



WARNING

- The three-point belt on your vehicle is equipped with a locking mode retractor which must be used when installing a child restraint.
- Failure to do so will result in the child

restraint not being properly secured. It could tip over or otherwise be unsecured and cause injury to the child in a sudden stop or collision.

When you install a child restraint in a rear outboard seat, follow these steps:

1. Position the child restraint on the seat. The direction of the child restraint depends on the type of the child restraint and the size of the child. Always follow the restraint manufacturer's instructions.

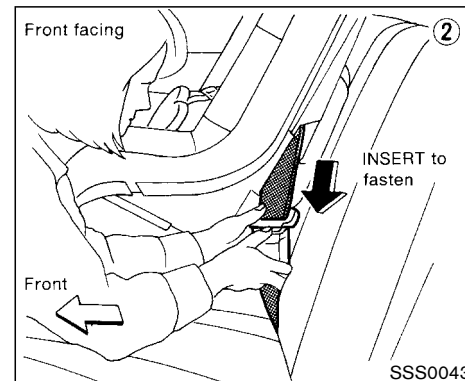

2. Route the seat belt tongue through the child restraint and insert it into the buckle until you hear and feel the latch engage. Be sure to follow the child restraint manufacturer's instructions for belt routing.

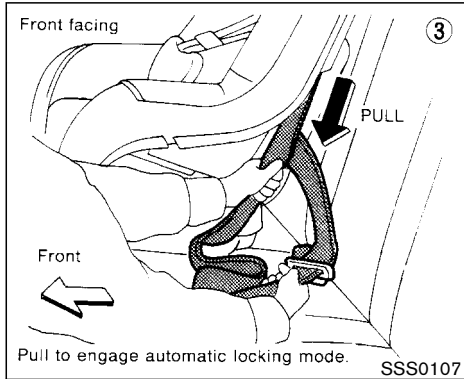

3. Pull on the shoulder belt until all of the belt is fully extended. At this time, the belt retractor is in the automatic locking mode (child restraint mode). It reverts back to emergency locking mode when the buckle is unlatched and the belt is allowed to fully retract.

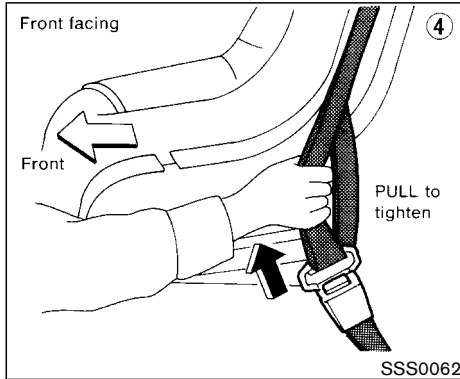

4. Allow the belt to retract. Pull up on the belt to remove any slack in the belt.

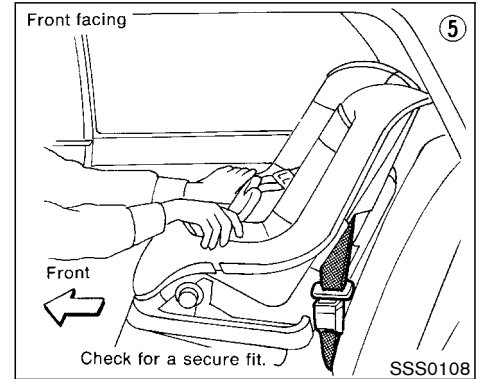

- 5. Before placing the child in the child restraint, use force to tilt the child restraint from side to side, and tug it forward to make sure that it is securely held in place.
- 6. Check that the retractor is in the automatic locking mode by trying to pull more belt out of the retractor. If you cannot pull any more belt webbing out of the retractor, the belt is in the automatic locking mode.
- 7. Check to make sure that the child restraint is properly secured prior to each use. If the belt is not locked, repeat steps 3 through 6.

After the child restraint is removed and the seat belt is allowed to wind back into the retractor,

the automatic locking mode (child restraint mode) is canceled; the seat belt only locks during a sudden stop or impact.

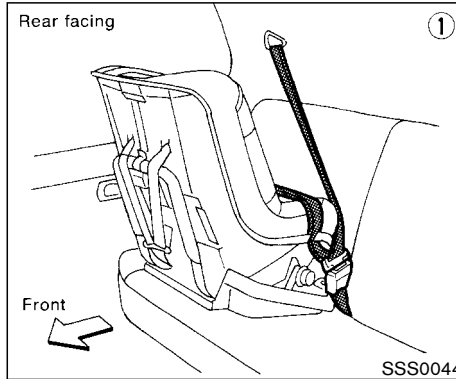

Rear facing

WARNING

- **The three-point belt on your vehicle is equipped with a locking mode retractor which must be used when installing a child restraint.**
- **Failure to do so will result in the child restraint not being properly secured. It could tip over or otherwise be unsecured and cause injury to the child**

in a sudden stop or collision.

When you install a child restraint in a rear outboard seat, follow these steps:

1. Position the child restraint on the seat. The direction of the child restraint depends on the type of the child restraint and the size of the child. Always follow the restraint manufacturer's instructions.

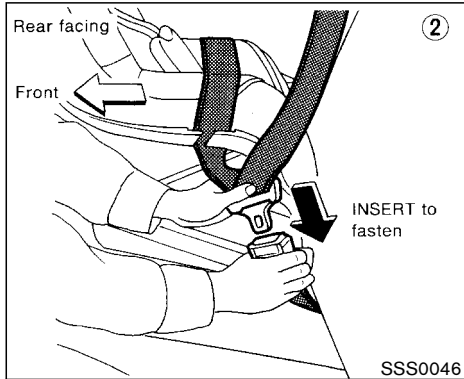

2. Route the seat belt tongue through the child restraint and insert it into the buckle until you hear and feel the latch engage. Be sure to follow the child restraint manufacturer's instructions for belt routing.

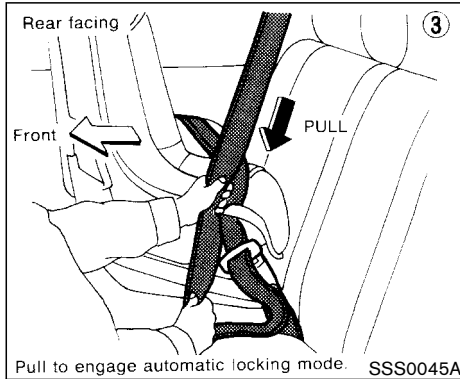

3. Pull on the shoulder belt until all of the belt is fully extended. At this time, the belt retractor is in the automatic locking mode (child restraint mode). It reverts back to emergency locking mode when the belt is fully retracted.

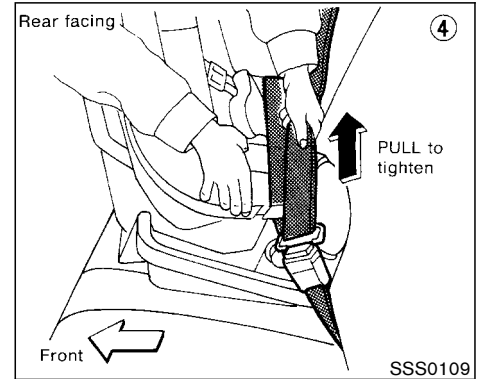

4. Allow the belt to retract. Pull up on the belt to remove any slack in the belt.

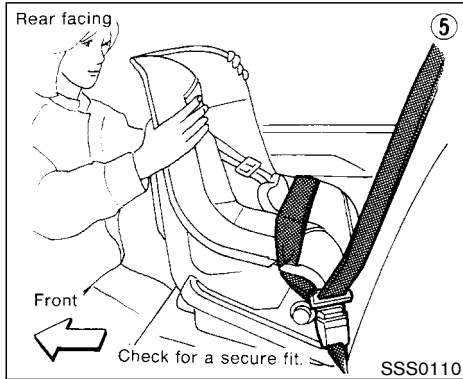

the automatic locking mode (child restraint mode) is canceled; the seat belt only locks during a sudden stop or impact.

5. Before placing the child in the child restraint, use force to tilt the child restraint from side to side, and tug it forward to make sure that it is securely held in place.
6. Check that the retractor is in the automatic locking mode by trying to pull more belt out of the retractor. If you cannot pull any more belt webbing out of the retractor, the belt is in the automatic locking mode.
7. Check to make sure that the child restraint is properly secured prior to each use. If the belt is not locked, repeat steps 3 through 6.

After the child restraint is removed and the seat belt is allowed to wind back into the retractor,

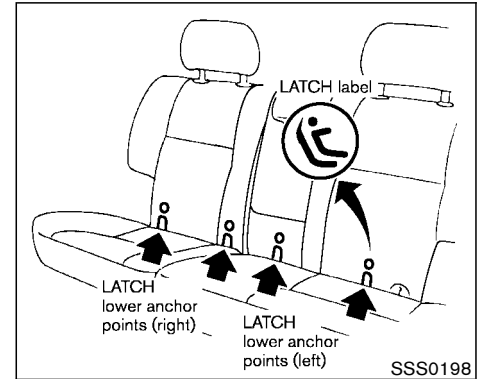

LATCH (LOWER ANCHORS AND TETHER FOR CHILDREN) SYSTEM
(if so equipped)

⚠ WARNING

- **Attach LATCH system compatible child restraints only at the locations shown. If a child restraint is not secured properly, your child could be seriously injured or killed in an accident.**

- **Do not secure a child restraint in the center rear seating position using the child restraint lower anchors. The child restraint will not be secured properly.**
- **The LATCH system anchors are designed to withstand only those loads imposed by correctly fitted child restraints. Under no circumstance are they to be used for adult seat belts or harnesses.**

Some child restraints include two rigid or webbing-mounted attachments that can be connected to two anchors located at certain seating positions in your vehicle. This system is known as the LATCH (Lower Anchors and Tether for Children) system. This system may also be referred to as the ISOFIX or ISOFIX compatible system. With this system, you do not have to use a vehicle seat belt to secure the child restraint. Your vehicle is equipped with special anchor points that are used with LATCH system compatible child restraints. Check your child restraint for a label stating that it is compatible with the LATCH system. This information may also be in the child restraint owner's manual. If you have such a child restraint, refer to the illustration for

the seating positions equipped with LATCH system anchors which can be used to secure the child restraint.

The LATCH system anchors are located at the rear of the seat cushion near the seatback. A label is attached to the seatback to help you locate the LATCH system anchors.

Some child restraints may also require the use of a top tether strap. See "Top tether strap child restraint" later in this section for installation instructions.

When installing a child restraint, carefully read and follow the instructions in this manual and those supplied with the child restraint.

When you install a LATCH system compatible child restraint to the lower anchor attachments in the rear seat, follow these steps.



WARNING

Inspect the lower anchors by inserting your fingers into the lower anchor area and feeling to make sure there are no obstructions over the LATCH system anchors, such as seat belt webbing or seat cushion material. The child restraint will

not be secured properly if the LATCH system anchors are obstructed.

1. To install the LATCH system compatible child restraint, adjust the height of the child restraint LATCH system anchor attachments to the anchor points on the seat.
2. Insert the anchor attachments into the anchor points. If the child restraint is equipped with a top tether, see "Top tether strap child restraint" later in this section for installation instructions.
3. After attaching the child restraint and before placing the child in it, use force to tilt the child restraint from side to side and tug it forward to make sure that the child restraint is securely held in place.
4. Check to make sure that the child restraint is properly secured prior to each use.

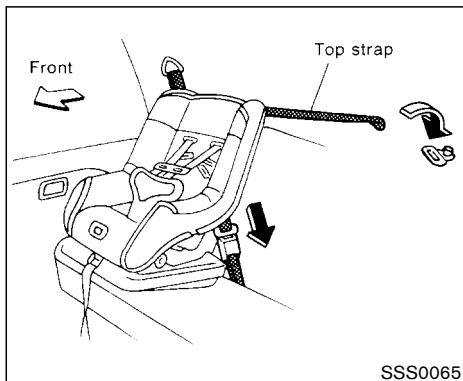

TOP TETHER STRAP CHILD RESTRAINT



WARNING

- **The child restraint anchor points are designed to withstand only those loads imposed by correctly fitted child restraints. Under no circumstances are they to be used for adult seat belts or harnesses.**
- **After removing a rear seat head re-**

straint for top tether installation, store it securely to prevent it from causing injury to passengers or damage to the vehicle in case of sudden braking or an accident. Always replace it and adjust properly when top tether is no longer in use.

- **The top tether strap may be damaged by contact with the tonneau cover or items in the cargo area. Remove the tonneau cover from the vehicle or secure it and any cargo. Your child could be seriously injured or killed in a collision if the top tether strap is damaged.**

If your child restraint has a top tether strap, it must be secured to the anchor point provided behind its position.

First, adjust the seatback so that it is upright. Then secure the child restraint with the rear seat belt or the LATCH system (outboard positions), as applicable.

Remove the head restraint from the seatback. Store it in a secure place. Position the top tether strap over the top of the seatback and secure it

to the tether anchor bracket that provides the straightest installation. Tighten the tether strap according to the manufacturer's instruction to remove any slack.

For best child restraint fit, see the child restraint installation instructions in this section and the child restraint manufacturer's instructions.

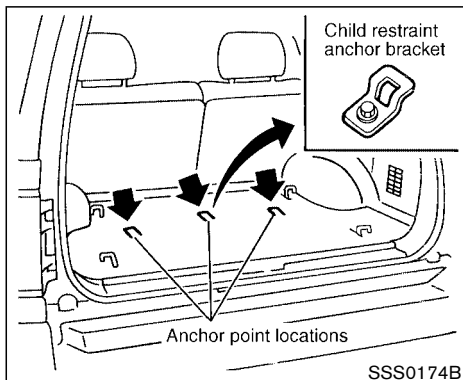

passenger compartment through the holes. See “Precautions when starting and driving” in the “5. Starting and driving” section for exhaust gas.

Anchor point locations

Anchor points are located under the carpet of the rear luggage area floor.

When installing a top strap child restraint on the rear seat for the first time, consult your NISSAN dealer for details.



WARNING

- The anchor bolt should be installed at all times to prevent the possibility of exhaust fumes entering the

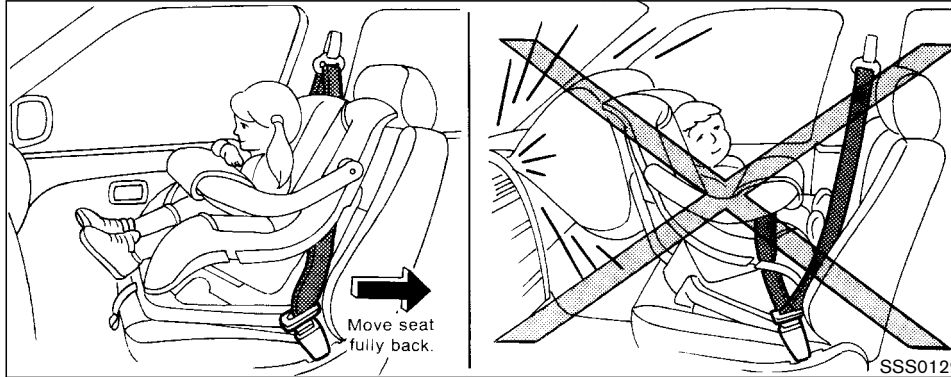

INSTALLATION ON FRONT PASSENGER SEAT

WARNING

- **Never install a rear facing child restraint in the front passenger seat. Supplemental front air bags inflate with great force. A rear facing child restraint could be struck by the front air bag in a crash and could seriously injure or kill your child.**

- **NISSAN recommends that child restraints be installed in the rear seat. However, if you must install a front facing child restraint in the front passenger seat, move the passenger seat to the rearmost position.**
- **A child restraint with a top tether strap should not be used in the front passenger seat.**
- **The three-point belt in your vehicle is equipped with a locking mode retractor**

for which must be used when installing a child restraint.

- **Failure to use the retractor's locking mode may result in the child restraint not being properly secured. The child restraint could tip over or otherwise be unsecured and cause injury to the child in a sudden stop or collision.**

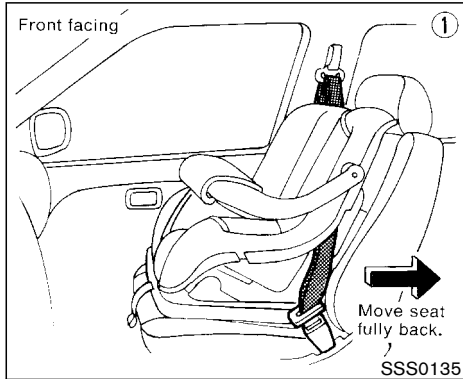

Front facing

If you must install a child restraint in the front seat, follow these steps:

1. Position the child restraint on the front passenger seat. **It should be placed in a front facing direction only.** Move the seat to the rear most position. Always follow the child restraint manufacturer's instructions. **Child restraints for infants must be used in the rear facing direction and therefore must not be used in the front seat.**

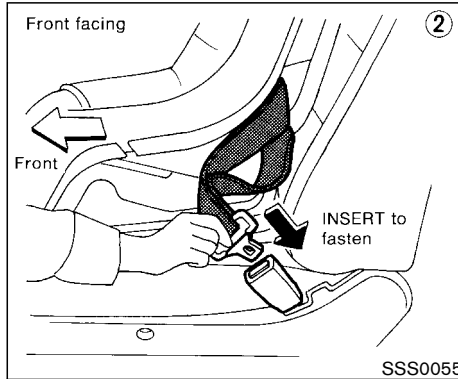

2. Route the seat belt tongue through the child restraint and insert it into the buckle until you hear and feel the latch engage. Be sure to follow the child restraint manufacturer's instructions for belt routing.

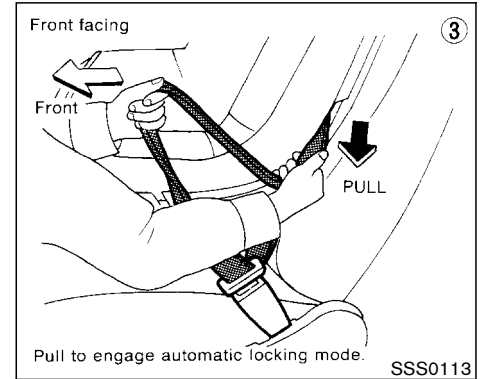

3. Pull on the shoulder belt until all of the belt is fully extended. At this time, the belt retractor is in the automatic locking mode (child restraint mode). It reverts back to emergency locking mode when the belt is fully retracted.

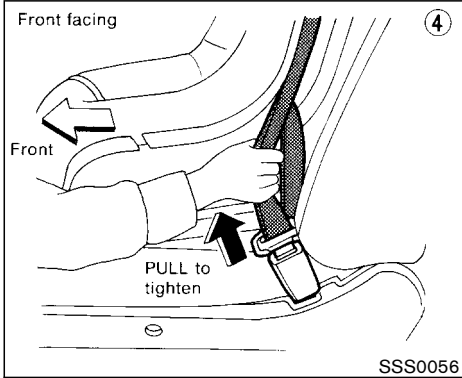

4. Allow the belt to retract. Pull up on the belt to remove any slack in the belt.

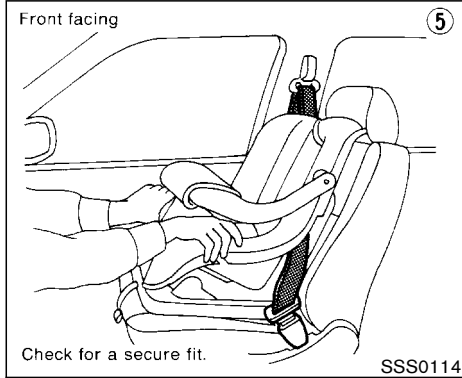

- 5. Before placing the child in the child restraint, use force to tilt the child restraint from side to side, and tug it forward to make sure that it is securely held in place.
- 6. Check that the retractor is in the automatic locking mode by trying to pull more belt out of the retractor. If you cannot pull any more belt webbing out of the retractor, the belt is in the automatic locking mode.
- 7. Check to make sure that the child restraint is properly secured prior to each use. If the lap belt is not locked, repeat steps 3 through 6.

After the child restraint is removed and the seat belt is allowed to wind back into the retractor,

the automatic locking mode (child restraint mode) is canceled; the seat belt only locks during a sudden stop or impact.

2 Instruments and controls

| | | | |
|------------------------------------------------------------------|------|-------------------------------------------------------------------|------|
| Instrument panel..... | 2-2 | Fog light switch (if so equipped) | 2-24 |
| Meters and gauges | 2-3 | Front fog light switch..... | 2-24 |
| Speedometer and odometer | 2-3 | Hazard warning flasher switch..... | 2-25 |
| Tachometer | 2-4 | Horn | 2-25 |
| Engine coolant temperature gauge | 2-4 | Heated seats (if so equipped)..... | 2-26 |
| Fuel gauge | 2-5 | Vehicle Dynamic Control (VDC) off switch (if so equipped)..... | 2-27 |
| Compass and outside temperature display (if so equipped)..... | 2-6 | Clock | 2-27 |
| Outside temperature display..... | 2-6 | Adjusting the time | 2-27 |
| Compass display..... | 2-7 | Power outlet (if so equipped) | 2-28 |
| Warning/indicator lights and audible reminders | 2-9 | Cigarette lighter and ashtray (if so equipped)..... | 2-29 |
| Checking bulbs..... | 2-9 | Storage | 2-29 |
| Warning lights..... | 2-9 | Tray..... | 2-29 |
| Indicator lights..... | 2-14 | Coin box (if so equipped) | 2-30 |
| Audible reminders..... | 2-16 | Sunglasses holder..... | 2-30 |
| Security systems..... | 2-16 | Cup holders | 2-31 |
| Vehicle security system..... | 2-16 | Glove box | 2-32 |
| Nissan vehicle immobilizer system | 2-18 | Console box..... | 2-33 |
| Windshield wiper and washer switch | 2-19 | Luggage hooks..... | 2-34 |
| Rear window wiper and washer switch | 2-19 | Cargo net..... | 2-36 |
| Glass hatch and outside mirror defogger switch | 2-20 | Tonneau cover | 2-36 |
| Headlight and turn signal switch..... | 2-21 | Luggage rack (if so equipped)..... | 2-37 |
| Headlight switch | 2-21 | Windows..... | 2-38 |
| Turn signal switch | 2-24 | Power windows..... | 2-38 |

| | |
|-------------------------------------------------------|------|
| Sunroof (if so equipped) | 2-40 |
| Electric sunroof | 2-40 |
| Interior lights (if so equipped)..... | 2-42 |
| Personal lights..... | 2-43 |
| Vanity mirror light (if so equipped) | 2-43 |
| HomeLink® Universal Transceiver (if so equipped).... | 2-44 |
| Programming HomeLink® | 2-44 |
| Programming HomeLink® for Canadian customers | 2-46 |

| | |
|-------------------------------------------------------------------|------|
| Operating the integrated HomeLink® Universal Transceiver | 2-46 |
| Programming trouble-diagnosis..... | 2-46 |
| Clearing the programmed information..... | 2-46 |
| Reprogramming a single HomeLink® button..... | 2-47 |
| If your vehicle is stolen..... | 2-47 |

INSTRUMENT PANEL

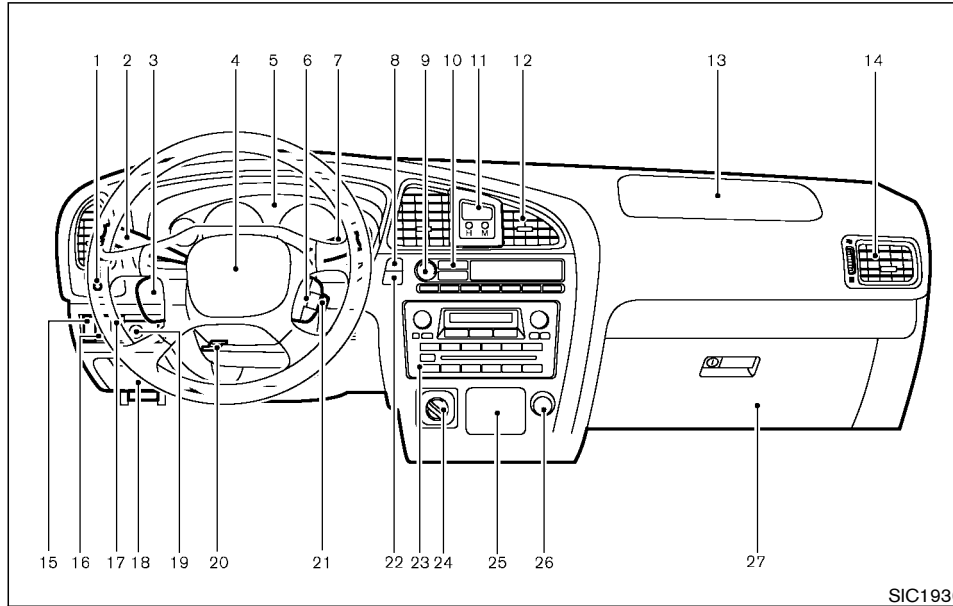

1. Security indicator light (P.2-17)
2. Headlight/dimmer/turn signal switch (P.2-21)
Front fog light switch (if so equipped) (P.2-24)
3. Steering switch for audio control (if so equipped) (P.4-28)

2-2 Instruments and controls

4. Driver's supplemental air bag (P.1-16)
5. Meters/gauges (P.2-3)
6. Cruise control main/set switch (if so equipped) (P.5-18)
7. Windshield and rear window wiper/washer switch (P.2-19)

8. Hazard warning flasher switch (P.2-25)
9. Air conditioner (P.4-2)
10. Glass hatch/outside mirror defogger switch (Type A) (P.2-20)
11. Clock (P.2-27)
12. Center ventilator (P.4-2)
13. Passenger air bag (P.1-16)
14. Side ventilator (P.4-2)
15. Instrument brightness control (P.2-22)
16. VDC OFF switch (if so equipped) (P.2-27)
17. Automatic drive positioner system cancel switch (if so equipped) (P.3-19)
18. Fuse box cover (P.8-28)/Pocket
19. Outside mirror remote control (P.3-16)
20. Tilting steering wheel adjust lever (P.3-15)
21. Ignition switch/steering lock (P.5-7)
22. Glass hatch/outside mirror defogger switch (Type B) (if so equipped) (P.2-21)
23. Audio system (P.4-13)
24. WD shift switch (if so equipped) (P.5-12)/
Coin box (if so equipped) (P.2-30)
25. Ashtray (P.2-29)
26. Cigarette lighter (P.2-29) or Power outlet (P.2-28)
27. Glove box (P.2-32)

See the page indicated in parentheses for operating details.

METERS AND GAUGES

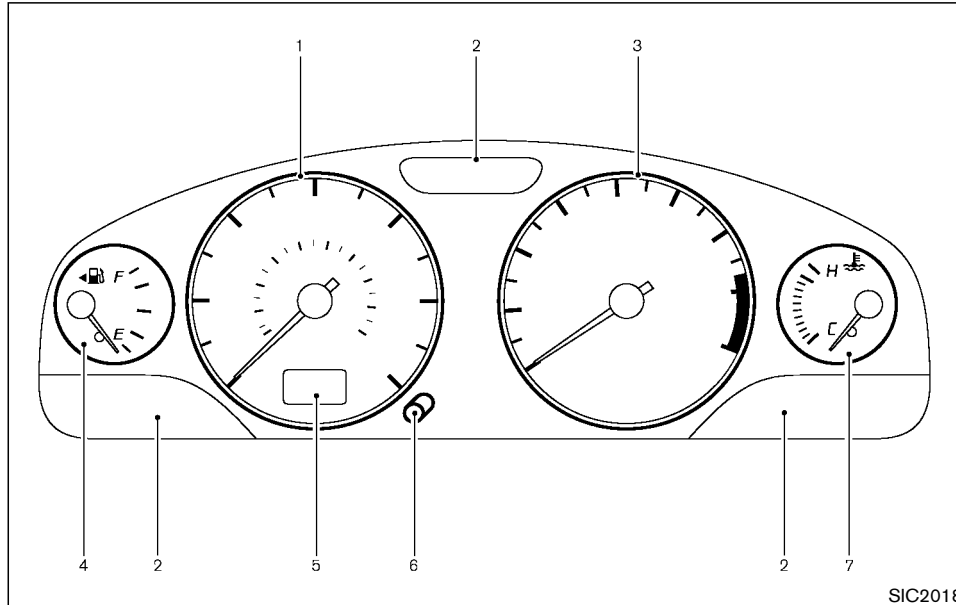

1. Speedometer
2. Warning/indicator lights
3. Tachometer
4. Fuel gauge
5. Odometer/trip odometer
6. Reset knob for trip odometer
7. Engine coolant temperature gauge

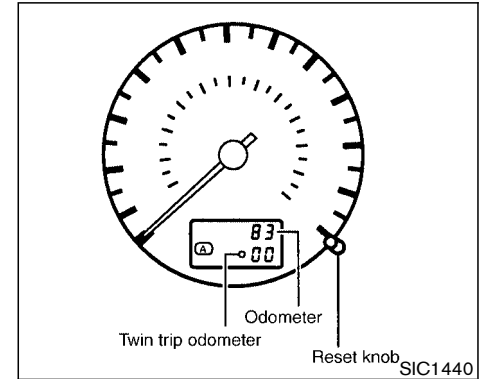

SPEEDOMETER AND ODOMETER

Speedometer

The speedometer indicates vehicle speed.

Odometer/twin trip odometer

The odometer/twin trip odometer are displayed when the ignition key is in the ON position.

The odometer records the total distance the vehicle has been driven.

The twin trip odometer records the distance of individual trips.

Changing the display:

Push the reset knob to change the display as follows:

TRIP A → TRIP B → TRIP A

Resetting the trip odometer:

Push the reset knob for more than 1 second to reset the trip odometer to zero.

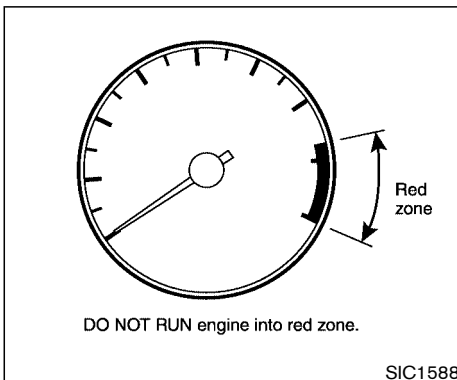

TACHOMETER

The tachometer indicates engine speed in revolutions per minute (r/min).

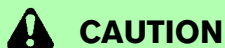

When engine speed approaches the red zone, shift to a higher gear. Operating the engine in the red zone may cause serious engine damage.

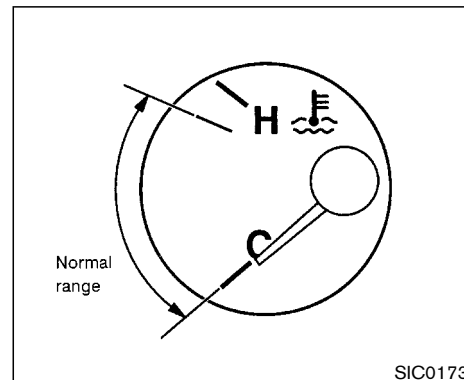

ENGINE COOLANT TEMPERATURE GAUGE

The gauge indicates the engine coolant temperature.

The engine coolant temperature will vary with the outside air temperature and driving conditions.

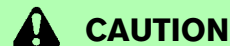

If the gauge indicates engine coolant temperature over the normal range, stop

the vehicle as soon as safely possible. If the engine is overheated, continued operation of the vehicle may seriously damage the engine. See “If your vehicle overheats” in the “6. In case of emergency” section for immediate action required.

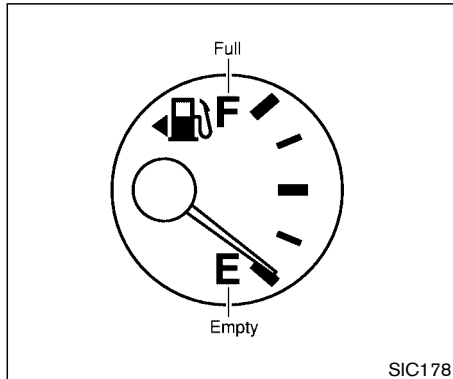

FUEL GAUGE

The gauge indicates the APPROXIMATE fuel level in the tank.

The gauge may move slightly during braking, turning, acceleration, or going up or down hill.

The gauge needle is designed to move to the E (Empty) position when the ignition key is turned to the OFF position.

Refill the fuel tank before the gauge registers Empty.

There will be a small reserve of fuel in the

tank when the fuel gauge needle reaches E.

The  indicates that the fuel filler lid is located on the driver's side of the vehicle.



CAUTION

- If the vehicle runs out of fuel, the SERVICE ENGINE SOON malfunction indicator lamp (MIL) may come on. Refuel as soon as possible. After a few driving trips, the SERVICE ENGINE SOON lamp should turn off. If the lamp remains on after a few driving trips, have the vehicle inspected by an authorized NISSAN dealer.
- For additional information, see the “Malfunction indicator lamp (MIL)” later in this section.

COMPASS AND OUTSIDE TEMPERATURE DISPLAY (if so equipped)

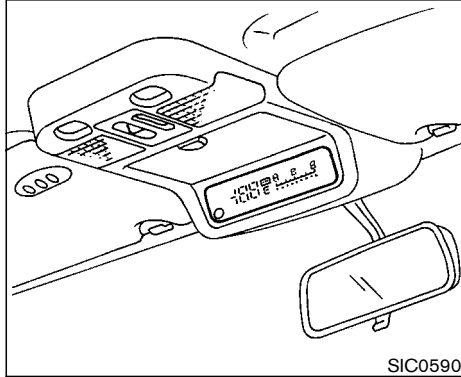

This unit is a display unit with the following functions:

- Function to measure terrestrial magnetism and indicate heading direction of vehicle
- Function to indicate outside air temperature
- Function to indicate caution for frozen road surfaces

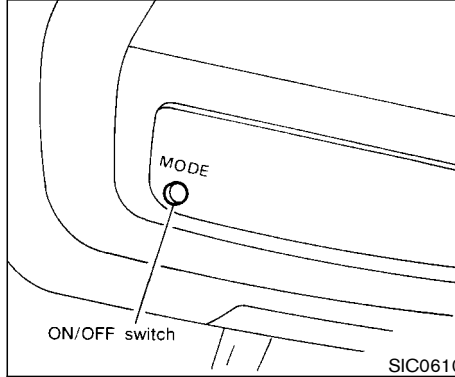

OUTSIDE TEMPERATURE DISPLAY

Push the switch when the ignition key is in the ACC or ON position. The outside temperature will be displayed in °F.

- Selecting the indication range
Push the switch to change from °F to °C.
- If the outside temperature drops below the freezing point, the display indicates ICE.

- When the outside temperature is between 130°F (55°C) and 158°F (70°C), the display shows 130°F (55°C).
- When the outside temperature is lower than -20°F (-30°C) or higher than 158°F (70°C), the display shows only --- though it is operating. This is not a malfunction.
- The outside temperature sensor is located in front of the radiator. The sensor may be affected by road or engine heat, wind direction and other driving conditions. The display may differ from the actual outside temperature or the temperature displayed on various signs or billboards.



CAUTION

Use the ICE indication for reference only. Confirm the traffic information and road conditions to drive safely.

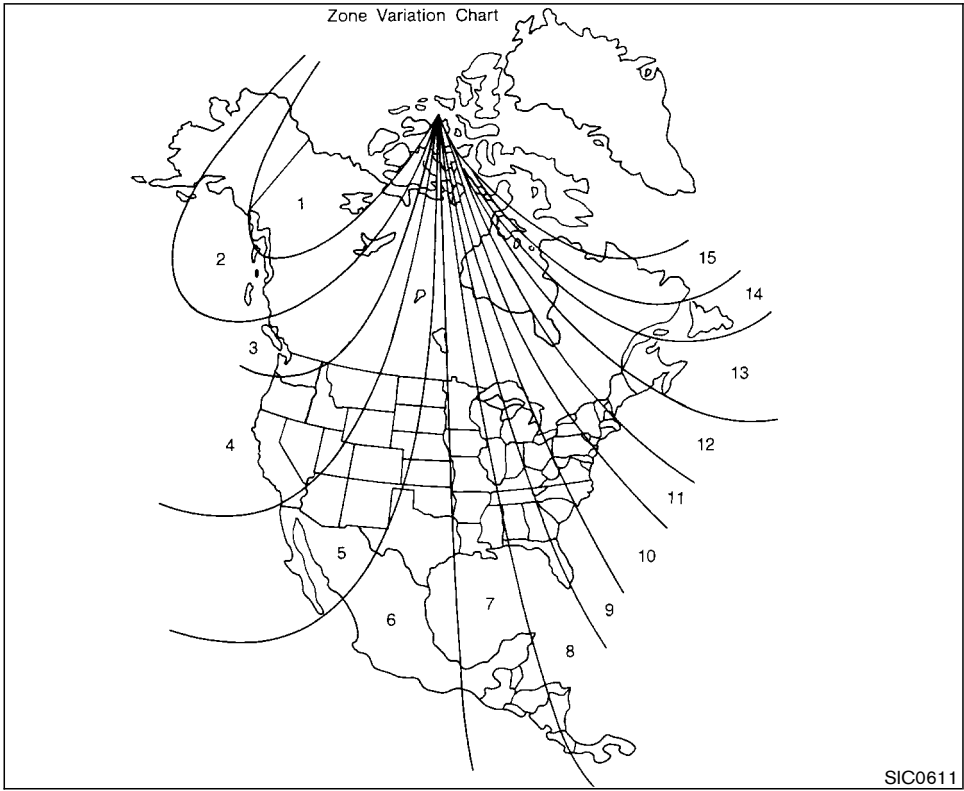

SIC0611

COMPASS DISPLAY

Push the switch when the ignition key is in the ACC or ON position. The direction will be displayed.

Zone variation change procedure

The difference between magnetic north and geographical north is known as variance. In some areas, this difference can sometimes be great enough to cause false compass readings. Follow these instructions to set the variance for your particular location if this happens:

1. Establish your location on the zone map. Record your zone number.
2. Push the ON/OFF switch in for five seconds until the current zone entry number is displayed.
3. Press the ON/OFF switch repeatedly until the new zone entry number is displayed.

Once the desired zone number is displayed, stop pressing the ON/OFF switch and the display will show compass direction within a few seconds.

- **If a magnet is located near the compass or the vehicle is driven where the terrestrial magnetism is disturbed, the compass display may not indicate the correct direction.**
- **In places where the terrestrial magnetism is disturbed, the correction of the direction starts automatically, extinguishing the direction bar. If turn is made one or two times, the correction is complete and the direction bar comes back on.**



CAUTION

In places where the earth's magnetism is disturbed, the initial correction procedure may start automatically.



























Correction functions of the compass display

The compass display is equipped with automatic correction function. If the direction is not shown correctly, carry out manual correction procedure set out below.

Manual correction procedure







1. Push the switch for about 10 seconds. The direction bar starts blinking.
2. Drive the vehicle slowly in an open and safe area. The initial correction is completed while turning one or two turns.

WARNING/INDICATOR LIGHTS AND AUDIBLE REMINDERS









| | | | | | |
|-----------------------------------------------------------------------------------------------------------------------------------------------------------------------|------------------------------------------------------|-----------------------------------------------------------------------------------|-----------------------------------------------------|-------------------------------------------------------------------------------------|--------------------------------------------------------------------|
|  or  | Anti-lock brake warning light |  | Low tire pressure warning light (if so equipped) |  | High beam indicator light |
|  | Automatic transmission oil temperature warning light |  | Low washer fluid warning light (Canada only) |  | Malfunction indicator lamp (MIL) |
|  | Automatic transmission park warning light |  | Seat belt warning light and chime |  | Overdrive off indicator light (Automatic transmission models only) |
|  or  | Brake warning light |  | Supplemental air bag warning light |  | Slip indicator light (if so equipped) |
|  | Charge warning light |  | Tire carrier open warning light (if so equipped) |  | Transfer 4LO position indicator light |
|  | Door open warning light |  | Cruise main switch indicator light (if so equipped) |  | Turn signal/hazard indicator lights |
|  | Engine oil pressure warning light |  | Cruise set switch indicator light (if so equipped) |  | Vehicle dynamic control off indicator light (if so equipped) |
|  | 4WD warning light |  | 4WD indicator light | | |
|  | Low fuel warning light |  | 4WD shift indicator light | | |

CHECKING BULBS

Apply the parking brake and turn the ignition key to ON without starting the engine. The following lights will come on:

 ,  ,  OR  ,  , 

The following lights come on briefly and then go off:

 ,  ,  ,  ,  ,  ,  , 

If any light fails to come on, it may indicate a burned-out bulb or an open circuit in the electrical system. Have the system repaired promptly.

WARNING LIGHTS

 or  Anti-lock brake warning light

If the light comes on while the engine is running, it may indicate the anti-lock brake system is not functioning properly. Have the system checked by your NISSAN dealer.

If an abnormality occurs in the system, the anti-lock function will cease but the ordinary brakes will continue to operate normally.

If the light comes on while you are driving, contact your NISSAN dealer for repair.

 Automatic transmission oil temperature warning light (4x4 model)

This light comes on when the automatic transmission oil temperature is too high. If the light comes on while driving, reduce the vehicle speed as soon as safely possible until the light turns off.



CAUTION

Continued vehicle operation when the A/T oil temperature warning light is on may damage the automatic transmission.

 Automatic transmission park warning light (4x4 model)



WARNING

- **If the ATP light is ON, this indicates that the automatic transmission P (Park) position will not function and the transfer lever or the transfer case is in neutral.**

Part time 4WD models:

- **When parking, always make sure that the transfer lever is in H or 4L and the parking brake is set. Failure to engage the transfer control lever in H or 4L could result in the vehicle moving unexpectedly, resulting in serious personal injury or property damage.**

All mode 4WD models:

- **When parking, always make sure that 4WD shift indicator light illuminates and the parking brake is set. Failure to engage the 4WD shift switch in 2H, AUTO, 4H or 4LO could result in the vehicle moving unexpectedly, result-**

ing in serious personal injury or property damage.

This light indicates that the automatic transmission parking function is not engaged. If the transfer control is not secured in any drive position while the automatic transmission selector lever is in the P (Park) position, the transmission will disengage and the wheel will not lock.

Part time 4WD models

Shift the transfer shift lever into the 2H, 4H or 4L position again to turn off the ATP warning light when the automatic transmission selector lever is in the P position and the ATP warning light is ON.

(Before shifting the transfer shift lever into the 4L position, move the automatic transmission selector lever into the N position once, shift the selector lever into P again and) make sure the ATP warning light is OFF.

All-mode 4WD models

The warning light may come on when the ignition switch is ON and the automatic transmission lever is shifted to the P position while shifting the transfer case between 4H and 4LO.

Shift the 4WD shift switch to the 2WD, AUTO,

4H or 4LO position again to turn off the ATP warning light when the warning light comes on. (Before shifting the 4WD shift switch into the 4LO position or out of 4LO into the 4H position, move the automatic transmission selector lever into the N position). Shift the selector lever into the P position and make sure that the 4WD shift indicator light is ON and the ATP warning light is OFF.

 or  Brake warning light

This light functions for both the parking brake and the foot brake systems.

Parking brake indicator:

The light comes on when the parking brake is applied.

Low brake fluid warning light:

When the ignition key is in the ON position, the light warns of a low brake fluid level. If the light comes on while the engine is running, stop the vehicle and perform the following:

1. Check the brake fluid level. Add brake fluid as necessary. See “Brake and clutch fluid” in the “8. Maintenance and do-it-yourself” section.

2. If the brake fluid level is correct:

Have the warning system checked by a NISSAN dealer.



WARNING

- **Your brake system may not be working properly if the warning light is on. Driving could be dangerous. If you judge it to be safe, drive carefully to the nearest service station for repairs. Otherwise, have your vehicle towed.**
- **Pressing the brake pedal with the engine stopped and/or low brake fluid level may increase your stopping distance and braking will require greater pedal effort as well as greater pedal travel.**
- **If the brake fluid level is below the MIN mark on the brake fluid reservoir, do not drive until the brake system has been checked at a NISSAN dealer.**



Charge warning light

If the light comes on while the engine is running, it may indicate the charging system is not functioning properly. Turn the engine off and check

the alternator belt. If the belt is loose, broken, missing or if the light remains on, see your NISSAN dealer immediately.



CAUTION

Do not continue driving if the belt is loose, broken or missing.



Door open warning light

This light comes on when any of the doors and/or rear window are not closed securely while the ignition key is ON.



Engine oil pressure warning light

This light warns of low engine oil pressure. If the light flickers or comes on during normal driving, pull off the road in a safe area, stop the engine **immediately** and call a NISSAN dealer or other authorized repair shop.

The oil pressure warning light is not designed to indicate a low oil level. Use the dipstick to check the oil level. See “Engine oil” in the “8. Maintenance and do-it-yourself” section.



CAUTION

Running the engine with the oil pressure warning light on could cause serious damage to the engine almost immediately. Turn off the engine as soon as it is safe to do so.

4WD 4WD warning light ( model)

The four wheel drive warning light comes on when the key switch is turned to ON. It turns off soon after the engine is started.

If the engine or vehicle is not functioning properly, the warning light will either remain illuminated or blink. See “4WD warning light” in the “5. Starting and driving” section.



CAUTION

- **If the warning light comes on or blinks during operation, have your vehicle checked by an authorized NISSAN dealer as soon as possible.**

- **Do not drive on dry hard surface roads in the 4H or 4LO position. If the 4WD warning light turns on when you are driving on dry hard surface roads**
 - **in the AUTO or 4H position, shift the 4WD shift switch to 2WD.**
 - **in the 4LO position, stop the vehicle, move the automatic transmission lever to the N position, and shift the 4WD shift switch to 2WD.**

If the warning light is still on after the above operation, have your vehicle checked by an authorized NISSAN dealer as soon as possible.



Low fuel warning light

This light comes on when the fuel in the tank is getting low. Refuel as soon as it is convenient, preferably before the fuel gauge reaches E.

There will be a small reserve of fuel remaining in the tank when the fuel gauge needle reaches E.



Low tire pressure warning light (if so equipped)

The light comes on for about 1 second when the key switch is turned ON, and then it turns off.

This light warns a low tire pressure.

Low tire pressure warning:

If the vehicle is being driven with flat tire or low tire pressure, the light will illuminate. Also a chime will sound for about 10 seconds.

For additional information, see “Low tire pressure warning system” in the “5. Starting and driving” section and “Flat tire” in the “6. In case of emergency” section.



WARNING

- **If the light does not come on with the key switch turned ON, have the vehicle checked by a NISSAN dealer as soon as possible.**
- **If the light comes on while driving, avoid sudden steering maneuvers or abrupt braking, reduce vehicle speed, pull off the road to a safe location and stop the vehicle as soon as possible.**

sible. Serious vehicle damage could occur and may lead to an accident and could result in serious personal injury. Check the tire pressure for all four wheels and adjust the pressure to the COLD tire pressure shown on the tire placard. If the light still comes on while driving after adjusting the tire pressure, a tire may be flat. If you have a flat tire, replace it with a spare tire as soon as possible.

- When a spare tire is mounted or a wheel is replaced, the low tire pressure warning system will not function. Contact your NISSAN dealer as soon as possible for tire replacement and/or system resetting.



CAUTION

- The low tire pressure warning is not a substitute for the regular tire pressure check. Be sure to check the tire pressure regularly.

- If the vehicle is being driven at speeds of less than 20 MPH (32 km/h), the low tire pressure warning system may not operate correctly.
- Be sure to install the specified size of tires to the four wheels correctly.



Low washer fluid warning light (Canada only)

This light comes on when the washer fluid in the washer tank is at a low level. Add washer fluid as necessary. See “Window washer fluid” in the “8. Maintenance and do-it-yourself” section.



Seat belt warning light and chime

The light and chime remind you to fasten seat belts. The light illuminates whenever the ignition key is turned to ON, and will remain illuminated until the driver's seat belt is fastened. At the same time, the chime will sound for about six seconds unless the driver's seat belt is securely fastened.

See “Seat belts” in the “1. Seats, restraints and supplemental air bag systems” section for precautions on seat belt usage.



Supplemental air bag warning light

After turning the ignition key to the ON position, the supplemental air bag warning light will illuminate. The supplemental air bag warning light will turn off after about 7 seconds if the supplemental front air bag and supplemental side air bag systems and pre-tensioner seat belt are operational.

If any of the following conditions occur, the supplemental front air bag, supplemental side air bag (if so equipped) and supplemental curtain side-impact air bag (if so equipped) systems, and pre-tensioner seat belt need servicing and your vehicle must be taken to your nearest NISSAN dealer.

- The supplemental air bag warning light remains on after approximately 7 seconds.
- The supplemental air bag light flashes intermittently.
- The supplemental air bag light does not come on at all.

Unless checked and repaired, the supplemental restraint system and/or the pre-tensioner seat belt may not function properly. For additional information, see “Supplemental restraint system” in the “1. Seats, restraints and supplemental air bag systems” section.



WARNING

If the supplemental air bag warning light is on, it could mean that the supplemental front air bag system, supplemental side air bag and curtain side-impact air bag systems (if so equipped) and/or pre-tensioner seat belt may not operate in an accident.



Tire carrier open warning light (if so equipped)

This light comes on when the tire carrier is not closed securely while the ignition key is ON.

INDICATOR LIGHTS



Cruise main switch indicator light (if so equipped)

The light comes on when the main switch is turned on.



Cruise set switch indicator light (if so equipped)

The light comes on while the vehicle speed is controlled by the cruise control system. If the light blinks while the engine is running, it may

indicate the cruise control system is not functioning properly. Have the system checked by your NISSAN dealer.



4WD indicator light (4x4 model)

This light comes on when the transfer shift control lever is in the 4H or 4L position.



4WD shift indicator light (4x4 model)

The light should turn off within 1 second after turning the ignition switch to ON.

While the engine is running, the 4WD shift indicator light will illuminate the position selected by the 4WD shift switch.

The 4WD shift indicator light may blink while shifting from one drive mode to the other.



High beam indicator light (Blue)

This light comes on when the headlight high beam is on, and goes out when the low beams are selected.



Malfunction indicator lamp (MIL)



If the Malfunction indicator lamp comes on steady or blinks while the engine is running, it may indicate a potential emission control malfunction.

The Malfunction indicator lamp may also come on steady if the fuel filler cap is loose or missing, or if the vehicle runs out of fuel. Check to make sure the fuel filler cap is installed and closed tightly, and that the vehicle has at least 3 US gallons (14 liters) of fuel in the fuel tank.

After a few driving trips, the  lamp should turn off if no other potential emission control system malfunction exists.

Operation

The Malfunction indicator lamp will come on in one of two ways:

- Malfunction indicator lamp on steady — An emission control system malfunction has been detected. Check the fuel filler cap. If the fuel filler cap is loose or missing, tighten or install the cap and continue to drive the vehicle. The  lamp should turn off after a few driving trips. If the  lamp does not turn off after a few driving trips, have the vehicle inspected by an authorized NISSAN

dealer. You do not need to have your vehicle towed to the dealer.

- Malfunction indicator lamp blinking — An engine misfire has been detected which may damage the emission control system. To reduce or avoid emission control system damage:
 - * do not drive at speeds above 45 MPH (72 km/h).
 - * avoid hard acceleration or deceleration.
 - * avoid steep uphill grades.
 - * if possible, reduce the amount of cargo being hauled or towed.

The malfunction indicator lamp may stop blinking and come on steady.

Have the vehicle inspected by an authorized NISSAN dealer. You do not need to have your vehicle towed to the dealer.



CAUTION

Continued vehicle operation without having the emission control system checked and repaired as necessary could lead to poor driveability, reduced fuel economy, and possible damage to

the emission control system.



Overdrive off indicator light (Automatic transmission models only)

This light comes on during driving when the overdrive switch is pressed to prevent overdrive operation.

The O/D OFF indicator light comes on for two seconds each time the ignition key is turned ON. This shows the light is functioning properly.

If the O/D OFF indicator light blinks for approximately 8 seconds after coming on for 2 seconds, have your NISSAN dealer check the transmission and repair it if necessary.

The automatic transmission is equipped with an electronic Fail-Safe mode. This system allows the vehicle to be driven even in the event of damage to the electrical circuits. If this occurs, the gears automatically engage and lock into 3rd gear.

See “Driving the vehicle” in the “5. Starting and driving” section for failsafe before visiting your NISSAN dealer.



Slip indicator light (if so equipped)

This indicator will blink when the VDC system is operating, thus alerting the driver to the fact that the road surface is slippery and the vehicle is nearing its traction limits.



Transfer 4LO position indicator light (4x4 model)

The light should turn off within 1 second after turning the ignition switch to ON.

This light comes on when the 4WD shift switch is set in the 4LO position with ignition key in the ON position.

If the 4WD shift switch is set in the 4LO position and the light blinks, stop the vehicle, drive slowly forward and the light will turn on.

When you shift between 4H and 4LO, stop the vehicle, move the automatic transmission selector lever to the N position, and press the 4WD shift switch and move it in 4LO or 4H.

The transfer case may be damaged if you shift the switch while driving.

You cannot move the transfer 4WD shift switch between 4H and 4LO unless you have first stopped the vehicle and moved the automatic transmission shift lever to neutral. Make sure the

transfer 4LO position indicator light turns on when you shift the 4WD shift switch to 4LO.

The indicator light may blink while shifting from one drive mode to the other.



Turn signal/hazard indicator lights

The light flashes when the turn signal switch lever or hazard switch is turned on.



Vehicle dynamic control off indicator light (if so equipped)

The light comes on when the vehicle dynamic control off switch is pushed to OFF. This indicates the vehicle dynamic control system and traction control system are not operating. When the vehicle dynamic control off indicator light and slip indicator light come on with the vehicle dynamic control system turned on, this light alerts the driver to the fact that the vehicle dynamic control system's fail-safe mode is operating, i.e. the vehicle dynamic control system may not be functioning properly. Have the system checked by your NISSAN dealer. If an abnormality occurs in the system, the vehicle dynamic control system function will be canceled but the vehicle is still driveable. For additional information, see "Vehicle dynamic control system (VDC)" in the "5. Starting and driving" section of this manual.

2-16 Instruments and controls

AUDIBLE REMINDERS

Key reminder chime

The chime will sound when the driver side door is opened if the key is left in the ignition switch. Take the ignition key when you leave the vehicle.

Light reminder chime

The chime will sound when the front door is opened with the headlight switch on unless the ignition key is in the ignition switch.

Brake pad wear warning

The disc brake pads have audible wear warnings. When a brake pad requires replacement, it will make a high pitched scraping sound. Have the brakes checked as soon as possible if the warning sound is heard when the vehicle is moving, whether or not the brake pedal is depressed.

SECURITY SYSTEMS



Your vehicle may have two types of security system, as follows:

- Vehicle security system
- Nissan Vehicle Immobilizer System

The security condition will be shown by the security indicator light.

VEHICLE SECURITY SYSTEM

The vehicle security system provides visual and audio alarm signals if parts of the vehicle are disturbed.

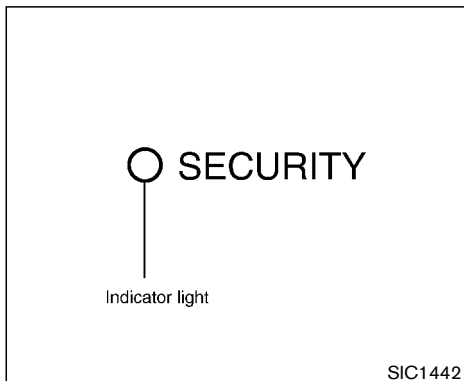

Security indicator light

This light blinks whenever the ignition switch is in the LOCK, OFF or ACC position. This function indicates the security systems equipped on the vehicle are operational.

How to activate the vehicle security system

1. Close all windows.

The system can be activated even if the windows are open.

2. Remove the key from the ignition switch.

3. Close and lock all doors, hood, back door and glass hatch. All doors can be locked either with the keyfob, a key, the door lock knob or the lock-unlock switch. See “Doors” in the “3. Pre-driving checks and adjustments” section for locking all doors simultaneously.
4. Confirm that the SECURITY indicator light comes on. The SECURITY light glows for about 30 seconds and then begins to flash. The system is now activated. If, during this 30 second time period, the door is unlocked by the key or keyfob, or the ignition key is turned to ACC or ON, the system will not activate.

Even when the driver and/or passengers are in the vehicle, the system will activate with all doors, hood, back door and back door glass hatch locked and ignition key off. Turn the ignition key to ACC to turn the system off.

Vehicle security system operation

The vehicle security system will give the following alarm:

- The headlights blink and the horn sounds intermittently.
- The alarm automatically turns off after 1 minute, however, the alarm will reactivate if the vehicle is tampered with again.

The alarm is activated by:

- Unlocking the door, back door or back door glass hatch without using the key or keyfob. (Even if the door is opened by releasing the door inside lock knob, the alarm is activated.)
- Opening the hood. (Even if the hood is opened by the hood release handle, the alarm is activated.)
- Opening the back door glass hatch.
- Connecting the battery connector after it has been disconnected from the battery for more than 1 second.

How to stop alarm

The alarm will stop only by unlocking a door, the back door or the back door glass hatch with the key or keyfob. The alarm will not stop if the ignition switch is turned to ACC or ON.

The alarm may be activated when the glass hatch is opened quickly with a key after the alarm has been set.

If the system does not operate as described above, have it checked by your NISSAN dealer.

NISSAN VEHICLE IMMOBILIZER SYSTEM

The Nissan Vehicle Immobilizer System will not allow the engine to start without the use of the registered Nissan Vehicle Immobilizer System key.

If the engine fails to start using the registered Nissan Vehicle Immobilizer System key (for example, when interference is caused by another Nissan Vehicle Immobilizer System key, an automated toll road device or automated payment device on the key ring), restart the engine using the following procedures:

1. Leave the ignition switch in the ON position for approximately 5 seconds.
2. Turn the ignition switch to the OFF or LOCK position, and wait approximately 10 seconds.
3. Repeat step 1 and 2.
4. Restart the engine while holding the device (which may have caused the interference) separate from the registered Nissan Vehicle Immobilizer System key.

If the no start condition re-occurs, NISSAN recommends placing the registered Nissan Vehicle Immobilizer System key on a separate key ring to avoid interference from other devices.

2-18 Instruments and controls

Statement related to section 15 of FCC rules for Nissan Vehicle Immobilizer System (CONT ASSY - IMMOBILIZER, ANT ASSY - IMMOBILIZER)

This device complies with part 15 of the FCC Rules and RSS-210 of Industry Canada. Operation is subject to the following two conditions;

(1) This device may not cause harmful interference, and (2) this device must accept any interference received, including interference that may cause undesired operation of the device.

CHANGES OR MODIFICATIONS NOT EXPRESSLY APPROVED BY THE MANUFACTURE RESPONSIBLE FOR COMPLIANCE COULD VOID THE USER'S AUTHORITY TO OPERATE THE EQUIPMENT.

Security indicator light

This light blinks whenever the ignition switch is in the LOCK, OFF or ACC position. This function indicates the security systems equipped on the vehicle are operational.

If the Nissan Vehicle Immobilizer System is malfunctioning, this light will remain on while the ignition key is in the ON position.

If the light still remains on and/or the engine will not start, see your NISSAN dealer for Nissan Vehicle Immobilizer System service as soon as possible. Please bring all Nissan Vehicle Immobilizer System keys that you have when visiting your NISSAN dealer for service.

WINDSHIELD WIPER AND WASHER SWITCH

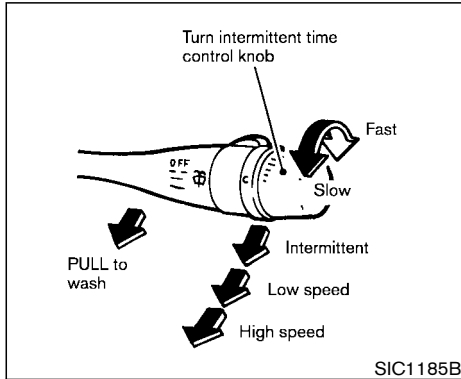

The windshield wiper and washer operates when the ignition key is in the ON position.

Push the lever down to operate the wiper.

Intermittent operation speed can be adjusted by turning the knob.

Pull the lever toward you to operate the washer. The wiper will also operate several times.



CAUTION

The following could damage the washer system:

- Do not operate the washer continuously for more than 30 seconds.
- Do not operate the washer if the reservoir tank is empty.



WARNING

In freezing temperatures the washer solution may freeze on the windshield and obscure your vision which may lead to an accident. Warm the windshield with the defroster before you wash the windshield.

REAR WINDOW WIPER AND WASHER SWITCH

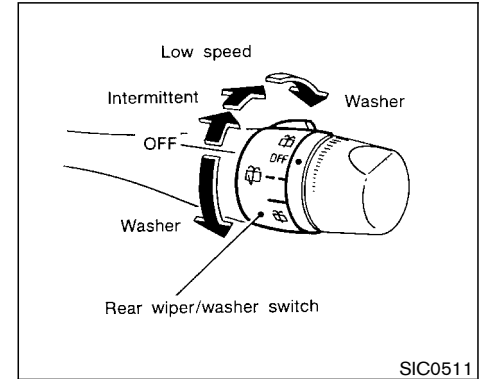

The rear window wiper and washer operates when the ignition switch is in the ON position.

Turn the switch clockwise to the intermittent, low speed  position to operate the wiper or washer.

Turn the switch counterclockwise to the  position to operate the washer. Then the wiper will also operate several times.



CAUTION

- Do not operate the washer continuously for more than 30 seconds.
 - Do not operate the washer if reservoir tank is empty.
 - Do not operate the washer when the glass hatch is open.
- The rear window wiper will not operate when the glass hatch is open.

The rear window wiper will not operate if the glass hatch is closed with the wiper switch on. To operate the window wiper, turn the switch to off and then to on.

- The glass hatch will not open while the rear window wiper is operating.



WARNING

In freezing temperatures the washer solution may freeze on the glass hatch and obscure your vision. Warm the glass hatch with the defroster before you

wash the glass hatch.

GLASS HATCH AND OUTSIDE MIRROR DEFOGGER SWITCH

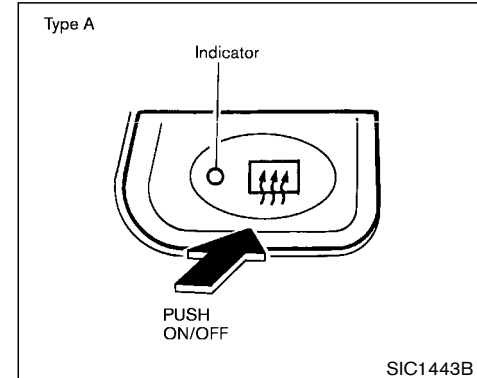

To defog the glass hatch and the outside door mirrors, start the engine and push the switch on. (The indicator light will come on.) Push the switch again to turn the defogger off.

It will automatically turn off in approximately 15 minutes. If the window clears before this time, push the switch off manually.



CAUTION

When cleaning the inner side of the glass hatch, be careful not to scratch or damage the glass hatch defogger.

HEADLIGHT AND TURN SIGNAL SWITCH

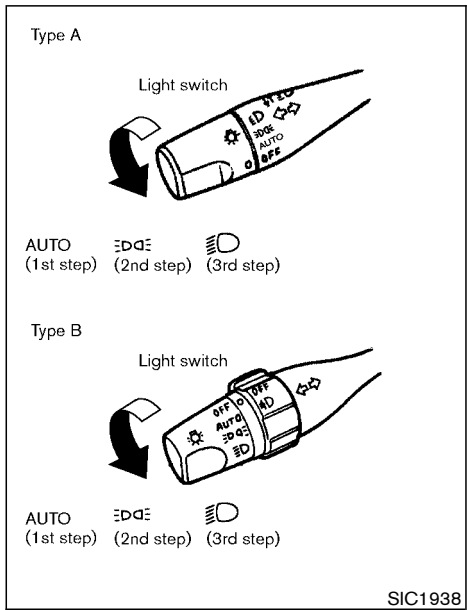
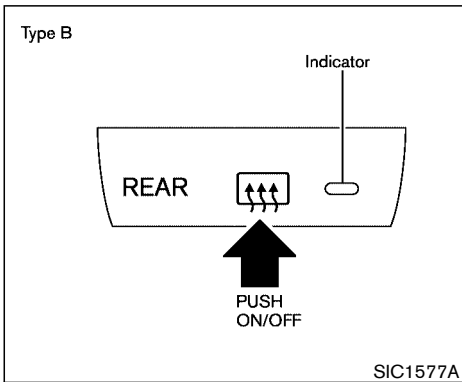

HEADLIGHT SWITCH

Lighting

Turn the switch to the AUTO position:

When the ignition key is in the ON position, the tail light, headlight, instrument light and other lights turn on automatically, depending on the brightness of the surroundings. The headlight will automatically turn off 5 minutes after the ignition switch is turned to the OFF position and the driver's or front passenger's door is opened.

The headlight will also automatically turn off 45 seconds after a front door is opened and closed.

When the light switch is turned to the AUTO position, the headlight low or high beam will turn off.

Turn the switch to the AUTO position:

The side combination, tail, license plate and instrument lights will come on.

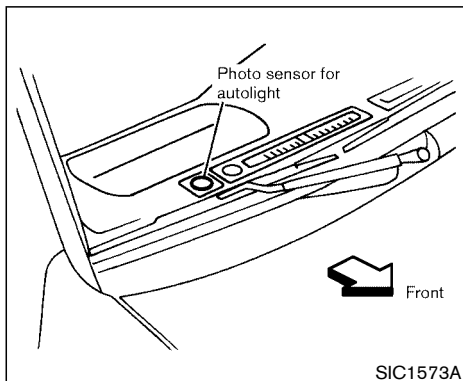

Turn the switch to the MD position:

Headlights will come on and all the other lights remain on.







Be sure not to put anything on top of the photo sensor located on the top right-hand side of the instrument panel. The photo sensor controls the autolight; if it is covered, the photo sensor reacts as if it is dark and the headlights will illuminate.

Battery saver system

- When the headlight switch is in the  or  position while the ignition switch is in the ON position, the lights (including the front fog light) will automatically turn off 5 minutes after the ignition switch has been turned to the OFF position.

2-22 Instruments and controls

- When the headlight switch remains in the  or  position after the lights automatically turn off, the lights will turn on when the headlight switch is turned to the OFF position and turn to the  or  position again.



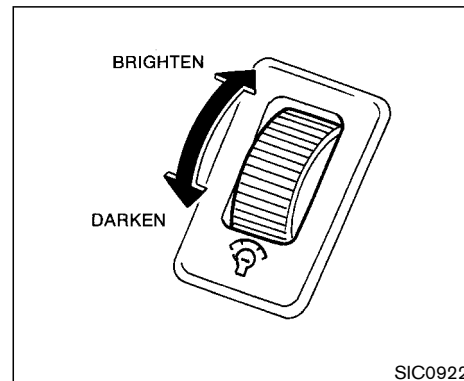

CAUTION

- **When you turn on the headlight switch after the lights automatically turn off, the lights will not turn off automatically. Be sure to turn the light switch to the OFF position when you leave the vehicle for extended periods of time, otherwise the battery will go dead.**
- **Never leave the light switch on when the engine is not running for extended periods of time.**



Instrument brightness control

The instrument brightness control operates when the light switch is in the Auto,  or  position.

Turn the control dial to adjust the brightness of instrument panel lights.

When the control is turned upward until a click sound is heard, the light intensity will be at maximum. When the control is turned downward until a click sound is heard or felt, the light will be turned off.

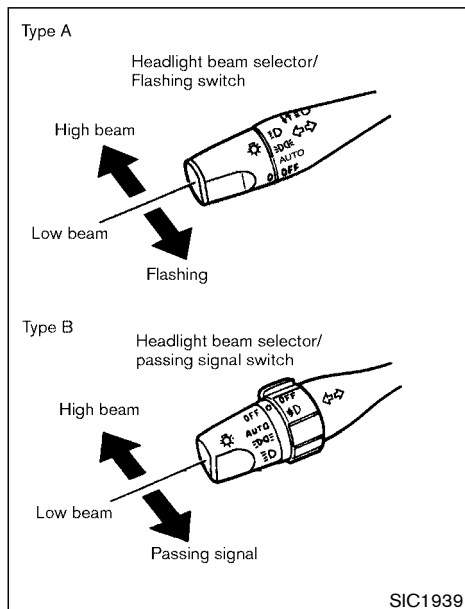



Headlight beam select

To select the high beam, push the lever forward. Pull it back to select the low beam.

Passing signal

Pulling the lever toward you will turn on the passing signal even when the headlight switch is off.

Daytime running light system (Canada only)

The headlights automatically illuminate at a reduced intensity when the engine is started with the parking brake released. The daytime running lights operate with the headlight switch in the off position or in the  position. Turn the headlight switch to the  position for full illumination when driving at night.

If the parking brake is applied before the engine is started, the daytime running lights do not illuminate. The daytime running lights illuminate once the parking brake is released. The daytime running lights will remain on until the ignition switch is turned off.

cause an accident injuring yourself and others.



WARNING

When the daytime running light system is active, tail lights on your vehicle are not on. It is necessary at dusk to turn on your headlights. Failure to do so could

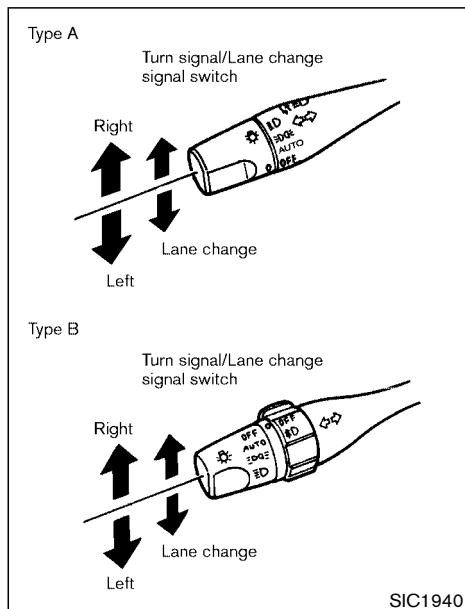

TURN SIGNAL SWITCH

Turn signal

Move the lever up or down to signal to the turning direction. When the turn is completed, the turn signals cancel automatically.

2-24 Instruments and controls



Lane change signal

To indicate a lane change, move the lever up or down to the point where lights begin flashing.

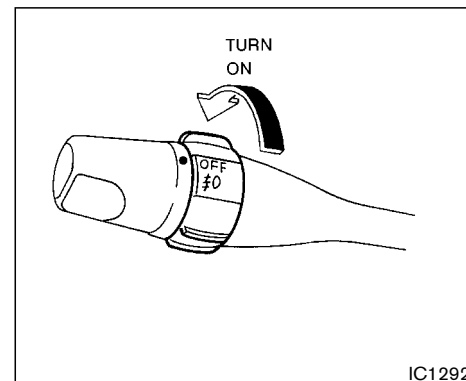
FOG LIGHT SWITCH (if so equipped)



FRONT FOG LIGHT SWITCH

To turn the fog lights on, turn the headlight switch to the  position, then turn the switch to the  position. To turn them off, turn the switch to the OFF position.

The headlights must be on for the fog lights to operate.

HAZARD WARNING FLASHER SWITCH

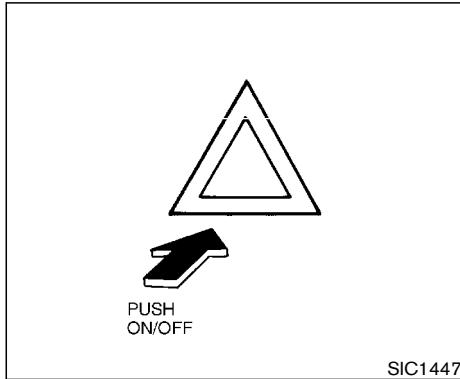

Push the switch on to warn other drivers when you must stop or park under emergency conditions. All turn signal lights will flash.

Some state laws may prohibit the use of the hazard warning flasher switch while driving.

WARNING

- If stopping for an emergency, be sure to move the vehicle well off the road.
- Do not use the hazard warning flash-

ers while moving on the highway unless unusual circumstances force you to drive so slowly that your vehicle might become a hazard to other traffic.

- Turn signals do not work when the hazard warning flasher lights are on.

The flasher can be actuated with the ignition switch either off or on.

HORN

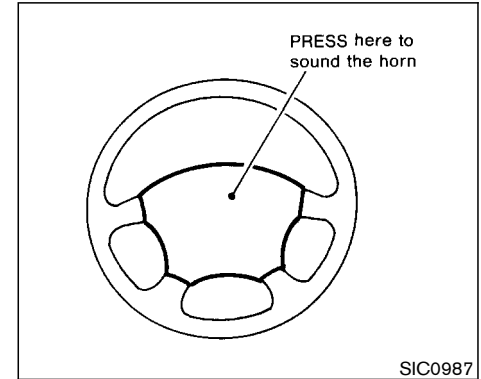

To sound the horn, push the center pad area of the steering wheel.

WARNING

Do not disassemble the horn. Doing so could affect proper operation of the supplemental front air bag system. Tampering with the supplemental front air bag system may result in serious personal injury.

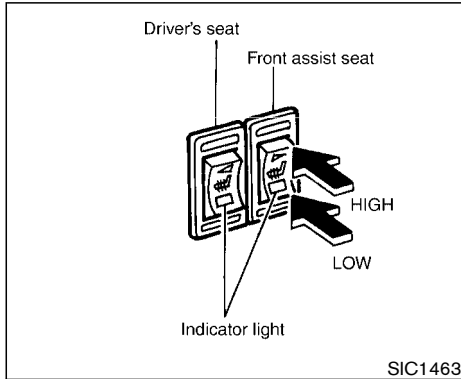

HEATED SEATS (if so equipped)



The front seat(s) are warmed by built-in heaters. The switches located on the instrument panel can be operated independently of each other.

1. Start the engine.

The battery could run down if the heater is operated while the engine is not running.

2. Push the  (Low) or  (High) position of the switch, as desired, depending on the temperature. The indicator light in the switch will illuminate.

The heater is controlled by a thermostat, automatically turning the heater on and off.

The indicator light will remain on as long as the switch is on.

3. When the vehicle's interior is warmed or before you leave the vehicle, be sure to turn the switch off.



CAUTION

- The battery could run down if the seat heater is operated while the engine is not running.
- Do not use the seat heater for extended periods or when no one is using the seat.
- Do not put anything on the seat which insulates heat, such as a blanket, cushion, seat cover, etc. Otherwise, the seat may become overheated.
- Do not place anything hard or heavy on the seat or pierce it with a pin or similar object. This may result in damage to the heater.
- Any liquid spilled on the heating seat

should be removed immediately with a dry cloth.

- When cleaning the seat, never use gasoline, thinner, or any similar materials.
- If any abnormalities are found or the heating seat does not operate, turn the switch off and have the system checked by your NISSAN dealer.

VEHICLE DYNAMIC CONTROL (VDC) OFF SWITCH (if so equipped)

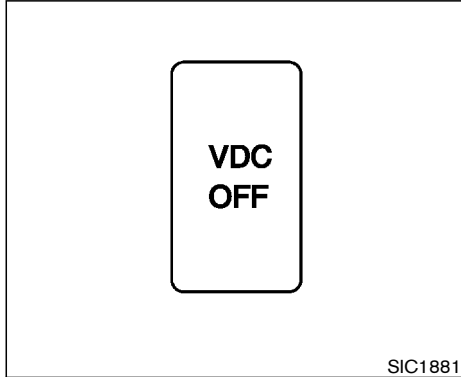

The vehicle should be driven with the Vehicle Dynamic Control System (VDC) on for most driving conditions.

When the vehicle is stuck in mud or snow, the VDC system reduces the engine output to reduce wheel spin. The engine RPM will be reduced even if the accelerator is depressed to the floor. If maximum engine power is needed to free a stuck vehicle, turn the VDC system off.

To cancel the Vehicle Dynamic Control System (VDC), push the VDC OFF switch to turn off the system. The ^{VDC}_{OFF} indicator will come on.

Push the VDC OFF switch again or restart the engine to turn ON the system. See "Vehicle

dynamic control system (VDC)" in the "5. Starting and driving" section.

CLOCK

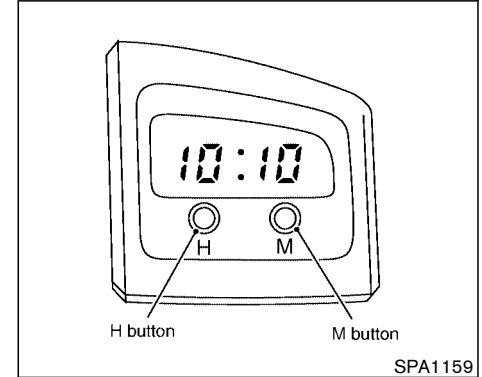

The digital clock displays time when the ignition key is in ACC or ON.

If the power supply is disconnected, the clock will not indicate the correct time. Readjust the time.

ADJUSTING THE TIME

Push the **H** button to adjust the hour.

Push the **M** button to adjust the minute.

POWER OUTLET (if so equipped)

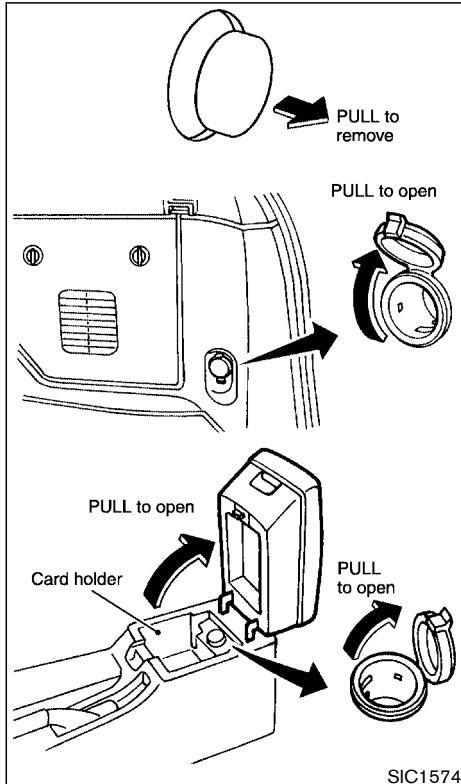

The power outlet is for powering electrical accessories such as cellular telephones.

CAUTION

- Use caution as the outlet and plug may be hot during or immediately after use.
- This power outlet is not designed for use with a cigarette lighter unit.
- Do not use with accessories that exceed a 12 volt, 120W (10A) power draw. Do not use double adapters or more than one electrical accessory.
- Use only one power outlet at a time.
- Use this power outlet with the engine running. (If the engine is stopped, this could result in a discharged battery.)
- Avoid using when the air conditioner, headlights or rear window defogger is on.
- Before inserting or disconnecting a plug, be sure to turn off the power

switch of electrical accessory being used or the ACC power of the vehicle.

- Push the plug in as far as it will go. If good contact is not made, the plug may overheat or the internal temperature fuse may blow.
- When not in use, be sure to close the cap. Do not allow water to contact the socket.

CIGARETTE LIGHTER AND ASHTRAY (if so equipped)

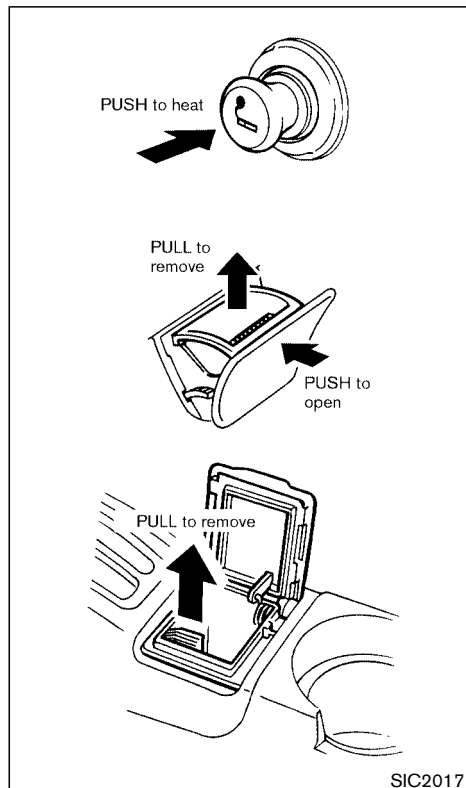

The cigarette lighter element is an accessory. A genuine NISSAN cigarette lighter unit can be purchased from your local NISSAN dealer.

The cigarette lighter operates when the ignition switch is in ACC or ON.

Push the lighter in all the way. When the lighter is heated, it will spring out.

Return the lighter to its original position after use.

WARNING

The cigarette lighter should not be used while driving so full attention may be given to vehicle operation.

CAUTION

The cigarette lighter socket is a power source for the cigarette lighter element only. The use of the cigarette lighter socket as a power source for any other accessory is not recommended.

STORAGE

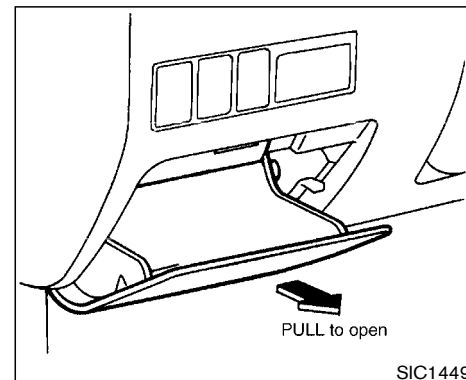

TRAY

WARNING

The storage tray should not be used while driving so full attention may be given to vehicle operation.

Do not place valuable items in the tray.

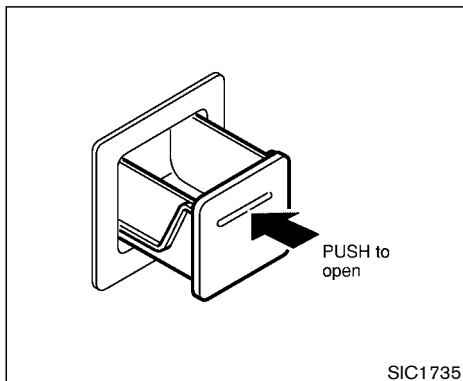

COIN BOX (if so equipped)

To open the box, lightly push it once and draw it out.

Do not use the box as an ashtray.

Do not place valuable items in the box.

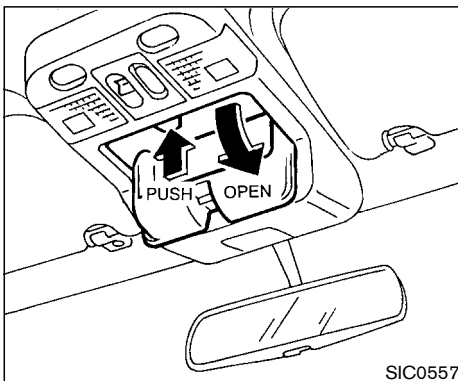

SUNGLASSES HOLDER

The sunglasses holder can be opened by pushing the button.

WARNING

The sunglasses holder should not be used while driving so full attention may be given to vehicle operation.

CAUTION

- Do not use for anything other than glasses.
- Do not leave glasses in the sunglasses holder while parking in direct sunlight. The heat may damage the glasses.

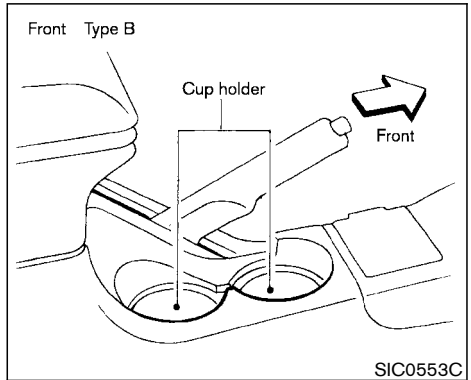
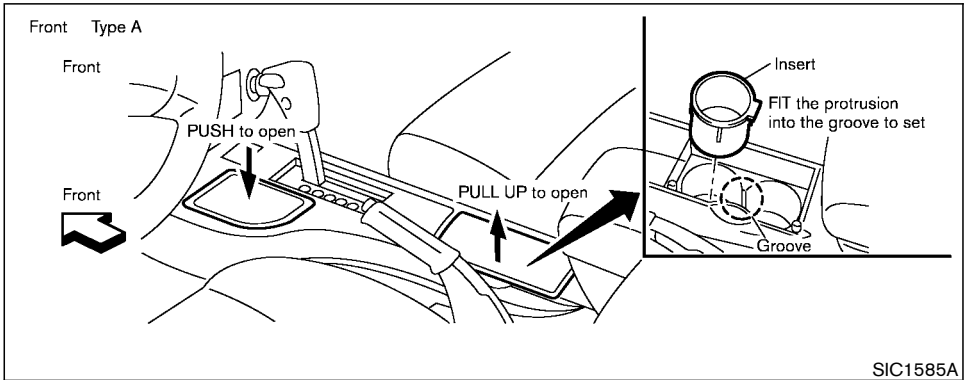

CUP HOLDERS

WARNING

The cup holders should not be used while driving so full attention may be given to vehicle operation.

CAUTION

- Avoid abrupt starting and braking

when the cup holder is being used to prevent spilling the drink. If the liquid is hot, it can scald you or your passenger.

- Use only soft cups in the cup holder. Hard objects can injure you in an accident.

The cup holders have an insert that can be removed for larger cups.

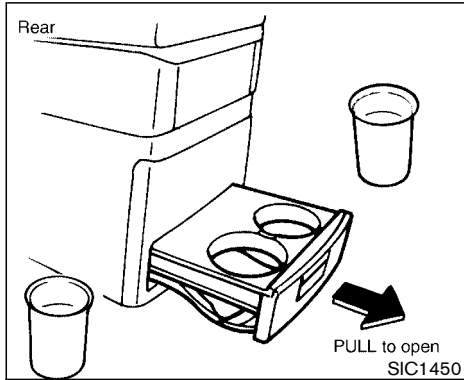

To open, pull the cup holder.
 To close, fully push the cup holder.

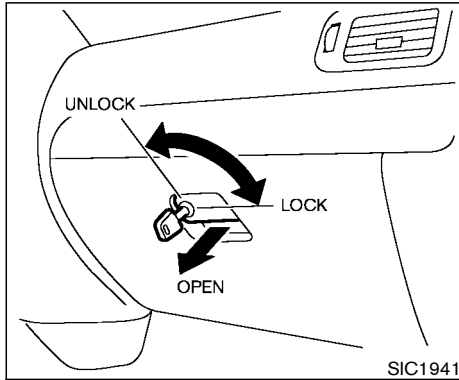

GLOVE BOX

When locking or unlocking the glove box, use the master key.

The glove box may be opened by the handle.

! WARNING

Keep glove box lid closed while driving to help prevent injury in an accident or during a sudden stop.

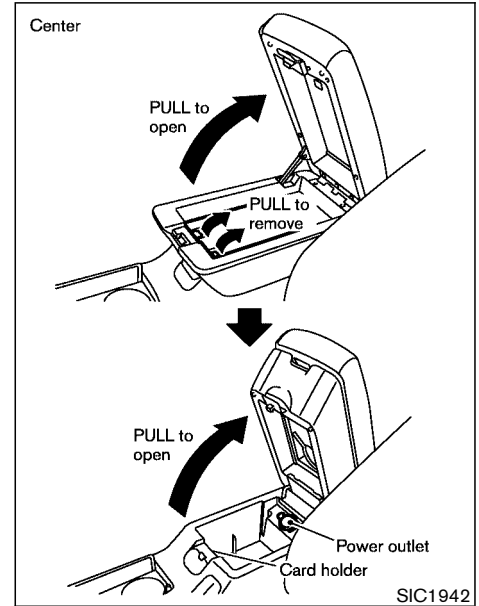

CONSOLE BOX



WARNING

- The center console box should not be used while driving so full attention may be given to vehicle operation.
- Keep the center console box lid closed while driving to prevent injury in an accident or sudden stop.

Do not place valuable items in the center console box.

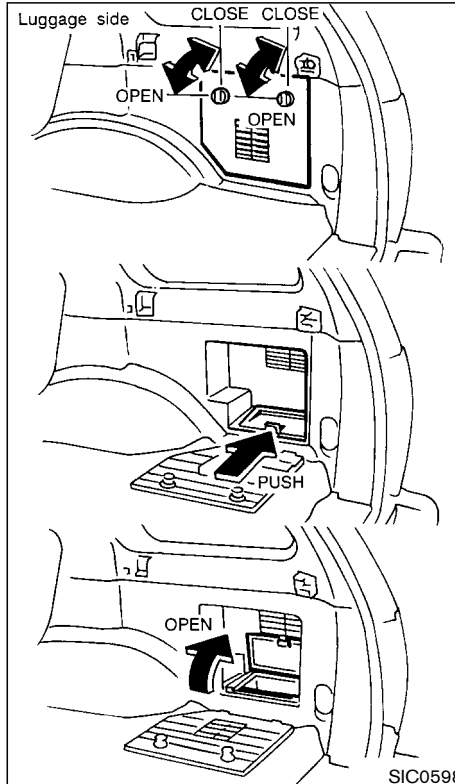

WARNING

Keep luggage side console box lids closed securely while driving to prevent injury in an accident or sudden stop.

Do not place valuable items in the luggage side console box.

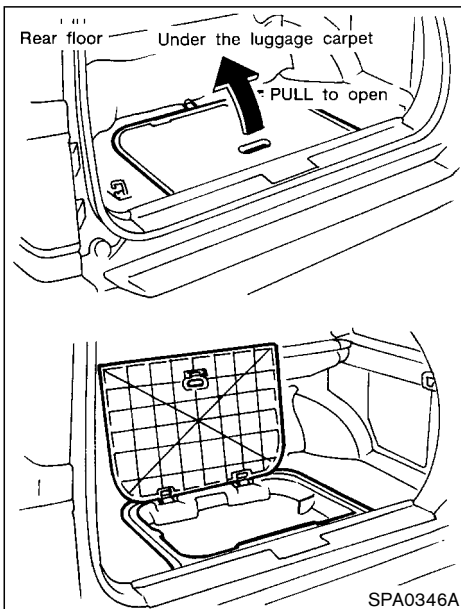

CAUTION

- Make sure the luggage board closes securely.

- Do not drive with the board removed.
- Properly secure all cargo to help prevent it from sliding or shifting. Do not place cargo higher than the seat-backs. In a sudden stop or collision, unsecured cargo could cause personal injury.
- Never allow anyone to ride in the luggage area or on the rear seat when it is in the fold-down position.
- It is extremely dangerous to ride in a cargo area inside of a vehicle. In a collision, people riding in these areas are more likely to be seriously injured or killed.
- Do not allow people to ride in any area of your vehicle that is not equipped with seats and seat belts.

LUGGAGE HOOKS

The luggage hooks can be used to secure cargo with ropes or other types of straps.



WARNING

- Properly secure all cargo to help prevent it from sliding or shifting. Do not place cargo higher than the seat-backs. In a sudden stop or collision, unsecured cargo could cause personal injury.
- Use the suitable ropes and hooks to secure cargo.
- Never allow anyone to ride in the luggage area. It is extremely dangerous to ride in a cargo area inside of a vehicle. In a collision, people riding in these areas are more likely to be seriously injured or killed.
- Do not allow people to ride in any area of your vehicle that is not equipped with seats and seat belts.
- Be sure everyone in your vehicle is in a seat and using a seat belt properly.

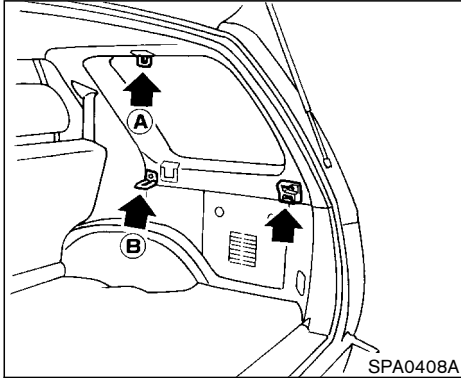

Side finisher

- **When hooking on ropes, do not apply a load of more than 22 lb (98 N) to a single hook.**
- **Do not use the luggage net between the A and B hooks.**

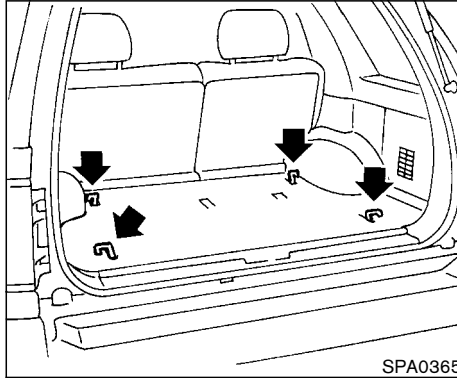

Floor hooks

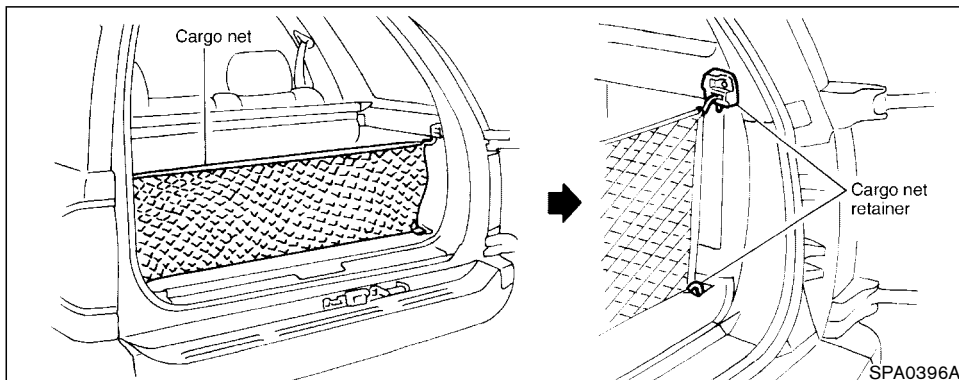

CARGO NET

The cargo net keeps packages in the cargo area from moving around while your vehicle is driven.

To install the cargo net, attach the four hooks to the four retainers.

To remove the cargo net, detach the four hooks from the cargo net retainers.



WARNING

- **Properly secure all cargo to help prevent it from sliding or shifting. Do not place cargo higher than the seatbacks. In a sudden stop or collision, unsecured cargo could cause personal injury.**
- **Be sure to secure all four hooks into the retainers. The cargo restrained in the net must not exceed 30 lbs. (13.6 kg) or the net may not stay secured.**

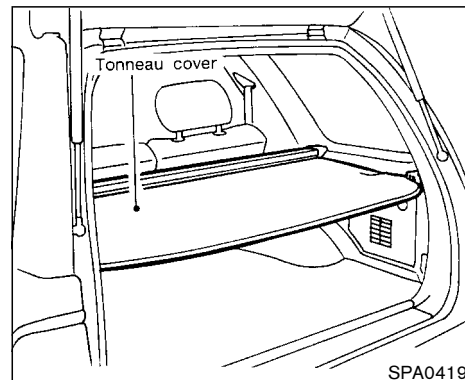

TONNEAU COVER

The tonneau cover keeps the luggage compartment contents hidden from the outside.

To open the tonneau cover, pull it out and hang both sides on the hooks. To close the tonneau cover, remove it from the hooks and release it.



WARNING

- **Never put anything on the tonneau cover, no matter how small. Any ob-**

ject on it could cause an injury in an accident or sudden stop.

- Do not leave the tonneau cover in the vehicle with it disengaged from the holder.
- Properly secure all cargo to help prevent it from sliding or shifting. Do not place cargo higher than the seat-backs. In a sudden stop or collision, unsecured cargo could cause personal injury.
- The child restraint top tether strap may be damaged by contact with the tonneau cover or items in the cargo area. Remove the tonneau cover from the vehicle or secure it and any cargo. Your child could be seriously injured or killed in a collision if the top tether strap is damaged.

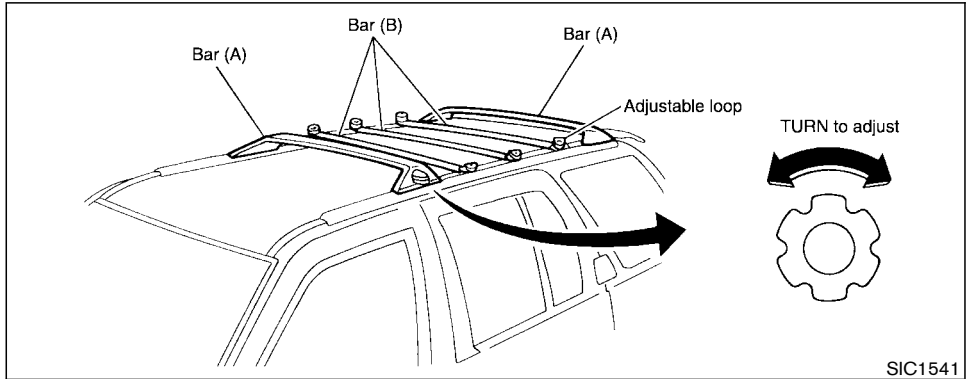

LUGGAGE RACK (if so equipped)

The cross-bars can be adjusted forward and backward. Place your luggage between the bars (A), adjust the bars (A), and secure the luggage with rope to the bars (A). There are also adjustable loops on the side bars for the rope attachment.

Always evenly distribute the luggage on the luggage rack. **Do not load more than 100 lb (45 kg).** Be careful that your vehicle does not exceed the Gross Vehicle Weight Rating (GVWR) or its Gross Axle Weight Rating (GAWR front and rear). The GVWR and GAWR are located on the Safety Compliance Certifica-

tion Label (located on the driver's door pillar). For more information regarding GVWR and GAWR, refer to "9. Technical and consumer information".



CAUTION

Use care when placing or removing items from the luggage rack. If you cannot comfortably lift the items onto the luggage rack from the ground, use a ladder or stool.

WINDOWS

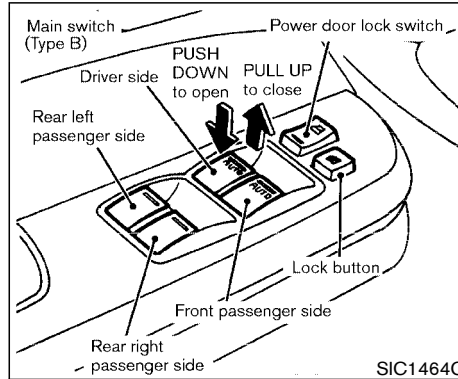
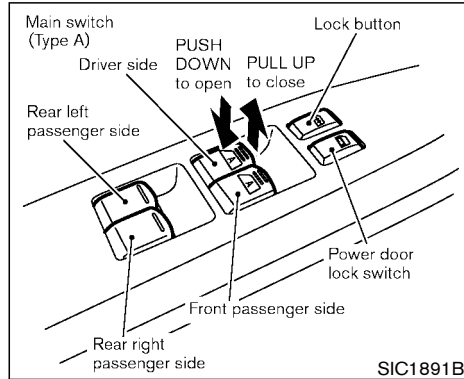

passenger's door is opened during this period of about 45 seconds, power to the windows is canceled.

POWER WINDOWS



WARNING

- **Make sure that all passengers have their hands, etc. inside the vehicle while it is in motion and before closing the windows. Use the window lock switch to prevent unexpected use of the power windows.**
- **Do not leave children unattended inside the vehicle. They could unknow-**

ingly activate switches or controls and become trapped in a window. Unattended children could become involved in serious accidents.

The power window operates when the ignition key is in the ON position.

To open or close the window, push down or pull up the switch and hold it. The main switch (driver side switches) will open or close all the windows.

The power windows are operational for about 45 seconds, even after the ignition key is turned to the OFF position. If the driver's door or the front

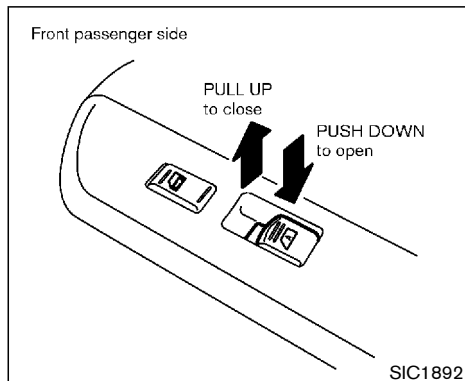

The passenger side switch will open or close only the corresponding window. To open or close the window, hold the switch down or up.

Locking passenger's windows

When the lock button is pushed in, only the driver side window can be opened or closed. Push it in again to cancel.

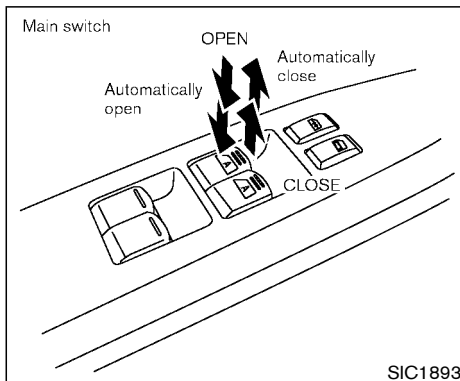

Automatic operation (For front windows)

To fully open or close front windows, completely push down or pull up the switch and release it; it need not be held. The window will automatically open or close all the way. To stop the window, just pull up or push down the switch toward the close or open side.

A light press on the switch will cause the window to open or close until the switch is released.

Auto reverse function (For front windows)

If the control unit detects something caught in a front window as it moves up, the window will be immediately lowered.

The auto reverse function can be activated when a front window is closed by automatic operation when the ignition key is in the ON position or for about 45 seconds after the ignition key is turned to the OFF position.

Depending on the environment or driving conditions, the auto reverse function may be activated if an impact or load similar to something being caught in the window occurs.

WARNING

There are some small distances immediately before the closed position which cannot be detected. Make sure that all passengers have their hands, etc., inside the vehicle before closing the window.

SUNROOF (if so equipped)

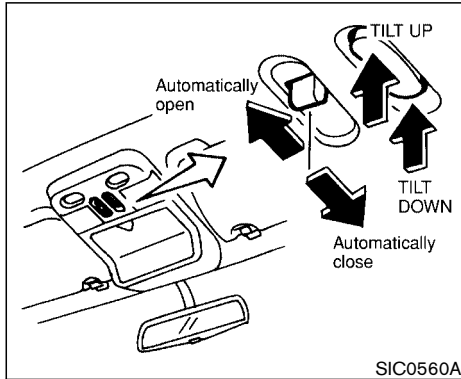

ELECTRIC SUNROOF

The sunroof will only operate when the ignition key is in the ON position.

The electric sunroof is operational for about 45 seconds, even if the ignition key is turned to the OFF position. If the driver's door or the front passenger's door is opened during this period of about 45 seconds, power to the sunroof is canceled.

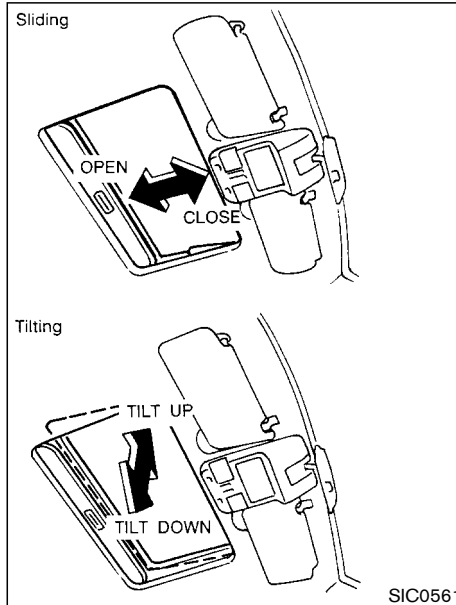

Sliding the sunroof

To open the roof, press the switch to the  side.

To close the roof, press the switch to the  side.

The roof will automatically open or close all the way. To stop the roof, just press the switch toward the either side.

Restarting the sunroof sliding switch

The switch may become inoperable after the battery terminal is disconnected, the electrical supply interrupted and/or some abnormality detected.

Use the following re-set procedure to return sunroof operation to normal.

1. If the sunroof lid is open, push the tilting switch toward tilt DOWN (or the sliding switch toward close) repeatedly to fully close the lid.
2. After the lid has closed all the way, keep pushing the tilting switch toward tilt DOWN (or the sliding switch toward close) for more than 1 second.

Auto reverse function (When closing the sunroof)

If the control unit detects something caught in the sunroof as it moves to the front, the sunroof will immediately open backward.

The auto reverse function can be activated when the sunroof is closed by automatic operation when the ignition key is in the ON position or for

about 45 seconds after the ignition key is turned to the OFF position.

Depending on the environment or driving conditions, the auto reverse function may be activated if an impact or load similar to something being caught in the sunroof occurs.



WARNING

There are some small distances immediately before the closed position which cannot be detected. Make sure that all passengers have their hands, etc., inside the vehicle before closing the sunroof.

Tilting the sunroof

To tilt up, first close the sunroof, then press the  side of the tilt switch.

To tilt down the sunroof, press the  side of the tilt switch.

Sun shade

Open/close the sun shade by sliding it backward/forward.

The shade will open automatically when the sunroof is opened. However, it must be closed manually.



WARNING

- **In an accident you could be thrown from the vehicle through an open sunroof. Always use seat belts and child restraints.**
- **Do not allow anyone to stand up or extend any portion of their body out of the opening while the vehicle is in motion or while the sunroof is closing.**



CAUTION

- **Remove water drops, snow, ice or sand from the sunroof before opening.**
- **Do not place any heavy object on the sunroof or surrounding area.**

If the sunroof does not close

Have your NISSAN dealer check and repair the sunroof.

INTERIOR LIGHTS (if so equipped)

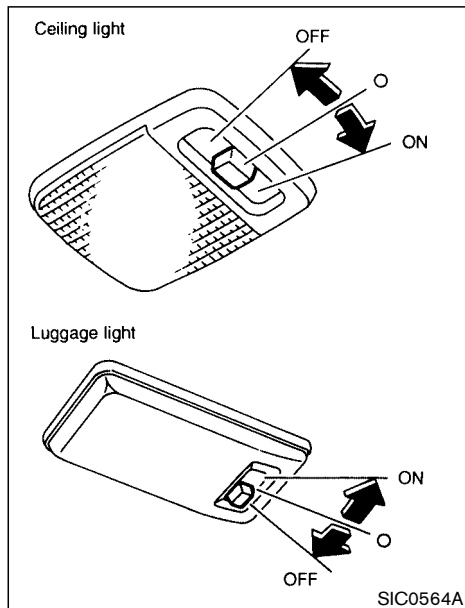

The lights have a three-position switch.

When the switch is in the center \bigcirc position, the lights will illuminate when a door or the back door is opened.

The ceiling light will stay on for about 30 seconds when:

- The driver's door is unlocked by the keyfob, a key or the power door lock switch when all doors are locked.
- The driver's door is opened and then closed without the key in the ignition switch.
- The key is removed from the ignition switch while all doors are closed.

The ceiling light will turn off while the 30 second timer is activated when:

- The driver's door is locked with the keyfob, a key or the power door lock switch.
- The ignition switch is turned ON.

When the interior light switch or the personal light switch is in the ON position, the interior, personal and vanity mirror lights will automatically turn off 30 minutes after the ignition switch has been turned to the OFF position to save the battery. To turn on the lights again, insert the key into the ignition switch and move it to the ON position.

After the above procedure, the interior, personal, or vanity mirror lights will automatically turn off 30 minutes after the latest operation of the

following with the ignition switch in the ACC or OFF position:

- Opening or closing any door
- Locking or unlocking any door with the keyfob, a key, or the power door lock switch
- Inserting or removing a key from the ignition switch

These lights will turn on again when any of the above operations is performed after the lights have turned off automatically. (The lights will turn off 30 minutes after the latest operation of the above as well.)



CAUTION

- **Turn off the interior, personal and vanity mirror lights when you leave the vehicle.**
- **Do not use for extended periods of time with the engine stopped. This could result in a discharged battery.**

PERSONAL LIGHTS

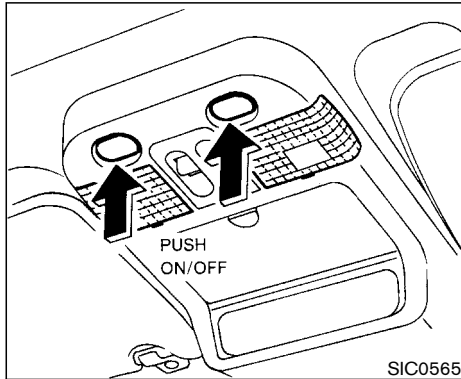

When the interior light or the personal light switch is in the ON position, the interior, personal, and vanity mirror lights will automatically turn off 30 minutes after the ignition switch has been turned to the OFF position. To turn on the light again, insert the key into the ignition switch and move it to the ON position.

After the above procedure, the interior, personal, or vanity mirror lights will automatically turn off 30 minutes after the latest operation of the following:

- Opening or closing any door
- Locking or unlocking the driver's door

- Inserting or removing a key from the ignition switch

These lights will turn on again when any of the above operations is performed after the lights have turned off automatically. (The lights will turn off 30 minutes after the latest operation of the above as well.)

CAUTION

- Turn off the interior, personal and vanity mirror lights when you leave the vehicle.
- Do not use for extended periods of time with the engine stopped. This could result in a discharged battery.

VANITY MIRROR LIGHT (if so equipped)

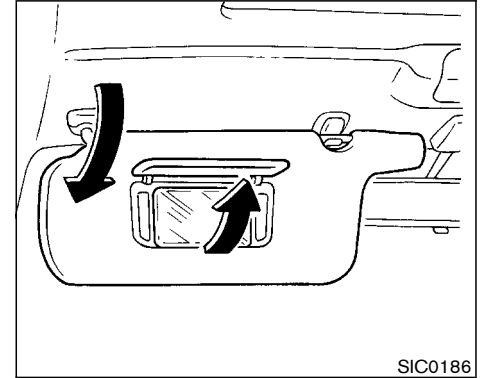

The light on the vanity mirror will turn on when the cover on the vanity mirror is opened.

HomeLink® UNIVERSAL TRANSCIEVER (if so equipped)

The HomeLink® Universal Transceiver provides a convenient way to consolidate the functions of up to three individual hand-held transmitters into one built-in device.

The HomeLink® Universal Transceiver power will automatically turn off 30 minutes after the ignition switch has been turned to the off position.

HomeLink® Universal Transceiver:

- Will operate most Radio Frequency (RF) devices such as garage doors, gates, home and office lighting, entry door locks and security systems.
- Is powered by your vehicle's battery. No separate batteries are required. If the vehicle's battery is discharged or is disconnected, HomeLink® will retain all programming.

Once the HomeLink® Universal Transceiver is programmed, retain the original transmitter for future programming procedures (i.e., new vehicle purchases). Upon sale of the vehicle, the programmed HomeLink® Universal Transceiver buttons should be erased for security purposes. For additional information, refer to "Programming HomeLink®" later in this section.



WARNING

- **Do not use the HomeLink® Universal Transceiver with any garage door opener that lacks safety stop and reverse features as required by federal safety standards. (These standards became effective for opener models manufactured after April 1, 1982). A garage door opener which cannot detect an object in the path of a closing garage door and then automatically stop and reverse, does not meet current federal safety standards. Using a garage door opener without these features increases the risk of serious injury or death.**
- **During programming, your garage door or gate may open or close. Make sure that people and objects are clear of the garage door or gate that you are programming.**
- **Your vehicle's engine should be turned off while programming the**

HomeLink® Universal Transceiver.

PROGRAMMING HomeLink®

To program your HomeLink Transceiver to operate a garage door, gate, or entry door opener, home or office lighting, you need to be at the same location as the device. Note: Garage door openers (manufactured after 1996) have "rolling code protection". To program a garage door opener equipped with "rolling code protection"; you will need to use a ladder to get up to the garage door opener motor to be able to access the "smart or learn" program button.

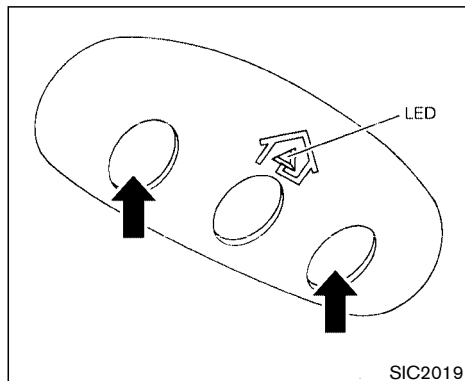

1. To begin, press and hold the 2 outer HomeLink® buttons (to clear the memory) until the indicator light blinks slowly (after 20 seconds). Release both buttons.
2. Position the end of the hand-held transmitter 1-3 inches away from the HomeLink® surface.

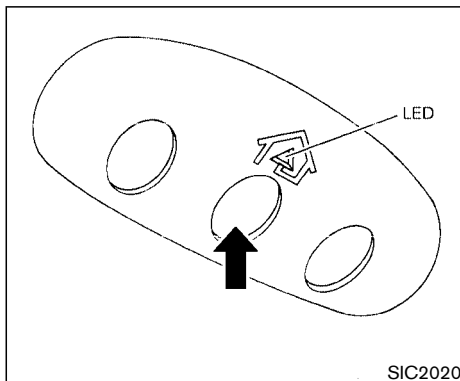

3. Using both hands, simultaneously press and hold both the HomeLink® button you want to program and the hand-held transmitter button.
DO NOT release the buttons until step 4 has been completed.
4. Hold down both buttons until the indicator light on the HomeLink® flashes, changing from a “slow blink” to a “rapidly flashing blink”. This could take up to 90 seconds. When the indicator light flashes rapidly, both buttons may be released. The rapidly flashing light indicates successful programming. To activate the garage door or other programmed device, press and hold the pro-

grammed HomeLink® button - releasing when the device begins to activate.

5. If the indicator light on the HomeLink® blinks rapidly for two seconds and then turns solid, HomeLink® has picked up a “rolling code” garage door opener signal. You will need to proceed with the next steps to train the HomeLink® to complete the programming which may require a ladder and another person for convenience.
6. Press and release the “smart” or “learn” program button located on the garage door opener’s motor to activate the “training mode”. This button is usually located near the antenna wire that hangs down from the motor. If the wire originates from under a light lens, you will need to remove the lens to access the program button.

NOTE:

Once you have pressed and released the program button on the garage door opener’s motor and the “training light” is lit, you have 30 seconds in which to perform step 7. Use the help of a second person for convenience to assist when performing this step.

7. Quickly within 30 seconds of pressing and releasing the garage door opener program

button, firmly press and release the HomeLink[®] button you've just programmed. Press and release the HomeLink[®] button up to three times to complete the training.

8. Your HomeLink[®] button should now be programmed. (To program the remaining HomeLink[®] buttons for additional door or gate openers, follow steps 2-8 only.

NOTE:

Do not repeat step one unless you want to “clear” all previously programmed HomeLink[®] buttons).

If you have any questions or are having difficulty programming your HomeLink[®] buttons, please refer to the HomeLink[®] web site at: www.homelink.com or call 1-800-662-6200.

PROGRAMMING HomeLink[®] FOR CANADIAN CUSTOMERS

Prior to 1992, D.O.C. regulations required hand-held transmitters to stop transmitting after 2 seconds. To program your hand-held transmitter to HomeLink[®], continue to press and hold the HomeLink[®] button (note steps 2 through 4 under “Programming HomeLink[®]”) while you press and re-press (“cycle”) your hand-held transmitter every 2 seconds until the indicator

light flashes rapidly (indicating successful programming).

NOTE:

If programming a garage door opener, etc., it is advised to unplug the device during the “cycling” process to prevent possible damage to the garage door opener components.

OPERATING THE HomeLink[®] UNIVERSAL TRANSCEIVER

The HomeLink[®] Universal Transceiver (once programmed) may now be used to activate the garage door, etc. To operate, simply press the appropriate programmed HomeLink[®] Universal Transceiver button. The red indicator light will illuminate while the signal is being transmitted.

PROGRAMMING TROUBLE DIAGNOSIS

If the HomeLink[®] does not quickly learn the hand-held transmitter information:

- replace the hand-held transmitter batteries with new batteries.
- position the hand-held transmitter with its battery area facing away from the HomeLink[®] surface.

- press and hold both the HomeLink[®] and hand-held transmitter buttons without interruption.
- position the hand-held transmitter 2 to 5 inches (50 to 127 mm) away from the HomeLink[®] surface. Hold the transmitter in that position for up to 15 seconds. If HomeLink[®] is not programmed within that time, try holding the transmitter in another position - keeping the indicator light in view at all times.

If you continue to have programming difficulties, please contact the NISSAN Consumer Affairs Department. The phone numbers are located in the Foreword of this Owner's Manual.

CLEARING THE PROGRAMMED INFORMATION

Individual buttons cannot be cleared, however to clear all programming, press and hold the two outside buttons and release when the indicator light begins to flash (approximately 20 seconds).

REPROGRAMMING A SINGLE HomeLink® BUTTON

To reprogram a HomeLink® Universal Transceiver button, complete the following.

1. Press and hold the desired HomeLink® button. **Do not** release the button until step 4 has been completed.
2. When the indicator light begins to flash slowly (after 20 seconds), position the hand-held transmitter 2 to 5 inches (50 to 127 mm) away from the HomeLink® surface.
3. Press and hold the hand-held transmitter button.
4. The HomeLink® indicator light will flash, first slowly and then rapidly. When the indicator light begins to flash rapidly, release both buttons.

The HomeLink® Universal Transceiver button has now been reprogrammed. The new device can be activated by pushing the HomeLink® button that was just programmed. This procedure will not affect any other programmed HomeLink® buttons.

IF YOUR VEHICLE IS STOLEN

If your vehicle is stolen, you should change the codes of any non-rolling code device that has

been programmed into HomeLink®. Consult the Owner's Manual of each device or call the manufacturer or dealer of those devices for additional information.

When your vehicle is recovered, you will need to reprogram the HomeLink® Universal Transceiver with your new transmitter information.

FCC Notice:

This device complies with FCC rules part 15. Operation is subject to the following two conditions: (1) This device may not cause harmful interference and (2) This device must accept any interference that may be received, including interference that may cause undesired operation.

The transmitter has been tested and complies with FCC and DOC/MDC rules. Changes or modifications not expressly approved by the party responsible for compliance could void the user's authority to operate the device.

DOC: ISTD 1763K1313

FCC I.D.: CB2V67690

|

MEMO

—

—

|

MEMO

|

MEMO

—

—

|

3 Pre-driving checks and adjustments

| | | | |
|-----------------------------------------------------------|------|--------------------------------------------------|------|
| Keys..... | 3-2 | Opener operation (if so equipped)..... | 3-11 |
| Doors..... | 3-2 | Key operation..... | 3-12 |
| Locking with key..... | 3-3 | Fuel filler lid..... | 3-13 |
| Front window open/close with key..... | 3-3 | Opener operation | 3-13 |
| Locking with inside lock knob | 3-3 | Fuel filler cap | 3-13 |
| Locking with power door lock switch (if so equipped)..... | 3-4 | Steering wheel | 3-15 |
| Child safety rear door lock..... | 3-4 | Tilt operation..... | 3-15 |
| Remote keyless entry system | 3-5 | Sun visors..... | 3-15 |
| How to use remote keyless entry system..... | 3-5 | Using the sun visors..... | 3-16 |
| Battery replacement | 3-8 | Mirrors | 3-16 |
| Hood | 3-9 | Inside mirror | 3-16 |
| Back door..... | 3-10 | Outside mirrors | 3-16 |
| Key operation..... | 3-10 | Automatic seat positioner (if so equipped) | 3-17 |
| Spare tire carrier (if so equipped) | 3-10 | Automatic seat positioner operation..... | 3-17 |
| Glass hatch..... | 3-11 | Cancel switch..... | 3-19 |

KEYS

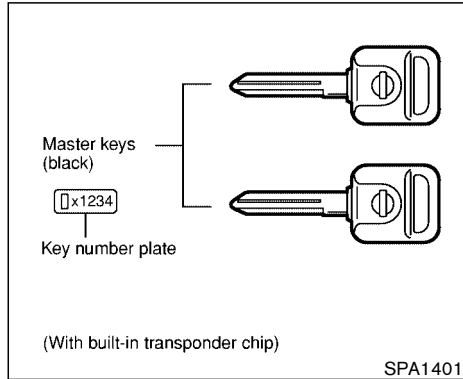

You can only drive your vehicle using the master keys which are registered to the Nissan Vehicle Immobilizer System components in your vehicle. These keys have a transponder chip in the key head.

The keys can be used for the door, back door or glove box locks.

Never leave these keys in the vehicle.

Record the key number on the key number plate supplied with your keys and keep it in a safe place (such as your wallet), not in the vehicle. NISSAN does not record any key number so it is very important to keep track of your key number plate.

3-2 Pre-driving checks and adjustments

A key number is only necessary when you have lost all keys and do not have one to duplicate from. If you still have a key, this key can be duplicated by your NISSAN dealer.

Nissan Vehicle Immobilizer System keys:

The key number is necessary when you need extra Nissan Vehicle Immobilizer System keys. As many as 5 Nissan Vehicle Immobilizer System keys can be used with one vehicle. New keys must be registered to the Nissan Vehicle Immobilizer System components in your vehicle by your NISSAN dealer. At this time, you should bring all Nissan Vehicle Immobilizer System keys that you have to your NISSAN dealer for registration. This is because the registration process will erase all memory of the Nissan Vehicle Immobilizer System components.

DOORS



WARNING

- **Always have the doors locked while driving. Along with the use of seat belts, this provides greater safety in the event of an accident by helping to prevent persons from being thrown from the vehicle. This also helps keep children and others from unintentionally opening the doors, and will help keep out intruders.**
- **Before opening any door, always look for and avoid oncoming traffic.**
- **Do not leave children unattended inside the vehicle. They could unknowingly activate switches or controls. Unattended children could become involved in serious accidents.**

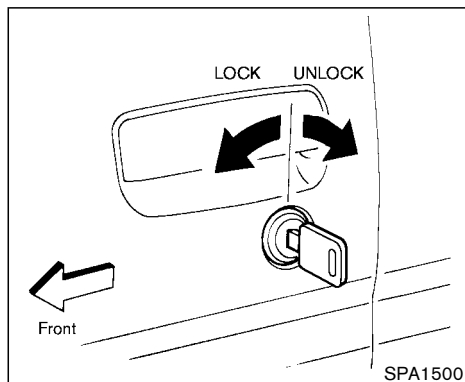

LOCKING WITH KEY

Manual

To lock the door, turn the key towards the front of the vehicle. To unlock, turn it towards the rear.

Power

The power door lock system allows you to lock or unlock all doors including the back door simultaneously.

- Turning the driver's door key to the front of the vehicle will lock all doors.
- Turning the driver's door key one time to the

rear of the vehicle will unlock the corresponding door. From that position, returning the key to neutral (where the key can only be removed and inserted.) and turning it to the rear again within 5 seconds will unlock all doors.

FRONT WINDOW OPEN/CLOSE WITH KEY

Turn the driver's door key to the unlock position and hold for about 1 second, the front windows will begin to lower.

To stop opening, turn the key to the neutral position.

To close the front windows with the door key cylinder, turn the key to the lock position and hold for about 1 second.

To stop closing, turn the key to the neutral position.

In the event of a hand in the way, or other obstruction, the auto reverse function will activate.

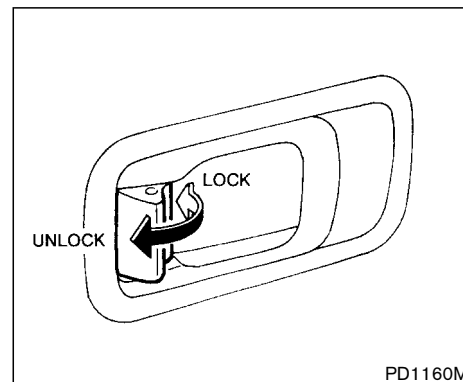

LOCKING WITH INSIDE LOCK KNOB

Pushing or pulling the door inside lock knob to the lock or unlock will lock or unlock the corresponding door.

To lock from the outside without a key, move the inside lock knob to the LOCK position. Then close the door. When locking the door this way, be certain not to leave the key inside the vehicle.

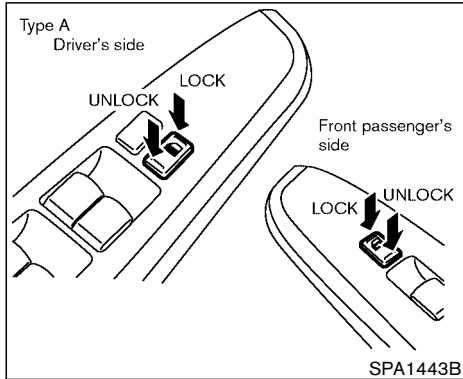

LOCKING WITH POWER DOOR LOCK SWITCH (if so equipped)

Operating the lock-unlock switch will lock or unlock all doors including the back door simultaneously.

All door locks will be engaged when the power door lock switch is moved to the LOCK position with the driver's or front passenger's door open. Then close the door and all doors will be locked.

When the power door lock switch is moved to the LOCK position while any front doors is open and a key is in the ignition switch, all doors will lock once and then unlock automatically.

3-4 Pre-driving checks and adjustments

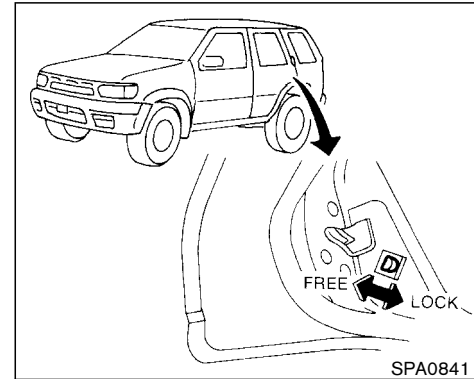
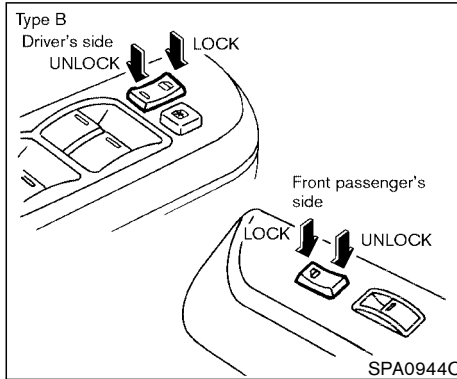

CHILD SAFETY REAR DOOR LOCK

Child safety locking helps prevent doors from being opened accidentally, especially when small children are in the vehicle.

When the lever is in the lock position, the rear door can be opened only from the outside.

REMOTE KEYLESS ENTRY SYSTEM

It is possible to lock/unlock all doors and activate the panic alarm by using the keyfob from outside the vehicle.

Before locking the doors, make sure the key is not left in the vehicle.

The keyfob can operate at a distance of approximately 33 ft (10 m) from the vehicle. (The effective distance depends upon the conditions around the vehicle.)

As many as four keyfobs can be used with one vehicle. For information concerning the purchase and use of additional keyfobs, contact your NISSAN dealer.

The keyfob will not function when:

- the battery is dead,
- the distance between the vehicle and the keyfob is over 33 ft (10 m).

The panic alarm will not activate when the key is in the ignition switch.



CAUTION

The following conditions or occurrences will damage the keyfob.

- **Do not allow the keyfob to become wet.**

- **Do not drop the keyfob.**
- **Do not strike the keyfob sharply against another object.**
- **Do not place the keyfob for an extended period in an area where temperatures exceed 140°F (60°C).**

If a keyfob is lost or stolen, NISSAN recommends erasing the ID code of that keyfob. This will prevent the keyfob from unauthorized use to unlock the vehicle. For information regarding the erasing procedure, please contact an authorized NISSAN dealer.

HOW TO USE REMOTE KEYLESS ENTRY SYSTEM

Setting hazard indicator and horn mode

This vehicle is set in hazard indicator and horn mode when you first receive the vehicle.

In hazard indicator and horn mode, when the LOCK button is pushed, the hazard indicator flashes twice and the horn chirps once. When

the UNLOCK button is pushed, the hazard indicator flashes once.

If hazard indicator and horn mode is not necessary, you can switch to hazard indicator only mode by following the switching procedure below.

In hazard indicator only mode, when the LOCK button is pushed, the hazard indicator flashes twice. When the UNLOCK button is pushed, neither the hazard indicator nor the horn operates.

(Switching procedure)

Press and hold the LOCK and UNLOCK buttons on the keyfob simultaneously for at least 2 seconds to switch from one mode to the other.

When pushing the buttons to set hazard indicator only mode, the hazard indicator flashes 3 times.

When pushing the buttons to set hazard indicator and horn mode, the hazard indicator flashes once and the horn chirps once.

| OPERATION GUIDE | | | |
|---------------------------------------------------------------------------------|------------------------------|-------------------------------|---------------|
| MODE (Push "LOCK" and "UNLOCK" buttons for more than 2 seconds to switch) | Switching indicator | LOCK | UNLOCK |
| Hazard indicator and horn → HAZARD INDICATOR ONLY | HAZARD – 3 times | HAZARD – twice | No operation |
| Hazard indicator only → HAZARD INDICATOR AND HORN | HAZARD – once HORN – once | HAZARD – twice HORN – once | HAZARD – once |

SPA1260

Locking doors

1. Remove the ignition key.*1
2. Close all the doors.*2
3. Push the LOCK button on the keyfob.
4. All the doors will lock.

All of the doors will lock when the LOCK button on the keyfob is pushed even though a door remains open and/or the ignition key is in the ON position.

5. The hazard indicator flashes twice and the horn chirps once.

- When the LOCK button is pushed with all doors locked, the hazard indicator flashes twice and the horn chirps once as a reminder that the doors are already locked.

*1: Doors lock with the keyfob while a key is in the ignition switch. However, the panic alarm will not activate when the ignition switch is in the ACC or ON position.

*2: Doors lock with the keyfob while any door is open. However, hazard indicator and horn mode will not function.

3-6 Pre-driving checks and adjustments

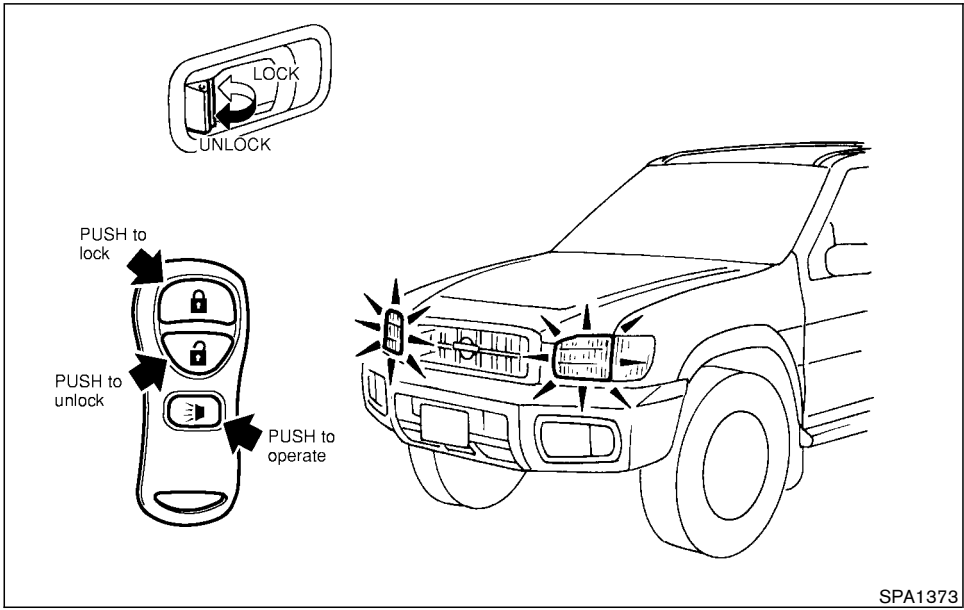

SPA1373

Unlocking doors

1. Push the UNLOCK button on the keyfob once.
- Only the driver's door unlocks

- The hazard indicator flashes once if all doors are completely closed with the ignition key in any position except the ON position.
- The interior light turns on and the light timer activates for 30 seconds when the switch is in the center ○ position with the ignition key

in any position except the ON position.

2. Push the UNLOCK button on the keyfob again within 5 seconds.

- All doors unlock
- The hazard indicator flashes once if all doors are completely closed.

If the following operation is not carried out within 5 minutes after pressing the UNLOCK button, all doors will be locked automatically.

- any door is opened.
- the ignition key is turned to the ON position

The interior light can be turned off without waiting for 30 seconds by turning the ignition switch to the ON position or by locking the doors with the keyfob.

Opening the front window

Push the UNLOCK button on the keyfob.

The driver's door will unlock.

Continue to press the UNLOCK button for 3 seconds. The driver's and front passenger's windows will be lowered.

Continue to press the UNLOCK button until windows are fully open.

To stop lowering the windows, release the UN-LOCK button.

To start lowering the windows, press the UN-LOCK button again for 3 more seconds.

This function will operate after the ignition switch is off and 45 seconds passed or either the front door is opened.

Using the panic alarm

If you are near your vehicle and feel threatened, you may activate the alarm to call attention as follows:

1. Push the PANIC button on the keyfob for **longer than 0.5 seconds**.
2. The theft warning alarm and headlights will stay on for 30 seconds.
3. The panic alarm stops when:
 - It has run for 30 seconds, or
 - The LOCK or the UNLOCK button is pressed, or
 - The panic button is pushed on the keyfob for more than 0.5 seconds.

3-8 Pre-driving checks and adjustments

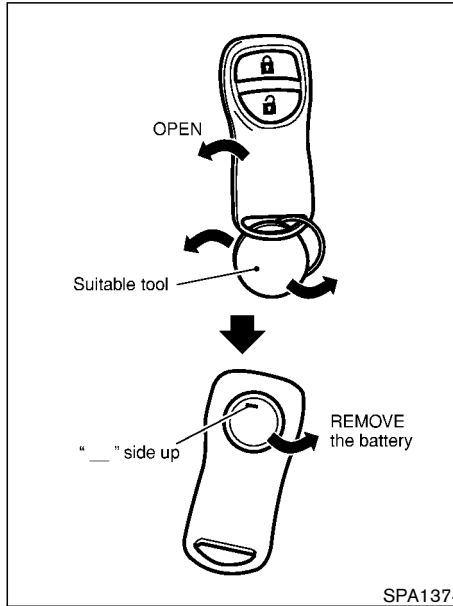

BATTERY REPLACEMENT

Replace the battery as follows:

1. Open the lid using a suitable tool.
2. Replace the battery with a new one.

Recommended battery: Sanyo CR2025 or equivalent

Make sure that the ⊕ side faces the bottom case.

3. Close the lid securely.
4. Push the keyfob button two or three times to check its operation.

See your NISSAN dealer if you need any assistance for replacement.

If the battery is removed for any reason other than replacement, perform step 4 above.

- Be careful not to touch a circuit board and a battery terminal.
- An improperly disposed battery can harm the environment. Always confirm local regulations for battery disposal.
- The keyfob is water-proof; however, if it does get wet, immediately wipe completely dry.
- When changing batteries, do not let dust or oil get on the keyfob.

FCC Notice:

Changes or modifications not expressly approved by the manufacturer compliance

HOOD

could void the user's authority to operate the equipment.

This device complies with Part 15 of the FCC Rules and RSS-210 of Industry Canada.

Operation is subject to the following two conditions: (1) This device may not cause harmful interference, and (2) this device must accept any interference received, including interference that may cause undesired operation of the device.

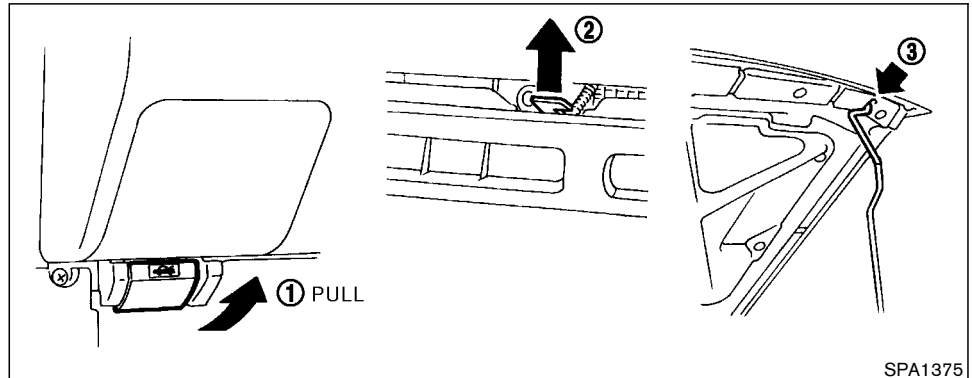

1. Pull the hood lock release handle located below the instrument panel; the hood will then spring up slightly.
2. Raise the lever at the front of the hood with your fingertips and raise the hood.
3. Insert the assist bar into the slot in the front edge of the hood.
4. When closing the hood, reset the assist bar to its original position, then slowly close the hood and make sure it locks into place.



WARNING

- **Make sure the hood is completely closed and latched before driving. Failure to do so could cause the hood to fly open and result in an accident.**
- **If you see steam or smoke coming from the engine compartment, to avoid injury do not open the hood.**

BACK DOOR

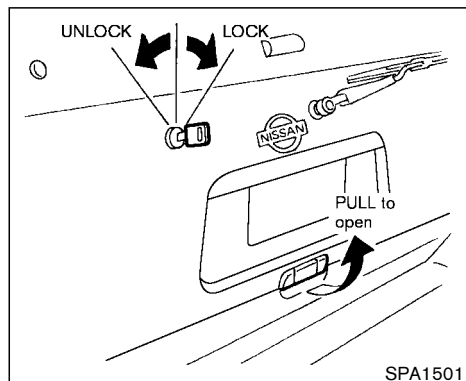

WARNING

Do not drive with the back door open. This could allow dangerous exhaust gases to be drawn into the vehicle. See "Precautions when starting and driving" in the "5. Starting and driving" section for exhaust gas.

KEY OPERATION

1. Turn the key counterclockwise to unlock the back door.

3-10 Pre-driving checks and adjustments

Turning the back door key one time counterclockwise will unlock the rear door. From that position, returning the key to neutral (where the key can only be removed and inserted.) and turning it counterclockwise again within 5 seconds will unlock all doors.

2. Pull the opener handle to open the back door.
3. To lock the back door, push it down firmly and turn the key clockwise.

The power door lock system allows you to lock or unlock all doors including the back door simultaneously.

- Turning the front door key to the front of the vehicle will lock all doors.
- Turning the front door key one time to the rear of the vehicle will unlock the corresponding door. From that position, returning the key to neutral (where the key can only be removed and inserted.) and turning it to the rear again within 5 seconds will unlock all doors.

SPARE TIRE CARRIER (if so equipped)

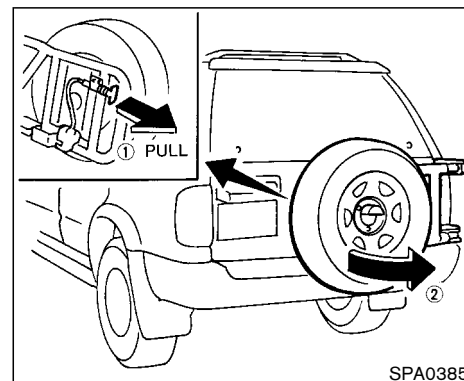

When opening the back door, first open the spare tire carrier in the sequence shown in the illustration above. Then insert the stopper into the hole to secure the carrier in the open position.



CAUTION

- Be certain that there is adequate area to allow the carrier to open fully.
- Open and close the spare tire carrier slowly.

GLASS HATCH

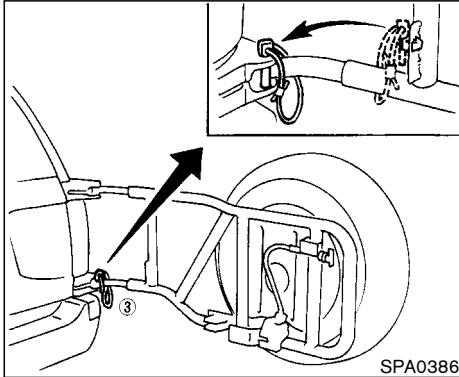

- Before driving, be certain that the spare tire carrier is firmly closed and latched.
- Failure to do so may injure pedestrians or damage the vehicle.

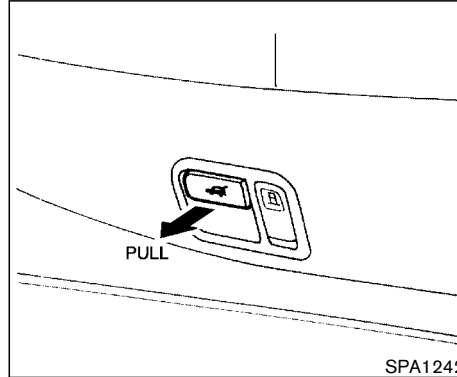

OPENER OPERATION (if so equipped)

WARNING

Do not drive with the glass hatch open. This could allow dangerous exhaust gases to be drawn into the vehicle. See “Precautions when starting and driving” in the “5. Starting and driving” section for exhaust gas.

CAUTION

Do not open the glass hatch unless the wiper is in the stowed position.

The glass hatch release handle is located under the driver’s arm rest.

To open the glass hatch from the inside, pull the glass hatch opener handle.

The glass hatch will not open while the rear window wiper is operating. Open the glass hatch after the rear window wiper returns to the STOP position. To close the glass hatch, push the glass hatch down securely.

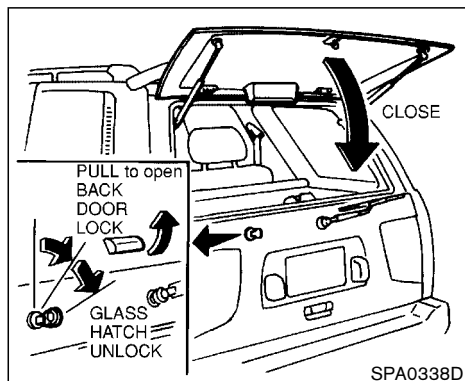

KEY OPERATION

To open the glass hatch, turn the key fully clockwise and pull the opener handle. To close, lower and push the glass hatch down securely.

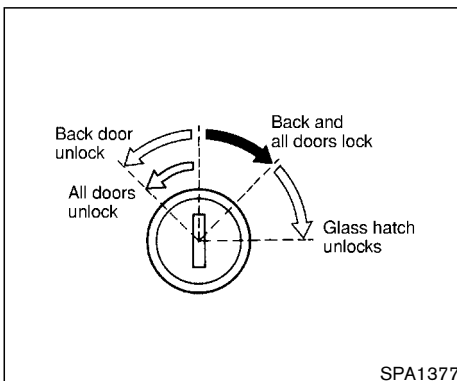

Other key operations

- Turning the key clockwise locks all doors including the back door.
- Turning the key counterclockwise unlocks the back door.
- Turning the key counterclockwise again within 5 seconds unlock all doors.



WARNING

Do not drive with the glass hatch open. This could allow dangerous exhaust

gases to be drawn into the vehicle. See “Precautions when starting and driving” in the “5. Starting and driving” section for exhaust gas.



CAUTION

Do not open the glass hatch unless the wiper is in the stowed position.

FUEL FILLER LID

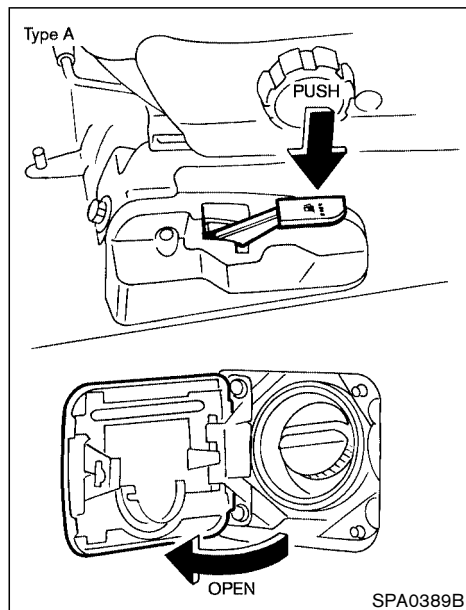

OPENER OPERATION

To open the fuel filler lid, push the opener lever down. To lock, close the fuel filler lid securely.

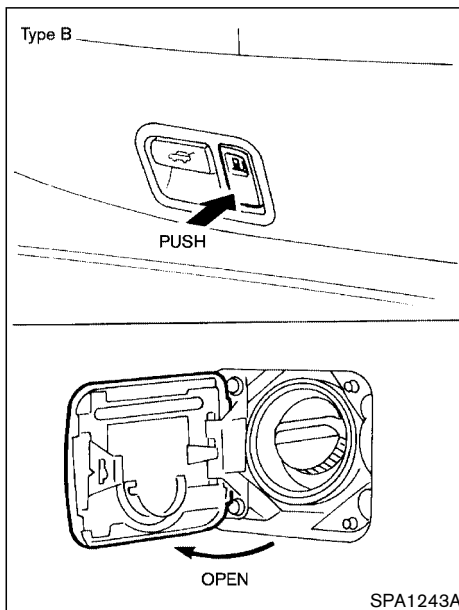

The fuel filler lid release switch is located on the floor below the driver's arm rest.

To open the fuel filler lid, push the opener switch. To lock, close the fuel filler lid securely.

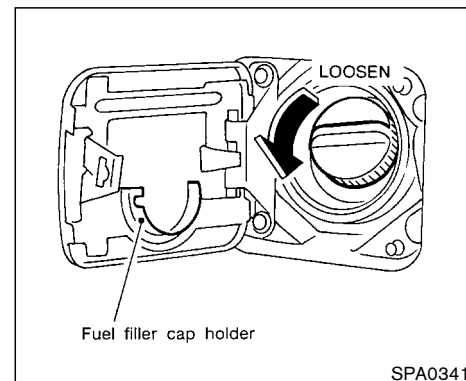

FUEL FILLER CAP

The fuel filler cap is a ratcheting type.

Tighten the cap clockwise until ratcheting clicks are heard.

WARNING

- **Gasoline is extremely flammable and highly explosive under certain conditions. You could be burned or seriously injured if it is misused or mis-handled. Always stop the engine and**

do not smoke or allow open flames or sparks near the vehicle when refueling.

- Fuel may be under pressure. Turn the cap one-half turn, and wait for any hissing sound to stop to prevent fuel from spraying out and possible personal injury. Then remove the cap.
- Do not attempt to top off the fuel tank after the fuel pump nozzle shuts off automatically. Continued refueling may cause fuel over-flow, resulting in fuel spray and possibly a fire.
- Only use an original equipment type fuel filler cap as a replacement. It has a built-in safety valve needed for proper operation of the fuel system and emission control system. An incorrect cap can result in a serious malfunction and possible injury. It could also cause the malfunction indicator lamp to come on.
- Never pour fuel into the throttle body to attempt to start your vehicle.

- Do not fill a portable fuel container in the vehicle or trailer. Static electricity can cause an explosion of flammable liquid, vapor or gas in any vehicle or trailer. To reduce the risk of serious injury or death when filling portable fuel containers:
 - Always place the container on the ground when filling.
 - Do not use electronic devices while filling.
 - Keep the pump nozzle in contact with the container while you are filling it.
 - Use only approved portable fuel containers for flammable liquid.



CAUTION

- If fuel is spilled on the vehicle body, flush it away with water to avoid paint damage.

- Tighten until the fuel filler cap clicks. Failure to tighten the fuel filler cap properly may cause the SERVICE ENGINE SOON malfunction indicator lamp (MIL) to illuminate. If the SERVICE ENGINE SOON lamp illuminates because the fuel filler cap is loose or missing, tighten or install the cap and continue to drive the vehicle. The SERVICE ENGINE SOON lamp should turn off after a few driving trips. If the SERVICE ENGINE SOON lamp does not turn off after a few driving trips, have the vehicle inspected by an authorized NISSAN dealer.
- For additional information, see the “Malfunction indicator lamp (MIL)” in the “2. Instruments and controls” section.

STEERING WHEEL

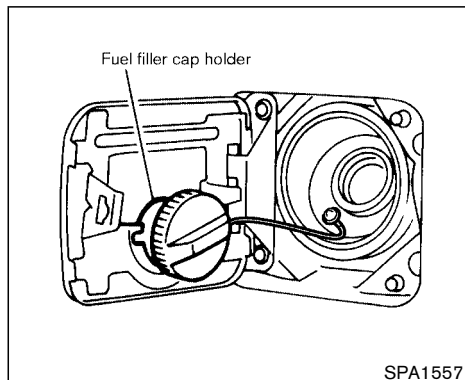

Put the fuel filler cap on the cap holder while refueling.

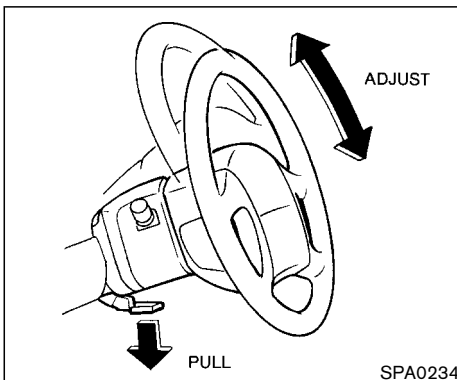

TILT OPERATION

While pushing down on the lock lever, adjust the steering wheel up or down to the desired position. Push the lock lever up securely to lock the steering wheel in place.

⚠ WARNING

Do not adjust the steering wheel while driving. You could lose control of your vehicle and cause an accident.

SUN VISORS

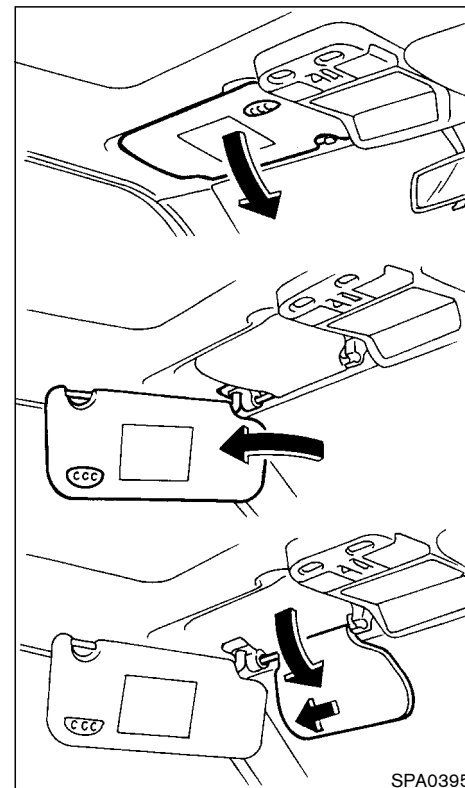

USING THE SUN VISORS

1. To block out glare from the front, swing down the main sun visor.
2. To block glare from the side, remove the main sun visor from the center mount and swing it to the side.
3. Then, to block glare from the front too, swing down the sub-sun visor (if so equipped).
4. To adjust the glare block position, slide the sub-sun visor to the left.



CAUTION

- Do not store the main sun visor before storing the sub-sun visor.
- Do not pull the sub-sun visor forcedly downwards.

MIRRORS

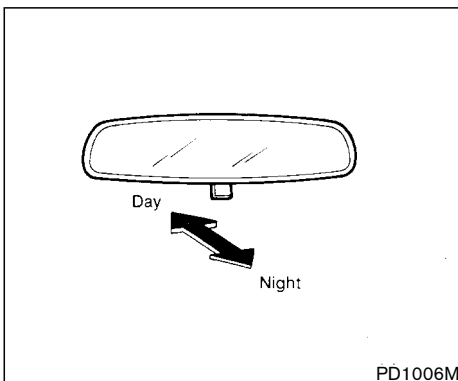

INSIDE MIRROR

The night position will reduce glare from the headlights of vehicles behind you at night.



WARNING

Use the night position only when necessary, because it reduces rear view clarity.

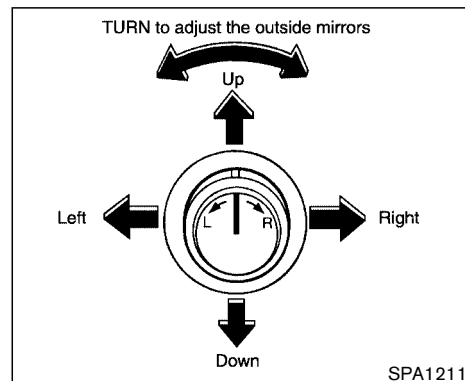

OUTSIDE MIRRORS

The outside mirror will operate only when the ignition switch is in the ACC or ON position.

Turn the control knob to the right or left to select the right or left outside mirror, then adjust.



WARNING

Objects viewed in the outside mirror on the passenger side are closer than they appear. Be careful when moving to the right. Using only this mirror could cause

an accident. Use inside mirror or glance over your shoulder to properly judge distances to other objects.

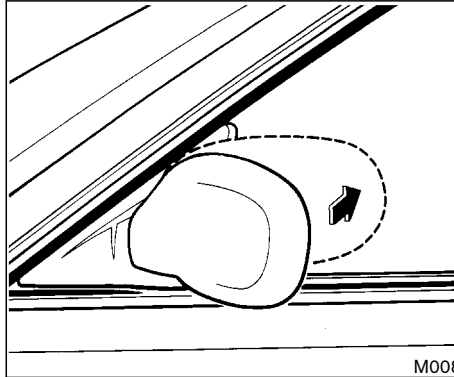

Foldable outside mirrors

Push the mirror backward to fold it.

AUTOMATIC SEAT POSITIONER (if so equipped)

AUTOMATIC SEAT POSITIONER OPERATION

This system is designed so that the driver's seat will automatically move when the automatic transmission selector lever is in the P (Park) position. This allows the driver to get into and out of the driver's seat more easily.

When one of the following conditions is met, the driver's seat will slide backward:

- When the key is removed from the ignition switch.
- When the driver's door is opened with the key turned to ACC or LOCK.
- When the key is turned from ON to LOCK with the driver's door open.

When one of the following conditions is met, the driver's seat will return to the positions before being set.

- When the key is inserted into the ignition switch.
- When the driver's door is closed with the key turned to ACC or LOCK.
- When the key is turned to ON.

Procedure for storing memory

Two positions can be stored in the automatic

Pre-driving checks and adjustments 3-17

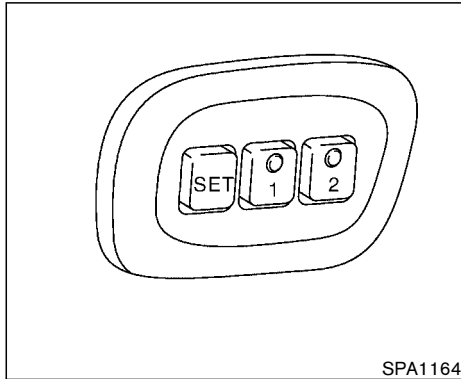

drive positioner memory. **Follow these procedures to use the memory system.**

1. Set the automatic transmission selector lever to the P (Park) position.
2. Turn the ignition ON.
3. Adjust the driver's seat to the desired positions by manually operating each adjusting switch. For additional information, see "Seats" in the "1. Seats, restraints and supplemental air bag systems" section.

During this step, do not turn the ignition to any positions other than ON.

4. Push the SET switch and, within 5 seconds,

3-18 Pre-driving checks and adjustments

push the memory switch 1 or 2 fully for at least 1 second.

The indicator light for the pushed memory switch will come on and stay on for approximately 5 seconds after pushing the switch. After the indicator light goes off, the selected positions are stored in the selected memory (1 or 2).

If memory is stored in the same memory switch, the previous memory will be deleted.

Confirming memory storage

- Turn the ignition ON and push the SET switch. If the main memory has not been stored, the indicator light will come on for approximately 0.5 seconds. When the memory has stored the position, the indicator light will stay on for approximately 5 seconds.
- If the battery cable is disconnected, or if the fuse blows, the memory will be canceled. In such a case, reset the desired positions using the following procedures.
 1. Open and close the driver's door more than two times with the ignition key in the LOCK position.
 2. Reset the desired position using the previous procedure.

Selecting the memorized position

1. Set the automatic transmission selector lever to the P (Park) position.
2. Turn the ignition ON.
3. Push the memory switch 1 or 2 fully for at least 1 second.

The driver's seat will move to the memorized position with the indicator light flashing, and then the light will stay on for approximately 5 seconds.

When the memory switch 1 or 2 is pushed with the driver's door open and then the key inserted into the ignition switch within approximately 1 minute, the driver's seat will move to the memorized position.

System operation

The automatic drive positioner system will not work or will stop operating under the following conditions:

- when the vehicle speed is above 4 MPH (7 km/h).
- when any two or more of the memory switches are simultaneously pushed while the automatic drive positioner is operating.
- when the adjusting switch for the driver's

seat is turned on while the automatic drive positioner is operating.

- when the cancel switch located on the instrument panel is pushed to cancel.
- when the memory switch 1 or 2 is not pushed for at least 1 second.
- when the seat has been already moved to the memorized position.
- when no seat position is stored in the memory switch.

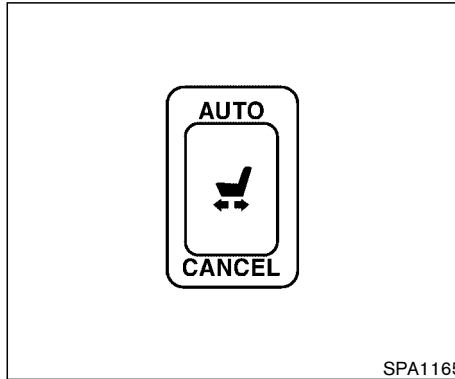

CANCEL SWITCH

When the CANCEL side of the switch is pushed, the automatic drive positioner system will not function.

When the AUTO side of the switch is pushed, the system will function.

|

MEMO

—

—

|

4 Heater, air conditioner and audio systems

| | | | |
|-------------------------------------------------|------|---------------------------------------------------|------|
| Ventilators | 4-2 | Servicing air conditioner..... | 4-12 |
| Heater and air conditioner (Manual) | 4-2 | Audio system | 4-13 |
| Controls | 4-3 | FM radio reception..... | 4-13 |
| Heater operation..... | 4-4 | AM radio reception | 4-14 |
| Air conditioner operation..... | 4-4 | Satellite radio reception..... | 4-14 |
| Air flow charts..... | 4-5 | Audio operation precautions..... | 4-14 |
| Heater and air conditioner (Automatic — Type A) | | FM-AM radio with cassette player and compact disc | |
| (if so equipped) | 4-8 | (CD) player..... | 4-16 |
| Automatic operation | 4-8 | FM-AM-SATELLITE radio with cassette player and | |
| Manual operation..... | 4-9 | compact disc (CD) player/CD changer..... | 4-23 |
| Heater and air conditioner (Automatic — Type B) | | CD care and cleaning..... | 4-28 |
| (if so equipped)..... | 4-10 | Steering wheel switch for audio control | |
| Automatic operation..... | 4-11 | (if so equipped)..... | 4-28 |
| Manual operation | 4-11 | Antenna | 4-29 |
| Operating tips..... | 4-12 | Car phone or CB radio | 4-31 |

VENTILATORS

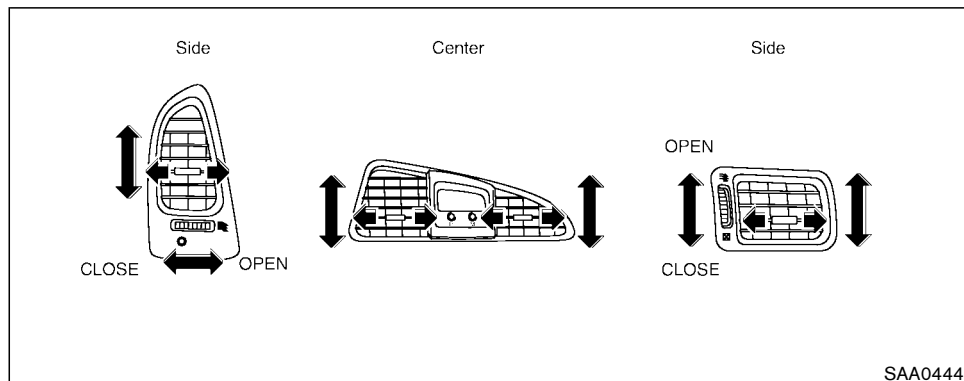

Open or close, and adjust the air flow direction of ventilators.

☒ : This symbol indicates that the vents are closed when the vent switch is moved to the left.

≡ : This symbol indicates that the vents are open when the vent switch is moved to the right.

HEATER AND AIR CONDITIONER (Manual)

WARNING

- The air conditioner cooling function operates only when the engine is running.
- Do not leave children or adults who would normally require the support of others alone in your vehicle. Pets should not be left alone either. On hot, sunny days, temperatures in a closed vehicle could quickly become high enough to cause severe or possibly fatal injuries to people or animals.
- Do not use the recirculation mode for long periods as it may cause the interior air to become stale and the windows to fog up.
- Positioning of the heating or air conditioning controls should not be done while driving so full attention may be given to vehicle operation.

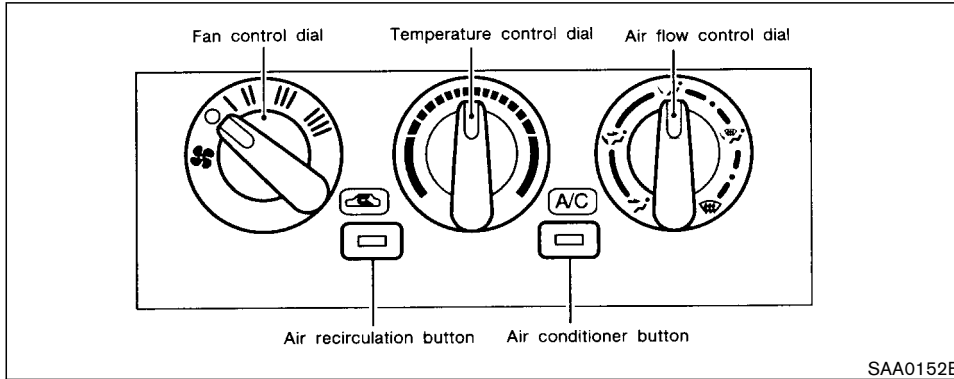



CONTROLS

Fan control dial

This dial turns the fan on and off, and controls fan speed.

Air flow control dial

This dial allows you to select the air flow outlets.

-  — Air flows from center and side ventilators.
-  — Air flows from center and side ventilators and foot outlets.
-  — Air flows mainly from foot outlets.

 — Air flows from defroster outlets and foot outlets.

 — Air flows mainly from defroster outlets.

Temperature control dial

This dial allows you to adjust the temperature of the outlet air.

Air recirculation button

Off position

Outside air is drawn into the passenger compartment.

Use the off position for normal heater, or air conditioner operation.

On position (Indicator light on)

Interior air is recirculated inside the vehicle.

Push the air recirculation button to the on position when driving on a dusty road or to avoid traffic fumes.

Air conditioner button

This button is provided only for vehicles with air conditioner.

Start the engine, move the fan control dial to the desired (1 to 4) position and push the air conditioner button to turn on the air conditioner. The indicator light will come on when the air conditioner button is on. To stop the air conditioner, push the switch again to return it to the original position.

The air conditioner cooling function operates only when the engine is running.

HEATER OPERATION

Heating

This mode is used to direct hot air from the floor outlets.

1. Push the air recirculation button to the off position for normal heating.
 2. Turn the air control dial to the  position.
 3. Turn on the fan control dial.
 4. Turn the temperature control dial to the desired position between the middle and the hot position.
- For quick heating, move the air recirculation button to the on position. Be sure to return the air recirculation button to the off position for normal heating.

Ventilation

This mode directs outside air from the side and center vents.

1. Push the air recirculation button to the off position.
2. Turn the air control dial to the  position.
3. Turn on the fan control dial.
4. Turn the temperature control dial to the desired position.

4-4 Heater, air conditioner and audio systems

Defrosting or defogging

This mode is used to defrost/defog the windows.

1. Push the air recirculation button to the off position.
 2. Turn the air control dial to the  position.
 3. Turn on the fan control dial.
 4. Turn the temperature control dial to the desired position between the middle and the hot position.
- To quickly remove ice or fog from the windows, push the air recirculation button to the on position, the fan control dial to 4 and the temperature control dial to the full hot position. As soon as possible after the window is clear, push the air recirculation button to the off position.

Bi-level heating

This mode directs outside air from the side and center vents and hot air from the floor outlets.

1. Push the air recirculation button to the off position.
2. Turn the air control dial to the  position.
3. Turn on the fan control dial.
4. Normally turn the temperature control dial to

the midpoint between hot and cold.

Heating and defogging

This mode heats the interior and defogs the windscreen.

1. Push the air recirculation button to the off position.
2. Turn the air control dial to the  position.
3. Turn on the fan control dial.
4. Turn the temperature control dial to the desired position between the middle and the hot position.

Operating tips

- **Clear snow and ice from the wiper blade and air inlet in front of the windshield. This will improve heater operation.**
- A slight delay may be experienced when turning the air control dial. The system is not malfunctioning, it is only the system motors and solenoids switching from one outlet to another.

AIR CONDITIONER OPERATION

Start the engine, move the fan control dial to the desired (1 to 4) position and push in the air conditioner button to activate the air conditioner. When the air conditioner is on, cooling and

dehumidifying functions will be added to the heater operation.

The air conditioner cooling function operates only when the engine is running.

Cooling

This mode is used to cool and dehumidify.

1. Push the air recirculation button to the off position.
 2. Turn the air control dial to the  position.
 3. Turn on the fan control dial.
 4. Push on the air conditioner button. The indicator light will come on.
 5. Turn the temperature control dial to the desired position.
- For quick cooling when the outside temperature is high, push the air recirculation button to the on position. Be sure to return the air recirculation button to the off position for normal cooling.

Dehumidified heating

This mode is used to heat and dehumidify.

1. Push the air recirculation button to the off position.
2. Turn the air control dial to the  position.
3. Turn on the fan control dial.
4. Push on the air conditioner button. The indicator light will come on.
5. Turn the temperature control dial to the desired position.

Dehumidified defogging

This mode is used to defog the windows and dehumidify.

1. Push the air recirculation button to the off position.
2. Turn the air control dial to the  position.
3. Turn on the fan control dial.
4. Push on the air conditioner button. The indicator light will come on.
5. Turn the temperature control dial to the desired position.

Operating tips

- Keep windows and sun roof closed while the

air conditioner is in operation.

- After parking in the sun, drive for two or three minutes with the windows open to vent hot air from the passenger compartment. Then, close the windows. This will allow the air conditioner to cool the interior more quickly.
- **The air conditioning system should be operated for about ten minutes at least once a month. This helps prevent damage to the system due to lack of lubrication.**
- If the coolant temperature gauge exceeds the hot position, turn the air conditioner off. For additional information, see "If your vehicle overheats" in the "6. In case of emergency" section.

AIR FLOW CHARTS

The following charts show the button and dial positions for **maximum and quick** heating, cooling or defrosting. **The air recirculation switch should always be in the off position for heating and defrosting.**

**DEFROSTING
DEFOGGING**

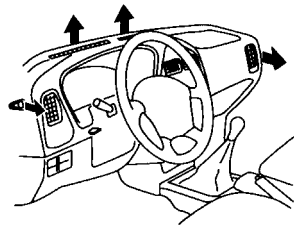

◀: Air passed through heater core

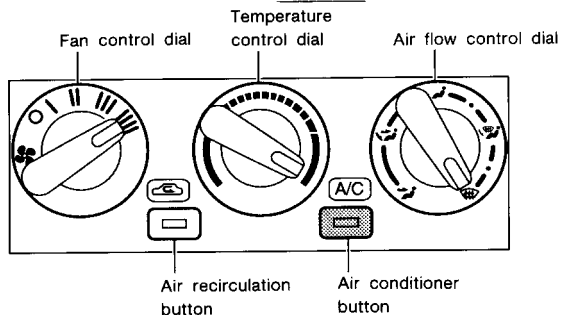

| A/C switch | Air recirculation button | Air control | Temp control | Fan control |
|------------|--------------------------|-------------|--------------|-------------|
| ON | OFF | DEF | HOT (RIGHT) | 4 |

SAA0154A

HEATING
No air at center vents

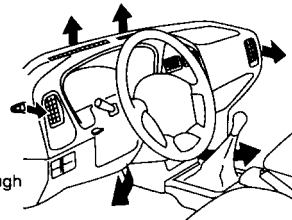

◀: Air passed through heater core

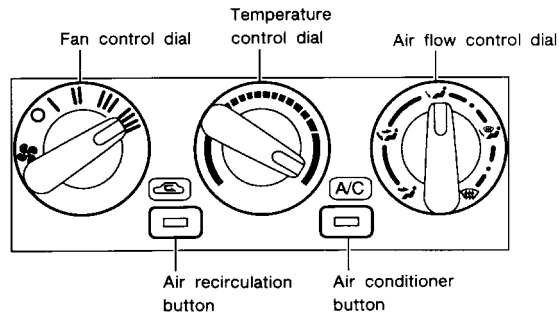

| A/C switch | Air recirculation button | Air control | Temp control | Fan control |
|------------|--------------------------|-------------|--------------|-------------|
| OFF | OFF | FOOT | HOT (RIGHT) | 4 |

SAA0155A

HEATING

Heated air at center vents

◀: Air passed through heater core

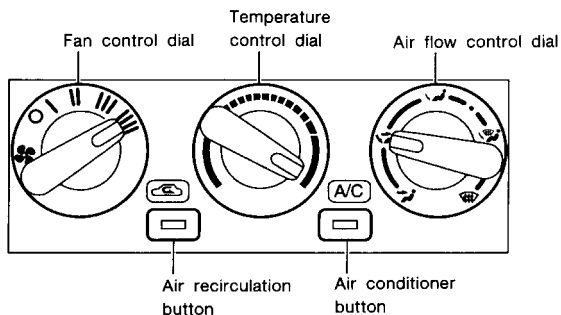
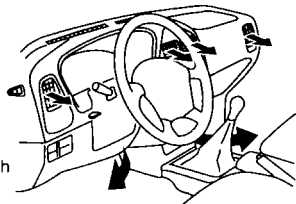

| A/C switch | Air recirculation button | Air control | Temp control | Fan control |
|------------|--------------------------|-------------|--------------|-------------|
| OFF | OFF | FOOT & FACE | HOT (RIGHT) | 4 |

SAA0156A

COOLING

◀: Air not passed through heater core

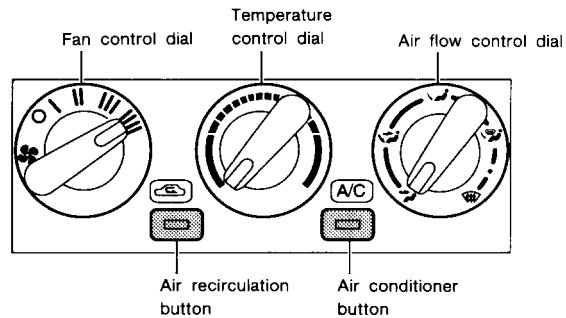
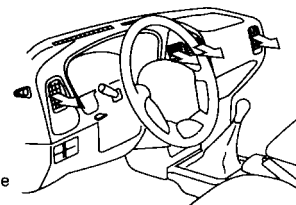

| A/C switch | Air recirculation button | Air control | Temp control | Fan control |
|------------|--------------------------|-------------|--------------|-------------|
| ON | ON | FACE | COLD (LEFT) | 4 |

SAA0157A

HEATER AND AIR CONDITIONER (Automatic — Type A) (if so equipped)

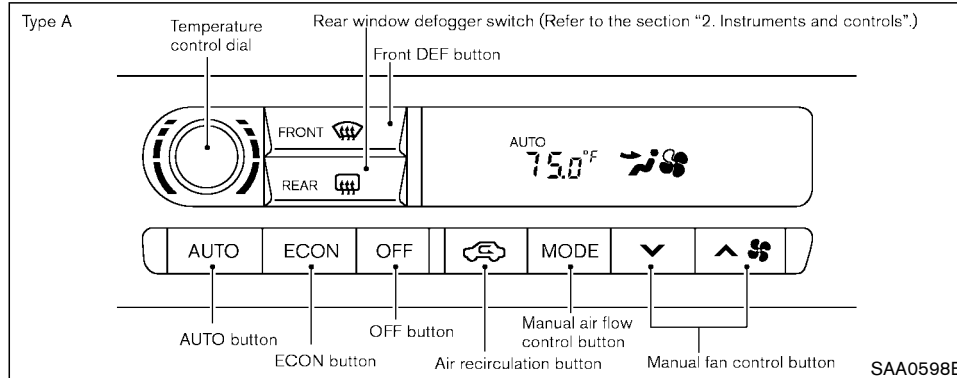

Start the engine and operate the controls to activate the air conditioner.

WARNING

- The air conditioner cooling function operates only when the engine is running.
- Do not leave children, impaired adults, or pets alone in your vehicle. On hot, sunny days, temperatures in a closed vehicle could quickly be-

come high enough to cause severe or possibly fatal injuries to people or animals.

- Do not use the recirculation mode for long periods as it may cause the interior air to become stale and the windows to fog up.
- Positioning of the heater and air conditioner controls should not be done while driving so full attention may be given to vehicle operation.

AUTOMATIC OPERATION

Cooling and/or dehumidified heating (AUTO)

This mode may be normally used all year round as the system automatically works to keep a constant temperature. Air flow distribution and fan speed are also controlled automatically.

1. Push the AUTO button on. (AUTO will be displayed.)
2. Turn the temperature control dial to the right or left to set the desired temperature.

- Adjust the temperature control dial to about 75°F (24°C) for normal operation.
- The temperature of the passenger compartment will be maintained automatically. Air flow distribution and fan speed are also controlled automatically.





Heating (ECON)

The air conditioner does not activate. When you need to heat only, use this mode.

1. Push the ECON (Economy) button on. (ECON will be displayed.)
2. Turn the temperature control dial to the right or left to set the desired temperature.

- The temperature of the passenger compartment will be maintained automatically. Air flow distribution and fan speed are also controlled automatically.
- Do not set the temperature lower than the outside air temperature. Otherwise the system may not work properly.
- Not recommended if windows fog up.

Dehumidified defogging

1. Push the DEF button  on. (The indicator light on the button will come on.)
 2. Turn the temperature set button to the right or left to set the desired temperature.
- To quickly remove ice or fog from the outside of the windows, push the manual fan control button  and set to the maximum position  .
 - As soon as possible after the windshield is clean, push the AUTO button to return to the auto mode.
 - When the DEF button  is pushed, the air conditioner will automatically be turned on at outside temperatures above 23°F (-5°C) to defog the windshield, and the air recirculation mode will automatically be turned off.

Outside air is drawn into the passenger

compartment to improve the defogging performance.

MANUAL OPERATION

Fan speed control

Push the fan control button  to manually control the fan speed.

Push the AUTO button to return to automatic control of the fan speed.

Air recirculation

Push the air recirculation button  to recirculate interior air inside the vehicle. The indicator light on the switch will come on.

Push it again to make the air inlet controlled automatically (FRESH, REC/FRE and RECIRCULATION). The indicator will go out.

The air recirculation button will not be activated when the air conditioner is in DEF mode.

Air flow control

Pushing the manual air flow control button selects the air outlet to:

 : Air flows from center and side ventilators.

 : Air flows from center and side ventilators and foot outlets.

 : Air flows mainly from foot outlets.

 : Air flow from defroster and foot outlets.

To turn the system off

Push the OFF button.

HEATER AND AIR CONDITIONER (Automatic — Type B) (if so equipped)

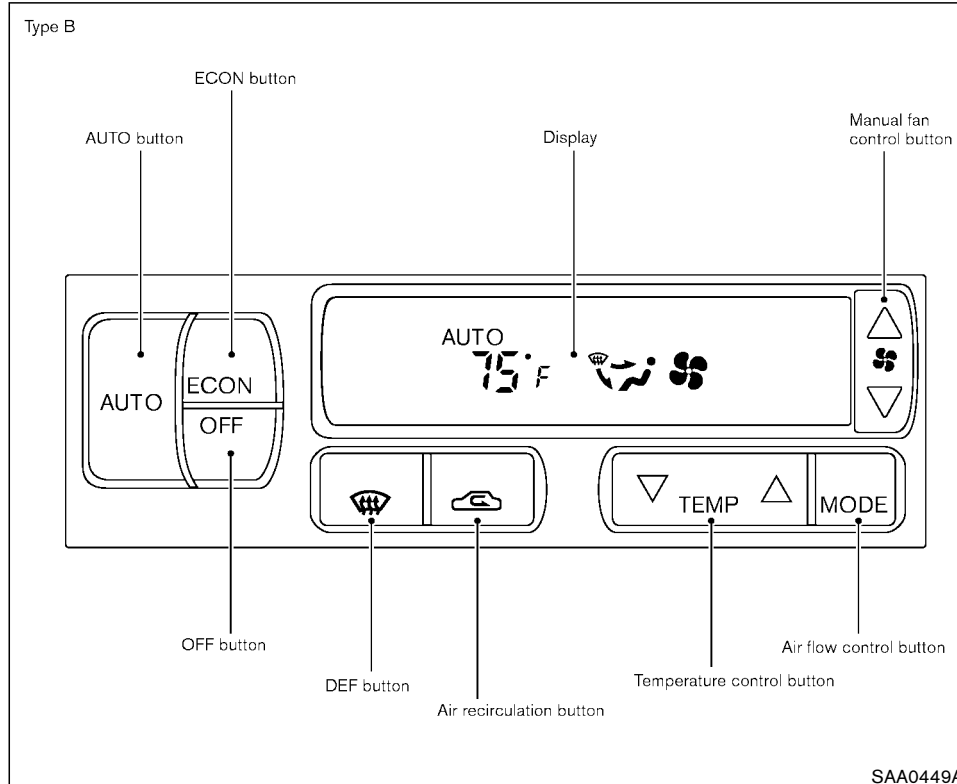

Start the engine and operate the controls to activate the air conditioner.



WARNING

- **The air conditioner cooling function operates only when the engine is running.**
- **Do not leave children, impaired adults, or pets alone in your vehicle. On hot, sunny days, temperatures in a closed vehicle could quickly become high enough to cause severe or possibly fatal injuries to people or animals.**
- **Do not use the recirculation mode for long periods as it may cause the interior air to become stale and the windows to fog up.**
- **Positioning of the heating or air conditioning controls should not be done while driving so full attention may be given to vehicle operation.**

AUTOMATIC OPERATION



Cooling and/or dehumidified heating (AUTO)

This mode may be used all year round. The system works automatically to maintain a constant temperature. Air flow distribution and fan speed are also controlled automatically.

1. Push the AUTO button on. (AUTO will appear on the display.)
2. Push the temperature control button   to set the desired temperature.
 - For normal operation, adjust the temperature control button to about 75°F (24°C).
 - The temperature of the passenger compartment will be maintained automatically. Air flow distribution and fan speed are also controlled automatically.

Heating (ECON)





Use this mode when you need to heat only.

1. Push the ECON (Economy) button on. (ECON appears on the display.)
2. Push the temperature control button   to set the desired temperature.
 - The temperature of the passenger compart-

ment will be maintained automatically. Air flow distribution and fan speed are also controlled automatically.

- Do not set the temperature lower than the outside air temperature. Otherwise the system may not work properly.
- If the windows fog up, do not use the ECON mode.

Dehumidified defogging

1. Push the DEF  switch on. (The indicator light will come on.)
2. Push the temperature control button   to set the desired temperature.
 - To remove ice or fog from the outside of the windows, push the manual fan control button  and set to the maximum position.
 - As soon as possible after the windshield is clean, push the AUTO button to return to the auto mode.
 - When the DEF  button is pushed, the air conditioner will automatically be turned on at outside temperatures above 23°F (-5°C) (for VQ35DE engine models) or 28°F (-2°C) (for VG33E engine models) to defog the windshield. The air recirculation mode will automatically be turned off.

Outside air is drawn into the passenger compartment to improve defogging performance.

MANUAL OPERATION

Fan speed control

Push the fan control button  to change the fan speed manually.

- Push the AUTO button to return to automatic control of the fan speed.

Air recirculation



Push the air recirculation button  to recirculate interior air inside the vehicle. The indicator light will come on.

Push it again to make the air inlet controlled automatically (FRESH, REC/FRE and RECIRCULATION). The indicator will go out.

The air recirculation button will not be activated when the air conditioner is in DEF mode.

Air flow control

Pushing the MODE button selects the air outlet to provide:

-  : Air flow from center and side ventilators.
-  : Air flow from center and side ventilators and foot outlets.

: Air flow mainly from foot outlets.

: Air flow from defroster and foot outlets.

To turn the system off

Push the OFF button.

OPERATING TIPS

- When the engine coolant temperature and outside air temperature are low, the air flow from the foot outlets may not operate for 0 to 126 seconds. This is not a malfunction. After the coolant temperature warms up, air flow from the foot outlets will operate normally.

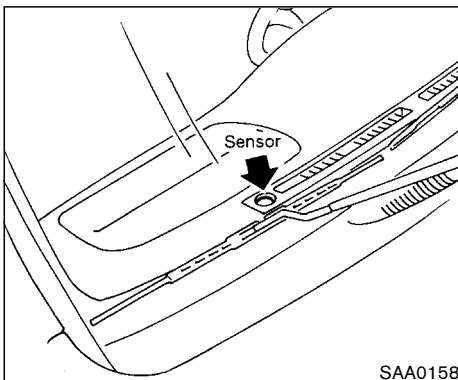

The sensor on the instrument panel helps maintain a constant temperature. Do not put anything on or around this sensor.

SERVICING AIR CONDITIONER

The air conditioning system in your NISSAN vehicle is charged with a refrigerant designed with the environment in mind.

This refrigerant will not harm the earth's ozone layer.

However, special charging equipment and lubricant are required when servicing your NISSAN air conditioner. Using improper refrigerants or lubricants will cause severe damage to your air conditioning system. See "Capacities and recommended fuel/lubricants" in the "9. Technical and consumer information" section for air conditioning system refrigerant and lubricant recommendation.

Your NISSAN dealer will be able to service your environmentally friendly air conditioning system.



WARNING

The air conditioner system contains refrigerant under high pressure. To avoid personal injury, any air conditioner service should be done only by an experienced technician with proper equipment.

AUDIO SYSTEM

Turn the ignition key to ACC or ON and press the power on switch to turn on the radio. If you listen to the radio with the engine not running, the key should be turned to the ACC position.

Radio reception is affected by station signal strength, distance from radio transmitter, buildings, bridges, mountains and other external influences. Intermittent changes in reception quality normally are caused by these external influences.

Using a cellular phone in or near the vehicle may influence radio reception quality.

Radio reception

Your radio system is equipped with state-of-the-art electronic circuits to enhance radio reception. These circuits are designed to extend reception range, and to enhance the quality of that reception.

However there are some general characteristics of FM, AM and satellite radio signals that can affect radio reception quality in a moving vehicle, even when the finest equipment is used. These characteristics are completely normal in a given reception area, and do not indicate any malfunction in your radio system.

Remember that a moving vehicle is not the ideal place to listen to a radio. Because of the movement, reception conditions will constantly

change. Buildings, terrain, signal distance and interference from other vehicles can work against ideal reception. Described below are some of the factors that can affect your radio reception.

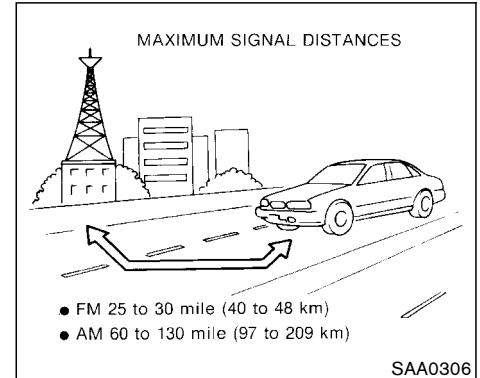

FM RADIO RECEPTION

Range: FM range is normally limited to 25 to 30 miles (40 to 48 km), with monaural (single channel) FM having slightly more range than stereo FM. External influences may sometimes interfere with FM station reception even if the FM station is within 25 miles (40 km). The strength of the FM signal is directly related to the distance between the transmitter and receiver. FM signals follow a line-of-sight path, exhibiting many of the same characteristics as light. For example they will reflect off objects.

Fade and drift: As your vehicle moves away from

a station transmitter, the signals will tend to fade and/or drift.

Static and flutter: During signal interference from buildings, large hills or due to antenna position, usually in conjunction with increased distance from the station transmitter, static or flutter can be heard. This can be reduced by adjusting the treble control counterclockwise to reduce treble response.

Multipath reception: Because of the reflective characteristics of FM signals, direct and reflected signals reach the receiver at the same time. The signals may cancel each other, resulting in momentary flutter or loss of sound.

The radio has an FM Diversity reception system, which employs two antennas if so equipped. One is a rod type antenna; the other is an antenna printed on the window. This system automatically switches to the antenna which is receiving less noise.

For additional information, see "Antenna" later in this section.

AM RADIO RECEPTION

AM signals, because of their low frequency, can bend around objects and skip along the ground. In addition, the signals can be bounced off the ionosphere and bent back to earth. Because of these characteristics. AM signals are also sub-

ject to interference as they travel from transmitter to receiver.

Fading: Occurs while the vehicle is passing through freeway underpasses or in areas with many tall buildings. It can also occur for several seconds during ionospheric turbulence even in areas where no obstacles exist.

Static: Caused by thunderstorms, electrical power lines, electric signs and even traffic lights.

SATELLITE RADIO RECEPTION

When the satellite radio is first installed or the battery has been replaced, the satellite radio may not work properly. This is not a malfunction. Wait more than 10 minutes with satellite radio ON for satellite radio to receive all of the necessary data.

Satellite radio reception capability is not functional, and "NO SAT" will be displayed during scrolling of modes, unless optional satellite receiver and antenna were factory installed prior to purchase (retrofit unavailable), and an XM[®] or SIRIUS[™] satellite radio service subscription is active.

Satellite radio performance may be affected if cargo carried on the roof rack blocks the satellite radio signal.

If possible, do not put cargo over the satellite radio antenna.

AUDIO OPERATION PRECAUTIONS

Cassette player

- **To maintain good quality sound, NISSAN recommends using cassette tapes of 60 minutes or shorter in length.**
- **Cassette tapes should be removed from the player when not in use. Store cassettes in their protective cases and away from direct sunlight, heat, dust, moisture and magnetic sources.**
- **Direct sunlight can cause the cassette to become deformed. The use of deformed cassettes may cause the cassette to jam in the player.**
- **Do not use cassettes with labels which are peeling and loose. If used, the label could jam in the player.**
- **If a cassette has loose tape, insert a pencil through one of the cassette hubs and rewind the tape firmly around the hubs. Loose tape may cause tape jamming and wavering sound quality.**
- **Over a period of time, the playback head, capstan and pinch roller may col-**

lect a tape coating residue as the tape is played. This residue accumulation can cause weak or wavering sound, and should be removed periodically with a head cleaning tape. If the residue is not removed periodically, the player may need to be disassembled for cleaning.

Compact Disc (CD) player

- During cold weather or rainy days, the player may malfunction due to the humidity. If this occurs, remove the CD and dehumidify or ventilate the player completely.
- The player may skip while driving on rough roads.
- The CD player sometimes cannot function when the compartment temperature is extremely high. Decrease the temperature before use.

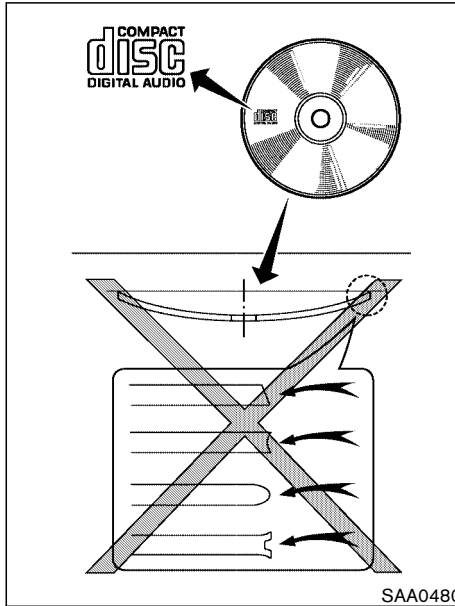

- Only use high quality 4.7 inches (12 cm) round discs that have the “COMPACT disc DIGITAL AUDIO” logo on the disc or packaging.
- Do not expose the CD to direct sunlight.

- CDs that are of poor quality, dirty, scratched, covered with fingerprints, or that have pin holes may not work properly.
- The following CDs may not work properly.
 - Copy control compact discs (CCCD)
 - Recordable compact discs (CD-R)
 - Rewritable compact discs (CD-RW)
- Do not use the following CDs as they may cause the CD player to malfunction.
 - 8 cm (3.1 in) discs with an adapter
 - CDs that are not round
 - CDs with a paper label
 - CDs that are warped, scratched, or have abnormal edges

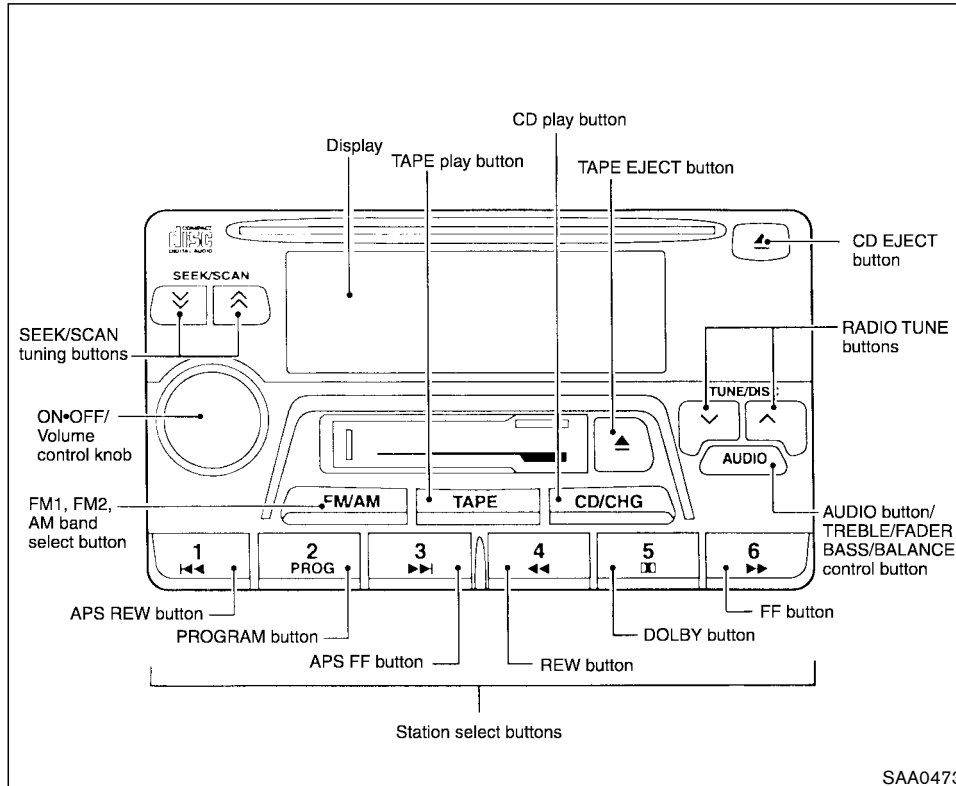

FM-AM RADIO WITH CASSETTE PLAYER AND COMPACT DISC (CD) PLAYER

Audio main operation

Head unit

The tape deck employs a permalloy head which allows for improved reproduction of high frequency ranges. Noise is also greatly reduced by the combined use of the Dolby NR (Noise Reduction) system. The auto loudness circuit enhances the low frequency range automatically in tape and CD playback.

Power/Volume control:

Turn the ignition key to ACC or ON, and then push the Power/Volume control dial while the system is off to call up the mode (radio, tape or CD) which was playing immediately before the system was turned off. When no CD or tape is loaded, the radio will come on. While the system is on, pushing the Power/Volume control dial turns the system off.

To turn the radio off, press the Power/Volume control dial.

Turn the Power/Volume control dial to adjust the volume.

SAA0473

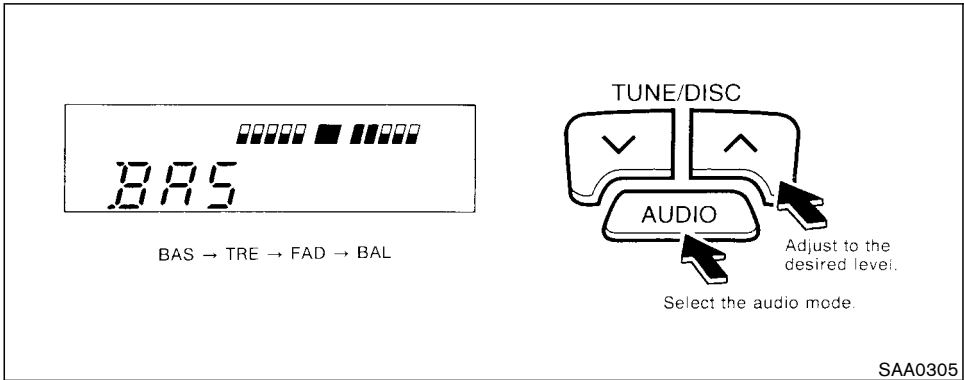

SAA0305

Adjusting tone quality and speaker balance:

To adjust BASS, TRE (Treble), BAL (Balance) and FAD (Fader), press the AUDIO button until the desired mode BAS, TRE, FAD or BAL appears in the display. Press the or button to adjust Bass (BAS) and Treble (TRE) to the desired level. Use the or button also to adjust Fader (FAD) or Balance (BAL) modes. FAD adjusts the sound level between the front and rear speakers and BAL adjusts the sound between the right and left speakers. After 10 seconds, the radio or cassette tape display reappears. Once the sound quality is set to the desired level, press the

AUDIO button repeatedly until the radio or cassette tape display appears.

FM-AM radio operation

FM-AM band select:

Pushing the FM/AM band select button will change the band FM1, FM2 or AM.

When FM/AM band select button is pushed while the ignition switch is in the ACC or ON, the radio will come on at the station last played.

The last station played will also come on when the power knob is turned to ON.

If a compact disc or tape is playing when the

FM/AM band select button is turned to ON, the compact disc or tape will automatically be turned off and the last radio station played will come on.

The FM stereo indicator ST will glow during FM stereo reception. When the stereo broadcast signal is weak, the radio will automatically change from stereo to monaural reception.



WARNING

The radio should not be tuned while driving so full attention may be given to vehicle operation.

Use these buttons for manual tuning. To move quickly through the channels, hold either of the TUNE buttons down for more than 0.5 seconds.



Push the SEEK/SCAN tuning button or for less than 1.5 seconds. SEEK tuning begins from high to low or low to high frequencies and stops at the next broadcasting station.

Push the SEEK/SCAN tuning button or

⏏ for more than 1.5 seconds. SCAN tuning begins from high to low or low to high frequencies and stops at each broadcasting station for 10 seconds. Pushing the button again during this 10 seconds period will stop SCAN tuning and the radio will remain tuned to that station.

If the SEEK/SCAN tuning button is not pushed within 10 seconds, SCAN tuning moves to the next station.

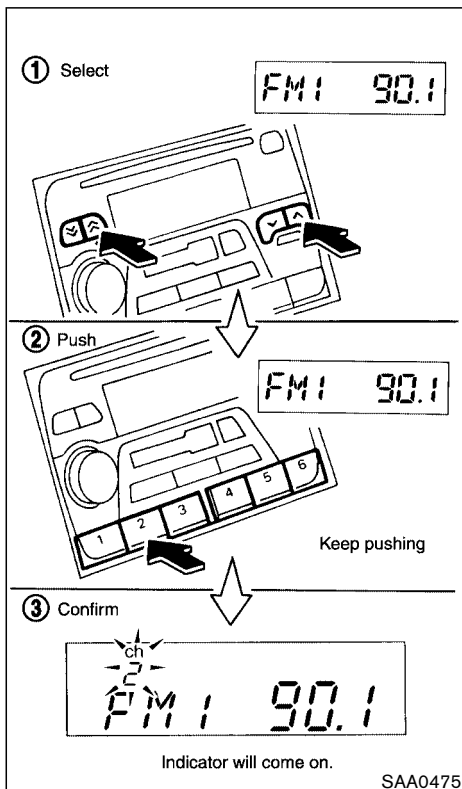

Station memory operations:

Twelve stations can be set for the FM band (six for FM1, six for FM2).

Six stations can be set for the AM band.

1. Tune to the desired station using the SEEK/SCAN or TUNE button.
2. Select the desired station and keep pushing any of the desired station memory buttons (1 to 6) until a beep sound is heard. (For example, in the diagram ch2 is to be memorized. The radio mutes when the select button is pushed.)
3. The indicator ch2 will then come on and the sound will resume. Memorizing is now complete.
4. Other buttons can be set in the same manner.

If the battery cable is disconnected, or if the fuse blows, the radio memory will be cancelled. In that case, reset the desired stations.

Cassette tape player operation

Turn the ignition key to ACC or ON, and then lightly insert the cassette tape into the tape door. The cassette tape will be automatically pulled into the player.

The radio or CD will turn off (if it is on) and the cassette tape will begin to play.



CAUTION

Do not force the cassette tape into the tape door. This could cause player damage.



If the system is turned off by pushing the ON-OFF/VOL control knob with the cassette tape still in the player, the tape will resume playing when the system is turned back on.



TAPE PLAY:

- When the TAPE button is pushed with the system turned off and a tape loaded, the system will come on and the tape will play.
- When the TAPE button is pushed with either the radio or compact disc turned on and the tape loaded, the compact disc or the radio will automatically be turned off and the tape will play.





FF (Fast Forward), REW (Rewind):



Push the  (fast forward) button to fast forward the tape. To rewind the tape, push the  (rewind) button. Either the FF or REW symbol illuminates on the right side of the display window. To stop the FF or REW function, press

the  (fast forward) or  (rewind) again, or the TAPE button.



APS (Automatic Program Search) FF, APS REW:

When the  (APS FF) button is pushed while the tape is being played, the next program will start to play from the beginning. Push the  (APS FF) button several times to skip through programs. The tape will advance the number of times the button is pushed (up to nine programs).

When the  (APS REW) button is pushed once, the program being played starts over from the beginning. Push the  (APS REW) button several times to skip back several selections. The tape will go back the number of times the button is pushed. Either the FF or REW symbol flashes on the right side of the display window while searching for the selection.

This system searches for the blank intervals between selections. If there is a blank interval within one program or there is no interval between programs, the system may not stop in the desired or expected location.



PROG (Program):

Push the PROG button to change the tape side while the tape is being played.

The cassette tape will automatically change di-

rections to play the other side when the first side is completed.



Dolby NR (Noise Reduction):

Push the Dolby NR  button for Dolby NR encoded tapes to reduce high frequency tape noise. The indicator will come on.

Dolby noise reduction manufactured under license from Dolby Laboratories Licensing Corporation. Dolby NR and the double-D symbol  are trademarks of Dolby Laboratories Licensing Corporation.

Metal or chrome tape usage:

The cassette player will be automatically set to high performance play when playing a metal or chrome cassette tape.



TAPE EJECT:

When this button is pushed with the tape loaded, the tape will be ejected.

When the tape is ejected while it is being played, the system will be turned off.

Compact Disc (CD) player operation

Turn the ignition key to the ACC or ON position and insert the compact disc into the slot with the label side facing up. The compact disc will be guided automatically into the slot and start playing.

After loading the disc, the number of tracks on the disc and the play time will appear on the display.

If the radio or tape is already operating, it will automatically turn off and the compact disc will play.

 **CAUTION**

Do not force the compact disc into the slot. This could damage the player.

If the system has been turned off while the compact disc was playing, pushing the ON:OFF/VOL control knob will start the compact disc.

8 cm diameter compact discs can also be used without an adapter.

CD/CHG PLAY:



When the CD/CHG button is pushed with the system off and the compact disc loaded, the system will turn on and the compact disc will start to play.

When the CD/CHG button is pushed with the compact disc loaded but the tape or the radio playing, the tape or radio will automatically be turned off and the compact disc will start to play.

4-20 Heater, air conditioner and audio systems





FF (Fast Forward), REW (Rewind):

When the  (fast forward) or  (rewind) button is pushed while the compact disc is being played, the compact disc will play while fast forwarding or rewinding. When the button is released, the compact disc will return to normal play speed.



APS (Automatic Program Search) FF, APS REW:

When the  (APS FF) button is pushed while the compact disc is being played, the program next to the present one will start to play from its beginning. Push several times to skip through programs. The compact disc will advance the number of times the button is pushed. (When the last program on the compact disc is skipped through, the first program will be played.) When the  (APS REW) button is pushed, the program being played returns to its beginning. Push several times to skip back through programs. The compact disc will go back the number of times the button is pushed.



PROG (Program):

When the PROG button is pushed while the compact disc is being played, the play pattern will change as follows:

no mark: All the programs will be played repeatedly in sequence.

1: Only one program (the one being played when the PROG button is pushed) will be repeated.

RANDOM: Programs will be played at random, not following the sequence on the compact disc. The same program may be repeated twice.

When the compact disc is ejected, the play pattern will automatically change to no mark.



CD EJECT:

When the CD EJECT button is pushed with the compact disc loaded, the compact disc will be ejected.

When the button is pushed twice consecutively the compact disc will be ejected further than when pushed once.

When this button is pushed while the compact disc is being played, the compact disc will come out and the system will turn off.

If the compact disc comes out and is not removed, it will be pulled back into the slot to protect it. (without 8 cm diameter compact discs)

CD IN indicator:

CD IN indicator appears on the display when the CD is loaded with the system on.

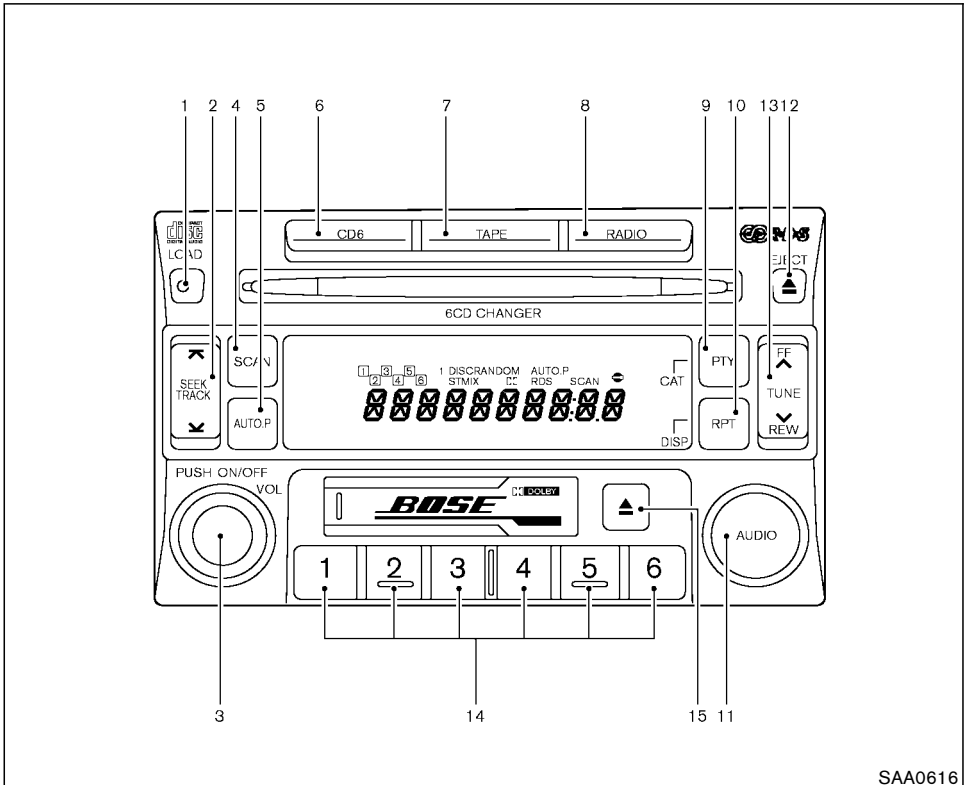

1. CD LOAD button
2. SEEK/APS REW, APS FF/TRACK CHANGE button
3. ON-OFF/VOLUME control knob
4. SCAN tuning button
5. AUTO.P (Automatic preset) button
6. CD play button
7. TAPE play button
8. RADIO (Mode) select button
9. PTY (Program type), CAT (Category) button
- 10.RPT (repeat), DISP (Display) play button
- 11.AUDIO (BASS, TREBLE, FADER, BALANCE and NR (Dolby)) button
- 12.CD EJECT button
- 13.RADIO TUNE/FF-REW/AUDIO (Bass, treble, fader, balance) ADJUSTING button
- 14.Station and preset (FM/AM/SAT)/CD insert or CD play select button
- 15.TAPE EJECT button

SAA0616

FM-AM-SATELLITE RADIO WITH CASSETTE PLAYER AND COMPACT DISC (CD) PLAYER/CD CHANGER

Satellite radio reception capability is not functional, and "NO SAT" will be displayed during scrolling of modes, unless optional satellite receiver and antenna were factory installed prior to purchase (retrofit unavailable), and an XM® or SIRIUS™ satellite radio service subscription is active.

Audio main operation

Head unit

The radio has an FM diversity reception system, which employs two antennas printed on the front windshield. This system automatically switches to the antenna which is receiving less interference.

The tape deck employs a permalloy head which allows for improved reproduction of high frequency ranges. Noise is also greatly reduced by the combined use of the Dolby NR (Noise Reduction) system. The auto loudness circuit enhances the low frequency range automatically in both radio reception and tape and CD playback.

ON-OFF/Volume control:

Turn the ignition key to ACC or ON, and then push the ON-OFF/VOL control knob while the system is off to call up the mode (radio, tape or CD) which was playing immediately before the system was turned off. When no CD or tape is loaded, the radio will come on. While the system is on, pushing the ON-OFF/VOL control knob turns the system off.





To turn the radio off, push the ON-OFF/VOL control knob.

Turn the ON-OFF/VOL control knob to adjust the volume.



AUDIO button (BASS, TREBLE, FADER, BALANCE and NR (Dolby)):

Push the AUDIO button to change the selecting mode as follows.

BASS → TREBLE → FADER → BALANCE → NR (when cassette playing) → BASS

To adjust BASS, TREBLE, FADER and BALANCE, push the AUDIO button until the desired mode BASS, TREBLE, FADER or BALANCE appears in the display. Push the TUNE ( or ) button to adjust Bass and Treble to the desired level. Use the TUNE ( or ) button also to adjust Fader or Balance modes. Fader adjusts the sound level

between the front and rear speakers and Balance adjusts the sound between the right and left speakers.

To change the NR (Dolby) mode to OFF or ON, push the TUNE ( or ) button while cassette tape is playing. When Dolby is ON, the display indicates the  mark.

After 10 seconds, the radio or cassette tape display reappears. Once the sound quality is set to the desired level, push the AUDIO button repeatedly until the radio or cassette tape display appears.

Dolby noise reduction manufactured under license from Dolby Laboratories Licensing Corporation. Dolby NR and the double-D symbol  are trademarks of Dolby Laboratories Licensing Corporation.

Metal or chrome tape usage:

The cassette player will be automatically set to high performance play when playing a metal or chrome cassette tape.

FM-AM-SAT radio operation

RADIO FM/AM/SAT mode select:

Pushing the RADIO mode select button will change the mode as follows:

AM → FM1 → FM2 → SAT1 → SAT2 → AM

Satellite radio reception capability is not functional, and "NO SAT" will be displayed during scrolling of modes, unless optional satellite receiver and antenna were factory installed prior to purchase (retrofit unavailable), and an XM® or SIRIUS™ satellite radio service subscription is active.

When RADIO mode select button is pushed while the ignition switch is in the ACC or ON, the radio will come on at the station/channel last played.

The last station/channel played will also come on when the ON/OFF knob is pushed to ON.

If a compact disc or tape is playing when the RADIO mode select button is turned to ON, the compact disc or tape will automatically be turned off and the last radio station/channel played will come on.

The FM stereo indicator ST will glow during FM stereo reception. When the stereo broadcast signal is weak, the radio will automatically change from stereo to monaural reception.

Satellite radio mode (if equipped with optional factory installed satellite receiver and antenna (retrofit unavailable), and with an active XM® or SIRIUS™ satellite radio service subscription):

To select the satellite radio mode SAT1 or SAT2, push the RADIO mode select button until

SAT1 or SAT2 appears on the display.



TUNE (Tuning):



WARNING



The radio should not be tuned while driving so full attention may be given to vehicle operation.

Use these buttons for manual tuning. To move quickly through the channels, hold either of the TUNE buttons down for more than 0.5 seconds.





SEEK tuning:

For AM and FM radio

Push the SEEK button  or , to tune from high to low or low to high frequencies and stops at the next broadcasting station.

For SATELLITE radio

Push the SEEK button  or  to seek channels of the next or previous category.



SCAN tuning:

Push the SCAN tuning button to tune from low to high frequencies and stops at each broadcasting station for 5 seconds. Pushing the button again during this 5 seconds period will stop

SCAN tuning and the radio will remain tuned to that station.

If the SCAN tuning button is not pushed within 5 seconds, SCAN tuning moves to the next station.

Display mode (RPT-DISP) of satellite radio:

- Pushing the "RPT" button will display additional information (for example: Title, Artist name) about the satellite radio broadcast.
- Pushing the "RPT" button for more than 1.5 seconds will change the display mode as follows:

Channel number → Channel name → Artist name → Song title → Channel number

Station memory operations:

Twelve stations/channel can be set for the FM band (six for FM1, six for FM2) and satellite radio (six for SAT1, six for SAT2) and six stations can be set for the AM band.

1. Tune to the desired station using the SEEK, SCAN or TUNE button.
2. Select the desired station/channel and keep pushing any of the desired station/channel memory buttons (1 to 6) until a beep sound is

heard. (The radio mutes when the select button is pushed.)

- The channel indicator will then come on and the sound will resume. Memorizing is now complete.
- Other buttons can be set in the same manner.

If the battery cable is disconnected, or if the fuse blows, the radio memory will be cancelled. In that case, reset the desired stations.

AUTO.P Automatic preset button:

To select the preset FM, AM, SAT or PTY station/channel, push the AUTO.P button for less than 1.5 seconds.

To preset the FM, AM, SAT or PTY station/channel, push the AUTO.P button for more than 1.5 seconds.

PTY Program type (Category (CAT)) button:

When PTY button is pressed during FM mode, the PTY name of the current tuned station is displayed. When the PTY (CAT) button is pressed during satellite radio mode, the category name of the current channel is displayed. During this time if the PTY data code is zero, or the data is unreadable; the display will show NONE.

1. PTY (CAT) selection mode

PTY (CAT) name selection can be done by the up/down TUNE button \wedge or \vee in the PTY (CAT) selection mode.

After selecting a PTY (CAT) name, push the TUNE button \vee or \wedge within 10 seconds. Tuning to the PTY (CAT) station will start. If you do not push the TUNE button within the 10 second period, the PTY (CAT) mode will be canceled.

It is possible to shift the PTY (CAT) name by one step, with one push of the up/down tuning button \wedge or \vee .

PTY name selection can also be achieved by pressing the preset buttons.

Initial PTY names are stored in the preset buttons; but these can be changed by pressing the preset buttons for more than 1.5 seconds when the desired PTY name is in the display.

For FM:

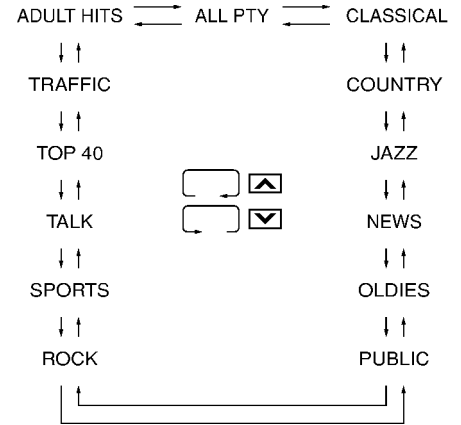

2. PTY SCAN tuning mode

Push the SCAN tuning button to tune the PTY name station, and stop at each broadcasting station for 5 seconds. Pushing the button again during this 5 second period will stop SCAN tuning and the radio will remain tuned to that station. If the SCAN tuning button is not pushed within 5 seconds, SCAN tuning moves to the next station.

Cassette tape player operation

Turn the ignition key to ACC or ON, and then lightly insert the cassette tape into the tape door.

The cassette tape will be automatically pulled into the player.

The radio or CD will turn off (if it is on) and the cassette tape will begin to play.



CAUTION

Do not force the cassette tape into the tape door. This could cause player damage.





If the system is turned off by pushing the ON-OFF/VOL control knob with the cassette tape still in the player, the tape will resume playing when the system is turned back on.

TAPE PLAY:

- When the TAPE button is pushed with the system turned off and a tape loaded, the system will come on and the tape will play.
- When the TAPE button is pushed with either the radio or compact disc turned on and the tape loaded, the compact disc or the radio will automatically be turned off and the tape will play.
- When the TAPE button is pushed while the tape is being played, the tape side will be changed.







FF (Fast Forward), REW (Rewind):

Push the  (fast forward) button to fast forward the tape. To rewind the tape, push the  (rewind) button. Either the FF or REW symbol illuminates on the right side of the display window. To stop the FF or REW function, press the  (fast forward) or  (rewind) again, or the TAPE button.



APS (Automatic Program Search) FF, APS REW:

When the  (APS FF) button is pushed while the tape is being played, the next program will start to play from the beginning. Push the  (APS FF) button several times to skip through programs. The tape will advance the number of times the button is pushed (up to nine programs).

When the  (APS REW) button is pushed once, the program being played starts over from the beginning. Push the  (APS REW) button several times to skip back several selections. The tape will go back the number of times the button is pushed. Either the FF or REW symbol flashes on the right side of the display window while searching for the selection.

This system searches for the blank intervals between selections. If there is a blank interval

within one program or there is no interval between programs, the system may not stop in the desired or expected location.



SCAN SCAN tuning:

Push the SCAN tuning button while playing tape, and it stops at the next tape program for 5 seconds. Pushing the button again during this 5 second period will stop SCAN tuning and the tape program is continued. If the SCAN tuning button is not pushed within 5 seconds, SCAN tuning moves to the next tape program.



TAPE EJECT:

When this button is pushed with the tape loaded, the tape will be ejected.

When the tape is ejected while it is being played, the system will be turned off.

Compact disc (CD) changer operation

Turn the ignition key to the ACC or ON position and insert the compact disc into the slot with the label side facing up. The compact disc will be guided automatically into the slot and start playing.

After loading the disc, the number of tracks on the disc and the play time will appear on the display.

If the radio or tape is already operating, it will

automatically turn off and the compact disc will play.



CAUTION

Do not force the compact disc into the slot. This could damage the player.

If the system has been turned off while the compact disc was playing, pushing the ON-OFF/VOL control knob will start the compact disc.

8 cm diameter compact discs can also be used without an adapter.



LOAD button:

To insert a CD in the CD changer, push the LOAD button for less than 1.5 seconds. And select the loading slot by pushing the CD insert select button (1 to 6) then insert the CD.

To insert 6 CDs to the CD changer, push the LOAD button for more than 1.5 seconds.

The inserted slot numbers will illuminate on the display.





PLAY:

When the CD6 button is pushed with the system off and the compact disc loaded, the system will turn on and the compact disc will start to play.

When the CD6 button is pushed with the compact disc loaded but the tape or the radio playing, the tape or radio will automatically be turned off and the compact disc will start to play.





FF (Fast Forward), REW (Rewind):

When the  (fast forward) or  (rewind) button is pushed while the compact disc is being played, the compact disc will play while fast forwarding or rewinding. When the button is released, the compact disc will return to normal play speed.



APS (Automatic Program Search) FF, APS REW:

When the  (APS FF) button is pushed while the compact disc is being played, the program next to the present one will start to play from its beginning. Push several times to skip through programs. The compact disc will advance the number of times the button is pushed. (When the last program on the compact disc is skipped through, the first program will be played.) When the  (APS REW) button is pushed, the program being played returns to its beginning. Push several times to skip back through programs. The compact disc will go back the number of times the button is pushed.

CD PLAY button:

To change CD, push the CD play select button (1 to 6).



SCAN tuning:

When the SCAN tuning button is pushed for less than 1.5 seconds while the CD is being played, the beginning of all the tracks of CDs will be played for 10 seconds in sequence.

When the SCAN tuning button is pushed for more than 1.5 seconds while the CD is being played, the first program in all the CDs will be played for 10 seconds.

Pushing the button again during this 10 second period will stop SCAN tuning.

If the SCAN tuning button is not pushed within 10 seconds, SCAN tuning moves to the next disc program.



REPEAT (RPT):

When the RPT button is pushed while the compact disc is played, the play pattern can be changed as follows:

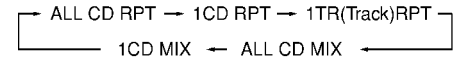

DISPLAY CD TEXT:

To indicate the CD mode text, push the PTY

button during CD playing.

To change the indicated text, push the PTY button.

The text will change as follows:

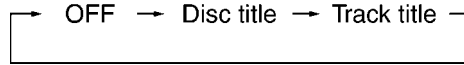

If the text is more than 11 letters, push the AUTO.P button to display the remaining text.



CD EJECT:

When the CD EJECT button is pushed with the compact disc loaded, the compact disc will be ejected.

To eject the discs selected by the CD select button, push the EJECT button for less than 1.5 seconds.

To eject all the discs, push the EJECT button for more than 1.5 seconds.

If the compact disc comes out and is not removed, it will be pulled back into the slot to protect it. (without 8 cm diameter compact discs)

CD IN indicator:

CD IN indicator appears on the display when the CD is loaded with the system on.

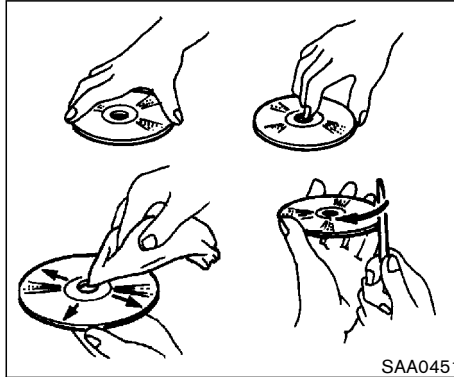

CD CARE AND CLEANING

- Handle a CD by its edges. Never touch the surface of the disc. Do not bend the disc.
- Always place the discs in the storage case when they are not being used.
- To clean a disc, wipe the surface from the center to the outer edge using a clean, soft cloth. Do not wipe the disc using a circular motion.
Do not use a conventional record cleaner or alcohol intended for industrial use.
- A new disc may be rough on its inner and outer edges. Remove the rough edges using the side of a pen or pencil as illustrated.

STEERING WHEEL SWITCH FOR AUDIO CONTROL (if so equipped)

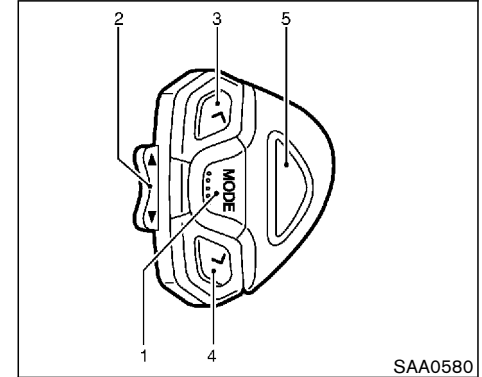

1. Mode select switch (if so equipped)
2. Volume control switch (up or down)
3. Memory change seek and APS switch (up)
4. Memory change seek and APS switch (down)
5. ON-OFF switch or Mode select switch (if so equipped)

“MODE” select switch (if so equipped)

Push the mode select switch to change the mode in the sequence of AM, FM1, FM2, (SAT1,

SAT2 if so equipped), CD autochanger and Tape.

Volume control switches

Push the upper or lower side switch to increase or decrease the volume.



Memory change (radio):

Push the tuning switch “ ∇ ” or “ \blacktriangle ” for less than 1.5 seconds to change the radio frequency/channel.

Seek tuning (radio):

Push the tuning switch “ ∇ ” or “ \blacktriangle ” for more than 1.5 seconds to seek the next or previous FM/AM radio station or satellite radio channel.

APS (Automatic Program Search) FF, APS REW (tape or CD changer):

Push the tuning switch “ ∇ ” or “ \blacktriangle ” for less than 1.5 seconds to return to the beginning of the present program or skip to the next program. Push several times to skip back or skip through programs.

This system searches for the blank intervals between selections. If there is a blank interval within one program or there is no interval be-

tween programs, the system may not stop in the desired or expected location.

FF REW (tape or CD changer):

Push the tuning switch “ ∇ ” or “ \blacktriangle ” for more than 1.5 seconds to rewind or fast forward the tape or to change the playing disc up or down.

To stop the FF or REW function, press the switch you pushed for more than 1.5 seconds again.

“ON-OFF” switch (if so equipped)

With the ignition key turned to the ACC or ON position, push the “**ON-OFF**” switch to turn the audio system ON or OFF.

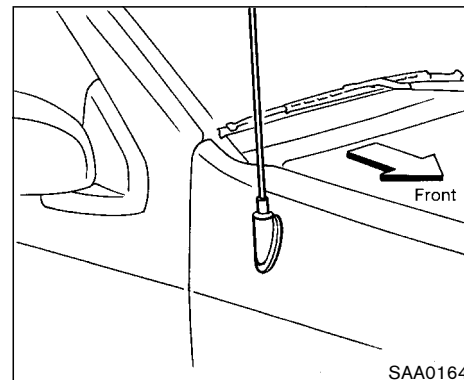

ANTENNA

Manual antenna

The manual antenna on your vehicle remains in the upper position at all times. The antenna cannot be shortened, but can be removed. When you need to remove the antenna, turn the antenna nut counterclockwise. To install the antenna rod, turn the antenna nut clockwise. Tighten the antenna rod to specification using a suitable tool, such as an open-end wrench. The antenna rod tightening specification is 3.4 to 3.6 N·m (30 to 32 in·lb). Do not use pliers to tighten the antenna as they can leave marks on the antenna surface. The antenna rod cannot be

hand tightened to the proper specification.



CAUTION

- **Always properly tighten the antenna rod during installation or the antenna rod may bend or break during vehicle operation.**
- **To prevent damage, be sure that manual antenna is removed before the vehicle enters an automated car wash.**

Power antenna

The antenna will automatically extend when the radio is turned on, and retract when switched off. If the radio is left on, the antenna will retract and extend with the ignition key OFF-ON operation.



CAUTION

- **Before turning the radio on, make sure that there is no one near the antenna outlet and there is enough space for it to extend.**

- **To prevent damage, be sure that power antenna is fully retracted before the vehicle enters an automated car wash.**
- **Dirt and other foreign matter on the power antenna rod may interrupt its operation. Clean the rod periodically with a damp cloth. This type of cleaning is especially important during the winter seasons in areas where road salt and other chemicals may be spread on road surfaces and splashed onto the antenna rod.**

Window antenna

The antenna pattern is printed inside the windshield.



CAUTION

- **Do not place metalized film near the windshield or attach any metal parts to it. This may cause poor reception or noise.**

- **When cleaning the inside of the windshield, be careful not to scratch or damage the window antenna. Lightly wipe along the antenna with a dampened soft cloth.**

CAR PHONE OR CB RADIO

When installing a car phone or CB, ham radio in your NISSAN, be sure to observe the following cautions, otherwise the new equipment may adversely affect the Engine control system and other electronic parts.



WARNING

- A cellular telephone should not be used while driving so full attention may be given to vehicle operation. Some jurisdictions prohibit the use of cellular telephones while driving.
- If you must make a call while your vehicle is in motion, the hands free cellular phone operational mode (if so equipped) is highly recommended. Exercise extreme caution at all times so full attention may be given to vehicle operation.
- If a conversation in a moving vehicle requires you to take notes, pull off the road to a safe location and stop your vehicle before doing so.



CAUTION

- Keep the antenna as far as possible away from the Engine Control Module (ECM).
- Keep the antenna wire more than 8 in (20 cm) away from the Multiport Fuel Injection harness. Do not route the antenna wire next to any harness.
- Adjust the antenna standing-wave ratio as recommended by the manufacturer.
- Connect the ground wire from the CB radio chassis to the body.
- For details, consult an authorized NISSAN dealer.

MEMO

5 Starting and driving

| | | | |
|-----------------------------------------------------------|------|---------------------------------------------------------------|------|
| Precautions when starting and driving..... | 5-2 | Break-in schedule | 5-20 |
| Exhaust gas (Carbon monoxide)..... | 5-2 | Increasing fuel economy..... | 5-20 |
| Three way catalyst..... | 5-3 | Using part time four wheel drive (4WD)..... | 5-21 |
| Low tire pressure warning system (if so equipped)..... | 5-3 | Transfer case shifting procedures..... | 5-23 |
| On-pavement and offroad driving precautions..... | 5-4 | Using all-mode four wheel drive (4WD) | 5-25 |
| Avoiding collision and rollover | 5-5 | Transfer case shifting procedures..... | 5-25 |
| Drinking alcohol/drugs and driving..... | 5-5 | Parking/parking on hills..... | 5-32 |
| Driving safety precautions..... | 5-5 | Power steering..... | 5-33 |
| Ignition switch..... | 5-7 | Brake system | 5-34 |
| Automatic transmission..... | 5-7 | Braking precautions | 5-34 |
| Manual transmission..... | 5-9 | Anti-lock brake system (ABS)..... | 5-34 |
| Key positions..... | 5-9 | Vehicle Dynamic Control (VDC) system (if so equipped)..... | 5-36 |
| Nissan vehicle immobilizer system..... | 5-9 | Cold weather driving | 5-37 |
| Before starting the engine | 5-10 | Freeing a frozen door lock | 5-37 |
| Starting the engine | 5-10 | Anti-freeze | 5-37 |
| Driving the vehicle..... | 5-11 | Battery | 5-37 |
| Automatic transmission | 5-11 | Draining of coolant water..... | 5-37 |
| Manual transmission | 5-15 | Tire equipment..... | 5-37 |
| Parking brake..... | 5-17 | Special winter equipment..... | 5-38 |
| Cruise control (if so equipped)..... | 5-18 | Driving on snow or ice..... | 5-38 |
| Precautions on cruise control | 5-18 | Engine block heater (if so equipped)..... | 5-39 |
| Cruise control operations..... | 5-18 | | |

PRECAUTIONS WHEN STARTING AND DRIVING



WARNING

- Do not leave children or adults who would normally require the support of others alone in your vehicle. Pets should not be left alone either. They could accidentally injure themselves or others through inadvertent operation of the vehicle. Also, on hot, sunny days, temperatures in a closed vehicle could quickly become high enough to cause severe or possibly fatal injuries to people or animals.
- Properly secure all cargo to help prevent it from sliding or shifting. Do not place cargo higher than the seat-backs. In a sudden stop or collision, unsecured cargo could cause personal injury.

EXHAUST GAS (Carbon monoxide)



WARNING

Do not breathe exhaust gases; they contain colorless and odorless carbon monoxide. Carbon monoxide is dangerous. It can cause unconsciousness or death.

- If you suspect that exhaust fumes are entering the vehicle, drive with all windows fully open, and have the vehicle inspected immediately.
- Do not run the engine in closed spaces such as a garage.
- Do not park the vehicle with the engine running for any extended length of time.
- Keep the back door and glass hatch closed while driving, otherwise exhaust gases could be drawn into the passenger compartment. If you must drive with the back door or glass hatch open, follow these precautions:

1. Open all the windows.
 2. Set the air recirculation switch OFF and the fan control at 4 (high) to circulate the air.
- If electrical wiring or other cable connections must pass to a trailer through the seal on the back door or the body, follow the manufacturer's recommendation to prevent carbon monoxide entry into the vehicle.
 - If a special body or other equipment is added for recreational or other usage, follow the manufacturer's recommendation to prevent carbon monoxide entry into the vehicle. (Some recreational vehicle appliances such as stoves, refrigerator, heaters, etc. may also generate carbon monoxide.)
 - The exhaust system and body should be inspected by a qualified mechanic whenever:
 - a. The vehicle is raised for service.

- b. You suspect that exhaust fumes are entering into the passenger compartment.
- c. You notice a change in the sound of the exhaust system.
- d. You have had an accident involving damage to the exhaust system, underbody, or rear of the vehicle.

THREE WAY CATALYST

The three way catalyst is an emission control device, installed in the exhaust system. In the converter, exhaust gases are burned at high temperatures to help reduce pollutants.



WARNING

- The exhaust gas and the exhaust system are very hot. Keep people, animals or flammable materials away from the exhaust system components.
- Do not stop or park the vehicle over flammable materials, such as dry

grass, waste paper or rags. They may ignite and cause a fire.



CAUTION

- Do not use leaded gasoline. Deposits from leaded gasoline seriously reduce the three way catalyst's ability to help reduce exhaust pollutants.
- Keep your engine tuned up. Malfunctions in the ignition, fuel injection, or electrical systems can cause overrich fuel flow into the three way catalyst, causing it to overheat. Do not keep driving if the engine misfires, or if noticeable loss of performance or other unusual operating conditions are detected. Have the vehicle inspected promptly by an authorized NISSAN dealer.
- Avoid driving with an extremely low fuel level. Running out of fuel could cause the engine to misfire, damaging the three way catalyst.

- Do not race the engine while warming it up.
- Do not push or tow your vehicle to start the engine.

LOW TIRE PRESSURE WARNING SYSTEM (if so equipped)

The low tire pressure warning system monitors tire pressure of all wheels (except the spare tire).

The low tire pressure warning system will activate only when the vehicle is driven at speeds above 20 MPH (32 km/h). Also, this system may not detect a sudden drop in tire pressure (for example a flat tire by catching something while driving).

Frequently check the tire pressure and adjust pressure of each tire properly.

LOW PRESSURE warning

If the vehicle is being driven with a flat tire or low tire pressure (lower than 25 psi, 171 kPa), the low tire pressure warning light illuminates and the chime sounds for about 10 seconds.

For additional information regarding the above warning, see "Warning/indicator lights and au-

dible reminders” in the “2. Instruments and controls” section.



WARNING

- If the low tire pressure warning light illuminates and the chime sounds for about 10 seconds while driving, avoid sudden steering maneuvers or abrupt braking, reduce vehicle speed, pull off the road to a safe location and stop the vehicle as soon as possible. Serious vehicle damage could occur and may lead to an accident and could result in serious personal injury. Check the tire pressure for all four wheels and adjust the pressure to the COLD tire pressure shown on the tire placard. If you have a flat tire, replace it with a spare tire as soon as possible. (See “Flat tire” in the “6. In case of emergency” section for changing a flat tire.)
- When a spare tire is mounted or a wheel is replaced, the low tire pressure warning system will not func-

tion. Contact your NISSAN dealer as soon as possible for tire replacement and/or system resetting.

- Do not inject any tire liquid or aerosol tire sealant into the tires, as this may cause a malfunction of the tire pressure sensors.



CAUTION

Do not place metalized film or any metal parts (antenna, etc.) on the windows. This may cause poor reception of the signals from the tire pressure sensors, and the low tire pressure warning system will not function properly.

FCC Notice:

Changes or modifications not expressly approved by the manufacturer compliance could void the user's authority to operate the equipment.

This device complies with Part 15 of the FCC Rules and RSS-210 of Industry Canada.

Operation is subject to the following two conditions: (1) This device may not cause harmful interference, and (2) this device must accept any interference received, including interference that may cause undesired operation of the device.

ON-PAVEMENT AND OFFROAD DRIVING PRECAUTIONS

Utility vehicles have a significantly higher rollover rate than other types of vehicles.

They have higher ground clearance than passenger cars to make them capable of performing in a variety of on-pavement and offroad applications. This gives them a higher center of gravity than ordinary cars. An advantage of higher ground clearance is a better view of the road, allowing you to anticipate problems. However, they are not designed for cornering at the same speeds as conventional two-wheel drive vehicles any more than low-slung sports cars are designed to perform satisfactorily under offroad conditions. If at all possible, avoid sharp turns or abrupt maneuvers, particularly at high speeds. As with other vehicles of this type, failure to operate this vehicle correctly may result in loss of control or vehicle rollover.

Be sure to read the driving safety precautions later in this section.

AVOIDING COLLISION AND ROLLOVER



WARNING

Failure to operate this vehicle in a safe and prudent manner may result in loss of control or an accident.

Be alert and drive defensively at all times. Obey all traffic regulations. Avoid excessive speed, high speed cornering, or sudden steering maneuvers, because these driving practices could cause you to lose control of your vehicle. **As with any vehicle, a loss of control could result in a collision with other vehicles or objects, or cause the vehicle to rollover, particularly if the loss of control causes the vehicle to slide sideways.** Be attentive at all times, and avoid driving when tired. Never drive when under the influence of alcohol or drugs (including prescription or over-the-counter drugs which may cause drowsiness). Always wear your seat belt as outlined in the “1. Seats, restraints and supplemental air bag systems” section of this manual, and also instruct your passengers to do so. Seat belts help reduce the risk of injury in collisions and rollovers. **In a rollover crash, an unbelted person is sig-**

nificantly more likely to die than a person wearing a seat belt.

DRINKING ALCOHOL/DRUGS AND DRIVING



WARNING

Never drive under the influence of alcohol or drugs. Alcohol in the bloodstream reduces coordination, delays reaction time and impairs judgement. Driving after drinking alcohol increases the likelihood of being involved in an accident injuring yourself and others. Additionally, if you are injured in the accident, alcohol can increase the severity of the injury.

Nissan is committed to safe driving. But, you must choose not to drive under the influence of alcohol. Every year thousands of people are injured or killed in alcohol related accidents. Although the local laws vary on what is considered to be legally intoxicated, the fact is that alcohol affects all people differently and most people underestimate the effects of alcohol.

Remember, drinking and driving don't mix!

And that's true for drugs too (over the counter, prescription, and illegal drugs). Don't drive if your ability to operate your vehicle is impaired by alcohol, drugs, or some other physical condition.

DRIVING SAFETY PRECAUTIONS

Your NISSAN is designed for both normal and offroad use. However, avoid driving in deep water or mud as your NISSAN is mainly designed for leisure use, unlike a conventional offroad vehicle.

Remember that two wheel drive models are less capable than four wheel drive models for rough road driving and extrication when stuck in deep snow or mud, or the like.

Please observe the following precautions:



WARNING

- **Drive carefully when off the road and avoid dangerous areas. Every person who drives or rides in this vehicle should be seated with their seat belt fastened. This will keep you and your passengers in position when driving over rough terrain.**

- Before driving up or down grades, check the road surface for bumps or potholes. Be sure to climb a gentle slope and descend a gentle slope.
- Do not drive across steep slopes. Instead drive either straight up or straight down the slopes. Off-road vehicles can tip over sideways much more easily than they can forward or backward.
- Many hills are too steep for any vehicle. If you drive up them, you may stall. If you drive down them, you may not be able to control your speed. If you drive across them, you may roll over.
- Do not shift gears while driving on downhill grades as this could cause loss of control of the vehicle.
- Be sure to use the engine brake. The foot brake performance may be reduced, resulting in a possible accident.
- Stay alert when driving to the top of a

hill. At the top there could be a drop-off or other hazard that could cause an accident.

- If your engine stalls or you cannot make it to the top of a steep hill, never attempt to turn around. Your vehicle could tip or roll over. Always back straight down in R (Reverse) gear. Never back down in N (Neutral) or with the clutch depressed (manual transmission vehicles), using only the brake, as this could cause loss of control.
- Heavy braking going down a hill could cause your brakes to overheat and fade, resulting in loss of control and an accident. Apply brakes lightly and use a low gear to control your speed.
- Unsecured cargo can be thrown around when driving over rough terrain. Properly secure all cargo so it will not be thrown forward and cause injury to you or your passengers.

- To avoid raising the center of gravity excessively, do not exceed the rated capacity of the roof rack and evenly distribute the load. Secure heavy loads in the cargo area as far forward and as low as possible. Do not equip the vehicle with tires larger than specified in this manual. This could cause your vehicle to roll over.
- Do not grip the inside or spokes of the steering wheel when driving off-road. The steering wheel could move suddenly and injure your hands. Instead drive with your fingers and thumbs on the outside of the rim.
- Before operating the vehicle, ensure that the driver and all passengers have their seat belts fastened.
- Always drive with the floor mats in place as the floor may become hot.
- Lower your speed when encountering strong crosswinds. With a higher center of gravity, your NISSAN is more affected by strong side winds.

Slower speeds ensure better vehicle control.

- **Do not drive beyond the performance of the tires, even with 4WD engaged.**

Accelerating quickly, sharp steering maneuvers or sudden braking may cause loss of control.

- **If at all possible, avoid sharp turning maneuvers, particularly at high speeds. Your NISSAN four wheel drive vehicle has a higher center of gravity than a two wheel drive vehicle. The vehicle is not designed for cornering at the same speeds as conventional two wheel drive vehicles. Failure to operate this vehicle correctly could result in loss of control and/or a roll over accident.**
- **Always use tires of the same type, size, brand, construction (bias, bias-belted or radial), and tread pattern on all four wheels. Install tire chains on the rear wheels when driving on slippery roads and drive carefully.**

- **Be sure to check the brakes immediately after driving in mud or water. See “Brake system” later in this section for wet brakes.**
- **Avoid parking your vehicle on steep hills. If you get out of the vehicle and it rolls forward, backward or sideways, you could be injured.**
- **Whenever you drive off-road through sand, mud or water as deep as the wheel hub, more frequent maintenance may be required. See “Periodic maintenance” in the “Service and Maintenance Guide”.**

IGNITION SWITCH

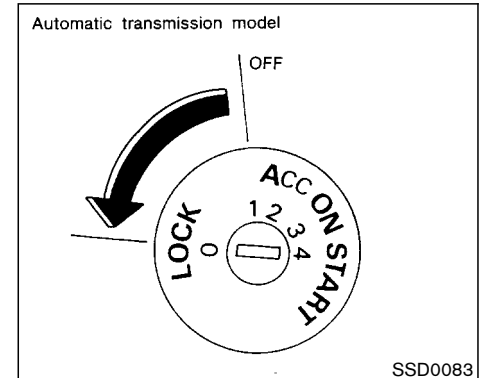

AUTOMATIC TRANSMISSION

On automatic transmission models, the ignition lock is designed so that the key cannot be turned to LOCK and removed until the selector lever is moved to the P (Park) position.

When removing the key from the ignition, make sure the selector lever is in the P (Park) position.

If the selector lever is not returned to P (Park), the key cannot be moved toward LOCK.

When the key cannot be turned toward the LOCK position, proceed as follows to remove the key:

- 1) Move the selector lever into the P (Park) position.
- 2) Turn the ignition key slightly in the ON direction.
- 3) Turn the key toward the LOCK position.
- 4) Remove the key.

If the key is removed from the ignition switch, the selector lever cannot be moved from P (Park). **The selector lever can be moved if the ignition switch is in the ON position and the foot brake pedal is depressed.**

There is an OFF position in between LOCK and ACC, although it does not show on the lock cylinder. When the ignition is in OFF the steering wheel is not locked.

In order for the steering wheel to be locked, it must be turned about 1/6 of a turn clockwise from the straight up position.

To lock the steering wheel, turn the key to the LOCK position. Remove the key. To unlock the steering wheel, insert the key and turn it gently while rotating the steering wheel slightly right and left.



WARNING

Never remove or turn the key to the LOCK position while driving. The steering wheel will lock. This may cause the driver to lose control of the vehicle and could result in serious vehicle damage or personal injury.

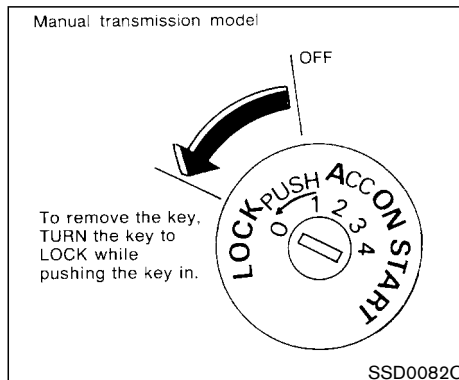

MANUAL TRANSMISSION

The switch includes an anti-theft steering lock device.

The ignition key can only be removed when the switch is in the LOCK position.

On manual transmission models, to turn the ignition key to LOCK from ACC or ON, first turn the key to OFF and turn the key to LOCK while pushing the key in.

In order for the steering wheel to be locked, it must be turned about 1/6 of a turn clockwise from the straight up position.

To lock the steering wheel, turn the key to

the LOCK position. Remove the key. To unlock the steering wheel, insert the key and turn it gently while rotating the steering wheel slightly right and left.



WARNING

Never remove or turn the key to the LOCK position while driving. The steering wheel will lock. This may cause the driver to lose control of the vehicle and could result in serious vehicle damage or personal injury.

KEY POSITIONS

LOCK (Normal parking position) (0)

The ignition key can only be removed when the switch is at this position.

OFF (1)

The engine can be turned off without locking the steering wheel.

ACC (Accessories) (2)

This position activates electrical accessories such as the radio when the engine is not running.

ON (Normal operating position) (3)

This position turns on the ignition system and the electrical accessories.

START (4)

This position activates the starter motor, starting the engine.

NISSAN VEHICLE IMMOBILIZER SYSTEM

The Nissan Vehicle Immobilizer System will not allow the engine to start without the use of the registered Nissan Vehicle Immobilizer System key.

If the engine fails to start using the registered Nissan Vehicle Immobilizer System key (for example, when interference is caused by another Nissan Vehicle Immobilizer System key, an automated toll road device or automated payment device on the key ring), restart the engine using the following procedures:

1. Leave the ignition switch in the ON position for approximately 5 seconds.
2. Turn the ignition switch to the OFF or LOCK position, and wait approximately 10 seconds.
3. Repeat step 1 and 2.
4. Restart the engine while holding the device (which may have caused the interference) separate from the registered Nissan Vehicle

Immobilizer System key.

If the no start condition re-occurs, NISSAN recommends placing the registered Nissan Vehicle Immobilizer System key on a separate key ring to avoid interference from other devices.

BEFORE STARTING THE ENGINE

- Make sure the area around the vehicle is clear.
- Check fluid levels such as engine oil, coolant, brake and clutch fluid, window washer fluid as frequently as possible, at least whenever you refuel.
- Check to be sure that all windows and light lenses are clean.
- Visually inspect tires for their appearance and condition. Also check tires for proper inflation.
- Lock all doors.
- Position seat and adjust head restraints.
- Adjust inside and outside mirrors.
- Fasten seat belts and ask all passengers to do likewise.
- Check the operation of warning lights when key is turned to the ON (3) position.

STARTING THE ENGINE

1. Apply the parking brake.

2. Automatic transmission:

Move the selector lever to P (Park position) or N (Neutral position). (P preferred)

The selector lever cannot be moved out of P and into any of the other gear positions if the ignition key is turned to LOCK or if the key is removed from the switch.

The starter is designed not to operate if the selector lever is in one of the driving positions.

Manual transmission:

Move the gearshift lever to N (Neutral position), and depress the clutch pedal to the floor while starting the engine.

The starter is designed not to operate unless the clutch pedal is fully depressed.

3. Crank the engine **with your foot off the accelerator pedal** by turning the ignition key to START. Release the key when the engine starts. If the engine starts, but fails to run, repeat the above procedure.

- If the engine is very hard to start in extremely cold weather or when restarting, depress the

accelerator pedal a little (approximately 1/5 to the floor) and hold it then crank the engine. Release the key and the accelerator pedal when the engine starts.

- If the engine is very hard to start because it is flooded, depress the accelerator pedal all the way to the floor and hold it. Crank the engine for 5 to 6 seconds. After cranking the engine, release the accelerator pedal. Crank the engine **with your foot off the accelerator pedal** by turning the ignition key to START. Release the key when the engine starts. If the engine starts, but fails to run, repeat the above procedure.



CAUTION

Do not operate the starter for more than 15 seconds at a time. If the engine does not start, turn the key off and wait 10 seconds before cranking again, otherwise the starter could be damaged.

4. Warm-up

Always allow the engine to idle for at least 30 seconds after starting. Drive at moderate speed for a short distance first, especially in cold weather.

DRIVING THE VEHICLE

AUTOMATIC TRANSMISSION

The automatic transmission in your vehicle is electronically controlled by a transmission control module to produce maximum power and smooth operation.

Shown on the following pages are the recommended operating procedures for this transmission. Follow these procedures for maximum vehicle performance and driving enjoyment. If your vehicle is equipped with four wheel drive, see "Using four wheel drive" later in this section.

- After starting the engine, fully depress the foot brake pedal and push the selector lever button before shifting the selector lever to the R, N, D, 2 or 1 position. Be sure the vehicle is fully stopped before attempting to shift the selector lever.

This automatic transmission is designed so that the foot brake pedal MUST be depressed before shifting from P to any drive position while the ignition switch is ON.

The selector lever cannot be moved out of P and into any of the other gear positions if the ignition key is turned to LOCK or if the key is removed from the switch.

1. Keep the foot brake pedal depressed and

push the selector lever button to shift into a driving gear.

2. Release the parking brake and foot brake, then gradually start the vehicle in motion.



WARNING

- **Do not depress the accelerator pedal while shifting from P or N to R, D, 2 or 1. Always depress the brake pedal until shifting is completed. Failure to do so could cause you to lose control and have an accident.**
- **Cold engine idle speed is high, so use caution when shifting into a forward or reverse gear before the engine has warmed up.**
- **Never shift to P or R while the vehicle is moving forward. Never shift to P or D while vehicle is moving rearward. These could cause an accident.**
- **On slippery roads, do not downshift. This may cause a loss of control.**



CAUTION

When stopping the vehicle on an uphill grade, do not hold the vehicle by depressing the accelerator pedal. The foot brake should be used for this purpose.

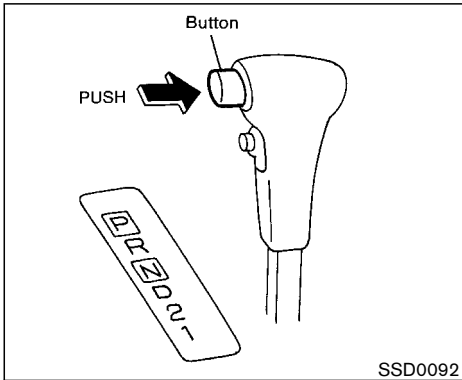

Shifting

Push the button to shift into P, R or from D to 2. All other positions can be selected without pushing the button.

P (Park):

Use this selector position when the vehicle is parked or when starting the engine. Make sure the vehicle is completely stopped. **The brake pedal must be depressed and the selector lever button pushed in to move the selector lever from N (Neutral) or any drive position to P (Park).** Apply the parking brake. When parking on a hill, apply the parking brake

5-12 Starting and driving

first, then move the lever to the P (Park) position.

R (Reverse):

Use this position to back up. Always be sure the vehicle is completely stopped before selecting R (Reverse). **The brake pedal must be depressed and selector lever button pushed in to move the selector lever from P (Park), N (Neutral) or any drive position to R (Reverse).**

N (Neutral):

Neither forward nor reverse gear is engaged. The engine can be started in this position. You may shift to N and restart a stalled engine while the vehicle is moving.

D (Drive):

Use this position for all normal forward driving.

2 (Second gear):

Use for hill climbing, effective engine braking on downhill grades or starting on slippery roads.

Do not downshift into the 2 position at speeds over the following speeds and do not exceed the following speeds in the 2 position:

- Two wheel drive: 60 MPH (95 km/h)

Four wheel drive:
(Part time)

- 2H and 4H positions 50 MPH (80 km/h)
- 4L position 19 MPH (30 km/h)

(All-mode)

- 2WD and AUTO positions 60 MPH (95 km/h)
- 4H position 50 MPH (80 km/h)
- 4LO position 22 MPH (35 km/h)

1 (Low gear):

Use this position when climbing steep hills slowly or driving slowly through deep snow, sand or mud, or for maximum engine braking on steep downhill grades.

Do not shift into 1 position at speeds over the following speeds:

- Two wheel drive: 60 MPH (95 km/h)

Four wheel drive:
(Part time)

- 2H and 4H positions 50 MPH (80 km/h)
- 4L position 19 MPH (30 km/h)

(All-mode)

2WD and AUTO positions

30 MPH (50 km/h)

4H position

30 MPH (50 km/h)

4LO position

10 MPH (15 km/h)

Do not exceed the following speeds in the 1 position:

Two wheel drive:

30 MPH (50 km/h)

Four wheel drive:

(Part time)

2H and 4H positions

30 MPH (50 km/h)

4L position

12 MPH (19 km/h)

(All-mode)

2WD and AUTO positions

30 MPH (50 km/h)

4H position

30 MPH (50 km/h)

4LO position

10 MPH (15 km/h)

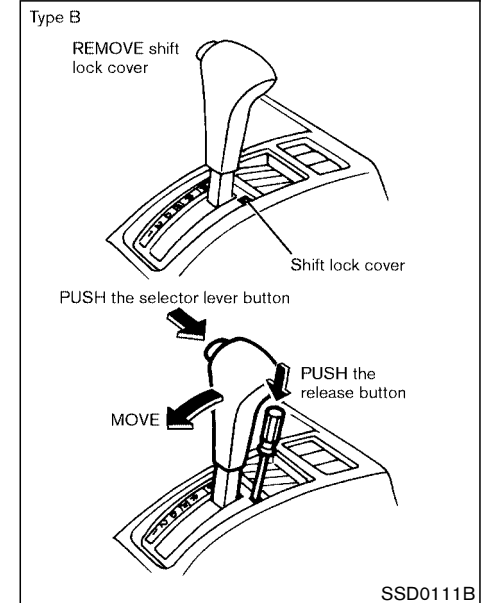
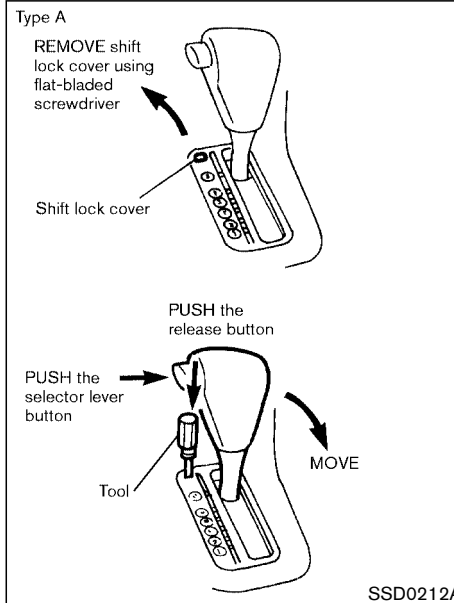

Shift lock release

If the battery charge is low, the select lever may not be moved from the P position even with the brake pedal depressed and the select lever button pushed.

To move the select lever, remove the shift lock cover using a flat-bladed screwdriver, and push the shift lock release button and select lever button with the parking brake securely applied and the brake pedal firmly depressed. The select lever can be moved to N (Neutral).

To push the shift lock release button, follow the procedure as illustrated.

If the lever cannot be moved out of P (Park) have your NISSAN dealer check the automatic transmission system as soon as possible.



WARNING

If the selector lever cannot be moved from the P position while the engine is running and the brake pedal is depressed, the stop lights may not work. Malfunctioning stop lights could cause an accident injuring yourself and others.

Accelerator downshift — In D position —

For rapid passing or hill climbing, fully depress the accelerator pedal to the floor. This shifts the transmission down into second gear or first gear, depending on the vehicle speed.

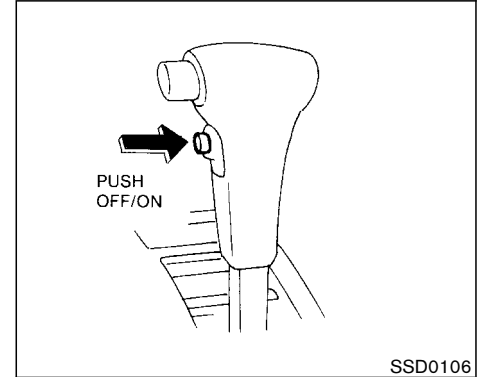

Overdrive switch

Each time your vehicle is started, the transmission is automatically reset to overdrive on.

ON: For normal driving the overdrive switch is engaged. The transmission is upshifted into overdrive as the vehicle speed increases.

The overdrive does not engage until the engine has warmed up.

OFF: For driving up and down long slopes where engine braking would be advantageous, push the overdrive switch. The O/D OFF light illuminates. When cruis-

ing at a low speed or climbing a gentle slope, you may feel uncomfortable shift shocks as the transmission shifts between 3rd and overdrive repeatedly. In this case, press the overdrive switch. The O/D OFF indicator light comes on at this time.

When driving conditions change, press the overdrive switch again. The O/D OFF indicator light goes out.

Remember not to drive at high speeds for extended periods of time with the O/D OFF light illuminated. This reduces the fuel economy.

Fail-safe

When the Fail-safe operation occurs, the next time the key is turned to the ON position, the O/D OFF light will blink for approximately 8 seconds after coming on for 2 seconds. While the vehicle can be driven under these circumstances please note that the gears in the automatic transmission may be locked in third gear.

If the vehicle is driven under extreme conditions, such as excessive wheel spinning and subsequent hard braking, the Fail-safe system may be activated. This will occur even if all electrical circuits are functioning properly. In this case, turn the ignition key OFF and wait for 3 seconds. Then turn the

key back to the ON position. The vehicle should return to its normal operating condition. If it does not return to its normal operating condition have your NISSAN dealer check the transmission and repair if necessary.

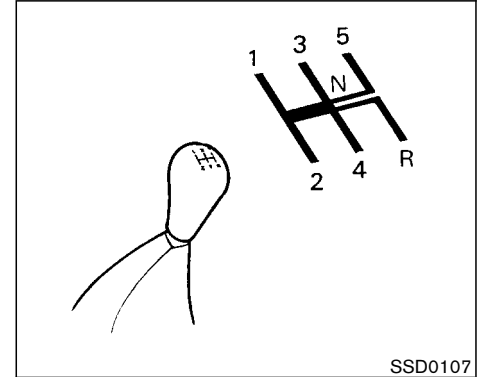

MANUAL TRANSMISSION

Shifting



WARNING

- Do not downshift abruptly on slippery roads. This may cause a loss of control.
- Do not over-rev the engine when shifting to a lower gear. This may cause a loss of control or engine

damage.

To change gears, or when up shifting or down shifting, depress the clutch pedal fully, shift into the appropriate gear, then release the clutch slowly and smoothly.

Start the vehicle in 1st gear and shift to 2nd, 3rd and 4th up to 5th gear in sequence according to the vehicle speed.

You cannot shift directly from 5th gear into Reverse. First shift into the Neutral position, then into Reverse.

If it is difficult to move the shift lever into Reverse or 1st, shift into Neutral, then release the clutch pedal and shift into Reverse or 1st again. If your vehicle is equipped with four wheel drive, see “Using four wheel drive” later in this section.

Suggested up-shift speeds

The table below provides suggested speed ranges for shifting into a higher gear. These suggestions relate to fuel economy and vehicle performance. Actual shift ranges should be adjusted for specific road conditions, weather conditions and individual driving habits.

- Two wheel drive models and four wheel drive models (2H and 4H position)

| | MPH (km/h) |
|------------|------------|
| 1st to 2nd | 15 (24) |
| 2nd to 3rd | 25 (40) |
| 3rd to 4th | 40 (64) |
| 4th to 5th | 45 (72) |

- Four wheel drive model (4L position)

| | MPH (km/h) |
|------------|------------|
| 1st to 2nd | 8 (13) |
| 2nd to 3rd | 12 (20) |
| 3rd to 4th | 20 (32) |
| 4th to 5th | 22 (36) |

Suggested maximum speed in each gear

Downshift to a lower gear if the engine is not running smoothly, or if you need to accelerate.

Do not exceed the maximum suggested speed (shown below) in any gear. For level road driving, use the highest gear suggested for that speed. Always observe posted speed limits, and drive according to the road conditions which will ensure safe operation. Do not overrev the engine when shifting to a lower gear as it may cause engine damage or loss of vehicle control.

Allowable maximum speed in each gear

Two wheel drive models and four wheel drive models (2H position)

| | MPH (km/h) |
|-----------|------------|
| 1st | 22 (36) |
| 2nd | 37 (60) |
| 3rd | 56 (90) |
| 4th & 5th | — (—) |

Four wheel drive models

| | MPH (km/h) |
|-------------|------------|
| 4H position | |
| 1st | 22 (36) |
| 2nd | 37 (60) |
| 3rd | 50 (80) |
| 4th & 5th | 50 (80) |
| 4L position | |
| 1st | 9 (15) |
| 2nd | 19 (30) |
| 3rd | 28 (45) |
| 4th & 5th | 31 (50) |



CAUTION

- **Do not rest your foot on the clutch pedal while driving. This may cause clutch damage.**
- **Stop your vehicle completely before shifting into R (Reverse).**

PARKING BRAKE

- When the vehicle is stopped for a period of time, for example at a stop light, shift to N (Neutral) and release the clutch pedal with the foot brake applied.

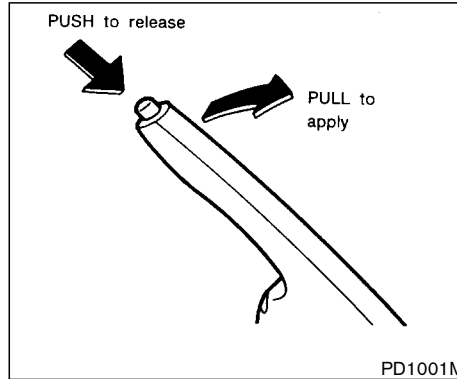

To apply: pull the lever up.

To release:

1. Firmly apply foot brake.
2. **Manual transmission models:**
Place the gearshift lever in the N (Neutral) position.
- Automatic transmission models:**
Move the selector lever to the P (Park) position.
3. While pulling up on the lever slightly, push the button and lower completely.

4. Before driving, be sure the brake warning light goes out.



WARNING

- Be sure the parking brake is fully released before driving. Failure to do so can cause brake failure and lead to an accident.
- Do not release the parking brake from outside the vehicle.
- Do not use the gear shift in place of the parking brake. When parking, be sure the parking brake is fully engaged.
- Do not leave children unattended in a vehicle. They could release the parking brake and cause an accident.

CRUISE CONTROL (if so equipped)



WARNING

Do not use the cruise control when driving under the following conditions:

- when it is not possible to keep the vehicle at a set speed.
- in heavy traffic or in traffic that varies in speed.
- on winding or hilly roads.
- on slippery roads (rain, snow, ice, etc.)
- in very windy areas.

Doing so could cause a loss of vehicle control and result in an accident.



CAUTION

On manual transmission models, do not shift into N (Neutral) without depressing the clutch pedal when the cruise control is set. Should this occur, depress the clutch pedal and turn the main switch

off immediately. Failure to do so may cause engine damage.

PRECAUTIONS ON CRUISE CONTROL

- If the engine coolant temperature becomes excessively high, the cruise control system will automatically be canceled.
- If the cruise control system malfunctions, it cancels automatically. The SET indicator light in the instrument panel then blinks to warn the driver.
- If the SET indicator light blinks, turn the cruise control main switch off and have the system checked by your NISSAN dealer.
- The SET indicator light may blink when the cruise control main switch is turned on while pushing the RES/ACCEL, COAST/SET, or CANCEL switch (located on the steering wheel). To properly set the cruise control system, perform the preceding steps in the order indicated.

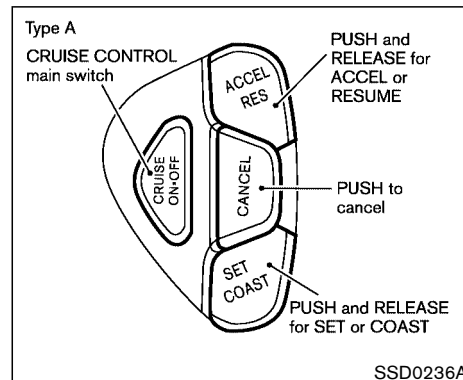

CRUISE CONTROL OPERATIONS

The cruise control allows driving at a fixed speed between 25 to 89 MPH (40 to 144 km/h) without keeping your foot on the accelerator pedal.

To turn on the cruise control, push the main switch on. The CRUISE indicator light on the meter panel will come on.

To set at cruising speed, accelerate your vehicle to the desired speed, push the SET/COAST switch and release it. (The SET light will come on.) Take your foot off the accel-

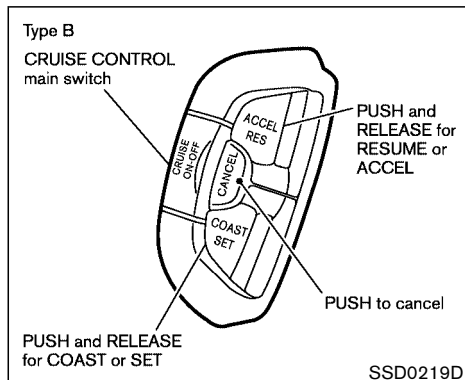

erator pedal. Your vehicle will maintain the set speed.

- **To pass another vehicle,** depress the accelerator pedal. When you release the pedal, the vehicle will return to the previously set speed.
- The vehicle may not maintain the set speed when going up or down steep hills. If this happens, drive without the cruise control.

To cancel the preset speed, follow any of these three methods:

- a) Push the cancel switch; The SET light will go out.

- b) Tap the brake pedal; The SET light will go out.

- c) Turn the main switch off. Both the CRUISE indicator and SET indicator lights will go out.

- If you depress the brake pedal while pushing the ACCEL/RES set switch and reset at the cruising speed, turn the main switch off once and then turn it on again.
- The cruise control will automatically be cancelled if the vehicle slows down more than 8 MPH (13 km/h) below the set speed.
- Depress the clutch pedal (manual transmission), or move the selector lever to N position (automatic transmission). The SET light will go out.

To reset at a faster cruising speed, follow either of these three methods:

- a) Depress the accelerator pedal. When the vehicle attains the desired speed, push and release the SET/COAST switch.

- b) Push and hold the ACCEL/RES set switch. When the vehicle attains the speed you desire, release the switch.

- c) Push, then quickly release the ACCEL/RES set switch. Each time you do this, the set speed will increase by about 1 MPH (1.6 km/h).

To reset at a slower cruising speed, follow either of these three methods:

- a) Lightly tap the brake pedal. When the vehicle attains the desired speed, push the SET/COAST switch and release it.

- b) Push and hold the SET/COAST switch. Release the switch when the vehicle slows down to the desired speed.

- c) Push, then quickly release the SET/COAST switch. Each time you do this, the set speed will decrease by about 1 MPH (1.6 km/h).

To resume the preset speed, push and release the ACCEL/RES set switch. The vehicle will resume the last set cruising speed when the vehicle speed is over 25 MPH (40 km/h).

Precautions

- The CRUISE indicator may sometimes blink when the cruise control switch (Main switch) is turned ON while pushing the ACCEL/RES switch or SET/COAST switch or CANCEL switch (located on the steering wheel). To properly set the cruise control system perform the steps above in the order indicated. (This is a fail-safe mode. Turn the main switch OFF and turn it ON again without pushing the set switch to return to normal operation.)

BREAK-IN SCHEDULE

- If the cruise control system malfunctions, it will cancel automatically. The SET indicator in the meter assembly will then blink to warn the driver.
- When the SET indicator blinks, turn the cruise control switch (Main switch) OFF and have the system checked by your NISSAN dealer.

During the first 1,200 miles (2,000 km), follow these recommendations to obtain maximum engine performance and ensure the future reliability and economy of your new vehicle. Failure to follow these recommendations may result in shortened engine life and reduced engine performance.

- Avoid driving for long periods at constant speed, either fast or slow. Do not run the engine over 4,000 rpm.
- Do not accelerate at full throttle in any gear.
- Avoid quick starts.
- Avoid hard braking as much as possible.
- Do not tow a trailer for the first 500 miles (800 km).

INCREASING FUEL ECONOMY

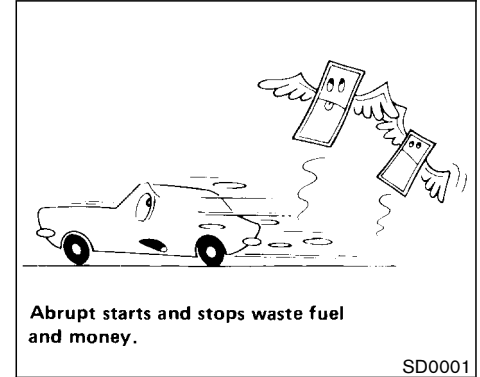

- Accelerate slowly and smoothly. Maintain cruising speeds with a constant accelerator position.
- Drive at moderate speeds on the highway. Driving at high speed will lower fuel economy.
- Avoid unnecessary stopping and braking. Maintain a safe distance behind other vehicles.
- Use a proper gear range which suits road conditions. On level roads, shift into high gear as soon as possible.
- Avoid unnecessary engine idling.
- Keep your engine tuned up.

USING PART TIME FOUR WHEEL DRIVE (4WD)

- Follow the recommended periodic maintenance schedule.
- Keep the tires inflated at the correct pressure. Low pressure will increase tire wear and waste fuel.
- Keep the front wheels in correct alignment. Improper alignment will cause increased tire wear and lower fuel economy.
- Air conditioner operation lowers fuel economy. Use the air conditioner only when necessary.
- When cruising at highway speeds, it is more economical to use the air conditioner and leave the windows closed to reduce drag.
-  Use 4H or 4L position only when necessary. Four wheel drive operation lowers fuel economy.

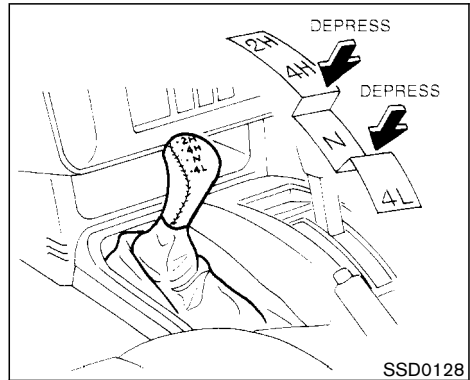

2H — (2WD, high range) Only the rear wheels are driven. Use for driving under the same conditions as standard 2WD vehicle, or state dynamometer I/M testing.

4H — (4WD, high range) Four wheels are driven. Use when driving on roads where it is difficult to drive in the 2H position (i.e., driving at normal speeds on snow covered, icy, wet, muddy or sandy roads).

The 4H position provides greater power and traction. Avoid excessive speed, as it will cause increased fuel consumption and higher oil temperature, and could damage drivetrain components. Speeds over 50

MPH (80 km/h) in 4H are not recommended.

4L — (4WD, low range) Four wheels are driven. Use when climbing or descending steep hills, or during hard driving in sand, mud or deep snow. **The 4L position provides maximum power and traction. Avoid raising vehicle speed excessively, as the maximum speed is approximately 30 MPH (50 km/h).**

N — No wheels are driven. Always keep the transfer lever out of the N position. Shift the lever quickly and smoothly when moving across the N position with the vehicle stopped.

WARNING

- **When parking the vehicle, apply the parking brake and shift the transfer control lever in the 2H, 4H or 4L position.**
- **Do not leave the transfer control lever in the N position. Otherwise, the vehicle could roll unexpectedly even if the manual transmission is in any gear or the automatic transmission in the P position. If the ATP light is on, this indicates that the automatic**

transmission P position will not function and the transfer lever is in neutral.

- Failure to engage the transfer control lever in 2H, 4H or 4L could result in the vehicle moving unexpectedly, resulting in serious personal injury or property damage.



CAUTION

Do not drive the vehicle in 4H or 4L on dry hard surface roads. Driving on dry, hard surfaces in 4H or 4L may cause unnecessary noise, tire wear and increased fuel consumption.

TRANSFER CASE SHIFTING PROCEDURES

| TO SHIFT TRANSFER CASE: | MANUAL TRANSMISSION MODELS SHIFT PROCEDURE |
|----------------------------|-----------------------------------------------------------------------------------------------------------------------------------------------------------------------------------------------------------|
| From 2H to 4H | Move the transfer lever to 4H. This can be done at any speed up to 50 MPH (80 km/h), and it is not necessary to depress the clutch pedal. Perform this operation when driving straight. |
| From 4H to 2H | Move the transfer lever to 2H. This can be done at any speed up to 50 MPH (80 km/h), and it is not necessary to depress the clutch pedal. Perform this operation when driving straight. |
| From 4H or 4L to 4L or 4H | <ol style="list-style-type: none"> 1. Stop the vehicle. 2. Depress the clutch pedal. 3. Depress the transfer lever and move it to the desired 4L or 4H position. |
| From 2H to 4L | <ol style="list-style-type: none"> 1. Stop the vehicle. 2. Depress the clutch pedal. 3. Depress the transfer lever and move it to 4L. Change gears quickly and smoothly. |
| From 4L to 2H | <ol style="list-style-type: none"> 1. Stop the vehicle. 2. Depress the clutch pedal. 3. Depress the transfer lever and move it to 2H. |

| TO SHIFT TRANSFER CASE: | AUTOMATIC TRANSMISSION MODELS SHIFT PROCEDURE |
|----------------------------|---------------------------------------------------------------------------------------------------------------------------------------------------------------------------------------------------------------------------------------------------------|
| From 2H to 4H | Move the transfer lever to 4H. This can be done at any speed up to 50 MPH (80 km/h), and it is not necessary to move the selector lever to the N position. Perform this operation when driving straight. |
| From 4H to 2H | Move the transfer lever to 2H. This can be done at any speed up to 50 MPH (80 km/h), and it is not necessary to move the selector lever to the N position. Perform this operation when driving straight. |
| From 4H or 4L to 4L or 4H | <ol style="list-style-type: none"> 1. Stop the vehicle. Keep the engine running. 2. Move the selector lever to the N position. 3. Depress the transfer lever and move it to the desired 4L or 4H position. |
| From 2H to 4L | <ol style="list-style-type: none"> 1. Stop the vehicle. Keep the engine running. 2. Move the selector lever to the N position. 3. Depress the transfer lever and move it to 4L. Change gears quickly and smoothly. |
| From 4L to 2H | <ol style="list-style-type: none"> 1. Stop the vehicle. Keep the engine running. 2. Move the selector lever to the N position. 3. Depress the transfer lever and move it to 2H. |

When moving the transfer lever from 4H or 4L to 4L or 4H, you must always move it quickly through the N position. If you are slow to shift, the engine idle speed will allow the transfer gears to speed up and gear clashing will occur.

Do not move the transfer lever from 4H or 4L to 4L or 4H, from 2H to 4L and from 4L to 2H with the engine turned off. Otherwise, you will have difficulty moving the transfer lever to the desired position.

Do not leave the transfer lever in the N position with the engine running. Stopping in the N position of the transfer case may cause gear grinding when selecting another gear. Changing the transfer case gear quickly and smoothly will eliminate this.

USING ALL-MODE FOUR WHEEL DRIVE (4WD)



CAUTION

- **Do not drive the vehicle in the 4H or 4LO position on dry hard surface roads. Driving on dry hard surface roads in 4H or 4L may cause unnecessary noise, tire wear and increased fuel consumption.**

If the 4WD warning light turns on when you are driving on dry hard surface roads









- **in the AUTO or 4H position, shift the 4WD shift switch to 2WD.**
- **in the 4LO position, stop the vehicle, move the automatic transmission lever to the N position, and shift the 4WD shift switch to 2WD.**

Have your vehicle checked by an authorized NISSAN dealer as soon as possible.

TRANSFER CASE SHIFTING PROCEDURES

All mode 4WD system provides 4 positions (AUTO, 2WD, 4H and 4LO), so you can select the desired drive mode according to the driving conditions.

2WD or 4WD shift procedure

| 4WD Shift Switch | Wheels Driven | Indicator Light | | Use Conditions | 4WD Shift Procedure |
|-------------------------------------------------------------------------------------------|-------------------------|-----------------------------------------------------------------------------------|-----------------------|-------------------------------------------------------------------------------------------------------------------------------------------------------------------|---------------------------------------------------------------------------------------------------------------------------------------------------------------------------------------------------------------------------------------------------------------------------------------------------------------------------------------------------------|
| | | 4WD shift | Transfer 4LO position | | |
|  AUTO | Rear wheels or 4 wheels |  | | For driving on paved or slippery roads. | Move the 4WD shift switch. 2WD ↔ AUTO ↔ 4H 4WD shift indicator light will indicate transfer shift position engaged. IT IS NOT NECESSARY TO MOVE THE AUTOMATIC TRANSMISSION SELECT LEVER TO THE N POSITION IN THIS OPERATION. PERFORM THIS OPERATION WHEN DRIVING STRAIGHT. |
|  2WD | Rear wheels |  | | For driving on dry, paved roads (Economy drive) or state dynamometer I/M testing. | |
|  4H | 4 wheels |  | | For driving on rocky, sandy or snow-covered roads. | |
|  4LO | 4 wheels |  | Illuminated | For use when maximum power and traction is required (for example on steep grades or rocky, sandy, muddy roads). | 1. Stop the vehicle. 2. Move the automatic transmission selector lever to the N position. 3. Push the 4WD shift switch and move it to 4LO or 4H. YOU CANNOT MOVE THE TRANSFER 4WD SHIFT SWITCH BETWEEN 4H AND 4LO (OR 4LO TO 4H) UNLESS YOU HAVE FIRST STOPPED THE VEHICLE AND MOVED THE AUTOMATIC TRANSMISSION SHIFT LEVER TO NEUTRAL. *2 |
| | Neutral |  | * 1 May blink | Neutral disengages the automatic transmission mechanical parking lock, which will allow the vehicle to roll. Do not leave the transfer shift position in Neutral. | |

- *1: ● The transfer 4LO position indicator light may blink. Stop the vehicle. Be sure to shift the 4WD shift switch after the automatic transmission lever has been shifted to the N position. If the indicator light keeps blinking after the 4WD shift procedure in the previous page, drive slowly without abrupt maneuvers for a while. Then the light will turn on or off.
- Avoid making a turn or abrupt starts while shifting to 4LO. Otherwise gears may grind, damaging the drive system.

*2: Make sure the transfer 4LO position indicator light turns on when you shift the 4WD shift switch to 4LO.

The transfer case 4WD shift switch is used to select either 2WD or 4WD depending on the driving conditions. There are four types of drive modes available, AUTO, 2WD, 4H and 4LO.

The 4WD shift switch electronically controls the transfer case operation. Rotate the switch to move between each mode, 2WD, AUTO, 4H and 4LO.

You must push the switch in to select 4LO, and the vehicle MUST be stationary and the automatic transmission selector lever is in the N position when changing into or out of 4LO.



WARNING

When parking, apply the parking brake before stopping the engine and make sure that the 4WD shift indicator light is on and the ATP warning light goes off. Otherwise, the vehicle could unexpectedly move even if the automatic transmission is in the P position.



CAUTION

- **Never shift the 4WD shift switch between 4LO and 4H while driving.**
- **The 4H position provides greater power and traction. Avoid excessive speed, as it will cause increased fuel consumption and higher oil temperature, and could damage drivetrain components. Speeds over 50 MPH (80 km/h) in 4H are not recommended.**
- **The 4LO position provides maximum power and traction. Avoid raising ve-**

hicle speed excessively, as the maximum speed is approximately 30 MPH (50 km/h).

- **When driving straight, shift the 4WD shift switch to the 2WD, AUTO or 4H position. Do not move the 4WD shift switch when making a turn or reversing.**
- **Do not shift the 4WD shift switch (between 2WD, AUTO and 4H) while driving on steep downhill grades. Use the engine brake.**
- **Do not operate the 4WD shift switch (between 2WD, AUTO and 4H) with the rear wheels spinning.**
- **Do not drive on dry hard surface roads in the 4H or 4LO position. Driving on dry hard surfaces in 4H or 4LO may cause unnecessary noise and tire wear. We recommend driving in the 2WD or AUTO position under these conditions.**
- **Vehicles equipped with a limited slip differential (LSD) have improved driv-**

ing performance on rough roads. They have increased traction performance, so when making a turn on paved roads, vibration and tire squealing may occur.

- The 4WD transfer case may not be shifted between 4H and 4LO at low ambient temperatures and the transfer 4LO position indicator light may blink even when the 4WD shift switch is shifted. After driving for a while you can change the 4WD transfer case between 4H and 4LO.

When driving on rough roads,

- Set the 4WD shift switch to AUTO, 4H or 4LO.
- Drive carefully according to the road surface conditions.

When the vehicle is stuck,

- Place stones or wooden blocks under the tires to free the vehicle.
- Set the 4WD shift switch to 4H or 4LO.
- If it is difficult to free the vehicle, repeat

5-28 Starting and driving

forward and backward movement to increase the movement.

- If the vehicle is stuck deep in mud, tire chains may be effective.



CAUTION

- Do not increase the tire rotation excessively. Tires will sink deep into the mud, making it difficult to free the vehicle.
- Avoid shifting gears with the engine running at high speeds as this may cause malfunction.

4WD shift switch operations

- Shift the 4WD shift switch to either the 2WD, AUTO, 4H or 4LO position, depending on driving conditions.

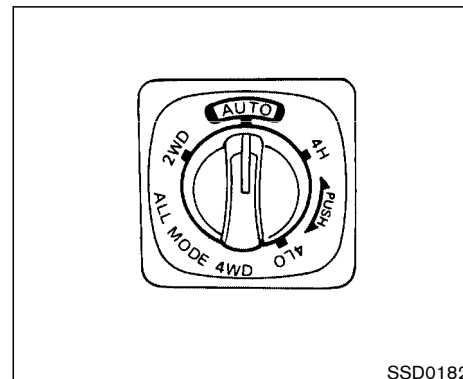

- With the switch set to the AUTO position, distribution of torque to the front and rear wheels changes automatically, depending on road conditions encountered [ratio; 0 : 100 (2WD) → 50 : 50 (4WD)]. This results in improved driving stability.
- If the 4WD shift switch is operated while making a turn, accelerating or decelerating or if the key switch is turned off while in the AUTO, 4H or 4LO, you may feel a jerk. This is not abnormal.
- When the vehicle is stopped after making a turn, you may feel a slight jolt after the selector lever is shifted to N or P.

This occurs because the transfer clutch is released and not because of a malfunction.



CAUTION

- When driving straight, shift the 4WD shift switch to the 2WD, AUTO, or 4H position. Do not move the 4WD shift switch when making a turn or reversing.
- Do not shift the 4WD shift switch while driving on steep downhill grades. Use the engine brake.
- Do not operate the 4WD shift switch with the rear wheels spinning.
- Before placing the 4WD shift switch in the 4H position from 2WD or AUTO, ensure the vehicle speed is less than 50 MPH (80 km/h). Failure to do so can damage the 4WD system.
- Never shift the 4WD shift switch between 4LO and 4H while driving.
- Engine idling speed is high while

warming up the engine. Be especially careful when starting or driving on slippery surfaces with the 4WD shift switch set in AUTO.

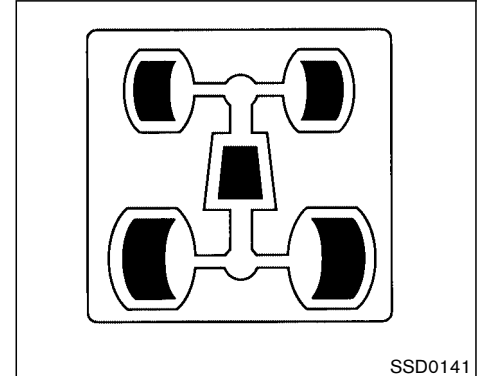

4WD shift indicator light

The 4WD shift indicator light is located in the tachometer.

The light should turn off within 1 second after turning the ignition switch to ON.

While the engine is running, the 4WD shift indicator light will illuminate the position selected by the 4WD shift switch.

- **The 4WD shift indicator light may blink while shifting from one drive mode to the other. When the shifting is completed, the 4WD shift indicator light will come on. If the indicator light does not**

come on immediately, make sure the area around the vehicle is safe, and drive the vehicle straight, accelerate or decelerate or move the vehicle in reverse, then shift the 4WD shift switch.



- If the 4WD warning light comes on, the 4WD shift indicator light goes out.



CAUTION

- When the 4WD shift switch is turned to the AUTO position at low ambient temperatures, the 4WD shift indicator light may show 4H. If this happens, all four wheels are driven as torque distribution is in the 4H position. Be careful as the vehicle may become difficult to turn. When the vehicle is driven, the 4WD shift indicator light should change to AUTO.
- If the 4WD shift indicator light indication changes to 2WD when the 4WD shift switch is shifted to the AUTO or 4H position at low ambient temperatures, the 2WD mode may be being engaged due to malfunctioning drive

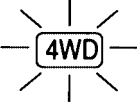
system. If the indicator does not return to normal and the 4WD warning light comes on, have the system checked by the nearest NISSAN dealer.

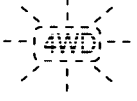
| Warning light | Comes on or blinks when |
|-----------------------------------------------------------------------------------------------------------|---------------------------------------------------------------|
|  <p>Comes on</p> | <p>There is a malfunction in the four wheel drive system.</p> |
|  <p>Blinks rapidly</p> | <p>The transfer oil temperature rises abnormally.</p> |
|  <p>Blinks slowly</p> | <p>The difference in wheel rotation is large.</p> |

SSD0142A

4WD warning light

The 4WD warning light is located in the meter.

The 4WD warning light comes on when the key switch is turned to ON. It turns off soon after the engine is started.

If any malfunction occurs in the 4WD system when the key switch is ON, the warning light will either remain illuminated or blink.

If the 4WD warning light comes on, the 4WD indicator light goes out.

High-temperature transfer case oil makes the warning light blink rapidly (about twice per second). If the warning light blinks rapidly during operation, stop the vehicle in a safe place immediately. Then if the light goes off after a while, you can continue driving.

A large difference between the diameters of front and rear wheels will make the warning light blink slowly (about once per two seconds). Change the 4WD shift switch into 2WD and do not drive fast.



CAUTION

- If the warning light comes on or blinks slowly during operation or rapidly after stopping the vehicle for a while, have your vehicle checked by an authorized NISSAN dealer as soon as possible.
- Shifting between 4H and 4LO is not

recommended when the 4WD warning light turns on.

- When the warning light comes on, the 2WD mode may be engaged even if the 4WD shift switch is in AUTO or 4H. Be especially careful when driving. If corresponding parts are malfunctioning, the 4WD mode will not be engaged even if the 4WD shift switch is shifted.
- Do not drive on dry hard surface roads in the 4H or 4LO position. Driving on dry hard surface roads in 4H or 4L may cause unnecessary noise, tire wear and increased fuel consumption.

If the 4WD warning light turns on when you are driving on dry hard surface roads

- in the AUTO or 4H position, shift the 4WD shift switch to 2WD.
- in the 4LO position, stop the vehicle, move the automatic transmission lever to the N position,

and shift the 4WD shift switch to 2WD.

- If the warning light is still on after the above operation, have your vehicle checked by an authorized NISSAN dealer as soon as possible.
- The transfer case may be damaged if you continue driving with the warning light blinking rapidly.

PARKING/PARKING ON HILLS

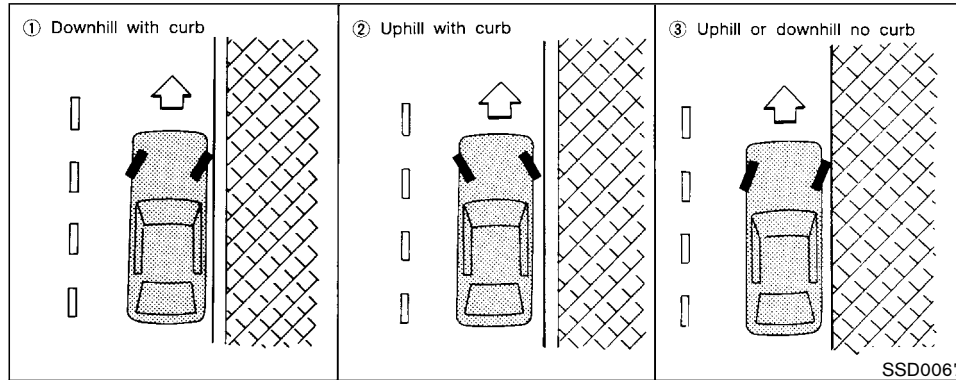

WARNING

- Do not stop or park the vehicle over flammable materials, such as dry grass, waste paper, or rags. They may ignite and cause a fire.
-  The transfer shift lever must be in the 2H, 4H or 4L position and the parking brake must be set to prevent the vehicle from rolling.
- Never place the transfer shift lever in

the N position, otherwise, the vehicle could roll unexpectedly even if the manual transmission is in gear or the automatic transmission is in the P position. This could result in serious personal injury or property damage.

- Never leave the engine running while the vehicle is unattended.
- Never leave children unattended in the vehicle.

1. Firmly apply the parking brake.

2. Manual transmission models:

Place the shift lever in the R (Reverse) position. When parking on an uphill grade, place the gearshift lever in the 1st position.

Automatic transmission models:

Move the selector lever to the P (Park) position.



WARNING

- Safe parking procedures require that both the parking brake be set and the transmission placed into the P (Park) for automatic transmission models or in an appropriate gear for manual transmission models. Failure to do so could cause the vehicle to move unexpectedly or roll away and result in an accident.
- Make sure the automatic transmission selector lever has been pushed as far forward as it can go and cannot be moved without depressing the button at the end of the lever.

Part time 4WD models:

- If the ATP light is ON, this indicates that the automatic transmission P (park) position will not function and the transfer shift lever is in the N position. Failure to engage the transfer shift lever in H or 4L could result in the vehicle moving unexpectedly, resulting in serious personal injury or property damage.

All-mode 4WD models:

- If the ATP light is ON, this indicates that the automatic transmission P (park) position will not function and the transfer case is in neutral. Make sure that the 4WD shift indicator light (and transfer 4LO position indicator) light remains illuminated before stopping the engine. Otherwise, the vehicle could unexpectedly move even if the automatic transmission is in the P (park) position.

3. To help prevent the vehicle rolling into the street when parked on a sloping drive way, it

is a good practice to turn the wheels as illustrated.

- **HEADED DOWNHILL WITH CURB:** ①

Turn the wheels into the curb and move the vehicle forward until the curb side wheel gently touches the curb.

- **HEADED UPHILL WITH CURB:** ②

Turn the wheels away from the curb and move the vehicle back until the curb side wheel gently touches the curb.

- **HEADED UPHILL OR DOWNHILL, NO CURB:** ③

Turn the wheels toward the side of the road so the vehicle will move away from the center of the road if it moves.

Make sure the ATP light is off before stopping the engine.

4. Turn the ignition key to the LOCK position and remove the key.

POWER STEERING

The power assisted steering is designed to use a hydraulic pump, driven by the engine, to assist steering.

If the engine stops or drive belt breaks, you will still have control of the vehicle. However, much greater steering effort is needed, especially in sharp turns or at low speeds.



WARNING

If the engine is not running or is turned off while driving, the power assist for the steering will not work. Steering will be much harder to operate.

BRAKE SYSTEM

BRAKING PRECAUTIONS

The brake system has two separate hydraulic circuits. If one circuit malfunctions, you will still have braking at two wheels.

Vacuum assisted brake

The brake booster aids braking by using engine vacuum. If the engine stops, you can stop the vehicle by depressing the brake pedal. However, greater foot pressure on the brake pedal will be required to stop the vehicle and the stopping distance will be longer.

Using the brakes

Avoid resting your foot on the brake pedal while driving. This will overheat the brakes, wear out the brake linings and pads faster and reduce gas mileage.

To help save the brakes and to prevent the brakes from overheating, before going down a slope or long grade, reduce speed and downshift to a lower gear.

Wet brakes

When the vehicle is washed or driven through water, the brakes may get wet. As a result, your braking distance will be longer and the vehicle may pull to one side during braking.

5-34 Starting and driving

To dry brakes, drive the vehicle at a safe speed while lightly pressing the brake pedal to heat-up the brakes. Do this until the brakes return to normal. Avoid driving the vehicle at high speeds until the brakes function correctly.



WARNING

- **While driving on a slippery surface, be careful when braking, accelerating or downshifting. Abrupt braking or accelerating could cause the wheels to skid and result in an accident.**
- **If the engine is not running or is turned off while driving, the power assist for the brakes will not work. Braking will be harder.**

ANTI-LOCK BRAKE SYSTEM (ABS)

The anti-lock brake system controls the brakes at each wheel so the wheels will not lock when braking abruptly or when braking on slippery surfaces. The system detects the rotation speed at each wheel and varies the brake fluid pressure to prevent each wheel from locking and sliding. By preventing wheel lockup, the system helps

the driver maintain steering control and helps to minimize swerving and spinning on slippery surfaces.

Using the system

Depress the brake pedal and hold it down.



WARNING

Do not pump the brake pedal. Doing so may result in increased stopping distances.

Normal operation

The anti-lock brake system will not operate at speeds below 3 to 6 MPH (5 to 10 km/h) to completely stop the vehicle. (The speeds will vary according to road conditions.) When the anti-lock system senses that one or more wheels are close to locking up, the actuator (under the hood) rapidly applies and releases hydraulic pressure (like pumping the brakes very quickly). While the actuator is working, you may feel a pulsation in the brake pedal and hear a noise or vibration from the actuator under the hood. This is normal and indicates that the anti-lock system is working properly. However, the pulsation may indicate that road conditions are hazardous and

extra care is required while driving.

If a tire slips on rough roads for more than 10 seconds, the ABS brake warning light may come on. Turn OFF the ignition key, restart the engine and drive the vehicle at speeds above 20 MPH (30 km/h). If the warning light does not go out, have the vehicle checked at a NISSAN dealer.

Self-test feature

The anti-lock brake system consists of electronic sensors, electric pumps, and hydraulic solenoids controlled by a computer. The computer has a built-in diagnostic feature that tests the system each time you start the engine and move the vehicle at a low speed in forward or reverse. When the self-test occurs, you may hear a clunk noise and/or feel a pulsation in the brake pedal. This is normal and is not an indication of any malfunction. If the computer senses any malfunction, it switches the anti-lock brake system OFF and turns on the ABS brake warning light in the dashboard. The brake system will then behave normally, but without anti-lock assistance.

If the light comes on during the self check, or while you are driving, you should take your vehicle to your NISSAN dealer for repair at your earliest convenience.



WARNING

The anti-lock brake system is a sophisticated device, but it cannot prevent accidents resulting from careless or dangerous driving techniques. It can help maintain vehicle control during braking on slippery surfaces, but remember that the stopping distance on slippery surfaces will be longer than on normal surfaces, even with the anti-lock system. Stopping distances may also be longer on rough, gravel or snow covered roads, or if you are using tire chains. Always maintain a safe distance from the vehicle in front of you. Ultimately, the responsibility for safety of self and others rests in the hands of the driver.

Tire type and condition of tires may also affect braking effectiveness.

- **When replacing tires, install the specified size of tires on all four wheels.**
- **When installing a spare tire, make sure it is the proper size and type as**

specified on the tire placard. See “Tire placard” in the “9. Technical and consumer information” section for tire placard location information.

VEHICLE DYNAMIC CONTROL (VDC) SYSTEM (if so equipped)

When driving on slippery surfaces or suddenly avoiding obstacles on roads, the vehicle might swerve or slip. With the vehicle dynamic control (VDC) system, sensors detect these movements and control the braking and engine output to help improve vehicle stability while driving.

- When the vehicle dynamic control system is operating, the slip indicator in the instrument panel blinks.
- When only the traction control system portion of the vehicle dynamic control system is operating, the slip indicator will also blink.
- If the slip indicator blinks, the vehicle is under slippery conditions. Be sure to drive carefully. See “Slip indicator light”, and “Vehicle dynamic control off indicator light” in the “2. Instruments and controls” section.
- Indicator light
If a malfunction occurs in the system, the SLIP and ^{VDC}_{OFF} indicator lights come on in the meter panel.
As long as these warning lights are on, the traction control function is canceled.

If the vehicle is operated with the vehicle dynamic control system turned off, all VDC functions will be turned off. The brake LSD and ABS system will still operate with the VDC system off. VDC is provided the “Brake Limited Slip Differ-

ential” system. The Brake LSD system works when the one of driving wheels is spinning on a slippery surface. The Brake LSD system brakes the spinning driving wheel, then distributes the driving power to the another. While the Brake LSD system or the ABS system is activated, the slip indicator light will blink and you may feel a pulsation in the brake pedal and hear operation sound. This is normal.

While the VDC system is operating, you may feel a pulsation in the brake pedal and hear a noise or vibration from under the hood. This is normal and indicates that the VDC system is working properly.

The computer has a built in diagnostic feature that tests the system each time you start the engine and move the vehicle forward or in reverse at a slow speed. When the self-test occurs, you may hear a clunk noise and/or feel a pulsation in the brake pedal. This is normal and is not an indication of a malfunction.



WARNING

- **The vehicle dynamic control system is designed to help improve driving stability but does not prevent accidents due to abrupt steering opera-**

tion at high speeds or by careless or dangerous driving techniques. Reduce vehicle speed and be especially careful when driving and cornering on slippery surfaces and always drive carefully.

- **If suspension parts such as shock absorbers, struts, springs and bushings are not standard equipment or are extremely deteriorated, the vehicle dynamic control off indicator light may come on.**
- **When driving on extremely inclined surfaces such as higher banked corners, the vehicle dynamic control system may not operate properly or the vehicle dynamic control off indicator light may come on. Do not drive on these types of roads.**
- **If the tires other than the recommended ones are used, the vehicle dynamic control system may not operate properly or the vehicle dynamic control off indicator light may come on.**

COLD WEATHER DRIVING

- **The vehicle dynamic control system is not a substitute for winter tires or tire chains on a snow covered road.**

FREEING A FROZEN DOOR LOCK

To prevent a door lock from freezing, apply de-icer or glycerin to it through the key hole. If the lock becomes frozen, heat the key before inserting it into the key hole.

ANTI-FREEZE

In the winter when it is anticipated that the temperature will drop below 32°F (0°C), check anti-freeze to assure proper winter protection. For details, see “Engine cooling system” in the “8. Maintenance and do-it-yourself” section.

BATTERY

If the battery is not fully charged during extremely cold weather conditions, the battery fluid may freeze and damage the battery. To maintain maximum efficiency, the battery should be checked regularly. For details, see “Battery” in the “8. Maintenance and do-it-yourself” section.

DRAINING OF COOLANT WATER

If the vehicle is to be left outside without anti-freeze, drain the cooling system by opening the drain valves located under the radiator and on the engine block. Refill before operating the vehicle. See “Engine cooling system” in the “8. Maintenance and do-it-yourself” section for Changing Engine Coolant.

TIRE EQUIPMENT

1. SUMMER tires are of a tread design to provide superior performance on dry pavement. However, the performance of these tires will be substantially reduced in snowy and icy conditions. If you operate your vehicle on snowy or icy roads, NISSAN recommends the use of MUD & SNOW or ALL SEASON tires on all four wheels. Please consult your NISSAN dealer for the tire type, size, speed rating and availability information.
2. For additional traction on icy roads, studded tires may be used. However, some Provinces and States prohibit their use, so, before installing studded tires, check local, state and provincial laws.

Skid and traction capabilities of studded snow tires, on wet or dry surfaces, may be poorer than that of non-studded snow tires.

3. TIRE CHAINS may be used if desired. Make sure they are of proper size for the tires on your vehicle and are installed according to the chain manufacturer’s suggestions. Use of tire chains may be prohibited according to location. Check the local laws before installing tire chains. When installing tire chains, make sure they are of proper size for the tires on your vehicle and are installed according to

the chain manufacturer's suggestions. **Use only SAE Class S chains.** Class "S" chains are used on vehicles with restricted tire to vehicle clearance. Vehicles that can use Class "S" chains are designed to meet the SAE standard minimum clearances between the tire and the closest vehicle suspension or body component required to accommodate the use of a winter traction device (tire chains or cables). The minimum clearances are determined using the factory equipped tire size. Other types may damage your vehicle. Use chain tensioners when recommended by the tire chain manufacturer to ensure a tight fit. Loose end links of the tire chain must be secured or removed to prevent the possibility of whipping action damage to the fenders or underbody. If possible, avoid fully loading your vehicle when using tire chains. In addition, drive at a reduced speed. Otherwise, your vehicle may be damaged and/or vehicle handling and performance may be adversely affected.

Do not use the chains on dry roads.

Tire chains must be installed only on the rear wheels and not on the front wheels.

Do not drive with tire chains on paved roads which are clear of snow. Driving with chains in such conditions can cause damage to the various mechanisms of the vehicle due to

some overstress. When driving on clear paved roads, be sure to change to 2WD.

4. For four wheel drive:
If you install snow tires, they must also be the same size, brand, construction and tread pattern on all four wheels.



CAUTION

ONLY use spare tires specified for each four wheel drive model.

SPECIAL WINTER EQUIPMENT

It is recommended that the following items be carried in the vehicle during winter:

- A scraper and stiff-bristled brush to remove ice and snow from the windows and wiper blades.
- A sturdy, flat board to be placed under the jack to give it firm support.
- A shovel to dig the vehicle out of snow- drifts.
- Extra window washer fluid to refill the reservoir tank.

DRIVING ON SNOW OR ICE



WARNING

- **Wet ice (32°F, 0°C and freezing rain), very cold snow or ice can be slick and very hard to drive on. The vehicle will have a lot less traction or grip under these conditions. Try to avoid driving on wet ice until the road is salted or sanded.**
- **Whatever the condition, drive with caution. Accelerate and slow down with care. If accelerating or downshifting too fast, the drive wheels will lose even more traction.**
- **Allow more stopping distance under these conditions. Braking should be started sooner than on dry pavement.**
- **Allow greater following distances on slippery roads.**
- **Watch for slippery spots (glare ice). These may appear on an otherwise clear road in shaded areas. If a patch of ice is seen ahead, brake before**

reaching it. Try not to brake while actually on the ice, and avoid any sudden steering maneuvers.

- **Do not use cruise control on slippery roads.**
- **Snow can trap dangerous exhaust gases under your vehicle. Keep snow clear of the exhaust pipe and from around your vehicle.**

ENGINE BLOCK HEATER (if so equipped)

An engine block heater to assist extreme cold temperature starting is available through your NISSAN dealer.



WARNING

Do not use your heater with an ungrounded electrical system or two-pronged (cheater) adapters. You can be injured by an electrical shock if you use an ungrounded connection.

|

MEMO

—

—

|

6 In case of emergency

| | | | |
|-----------------------------------------------------------|-----|-------------------------------------------------|------|
| Flat tire..... | 6-2 | Push starting..... | 6-11 |
| Low tire pressure warning system (if so equipped)..... | 6-2 | If your vehicle overheats..... | 6-11 |
| Changing a flat tire..... | 6-2 | Towing your vehicle..... | 6-12 |
| Jump starting..... | 6-9 | Towing recommended by Nissan..... | 6-14 |
| | | Vehicle recovery (Freeing a stuck vehicle)..... | 6-16 |

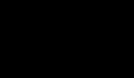

FLAT TIRE

LOW TIRE PRESSURE WARNING SYSTEM (if so equipped)

The low tire pressure warning system monitors tire pressure of all wheels (except the spare tire). If the vehicle is being driven with very low tire pressure (lower than 25 psi, 171 kPa), the low tire pressure warning system will activate and warn you of it by the low tire pressure warning light. This system will activate only when the vehicle is driven at speeds above 20 MPH (32 km/h). For more details, please refer to "Warning/indicator lights and audible reminders" in the "2. Instruments and controls" section, and "Low tire pressure warning system" in the "5. Starting and driving" section.



WARNING

- **If the low tire pressure warning light illuminates while driving, avoid sudden steering maneuvers or abrupt braking, reduce vehicle speed, pull off the road to a safe location and stop the vehicle as soon as possible. Serious vehicle damage could occur and may lead to an accident and could result in serious personal in-**

jury. Check the tire pressure for all four wheels and adjust the pressure to the COLD tire pressure shown on the tire placard. If you have a flat tire, replace it with a spare tire as soon as possible.

- **When a spare tire is mounted or a wheel is replaced, the low tire pressure warning system will not function. Contact your NISSAN dealer as soon as possible for tire replacement and/or system resetting.**
- **Do not inject any tire liquid or aerosol tire sealant into the tires, as this may cause a malfunction of the tire pressure sensors.**

CHANGING A FLAT TIRE

If you have a flat tire, follow the instructions below.

Stopping the vehicle

1. Safely move the vehicle off the road away from traffic.
2. Turn on the hazard warning flasher.

3. Park on a level surface and apply the parking brake. Shift the manual transmission into reverse (automatic transmission in P).



WARNING

- **4x4** The transfer control lever must be in the 2H, 4H or 4L position.
- **Never place the transfer control lever in the N position. Otherwise, the vehicle could roll unexpectedly even if the manual transmission is in gear or the automatic transmission is in the P position. This could result in serious personal injury or property damage.**

All-mode 4WD models:

- **Make sure the 4WD shift indicator and/or transfer 4LO position indicator light remains illuminated before stopping the engine.**
- **Make sure the ATP light is off before stopping the engine. Otherwise, the vehicle could roll unexpectedly even if the automatic transmission is in**

the P position. This could result in serious personal injury or property damage.

4. Turn off the engine.
5. Raise the hood to warn other traffic and to signal professional road assistance personnel that you need help.
6. Have all passengers get out of the vehicle and stand in a safe place away from traffic and clear of the vehicle.



WARNING

- **Make sure that the parking brake is securely applied and the manual transmission is shifted into R (reverse), on the automatic transmission in P (Park).**
- **Never change tires when the vehicle is on a slope, ice or a slippery area. This is hazardous.**
- **Never change tires if oncoming traffic**

is close to your vehicle. Wait for professional road assistance.

- **When a spare tire is mounted or a wheel is replaced, the low tire pressure warning system will not function. Contact your NISSAN dealer as soon as possible for tire replacement and/or system resetting. (For models with the low tire pressure warning system)**

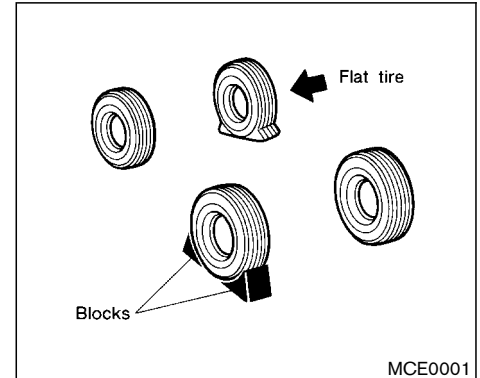

Blocking wheels

Place suitable blocks at both the front and back of the wheel diagonally opposite the flat tire to prevent the vehicle from rolling when it is jacked up.



WARNING

Be sure to block the wheel as the vehicle may move and could cause personal injury.

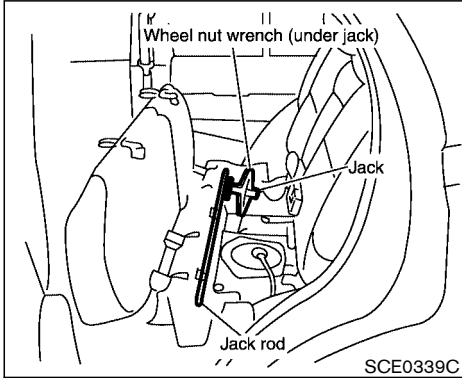

Getting the spare tire and tools

Remove jacking tools and spare tire from storage area.

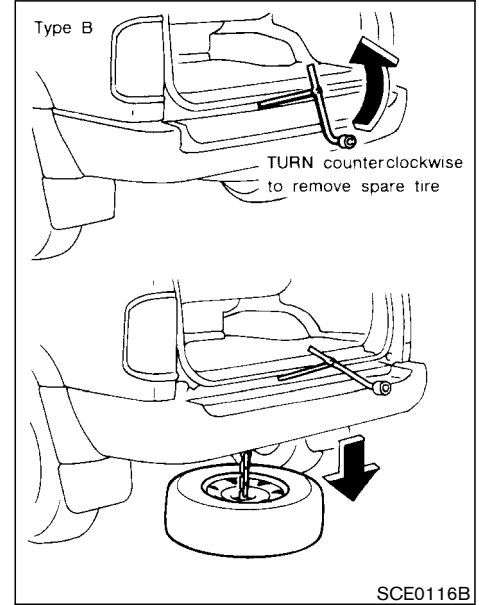
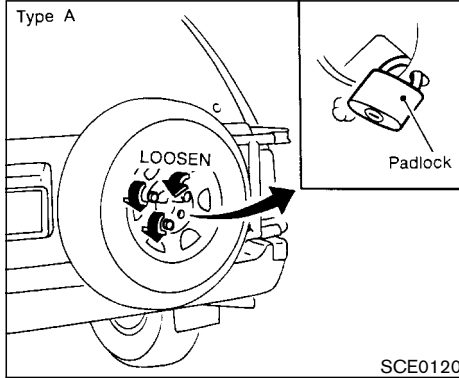

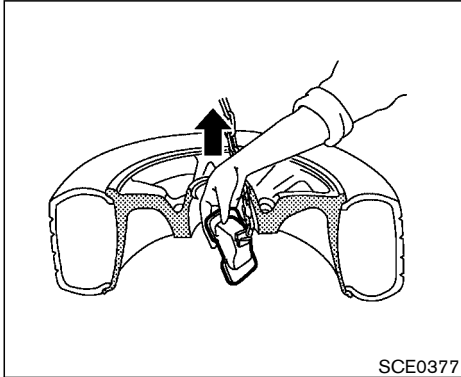

⚠ CAUTION

- Do not insert the jack rod straight as it is designed to be inserted at an angle as shown.
- Make sure the rod tip fits in the fitting portion of the spare tire hanger and turn the rod.
- Be sure to center the spare tire suspending plate on the wheel and then lift the spare tire.

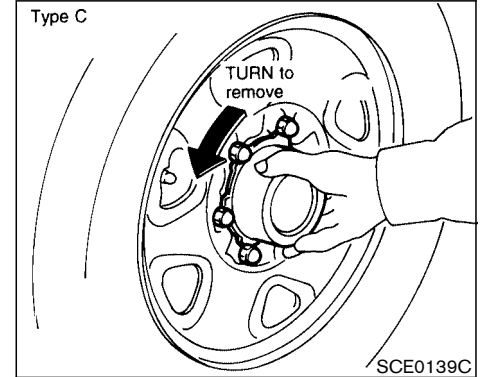
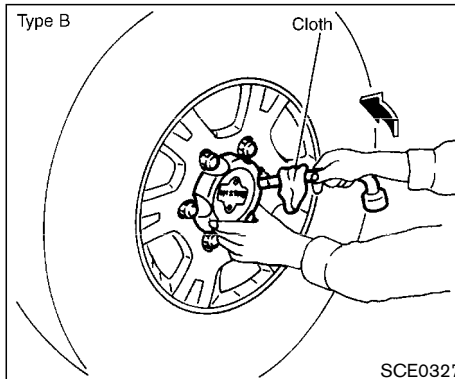
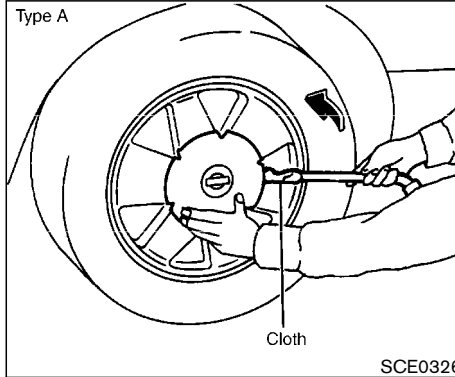

Removing wheel cap

⚠ CAUTION

Do not use your hands to pry off wheel caps. Doing so could result in personal injury.

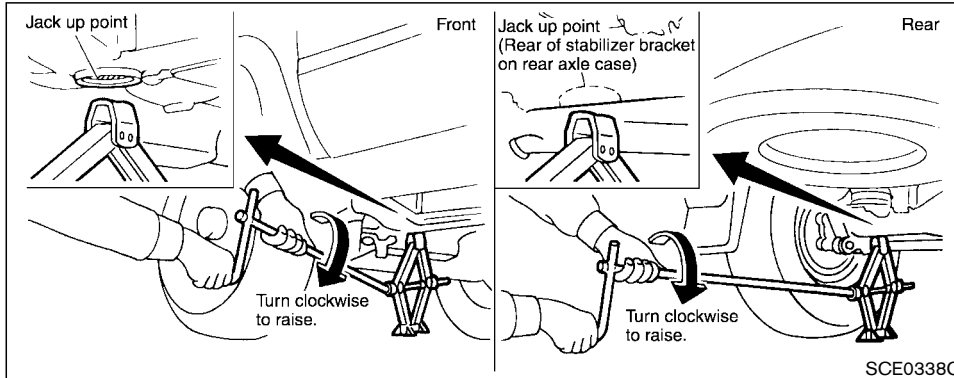

Jacking up the vehicle and removing the damaged tire

WARNING

- Never get under the vehicle while it is supported only by the jack.
- Use only the jack provided with your vehicle to lift the vehicle. Do not use the jack provided with your vehicle on other vehicles. The jack is designed only for lifting your vehicle

during a tire change.

- Use the correct jack up points; never use any other part of the vehicle for jack support.
- Never jack up the vehicle more than necessary.
- Never use blocks on or under the jack.
- Do not start or run engine while vehicle is on the jack, as it may cause

the vehicle to move. This is especially true for vehicle with limited slip differential carriers.

- Do not allow passengers to stay in the vehicle while it is on the jack.

Carefully read the following instructions.

1. Place the jack directly under the jack-up point.

The jack should be used on level firm ground.

2. Loosen each wheel nut one or two turns by turning counterclockwise with the wheel nut wrench.

Do not remove the wheel nuts until the tire is off the ground.

3. Carefully raise the vehicle until the tire clears the ground. To lift the vehicle, securely hold the jack lever and rod with both hands as shown above. Remove the wheel nuts, and then remove the wheel. Do not remove the brake drum with the wheel.

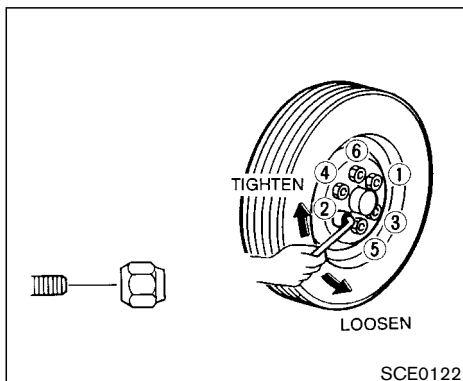

Installing the spare tire

1. Clean any mud or dirt from the surface between the wheel and hub.
2. Carefully put the wheel on and tighten the wheel nuts finger tight.
3. With the wheel nut wrench, tighten wheel nuts alternately and evenly until they are tight.
4. Lower the vehicle slowly until the tire touches the ground. Then, with the wheel nut wrench, tighten the wheel nuts securely in the sequence as illustrated.



WARNING

- **Incorrect wheel nuts or improperly tightened wheel nuts can cause the wheel to become loose or come off. This could cause an accident.**
- **Do not use oil or grease on the wheel studs or nuts. This could cause the nuts to become loose.**

As soon as possible tighten the wheel nuts to the specified torque with a torque wrench.

**Wheel nut tightening torque:
98 ft-lb (133 N·m)**

Adjust tire pressure to the COLD pressure.

COLD pressure:

After vehicle has been parked for three hours or more or driven less than 1 mile (1.6 km).

COLD tire pressures are shown on the tire placard affixed to the glove box lid.



WARNING

Retighten the wheel nuts when the vehicle has been driven for 600 miles (1,000 km) (also in cases of a flat tire, etc.).

5. Securely store the spare tire and jacking equipment in the vehicle.

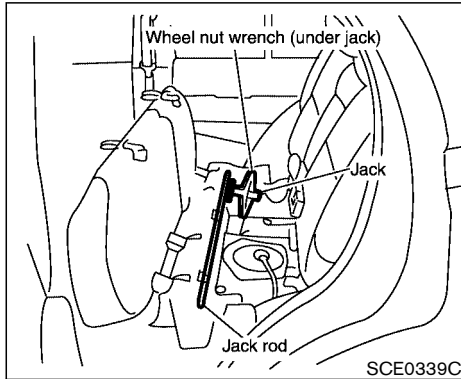

Stowing the damaged tire and tools

Securely store the tire and jacking equipment in the vehicle as illustrated.

WARNING

- **Always make sure that the spare tire and jacking equipment are properly secured after use. Such items can become dangerous projectiles in an accident or sudden stop.**
- **The small size spare tire is designed**

for emergency use. See “Tires and wheels” in the “8. Maintenance and do-it-yourself” section.

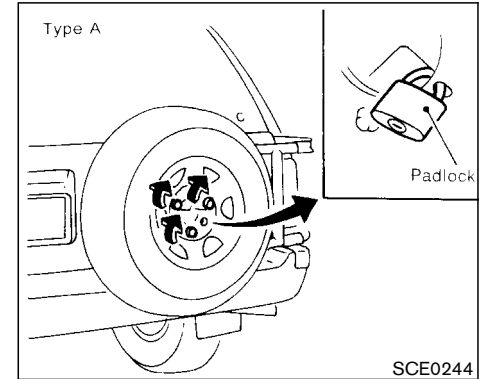

Tightening torque of nuts:

**48 to 66 ft-lb
(66 to 89 N·m)
Use a suitable padlock.**

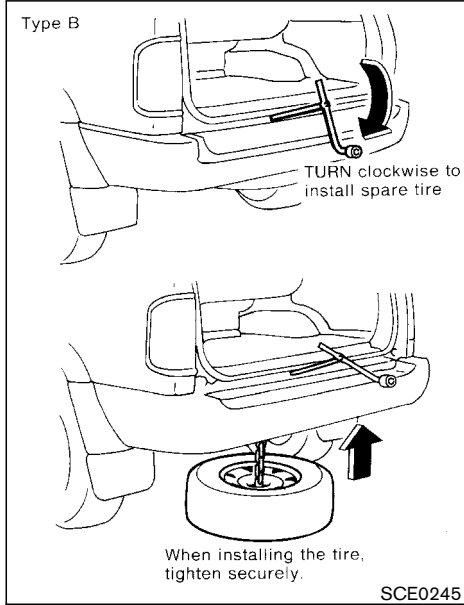

designed to be inserted at an angle as shown.

When stowing the 17 inch wheel, remove the cap pushing it from the inside of the wheel.

CAUTION

Do not insert the jack rod straight as it is

JUMP STARTING

If you try to start your engine with a booster battery, follow the instructions and precautions below:

WARNING

- If done incorrectly, jump starting can lead to a battery explosion, resulting in severe injury or death. It could also damage your vehicle.
- Explosive hydrogen gas is always present in the vicinity of the battery. Keep all sparks and flames away from it.
- Do not allow battery fluid to come into contact with eyes, skin, cloth or painted surfaces. Battery fluid is a corrosive sulphuric acid solution which can cause severe burns. If the fluid should come into contact with anything, immediately flush the contacted area with water.
- Keep battery out of the reach of children.
- The booster battery must be rated at

12 volts. Use of an improperly rated battery can damage your vehicle.

- **Whenever working on or near a battery, always wear suitable eye protectors (for example, goggles or industrial safety spectacles) and remove rings, metal bands, or any other metal jewelry. Do not lean over battery when jump starting.**
- **Do not attempt to jump start a frozen battery. It could explode and cause serious injury.**
- **Your vehicle has an automatic engine cooling fan. It could come on at any time. Keep hands and other objects away from it.**

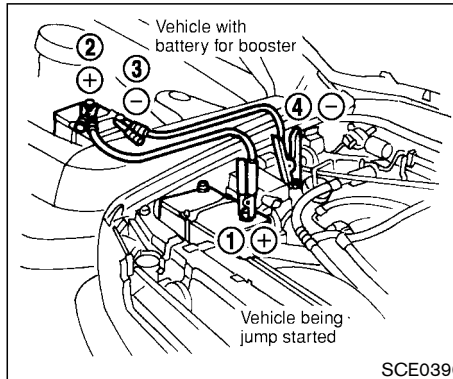

WARNING

Always follow the instructions below. Failure to do so could result in damage to the charging system and cause personal injury.

1. Position the two vehicles to bring their batteries into close proximity to each other if the booster battery is in another vehicle. **Do not allow the two vehicles to touch.**
2. Apply parking brakes. Move the shift lever to

Neutral position (On automatic transmission models, move the selector lever to P (Park)). Switch off all unnecessary electrical systems (light, heater, air conditioner, etc.).

3. Remove vent caps on the battery (if so equipped). Cover the battery with an old cloth to reduce explosion hazard.
4. Connect jumper cables in the sequence as illustrated.

CAUTION

- **Always connect positive (+) to positive (+) and negative (-) to body ground, (for example, strut mounting bolt, engine lift bracket, etc. — not to the battery).**
 - **Make sure that cables do not touch moving parts in the engine compartment and that clamps do not contact any other metal.**
5. Start the engine of the other vehicle and let it run for a few minutes.
 6. Keep the engine speed of the other vehicle at about 2,000 rpm, and start your engine in the normal manner.



CAUTION

Do not keep starter motor engaged for more than 10 seconds. If the engine does not start right away, turn the key off and wait 3 to 4 seconds before trying again.

- After starting your engine, carefully disconnect the negative cable and then the positive cable.
- Replace the vent caps (if so equipped). Be sure to dispose of the cloth used to cover the vent holes as it may be contaminated with corrosive acid.



CAUTION

- **Automatic transmission models cannot be push started. This may cause transmission damage.**
- **Three way catalyst equipped models should not be started by pushing since the three way catalyst may be damaged.**
- **Never try to start the vehicle by towing it; when the engine starts, the forward surge could cause the vehicle to collide with the tow vehicle.**

IF YOUR VEHICLE OVERHEATS

If your vehicle is overheating indicated by an extremely high temperature gauge reading, or if you feel a lack of engine power, detect abnormal noise, etc., take the following steps:



WARNING

- **Do not continue to drive if your vehicle overheats. Doing so could cause a vehicle fire.**
- **To avoid the danger of being scalded, never remove the radiator cap while the engine is still hot. When the radiator cap is removed, pressurized hot water will spurt out, possibly causing serious injury.**
- **Do not open the hood if steam is coming out.**

1. Move the vehicle safely off the road, apply the parking brake and move the gearshift lever to the neutral position (automatic transmission to P (Park)).

Do not stop the engine.

2. Turn off the air conditioner switch. Open all the windows, move the heater or air condi-

In case of emergency 6-11

tioner temperature control to maximum hot and fan control to high speed.

3. If engine overheating is caused by climbing a long hill on a hot day, run the engine at a fast idle (approximately 1,500 rpm) until the temperature gauge indication returns to normal.
4. Get out of the vehicle. Look and listen for steam or coolant escaping from the radiator before opening the hood. Wait until no steam or coolant can be seen before proceeding.
5. Open the engine hood.



WARNING

If steam or water is coming from the engine, stand clear to prevent getting burned.

6. Visually check drive belts for damage or looseness. Also check if the cooling fan is running. The radiator hoses and radiator should not leak water. If coolant is leaking, the cooling fan belt is missing or loose or the cooling fan does not run, stop the engine.



WARNING

- **Be careful not to allow your hands, hair, jewelry or clothing to come into contact with, or to get caught in, the cooling fan, or drive belt.**
- **The engine cooling fan can start at any time when the coolant temperature is high.**

7. After the engine cools down, check the coolant level in the reservoir tank with the engine running. Add coolant to the reservoir tank if necessary. Have your vehicle repaired at the nearest NISSAN dealer.



WARNING

- **Never ride in a vehicle that is being towed.**
- **Never get under your vehicle after it has been lifted by a tow truck.**



CAUTION

- **When towing, make sure that the transmission, axles, steering system and powertrain are in working condi-**

TOWING YOUR VEHICLE

When towing your vehicle, all State (Provincial in Canada) and local regulations for towing must be followed. Incorrect towing equipment could damage your vehicle. Towing instructions are available from your NISSAN dealer. Local service operators are generally familiar with the applicable laws and procedures for towing. To assure proper towing and to prevent accidental damage to your vehicle, NISSAN recommends having a service operator tow your vehicle. It is advisable to have the service operator carefully read the following precautions:

tion. If any unit is damaged, dollies must be used.

- Always attach safety chains before towing.

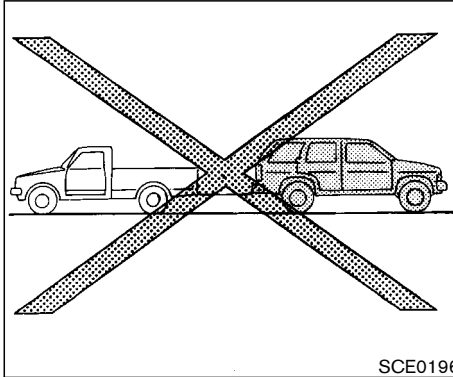

Two wheel drive models

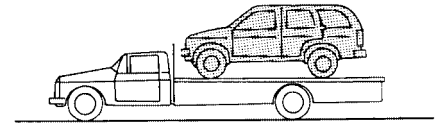
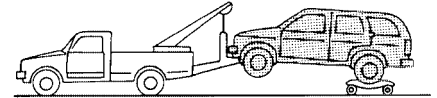
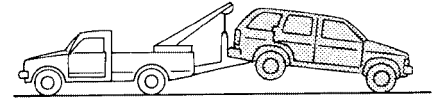

SCE0197B

TOWING RECOMMENDED BY NISSAN

Two wheel drive models

NISSAN recommends that your vehicle be towed with the driving (rear) wheels off the ground or place the vehicle on a flat bed truck as illustrated.



CAUTION

- **Never tow automatic transmission models with the rear wheels on the ground or four wheels on the ground (forward or backward), as this may cause serious and expensive damage to the transmission. If it is necessary to tow the vehicle with the front wheels raised, always use towing dollies under the rear wheels.**
- **When towing automatic or manual transmission models with the front wheels on the ground or on towing dollies:**
 - **Turn the ignition key to the OFF position, and secure the steering**

wheel in a straightahead position with a rope or similar device. Never secure the steering wheel by turning the ignition key to the LOCK position. This may damage the steering lock mechanism.

- **If you have to tow manual transmission models with the rear wheels on the ground or four wheels on the ground (if you do not use towing dollies):**
 - **Always release the parking brake.**
 - **Move the transmission shift lever to the N (Neutral) position.**
- **Observe the following restricted towing speeds and distances for manual transmission models only:**
 - **Speed: Below 60 MPH (95 km/h)**
 - **Distance: Less than 500 miles (800 km)**

If the speed or distance must necessarily be greater, remove the propeller shaft before towing to prevent damage to the transmission.

Four wheel drive models (part time)

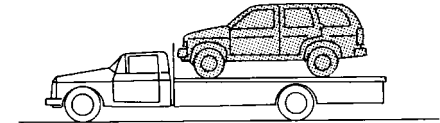
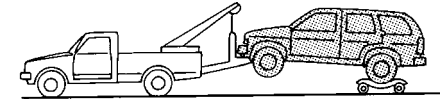
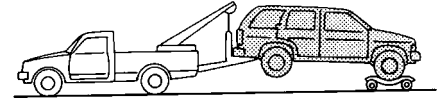

SCE0198

Part time four wheel drive models

NISSAN recommends that towing dollies be used when towing your vehicle or the vehicle be placed on a flat bed truck as illustrated.



CAUTION

- **Never tow automatic transmission models with the rear wheels on the ground or four wheels on the ground, as this may cause serious and expensive damage to the transmission. If it is necessary to tow the vehicle with the front wheels raised, always use towing dollies under the rear wheels.**
- **When towing automatic or manual transmission models with the front wheels on the ground or on towing dollies:**
 - **Move the transfer case shift lever to the 2H position.**
 - **Turn the ignition key to the OFF position, and secure the steering wheel in a straight ahead position with a rope or similar device. Never secure the steering wheel by turning the ignition key to the LOCK position. This may damage the steering lock mechanism.**

- **If you have to tow manual transmission models with the rear wheels on the ground (if you do not use towing dollies) or four wheels on the ground:**
 - **Move the transfer case shift lever to the 2H position.**
 - **Move the transmission shift lever to the N (Neutral) position.**
 - **Always release the parking brake.**
- **Observe the following restricted towing speeds and distances manual transmission models only:**
 - **Speed: Below 60 MPH (95 km/h)**
 - **Distance: Less than 500 miles (800 km)**

If the speed or distance must necessarily be greater, remove the front and rear propeller shafts before towing to prevent damage to the transmission.

Four wheel drive models (All-mode)

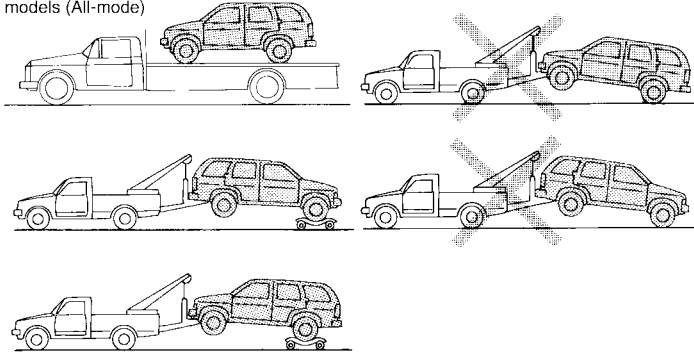

SCE0328

All-mode four wheel drive models

NISSAN recommends that towing dollies be used when towing your vehicle or the vehicle be placed on a flat bed truck as illustrated.



CAUTION

Never tow All-mode 4WD models with any of the wheels on the ground as this may cause serious and expensive damage to the transfer case.

6-16 In case of emergency

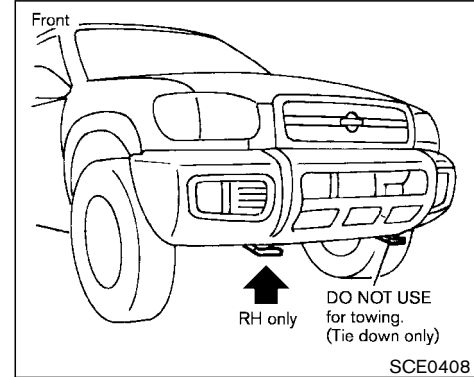

SCE0408

VEHICLE RECOVERY (Freeing a stuck vehicle)



WARNING

- Stand clear of a stuck vehicle.
- Do not spin your tires at high speed. This could cause them to explode and result in serious injury. Parts of your vehicle could also overheat and be damaged.

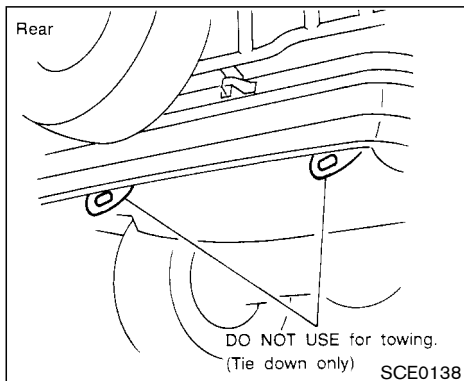

vehicle. Always pull the cable straight out from the front of the vehicle. Never pull on the hook at an angle.



CAUTION

- **Use the towing hook only, not other parts of the vehicle. Otherwise, the vehicle body will be damaged.**
- **Use the towing hook only to free a vehicle stuck in sand, snow, mud, etc. Never tow the vehicle for a long distance using only the towing hook.**
- **The towing hook is under tremendous force when used to free a stuck**

|

MEMO

—

—

|

7 Appearance and care

| | | | |
|----------------------------|-----|----------------------------------------------|-----|
| Cleaning exterior | 7-2 | Cleaning interior | 7-3 |
| Washing | 7-2 | Floor mats | 7-4 |
| Waxing | 7-2 | Seat belts | 7-4 |
| Removing spots..... | 7-3 | Corrosion protection | 7-4 |
| Underbody | 7-3 | Most common factors contributing to vehicle | |
| Glass | 7-3 | corrosion..... | 7-4 |
| Aluminum alloy wheels..... | 7-3 | To protect your vehicle from corrosion | 7-5 |
| Chrome parts | 7-3 | | |

CLEANING EXTERIOR



In order to maintain the appearance of your vehicle, it is important to take proper care of it.

In the following cases, please wash your vehicle as soon as possible to protect the paint surface.

- After a rainfall to prevent possible damage from acid rain
- After driving on coastal roads
- When contaminants such as soot, bird droppings, tree sap, metal particles or bugs get on the paint surface
- When dust or mud builds up on the surface

Whenever possible, store or park your vehicle

7-2 Appearance and care

inside a garage or in a covered area.

When it is necessary to park outside, park in a shady area or protect the vehicle with a body cover.

Be careful not to scratch the paint surface when putting on or removing the body cover.

WASHING

Wash dirt off with a wet sponge and plenty of water. Clean the vehicle thoroughly using a mild soap such as Nissan Car Wash, or a general purpose dish-washing liquid mixed with clean, lukewarm (never hot) water.

! CAUTION

- **Do not use strong household soap, strong chemical detergents, gasoline or solvents.**
- **Do not wash the vehicle in direct sunlight or while the vehicle body is hot, as the surface may become water-spotted.**
- **Avoid using tight-napped or rough**

cloths, such as washing mitts. Care must be taken when removing caked-on dirt or other foreign substance so that the paint surface is not scratched or damaged.

Rinse the vehicle thoroughly with plenty of clean water.

Inside flanges, seams and folds on the doors, hatches and hood are particularly endangered by the effects of road salt. Therefore, these areas must be regularly cleaned. Take care that the drain holes in the lower edge of the door are open. Spray water under the body and in the wheel wells to loosen the dirt and wash away road salt.

A damp chamois can be used to dry the vehicle to avoid water spots.

WAXING

Regular waxing protects the paintwork and keeps the finish. After waxing, polishing is recommended to remove built-up residue and avoid a “weathered” appearance.

Your NISSAN dealer can assist you in choosing the proper product.

- Wax your vehicle only after a thorough wash-

ing. Follow the instructions supplied with the wax.

- Do not use a wax containing any abrasives, cutting compounds or cleaners that may damage the vehicle finish.
- If the surface does not polish easily, use a road tar remover and wax again.

Machine compounding or aggressive polishing on a base coat/clear coat paint finish may dull the finish or leave swirl marks.

Only apply black wax or black shoe polish to the black urethane or polypropylene bumper.

REMOVING SPOTS

Remove tar and oil spots, industrial dust, insects and tree sap as quickly as possible from the surface of the paint to avoid lasting damage or staining. Special cleaning products are available at your NISSAN dealer or any automotive accessories store.

UNDERBODY

In areas where road salt is used in winter, it is necessary to clean the underbody regularly in order to prevent dirt and salt from building up and causing corrosion on the underbody and suspension. Before the winter period and again

in the spring, the underseal must be checked and, if necessary, re-treated.

GLASS

Use glass cleaner to remove smoke and dust film from the glass surfaces. It is normal for glass to be coated with a film after the vehicle is parked in the hot sun. Glass cleaner and a soft cloth will easily remove this film.



CAUTION

When cleaning the inside of the window, do not use sharp-edged tools, abrasive cleaners or chlorine based disinfectant cleaners. They could damage the electrical conductors, radio antenna elements or rear window defogger elements.

ALUMINUM ALLOY WHEELS

Wash regularly, especially during winter months in areas where road salt is used. Salt could discolor the wheel if not removed.

CHROME PARTS

Clean all chrome parts regularly with a non-abrasive chrome polish to maintain the finish.

CLEANING INTERIOR

Occasionally remove loose dust from the interior trim, plastic parts and seats using a vacuum cleaner or soft brush. Wipe the vinyl and leather surfaces with a clean, soft cloth dampened in mild soap solution, then wipe clean with a dry soft cloth. Before using any fabric protector, read the manufacturer's recommendations. Some fabric protectors contains chemicals that stain or bleach the seat material. Use a cloth dampened only with water, to clean the meter and gauge lens.



CAUTION

- **Never use gasoline, thinner or any similar material.**
- **The leather seats should be regularly coated with a leather wax like saddle soap. Never use car wax.**
- **Never use fabric protectors unless recommended by the manufacturer.**
- **Do not use glass or plastic cleaner on meter or gauge lens covers. It may damage the lens cover.**

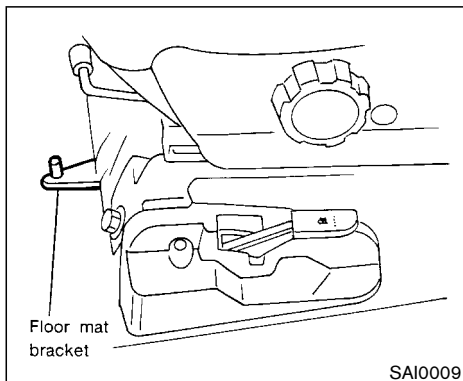

Floor mat positioning aid (Driver side only)

This model includes a front floor mat bracket to act as a floor mat positioning aid. NISSAN floor mats have been specially designed for your vehicle model. The driver side floor mat has a grommet hole incorporated in it. Simply position the mat by placing the floor mat bracket through the floor mat grommet hole while centering the mat in the floorpan contour.

Periodically check to make certain the mats are properly positioned.

SEAT BELTS

The seat belts can be cleaned by wiping them with a sponge dampened in a mild soap solution. Allow the belts to dry completely before using them.

WARNING

Do not allow wet belts to roll up in the retractor. NEVER use bleach, dye or chemical solvents since these may severely weaken the seat belt webbing.

CORROSION PROTECTION

MOST COMMON FACTORS CONTRIBUTING TO VEHICLE CORROSION

1. The accumulation of moisture-retaining dirt and debris in body panel sections, cavities, and other areas.
2. Damage to paint and other protective coatings caused by gravel and stone chips or minor traffic accidents.

Moisture

The accumulation of sand, dirt and water on the underside of the body will accelerate corrosion. Floor sections which have snow and ice trapped under the floor matting will not dry.

Relative humidity

Corrosion will be accelerated:

- in areas of high relative humidity
- especially in areas where the temperatures stay above freezing
- where atmospheric pollution exists
- where road salt is used

FLOOR MATS

The use of Genuine Nissan floor mats can extend the life of your vehicle carpet and make it easier to clean the interior. **No matter what mats are used, be sure they are fitted for your vehicle and are properly positioned in the footwell to prevent interference with pedal operation.** Mats should be maintained with regular cleaning and replaced if they become excessively worn.

Temperature

A temperature increase will accelerate the rate of corrosion to those parts which are not well ventilated.

Air pollution

Industrial pollution, the presence of salt in the air in coastal areas, or heavy road salt use will accelerate the corrosion process. Road salt will also accelerate the disintegration of paint surfaces.

TO PROTECT YOUR VEHICLE FROM CORROSION

- Wash and wax your vehicle often to keep the vehicle clean.
- Always check for minor damage to the paint and repair it as soon as possible.
- Keep drain holes at the bottom of the doors and tailgate open to avoid water accumulation.
- Check the underbody. If any sand, dirt or salt is accumulated, wash it off with water as soon as possible.



CAUTION

- **NEVER remove dirt, sand or other debris from the passenger compartment by washing it out with a hose. Remove dirt with a vacuum cleaner or broom.**
- **Never allow water or other liquids to come in contact with electronic components inside the vehicle as this may damage them.**

Chemicals used for road surface de-icing are extremely corrosive and will accelerate corrosion and the deterioration of underbody components such as the exhaust system, fuel and brake lines, brake cables, floor pan and fenders.

In winter, the underbody must be cleaned periodically.

For additional protection against rust and corrosion, which may be required in some areas, consult your local NISSAN dealer.

|

MEMO

—

—

|

8 Maintenance and do-it-yourself

| | | | |
|------------------------------------------------|------|------------------------------------|------|
| Maintenance requirements | 8-2 | Replacing spark plugs..... | 8-23 |
| General maintenance..... | 8-2 | Air cleaner | 8-23 |
| Explanation of general maintenance items | 8-2 | Windshield wiper blades..... | 8-24 |
| Maintenance precautions..... | 8-5 | Cleaning..... | 8-24 |
| Engine compartment check locations | 8-7 | Replacing..... | 8-24 |
| Engine cooling system..... | 8-9 | Parking brake and brake pedal..... | 8-25 |
| Checking engine coolant level..... | 8-9 | Checking parking brake..... | 8-25 |
| Changing engine coolant | 8-10 | Checking brake pedal | 8-26 |
| Engine oil..... | 8-13 | Brake booster..... | 8-26 |
| Checking engine oil level | 8-13 | Fuses | 8-27 |
| Changing engine oil..... | 8-14 | Engine compartment..... | 8-27 |
| Changing engine oil filter | 8-15 | Passenger compartment..... | 8-28 |
| Automatic transmission fluid..... | 8-16 | Keyfob battery replacement | 8-28 |
| Temperature conditions for checking..... | 8-17 | Lights | 8-30 |
| Power steering fluid..... | 8-18 | Headlights | 8-31 |
| Brake and clutch fluid | 8-19 | Wheels and tires | 8-34 |
| Brake fluid | 8-19 | Tire pressure | 8-34 |
| Clutch fluid..... | 8-19 | Types of tires | 8-35 |
| Window washer fluid..... | 8-20 | Tire chains | 8-36 |
| Window washer fluid reservoir | 8-20 | Changing wheels and tires | 8-37 |
| Battery..... | 8-21 | | |
| Jump starting | 8-21 | | |
| Drive belts | 8-22 | | |
| Spark plugs..... | 8-23 | | |

MAINTENANCE REQUIREMENTS

Your new NISSAN has been designed to have minimum maintenance requirements with longer service intervals to save you both time and money. However, some day-to-day and regular maintenance is essential to maintain your NISSAN's good mechanical condition, as well as its emission and engine performance.

It is the owner's responsibility to make sure that scheduled maintenance, as well as general maintenance, is performed.

As the vehicle owner, you are the only one who can ensure that your vehicle receives the proper maintenance care. You are a vital link in the maintenance chain.

Scheduled maintenance:

For your convenience, both required and optional scheduled maintenance items are described and listed in your "Service and Maintenance Guide". You must refer to that guide to ensure that necessary maintenance is performed on your NISSAN at regular intervals.

General maintenance:

General maintenance includes those items which should be checked during normal day-to-day operation of the vehicle. They are essential if your vehicle is to continue to operate properly. It is your responsibility to perform these procedures regularly as prescribed.

8-2 Maintenance and do-it-yourself

Performing general maintenance checks require minimal mechanical skill and only a few general automotive tools.

These checks or inspections can be done by yourself, a qualified technician or, if you prefer, your NISSAN dealer.

Where to go for service:

If maintenance service is required or your vehicle appears to malfunction, have the systems checked and tuned by NISSAN dealer.

NISSAN technicians are well-trained specialists and are kept up to date with the latest service information through technical bulletins, service tips, and in-dealership training programs. They are completely qualified to work on NISSAN vehicles **before** they work on your vehicle, rather than after they have worked on it.

You can be confident that your NISSAN dealer's service department performs the best job to meet the maintenance requirements of your vehicle — in a reliable and economic way.

GENERAL MAINTENANCE

During the normal day-to-day operation of the vehicle, general maintenance should be performed regularly as prescribed in this section. If you detect any unusual sounds, vibrations or smell, be sure to check for the cause or have your NISSAN dealer check it promptly. In addition, you should notify your NISSAN dealer if you think that repairs are required.

When performing any checks or maintenance work, closely observe the "Maintenance precautions" later in this section.

EXPLANATION OF GENERAL MAINTENANCE ITEMS

Additional information on the following items with "*" is found later in this section.

Outside the vehicle

The maintenance items listed here should be performed from time to time, unless otherwise specified.

Tires*:

Check the pressure with a gauge at least once a month and always prior to long distance trips. If necessary, adjust the pressure in all tires, including the spare, to the pressure specified. Check carefully for damage, cuts or excessive wear.

Wheel nuts*:

When checking the tires, make sure no nuts are missing, and check for any loose nuts. Tighten if necessary.

Tire rotation*:

Tires should be rotated every 7,500 miles (12,000 km). However, the timing for tire rotation may vary according to your driving habits and road surface conditions.

Wheel alignment and balance:

If the vehicle should pull to either side while driving on a straight and level road, or if you detect uneven or abnormal tire wear, there may be a need for wheel alignment.

If the steering wheel or seat vibrates at normal highway speeds, wheel balancing may be needed.

For additional information regarding tires, refer to "Important Tire Safety Information" (US) or "Tire Safety Information" (Canada) in the Warranty Information booklet.

Windshield:

Clean the windshield on a regular basis. Check the windshield at least every six months for cracks or other damage. Have a damaged windshield repaired by a qualified repair facility.

Windshield wiper blades*:

Check for cracks or wear if they do not wipe properly.

Doors and engine hood:

Check that all doors and the engine hood operate properly. Also ensure that all latches lock securely. Lubricate hinges, latches, rollers and links if necessary. Make sure that the secondary latch keeps the hood from opening when the primary latch is released.

When driving in areas using road salt or other corrosive materials, check lubrication frequently.

Lights*:

Clean the headlights on a regular basis. Make sure that the headlights, stop lights, tail lights, turn signal lights, and other lights are all operating properly and installed securely. Also check headlight aim.

Inside the vehicle

The maintenance items listed here should be checked on a regular basis, such as when performing periodic maintenance, cleaning the vehicle, etc.

Warning lights and chimes:

Make sure that all warning lights and chimes are operating properly.

Windshield wiper and washer*:

Check that the wipers and washer operate properly and that the wipers do not streak.

Windshield defroster:

Check that the air comes out of the defroster outlets properly and in sufficient quantity when operating the heater or air conditioner.

Steering wheel:

Check for changes in the steering conditions, such as excessive freeplay, hard steering or strange noises.

Seats:

Check seat position controls such as seat adjusters, seatback recliner, etc. to ensure they operate smoothly and that all latches lock securely in every position. Check that the head restraints move up and down smoothly and that the locks (if so equipped) hold securely in all latched positions.

Seat belts:

Check that all parts of the seat belt system (e.g. buckles, anchors, adjusters and retractors) op-

erate properly and smoothly, and are installed securely. Check the belt webbing for cuts, fraying, wear or damage.

Accelerator pedal:

Check the pedal for smooth operation and make sure the pedal does not catch or require uneven effort. Keep the floor mats away from the pedal.

Clutch pedal*:

Make sure the pedal operates smoothly and check that it has the proper free travel.

Brakes:

Check that the brakes do not pull the vehicle to one side when applied.

Brake pedal and booster*:

Check the pedal for smooth operation and make sure it has the proper distance under it when depressed fully. Check the brake booster function. Be certain to keep floor mats away from the pedal.

Parking brake*:

Check that the lever has the proper travel and confirm that your vehicle is held securely on a fairly steep hill with only the parking brake applied.

Automatic transmission P (Park) position mechanism:

On a fairly steep hill check that your vehicle is held securely with the selector lever in the P position without applying any brakes.

Under the hood and vehicle

The maintenance items listed here should be checked periodically e.g. each time you check the engine oil or refuel.

Windshield washer fluid*:

Check that there is adequate fluid in the tank.

Engine oil level*:

Check the level after parking the vehicle on a level spot and turning off the engine. (Be sure to wait a few minutes to allow the oil to drain back into the sump.)

Brake and clutch fluid levels*:

Make sure that the brake and clutch fluid level is between the MAX and MIN lines on the reservoir.

Power steering fluid level* and lines:

Check the level when the fluid is cold and the engine is turned off. Check the lines for proper attachment, leaks, cracks, etc.

Automatic transmission fluid level*:

Check the level after putting the selector lever in P (Park) with the engine idling.

Engine coolant level*:

Check the coolant level when the engine is cold.

Radiator and hoses:

Check the front of the radiator and clean off any dirt, insects, leaves, etc., that may have accumulated. Make sure the hoses have no cracks, deformation, rot or loose connections.

Engine drive belts*:

Make sure that no belt is frayed, worn, cracked or oily.

Battery*:

Check the fluid level in each cell. It should be between the MAX and MIN lines.

Vehicles operated in high temperatures or under severe conditions require frequent checks of the battery fluid level.

Exhaust system:

Make sure there are no loose supports, cracks or holes. If the sound of the exhaust seems unusual or there is a smell of exhaust fumes, immediately locate the trouble and correct it. See "Precautions when starting and driving" in the "5. Start-

ing and driving” section for exhaust gas (carbon monoxide).

Underbody:

The underbody is frequently exposed to corrosive substances such as those used on icy roads or to control dust. It is very important to remove these substances, otherwise rust will form on the floor pan, frame, fuel lines and around the exhaust system. At the end of winter, the underbody should be thoroughly flushed with plain water, being careful to clean those areas where mud and dirt may accumulate. For additional information, see “Cleaning exterior” in the “7. Appearance and care” section.

Fluid leaks:

Check under the vehicle for fuel, oil, water or other fluid leaks after the vehicle has been parked for a while. Water dripping from the air conditioner after use is normal. If you should notice any leaks or if gasoline fumes are evident, check for the cause and have it corrected immediately.

MAINTENANCE PRECAUTIONS

When performing any inspection or maintenance work on your vehicle, always take care to prevent serious accidental injury to yourself or damage to the vehicle. The following are general precautions which should be closely observed.



WARNING

- **Park the vehicle on a level surface, apply the parking brake securely and block the wheels to prevent the vehicle from moving. For a manual transmission, move the shift lever to Neutral. For an automatic transmission, move the selector lever to the P (Park) position.**
- **Be sure the ignition key is in the OFF or LOCK position when performing any replacement or repair.**
- **If you must work with the engine running, keep your hands, clothing, hair and tools away from moving fans belts and any other moving parts.**
- **It is advisable to secure or remove any loose clothing and any jewelry,**

such as rings, watches, etc. before working on your vehicle.

- **Always wear eye protection whenever you work on your vehicle.**
- **If you must run the engine in an enclosed space such as a garage, be sure there is proper ventilation for exhaust gases to escape.**
- **Never get under the vehicle while it is supported only by a jack. If it is necessary to work under the vehicle, support it with safety stands.**
- **Keep smoking materials, flame and sparks away from fuel and battery.**
- **Your vehicle is equipped with an automatic engine cooling fan. It may come on at any time without warning, even if the ignition key is in the OFF position and the engine is not running. To avoid injury, always disconnect the negative battery cable before working near the fan.**
- **On gasoline engine models with the**

multiport fuel injection (MFI) system, the fuel filter or fuel lines should be serviced by a NISSAN dealer because the fuel lines are under high pressure even when the engine is off.



CAUTION

- **Do not work under the engine hood while it is hot. Turn off the engine and wait until it cools down.**
- **Never connect or disconnect either the battery or any transistorized component connector while the ignition key is on.**
- **Never leave the engine or the automatic transmission related component harness connector disconnected while the ignition key is on.**
- **Avoid direct contact with used engine oil and coolant. Improperly disposed engine oil, engine coolant, and/or other vehicle fluids can hurt the envi-**

ronment. Always conform to local regulations for disposal of vehicle fluid.

This section gives instructions regarding only those items which are relatively easy for an owner to perform. More involved service should be done by your NISSAN dealer.

A genuine NISSAN Service Manual is also available. See "Owner's Manual/Service Manual order information" in the "9. Technical and consumer information" section.

You should be aware that incomplete or improper servicing may result in operating difficulties or excessive emissions, and could affect your warranty coverage. **If in doubt about any servicing, have it done by your NISSAN dealer.**

ENGINE COMPARTMENT CHECK LOCATIONS

VQ35DE engine

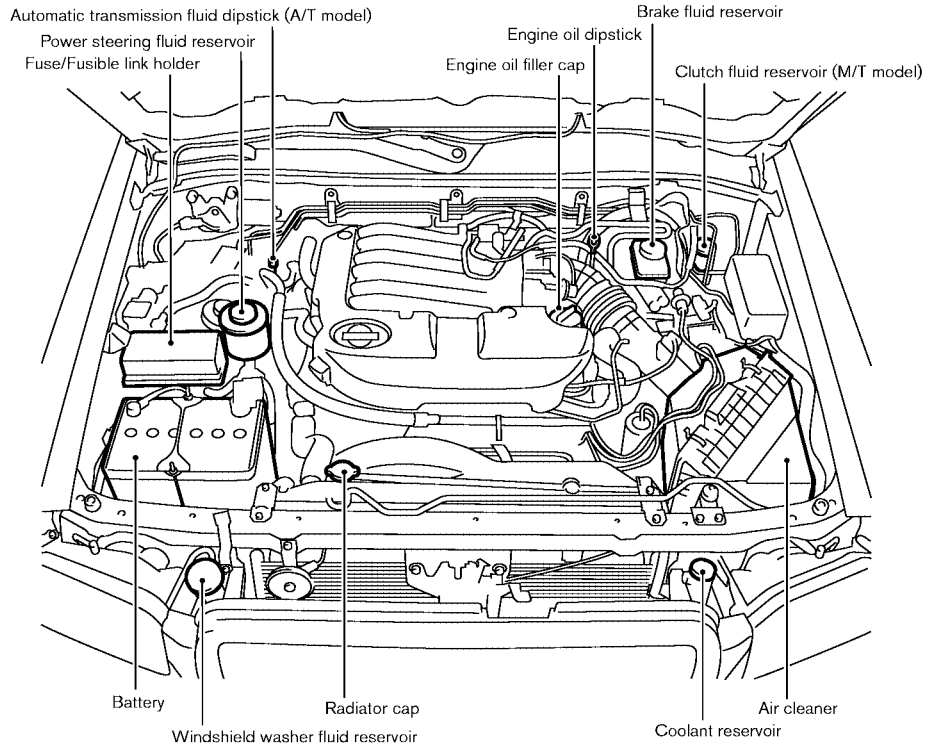

SD11482

VG33E engine

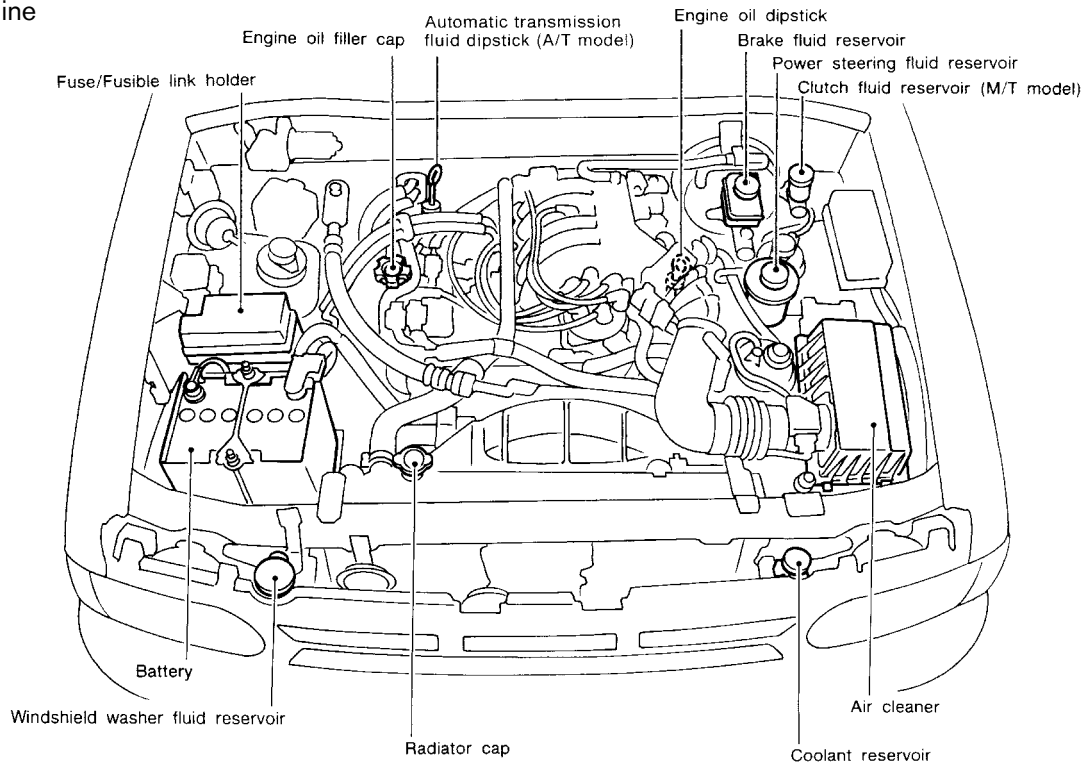

ENGINE COOLING SYSTEM

The engine cooling system is filled at the factory with a high-quality, year-round, anti-freeze coolant solution. The anti-freeze solution contains rust and corrosion inhibitors, therefore additional cooling system additives are not necessary.

CAUTION

When adding or replacing the coolant, be sure to use only a genuine NISSAN anti-freeze coolant or equivalent with the proper mixture ratio of 50% anti-freeze and 50% demineralized water/distilled water. The use of other types of coolant solutions may damage your engine cooling system.

| Outside temperature down to | | Anti-freeze | Demineralized water or distilled water |
|-----------------------------|-----|-------------|----------------------------------------|
| °C | °F | | |
| -35 | -30 | 50% | 50% |

WARNING

- Never remove the radiator cap when the engine is hot. Serious burns could be caused by high pressure fluid escaping from the radiator. Wait until the engine and radiator cool down. See “If your vehicle overheats” in the “6. In case of emergency” section.
- The radiator is equipped with a pressure cap. To prevent engine damage, use only a genuine NISSAN radiator cap.

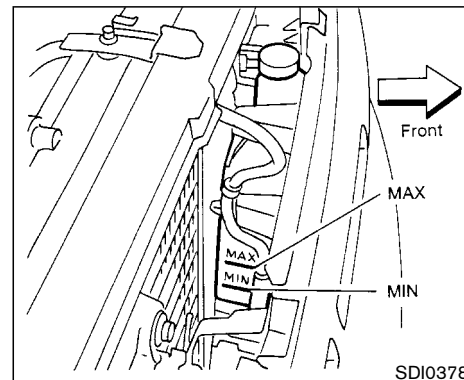

CHECKING ENGINE COOLANT LEVEL

Check the coolant level in the reservoir tank **when the engine is cold**. If the coolant level is below the MIN level, add coolant to the MAX level. If the reservoir tank is empty, check the coolant level in the radiator **when the engine is cold**. If there is insufficient coolant in the radiator, fill the radiator with coolant up to the filler opening and also add it to the reservoir tank up to the MAX level.

If the engine cooling system frequently requires coolant, have it checked by your NISSAN dealer.

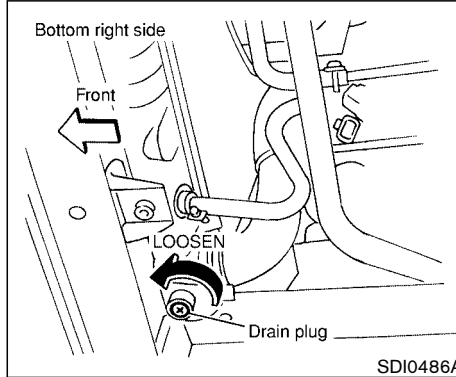
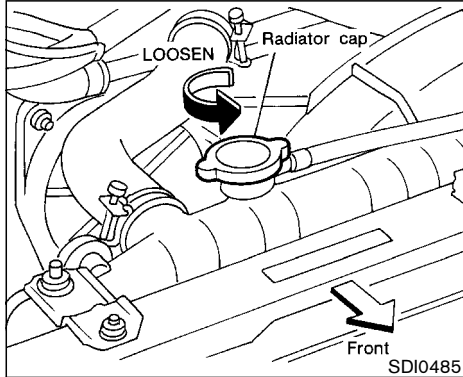

thoroughly with soap or hand cleaner as soon as possible.

- **Keep coolant out of reach of children and pets.**

CHANGING ENGINE COOLANT

- Major cooling system repairs should be performed by your NISSAN dealer. The service procedures can be found in the appropriate NISSAN Service Manual.
- Improper servicing can result in reduced heater performance and engine overheating.

WARNING

- **To avoid the danger of being scalded, never change the coolant when the engine is hot.**
- **Never remove the radiator cap when the engine is hot. Serious burns could be caused by high pressure fluid escaping from the radiator.**
- **Avoid direct skin contact with used coolant. If skin contact is made, wash**

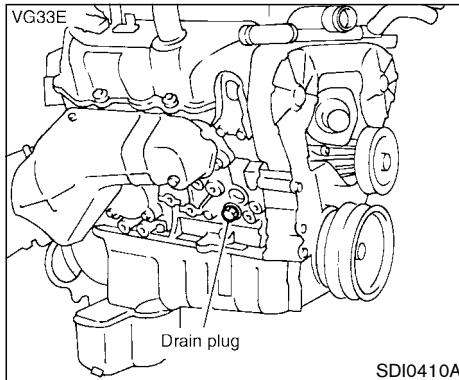
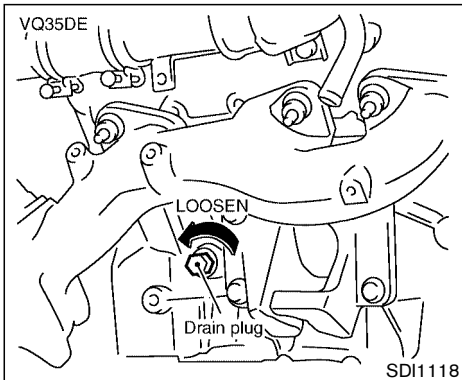
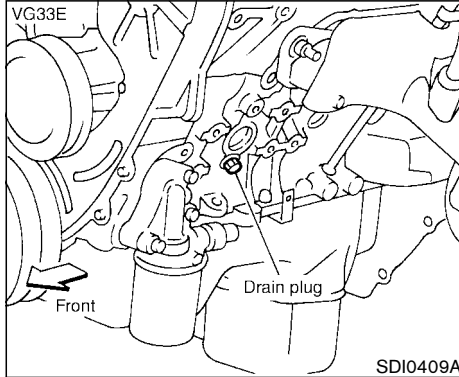
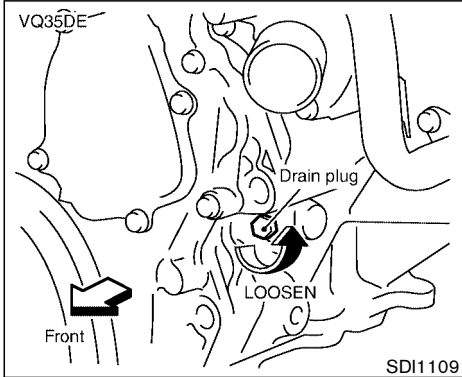

1. Perform the following procedure to open the heater water cock.
 - Turn the ignition key from OFF to ON.
 - Move the heater or air conditioner temperature control dial to the maximum hot position then turn the ignition key to OFF.
2. Open the radiator drain plugs and radiator cap.

Open the drain plugs on the engine block.

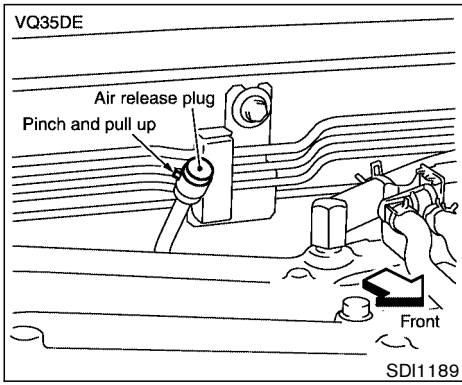
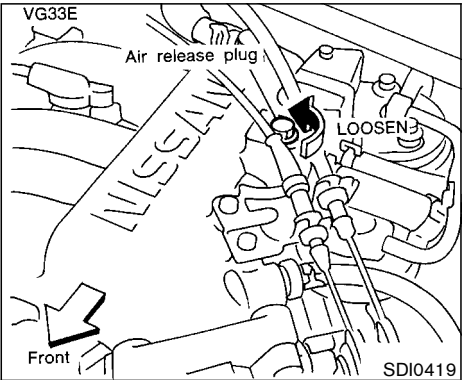
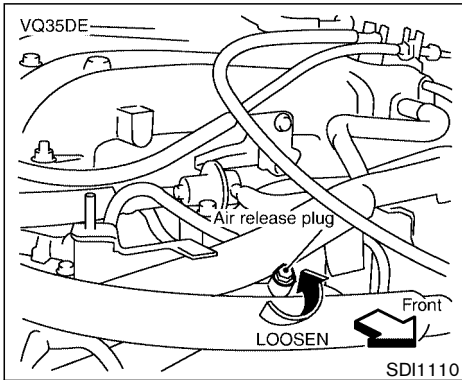

of coolant and water. Fill the reservoir tank slowly up to the MAX level. Then install the radiator cap and close the air release plug(s).

7. Start the engine and warm it up until it reaches normal operating temperature. Then race the engine 2 or 3 times under no load.

Watch the coolant temperature gauge for signs of overheating.

8. Stop the engine. After it completely cools down, refill the radiator up to the filler opening. Fill the reservoir tank up the MAX level.
9. Check the radiator drain plug and engine block drain plugs for any sign of leakage.

3. Open the air release plug(s) to drain the coolant.
4. Flush the cooling system by running fresh water through the radiator.
 - **Waste coolant must be disposed of properly.**
 - **Check your local regulations.**
5. Close the radiator drain plugs and engine block drain plugs securely.
6. See the "9. Technical and consumer information" section for cooling system capacity.

Fill the radiator slowly with the proper mixture

ENGINE OIL

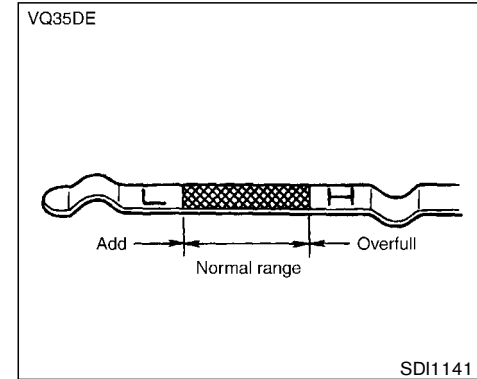
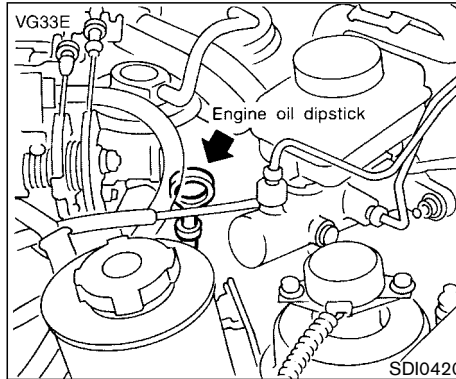
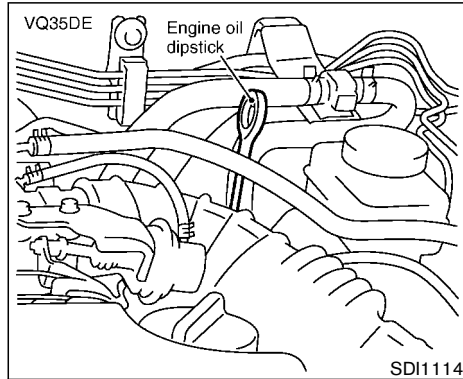

CHECKING ENGINE OIL LEVEL

1. Park the vehicle on a level surface and apply the parking brake.
2. Run the engine until it reaches operating temperature.
3. Turn off the engine. **Wait more than 10 minutes for the oil to drain back into the oil pan.**
4. Remove the dipstick and wipe it clean. Reinsert it all the way.
5. Remove the dipstick again and check the oil level. It should be between the H and L

marks. If the oil level is below the L mark, remove the oil filler cap and pour recommended oil through the opening. Do not overfill.

6. Recheck oil level with dipstick.

It is normal to add some oil between oil changes or during the break-in period, depending on the severity of operating conditions.



CAUTION

Oil level should be checked regularly. Operating with insufficient amount of oil can damage the engine, and such damage is not covered by warranty.

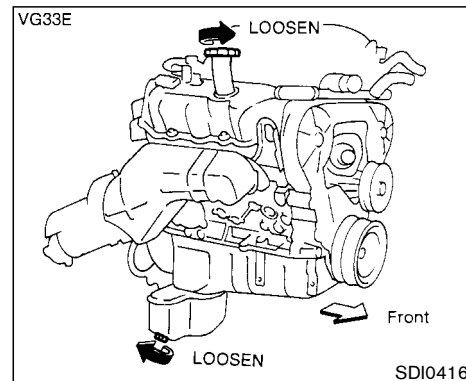
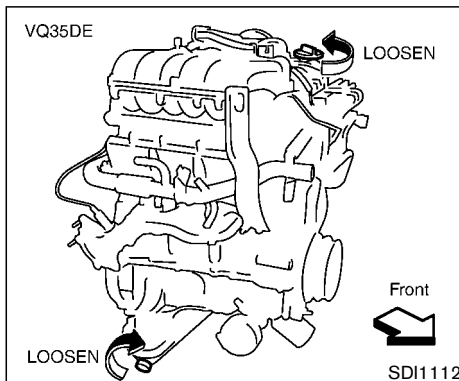
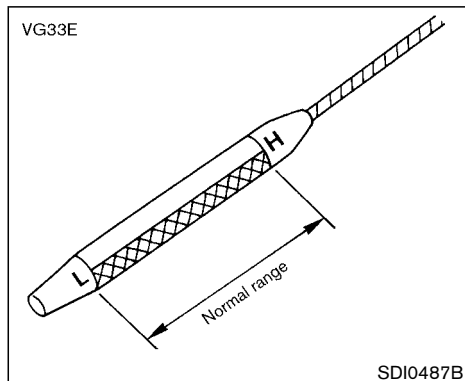

CHANGING ENGINE OIL

1. Park the vehicle on a level surface and apply the parking brake.
2. Warm up the engine until it reaches operating temperature, and then turn it off and wait more than 10 minutes.
3. Place a large drain pan under the drain plug.
4. Remove the oil filler cap.
5. Remove the drain plug with a wrench and completely drain the oil.

If the oil filter is to be changed, remove and replace it at this time. See later in this section for changing engine oil filter.

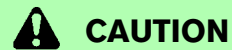

Be careful not to burn yourself, as the engine oil is hot.

- **Waste oil must be disposed of properly.**
- **Check your local regulations.**

6. Clean and re-install the drain plug and new

washer. Securely tighten the drain plug with a wrench. Do not use excessive force.

**Drain plug tightening torque:
22 to 29 ft-lb (29 to 39 N·m)**

7. Refill engine with recommended oil through the oil filler opening, then install the oil filler cap securely.

See “Capacities and recommended fuel/lubricants” in the “9. Technical and consumer information” section for drain and refill capacity.

The drain and refill capacity depends on the oil temperature and drain time. Use these specifications for reference only. Always use the dipstick to determine when the proper amount of oil is in the engine.

8. Start the engine.
Check for leakage around the drain plug.
Correct as required.
9. Turn the engine off and wait more than 10 minutes. Check the oil level with the dipstick.
Add engine oil if necessary.



WARNING

- **Prolonged and repeated contact with**

used engine oil may cause skin cancer.

- **Try to avoid direct skin contact with used oil. If skin contact is made, wash thoroughly with soap or hand cleaner as soon as possible.**
- **Keep used engine oil out of reach of children.**

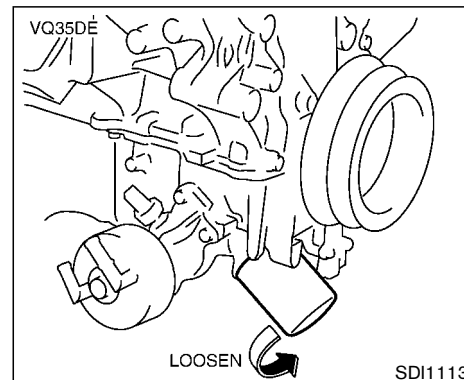

CHANGING ENGINE OIL FILTER

1. Park the vehicle on a level surface and apply the parking brake.
2. Turn the engine off.
3. Loosen the oil filter with an oil filter wrench. (Depending on the engine model, a special cap-type wrench may be required. See your NISSAN dealer.) Then remove the oil filter by turning it by hand.

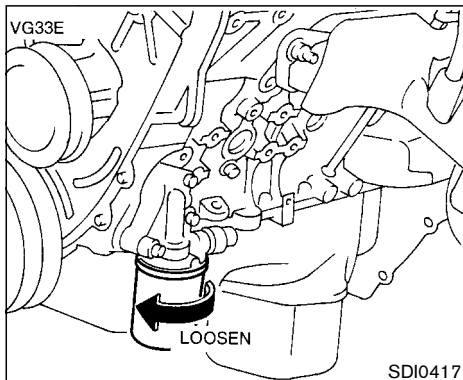

CAUTION

Be careful not to burn yourself, as the engine oil may be hot.

- Wipe the engine oil filter mounting surface with a clean rag.

Be sure to remove any old rubber gasket remaining on the mounting surface of the engine.

- Coat the rubber gasket on the new filter with engine oil.

8-16 Maintenance and do-it-yourself

- Screw in the oil filter until a slight resistance is felt, then tighten an additional 2/3 turn.

Oil filter tightening torque:
10.85 to 15.12 ft-lb
(14.7 to 20.5 N·m)

- Start the engine and check for leakage around the oil filter. Correct as required.
- Turn the engine off and wait several minutes. Check the oil level. Add engine oil if necessary.

AUTOMATIC TRANSMISSION FLUID

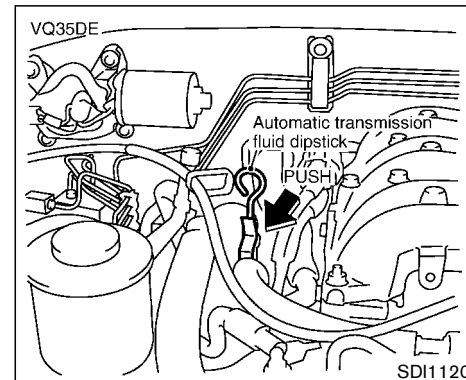

WARNING

- When engine is running, keep hands, jewelry, and clothing away from any moving parts such as fan and drive belt.
- Automatic transmission fluid is poisonous and should be stored carefully in marked containers out of the reach of children.

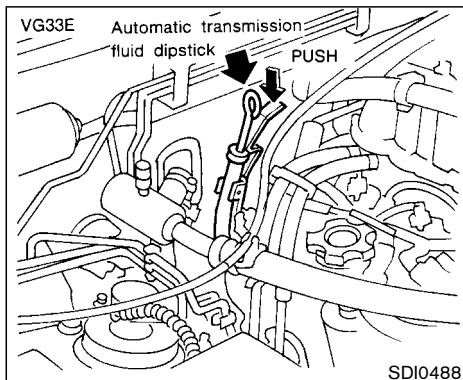

TEMPERATURE CONDITIONS FOR CHECKING

The fluid level should be checked using the HOT range (L & H marks) on the dipstick at fluid temperatures between 122 and 176°F (50 and 80°C) after the vehicle has been driven approximately 5 minutes in urban areas after the engine is warmed up. The level can be checked at fluid temperatures between 86 and 122°F (30 and 50°C) using the COLD range on the dipstick for reference, after the engine is warmed up but before driving. However, the fluid level must be rechecked using the HOT range.

1. Park the vehicle on a level surface and set the parking brake.
2. Start the engine and then move the selector lever through each gear range, ending in P.
3. Check the fluid level with the engine idling.
4. Expand the spring stopper and remove the dipstick. Wipe it clean with lint-free paper.
5. Re-insert the dipstick into the charging pipe as far as it will go.
6. Remove the dipstick and note the reading.
If the level is on the low side of either range, add fluid to the charging pipe.
7. When inserting the dipstick, set it so that the spring stopper presses the upper part of the dipstick rubber to lock the dipstick.



CAUTION

- Do not overfill.
- Use only Nissan Matic D (Continental U.S. and Alaska) or Canada Nissan automatic transmission fluid. Dexron™III/Mercon™ or equivalent

may also be used. Outside the continental US and Alaska contact a NISSAN dealer for more information regarding suitable fluids, including recommended brand(s) of Dexron™ III/Mercon™ automatic transmission fluid.

If the vehicle has been driven for a long time at high speeds, or in city traffic in hot weather, or if it is being used to pull a trailer, the fluid level cannot be read accurately. You should wait until the fluid has cooled down (about 30 minutes).

POWER STEERING FLUID

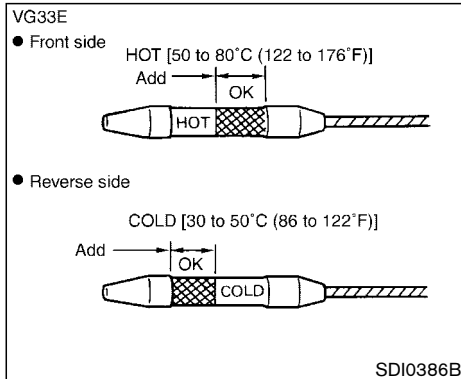
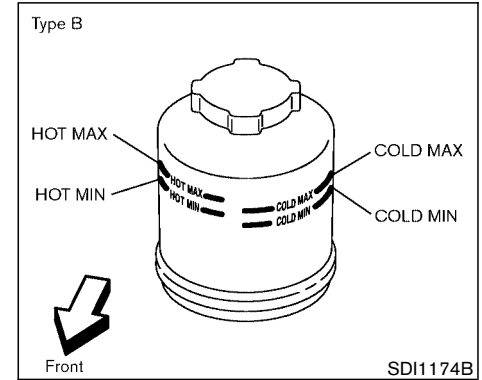
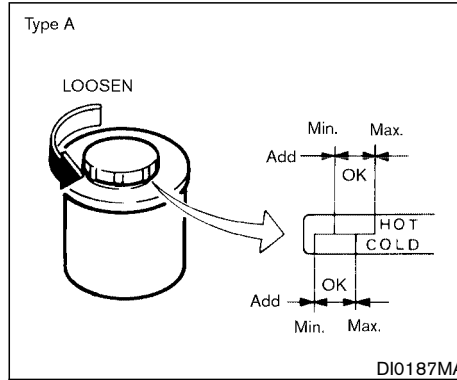
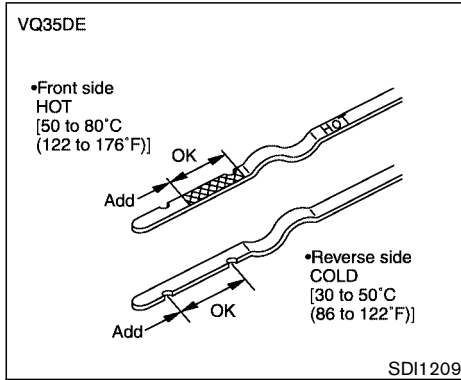

Check the fluid level.

Type A:

The fluid level should be checked using the HOT range on the dipstick at fluid temperatures of 122 to 176°F (50 to 80°C) or using the COLD range on the dipstick at fluid temperatures of 32 to 86°F (0 to 30°C).

Check the fluid level.

Type B:

The fluid level should be checked using the HOT range at fluid temperatures of 50 to 80°C (122 to 176°F) or using the COLD range at fluid temperatures of 0 to 30°C (32 to 86°F).



CAUTION

- Do not overfill.
- Use Genuine Nissan PSF or equivalent.

BRAKE AND CLUTCH FLUID



WARNING

Use only new fluid from a sealed container. Old, inferior or contaminated fluid may damage the brake and clutch systems. The use of improper fluids can affect the vehicle's stopping ability.



CAUTION

Do not spill the fluid on painted surfaces. This will damage the paint. If fluid is spilled, wash the surface with water.

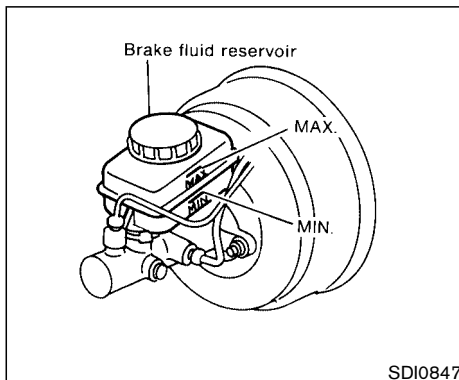

BRAKE FLUID

Check the fluid level in the reservoir. If the fluid level is below the MIN. line or the brake warning light comes on, add Genuine Nissan Brake Fluid or equivalent DOT 3 fluid up to the MAX. line.

If fluid must be added frequently, the system should be thoroughly checked by your NISSAN dealer.

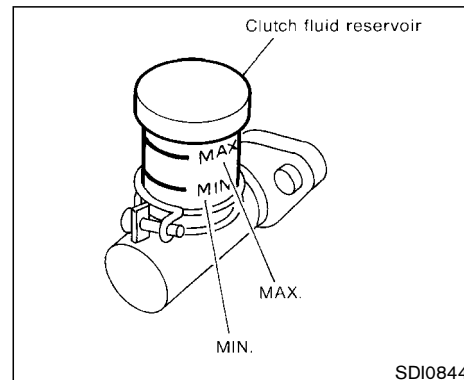

CLUTCH FLUID

Check the fluid level in the reservoir. If the fluid level is below the MIN. line, add Genuine Nissan Brake Fluid or equivalent DOT 3 fluid up to the MAX. line.

If fluid is added frequently, the system should be thoroughly checked by your NISSAN dealer.

WINDOW WASHER FLUID

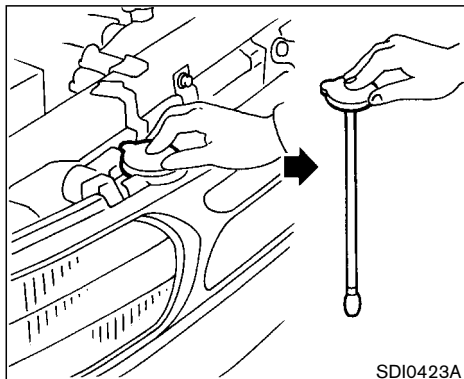

WINDOW WASHER FLUID RESERVOIR

For US

To check the fluid level, use your finger to plug the center hole of the cap/tube assembly (as shown above), then remove it from the tank. If there is no fluid in the tube, add fluid. Add a washer solvent to the water for better cleaning. In the winter season, add a windshield washer anti-freeze. Follow the manufacturer's instructions for the mixture ratio.

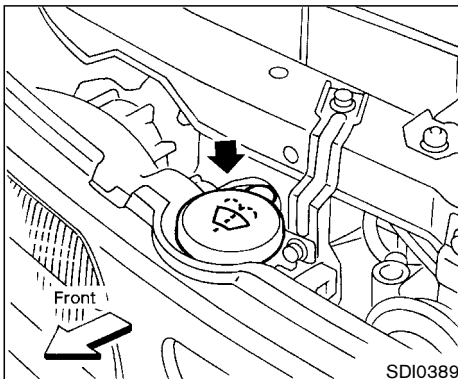

For CANADA

Add fluid when the low washer fluid warning light comes on. Add a washer solvent to the water for better cleaning. In the winter season, add a windshield washer anti-freeze. Follow the manufacturer's instructions for the mixture ratio.

CAUTION

Do not substitute engine anti-freeze coolant for window washer solution. This may result in damage to the paint.

WARNING

Anti-freeze is poisonous and should be stored carefully marked containers out of the reach of children.

BATTERY

- Keep the battery surface clean and dry. Any corrosion should be washed off with a solution of baking soda and water.
- Make certain the terminal connections are clean and securely tightened.
- If the vehicle is not to be used for 30 days or longer, disconnect the (–) negative battery terminal cable to prevent discharge.



WARNING

- **Do not expose the battery to flames or electrical sparks. Hydrogen gas generated by battery action is explosive. Do not allow battery fluid to contact your skin, eyes, fabrics, or painted surfaces. After touching a battery or battery cap, do not touch or rub your eyes. Thoroughly wash your hands. If the acid contacts your eyes, skin or clothing, immediately flush with water for at least 15 minutes and seek medical attention.**
- **When working on or near a battery, always wear suitable eye protection and remove all jewelry.**

- **Battery posts, terminals and related accessories contain lead and lead compounds. Wash hands after handling.**
- **Keep the battery out of the reach of children.**
- **Do not operate the vehicle if the fluid in the battery is low. Low battery fluid can cause a higher load on the battery which can generate heat, reduce battery life, and in some cases lead to an explosion.**

JUMP STARTING

If jump starting is necessary, see “Jump starting” in the “6. In case of emergency” section. If the engine does not start by jump starting, the battery may have to be replaced. Contact your NISSAN dealer.

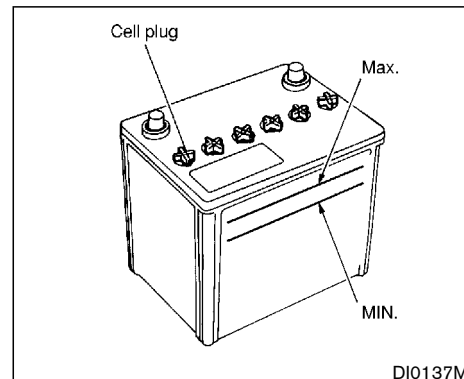

Check the fluid level in each cell. It should be between the MAX. and MIN. lines.

If it is necessary to add fluid, add only distilled water to bring the level to the indicator in each filler opening. **Do not overfill.**

1. Remove the cell plugs using a suitable tool.
2. Add distilled water up to the MAX. level.

If the side of the battery is not visible, the electrolyte level can be checked through each filler opening as illustrated.

3. Tighten cell plugs.

**Vehicles operated in high temperatures or
Maintenance and do-it-yourself 8-21**

DRIVE BELTS

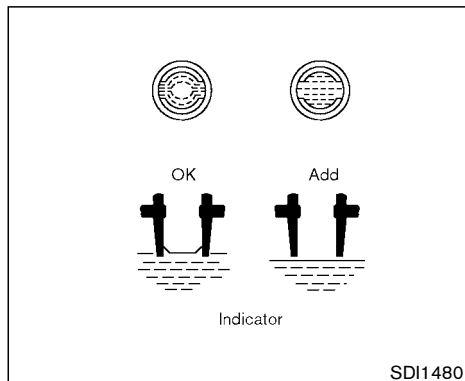

under severe conditions require frequent checks of the battery fluid level.

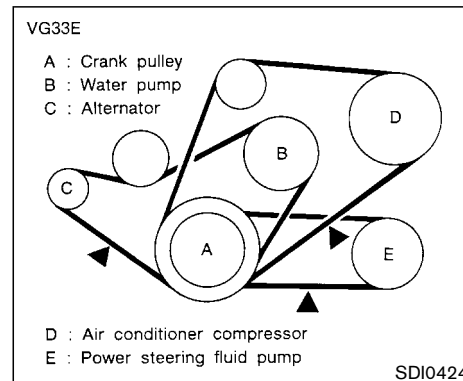
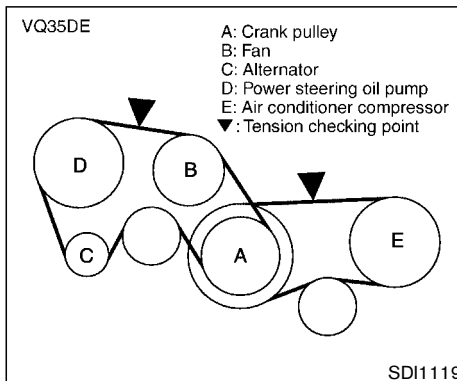

tion and tension.

⚠ WARNING

Be sure the ignition key is in the OFF or LOCK position. The engine could rotate unexpectedly.

1. Visually inspect each belt for signs of unusual wear, cuts, fraying oil adhesion or looseness. If the belt is in poor condition or loose, have it replaced or adjusted by your NISSAN dealer.
2. Have the belts checked regularly for condi-

SPARK PLUGS

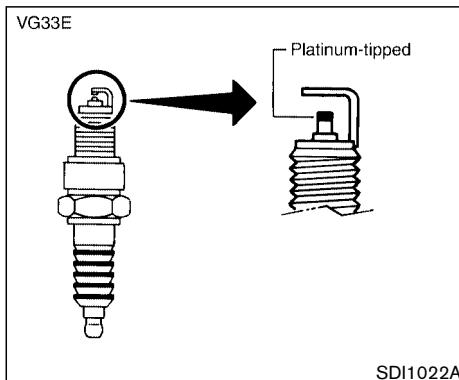
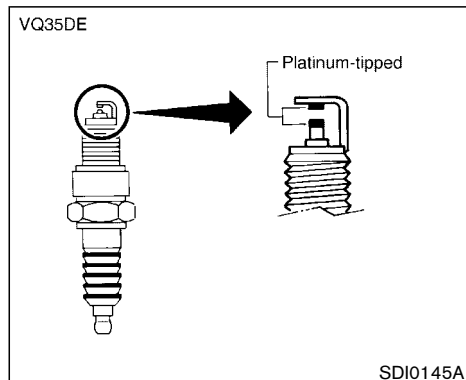

REPLACING SPARK PLUGS

WARNING

Be sure the engine and ignition switch are off and that the parking brake is engaged securely.

CAUTION

Be sure to use the correct socket to

remove the spark plugs. An incorrect socket can cause damage to the spark plugs.

Platinum-tipped spark plugs

It is not necessary to replace the platinum-tipped spark plugs as frequently as the conventional type spark plugs since they will last much longer. Follow the maintenance schedule, but do not reuse them by cleaning or regapping. If replacement is required, see your NISSAN dealer for servicing.

Always replace with recommended platinum-tipped spark plugs.

AIR CLEANER

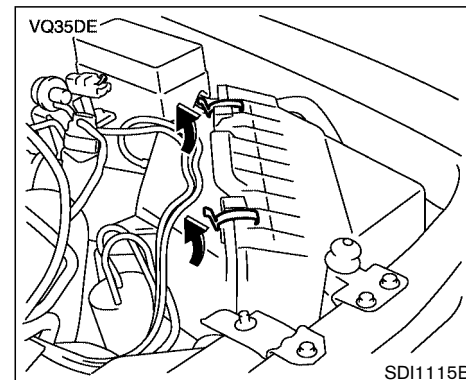

The filter element should not be cleaned and reused as it is given a special treatment. We recommend it be replaced according to the maintenance log shown in a separate "Service and Maintenance Guide". When replacing the filter, wipe the inside of the air cleaner housing and the cover with a damp cloth.

WARNING

- **Operating the engine with the air cleaner removed can cause you or others to be burned. The air cleaner**

WINDSHIELD WIPER BLADES

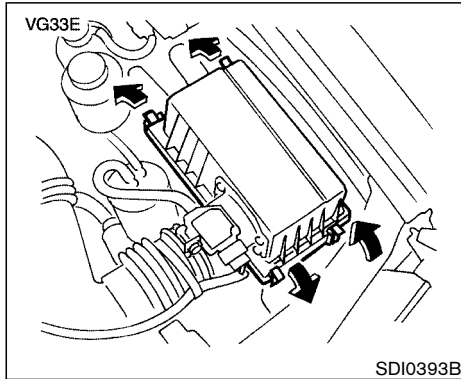

not only cleans the air, it stops flame if the engine backfires. If it is not there, and the engine backfires, you could be burned. Do not drive with the air cleaner removed and be careful working on the engine with the air cleaner removed.

- Never pour fuel into the throttle body or attempt to start the engine with the air cleaner removed. Doing so could result in serious injury.

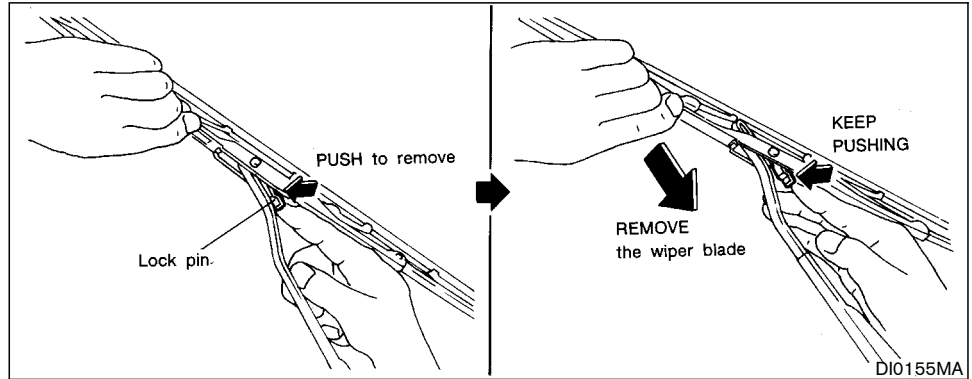

CLEANING

If your windshield is not clear after using the windshield washer or if a wiper blade chatters when running, wax or other material may be on the blade or windshield.

Clean the outside of the windshield with a washer solution or a mild detergent. Your windshield is clean if beads do not form when rinsing with clear water.

Clean the blade by wiping it with a cloth soaked in a washer solution or a mild detergent. Then rinse the blade with clear water. If your windshield is still not clear after cleaning the blades

and using the wiper, replace the blades.

REPLACING

Replace the wiper blades if they are worn.

1. Pull the wiper arm.
2. Push the lock pin, then remove the wiper blade.
3. Insert the new wiper blade to the wiper arm until a click sounds.



CAUTION

After wiper blade replacement, return the wiper arm to its original position; otherwise it may be damaged when the hood is opened.

Make sure the wiper blade contacts the glass, otherwise the arm may be damaged from wind pressure.

Worn windshield wiper blades can damage the windshield and impair driver vision.

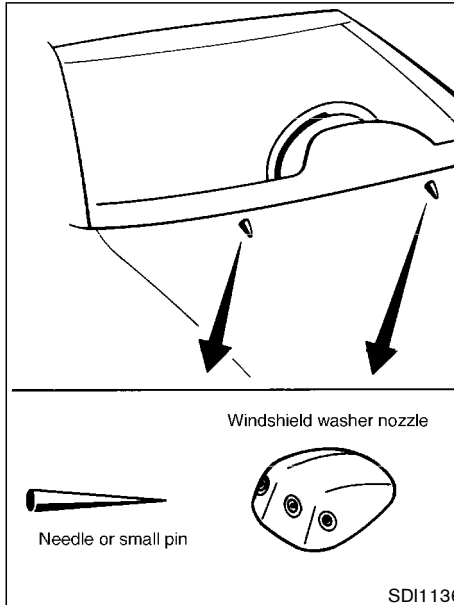

If you wax the surface of the hood, be careful not to let wax get into the washer nozzle. This may cause clogging or improper windshield washer operation. If wax gets into the nozzle, remove it with a needle or small pin.

PARKING BRAKE AND BRAKE PEDAL

6 to 8 clicks
under pulling force of 44 lb (196 N)

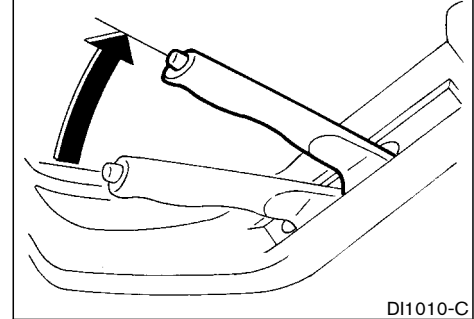

CHECKING PARKING BRAKE

Pull the parking brake lever up. If the number of clicks is out of the range as listed above, see your NISSAN dealer.

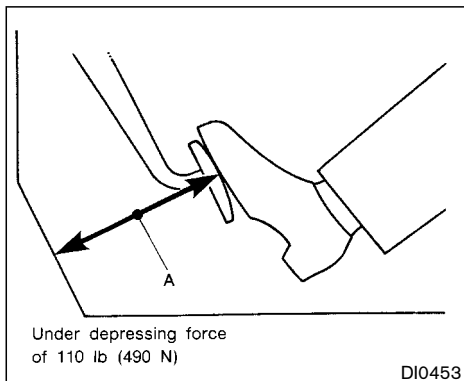

CHECKING BRAKE PEDAL

With the engine running, check distance A between the upper surface of the pedal and the dash lower panel.

Distance A

M/T models

2-1/2 in (65 mm) or more

A/T models

2-3/4 in (70 mm) or more

If it is out of the range shown above, see your NISSAN dealer.

Self-adjusting brakes

Your vehicle is equipped with self-adjusting brakes.

The front and rear brakes self-adjust every time the brake pedal is applied.



WARNING

See your NISSAN dealer and have it checked if the brake pedal height does not return to normal.

Brake pad wear indicators

The disc brake pads on your vehicle have audible wear indicators. When a brake pad requires replacement, it will make a high pitched scraping or screeching sound when the vehicle is in motion whether or not the brake pedal is depressed. Have the brakes checked as soon as possible if the wear indicator sound is heard.

Under some driving or climate conditions, occasional brake squeak, squeal or other noise may be heard. Occasional brake noise during light to moderate stops is normal and does not affect the function or performance of the brake system.

The rear drum brakes (if so equipped) do not

have audible wear indicators. Should you ever hear an unusually loud noise from the rear drum brakes, have them inspected as soon as possible by your NISSAN dealer.

Proper brake inspection intervals should be followed. For additional information, see the separate "Service and Maintenance Guide".

BRAKE BOOSTER

Check the brake booster function with the following steps:

1. With the engine off, press and release the brake pedal several times. When brake pedal movement (distance of travel) remains the same from one pedal application to the next, continue on to the next step.
2. While depressing the brake pedal, start the engine. The pedal height should drop a little.
3. With the brake pedal depressed, stop the engine. Keeping the pedal depressed for about 30 seconds, the pedal height should not change.
4. Run the engine for one minute without depressing the brake pedal, then turn it off. Depress the brake pedal several times. The pedal travel distance will decrease gradually with each depression as the vacuum is released from the booster.

FUSES

If the brakes do not operate properly, have the brake checked by your NISSAN dealer.

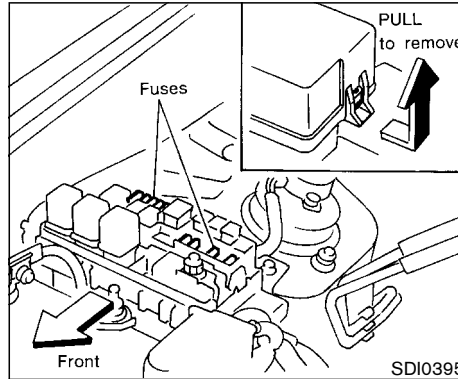

2. Open the engine hood.
3. Remove the fuse box cover.
4. Remove the fuse with the fuse puller.
5. If the fuse is open, replace it with a new fuse.
6. If a new fuse opens again, have the electrical system checked and repaired by your NISSAN dealer.

Fusible links

If any electrical equipment does not operate and fuses are in good condition, check the fusible links. If any of these fusible links are melted, replace only with genuine NISSAN parts.

ENGINE COMPARTMENT

CAUTION

Never use a fuse of higher amperage rating than that specified on the fuse box cover. This could damage the electrical system or cause a fire.

If any electrical equipment does not operate, check for an open fuse.

1. Be sure the ignition key and the headlight switch are OFF.

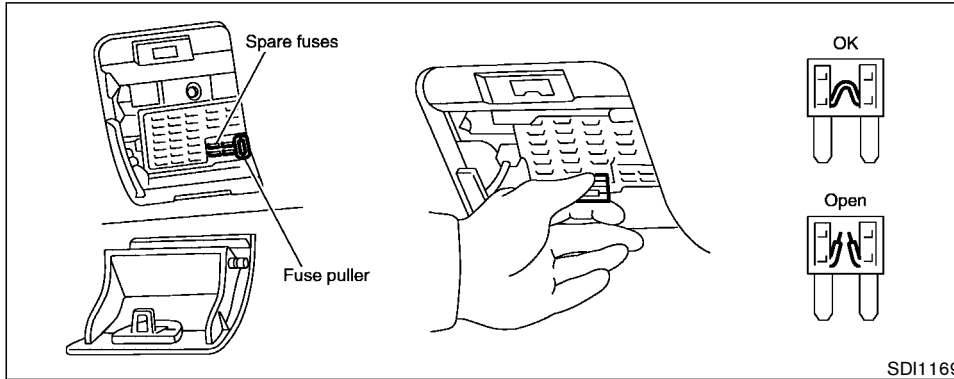

PASSENGER COMPARTMENT

If any electrical equipment does not operate, check for an open fuse.

1. Be sure the ignition key and the headlight switch are OFF.
2. Pull to open the fuse box cover/coin tray.
3. Pull down the fuse box cover/coin tray to remove it.
4. Remove the fuse with the fuse puller.
5. If the fuse is open, replace it with a new fuse.
6. If a new fuse opens again, have the electrical

system checked and repaired by your NISSAN dealer.

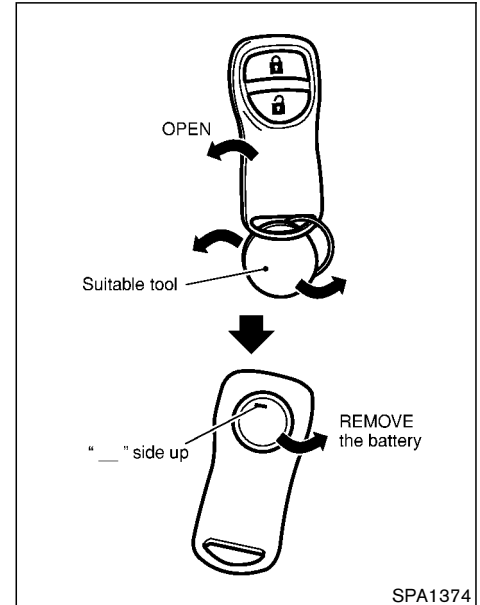

KEYFOB BATTERY REPLACEMENT

Replace the battery as follows:

1. Open the lid using a suitable tool.
2. Replace the battery with a new one.

Recommended battery: Sanyo CR2025 or equivalent

Make sure that the ⊕ side faces the bottom case.

3. Close the lid securely.
4. Push the keyfob button two or three times to check its operation.

See your NISSAN dealer if you need any assistance for replacement.

If the battery is removed for any reason other than replacement, perform step 4 above.

- **Be careful not to touch a circuit board and a battery terminal.**
- **An improperly disposed battery can harm the environment. Always confirm local regulations for battery disposal.**
- **The keyfob is water-resistant; however, if it does get wet, immediately wipe completely dry.**
- **When changing batteries, do not let dust or oil get on the controller.**

FCC Notice:

Changes or modifications not expressly approved by the manufacturer compliance

could void the user's authority to operate the equipment.

This device complies with Part 15 of the FCC Rules and RSS-210 of Industry Canada.

Operation is subject to the following two conditions: (1) This device may not cause harmful interference, and (2) this device must accept any interference received, including interference that may cause undesired operation of the device.

LIGHTS

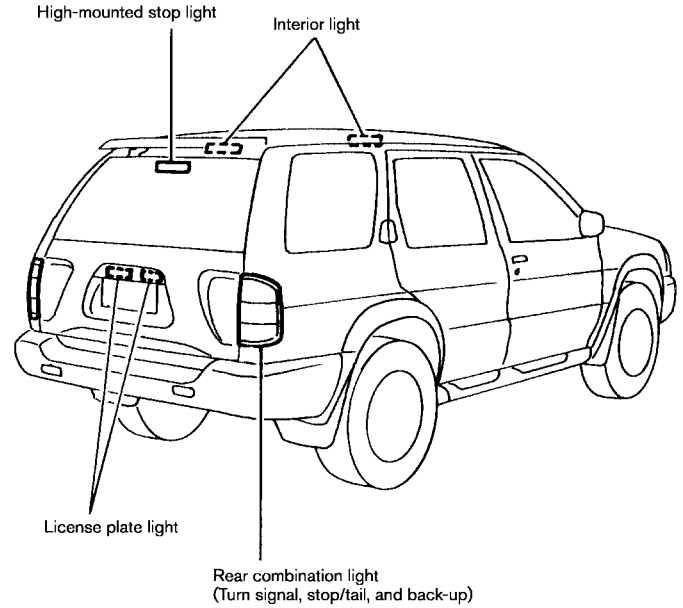
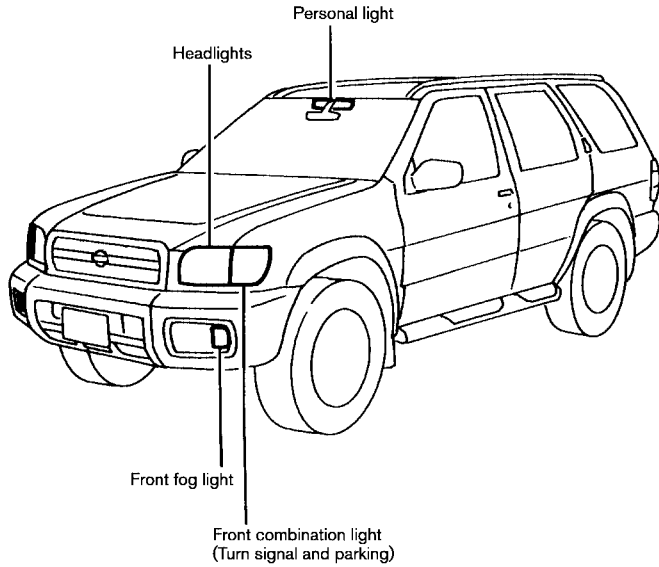

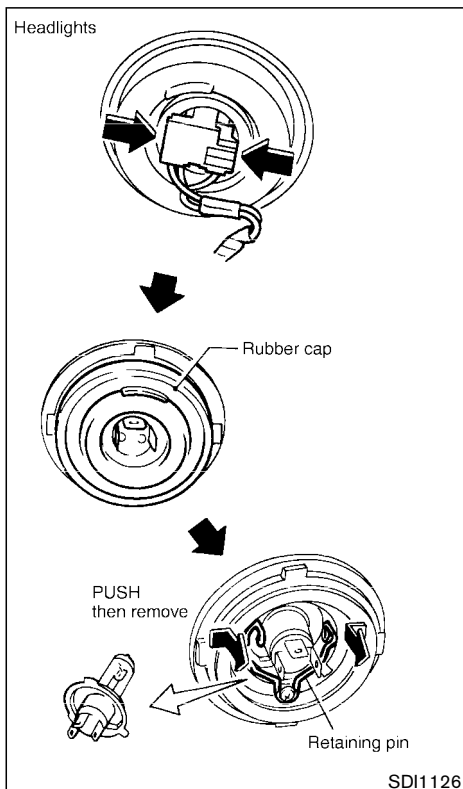

HEADLIGHTS

The headlight is a semi-sealed beam type which uses a replaceable headlight (halogen) bulb. A bulb can be replaced inside the engine compartment without removing the headlight assembly.

⚠ CAUTION

- **High pressure halogen gas is sealed inside the halogen bulb. The bulb may break if the glass envelope is scratched or the bulb is dropped.**
- **When handling the bulb, do not touch the glass envelope.**

Removing the headlight bulb

1. Disconnect the battery negative cable.
2. Disconnect the electrical connector from the rear end of the bulb.
3. Pull off the rubber cap.
4. Push and turn the retaining pin to loosen it.
5. Remove the headlight bulb. Do not shake or rotate the bulb when removing it.

6. Install the new bulb in the reverse order of removal.

Aiming is not necessary after replacing the bulb. When aiming adjustment is necessary, contact your NISSAN dealer.

⚠ CAUTION

- **Do not touch the bulb.**
- **Use the same number and wattage as originally installed:**
Wattage 60/55
Bulb No. HB2
- **Do not leave the bulb out of the headlight reflector for a long period of time as dust, moisture, and smoke may enter the headlight body and affect the performance of the headlight.**

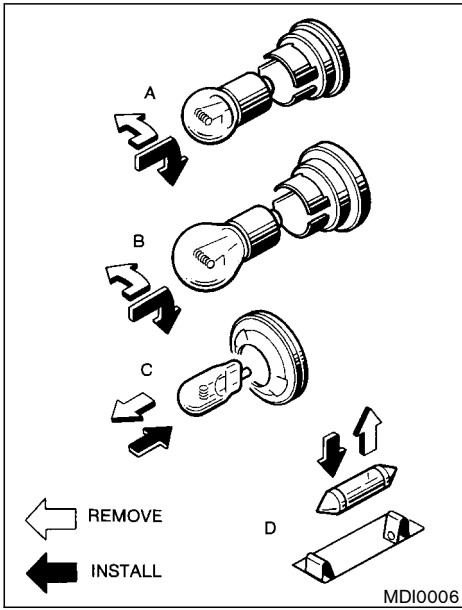

Replacement procedures

All other lights are either type A, B, C or D. When replacing a bulb, first remove the lens and/or cover.

| Item | Wattage (W) | Bulb No. |
|---------------------------|-------------|----------|
| Front combination light | 21/5 | 7443 |
| Front fog light (H3 type) | 55 | |
| Rear combination light | | |
| Turn signal | 27 | 1156NA |
| Stop/Tail | 21/5 | 7443 |
| Back-up | 18 | 921 |
| High mounted stop light | 5 | 168 |
| License plate light | 5 | 168 |
| Interior light | 10 | — |
| Vanity mirror light | 1.4 | — |
| Personal light | 8 | — |

Bulb identification

Personal light

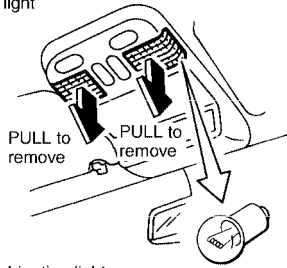

Front combination light

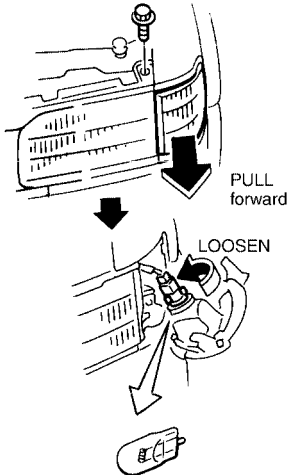

SDI1137

Interior light

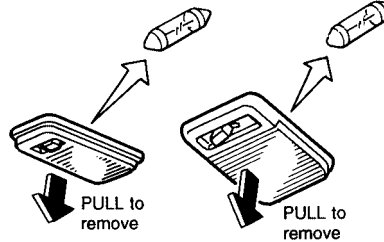

Rear combination light

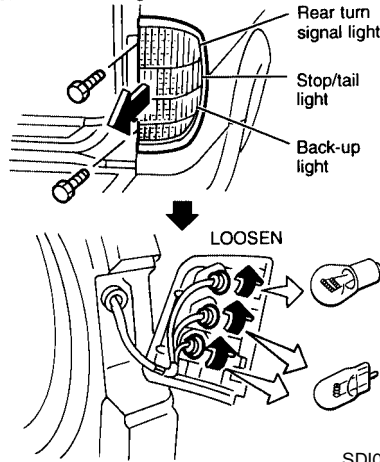

SDI0911

High-mounted stop light

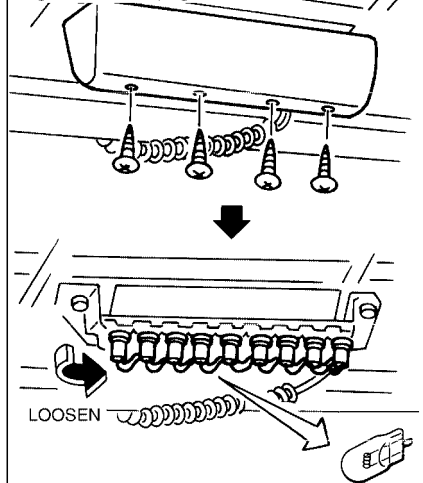

License plate light

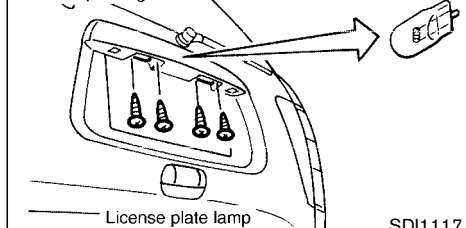

SDI1117

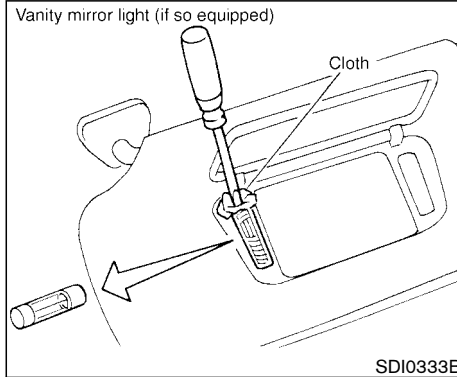
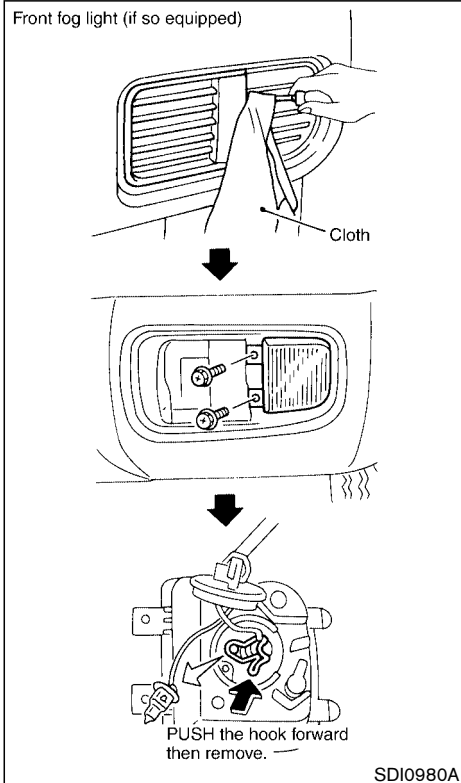

WHEELS AND TIRES

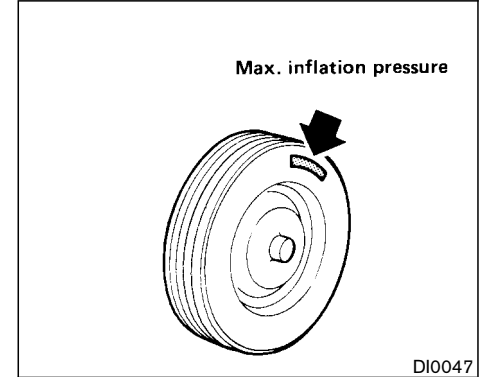

If you have a flat tire, see “Flat tire” in the “6. In case of emergency” section.

TIRE PRESSURE

Maximum inflation pressure

Do not exceed the maximum inflation pressures shown on the side wall of the tire.

Tire inflation pressure

Check the tire pressure (including spare) at least once a month and always prior to long distance trip. Incorrect tire pressure may adversely affect tire life and vehicle handling. Tire pressure should be checked when tires are COLD. Tires

are considered COLD after the vehicle has been parked for three or more hours, or driven less than 1 mile (1.6 km) at moderate speeds. COLD tire pressures are shown on the tire placard affixed to the inside of the glove box lid.

Low tire pressure warning system (if so equipped)

The low tire pressure warning system monitors the tire pressure of all tires (except the spare tire). For more details, refer to “Low tire pressure warning light” in the “2. Instruments and Controls” section, “Low tire pressure warning system” in the “starting and driving” section, and “Flat tire” in the “6. In case of emergency” section. The low tire pressure warning system will activate only when the vehicle is driven at speeds above 20 MPH (32 km/h).



WARNING

- **Improperly inflated tires can fail suddenly and cause an accident.**
- **The vehicle capacity weight is indicated on the tire placard. Do not load your vehicle beyond this capacity. Overloading your vehicle may result in reduced tire life, unsafe operating**

conditions due to premature tire failure, or unfavorable handling characteristics and could also lead to a serious accident. Loading beyond the specified capacity may also result in failure of other vehicle components.

- **Before taking a long trip, or whenever you have loaded your vehicle heavily, use a tire pressure gauge to ensure that the tire pressure is at the specified level.**
- **Do not drive your vehicle over 85 MPH (140 km/h) unless it is equipped with high speed capability tires. Driving faster than 85 MPH (140 km/h) may result in tire failure, loss of control and possible injury.**
- **For additional information regarding tires, refer to “Important Tire Safety Information” (US) or “Tire Safety Information” (Canada) in the Warranty Information booklet.**

TYPES OF TIRES



CAUTION

- **When changing or replacing tires, be sure all four tires are of the same type (i.e., summer, all season or snow) and construction. Your NISSAN dealer may be able to help you with information about tire type, size, speed rating and availability. Replacement tires may have a lower speed rating than the factory equipped tires, and may not match the potential maximum vehicle speed. Never exceed the maximum speed rating of the tire.**
- **For additional information regarding tires, refer to “Important Tire Safety Information” (US) or “Tire Safety Information” (Canada) in the Warranty Information booklet.**

All season tires

NISSAN specifies all season tires on some models to provide good performance for use all

year around, including snowy and icy road conditions. All season tires are identified by ALL SEASON and/or M&S on the tire sidewall. Snow tires have better snow traction than all season tires and may be more appropriate in some areas.

Summer tires

NISSAN specifies summer tires on some models to provide superior performance on dry roads. Summer tire performance in snow and ice will be substantially reduced. Summer tires do not have the tire traction rating M&S on the tire sidewall.

If you operate your vehicle in snowy or icy conditions, NISSAN recommends the use of SNOW or ALL SEASON tires on all four wheels.

Snow tires

If snow tires are needed, it is necessary to select tires equivalent in size and load rating to the original equipment tires. If you do not, it can adversely affect the safety and handling of your vehicle.

Generally, snow tires will have lower speed ratings than factory equipped tires and may not match the potential maximum vehicle speed. Never exceed the maximum speed rating of the tire.

If you install snow tires on four wheel drive

models, they must also be the same size, brand, construction and tread pattern on all four wheels.

If you operate your vehicle in snowy or icy conditions, NISSAN recommends the use of SNOW or ALL SEASON tire on all four wheels.

For additional traction on icy roads, studded tires may be used. However, some provinces and states prohibit their use. Check local, state and provincial laws before installing studded tires. Skid and traction capabilities of studded snow tires, on wet or dry surfaces, may be poorer than that of non-studded snow tires.

TIRE CHAINS

Use of tire chains is prohibited according to location. Check the local laws before installing tire chains. When installing tire chains, make sure they are of proper size for the tires on your vehicle and are installed according to the chain manufacturer's suggestions. **Use only SAE class S chains.** Class "S" chains are used on vehicles with restricted tire to vehicle clearance. Vehicles that can use Class "S" chains are designed to meet the SAE standard minimum clearances between the tire and the closest vehicle suspension or body component required to accommodate the use of a winter traction device (tire chains or cables). The minimum clearances are determined using the factory

equipped tire size. Other types may damage your vehicle. Use chain tensioners when recommended by the tire chain manufacturer to ensure a tight fit. Loose end links of the tire chain must be secured or removed to prevent the possibility of whipping action damage to the fenders or underbody. If possible, avoid fully loading your vehicle when using tire chains. In addition, drive at a reduced speed. Otherwise, your vehicle may be damaged and/or vehicle handling and performance may be adversely affected.

Never install tire chains on TEMPORARY USE ONLY spare tires.

Do not use tire chains on dry roads.

Tire chains must be installed only on the rear wheels and not on the front wheels.

Do not drive with tire chains on paved roads which are clear of snow. Driving with chains in such conditions can cause damage to the various mechanisms of the vehicle due to some overstress. When driving on clear paved roads, be sure to change to 2WD.

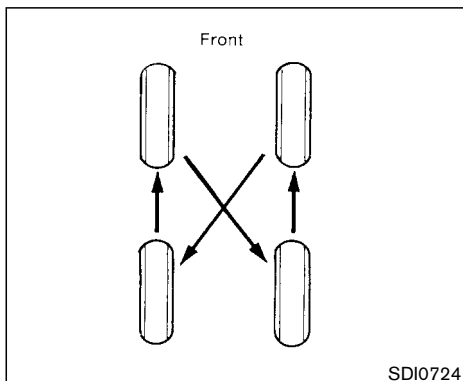

CHANGING WHEELS AND TIRES

Tire rotation

NISSAN recommends that tires be rotated every 7,500 miles (12,000 km). However, the timing for tire rotation may vary according to your driving habits and road surface conditions.

See "Flat tire" in the "6. In case of emergency" section for tire replacing procedures.

**Wheel nut tightening torque:
98 ft-lb (133 N·m)**



WARNING

- After rotating the tires, adjust the tire pressure.
- Retighten the wheel nuts after the vehicle has been driven for 600 miles (1,000 km) (also in cases of a flat tire, etc.).
- Do not include small size spare tire in the tire rotation.
- For additional information regarding tires, refer to "Important Tire Safety Information" (US) or "Tire Safety Information" (Canada) in the Warranty Information booklet.

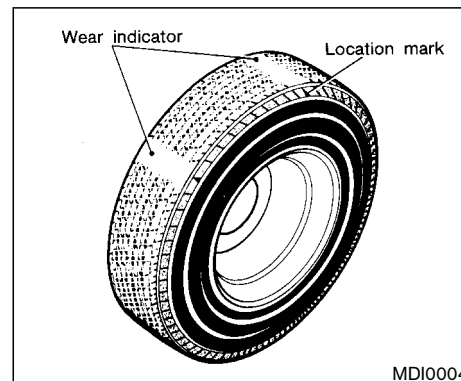

Tire wear and damage



WARNING

- Tires should be periodically inspected for wear, cracking, bulging or objects caught in the tread. If excessive wear, cracks, bulging or deep cuts are found, the tire should be replaced.
- The original tires have a built-in tread wear indicator. When the wear

indicator is visible, the tire should be replaced.

- **Improper service for a TEMPORARY USE ONLY spare tire may result in serious personal injury. If it is necessary to repair the TEMPORARY USE ONLY spare tire, contact your NISSAN dealer.**
- **For additional information regarding tires, refer to “Important Tire Safety Information” (US) or “Tire Safety Information” (Canada) in the Warranty Information booklet.**

Replacing wheels and tires

When replacing a tire, use the same size, speed rating and load carrying capacity as originally equipped. See “Specifications” in the “9. Technical and consumer information” section for tires and wheels.



WARNING

- **The use of tires other than those recommended or the mixed use of tires of different brands, construction (bias, bias-belted or radial), or tread patterns can adversely affect the ride, braking, handling, ground clearance, body-to-tire clearance, tire chain clearance, speedometer calibration, headlight aim and bumper height. Some of these effects may lead to accidents and could result in serious personal injury.**
- **If the wheels are changed for any reason, always replace with wheels which have the same offset dimension. Wheels of a different offset could cause early tire wear, possibly degraded vehicle handling characteristics and/or interference with the brake discs. Such interference can lead to decreased braking efficiency and/or early brake pad wear.**
- **When a spare tire is mounted or a**

wheel is replaced, the low tire pressure warning system will not function. Contact your NISSAN dealer as soon as possible for tire replacement and/or system resetting. (For models with the low tire pressure warning system)

- **Do not install a deformed wheel or tire even if it has been repaired. Such wheels or tires could have structural damage and could fail without warning.**
- **The use of a retread tire is not recommended.**
- **For additional information regarding tires, refer to “Important Tire Safety Information” (US) or “Tire Safety Information” (Canada) in the Warranty Information booklet.**

4x4 Four wheel drive models



CAUTION

Always use tires of the same size, brand, construction (bias, bias-belted or radial), and tread pattern on all four wheels. Failure to do so may result in a circumference difference between tires on the front and rear axles which will cause excessive tire wear and may damage the transmission, transfer case and differential gears.

If excessive tire wear is found, it is recommended that all four tires be replaced with tires of the same size, brand, construction and tread pattern. The tire pressure and wheel alignment should also be checked and corrected as necessary. Contact your NISSAN dealer.

Wheel balance

Unbalanced wheels may affect vehicle handling and tire life. Even with regular use, wheels can get out of balance. Therefore, they should be balanced as required.

Wheel balance service should be performed with the wheels off the vehicle. Spin balancing

the rear wheels on the vehicle could lead to transmission damage.

- For additional information regarding tires, refer to "Important Tire Safety Information" in the Warranty Information Booklet (US) or "Tire Safety Information" in the Warranty Information Booklet (Canada).

Care of wheels

- Wash the wheels when washing the vehicle to maintain their appearance.
- Clean the inner side of the wheels when the wheel is changed or the underside of the vehicle is washed.
- Do not use abrasive cleaners when washing the wheels.
- Inspect wheel rims regularly for dents or corrosion. This may cause loss of pressure or damage the tire bead.
- NISSAN recommends that the road wheels be waxed to protect against road salt in areas where it is used during winter.

TEMPORARY USE ONLY spare tire (if so equipped)

U.S. only. Canadian vehicles are equipped with a full size spare tire.

Observe the following precautions if the TEMPORARY USE ONLY spare tire must be used, otherwise your vehicle could be damaged or involved in an accident.



WARNING

- **The TEMPORARY USE ONLY spare tire should be used only for emergency. It should be replaced by the standard tire at the first opportunity.**
- **Drive carefully while the TEMPORARY USE ONLY spare tire is installed.**

Avoid sharp turns and abrupt braking while driving.

- **Periodically check the TEMPORARY USE ONLY spare tire inflation pressure, and always keep it at 60 psi (420 kPa, 4.2 bar).**
- **Always keep the pressure of the full size spare tire (if so equipped) at the recommended pressure for standard tires, as indicated on the tire placard. For tire placard location, see "Tire**

placard” in the “9. Technical and consumer information” section.

- Do not drive your vehicle at speeds faster than 50 MPH (80 km/h).
- When driving on roads covered with snow or ice, the **TEMPORARY USE ONLY** spare tire should be used on the front axle and original tire used on the rear axle (drive wheels). Use tire chains only on the rear (original) tires.
- Tire tread of the **TEMPORARY USE ONLY** spare tire will wear at a faster rate than the original tire. Replace the **TEMPORARY USE ONLY** spare tire as soon as the tread wear indicators appear.
- Do not use the **TEMPORARY USE ONLY** spare tire on other vehicles.
- Do not use more than one **TEMPORARY USE ONLY** spare tire at the same time.
- Do not tow a trailer while the **TEMPORARY USE ONLY** spare tire is installed.



CAUTION

- Do not use tire chains on a **TEMPORARY USE ONLY** spare tire. Tire chains will not fit properly on the **TEMPORARY USE ONLY** spare tire and may cause damage to the vehicle.
- Because the **TEMPORARY USE ONLY** spare tire is smaller than the original tire, ground clearance is reduced. To avoid damage to the vehicle do not drive over obstacles. Also do not drive the vehicle through an automatic car wash since it may get caught.

MEMO

|

MEMO

—

—

|

9 Technical and consumer information

| | | | |
|----------------------------------------------------------------------------|------|-------------------------------------------------------------------|------|
| Capacities and recommended fuel/lubricants..... | 9-2 | Air conditioner specification label | 9-14 |
| Fuel recommendation..... | 9-4 | Vehicle loading information..... | 9-15 |
| Engine oil and oil filter recommendation..... | 9-6 | Terms | 9-15 |
| Recommended SAE oil viscosity number..... | 9-7 | Determining vehicle payload capacity..... | 9-15 |
| Air conditioning system refrigerant and lubricant recommendations | 9-8 | Securing the load | 9-16 |
| Specifications..... | 9-9 | Loading tips | 9-16 |
| Engine | 9-9 | Payload weight capacity | 9-17 |
| Wheels and tires | 9-11 | Measurement of weights | 9-17 |
| Dimensions and weights..... | 9-11 | Towing a trailer | 9-17 |
| When traveling or registering your vehicle in another country..... | 9-12 | Maximum load limits..... | 9-17 |
| Vehicle identification..... | 9-12 | Towing load/specification chart..... | 9-19 |
| Vehicle identification number (VIN) plate | 9-12 | Towing safety..... | 9-19 |
| Vehicle identification number (Chassis number)..... | 9-12 | Uniform tire quality grading..... | 9-21 |
| Engine serial number | 9-13 | Emission control system warranty..... | 9-22 |
| F.M.V.S.S. certification label..... | 9-13 | Reporting safety defects (US only) | 9-22 |
| Emission control information label | 9-14 | Readiness for inspection/maintenance (I/M) test (US only)..... | 9-23 |
| Tire placard | 9-14 | Owner's Manual/Service Manual order information .. | 9-25 |
| | | In the event of a collision | 9-25 |

CAPACITIES AND RECOMMENDED FUEL/LUBRICANTS

The following values are approximate capacities. The actual refill capacities may be a little different from them. When refilling, follow the procedure instructed in the “8. Maintenance and do-it-yourself” section to determine the proper refill capacity.

| | Capacity (Approximate) | | | Recommended specifications |
|-------------------------------------------------|------------------------|-------------|-------|-------------------------------------------------------------------------------------------------------------------------------------------------------------------------------------------------------------------------------------------|
| | US measure | Imp measure | Liter | |
| Fuel | 20-7/8 gal | 17-3/8 gal | 79 | Unleaded gasoline with an octane rating of at least 91 AKI (RON 96) (VQ35DE) or 87AKI (RON 91) (VG33E)*1 |
| Engine oil*4 Drain and refill | | | | |
| with oil filter change | 5-1/4 qt | 4-3/8 qt | 5.0 | <ul style="list-style-type: none"> ● API Certification Mark*2 *3 ● API grade SG/SH, Energy Conserving I & II or API grade SJ, SL, Energy Conserving*2 *3 ● ILSAC grade GF-I, GF-II & GF-III*2 *3 |
| without oil filter change | 5-1/8 qt | 4-1/4 qt | 4.8 | |
| Cooling system (with heater and reservoir tank) | 9-3/4 qt | 8-1/8 qt | 9.2 | Genuine Nissan Anti-Freeze Coolant or equivalent |

*1: See later in this section for fuel recommendation.

*2: See later in this section for recommended SAE viscosity number.

*3: See later in this section for engine oil and oil filter recommendation.

*4: See “Changing engine oil” in the “8. Maintenance and do-it-yourself” section for further details.

| | Capacity (Approximate) | | | Recommended specifications |
|------------------------------------------|------------------------------------------------------------------------------------------------------------------|-------------|-------|----------------------------------------------------------------------------------------------------------------------------------|
| | US measure | Imp measure | Liter | |
| Manual transmission | — | — | — | API GL-4 Viscosity SAE 75W-85 |
| Differential gear oil (exc. LSD) | — | — | — | API GL-5 Viscosity SAE 80W-90*1 |
| Limited-slip differential (LSD) gear oil | — | — | — | Only LSD gear oil: API GL-5 and SAE 80W-90*1 approved for Nissan LSD*2 |
| Automatic transmission fluid | | | | Nissan Matic "D" (Continental U.S. and Alaska) or Canada NISSAN Automatic Transmission Fluid.*6 |
| Power steering fluid | | | | Genuine Nissan PSF or equivalent*5 |
| All-mode 4WD transfer fluid | Refill to the proper oil level according to the instructions in the "8. Maintenance and do-it-yourself" section. | | | Nissan Matic "D" (Continental U.S. and Alaska) or Canada NISSAN Automatic Transmission Fluid.*6 |
| Transfer fluid | | | | Nissan Matic "D" (Continental U.S. and Alaska) or Canada NISSAN Automatic Transmission Fluid.*6 or API GL-4 Viscosity SAE 75W-90 |
| Brake and clutch fluid | | | | Genuine Nissan Brake Fluid*4 or equivalent DOT 3 (U.S. F.M.V.S.S. No. 116) |
| Propeller shaft grease | — | — | — | NLGI No. 2 (Lithium soap base) |
| Multi-purpose grease | — | — | — | NLGI No. 2 (Lithium soap base) |
| Air conditioning system refrigerant | — | — | — | HFC-134a (R-134a)*4 |
| Air conditioning system lubricants | — | — | — | Nissan A/C System Oil Type S or exact equivalent*4 |

*1: For hot areas, viscosity SAE 90 is suitable for ambient temperatures above 0°C (32°F).

*2: Contact your NISSAN dealer for a list of approved oils.

*3: Available in mainland U.S. through your NISSAN dealer.

*4: See "Vehicle identification" later in this section for air conditioner specification label.

*5: For Canada, NISSAN Automatic Transmission Fluid (ATF), DEXRONTMIII/MERCONTM or equivalent ATF may also be used.

*6: DexronTMIII/MerconTM or equivalent may also be used. Outside the continental U.S. and Alaska contact an authorized NISSAN dealer for more information regarding suitable fluids, including recommended brand(s) of DEXRONTMIII/MERCONTM Automatic Transmission Fluid.

FUEL RECOMMENDATION

VG33E engine:

Use unleaded regular gasoline with an octane rating of at least 87 AKI (Anti-Knock Index) number (Research octane number 91).

VQ35DE engine:

Use unleaded regular gasoline with an octane rating of at least 87 AKI (Anti-Knock Index) number (Research octane number 91).

For improved vehicle performance, NISSAN recommends the use of unleaded premium gasoline with an octane rating of at least 91 AKI number (Research octane number 96).



CAUTION

Using a fuel other than that specified could adversely affect the emission control devices and systems, and could also affect the warranty coverage.

Under no circumstances should a leaded gasoline be used since this will

damage the three way catalyst.

Reformulated gasoline

Some fuel suppliers are now producing reformulated gasolines. These gasolines are specially designed to reduce vehicle emissions. NISSAN supports efforts towards cleaner air and suggest that you use reformulated gasoline when available.

Gasoline containing oxygenates

Some fuel suppliers sell gasoline containing oxygenates such as ethanol, MTBE and methanol with or without advertising their presence. NISSAN does not recommend the use of fuels of which the oxygenate content and the fuel compatibility for your Nissan cannot be readily determined.

If you use oxygenate-blend gasoline, please take the following precautions as the usage of such fuels may cause vehicle performance problems and/or fuel system damage.

- The fuel should be unleaded and have an octane rating no lower than that recommended for unleaded gasoline.
- If an oxygenate-blend, excepting a methanol blend, is used, it should con-

tain no more than 10% oxygenate. (MTBE may, however, be added up to 15%.)

- If a methanol blend is used, it should contain no more than 5% methanol (methyl alcohol, wood alcohol). It should also contain a suitable amount of appropriate cosolvents and corrosion inhibitors. If not properly formulated with appropriate cosolvents and corrosion inhibitors, such methanol blends may cause fuel system damage and/or vehicle performance problems. At this time, sufficient data is not available to ensure that all methanol blends are suitable for use in Nissan vehicles.

If any undesirable driveability problems such as engine stalling and hard hot starting are experienced after using oxygenate-blend fuels, immediately change to a non-oxygenate fuel or a fuel with a low blend of MTBE.

Take care not to spill gasoline during refueling. Gasoline containing oxygenates can cause paint damage.

Aftermarket fuel additives

NISSAN does not recommend the use of any fuel additives (i.e.: fuel injector cleaner, octane booster, intake valve deposit removers, etc.)

which are sold commercially. Many of these additives intended for gum, varnish or deposit removal may contain active solvents or similar ingredients that can be harmful to the fuel system and engine.

Octane rating tips

In most parts of North America, you should use unleaded gasoline with an octane rating of at least 91 AKI (Anti-Knock Index) number (VQ35DE engine) or 87 AKI (Anti-knock Index) number (VG33E engine). However, you may use unleaded gasoline with an octane rating as low as 85 AKI (Anti-Knock Index) number in these high altitude areas [over 4,000 ft (1,219 m)] such as: Colorado, Montana, New Mexico, Utah, Wyoming, northeastern Nevada, southern Idaho, western South Dakota, western Nebraska, and that part of Texas which is directly south of New Mexico.

Using unleaded gasoline with an octane rating lower than stated above can cause persistent, heavy spark knock. (Spark knock is a metallic rapping noise.) If severe, this can lead to engine damage. If you detect a persistent heavy spark knock even when using gasoline of the stated octane rating, or if you hear steady spark knock while holding a steady speed on level roads, have your dealer correct the condi-

tion. Failure to correct the condition is misuse of the vehicle, for which NISSAN is not responsible.

Incorrect ignition timing will result in knocking, after-run or overheating. This in turn may cause excessive fuel consumption or damage to the engine. If any of the above symptoms are encountered, have your vehicle checked at a NISSAN dealer or other competent service facility.

However, now and then you may notice light spark knock for a short time while accelerating or driving up hills. This is no cause for concern, because you get the greatest fuel benefit when there is light spark knock for a short time.

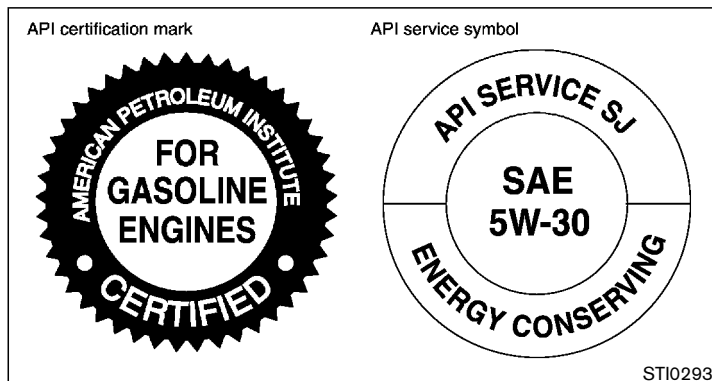

ENGINE OIL AND OIL FILTER RECOMMENDATION

Selecting the correct oil

It is essential to choose the correct quality, and viscosity oil to ensure satisfactory engine life and performance. Nissan recommends the use of a low friction oil (energy conserving oil) in order to improve fuel economy and conserve energy. Oils which do not have the specified quality label should not be used as they could cause engine damage.

Only those engine oils with the American Petroleum Institute (API) CERTIFICATION MARK on

the front of the container should be used. This type of oil supersedes the existing API SG, SH, or SJ and Energy Conserving I & II categories.

If you cannot find engine oil with the API CERTIFICATION MARK, use an API grade SG/SH, Energy Conserving I & II or API grade SJ, Energy Conserving oil. An oil with a single designation SG or SH, or in combination with other categories (for example, SG/CC or SG/CD) may also be used if one with the API CERTIFICATION MARK cannot be found. An ILSAC grade GF-I & GF-II oil can also be used.

NISSAN does not recommend synthetic type oils but recommends mineral based oils. These

oils must however, meet the API quality and SAE viscosity ratings specified for your vehicle.

Oil additives

NISSAN does not recommend the use of oil additives. The use of an oil additive is not necessary when the proper oil type is used and maintenance intervals are followed.

Oil which may contain foreign matter or has been previously used should not be used.

Oil viscosity

The engine oil viscosity or thickness changes with temperature. Because of this, it is important that the engine oil viscosity be selected based on the temperatures at which the vehicle will be operated before the next oil change. The chart recommended SAE viscosity number shows the recommended oil viscosities for the expected ambient temperatures. Choosing an oil viscosity other than that recommended could cause serious engine damage.

Selecting the correct oil filter

Your new vehicle is equipped with a high-quality genuine Nissan oil filter. When replacing, use the genuine oil filter or its equivalent for the reason described in change intervals.

Change intervals

The oil and oil filter change intervals for your engine are based on the use of the specified quality oils and filters. Oil and filter other than the specified quality, or oil and filter change intervals longer than recommended could reduce engine life. Damage to engines caused by improper maintenance or use of incorrect oil and filter quality and/or viscosity is not covered by the new Nissan vehicle warranties.

Your engine was filled with a high quality engine oil when it was built. You do not have to change the oil before the first recommended change interval. Oil and filter change intervals depend upon how you use your vehicle. Operation under the following conditions may require more frequent oil and filter changes.

- repeated short distance driving at cold outside temperatures,
- driving in dusty conditions,
- extensive idling,
- towing a trailer.

RECOMMENDED SAE OIL VISCOSITY NUMBER

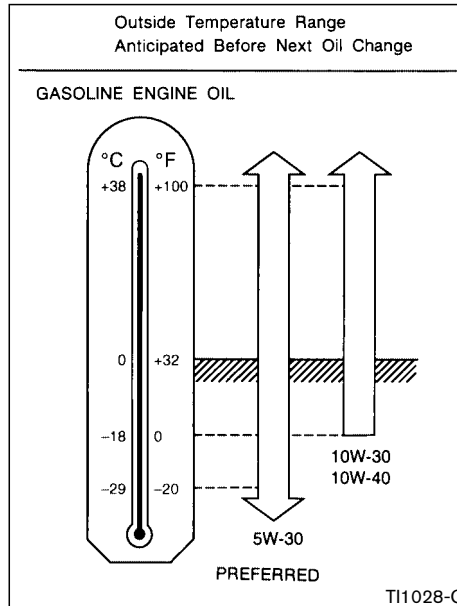

SAE 5W-30 viscosity oil is preferred for all ambient temperatures. SAE 10W-30, 10W-40 viscosity oil may be used if the ambient temperature is above 0°F (-18°C).

AIR CONDITIONING SYSTEM REFRIGERANT AND LUBRICANT RECOMMENDATIONS

The air conditioning system in this NISSAN vehicle must be charged with the refrigerant HFC-134a (R-134a) and the lubricant, Nissan A/C System Oil Type S or the exact equivalents.



CAUTION

The use of any other refrigerants or lubricants will cause severe damage to the air conditioning system and will require the replacement of all air conditioning system components.

The refrigerant HFC-134a (R-134a) in your NISSAN vehicle will not harm the earth's ozone layer. Although this refrigerant does not affect the earth's atmosphere, certain governmental regulations require the recovery and recycling of any refrigerant during automotive air condition-

ing system service. Your NISSAN dealer has the trained technicians and equipment needed to recover and recycle your air conditioning system refrigerant.

Contact your NISSAN dealer when servicing your air conditioning system.

SPECIFICATIONS

ENGINE

| Model | VQ35DE | VG33E |
|-----------------------------|-------------------------------------------------------------------------------------|----------------------------------------------------------------|
| Type | Gasoline, 4-cycle | Gasoline, 4-cycle |
| Cylinder arrangement | 6-cylinder, V-slanted at 60° | 6-cylinder, V-slanted at 60° |
| Bore × Stroke | in (mm) 3.760 × 3.205 (95.5 × 81.4) | 3.602 × 3.268 (91.5 × 83.0) |
| Displacement | cu in (cm ³) 213.45 (3,498) | 199.84 (3,275) |
| Firing order | 1-2-3-4-5-6 | 1-2-3-4-5-6 |
| Idle speed | rpm | |
| Ignition timing (BTDC) | degree/rpm See the "Emission control label" on the underside of the hood. | See the "Emission control label" on the underside of the hood. |
| CO percentage at idle speed | [No air] % | |
| Spark plug | PL FR5A-11 (Standard) PL FR4A-11 (Service option) PL FR6A-11 (Service option) | FR4AP-10 (Hot) FR5AP-10 (Standard) FR6AP-10 (Cold) |
| Spark plug gap | in (mm) 0.043 (1.1) | 0.039 (1.0) |
| Camshaft operation | Timing chain | Timing belt*1 |
| Alternator belt size | | |
| Width × Length | in (mm) 0.8409 × 46.26 (21.36 × 1,175) | 0.8409 × 41.93 (21.36 × 1,065) |

*1: Periodic maintenance is necessary. See "Periodic maintenance" in the "Service and Maintenance Guide" for maintenance intervals.

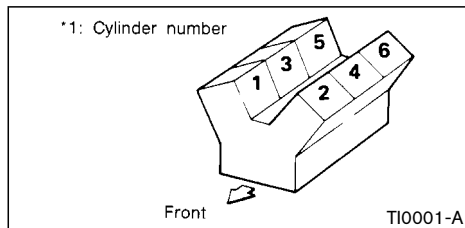

The spark ignition system of this vehicle meets all requirements of the Canadian Interference-Causing Equipment Regulations.

WHEELS AND TIRES

| Grade | Road wheel/ offset in (mm) | Tire | Spare tire size |
|------------|---------------------------------|-------------------|-------------------------------------|
| XE | 16x7JJ Aluminum/ 1.97 (50) | P245/70R16 106S | P245/70R16 106S 215/80R16 103M*2 |
| SE WIDE | 16x7JJ Aluminum/ 0.79 (20)*1 | P255/65R16 106S*1 | P255/65R16 106S*1 |
| LE WIDE | 17x8JJ Aluminum/ 0.79 (20) | P245/65R17 105S | P245/65R17 105S 255/65R16 106S*1 |

*1: Option for XE

*2: If so equipped (for US)

DIMENSIONS AND WEIGHTS

| PATHFINDER | | |
|-----------------------------|---------|----------------------------------------------------------------------------|
| Overall length*1 | in (mm) | 182.7 (4,640) |
| Overall width | in (mm) | 69.7 (1,770) 71.7 (1,820)*2 |
| Overall height | in (mm) | 68.1 (1,730) 67.9 (1,725)*2 |
| Front tread | in (mm) | 58.3 (1,480) 60.6 (1,540)*2 |
| Rear tread | in (mm) | 58.5 (1,485) 60.8 (1,545)*2 |
| Wheelbase | in (mm) | 106.3 (2,700) |
| Gross vehicle weight rating | lb (kg) | See the "F.M.V.S.S. certification label" on the driver's side lock pillar. |
| Gross axle weight rating | | |
| Front | lb (kg) | |
| Rear | lb (kg) | |

*1: On spare tire carrier equipped models, the spare tire carrier adds 9.45 in (240 mm) to the overall length.

*2: SE and LE wide models

WHEN TRAVELING OR REGISTERING YOUR VEHICLE IN ANOTHER COUNTRY

When planning to travel in another country, you should first find out if the fuel available is suitable for your vehicle's engine.

Using fuel with too low an octane rating may cause engine damage. All gasoline vehicles can be operated with unleaded gasoline. Therefore, avoid taking your vehicle to areas where appropriate fuel is not available.

When transferring the registration of your vehicle to another country, state, province or district, it may be necessary to modify the vehicle to meet local laws and regulations.

The laws and regulations for motor vehicle emission control and safety standards vary according to the country, state, province or district; therefore, vehicle specifications may differ.

When any vehicle is to be taken into another country, state, province or district and registered, its modifications, transportation and registration are the responsibility of the user. NISSAN is not responsible for any inconvenience that may result.

VEHICLE IDENTIFICATION

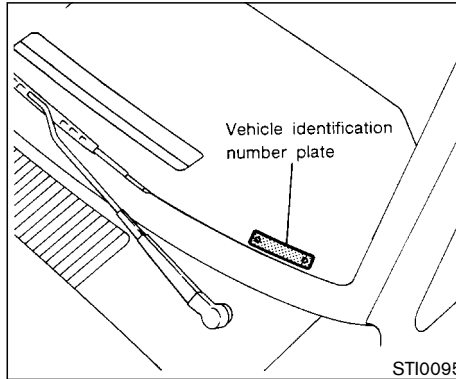

VEHICLE IDENTIFICATION NUMBER (VIN) PLATE

The vehicle identification number plate is attached as shown. This number is the identification for your vehicle and is used in the vehicle registration.

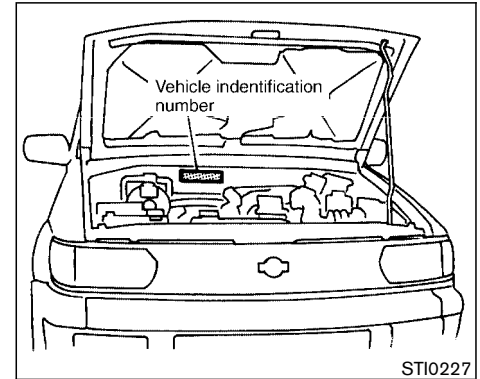

VEHICLE IDENTIFICATION NUMBER (Chassis number)

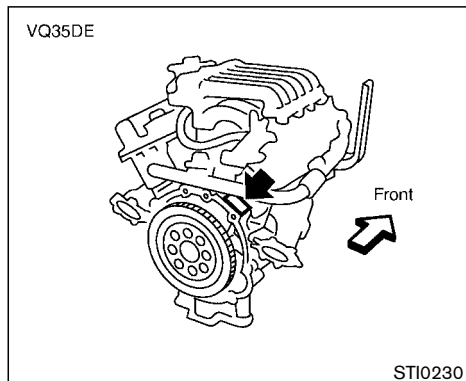

ENGINE SERIAL NUMBER

The number is stamped on the engine as shown.

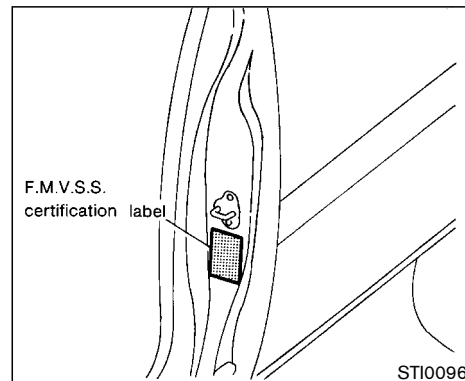
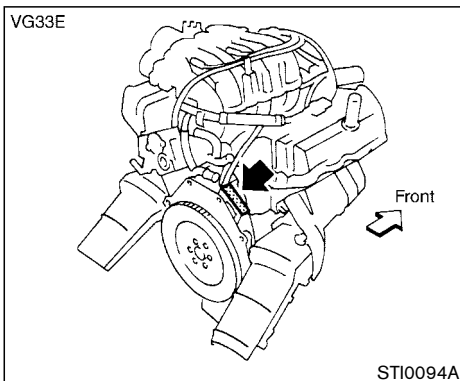

F.M.V.S.S. CERTIFICATION LABEL

The Federal Motor Vehicle Safety Standard (F.M.V.S.S.) certification label is affixed as shown. This label contains valuable vehicle information, such as: Gross Vehicle Weight Ratings (GVWR), Gross Axle Weight Rating (GAWR), month and year of manufacture, Vehicle Identification Number, (VIN), etc. Review it carefully.

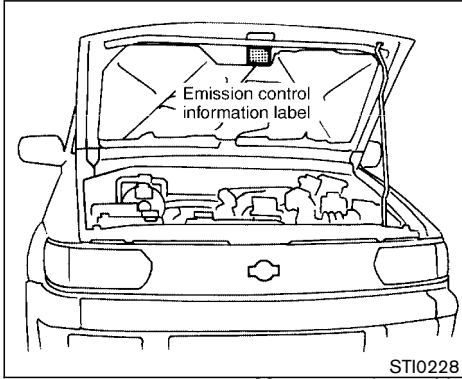

EMISSION CONTROL INFORMATION LABEL

The emission control information label is attached as shown.

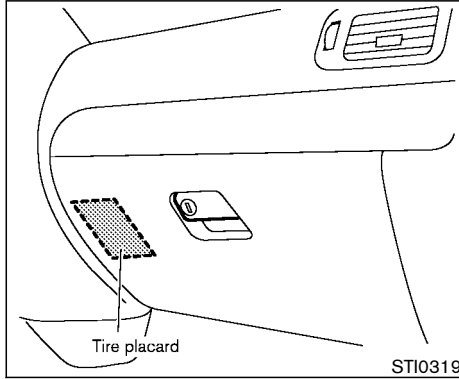

TIRE PLACARD

The cold tire pressure is shown on the tire placard.

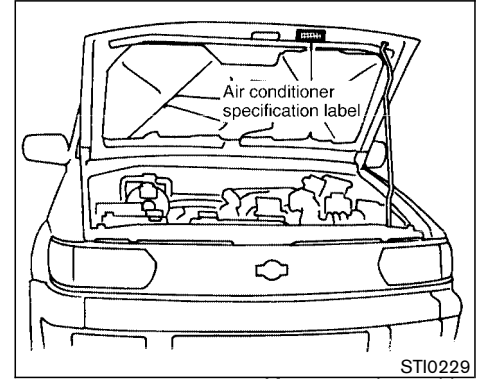

AIR CONDITIONER SPECIFICATION LABEL

The air conditioner specification label is attached as shown.

VEHICLE LOADING INFORMATION



WARNING

- It is extremely dangerous to ride in a cargo area inside of a vehicle. In a collision, people riding in these areas are more likely to be seriously injured or killed.
- Do not allow people to ride in any area of your vehicle that is not equipped with seats and seat belts.
- Be sure everyone in your vehicle is in a seat and using a seat belt properly.

TERMS

It is important to familiarize yourself with the following terms before loading your vehicle:

- Curb Weight (actual weight of your vehicle) - vehicle weight including: standard and optional equipment, fluids, emergency tools, and spare tire assembly. This weight **does not** include passengers and cargo.
- GVW (Gross Vehicle Weight) - curb weight plus the combined weight of passengers and cargo.

- GVWR (Gross Vehicle Weight Rating) - maximum total weight (load) limit specified for the vehicle.
- GAWR (Gross Axle Weight Rating) - maximum weight (load) limit specified for the front or rear axle.

DETERMINING VEHICLE PAYLOAD CAPACITY

The payload capacity of this vehicle is determined by weight, not by available cargo space. For example, a luggage rack, bike carrier, cartop carrier or similar equipment does not increase payload carrying capacity of your vehicle.

To determine vehicle payload capacity:

Vehicle weight can be determined by using a commercial-grade scale, found at places such as a truck stop, gravel quarry, grain elevator, or a scrap metal recycling facility.

- 1) Determine the curb weight of your vehicle.
- 2) Compare the curb weight amount to the GVWR specified for your vehicle to determine how much more weight your vehicle can carry.
- 3) After loading (cargo and passengers), re-weigh your vehicle to determine if either GVWR or GAWR for your vehicle is ex-

ceeded. If GVWR is exceeded, remove cargo as necessary. If either the front or rear GAWR is exceeded, shift the load or remove cargo as necessary.

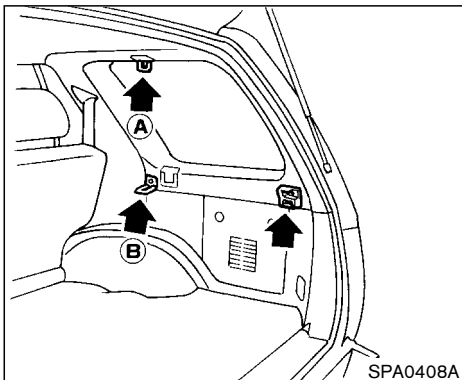

SECURING THE LOAD

There are tie down hooks located in the cargo area. The tie down hooks can be used to secure cargo with ropes or other types of straps.

Do not apply a total load of more than 22 lbs. (10 kg) to a single hook when securing cargo.

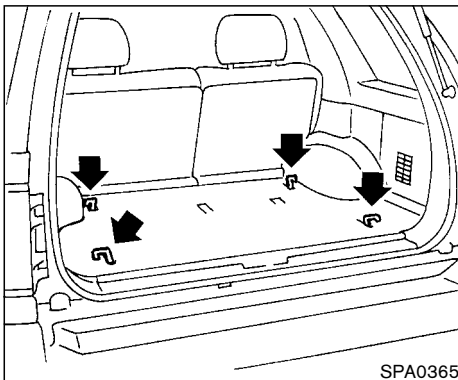

LOADING TIPS

- The GVW must not exceed GVWR or GAWR as specified on the FMVSS Certification Label located on the driver's door center pillar.
- Do not load the front and rear axle to the GAWR. Doing so will exceed the GVWR.
- Loads should be spread out, and cargo should be properly secured. Large or heavy objects should be placed toward the front of the cargo area to help prevent sliding or shifting.



WARNING

- **Properly secure all cargo to help prevent it from sliding or shifting. Do not place cargo higher than the seat-backs. In a sudden stop or collision, unsecured cargo could cause personal injury.**
- **Do not load your vehicle any heavier than the GVWR or the maximum front and rear GAWRs. If you do, parts on your vehicle can break, or it can change the way your vehicle handles.**

This could result in loss of control and cause personal injury.

PAYLOAD WEIGHT CAPACITY

The payload weight capacity is the maximum total weight of passengers, optional equipment (air conditioning, trailer hitch, etc.) and cargo that your vehicle is designed to carry.

Before driving a loaded vehicle, confirm that you do not exceed the Gross Vehicle Weight Rating (GVWR) or the Gross Axle Weight Rating (GAWR) for your vehicle. See "Vehicle loading information" earlier in this section for details.

Also check tires for proper inflation pressures. See the tire placard affixed to the glove box lid.

| Payload Weight Capacity Unit: lb (kg) | | |
|---------------------------------------|-----------------------------------|-----------------------------------|
| VQ35DE | | |
| | 2WD | 4WD |
| | Automatic and Manual Transmission | Automatic and Manual Transmission |
| | XE, SE, LE | |
| US | 980 (445) | 970 (440) |
| Canada | — | 945 (430) |

MEASUREMENT OF WEIGHTS

Secure loose items to prevent weight shifts that could affect the balance of your vehicle. When the vehicle is loaded, drive to a scale and weight the front and the rear wheels separately to determine axle loads. Individual axle loads should not exceed either of the gross axle weight ratings (GAWR). The total of the axle loads should not exceed the gross vehicle weight rating (GVWR). These ratings are given on the vehicle certification label that is located on the driver's door lock pillar. If weight ratings are exceeded, move or remove items to bring all weights below the ratings.



CAUTION

Overloading can shorten the life of your vehicle. Failures caused by overloading are not covered by your warranty.

TOWING A TRAILER

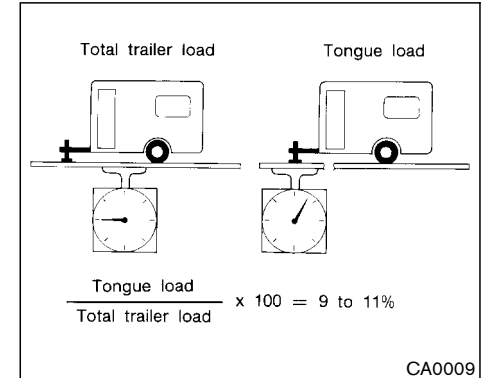

Your new vehicle was designed to be used primarily to carry passengers and cargo. Remember that towing a trailer will place additional loads on your vehicle's engine, drive train, steering, braking and other systems.

A **Nissan Trailer Towing Guide (US only)** is available from an authorized NISSAN dealer. This guide includes information on trailer towing ability and the special equipment required for proper towing.

MAXIMUM LOAD LIMITS

Maximum trailer loads

Never allow the total trailer load to exceed the

Technical and consumer information 9-17

value specified in the following Towing Load/Specification Chart. The total trailer load equals trailer weight plus its cargo weight.

- When towing a trailer load of 1,000 lbs. (454 kg) or more, trailers with a brake system **MUST** be used.

The maximum GCWR (Gross Combined Weight Rating) should not exceed the value specified in the following Towing Load/Specification Chart.

The GCWR equals the combined weight of the towing vehicle (including passengers and cargo) plus the total trailer load. Towing loads greater than these or using improper towing equipment could adversely affect vehicle handling, braking and performance.

The ability of your vehicle to tow a trailer is not only related to the maximum trailer loads, but also the places you plan to tow. Tow weights appropriate for level highway driving may have to be reduced on very steep grades or in low traction situations (for example, on slippery boat ramps).



WARNING

Vehicle damage and/or personal injury resulting from improper towing procedures is not covered by NISSAN warranties. A NISSAN Trailer Towing Guide (U.S. only) containing information on trailer towing ability and the special equipment required may be obtained from an authorized NISSAN dealer.

Tongue load

Keep the tongue load between 9 to 11% of the total trailer load within the maximum tongue load limits shown in the following Towing Load/Specifications Chart. If the tongue load becomes excessive, rearrange cargo to allow for proper tongue load.

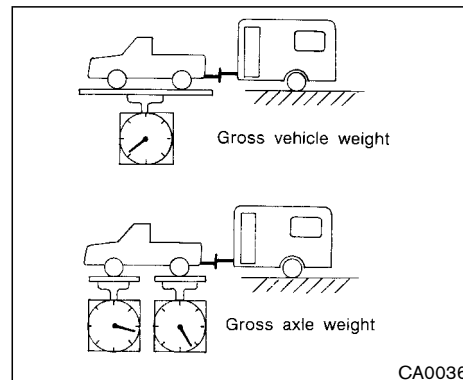

Maximum gross vehicle weight/ maximum gross axle weight

The gross vehicle weight of the towing vehicle must not exceed the gross vehicle weight rating (GVWR) shown on the F.M.V.S.S. certification label. The gross vehicle weight equals the combined weight of the unloaded vehicle, passengers, luggage, hitch, trailer tongue load and any other optional equipment. In addition, front or rear gross axle weight must not exceed the gross axle weight rating (GAWR) shown on the F.M.V.S.S. certification label.

TOWING LOAD/SPECIFICATION CHART

| TOWING LOAD/SPECIFICATION CHART | | | |
|---------------------------------|---------------------------|----------------------------------|---------------|
| | | Unit: lb (kg) | |
| WEIGHT | MODEL | PATHFINDER VQ35DE/VG33E (6-Cyl.) | |
| | | M/T | A/T |
| MAXIMUM TRAILER WEIGHT*1 | | 3,500 (1,588) | 5,000 (2,268) |
| MAXIMUM TONGUE LOAD | | 350 (159) | 500 (227) |
| GROSS COMBINED WEIGHT RATING | | 8,000 (3,628) | 9,500 (4,308) |
| RECOMMENDED EQUIPMENT*2 | Sway Control Device (SCD) | | |

*1: All towing above 1,000 lb (454 kg) requires the use of trailer brakes. NISSAN recommends the use of a tandem axle trailer whenever towing above 3,000 lb (1,361 kg).

*2: A sway control device is recommended for all towing above 2,000 lb (907 kg). Sway control devices are not offered by NISSAN. See a professional trailer/hitch outlet for a properly designed sway control device for your trailer.

TOWING SAFETY

Trailer hitch

Check the towing capacity of your receiver type frame mounted hitch. Choose a proper hitch for your vehicle and trailer. A genuine NISSAN trailer hitch is available from your NISSAN dealer (US only). Make sure the trailer hitch is securely attached to the vehicle, to help avoid personal injury or property damage due to sway caused by crosswinds, rough road surfaces or passing trucks.



CAUTION

- **Special hitches which include frame reinforcements are required for towing above 2,000 lb (907 kg). Suitable Genuine NISSAN hitches for pickup truck and sport utility vehicles are available at an authorized NISSAN dealer.**
- **Do not use axle-mounted hitches.**
- **Do not modify the vehicle exhaust system, brake system, etc. to install a trailer hitch.**

- **After the hitch is removed, seal the bolt holes to prevent exhaust fumes, water or dust from entering the passenger compartment.**
- **Regularly check all hitch mounting bolts are securely mounted.**
- **To reduce the possibility of additional damage if your vehicle is struck from the rear, where practical, remove the hitch and/or receiver when not in use.**
- **Never connect a trailer brake system directly to the vehicle brake system.**

Tire pressures

- When towing a trailer, inflate the vehicle tires to the recommended cold tire pressure indicated on the tire placard (affixed to the glove box lid).
- Trailer tire condition, size, load rating and proper inflation pressure should be in accordance with the trailer and tire manufacturers' specifications.

Safety chains

9-20 Technical and consumer information

Always use a suitable chain between your vehicle and the trailer. The chain should be crossed and should be attached to the hitch, not to the vehicle bumper or axle. Be sure to leave enough slack in the chain to permit turning corners.

Trailer lights

Trailer lights should comply with Federal and/or local regulations.

When wiring vehicle for towing connection, connect stop and tail light pickup into the vehicle electrical circuit at point between the sensor and stop light switch or light switch.

Trailer brakes

If your trailer is equipped with a braking system, make sure it conforms to Federal and/or local regulations and that it is properly installed.



WARNING

Never connect a trailer brake system directly to the vehicle brake system.

Trailer towing tips

In order to gain skill and an understanding of the

vehicle's behavior, you should practice turning, stopping and backing up in an area which is free from traffic. Steering stability and braking performance will be somewhat different than under normal driving conditions.

- Always secure items in the trailer to prevent load shift while driving.
- Avoid abrupt starts, acceleration or stops.
- Avoid sharp turns or lane changes.
- Always drive your vehicle at a moderate speed.
- Always block the wheels on both vehicle and trailer when parking. Parking on a slope is not recommended; however, if you must do so, and if your vehicle is equipped with automatic transmission, first block the wheels and apply the parking brake, and then move the transmission selector lever into the P position. If you move the selector lever to the P position before blocking the wheels and applying the parking brake, transmission damage could occur.
- When going down a hill, shift into a lower gear and use the engine braking effect. When ascending a long grade, downshift the transmission to a lower gear and reduce speed to reduce chances of engine overloading and/or overheating.

However, for long steep grades, do not stay in 1st or 2nd gear when driving above 35 MPH (56 km/h).

- If the engine coolant rises to an extremely high temperature when the air conditioning system is on, turn off the air conditioner. Coolant heat can be additionally vented by opening the windows, switching the fan control to high and setting the temperature control to the HOT position.
- Trailer towing requires more fuel than normal circumstances.
- Avoid towing a trailer for the first 500 miles (800 km).
- Have your vehicle serviced more often than at intervals specified in the recommended Maintenance Schedule.

When towing a trailer, change oil in the transmission more frequently. See the Maintenance Schedule.

UNIFORM TIRE QUALITY GRADING

DOT (Department of Transportation) Quality Grades: All passenger car tire must conform to Federal Safety Requirements in addition to these grades.

Quality grades can be found where applicable on the tire sidewall between tread shoulder and

maximum section width. For example:

Treadwear 200 Traction AA Temperature A

Treadwear

Treadwear grade is a comparative rating based on tire wear rate when tested under controlled conditions on specified government test courses. For example, a tire graded 150 would wear one and a half (1-1/2) times as well on the government course as a tire graded 100. However, relative tire performance depends on actual driving conditions, and may vary significantly due to variations in driving habits, service practices and differences in road characteristics and climate.

Traction AA, A, B and C

The traction grades from highest to lowest are AA, A, B, and C. Those grades represent the tire's ability to stop on wet pavement as measured under controlled conditions on specified government test surfaces of asphalt and concrete. A tire marked C may have poor traction performance.



WARNING

The traction grade assigned to your vehicle tires is based on straight-ahead braking traction tests, and does not include acceleration, cornering, hydroplaning, or peak traction characteristics.

Temperature A, B and C

Temperature grades are A (the highest), B, and C. They represent a tire's resistance to heat build-up, and its ability to dissipate heat when tested under controlled conditions on a specified indoor laboratory test wheel. Sustained high temperature can cause tire material to degenerate, reducing tire life. Excessive temperatures can lead to sudden tire failure. Grade C corresponds to a performance level which all passenger car tires must meet under the Federal Motor Vehicle Safety Standard No. 109. Grades A and B represent higher levels of performance on laboratory test wheels than the minimum required by law.



WARNING

The temperature grade for this tire is established for a tire that is properly inflated and not overloaded. Excessive speed, under inflation, or excessive loading, either separately or in combination, can cause heat build-up and possible tire failure.

EMISSION CONTROL SYSTEM WARRANTY

Your NISSAN is covered by the following emission warranties.

For US:

- Emission Defects Warranty
- Emissions Performance Warranty

For CANADA:

Emission Control System Warranty

Details of these warranties may be found with other vehicle warranties in your Warranty Information Booklet which comes with your NISSAN. If you did not receive a Warranty Information Booklet or it becomes lost, you may obtain a replacement by writing to:

- Nissan North America, Inc. Consumer Affairs Department P.O. Box 191 Gardena. CA 90248-0191
- Nissan Canada Inc. 5290 Orbitor Drive Mississauga, Ontario, L4W 4Z5

REPORTING SAFETY DEFECTS (US only)

If you believe that your vehicle has a defect which could cause a crash or could cause injury or death, you should immediately inform the National Highway Traffic Safety Administration (NHTSA) in addition to notifying NISSAN.

If NHTSA receives similar complaints, it may open an investigation, and if it finds that a safety defect exists in a group of vehicles, it may order a recall and remedy campaign. However, NHTSA cannot become involved in individual problems between you, your dealer, or NISSAN.

To contact NHTSA, you may call the Auto Safety Hotline toll-free at 1-888-327-4236. You may also write to: NHTSA, U.S. Department of Transportation, Washington, D.C. 20590. You can also obtain other information about motor vehicle safety from the Hotline.

You may notify NISSAN by contacting our Consumer Affairs Depart-

ment, toll-free, at 1-800-NISSAN-1.
In Hawaii call (808) 836-0888.

READINESS FOR INSPECTION/ MAINTENANCE (I/M) TEST (US only)

Due to legal requirements in some states/areas, your vehicle may be required to be in what is called the ready condition for an Inspection/Maintenance (I/M) test of the emission control system.

The vehicle is set to the ready condition when it is driven through certain driving patterns. Usually, the ready condition can be obtained by ordinary usage of the vehicle.

If a powertrain system component is repaired or the battery is disconnected, the vehicle may be reset to a not ready condition. Before taking the I/M test, drive the vehicle through the following pattern to set the vehicle to the ready condition. If you cannot or do not want to perform the driving pattern, a NISSAN dealer can conduct it for you.



WARNING

Always drive the vehicle in a safe and prudent manner according to traffic conditions, and obey all traffic laws.

1. Start the engine. Allow the engine to idle until the engine coolant temperature gauge needle points between the C and H (normal operating temperature).

2. Accelerate the vehicle to 55 MPH (88 km/h), then quickly release the accelerator pedal completely and keep it released for at least 6 seconds.
3. Quickly depress the accelerator pedal for a moment, then drive the vehicle at a speed of 53 to 60 MPH (86 to 96 km/h) for at least 5 minutes.
4. Stop the vehicle. Leave the engine running.
5. Accelerate the vehicle to 35 MPH (55 km/h) and maintain the speed for 20 seconds.
6. Repeat steps 4 and 5 at least 3 times.
7. Accelerate the vehicle to 55 MPH (88 km/h) and maintain the speed for at least 3 minutes.
8. Stop the vehicle. Place the transmission gear shift lever in the "P" or "N" position.
9. Turn the engine off.
10. Repeat steps 1 through 8 at least one more time.

If step 1 through 7 is interrupted, repeat the preceding step. Any safe driving mode is acceptable between steps. Do not stop the engine until step 7 is completed.

Dynamometer testing for Inspection/ Maintenance (I/M) test (US only)

Due to legal requirements in some states/areas, your vehicle may be tested for emissions on a dynamometer. The transfer control lever (if so equipped) **MUST** be in the 2H position for I/M testing on a two wheel dynamometer.



WARNING

- **If the transfer control lever is not in the 2H position during the dynamometer I/M testing, the vehicle could come off the dynamometer and cause serious personal injury and/or body damage to the vehicle.**
- **Serious damage will occur to the 4WD system if the transfer control lever is not in the 2H position.**

**OWNER'S MANUAL/SERVICE
MANUAL ORDER INFORMATION**

Genuine Nissan Service Manuals

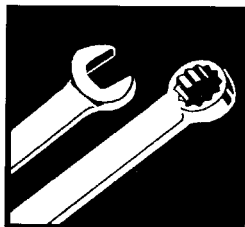

GET THE INSIDE STORY

A genuine NISSAN Service Manual is the best source of service and repair information for your vehicle. Filled with wiring diagrams, illustrations and step-by-step diagnostic and adjustment procedures, this manual is the same one used by the factory trained technicians working at authorized NISSAN dealerships. Also available are genuine NISSAN Owner's Manuals, and genuine NISSAN Service and Owner's Manuals for older NISSAN models.

In the USA:

For current pricing and availability of genuine **NISSAN Service Manuals** for the 2000 model year and later, contact:

Tweddle Litho Company
1-800-639-8841
www.nissan-techinfo.com

For current pricing and availability of genuine **NISSAN Service Manuals** for the 1999 model year and prior, see an authorized NISSAN dealer, or contact:

DDS Distribution Services, Ltd.
20770 Westwood Dr.
Strongsville OH 44136
1-800-247-5321

For current pricing and availability of genuine **NISSAN Owner's Manuals** for the 2002 model year and prior, see an authorized NISSAN dealer, or contact:

DDS Distribution Services, Ltd.
20770 Westwood Dr.
Strongsville OH 44136
1-800-247-5321

In Canada:

To purchase a copy of a genuine NISSAN Service Manual or Owner's Manual please contact your nearest NISSAN dealer. For the phone number and location of a NISSAN Dealer in your area call the NISSAN Satisfaction Center at 1-800-387-0122 and a bilingual NISSAN representative will assist you.

Also available are Genuine NISSAN Service and Owner's Manuals for older NISSAN models.

IN THE EVENT OF A COLLISION

Unfortunately, accidents do occur. In this unlikely event, there is some important information you should know. Many insurance companies routinely authorize the use of non-genuine collision parts in order to cut costs, among other reasons.

Insist on the use of Genuine Nissan Collision Parts!

If you want your vehicle to be restored using parts made to NISSAN's original exacting specifications — if you want to help it to last and hold its resale value, the solution is simple. **Tell your insurance agent and your repair shop to only use Genuine Nissan Collision Parts.** NISSAN does not warrant non-Nissan parts, nor does NISSAN's warranty apply to damage caused by a non-genuine part.

Using Genuine Nissan Parts can help protect your personal safety, preserve your warranty protection and maintain the resale value of your vehicle. And if your vehicle was leased, using Genuine Nissan Parts may prevent or limit unnecessary excess wear and tear expenses at the end of your lease.

NISSAN designs its hoods with crumple zones to minimize the risk that the hood will penetrate the windshield of your vehicle in an accident. Non-genuine (imitation) parts may not provide such built in safeguards. Also, non-genuine parts often show premature wear, rust and corrosion.

Why should you take a chance?

In over 40 states, the law says you must be advised if non-genuine parts are used to repair your vehicle. And some states and provinces have enacted laws that restrict insurance companies from authorizing the use of non-genuine collision parts during the new vehicle warranty. These laws help protect you, so you can take action to protect yourself.

It's your right!

If you should need further information visit us at: www.nissanusa.com.

MEMO

|

MEMO

—

—

|

10 Index

A

| | |
|------------------------------------------------------------------------|------------|
| ABS (Anti-lock brake system)..... | 5-34 |
| Air bag system, Front (See supplemental front air bag system)..... | 1-16 |
| Air bag warning labels..... | 1-21 |
| Air bag warning light..... | 1-21, 2-13 |
| Air cleaner housing filter..... | 8-23 |
| Air conditioner | |
| Air conditioner operation..... | 4-4 |
| Air conditioner specification label..... | 9-14 |
| Air conditioning system refrigerant and lubricant recommendations..... | 4-12, 9-7 |
| Heater and air conditioner controls..... | 4-2 |
| Servicing air conditioner..... | 4-12 |
| Air flow charts..... | 4-5 |
| Alcohol, drugs and driving..... | 5-5 |
| Anchor point locations | |
| Top tether strap..... | 1-44 |
| Antenna..... | 4-29 |
| Anti-lock Brake System (ABS)..... | 5-34 |
| Anti-lock brake warning light..... | 2-9 |
| Appearance care | |
| Exterior appearance care..... | 7-2 |
| Interior appearance care..... | 7-3 |
| Armrest (if so equipped)..... | 1-9 |
| Ashtray (See cigarette lighter and ashtray)..... | 2-29 |
| ATP warning light..... | 2-10 |
| Audible reminders..... | 2-16 |

| | |
|-----------------------------------------------|-----------|
| Audio operation precautions..... | 4-14 |
| Audio system..... | 4-13 |
| Steering wheel audio controls..... | 4-28 |
| Autochanger | |
| Compact Disc (CD)..... | 4-26 |
| Automatic | |
| Automatic transmission fluid (ATF)..... | 8-16 |
| Drive positioner..... | 3-17 |
| Driving with automatic transmission..... | 5-7, 5-11 |
| Seat positioner, seat..... | 3-17 |
| Transmission park warning light..... | 2-10 |
| Transmission selector lever lock release..... | 5-14 |
| Avoiding collision and rollover..... | 5-5 |

B

| | |
|-------------------------------------------------------------|------|
| Back door..... | 3-10 |
| Battery..... | 8-21 |
| Battery saver system..... | 2-22 |
| Battery replacement, (See remote keyless entry system)..... | 3-8 |
| Before starting the engine..... | 5-10 |
| Belts (See drive belts)..... | 8-22 |
| Brake | |
| Anti-lock brake system (ABS)..... | 5-34 |
| Brake and clutch fluid..... | 8-19 |
| Brake booster..... | 8-26 |
| Brake fluid..... | 8-19 |
| Brake pedal..... | 8-25 |

| | |
|----------------------------------|------------|
| Brake pedal check..... | 8-26 |
| Brake system..... | 5-34 |
| Parking brake check..... | 5-17, 8-25 |
| Parking brake operation..... | 5-17 |
| Warning light..... | 2-9 |
| Break-in schedule..... | 5-20 |
| Bulb check/instrument panel..... | 2-9 |
| Bulb replacement..... | 8-30 |

C

| | |
|---------------------------------------------------|------------|
| Capacities and recommended fuel/lubricants..... | 9-2 |
| Car phone or CB radio..... | 4-31 |
| Cargo (See vehicle loading information)..... | 2-36 |
| Cargo net..... | 2-36 |
| Cassette player (See audio system)..... | 4-18, 4-25 |
| Catalytic converter, Three way catalyst..... | 5-3 |
| CD care and cleaning..... | 4-28 |
| Child restraints..... | 1-32 |
| Installation on front passenger seat..... | 1-45 |
| Installation on rear seat outboard positions..... | 1-37 |
| Installation on rear seat center position..... | 1-34 |
| Precautions on child restraints..... | 1-32 |
| Top tether strap anchor point locations..... | 1-44 |
| With top tether strap..... | 1-43 |
| Child safety..... | 1-25 |
| Child safety rear door lock..... | 3-4 |
| Chimes, Audible reminders..... | 2-16 |

| | |
|--------------------------------------------------|----------|
| Cigarette lighter and ashtray..... | 2-29 |
| Circuit breaker, Fusible link..... | 8-27 |
| Cleaning exterior and interior..... | 7-2, 7-3 |
| Clock..... | 2-27 |
| Clutch | |
| Fluid..... | 8-19 |
| Cold weather driving..... | 5-37 |
| Compact Disc (CD) changer operation..... | 4-26 |
| Compact Disc (CD) player (See audio system)..... | 4-19 |
| Compact spare tire..... | 8-39 |
| Compass display..... | 2-7 |
| Console box..... | 2-33 |
| Controls | |
| Heater and air conditioner controls..... | 4-2 |
| Steering wheel audio controls..... | 4-28 |
| Coolant | |
| Capacities and recommended fuel/lubricants..... | 9-2 |
| Changing engine coolant..... | 8-10 |
| Checking engine coolant level..... | 8-9 |
| Corrosion protection..... | 7-4 |
| Cover, Tonneau cover..... | 2-36 |
| Cruise control..... | 5-18 |
| Cup holders..... | 2-31 |

D

| | |
|----------------------------------------------------------------------|------|
| Daytime running light system..... | 2-23 |
| Defogger switch, Glass hatch and outside mirror defogger switch..... | 2-20 |
| Determining vehicle payload capacity..... | 9-15 |
| Dimensions and weights..... | 9-11 |
| Door open warning light..... | 2-11 |

| | |
|--------------------------------------------|-----------|
| Drive belts..... | 8-22 |
| Drive positioner, Automatic..... | 3-17 |
| Driving | |
| Cold weather driving..... | 5-37 |
| Driving with automatic transmission..... | 5-7, 5-11 |
| Driving with manual transmission..... | 5-8, 5-15 |
| On-pavement and offroad driving..... | 5-4 |
| Precautions when starting and driving..... | 5-2 |
| Safety precautions..... | 5-5 |

E

| | |
|-------------------------------------------------|------|
| Economy, Fuel..... | 5-20 |
| Electric sunroof..... | 2-40 |
| Emission control information label..... | 9-14 |
| Emission control system warranty..... | 9-22 |
| Engine | |
| Before starting the engine..... | 5-10 |
| Capacities and recommended fuel/lubricants..... | 9-2 |
| Changing engine coolant..... | 8-10 |
| Changing engine oil..... | 8-14 |
| Changing engine oil filter..... | 8-15 |
| Checking engine coolant level..... | 8-9 |
| Checking engine oil level..... | 8-13 |
| Coolant temperature gauge..... | 2-4 |
| Engine block heater..... | 5-39 |
| Engine compartment check locations..... | 8-7 |
| Engine cooling system..... | 8-9 |
| Engine oil..... | 8-13 |
| Engine oil and oil filter recommendation..... | 9-6 |
| Engine oil viscosity..... | 9-6 |
| Engine serial number..... | 9-13 |
| Engine specifications..... | 9-9 |

| | |
|------------------------------------|------|
| If your vehicle overheats..... | 6-11 |
| Starting the engine..... | 5-10 |
| Exhaust gas (Carbon monoxide)..... | 5-2 |

F

| | |
|-----------------------------------------------------------------------------------------|------------|
| 4WD shift switch operations..... | 5-28 |
| F.M.V.S.S. certification label..... | 9-13 |
| Filter, Air cleaner housing filter..... | 8-23 |
| Flashers (See hazard warning flasher switch)... | 2-25 |
| Flat tire..... | 6-2 |
| Floor mat cleaning..... | 7-4 |
| Fluid | |
| Automatic transmission fluid (ATF)..... | 8-16 |
| Brake and clutch fluid..... | 8-19 |
| Brake fluid..... | 8-19 |
| Capacities and recommended fuel/lubricants..... | 9-2 |
| Engine coolant..... | 8-9 |
| Engine oil..... | 8-13 |
| Power steering fluid..... | 8-18 |
| Window washer fluid..... | 8-20 |
| FM-AM radio with cassette player and Compact Disc (CD) player..... | 4-16 |
| FM-AM-SATELLITE radio with cassette player and Compact Disc (CD) player/CD changer..... | 4-23 |
| Fog light switch..... | 2-24 |
| Four wheel drive (4WD)..... | 5-21, 5-25 |
| Front air bag system (See supplemental restraint system)..... | 1-16 |
| Front fog light switch..... | 2-24 |
| Front manual seat adjustment..... | 1-2 |
| Front power seat adjustment..... | 1-4 |

| | |
|------------------------------------------------------|------|
| Front window open/close with key | 3-3 |
| Fuel | |
| Capacities and recommended fuel/ lubricants | 9-2 |
| filler cap | 3-13 |
| filler lid | 3-13 |
| Fuel economy | 5-20 |
| Fuel octane rating | 9-4 |
| Fuel recommendation | 9-4 |
| Gauge | 2-5 |
| Fuses | 8-27 |
| Fusible links | 8-27 |

G

| | |
|--------------------------------------------------------------|------|
| Garage door opener, HomeLink® Universal Transceiver | 2-44 |
| Gas cap | 3-13 |
| Gauge | 2-3 |
| Engine coolant temperature gauge | 2-4 |
| Fuel gauge | 2-5 |
| Odometer | 2-3 |
| Speedometer | 2-3 |
| Tachometer | 2-4 |
| General maintenance | 8-2 |
| Glass hatch and outside mirror defogger switch | 2-20 |
| Glass hatch lock | 3-11 |
| Glass hatch opener | 3-11 |
| Glove box | 2-32 |
| Glove box lock | 2-32 |

H

| | |
|---------------------------------------------------------------------------|------|
| Hazard warning flasher switch | 2-25 |
| Head restraints | 1-9 |
| Headlights | |
| Bulb replacement | 8-31 |
| Headlight switch | 2-21 |
| Heated seats | 2-26 |
| Heater | |
| Engine coolant heater | 5-39 |
| Heater and air conditioner controls | 4-2 |
| Heater operation | 4-4 |
| Heater and air conditioner (Automatic — Type A) (if so equipped) | 4-8 |
| Heater and air conditioner (Automatic — Type B) (if so equipped) | 4-10 |
| HomeLink® Universal Transceiver | 2-44 |
| Hood, release | 3-9 |
| Hook, Luggage hook | 2-34 |
| Horn | 2-25 |
| How to stop alarm, Vehicle security | 2-17 |

I

| | |
|-----------------------------------------|-----------|
| Ignition switch | 5-7 |
| Automatic transmission models | 5-7, 5-11 |
| Key positions | 5-9 |
| Manual transmission models | 5-8, 5-15 |
| Immobilizer system | 2-18 |
| Indicator lights | 2-14 |
| Inside mirror | 3-16 |
| Inspection/maintenance (I/M) test | 9-23 |
| Instrument panel | 2-2 |

| | |
|-----------------------|------|
| Interior lights | 2-42 |
|-----------------------|------|

J

| | |
|---------------------|-----|
| Jump starting | 6-9 |
|---------------------|-----|

K

| | |
|----------------------------------------------------------|-----|
| Keyless entry (See remote keyless entry system) | 3-5 |
| Keys | 3-2 |

L

| | |
|--------------------------------------------------------------------------------|------|
| Label, Air conditioner specification label | 9-14 |
| Label, Emission control information label | 9-14 |
| Label, F.M.V.S.S. certification label | 9-13 |
| Labels | |
| Air bag warning labels | 1-21 |
| Engine serial number | 9-13 |
| Vehicle identification number (VIN) | 9-12 |
| LATCH (Lower Anchors and Tether For Children) system (if so equipped) | 1-41 |
| Light | |
| Air bag warning light | 1-21 |
| Bulb replacement | 8-30 |
| Fog light switch | 2-24 |
| Front fog light switch | 2-24 |
| Headlight switch | 2-21 |
| Headlights Bulb replacement | 8-31 |
| Interior lights | 2-42 |
| Personal lights | 2-43 |
| Replacement | 8-30 |

Vanity mirror light..... 2-43
 Warning/indicator lights and audible reminders..... 2-9, 2-14
 Loading information (See vehicle loading information)..... 9-15
 Lock
 Door locks..... 3-2
 Glass hatch lock..... 3-11
 Glove box lock..... 2-32
 Power door lock..... 3-2
 Low fuel warning light 2-12
 Low tire pressure warning light (if so equipped) 2-12
 Low tire pressure warning system (if so equipped)..... 5-3, 6-2
 Luggage hooks 2-34
 Luggage rack 2-37

M

Maintenance
 Battery 8-21
 General maintenance 8-2
 Inside the vehicle..... 8-3
 Maintenance precautions 8-5
 Outside the vehicle..... 8-2
 Seat belt maintenance 1-32
 Under the hood and vehicle..... 8-4
 Manual front seat adjustment 1-2
 Meters and gauges 2-3
 Mirror
 Inside mirror 3-16
 Outside mirror control 3-16
 Outside mirrors 3-16

N

Net, Cargo net..... 2-36
 New vehicle break-in..... 5-20
 Nissan vehicle Immobilizer System..... 2-16
 Nissan Vehicle Immobilizer System, Engine start..... 5-9

O

Odometer..... 2-3
 Oil
 Capacities and recommended fuel/lubricants 9-2
 Changing engine oil..... 8-14
 Changing engine oil filter 8-15
 Checking engine oil level 8-13
 Engine oil..... 8-13
 Engine oil viscosity 9-6
 Outside mirror control..... 3-16
 Outside mirrors 3-16
 Outside temperature display..... 2-6
 Overdrive switch..... 5-14
 Overheat, If your vehicle overheats 6-11

P

Parking
 Brake check 8-25
 Parking brake check 5-17
 Parking brake operation 5-17
 Parking on hills..... 5-17
 Parking/parking on hills 5-32

R

Payload weight capacity..... 9-17
 Personal lights..... 2-43
 Phone, Car phone or CB radio 4-31
 Power
 Front seat adjustment 1-4
 Power door lock 3-2
 Power outlet..... 2-28
 Power steering fluid 8-18
 Power steering system..... 5-33
 Power windows..... 2-38
 Pre-tensioner seat belt system..... 1-20
 Precautions
 Audio operation precautions..... 4-14
 Braking precautions 5-34
 Cruise control operations 5-19
 Cruise control precautions..... 5-18
 Driving safety..... 5-5
 Maintenance precautions 8-5
 On child restraints..... 1-32
 On seat belt usage 1-24
 On-pavement and offroad driving precautions 5-4
 Precautions on supplemental restraint system..... 1-10
 Precautions when starting and driving 5-2
 Push starting 6-11
 Rack, Luggage rack..... 2-37
 Radio
 Car phone or CB radio..... 4-31
 Steering wheel audio controls 4-28

| | |
|-----------------------------------------------------------------|------|
| Readiness for inspection/maintenance (I/M) test (US only) | 9-23 |
| Rear door lock, Child safety rear door lock..... | 3-4 |
| Rear power point..... | 2-28 |
| Rear seat adjustment..... | 1-6 |
| Rear window wiper and washer switch..... | 2-19 |
| Registering your vehicle in another country..... | 9-12 |
| Remote keyless entry system | 3-5 |
| Reporting safety defects (US only)..... | 9-22 |
| Rollover..... | 5-5 |

S

| | |
|-----------------------------------------|------|
| Safety | |
| Child seat belts..... | 1-25 |
| Reporting safety defects (US only)..... | 9-22 |
| Towing safety..... | 9-19 |
| Satellite radio reception..... | 4-14 |
| Seat | |
| Belt warning light..... | 2-13 |
| Seat adjustment | |
| Front manual seat adjustment..... | 1-2 |
| Front power seat adjustment | 1-4 |
| Rear seat adjustment | 1-6 |
| Seat belt(s) | |
| Child safety | 1-25 |
| Infants and small children..... | 1-26 |
| Injured persons..... | 1-26 |
| Larger children | 1-26 |
| Pre-tensioner seat belt system | 1-20 |
| Precautions on seat belt usage..... | 1-24 |
| Pregnant women..... | 1-26 |
| Seat belt cleaning..... | 7-4 |
| Seat belt extenders..... | 1-32 |

| | |
|--------------------------------------------------------------------------|-----------|
| Seat belt hook..... | 1-30 |
| Seat belt maintenance | 1-32 |
| Seat belts | 1-23 |
| Three-point type with retractor | 1-26 |
| Two-point type without retractor (rear center lap belt)..... | 1-30 |
| Seat(s) | |
| Heated seats..... | 2-26 |
| Seats | 1-2 |
| Security system, vehicle security system..... | 2-16 |
| Security systems (Nissan Vehicle Immobilizer System), Engine start | 2-18 |
| Security systems (See vehicle security system)..... | 2-16 |
| Servicing air conditioner..... | 4-12 |
| Shift lock release..... | 5-14 |
| Shifting | |
| Automatic transmission..... | 5-7, 5-11 |
| Manual transmission | 5-8, 5-15 |
| Shoulder belt height adjustment, For front seats | 1-29 |
| Spare tire carrier | 3-10 |
| Spark plugs..... | 8-23 |
| Speedometer | 2-3 |
| Starting | |
| Before starting the engine..... | 5-10 |
| Jump starting..... | 6-9 |
| Precautions when starting and driving | 5-2 |
| Push starting..... | 6-11 |
| Starting the engine..... | 5-10 |
| Steering | |
| Power steering fluid..... | 8-18 |
| Power steering system..... | 5-33 |
| Steering wheel switch for audio controls.... | 4-28 |

| | |
|-----------------------------------------------------------------------------------------|------------|
| Tilting steering wheel..... | 3-15 |
| Storage | 2-29 |
| Sun shade..... | 2-41 |
| Sun visors | 3-15 |
| Sunglasses holder | 2-30 |
| Sunroof | 2-40 |
| Electric sunroof..... | 2-40 |
| Supplemental air bag warning labels..... | 1-21 |
| Supplemental air bag warning light..... | 1-21, 2-13 |
| Supplemental front air bag system..... | 1-16 |
| Supplemental restraint system..... | 1-10 |
| Precautions on supplemental restraint system..... | 1-10 |
| Supplemental side air bag and curtain side-impact air bag system (if so equipped) | 1-18 |
| Switch | |
| 4WD shift switch operations..... | 5-28 |
| Audio control | 4-28 |
| Fog light switch..... | 2-24 |
| Front fog light switch..... | 2-24 |
| Glass hatch and outside mirror defogger switch..... | 2-20 |
| Hazard warning flasher switch..... | 2-25 |
| Headlight switch | 2-21 |
| Ignition switch | 5-7 |
| Ignition switch automatic transmission models..... | 5-7, 5-11 |
| Ignition switch manual transmission models..... | 5-8, 5-15 |
| Overdrive switch | 5-14 |
| Power door lock switch..... | 3-4 |
| Turn signal switch | 2-24 |

T

| | |
|--------------------------------------------------------------|------------|
| Tachometer..... | 2-4 |
| Temperature display..... | 2-6 |
| Temperature gauge, Engine coolant temperature gauge..... | 2-4 |
| Theft (Nissan Vehicle Immobilizer System), Engine start..... | 2-18 |
| Three way catalyst..... | 5-3 |
| Tilting steering wheel..... | 3-15 |
| Tire | |
| Flat tire..... | 6-2 |
| Uniform tire quality grading..... | 9-21 |
| Tires | |
| Spare tire..... | 8-39 |
| Tire chains..... | 8-36 |
| Tire placard..... | 9-14 |
| Tire pressure..... | 8-34 |
| Tire rotation..... | 8-37 |
| Types of tires..... | 8-35 |
| wheel/tire size..... | 9-11 |
| Wheels and tires..... | 8-34 |
| Tonneau cover..... | 2-36 |
| Top tether strap child restraints..... | 1-44 |
| Towing | |
| Tow truck towing..... | 6-12 |
| Towing a trailer..... | 9-17 |
| Towing load/specification chart..... | 9-19 |
| Towing safety..... | 9-19 |
| Trailer towing..... | 9-17 |
| Transceiver, HomeLink® Universal | |
| Transceiver..... | 2-44 |
| Transfer case shifting procedures..... | 5-23, 5-25 |

Transmission

| | |
|---------------------------------------------------------------|-----------|
| Automatic transmission fluid (ATF)..... | 8-16 |
| Driving with automatic transmission..... | 5-7, 5-11 |
| Driving with manual transmission..... | 5-8, 5-15 |
| Transmission selector lever lock release..... | 5-14 |
| Transmitter (See remote keyless entry system)... | 3-5 |
| Traveling or registering your vehicle in another country..... | 9-12 |
| Turn signal switch..... | 2-24 |

U

| | |
|-----------------------------------|------|
| Underbody cleaning..... | 7-3 |
| Uniform tire quality grading..... | 9-21 |

V

| | |
|------------------------------------------------------------|------|
| Vanity mirror light..... | 2-43 |
| Vehicle | |
| Dimensions and weights..... | 9-11 |
| Identification number (VIN)..... | 9-12 |
| Loading information..... | 9-15 |
| Recovery (freeing a stuck vehicle)..... | 6-16 |
| Security system..... | 2-16 |
| Vehicle Dynamic Control (VDC) system (if so equipped)..... | 5-36 |
| Ventilators..... | 4-2 |

W

| | |
|---------------------------------------------|------|
| Warning labels, Air bag warning labels..... | 1-21 |
| Warning light | |
| 4WD warning light..... | 5-30 |

| | |
|--------------------------------------------------------------|------------|
| Air bag warning light..... | 1-21, 2-13 |
| Anti-lock brake warning light..... | 2-9 |
| Automatic transmission park warning light.. | 2-10 |
| Brake warning light..... | 2-11 |
| Door open warning light..... | 2-11 |
| Low fuel warning light..... | 2-12 |
| Seat belt warning light and chime..... | 2-13 |
| Warning lights..... | 2-9 |
| Warning, Hazard warning flasher switch..... | 2-25 |
| Warning, Warning/indicator lights and audible reminders..... | 2-9 |
| Warranty, Emission control system warranty..... | 9-22 |
| Washer switch | |
| Rear window wiper and washer switch..... | 2-19 |
| Windshield wiper and washer switch..... | 2-19 |
| Washing..... | 7-2 |
| Waxing..... | 7-2 |
| Weights (See dimensions and weights)..... | 9-11 |
| Wheel/tire size..... | 9-11 |
| Wheels and tires..... | 8-34 |
| Cleaning aluminum alloy wheels..... | 7-3 |
| Window washer fluid..... | 8-20 |
| Window(s) | |
| Cleaning..... | 7-3 |
| Power windows..... | 2-38 |
| Windshield wiper and washer switch..... | 2-19 |
| Wiper | |
| Rear window wiper and washer switch..... | 2-19 |
| Windshield wiper and washer switch..... | 2-19 |
| Wiper blades..... | 8-24 |

GAS STATION INFORMATION

FUEL RECOMMENDATION:

VG33E engine:

Use unleaded regular gasoline with an octane rating of at least 87 AKI (Anti-Knock Index) number (Research octane number 91).

VQ35DE engine:

Use unleaded regular gasoline with an octane rating of at least 87 AKI (Anti-Knock Index) number (Research octane number 91).

For improved vehicle performance, NISSAN recommends the use of unleaded premium gasoline with an octane rating of at least 91 AKI number (Research octane number 96).



CAUTION

Using a fuel other than that specified could adversely affect the emission control devices and systems, and could also affect the warranty coverage.

Under no circumstances should a leaded gasoline be used since this will damage the three way catalyst.

For additional information, see “Capacities and recommended fuel/lubricants” in the “9. Technical and consumer information” section.

ENGINE OIL RECOMMENDATION:

- API Certification Mark
- API grade SG/SH, Energy Conserving I & II or API grade SJ or SL, Energy Conserving.
- ILSAC grade GF-I, GF-II & GF-III.
- SAE 5W-30 viscosity oil is preferred for all ambient temperatures.

See “Capacities and recommended fuel/lubricants” in the “9. Technical and consumer information” section for engine oil and oil filter recommendation.

COLD TIRE PRESSURES:

See the tire placard affixed to the glove box.

