

# Foreword

Welcome to the growing family of new NISSAN owners. This vehicle is delivered to you with confidence. It was produced using the latest techniques and strict quality control.

This manual was prepared to help you understand the operation and maintenance of your vehicle so that you may enjoy many miles of driving pleasure. Please read through this manual before operating your vehicle.

A separate Warranty Information and Maintenance Log Booklet explains details about the warranties covering your vehicle and vehicle maintenance schedules.

Your NISSAN dealer knows your vehicle best. When you require any service or have any questions, he will be glad to assist you with the extensive resources available to him.

## READ FIRST — THEN DRIVE SAFELY

Before driving your vehicle please read your Owner's Manual carefully. This will ensure familiarity with controls and maintenance requirements, assisting you in the safe operation of your vehicle.

### WARNING

#### IMPORTANT SAFETY INFORMATION REMINDERS FOR SAFETY!

Follow these important driving rules to help ensure a safe and comfortable trip for you and your passengers!

- Never drive under the influence of alcohol or drugs.
- Always observe posted speed limits and never drive too fast for conditions.
- Always use your seat belts and appropriate child restraint systems. Preteen children should be seated in the rear seat.
- Always provide information about the proper use of vehicle safety features to all occupants of the vehicle.
- Always review this Owner's Manual for important safety information.

For descriptions specified for four wheel drive models, a **4x4** mark is placed at the beginning of the applicable sections/items.

As with other vehicles with features for offroad use, failure to operate four wheel drive models correctly may result in loss of control or an accident. For additional information, see "Driving your four wheel drive safely" in the "5. Starting and driving" section.

#### ON-PAVEMENT AND OFFROAD DRIVING

This vehicle will handle and maneuver differently from an ordinary passenger car because it has a higher center of gravity for offroad use. As with other vehicles with features of this type, failure to operate this vehicle correctly may result in loss of control or an accident. For additional information, see "On-pavement and offroad driving precautions" and "Avoiding collision and rollover" in the "5. Starting and driving" section.

## MODIFICATION OF YOUR VEHICLE

**This vehicle should not be modified. Modification could affect its performance, safety or durability, and may even violate governmental regulations. In addition, damage or performance problems resulting from modification may not be covered under NISSAN warranties.**

## WHEN READING THE MANUAL

**This manual includes information for all options available on this model. Therefore, you may find some information that does not apply to your vehicle.**

All information, specifications and illustrations in this manual are those in effect at the time of printing. NISSAN reserves the right to change specifications or design at any time without notice.

## IMPORTANT INFORMATION ABOUT THIS MANUAL

You will see various symbols in this manual. They are used in the following ways:

### **WARNING**

**This is used to indicate the presence of a hazard that could cause death or serious personal injury. To avoid or reduce the risk, the procedures must be followed precisely.**

### **CAUTION**

**This is used to indicate the presence of a hazard that could cause minor or moderate personal injury or damage to your vehicle. To avoid or reduce the risk, the procedures must be followed carefully.**

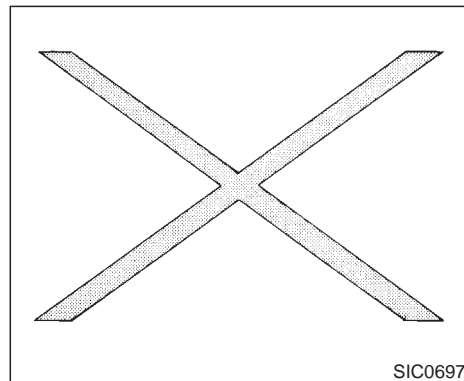

If you see this symbol, it means **Do not do this** or **Do not let this happen**.

© 1997 NISSAN MOTOR CO., LTD.  
TOKYO, JAPAN

All rights reserved. No part of this Owner's Manual may be reproduced or stored in a retrieval system, or transmitted in any form, or by any means, electronic, mechanical, photocopying, recording or otherwise, without the prior written permission of Nissan Motor Co., Ltd.

# Welcome To The World Of NISSAN

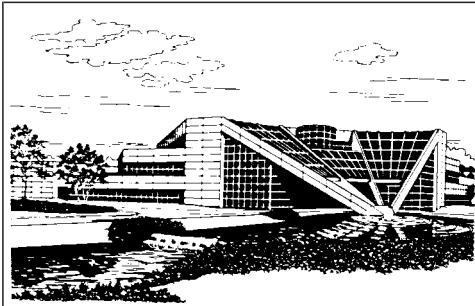

NISSAN RESEARCH & DEVELOPMENT, INC.  
in Farmington Hills, Michigan

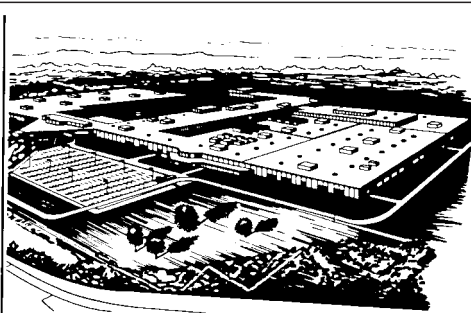

NISSAN MOTOR MANUFACTURING CORPORATION  
U.S.A. in Smyrna, Tennessee AFW0001

Your new NISSAN is the result of our dedication to produce the finest in safe, reliable and economical transportation. Your vehicle is the product of a successful worldwide company that manufactures cars and trucks in over 17 countries and distributes them in 170 nations.

NISSAN vehicles are designed and manufactured by Nissan Motor Co., Ltd. which was founded in Tokyo, Japan in 1933, and NISSAN affiliates world wide, collectively growing to become the fifth largest automaker in the world. In addition to cars and trucks, NISSAN also makes textile machinery, fork-lift trucks, marine engines, boats and other products.

NISSAN has made a substantial and growing investment in North America, starting with the opening of Nissan Motor Corporation U.S.A. in 1960 and continuing with the production of some

cars and trucks at one of the world's most modern manufacturing facilities, Nissan Motor Manufacturing Corporation U.S.A. in Smyrna, Tennessee, vehicle styling at Nissan Design International in San Diego, California, and engineering at Nissan Research and Development in Farmington Hills, Michigan.

Nissan Motor Corporation U.S.A. and its dealers indirectly employ about 60,000 Americans.

NISSAN is also a substantial contributor to the Canadian economy. Nissan Canada Inc., its suppliers and over 170 dealers employ approximately 4,500 people. These include company employees and the staffs of NISSAN dealers all across Canada. In addition, many Canadians work for companies that supply NISSAN and NISSAN dealers with materials and services ranging from operation of port facilities and

transportation services to the supply of lubricants, parts and accessories.

NISSAN pioneered the use of electronics and computers in automobiles, and has led the industry in improving both performance and fuel efficiency through new engine designs and the use of synthetic materials to reduce vehicle weight. The company has also developed ways to build quality into its vehicles at each stage of the production process, both through extensive use of automation and — most importantly — through an awareness that **people** are the central element in quality control.

From the time the parts arrived from our suppliers until you took delivery of your new Nissan, dozens of checks were made to ensure that only the best job was being done in producing and delivering your vehicle. NISSAN also takes great care to ensure that when you take your NISSAN to your dealer for maintenance, the service technician will perform his work according to the quality standards that have been established by the factory.

Safety has also been built into your NISSAN. As you know, seat belts are an integral part of the safety systems that will help protect you and your passengers in the event of a sudden stop or an accident. We urge you to use the seat belts every time you drive the vehicle.

The NISSAN story of growth and achievement reflects our major goal: to provide you, our customer, with a vehicle that is built with quality and craftsmanship — a product that we can be proud to build and you can be proud to own.

# NISSAN CUSTOMER CARE PROGRAM

## NISSAN CARES ...

Both NISSAN and your NISSAN dealer are dedicated to serving all your automotive needs. Your satisfaction with your vehicle and your NISSAN dealer are our primary concerns. Your NISSAN dealer is always available to assist you with all your automobile sales and service needs.

However, if there is something that your NISSAN dealer cannot assist you with or you would like to provide NISSAN directly with comments or questions, please contact our (NISSAN's) Consumer Affairs Department using our toll-free number:

- For U.S. mainland customers**  
**1-800-NISSAN-1 (1-800-647-7261)**
- For Hawaii customers**  
**(808) 836-0888 (Oahu Number)**
- For Canada customers**  
**1-800-387-0122**

The Consumer Affairs Department will ask for the following information:

- Your name, address, and telephone number
- Vehicle identification number (on dashboard)
- Date of purchase
- Current odometer reading
- Your NISSAN dealer's name
- Your comments or questions

OR

You can write to NISSAN with the information on the left at:

- For U.S. mainland and Alaska customers**  
**Nissan Motor Corporation U.S.A.**  
**Consumer Affairs Department**  
**P.O. Box 191**  
**Gardena, California 90248-0191**
- For Hawaii customers**  
**Nissan Motor Corporation in Hawaii**  
**2880 Kilihau St.**  
**Honolulu, Hawaii 96819**
- For Canada customers**  
**Nissan Canada Inc.**  
**5290 Orbitor Drive**  
**Mississauga, Ontario L4W 4Z5**

We appreciate your interest in NISSAN and thank you for buying a quality NISSAN vehicle.



# Table of Contents

<b>Seats, restraints and supplemental air bag systems</b>	<b>1</b>
<b>Instruments and controls</b>	<b>2</b>
<b>Pre-driving checks and adjustments</b>	<b>3</b>
<b>Heater, air conditioner and audio systems</b>	<b>4</b>
<b>Starting and driving</b>	<b>5</b>
<b>In case of emergency</b>	<b>6</b>
<b>Appearance and care</b>	<b>7</b>
<b>Do-it-yourself</b>	<b>8</b>
<b>Maintenance</b>	<b>9</b>
<b>Technical and consumer information</b>	<b>10</b>
<b>Index</b>	<b>11</b>



# 1 Seats, restraints and supplemental air bag systems

Seats .....	1-2
Supplemental restraint system .....	1-9
Seat belts .....	1-17
Child restraints .....	1-25



## SEATS

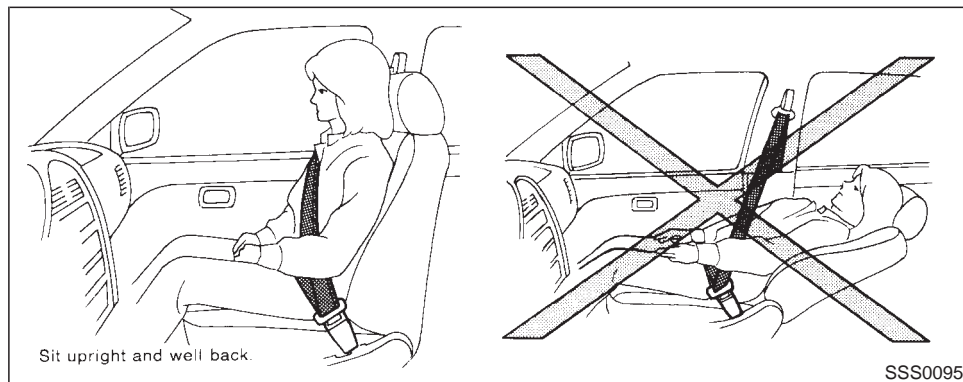

### FRONT MANUAL SEAT ADJUSTMENT

#### **WARNING**

- Do not adjust the driver's seat while driving. The seat may move suddenly and could cause loss of control of the vehicle.
- After adjustment, gently rock in the seat to make sure it is securely locked.

#### **WARNING**

Do not ride in a moving vehicle when the seatback is reclined. This can be dangerous. The shoulder belt will not be against your body. In an accident you could be thrown into it and receive neck or other serious injuries. You could also slide under the lap belt and receive serious internal injuries.

For most effective protection when the

vehicle is in motion, the seat should be upright. Always sit well back in the seat and adjust the seat properly. See "Seat belts" later in this section for precautions on seat belt usage.

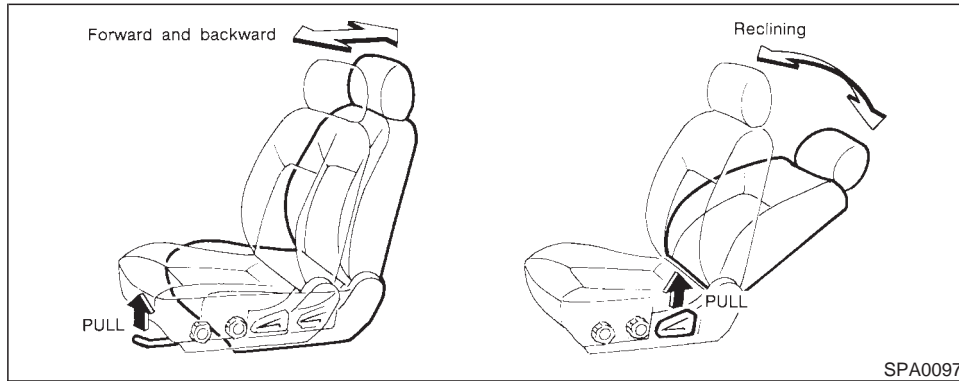

### Forward and backward

Pull the lever up while you slide the seat forward or backward to the desired position. Release the lever to lock the seat in position.

### Reclining

To recline the seatback, pull the lever up and lean back. To bring the seatback forward again, pull the lever and move your body forward. The seatback will move forward.

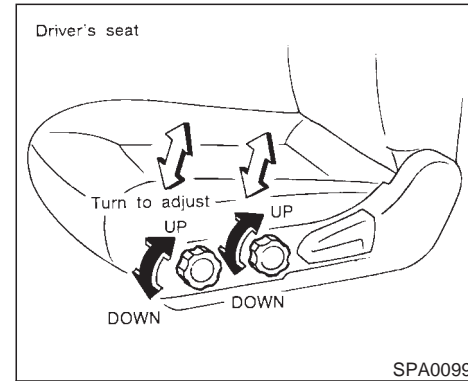

### Seat lifter (Driver's seat)

Turn either dial to adjust the angle and height of the seat cushion to the desired position.

## FRONT POWER SEAT ADJUSTMENT

### **⚠ WARNING**

- Do not adjust the driver's seat while driving in order that full attention may be given to the driving operations.
- Do not leave children unattended inside the vehicle. They could unknowingly activate switches or controls unattended children could become involved in serious accidents.

### Operating tips

- The motor has an auto-reset overload protection circuit. If the motor stops during operation, wait 30 seconds, then reactivate the switch.
- Do not operate the power support seat for a long period of time when the engine is off. This will discharge the battery.

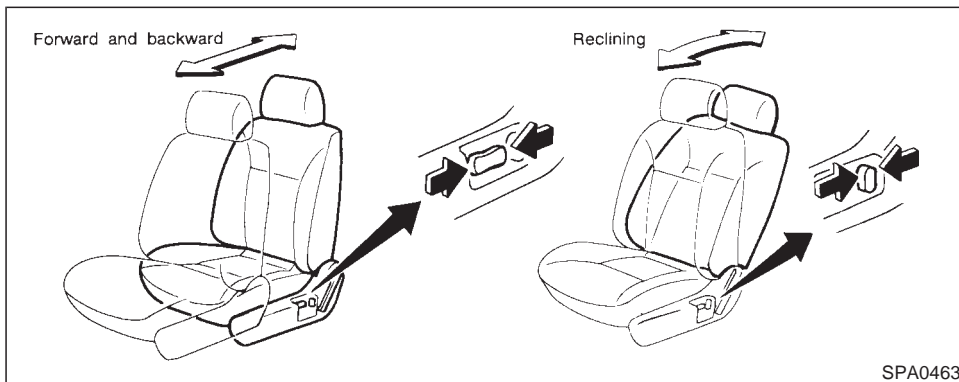

### Forward and backward

Moving the switch forward or backward will slide the seat forward or backward to the desired position.

### Reclining

Move the recline switch backward until the desired angle is obtained. To bring the seat back forward again, move the switch forward and move your body forward. The seat back will move forward.

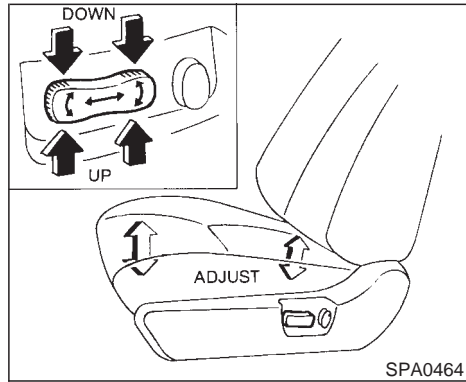

SPA0464

### Seat lifter (Driver's seat)

Push the front or rear end of the switch up or down to adjust the angle and height of the seat cushion.

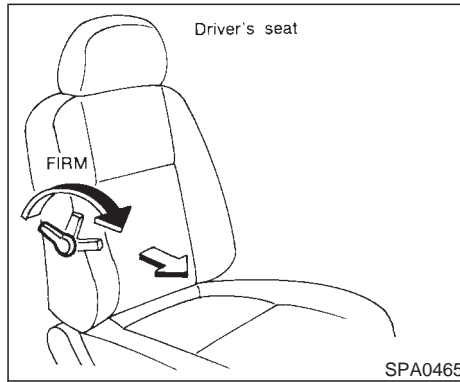

SPA0465

### Lumbar support (Driver's seat)

Turn the lever forward or backward to adjust the seat lumbar area.

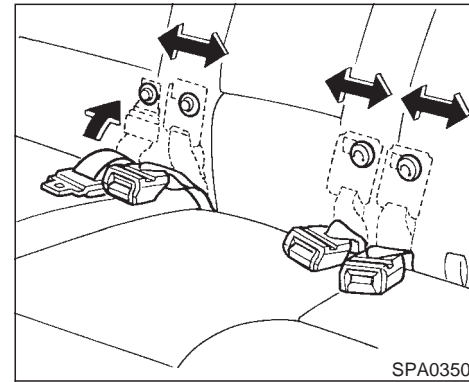

SPA0350

### REAR SEAT ADJUSTMENT

Before folding down the seat, hook the buckle sideways on to the button and hook on the tongue from the top.

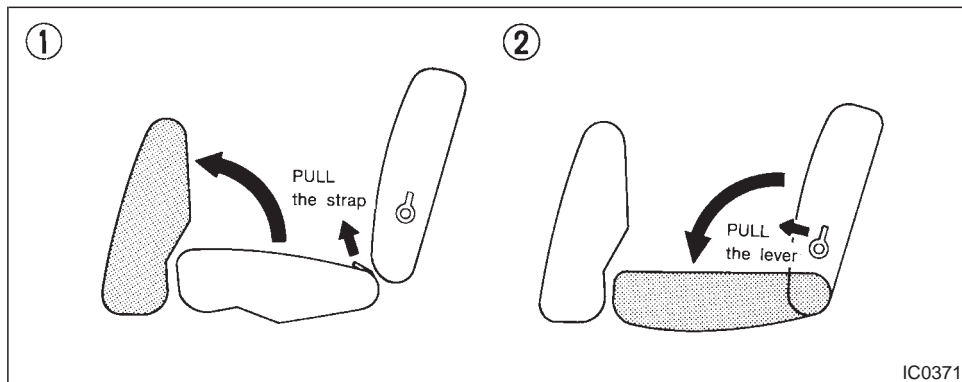

## Folding

1. Remove the head restraints.
2. Pull the strap forward and fold the seat cushion up.
3. Pull the lever and pull the seatback forward to fold it down.
4. When resetting the seat, be sure to install the head restraints.

## **⚠️ WARNING**

- **Never allow anyone to ride in the cargo area or on the rear seat when it is in the fold-down position. Use of these areas by passengers without proper restraints could result in serious injury in an accident or sudden stop.**
- **It is extremely dangerous to ride in a cargo area inside of a vehicle. In a collision, people riding in these areas**

are more likely to be seriously injured or killed.

- **Do not allow people to ride in any area of your vehicle that is not equipped with seats and seat belts. Be sure everyone in your vehicle is in a seat and using a seat belt properly.**
- **Head restraints should be adjusted properly as they may provide significant protection against injury in an accident. Always replace and adjust them properly if they have been removed for any reason.**
- **If the head restraints are removed for any reason, they should be securely stored to prevent them from causing injury to passengers or damage to the vehicle in case of sudden braking or an accident.**
- **Properly secure all cargo to help prevent it from sliding or shifting. Do not place cargo higher than the seatbacks. In a sudden stop or collision, unsecured cargo could cause personal injury.**

- When returning the seatbacks to the upright position, be certain they are completely secured in the latched position.

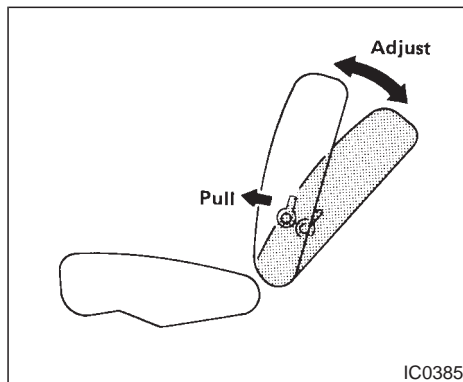

## Reclining

Pull the reclining lever and position the seat back at the desired angle. Release the reclining lever after positioning the seat at the desired angle.

### **WARNING**

- Do not ride in a moving vehicle when the seatback is reclined. This can be dangerous. The shoulder belt will not be against your body. In an accident you could be thrown into it and receive neck or other serious injuries.

You could also slide under the lap belt and receive serious internal injuries.

- For most effective protection when the vehicle is in motion, the seat should be upright. Always sit well back in the seat and adjust the seat belt properly. See "Seat belts" later in this section for precautions on seat belt usage.
- After adjustment, check to be sure the seat is securely locked.

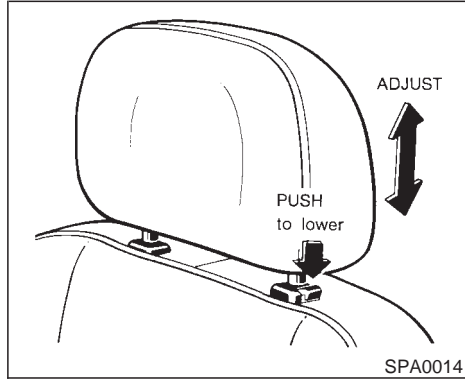

lower, push the lock knob and push the head restraint down.

## HEAD RESTRAINT ADJUSTMENT

### **WARNING**

Head restraints should be adjusted properly as they may provide significant protection against injury in an accident. Do not remove them. Check the adjustment after someone else uses the seat.

Adjust the head restraints so the top is level with the top of your ears.

To raise the head restraint, just pull it up. To

1-8 Seats, restraints and supplemental air bag systems

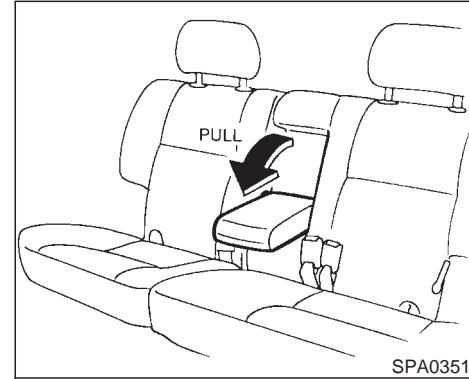

## ARMREST

Pull the armrest forward until it is horizontal.

### **WARNING**

Properly secure all cargo to help prevent it from sliding or shifting. Do not place cargo higher than the seatbacks. In a sudden stop or collision, unsecured cargo could cause personal injury.

## SUPPLEMENTAL RESTRAINT SYSTEM

This Supplemental Restraint System section contains important information concerning the driver and passenger supplemental air bags. The Supplemental Restraint System Air Bag can help reduce impact force to the driver and to the front passenger in certain frontal collisions. The supplemental air bags are designed to **supplement** the crash protection provided by the driver and passenger seat belts and are **not a substitute** for them. The seat belts should always be correctly worn and the driver and front passenger seated a suitable distance away from the steering wheel and instrument panel. (See "Seat belts" later in this section for instructions and precautions on seat belt usage.)

After turning the ignition key to the ON position, the supplemental air bag warning light illuminates. The supplemental air bag warning light will turn off after about 7 seconds if the system is operational.

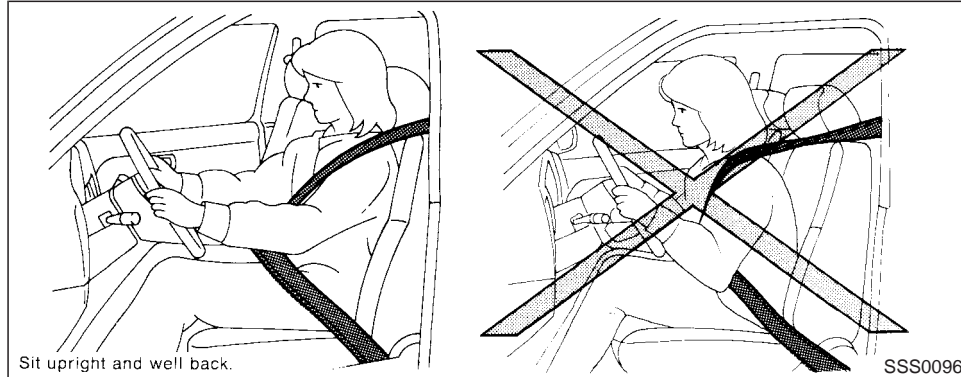

### WARNING

- The supplemental air bags ordinarily will not inflate in the event of a side impact, rear impact, roll over, or lower severity frontal collision. Always wear your seat belts to help reduce the risk or severity of injury in various kinds of accidents.
- The seat belts and the supplemental air bags are most effective when you

are sitting back and upright in the seat. Supplemental air bags inflate with great force. If you are unrestrained, leaning forward, sitting sideways or out of position in any way, you are at greater risk of injury or death in a crash and may also receive serious or fatal injuries from the supplemental air bag if you are up against it when it inflates. Always sit back against the seatback and as far away as practical from the steering



wheel or instrument panel. Always use the seat belts.

- Keep hands on the outside of the steering wheel. Placing them inside the steering wheel rim could increase the risk that they are injured when the supplemental air bag inflates.

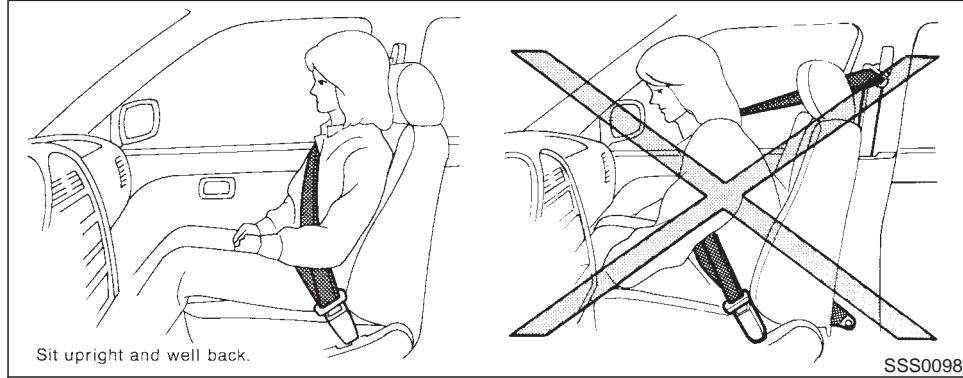

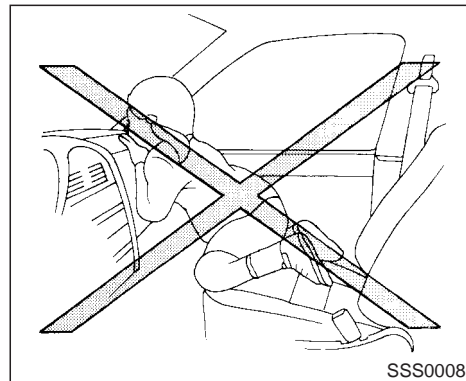
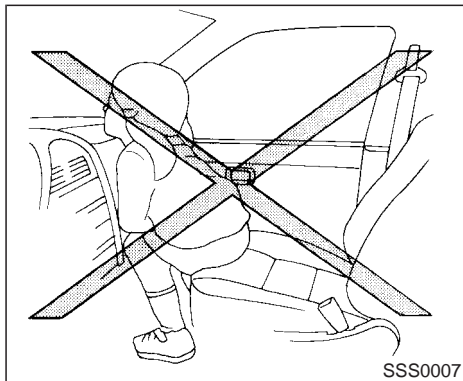
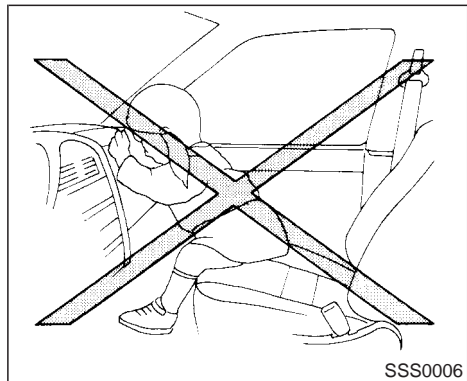

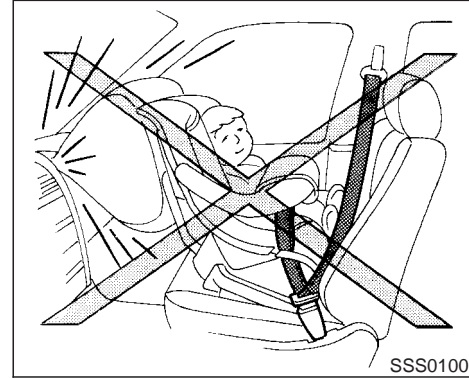
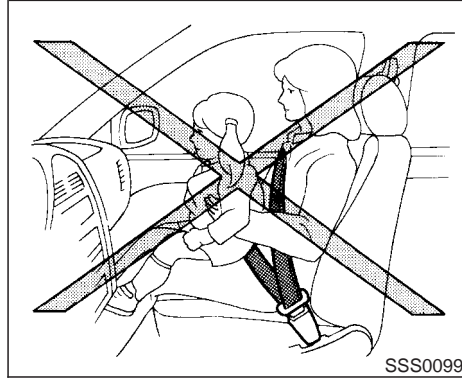
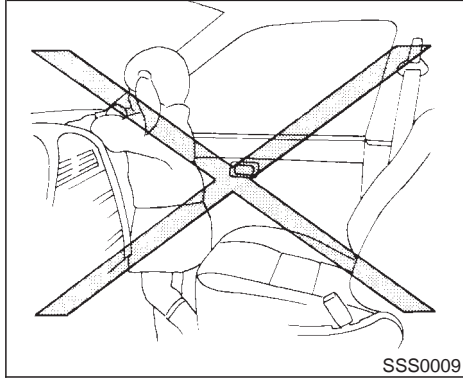

**⚠ WARNING**

- Never let children ride unrestrained. Do not attempt to hold them in your lap or arms. Some examples of dangerous riding positions are shown in the previous illustrations.
- Children may be severely injured or killed when the supplemental air bag inflates if they are not properly restrained.
- Also, never install a rear facing child

**restraint in the front seat. An inflating supplemental air bag could seriously injure or kill your child. See “Seat belts” later in this section for infants and small children.**

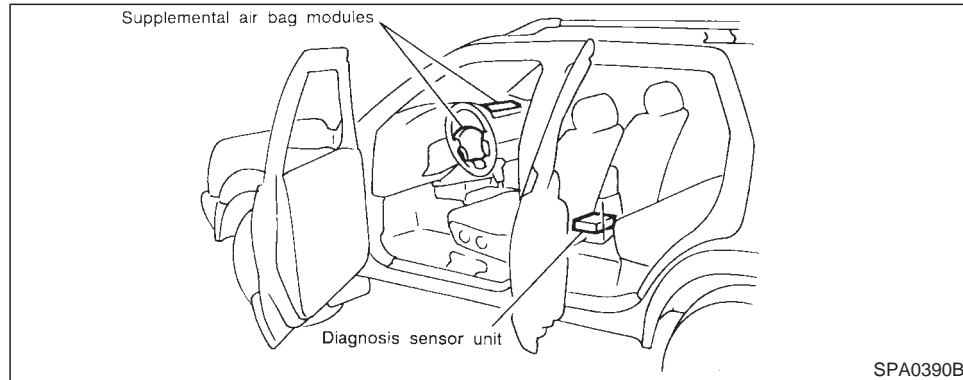

## Supplemental air bag system

The driver supplemental air bag is located in the center of the steering wheel; the front passenger supplemental air bag is mounted in the dashboard above the glove box. The supplemental air bag system is designed to inflate in higher severity frontal collisions, although it may inflate if the forces in another type of collision are similar to those of a higher severity frontal impact. It may not inflate in certain frontal collisions. Vehicle damage (or lack of it) is not always an indication of proper supplemental air bag operation.

When the supplemental air bag inflates, a fairly loud noise may be heard, followed by release of smoke. This smoke is not harmful and does not indicate a fire, but care should be taken not to inhale it, as it may cause irritation and choking. Those with a history of a breathing condition should get fresh air promptly.

Supplemental air bags, along with the use of seat belts, help to cushion the impact force on the face and chest of the occupant. They can help save lives and reduce serious injuries. However, an inflating supplemental air bag may cause facial abrasions or other injuries. Supplemental air bags do not provide restraint to the lower body.

The seat belts should be correctly worn and the driver and passenger seated upright as far as practical away from the steering wheel or dashboard. Since the supplemental air bag inflates quickly in order to help protect the occupant, the force of the supplemental air bag inflating can increase the risk of injury if the occupant is too close to or is against the supplemental air bag module during inflation.

The supplemental air bag will deflate quickly after a collision.

After turning the ignition key to the ON position, the supplemental air bag warning light illuminates. The supplemental air bag warning light will turn off after about 7 seconds if the system is operational.

## **WARNING**

- Do not place any objects on the steering wheel pad or on the instrument panel. Also, do not place any objects between any occupant and the steering wheel or instrument panel. Such objects may become dangerous projectiles and cause injury if the supplemental air bag inflates.
- Right after inflation, several supple-

mental air bag system components will be hot. Do not touch them; you may severely burn yourself.

- No unauthorized changes should be made to any components or wiring of the supplemental air bag system. This is to prevent accidental inflation of the supplemental air bag or damage to the supplemental air bag system.
- Do not make unauthorized changes to your vehicle's electrical system, suspension system or front end structure. This could affect proper operation of the supplemental air bag system.
- Tampering with the supplemental air bag system may result in serious personal injury. Tampering includes changes to the steering wheel and the instrument panel assembly by placing material over the steering wheel pad and above the dashboard, or by installing additional trim material around the supplemental air bag system.

- Work around and on the supplemental air bag system should be done by an authorized NISSAN dealer. Installation of electrical equipment should also be done by an authorized NISSAN dealer. The SRS wiring harnesses\* should not be modified or disconnected. Unauthorized electrical test equipment and probing devices should not be used on the supplemental air bag system.

\* The SRS wiring harnesses are covered with yellow insulation either just before the harness connectors or over the complete harness for easy identification.

When selling your vehicle, we request that you inform the buyer about the supplemental air bag system and guide the buyer to the appropriate sections in this Owner's Manual.

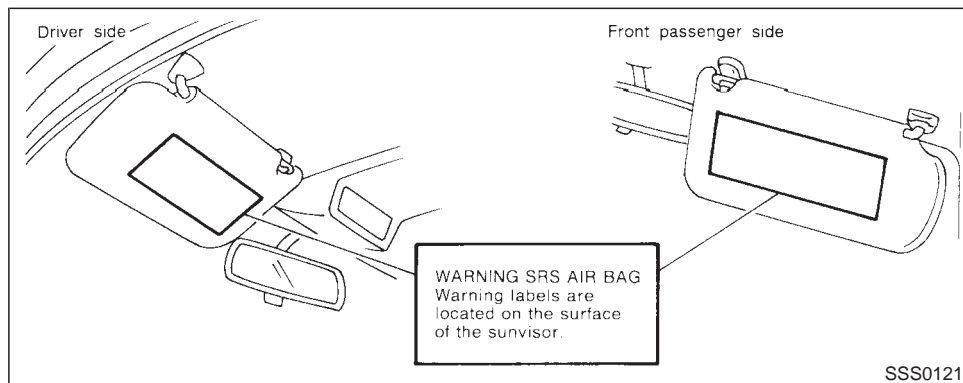

## SUPPLEMENTAL AIR BAG WARNING LABELS

Warning labels about the supplemental air bag system are placed in the vehicle.

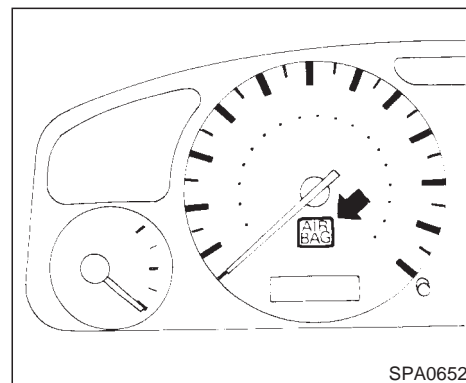

## SUPPLEMENTAL AIR BAG WARNING LIGHT

The supplemental air bag light, displaying AIR BAG in the instrument panel, monitors the circuits of the supplemental air bag. The circuits monitored by the supplemental air bag light are the diagnosis sensor unit, supplemental air bag modules and all related wiring.

After turning the ignition key to the ON position, the air bag warning light illuminates. The supplemental air bag warning light will turn off after about 7 seconds if the system is operational.

If any of the following conditions occurs, the supplemental air bag needs servicing.

1. The supplemental air bag light does not come on and remain on for 7 seconds and then go off as described above.
2. The supplemental air bag light flashes intermittently or remains on (after 7 seconds).
3. The supplemental air bag light does not come on at all.

Under these conditions, the Supplemental Restraint System Air Bag may not operate properly. It must be checked and repaired. Take your vehicle to the nearest authorized NISSAN dealer.

 **WARNING**

**If the supplemental air bag warning light is on, it could mean that the supplemental air bag system will not operate in an accident.**

## Repair and replacement procedure

The supplemental air bag system is designed to inflate on a one-time-only basis. As a reminder, unless it is damaged, the supplemental air bag light will remain illuminated after inflation has occurred. Repair and replacement of the supplemental air bag system should be done only by authorized NISSAN dealers.

**To ensure long-term functioning, the system must be inspected 10 years after the date of manufacture noted on the certification label located on the driver side center pillar.**

When maintenance work is required on the vehicle, the supplemental air bag system and related parts should be pointed out to the person conducting the maintenance. The ignition key should always be in the LOCK position when working under the hood or inside the vehicle.

 **WARNING**

- **Once the supplemental air bag has inflated, the supplemental air bag module will not function again and must be replaced. The supplemental**

**air bag module should be replaced by an authorized NISSAN dealer. The supplemental air bag module cannot be repaired.**

- **The supplemental air bag system should be inspected by an authorized NISSAN dealer if there is any damage to the front end portion of the vehicle.**
- **If you need to dispose of a supplemental air bag or scrap the vehicle, contact an authorized NISSAN dealer. Correct supplemental air bag disposal procedures are set forth in the appropriate NISSAN Service Manual. Incorrect disposal procedures could cause personal injury.**

## SEAT BELTS

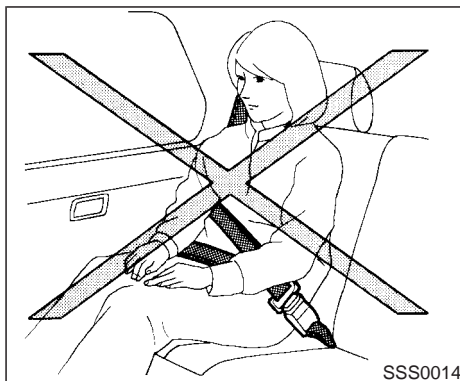
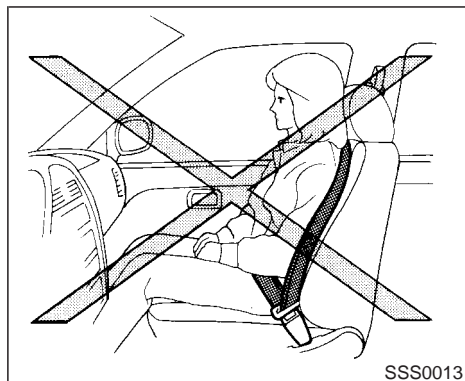
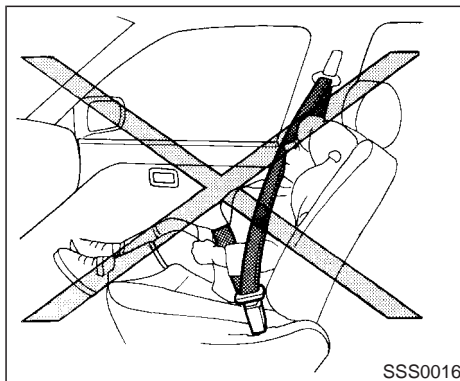
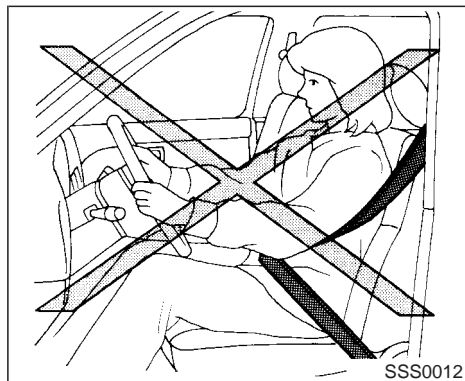

## PRECAUTIONS ON SEAT BELT USAGE

Your chances of being injured or killed in an accident and/or the severity of injury may be greatly reduced if you are wearing your seat belt and it is properly adjusted. NISSAN strongly encourages you and all of your passengers to buckle up every time you drive, even if your seating position includes a supplemental air bag.

**Most states, provinces or territories require that seat belts be worn at all times when a vehicle is being driven.**

### **WARNING**

- Every person who drives or rides in this vehicle should use a seat belt at all times. Children should be properly restrained and, if appropriate, in a child restraint.
- The belt should be properly adjusted to a snug fit. Failure to do so may reduce the effectiveness of the entire restraint system and increase the chance or severity of injury in an accident. Serious injury or death can



occur if the seat belt is not worn properly.

- Always route the shoulder belt over your shoulder and across your chest. Never run the belt behind your back, under your arm or across your neck. The belt should be away from your face and neck, but not falling off your shoulder.
- Position the lap belt as low and snug as possible **AROUND THE HIPS, NOT THE WAIST**. A lap belt worn too high could increase the risk of internal injuries in an accident.
- Be sure the seat belt tongue is securely fastened to the proper buckle.
- Do not wear the belt inside out or twisted. Doing so may reduce its effectiveness.
- Do not allow more than one person to use the same belt.
- Never carry more people in the vehicle than there are seat belts.
- If the seat belt warning light glows continuously while the ignition is

turned ON with all doors closed and all seat belts fastened, it may indicate a malfunction in the system. Have the system checked by your NISSAN dealer.

- All seat belt assemblies including retractors and attaching hardware should be inspected after any collision by your NISSAN dealer. NISSAN recommends that all seat belt assemblies in use during a collision be replaced unless the collision was minor and the belts show no damage and continue to operate properly. **Seat belt assemblies not in use during a collision should also be inspected and replaced if either damage or improper operation is noted.**

## CHILD SAFETY

**Children need adults to help protect them. They need to be properly restrained.**

The proper restraint depends on the child's size. Generally, infants (up to about 1 year and less than 20 lb (9 kg)) should be placed in rear facing child restraints. Front facing child restraints are available for children who outgrow

rear facing child restraints.

### **WARNING**

**Infants and children need special protection. The vehicle's seat belts may not fit them properly. The shoulder belt may come too close to the face or neck. The lap belt may not fit over their small hip bones. In an accident, an improperly fitting seat belt could cause serious or fatal injury. Always use appropriate child restraints.**

All US states and provinces of Canada require the use of approved child restraints for infants and small children. (See "Child restraints for infants and small children" later in this section.)

In addition, there are many types of child restraints available for larger children which should be used for maximum protection.

**NISSAN recommends that all preteens and children be restrained in the rear seat if possible. According to accident statistics, children are safer when properly restrained in the rear seat than in the front seat. This is especially important because your ve-**

hicle has a **Supplemental Restraint System (Air Bag System)** for the front passenger (See “**Supplemental Restraint System**” earlier in this section for precaution).

### Infants and small children

NISSAN recommends that infants and small children be placed in child restraints that comply with Federal Motor Vehicle Safety Standards or Canadian Motor Vehicle Safety Standards. You should choose a child restraint that fits your vehicle and always follow the manufacturer's instructions for installation and use.

### Larger children

Children who are too large for child restraints should be seated and restrained by the seat belts which are provided.

If the child's seating position has a shoulder belt that fits close to the face or neck, the use of a booster seat (commercially available) may help overcome this. The booster seat should raise the child so that the shoulder belt is properly positioned across the top, middle portion of the shoulder and the lap belt is low on the hips. The booster seat should fit the vehicle seat and have a label certifying that it complies with Federal Motor Vehicle Safety Standards or Canadian Motor Vehicle Safety Standards. Once the child has grown so the

shoulder belt is no longer on or near the face and neck, use the shoulder belt without the booster seat.

### **WARNING**

**Never let a child stand or kneel on any seat and do not allow a child in the cargo areas while the vehicle is moving. The child could be seriously injured or killed in an accident.**

### PREGNANT WOMEN

NISSAN recommends that pregnant women use seat belts. Contact your doctor for specific recommendations. The lap belt should be worn snug and positioned as low as possible around the hips, not the waist.

### INJURED PERSONS

NISSAN recommends that injured persons use seat belts, depending on the injury. Check with your doctor for specific recommendations.

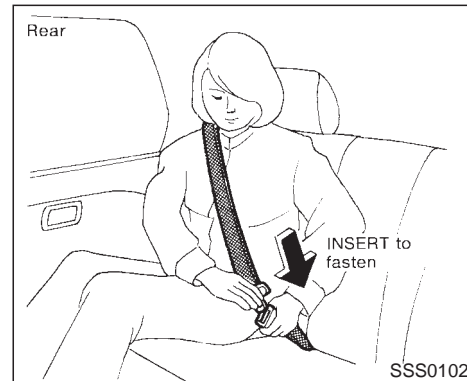
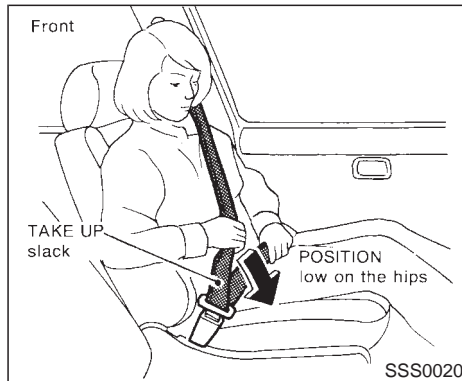
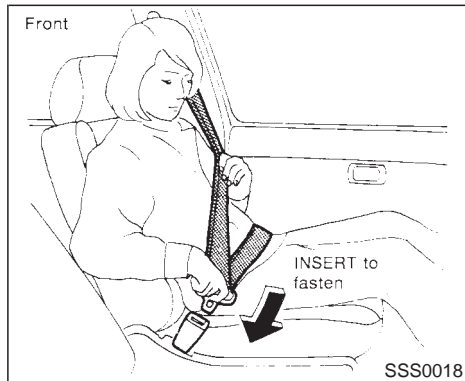

## THREE-POINT TYPE SEAT BELT WITH RETRACTOR

### **⚠️ WARNING**

- Every person who drives or rides in this vehicle should use a seat belt at all times.
- Do not ride in a moving vehicle when the seatback is reclined. This can be dangerous. The shoulder belt will not be against your body. In an accident

**you could be thrown into it and receive neck or other serious injuries. You could also slide under the lap belt and receive serious internal injuries.**

- For most effective protection when the vehicle is in motion, the seat should be upright. Always sit well back in the seat and adjust the seat belt properly.

### Fastening the seat belts

1. Adjust the seat.

2. Slowly pull the seat belt out of the retractor and insert the tongue into the buckle until it snaps.

**The retractor is designed to lock during a sudden stop or on impact. A slow pulling motion will permit the belt to move, and allow you some freedom of movement in the seat.**

3. Position the lap belt portion **low and snug on the hips** as shown.
4. Pull the shoulder belt portion toward the retractor to take up extra slack.

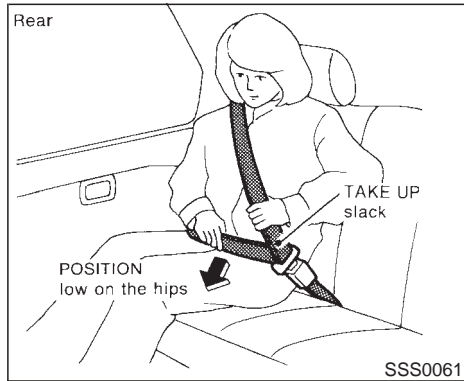

ger, the locking mode should not be activated. If it is activated it may cause uncomfortable seat belt tension.

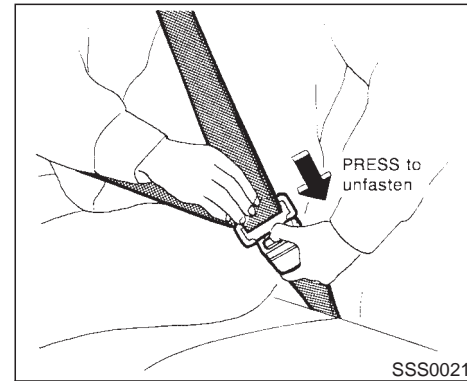

The front seat passenger side seat belt and rear three-point seat belts have a cinching mechanism for child restraint installation. It is referred to as the automatic locking mode.

When the cinching mechanism is activated the seat belt cannot be withdrawn again until the seat belt tongue is detached from the buckle and fully retracted. For additional information, see “Child Restraint Systems for Infants and Small Children” later in this section.

**The automatic locking mode should be used only for child restraint installation.**

**During normal seat belt use by a passen-**

## Unfastening the seat belts

To unfasten the belt, press the button on the buckle. The seat belt will automatically retract.

## Checking seat belt operation

Your seat belt retractors are designed to lock belt movement by two separate methods:

- When the belt is pulled quickly from the retractor.
- When the vehicle slows down rapidly.

You can check the operation as follows:

- Grasp the shoulder belt and pull quickly

forward. The retractor should lock and restrict further belt movement.

If the retractor does not lock during this check or if you have any question about belt operation, see your NISSAN dealer.

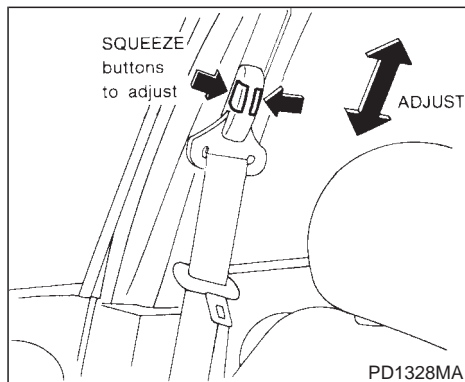

### Shoulder belt height adjustment (for front seats)

The shoulder belt anchor height should be adjusted to the position best suited for you (see "Precautions on Seat Belt Usage" earlier in this section). To adjust, squeeze the release buttons, then move the shoulder belt anchor to the desired position so that the belt passes over the shoulder. Release the adjustment buttons to lock the shoulder belt anchor into position.

### WARNING

- After adjustment, release the button and try to move the shoulder belt anchor up and down to make sure it securely fixed in position.
- The shoulder belt anchor height should be adjusted to the position best for you. Failure to do so may reduce the effectiveness of the entire restraint system and increase the chance or severity of injury in an accident.

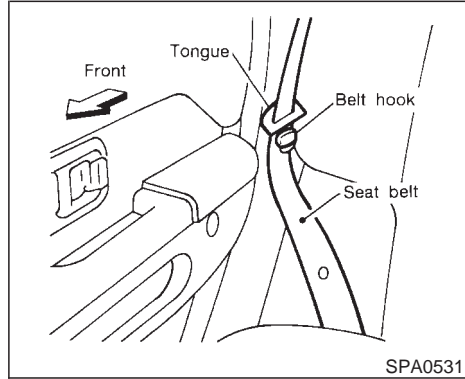

### Seat belt hook

When the rear seat belt is not in use, hook it at the belt hook.

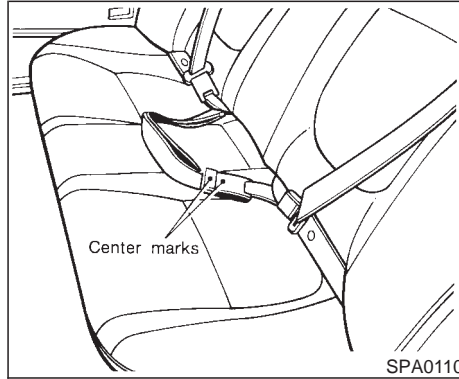

### TWO-POINT TYPE SEAT BELT WITHOUT RETRACTOR (Center of rear seat)

#### Selecting correct set of seat belts

The center seat belt buckle and tongue are identified by the CENTER mark. The center seat belt tongue can be fastened only into the center seat belt buckle.

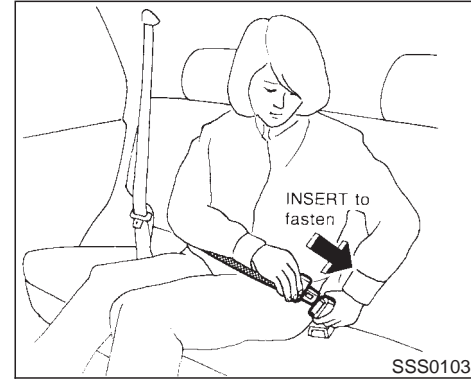

### Fastening the seat belts

1. Insert the tongue into the buckle marked CENTER until it snaps.

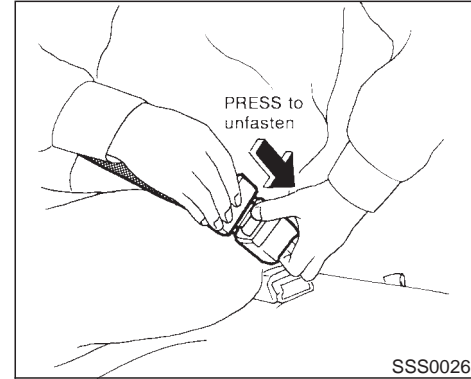
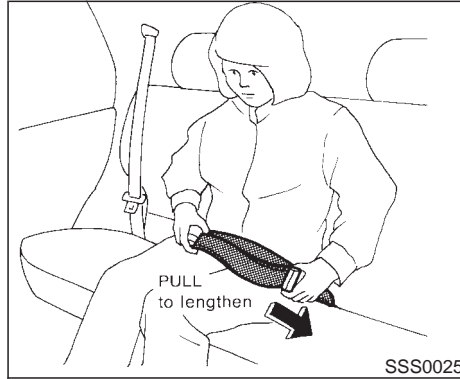
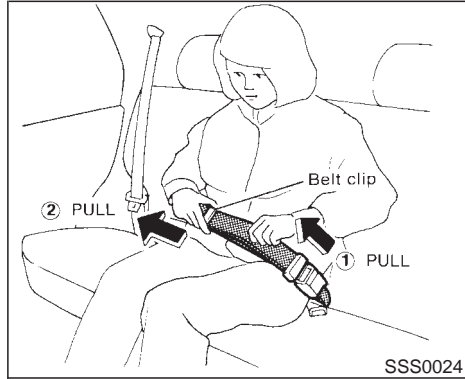

2. To lengthen, hold the tongue at a right angle to the belt and pull on the belt.

To shorten, pull the free end of the belt away from the tongue, then pull the belt clip to take up the slack.

3. Position the lap belt **low and snug on the hips** as shown.

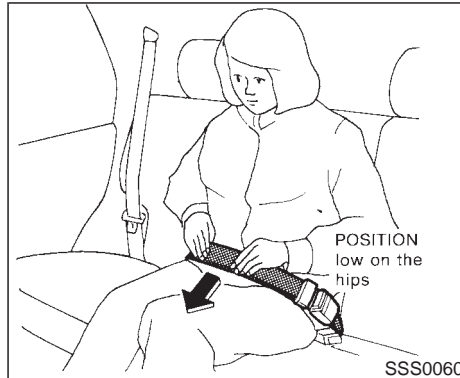

## Unfastening the seat belts

To unfasten the belt, press the button on the buckle.

## SEAT BELT EXTENDERS

If, because of body size or driving position, it is not possible to properly fit the lap-shoulder belt and fasten it, an extender is available which is compatible with the installed seat belts. The extender adds approximately 8 inches (200 mm) of length and may be used for either the driver or right passenger seating position. See your NISSAN dealer for assistance if the extender is required.

### WARNING

- Only NISSAN belt extenders, made by the same company which made the original equipment belts, should be used with NISSAN belts.
- Persons who can use the standard seat belt should not use an extender. Such unnecessary use could result in serious personal injury in the event of an accident.

## SEAT BELT MAINTENANCE

- To clean the seat belt webbings, apply a mild soap solution or any solution recommended for cleaning upholstery or carpets. Then brush the webbing, wipe it with a cloth and allow it to dry in the shade. Do not allow the seat belts to retract until they are completely dry.
- If dirt builds up in the shoulder belt guide of the seat belt anchors, the seat belts may retract slowly. Wipe the shoulder belt guide with a clean, dry cloth.
- Periodically check to see that the seat belt and the metal components such as buckles, tongues, retractors, flexible wires and anchors work properly. If loose parts, deterioration, cuts or other damage on the webbing is found, the entire belt assembly should be replaced.

## CHILD RESTRAINTS

### PRECAUTIONS ON CHILD RESTRAINTS

#### WARNING

- Infants and small children should always be placed in an appropriate child restraint while riding in the vehicle. Failure to use a child restraint can result in serious injury or death.
- Infants and small children should never be carried on your lap. It is not possible for even the strongest adult to resist the forces of a severe accident. The child could be crushed between the adult and parts of the vehicle. Also, do not put the same seat belt around both your child and yourself.
- Never install a rear facing child restraint in the front seat. An inflating supplemental air bag could seriously injure or kill your child. A rear facing child restraint must only be used in the rear seat.
- Nissan recommends that the child restraint be installed in the rear seat.



**According to accident statistics, children are safer when properly restrained in the rear seat than in the front seat.**

- **An improperly installed child restraint could lead to serious injury or death in an accident.**

In general, child restraints are designed to be installed with a lap belt or the lap portion of a three point type seat belt. Child restraints for infants and children of various sizes are offered by several manufacturers. When selecting any child restraint, keep the following points in mind:

- Choose only a restraint with a label certifying that it complies with Federal Motor Vehicle Safety Standard 213 or Canadian Motor Vehicle Safety Standard 213.
- Check that child restraint in your vehicle to be sure it is compatible with the vehicle's seat and seat belt system. Choose a child restraint that meets the guidelines of the Society of Automotive Engineers recommended practice J1819 for child restraint installation.
- If the child restraint is compatible with your vehicle, place your child in the child restraint and check the various adjustments to be sure the child restraint is compatible

with your child. Always follow all recommended procedures.

**All US states and provinces of Canada require that infants and small children be restrained in approved child restraints at all times while the vehicle is being operated.**

### **WARNING**

- **Improper use of a child restraint can result in increased injuries for both the infant or child and other occupants in the vehicle.**
- **Follow all of the child restraint manufacturer's instructions for installation and use. When purchasing a child restraint, be sure to select one which will fit your child and vehicle. It may not be possible to properly install some types of child restraints in your vehicle.**
- **If the child restraint is not anchored properly, the risk of a child being injured in a collision or a sudden stop greatly increases.**
- **Adjustable seatbacks should be posi-**

**tioned to fit the child restraint, but as upright as possible.**

- **After attaching the child restraint, test it before you place the child in it. Tilt it from side to side. Try to tug it forward and check to see if the belt holds the restraint in place. If the restraint is not secure, tighten the belt as necessary, or put the restraint in another seat and test it again.**
- **For a front facing child restraint, if the seat position where it is installed has a three-point type lap/shoulder belt, check to make sure the shoulder belt does not go in front of the child's face or neck. If it does, put the shoulder belt behind the child restraint. If you must install a front facing child restraint in the front seat. See later in "Child restraints" for installation on front passenger seat.**
- **When your child restraint is not in use, store it in the trunk or keep it secured with a seat belt to prevent it from being thrown around in case of a sudden stop or accident.**

## CAUTION

Remember that a child restraint left in a closed vehicle can become very hot. Check the seating surface and buckles before placing your child in the child restraint.

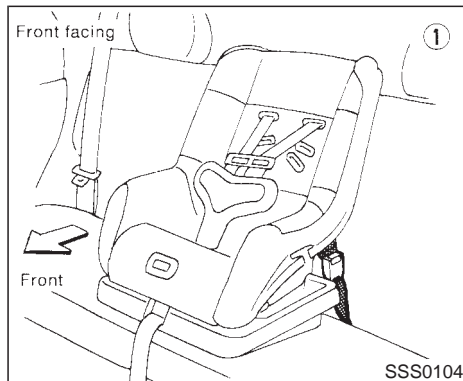

### INSTALLATION ON REAR SEAT CENTER POSITION

#### Front facing

When you install a child restraint in a rear center seat, follow these steps:

1. Position the child restraint on the seat as illustrated. The direction of the child restraint depends on the type of the child restraint and the size of the child. Always follow the restraint manufacturer's instructions.

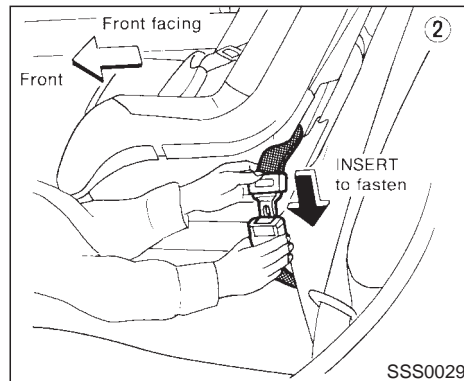

2. Route the seat belt tongue through the child restraint and insert it into the buckle until you hear and feel the latch engage. Be sure to follow the child restraint manufacturer's instructions for belt routing.

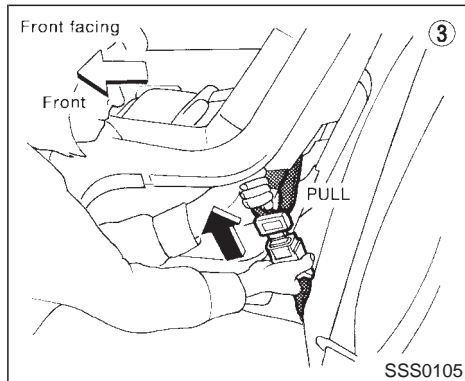

3. Remove all slack in the lap belt for a very tight fit by pulling forcefully on the lap belt adjustment.

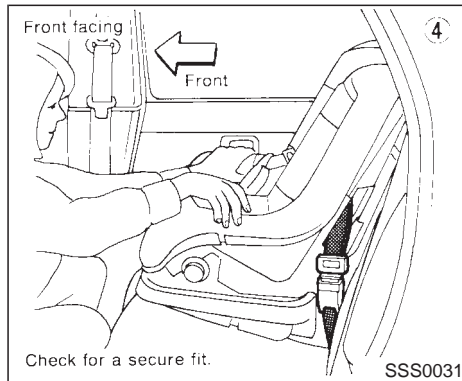

4. Before placing the child in the child restraint, use force to tilt the child restraint from side to side, and tug it forward to make sure that it is securely held in place.
5. If it is not secure, try to tighten the belt again, or put the restraint in another seat.
6. Check to make sure the child restraint is properly secured prior to each use.

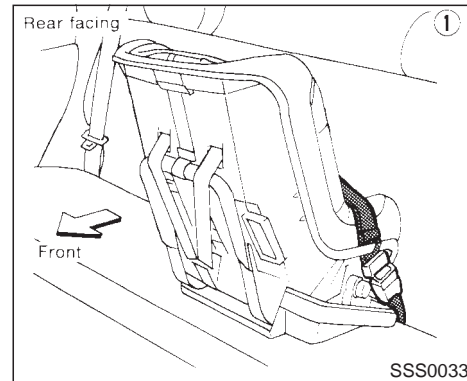

## Rear facing

When you install a child restraint in a rear center seat, follow these steps:

1. Position the child restraint on the seat as illustrated. The direction of the child restraint depends on the type of the child restraint and the size of the child. Always follow the restraint manufacturer's instructions.

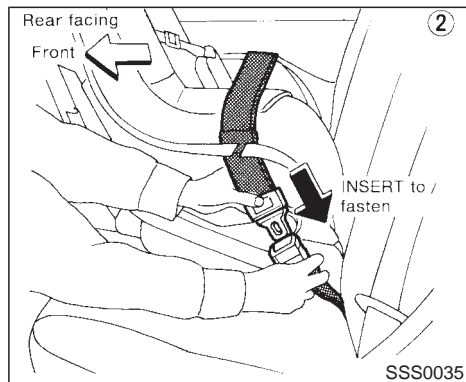

2. Route the seat belt tongue through the child restraint and insert it into the buckle until you hear and feel the latch engage. Be sure to follow the child restraint manufacturer's instructions for belt routing.

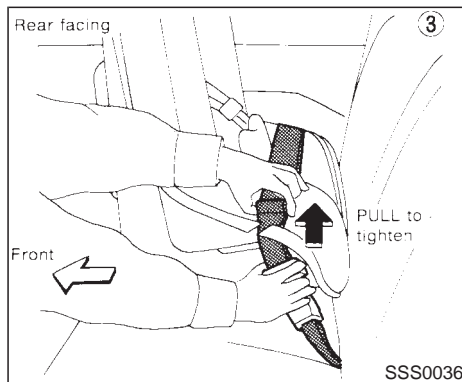

3. Remove all slack in the lap belt for a very tight fit by pulling forcefully on the lap belt adjustment.

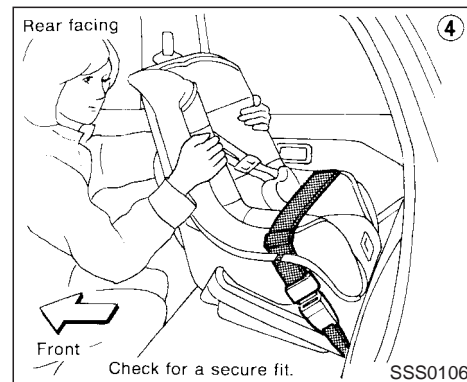

4. Before placing the child in the child restraint, use force to tilt the child restraint from side to side, and tug it forward to make sure that it is securely held in place.

5. If it is not secure, try to tighten the belt again, or put the restraint in another seat.

6. Check to make sure the child restraint is properly secured prior to each use.

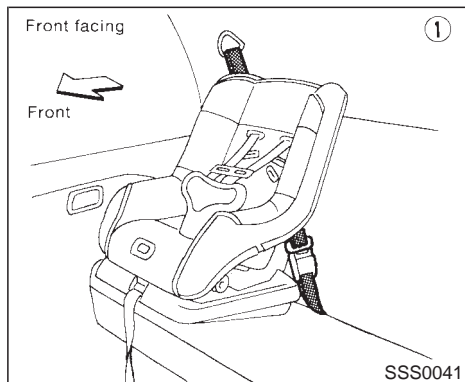

**It could tip over or otherwise be unsecured and cause injury to the child in a sudden stop or collision.**

When you install a child restraint in a rear outboard seat, follow these steps:

1. Position the child restraint on the seat. The direction of the child restraint depends on the type of the child restraint and the size of the child. Always follow the restraint manufacturer's instructions.

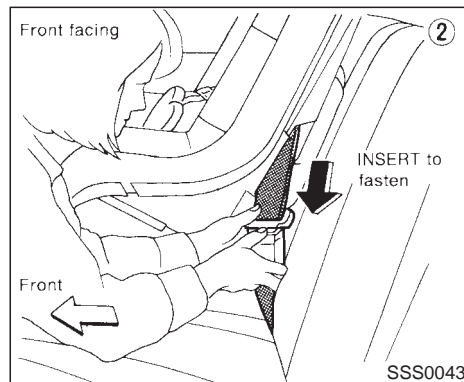

2. Route the seat belt tongue through the child restraint and insert it into the buckle until you hear and feel the latch engage. Be sure to follow the child restraint manufacturer's instructions for belt routing.

## INSTALLATION ON REAR SEAT OUTBOARD POSITIONS

Front facing

### **WARNING**

- The three-point belt on your vehicle is equipped with a locking mode retractor which must be used when installing a child restraint.
- Failure to do so will result in the child restraint not being properly secured.

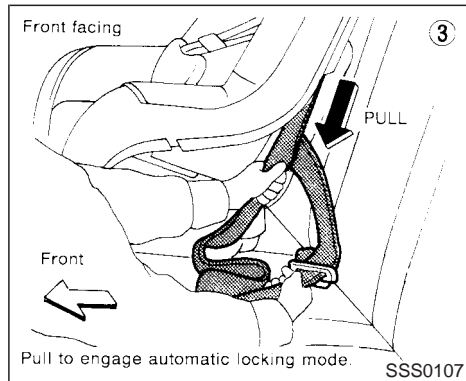

3. Pull on the shoulder belt until all of the belt is fully extended. At this time, the belt retractor is in the automatic locking mode (child restraint mode). It reverts back to emergency locking mode when the belt is fully retracted.

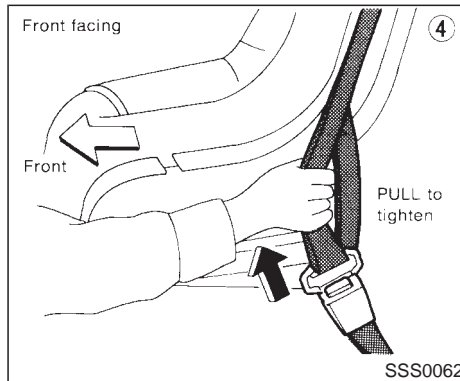

4. Allow the belt to retract. Pull up on the belt to remove any slack in the belt.

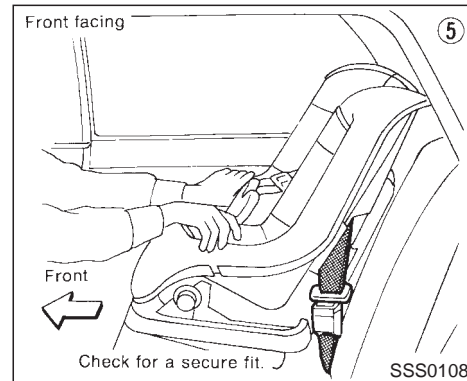

5. Before placing the child in the child restraint, use force to tilt the child restraint from side to side, and tug it forward to make sure that it is securely held in place.
6. Check that the retractor is in the automatic locking mode by trying to pull more belt out of the retractor. If you cannot pull any more belt webbing out of the retractor, the belt is in the automatic locking mode.
7. Check to make sure that the child restraint is properly secured prior to each use. If the belt is not locked, repeat steps 3 through 6.

After the child restraint is removed and the seat belt is allowed to wind back into the retractor, the automatic locking mode (child restraint mode) is canceled; the seat belt only locks during a sudden stop or impact.

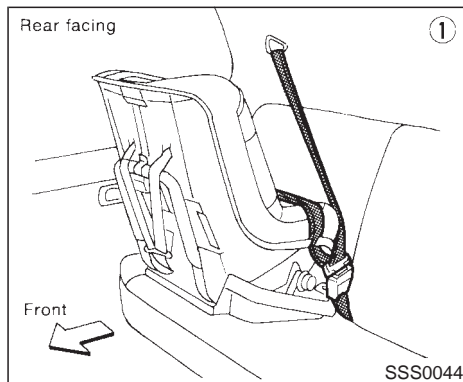

Rear facing

**⚠ WARNING**

- The three-point belt on your vehicle is equipped with a locking mode retractor which must be used when installing a child restraint.
- Failure to do so will result in the child restraint not being properly secured. It could tip over or otherwise be unsecured and cause injury to the child

**in a sudden stop or collision.**

When you install a child restraint in a rear outboard seat, follow these steps:

1. Position the child restraint on the seat. The direction of the child restraint depends on the type of the child restraint and the size of the child. Always follow the restraint manufacturer's instructions.

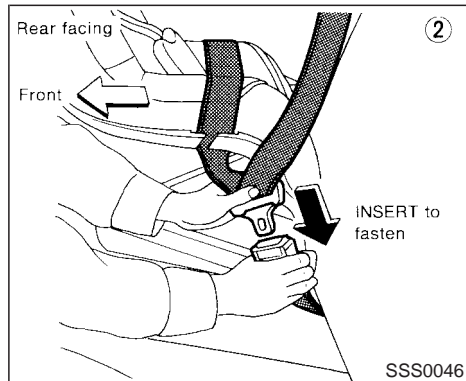

2. Route the seat belt tongue through the child restraint and insert it into the buckle until you hear and feel the latch engage. Be sure to follow the child restraint manufacturer's instructions for belt routing.

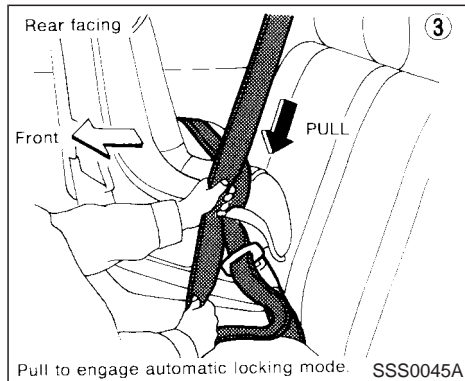

3. Pull on the shoulder belt until all of the belt is fully extended. At this time, the belt retractor is in the automatic locking mode (child restraint mode). It reverts back to emergency locking mode when the belt is fully retracted.

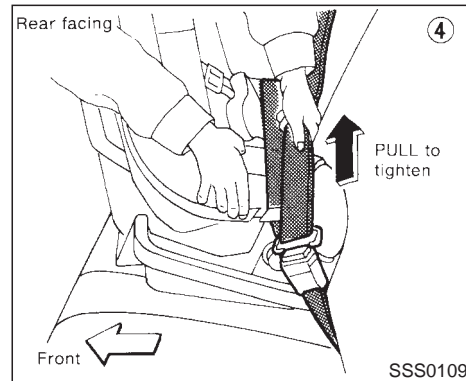

4. Allow the belt to retract. Pull up on the belt to remove any slack in the belt.



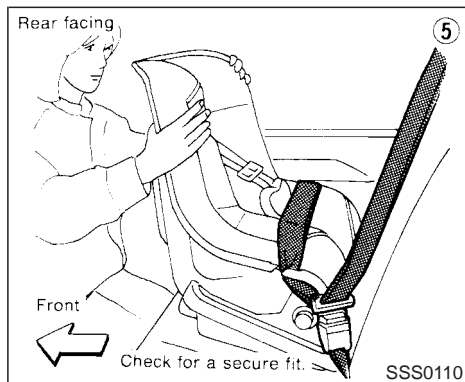

After the child restraint is removed and the seat belt is allowed to wind back into the retractor, the automatic locking mode (child restraint mode) is canceled; the seat belt only locks during a sudden stop or impact.

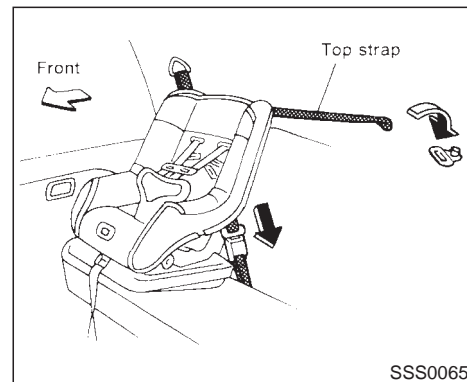

5. Before placing the child in the child restraint, use force to tilt the child restraint from side to side, and tug it forward to make sure that it is securely held in place.
6. Check that the retractor is in the automatic locking mode by trying to pull more belt out of the retractor. If you cannot pull any more belt webbing out of the retractor, the belt is in the automatic locking mode.
7. Check to make sure that the child restraint is properly secured prior to each use. If the belt is not locked, repeat steps 3 through 6.

## TOP STRAP CHILD RESTRAINT

If your child restraint has a top strap, it must be secured to the provided anchor point. Anchor bracket hardware must be installed. The top strap anchor bracket is available through your NISSAN dealer.

### Part No. 88894-89900

Secure the child restraint with the center lap belt or the lap portion of an outboard three-point belt and latch the top strap hook onto the appropriate anchor bracket. To install the anchor bracket, a metric bolt of the dimensions listed below must be used.

**Bolt diameter: 8.0 mm**  
**Bolt length: more than 1.18 in (30 mm)**  
**Thread pitch: 1.25 mm**

Secure the top strap to the attaching bolt which provides the straightest installation of the top strap.

### **WARNING**

Child restraint anchor points are designed to withstand only those loads imposed by correctly fitted child restraints. Under no circumstances are they to be used for adult seat belts or harnesses.

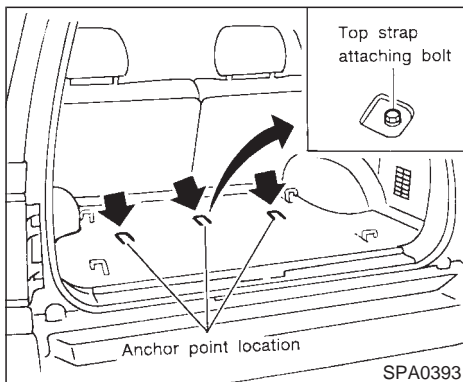

in the “5. Starting and driving” section for exhaust gas.

### Anchor point locations

Anchor point attaching bolts are located under the carpet of the rear luggage area floor.

Your NISSAN dealer can assist you with the installation of your child restraint.

### **WARNING**

The anchor bolt should be installed at all times to prevent the possibility of exhaust fumes entering the passenger compartment through the holes. See “Precautions when starting and driving”

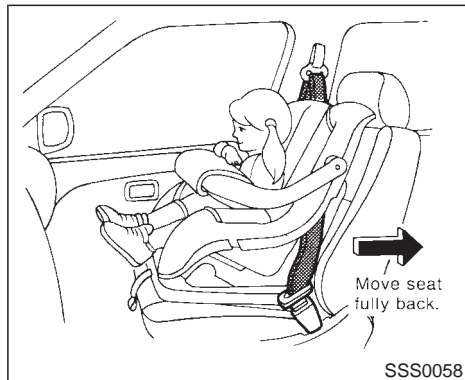

## INSTALLATION ON FRONT PASSENGER SEAT

Front facing

### **WARNING**

- Never install a rear facing child restraint in the front passenger seat. Supplemental air bags inflate with great force. A rear facing child restraint could be struck by the supplemental air bag in a crash and could

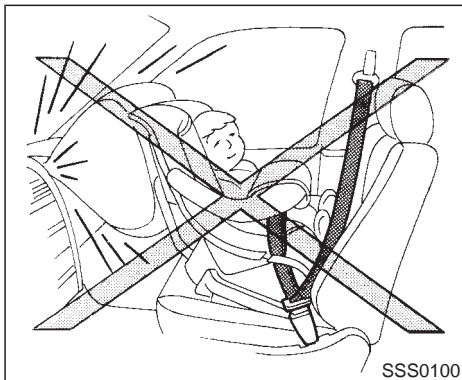

seriously injure or kill your child.

- NISSAN recommends that child restraints be installed in the rear seat. However, if you must install a front facing child restraint in the front passenger seat, move the passenger seat to the rear most position.
- A child restraint with a top strap should not be used in the front passenger seat.
- The three-point belt in your vehicle is

equipped with a locking mode retractor which must be used when installing a child restraint.

- Failure to use the retractor's locking mode may result in the child restraint not being properly secured. The child restraint could tip over or otherwise be unsecured and cause injury to the child in a sudden stop or collision.

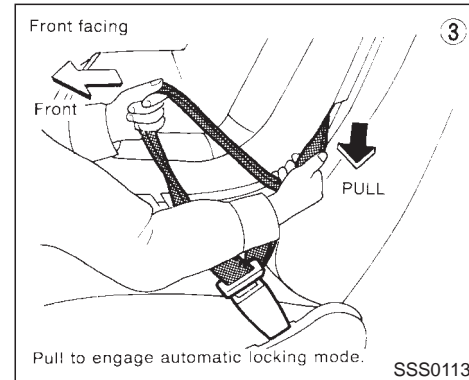
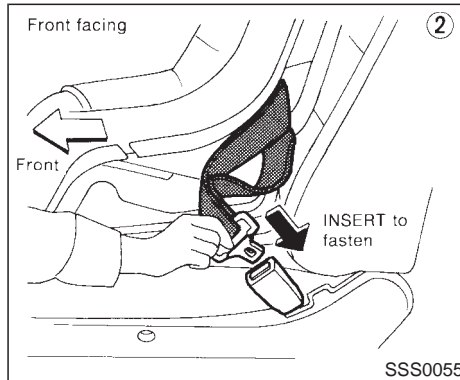
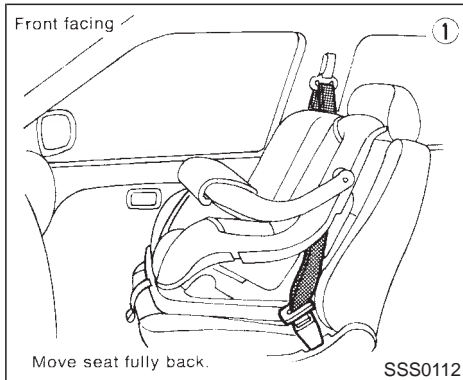

If you must install a child restraint in the front seat, follow these steps:

1. Position the child restraint on the front passenger seat. **It should be placed in a front facing direction only.** Move the seat to the rear most position. Always follow the child restraint manufacturer's instructions. **Child restraints for infants must be used in the rear facing direction and therefore must not be used in the front seat.**

2. Route the seat belt tongue through the child restraint and insert it into the buckle until you hear and feel the latch engage. Be sure to follow the child restraint manufacturer's instructions for belt routing.

3. Pull on the shoulder belt until all of the belt is fully extended. At this time, the belt retractor is in the automatic locking mode (child restraint mode). It reverts back to emergency locking mode when the belt is fully retracted.

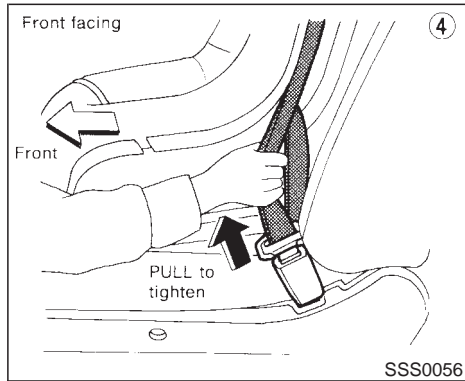

4. Allow the belt to retract. Pull up on the belt to remove any slack in the belt.

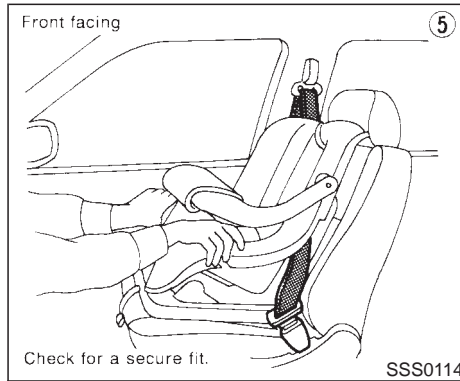

5. Before placing the child in the child restraint, use force to tilt the child restraint from side to side, and tug it forward to make sure that it is securely held in place.
6. Check that the retractor is in the automatic locking mode by trying to pull more belt out of the retractor. If you cannot pull any more belt webbing out of the retractor, the belt is in the automatic locking mode.
7. Check to make sure that the child restraint is properly secured prior to each use. If the lap belt is not locked, repeat steps 3 through 6.

After the child restraint is removed and the seat belt is allowed to wind back into the retractor, the automatic locking mode (child restraint mode) is canceled; the seat belt only locks during a sudden stop or impact.

## 2 Instruments and controls

Instrument panel .....	2-2	Heated seats (if so equipped).....	2-20
Meters and gauges .....	2-3	Power socket.....	2-21
Compass and outside temperature display (if so equipped) .....	2-6	Cigarette lighter and ashtrays.....	2-22
Warning/indicator lights and buzzers.....	2-9	Storage .....	2-23
Security system.....	2-14	Windows.....	2-30
Windshield wiper and washer switch.....	2-15	Sunroof (if so equipped) .....	2-32
Rear window wiper and washer switch.....	2-16	Clock .....	2-33
Rear window and outside mirror defogger switch .....	2-16	Interior light .....	2-34
Headlight and turn signal switch.....	2-17	Personal light .....	2-35
Front fog light switch.....	2-19	Vanity mirror light.....	2-35
Hazard warning flasher switch .....	2-19	Integrated HomeLink <sup>®</sup> transmitter (if so equipped) .....	2-35
Horn.....	2-20		

# INSTRUMENT PANEL

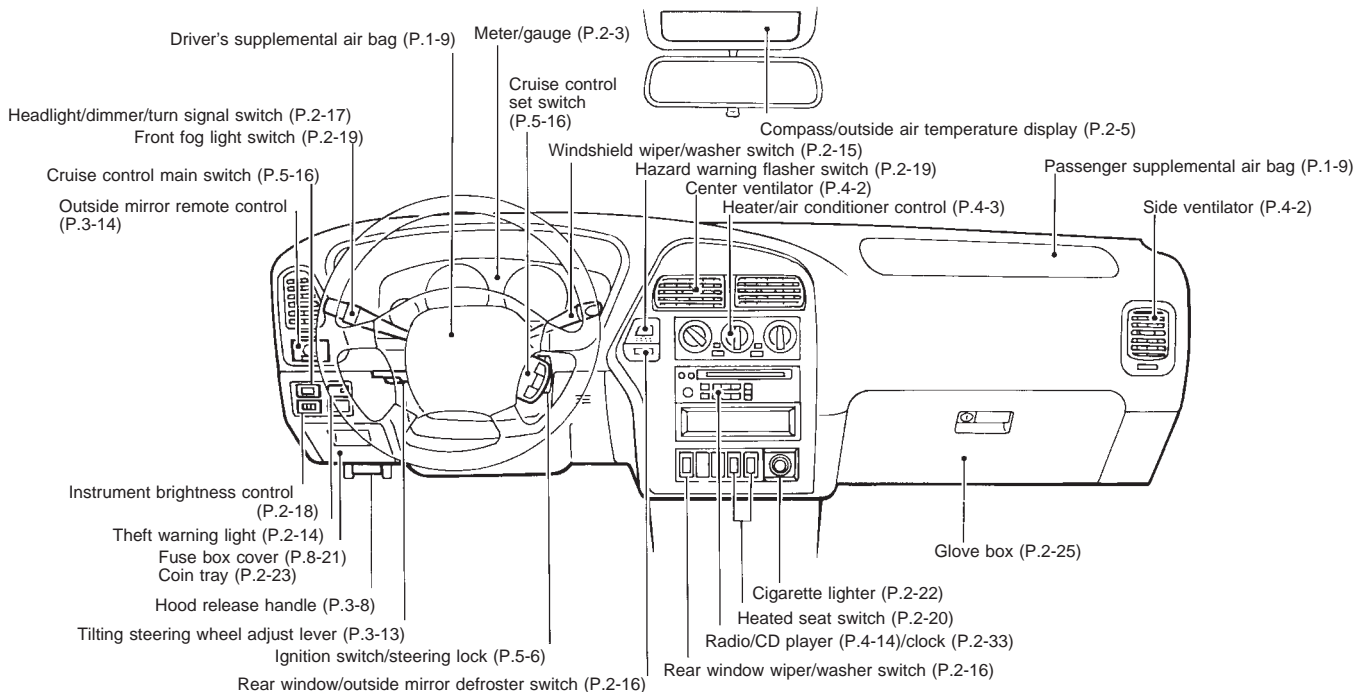

See the page indicated in parentheses for operating details.

SIC0682

## METERS AND GAUGES

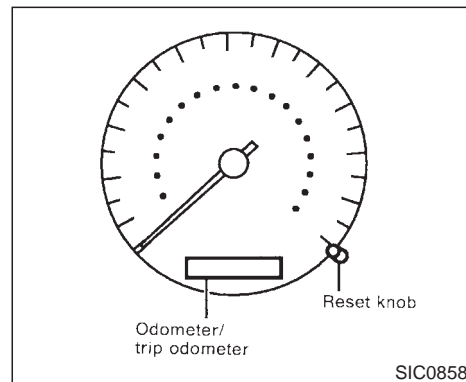
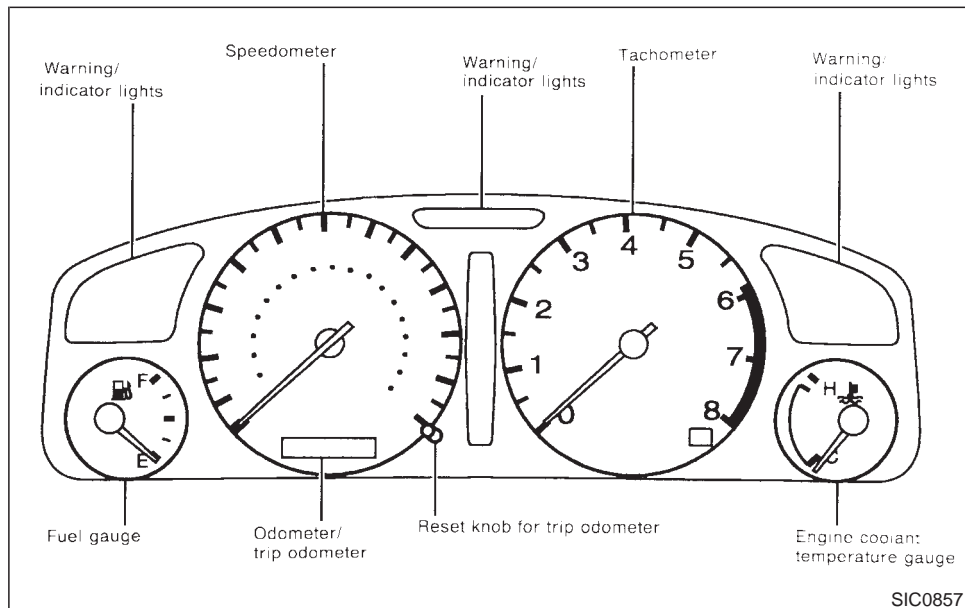

### SPEEDOMETER AND ODOMETER

#### Speedometer

The speedometer indicates vehicle speed.

#### Odometer

The odometer records the total distance the vehicle has been driven.

#### Twin trip odometer

The trip odometer records the distance of individual trips.



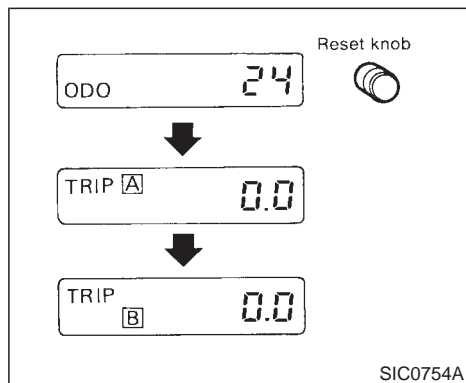

### Changing the display:

Push the reset knob to change the display as follows:

ODO → TRIP A → TRIP B → ODO

### Resetting the trip odometer:

Push the reset knob for more than 1 second to reset the trip odometer to zero.

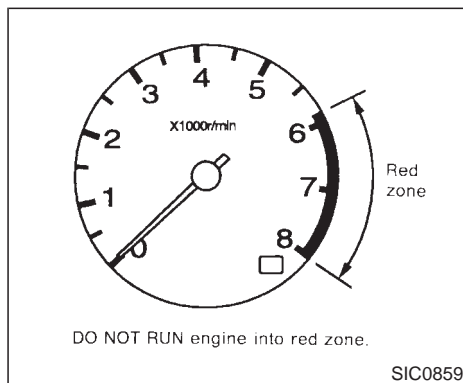

### TACHOMETER

The tachometer indicates engine speed in revolutions per minute (r/min).



**When engine speed approaches the red zone, shift to a higher gear. Operating the engine in the red zone may cause serious engine damage.**

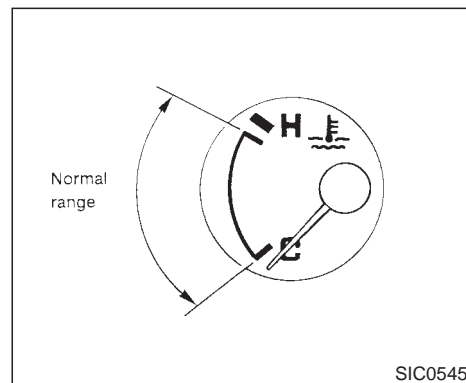

### ENGINE COOLANT TEMPERATURE GAUGE

The gauge indicates the engine coolant temperature.

The engine coolant temperature will vary with the outside air temperature and driving conditions.



**If the gauge indicates engine coolant temperature over the normal range, stop the vehicle as soon as safely possible. If**

the engine is overheated, continued operation of the vehicle may seriously damage the engine. See “If your vehicle overheats” in the “6. In case of emergency” section for immediate action required.

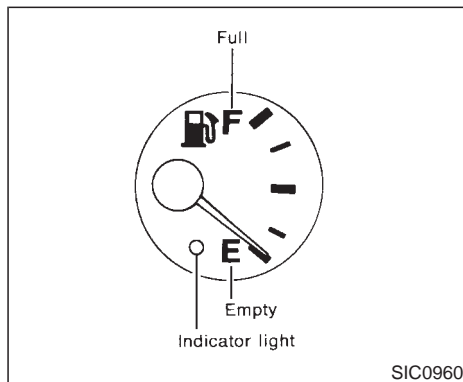

convenient, preferably before the gauge reaches “E”. There will be a small reserve of fuel in the tank when the fuel gauge needle reaches “E”.

## FUEL GAUGE

The gauge indicates the APPROXIMATE fuel level in the tank.

The gauge may move slightly during braking, turning, acceleration, or going up or down hill.

The gauge needle is designed to remain in approximately the same position, even when the ignition key is turned OFF.

**Refill the fuel tank before the gauge registers Empty.**

**The indicator light comes on when the fuel tank is getting low. Refuel as soon as it is**

## COMPASS AND OUTSIDE TEMPERATURE DISPLAY (if so equipped)

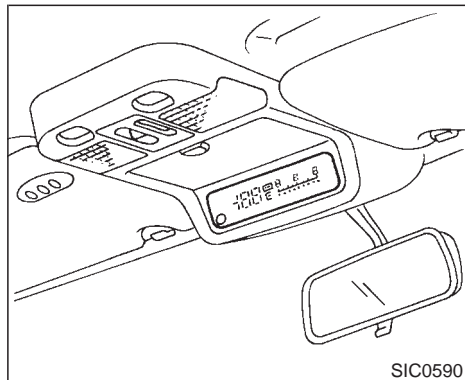

This unit is a display unit with the following functions:

- Function to measure terrestrial magnetism and indicate heading direction of vehicle
- Function to indicate outside air temperature
- Function to indicate caution for frozen road surfaces

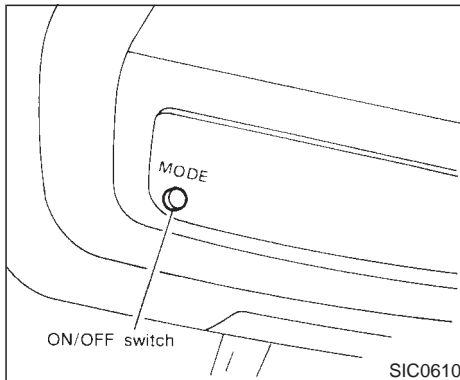

## OUTSIDE TEMPERATURE DISPLAY

Push the switch when the ignition key is in the ACC or ON position. The outside temperature will be displayed in °F.

- Selecting the indication range  
Push the switch to change from °F to °C.
- If the outside temperature drops below the freezing point, the display indicates ICE.

- When the outside temperature is between 130°F (55°C) and 158°F (70°C), the display shows 130°F (55°C).
- When the outside temperature is lower than -20°F (-30°C) or higher than 158°F (70°C), the display shows only ... though it is operating. This is not a problem.

### CAUTION

- The outside temperature sensor is installed in the front of the radiator. The display may not indicate the precise temperature due to the heat of the road and engine depending on the direction of the wind and driving conditions, etc.
- Use the ICE indication for reference only. Confirm the traffic information and road conditions to drive safely.

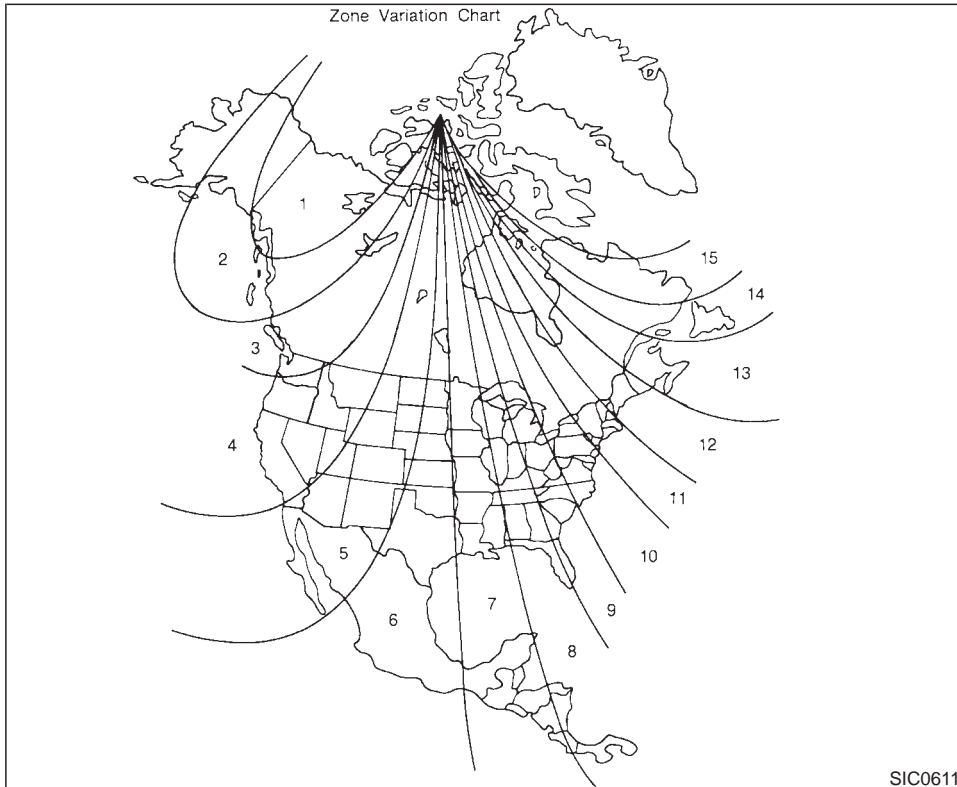

## COMPASS DISPLAY

Push the switch when the ignition key is in the ACC or ON position. The direction will be displayed.

### Zone variation change procedure

The difference between magnetic north and geographical north is known as variance. In some areas, this difference can sometimes be great enough to cause false compass readings. Follow these instructions to set the variance for your particular location if this happens:

1. Establish your location on the zone map. Record your zone number.
2. Push the ON/OFF switch in for five seconds until the current zone entry number is displayed.
3. Press the ON/OFF switch repeatedly until the new zone entry number is displayed.

Once the desired zone number is displayed, stop pressing the ON/OFF switch and the display will show compass direction within a few seconds.

- If a magnet is located near the compass or the vehicle is driven where the terrestrial magnetism is disturbed, the compass display may not indicate the correct direction.
  - In places where the terrestrial magnetism is disturbed, the correction of the direction starts automatically, extinguishing the direction bar. If turn is made one or two times, the correction is complete and the direction bar comes back on.
- tion procedure may start automatically.

### Correction functions of the compass display













The compass display is equipped with automatic correction function. If the direction is not shown correctly, carry out manual correction procedure set out below.

### Manual correction procedure

1. Push the switch for about 10 seconds. The direction bar starts blinking.
2. Drive the vehicle slowly in an open and safe area. The initial correction is completed while turning one or two turns.





**In places where the terrestrial magnetism is extremely disturbed, the initial correc-**

## WARNING/INDICATOR LIGHTS AND BUZZERS



	Engine oil pressure warning light	 or <b>BRAKE</b>	Brake warning light		Overdrive off indicator light
	Charge warning light	<b>ABS</b>	Anti-lock brake warning light (Except for Canada)		Turn signal/hazard indicator lights
	Door open warning light		Anti-lock brake warning light (For Canada)		High beam indicator light (Blue)
	Seat belt warning light and buzzer	<b>ATP</b>	Automatic transmission park warning light	<b>CRUISE</b>	CRUISE indicator light
<b>AIR BAG</b>	Supplemental air bag warning light	<b>A / T OIL TEMP</b>	Automatic transmission oil temperature warning light	<b>SERVICE ENGINE SOON</b>	Malfunction indicator light (MIL)
	Low washer fluid warning light (For Canada)		Tire carrier open warning light		Four-wheel drive indicator light

## CHECKING BULBS

Turn the ignition key to ON without starting the engine. The following lights will come on:

 ,  ,  or **BRAKE** ,  , 

The following lights come on briefly and then go off:

 , **ABS** or  , 

If any light fails to come on, it may indicate a burned-out bulb or an open circuit in the electrical system. Have the system repaired promptly.

## WARNING LIGHTS

 Engine oil pressure warning light

This light warns of low engine oil pressure. If the light flickers or comes on during normal driving, pull off the road in a safe area, stop the engine **immediately** and call a NISSAN dealer or other authorized repair shop.

**The oil pressure warning light is not designed to indicate a low oil level. Use the dipstick to check the oil level.** See “Engine oil” in the “8. Do-it-yourself” section.

## CAUTION

**Running the engine with the oil pressure warning light on could cause serious damage to the engine almost immediately. Turn off the engine as soon as it is safe to do so.**



## Charge warning light

If the light comes on while the engine is running, it may indicate that there is something wrong with the charging system. Turn the engine off and check the alternator belt. If the belt is loose, broken, missing or if the light remains on, see your NISSAN dealer immediately.

## CAUTION

**Do not continue driving if the belt is loose, broken or missing.**



## Door open warning light

This light comes on when any of the doors and/or rear window are not closed securely while the ignition key is ON.



## Seat belt warning light and buzzer

The light and buzzer remind you to fasten seat belts. The light illuminates whenever the ignition key is turned to ON, and will remain illuminated until the driver's seat belt is fastened. At the same time, the buzzer will sound for about six seconds unless the driver's seat belt is securely fastened.

See "Seat belts" in the "1. Seats, restraints and supplemental air bag systems" section for precautions on seat belt usage.



## Supplemental air bag warning light

When the ignition key is in the ON or "START" position, the supplemental air bag light will illuminate for about 7 seconds and then turn off. This means the system is operational.

If any of the following conditions occur, the supplemental air bag needs servicing and your vehicle must be taken to your nearest authorized NISSAN dealer.

1. The supplemental air bag light does not come on and remain on for 7 seconds and then go off as described above.
2. The supplemental air bag light flashes intermittently or remains on. (after 7 seconds)
3. The supplemental air bag light does not come on at all.

Unless checked and repaired, the Supplemental Restraint System may not function properly. For additional details on the Supplemental Air Bag System, see Section 2.

## WARNING

**If the supplemental air bag warning light is on, it could mean that the supplemental air bag system will not operate in an accident.**



## Low washer fluid warning light (For Canada)

This light comes on when the washer fluid in the washer tank is at a low level. Add washer fluid as necessary. See "Window washer fluid" in the "8. Do-it-yourself" section.



## Brake warning light

This light functions for both the parking brake and the foot brake systems.

### Parking brake indicator:

The light comes on when the parking brake is applied.

### Low brake fluid warning light:

When the ignition key is in the ON position, the light warns of a low brake fluid level. If the light comes on while the engine is running, stop the vehicle and perform the following:

1. Check the brake fluid level. Add brake fluid as necessary. See “Brake and clutch fluid” in the “8. Do-it-yourself” section.
2. If the brake fluid level is correct:  
Have the warning system checked by a NISSAN dealer.

## WARNING

- **Your brake system may not be working properly if the warning light is on. Driving could be dangerous. If you judge it to be safe, drive carefully to the nearest service station for repairs. Otherwise, have your vehicle towed.**
- **Pressing the brake pedal with the engine stopped and/or low brake fluid level may increase your stopping distance and braking will require greater pedal effort as well as greater pedal travel.**
- **If the brake fluid level is below the MIN mark on the brake fluid reservoir, do not drive until the brake system has been checked at a NISSAN**

dealer.

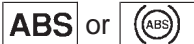



Anti-lock  
brake warning  
light

If the light comes on while the engine is running, it may indicate there is something wrong with the anti-lock brake system. Have the system checked by your NISSAN dealer.

If an abnormality occurs in the system, the anti-lock function will cease but the ordinary brakes will continue to operate normally.

**If the light comes on while you are driving, contact your NISSAN dealer for repair.**

 Automatic transmission park  
warning light (  model)

This light indicates that the automatic transmission parking function is not engaged. If the transfer control is not secured in any drive position while the automatic transmission selector lever is in the P position, the transmission will disengage and the wheel will not lock.

Shift the transfer control lever into the 2H or 4L position when the warning light comes on.

- When parking, always make sure that the transfer lever is in H or 4L and the parking brake is set.
- If the ATP light is ON, this indicates that the automatic transmission P position will not function and the transfer lever is in neutral.
- Failure to engage the transfer control lever in H or 4L could result in the vehicle moving unexpectedly, resulting in serious personal injury or property damage.





**Automatic transmission oil temperature warning light**  
(**4x4** model)

This light comes on when the automatic transmission oil temperature is too high. If the light comes on while driving, reduce the vehicle speed as soon as safely possible until the light turns off.

**Continued vehicle operation when the A/T oil temperature warning light is on may damage the automatic transmission.**



**Tire carrier open warning light**  
(if so equipped)

This light comes on when the tire carrier is not closed securely while the ignition key is ON.

## INDICATOR LIGHTS



**Overdrive off indicator light**

This light comes on during driving when the overdrive switch is pressed to prevent overdrive operation.

The O/D OFF indicator light comes on for two seconds each time the ignition key is turned ON. This shows the light is functioning properly.

If the O/D OFF indicator light blinks for  
**2-12 Instruments and controls**

approximately 8 seconds after coming on for 2 seconds, have your NISSAN dealer check the transmission and repair it if necessary.

The automatic transmission is equipped with an electronic Fail-Safe mode. This system allows the vehicle to be driven even in the event of damage to the electrical circuits. If this occurs, the gears automatically engage and lock into 3rd gear.

**See “Driving the vehicle” in the “5. Starting and driving” section for failsafe before visiting your NISSAN dealer.**



**Turn signal/hazard indicator lights**

The light flashes when the turn signal switch lever or hazard switch is turned on.



**High beam indicator light**  
(Blue)

This light comes on when the headlight high beam is on, and goes out when the low beams are selected.



**CRUISE indicator light**

The light comes on while the vehicle speed is controlled by the cruise control system.

If the light flickers while the engine is running,

it may indicate there is something wrong with the cruise control system. Have the system checked by your NISSAN dealer.



**Malfunction indicator light**  
(MIL)

If the Malfunction indicator light comes on steady or blinks while the engine is running, it may indicate a potential emission control problem.

The Malfunction indicator light will come on in one of two ways:

- Malfunction indicator light on steady — An emission control system malfunction has been detected. Have the vehicle inspected by an authorized NISSAN dealer. You do not need to have your vehicle towed to the dealer.
- Malfunction indicator light blinking — An engine misfire has been detected which may damage the emission control system. To reduce or avoid emission control system damage:
  - \* do not drive at speeds above 45 MPH (72 km/h).
  - \* avoid hard acceleration or deceleration.
  - \* avoid steep uphill grades.
  - \* if possible, reduce the amount of cargo

being hauled or towed.

The malfunction indicator light may stop blinking and come on steady.

Have the vehicle inspected by an authorized NISSAN dealer. You do not need to have your vehicle towed to the dealer.

## CAUTION

**Continued vehicle operation without having the emission control system checked and repaired as necessary could lead to poor driveability, reduced fuel economy, and possible damage to the emission control system.**

Some conditions may cause the malfunction indicator light to come on steady or blink. Examples are as follows:

- vehicle ran out of fuel, which caused the engine to misfire.
- fuel filler cap was left off or improperly installed, allowing fuel to evaporate into the atmosphere.

If you suspect that you experienced one or both of the above conditions, drive the vehicle to an authorized NISSAN dealer and have the

vehicle inspected. Avoid any unnecessary diagnosis during the service by informing the dealer of the conditions listed above that may have occurred.



### Four wheel drive indicator light

This light comes on when the transfer shift control lever is in the 4H or 4L position.

## BUZZERS

### Key reminder buzzer

The buzzer will sound when the driver side door is opened if the key is left in the ignition switch. Take the ignition key when you leave the vehicle.

### Light reminder buzzer

A buzzer will sound if the driver's door is opened with the light switch on unless the ignition key in the ON position. Turn the light switch off when you leave the vehicle.

### Brake pad wear warning

The disc brake pads have audible wear warnings. When a brake pad requires replacement, it will make a high pitched scraping sound. Have the brakes checked as soon as possible if the warning sound is heard when the vehicle

is moving, whether or not the brake pedal is depressed.

## SECURITY SYSTEM



### THEFT WARNING

The theft warning system provides visual and audio alarm signals if parts of the vehicle are disturbed.

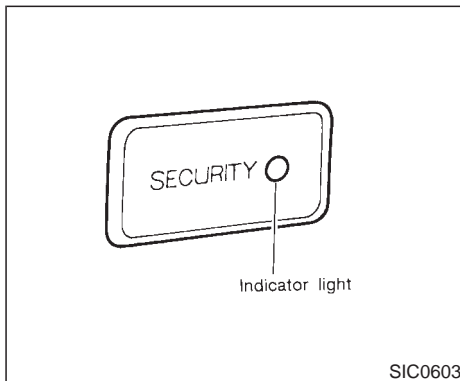

### Security indicator light

- **If the key is turned slowly toward the front of the vehicle when locking the door, the system may not activate. If the key is returned beyond the vertical position toward the rear of the vehicle to remove the key, the system may be deactivated. When the indicator light fails to glow for 30 seconds, unlock the door once and lock it again.**
- **Even when the driver and/or passengers are in the vehicle, the system will activate with all doors, hood and back door**

**locked and ignition key off. Turn the ignition key to ACC to turn the system off.**

### How to activate the theft warning system

1. Close all windows.
2. Remove the key from the ignition switch.
3. Close and lock all doors, hood, back door and glass hatch. The doors can be locked either with or without the key.

**The system can be activated even if the windows are open.**

4. Confirm that the SECURITY indicator light comes on. The SECURITY light glows for about 30 seconds and then begins to flash. The system is now activated. If, during this 30 second time period, the door is unlocked by the key or multi-remote controller, or the ignition key is turned to ACC or ON, the system will not activate.

### THEFT WARNING SYSTEM OPERATION

The warning system will give the following alarm:

- The headlights blink and the horn sounds intermittently. In addition, the starter motor will not operate.
- The alarm automatically turns off after 2 to 3 minutes; however, the alarm will reactivate if the vehicle is tampered with again.

The alarm is activated by:

- Unlocking the door, back door or back door glass hatch without using the key or multi-remote controller. (Even if the door is opened by releasing the door inside lock knob, the alarm is activated.)
- Opening the hood.

### How to stop alarm

The alarm will stop only by unlocking a door or back door with the key or multi-remote controller. The alarm will not stop if the ignition switch is turned to ACC.

**If the system does not operate as described above, have it checked by your NISSAN dealer.**

## WINDSHIELD WIPER AND WASHER SWITCH

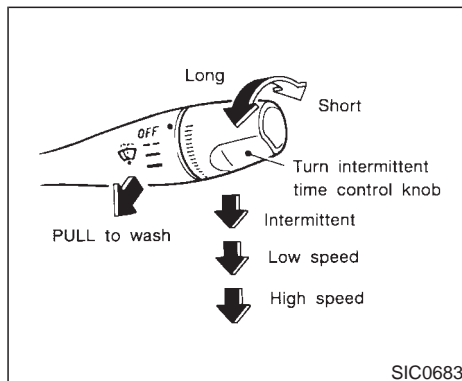

The windshield wiper and washer operates when the ignition key is in the ACC or ON position.

Push the lever down to operate the wiper.

Intermittent operation can be adjusted from 4 to 12 seconds by turning the knob.

Pull the lever toward you to operate the washer. Then the wiper will also operate several times.

### CAUTION

The following could damage the washer system:



- Do not operate the washer continuously for more than 30 seconds.
- Do not operate the washer if the reservoir tank is empty.

### WARNING

In freezing temperatures the washer solution may freeze on the windshield and obscure your vision which may lead to an accident. Warm the windshield with the defroster before you wash the windshield.

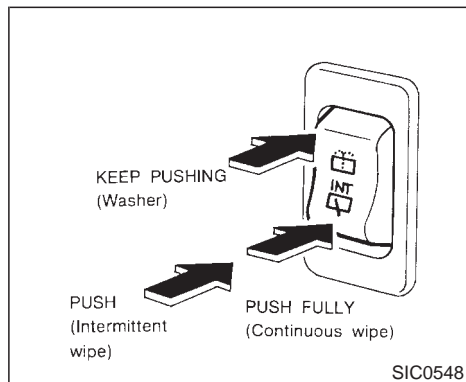
## REAR WINDOW WIPER AND WASHER SWITCH



To operate the wiper, push the switch to the  side. This wiper operates intermittently. Push the switch to the  side fully, this operates the wiper continuously.

To operate the washer, hold the switch down to the  side.

Then the wiper will also operate several times.

### CAUTION

- Do not operate the washer continuously for more than 30 seconds.
  - Do not operate the washer if reservoir tank is empty.
  - The rear window wiper will not operate when the rear window is open.
- The rear window wiper will not operate if the rear window is closed with the wiper switch on. To operate the window wiper, turn the switch to off and then to on.
- The rear window will not open while the rear window wiper is operating.

### WARNING

In freezing temperatures the washer solution may freeze on the rear window and obscure your vision. Warm the rear window with the defroster before you wash the rear window.

## REAR WINDOW AND OUTSIDE MIRROR DEFOGGER SWITCH

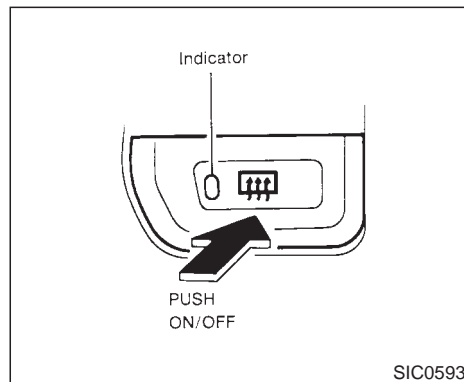

To defog the rear window glass and the outside door mirrors, start the engine and push the switch on. (The indicator light will come on.) Push the switch again to turn the defogger off.

It will automatically turn off in approximately 15 minutes. If the window clears before this time, push the switch off manually.

## CAUTION

When cleaning the inner side of the rear window, be careful not to scratch or damage the rear window defogger.

## HEADLIGHT AND TURN SIGNAL SWITCH

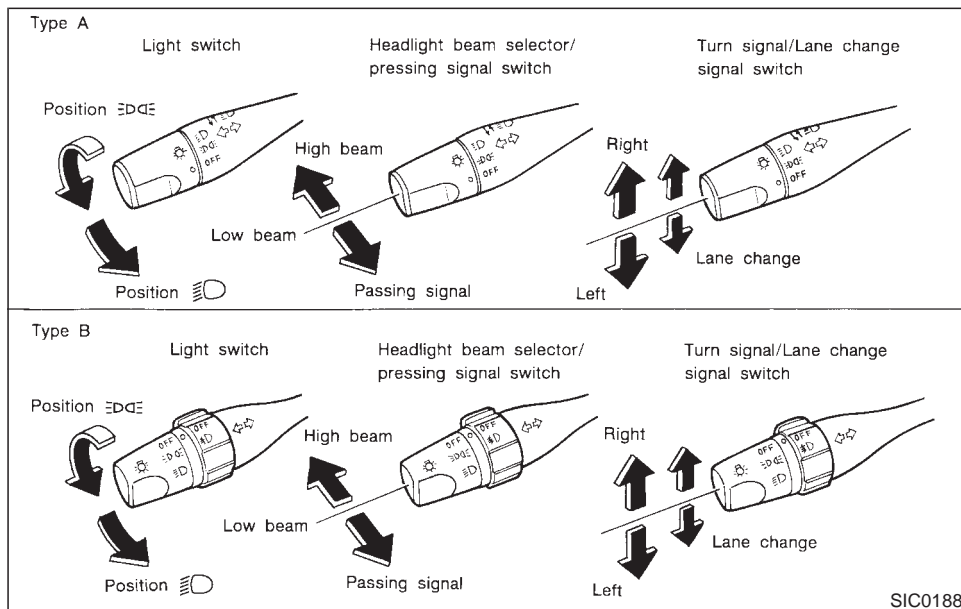

SIC0188

## HEADLIGHT SWITCH

### Lighting

Turn the switch to the  position:

The side combination, tail, license plate and

instrument lights will come on.

Turn the switch to the  position: Headlights will come on and all the other lights remain on.

To select the high beam, push the lever forward. Pull it back to select the low beam.

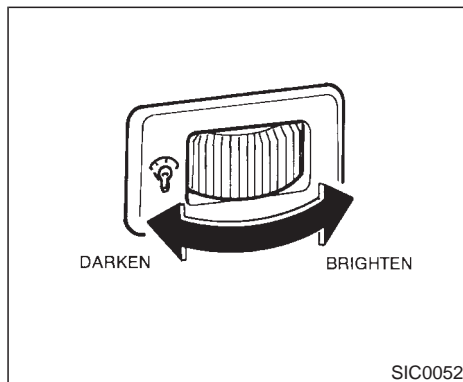

### Instrument brightness control

The instrument brightness control operates when the light switch is in the  $\text{D}$  or  $\text{D}$  position.

Turn the control to adjust the brightness of instrument panel lights and power window switch lights.

When the control is turned to the right until a click sound is heard, the light intensity will be at maximum. When the control is turned to the left until a click sound is heard, the light will be turned off.

### Passing signal

Pulling the lever toward you will turn on the passing signal even when the headlight switch is off.

### TURN SIGNAL SWITCH

#### Turn signal

Move the lever up or down to signal to the turning direction. When the turn is completed, the turn signals cancel automatically.

#### Lane change signal

To indicate a lane change, move the lever up or down to the point where lights begin flashing.

### Daytime running light system (For Canada)

The headlights automatically illuminate at a reduced intensity when the engine is started with the parking brake released. The daytime running lights operate with the headlight switch in the off position or in the  $\text{D}$  position. Turn the headlight switch to the  $\text{D}$  position for full illumination when driving at night.

If the parking brake is applied before the engine is started, the daytime running lights do not illuminate.



The daytime running lights illuminate once the parking brake is released. The daytime running lights will remain on until the ignition switch is turned off.

## WARNING

**When the daytime running light system is active, tail lights on your vehicle are not on. It is necessary at dusk to turn on your headlights. Failure to do so could cause an accident injuring yourself and others.**

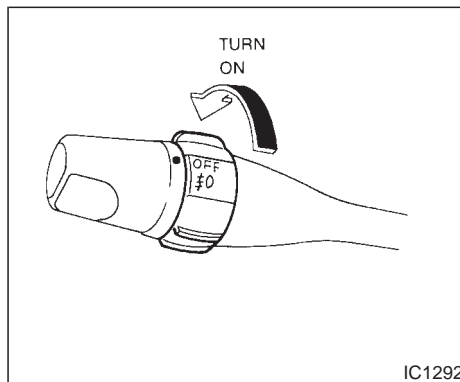
## FRONT FOG LIGHT SWITCH



To turn the fog lights on, turn the headlight switch to the  position, then turn the switch to the  position. To turn them off, turn the switch to the OFF position.

The headlights must be on for the fog lights to operate.

## HAZARD WARNING FLASHER SWITCH

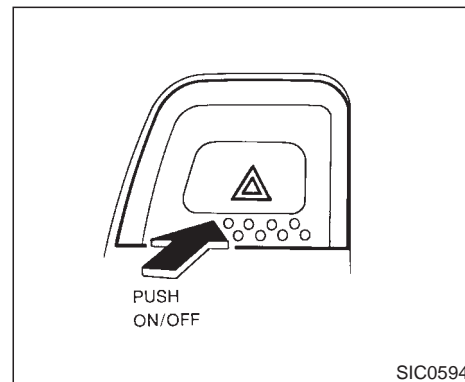

Push the switch on to warn other drivers when you must stop or park under emergency conditions. All turn signal lights will flash.

**Some state laws may prohibit the use of the hazard warning flasher switch while driving.**

## WARNING

- **When stalled or stopped on the roadway under emergency conditions, move the vehicle well off the road.**



## HORN

- Do not use the switch while moving on the highway unless unusual circumstances force you to drive so slowly that your vehicle might become a hazard to other traffic.
- Turn signals do not work when the switch is operating.

The flasher can be actuated with the ignition switch either off or on.

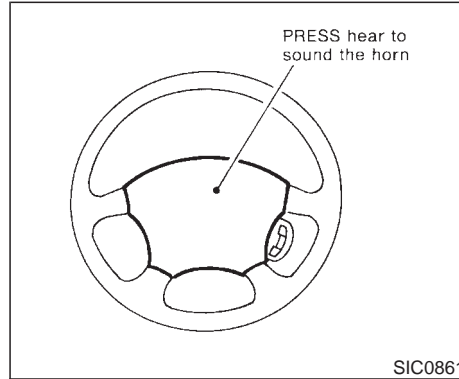

To sound the horn, push the center pad area of the steering wheel.

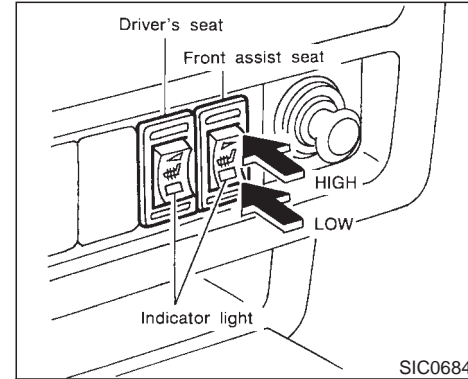

## HEATED SEATS (if so equipped)



The front seat(s) are warmed by built-in heaters. The switches located on the instrument panel can be operated independently of each other.

1. Start the engine.

**The battery could run down if the heater is operated while the engine is not running.**

2. Push the  (Low) or  (High) position of the switch, as desired, depending on the temperature. The indicator light in the switch will illuminate.

The heater is controlled by a thermostat, automatically turning the heater on and off.

The indicator light will remain on as long as the switch is on.

- When the vehicle's interior is warmed or before you leave the vehicle, be sure to turn the switch off.

### CAUTION

- Do not use the seat heater for extended periods or when no one is using the seat.
- Do not put anything on the seat which insulates heat, such as a blanket, cushion, seat cover, etc. Otherwise, the seat may become overheated.
- Do not place anything hard or heavy on the seat or pierce it with a pin or similar object. This may result in damage to the heater.
- Any liquid spilled on the heating seat should be removed immediately with a dry cloth.
- When cleaning the seat, never use benzene, thinner, or any similar materials.

- If any abnormalities are found or the heating seat does not operate, turn the switch OFF and have the system checked by your NISSAN dealer.

## POWER SOCKET

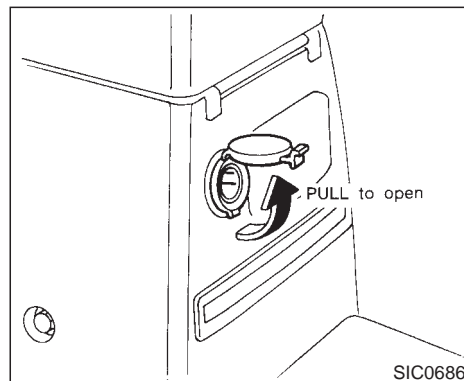

### CAUTION

- Take care as the socket and plug may be hot during or immediately after use.
- This power socket is not designed for use with a cigarette lighter unit.
- Do not use with accessories that exceed a 12 volt, 120W (10A) power draw. Do not use double adapters or more than one electrical accessory.

## CIGARETTE LIGHTER AND ASHTRAYS

- Use this power socket with the engine running. (If the engine is stopped, this could result in a discharged battery.)
- Avoid using when the air conditioner, headlights or rear window defogger is on.
- Before inserting or disconnecting a plug, be sure to turn off the power switch of electrical accessory being used or the ACC power of the vehicle.
- Push the plug in as far as it will go. If good contact is not made, the plug may overheat or the internal temperature fuse may blow.
- When not in use, be sure to close the cap. Do not allow water to contact the socket.

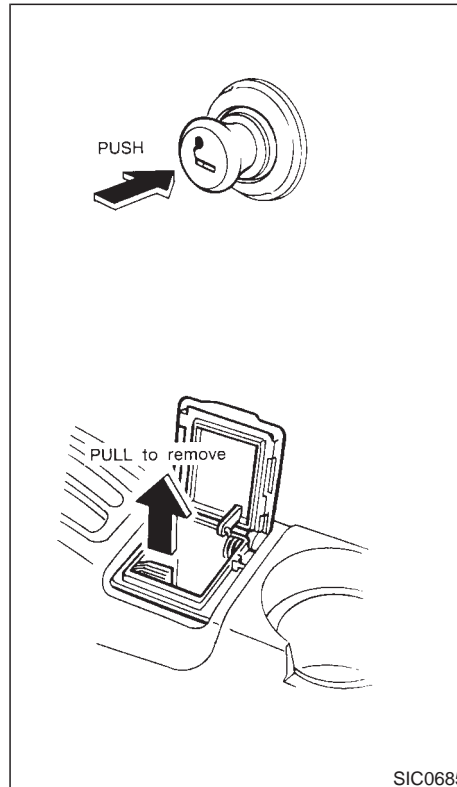

The cigarette lighter operates when the ignition switch is in ACC or ON.

Push the lighter in all the way. When the lighter is heated, it will spring out.

Replace the lighter in its original position after use.

### WARNING

The cigarette lighter should not be used while driving in order that full attention may be given to the driving operation.

### CAUTION

The cigarette lighter socket is a power source for the cigarette lighter element only. The use of the cigarette lighter socket as a power source for any other accessory is not recommended.

SIC0685

## STORAGE

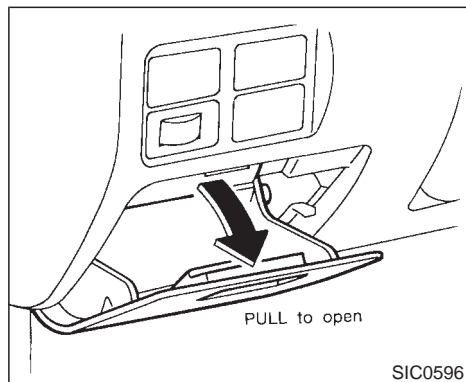

## TRAY

### WARNING

The coin tray should not be used while driving in order that full attention may be given to the driving operation.

Do not place valuable items in the tray.

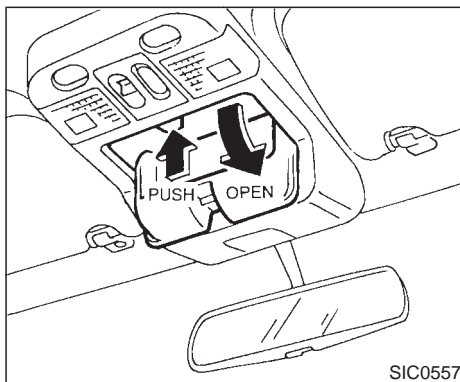

## GLASSES CASE

The glasses case can be opened by pushing the button.

### WARNING

The glasses case should not be used while driving in order that full attention may be given to the driving operation.

### CAUTION

- Do not use for anything other than glasses.
- Do not leave glasses in the glasses case while parking in direct sunlight. The heat may damage the glasses.

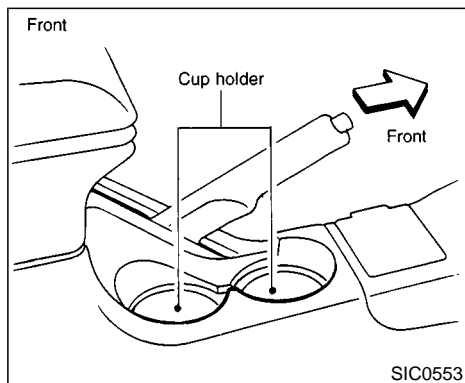

## CUP HOLDERS

### WARNING

The cup holders should not be used while driving in order that full attention may be given to the driving operation.

### CAUTION

- Avoid abrupt starting and braking when the cup holder is being used to prevent spilling the drink. If the liquid

is hot, it can scald you or your passenger.

- Use only soft cups in the cup holder. Hard objects can injure you in an accident.

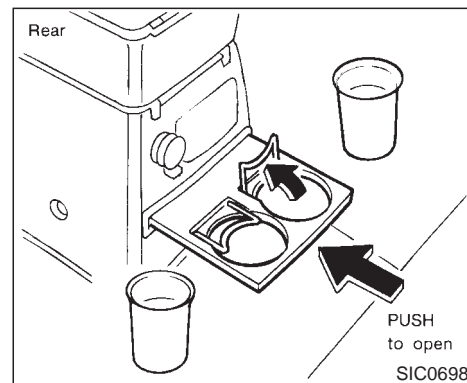

To open, push the cup holder.

To close, fully push the cup holder.

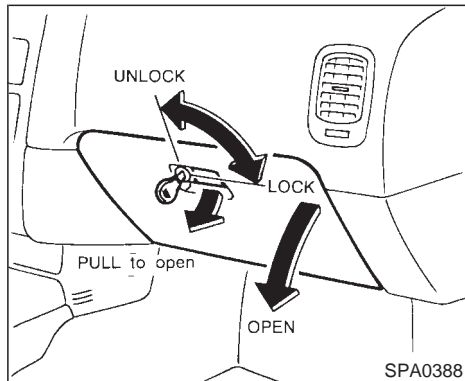

## GLOVE BOX

When locking or unlocking the glove box, use the master key.

The glove box may be opened by the handle.

### CAUTION

Keep glove box lid closed while driving to help prevent injury in an accident or during a sudden stop.

## CONSOLE BOX

### WARNING

- The center console box should not be used while driving in order that full attention may be given to the driving operation.
- Keep the center console box lid closed while driving to prevent injury in an accident or a sudden stop.

Do not place valuable items in the center console box.

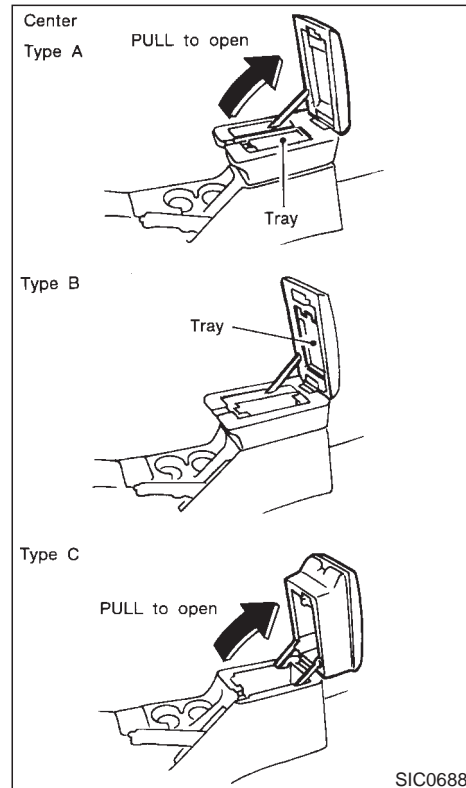

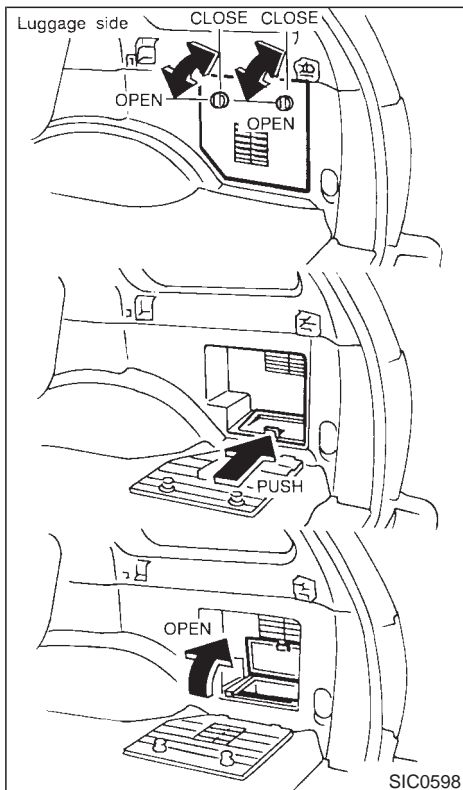

## LUGGAGE STORAGE

### **⚠ WARNING**

Keep luggage side console box lids closed securely while driving to prevent injury in an accident or sudden stop.

Do not place valuable items in the luggage side console box.

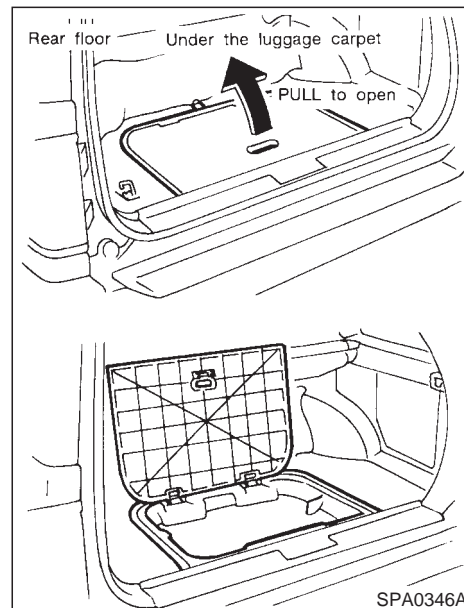

### **⚠ CAUTION**

- Make sure the luggage board closes securely.
- Do not drive with the board removed.

- Properly secure all cargo to help prevent it from sliding or shifting. Do not place cargo higher than the seat-backs. In a sudden stop or collision, unsecured cargo could cause personal injury.
- Never allow anyone to ride in the luggage area or on the rear seat when it is in the fold-down position.
- It is extremely dangerous to ride in a cargo area inside of a vehicle. In a collision, people riding in these areas are more likely to be seriously injured or killed.
- Do not allow people to ride in any area of your vehicle that is not equipped with seats and seat belts.

## LUGGAGE HOOKS

The luggage hooks can be used to secure cargo with ropes or other types of straps.

## WARNING

- Properly secure all cargo to help prevent it from sliding or shifting. Do not place cargo higher than the seat-backs. In a sudden stop or collision, unsecured cargo could cause personal injury.
- Use the suitable ropes and hooks to secure cargo.
- Never allow anyone to ride in the luggage area. It is extremely dangerous to ride in a cargo area inside of a vehicle. In a collision, people riding in these areas are more likely to be seriously injured or killed.
- Do not allow people to ride in any area of your vehicle that is not equipped with seats and seat belts.
- Be sure everyone in your vehicle is in a seat and using a seat belt properly.

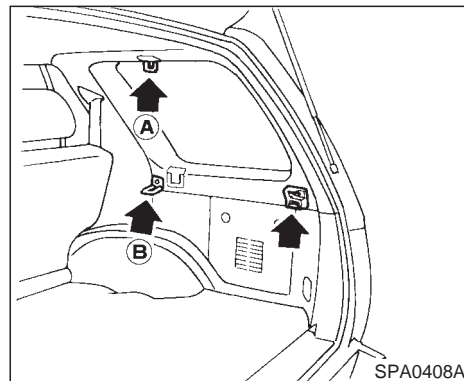

## Side finisher

- When hooking on ropes, do not apply a load of more than 22 lb (98 N) to a single hook.
- Do not use the luggage net between the A and B hooks.



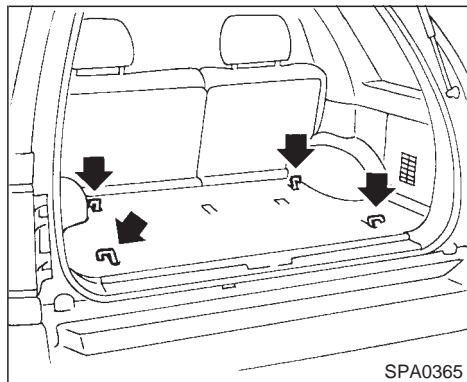

Floor

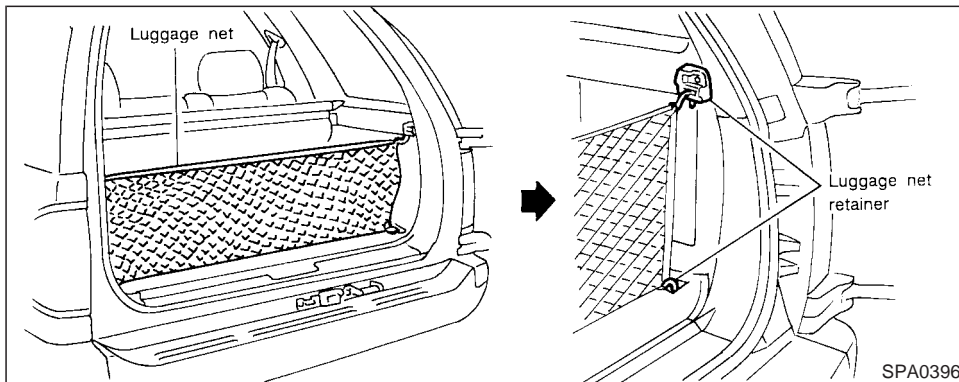

### LUGGAGE NET (if so equipped)

The luggage net keeps packages in the cargo area from moving around while your vehicle is driven.

To install the luggage net, attach the four hooks to the four retainers.

To remove the luggage net, detach the four hooks from the luggage net retainers.

### WARNING

- **Properly secure all cargo to help prevent it from sliding or shifting. Do not place cargo higher than the seat-backs. In a sudden stop or collision, unsecured cargo could cause personal injury.**
- **Be sure to secure all four hooks into the retainers. The cargo restrained in the net must not exceed 30 lbs. (13.6 kg) or the net may not stay secured.**

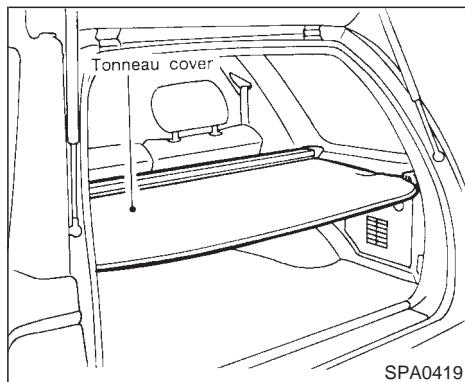

- **Properly secure all cargo to help prevent it from sliding or shifting. Do not place cargo higher than the seat-backs. In a sudden stop or collision, unsecured cargo could cause personal injury.**

## TONNEAU COVER

The tonneau cover keeps the luggage compartment contents hidden from the outside.

### **WARNING**

- **Never put anything on the tonneau cover, no matter how small. Any object on it could cause an injury in an accident or sudden stop.**
- **Do not leave the tonneau cover in the vehicle with it disengaged from the holder.**

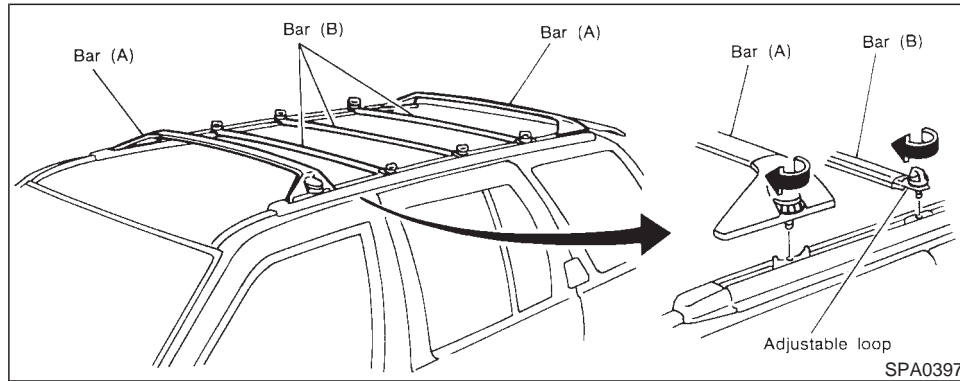

## LUGGAGE RACK (if so equipped)

The cross-bars can be adjusted forward and backward. Place your luggage between the bars (A), adjust the bars (A), and secure the luggage with rope to the bars (A). There are also adjustable loops on the side bars for the rope attachment.

Always evenly distribute the luggage on the luggage rack. **Do not load more than 100 lb (45 kg)**. Be careful that your vehicle does not exceed the Gross Vehicle Weight Rating (GVWR) or its Gross Axle Weight Rating (GAWR front and rear). The GVWR and GAWR are located on the Safety Compliance

2-30 Instruments and controls

Certification Label (located on the driver's door pillar). For more information regarding GVWR and GAWR, refer to "10. Technical and customer information".

### CAUTION

Use care when placing or removing items from the luggage rack. If you cannot comfortably lift the items onto the luggage rack from the ground, use a ladder or stool.

## WINDOWS

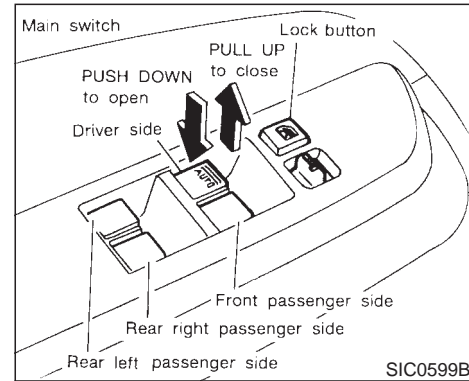

## POWER WINDOWS

### WARNING

- Make sure that all passengers have their hands, etc. inside the vehicle before closing the windows. Use the window lock switch to prevent unexpected use of the power windows.
- Do not leave children unattended inside the vehicle. They could unknowingly activate switches or controls and become trapped in a window.

**Unattended children could become involved in serious accidents.**

The power window only operates when the ignition key is in the ON position.

To open or close the window, push down or pull up the switch and hold it. The main switch (driver side switches) will open or close all the windows.

**Locking passenger's window**

When the lock button is pushed in, only the driver side window can be opened or closed. Push it in again to cancel.

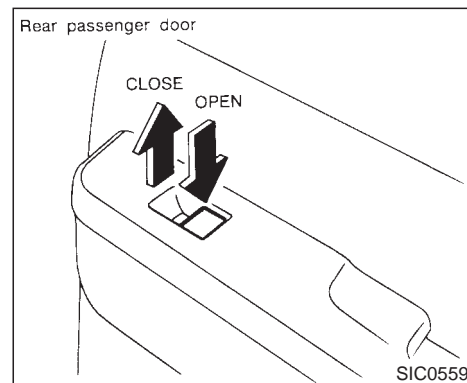
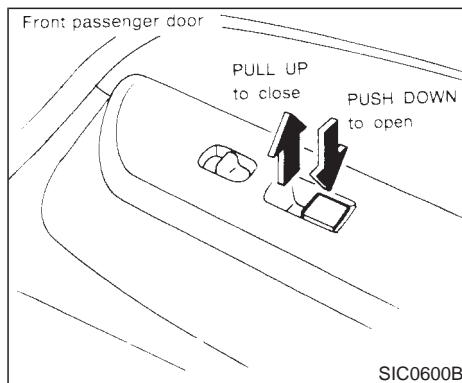

The passenger side switch will open or close only the corresponding window. To open or close the window, hold the switch down or up.

## SUNROOF (if so equipped)

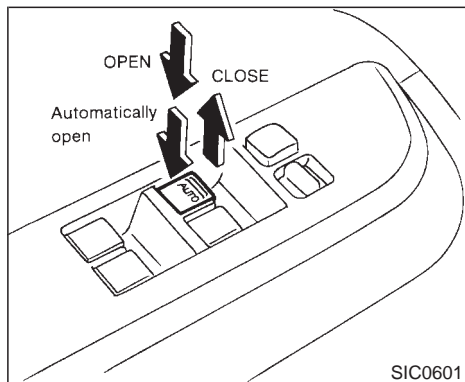

### Automatic operation

To fully open the driver side window, completely push down the switch and release it; it need not be held. The window will automatically open all the way. To stop the window, just pull up the switch toward the close side.

A light press on the switch will cause the window to open until the switch is released.

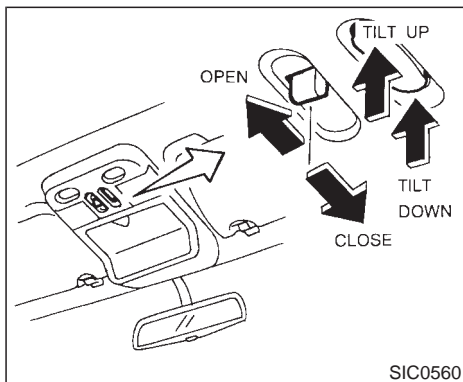

### AUTOMATIC SUNROOF

The sunroof will only operate when the ignition key is in the ON position.

### Sliding the sunroof

To open the roof, keep pressing the switch to the ☁ side.

To close the roof, keep pressing the switch to the ☁ side.

### Tilting the sunroof

To tilt up, first close the sunroof, then keep pushing the ☁ side of the tilt switch.

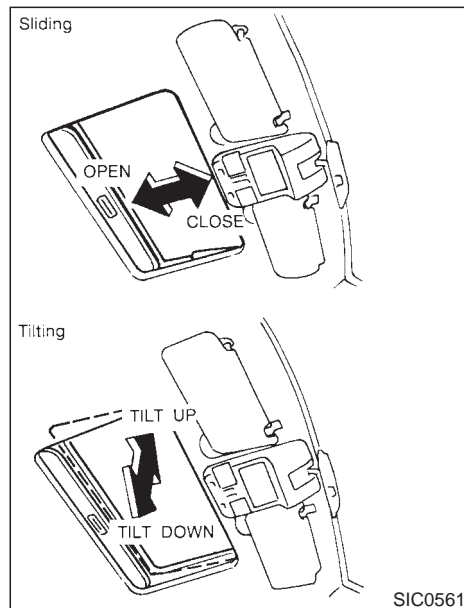

To tilt down the sunroof, keep pushing the ☁ side.

### Sun shade

Open/close the sun shade by sliding it backward/forward.

The shade will open automatically when the sunroof is opened. However, it must be closed manually.

### WARNING

- In an accident you could be thrown from the vehicle through an open sunroof. Always use seat belts and child restraints.
- Do not allow anyone to stand up or extend any portion of their body out of the opening while the vehicle is in motion or while the sunroof is closing.

### CAUTION

- Remove water drops, snow, ice or sand from the sunroof before opening.
- Do not place any heavy object on the sunroof or surrounding area.

### If the sunroof does not close

Have your NISSAN dealer check and repair the sunroof.

## CLOCK

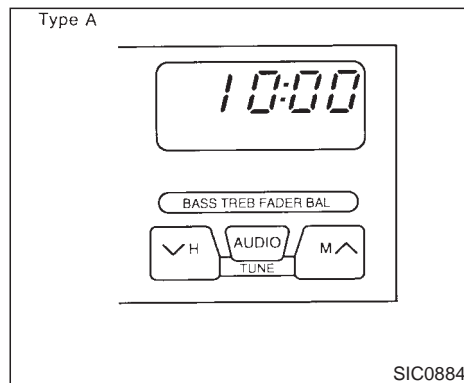

The digital clock displays time when the ignition key is in ACC or ON.

**If the power supply is disconnected, the clock will not indicate the correct time. Readjust the time.**

### ADJUSTING THE TIME

Depressing the CLOCK and the  $\checkmark$ <sub>H</sub> or  $\checkmark$  buttons together will set hours. Depressing the CLOCK and  $\wedge$ <sub>M</sub> or  $\wedge$  buttons together will set minutes.

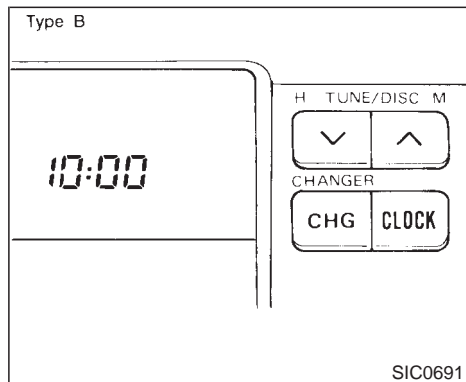

## CLOCK OPERATION

By pressing the CLOCK button, you can alternate the clock and the radio/cassette tape options in the display.

## CLOCK PRIORITY MODE

In this mode the clock will be shown in the display. If any radio or cassette tape functions are activated, the radio, cassette or CD display will illuminate for ten seconds then return to the clock mode.

**After clock adjustment, the radio is in the clock priority mode.**

## INTERIOR LIGHT

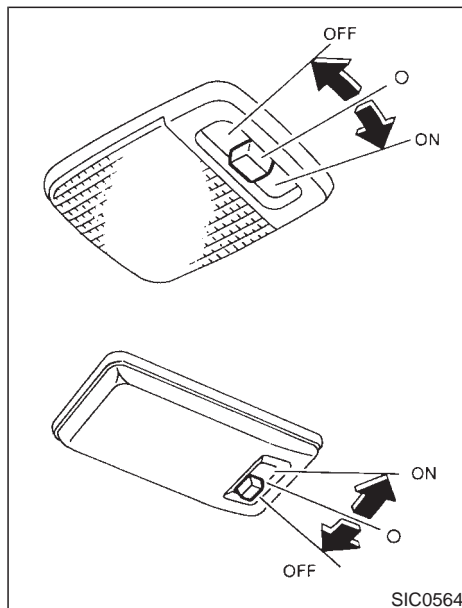

The interior light has a three position switch. The interior light will operate regardless of ignition key position.

- When the switch is in the OFF position, the

interior light will not illuminate, regardless of door position.

- When the switch is in the center O position, the light will illuminate when a door is opened.
- When the switch is in the ON position, the interior light will illuminate, whether any door is open or closed.

## CAUTION

**Leaving the interior light switch in the ON position for extended periods of time will result in a discharged battery.**

## PERSONAL LIGHT

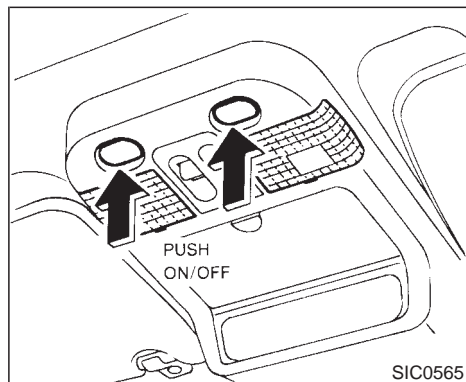

### CAUTION

Do not use for extended periods of time with the engine stopped. This could result in a discharged battery.

## VANITY MIRROR LIGHT

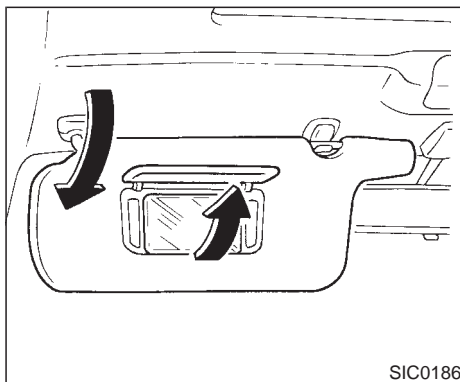

The light on the vanity mirror will turn on when the cover on the vanity mirror is opened.

## INTEGRATED HomeLink<sup>®</sup> TRANSMITTER (if so equipped)

The Integrated HomeLink<sup>®</sup> Transmitter provides a convenient way to consolidate the functions of up to three individual hand-held transmitters into one built-in device.

- The Integrated HomeLink<sup>®</sup> Transmitter will operate garage doors, gates, home/office lighting systems and security systems by storing and transmitting the programming information of your current hand-held transmitters.
- The Integrated HomeLink<sup>®</sup> Transmitter is built-in and powered by your vehicle's battery and charging system. No separate batteries are necessary.

### WARNING

Do not use this Integrated HomeLink<sup>®</sup> Transmitter with any garage door opener that lacks safety stop and reverse features as required by federal safety standards (these standards became effective for models manufactured after April 1, 1982). A garage door opener which cannot detect an object in the path of a closing garage door and then automatically stop and reverse the door, does not meet current federal safety standards. Using a garage door



opener without these features increases the risk of serious injury or death.

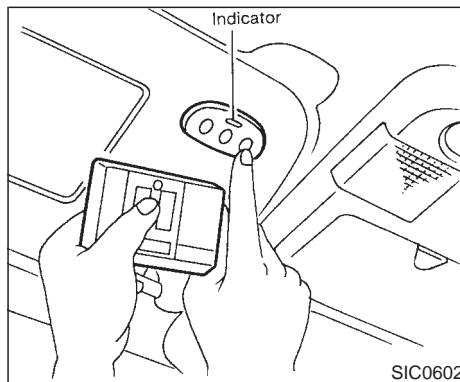

## PROGRAMMING THE HomeLink® TRANSMITTER

### **WARNING**

**During the programming procedure your garage door or security gate will open and close (if the transmitter is within range). Make sure that people or objects are clear of the garage door, gate, etc. that you are programming.**

**Your vehicle's engine should be turned off while programming your transmitter.**

**The Integrated HomeLink® Transmitter may not work with older garage door openers that do not meet current Federal Consumer Safety Standards.**

1. Test the Integrated HomeLink® Transmitter by pressing any button. The red indicator light should come on. If you have previously programmed a button proceed to step 3.
2. Clear all channels on the Integrated HomeLink® Transmitter by holding down both outside buttons (#1 & #3) until the red light begins to flash rapidly (approximately 20 seconds). Then release both buttons.
3. Select which of the three Integrated HomeLink® Transmitter buttons you want to program.
4. Hold your hand-held transmitter against the bottom surface of the Integrated HomeLink® Transmitter so that you can still see the red indicator light.
5. Press the desired button until the red indicator light flashes slowly. Do not release the button. Continue holding and press the hand-held transmitter button through step 6.

6. Hold down both buttons until the red indicator light on the Integrated HomeLink<sup>®</sup> Transmitter flashes rapidly (This may take 1 to 90 seconds). Then release both buttons. The rapid flashing means that the transmitter has been successfully programmed to match your hand-held transmitter. You can now use the Integrated HomeLink<sup>®</sup> Transmitter instead of your hand-held transmitter.

**Note to Canadian users:**

Prior to 1992, D.O.C. regulations required many hand-held transmitters to stop transmitting after one or two seconds, even though you continue to hold down the button. If you think you have one of these hand-held transmitters, you should press and re-press the transmitter button every 2 seconds without ever releasing the integrated HomeLink<sup>®</sup> Transmitter button. The indicator light on the Integrated HomeLink<sup>®</sup> Transmitter should blink rapidly indicating a successful programming procedure. If it returns to the slow blink of program mode, continue to periodically reactivate your hand-held transmitter until a successful programming procedure is indicated by the rapidly flashing indicator light.

## OPERATING THE TRANSMITTER

To operate, simply press the appropriate button on the Integrated HomeLink<sup>®</sup> Transmitter. The red indicator light illuminates while the signal is being transmitted. The effective transmission range of the Integrated HomeLink<sup>®</sup> Transmitter may differ from your hand-held transmitter.

## PROGRAMMING PROBLEM DIAGNOSIS

Be sure to keep your original hand-held transmitter for possible reprogramming if necessary.

- Make sure batteries in the hand-held transmitter are fully charged.
- Hold your hand-held transmitter against the bottom surface of the Integrated HomeLink<sup>®</sup> Transmitter so that you can still see the red indicator light.
- Hold buttons for duration of the programming without interruption.

- Rotate your hand-held transmitter end-over-end and program again. For best results, place the end opposite the battery compartment against the Integrated HomeLink<sup>®</sup> Transmitter when programming.

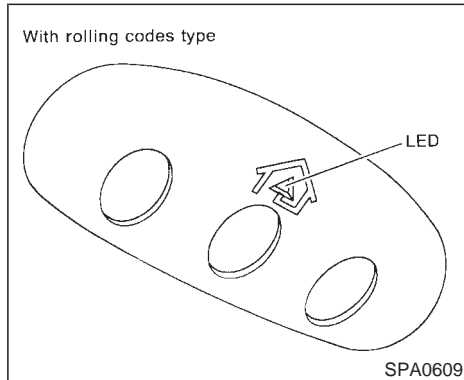

## ROLLING CODES (if so equipped)

If your hand held transmitter appears to train to the HomeLink<sup>®</sup> Transmitter, but does not open your garage door, and your garage door opener was manufactured after 1995, your garage door opener may have a Code Protected or Rolling Code feature. This type of system will change the code of your garage door opener every time you open or close your garage door.

To determine if you have one of these systems, depress the button on the HomeLink<sup>®</sup> Transmitter that you have just programmed. If the LED on the HomeLink<sup>®</sup> Transmitter

flashes rapidly for 1 to 2 seconds, then remains on, your garage door opener has a rolling code system.

To operate your Rolling Code garage door opener from your HomeLink<sup>®</sup> Transmitter, follow these steps:

1. Program your hand held transmitter to the HomeLink<sup>®</sup> Transmitter by following the procedures outlined above (if not yet programmed).
2. Program your garage door opener receiver to recognize your HomeLink<sup>®</sup> Transmitter (The HomeLink<sup>®</sup> Transmitter follows the same procedure to train to the receiver as your hand held transmitter did when it was first installed):
  - a) Remove the cover panel from your garage door opener receiver. The receiver should be located by the garage door opener motor.
  - b) Locate the training button on the garage door opener receiver. The exact location and color of the button may vary by garage door opener brand. If you have difficulty locating the training button, reference your garage door opener manual. If you have difficulty programming your garage door opener equipped

with a rolling code system to recognize the HomeLink<sup>®</sup> Transmitter with the Rolling Code feature, call NISSAN Consumer Affairs Department.

- c) Press the training button on the garage door opener receiver for 1 to 2 seconds.
- d) Return to the HomeLink<sup>®</sup> Transmitter in the vehicle, and depress the programmed HomeLink<sup>®</sup> button for the duration of the fast blink on the HomeLink<sup>®</sup> Transmitter (1 to 2 seconds). Release the button, and re-press to confirm that the system has trained.
- e) Your garage door opener should now recognize your HomeLink<sup>®</sup> Transmitter. You may use either your HomeLink<sup>®</sup> Transmitter or your original hand held transmitter to open your garage door.

## CLEARING THE PROGRAMMING INFORMATION

Should you sell your vehicle, be sure to clear the channels of the Integrated HomeLink<sup>®</sup> Transmitter. To clear the channels, simultaneously hold down the outside two buttons (#1 & #3) until the red indicator light begins to flash rapidly (approximately 20 seconds). This will clear all three buttons. Individual buttons cannot be cleared, but can be reprogrammed at

any time by following the programming procedures described above.

## **IF YOUR VEHICLE IS EVER STOLEN**

If your vehicle has been stolen, you should change the codes of any device that was programmed into the Integrated HomeLink<sup>®</sup> Transmitter as soon as possible. Consult the owners manual of each device, or call the manufacturer or dealer of those devices.

**When your vehicle is recovered, you will have to reprogram the Integrated HomeLink<sup>®</sup> Transmitter with your new transmitter information.**

### **FCC Notice:**

**This device complies with FCC rules part 15. Operation is subject to the following two conditions: (1) This device may not cause harmful interference and (2) This device must accept any interference that may be received, including interference that may cause undesired operation.**

**The transmitter has been tested and complies with FCC and DOC/MDC rules. Changes or modifications not expressly approved by the party responsible for com-**

**pliance could void the user's authority to operate the device.**

**DOC: ISTD 1763K1313**

**FCC I.D.: CB2V67690**

**MEMO**

# 3 Pre-driving checks and adjustments

Keys .....	3-2
Doors.....	3-2
Multi-remote control system (if so equipped).....	3-4
Hood.....	3-8
Back door .....	3-9
Spare tire carrier .....	3-9
Rear window .....	3-10
Fuel filler lid.....	3-11
steering wheel .....	3-13
Sun visors .....	3-13
Mirrors .....	3-14

## KEYS

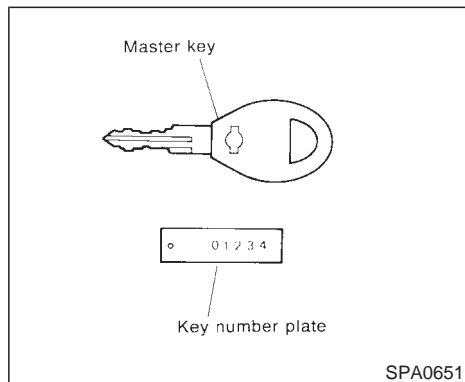

The key can only be inserted fully in the ignition key cylinder. For the door, back door and glove box key cylinders, it is normal for the key not to go into the key cylinder all the way. Record the key number on the key number plate and keep it in a safe place (such as your wallet), **NOT IN THE CAR**. A key number plate is supplied with your key. Keep the plate in a safe place. NISSAN does not record key numbers so it is very important to keep track of your key number plate. A key number is only necessary when you have lost all keys and do not have one to duplicate from. If you still have a key, this key can be duplicated by your NISSAN dealer or a lock smith shop.

## DOORS

### **WARNING**

- **Always have the doors locked while driving. Along with the use of seat belts, this provides greater safety in the event of an accident by helping to prevent persons from being thrown from the vehicle. This also helps keep children and others from unintentionally opening the doors, and will help keep out intruders.**
- **Before opening any door, always look for and avoid oncoming traffic.**
- **Do not leave children unattended inside the vehicle. They could unknowingly activate switches or controls. Unattended children could become involved in serious accidents.**

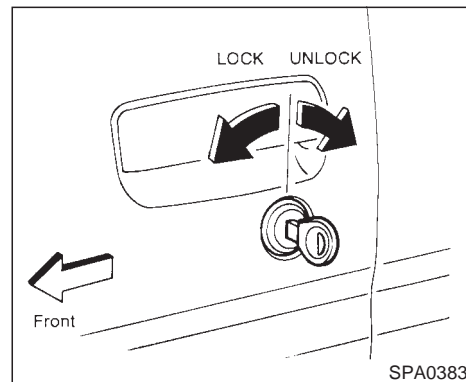

### LOCKING WITH KEY

To lock the door, turn the key towards the front of the vehicle. To unlock, turn it towards the rear.

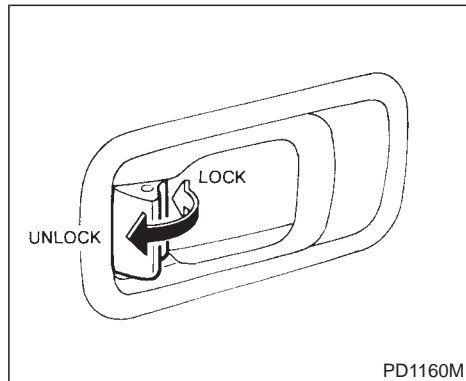

### LOCKING WITH INSIDE LOCK KNOB

To lock from the outside without a key, move the inside lock knob to the lock position. Then close the door.

When locking the door this way, be certain not to leave the key inside the vehicle.

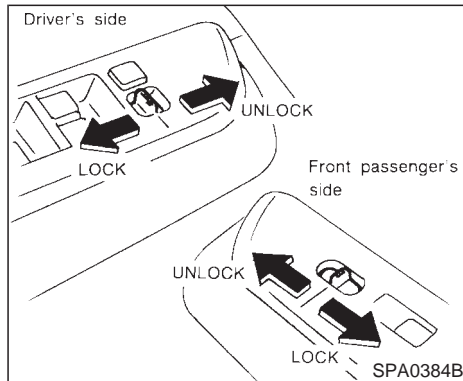

### LOCKING WITH POWER DOOR LOCK SWITCH

The power door lock system allows you to lock or unlock all doors simultaneously.

Operating the lock-unlock switch will lock or unlock all doors including the back door.

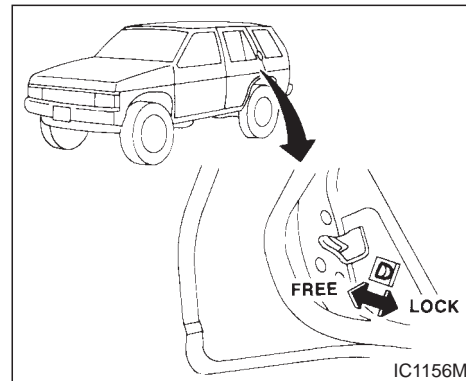

### CHILD SAFETY REAR DOOR LOCK

Child safety locking helps prevent doors from being opened accidentally, especially when small children are in the vehicle.

**When the lever is in the lock position, the rear door can be opened only from the outside.**



## MULTI-REMOTE CONTROL SYSTEM (if so equipped)

It is possible to lock/unlock all doors including the back door.

**Be sure to remove the key from the vehicle before locking the doors and leaving it.**

The remote controller can operate at a distance of approximately 49 ft (15 m) from the vehicle. (The effective distance depends upon the conditions around the vehicle.)

As many as four remote controllers can be used with one vehicle. For information concerning the purchase and use of additional remote controllers, contact your NISSAN dealer.



### CAUTION

Listed below are conditions or occurrences which will damage the remote controller.

- Do not allow the remote controller to become wet.
- Do not drop the remote controller.
- Do not strike the remote controller sharply against another object.
- Do not place the remote controller for an extended period in an area where temperatures exceed 140°F (60°C).



## HOW TO USE MULTI-REMOTE CONTROL SYSTEM

### Locking doors

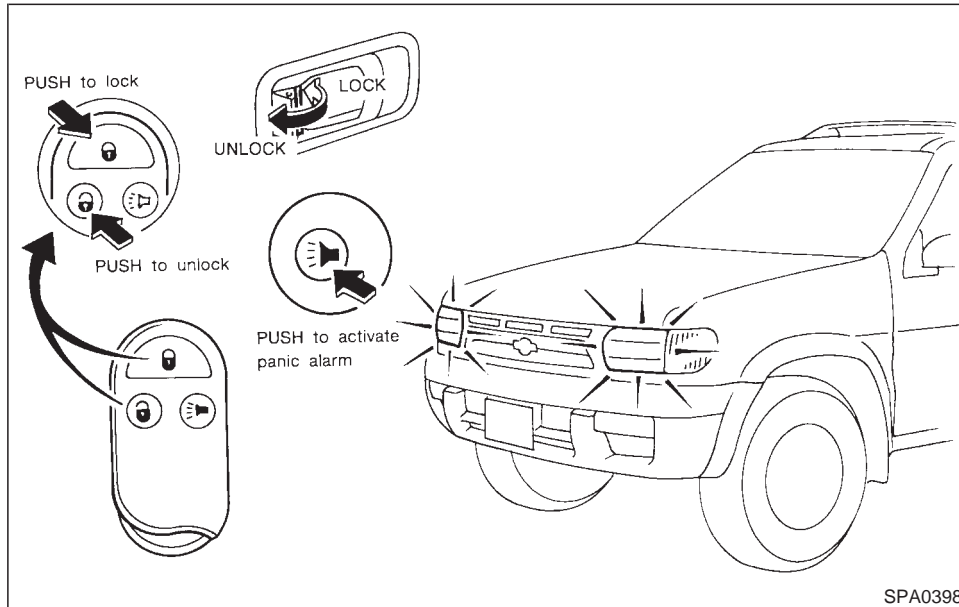
1. Remove the ignition key.
  2. Close all the doors.
  3. Push the  button on the multi-remote controller.
  4. All the doors will lock.
  5. The hazard indicator flashes twice.
- When the  button is pushed with all doors locked, the hazard indicator flashes twice as a reminder that the doors are already locked.



## Unlocking doors

1. Push the  button on the multi-remote controller. Only the driver side door will unlock.
2. Push the  button on the multi-remote





controller again within 5 seconds. All doors will unlock.

3. The interior light will stay on for 30 seconds when the interior light switch is in the center  position.

The interior light can be turned off without waiting for 30 seconds by inserting the key into the ignition or by locking the doors with the multi-remote controller or by pushing the interior light button.

## Using the panic alarm

If you are near your vehicle and feel threatened, you may activate the alarm to call attention as follows:

1. Push the  button on the remote controller for **longer than 1.5 seconds**.
2. The theft warning alarm and headlights will stay on for 30 seconds.
3. The alarm will stop when any of the key functions are used. For example, when the  or the  button is pushed, or the  button is pushed for longer than 1.5 seconds on the multi-remote controller, the panic alarm function will be cancelled.

## The remote controller will not function.

- When the key is inserted into the key switch.
  - When the battery in the remote controller is dead.
  - The distance between the remote controller and the vehicle is too far.
- Pre-driving checks and adjustments 3-5

trolley and vehicle is more than approx. 49 ft (15 m).

- When one of the doors is ajar, only the unlock function can be operated.

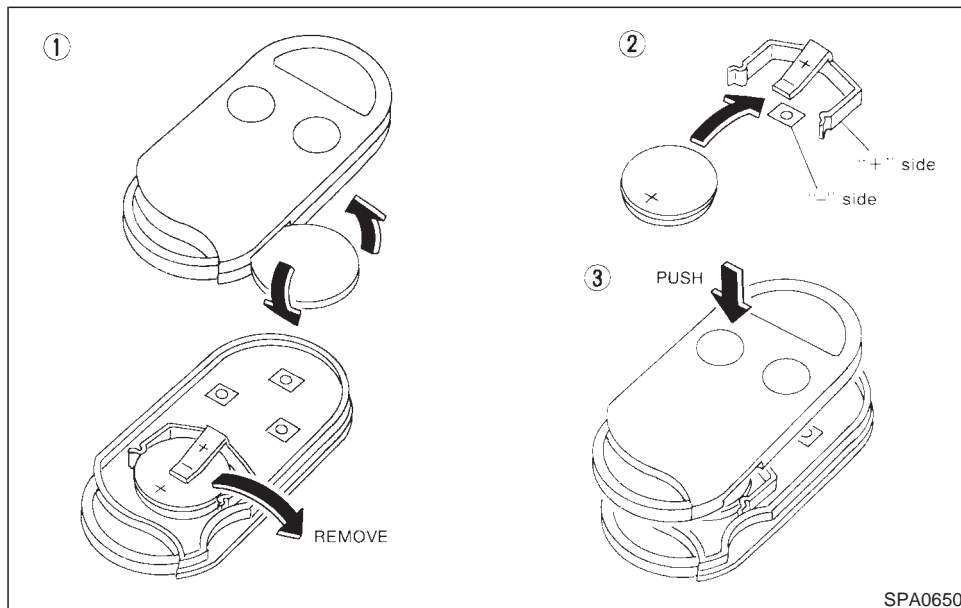

## BATTERY REPLACEMENT



Replace the battery as follows:

1. Open the lid using a coin.
2. Replace the battery with a new one. Insert

the battery as illustrated above.

Recommended battery: Sanyo CR2025 or equivalent.

3. Close the lid securely.

4. Press the  button, then the  button two or three times to check the multi-remote controller operation.

**If the battery is removed for any reason other than replacement, perform step 4 above.**

- An improperly disposed battery can hurt the environment. Always confirm local regulations for battery disposal.
- The multi-remote controller is water-resistant; however, if it does get wet, immediately wipe completely dry.
- When changing battery, do not let dust or oil get on the controller.

**FCC Notice:**

Changes or modifications not expressly approved by the manufacturer compliance could void the user's authority to operate the equipment.

This device complies with Part 15 of the FCC Rules and RSS-210 of Industry Canada. Operation is subject to the following two conditions: (1) This device may not cause harmful interference and (2) this device must accept any interference received, including interference that may cause undesired operation of the device.

## HOOD

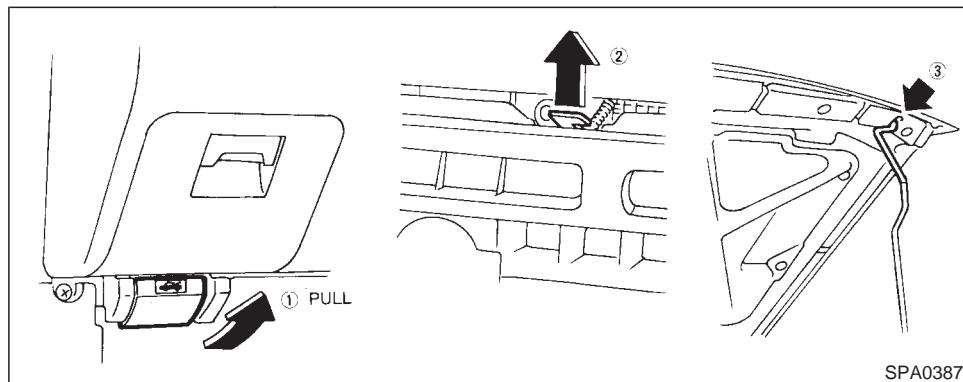

from the engine compartment, to avoid injury do not open the hood.

1. Pull the hood lock release handle located below the instrument panel; the hood will then spring up slightly.
2. Raise the lever at the front of the hood with your fingertips and raise the hood.
3. Insert the assist bar into the slot in the front edge of the hood.
4. When closing the hood, reset the assist bar to its original position, then slowly close the hood and make sure it locks into place.

### **! WARNING**

- **Make sure the hood is completely closed and latched before driving. Failure to do so could cause the hood to fly open and result in an accident.**
- **If you see steam or smoke coming**

## BACK DOOR

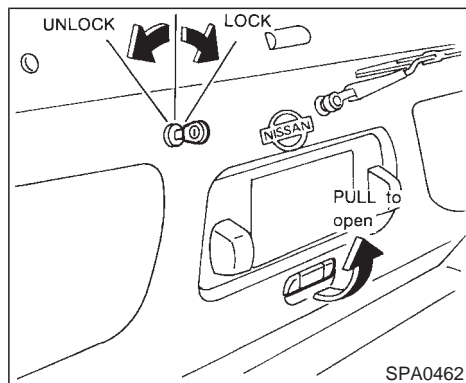

## KEY OPERATION

1. Turn the key counterclockwise to unlock the back door.
2. Pull the opener handle to open the back door.
3. To lock the back door, push it down firmly and turn the key clockwise.

### WARNING

- Always check the back door has been closed securely to prevent it from opening while driving.

- Do not drive with the back door open. This could allow dangerous exhaust gases to be drawn into the vehicle. See "Precautions when starting and driving" in the "5. Starting and driving" section for exhaust gas.

## SPARE TIRE CARRIER

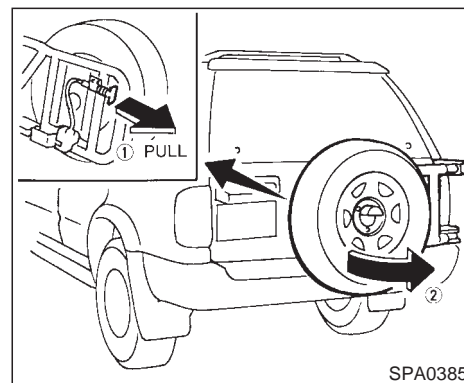

When opening the back door, first open the spare tire carrier in the sequence shown in the illustration above. Then insert the stopper into the hole to secure the carrier in the open position.

### CAUTION

- Be certain that there is adequate area to allow the carrier to open fully.
- Open and close the spare tire carrier slowly.

## REAR WINDOW

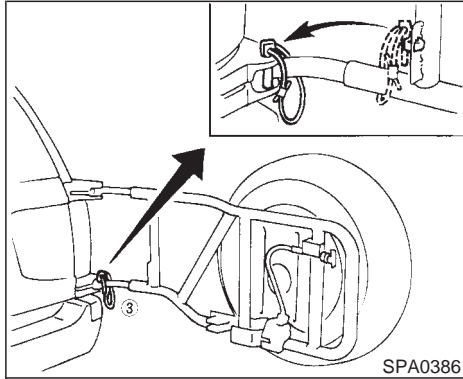

- Before driving, be certain that the spare tire carrier is firmly closed and latched.
- Failure to do so may injure pedestrians or damage the vehicle.

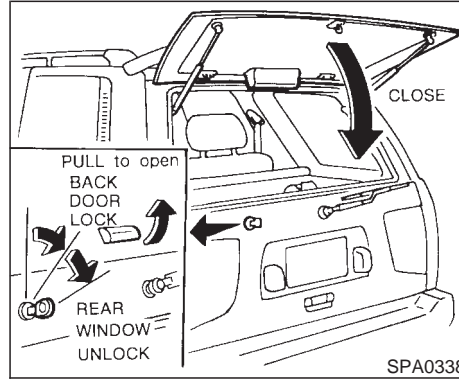

To open the rear window, turn the key fully clockwise and pull the opener handle. To close, lower and push the rear window down securely.

## WARNING

Do not drive with the rear window open. This could allow dangerous exhaust gases to be drawn into the vehicle. See "Precautions when starting and driving" in the "5. Starting and driving" section for exhaust gas.

## CAUTION

Do not open the rear window unless the wiper is in the stowed position.

## FUEL FILLER LID

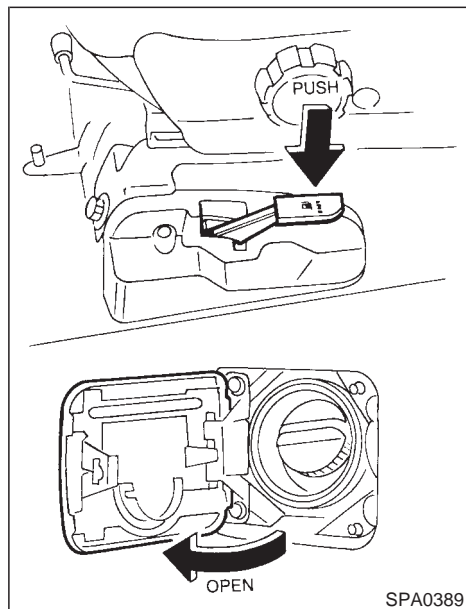

### OPENER OPERATION

#### Opener lever

To open the fuel filler lid, push the opener lever down. To lock, close the fuel filler lid securely.

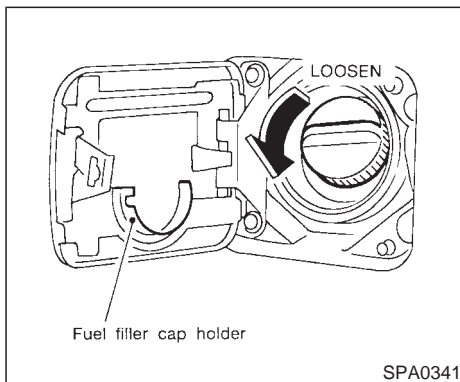

### FUEL FILLER CAP

The fuel filler cap is a screw-on ratcheting type. Tighten the cap clockwise until ratcheting clicks are heard.

#### **⚠ WARNING**

- Gasoline is extremely flammable and highly explosive under certain conditions. You could be burned or seriously injured if it is misused or mishandled. Always stop the engine and do not smoke or allow open flames or

sparks near the vehicle when refueling.

- Fuel may be under pressure. Turn the cap one-half turn, and wait for any hissing sound to stop to prevent fuel from spraying out and possible personal injury. Then remove the cap.
- Do not attempt to top off the fuel tank after the fuel pump nozzle shuts off automatically. Continued refueling may cause fuel over-flow, resulting in fuel spray and possibly a fire.
- Use only a genuine NISSAN fuel filler cap as a replacement. It has a built-in safety valve needed for proper operation of the fuel system and emission control system. An incorrect cap can result in a serious malfunction and possible injury.
- Never pour fuel into the throttle body to attempt to start your vehicle.



## CAUTION

- If fuel is spilled on the vehicle body, flush it away with water to avoid paint damage.
- Tighten until cap clicks, failure to tighten fuel cap properly may cause the SERVICE ENGINE SOON malfunction indicator light (MIL) to illuminate. If this occurs, it will be necessary to take your vehicle in for service by an authorized NISSAN dealer.

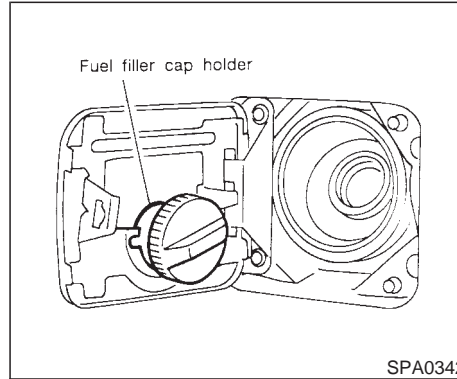

Put the fuel filler cap on the cap holder while refueling.

## STEERING WHEEL

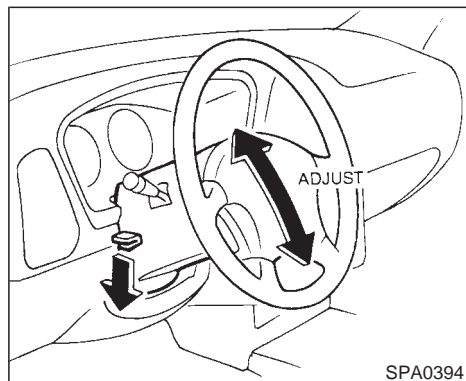

## TILT OPERATION

While pushing down on the lock lever, adjust the steering wheel up or down to the desired position. Push the lock lever up securely to lock the steering wheel in place.

### **WARNING**

**Do not adjust the steering wheel while driving. You could lose control of your vehicle and cause an accident.**

## SUN VISORS

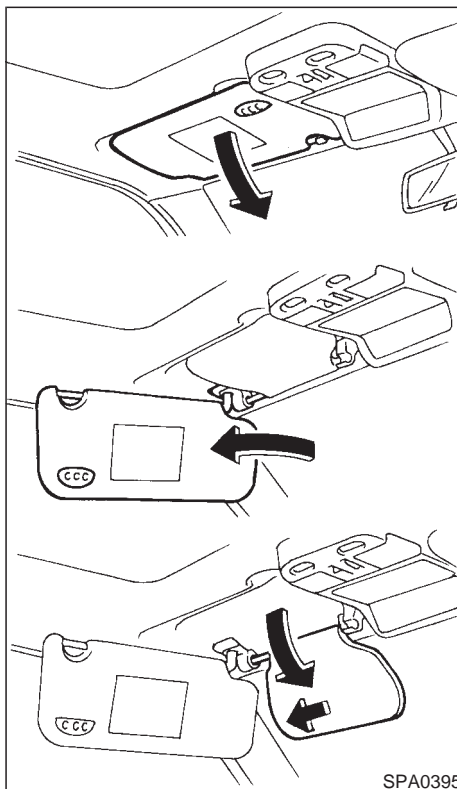

## USING THE SUN VISORS

1. To block out glare from the front, swing down the main sun visor.
2. To block glare from the side, remove the main sun visor from the center mount and swing it to the side.
3. Then, to block glare from the front too, swing down the sub-sun visor.
4. To adjust the glare block position, slide the sub-sun visor to the left.

### **CAUTION**

- Do not store the main sun visor before storing the sub-sun visor.
- Do not pull the sub-sun visor forcedly downwards.

## MIRRORS

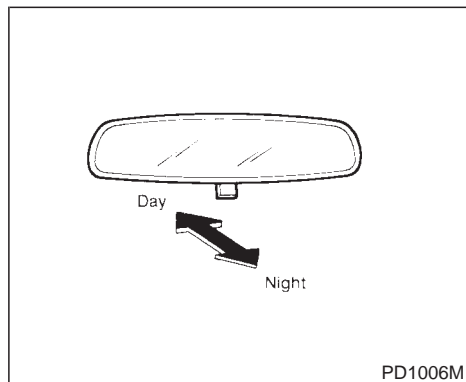

### INSIDE MIRROR

The night position will reduce glare from the headlights of vehicles behind you at night.

#### WARNING

Use the night position only when necessary, because it reduces rear view clarity.

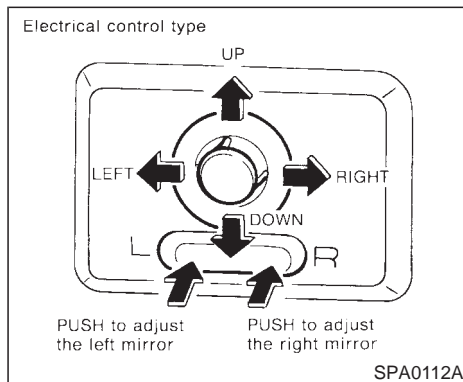

### OUTSIDE MIRRORS

Push the right or left end of the switch to adjust the right or left side mirror, then control the lever.

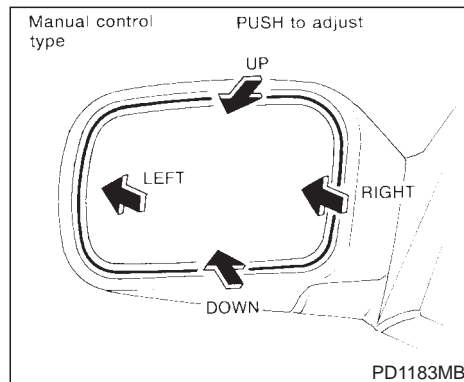

#### WARNING

Objects viewed in the outside mirror on the passenger side are closer than they appear. Be careful when moving to the right. Using only this mirror could cause an accident. Use inside mirror or glance over your shoulder to properly judge distances to other objects.

The outside mirror can be moved in any direction for a better rear view.

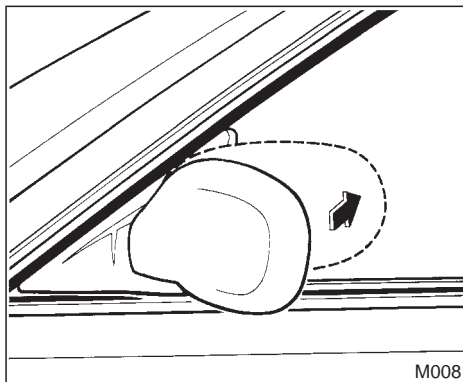

### FOLDING OUTSIDE MIRROR

Push the mirror backward to fold it.

**MEMO**

# 4 Heater, air conditioner and audio systems

Ventilators .....	4-2
Heater and air conditioner (Manual) .....	4-3
Heater and air conditioner (Semiautomatic) .....	4-9
Servicing air conditioner.....	4-13
Audio system.....	4-14
CB radio or car phone .....	4-26



## VENTILATORS

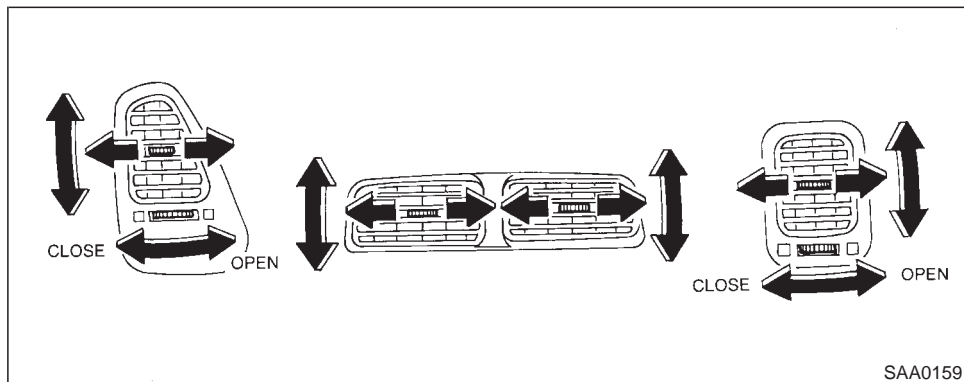

Open or close, and adjust the air flow direction of ventilators.

☒ : This symbol indicates that the vents are closed when the vent switch is moved to the left.

≡ : This symbol indicates that the vents are open when the vent switch is moved to the right.

## HEATER AND AIR CONDITIONER (Manual)

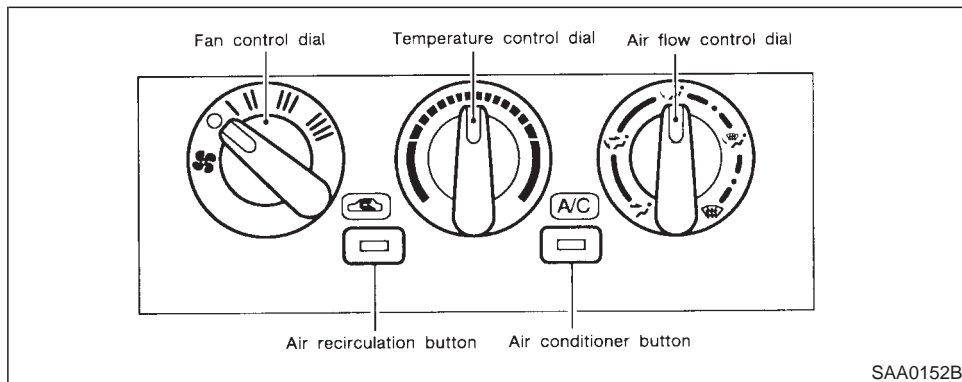

### WARNING

- The air conditioner cooling function operates only when the engine is running.
- Do not leave children, unreliable adults, or pets alone in your vehicle. On hot, sunny days, temperatures in a closed vehicle could quickly become high enough to cause severe or possibly fatal injuries to people or animals.

- Do not use the recirculation mode for long periods as it may cause the interior air to become stale and the windows to fog up.
- Positioning of the heating or air conditioning controls should not be done while driving, in order that full attention may be given to the driving operation.





## CONTROLS

### Fan control dial

This dial turns the fan on and off, and controls fan speed.

### Air flow control dial

This dial allows you to select the air flow outlets.

-  — Air flows from center and side ventillators.
-  — Air flows from center and side ventillators and foot outlets.
-  — Air flows mainly from foot outlets.
-  — Air flows from defroster outlets and foot outlets.
-  — Air flows mainly from defroster outlets.

### Temperature control dial

This dial allows you to adjust the temperature of the outlet air.



## Air recirculation button

### Off position

Outside air is drawn into the passenger compartment.

Use the off position for normal heater, or air conditioner operation.

### On position (Indicator light on)

Interior air is recirculated inside the vehicle.

Push the air recirculation button to the on position when driving on a dusty road or to avoid traffic fumes.

## Air conditioner button

This button is provided only for vehicles with air conditioner.

Start the engine, move the fan control dial to the desired (1 to 4) position and push the air conditioner button to turn on the air conditioner. The indicator light will come on when the air conditioner button is on. To stop the air conditioner, push the switch again to return it to the original position.

**The air conditioner cooling function operates only when the engine is running.**

## HEATER OPERATION

### Heating

This mode is used to direct hot air from the floor outlets.

1. Push the air recirculation button to the off position for normal heating.
  2. Turn the air control dial to the  position.
  3. Turn on the fan control dial.
  4. Turn the temperature control dial to the desired position between the middle and the hot position.
- For quick heating, move the air recirculation button to the on position. Be sure to return the air recirculation button to the off position for normal heating.

### Ventilation

This mode directs outside air from the side and centre vents.

1. Push the air recirculation button to the off position.
2. Turn the air control dial to the  position.
3. Turn on the fan control dial.

4. Turn the temperature control dial to the desired position.

### Defrosting or defogging

This mode is used to defrost/defog the windows.

1. Push the air recirculation button to the off position.
  2. Turn the air control dial to the  position.
  3. Turn on the fan control dial.
  4. Turn the temperature control dial to the desired position between the middle and the hot position.
- To quickly remove ice or fog from the windows, push the air recirculation button to the on position, the fan control dial to 4 and the temperature control dial to the full hot position. As soon as possible after the window is clear, push the air recirculation button to the off position.

### Bi-level heating

This mode directs outside air from the side and center vents and hot air from the floor outlets.

1. Push the air recirculation button to the off position.

2. Turn the air control dial to the  position.
3. Turn on the fan control dial.
4. Normally turn the temperature control dial to the midpoint between hot and cold.

## Heating and defogging

This mode heats the interior and defogs the windshield.

1. Push the air recirculation button to the off position.
2. Turn the air control dial to the  position.
3. Turn on the fan control dial.
4. Turn the temperature control dial to the desired position between the middle and the hot position.

## Operating tips

- **Clear snow and ice from the wiper blade and air inlet in front of the windshield. This will improve heater operation.**
- A slight delay may be experienced when turning the air control dial. This is not a problem, it is only the system motors and solenoids switching from one outlet to another.

## AIR CONDITIONER OPERATION

Start the engine, move the fan control dial to the desired (1 to 4) position and push in the air conditioner button to activate the air conditioner. When the air conditioner is on, cooling and dehumidifying functions will be added to the heater operation.

**The air conditioner cooling function operates only when the engine is running.**

## Cooling

This mode is used to cool and dehumidify.

1. Push the air recirculation button to the off position.
  2. Turn the air control dial to the  position.
  3. Turn on the fan control dial.
  4. Push on the air conditioner button. The indicator light will come on.
  5. Turn the temperature control dial to the desired position.
- For quick cooling when the outside temperature is high, push the air recirculation button to the on position. Be sure to return the air recirculation button to the off position for normal cooling.

## Dehumidified heating

This mode is used to heat and dehumidify.

1. Push the air recirculation button to the off position.
2. Turn the air control dial to the  position.
3. Turn on the fan control dial.
4. Push on the air conditioner button. The indicator light will come on.
5. Turn the temperature control dial to the desired position.

## Dehumidified defogging

This mode is used to defog the windows and dehumidify.

1. Push the air recirculation button to the off position.
2. Turn the air control dial to the  position.
3. Turn on the fan control dial.
4. Push on the air conditioner button. The indicator light will come on.
5. Turn the temperature control dial to the desired position.

## Operating tips

- Keep windows and sun roof closed while the air conditioner is in operation.
- After parking in the sun, drive for two or three minutes with the windows open to vent hot air from the passenger compartment. Then, close the windows. This will allow the air conditioner to cool the interior more quickly.
- **The air conditioning system should be operated for about ten minutes at least once a month. This helps prevent damage to the system due to lack of lubrication.**
- If the coolant temperature gauge exceeds the hot position, turn the air conditioner off. For additional information, see “If your vehicle overheats” in the “6. In case of emergency” section.

## AIR FLOW CHARTS

The following charts show the button and dial positions for **maximum and quick** heating, cooling or defrosting. **The air recirculation switch should always be in the off position for heating and defrosting.**

**DEFROSTING  
DEFOGGING**

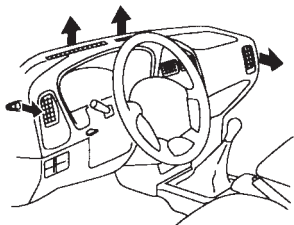

← : Air passed through heater core

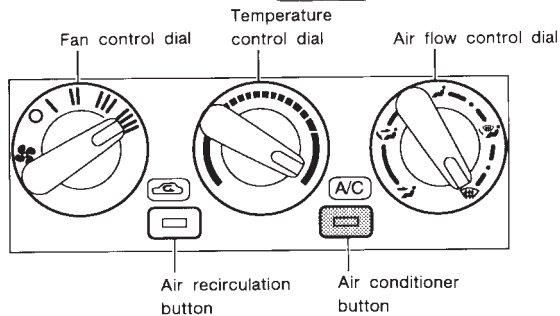

A/C switch	Air recirculation button	Air control	Temp control	Fan control
ON	OFF	DEF	HOT (RIGHT)	4

SAA0154A

**HEATING**  
No air at center vents

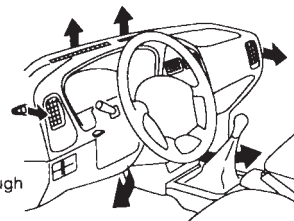

← : Air passed through heater core

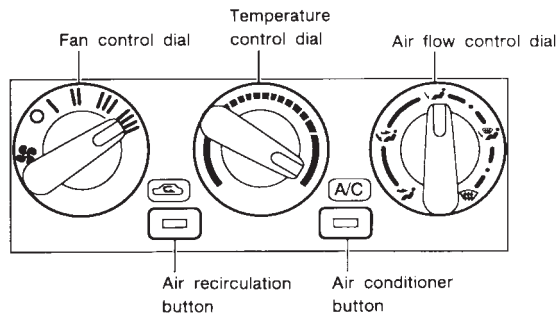

A/C switch	Air recirculation button	Air control	Temp control	Fan control
OFF	OFF	FOOT	HOT (RIGHT)	4

SAA0155A

## HEATING

Heated air at center vents

← : Air passed through heater core

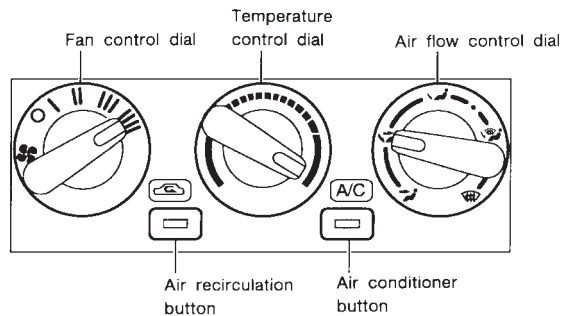
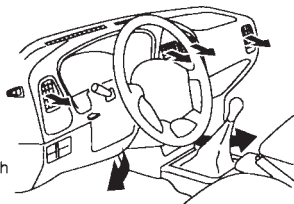

A/C switch	Air recirculation button	Air control	Temp control	Fan control
OFF	OFF	FOOT & FACE	HOT (RIGHT)	4

SAA0156A

## COOLING

← : Air not passed through heater core

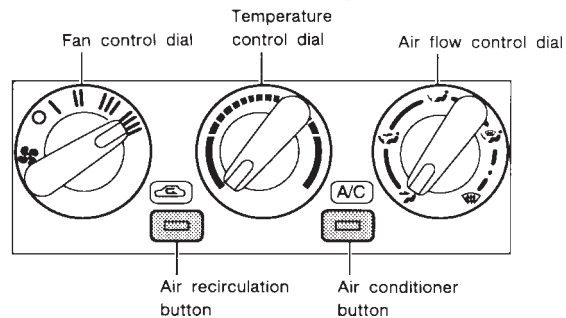
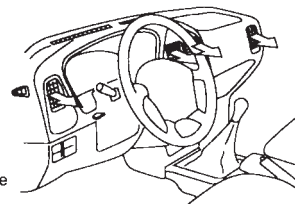

A/C switch	Air recirculation button	Air control	Temp control	Fan control
ON	ON	FACE	COLD (LEFT)	4

SAA0157A

## HEATER AND AIR CONDITIONER (Semiautomatic)

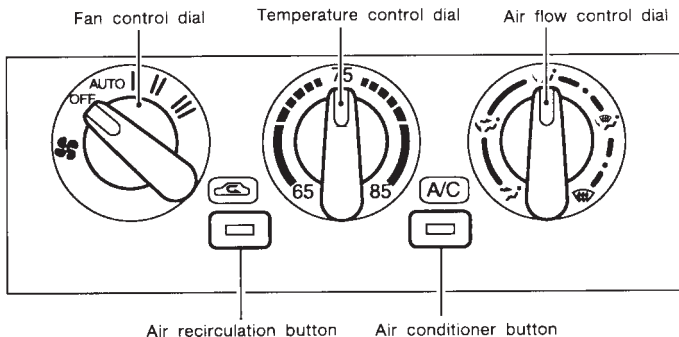

SAA0153B

### WARNING

- The air conditioner cooling function operates only when the engine is running.
- Do not leave children, unreliable adults, or pets alone in your vehicle. On hot, sunny days, temperatures in a closed vehicle could quickly become high enough to cause severe or possibly fatal injuries to people or animals.

- Do not use the recirculation mode for long periods as it may cause the interior air to become stale and the windows to fog up.
- Positioning of the heating or air conditioning controls should not be done while driving, in order that full attention may be given to the driving operation.

## CONTROLS





### Fan control dial

This dial turns the fan on and off, and controls fan speed.

**AUTO mode:** This mode controls the fan speed automatically.

### Air flow control dial

This dial allows you to select the air flow outlets.

-  — Air flows from center and side ventilators.
-  — Air flows from center and side ventilators and foot outlets.
-  — Air flows mainly from foot outlets.
-  — Air flows from defroster outlets and foot outlets.
-  — Air flows mainly from defroster outlets.

### Temperature control dial

This dial allows you to adjust the temperature of the outlet air.

## Air recirculation button

### Off position

Outside air is drawn into the passenger compartment when this button is off.

Use the off position for normal heater or air conditioner operation.

### On position

Interior air is recirculated inside the vehicle.

Push the button on when driving on a dusty road. The indicator light will come on.

## Air conditioner button

Start the engine, turn the fan control dial to the desired (Auto, 1 to 3) position and push the air conditioner button to turn on the air conditioner. The indicator light will come on when the air conditioner is on. To stop the air conditioner, push the switch again to return it to the original position.

**The air conditioner cooling function operates only when the engine is running.**

## HEATER OPERATION

### Heating

This mode is used to direct hot air from the floor outlets.

1. Push the air recirculation button off for normal heating.
2. Turn the air control dial to the  position.
3. (Manual mode)

Turn on the fan control dial (1 to 3).

(Auto mode)

Turn the fan control dial to the AUTO position.

- The fan speed will be maintained automatically.
- 4. Turn the temperature control dial to set the desired temperature.
- Adjust the temperature control dial to about 75°F (24°C) for normal operation.
- The temperature will be maintained automatically.
- For quick heating, push the air recirculation button on. Be sure to turn off the air recirculation button for normal heating.

- When starting up from cold with the fan control dial in the AUTO position, the blower speed will be fixed in the low mode until the coolant temperature rises.

### Ventilation

This mode directs outside air from the side, center and driver vents.

1. Push the air recirculation button off.
2. Turn the air control dial to the  position.
3. (Manual mode)

Turn on the fan control dial (1 to 3).

(Auto mode)

Turn the fan control dial to the AUTO position.

- The fan speed will be maintained automatically.
- 4. Turn the temperature control dial to set the desired temperature.
- The temperature will be maintained automatically.

## Defrosting or defogging

This mode is used to defrost/defog the windows.

1. Push the air recirculation button off.
2. Turn the air control dial to the  position.
3. (Manual mode)

Turn on the fan control dial (1 to 3).

(Auto mode)

Turn the fan control dial to the AUTO position.

- The fan speed will be maintained automatically.
4. Turn the temperature control dial to the desired position.
- To quickly remove ice or fog from the windows, turn the fan control dial to 3 and the temperature control dial fully over to the hot position.

## Bi-level heating

This mode directs outside air from the side and center vents and hot air from the floor outlets.

1. Push the air recirculation button off.

2. Turn the air control dial to the  position.

3. (Manual mode)

Turn on the fan control dial (1 to 3).

(Auto mode)

Turn the fan control dial to the AUTO position.

- The fan speed will be maintained automatically.
4. Turn the temperature control dial to set the desired temperature.
- Adjust the temperature control dial to about 75°F (24°C) for normal operation.
  - The temperature will be maintained automatically.

## Heating and defogging

This mode heats the interior and defogs the windshield.

1. Push the air recirculation button off.
2. Turn the air control dial to the  position.
3. (Manual mode)

Turn on the fan control dial (1 to 3).

(Auto mode)

Turn the fan control dial to the AUTO position.

- The fan speed will be maintained automatically.
4. Turn the temperature control dial to set the desired temperature.
- Adjust the temperature control dial to about 75°F (24°C) for normal operation.
  - The temperature will be maintained automatically.

## Operating tips

- **Clear snow and ice from the wiper blade and air inlet in front of the windshield. This will improve heater operation.**

## AIR CONDITIONER OPERATION

Start the engine, turn the fan control dial to the desired (Auto, 1 to 3) position and push in the air conditioner button to activate the air conditioner. When the air conditioner is on, cooling and dehumidifying functions will be added to the heater operation.

**The air conditioner cooling function operates only when the engine is running.**



## Cooling

This mode is used to cool and dehumidify.

1. Push the air recirculation button off.
2. Turn the air control dial to the  position.
3. (Manual mode)

Turn on the fan control dial (1 to 3).

(Auto mode)

Turn the fan control dial to the AUTO position.

- The fan speed will be maintained automatically.
4. Push the air conditioner button on. The indicator light will come on.
  5. Turn the temperature control dial to set the desired temperature.
- Adjust the temperature control dial to about 75°F (24°C) for normal operation.
  - The temperature will be maintained automatically.
  - For quick cooling when the outside temperature is high, push the air recirculation button on. Be sure to turn off the air recirculation button for normal cooling.

## Dehumidified heating

This mode is used to heat and dehumidify.

1. Push the air recirculation button off.
2. Turn the air control dial to the  position.
3. (Manual mode)

Turn on the fan control dial (1 to 3).

(Auto mode)

Turn the fan control dial to the AUTO position.

- The fan speed will be maintained automatically.
4. Push on the air conditioner button. The indicator light will come on.
  5. Turn the temperature control dial to set the desired temperature.
- Adjust the temperature control dial to about 75°F (24°C) for normal operation.
  - The temperature will be maintained automatically.

## Dehumidified defogging

This mode is used to defog the windows and dehumidify.

1. Push the air recirculation button off to improve the defogging performance.
2. Turn the air control dial to the  position.
3. (Manual mode)  
Turn on the fan control dial (1 to 3).  
(Auto mode)  
Turn the fan control dial to the AUTO position.
4. Turn the temperature control dial to the desired position.

## Operating tips

- Keep windows and sun roof closed while the air conditioner is in operation.
- After parking in the sun, drive for two or three minutes with the windows open to vent hot air from the passenger compartment. Then, close the windows. This will allow the air conditioner to cool the interior more quickly.
- The air conditioning system should be operated for about ten minutes at least once a month. This helps prevent damage to the system due to lack of lubrication.
- If the engine coolant temperature gauge

exceeds the hot position, turn the air conditioner off. For additional information, see “If your vehicle overheats” in the “6. In case of emergency” section.

- If the engine coolant reaches an extremely high temperature, the air conditioning system will automatically turn off. This may happen for example if the engine is run at idle for a long time on a hot day.

## AIR FLOW CHARTS

See earlier in the “Heater and air conditioner (manual)” section for air flow charts.

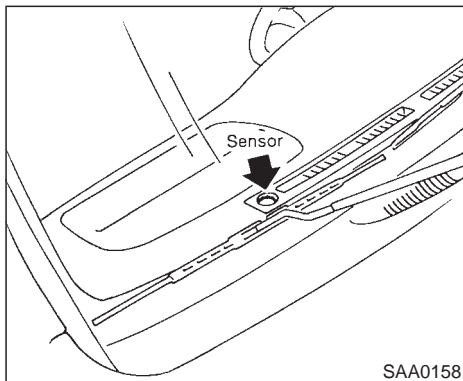

The sensor on the instrument panel helps maintain a constant temperature. Do not put anything on or around this sensor.

## SERVICING AIR CONDITIONER

The air conditioning system in your NISSAN vehicle is charged with a refrigerant designed with the environment in mind.

**This refrigerant will not harm the earth's ozone layer.**

However, special charging equipment and lubricant are required when servicing your NISSAN air conditioner. Using improper refrigerants or lubricants will cause severe damage to your air conditioning system. See “Capacities and recommended fuel/lubricants” in the “10. Technical and consumer information” section for air conditioning system refrigerant and lubricant recommendation.

Your NISSAN dealer will be able to service your environmentally friendly air conditioning system.

### **WARNING**

**The air conditioner system contains refrigerant under high pressure. To avoid personal injury, any air conditioner service should be done only by an experienced technician with proper equipment.**

# AUDIO SYSTEM

## RADIO

To turn the radio on, turn the ignition key to ACC or ON. If you listen to the radio with the engine not running, turn the key to the ACC position.

### Radio reception

Radio reception is affected by station signal strength, distance from radio transmitter, buildings, bridges, mountains, and other external influences. Intermittent changes in reception quality normally are caused by these external influences.

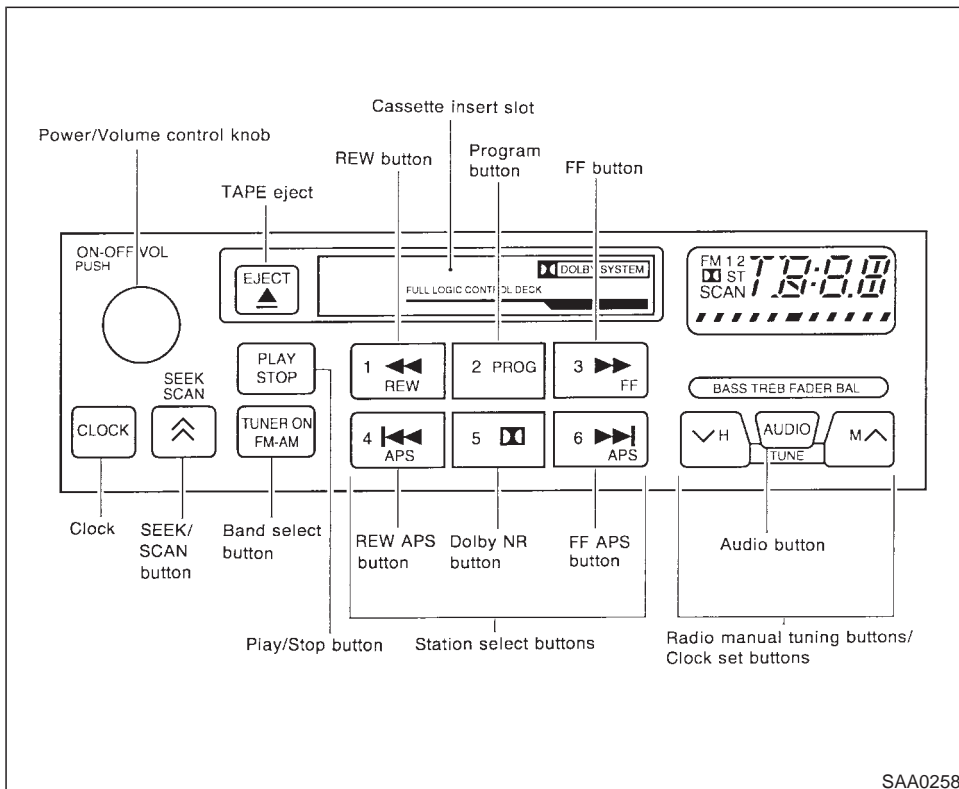

SAA0258

## FM-AM RADIO WITH CASSETTE PLAYER

### Audio main operation

#### Power/Volume control:

Turn the ignition key to ACC or ON, then push the Power/Volume control knob. The mode (radio or cassette) which was playing immediately before the system was turned off resumes playing. When no cassette is loaded, the radio comes on. Pushing the Power/Volume button again turns the system off.

Turn the Power/Volume control knob to adjust the volume.

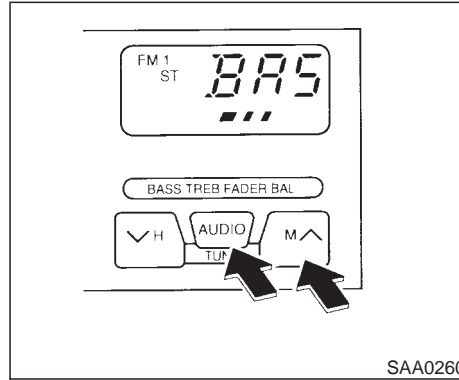

#### Adjusting tone quality and speaker balance:

To adjust BASS-TREB-FADER-BAL (Bass, Treble, Fader, Balance), press the AUDIO button until the desired mode (BAS, TRE, FAD or BAL) appears in the display.

Press the  $\checkmark_H$  or  $M^{\wedge}$  button to adjust Bass (BAS) and Treble (TRE) to the desired level. Use the  $\checkmark_H$  or  $M^{\wedge}$  button to adjust Fader or Balance modes. Fader adjusts the sound level between the front and rear speakers and Balance (BAL) adjusts the sound level between the right and left speakers.

After 10 seconds, the radio or cassette tape display reappears. Once the sound quality is set to the desired level, press the AUDIO button repeatedly until the radio or cassette tape display appears.

#### Clock operation:

Pressing the CLOCK button alternates the clock and the radio/cassette tape options in the display.

#### Radio/Cassette tape priority mode:

In this mode, the radio station illuminates in the display during radio operation. During cassette tape operation, TAPE illuminates in the display.

#### FM-AM radio operation



#### FM-AM band select:



Pushing the FM-AM band select button will change the band FM on AM.

The FM stereo indicator, ST illuminates during FM stereo reception. When the stereo broadcast signal is weak, the radio automatically changes from stereo to monaural reception.

  **TUNE (Tuning):**

## **WARNING**

**The radio should not be tuned while driving in order that full attention may be given to the driving operation.**

Push either manual tuning button  or .

 **SEEK/SCAN tuning:**

Push the SEEK/SCAN tuning button  for less than 1.5 seconds. SEEK tuning begins from low to high frequencies and stops at the next broadcasting station. Pushing the button again continues the SEEK function. Once the highest broadcasting station is reached, the radio continues in the SEEK mode at the lowest broadcast station.

Push the SEEK/SCAN tuning button  for more than 1.5 seconds. SCAN illuminates in the display window. SCAN tuning begins from low to high frequencies and stops at each broadcasting station for 5 seconds. Pushing the button again during this 5 second period stops SCAN tuning and the radio remains tuned to that station.

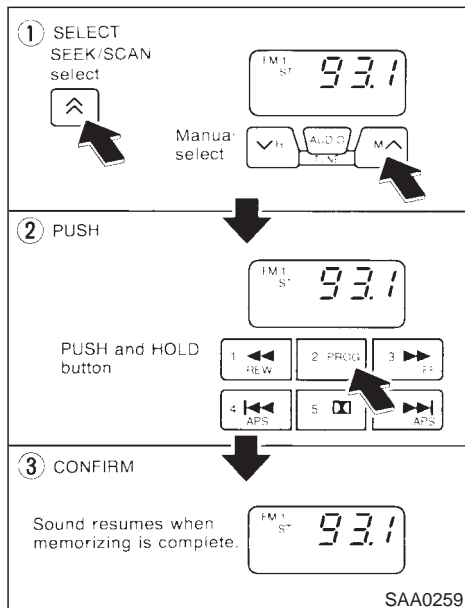

### Station memory operations:

Six stations can be set for the AM band. 12 stations can be set for the FM band (six for FM1, six for FM2).

1. Push the  to select AM, FM1, or FM2.

The selected band illuminates in the display.

2. Tune to the desired station.
3. Push the desired select button for more than 2 seconds. For example, in the illustrations ch2 is to be memorized. The radio mutes when the select button is pushed.
4. When the sound resumes, memorizing is complete.
5. Other station select buttons can be set in the same manner.

If the battery cable is disconnected, or if the radio fuse opens, the radio memory is cancelled. In that case, reset the desired stations.

### Cassette tape player operation

Turn the ignition key to ACC or ON, then carefully insert a cassette tape into the tape door.

The cassette tape automatically pulls into the player. The word TAPE and moving digital squares illuminate on the right side of the display window.

## CAUTION

**Do not force the cassette tape into the tape door. This could cause player damage.**

The cassette tape automatically changes directions to play the other side when the first side is complete. At this time, the moving digital squares illuminate on the left side of the display window.

### Precaution on cassette player operation:

- To maintain good quality sound, NISSAN recommends using cassette tapes of 60 minutes or shorter in length.
- Cassette tapes should be removed from the player when not in use. Store cassettes in their protective cases and away from direct sunlight, heat, moisture and magnetic sources.
- Direct sunlight can cause the cassette to become deformed. The use of deformed cassettes may cause the cassette to jam in the player.
- Do not use cassettes with labels which are peeling and loose. If used, the label could jam in the player.

- If a cassette has loose tape, insert a pencil through one of the cassette hubs and rewind the tape firmly around the hubs. Loose tape may cause tape jamming and wavering sound quality.
- Over a period of time, the playback head, capstan and pinch roller may collect a tape coating residue as the tape is played. This residue accumulation can cause weak or wavering sound, and should be removed periodically with a head cleaning tape. If the residue is not removed periodically, the player may need to be disassembled for cleaning.

### **PLAY/STOP:**



Push the  button while the cassette tape is playing to stop the tape. Push the button again to play the tape.



### **FF (fast forward), REW (rewind):**



Push either the  or  button for the desired direction.

The FF or REW symbol illuminates in the display.

To stop the FF or REW function, press the  or  again, or the  button.



### **APS (automatic program search) FF, APS REW:**

Push either the  or  button while the cassette tape is playing. The tape runs quickly, stops, then plays the next selection. Either the FF or REW symbol flashes in the display while searching for the selection.

This system searches at the blank intervals between selections. If there is a blank interval within one selection or there is no interval between selections, the system may not stop in the desired or expected location.







### **PROG (program):**

Push the  (program) select button. The moving digital squares illuminate on either the right or left side of the display window to indicate the side of program play.



### **Dolby NR (noise reduction):**

Push the  button for Dolby NR encoded tapes to reduce high frequency tape noise. The  indicator light comes on.

If in the clock display is in priority mode when the  button is pressed,  and TAPE illuminate in the display window for about 10 seconds. The clock mode then returns to the display window.

Dolby NR is manufactured under license from

Dolby Laboratories Licensing Corporation. DOLBY NR and the double-D symbol are trademarks of Dolby Laboratories Licensing Corporation.

**Metal or chrome tape usage:**

The cassette player is automatically set to high performance play when playing a metal or chrome cassette tape.

**Ejecting the cassette tape:**

Push the  button. The cassette tape automatically comes out.

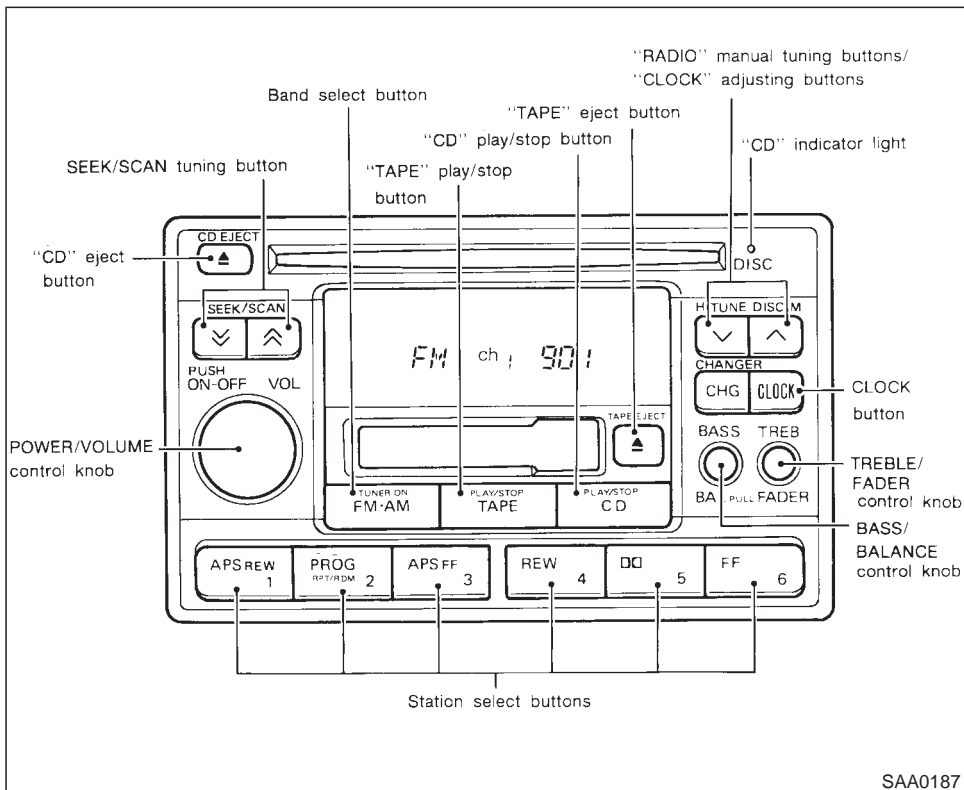

SAA0187

## FM-AM RADIO WITH CASSETTE PLAYER AND COMPACT DISC (CD) PLAYER (Bose)

### Audio main operation

#### Head unit

The radio has an FM Diversity reception system, which employs two antennas. One is a rod type antenna; the other is an antenna printed on the window. This system automatically switches to the antenna which is receiving less noise.

The tape deck employs a permalloy head which allows for improved reproduction of high frequency ranges. Noise is also greatly reduced by the combined use of the Dolby NR (noise reduction) system. The auto loudness circuit enhances the low frequency range automatically in both radio reception and tape playback.

#### **Power/Volume control:**

Turn the ignition key to ACC or ON, and then push the Power/Volume control knob while the system is off to call up the mode (radio, tape or CD) which was playing immediately before the system was turned off. When no CD or tape is loaded, the radio will come on. While the system is on, pushing the Power/Volume con-

trol knob turns the system off.

To turn the radio off, press the Power/Volume control knob.

Turn the Power/Volume control knob to adjust the volume.



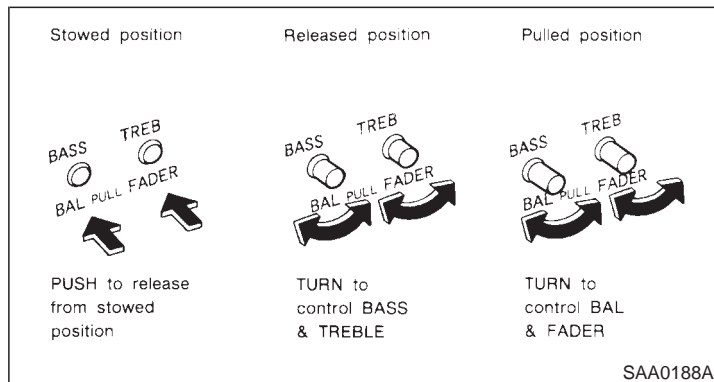

### Adjusting tone quality and speaker sound balance:

To adjust BASS, TREB (treble), FADER, and BAL (balance) the control knobs must be released from their stowed positions. Pushing the knobs once moves them to the released position.

In the released position, the knobs control tone quality. Turn the control knobs to adjust BASS and TREB to the most pleasing level.

From the released position, the knobs must be pulled out in order to control FADER and BAL. FADER adjusts the sound level between the

front and rear speakers, and BAL adjusts the sound level between the right and left speakers.

Once sound quality is set to the desired levels, return the control knobs to the stowed position by pushing them in completely and releasing.

### Clock operation:

By pressing the CLOCK button, you can alternate the clock and the radio/cassette tape/CD options in the display.

## FM-AM radio operation

**TUNER ON  
FM - AM** **FM-AM band select:**

Pushing the FM-AM band select button will change the band FM1, FM2 or AM.

When FM-AM band select button is pushed while the ignition switch is at ACC or ON, the radio will come on at the station last played.

The last station played will also come on when the power button is turned to ON.

If a compact disc or tape is inserted when the FM-AM band select button is turned to ON, the compact disc or tape will automatically be turned off and the last radio station played will come on.

The FM stereo indicator ST will glow during FM stereo reception. When the stereo broadcast signal is weak, the radio will automatically change from stereo to monaural reception.

  **TUNE (Tuning) :**



## **WARNING**

**The radio should not be tuned while driving in order that full attention may be given to the driving operation.**



Use these buttons for manual tuning. To move quickly through the channels, hold either of the tuning buttons down for more than 0.5 seconds.

  **SEEK/SCAN tuning:**

SEEK tuning

Push the SEEK/SCAN tuning button  or  for less than 1.5 seconds. SEEK tuning begins from low to high or high to low frequencies and stops at the next broadcasting station.

SCAN tuning

Push the SEEK/SCAN tuning button  or  for more than 1.5 seconds. SCAN tuning begins from low to high or high to low frequencies and stops at each broadcasting station for five seconds. Pushing the button again during this five second period will stop SCAN tuning

and the radio will remain tuned to that station.

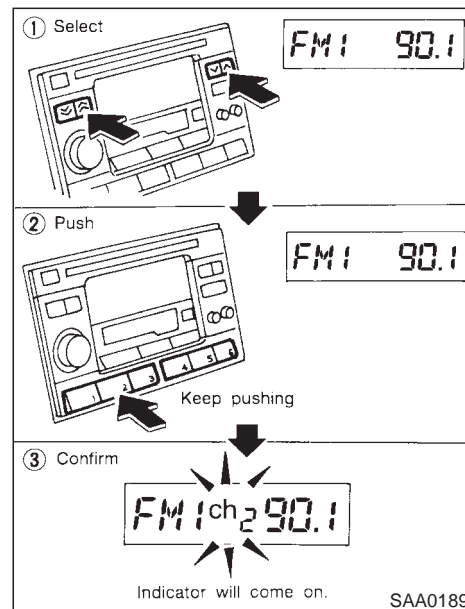

### **Station memory operations:**

Twelve stations can be set for the FM band (FM1 and FM2).

Six stations can be set for the AM band.

1. Tune to the desired station.
2. Push the desired select button for more than 1.5 seconds. (For example, in the diagram ch2 is to be memorized. The radio mutes when the select button is pushed.)
3. The indicator ch2 will then come on and the sound will resume. Memorizing is now complete.
4. Other buttons can be set in the same manner.

If the battery cable is disconnected, or if the fuse blows, the radio memory will be cancelled. In that case, reset the desired stations.

### Cassette tape player operation

Turn the ignition key to ACC or ON, and then lightly insert the cassette tape into the tape door. The cassette tape will be automatically pulled into the player.

The radio or CD will turn off (if it is on) and the cassette tape will begin to play.

### CAUTION

**Do not force the cassette tape into the tape door.**

**This could cause player damage.**

If the system is turned off by pushing the Power/Volume control knob with the cassette tape still in the player, the tape will resume playing when the Power/Volume control knob is pushed again.

#### Precautions on cassette player operation:

- **To maintain good quality sound, NISSAN recommends that you use cassette tapes of 60 minutes or shorter in length.**
- **Cassette tapes should be removed from the player when not in use. Store cassettes in their protective cases and away from direct sunlight, heat, moisture or magnetic sources.**

**Direct sunlight can cause the cassette to become deformed. The use of deformed cassettes may cause the cassette to jam in the player.**

- **Do not use cassettes that have peeling**

or loose labels. If used, the label could jam in the player.

- **If a cassette has loose tape, insert a pencil through one of the cassette hubs and rewind the tape firmly. Loose tape may cause jamming and wavering sound quality.**
- **Over a period of time, the playback head, capstan and pinch roller may gather a tape coating residue as the tape passes over the head. This residue accumulation can cause a weak or wavering sound and should be removed periodically with a head cleaning tape.**

**If the residue is not removed periodically, the player may need to be disassembled for cleaning.**







#### PLAY/STOP:

- When this button is pushed with the system turned off and a tape loaded, the system will come on and the tape will play.
- When this button is pushed with either the radio or compact disc turned on and the tape loaded, the compact disc or the radio will automatically be turned off and the tape will play.

While the tape is playing, pushing the TAPE





button stops the tape. Pushing the button again allows the tape to play.

 **FF (fast forward), REW (rewind):**

Push the FF (fast forward) button to fast forward the tape. To rewind the tape, push the REW (rewind) button. Either the indicator light , ,  or  will come on when the FF or REW function is started.

 **APS (automatic program search) FF, APS REW:**

When the APS FF button is pushed while the tape is being played, the next program will start to play from the beginning. Push the APS FF button several times to skip through programs. The tape will advance the number of times the button is pushed (up to 9 programs).

When the APS REW button is pushed once, the program being played starts over from the beginning. Push several times to fast rewind programs. The tape will go back the number of times the button is pushed. Either the indicator light , ,  or  will come on when the APS FF or APS REW function is started.

This system searches for the blank intervals between selections. If there is a blank interval

within one program or there is no interval between programs, the system may not stop in the desired or expected location.

 **PROG (program):**

Push the PROG (program) button to change the tape side while the tape is being played.

The cassette tape will automatically change directions to play the other side when the first side is completed.

 **Dolby NR (noise reduction):**

Push the  Dolby NR button for Dolby NR encoded tapes to reduce high frequency tape noise. The indicator will come on.

Dolby noise reduction manufactured under license from Dolby Laboratories Licensing Corporation. Dolby and the double-D symbol  are trademarks of Dolby Laboratories Licensing Corporation.

**Metal or chrome tape usage:**

The cassette player will be automatically set to high performance play when playing a metal or chrome cassette tape.

 **TAPE EJECT:**

When this button is pushed with the tape loaded, the tape will be ejected.

When the tape is ejected while it is being played, the system will be turned off.

Compact disc (CD) player operation

### CAUTION

- **During cold weather or rainy days, the player may malfunction due to the humidity. If this occurs, remove the CD and dehumidify or ventilate the player completely.**
- **The player may skip while driving on rough roads.**
- **The CD player sometimes cannot function when the compartment temperature is extremely high. Decrease the temperature before use.**
- **Do not expose the CD to direct sunlight.**

Turn the ignition key to the ACC or ON position and insert the compact disc into the slot with the label side facing up. The compact disc will be guided automatically into the slot and start playing.

After loading the disc, the number of tracks on

the disc and the play time will appear on the display.

If the radio or tape is already operating, it will automatically turn off and the compact disc will play.

## CAUTION

**Do not force the compact disc into the slot. This could damage the player.**

If the system has been turned off while the compact disc was playing, pushing the Power/Volume control knob will start the compact disc.



### PLAY/STOP:

When this button is pushed with the system off and the compact disc loaded, the system will turn on and the compact disc will start to play.

When this button is pushed with the compact disc loaded but the tape or the radio playing, the tape or radio will automatically be turned off and the compact disc will start to play.

When this button is pushed while the compact disc is playing, the compact disc will stop playing. When this button is pushed with the

compact disc stopped, the compact disc will start to play.



### FF (fast forward), REW (rewind):

When the FF (fast forward) or REW (rewind) button is pushed while the compact disc is being played, the compact disc will play while fast forwarding or rewinding. When the button is released, the compact disc will return to normal play speed.

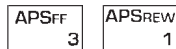

### APS (automatic program search) FF, APS REW:

When the APS FF button is pushed while the compact disc is being played, the program next to the present one will start to play from its beginning. Push several times to skip through programs. The compact disc will advance the number of times the button is pushed. (When the last program on the compact disc is skipped through, the first program will be played.) When the APS REW button is pushed, the program being played returns to its beginning. Push several times to skip back through programs. The compact disc will go back the number of times the button is pushed.



### PROG (program):

When this button is pushed while the compact

disc is being played, the play pattern will change as follows:

**ALL:** All the programs will be played repeatedly in sequence.

**1:** Only one program (the one being played when the PROG button is pushed) will be repeated.

**RANDOM:** Programs will be played at random, not following the sequence on the compact disc. The same program may be repeated twice.

(no mark): All the programs will be played in sequence and stop when the last program is finished.

- **When the compact disc is ejected, the play pattern will automatically change to ALL.**



### CD EJECT:

When the CD EJECT button is pushed with the compact disc loaded, the compact disc will be ejected.

When this button is pushed while the compact disc is being played, the compact disc will come out and the system will turn off.

**If the compact disc comes out and is not**

removed, it will be pulled back into the slot to protect it.

#### **DISC indicator light:**

This light comes on when the compact disc is loaded.

#### **ANTENNA**

##### **Power antenna**

The antenna will automatically extend when the radio is turned on, and retract when switched off. If the radio is left on, the antenna will retract and extend with the ignition key OFF-ON operation.

operation. Clean the rod periodically with a damp cloth. This type of cleaning is especially important during the winter seasons in areas where road salt and other chemicals may be spread on road surfaces and splashed onto the antenna rod.

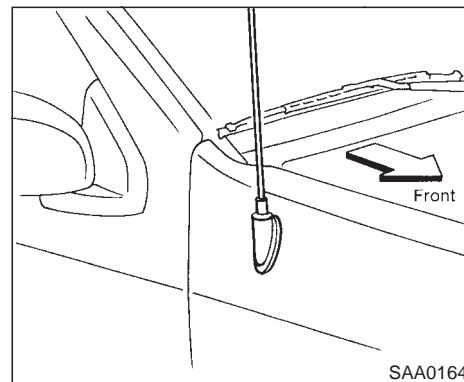

##### **Manual antenna**

The antenna cannot be shortened but can be removed. Turn its root counterclockwise to remove the antenna.

#### **CAUTION**

- Before turning the radio on, make sure that there is no one near the antenna outlet and there is enough space for it to extend.
- To prevent damage, be sure that antenna is fully retracted before the vehicle enters an automated car wash.
- Dirt and other foreign matter on the power antenna rod may interrupt its

#### **CAUTION**

Be sure to remove the antenna before washing the vehicle in an automatic car washing machine, or the antenna may be damaged.

## CB RADIO OR CAR PHONE

When installing a CB, ham radio or a car phone in your NISSAN, be sure to observe the following cautions, otherwise the new equipment may adversely affect the Multiport Fuel Injection system and other electronic parts.

### CAUTION

- **Keep the antenna as far as possible away from the Electronic Control Unit (including radio).**
- **Keep the antenna wire more than 8 in (20 cm) away from the Multiport Fuel Injection harness. Do not route the antenna wire next to any harness.**
- **Adjust the antenna standing-wave ratio as recommended by the manufacturer.**
- **Connect the ground wire from the radio chassis to the body.**
- **For details, consult your NISSAN dealer.**

# 5 Starting and driving

Precautions when starting and driving.....	5-2
Ignition switch.....	5-6
Before starting the engine.....	5-8
Starting the engine.....	5-9
Driving the vehicle.....	5-9
Parking brake.....	5-15
Cruise control.....	5-16
Break-in schedule.....	5-18
Increasing fuel economy.....	5-19
Using four wheel drive.....	5-20
Parking/parking on hills.....	5-23
Power steering.....	5-24
Brake system.....	5-24
Cold weather driving.....	5-26





## PRECAUTIONS WHEN STARTING AND DRIVING

### **WARNING**

- Do not leave children, unreliable adults, or pets alone in your vehicle. They could accidentally injure themselves or others through inadvertent operation of the vehicle. Also, on hot, sunny days, temperatures in a closed vehicle could quickly become high enough to cause severe or possibly fatal injuries to people or animals.
- Properly secure all cargo to help prevent it from sliding or shifting. Do not place cargo higher than the seatbacks. In a sudden stop or collision, unsecured cargo could cause personal injury.

## EXHAUST GAS (Carbon monoxide)

### **WARNING**

Do not breathe exhaust gases; they contain colorless and odorless carbon monoxide. Carbon monoxide is a dangerous. It can cause unconsciousness or death.

- If you suspect that exhaust fumes are entering the vehicle, drive with all windows fully open, and have the vehicle inspected immediately.
- Do not run the engine in closed spaces such as a garage.
- Do not park the vehicle with the engine running for any extended length of time.
- Keep the back door and rear window closed while driving, otherwise exhaust gases could be drawn into the passenger compartment. If you must drive with the back door or rear window open, follow these precautions:
  1. Open all the windows.
  2. Set the air recirculation switch

OFF and the fan control at 4 (high) to circulate the air.

- If electrical wiring or other cable connections must pass to a trailer through the seal on the back door or the body, follow the manufacturer's recommendation to prevent carbon monoxide entry into the vehicle.
- If a special body or other equipment is added for recreational or other usage, follow the manufacturer's recommendation to prevent carbon monoxide entry into the vehicle. (Some recreational vehicle appliances such as stoves, refrigerator, heaters, etc. may also generate carbon monoxide.)
- The exhaust system and body should be inspected by a qualified mechanic whenever:
  - a. The vehicle is raised for service.
  - b. You suspect that exhaust fumes are entering into the passenger compartment.
  - c. You notice a change in the sound

of the exhaust system.

- d. You have had an accident involving damage to the exhaust system, underbody, or rear of the vehicle.

## THREE WAY CATALYST

The three way catalyst is an emission control device, installed in the exhaust system. In the converter, exhaust gases are burned at high temperatures to help reduce pollutants.

### WARNING

- The exhaust gas and the exhaust system are very hot. Keep people, animals or flammable materials away from the exhaust system.
- Do not stop or park the vehicle over flammable materials, such as dry grass, waste paper or rags. They may ignite and cause a fire.

### CAUTION

- Do not use leaded gasoline. Deposits from leaded gasoline seriously reduce the three way catalyst's ability to help reduce exhaust pollutants.
- Keep your engine tuned up. Malfunctions in the ignition, fuel injection, or electrical systems can cause over-rich fuel flow into the three way catalyst, causing it to overheat. Do not keep driving if the engine misfires, or if noticeable loss of performance or other unusual operating conditions are detected. Have the vehicle inspected promptly by an authorized NISSAN dealer.
- Avoid driving with an extremely low fuel level. Running out of fuel could cause the engine to misfire, damaging the three way catalyst.
- Do not race the engine while warming it up.
- Do not push or tow your vehicle to start the engine.

## ON-PAVEMENT AND OFFROAD DRIVING PRECAUTIONS

Utility vehicles have higher ground clearance than passenger cars and a narrower track to make them capable of performing in a wide variety of offroad applications. Specific design characteristics give them a higher center of gravity than ordinary cars. An advantage of higher ground clearance is a better view of the road, allowing you to anticipate problems. They are not designed for cornering at the same speeds as conventional two-wheel drive vehicles any more than low-slung sports cars are designed to perform satisfactorily under offroad conditions. If at all possible, avoid sharp turns or abrupt maneuvers. As with other vehicles of this type, failure to operate this vehicle correctly may result in loss of control or vehicle rollover.

Be sure to read the driving safety precautions later in this section.

### 5-4 Starting and driving

## AVOIDING COLLISION AND ROLLOVER

### WARNING

**Failure to operate this vehicle in a safe and prudent manner may result in loss of control or an accident.**

Be alert and drive defensively at all times. Obey all traffic regulations. Avoid excessive speed, high speed cornering, or sudden steering maneuvers, because these driving practices could cause you to lose control of your vehicle. **As with any vehicle, a loss of control could result in a collision with other vehicles or objects, or cause the vehicle to rollover, particularly if the loss of control causes the vehicle to slide sideways.** Be attentive at all times, and avoid driving when tired. Never drive when under the influence of alcohol or drugs (including prescription or over-the-counter drugs which may cause drowsiness). Always wear your seat belt as outlined in the “Seat belts” in the “1. Seats, restraints and supplemental air bag systems” section of this manual, and also instruct your passengers to do so.

## DRINKING ALCOHOL/DRUGS AND DRIVING

### WARNING

**Never drive under the influence of alcohol or drugs. Alcohol in the bloodstream reduces coordination, delays reaction time and impairs judgement. Driving after drinking alcohol increases the likelihood of being involved in an accident injuring yourself and others. Additionally, if you are injured in the accident, alcohol can increase the severity of the injury.**

Nissan is committed to safe driving. But, you must choose not to drive under the influence of alcohol. Every year thousands of people are injured or killed in alcohol related accidents. Although the local laws vary on what is considered to be legally intoxicated, the fact is that alcohol affects all people differently and most people underestimate the effects of alcohol.

Remember, drinking and driving don't mix!

And that's true for drugs too (over the counter, prescription, and illegal drugs). Don't drive if your ability to operate your vehicle is impaired

by alcohol, drugs, or some other physical condition.

## DRIVING SAFETY PRECAUTIONS

Your NISSAN is designed for both normal and offroad use. However, avoid driving in deep water or mud as your NISSAN is mainly designed for leisure use, unlike a conventional offroad vehicle.

Remember that two wheel drive models are less capable than four wheel drive models for rough road driving and extrication when stuck in deep snow or mud, or the like.

Please observe the following precautions:

### **WARNING**

- **Drive carefully when off the road and avoid dangerous areas. Always wear your seat belts to help keep you and your passengers in position when driving over rough terrain.**
- **Do not drive across steep slopes. Instead drive either straight up or straight down the slopes. Offroad vehicles can tip over sideways much more easily than they can forward or backward.**

- **Many hills are too steep for any vehicle. If you drive up them, you may stall. If you drive down them, you may not be able to control your speed. If you drive across them, you may roll over.**
- **Stay alert when driving to the top of a hill. At the top there could be a drop-off or other hazard that could cause an accident.**
- **If your engine stalls or you cannot make it to the top of a steep hill, never attempt to turn around. Your vehicle could tip or roll over. Always back straight down in reverse gear. Never back down in neutral (N) or with the clutch depressed, using only the brake, as this could cause loss of control.**
- **Heavy braking going down a hill could cause your brakes to overheat and fade, resulting in loss of control and an accident. Apply brakes lightly and use a low gear to control your speed.**
- **Unsecured cargo can be thrown**

**around when driving over rough terrain. Properly secure it so that it will not be thrown forward and cause injury to you or your passengers.**

- **Avoid raising the center of gravity by loading things on the roof or equipping the vehicle with tires larger than specified in this manual. This could cause your vehicle to rollover. Put heavy loads in the cargo area as far forward and as low as possible.**
- **Do not grip the inside or spokes of the steering wheel when driving offroad. The steering wheel could jerk and injure your hands. Instead drive with your fingers and thumbs on the outside of the rim.**
- **Before operating the vehicle, ensure that the driver and all passengers have their seat belts fastened.**
- **Always drive with the floor mats in place as the floor may become very hot. Particular care should be taken if you are barefoot.**
- **Lower your speed when encountering strong crosswinds. With its**

higher center of gravity, your NISSAN is more affected by gusty side winds. Slower speeds ensure better vehicle control.

- Do not drive beyond the performance of the tires even with 4WD.

Accelerating quickly, sharp steering maneuvers or sudden braking may cause loss of control.

- Install the same size of winter tires on all four wheels (such as studless tires) or install tire chains to the rear wheels when driving on slippery roads (for example, after a snow) and drive carefully using 4WD.
- Be sure to check the brakes immediately after driving in mud or water. See “Brake system” later in this section for wet brakes.
- Avoid parking your vehicle on steep hills. If you get out of the vehicle and it rolls forward, backward or sideways, you could be injured.
- Whenever you drive offroad through sand, mud or water as deep as the

wheel hub, more frequent maintenance may be required. See “Periodic maintenance” in the “9. Maintenance” section for maintenance under severe driving conditions.

## IGNITION SWITCH

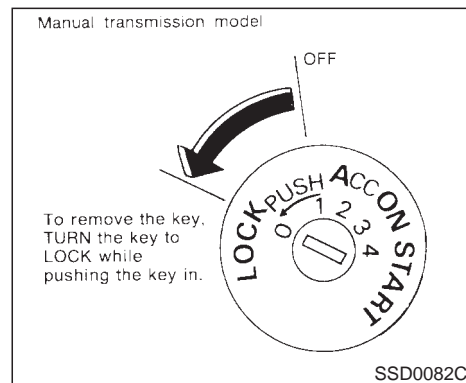

## MANUAL TRANSMISSION

The switch includes an anti-theft steering lock device.

LOCK Normal parking position (0)

The ignition key can only be removed when the switch is in this position.

On manual transmission models, to turn the ignition key to LOCK from ACC or ON, first turn the key to OFF and turn the key to LOCK while pushing the key in.

In order for the steering wheel to be locked, it must be turned about 1/6 of a turn clockwise from the straight up position.

To lock the steering wheel, remove the key. To unlock the steering wheel, insert the key and turn it gently while rotating the steering wheel slightly right and left.

## WARNING

Never remove the key while driving. If the key is removed, the steering wheel will lock. This may cause the driver to lose control of the vehicle and could result in serious vehicle damage or personal injury.

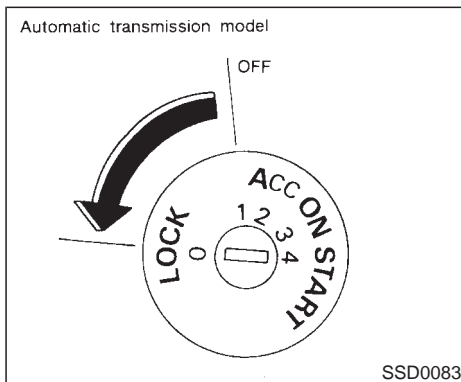

## AUTOMATIC TRANSMISSION

On automatic transmission models, the ignition lock is designed so that the key cannot be turned to LOCK and removed until the selector lever is moved to the P (Park) position.

When removing the key from the ignition, make sure the selector lever is in the P (Park) position.

If the selector lever is not returned to P (Park), the key cannot be moved toward LOCK.

When the key cannot be turned toward the LOCK position, proceed as follows to remove the key:

- 1) Move the selector lever into the P (Park) position.
- 2) Turn the ignition key slightly in the ON direction.
- 3) Turn the key toward the LOCK position.
- 4) Remove the key.

If the key is removed from the ignition switch, the selector lever cannot be moved from P (Park). **The selector lever can be moved if the ignition switch is in the ACC position. The selector lever can also be moved if the ignition switch is in the ON position and the foot brake pedal is depressed.**

There is an OFF position in between LOCK and ACC, although it does not show on the lock cylinder. When the ignition is in OFF the steering wheel is not locked.

In order for the steering wheel to be locked, it must be turned about 1/6 of a turn clockwise from the straight up position.

**To lock the steering wheel, remove the key. To unlock the steering wheel, insert the key and turn it gently while rotating the steering wheel slightly right and left.**

## **WARNING**

**Never remove the key while driving. If the key is removed, the steering wheel will lock. This may cause the driver to lose control of the vehicle and could result in serious vehicle damage or personal injury.**

## KEY POSITIONS

### OFF (1)

The engine can be turned off without locking the steering wheel.

### ACC (Accessories) (2)

This position activates electrical accessories such as the radio when the engine is not running.

### ON (Normal operating position) (3)

This position turns on the ignition system and the electrical accessories.

## 5-8 Starting and driving

### START (4)

This position activates the starter motor, starting the engine.

## BEFORE STARTING THE ENGINE

- Make sure the area around the vehicle is clear.
- Check fluid levels such as engine oil, coolant, brake and clutch fluid, window washer fluid as frequently as possible, at least whenever you refuel.
- Check to be sure that all windows and light lenses are clean.
- Visually inspect tires for their appearance and condition. Also check tires for proper inflation.
- Lock all doors.
- Position seat and adjust head restraints.
- Adjust inside and outside mirrors.
- Fasten seat belts and ask all passengers to do likewise.
- Check the operation of warning lights when key is turned to the ON (3) position.

## STARTING THE ENGINE

1. Apply the parking brake.
2. **Automatic transmission:**

Move the selector lever to P (Park position) or N (Neutral position). (P preferred)

**The selector lever cannot be moved out of P and into any of the other gear positions if the ignition key is turned to LOCK or if the key is removed from the switch.**

**The starter is designed not to operate if the selector lever is in one of the driving positions.**

### **Manual transmission:**

Move the gearshift lever to N (Neutral position), and depress the clutch pedal to the floor while starting the engine.

**The starter is designed not to operate unless the clutch pedal is depressed.**

3. Crank the engine **with your foot off the accelerator pedal** by turning the ignition key to START. Release the key when the engine starts. If the engine starts, but fails to run, repeat the above procedure.

— **If the engine is very hard to start in extremely cold or hot weather** —

Use the accelerator pedal to help start the engine.



**Do not operate the starter for more than 10 seconds at a time. If the engine does not start, turn the key off and wait 10 seconds before cranking again, otherwise the starter could be damaged.**

### 4. Warm-up

Always allow the engine to idle for at least 30 seconds after starting. Drive at moderate speed for a short distance first, especially in cold weather.

## DRIVING THE VEHICLE

### AUTOMATIC TRANSMISSION

The automatic transmission in your vehicle is electronically controlled by a transmission control module to produce maximum power and smooth operation.

Shown on the following pages are the recommended operating procedures for this transmission. Follow these procedures for maximum vehicle performance and driving enjoyment. If your vehicle is equipped with four wheel drive, see “Using four wheel drive” later in this section.

### Starting the vehicle

- After starting the engine, fully depress the foot brake pedal and push the selector lever button before shifting the selector lever to the D, R, 2 or 1 position. Be sure the vehicle is fully stopped before attempting to shift the selector lever.

**This automatic transmission is designed so that the foot brake pedal MUST be depressed before shifting from P to any drive position while the ignition switch is ON.**

**The selector lever cannot be moved out of P and into any of the other gear positions if the ignition key is turned to LOCK or if the key is removed from the switch.**



When the battery charge is low, the selector lever can be moved if the ignition switch is in the ACC position.

1. Keep the foot brake pedal depressed and push the selector lever button to shift into a driving gear.
2. Release the parking brake and foot brake, then gradually start the vehicle in motion.

## WARNING

- **Do not depress the accelerator pedal while shifting from P or N to R, D, 2 or 1. Always depress the brake pedal until shifting is completed. Failure to do so could cause you to lose control and have an accident.**
- **Cold engine idle speed is high, so use caution when shifting into a forward or reverse gear before the engine has warmed up.**
- **Never shift to P or R while the vehicle is moving. This could cause an accident.**
- **On slippery roads, do not downshift. This may cause a loss of control.**

## CAUTION

**When stopping the vehicle on an uphill grade, do not hold the vehicle by depressing the accelerator pedal. The foot brake should be used for this purpose.**

### Shifting from P (Park)

If the ignition switch is in the ON position and the foot brake pedal is depressed, but the selector lever still cannot be moved out of P (Park), follow these instructions:

1. Shut the engine off and remove the key.
2. Apply the parking brake.
3. Reinsert the ignition key and turn it clockwise to the ACC position.
4. Depress the brake pedal, move the selector lever to N (Neutral) and start the engine.
5. Check stop light operation.

## WARNING

**If the selector lever cannot be moved from the P (Park) position while the engine is running and the brake pedal**

**depressed, the stop lights may not work. Malfunctioning stop lights could cause an accident injuring yourself and others.**

These instructions for starting the vehicle in N (Neutral) should only be used until service can be obtained. Never drive the vehicle if the stop lights are not operating properly.

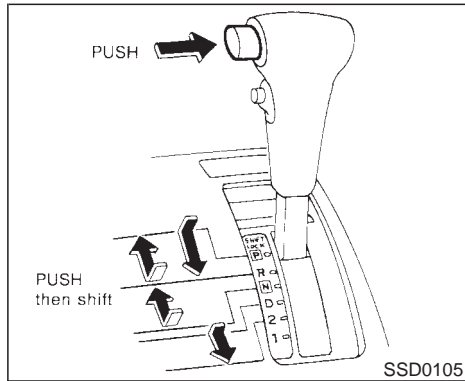

Push the button to shift into P, R or from D to 2. All other positions can be selected without pushing the button.

#### P (Park):

Use this selector position when the vehicle is parked or when starting the engine. Always be sure the vehicle is at a complete stop. For maximum safety, depress the brake pedal, then push in the select lever button and move the lever to the P position. Apply the parking brake. When parking on a hill, apply the parking brake first, then shift the lever into the P position.

#### R (Reverse):

Use this position to back up. Shift into this position only after the vehicle has completely stopped.

#### N (Neutral):

Neither forward nor reverse gear is engaged. The engine can be started in this position. You may shift to N and restart a stalled engine while the vehicle is moving.

#### D (Drive):

Use this position for all normal forward driving.

#### 2 (Second gear):

Use for hill climbing, effective engine braking on downhill grades or starting on slippery roads.

Do not downshift into the 2 position at speeds over the following speeds and do not exceed the following speeds in the 2 position:

Two wheel drive:

60 MPH (95 km/h)

Four wheel drive:

50 MPH (80 km/h)

#### 1 (Low gear):

Use this position when climbing steep hills slowly or driving slowly through deep snow, sand or mud, or for maximum engine braking on steep downhill grades.

Do not shift into 1 position at speeds over the following speeds:

Two wheel drive:

60 MPH (95 km/h)

Four wheel drive:

50 MPH (80 km/h)

Do not exceed the following speeds in the 1 position:

Two wheel drive:

30 MPH (50 km/h)

Four wheel drive:

30 MPH (50 km/h)

## Accelerator downshift

### — In D position —

For rapid passing or hill climbing, fully depress the accelerator pedal to the floor. This shifts the transmission down into second gear or first gear, depending on the vehicle speed.

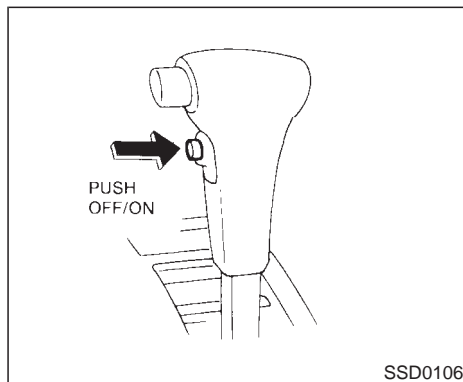

## Overdrive switch

Each time your vehicle is started, the transmission is automatically reset to overdrive on.

**ON:** For normal driving the overdrive switch is engaged. The transmission is upshifted into overdrive as the vehicle speed increases.

**The overdrive does not engage until the engine has warmed up.**

**OFF:** For driving up and down long slopes where engine braking would be advantageous, push the overdrive switch. The O/D OFF light illuminates.

When cruising at a low speed or climbing a gentle slope, you may feel uncomfortable shift shocks as the transmission shifts between 3rd and overdrive repeatedly. In this case, press the overdrive switch. The O/D OFF indicator light comes on at this time.

When driving conditions change, press the overdrive switch again. The O/D OFF indicator light goes out.

Remember not to drive at high speeds for extended periods of time with the O/D OFF light illuminated. This reduces the fuel economy.

## Fail-safe

When the Fail-safe operation occurs, the next time the key is turned to the ON position, the O/D OFF light will blink for approximately 8 seconds after coming on for 2 seconds. While the vehicle can be driven under these circumstances please note that the gears in the automatic transmission will be locked in third gear.

**If the vehicle is driven under extreme conditions, such as excessive wheel spinning and subsequent hard braking, the Fail-safe system may be activated. This will occur**

even if all electrical circuits are functioning properly. In this case, turn the ignition key OFF and wait for 3 seconds. Then turn the key back to the ON position. The vehicle should return to its normal operating condition. If it does not return to its normal operating condition have your NISSAN dealer check the transmission and repair if necessary.

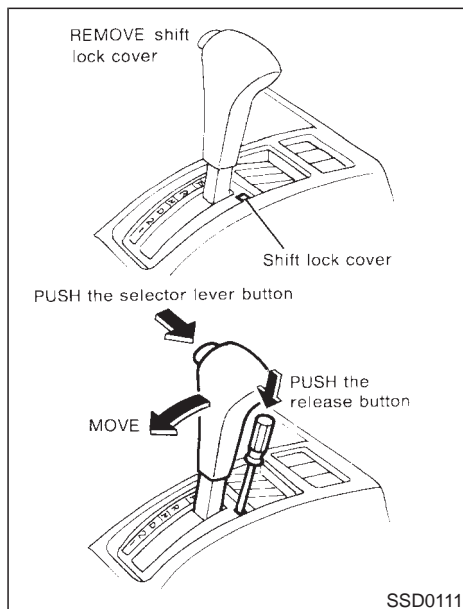

## Shift lock release

If the battery charge is low, the select lever may not be moved from the P position even with the brake pedal depressed and the select lever button pushed.

To move the select lever, push the shift lock release button and select lever button. The select lever can be moved to N (Neutral).

To push the shift lock release button, follow the procedure as illustrated.

If there is any problem moving the lever out of P (Park) have your NISSAN dealer check the automatic transmission system as soon as possible.

### **WARNING**

If the selector lever cannot be moved from the P position while the engine is running and the brake pedal is depressed, the stop lights may not work. Malfunctioning stop lights could cause an accident injuring yourself and others.

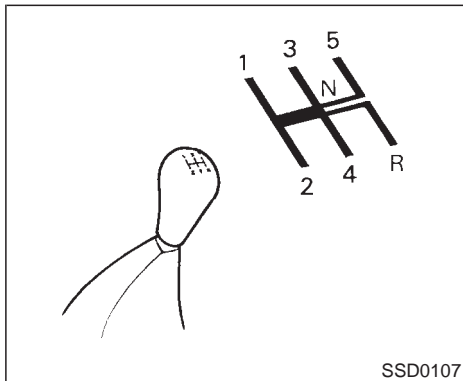

## MANUAL TRANSMISSION

### **⚠ WARNING**

- **Do not downshift abruptly on slippery roads. This may cause a loss of control.**
- **Do not over-rev the engine when shifting to a lower gear. This may cause a loss of control or engine damage.**

To change gears, fully depress the clutch  
5-14 Starting and driving

pedal, then move the gearshift lever. After shifting, release the clutch slowly.

You cannot shift directly from 5th gear into Reverse. First shift into the Neutral position, then into Reverse.

If it is difficult to move the shift lever into Reverse or 1st, shift into Neutral, then release the clutch pedal and shift into Reverse or 1st again. If your vehicle is equipped with four wheel drive, see "Using four wheel drive" later in this section.

### Suggested shift-up speeds

The table below provides suggested speed ranges for shifting into a higher gear. These suggestions relate to fuel economy and vehicle performance. Actual shift ranges should be adjusted for specific road conditions, weather conditions and individual driving habits.

- Two wheel drive models and four wheel drive models (2H and 4H position)

	MPH (km/h)
1st to 2nd	15 (25)
2nd to 3rd	25 (40)
3rd to 4th	40 (65)
4th to 5th	45 (75)

### \*1 Acceleration:

**Normal acceleration such as standing start**

### \*2 Cruise:

**Driving without rapid acceleration or deceleration at moderate speed which permits maximum fuel economy**

- Four wheel drive model (4L position)
 

	MPH (km/h)
1st to 2nd	8 (13)
2nd to 3rd	12 (20)
3rd to 4th	20 (32)
4th to 5th	22 (36)

### Suggested maximum speed in each gear

Downshift to a lower gear if the engine is not running smoothly, or if you need to accelerate.

Do not exceed the maximum suggested speed (shown below) in any gear. For level road driving, use the highest gear suggested for that speed. Always observe posted speed limits, and drive according to the road conditions which will ensure safe operation. Do not overrev the engine when shifting to a lower gear as it may cause engine damage or loss of vehicle control.

Allowable maximum speed in each gear

Two wheel drive models	MPH (km/h)
Four wheel drive models	
2H position	
1st	22 (35)
2nd	37 (60)
3rd	56 (90)
4th & 5th	78 (125)
Four wheel drive models	MPH (km/h)
4H position	
1st	22 (35)
2nd	37 (60)
3rd	50 (80)
4th & 5th	50 (80)
4L position	
1st	9 (15)
2nd	19 (30)
3rd	28 (45)
4th & 5th	31 (50)

**shift to N (Neutral) and release the clutch pedal with the foot brake applied.**

## PARKING BRAKE

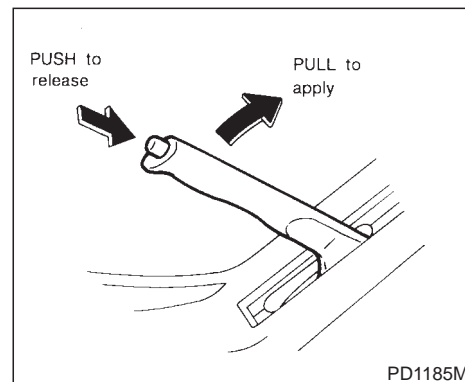

**To apply:** pull the lever up.

**To release:**

1. Firmly apply foot brake.
2. **Manual transmission models:**  
Place the gearshift lever in the N (Neutral) position.
- Automatic transmission models:**  
Move the selector lever to the P (Park) position.
3. While pulling up on the lever slightly, push the button and lower completely.

### CAUTION

- **Do not rest your foot on the clutch pedal while driving. This may cause clutch damage.**
- **Stop your vehicle completely before shifting into R (Reverse).**
- **When the vehicle is stopped for a duration, for example at a stop light,**

4. Before driving, be sure the brake warning light goes out.

### **WARNING**

- **Be sure the parking brake is fully released before driving. Failure to do so can cause brake failure and lead to an accident.**
- **Do not release the parking brake from outside the vehicle.**
- **Do not use the gear shift in place of the parking brake. When parking, be sure the parking brake is fully engaged.**
- **Do not leave children unattended in a vehicle. They could release the parking brake and cause an accident.**

## **CRUISE CONTROL**

### **PRECAUTIONS ON CRUISE CONTROL**

- If the cruise control system malfunctions, it cancels automatically. The cruise indicator light in the instrument panel then blinks to warn the driver.
- If the cruise indicator light blinks, turn the cruise control main switch off and have the system checked by your NISSAN dealer.
- The cruise indicator light may blink when the cruise control main switch is turned on while pushing the RES/ACCEL, COAST/SET, or CANCEL switch (located on the steering wheel). To properly set the cruise control system, perform the preceding steps in the order indicated.

### **WARNING**

**Do not use the cruise control when driving under the following conditions:**

- **when it is not possible to keep the vehicle at set speed.**
- **in heavy traffic or in traffic that varies in speed.**
- **on winding or hilly roads.**

- **on slippery roads (rain, snow, ice, etc.)**
- **in very windy areas.**

**Doing so could cause a loss of vehicle control and result in an accident.**

### **CAUTION**

**On manual transmission models, do not shift into N (Neutral) without depressing the clutch pedal when the cruise control is on. This could cause engine damage. If this happens, depress the clutch pedal and turn the main switch off immediately.**

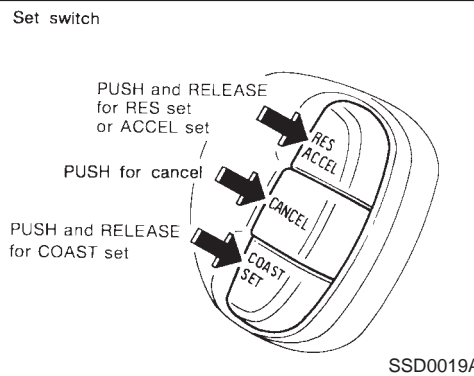
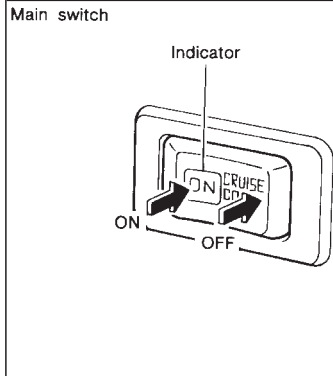

## CRUISE CONTROL OPERATION

The cruise control allows driving at a fixed speed between 30 to 90 MPH (48 to 144 km/h) without keeping your foot on the accelerator pedal.

**To turn on the cruise control**, push the main switch on. The indicator light on the switch will come on.

**To set at cruising speed**, accelerate your vehicle to the desired speed, push the COAST/SET switch and release it. (The CRUISE light will come on.) Take your foot off

the accelerator pedal. Your vehicle will maintain the set speed.

- **To pass another vehicle**, depress the accelerator pedal. When you release the pedal, the vehicle will return to the previously set speed.
- The vehicle may not maintain the set speed when going up or down steep hills. If this happens, drive without the cruise control.

**To cancel the preset speed**, follow any of these three methods:

- a) Push the cancel switch; The CRUISE light will go out.
  - b) Tap the brake pedal; The CRUISE light will go out.
  - c) Turn the main switch off. Both the ON indicator and CRUISE light will go out.
- If you depress the brake pedal while pushing the ACCEL set switch and reset at the cruising speed, turn the main switch off once and then turn it on again.
  - The cruise control will automatically be cancelled if the vehicle slows down more than 8 MPH (13 km/h) below the set speed.
  - Depress the clutch pedal (manual transmission), or move the selector lever to N position (automatic transmission). CRUISE light will go out.

**To reset at a faster cruising speed**, follow either of these three methods:

- a) Depress the accelerator pedal. When the vehicle attains the desired speed, push and release the COAST/SET switch.
- b) Push and hold the RES/ACCEL set switch. When the vehicle attains the speed you desire, release the switch.
- c) Push, then quickly release the RES/



ACCEL set switch. Each time you do this, the set speed will increase by about 1 MPH (1.6 km/h).

**To reset at a slower cruising speed**, follow either of these three methods:

- a) Lightly tap the brake pedal. When the vehicle attains the desired speed, push the COAST/SET switch and release it.
- b) Push and hold the COAST/SET switch. Release the switch when the vehicle slows down to the desired speed.
- c) Push, then quickly release the COAST/SET switch. Each time you do this, the set speed will decrease by about 1 MPH (1.6 km/h).

**To resume the preset speed**, push and release the resume set switch. The vehicle will resume the last set cruising speed when the vehicle speed is over 30 MPH (48 km/h).

## Precautions

- The cruise indicator may sometimes blink when the cruise control switch (Main switch) is turned ON while pushing the RES/ACCEL switch or COAST/SET switch or CANCEL switch (located on the steering wheel). To properly set the cruise control system perform the steps above in the

order indicated. (This is a fail-safe mode. Turn the main switch OFF and turn it ON again without pushing the set switch to return to normal operation.)

- If the cruise control system malfunctions, it will cancel automatically. The cruise indicator in the meter assembly will then blink to warn the driver.
- When the cruise indicator blinks, turn the cruise control switch (Main switch) OFF and have the system checked by your NISSAN dealer.

## BREAK-IN SCHEDULE

During the first 1,000 miles (1,600 km), follow these recommendations for the future reliability and economy of your new vehicle. Failure to follow these recommendations may result in vehicle damage or shortened engine life.

- Do not run the engine over 4,000 rpm.

Do not drive over the following speed limits:

Two wheel drive models:

Four wheel drive models

(2H position):

55 MPH (90 km/h)

Four wheel drive models

(4H position):

50 MPH (80 km/h)

Four wheel drive models

(4L position):

30 MPH (50 km/h)

- Do not accelerate hard in top gear.
- Avoid quick starts and full acceleration.
- Avoid hard stops as much as possible.
- 

For the first 300 miles (500 km), it is recommended that you drive in the two wheel drive (2H) position.

- Do not tow a trailer for the first 500 miles (800 km).

## INCREASING FUEL ECONOMY

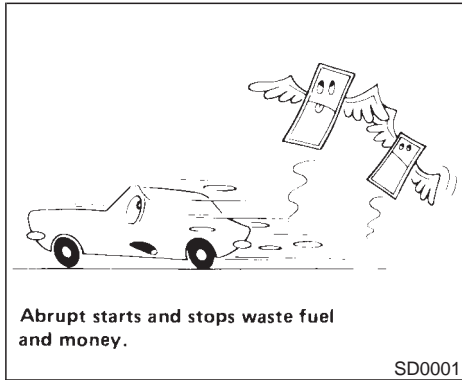

- Accelerate slowly and smoothly. Maintain cruising speeds with a constant accelerator position.
- Drive at moderate speeds on the highway. Driving at high speed will lower fuel economy.
- Avoid unnecessary stopping and braking. Maintain a safe distance behind other vehicles.
- Use a proper gear range which suits road conditions. On level roads, shift into high gear as soon as possible.
- Avoid unnecessary engine idling.
- Keep your engine tuned up.
- Follow the recommended periodic maintenance schedule.
- Keep the tires inflated at the correct pressure. Low pressure will increase tire wear and waste fuel.
- Keep the front wheels in correct alignment. Improper alignment will cause increased tire wear and lower fuel economy.
- Air conditioner operation lowers fuel economy. Use the air conditioner only when necessary.
- When cruising at highway speeds, it is more economical to use the air conditioner and leave the windows closed to reduce drag.
- **4x4**  
Use 4H or 4L position only when necessary. Four wheel drive operation lowers fuel economy.

## USING FOUR WHEEL DRIVE

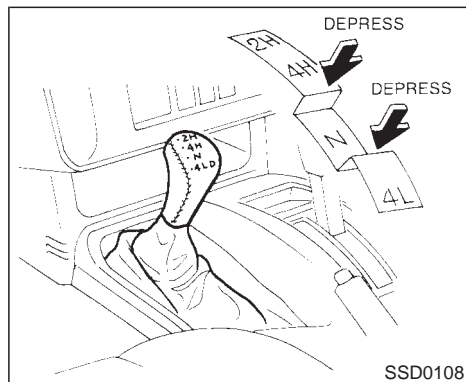

**2H** — (2WD, high range) Only the rear wheels are driven. Use when driving under the same conditions as standard 2WD vehicle.

**4H** — (4WD, high range) Four wheels are driven. Use when driving on roads where it is difficult to drive in the 2H position (i.e., driving at normal speeds on snow covered, icy, wet, muddy or sandy roads).

**The 4H position provides maximum power and traction. Avoid excessive speed, as it will cause loss of traction. Speed over 50 MPH (80 km/h) in 4H is not recommend.**

**4L** — (4WD, low range) Four wheels are  
5-20 Starting and driving

driven. Use when climbing or descending steep hills, or during hard driving in sand, mud or deep snow. The 4L position provides maximum power and traction. Avoid raising vehicle speed excessively, as the maximum speed is approximately 30 MPH (50 km/h).

**N** — No wheels are driven. Always keep the transfer lever out of the N position. Shift the lever quickly and smoothly when moving across the N position with the vehicle stopped.

### CAUTION

- Do not drive on dry hard surface roads in four wheel drive.

**Driving on dry hard surfaces in 4H or 4L may cause unnecessary noise and tire wear. We recommend driving in the 2H position under these conditions.**

### WARNING

- When parking the vehicle, apply the parking brake and shift the transfer control lever in the 2H, 4H or 4L position.
- Do not leave the transfer control lever in the N position. Otherwise, the vehicle could roll unexpectedly even if the manual transmission is in any gear or the automatic transmission in the P position. If the ATP light is on, this indicates that the automatic transmission P position will not function and the transfer lever is in neutral.
- Failure to engage the transfer control lever in 2H, 4H or 4L could result in the vehicle moving unexpectedly, resulting in serious personal injury or property damage.

TO SHIFT TRANSFER CASE:	MANUAL TRANSMISSION MODELS SHIFT PROCEDURE
From 2H to 4H	Move the transfer lever to 4H. This can be done at any speed up to 50 MPH (80 km/h), and it is not necessary to depress the clutch pedal. Perform this operation when driving straight.
From 4H to 2H	Move the transfer lever to 2H. This can be done at any speed up to 50 MPH (80 km/h), and it is not necessary to depress the clutch pedal. Perform this operation when driving straight.
From 4H or 4L to 4L or 4H	<ol style="list-style-type: none"> <li>1. Stop the vehicle.</li> <li>2. Depress the clutch pedal.</li> <li>3. Depress the transfer lever and move it to the desired 4L or 4H position.</li> </ol>
From 2H to 4L	<ol style="list-style-type: none"> <li>1. Stop the vehicle.</li> <li>2. Depress the clutch pedal.</li> <li>3. Depress the transfer lever and move it to 4L. Change gears quickly and smoothly.</li> </ol>
From 4L to 2H	<ol style="list-style-type: none"> <li>1. Stop the vehicle.</li> <li>2. Depress the clutch pedal.</li> <li>3. Depress the transfer lever and move it to 2H.</li> </ol>

## TRANSFER CASE SHIFTING PROCEDURES

TO SHIFT TRANSFER CASE:	AUTOMATIC TRANSMISSION MODELS SHIFT PROCEDURE
From 2H to 4H	Move the transfer lever to 4H. This can be done at any speed up to 50 MPH (80 km/h), and it is not necessary to move the selector lever to the N position. Perform this operation when driving straight.
From 4H to 2H	Move the transfer lever to 2H. This can be done at any speed up to 50 MPH (80 km/h), and it is not necessary to move the selector lever to the N position. Perform this operation when driving straight.
From 4H or 4L to 4L or 4H	<ol style="list-style-type: none"> <li>1. Stop the vehicle.</li> <li>2. Move the selector lever to the N position.</li> <li>3. Depress the transfer lever and move it to the desired 4L or 4H position.</li> </ol>
From 2H to 4L	<ol style="list-style-type: none"> <li>1. Stop the vehicle.</li> <li>2. Move the selector lever to the N position.</li> <li>3. Depress the transfer lever and move it to 4L. Change gears quickly and smoothly.</li> </ol>
From 4L to 2H	<ol style="list-style-type: none"> <li>1. Stop the vehicle.</li> <li>2. Move the selector lever to the N position.</li> <li>3. Depress the transfer lever and move it to 2H.</li> </ol>

## PARKING/PARKING ON HILLS

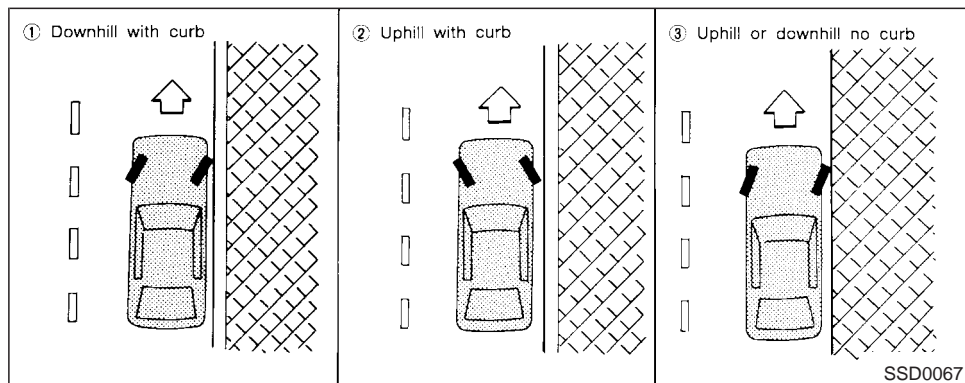

### WARNING

- Do not park the vehicle over flammable materials, such as dry grass, waste paper, or rags. They may ignite and cause a fire.
-  The transfer shift lever must be in the 2H, 4H or 4L position and the parking brake must be set to prevent the vehicle from rolling.

- Never place the transfer shift lever in the N position, otherwise, the vehicle could roll unexpectedly even if the manual transmission is in gear or the automatic transmission is in the P position. This could result in serious personal injury or property damage.

1. Firmly apply the parking brake.
2. **Manual transmission models:**  
Place the shift lever in the R (Reverse)

position. When parking on an uphill grade, place the gearshift lever in the 1st position.

### **Automatic transmission models:**

Move the selector lever to the P (Park) position.

### WARNING

- Safe parking procedures require that both the parking brake be set and the transmission placed into the P (Park) for automatic transmission models or in an appropriate gear for manual transmission models. Failure to do so could cause the vehicle to move unexpectedly or roll away and result in an accident.
- Make sure the automatic transmission selector lever has been pushed as far forward as it can go and cannot be moved without depressing the button at the end of the lever.

3. To help prevent the vehicle rolling into the street when parked on a sloping drive way, it is a good practice to turn the wheels as illustrated.

- **HEADED DOWNHILL WITH CURB:** ①

Turn the wheels into the curb and move the vehicle forward until the curb side wheel gently touches the curb.

- **HEADED UPHILL WITH CURB:** ②

Turn the wheels away from the curb and move the vehicle back until the curb side wheel gently touches the curb.

- **HEADED UPHILL OR DOWNHILL, NO CURB:** ③

Turn the wheels toward the side of the road so the vehicle will move away from the center of the road if it moves.

4. Turn the ignition key to the LOCK position and remove the key.

 **WARNING**

- **Never leave the engine running while vehicle is unattended.**
- **Never leave children unattended in the vehicle.**

## POWER STEERING

The power assisted steering is designed to use a hydraulic pump, driven by the engine, to assist steering.

If the engine stops or drive belt breaks, you will still have control of the vehicle. However, much greater steering effort is needed, especially in sharp turns or at low speeds.

 **WARNING**

**If the engine is not running or is turned off while driving, the power assist for the steering will not work. Steering will be much harder to operate.**

## BRAKE SYSTEM

The brake system has two separate hydraulic circuits. If one circuit develops a problem, you will still have braking at two wheels.

### Vacuum assisted brake

The brake booster aids braking by using engine vacuum. If the engine stops, you can stop the vehicle by depressing the brake pedal. However, greater foot pressure on the brake pedal will be required to stop the vehicle and the stopping distance will be longer.

### Wet brakes

When the vehicle is washed or driven through water, the brakes may get wet. As a result, your braking distance will be longer and the vehicle may pull to one side during braking.

To dry brakes, drive the vehicle at a safe speed while lightly pressing the brake pedal to heat-up the brakes. Do this until the brakes return to normal. Avoid driving the vehicle at high speeds until the brakes function correctly.

### Using the brakes

Avoid resting your foot on the brake pedal while driving. This will overheat the brakes, wear out the brake linings and pads faster and reduce gas mileage.

To help save the brakes and to prevent the brakes from overheating, before going down a

slope or long grade, reduce speed and downshift to a lower gear.

### **WARNING**

- While driving on a slippery surface, be careful when braking, accelerating or downshifting. Abrupt braking or accelerating could cause the wheels to skid and result in an accident.
- If the engine is not running or is turned off while driving, the power assist for the brakes will not work. Braking will be harder.

## ANTI-LOCK BRAKE SYSTEM (ABS)

The anti-lock brake system controls the brakes at each wheel so the wheels will not lock when braking abruptly or when braking on slippery surfaces. The system detects the rotation speed at each wheel and varies the brake fluid pressure to prevent each wheel from locking and sliding. By preventing wheel lockup, the system helps the driver maintain steering control and helps to minimize swerving and spinning on slippery surfaces.

## Using the system

Depress the brake pedal and hold it down.

### **WARNING**

**Do not pump the brake pedal. Doing so may result in increased stopping distances.**

## Normal operation

The anti-lock brake system will not operate at speeds below 3 to 6 MPH (5 to 10 km/h) to completely stop the vehicle. (The speeds will vary according to road conditions.) When the anti-lock system senses that one or more wheels are close to locking up, the actuator (under the hood) rapidly applies and releases hydraulic pressure (like pumping the brakes very quickly). While the actuator is working, you may feel a pulsation in the brake pedal and hear a noise or vibration from the actuator under the hood. This is normal and indicates that the anti-lock system is working properly. However, the pulsation may indicate that road conditions are hazardous and extra care is required while driving.

**If a tire slips on rough roads for more than 10 seconds, the ABS brake warning light**

**may come on. Turn OFF the ignition key, restart the engine and drive the vehicle at speeds above 20 MPH (30 km/h). If the warning light does not go out, have the vehicle checked at a NISSAN dealer.**

## Self-test feature

The anti-lock brake system consists of electronic sensors, electric pumps, and hydraulic solenoids controlled by a computer. The computer has a built-in diagnostic feature that tests the system each time you start the engine and move the vehicle at a low speed in forward or reverse. When the self-test occurs, you may hear a clunk noise and/or feel a pulsation in the brake pedal. This is normal and is not an indication of any malfunction. If the computer senses any malfunction, it switches the anti-lock brake system OFF and turns on the ABS brake warning light in the dashboard. The brake system will then behave normally, but without anti-lock assistance.

If the light comes on during the self check, or while you are driving, you should take your vehicle to your NISSAN dealer for repair at your earliest convenience.



## **WARNING**

The anti-lock brake system is a sophisticated device, but it cannot prevent accidents resulting from careless or dangerous driving techniques. It can help maintain vehicle control during braking on slippery surfaces, but remember that the stopping distance on slippery surfaces will be longer than on normal surfaces, even with the anti-lock system. Stopping distances may also be longer on rough, gravel or snow covered roads, or if you are using tire chains. Always maintain a safe distance from the vehicle in front of you. Ultimately, the responsibility for safety of self and others rests in the hands of the driver.

Tire type and condition of tires may also affect braking effectiveness.

- When replacing tires, install the specified size of tires on all four wheels.
- When installing a spare tire, make sure it is the proper size and type as specified on the tire placard. See

“Tire placard” in the “10. Technical and consumer information” section for tire placard location information.

## **COLD WEATHER DRIVING**

### **FREEING A FROZEN DOOR LOCK**

To prevent a door lock from freezing, apply de-icer or glycerin to it through the key hole. If the lock becomes frozen, heat the key before inserting it into the key hole.

### **ANTI-FREEZE**

In the winter when it is anticipated that the temperature will drop below 32°F (0°C), check anti-freeze (ethylene glycol base) to assure proper winter protection. For details, see “Engine Cooling System” in the “8. Do-it-yourself” section.

### **BATTERY**

If the battery is not fully charged during extremely cold weather conditions, the battery fluid may freeze and damage the battery. To maintain maximum efficiency, the battery should be checked regularly. For details, see “Battery” in the “8. Do-it-yourself” section.

### **DRAINING OF COOLANT WATER**

If the vehicle is to be left outside without anti-freeze, drain the cooling system by opening the drain valves located under the radiator and on the engine block. Refill before operating the vehicle. See “Engine cooling system” in the “8. Do-it-yourself” section for Changing Engine Coolant.

## TIRE EQUIPMENT

1. SUMMER tires are of a tread design to provide superior performance on dry pavement. However, the performance of these tires will be substantially reduced in snowy and icy conditions. If you operate your vehicle on snowy or icy roads, NISSAN recommends the use of MUD & SNOW or ALL SEASON tires on all four wheels. Please consult your NISSAN dealer for the tire type, size, speed rating and availability information.
2. For additional traction on icy roads, studded tires may be used. However, some Provinces and States prohibit their use, so, before installing studded tires, check local, state and provincial laws.

**Skid and traction capabilities of studded snow tires, on wet or dry surfaces, may be poorer than that of non-studded snow tires.**

3. Tire chains may be used if desired. Make sure they are of proper size for the tires on your vehicle and are installed according to the chain manufacturer's suggestions. Use of tire chains may be prohibited according to location. Check the local laws before installing tire chains. When installing tire chains, make sure they are of proper size

for the tires on your vehicle and are installed according to the chain manufacturer's suggestions. **Use only SAE Class S chains.** Other types may damage your vehicle. Use chain tensioners when recommended by the tire chain manufacturer to ensure a tight fit. Loose end links of the tire chain must be secured or removed to prevent the possibility of whipping action damage to the fenders or underbody. If possible, avoid fully loading your vehicle when using tire chains. In addition, drive at a reduced speed. Otherwise, your vehicle may be damaged and/or vehicle handling and performance may be adversely affected.

Do not use the chains on dry roads.

## SPECIAL WINTER EQUIPMENT

It is recommended that the following items be carried in the vehicle during winter:

1. A scraper and stiff-bristled brush to remove ice and snow from the windows and wiper blades.
2. A sturdy, flat board to be placed under the jack to give it firm support.
3. A shovel to dig the vehicle out of snow-drifts.

4. Extra window washer fluid to refill the reservoir tank.

## DRIVING ON SNOW OR ICE

### **WARNING**

- **Wet ice (32°F, 0°C and freezing rain), very cold snow or ice can be slick and very hard to drive on. The vehicle will have a lot less traction or grip under these conditions. Try to avoid driving on wet ice until the road is salted or sanded.**
- **Whatever the condition, drive with caution. Accelerate and slow down with care. If accelerating or downshifting too fast, the drive wheels will lose even more traction.**
- **Allow more stopping distance under these conditions. Braking should be started sooner than on dry pavement.**
- **Allow greater following distances on slippery roads.**
- **Watch for slippery spots (glare ice). These may appear on an otherwise clear road in shaded areas. If a patch of ice is seen ahead, brake before reaching it. Try not to brake while**

**actually on the ice, and avoid any sudden steering maneuvers.**

- **Do not use cruise control on slippery roads.**
- **Snow can trap dangerous exhaust gases under your vehicle. Keep snow clear of the exhaust pipe and from around your vehicle.**

### ENGINE BLOCK HEATER (if so equipped)

An engine block heater to assist extreme cold temperature starting is available through your NISSAN dealer.

### **WARNING**

**Do not use your heater with an ungrounded electrical system or two-pronged (cheater) adapters. You can be injured by an electrical shock if you use an ungrounded connection.**

# 6 In case of emergency

Flat tire .....	6-2
Jump starting.....	6-7
Push starting .....	6-9
If your vehicle overheats .....	6-9
Tow truck towing .....	6-10



## FLAT TIRE

### CHANGING A FLAT TIRE

If you have a flat tire, follow the instructions below.

#### Stopping the vehicle

1. Safely move the vehicle off the road away from traffic.
2. Turn on the hazard warning flasher.
3. Park on a level surface and apply the parking brake. Shift the manual transmission into reverse (automatic transmission in P).

#### WARNING

 The transfer control lever must be in the 2H, 4H or 4L position.

Never place the transfer control lever in the N position. Otherwise, the vehicle could roll unexpectedly even if the manual transmission is in gear or the automatic transmission is in the P position. This could result in serious personal injury or property damage.

4. Turn off the engine.

#### 6-2 In case of emergency

5. Raise the hood to warn other traffic and to signal professional road assistance personnel that you require assistance.
6. Have all passengers get out of the vehicle and stand in a safe place away from traffic and clear of the vehicle.

#### WARNING

- Make sure that the parking brake is securely applied and the manual transmission is shifted into R (reverse), on the automatic transmission in P (Park).
- Never change tires when the vehicle is on a slope, ice or a slippery area. This is hazardous.
- Never change tires if oncoming traffic is close to your vehicle. Wait for professional road assistance.

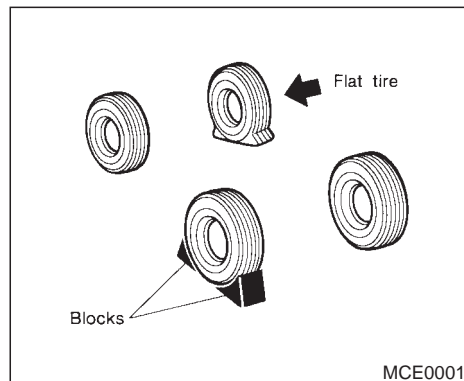

#### Blocking wheels

Place suitable blocks at both the front and back of the wheel diagonally opposite the flat tire.

#### WARNING

Be sure to block the wheel as the vehicle may move and could cause personal injury.

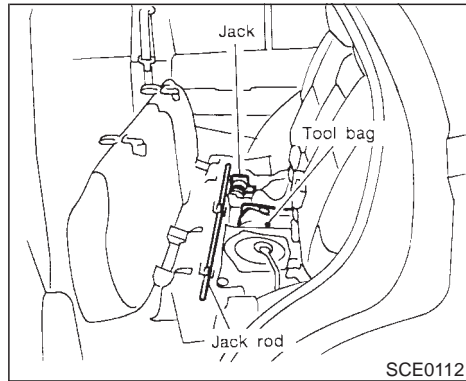

### Getting the spare tire and tools

Remove jacking tools and spare tire from storage area.

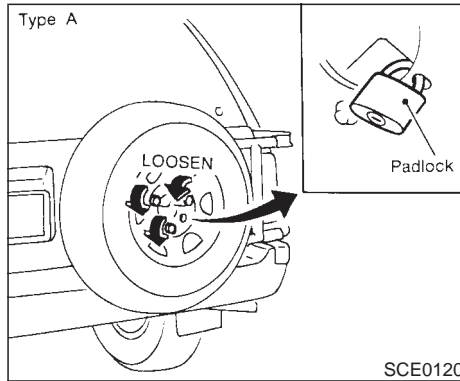

**Tightening torque of nuts:**  
**48 to 66 ft-lb**  
**(66 to 89 N·m)**  
**Use a suitable padlock.**

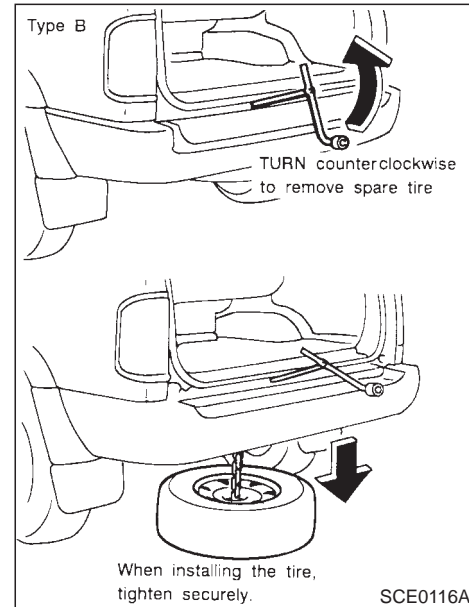

### **CAUTION**

- Do not insert the jack rod straight as it is designed to be inserted obliquely.

- Make sure the rod tip fits in the fitting portion of the spare tire hanger and turn the rod.
- Be sure to center the spare tire suspending plate on the wheel and then lift the spare tire.

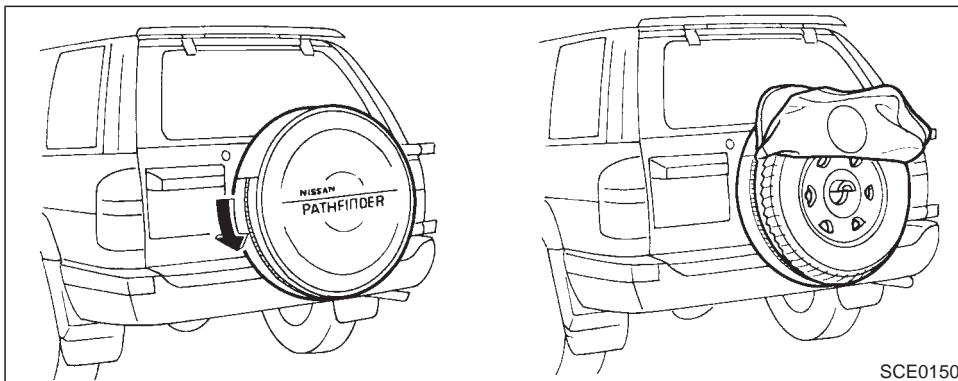

### Removing the spare tire cover (if so equipped)

The spare tire cover cannot be removed or attached unless the spare tire is detached from the spare tire carrier.

1. Attach the cover to the entire periphery of the inner half and the top part of the spare tire.
2. Secure the spare tire to the spare tire carrier as shown in the illustration.
3. Fasten the zip fastener of the spare tire cover.

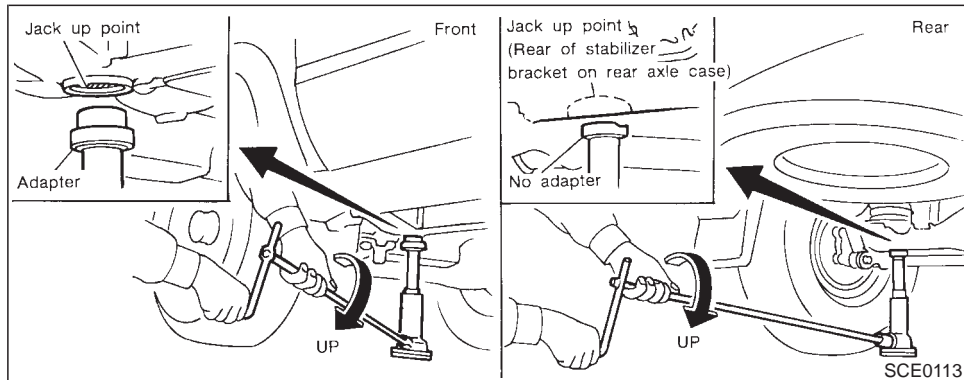

Jacking up the vehicle and removing the damaged tire

Carefully read the following instructions.

1. On models with 265/70 R15 size tires, put the adapter stored in the tool bag on the jack when jacking up the front side.

**Do not use the jack adapter for the rear.**

2. Place the jack directly under the jack-up point.

**The jack should be used on level firm ground.**

3. Loosen each wheel nut one or two turns by turning counterclockwise with the wheel nut wrench.

**Do not remove the wheel nuts until the tire is off the ground.**

4. Carefully raise the vehicle until the tire clears the ground. To lift the vehicle, securely hold the jack lever and rod with both hands as shown above. Remove the wheel nuts, and then remove the wheel. Do not remove the brake drum with the wheel.

## **⚠ WARNING**

- Never get under the vehicle while it is supported only by the jack.
- Use only the jack provided with your vehicle. Do not use the jack provided with your vehicle on other vehicles. The jack is designed only for lifting your vehicle during a tire change.
- Use the correct jack up points; never use any other part of the vehicle for jack support.
- Never jack up the vehicle more than necessary.
- Never use blocks on or under the jack.
- Do not start or run engine while vehicle is on the jack, as it may cause the vehicle to move. This is especially true for vehicle with limited slip differential carriers.
- Do not allow passengers to stay in the vehicle while it is on the jack



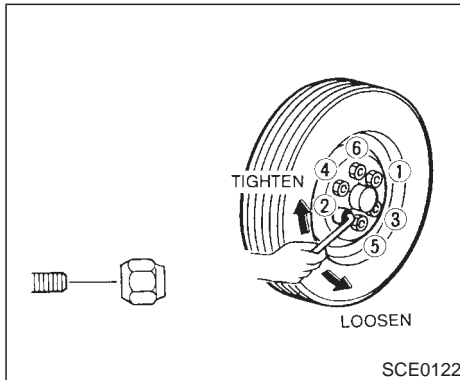
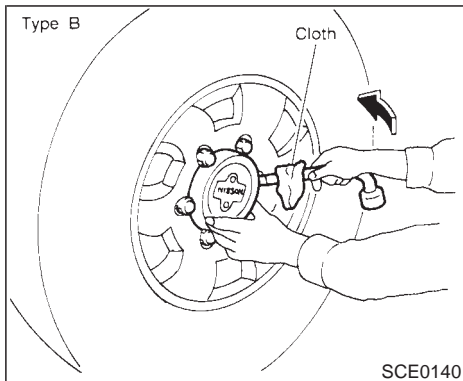
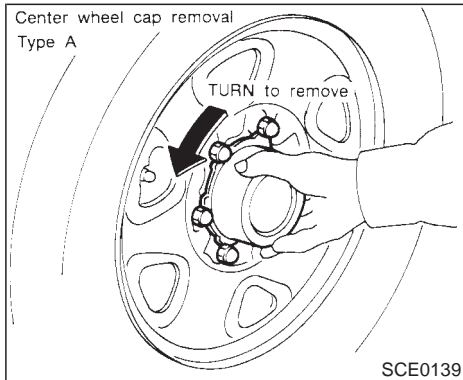

### Installing the spare tire

1. Clean any mud or dirt from the surface between the wheel and hub.
2. Carefully put the wheel on and tighten the wheel nuts finger tight.
3. With the wheel nut wrench, tighten wheel nuts alternately and evenly until they are tight.
4. Lower the vehicle slowly until the tire touches the ground. Then, with the wheel nut wrench, tighten the wheel nuts securely in the sequence as illustrated.

### **! WARNING**

- Incorrect wheel nuts or improperly tightened wheel nuts can cause the wheel to become loose or come off. This could cause an accident.
- Do not use oil or grease on the wheel studs or nuts. This could cause the nuts to become loose.

As soon as possible tighten the wheel nuts to the specified torque with a torque wrench.

Wheel nut tightening torque:  
87 to 108 ft-lb (118 to 147 N·m)

Adjust tire pressure to the COLD pressure.

**COLD** pressure:

After vehicle has been parked for three hours or more or driven less than 1 mile (1.6 km).

**COLD** tire pressures are shown on the tire placard affixed to the glove box lid.

Retighten the wheel nuts when the vehicle has been run for 600 miles (1,000 km) after installing the aluminum wheel.

5. Securely store the spare tire and jacking equipment in the vehicle.

 **WARNING**

Always make sure that the spare tire and jacking equipment are properly secured after use. Such items can become dangerous projectiles in an accident or sudden stop.

## JUMP STARTING

If you try to start your engine with a booster battery, follow the instructions and precautions below:

 **WARNING**

- If done incorrectly, jump starting can lead to a battery explosion, resulting in severe injury or death. It could also damage your vehicle.
- Explosive hydrogen gas is always present in the vicinity of the battery. Keep all sparks and flames away from it.
- Do not allow battery fluid to come into contact with eyes, skin, cloth or painted surfaces. Battery fluid is a corrosive sulphuric acid solution which can cause severe burns. If the fluid should come into contact with anything, immediately flush the contacted area with water.
- Keep battery out of the reach of children.
- The booster battery must be rated at 12 volts. Use of an improperly rated battery can damage your vehicle.

- Whenever working on or near a battery, always wear suitable eye protectors (for example, goggles or industrial safety spectacles) and remove rings, metal bands, or any other metal jewelry. Do not lean over battery when jump-starting.
- Do not attempt to jump start a frozen battery. It could explode and cause serious injury.
- Your vehicle has an automatic engine cooling fan. It could come on at any time. Keep hands and other objects away from it.

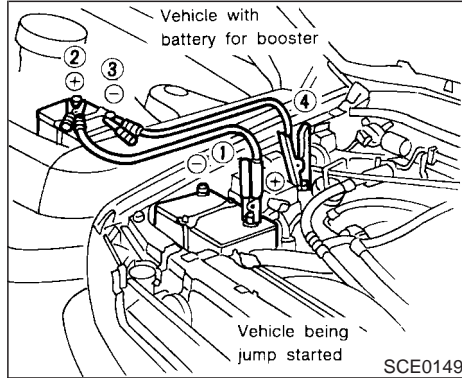

## WARNING

Always follow the instructions below exactly. Failure to do so could result in damage to the charging system and cause personal injury.

1. Position the two vehicles to bring their batteries into close proximity to each other if the booster battery is in another vehicle. **Do not allow the two vehicles to touch.**
2. Apply parking brakes. Move the shift lever to Neutral position (On automatic transmis-

## 6-8 In case of emergency

sion models, move the selector lever to P (Park)). Switch off all unnecessary electrical systems (light, heater, air conditioner, etc.).

3. Remove vent caps on the battery (if so equipped). Cover the battery with an old cloth to reduce explosion hazard.
4. Connect jumper cables in the sequence as illustrated.

## CAUTION

- Always connect positive (+) to positive (+) and negative (-) to body ground, (for example, engine lift bracket, etc. — not to the battery).
- Make sure that cables do not touch any moving parts in the engine compartment and that clamps do not contact any other metal.

5. Start the engine of the other vehicle and let it run for a few minutes.
6. Keep the engine speed of the other vehicle at about 2,000 rpm, and start your engine in the normal manner.

## CAUTION

**Do not keep starter motor engaged for more than 10 seconds. If the engine does not start right away, turn the key off and wait 3 to 4 seconds before trying again.**

7. After starting your engine, carefully disconnect the negative cable and then the positive cable.
8. Replace the vent caps (if so equipped). Be sure to dispose of the cloth used to cover the vent holes as it may be contaminated with corrosive acid.

## PUSH STARTING

### CAUTION

- Automatic transmission models cannot be push started. This may cause transmission damage.
- Three way catalyst equipped models should not be started by pushing since the three way catalyst may be damaged.
- Never try to start the vehicle by towing it; when the engine starts, the forward surge could cause the vehicle to collide with the tow vehicle.

## IF YOUR VEHICLE OVERHEATS

If your vehicle is overheating indicated by an extremely high temperature gauge reading, or if you feel a lack of engine power, detect abnormal noise, etc., take the following steps:

### WARNING

- Do not continue to drive if your vehicle overheats. Doing so could cause a vehicle fire.
- To avoid the danger of being scalded, never remove the radiator cap while the engine is still hot. When the radiator cap is removed, pressurized hot water will spurt out, possibly causing serious injury.
- Do not open the hood if steam is coming out.

1. Move the vehicle safely off the road, apply the parking brake and move the gearshift lever to the neutral position (automatic transmission to P (Park)).

**Do not stop the engine.**

2. Turn off the air conditioner switch. Open all the windows, move the heater or air conditioner temperature control to maximum hot

and fan control to high speed.

3. If engine overheating is caused by climbing a long hill on a hot day, run the engine at a fast idle (approximately 1,500 rpm) until the temperature gauge indication returns to normal.
4. Get out of the vehicle. Look and listen for steam or coolant escaping from the radiator before opening the hood. Wait until no steam or coolant can be seen before proceeding.
5. Open the engine hood.

### WARNING

**If steam or water is coming from the engine, stand clear to prevent getting burned.**

6. Visually check drive belts for damage or looseness. Also check if the cooling fan is running. The radiator hoses and radiator should not leak water. If coolant is leaking, the cooling fan belt is missing or loose or the cooling fan does not run, stop the engine.

## TOW TRUCK TOWING

### **WARNING**

**Be careful not to allow your hands, hair, jewelry or clothing to come into contact with, or to get caught in, the cooling fan, or drive belt.**

7. After the engine cools down, check the coolant level in the reservoir tank with the engine running. Add coolant to the reservoir tank if necessary. Have your vehicle repaired at the nearest NISSAN dealer.

When towing your vehicle, all State (Provincial in Canada) and local regulations for towing must be followed. Incorrect towing equipment could damage your vehicle. Towing instructions are available from your NISSAN dealer. Local service operators will generally be familiar with the applicable laws and procedures for towing. To assure proper towing and to prevent accidental damage to your vehicle, NISSAN recommends that you have a service operator tow your vehicle. It is advisable to have the service operator carefully read the following precautions.

### **WARNING**

- **Never ride in a vehicle that is being towed.**
- **Never get under your vehicle after it has been lifted by a tow truck.**

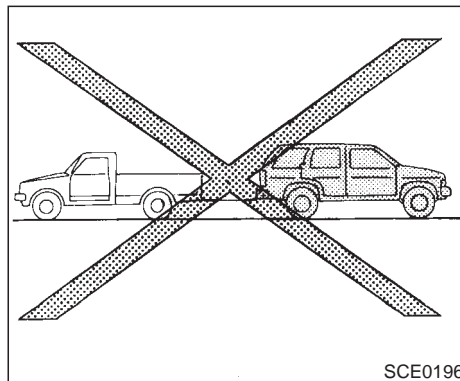

SCE0196

### **CAUTION**

- **When towing, make sure that the transmission, axles, steering system and power train are in working condition. If any unit is damaged, dollies must be used.**
- **Always attach safety chains before towing.**
- **Never tow an automatic transmission model from the rear (that is backward) with four wheels on the**

ground as this may cause serious and expensive damage to the transmission.

Two wheel drive models

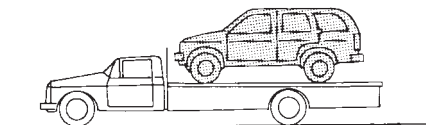
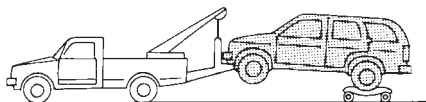
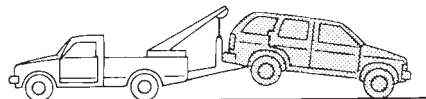

SCE0197

## TOWING RECOMMENDED BY NISSAN

NISSAN recommends that your vehicle be towed with the driving (rear) wheels off the ground as illustrated.

## CAUTION

- When towing with the front wheels on the ground: Turn the ignition key to the OFF position and secure the steering wheel in a straightahead position with a rope or similar device. Never place the ignition key in the LOCK position. This will result in damage to the steering lock mechanism.
- When towing manual transmission models with the rear wheels on the ground (if you do not use towing dollies): Always release the parking brake and move the transmission shift lever to the N (neutral) position.

Observe the following restricted towing speeds and distances.

- **Speed:** Below 60 MPH (95 km/h)
- **Distance:** Less than 500 miles (800 km)

If the speed or distance must necessarily be greater, remove the propeller shaft beforehand to prevent damage to the transmission.

Four wheel drive models (part time)

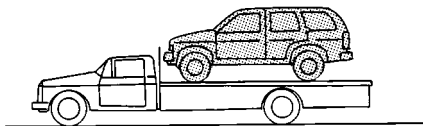
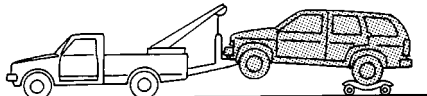
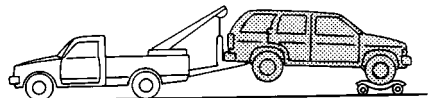

SCE0198

NISSAN recommends that a dolly be used as illustrated when towing four wheel drive models.

## CAUTION

When towing with the front wheels on the ground or with the rear wheels on the ground (if you do not use towing dollies): Move the transfer case shift lever into the 2H position.

- When towing with the front wheels on the ground: Turn the ignition key to the OFF position and move the transmission shift lever to the N (neutral) position, on automatic transmission models to move the selector lever to N (neutral) position, turn the ignition key to the ACC position. After moving the selector lever to the N (neutral) position. Turn the ignition key to the OFF position and secure the steering wheel in a straightahead position with a rope or similar device. Never place the ignition key in the LOCK position. This will result in damage to the steering lock mechanism.
- When towing manual transmission models with the rear wheels on the ground:  
Always release the parking brake and

move the transmission shift lever to the N (neutral) position.

Observe the following restricted towing speeds and distances.

**Speed: Below 60 MPH (95 km/h)**

**Distance: Less than 500 miles (800 km)**

If the speed or distance must necessarily be greater, remove the front and rear propeller shafts beforehand to prevent damage to the transmission.

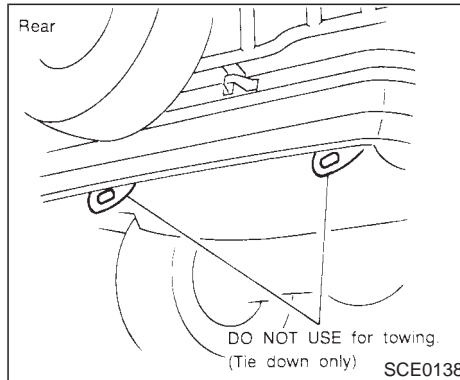
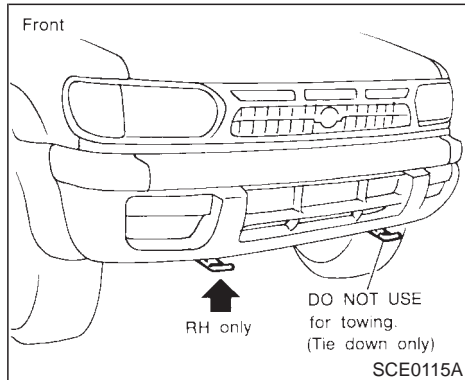

damaged.

## VEHICLE RECOVERY (Freeing a stuck vehicle)

- Use the towing **hook** only, not other parts of the vehicle. Otherwise, the vehicle body will be damaged.
- Use the towing hook **only** to free a vehicle stuck in sand, snow, mud, etc. **Never** tow the vehicle for a long distance using only the towing hook.

- The towing hook is under tremendous force when used to free a stuck vehicle. Always pull the cable straight out from the front of the vehicle. **Never** pull on the hook at an angle.
- Stand clear of a stuck vehicle.

### **WARNING**

**Do not spin your tires at high speed. This could cause them to explode and result in serious injury. Parts of your vehicle could also overheat and be**



**MEMO**

# 7 Appearance and care

Cleaning exterior .....	7-2
Washing .....	7-2
Cleaning interior .....	7-4
Corrosion protection .....	7-5



## CLEANING EXTERIOR



In order to maintain the appearance of your vehicle, it is important to take proper care of it.

In the following cases, please wash your vehicle as soon as possible to protect the paint surface.

- After a rainfall to prevent possible damage from acid rain
- After driving on coastal roads
- When contaminants such as soot, bird droppings, tree sap, metal particles or bugs get on the paint surface
- When dust or mud builds up on the surface

### 7-2 Appearance and care

Whenever possible, store or park your vehicle inside a garage or in a covered area.

When it is necessary to park outside, park in a shady area or protect the vehicle with a body cover.

**Be careful not to scratch the paint surface when putting on or removing the body cover.**

## WASHING

Wash dirt off with a wet sponge and plenty of water. Clean the vehicle thoroughly using a mild soap such as Nissan Car Wash, or a general purpose dish-washing liquid mixed with clean, lukewarm (never hot) water.

### CAUTION

- Do not use strong household soap, strong chemical detergents, gasoline or solvents.
- Do not wash the vehicle in direct sunlight or while the vehicle body is hot, as the surface may become water-spotted.
- Avoid using tight-napped or rough cloths, such as washing mitts. Care must be taken when removing caked-on dirt or other foreign substance so that the paint surface is not scratched or damaged.

Rinse the vehicle thoroughly with plenty of clean water.

Inside flanges, seams and folds on the doors, hatches and hood are particularly endangered by the effects of road salt. Therefore, these

areas must be regularly cleaned. Take care that the drain holes in the lower edge of the door are open. Spray water under the body and in the wheel wells to loosen the dirt and wash away road salt.

A damp chamois can be used to dry the vehicle to avoid water spots.

## WAXING

Regular waxing protects the paintwork and keeps the finish. After waxing, polishing is recommended to remove built-up residue and avoid a “weathered” appearance.

Your NISSAN dealer can assist you in choosing the proper product.

- Wax your vehicle only after a thorough washing. Follow the instructions supplied with the wax.
- Do not use a wax containing any abrasives, cutting compounds or cleaners that may damage the vehicle finish.
- If the surface does not polish easily, use a road tar remover and wax again.

**Machine compounding or aggressive polishing on a base coat/clear coat paint finish may dull the finish or leave swirl marks.**

Only apply black wax or black shoe polish to

the black urethane or polypropylene bumper.

## REMOVING SPOTS

Remove tar and oil spots, industrial dust, insects and tree sap as quickly as possible from the surface of the paint to avoid lasting damage or staining. Special cleaning products are available at your NISSAN dealer or any automotive accessories store.

## UNDERBODY

In areas where road salt is used in winter, it is necessary to clean the underbody regularly in order to prevent dirt and salt from building up and causing corrosion on the underbody and suspension. Before the winter period and again in the spring, the underseal must be checked and, if necessary, re-treated.

## GLASS

Use glass cleaner to remove smoke and dust film from the glass surfaces. It is normal for glass to be coated with a film after the vehicle is parked in the hot sun. Glass cleaner and a soft cloth will easily remove this film.

**tools or abrasive cleaners or chlorine-based disinfectant cleaners.**

- **These may damage the radio antenna elements or rear window defroster.**

## ALUMINUM ALLOY WHEELS

Wash regularly, especially during winter months in areas where road salt is used. Salt could discolor the wheel if not removed.

## CHROME PARTS

Clean all chrome parts regularly with a non-abrasive chrome polish to maintain the finish.



- **When cleaning the inside of the window, do not use any sharp-edged**

## CLEANING INTERIOR

Occasionally remove loose dust from the interior trim, plastic parts and seats using a vacuum cleaner or soft brush. Wipe the vinyl and leather surfaces with a clean, soft cloth dampened in mild soap solution, then wipe clean with a dry soft cloth. Before using any fabric protector, read the manufacturer's recommendations. Some fabric protectors contains chemicals that stain or bleach the seat material.

### CAUTION

- **Never use benzine, thinner or any similar material.**
- **The leather seats should be regularly coated with a leather wax like saddle soap. Never use car wax.**
- **Never use fabric protectors unless recommended by the manufacturer.**

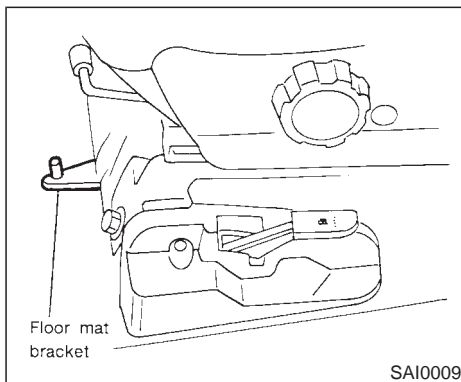

## FLOOR MATS

The use of Genuine Nissan floor mats can extend the life of your vehicle carpet and make it easier to clean the interior. **No matter what mats are used, be sure they are fitted for your vehicle and are properly positioned in the footwell to prevent interference with pedal operation.** Mats should be maintained with regular cleaning and replaced if they become excessively worn.

## Floor mat positioning aid (Driver side only)

This model includes a front floor mat bracket to act as a floor mat positioning aid. NISSAN floor mats have been specially designed for your vehicle model. The driver side floor mat has a grommet hole incorporated in it. Simply position the mat by placing the floor mat bracket hook through the floor mat grommet hole while centering the mat in the floorpan contour.

Periodically check to make certain the mats are properly positioned.

## SEAT BELTS

The seat belts can be cleaned by wiping them with a sponge dampened in a mild soap solution. Allow the belts to dry completely before using them.

### WARNING

**Do not allow wet belts to roll up in the retractor. NEVER use bleach, dye or chemical solvents since these may severely weaken the seat belt webbing.**

## CORROSION PROTECTION

### MOST COMMON FACTORS CONTRIBUTING TO VEHICLE CORROSION

1. The accumulation of moisture-retaining dirt and debris in body panel sections, cavities, and other areas.
2. Damage to paint and other protective coatings caused by gravel and stone chips or minor traffic accidents.

### ENVIRONMENTAL FACTORS INFLUENCE THE RATE OF CORROSION

#### Moisture

The accumulation of sand, dirt and water on the underside of the body will accelerate corrosion. Floor sections which have snow and ice trapped under the floor matting will not dry.

#### Relative humidity

Corrosion will be accelerated:

- in areas of high relative humidity
- especially in areas where the temperatures stay above freezing
- where atmospheric pollution exists
- where road salt is used

#### Temperature

A temperature increase will accelerate the rate of corrosion to those parts which are not well ventilated.

#### Air pollution

Industrial pollution, the presence of salt in the air in coastal areas, or heavy road salt use will accelerate the corrosion process. Road salt will also accelerate the disintegration of paint surfaces.

### TO PROTECT YOUR VEHICLE FROM CORROSION

- Wash and wax your vehicle often to keep the vehicle clean.
- Always check for minor damage to the paint and repair it as soon as possible.
- Keep drain holes at the bottom of the doors and tailgate open to avoid water accumulation.
- Check the underbody. If any sand, dirt or salt is accumulated, wash it off with water as soon as possible.

### CAUTION

- **NEVER** remove dirt, sand or other debris from the passenger compartment by washing with a hose. Remove dirt with a vacuum cleaner or broom.
- **Never** allow water or other liquids to come in contact with electronic components inside the vehicle.

Chemicals used for road surface de-icing are extremely corrosive and will accelerate corrosion and the deterioration of underbody components such as the exhaust system, fuel and brake lines, brake cables, floor pan and fenders.

**In winter, the underbody must be cleaned periodically.**

For additional protection against rust and corrosion, which may be required in some areas, consult your local NISSAN dealer.

**MEMO**

# 8 Do-it-yourself

Maintenance precautions .....	8-2
Engine compartment check locations .....	8-3
Engine cooling system .....	8-4
Engine oil .....	8-7
Automatic transmission fluid .....	8-9
Power steering fluid .....	8-11
Brake and clutch fluid .....	8-11
Window washer fluid .....	8-12
Battery .....	8-13
Drive belts .....	8-14
Spark plugs .....	8-14
Air cleaner .....	8-16
Windshield wiper blades .....	8-17
Parking brake and brake pedal.....	8-18
Clutch pedal .....	8-20
Fuses.....	8-20
Lights .....	8-21
Tires and wheels.....	8-26
<b>4x4</b> Clutch housing drain .....	8-30



## MAINTENANCE PRECAUTIONS

When performing any inspection or maintenance work on your vehicle, always take care to prevent serious accidental injury to yourself or damage to the vehicle. The following are general precautions which should be closely observed.

### WARNING

- **Park the vehicle on a level surface, apply the parking brake securely and block the wheels to prevent the vehicle from moving. For a manual transmission, move the shift lever to Neutral. For an automatic transmission, move the selector lever to P (Park).**
- **Be sure the ignition key is in the OFF or LOCK position when performing any replacement or repair.**
- **If you must work with the engine running, keep your hands, clothing, hair and tools away from moving fans and fan belts.**
- **It is advisable to remove necktie and any jewelry, such as rings, watches, etc. before working on your vehicle.**

- **Always wear eye protection whenever you work on your vehicle.**
- **If you must run the engine in an enclosed space such as a garage, be sure there is proper ventilation for exhaust gases.**
- **Never get under the vehicle while it is supported only by a jack. If it is necessary to work under the vehicle, support it with safety stands.**
- **Keep smoking materials, flame and sparks away from fuel and battery.**
- **The fuel filter or fuel lines should be serviced by a NISSAN dealer because the fuel lines are under high pressure even when the engine is off.**

### CAUTION

- **Do not work under the engine hood while it is hot. Always turn off the engine and wait until it cools down.**
- **Never connect or disconnect either the battery or any transistorized com-**

**ponent connector while the ignition key is on.**

- **Avoid direct contact with used engine oil. Improperly disposed motor oil and/or other vehicle fluids can hurt the environment. Always conform to local regulations for disposal of vehicle fluid.**

This "8. Do-it-yourself" section gives instructions regarding only those items which are relatively easy for an owner to perform.

You should be aware that incomplete or improper servicing may result in operating difficulties or excessive emissions, and could affect your warranty coverage. **If in doubt about any servicing, have it done by your NISSAN dealer.**

# ENGINE COMPARTMENT CHECK LOCATIONS

## VG33E engine

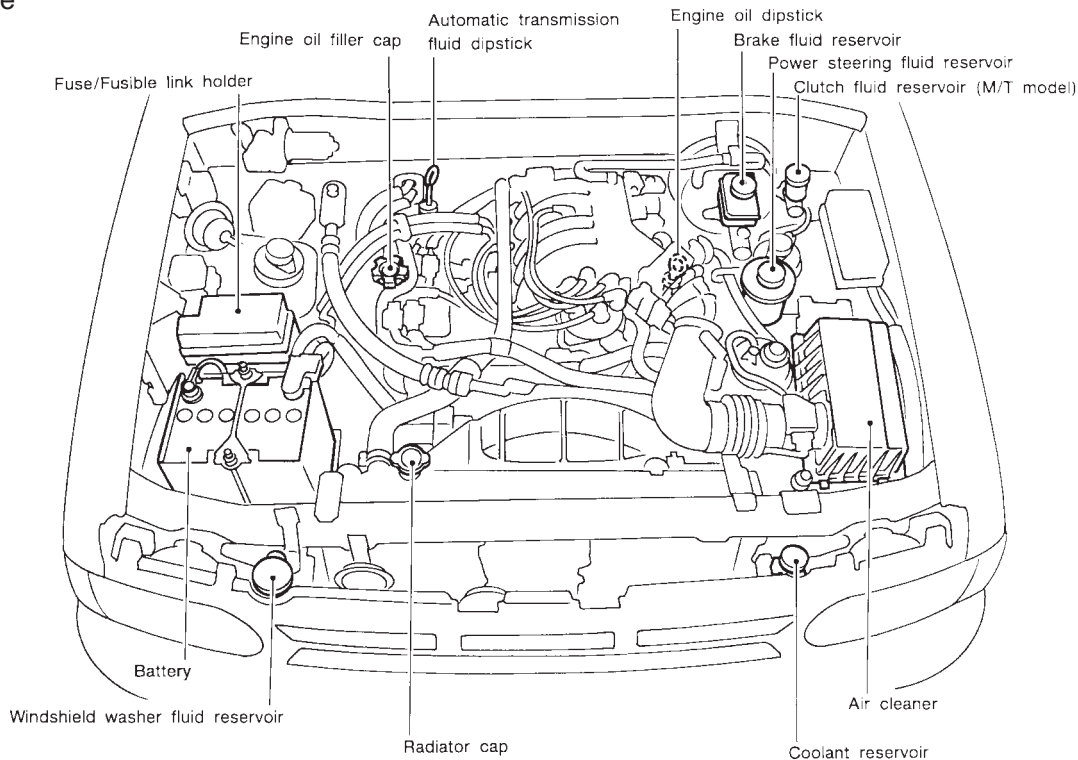

SDI0418

## ENGINE COOLING SYSTEM

The engine cooling system is filled at the factory with a high-quality, year-round, anti-freeze coolant solution. The anti-freeze solution contains rust and corrosion inhibitors, therefore additional cooling system additives are not necessary.

### CAUTION

When adding or replacing the coolant, be sure to use an ethylene glycol anti-freeze with the proper mixture ratio of 50% anti-freeze and 50% distilled water. The use of other types of coolant solutions may damage your engine cooling system.

Outside temperature down to		Anti-freeze	Distilled water
°C	°F		
-35	-30	50%	50%

### WARNING

- Never remove the radiator cap when the engine is hot; serious burns could be caused by high pressure fluid escaping from the radiator. Wait until the engine and radiator cool down. Serious burns could be caused by high pressure fluid escaping from the radiator. See “If your vehicle overheats” in the “6. In case of emergency” section.
- The radiator is equipped with a pressure cap. Use only a genuine cap as a replacement.

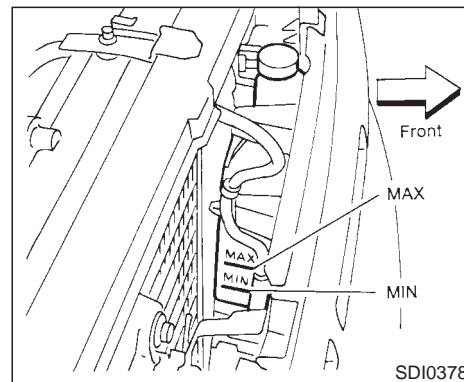

### CHECKING ENGINE COOLANT LEVEL

Check the coolant level in the reservoir tank when the engine is cold. If the coolant level is below the MIN level, add coolant to the MAX level. If the reservoir tank is empty, check the coolant level in the radiator **when the engine is cold**. If there is insufficient coolant in the radiator, fill the radiator with coolant up to the filler opening and also add it to the reservoir tank up to the MAX level.

**If the engine cooling system frequently**

requires coolant, have it checked by your NISSAN dealer.

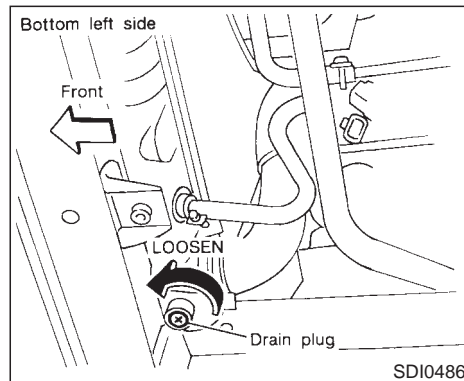
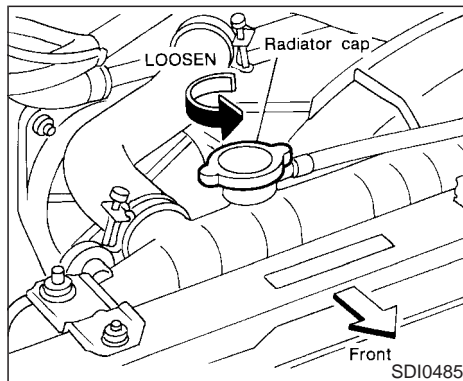

## CHANGING ENGINE COOLANT

- Major cooling system repairs should be performed by your NISSAN dealer. The service procedures can be found in the appropriate NISSAN Service Manual.
- Improper servicing can result in reduced heater performance and engine overheating.

### WARNING

- To avoid the danger of being scalded, never change the coolant when the engine is hot.
- Never remove the radiator cap when the engine is hot. Serious burns could be caused by high pressure fluid escaping from the radiator.

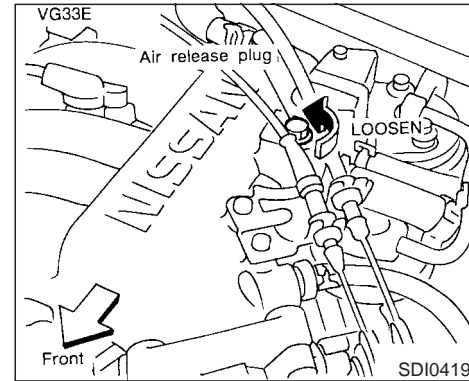
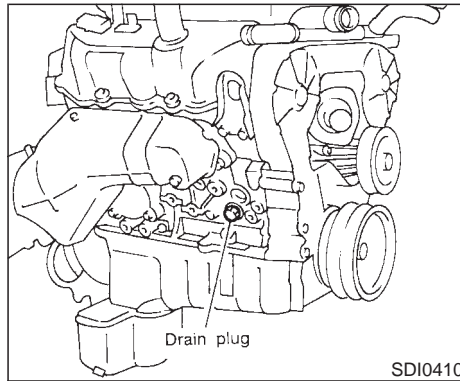
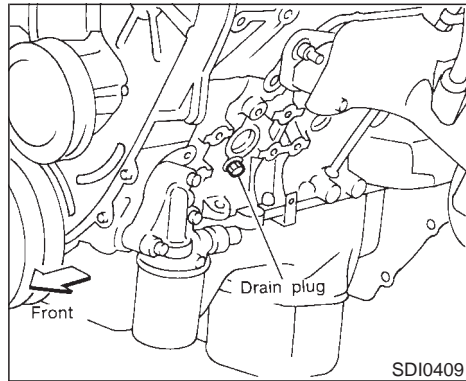

1. Perform the following procedure to open the heater water cock.
  - Turn the ignition key from OFF to ON.
  - Move the heater or air conditioner temperature control dial to the maximum hot position then turn the ignition key to OFF.
2. Open the radiator drain plug and radiator cap.
 

Open the drain plugs on the engine block.

3. Open the air release plug to drain the coolant.
4. Flush the cooling system by running fresh water through the radiator.
5. Close the radiator drain plug and engine block drain plugs securely.
6. See the "Technical information" section for cooling system capacity.
 

Fill the radiator slowly with the proper mixture of coolant and water. Fill the reservoir tank slowly up to the MAX level. Then install the radiator cap and close the air release plug.

7. Start the engine and warm it up until it reaches normal operating temperature. Then race the engine 2 or 3 times under no load.
 

Watch the coolant temperature gauge for signs of overheating.
8. Stop the engine. After it completely cools down, refill the radiator up to the filler opening. Fill the reservoir tank up the MAX level.
9. Check the radiator drain plug and engine block drain plugs for any sign of leakage.

## ENGINE OIL

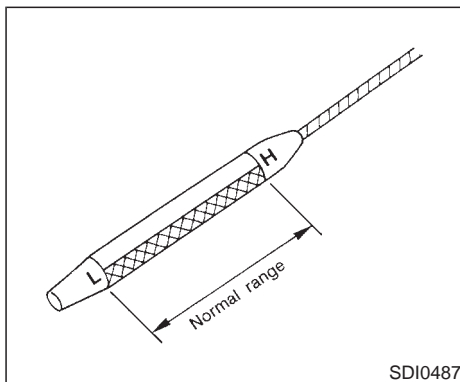
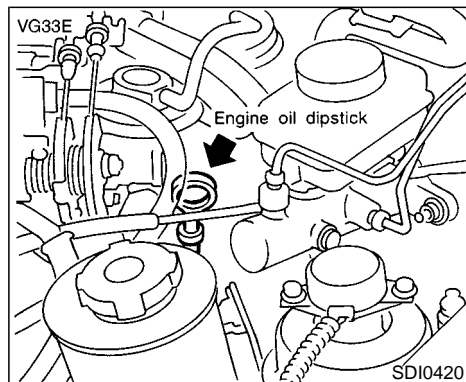

### CAUTION

Oil level should be checked regularly. Operating with insufficient amount of oil can damage the engine, and such damage is not covered by warranty.

### CHECKING ENGINE OIL LEVEL

1. Park the vehicle on a level surface and apply the parking brake.
2. Run the engine until it reaches operating temperature.
3. Turn off the engine. **Wait more than 10 minutes for the oil to drain back into the oil pan.**
4. Remove the dipstick and wipe it clean. Reinsert it all the way.

5. Remove the dipstick again and check the oil level. It should be between the H and L marks. If the oil level is below the L mark, remove the oil filler cap and pour recommended oil through the opening. Do not overfill.
6. Recheck oil level with dipstick.

**It is normal to add some oil between oil changes or during the break-in period, depending on the severity of operating conditions.**

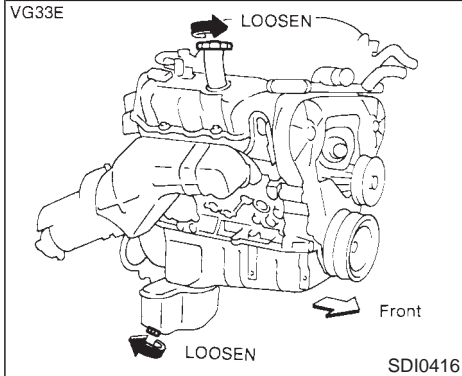

## CHANGING ENGINE OIL

1. Park the vehicle on a level surface and apply the parking brake.
2. Warm up the engine until it reaches operating temperature, and then turn it off.
3. Place a large drain pan under the drain plug.
4. Remove the oil filler cap.
5. Remove the drain plug with a wrench and completely drain the oil.

If the oil filter is to be changed, remove and replace it at this time. See later in this

### 8-8 Do-it-yourself

section for changing engine oil filter.

### CAUTION

Be careful not to burn yourself, as the engine oil is hot.

Waste oil must be disposed of properly. Check your local regulations.

6. Clean and re-install the drain plug and new washer. Securely tighten the drain plug with a wrench. Do not use excessive force.

**Drain plug tightening torque:**  
22 to 29 ft-lb (29 to 39 N·m)

7. Refill engine with recommended oil and install the oil filler cap securely.

See “Capacities and recommended fuel/lubricants” in the “10. Technical and consumer information” section for refill capacity.

8. Start the engine.

Check for leakage around the drain plug. Correct as required.

9. Turn the engine off and wait several minutes. Check the oil level with the dipstick. Add engine oil if necessary.

### WARNING

- Prolonged and repeated contact with used engine oil may cause skin cancer.
- Try to avoid direct skin contact with used oil. If skin contact is made, wash thoroughly with soap or hand cleaner as soon as possible.
- Keep used engine oil out of reach of children.

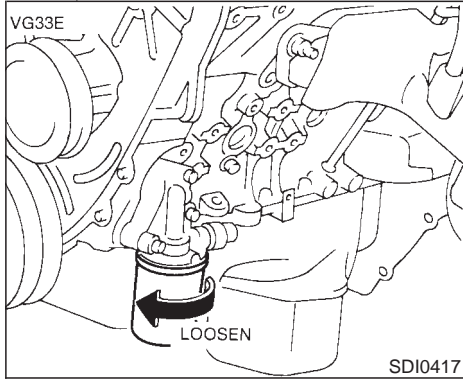

## CHANGING ENGINE OIL FILTER

1. Park the vehicle on a level surface and apply the parking brake.
2. Turn the engine off.
3. Loosen the oil filter with an oil filter wrench. (A special **cap-type** wrench will assist with oil filter removal on models with the V6 engine. This tool can be purchased from your NISSAN dealer.) Then remove the oil filter by turning it by hand.

### CAUTION

Be careful not to burn yourself, as the engine oil may be hot.

4. Wipe the engine oil filter mounting surface with a clean rag.  
Be sure to remove any old rubber gasket remaining on the mounting surface of the engine.
5. Coat the rubber gasket on the new filter with engine oil.
6. Screw in the oil filter until a slight resistance is felt, then tighten an additional 2/3 turn.
7. Start the engine and check for leakage around the oil filter. Correct as required.
8. Turn the engine off and wait several minutes. Check the oil level. Add engine oil if necessary.

## AUTOMATIC TRANSMISSION FLUID

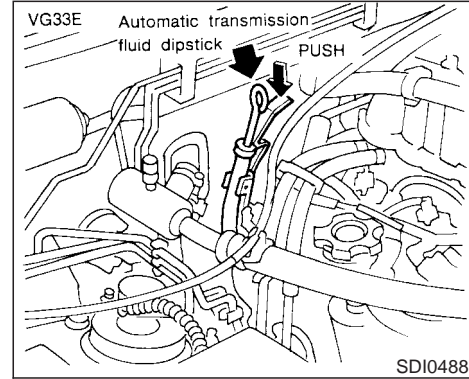

### WARNING

- When engine is running, keep hands, jewelry, and clothing away from any moving parts such as fan and drive belt.
- Automatic transmission fluid is poisonous and should be stored carefully in marked containers out of the reach of children.



## TEMPERATURE CONDITIONS FOR CHECKING

The fluid level should be checked using the HOT range (L & H marks) on the dipstick at fluid temperatures between 122 and 176°F (50 and 80°C) after the vehicle has been driven approximately 5 minutes in urban areas after the engine is warmed up. The level can be checked at fluid temperatures between 86 and 122°F (30 and 50°C) using the COLD range on the dipstick for reference, after the engine is warmed up but before driving. However, the fluid level must be rechecked using the HOT range.

1. Park the vehicle on a level surface and set the parking brake.
2. Start the engine and then move the selector lever through each gear range, ending in P.
3. Check the fluid level with the engine idling.

**If the vehicle has been driven for a long time at high speeds, or in city traffic in hot weather, or if it is being used to pull a trailer, the fluid level cannot be read accurately. You should wait until the fluid has cooled down (about 30 minutes).**

4. Remove the dipstick and wipe it clean with lint-free paper.

### 8-10 Do-it-yourself

5. Re-insert the dipstick into the charging pipe as far as it will go.
  6. Remove the dipstick and note the reading.
- If the level is on the low side of either range, add fluid to the charging pipe.

### CAUTION

- Do not overfill.
- **USE ONLY Nissan Matic D (Continental U.S. and Alaska) or Genuine Nissan Automatic Transmission Fluid (Canada). Dexron™ III/Mercon™ or equivalent may also be used. Outside the continental United States and Alaska contact a NISSAN dealer for more information regarding suitable fluids, including recommended brand(s) of Dexron™ III/Mercon™ or Dexron™ IIE/Mercon™ Automatic Transmission Fluid.**

- Front side

HOT [122 to 176°F (50 to 80°C)]

Add → | ← OK



- Reverse side

COLD [86 to 122°F (30 to 50°C)]

Add → | ← OK

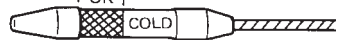

SDI0386A

## POWER STEERING FLUID

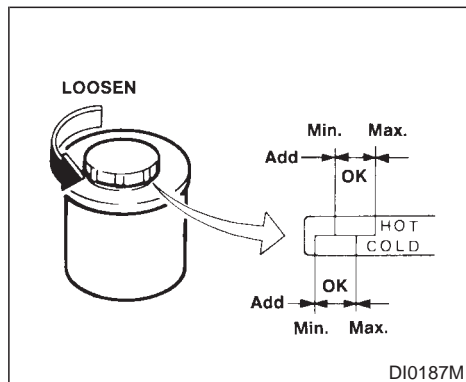

Check the fluid level.

The fluid level should be checked using the HOT range on the dipstick at fluid temperatures of 122 to 176°F (50 to 80°C) or using the COLD range on the dipstick at fluid temperatures of 32 to 86°F (0 to 30°C).

### CAUTION

- Do not overfill.
- Use type DEXRON™III or equivalent.

## BRAKE AND CLUTCH FLUID

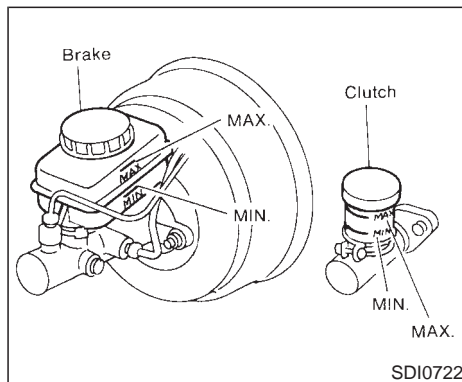

Check the fluid level in the reservoir. If the fluid level is below the MIN. line or the brake warning light comes on, add DOT 3 fluid up to the MAX. line.

If fluid is added frequently, the system should be thoroughly checked by your NISSAN dealer.

### WARNING

Use only new fluid. Old, inferior or contaminated fluid may damage the brake and clutch systems. The use of improper fluids can damage the brake sys-

tem and affect the vehicle's stopping ability.

### CAUTION

Do not spill the fluid on any painted surfaces. This will damage the paint. If fluid is spilled, wash with water.

## WINDOW WASHER FLUID

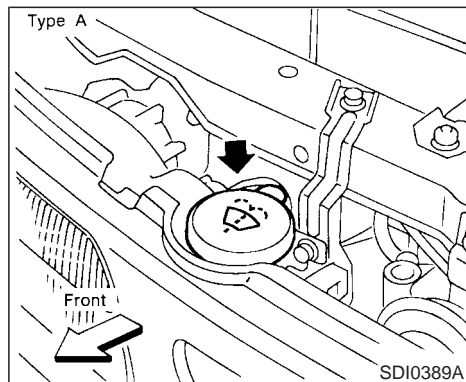

### Type A:

Add fluid when the low washer fluid warning light comes on. Add a washer solvent to the water for better cleaning. In the winter season, add a windshield washer anti-freeze. Follow the manufacturer's instructions for the mixture ratio.

### Type B:

To check the fluid level, use your finger to plug the center hole of the cap/tube assembly (as shown above), then remove it from the tank. If there is no fluid in the tube, add fluid.

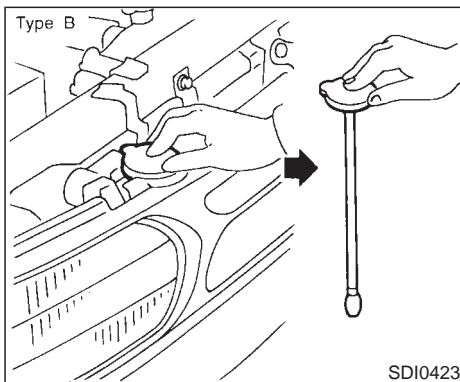

Add a washer solvent to the water for better cleaning. In the winter season, add a windshield washer anti-freeze. Follow the manufacturer's instructions for the mixture ratio.

### CAUTION

**Do not substitute engine anti-freeze coolant for window washer solution. This may result in damage to the paint.**

### WARNING

**Anti-freeze is poisonous and should be stored carefully marked containers out of the reach of children.**

## BATTERY

- Keep the battery surface clean and dry. Any corrosion should be washed off with a solution of baking soda and water.
- Make certain the terminal connections are clean and securely tightened.
- If the vehicle is not to be used for 30 days or longer, disconnect the (—) negative battery terminal cable to prevent discharge.

### WARNING

- **Do not expose the battery to flames or electrical sparks. Hydrogen gas generated by battery action is explosive. Do not allow battery fluid to contact your skin, eyes, fabrics, or painted surfaces. After touching a battery or battery cap, do not touch or rub your eyes. Thoroughly wash your hands. If the acid contacts your eyes, skin or clothing, immediately flush with water for at least 15 minutes and seek medical attention.**
- **When working on or near a battery, always wear suitable eye protection and remove all jewelry.**
- **Keep the battery out of the reach of**

### children.

If jump starting is necessary, see “Jump starting” in the “6. In case of emergency” section. If the engine does not start by jump starting, the battery may have to be replaced. Contact your NISSAN dealer.

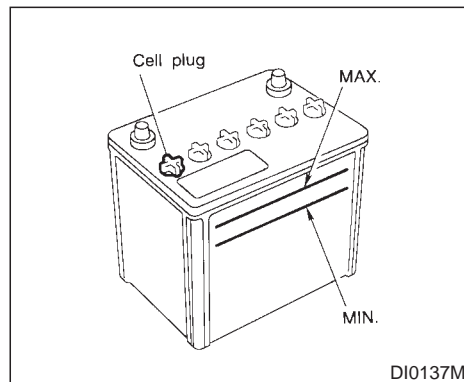

Check the fluid level in each cell. It should be between the MAX. and MIN. lines.

If it is necessary to add fluid, add only distilled water to bring the level to the indicator in each filler opening. **Do not overfill.**

1. Remove the cell plugs using a suitable tool.
2. Add distilled water up to the MAX. level.
3. Tighten cell plugs.

## DRIVE BELTS

VG33E

A : Crank pulley  
B : Water pump  
C : Alternator

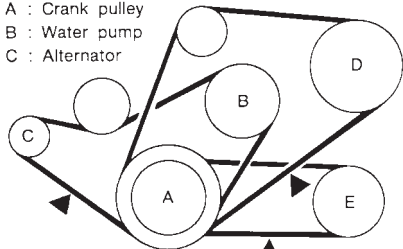

D : Air conditioner compressor  
E : Power steering fluid pump

SDI0424

### **WARNING**

**Be sure the ignition key is OFF. The engine could rotate unexpectedly.**

1. Visually inspect each belt for signs of unusual wear, cuts, fraying or looseness. If the belt is in poor condition or loose, have it replaced or adjusted by your NISSAN dealer.
2. Have the belts checked regularly for condition and tension in accordance with the maintenance schedule in this manual.

8-14 Do-it-yourself

## SPARK PLUGS

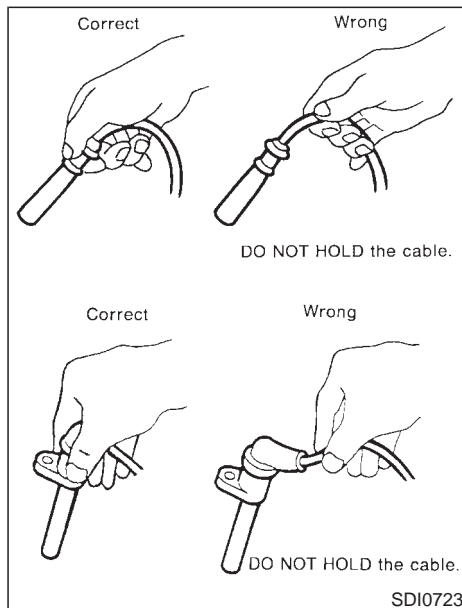

### **WARNING**

**Be sure the engine and ignition switch are off and that the parking brake is**

**engaged securely.**

## REPLACING SPARK PLUGS

1. Disconnect spark plug cables. Keep track of the original cable location.

**When disconnecting, always hold the boots — not the cables. Mark all cables to identify their original location.**

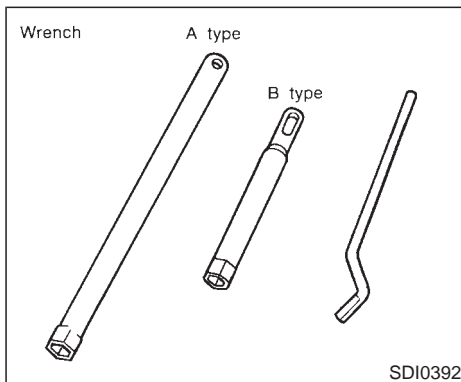

2. Remove spark plugs with a spark plug wrench. (Type A or B)

### CAUTION

**Be sure to use the correct wrench to remove the plugs. An incorrect wrench can cause damage.**

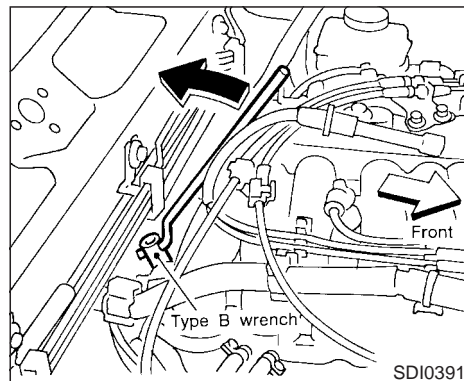
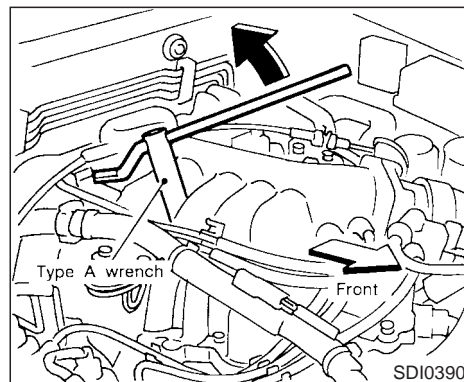

## AIR CLEANER

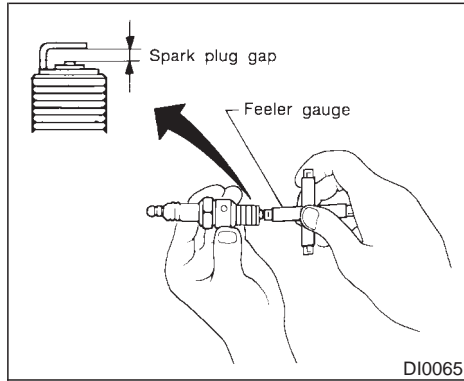

3. Check each new spark plug gap with a feeler gauge. Correct it as required.
4. Install spark plugs.

**When installing a plug, turn it in two or three turns by hand and then tighten with a spark plug wrench. Be careful not to over-tighten it.**

### Tightening torque:

14 to 22 ft-lb (20 to 29 N·m)

5. Reconnect the spark plug cables to their original positions.

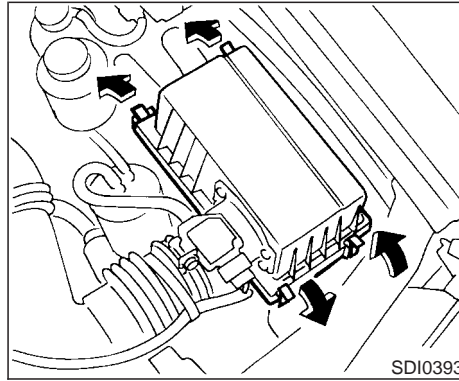

The filter element should not be cleaned and reused as it is given a special treatment. We recommend it be replaced according to the maintenance intervals. See "Periodic maintenance" in the "9. Maintenance" section for maintenance intervals. When replacing the filter, wipe the inside of the air cleaner housing and the cover with a damp cloth.

### **WARNING**

- **Operating the engine with the air cleaner off can cause you or others to be burned. The air cleaner not only**

cleans the air, it stops flame if the engine backfires. If it is not there, and the engine backfires, you could be burned. Do not drive with it off, and be careful working on the engine with the air cleaner off.

- **Never pour fuel into the throttle body or attempt to start the engine with the air cleaner removed. Doing so could result in serious injury.**

## WINDSHIELD WIPER BLADES

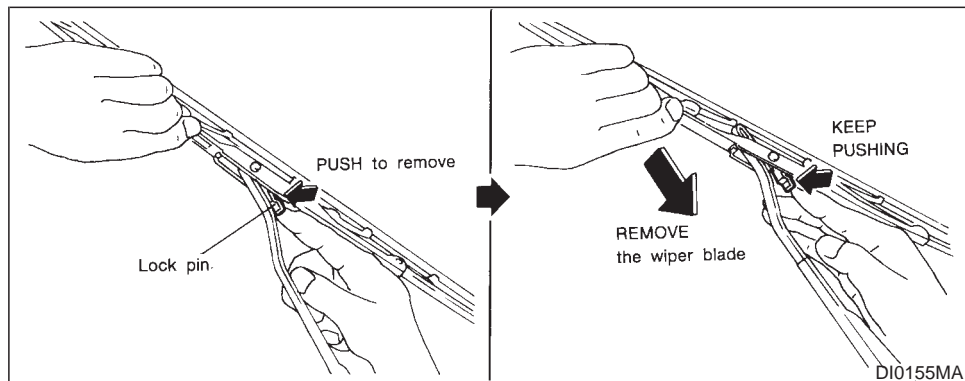

### CLEANING

If your windshield is not clear after using the windshield washer or if a wiper blade chatters when running, wax or other material may be on the blade or windshield.

Clean the outside of the windshield with a washer solution or a mild detergent. Your windshield is clean if beads do not form when rinsing with clear water.

Clean the blade by wiping it with a cloth soaked in a washer solution or a mild detergent. Then rinse the blade with clear water. If your windshield is still not clear after cleaning

the blades and using the wiper, replace the blades.

### REPLACEMENT

1. Pull the wiper arm.
2. Push the lock pin, then remove the wiper blade.
3. Insert the new wiper blade to the wiper arm until a click sounds.

### CAUTION

After wiper blade replacement, return the wiper arm to its original position.

Otherwise it may be damaged when the engine hood is opened.

Make sure the wiper blade contacts the glass. Otherwise, the arm may be damaged from wind pressure.



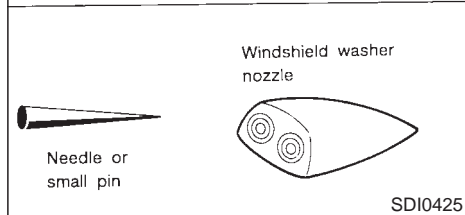
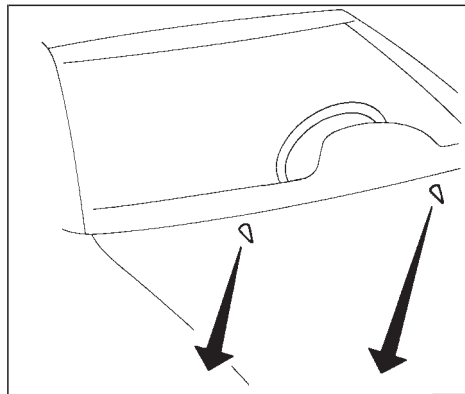

If you wax the surface of the hood, be careful not to let wax get into the washer nozzle. This may cause clogging or improper windshield washer operation. If wax gets into the nozzle, remove it with a needle or small pin.

8-18 Do-it-yourself

## PARKING BRAKE AND BRAKE PEDAL

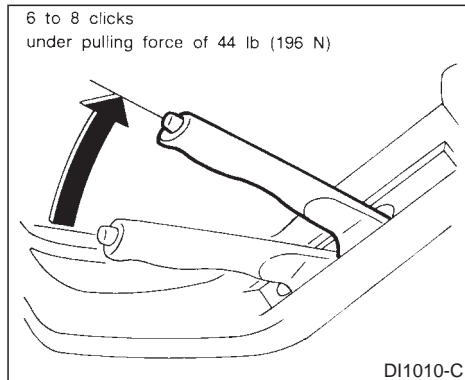

### CHECKING PARKING BRAKE

Pull the parking brake lever up. If the number of clicks is out of the range as listed above, see your NISSAN dealer.

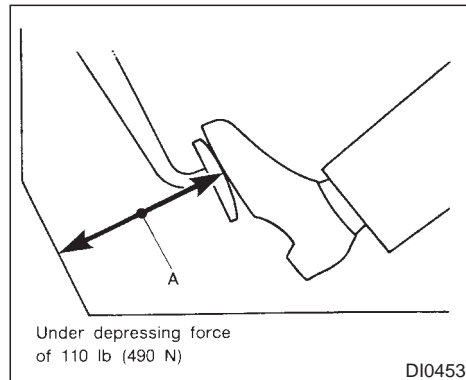

### CHECKING BRAKE PEDAL

With the engine running, check distance A between the upper surface of the pedal and the dash lower panel.

#### Distance A

##### M/T models

2-1/2 in (65 mm) or more

##### A/T models

2-3/4 in (70 mm) or more

If it is out of the range shown above, see your NISSAN dealer.

## Self-adjusting brakes

Your vehicle is equipped with self-adjusting brakes.

The front disc-type brakes self-adjust every time the brake pedal is applied. The rear drum-type brakes self-adjust every time the parking brake is applied. If the brake pedal goes down farther than normal, it may be due to a lack of adjustment of the rear drum brakes. Apply the parking brake several times.

### **WARNING**

**See your NISSAN dealer and have it checked if the brake pedal height does not return to normal.**

## Brake pad wear indicators

The disc brake pads on your vehicle have audible wear indicators. When a brake pad requires replacement, it will make a high pitched scraping or screeching sound when the vehicle is in motion whether or not the brake pedal is depressed. Have the brakes checked as soon as possible if the wear indicator sound is heard.

Under some driving or climate conditions, oc-

casional brake squeak, squeal or other noise may be heard. Occasional brake noise during light to moderate stops is normal and does not affect the function or performance of the brake system.

The rear drum brakes (if so equipped) do not have audible wear indicators. Should you ever hear an unusually loud noise from the rear drum brakes, have them inspected as soon as possible by your NISSAN dealer.

**Proper brake inspection intervals should be followed.** For additional information, see “Periodic maintenance” in the “9. Maintenance” section for maintenance intervals.

## BRAKE BOOSTER

Check the brake booster function with the following steps:

1. With the engine off, press and release the brake pedal several times. When brake pedal movement (distance of travel) remains the same from one pedal application to the next, continue on to the next step.
2. While depressing the brake pedal, start the engine. The pedal height should drop a little.
3. With the brake pedal depressed, stop the engine. Keeping the pedal depressed for

about 30 seconds, the pedal height should not change.

4. Run the engine for one minute without depressing the brake pedal, then turn it off. Depress the brake pedal several times. The pedal travel distance will decrease gradually with each depression as the vacuum is released from the booster.

If the brakes do not operate properly, have the brake checked by your NISSAN dealer.

## CLUTCH PEDAL

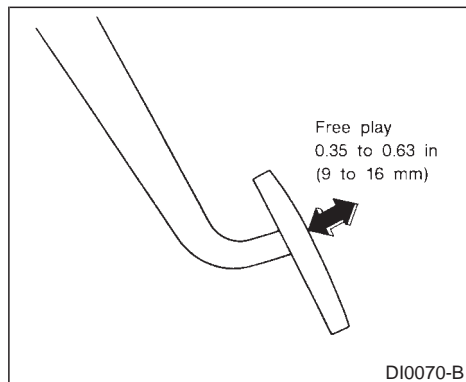

Press the pedal by hand and be sure the free travel is within the above limit. If free travel is out of the range shown above, see your NISSAN dealer.

## FUSES

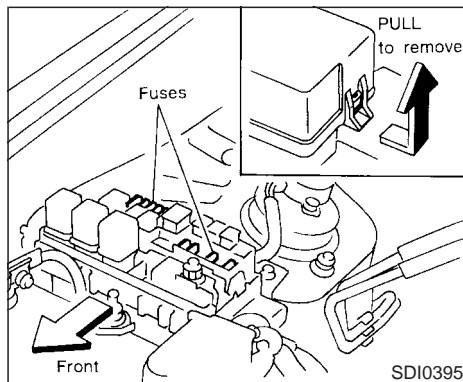

2. Open the engine hood.
3. Remove the fusible link cover.
4. Remove the fuse with the fuse puller.
5. If the fuse is open, replace it with a new fuse.
6. If a new fuse opens again, have the electrical system checked and repaired by your NISSAN dealer.

## ENGINE COMPARTMENT

### CAUTION

**Never use a fuse of higher amperage rating than that specified on the fuse box cover. This could damage the electrical system or cause a fire.**

If any electrical equipment does not operate, check for an open fuse.

1. Be sure the ignition key and the headlight switch are OFF.

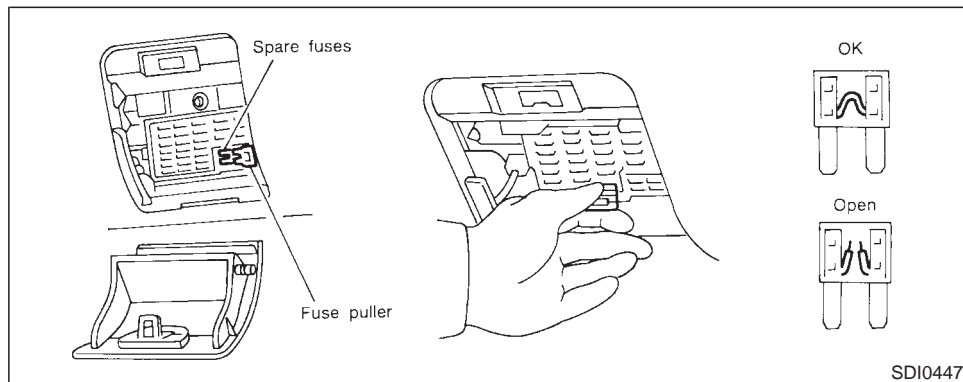

## PASSENGER COMPARTMENT

### **CAUTION**

**Never use a fuse of higher amperage rating than that specified on the fuse box cover. This could damage the electrical system or cause a fire.**

If any electrical equipment does not operate, check for an open fuse.

1. Be sure the ignition key and the headlight switch are OFF.

2. Pull to open the fuse box cover/coin tray.
3. Pull the fuse box cover/coin tray horizontally to remove it.
4. Remove the fuse with the fuse puller.
5. If the fuse is open, replace it with a new fuse.
6. If a new fuse opens again, have the electrical system checked and repaired by your NISSAN dealer.

## LIGHTS

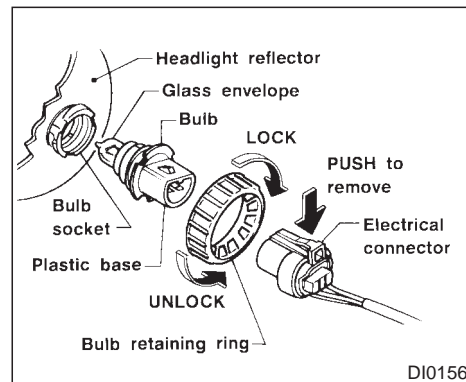

## HEADLIGHTS

The headlight is a semi-sealed beam type which uses a replaceable headlight (halogen) bulb. A bulb can be replaced inside the engine compartment without removing the headlight assembly.

### **CAUTION**

**High pressure halogen gas is sealed inside the halogen bulb. The bulb may break if the glass envelope is scratched or the bulb is dropped.**

**Hold the plastic base when handling the bulb. Never touch the glass envelope.**

## Replacing the headlight bulb

1. Disconnect the battery negative cable.
2. Disconnect the electrical connector from the rear end of the bulb.
3. Turn the bulb retaining ring counterclockwise until it is free from the headlight reflector, then remove it.
4. Remove the headlight bulb. Do not shake or rotate the bulb when removing it.
5. Insert the bulb into the headlight reflector with the flat side of the plastic base facing upward.
6. Install the bulb retaining ring and turn it clockwise until it stops.
7. Push the electrical connector into the bulb plastic base until it snaps and stops.
8. Connect the battery negative cable.

 **CAUTION**

**DO NOT TOUCH THE BULB.**

- Use the same number and wattage as originally installed:

**Wattage 65/45**

**Bulb no. 9004**

- **Aiming is not necessary after replacing the bulb. When aiming adjustment is necessary, contact your NISSAN dealer.**
- **Do not leave the bulb out of the headlight reflector for a long period of time as dust, moisture, and smoke may enter the headlight body and affect the performance of the headlight.**

## EXTERIOR AND INTERIOR LIGHTS

Item	Wattage (W)	Bulb No.
Front turn signal light	27	1156
Front fog light (H3 type)	55	
Side combination light	5	168
Rear combination light		
Turn signal	27	1156
Stop/Tail	27/8	1157
Back-up	27	1156
High mounted stop light	5	168
License plate light	5 or 10 7.5	168*1 89*2
Interior light	10	—
Vanity mirror light	1.4	—
Spot light	8	—

\*1: For 5W light

\*2: Option

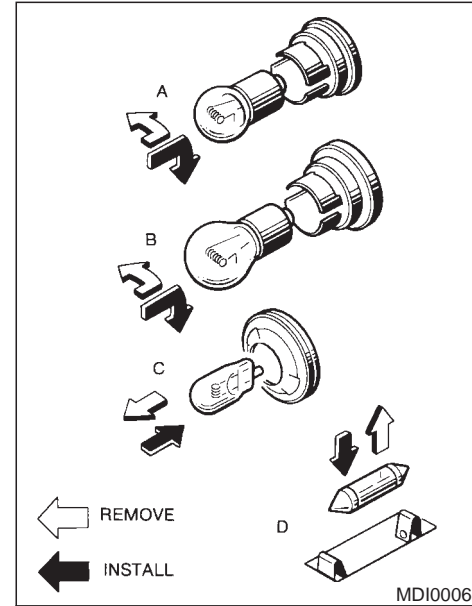

### Replacing procedures

All other lights are either type A, B, C or D. When replacing a bulb, first remove the lens and/or cover.

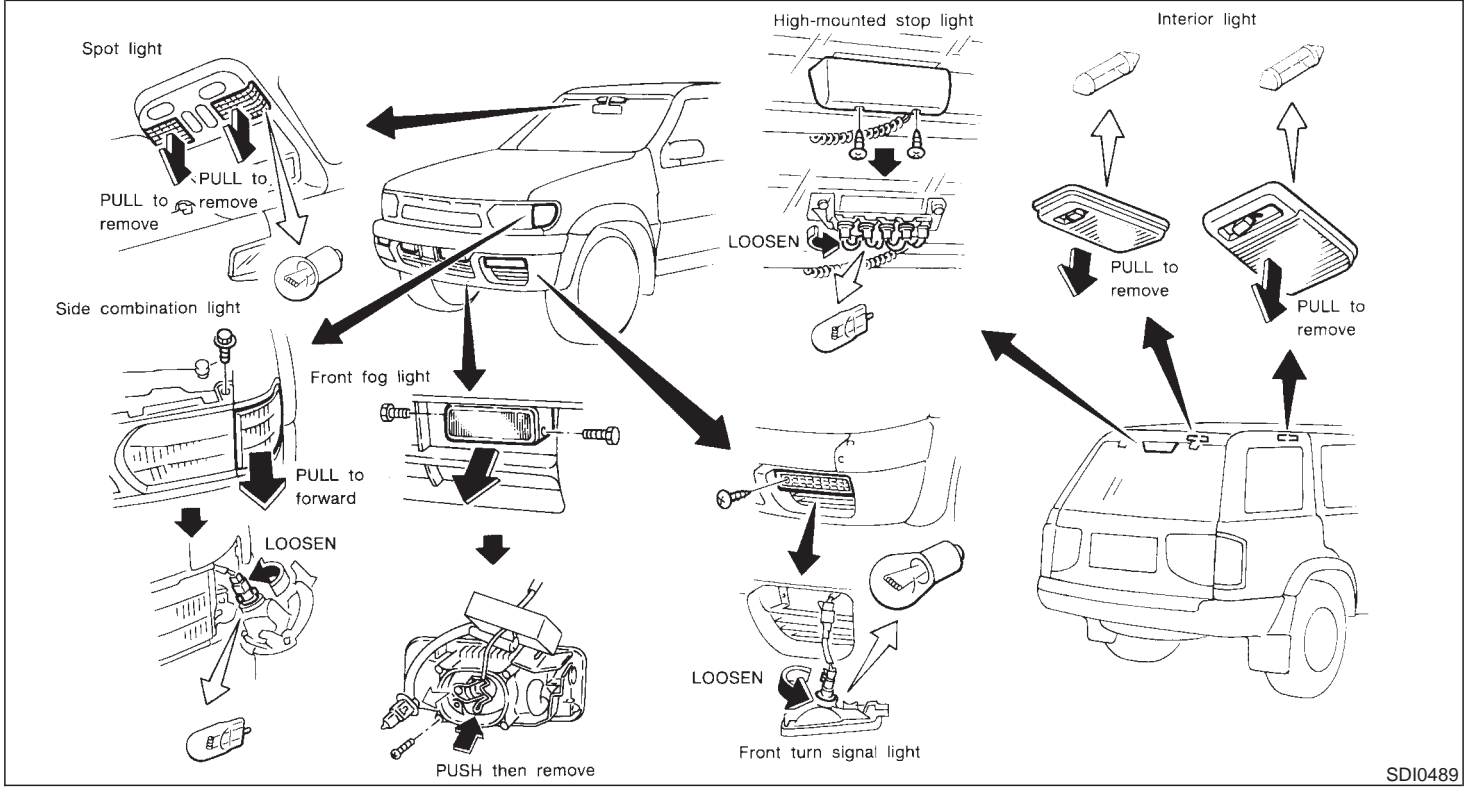

SDI0489

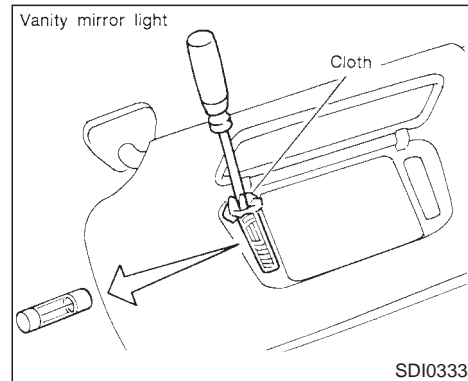
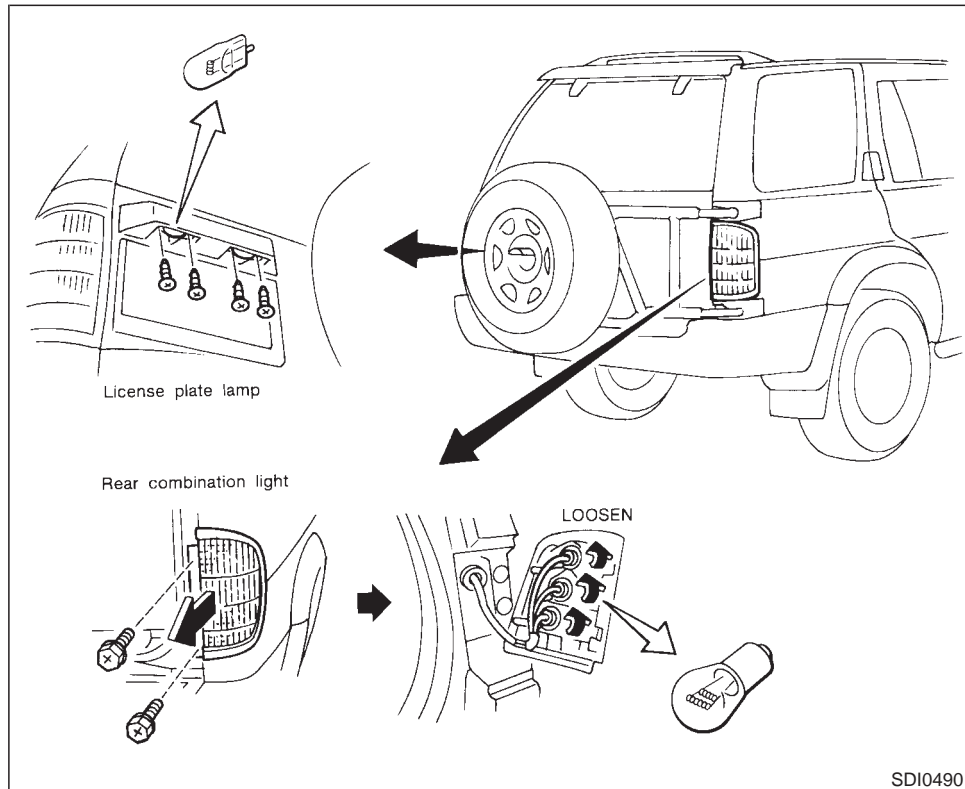



## TIRES AND WHEELS

Max. inflation pressure

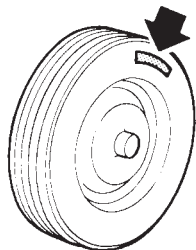

D10047

If you have a flat tire, see “Flat tire” in the “6. In case of emergency” section.

### TIRE PRESSURE

#### Maximum inflation pressure

Do not exceed the maximum inflation pressures shown on the side wall of the tire.

#### Tire inflation pressure

Periodically check the tire pressure (including spare). Incorrect tire pressure may adversely affect tire life and vehicle handling. Tire pressure should be checked when tires are COLD. Tires are considered COLD after the vehicle

8-26 Do-it-yourself

has been parked for three or more hours, or driven less than 1 mile (1.6 km). COLD tire pressures are shown on the tire placard affixed to the inside of the glove box lid.

### WARNING

- Improperly inflated tires can fail suddenly and cause an accident.
- The vehicle capacity weight is indicated on the tire placard. Do not load your vehicle beyond this capacity. Overloading your vehicle may result in reduced tire life, unsafe operating conditions due to premature tire failure, or unfavorable handling characteristics and could also lead to a serious accident. Loading beyond the specified capacity may also result in failure of other vehicle components.
- Before taking a long trip, or whenever you have loaded your vehicle heavily, use a tire pressure gauge to ensure that the tire pressure is at the specified level.
- Do not drive your vehicle over 85 MPH (140 km/h) unless it is equipped

with high speed capability tires. Driving faster than 85 MPH (140 km/h) may result in tire failure, loss of control and possible injury.

### TYPES OF TIRES

### CAUTION

When changing or replacing tires, be sure all four tires are of the same type (for example, summer, all season or snow) and construction. Your NISSAN dealer may be able to help you with information about tire type, size, speed rating and availability. Replacement tires may have a lower speed rating than the factory equipped tires, and may not match the potential maximum vehicle speed. Never exceed the maximum speed rating of the tire.

#### All season tires

NISSAN specifies all season tires on some models to provide good performance for use all year around, including snowy and icy road conditions. All season tires are identified by

ALL SEASON and/or M&S on the tire sidewall. Snow tires have better snow traction than all season tires and may be more appropriate in some areas.

## Summer tires

NISSAN specifies summer tires on some models to provide superior performance on dry roads. Summer tire performance in snow and ice will be substantially reduced. Summer tires do not have the tire traction rating M&S on the tire sidewall.

If you operate your vehicle in snowy or icy conditions, NISSAN recommends the use of SNOW or ALL SEASON tires on all four wheels.

## Snow tires

If snow tires are needed, it is necessary to select tires equivalent in size and load rating to the original equipment tires. If you do not, it can adversely affect the safety and handling of your vehicle.

Generally, snow tires will have lower speed ratings than factory equipped tires and may not match the potential maximum vehicle speed. Never exceed the maximum speed rating of the tire.

If you operate your vehicle in snowy or icy

conditions, NISSAN recommends the use of SNOW or ALL SEASON tire on all four wheels.

For additional traction on icy roads, studded tires may be used. However, some provinces and states prohibit their use. Check local, state and provincial laws before installing studded tires. Skid and traction capabilities of studded snow tires, on wet or dry surfaces, may be poorer than that of non-studded snow tires.

## Four wheel drive models tire

If you install snow tires, they must also be the same size, brand, construction and tread pattern on all four wheels.



**ONLY use spare tires specified for each four wheel drive model.**

## TIRE CHAINS

Use of tire chains is prohibited according to location. Check the local laws before installing tire chains. When installing tire chains, make sure they are of proper size for the tires on your vehicle and are installed according to the chain manufacturer's suggestions. **Use only SAE class S chains.** Other types may damage your vehicle. Use chain tensioners when recommended by the tire chain manufacturer to ensure a tight fit. Loose end links of the tire chain must be secured or removed to prevent the possibility of whipping action damage to the fenders or underbody. If possible, avoid fully loading your vehicle when using tire chains. In addition, drive at a reduced speed. Otherwise, your vehicle may be damaged and/or vehicle handling and performance may be adversely affected.

Do not use tire chains on dry roads.

**Tire chains must be installed only on the rear wheels and not on the front wheels.**

Do not drive with tire chains on paved roads which are clear of snow. Driving with chains in such conditions can cause damage to the various mechanisms of the vehicle due to some overstress. When driving on clear paved roads, be sure to change to 2WD.

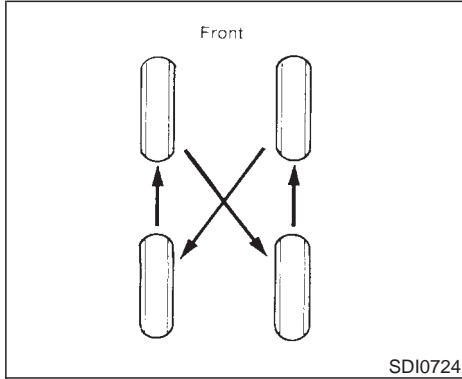

**Wheel nut tightening torque:**  
**87 to 108 ft-lb (118 to 147 N·m)**

**⚠ WARNING**

- After rotating the tires, adjust the tire pressure.
- Retighten the wheel nuts after the aluminum wheel has been run for the first 600 miles (1,000 km). (also in cases of a flat tire, etc.)

## CHANGING TIRES AND WHEELS

### Tire rotation

NISSAN recommends that tires be rotated every 7,500 miles (12,000 km) for 2WD vehicles and 3,750 miles (6,000 km) for 4WD vehicles. However, the timing for tire rotation may vary according to your driving habits and road surface conditions.

See "Flat tire" in the "6. In case of emergency" section for tire replacing procedures.

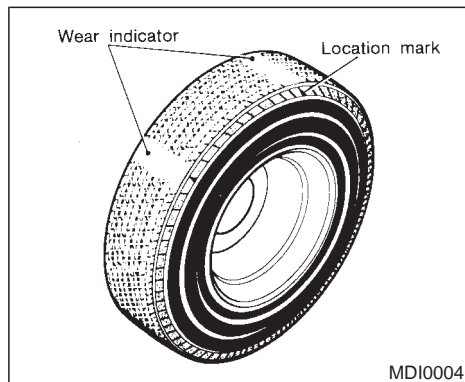

Tire wear and damage

### WARNING

- Tires should be periodically inspected for wear, cracking, bulging or objects caught in the tread. If excessive wear, cracks, bulging or deep cuts are found, the tire should be replaced.
- The original tires have a built-in tread wear indicator. When the wear indicator is visible, the tire should be

replaced.

### Replacing tires and wheels

When replacing a tire, use the same size, speed rating and load carrying capacity as originally equipped. See "Specifications" in the "10. Technical and consumer information" section for tires and wheels.

### WARNING

- The use of tires other than those recommended or the mixed use of tires of different brands, construction (bias, bias-belted or radial), or tread patterns can adversely affect the ride, braking, handling, ground clearance, body-to-tire clearance, snow chain clearance, speedometer calibration, headlight aim and bumper height. Some of these effects may lead to accidents and could result in serious personal injury.
- If the wheels are changed for any reason, always replace with wheels which have the same offset dimension. Wheels of a different offset could cause early tire wear, possibly

degraded vehicle handling characteristics and/or interference with the brake discs/drums. Such interference can lead to decreased braking efficiency and/or early brake pad/shoe wear.

- Do not install a deformed wheel or tire even if it has been repaired. Such wheels or tires could have structural damage and could fail without warning.
- The use of retread tire is not recommended.

### Four wheel drive models

### CAUTION

Always use tires of the same size, brand, construction (bias, bias-belted or radial), and tread pattern on all four wheels. Failure to do so may result in a circumference difference between tires on the front and rear axles which will cause excessive tire wear and may damage the transmission, transfer case and differential gears.

## 4x4 CLUTCH HOUSING DRAIN

If excessive tire wear is found, it is recommended that all four tires be replaced with tires of the same size, brand, construction and tread pattern. The tire pressure and wheel alignment should also be checked and corrected as necessary. Contact your NISSAN dealer.

**ONLY use spare tires specified for each four wheel drive model.**

### Wheel balance

Unbalanced wheels may affect vehicle handling and tire life. Even with regular use, wheels can get out of balance. Therefore, they should be balanced as required.

Wheel balance service should be performed with the wheels off the vehicle. Spin balancing the rear wheels on the vehicle could lead to transmission damage.

### Care of wheels

- Wash the wheels when washing the vehicle to maintain their appearance.
- Clean the inner side of the wheels when the wheel is changed or the underside of the vehicle is washed.
- Do not use abrasive cleaners when washing the wheels.
- Inspect wheel rims regularly for dents or corrosion. This may cause loss of pressure or damage the tire bead.
- We recommend that the road wheels be waxed to protect against road salt in areas where it is used during winter.

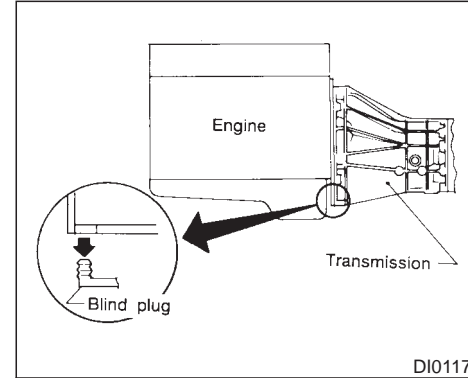

DI0117

### Checking water entry

Whenever you drive in deep water or mud, check water entry in the clutch housing by removing the blind plug at the bottom of the transmission case. After checking, be sure to reinstall the plug.

**MEMO**

**MEMO**

# 9 Maintenance

General maintenance .....	9-2
Periodic maintenance schedules .....	9-5





Your new NISSAN has been designed to have minimum maintenance requirements with longer service intervals to save you both time and money. However, some day-to-day and regular maintenance is essential to maintain your NISSAN's good mechanical condition, as well as its emission and engine performance.

It is the owner's responsibility to make sure that the specified maintenance, as well as general maintenance, is performed.

As the vehicle owner, you are the only one who can ensure that your vehicle receives the proper maintenance care. You are a vital link in the maintenance chain.

#### **General maintenance:**

General maintenance includes those items which should be checked during normal day-to-day operation of the vehicle. They are essential if your vehicle is to continue to operate properly. It is your responsibility to perform these procedures regularly as prescribed.

These checks or inspections can be done by yourself, a qualified technician or, if you prefer, your NISSAN dealer.

#### **Periodic maintenance:**

The maintenance items listed in this part are required to be serviced at regular intervals.

### **9-2 Maintenance**

However, under severe driving conditions, additional or more frequent maintenance will be required.

#### **Where to go for service:**

If maintenance service is required or your vehicle appears to malfunction, have the systems checked and tuned by an authorized NISSAN dealer.

NISSAN technicians are well-trained specialists and are kept up to date with the latest service information through technical bulletins, service tips, and in-dealership training programs. They are completely qualified to work on NISSAN's vehicles before they work on your vehicle, rather than after they have worked on it.

You can be confident that your NISSAN dealer's service department performs the best job to meet the maintenance requirements on your vehicle — in a reliable and economic way.

## **GENERAL MAINTENANCE**

During the normal day-to-day operation of the vehicle, general maintenance should be performed regularly as prescribed in this section. If you detect any unusual sounds, vibrations or smell, be sure to check for the cause or have your NISSAN dealer do it promptly. In addition, you should notify your NISSAN dealer if you think that repairs are required.

When performing any checks or maintenance work, see "Maintenance precautions" in the "8. Do-it-yourself" section.

### **EXPLANATION OF MAINTENANCE ITEMS**

**Additional information on the following items with \* is found in the "8. Do-it-yourself" section.**

#### **Outside the vehicle**

The maintenance items listed here should be performed from time to time, unless otherwise specified.

**Tires\*** Check the pressure with a gauge periodically when at a service station, including the spare, and adjust to the specified pressure if necessary. Check carefully for damage, cuts or excessive wear.

**Wheel nuts\*** When checking the tires, make

sure no nuts are missing, and check for any loose nuts. Tighten if necessary.

**Tire rotation\*** Tires should be rotated every 7,500 miles (12,000 km) for 2WD vehicles and 3,750 miles (6,000 km) for 4WD vehicles. However, the timing for tire rotation may vary according to your driving habits and road surface conditions.

**Wheel alignment and balance** If the vehicle should pull to either side while driving on a straight and level road, or if you detect uneven or abnormal tire wear, there may be a need for wheel alignment.

If the steering wheel or seat vibrates at normal highway speeds, wheel balancing may be needed.

**Windshield wiper blades\*** Check for cracks or wear if they do not wipe properly.

**Doors and engine hood** Check that all doors and the engine hood, operate properly. Also ensure that all latches lock securely. Lubricate hinges, latches, rollers and links if necessary. Make sure that the secondary latch keeps the hood from opening when the primary latch is released.

When driving in areas using road salt or other

corrosive materials, check lubrication frequently.

## Inside the vehicle

The maintenance items listed here should be checked on a regular basis, such as when performing periodic maintenance, cleaning the vehicle, etc.

**Lights\*** Make sure that the headlights, stop lights, tail lights, turn signal lights, and other lights are all operating properly and installed securely. Also check headlight aim.

**Warning lights and buzzers/chimes** Make sure that all warning lights and buzzers/chimes are operating properly.

**Windshield wiper and washer\*** Check that the wipers and washer operate properly and that the wipers do not streak.

**Windshield defroster** Check that the air comes out of the defroster outlets properly and in sufficient quantity when operating the heater or air conditioner.

**Steering wheel** Check for changes in the steering conditions, such as excessive free-play, hard steering or strange noises.

**Seats** Check seat position controls such as

seat adjusters, seatback recliner, etc. to ensure they operate smoothly and that all latches lock securely in every position. Check that the head restraints move up and down smoothly and that the locks (if so equipped) hold securely in all latched positions.

**Seat belts** Check that all parts of the seat belt system (e.g. buckles, anchors, adjusters and retractors) operate properly and smoothly, and are installed securely. Check the belt webbing for cuts, fraying, wear or damage.

**Accelerator pedal** Check the pedal for smooth operation and make sure the pedal does not catch or require uneven effort. Keep the floor mats away from the pedal.

**Clutch pedal\*** Make sure the pedal operates smoothly and check that it has the proper free travel.

**Brakes** Check that the brakes do not pull the vehicle to one side when applied.

**Brake pedal and booster\*** Check the pedal for smooth operation and make sure it has the proper distance under it when depressed fully. Check the brake booster function. Be certain to keep floor mats away from the pedal.

**Parking brake\*** Check that the lever has the proper travel and confirm that your vehicle is held securely on a fairly steep hill with only the parking brake applied.

**Automatic transmission P position mechanism** On a fairly steep hill check that your vehicle is held securely with the selector lever in the P position without applying any brakes.

## Under the hood and vehicle

The maintenance items listed here should be checked periodically e.g. each time you check the engine oil or refuel.

**Windshield washer fluid\*** Check that there is adequate fluid in the tank.

**Engine coolant level\*** Check the coolant level when the engine is cold.

**Radiator and hoses** Check the front of the radiator and clean off any dirt, insects, leaves, etc., that may have accumulated. Make sure the hoses have no cracks, deformation, rot or loose connections.

**Brake and clutch fluid levels\*** Make sure that the brake and clutch fluid level is between the MAX and MIN lines on the reservoir.

**Battery\*** Check the fluid level in each cell. It

should be between the MAX and MIN lines.

**Engine drive belts\*** Make sure that no belt is frayed, worn, cracked or oily.

**Engine oil level\*** Check the level after parking the vehicle on a level spot and turning off the engine. (Be sure to wait a few minutes to allow the oil to drain back into the sump.)

**Power steering fluid level\* and lines** Check the level when the fluid is cold and the engine is turned off. Check the lines for proper attachment, leaks, cracks, etc.

**Automatic transmission fluid level\*** Check the level after putting the selector lever in P (Park) with the engine idling.

**Exhaust system** Make sure there are no loose supports, cracks or holes. If the sound of the exhaust seems unusual or there is a smell of exhaust fumes, immediately locate the trouble and correct it. See “Precautions when starting and driving” in the “5. Starting and driving” section for exhaust gas (carbon monoxide).

**Underbody** The underbody is frequently exposed to corrosive substances such as those used on icy roads or to control dust. It is very

important to remove these substances, otherwise rust will form on the floor pan, frame, fuel lines and around the exhaust system. At the end of winter, the underbody should be thoroughly flushed with plain water, being careful to clean those areas where mud and dirt may accumulate. For additional information, see “Cleaning exterior” in the “7. Appearance and care” section.

**Fluid leaks** Check under the vehicle for fuel, oil, water or other fluid leaks after the vehicle has been parked for a while. Water dripping from the air conditioner after use is normal. If you should notice any leaks or if gasoline fumes are evident, check for the cause and have it corrected immediately.

## PERIODIC MAINTENANCE SCHEDULES

To ensure smooth, trouble-free, safe and economical driving, NISSAN provides two different maintenance schedules that may be used, depending upon the conditions in which you usually drive. These schedules contain both distance and time intervals, up to 60,000 miles (96,000 km)/48 months. For most people, the odometer reading will indicate when service is needed. However, if you drive very little, your vehicle should be serviced at the regular time intervals shown in the schedule.

**After 60,000 miles (96,000 km) or 48 months, continue periodic maintenance at the same mileage/time intervals.**

### SCHEDULE 1

Follow Periodic Maintenance Schedule 1 if your driving habits frequently include one or more of the following driving conditions:

- **Repeated short trips of less than 5 miles (8 km).**
- **Repeated short trips of less than 10 miles (16 km) with outside temperatures remaining below freezing.**
- **Operating in hot weather in stop-and-go rush hour traffic.**
- **Extensive idling and/or low speed driv-**

**ing for long distances, such as police, taxi or door-to-door delivery use.**

- **Driving in dusty conditions.**
- **Driving on rough, muddy, or salt spread roads.**
- **Towing a trailer, using a camper or a car-top carrier.**

### SCHEDULE 2

Follow Periodic Maintenance Schedule 2 if none of the driving conditions shown in Schedule 1 apply to your driving habits.

### Maintenance for offroad driving

Whenever you drive offroad through sand, mud or water as deep as the wheel hub, more frequent maintenance may be required of the following items:

- ▲ Brake pads and discs
- ▲ Brake lining and drums
- ▲ Brake lines and hoses
- ▲ Wheel bearing grease
- ▲ Differential, transmission and transfer oil
- ▲ Steering linkage
- ▲ Propeller shafts and front drive shafts
- ▲ Air cleaner filter
- ▲ Clutch housing (See "Clutch housing drain" in the "8. Do-it-yourself" section for checking water entry.)

These items should be checked frequently to assure safe and proper operation of your vehicle.

# SCHEDULE 1

Abbreviations: R = Replace

I = Inspect. Correct or replace if necessary.

[ ]: At the mileage intervals only

MAINTENANCE OPERATION	MAINTENANCE INTERVAL																
	Miles × 1,000 (km × 1,000)	3.75 (6)	7.5 (12)	11.25 (18)	15 (24)	18.75 (30)	22.5 (36)	26.25 (42)	30 (48)	33.75 (54)	37.5 (60)	41.25 (66)	45 (72)	48.75 (78)	52.5 (84)	56.25 (90)	60 (96)
	Months	3	6	9	12	15	18	21	24	27	30	33	36	39	42	45	48
<b>Emission control system maintenance</b>																	
Drive belts										I*							I*
Air cleaner filter	See NOTE (1)									[R]							[R]
EVAP vapor lines										I*							I*
Fuel lines										I*							I*
Fuel filter	See NOTE (2)*																
Engine coolant	See NOTE (3)																R*
Engine oil		R	R	R	R	R	R	R	R	R	R	R	R	R	R	R	R
Engine oil filter (Use Part No. 15208 31U00 or equivalent.)		R	R	R	R	R	R	R	R	R	R	R	R	R	R	R	R
Spark plugs										[R]							[R]
Timing belt																	Replace every 105,000 miles (168,000 km)

- NOTE:**
- (1) If operating mainly in dusty conditions, more frequent maintenance may be required.
  - (2) If vehicle is operated under extremely adverse weather conditions or in areas where ambient temperatures are either extremely low or extremely high, the filters might become clogged. In such an event, replace them immediately.
  - (3) After 60,000 miles (96,000 km) or 48 months, replace every 30,000 miles (48,000 km) or 24 months.
  - (4) Maintenance items and intervals with "\*" are recommended by NISSAN for reliable vehicle operation. The owner need not perform such maintenance in order to maintain the emission warranty or manufacturer recall liability. Other maintenance items and intervals are required.

# SCHEDULE 1

Abbreviations: R = Replace I = Inspect. Correct or replace if necessary. L = Lubricate [ ]: At the mileage intervals only

MAINTENANCE OPERATION	MAINTENANCE INTERVAL																	
	Miles × 1,000	3.75	7.5	11.25	15	18.75	22.5	26.25	30	33.75	37.5	41.25	45	48.75	52.5	56.25	60	
Perform at number of miles, kilometers or months, whichever comes first.	(km × 1,000)	(6)	(12)	(18)	(24)	(30)	(36)	(42)	(48)	(54)	(60)	(66)	(72)	(78)	(84)	(90)	(96)	
	Months	3	6	9	12	15	18	21	24	27	30	33	36	39	42	45	48	
<b>Chassis and body maintenance</b>																		
Brake lines & cables					I				I				I					I
Brake pads, discs, drums & linings			I		I		I		I		I		I		I		I	
Automatic transmission & transfer fluid, manual transmission & differential gear oil (exc. LSD)	See NOTE (1)				I				I				I					I
Limited-slip differential (LSD) gear oil	See NOTE (1)				I				R				I					R
Steering gear & linkage, axle & suspension parts			I		I		I		I		I		I		I		I	
Drive shaft boots & propeller shaft ( <del>4x4</del> )			I		I		I		I		I		I		I		I	
Propeller shaft grease	See NOTE (2)		L		L		L		L		L		L		L		L	
Front wheel bearing grease (4x2)									I									I
Front wheel bearing grease ( <del>4x4</del> )	See NOTE (3)				I				R				I					R
Exhaust system			I		I		I		I		I		I		I		I	
Supplemental air bag system	See NOTE (4)																	

- NOTE:**
- (1) If towing a trailer, using a camper or a car-top carrier, or driving on rough or muddy roads, change (not just inspect) oil at every 30,000 miles (48,000 km) or 24 months except for LSD. Change LSD gear oil every 15,000 miles (24,000 km) or 12 months.
  - (2) The propeller shaft should be re-greased daily if it is immersed in water.
  - (3) If operating frequently in water, replace grease every 3,750 miles (6,000 km) or 3 months.
  - (4) Inspect the supplemental air bag system 10 years after the date of manufacture noted on the F.M.V.S.S. certification label.

## SCHEDULE 2

Abbreviations: R = Replace

I = Inspect. Correct or replace if necessary.

[ ]: At the mileage intervals only

MAINTENANCE OPERATION	MAINTENANCE INTERVAL								
	Miles × 1,000	7.5	15	22.5	30	37.5	45	52.5	60
Perform at number of miles, kilometers or months, whichever comes first.	(km × 1,000)	(12)	(24)	(36)	(48)	(60)	(72)	(84)	(96)
	Months	6	12	18	24	30	36	42	48
<b>Emission control system maintenance</b>									
Drive belts					I*				I*
Air cleaner filter					[R]				[R]
EVAP vapor lines					I*				I*
Fuel lines					I*				I*
Fuel filter	See NOTE (1)*								
Engine coolant	See NOTE (2)								R*
Engine oil		R	R	R	R	R	R	R	R
Engine oil filter (Use Part No. 15208 31U00 or equivalent.)		R	R	R	R	R	R	R	R
Spark plugs					[R]				[R]
Timing belt					Replace every 105,000 miles (168,000 km)				

**NOTE:** (1) If vehicle is operated under extremely adverse weather conditions or in areas where ambient temperatures are either extremely low or extremely high, the filters might become clogged. In such an event, replace them immediately.

(2) After 60,000 miles (96,000 km) or 48 months, replace every 30,000 miles (48,000 km) or 24 months.

(3) Maintenance items and intervals with “\*” are recommended by NISSAN for reliable vehicle operation. The owner need not perform such maintenance in order to maintain the emission warranty or manufacturer recall liability. Other maintenance items and intervals are required.

## SCHEDULE 2

Abbreviations: R = Replace I = Inspect. Correct or replace if necessary. L = Lubricate [ ]: At the mileage intervals only

MAINTENANCE OPERATION	MAINTENANCE INTERVAL								
	Miles × 1,000	7.5	15	22.5	30	37.5	45	52.5	60
Perform at number of miles, kilometers or months, whichever comes first.	(km × 1,000)	(12)	(24)	(36)	(48)	(60)	(72)	(84)	(96)
	Months	6	12	18	24	30	36	42	48
<b>Chassis and body maintenance</b>									
Brake lines & cables			I		I		I		I
Brake pads, discs, drums & linings			I		I		I		I
Automatic transmission & transfer fluid, manual transmission & differential gear oil (exc. LSD)			I		I		I		I
Limited-slip differential (LSD) gear oil			I		R		I		R
Steering gear & linkage, axle & suspension parts					I				I
Drive shaft boots ( <del>4x2</del> )			I		I		I		I
Propeller shaft grease	See NOTE (1)		L		L		L		L
Front wheel bearing grease (4x2)					I				I
Front wheel bearing grease ( <del>4x2</del> )			I		R		I		R
Exhaust system					I				I
Supplemental air bag system	See NOTE (2)								

**NOTE:** (1) The propeller shaft should be re-greased daily if it is immersed in water.

(2) Inspect the supplemental air bag system 10 years after the date of manufacture noted on the F.M.V.S.S. certification label.



## EXPLANATION OF MAINTENANCE ITEMS

**Additional information on the following items with \* is found in the “8. Do-it-yourself” section.**

### Emission control system maintenance

**Drive belts\*** Check drive belts for wear, fraying or cracking and also for proper tension. Replace the drive belts if found damaged.

**Air cleaner filter** Under normal driving conditions, the air cleaner filter should be replaced in accordance with the maintenance schedule. However, driving the vehicle in dusty areas may cause more rapid clogging of the element. Consequently, the element may have to be replaced more frequently.

**Vapor lines** Check vapor lines and connections for failure or looseness. If leaks are found, replace the lines.

**Fuel lines** Check the fuel hoses, piping and connections for leaks, looseness or deterioration. Replace any parts if they are damaged.

**Fuel filter** If the vehicle is operated under  
9-10 **Maintenance**

extremely adverse weather conditions or in areas where ambient temperatures are either extremely low or extremely high, the filter might become clogged. In such an event, replace the filter immediately.

**Engine coolant\*** Flush and refill the cooling system.

**Engine oil & oil filter\*** Under normal driving conditions, the engine oil and oil filter should be replaced in accordance with the maintenance schedule. However, under severe driving conditions, they may have to be replaced more frequently.

**Spark plugs\*** Replace with new plugs having the correct heat range.

### Timing belt

Replace the timing belt for driving the camshafts.

### Chassis and body maintenance

**Brake lines & cables** Check the brake lines and hoses (including brake booster vacuum hoses, connections & check valve) and parking brake cables for proper attachment, leaks, cracks, chafing, abrasion, deterioration, etc.

**Brake pads, discs, drums & linings** Check these and the other neighboring brake components for wear, deterioration and leaks. Under severe driving conditions, they may have to be inspected more frequently.

**Manual and automatic transmission, transfer & differential gear oil** Visually inspect for signs of leakage and replace oil for limited-slip differential. Under severe driving conditions, the oil should be replaced at the specified interval.

**Steering gear & linkage, axle & suspension parts & drive axle shaft boots** Check for damage, looseness and leakage of oil or grease. Under severe driving conditions, more frequent inspection should be performed.

**Steering linkage ball joints & front suspension ball joints** Check the ball joints for damage, looseness and grease leakage. Under severe driving conditions, more frequent inspection should be performed.

**Propeller shaft(s)** Check the propeller shaft(s) for damage, looseness and grease leakage under severe driving condition ( only).

**Propeller shaft grease** Apply specified grease to the greasing points of propeller shafts in accordance with the maintenance schedule. In the case of driving in water, greasing should be performed immediately afterwards.

**Front wheel bearing grease** Check the wheel bearing for grease leakage around grease seals, axial end play and smooth turning (4x2).

Check the wheel bearing grease condition or repack these in accordance with the maintenance schedule. In case of frequent driving in muddy water, the bearing grease inspection should be performed more frequently (  ).

**Exhaust system** Visually check the exhaust pipes, muffler, and hangers for proper attachment, leaks, cracks, chafing, abrasion, deterioration, etc. Under severe driving conditions, inspection should be performed more frequently.

**Supplemental air bag system** Check the supplemental air bag system components for proper attachment, damage, deformities, cracks, rust, etc. Work around and on the supplemental air bag system should be done by an authorized NISSAN dealer.

**MEMO**

# 10 Technical and consumer information

Capacities and recommended fuel/lubricants .....	10-2
Specifications .....	10-9
Tires and wheels .....	10-10
When traveling or registering your vehicle in another country .....	10-11
Vehicle identification .....	10-12
Vehicle loading information .....	10-14
Towing a trailer .....	10-15
Emission control system warranty .....	10-19
Reporting safety defects (US only) .....	10-19
Readiness for inspection/ maintenance (I/M) test (US only) .....	10-20



## CAPACITIES AND RECOMMENDED FUEL/LUBRICANTS

The following values are approximate capacities. The actual refill capacities may be a little different from them. When refilling, follow the procedure instructed in the “8. Do-it-yourself” section to determine the proper refill capacity.

	Capacity (Approximate)			Recommended specifications
	US measure	Imp measure	Liter	
Fuel	21-1/8 gal	17-5/8 gal	80	Unleaded gasoline with an octane rating of at least 87 AKI (RON 91)*1
Engine oil (Refill)				
with oil filter	3-7/8 qt	3-1/4 qt	3.7	● API SG or SH and Energy Conserving II*2 *3
without oil filter	3-5/8 qt	3 qt	3.4	● API Certification Mark*2 *3
Cooling system (with heater and reservoir tank)	11-1/4 qt	9-3/8 qt	10.6	Anti-freeze coolant (Ethylene glycol base)

\*1: See later in this section for fuel recommendation.

\*2: See later in this section for recommended SAE viscosity number.

\*3: See later in this section for engine oil and oil filter recommendation.

	Capacity (Approximate)			Recommended specifications
	US measure	Imp measure	Liter	
Manual transmission	—	—	—	API GL-4 Viscosity SAE 75W-90 only
Differential gear oil (exc. LSD)	—	—	—	API GL-5*1
Limited-slip differential (LSD) gear oil	—	—	—	Only LSD gear oil: API GL-5 and SAE 80W-90*2 approved for Nissan LSD*3
Automatic transmission fluid				Nissan Matic "D" (Continental US and Alaska) or Genuine Nissan Automatic Transmission Fluid (Canada).*6
Power steering fluid	Refill to the proper oil level according to the instructions in the "8. Do-it-yourself" section.			Type DEXRON™III or equivalent
Transfer fluid				Nissan Matic "D" or Equivalent Automatic Transmission Fluid*6 or API GL-4*1
Brake and clutch fluid				Genuine Nissan Brake Fluid*4 or equivalent DOT 3 (US F.M.V.S.S. No. 116)
Propeller shaft grease	—	—	—	NLGI No. 2 (Molybdenum disulphide lithium soap base)
Multi-purpose grease	—	—	—	NLGI No. 2 (Lithium soap base)
Air conditioning system refrigerant	—	—	—	HFC-134a (R-134a)*5
Air conditioning system lubricants	—	—	—	Nissan A/C System Oil Type S or exact equivalent

\*1: For further details, see recommended SAE viscosity number chart.

\*2: SAE 90 is acceptable in temperatures above 0°F (-18°C).

\*3: Contact your NISSAN dealer for a list of approved oils.

\*4: Available in mainland USA through your NISSAN dealer.

\*5: See "Vehicle identification" later in this section for air conditioner specification label.

\*6: Dexron™ III/Mercon™ or equivalent may also be used. Outside the continental United States and Alaska contact a NISSAN dealer for more information regarding suitable fluids, including recommended brand(s) of Dexron™ III/Mercon™ Automatic Transmission Fluid.

## FUEL RECOMMENDATION

**Your vehicle is designed to operate on unleaded gasoline with an octane rating of at least 87 AKI (Anti-Knock Index) number (Research octane number 91).**

### CAUTION

**Using a fuel other than that specified could adversely affect the emission control devices and systems, and could also affect the warranty coverage.**

**Under no circumstances should a leaded gasoline be used since this will damage the three way catalyst.**

### Reformulated gasoline

Some fuel suppliers are now producing reformulated gasolines. These gasolines are specially designed to reduce vehicle emissions. NISSAN supports efforts towards cleaner air and suggest that you use reformulated gasoline when available.

### Gasoline containing oxygenates

Some fuel suppliers sell gasoline containing oxygenates such as ethanol, MTBE and

methanol with or without advertising their presence. Nissan does not recommend the use of fuels of which the oxygenate content and the fuel compatibility for your Nissan cannot be readily determined.

If you use oxygenate-blend gasoline, please take the following precautions as the usage of such fuels may cause vehicle performance problems and/or fuel system damage.

- **The fuel should be unleaded and have an octane rating no lower than that recommended for unleaded gasoline.**
- **If an oxygenate-blend, excepting a methanol blend, is used, it should contain no more than 10% oxygenate. (MTBE may, however, be added up to 15%).**
- **If a methanol blend is used, it should contain no more than 5% methanol (methyl alcohol, wood alcohol). It should also contain a suitable amount of appropriate cosolvents and corrosion inhibitors. If not properly formulated with appropriate cosolvents and corrosion inhibitors, such methanol blends may cause fuel system damage and/or vehicle performance problems. At this time, sufficient data is not available to ensure that all methanol blends are suit-**

**able for use in Nissan vehicles.**

If any undesirable driveability problems such as engine stalling and hard hot starting are experienced after using oxygenate-blend fuels, immediately change to a non-oxygenate fuel or a fuel with a low blend of MTBE.

**Take care not to spill gasoline during refueling. Gasoline containing oxygenates can cause paint damage.**

### After market fuel additives

NISSAN does not recommend the use of any fuel additives (i.e.: fuel injector cleaner, octane booster, intake valve deposit removers, etc.) which are sold commercially. Many of these additives intended for gum, varnish or deposit removal may contain active solvents or similar ingredients that can be harmful to the fuel system and engine.

### Octane rating tips

In most parts of North America, you should use unleaded gasoline with an octane rating of at least 87 AKI (Anti-Knock Index) number. However, you may use unleaded gasoline with an octane rating as low as 85 AKI (Anti-Knock Index) number in these high altitude areas [over 4,000 ft (1,219 m)] such as: Colorado, Montana, New Mexico, Utah, Wyoming, north-

eastern Nevada, southern Idaho, western South Dakota, western Nebraska, and that part of Texas which is directly south of New Mexico.

**Using unleaded gasoline with an octane rating lower than stated above can cause persistent, heavy spark knock. (Spark knock is a metallic rapping noise.) If severe, this can lead to engine damage. If you detect a persistent heavy spark knock even when using gasoline of the stated octane rating, or if you hear steady spark knock while holding a steady speed on level roads, have your dealer correct the condition. Failure to correct the condition is misuse of the vehicle, for which NISSAN is not responsible.**

Incorrect ignition timing will result in knocking, after-run or overheating. This in turn may cause excessive fuel consumption or damage to the engine. If any of the above symptoms are encountered, have your vehicle checked at a NISSAN dealer or other competent service facility.

**However, now and then you may notice light spark knock for a short time while accelerating or driving up hills. This is no cause for concern, because you get the**

**greatest fuel benefit when there is light spark knock for a short time.**



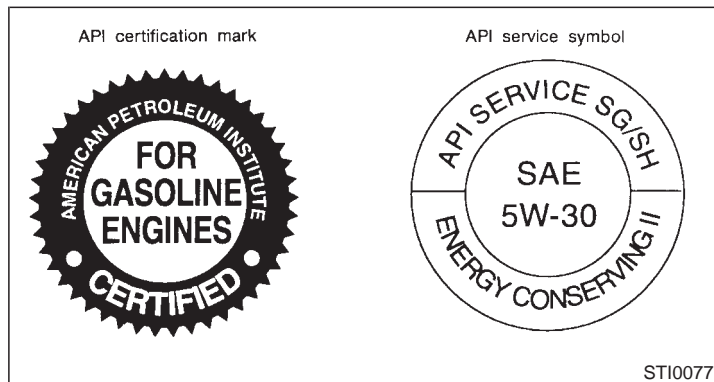

## ENGINE OIL AND OIL FILTER RECOMMENDATION

### Selecting the correct oil

It is essential to choose the correct quality, and viscosity oil to ensure satisfactory engine life and performance. Nissan recommends the use of a low friction oil (energy conserving oil) in order to improve fuel economy and conserve energy. Oils which do not have the specified quality label should not be used as they could cause engine damage.

### 10-6 Technical and consumer information

Only those engine oils with the American Petroleum Institute (API) CERTIFICATION MARK on the front of the container should be used. This type of oil supersedes the existing API SG or SH and Energy Conserving II categories.

If you cannot find engine oil with the CERTIFICATION MARK, an API SG or SH and Energy Conserving II oil with API Service Symbol may be used. An oil with a single designation SG or SH, or in combination with other categories (for example, SG/CC or SG/CD) may also be used if one with the API CERTIFICATION MARK cannot be found.

Mineral based or synthetic type oils may be used in your NISSAN vehicle. These oils must however, meet the API quality and SAE viscosity ratings specified for your vehicle. Do not mix mineral based and synthetic type oils in the engine at the same time.

### Oil additives

NISSAN does not recommend the use of oil additives. The use of an oil additive is not necessary when the proper oil type is used and maintenance intervals are followed.

Oil which may contain foreign matter or has been previously used should not be used.

### Oil viscosity

The engine oil viscosity or thickness changes with temperature. Because of this, it is important that the engine oil viscosity be selected based on the temperatures at which the vehicle will be operated before the next oil change. The chart recommended SAE viscosity number shows the recommended oil viscosities for the expected ambient temperatures. Choosing an oil viscosity other than that recommended could cause serious engine damage.

## Selecting the correct oil filter

Your new vehicle is equipped with a high-quality genuine Nissan oil filter. When replacing, use the genuine oil filter or its equivalent for the reason described in change intervals.

## Change intervals

The oil and oil filter change intervals for your engine are based on the use of the specified quality oils and filters. Oil and filter other than the specified quality, or oil and filter change intervals longer than recommended could reduce engine life. Damage to engines caused by improper maintenance or use of incorrect oil and filter quality and/or viscosity is not covered by the new Nissan vehicle warranties.

Your engine was filled with a high quality engine oil when it was built. You do not have to change the oil before the first recommended change interval. Oil and filter change intervals depend upon how you use your vehicle. Operation under the following conditions may require more frequent oil and filter changes.

- repeated short distance driving at cold outside temperatures,
- driving in dusty conditions,
- extensive idling,

— towing a trailer.

## RECOMMENDED SAE VISCOSITY NUMBER

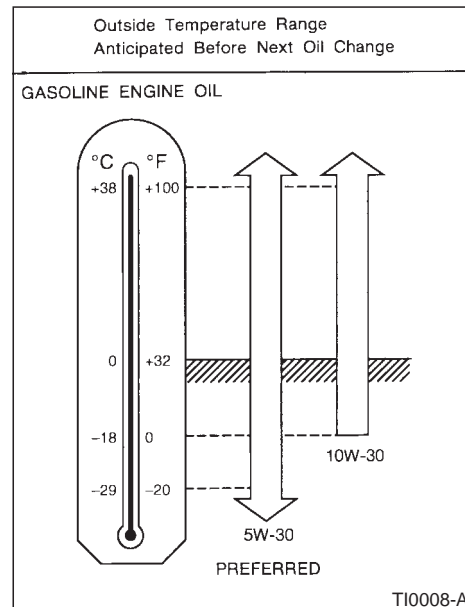

SAE 5W-30 viscosity oil is preferred for all temperatures. SAE 10W-30 viscosity oil may be used if the ambient temperature is above 0°F (-18°C).

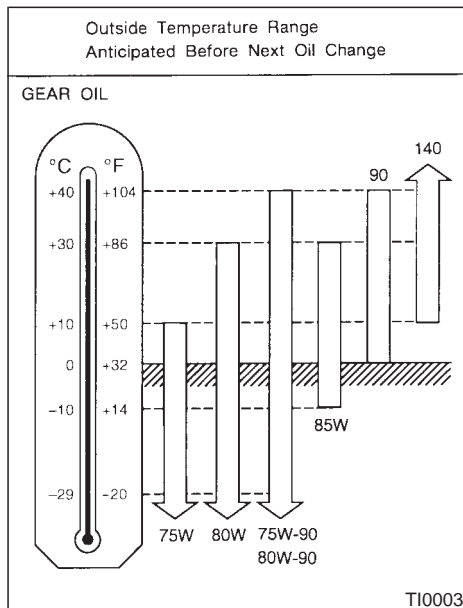

**75W-90 for transfer, and 80W-90 for differential are preferable if the ambient temperature is below 104°F (40°C).**

## AIR CONDITIONING SYSTEM REFRIGERANT AND LUBRICANT RECOMMENDATIONS

**The air conditioning system in this NISSAN vehicle must be charged with the refrigerant HFC-134a (R-134a) and the lubricant, Nissan A/C System Oil Type S or the exact equivalents. Use of any other refrigerants or lubricants will cause severe damage and you will need to replace your vehicle's entire air conditioning system.**

The refrigerant HFC-134a (R-134a) in your NISSAN vehicle will not harm the earth's ozone layer. Although this refrigerant does not affect the earth's atmosphere, certain governmental regulations require the recovery and recycling of any refrigerant during automotive air conditioning system service. Your NISSAN dealer has the trained technicians and equipment needed to recover and recycle your air conditioning system refrigerant.

Contact your NISSAN dealer when servicing your air conditioning system.

## SPECIFICATIONS

### ENGINE

Model		VG33E
Type		Gasoline, 4-cycle
Cylinder arrangement		6-cylinder, V-slanted at 60°
Bore × Stroke	in (mm)	3.602 × 3.268 (91.5 × 83.0)
Displacement	cu in (cm <sup>3</sup> )	199.84 (3,275)
Firing order		1-2-3-4-5-6*1
Idle speed	rpm	
Ignition timing (BTDC)	degree/rpm	See the "Emission control label" on the underside of the hood.
CO percentage at idle speed [No air] %		
Spark plug		BKR4E-11 (Hot) BKR5E-11 (Standard) BKR6E-11 (Cold)
Spark plug gap	in (mm)	0.039 to 0.043 (1.0 to 1.1)
Camshaft operation		Timing belt*2
Alternator belt size		
Width × Length	in (mm)	0.8409 × 41.93 (21.36 × 1,065)

\*2: Periodic maintenance is necessary. See "Periodic maintenance" in the "9. Maintenance" section for maintenance intervals.

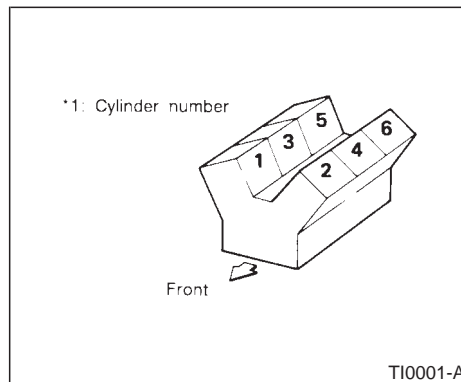

**The spark ignition system of this vehicle meets all requirements of the Canadian Interference-Causing Equipment Regulations.**

## TIRES AND WHEELS

### For US

	Grade	Road wheel/ offset in (mm)	Tire	Spare tire size
4x2	PATH- FINDER	XE LE	15x6-1/2JJ/1.97 (50) 15x6-1/2JJ Aluminum/1.97 (50)	P235/70R15 102S P235/70R15 102S
4x4	PATH- FINDER	XE LE	15x6-1/2JJ/1.97 (50) 15x6-1/2JJ Aluminum/1.97 (50)	P235/70R15 102S P235/70R15 102S
		SE	15x7JJ/1.57 (40) 15x7JJ Aluminum/1.57 (40)	P265/70R15 110S P265/70R15 110S

### For Canada

	Grade	Road wheel/offset in (mm)	Tire	Spare tire size
4x4	PATH- FINDER	LE	15x6-1/2JJ/1.97 (50) 15x6-1/2JJ Aluminum/1.97 (50)	P235/70R15 102S P235/70R15 102S
		XE SE	15x7JJ/1.57 (40) 15x7JJ Aluminum/1.57 (40)	P265/70R15 110S P265/70R15 110S

## DIMENSIONS AND WEIGHTS

PATHFINDER		
Overall length*1	in (mm)	178.3 (4,530)
Overall width	in (mm)	68.7 (1,745) 72.4 (1,840)*2*3
Overall height	in (mm)	67.1 (1,705) 67.9 (1,725)*2
Front tread	in (mm)	58.3 (1,480) 59.1 (1,500)*2
Rear tread	in (mm)	58.5 (1,485) 59.3 (1,505)*2
Wheelbase	in (mm)	106.3 (2,700)
Gross vehicle weight rating		See the "F.M.V.S.S. certification label" on the driver's side lock pillar.
Gross axle weight rating		
Front	lb (kg)	
Rear	lb (kg)	

\*1: On spare tire carrier equipped models, the spare tire carrier adds 9.45 in (240 mm) to the overall length.

\*2: SE models

\*3: XE models with overfender

## WHEN TRAVELING OR REGISTERING YOUR VEHICLE IN ANOTHER COUNTRY

When planning to travel in another country, you should first find out if the fuel available is suitable for your vehicle's engine.

**Using fuel with too low an octane rating may cause engine damage. All gasoline vehicles can be operated with unleaded gasoline. Therefore, avoid taking your vehicle to areas where appropriate fuel is not available.**

**When transferring the registration of your vehicle to another country, state, province or district, it may be necessary to modify the vehicle to meet local laws and regulations.**

The laws and regulations for motor vehicle emission control and safety standards vary according to the country, state, province or district; therefore, vehicle specifications may differ.

**When any vehicle is to be taken into another country, state, province or district and registered, its modifications, transportation and registration are the responsibility of the user. NISSAN is not responsible for any inconvenience that may result.**

## VEHICLE IDENTIFICATION

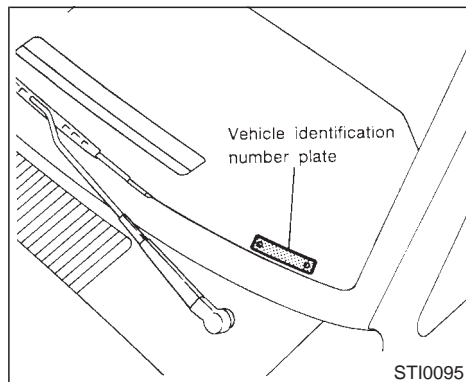

### VEHICLE IDENTIFICATION NUMBER PLATE

The vehicle identification number plate is attached as shown. This number is the identification for your vehicle and is used in the vehicle registration.

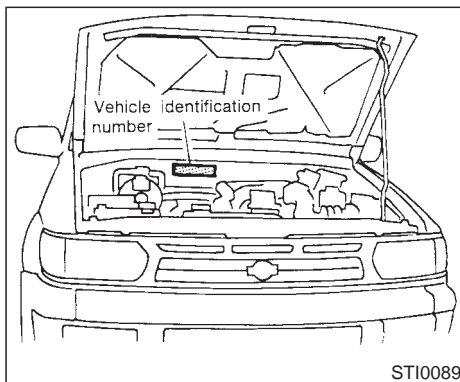

### VEHICLE IDENTIFICATION NUMBER (Chassis number)

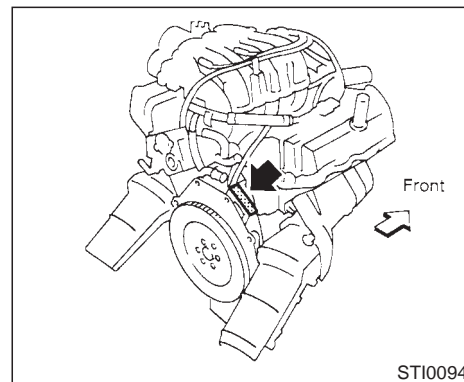

### ENGINE SERIAL NUMBER

The number is stamped on the engine as shown.

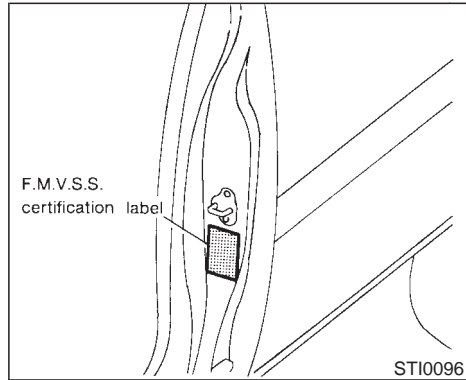

### F.M.V.S.S. CERTIFICATION LABEL

The Federal Motor Vehicle Safety Standard (F.M.V.S.S.) certification label is affixed as shown. This label contains valuable vehicle information, such as: Gross Vehicle Weight Ratings (GVWR), Gross Axle Weight Rating (GAWR), month and year of manufacture, Vehicle Identification Number, (VIN), etc. Review it carefully.

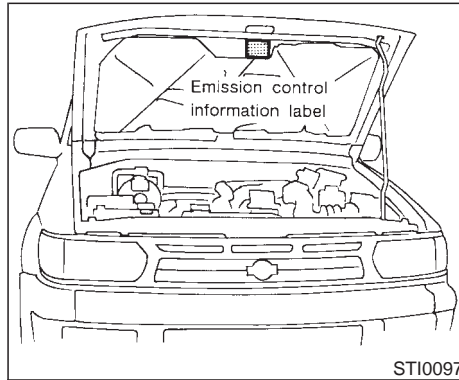

### EMISSION CONTROL INFORMATION LABEL

The emission control information label is attached as shown.

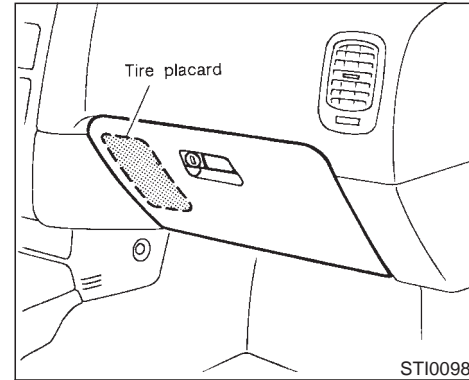

### TIRE PLACARD

The cold tire pressure is shown on the tire placard.



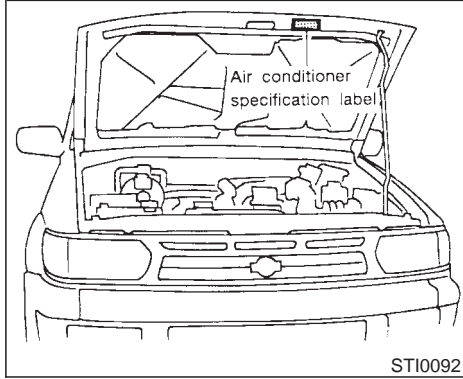

ST10092

## AIR CONDITIONER SPECIFICATION LABEL

The air conditioner specification label is attached as shown.

## VEHICLE LOADING INFORMATION

### WARNING

- It is extremely dangerous to ride in a cargo area inside of a vehicle. In a collision, people riding in these areas are more likely to be seriously injured or killed.
- Do not allow people to ride in any area of your vehicle that is not equipped with seats and seat belts.
- Be sure everyone in your vehicle is in a seat and using a seat belt properly.

## TERMS

It is important to familiarize yourself with the following terms before loading your vehicle:

- Curb Weight (actual weight of your vehicle) - vehicle weight including: standard and optional equipment, fluids, emergency tools, and spare tire assembly. This weight **does not** include passengers and cargo.
- GVW (Gross Vehicle Weight) - curb weight plus the combined weight of passengers and cargo.
- GVWR (Gross Vehicle Weight Rating) -

maximum total weight (load) limit specified for the vehicle.

- GAWR (Gross Axle Weight Rating) - maximum weight (load) limit specified for the front or rear axle.

## DETERMINING VEHICLE LOAD CAPACITY

The load capacity of this vehicle is determined by weight, not by available cargo space. For example, a luggage rack, bike carrier, cartop carrier or similar equipment does not increase load carrying capacity of your vehicle.

To determine vehicle load capacity:

Vehicle weight can be determined by using a commercial-grade scale, found at places such as a truck stop, gravel quarry, grain elevator, or a scrap metal recycling facility.

- 1) Determine the curb weight of your vehicle.
- 2) Compare the curb weight amount to the GVWR specified for your vehicle to determine how much more weight your vehicle can carry.
- 3) After loading (cargo and passengers), re-weigh your vehicle to determine if either GVWR or GAWR for your vehicle is exceeded. If GVWR is exceeded, remove

cargo as necessary. If either the front or rear GAWR is exceeded, shift the load or remove cargo as necessary.

## LOADING TIPS

- The GVW must not exceed GVWR or GAWR as specified on the FMVSS Certification Label.
- Do not load the front and rear axle to the GAWR. Doing so will exceed the GVWR.

### WARNING

- **Properly secure all cargo to help prevent it from sliding or shifting. Do not place cargo higher than the seat-backs. In a sudden stop or collision, unsecured cargo could cause personal injury.**
- **Do not load your vehicle any heavier than the GVWR or the maximum front and rear GAWRs. If you do, parts on your vehicle can break, or it can change the way your vehicle handles. This could result in loss of control and cause personal injury.**
- **Overloading can shorten the life of**

**your vehicle. Failures caused by overloading are not covered by your warranty.**

## TOWING A TRAILER

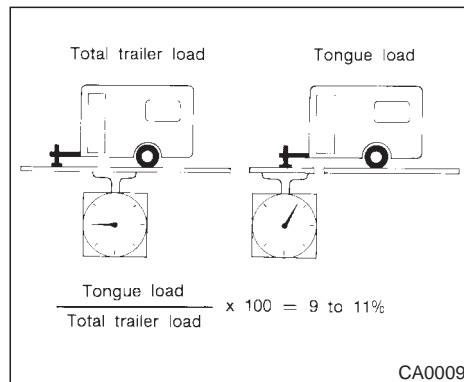

Your new vehicle was designed to be used primarily to carry passengers and cargo. Remember that towing a trailer will place additional loads on your vehicle's engine, drive train, steering, braking and other systems.

Information on trailer towing ability and the special equipment required should be obtained from your Nissan dealer. He can obtain a **Nissan Trailer Towing Guide** for you.

## MAXIMUM LOAD LIMITS

### Maximum trailer loads

Never allow the total trailer load to exceed the value specified in the following Towing Load/Specification Chart. The total trailer load equals trailer weight plus its cargo weight.

- When towing a trailer load of 1,000 lb (454 kg) or more, trailers with a brake system MUST be used.

The maximum GCWR (Gross Combined Weight Rating) should not exceed the value specified in the following Towing Load Specification Chart.

The GCWR equals the combined weight of the towing vehicle (including passengers and cargo) plus the total trailer load. Towing loads greater than these or using improper towing equipment could adversely affect vehicle handling, braking and performance.

### WARNING

**Vehicle damage and/or personal injury resulting from improper towing procedures is not covered by NISSAN warranties.**

**Information on trailer towing and re-**

**10-16 Technical and consumer information**

**quired towing equipment should be obtained from dealers who specialize in providing trailers or other towing equipment.**

### Tongue load

Keep the tongue load between 9 to 11% of the total trailer load within the maximum tongue load limits shown in the following Towing Load/Specifications Chart. If the tongue load becomes excessive, rearrange cargo to allow for proper tongue load.

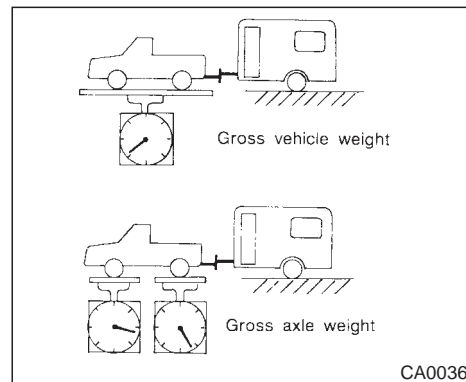

### Maximum gross vehicle weight/ maximum gross axle weight

The gross vehicle weight of the towing vehicle must not exceed the gross vehicle weight rating (GVWR) shown on the F.M.V.S.S. certification label. The gross vehicle weight equals the combined weight of the unloaded vehicle, passengers, luggage, hitch, trailer tongue load and any other optional equipment. In addition, front or rear gross axle weight must not exceed the gross axle weight rating (GAWR) shown on the F.M.V.S.S. certification label.

TOWING LOAD/SPECIFICATION CHART			
		Unit: lb (kg)	
WEIGHT	MODEL	PATHFINDER VG33E (6-Cyl.)	
		M/T	A/T
MAXIMUM TRAILER WEIGHT*1		3,500 (1,588)	5,000 (2,268)
MAXIMUM TONGUE LOAD		350 (159)	500 (227)
GROSS COMBINED WEIGHT RATING		8,000 (3,628)	9,500 (4,308)
RECOMMENDED EQUIPMENT*2	Sway Control Device (SCD)		

\*1: All towing above 1,000 lb (454 kg) requires the use of trailer brakes. NISSAN recommends the use of a tandem axle trailer whenever towing above 3,000 lb (1,361 kg).

\*2: A sway control device is recommended for all towing above 2,000 lb (907 kg). Sway control devices are not offered by NISSAN. See a professional trailer/hitch outlet for a properly designed sway control device for your trailer.

## TOWING SAFETY

### Trailer hitch

Check the towing capacity of your receiver type frame mounted hitch. Choose a proper hitch for your vehicle and trailer. Make sure the trailer hitch is securely attached to the vehicle, to help avoid personal injury or property damage due to sway caused by crosswinds, rough road surfaces or passing trucks.

### CAUTION

- **Special hitches which include frame reinforcements are required for towing above 2,000 lb (907 kg). Suitable Genuine NISSAN hitches for pickup truck and Pathfinder models are available at your Nissan dealer.**
- **Do not use axle-mounted hitches.**
- **Do not modify the vehicle exhaust system, brake system, etc. when the hitch is installed. After the hitch is removed, seal the bolt holes to prevent exhaust fumes, water or dust from entering the passenger compartment.**

- **Check regularly to make sure that all trailer hitch mounting bolts are securely fastened.**
- **To reduce the possibility of additional damage if your vehicle is struck from the rear, where practical, remove the hitch when not in use. Remove the receiver when not in use.**

## Tire pressures

- When towing a trailer, inflate the vehicle tires to the recommended cold tire pressure indicated on the tire placard (affixed to the glove box lid).
- Trailer tire condition, size, load rating and proper inflation pressure should be in accordance with the trailer and tire manufacturers' specifications.

## Safety chain

Always use a suitable chain between your vehicle and the trailer. The chain should be crossed and should be attached to the hitch, not to the vehicle bumper or axle. Be sure to leave enough slack in the chain to permit turning corners.

## Trailer lights

Trailer lights should comply with Federal and/or local regulations.

**When wiring vehicle for towing connection, connect stop and tail light pickup into the vehicle electrical circuit at point between the sensor and stop light switch or light switch.**

## Trailer brakes

If your trailer is equipped with a braking system, make sure it conforms to Federal and/or local regulations and that it is properly installed.



**Never connect a trailer brake system directly to the vehicle brake system.**

## Trailer towing tips

In order to gain skill and an understanding of the vehicle's behavior, you should practice turning, stopping and backing up in an area which is free from traffic. Steering stability and braking performance will be somewhat different than under normal driving conditions.

- Always secure items in the trailer to prevent load shift while driving.
  - Avoid abrupt starts, acceleration or stops.
  - Avoid sharp turns or lane changes.
  - Always drive your vehicle at a moderate speed.
  - Always block the wheels on both vehicle and trailer when parking. Parking on a slope is not recommended; however, if you must do so, and if your vehicle is equipped with automatic transmission, first block the wheels and apply the parking brake, and then move the transmission selector lever into the P position. If you move the selector lever to the P position before blocking the wheels and applying the parking brake, transmission damage could occur.
  - When going down a hill, shift into a lower gear and use the engine braking effect. When ascending a long grade, downshift the transmission to a lower gear and reduce speed to reduce chances of engine overloading and/or overheating.
- However, for long steep grades, do not stay in 1st or 2nd gear when driving above 35 MPH (56 km/h).
- If the engine coolant rises to an extremely

high temperature when the air conditioning system is on, turn off the air conditioner. Coolant heat can be additionally vented by opening the windows, switching the fan control to high and setting the temperature control to the HOT position.

- Trailer towing requires more fuel than normal circumstances.
- Avoid towing a trailer for the first 500 miles (800 km).
- Have your vehicle serviced more often than at intervals specified in the recommended Maintenance Schedule.

**When towing a trailer, change oil in the transmission more frequently. See the Maintenance Schedule.**

## **EMISSION CONTROL SYSTEM WARRANTY**

Your NISSAN is covered by the following emission warranties.

For US:

- 1) Emission Defects Warranty
- 2) Emissions Performance Warranty

For Canada:

Emission Control System Warranty

Details of these warranties may be found with other vehicle warranties in your Warranty Information and Maintenance Log Booklet which comes with your NISSAN. If you did not receive a Warranty Information and Maintenance Log Booklet or it becomes lost, you may obtain a replacement by writing.

- Nissan Motor Corporation USA Consumer Affairs Department P.O. Box 191 Gardena, CA 90248-0191
- Nissan Canada Inc. 5290 Orbitor Drive Mississauga, Ontario, L4W 4Z5

## **REPORTING SAFETY DEFECTS (US only)**

If you believe that your vehicle has a defect which could cause a crash or could cause injury or death, you should immediately inform the National Highway Traffic Safety Administration (NHTSA) in addition to notifying NISSAN.

If NHTSA receives similar complaints, it may open an investigation, and if it finds that a safety defect exists in a group of vehicles, it may order a recall and remedy campaign. However, NHTSA cannot become involved in individual problems between you, your dealer, or NISSAN.

To contact NHTSA, you may either call the Auto Safety Hotline toll-free at 1-800-424-9393 (or 366-0123 in Washington, D.C. area) or write to: NHTSA, U.S. Department of Transportation, Washington, D.C. 20590. You can also obtain other information about motor vehicle safety from the Hotline.

You may notify NISSAN by contacting our Consumer Affairs Department, toll-free, at 1-800-NISSAN-1. In Hawaii call (808) 836-0888.

## READINESS FOR INSPECTION/ MAINTENANCE (I/M) TEST (US only)

Due to legal requirements in some states/ areas, your vehicle may be required to be in what is called the “ready condition” for an Inspection/Maintenance (I/M) test of the emission control system.

The vehicle is set to the “ready condition” when it is driven through certain driving patterns. Usually, the ready condition can be obtained by ordinary usage of the vehicle.

If a powertrain system component is repaired or the battery is disconnected, the vehicle may be reset to a not ready condition. Before taking the I/M test, drive the vehicle through the following pattern to set the vehicle to the ready condition. If you cannot or do not want to perform the driving pattern, an NISSAN dealer can conduct it for you.

### **WARNING**

**Always drive the vehicle in a safe manner according to traffic conditions and obey all traffic laws.**

1. Start the engine when the engine coolant temperature gauge needle points to C. Allow the engine to idle until the gauge needle points between the C and H (normal operating temperature).

2. Accelerate the vehicle to 55 MPH (88 km/h), then quickly release the accelerator pedal completely and keep it released for at least 6 seconds.
3. Quickly depress the accelerator pedal for a moment, then drive the vehicle at a speed of 53 to 60 MPH (86 to 96 km/h) for at least 5 minutes.
4. Stop the vehicle.
5. Accelerate the vehicle to 35 MPH (55 km/h) and maintain the speed for 20 seconds.
6. Repeat steps 4 through 5 at least 3 times.
7. Accelerate the vehicle to 55 MPH (88 km/h) and maintain the speed for at least 3 minutes.
8. Stop the vehicle and turn the engine off.
9. Repeat steps 1 through 8 at least one more time.

If step 1 through 7 is interrupted, repeat the preceding step. Any safe driving mode is acceptable between steps. Do not stop the engine until step 7 is completed.

## **Genuine Nissan Service Manuals**



# **GET THE INSIDE STORY**

A Genuine Nissan Service Manual is the best source of service and repair information for your vehicle. Filled with wiring diagrams, illustrations and step-by-step diagnostic and adjustment procedures, this manual is the same one used by the factory trained technicians working at your Nissan dealership. Also available are Genuine NISSAN Owner's Manuals.

For current pricing and availability of a Genuine NISSAN Service Manual or Genuine NISSAN Owner's Manual, contact:

In the US:

See your NISSAN dealer or contact:

Dymont Distribution Services  
20770 Westwood Dr.  
Strongsville OH 44136

In a hurry? Call 1-800-247-5321 and charge your purchase to Visa/Master Card.

In Canada:

To purchase a copy of a Genuine NISSAN Service Manual or Owner's Manual please contact your nearest NISSAN Dealer. For the phone number and location of a NISSAN Dealer in your area call the Nissan Satisfaction Center at 1-800-387-0122 and a

bilingual NISSAN representative will assist you.

Also available are Genuine NISSAN Service and Owner's Manuals for older Nissan models.



# MEMO

# 11 Index

## A

ABS .....	5-25
Adjusting the time .....	2-33
Adjustment	
Front manual seat .....	1-2
Front power seat .....	1-4
Head restraint .....	1-8
Rear seat .....	1-5
Shoulder belt .....	1-22
Air bag	
System .....	1-13
Warning label .....	1-15
Warning light .....	1-15, 2-10
Air cleaner .....	8-16
Air conditioner	
Manual .....	4-3
Operation, Manual .....	4-5
Operation, Semiautomatic .....	4-11
Semiautomatic .....	4-9
Servicing .....	4-13
Specification label .....	10-14
Air conditioning system refrigerant and lubricant recommendations .....	10-8
Aluminum alloy wheels, Cleaning .....	7-3
Anchor point location, Top strap .....	1-35
Antenna .....	4-25
Anti-freeze, Cold weather .....	5-26
Anti-lock Brake System (ABS) .....	5-25

Appearance care	
Exterior .....	7-2
Interior .....	7-4
Armrest .....	1-8
Ashtray .....	2-22
Audio system .....	4-14
Automatic	
Sunroof, Operation .....	2-32
Transmission fluid .....	8-9
Transmission, Driving .....	5-9
Avoiding collision and rollover .....	5-4

## B

Back door .....	3-9
Battery	
Cold weather .....	5-26
Maintenance .....	8-13
Replacement, Multi-remote control .....	3-6
Before starting the engine .....	5-8
Belt	
Drive .....	8-14
Extender, Seat .....	1-25
Height adjustment, Shoulder .....	1-22
Maintenance, Seat .....	1-25
Seat .....	1-17
Brake	
Booster .....	8-19
Fluid .....	8-11

## C

Parking .....	5-15
Pedal .....	8-18
System .....	5-24
Warning light .....	2-10
Break-in schedule .....	5-18
Bulb	
Checking .....	2-9
Indicator .....	2-12
Replacement .....	8-22
Warning light .....	2-9
Buzzer .....	2-13
Capacities and recommended fuel/lubricant ..	10-2
Car phone .....	4-26
Carbon monoxide, Exhaust gas .....	5-2
Cassette tape player operation .....	4-16
Cassette tape player operation, with compact disc (CD) player type .....	4-22
Catalytic converter, Three way catalyst .....	5-3
CB radio or car phone .....	4-26
Certification label, F.M.V.S.S. .....	10-13
Chain, Tire .....	8-27
Changing	
A flat tire .....	6-2
Engine coolant .....	8-5
Engine oil .....	8-8
Engine oil filter .....	8-9
Tire and wheel .....	8-28

Checking	
Brake pedal .....	8-18
Bulb .....	2-9
Engine coolant level .....	8-4
Engine oil level .....	8-7
Parking brake .....	8-18
Seat belt operation, Three-point .....	1-21
Child restraint.....	1-25
Installation on front seat.....	1-36
Installation on rear seat center .....	1-27
Installation on rear seat outboard .....	1-30
Precaution .....	1-25
Top strap .....	1-34
Child safety	
Rear door lock.....	3-3
Seat belt .....	1-18
Chrome parts, Cleaning.....	7-3
Cigarette lighter and ashtray .....	2-22
Cleaner, Air.....	8-16
Cleaning	
Exterior .....	7-2
Interior .....	7-4
Clock .....	2-33
Adjusting.....	2-33
Operation .....	2-34
Clutch	
Fluid.....	8-11
Housing drain,  .....	8-30
Pedal .....	8-20
Cold weather driving.....	5-26
Compact disc (CD) player operation, with cassette player type.....	4-23
Compass display .....	2-7
Console box.....	2-25

Controls, Heater and manual air conditioner....	4-3
Controls, Heater and semiautomatic air conditioner .....	4-9
Cooling system, Engine.....	8-4
Corrosion protection .....	7-5
Cover, Tonneau.....	2-29
Cruise control.....	5-16
Cup holder .....	2-24

## D

Defogger switch, Rear window and outside mirror.....	2-16
Dimensions and weights, Vehicle.....	10-11
Door .....	3-2
Door open warning light .....	2-10
Drinking alcohol/drugs and driving .....	5-4
Drive belt.....	8-14
Driving	
Cold weather .....	5-26
On snow or ice .....	5-28
On-pavement and offroad .....	5-4
Precaution .....	5-2
The vehicle .....	5-9
Drugs .....	5-4

## E

Economy, Fuel.....	5-19
Emission control	
Information label.....	10-13
System warranty.....	10-19
Engine	
Block heater .....	5-28

Compartment check location.....	8-3
Coolant heater.....	5-28
Coolant temperature gauge .....	2-4
Cooling system.....	8-4
Oil .....	8-7
Oil and oil filter recommendation .....	10-6
Overheat.....	6-9
Serial number .....	10-12
Specifications .....	10-9
Exhaust gas (Carbon monoxide).....	5-2
Explanation of maintenance items .....	9-2, 9-10
Exterior and interior light, Replacement .....	8-23

## F

F.M.V.S.S. certification label.....	10-13
Fastening the seat belt	
Three-point .....	1-20
Two-point.....	1-23
Filling, Fuel filler lid.....	3-11
Filter, Air .....	8-16
Flasher switch, Hazard warning .....	2-19
Flat tire .....	6-2
Floor mats, Cleaning .....	7-4
Fluid	
Automatic transmission .....	8-9
Brake .....	8-11
Engine .....	8-7
Power steering .....	8-11
Window washer .....	8-12
Fog light switch.....	2-19
Four by four clutch housing drain.....	8-30
Four wheel drive, Using.....	5-20

Front	
Fog light switch .....	2-19
Manual seat adjustment .....	1-2
Power seat adjustment.....	1-4

Fuel	
Economy.....	5-19
Filler cap.....	3-11
Filler lid.....	3-11
Gauge.....	2-5
Recommendation .....	10-4
Fuse .....	8-20

## G

Garage door opener, Integrated	
HomeLink <sup>®</sup> .....	2-35
Gas cap, Fuel filler .....	3-11
Gas economy, Fuel .....	5-19
Gauge .....	2-3
Engine coolant temperature .....	2-4
Fuel.....	2-5
Speedometer and odometer .....	2-3
Tachometer .....	2-4
General maintenance .....	9-2
Glass, Cleaning .....	7-3
Glasses case .....	2-23
Glove box.....	2-25

## H

Hazard warning flasher switch.....	2-19
Head restraint adjustment .....	1-8
Headlamp, Replacement .....	8-21

Headlight	
Replacement .....	8-22
Switch .....	2-17
Heated seat .....	2-20
Heater and air conditioner	
(Manual) .....	4-3
(Semiautomatic) .....	4-9
Heater operation	
Manual air conditioner.....	4-4
Semiautomatic air conditioner.....	4-10
HomeLink <sup>®</sup> .....	2-35
Hood .....	3-8
Hook, Luggage .....	2-27
Horn .....	2-20
How to stop alarm, Theft warning .....	2-15
How to use multi-remote control system.....	3-4

## I

Identification, Vehicle .....	10-12
Ignition switch .....	5-6
Indicator light .....	2-12
Infants and small children, Seat belt .....	1-19
Information label, Emission.....	10-13
Injured persons, Seat belt .....	1-19
Inside mirror.....	3-14
Instrument panel.....	2-2
Integrated HomeLink <sup>®</sup> transmitter .....	2-35
Interior light .....	2-34
Replacement .....	8-23

## J

Jump starting .....	6-7
---------------------	-----

## K

Key.....	3-2
Position, Ignition switch.....	5-8
Key operation, Back door .....	3-9
Keyless entry, Multi-remote control .....	3-4

## L

Label, Air bag warning.....	1-15
Lamp, Replacement.....	8-22
Larger children, Seat belt .....	1-19
Light	
Air bag warning .....	1-15
Front fog light switch .....	2-19
Headlight replacement .....	8-21
Headlight switch .....	2-17
Indicator.....	2-12
Interior .....	2-34
Personal .....	2-35
Replacement .....	8-22
Vanity.....	2-35
Warning .....	2-9
Loading information, Vehicle .....	10-14
Loading tips .....	10-15
Lock	
Back door .....	3-9
Door.....	3-2
Locking with	
Inside lock knob .....	3-3

Key .....	3-2
Power door lock switch .....	3-3
Low fuel warning light .....	2-11
Lubricant, Capacities and recommended .....	10-2
Luggage	
Hook .....	2-27
Net .....	2-28
Rack .....	2-30
Storage .....	2-26

## M

Maintenance	
General .....	9-2
Item .....	9-2, 9-10
Periodic .....	9-5
Precaution .....	8-2
Seat belt .....	1-25
Manual	
Front seat adjustment .....	1-2
Transmission, Driving .....	5-14
Meter	
And gauge .....	2-3
Speedometer and odometer .....	2-3
Tachometer .....	2-4
Mirror .....	3-14
Inside .....	3-14
Outside .....	3-14
Multi-remote control system .....	3-4

## N

Net, Luggage .....	2-28
--------------------	------

New vehicle, Break-in .....	5-18
-----------------------------	------

## O

Odometer .....	2-3
Oil	
Automatic transmission .....	8-9
Brake .....	8-11
Engine .....	8-7
Filter recommendation .....	10-6
Power steering .....	8-11
Opener operation	
Back door .....	3-11
Fuel filler lid .....	3-11
Rear window .....	3-11
Trunk lid .....	3-11
Operating tips, Automatic air conditioner .....	4-5, 4-6, 4-11, 4-12
Operation, Clock .....	2-34
Outside mirror .....	3-14
Outside temperature display .....	2-6
Overheat .....	6-9

## P

Parking	
Brake .....	5-15
Brake and brake pedal .....	8-18
Parking/parking on hills .....	5-23
Pedal	
Brake .....	8-18
Clutch .....	8-20
Periodic maintenance .....	9-5
Personal light .....	2-35

## Power

Front seat adjustment .....	1-4
Seat operating tips .....	1-4
Socket .....	2-21
Steering .....	5-24
Steering fluid .....	8-11
Window .....	2-30

## Precaution

Maintenance .....	8-2
On child restraint .....	1-25
On seat belt usage .....	1-17
On-pavement and offroad .....	5-4
When starting and driving .....	5-2
Pregnant women, Seat belt .....	1-19
Push starting .....	6-9

## R

Rack, Luggage .....	2-30
Radio .....	4-14
With cassette player .....	4-15
With cassette player and compact disc (CD) player .....	4-19
Readiness for inspection/maintenance (I/M) test (US only) .....	10-20
Rear	
Door lock, Child safety .....	3-3
Seat adjustment .....	1-5
Window and outside mirror defogger switch .....	2-16
Window wiper and washer switch .....	2-16
Window, Lock .....	3-10
Recommended	
Fuel/lubricant .....	10-2

SAE viscosity number .....	10-7
Recovery, Freeing a stuck vehicle .....	6-13
Refrigerant, air conditioning.....	10-8
Registering your vehicle in another country. ....	10-11
Release, Hood .....	3-8
Remote keyless entry, Multi-remote control .....	3-4
Reporting safety defects (US only).....	10-19
Restraint, Child .....	1-25
Rollover .....	5-4
Rotation, Tire .....	8-28

## S

Safety	
Belt .....	1-17
Child seat belt .....	1-18
Defects, Reporting.....	10-19
Towing .....	10-17
Seat.....	1-2
Heated.....	2-20
Seat adjustment	
Front manual .....	1-2
Front power .....	1-4
Rear.....	1-5
Seat belt.....	1-17
Cleaning .....	7-4
Extender .....	1-25
Hook .....	1-23
Maintenance .....	1-25
Operation, Three-point .....	1-21
Precautions.....	1-17
Warning light and buzzer .....	2-10
With retractor, Three-point .....	1-20

Without retractor, Two-point.....	1-23
Security system .....	2-14
Selecting correct set of seat belt .....	1-23
Servicing air conditioner .....	4-13
Setting, Clock.....	2-33
Shifting procedure, Transfer .....	5-21
Shoulder belt height adjustment (For front seats) .....	1-22
Socket .....	2-21
Sound system, Audio system .....	4-14
Sound, Buzzer .....	2-13
Spare tire carrier .....	3-9
Spark plug.....	8-14
Specifications .....	10-9
Speedometer and odometer.....	2-3
Starting	
Automatic transmission .....	5-7
Jump.....	6-7
Manual transmission .....	5-6
Precaution .....	5-2
Push .....	6-9
The engine .....	5-9
Steering	
Power .....	5-24
Wheel .....	3-13
Storage .....	2-23
Stuck, Vehicle recovery .....	6-13
Sun shade.....	2-32
Sun visor.....	3-13
Sunroof .....	2-32
Supplemental	
Air bag system .....	1-13
Air bag warning label .....	1-15
Air bag warning light .....	1-15, 2-10

Restraint system.....	1-9
Switch	
Front fog light .....	2-19
Hazard warning .....	2-19
Headlight .....	2-17
Ignition .....	5-6
Rear window and outside mirror defogger .....	2-16
Turn signal.....	2-18

## T

Tachometer.....	2-4
Temperature display .....	2-6
Temperature gauge, Engine coolant .....	2-4
Theft warning .....	2-14
Three way catalyst.....	5-3
Three-point type seat belt with retractor.....	1-20
Tire .....	8-26
Chain .....	8-27
Changing .....	8-28
Equipment, Cold weather.....	5-27
Flat.....	6-2
Placard .....	10-13
Pressure .....	8-26
Rotation .....	8-28
Type.....	8-26
Tires, Specifications.....	10-10
Tonneau cover.....	2-29
Top strap child restraint.....	1-34
Towing	
A trailer .....	10-15
Safety .....	10-17
Trailer, Towing .....	10-15

Transfer case shifting procedure .....	5-21
Transmitter	
Integrated HomeLink® .....	2-35
Multi-remote control .....	3-4
Traveling or registering your vehicle in another country .....	10-11
Turn signal switch .....	2-18
Two-point type seat belt without retractor (Center of rear seat) .....	1-23
Type of tire .....	8-26

## U

Underbody, Cleaning .....	7-3
Unfastening the seat belt	
Three-point .....	1-21
Two-point .....	1-24
Using four wheel drive .....	5-20

## V

Vanity mirror light .....	2-35
Vehicle	
Identification .....	10-12
Loading information .....	10-14
Ventilator .....	4-2
Viscosity number .....	10-7
Visor, Sun .....	3-13

## W

Warning	
Buzzer, Seat belt .....	2-10
Flasher switch .....	2-19

Label, Air bag .....	1-15
Light .....	2-9
Light, Air bag .....	1-15, 2-10
Light, Brake .....	2-10
Light, Door open .....	2-10
Light, Low fuel .....	2-11
Light, Seat belt .....	2-10
Theft .....	2-14
Warranty, Emission control .....	10-19
Washer switch	
Rear window .....	2-16
Windshield .....	2-15
Washing .....	7-2
Waxing .....	7-3
Weights, Vehicle .....	10-11
Wheel .....	8-26
Wheels, Specifications .....	10-10
Window .....	2-30
Power .....	2-30
Washer fluid .....	8-12
Windshield wiper and washer switch .....	2-15
Windshield wiper blade .....	8-17
Winter equipment .....	5-27
Wiper	
Blade .....	8-17
Rear window .....	2-16
Windshield .....	2-15

## GAS STATION INFORMATION

### FUEL RECOMMENDATION

Your vehicle is designed to operate on unleaded gasoline with an octane rating of at least 87 AKI (Anti-Knock Index) number (Research octane number 91).

 **CAUTION**

**Using a fuel other than that specified could adversely affect the emission control devices and systems, and could also affect the warranty coverage.**

**Under no circumstances should a leaded gasoline be used since this will damage the three way catalyst.**

For additional information, see “Capacities and recommended fuel/lubricants” in the “10. Technical and consumer information” section.

### ENGINE OIL RECOMMENDATION

- API SG or SH and Energy Conserving II
- API Certification Mark
- SAE 5W-30 viscosity oil is preferred for all ambient temperatures.

See “Capacities and recommended fuel/lubricants” in the “10. Technical and consumer information” section for engine oil and

oil filter recommendation.

### COLD TIRE PRESSURE

See the tire placard affixed to the glove box.

### NEW VEHICLE BREAK-IN PROCEDURE RECOMMENDATION

During the first 1,000 miles (1,600 km) of vehicle use, follow the recommendations outlined in the “Break-in schedule” Information found in the “5. Starting and driving” section of this Owner’s Manual. Follow these recommendations for the future reliability and economy of your new vehicle. Failure to follow these recommendations may result in vehicle damage or shortened engine life.



