



V60

OWNERS MANUAL

WEB EDITION





DEAR VOLVO OWNER

THANK YOU FOR CHOOSING VOLVO

We hope you will enjoy many years of driving pleasure in your Volvo. The car has been designed for the safety and comfort of you and your passengers. Volvo is one of the safest cars in the world. Your Volvo has also been designed to satisfy all current safety and environmental requirements.

In order to increase your enjoyment of the car, we recommend that you familiarise yourself with the equipment, instructions and maintenance information contained in this owner's manual.



00 Introduction

Important information.....	6
Volvo and the environment.....	11

00



01 Safety

Seatbelts	16
Airbags.....	19
Activating/deactivating the airbag*.....	22
Side airbags (SIPS bags)	24
Inflatable Curtain (IC)	26
WHIPS	27
When the systems deploy	29
Safety mode.....	30
Child safety.....	31

01



02 Locks and alarm

Remote control key/key blade.....	44
Privacy locking*.....	49
Battery replacement, remote control key/ PCC*.....	51
Keyless drive*.....	53
Locking/unlocking.....	57
Child safety locks.....	62
Alarm*.....	63

02



03 Your driving environment

Instruments and controls.....	68
Volvo Sensus	77
Key positions.....	78
Seats.....	80
Steering wheel.....	85
Lighting.....	86
Wipers and washing.....	98
Windows, rearview and door mirrors.....	101
Compass*.....	106
Power sunroof*.....	107
Alcolock*.....	109
Starting the engine.....	113
Starting the engine – Flexifuel.....	118
Starting the engine – external battery.....	120
Gearboxes.....	121
DRIVE Start/Stop*.....	127
All-wheel drive – AWD*.....	134
Foot brake.....	135
Parking brake.....	137
HomeLink® *.....	141



04 Driver support

DSTC – Stability and traction control system.....	146
Road sign information - RSI*.....	148
Speed limiter*.....	150
Cruise control*.....	152
Adaptive cruise control*.....	154
Distance Warning*.....	165
City Safety™.....	168
Collision Warning with Auto Brake & Pedestrian Protection*.....	173
Driver Alert System*.....	181
Driver Alert System - DAC*.....	182
Driver Alert System - LDW*.....	185
Park assist syst*.....	188
Park assist camera*.....	191
BLIS* – Blind Spot Information System. .	194



05 Comfort and driving pleasure

Menus and messages.....	200
Menu source MY CAR.....	202
Climate control.....	210
Fuel-driven engine block heater and passenger compartment heater*.....	220
Additional heater*.....	223
Trip computer.....	224
Adapting driving characteristics.....	226
Comfort inside the passenger compartment.....	227



06 Infotainment system

General information on infotainment.....	234
Radio.....	245
Media player.....	252
External audio source via AUX/USB* input.....	256
Media Bluetooth®*	259
Bluetooth® handsfree*.....	262
Voice recognition* mobile phone.....	271
TV*.....	275
Remote control*	279



07 During your journey

Recommendations during driving.....	284
Refuelling.....	287
Fuel.....	288
Loading.....	292
Cargo area.....	295
Driving with a trailer.....	298
Towing and recovery.....	304



08 Wheels and tyres

General	310
Changing wheels	314
Tyre pressure	317
Warning triangle and first-aid kit*.....	318
Tyre pressure monitoring (TPMS)*.....	319
Emergency puncture repair (TMK)	321



09 Maintenance and service

Engine compartment.....	328
Lamps.....	335
Wiper blades and washer fluid.....	341
Battery.....	344
Fuses.....	350
Car care.....	361



10 Specifications

Type designations.....	370
Dimensions and weights.....	372
Engine specifications.....	376
Engine oil.....	378
Fluids and lubricants.....	381
Fuel.....	384
Wheel and tyres, dimensions and pressure	388
Electrical system.....	391
Type approval.....	392
Symbols in the display.....	404



11 Alphabetical Index

Alphabetical Index.....	408
-------------------------	-----



Important information

Reading the Owner's Manual

Introduction

A good way of getting to know your new car is to read the owner's manual, ideally before your first journey. This will give you the opportunity to familiarise yourself with new functions, to see how best to handle the car in different situations, and to make the best use of all the car's features. Please pay attention to the safety instructions contained in the manual.

The specifications, design features and illustrations in this owner's manual are not binding. We reserve the right to make modifications without prior notice.

© Volvo Car Corporation

Option

All types of option/accessory are marked with an asterisk*.

In addition to standard equipment, this manual also describes options (factory fitted equipment) and certain accessories (retrofitted extra equipment).

The equipment described in the owner's manual is not available in all cars - they have different equipment depending on adaptations for the needs of different markets and national or local laws and regulations.

In the event of uncertainty over what is standard or an option/accessory, contact a Volvo dealer.

Special texts

WARNING

Warning texts advise of a risk of personal injury.

IMPORTANT

Important texts advise of a risk of material damage.

NOTE

NOTE texts give advice or tips that facilitate the use of features and functions for example.

Footnote

There is footnote information in the owner's manual that is located at the bottom of the page. This information is an addition to the text that it refers to via a number. If the footnote refers to text in a table then letters are used instead of numbers for referral.

Message texts

There are displays in the car that show text messages. These text messages are high-

lighted in the owner's manual by means of the text being slightly larger and printed in grey. Examples of this are in menu texts and message texts on the information display (e.g. **Audio settings**).

Decals

The car contains different types of decal which are designed to convey important information in a simple and clear manner. The decals in the car have the following descending degree of importance for the warning/information.

Warning for personal injury

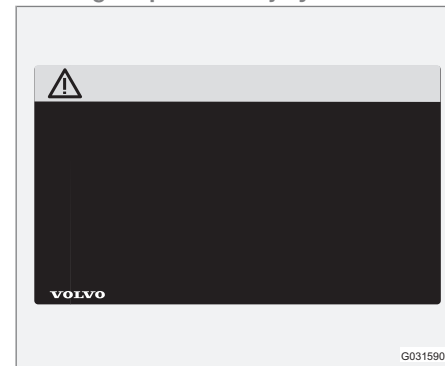

Black ISO symbols on yellow warning field, white text/image on black message field. Used to indicate the presence of danger which, if the



Important information

warning is ignored, may result in serious personal injury or fatality.

Risk of property damage

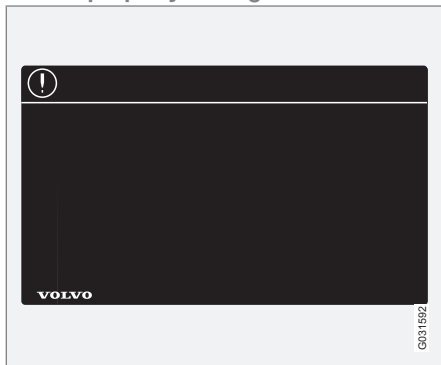

White ISO symbols and white text/image on black or blue warning field and message field. Used to indicate the presence of danger which, if the warning is ignored, may result in damage to property.

Information

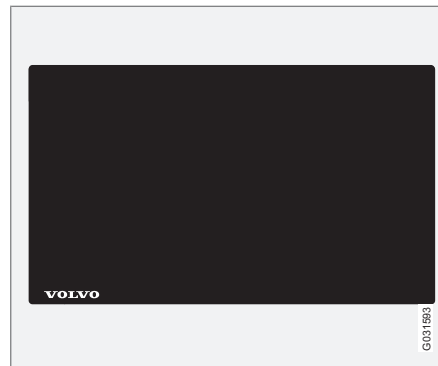

White ISO symbols and white text/image on black message field.

NOTE

The labels shown in the owner's manual are not provided as exact reproductions of those in the car. The purpose is to show their approximate appearance and location in the car. The information that applies to your car in particular is available on the label in question in your car.

Procedure lists

Procedures where action must be taken in a certain sequence are numbered in the owner's manual.

- 1** When there is a series of illustrations for step-by-step instructions each step is numbered in the same way as the corresponding illustration.
- A** There are numbered lists with letters adjacent to the series of illustrations where the order of the instructions is not significant.
- 1** Arrows appear numbered and unnumbered and are used to illustrate a movement.
- A** Arrows with letters are used to clarify a movement when the reciprocal order is of no relevance.

If there is no series of illustrations for step-by-step instructions then the different steps are numbered with normal numbers.

Position lists

- 1** Red circles containing a number are used in overview images where different components are pointed out. The number recurs in the position list featured in connection with the illustration that describes the item.



Important information

Bulleted lists

A bulleted list is used when there is a list of points in the owner's manual.

Example:

- Coolant
- Engine oil

To be continued

▶▶ This symbol is located furthest down to the right when a section continues on the following page.

Recording data

Your vehicle contains a number of computers whose function is to continuously check and monitor the vehicle's operation and functionality. Some of the computers can record information during normal driving if they detect an error. In addition, information is recorded in the event of a collision or incident. Parts of the recorded information are required so that technicians can diagnose and rectify faults in the vehicle during servicing and maintenance and so that Volvo can fulfil legal requirements and other regulations. In addition to this, the information is used for research purposes by Volvo in order to continually develop quality and safety, as the information can contribute to a better understanding of the factors that cause accidents and injuries. The information

includes details of the status and functionality of various systems and modules in the vehicle with regard to engine, throttle, steering and brake systems, amongst other things. This information may include details regarding the way the driver drives the vehicle, such as vehicle speed, brake and accelerator pedal use, steering wheel movement and whether or not the driver and passengers have used their seatbelts. For the reasons given this information may be stored in the vehicle's computers for a certain length of time, but also as a result of a collision or incident. This information may be stored by Volvo as long as it can help to further develop and further enhance safety and quality and as long as there are legal requirements and other regulations that Volvo needs to consider.

Volvo will not contribute to the above-described information being disclosed to third parties without the vehicle owner's consent. However, due to national legislation and regulations Volvo may be required to disclose such information to authorities such as police authorities, or others who may assert a legal right to have access to it.

To be able to read and interpret the information recorded by the computers in the vehicle requires special technical equipment that Volvo, and workshops that have entered into agreements with Volvo, have access to. Volvo

is responsible that the information, which is transferred to Volvo during servicing and maintenance, is stored and handled in a secure manner and that the handling complies with applicable legal requirements. For further information - contact a Volvo dealer.

Accessories and extra equipment

The incorrect connection and installation of accessories can negatively affect the car's electrical system. Certain accessories only function when their associated software is installed in the car's computer system. Volvo therefore recommends that you always contact an authorised Volvo workshop before installing accessories which are connected to or affect the electrical system.

Change of ownership for cars with Volvo On Call*

Volvo On Call is a supplemental service that consists of safety, security and comfort services. If the car has Volvo On Call and there is a change of owner, it is very important that these services are discontinued so that the former owner cannot access the services in the car. Contact the call centre by pressing the **ON CALL** button in the car or contact an authorised Volvo workshop. See also "Changing the security code" in the owner's manual for Volvo On Call.



Important information

Laser sensor

This vehicle is equipped with a sensor which transmits laser light. It is absolutely essential to follow the prescribed instructions when handling the laser sensor.

The following two labels in English are fitted directly on the laser sensor unit:

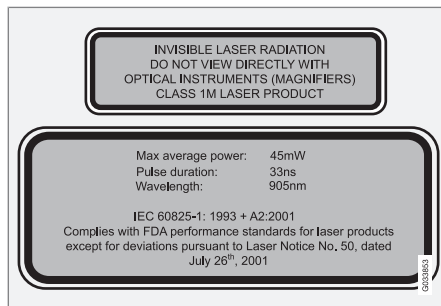

The upper label in the figure describes the laser beam's classification:

- Laser radiation - Do not look into the laser beam with optical instruments - Class 1M laser product.

The lower label in the figure describes the laser beam's physical data:

- IEC 60825-1:1993 + A2:2001. Complies with FDA (U.S. Food Administration) standards for laser product design with the

exception of deviations in accordance with "Laser Notice No. 50" from 26 July 2001.

Radiation data for the laser sensor

The following table specifies the laser sensor's physical data.

Maximum pulse energy	2.64 μ J
Maximum average output	45 mW
Pulse duration	33 ns
Divergence (horizontal x vertical)	28° × 12°

WARNING

If any of these instructions are not followed then there is a risk of eye injury!

- Never look into the laser sensor (which emits spreading invisible laser radiation) at a distance of 100 mm or closer with magnifying optics such as a magnifying glass, microscope, lens or similar optical instruments.
- Testing, repair, removal, adjustment and/or replacement of the laser sensor's spare parts must only be carried out by a qualified workshop - we recommend an authorised Volvo workshop.
- To avoid exposure to harmful radiation, do not carry out any readjustments or maintenance other than those specified here.
- The repairer must follow specially drawn up workshop information for the laser sensor.
- Do not remove the laser sensor (this includes removing the lenses). A removed laser sensor does not fulfil laser class 3B as per standard IEC 60825-1. Laser class 3B is not eye-safe and therefore entails a risk of injury.



Important information

- The laser sensor's connector must be unplugged before removal from the windscreen.
- The laser sensor must be fitted onto the windscreen before the sensor's connector is plugged in.
- The laser sensor transmits laser light when the remote control key is in position II and also with the engine switched off (see page 78 on key positions).

For more information on the laser sensor, see page 168.

Information on the Internet

At www.volvocars.com there is further information concerning your car.

To be able to read the QR code, you need a QR code reader, which is available as an add-on for a number of mobile phones. A QR code reader can be downloaded from the App Store or Android Market.



QR code



Volvo and the environment

Volvo Cars' environmental philosophy



Environmental care is one of Volvo Car Corporation's core values which influence all operations. We also believe that our customers share our consideration for the environment.

Your Volvo complies with strict international environmental standards and is also manufactured in one of the cleanest and most resource-efficient plants in the world. Volvo Car Corporation has global ISO certification, which includes the environmental standard ISO 14001 covering all factories and several of our other units. We also set requirements for our partners so that they work systematically with environmental issues.

Fuel consumption

Volvo cars have competitive fuel consumption in each of their respective classes. Lower fuel consumption generally results in lower emission of the greenhouse gas, carbon dioxide.

It is possible for the driver to influence fuel consumption. For more information read under the heading, **Reducing environmental impact**.

Efficient emission control

Your Volvo is manufactured following the concept "Clean inside and out" – a concept that encompasses a clean interior environment as well as highly efficient emission control. In

many cases the exhaust emissions are well below the applicable standards.

Clean air in the passenger compartment

A passenger compartment filter prevents dust and pollen from entering the passenger compartment via the air intake.

A sophisticated air quality system, IAQS* (Interior Air Quality System) ensures that the incoming air is cleaner than the air in the traffic outside.

The system consists of an electronic sensor and a carbon filter. The incoming air is monitored continuously and if there is an increase in

* Option/accessory, for more information, see Introduction.



Volvo and the environment

the level of certain unhealthy gases such as carbon monoxide then the air intake is closed. Such a situation may arise in heavy traffic, queues and tunnels for example.

The entry of nitrous oxides, ground-level ozone and hydrocarbons is prevented by the carbon filter.

Interior

The interior of a Volvo is designed to be pleasant and comfortable, even for people with contact allergies and for asthma sufferers. Extreme attention has been given to choosing environmentally-compatible materials.

Volvo workshops and the environment

Regular maintenance creates the conditions for a long service life and low fuel consumption for your car. In this way you contribute to a cleaner environment. When Volvo's workshops are entrusted with the service and maintenance of your car it becomes part of our system. Volvo makes clear demands regarding the way in which our workshops are designed in order to prevent spills and discharges into the environment. Our workshop staff have the knowledge and the tools required to guarantee good environmental care.

Reducing environmental impact

You can easily help reduce environmental impact - here are a few tips:

- Avoid letting the engine idle - switch off the engine when stationary for longer periods. Pay attention to local regulations.
- Drive economically - think ahead.
- Perform service and maintenance in accordance with the owner's manual's instructions - follow the Service and Warranty Booklet's recommended intervals.
- If the car is equipped with an engine block heater*, use it before starting from cold - it improves starting capacity and reduces wear in cold weather and the engine reaches normal operating temperature more quickly, which lowers consumption and reduces emissions.
- High speed increases consumption considerably due to increased wind resistance - a doubling of speed increases wind resistance 4 times.
- Always dispose of environmentally hazardous waste, such as batteries and oils, in an environmentally safe manner. Consult a workshop in the event of uncertainty about how this type of waste should be discarded - an authorised Volvo workshop is recommended.

Following this advice can save money, the planet's resources are saved, and the car's durability is extended. For more information and further advice, see the pages 284 and 384.

Recycling

As a part of Volvo's environmental work, it is important that the car is recycled in an environmentally sound manner. Almost all of the car can be recycled. The last owner of the car is therefore requested to contact a dealer for referral to a certified/approved recycling facility.

The owner's manual and the environment

The Forest Stewardship Council® symbol shows that the paper pulp in this publication comes from FSC® certified forests or other controlled sources.



00449500



Seatbelts	16
Airbags.....	19
Activating/deactivating the airbag*	22
Side airbags (SIPS bags)	24
Inflatable Curtain (IC)	26
WHIPS	27
When the systems deploy	29
Safety mode.....	30
Child safety.....	31



01

SAFETY





Seatbelts

General information



Heavy braking can have serious consequences if the seatbelts are not used. Ensure that all passengers use their seatbelts.

It is important that the seatbelt lies against the body so it can provide maximum protection. Do not lean the backrest too far back. The seatbelt is designed to protect in a normal seating position.

Putting on a seatbelt

Pull the belt out slowly and secure it by pressing its locking tab into the seatbelt buckle. A loud "click" indicates that the belt has locked.



Correctly fitted seatbelt.



Incorrectly fitted seatbelt. The belt must rest on the shoulder.



Seatbelt height adjustment. Press the button and move the belt vertically. Position the belt as high as possible without it chafing against your throat.

The buckles only fit the intended lock in the rear seat¹.

Releasing the seatbelt

Press the red button on the seatbelt buckle and then let the belt retract. If the seatbelt does not retract fully, feed it in by hand so that it does not hang loose.

The seatbelt locks and cannot be withdrawn:

- if it is pulled out too quickly
- during braking and acceleration
- if the car leans heavily.

¹ Certain markets.



Seatbelts

Make sure that you:

- do not use clips or anything else that can prevent the seatbelt from fitting properly
- ensure that the seatbelt is not twisted or caught on anything
- the hip strap must be positioned low down (not over the abdomen)
- tension the hip strap over the lap by pulling the diagonal shoulder belt up towards the shoulder.

WARNING

The seatbelts and airbags interact. If a seatbelt is not used or is used incorrectly, this may diminish the protection provided by the airbag in the event of a collision.

WARNING

Each seatbelt is designed for only one person.

WARNING

Never modify or repair the seatbelts yourself. Volvo recommends that you contact an authorised Volvo workshop.

If a seatbelt has been subjected to a major load, such as in conjunction with a collision, the entire seatbelt must be replaced. Some of the protective characteristics of the seatbelt may have been lost, even if it appears to be undamaged. In addition, replace the seatbelt if the belt is worn or damaged. The new seatbelt must be type-approved and intended for installation in the same position as the replaced seatbelt.

Seatbelts and pregnancy



The seatbelt should always be worn during pregnancy. But it is crucial that it be worn in the

correct way. The diagonal section should wrap over the shoulder then be routed between the breasts and to the side of the abdomen.

The lap section should lay flat over the thighs and as low as possible under the abdomen. – It must never be allowed to ride upward. Remove the slack from the seatbelt and ensure that it fits as close to the body as possible. In addition, check that there are no twists in the seatbelt.

As the pregnancy progresses, pregnant drivers should adjust their seats and steering wheel such that they can easily maintain control of the vehicle as they drive (which means that they must be able to easily operate the foot pedals and steering wheel). The aim should be to position the seat with as large a distance as possible between abdomen and steering wheel.



Seatbelts

Seatbelt reminder



Unbelted occupants will be reminded to fasten their seatbelts by means of an audio and visual reminder. The audio reminder is speed dependent, and in some cases time dependent. The visual reminder is located in the roof console and the combined instrument panel.

Child seats are not covered by the seatbelt reminder system.

Rear seat

The seatbelt reminder in the rear seat has two subfunctions:

- Provides information on which seatbelts are being used in the rear seat. A message appears in the information display when the seatbelts are in use, or if one of the rear doors has been opened. The message is cleared automatically after driving for approximately 30 seconds or after pressing the indicator stalk's **OK** button.
- Provides a warning if one of the rear seatbelts is unfastened during travel. This warning takes the form of a message on the information display along with the audio/visual signal. The warning stops when the seatbelt is re-fastened, or it can also be acknowledged manually by pressing the **OK** button.

The message on the information display showing which seatbelts are in use is always available. Press the **OK** button to see stored messages.

Certain markets

An acoustic signal and indicator lamp remind the driver and front seat passenger to use a seatbelt if either of them is not wearing one. At low speed, the audio reminder will sound for the first 6 seconds.

Seatbelt tensioner

All the seatbelts are equipped with belt tensioners. A mechanism in the seatbelt tensioner tightens the seatbelt in the event of a sufficiently violent collision. The seatbelt then provides more effective restraint for the occupants.



WARNING

Never insert the tongue of the passenger's seatbelt into the buckle on the driver's side. Always insert the tongue of the seatbelt into the buckle on the correct side. Do not make any damages on seatbelts nor insert any foreign objects into a buckle. The seatbelts and buckles would then possibly not function as intended in the event of a collision. There is a risk of serious injury.



Airbags

Warning symbol on the combined instrument panel

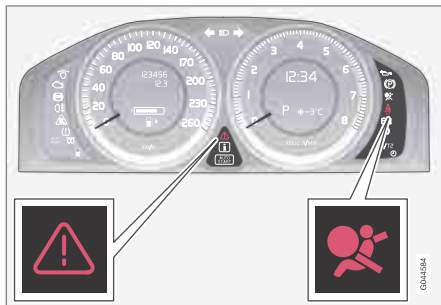

The warning symbol in the combined instrument panel illuminates when the remote control key is in key position II. The symbol clears after approx. 6 seconds provided the airbag system is fault-free.

WARNING

If the warning symbol for the airbag system remains illuminated or illuminates while driving, it means that the airbag system does not have full functionality. The symbol indicates a fault in the seatbelt tensioner system, SIPS, the IC system or some other fault in the system. Volvo recommends that you contact an authorised Volvo workshop immediately.

As well as the warning symbol, a message may appear on the information display in appropriate cases. If the warning symbol malfunctions, the warning triangle illuminates and **SRS Airbag Service required** or **SRS Airbag Service urgent** appears in the display. Volvo recommends that you contact an authorised Volvo workshop immediately.

Airbag system

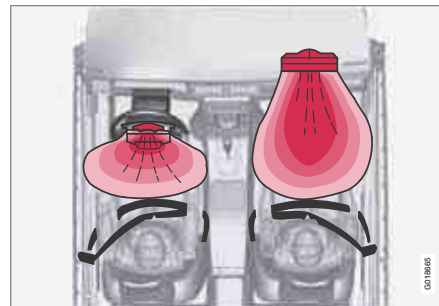

Airbag system, left-hand drive car.

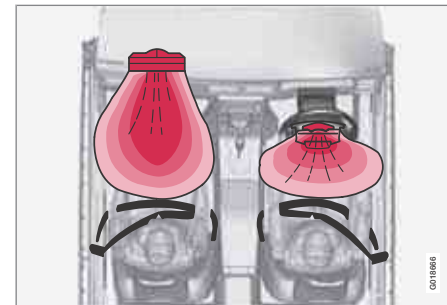

Airbag system, right-hand drive car.

The system consists of airbags and sensors. A sufficiently violent collision trips the sensors and the airbag(s) are inflated and become hot. To cushion the impact, the airbag deflates when compressed. When this occurs, smoke escapes into the car. This is completely normal. The entire process, including inflation and deflation of the airbag, occurs within tenths of a second.

WARNING

Volvo recommends that you contact an authorised Volvo workshop for repair. Defective work in the airbag system could cause malfunction and result in serious personal injury.



Airbags

NOTE

The sensors react differently depending on the course of the collision and whether or not the seatbelts on the driver and passenger side are used.

It is therefore possible that only one (or none) of the airbags may inflate in a collision. The airbag system senses the force of the collision on the car and adapts accordingly so that one or more airbags are deployed.

The capacity of the airbags is also adapted to the collision force to which the vehicle is subjected.

Airbag on the driver's side

The car has an airbag to supplement the protection afforded by the seatbelt on the driver's side. It is folded up into the centre of the steering wheel. The steering wheel is marked **AIRBAG**.

WARNING

The seatbelts and airbags interact. If a seatbelt is not used or is used incorrectly, this may diminish the protection provided by the airbag in the event of a collision.

Passenger airbag



Location of the front passenger airbag in a left-hand drive car.



Location of the front passenger airbag in a right-hand drive car.

The car has an airbag to supplement the protection afforded by the seatbelt on the passenger side. It is folded up into a compartment above the glovebox. Its cover panel is marked **AIRBAG**.

WARNING

The seatbelts and airbags interact. If the belt is not used or is used incorrectly, this may diminish the protection provided by the airbag in the event of a collision.

To minimise the risk of injury if the airbag deploys, passengers must sit as upright as possible with their feet on the floor and backs against the backrest. Seatbelts must be secured.

WARNING

Do not put objects in front of or above the dashboard where the passenger airbag is located.

**WARNING**

Never place a child in a child seat or on a booster cushion in the front seat if the airbag is activated.

Never allow anybody to stand or sit in front of the front passenger seat.

No one shorter than 140 cm should ever sit in the front passenger seat if the airbag is activated.

Failure to follow the advice given above can endanger life.



Activating/deactivating the airbag*

Key switch off - PACOS*

General information

The airbag for the front passenger seat can be deactivated if the car is equipped with a switch, PACOS (Passenger Airbag Cut Off Switch). For information on how to activate/deactivate, see under the heading Activating/deactivating.

Key switch off/switch

The switch for the passenger airbag (PACOS) is located on the passenger end of the instrument panel and is accessible when the passenger door is open (see under the heading below, Activating/deactivating).

Check that the switch is in the required position. Volvo recommends that the remote control key's key blade be used to change position.

For information on the key blade, see page 48.

WARNING

Failure to follow the advice given above could endanger the life of passengers in the car.

WARNING

If the car is equipped with a front passenger airbag, but does not have a PACOS switch (Passenger Airbag Cut Off Switch), then the airbag will always be activated.

WARNING

Never place a child in a child seat or on a booster cushion in the front seat if the airbag is activated and the symbol  in the roof console is illuminated. Failure to follow this advice could endanger the life of the child.

WARNING

Do not allow anyone to sit in the front passenger seat if the message in the roof console (see page 23) indicates that the airbag is deactivated and if the warning symbol for the airbag system is also displayed in the combined instrument panel. This indicates that there has been a severe malfunction. Visit a workshop as soon as possible. Volvo recommends that you contact an authorised Volvo workshop.

Activating/deactivating

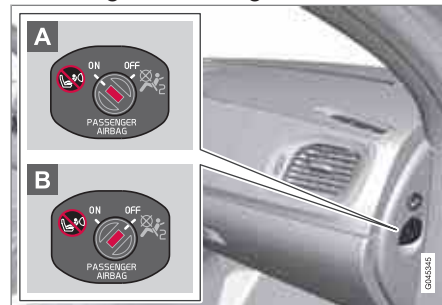

Switch location.

- A** The airbag is activated. With the switch in this position, persons taller than 140 cm can sit in the front passenger seat, but never children in a child seat or on a booster cushion.
- B** The airbag is deactivated. With the switch in this position, children in a child seat or on a booster cushion can sit in the front passenger seat, but never persons taller than 140 cm.



Activating/deactivating the airbag*

! WARNING

Activated airbag (passenger seat):

Never place a child in a child seat or on a booster cushion on the front passenger seat when the airbag is activated. This applies to everyone shorter than 140 cm.

Deactivated airbag (passenger seat):

No one taller than 140 cm should ever sit in the front passenger seat when the airbag is deactivated.

Failure to follow the advice given above can endanger life.

i NOTE

When the remote control key is in key position **II** the warning symbol for the airbag is displayed on the combined instrument panel for approx. 6 seconds (see page 19).

Following which, the indicator in the roof console is illuminated showing the correct status for the front passenger seat airbag. For more information about the different key positions for the remote control key, see page 78.

Activated airbag



Indicator showing that the passenger airbag is activated.

A warning symbol in the roof console indicates that the airbag for the front passenger seat is activated (see preceding illustration).

Deactivated airbag



Indicator showing that the passenger airbag is deactivated.

A text message and a symbol in the roof console indicate that the airbag for the front passenger seat is deactivated (see preceding illustration).

* Option/accessory, for more information, see Introduction.



Side airbags (SIPS bags)

Side airbag



In a side impact collision a large proportion of the collision force is transferred by the SIPS (Side Impact Protection System) to beams, pillars, the floor, the roof and other structural parts of the body. The side airbags at the driver's and front passenger seats protect the chest area and the hip and are an important part of the SIPS.

The SIPS bag system consists of two main components, side airbag and sensors. The side airbags are located in the front seat backrests.

⚠ WARNING

- Volvo recommends that repairs are only carried out by an authorised Volvo workshop. Defective work in the SIPS-bag system could cause malfunction and result in serious personal injury.
- Do not put objects in the area between the outside of the seat and the door panel, since this area is required by the side airbag.
- Volvo recommends the use only of car seat covers approved by Volvo. Other seat covers may impede the operation of the side airbags.
- The side airbag is a supplement to the seatbelts. Always use a seatbelt.

Child seats and side airbags

The protection provided by the car to children seated in a child seat or on a booster cushion is not diminished by the side airbag.

A child seat or booster cushion can be placed on the front passenger seat provided that the car does not have an activated¹ passenger airbag.

Location

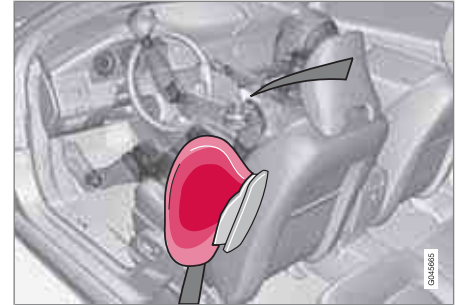

Driver's seat, left-hand drive.

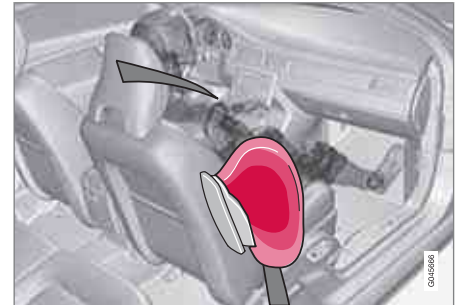

Front passenger seat, left-hand drive.

The SIPS bag system consists of side airbags and sensors. A sufficiently violent collision trips

¹ For information on activating/deactivating the airbag, see page 22.

**Side airbags (SIPS bags)**

the sensors and the side airbags are inflated. The airbag inflates between the occupant and the door panel and thereby cushions the initial impact. The airbag deflates when compressed by the collision. The side airbag is normally only deployed on the side of the collision.



Inflatable Curtain (IC)

Properties



The inflatable curtain IC (Inflatable Curtain) is a part of SIPS and the airbags. It is fitted in the headlining along both sides of the roof and protects the car's occupants sitting in the outer seats. A sufficiently violent collision trips the sensors and the inflatable curtain is inflated. The inflatable curtain helps to prevent the driver and passengers from striking their heads on the inside of the car during a collision.

WARNING

Never hang or attach heavy items onto the handles in the roof. The hook is only designed for light clothing (not for solid objects such as umbrellas for example).

Do not screw or install anything onto the car's headlining, door pillars or side panels. This could compromise the intended protection. Volvo recommends that you only ever use Volvo genuine parts that are approved for placement in these areas.

WARNING

Do not load the car higher than 50 mm under the top edge of the door windows. Otherwise, the intended protection of the inflatable curtain, which is concealed in the headlining, may be compromised.

WARNING

The inflatable curtain is a supplement to the seatbelts.

Always use a seatbelt.

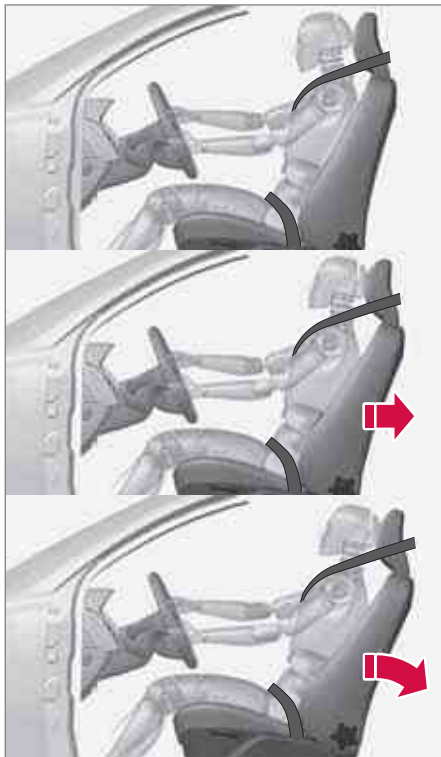
**WHIPS****Protection against whiplash injury – WHIPS**

The whiplash protection system (WHIPS) consists of energy absorbing backrests and specially designed head restraints in the front seats. The system is actuated by a rear-end collision, where the angle and speed of the collision, and the nature of the colliding vehicle all have an influence.

WARNING

The WHIPS system is a supplement to the seatbelts. Always use a seatbelt.

Properties of the seat

When the WHIPS system is deployed, the front seat backrests are lowered backward to alter the seating position of the driver and front seat passenger. This reduces the risk of whiplash injury.

WARNING

Never modify or repair the seat or WHIPS system yourself. Volvo recommends that you contact an authorised Volvo workshop.

WHIPS system and child seats/booster cushions

The protection provided by the car to children seated in a child seat or on a booster cushion is not diminished by the WHIPS system.

Correct seating position

For the best possible protection, the driver and front seat passenger should sit in the centre of the seat with as little space as possible between the head and the head restraint.

Do not obstruct the WHIPS system

Do not leave any objects on the floor behind the driver's seat/passenger seat that may prevent the WHIPS system from functioning.

WARNING

Do not squeeze rigid objects between the rear seat cushion and the front seat backrest. Make sure you do not obstruct the function of the WHIPS system.



WHIPS



Do not place objects on the rear seat that may prevent the WHIPS system from functioning.

WARNING

If a rear seat backrest is folded down, the corresponding front seat must be moved forward so that it does not touch the folded backrest.

WARNING

If a seat has been subjected to extreme forces, such as due to a rear-end collision, the WHIPS system must be checked. Volvo recommends that it is checked by an authorised Volvo workshop.

Part of the WHIPS system's protective capacity may have been lost even if the seats appear to be undamaged.

Volvo recommends that you contact an authorised Volvo workshop to have the system checked even after a minor rear-end collision.



When the systems deploy

When the systems deploy

System	Triggered
Seatbelt tensioner, front seat	In the event of a frontal collision, and/or side-impact collision, and/or rear-end collision and/or overturning
Seatbelt tensioner, rear seat	In a frontal collision and/or side-impact accident and/or overturning
Airbags (SRS)	In a frontal collision ^A
Side airbags (SIPS)	In a side-impact accident
Inflatable Curtain IC	In the event of a side impact and/or overturning and/or some frontal collisions
Whiplash protection WHIPS	In a rear-end collision

^A The bodywork of the car could be greatly deformed in a collision without airbag deployment. A number of factors such as the rigidity and weight of the object hit, the speed of the car, the angle of the collision etc. affects how the different safety systems of the car are activated.

If the airbags have deployed, the following is recommended:

- Recovering the car. Volvo recommends that you have it conveyed to an authorised Volvo workshop. Do not drive with deployed airbags.
- Volvo recommends that you engage an authorised Volvo workshop to handle the replacement of components in the car's safety systems.
- Always contact a doctor.



NOTE

The airbags and belt tensioner system are deployed only once during a collision.



WARNING

The airbag control module is located in the centre console. If the centre console is drenched with water or other liquid, disconnect the battery cables. Do not attempt to start the car since the airbags may deploy. Recovering the car. Volvo recommends that you have it conveyed to an authorised Volvo workshop.



WARNING

Never drive with deployed airbags. They can make steering difficult. Other safety systems may also be damaged. The smoke and dust created when the airbags are deployed can cause skin and eye irritation/injury after intensive exposure. In case of irritation, wash with cold water. The rapid deployment sequence and airbag fabric may cause friction and skin burns.



Safety mode

Driving after a collision

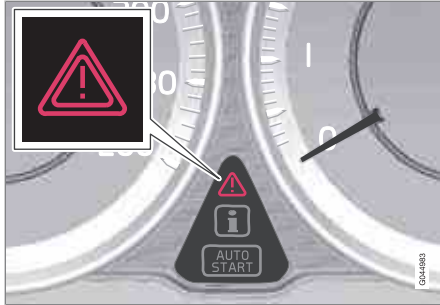

If the car is involved in a collision, the text **Safety mode See manual** may appear on the information display. This means that the car has reduced functionality. Safety mode is a protective state that is enforced when the collision may have damaged any of the car's vital functions, such as the fuel lines, sensors for one of the safety systems, or the brake system.

Attempting to start the car

First, check that no fuel is leaking from the car. There must be no smell of fuel either.

If everything seems normal and you have checked for indications of fuel leakage, you may attempt to start the car.

Remove the remote control key and open the driver's door. If a message is now shown to the

effect that the ignition is on, press the start button. Then close the door and reinsert the remote control key. The car's electronics will now try to reset themselves to normal mode. Then try to start the car.

If the message **Safety mode See manual** is still shown on the display then the car must not be driven or towed, but a vehicle recovery service used instead. Even if the car appears to be driveable, hidden damage may make the car impossible to control once moving.

Moving the car

If **Normal mode** is shown after **Safety mode See manual** has been reset, the car can be moved carefully out of a dangerous position. Do not move the car further than necessary.

WARNING

Never attempt to repair your car or reset the electronics yourself if the car has been in safety mode. This could result in personal injury or the car not functioning as normal. Volvo recommends that you engage an authorised Volvo workshop to check and restore the car to normal status after **Safety mode See manual** has been displayed.

WARNING

Never, under any circumstances, attempt to restart the car if it smells of fuel when the **Safety mode See manual** message is displayed. Leave the car at once.

WARNING

If the car is in safety mode it must not be towed. It must be transported from its location. Volvo recommends that it is transported to an authorised Volvo workshop.



Child safety

Children should sit comfortably and safely

Volvo recommends that children travel in rear-facing child seats until as late an age as possible, at least until 3-4 years of age, and then front-facing booster cushions/child seats until up to 10 years of age.

The position of a child in the car and the choice of equipment are dictated by the child's weight and size, for more information, see page 32.

i NOTE

Regulations regarding the placement of children in cars vary from country to country. Check what does apply.

Children of all ages and sizes must always sit correctly secured in the car. Never allow a child to sit on the knee of a passenger.

Volvo has child safety equipment (child seats, booster cushions & attachment devices) which is designed for your particular car. Using Volvo's child safety equipment provides you with optimum conditions for your child to travel safely in the car. Furthermore, the child safety equipment fits and is easy to use.

i NOTE

In the event of questions when fitting child safety products, contact the manufacturer for clearer instructions.

Child seats



Child seats and airbags are not compatible.

i NOTE

When using child safety products it is important to read the installation instructions included.

! WARNING

Do not secure the straps of the child seat to the seat's horizontal adjustment bar, springs or the rails and beams under the seat. Sharp edges may damage the straps.

Look in the installation instructions for the child seat for the correct fitting.

Location of child seats

You may place:

- a child seat/booster cushion on the passenger seat, provided the passenger airbag is not activated¹.
- one or more child seats/booster cushions in the rear seat.

Always fit child seats/booster cushions in the rear seat if the passenger airbag is activated. If a child is sitting on the front passenger seat then he/she could suffer serious injury if the airbag deploys.

¹ For information on activated/deactivated airbag, see page 22.



Child safety

WARNING

Never place a child in a child seat or on a booster cushion in the front seat if the airbag (SRS) is activated.

No one shorter than 140 cm should ever sit in the front passenger seat if the airbag (SRS) is activated.

Failure to follow the advice given above can endanger life.

WARNING

Booster cushions/child seats with steel braces or some other design that could rest on the seatbelt buckle's opening button must not be used, as they could cause the seatbelt buckle to open accidentally.

Do not allow the upper section of the child seat to rest against the windscreen.

Label Airbag



The label becomes visible when the passenger door is opened; see the illustration on page 22.

Recommended child seats²

Weight	Front seat (with deactivated airbag)	Outer rear seat	Centre rear seat
Group 0 max 10 kg		Volvo infant seat (Volvo Infant Seat) - rear-facing child seat, secured with the ISOFIX fixture system.	
Group 0+ max 13 kg		Type approval: E5 04301146 (L)	
Group 0 max 10 kg	Volvo infant seat (Volvo Infant Seat) - rear-facing child seat, secured with the car's seatbelt.	Volvo infant seat (Volvo Infant Seat) - rear-facing child seat, secured with the car's seatbelt.	Volvo infant seat (Volvo Infant Seat) - rear-facing child seat, secured with the car's seatbelt.
Group 0+ max 13 kg	Type approval: E1 04301146 (U)	Type approval: E1 04301146 (U)	Type approval: E1 04301146 (U)

² With regard to other child seats your car should be included in the manufacturer's enclosed list of vehicles or be universally approved in accordance with the ECE R44 legal requirement.



Child safety

Weight	Front seat (with deactivated air-bag)	Outer rear seat	Centre rear seat
Group 0 max 10 kg Group 0+ max 13 kg	Child seats which are universally approved. (U)	Child seats which are universally approved. (U)	Child seats which are universally approved. (U)
Group 1 9-18 kg	Volvo rear-facing/turnable child seat (Volvo Convertible Child Seat) - rear-facing child seat, secured with the car's seatbelt and straps. Type approval: E5 04192 (L)	Volvo rear-facing/turnable child seat (Volvo Convertible Child Seat) - rear-facing child seat, secured with the car's seatbelt and straps. Type approval: E5 04192 (L)	
Group 1 9-18 kg	Child seats which are universally approved. (U)	Child seats which are universally approved. (U)	Child seats which are universally approved. (U)
Group 2 15-25 kg	Volvo rear-facing/turnable child seat (Volvo Convertible Child Seat) - rear-facing child seat, secured with the car's seatbelt and straps. Type approval: E5 04192 (L)	Volvo rear-facing/turnable child seat (Volvo Convertible Child Seat) - rear-facing child seat, secured with the car's seatbelt and straps. Type approval: E5 04192 (L)	



Child safety

Weight	Front seat (with deactivated air-bag)	Outer rear seat	Centre rear seat
Group 2 15-25 kg	Volvo rear-facing/turnable child seat (Volvo Convertible Child Seat) - front-facing child seat, secured with the car's seatbelt. Type approval: E5 04191 (L)	Volvo rear-facing/turnable child seat (Volvo Convertible Child Seat) - front-facing child seat, secured with the car's seatbelt. Type approval: E5 04191 (L)	Volvo rear-facing/turnable child seat (Volvo Convertible Child Seat) - front-facing child seat, secured with the car's seatbelt. Type approval: E5 04191 (L)
Group 2/3 15-36 kg	Volvo booster seat with backrest (Volvo Booster Seat with backrest). Type approval: E1 04301169 (UF)	Volvo booster seat with backrest (Volvo Booster Seat with backrest). Type approval: E1 04301169 (UF)	Volvo booster seat with backrest (Volvo Booster Seat with backrest). Type approval: E1 04301169 (UF)
Group 2/3 15-36 kg	Booster cushion with and without backrest (Booster Cushion with and without backrest). Type approval: E5 03139 (UF)	Booster cushion with and without backrest (Booster Cushion with and without backrest). Type approval: E5 03139 (UF)	Booster cushion with and without backrest (Booster Cushion with and without backrest). Type approval: E5 03139 (UF)



Child safety

Weight	Front seat (with deactivated air-bag)	Outer rear seat	Centre rear seat
Group 2/3 15-36 kg		Integrated booster cushion (Integrated Booster Cushion) - available as a factory fitted option. Type approval: E5 04189 (B)	

L: Suitable for specific child seats. These child seats may be intended for use in a special car model, limited or semi-universal categories.

U: Suitable for universally approved child seats in this weight class.

UF: Suitable for front-facing universally approved child seats in this weight class.

B: Built-in child seats approved for this weight class.



Child safety

Integrated two-stage booster cushions*



Correct position, the seatbelt should be positioned in on the shoulder.



Incorrect position, the head restraint must be adjusted as high as the head and the seatbelt must not be below the shoulder.

The booster cushions are specially designed to provide optimum safety. In combination with the seatbelt they are approved for children who weigh between 15 and 36 kg and who are at least 95 cm in height.

Check before driving that:

- the integrated 2-stage booster cushion is correctly set (see table page 36) and in locked position
- the seatbelt is in contact with the child's body and is not slack or twisted
- the seatbelt does not lie across the child's throat or below the shoulder (see preceding illustrations)
- the lap section of the seatbelt is positioned low over the pelvis to provide optimal protection.

For instructions on adjusting the booster cushion's two levels, see pages 36–37.

Raising the two-stage booster cushion

The integrated booster cushion can be folded up into two stages. How many stages the cushion should be folded up depends on the child's weight.

	Stage 1	Stage 2
Weight	22-36 kg	15-25 kg

Stage 1



1 Pull the handle forward and up in order to release the booster cushion.



2 Press the booster cushion backwards to lock.



Child safety

01

Stage 2



1 Start from the lower stage. Press the button.



2 Lift the booster cushion up at the front edge and press it back against the backrest to lock.

WARNING

Volvo recommends that repair or replacement is only carried out by an authorised Volvo workshop. Do not make any modifications or additions to the booster cushion. If an integrated booster cushion has been subjected to a major load, such as in conjunction with a collision, the entire booster cushion must be replaced. Even if the booster cushion appears to be undamaged, it may not afford the same level of protection. The booster cushion must also be replaced if it is heavily worn.

NOTE

It is not possible to adjust the booster cushion from stage 2 to stage 1. It must first be reset by being fully folded into the seat cushion. Refer to the heading below, Lowering the two-stage booster cushion.

Lowering the two-stage booster cushion

Lowering can take place from both the upper and lower stage to fully lowered position in the cushion. However, it is not possible to adjust

the booster cushion from the upper stage to the lower stage.



1 Pull the handle forwards to release the cushion.





Child safety

2 Press down with your hand in the centre of the cushion in order to lock it.

WARNING

If the instructions regarding the two-stage booster cushion are not followed then this could cause serious injury to a child in the event of an accident.

IMPORTANT

Check that there are no loose objects (e.g. toys) left behind in the space under the cushion before lowering.

NOTE

The booster cushion must be lowered first when lowering the backrest.

Child safety locks, rear doors

The controls for operating the rear door power windows and the rear door opening handles can be blocked from opening from the inside. For more information, see page 62.

ISOFIX fixture system for child seats

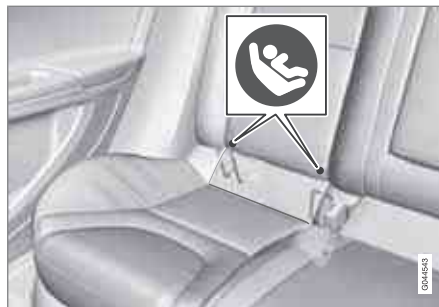

Mounting points for the ISOFIX fixture system are concealed behind the lower section of the rear seat backrest, in the outer seats.

The location of the mounting points is indicated by symbols in the backrest upholstery (see preceding illustration).

Press the seat cushion down to access the mounting points.

Always follow the manufacturer's installation instructions when connecting a child seat to the ISOFIX mounting points.

Size classes

Child seats are in different sizes – cars are in different sizes. This means that not all child seats are suitable for all seats in all car models.

Consequently, there is a size classification for child seats using the ISOFIX fixture system in order to assist users in choosing the correct child seat (see the following table).

Size class	Description
A	Full size, front-facing child seat
B	Reduced size (alt. 1), front-facing child seat
B1	Reduced size (alt.2), front-facing child seat
C	Full size, rear-facing child seat
D	Reduced size, rear-facing child seat
E	Rear-facing infant seat
F	Transverse infant seat, left-hand
G	Transverse infant seat, right-hand



Child safety

WARNING

Never place a child in the passenger seat if the car is equipped with an activated airbag.

NOTE

If an ISOFIX child seat has no size classification then the car model must be included on the child seat's vehicle list.

NOTE

Volvo recommends that you contact an authorised Volvo dealer for recommendations about which ISOFIX child seats Volvo recommends.

Types of ISOFIX child seat

Type of child seat	Weight	Size class	Passenger seats for ISOFIX installation of child seats	
			Front seat	Outer rear seat
Infant seat transverse	max 10 kg	F	X	X
		G	X	X
Infant seat, rear-facing	max 10 kg	E	X	OK (IL)
Infant seat, rear-facing	max 13 kg	E	X	OK (IL)
		D	X	OK (IL)
		C	X	OK (IL)



Child safety

Type of child seat	Weight	Size class	Passenger seats for ISOFIX installation of child seats	
			Front seat	Outer rear seat
Child seat, rear-facing	9-18 kg	D	X	OK (IL)
		C	X	OK (IL)
Front-facing child seat	9-18 kg	B	X	OK ^A (IUF)
		B1	X	OK ^A (IUF)
		A	X	OK ^A (IUF)

X: The ISOFIX position is not suitable for ISOFIX child seats in this weight class and/or size class.

IL: Suitable for specific ISOFIX child seats. These child seats may be intended for use in a special car model, limited or semi-universal categories.

IUF: Suitable for front-facing ISOFIX child seats that are universally approved in this weight class.

^A Volvo recommends rear-facing child seats for this group.



Upper mounting points for child seats

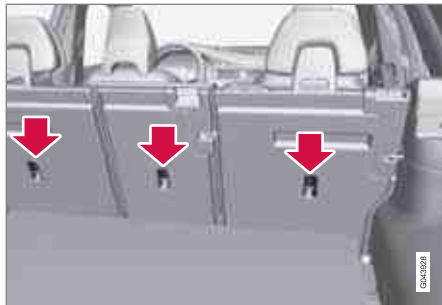

The car is equipped with upper mounting points for certain front-facing child seats. These mounting points are located on the rear of the seat.

The upper mounting points are primarily intended for use with front-facing child seats. Volvo recommends that small children should sit in rear-facing child seats to as late an age as possible.

i NOTE

Fold the head restraints in order to facilitate fitting this type of child seat in cars with folding head restraints on the outer seats.

i NOTE

For cars equipped with a cargo area cover over the cargo area, this must be removed before a child seat can be fitted in the mounting points.

For detailed information on how the child seat should be tensioned in the upper mounting points, see the seat manufacturer's instructions.

⚠ WARNING

The child seat's straps must always be drawn through the hole in the head restraint leg before they are tensioned at the attachment point.

Remote control key/key blade.....	44
Privacy locking*.....	49
Battery replacement, remote control key/PCC*.....	51
Keyless drive*.....	53
Locking/unlocking.....	57
Child safety locks.....	62
Alarm*.....	63



02

LOCKS AND ALARM





Remote control key/key blade

General

The car is supplied with 2 remote control keys or PCCs (Personal Car Communicator). They are used to start the car and for locking and unlocking.

Additional remote control keys can be ordered - up to 6 can be programmed and used for the same car.

The remote control key contains a removable key blade made of metal. The visible section is available in two versions so that it is possible to distinguish between the remote control keys.

The PCC has increased functionality compared with the remote control key. The continuation of this chapter describes the functions available in both the PCC and the remote control key.

WARNING

If there are children in the car:

Remember to switch off the supply to the power windows and sunroof by removing the remote control key if the driver leaves the car.

Loss of a remote control key

If you lose a remote control key then a new one can be ordered at a workshop - an authorised Volvo workshop is recommended. The remaining remote control keys must then be taken to the workshop. The code of the missing remote control key must be erased from the system as a theft prevention measure.

The current number of keys registered to the car can be checked in the menu system **MY CAR** under **Information** → **Number of keys**. For a description of the menu system, see page 202.

Key memory¹ – door mirrors and driver's seat

The settings are automatically connected to each respective remote control key, see pages 81 and 103.

The function can be activated/deactivated in the menu system **MY CAR** under **Settings** → **Car settings** → **Car key memory**.

For a description of the menu system, see page 202.

For cars with the Keyless drive system, see page 53.

Indicator for locking/unlocking

When the car is locked or unlocked using the remote control key, the direction indicators confirm that locking/unlocking was correctly performed.

- Locking - one flash and the door mirrors are folded² in.
- Unlocking - two flashes and the door mirrors are folded² out.

After locking the indication is only given if all locks have been activated once the doors have been closed.

Selecting the function

Different options for indicating locking/unlocking with light can be set in the car's menu system, see page 202.

Search in the menu system **MY CAR** for **Settings** → **Car settings** → **Light settings** and select **Door lock confirmation light** and/or **Unlock confirmation light**.

¹ Only in combination with power driver's seat and power mirrors.

² Only for cars with retractable power door mirrors.



Remote control key/key blade

Lock indicator

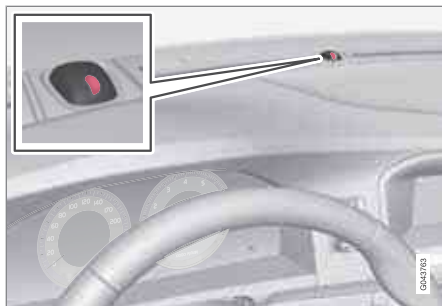

Same LED as alarm indicator, see page 63.

A flashing LED by the windscreen verifies that the car is locked.

i NOTE

Cars that are not equipped with alarm also have this indicator.

Immobiliser

Each remote control key has a unique code. The car can only be started with the correct remote control key with the correct code.

The following error messages in the combined instrument panel's information display are related to the electronic immobiliser:

Message	Specification
Insert car key	Error when reading the remote control key during starting - Remove the key from the ignition switch, press it in again and make a new start attempt.
Car key not found	Error reading the remote control key during starting - Try to start again. If the error persists: Insert the remote control key into the ignition switch and try to start again.
Immobiliser Try start again	Error in immobiliser system during starting. If the error persists: Contact a workshop - an authorised Volvo workshop is recommended.

For starting the car, see page 113.

Functions

Remote control key, standard version.

- Locking
- Unlocking
- Approach light duration
- Tailgate
- Panic function



Remote control key/key blade



Remote control key with PCC* - Personal Car Communicator.

Information

Function buttons

Locking – Locks the doors and tailgate while the alarm is activated.

Press and hold (at least 2 seconds) to close all the windows and sunroof* simultaneously.

WARNING

If the sunroof and windows are closed using the remote control key, check that no one is in danger of getting hands caught.

Unlocking – Unlocks the doors and tailgate while the alarm is deactivated.

Press and hold (at least 4 seconds) to open all windows simultaneously.

The function can be changed from unlocking all doors simultaneously, to unlocking the driver's door only with one press of the button and, after a further press of the button - within 10 seconds - unlocking the remaining doors.

The function can be changed in the menu system **MY CAR** under **Settings** → **Car settings** → **Lock settings** → **Doors unlock** with both the alternatives **All doors** and **Driver door, then all**. For a description of the menu system, see page 202.

Approach light duration – Used to switch on the car's lighting at a distance. For more information, see page 94.

Tailgate - Unlocks and disarms the alarm for the tailgate only. For more information, see page 60.

Panic function – Used to attract attention in an emergency.

Press and hold the button for at least 3 seconds or press it twice within 3 seconds to activate the direction indicators and the horn.

The function can be turned off with the same button once it has been active for at least 5 seconds. Otherwise the function switches off automatically after 2 minutes and 45 seconds.

Range

The remote control key's functions have a range of about 20 m from the car.

If the car does not verify a button being pressed - move closer and try again.

NOTE

The remote control key functions can be disrupted by surrounding radio waves, buildings, topographical conditions etc. The car can always be locked/unlocked using the key blade, see page 48.

If the remote control key is removed from the car when the engine is running or key position **I** or **II** is active (see page 78) and if all doors are closed, then a warning message is shown in the information display and an audible reminder signal sounds at the same time.

The warning message clears and the audio reminder signal stops when the remote control key is brought back to the car after:

- The remote control key has been inserted in the ignition switch
- Speed exceeds 30 km/h
- the **OK** button has been pressed.

**Remote control key/key blade****Unique PCC functions***

Remote control key with PCC* - Personal Car Communicator.

- 1 Information button
- 2 Indicator lamps

Using the information button enables access to certain information from the car via the indicator lamps.

Using the information button

- Press the information button .
 - > All indicator lamps flash for approximately 7 seconds and the light travels around on the PCC. This indicates that information from the car has been read.

If any of the other buttons are pressed during this time then the reading is interrupted.

NOTE

 If none of the indicator lamps illuminates with repeated use of the information button and in different locations (as well as after 7 seconds and after the light has travelled around on the PCC), contact a workshop - an authorised Volvo workshop is recommended.

Indicator lamps display information in accordance with the following illustration:

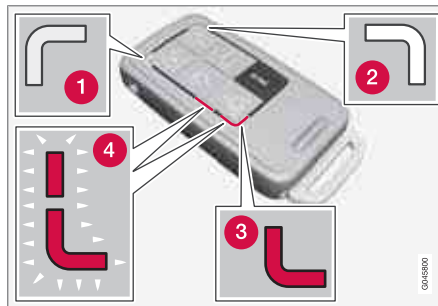

- 1 Green continuous light – the car is locked.
- 2 Yellow continuous light – the car is unlocked.

- 3 Red continuous light – the alarm has been triggered since the car was locked.
- 4 Red light flashing alternately in both indicator lamps – The alarm was triggered less than 5 minutes ago.

Range PCC

The PCC's range for locking, unlocking and tailgate is about 20 m from the car - for other functions up to about 100 m.

If the car does not verify a button being pressed - move closer and try again.

NOTE

The information button functions can be disrupted by surrounding radio waves, buildings, topographical conditions etc.

Out of PCC range

If the PCC is too far away from the car for the information to be read then the status the car was last left in is shown, without the light travelling around on the PCC.

If several PCCs are used for the car then it is only the PCC last used for locking/unlocking that shows correct status.



Remote control key/key blade

NOTE

If no indicator lamps illuminate when the information button is used within range then this may be because the last communication between the PCC and the car was disrupted by surrounding radio waves, buildings, topographical conditions etc.

Detachable key blade

A remote control key contains a detachable key blade of metal with which some functions can be activated and some operations carried out.

The key blade's unique code is provided by authorised Volvo workshops, which are recommended when ordering new key blades.

Key blade functions

Using the remote control key's detachable key blade:

- the left-hand front door can be opened manually if central locking cannot be activated with the remote control key, see page 54.
- the rear doors' mechanical child safety locks can be activated/deactivated, see page 62.

- the right-hand front door and the rear doors can be locked manually, e.g. in the event of power failure, see page 57.
- access to the glovebox and cargo area (privacy locking*) can be blocked, see page 49.
- the airbag for front passenger seat (PACOS)* can be activated/deactivated, see page 22.

Removing the key blade



- ➔ Slide the spring-loaded catch to the side.
- ➔ At the same time pull the key blade straight out backwards.

Attaching the key blade

Carefully refit the key blade into its location in the remote control key.

1. Hold the remote control key with the slot pointed up and lower the key blade into its slot.
2. Lightly press the key blade. You should hear a "click" when the key blade is locked in.

Unlocking doors with the key blade

If central locking cannot be activated with the remote control key - e.g. if the batteries are discharged - then the left-hand front door can be opened as follows:

1. Unlock the left-hand front door with the key blade in the door handle's lock cylinder.

See also the illustration and further information see page 54.

NOTE

When the door has been unlocked using the key blade and is opened, the alarm is triggered.

2. Deactivate the alarm by inserting the remote control key in the ignition switch.

For a car with the Keyless system, see page 54.



Privacy locking*

General information on privacy locking

Active locks for remote control key **with** key blade.Active locks for remote control key, **without** key blade and privacy locking **activated**.

The privacy locking function is intended for when the car is left for service, with a hotel parking valet or similar. The glovebox is then

locked and the tailgate lock is disconnected from the central locking - the tailgate cannot be opened with either the central locking button in the front doors or the remote control key.

This means that the remote control key without key blade can only be used to activate/deactivate the alarm, to open the doors and to drive the car.

The remote control key without key blade can then be handed over to the service or hotel staff - the loose key blade is retained by the car owner.

i NOTE

Do not forget to pull out the cargo cover over the cargo area before closing the tailgate, see page 296.

Activate/deactivate



Activating privacy locking.

To activate privacy locking:

- 1** Insert the key blade in the glovebox lock cylinder.
- 2** Turn the key blade 180 degrees clockwise. The keyhole is vertical in the locked position for privacy locking.
- 3** Pull out the key blade. The information display shows a message at the same time.

The glovebox is then locked and the tailgate can no longer be unlocked with the remote control key or the central locking button.



Privacy locking*



NOTE

Do not reinsert the key blade into the remote control key but keep it in a safe place instead.

- Deactivation takes place in reverse order.

For information on locking the glovebox only, see page 59.



Battery replacement, remote control key/PCC*

Replacing the battery

The batteries should be replaced if:

- the information symbol is illuminated and the display shows **Low battery in remote control**. Please change batteries.

and/or

- the locks repeatedly do not react to signals from the remote control key within 20 metres from the car.

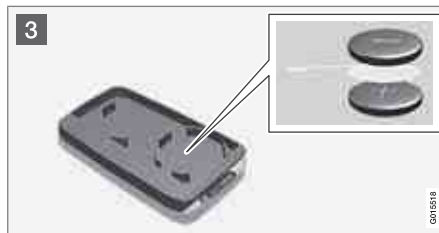
**Opening**

- 1 Slide the spring-loaded catch to the side.

- 2 At the same time pull the key blade straight out backwards.

- 2 Insert a 3 mm slot screwdriver in the hole behind the spring-loaded catch and gently prize the remote control key up.

NOTE

Turn the remote control key over with the buttons facing up, this is to avoid the batteries falling out when it is opened.

IMPORTANT

Avoid touching the battery and its terminals with your fingers, as this could damage their functionality.

Battery replacement

- 3 Closely study how the battery/batteries are secured on the inside of the cover, with regard to their (+) and (-) sides.

Remove control key (1 battery)

1. Carefully prize out the battery.
2. Install a new one with the (+) side down.

PCC* (2 batteries)

1. Carefully prize out the batteries.
2. First install one new one with the (+) side up.
3. Position the white plastic tab in between and finally install a second new battery with the (+) side down.

Battery type

Use batteries with the designation CR2430, 3V - one in the remote control key and two in the PCC.

Assembly

1. Press the remote control key together.
2. Hold the remote control key with the slot pointed up and lower the key blade into its slot.
3. Lightly press the key blade. You should hear a "click" when the key blade is locked in.



02 Locks and alarm

Battery replacement, remote control key/PCC*



IMPORTANT

Make sure that you dispose of old batteries in an environmentally-friendly way.

02

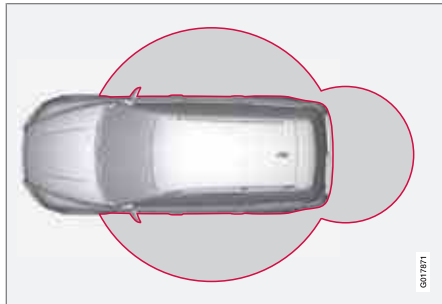
**Keyless drive*****Keyless lock and ignition system (only PCC¹)****General**

The keyless drive function in the PCC allows the car to be unlocked, driven and locked without the need for a key. You simply have to have the PCC with you. The system makes it easier and more convenient to open the car, e.g. when your hands are full.

Both of the car's PCCs incorporate the Keyless function. Additional PCCs can be ordered, see page 44.

PCC range

In order to open a door or the tailgate, a PCC must be no more than approx. 1.5 metres from

the car door handle or tailgate. This means that the person who wishes to lock or unlock a door must have the PCC with him or her. It is not possible to lock or unlock a door if the PCC is on the opposite side of the car.

The red rings in the preceding illustration indicate the range covered by the system's antennas.

If all PCCs are removed from the car when the engine is running or key position **I** or **II** is active (see page 78) and if all doors are closed, then a warning message is shown in the information display and an audible reminder signal sounds at the same time.

The warning message clears and the audio reminder signal stops when the PCC is brought back to the car after:

- a door has been opened and closed
- the PCC is inserted into the ignition switch
- the **OK** button has been pressed.

Handling the PCC safely

If a PCC with keyless drive function is left in the car, it is deactivated temporarily when the car is locked. This prevents unauthorised entry.

However, if someone breaks into the car, opens the door and finds the PCC, it can be

reactivated. It is therefore important to handle all PCCs with great care.

! IMPORTANT

Never leave a PCC behind in the car.

Interference to PCC function

Electromagnetic fields and screening can interfere with the keyless drive system.

i NOTE

Do not place/store the PCC near a mobile phone or metal object - no closer than 10-15 cm.

If interference is experienced nonetheless, use the PCC and the key blade as a remote control key, see page 45.

¹ Personal Car Communicator, see page 47.



02 Locks and alarm

Keyless drive*

Locking

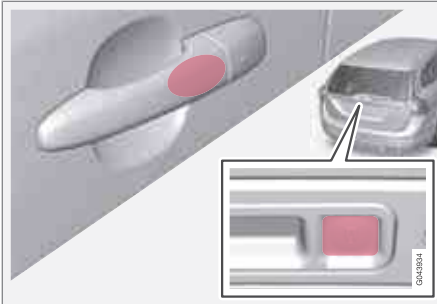

Cars with the Keyless system have a pressure-sensitive area on the outer handle of the doors and a rubberised button next to the tailgate's rubberised pressure plate.

Lock the doors and the tailgate with one long press on any of the door handles' pressure-sensitive areas or press the smaller of the tailgate's two rubberised buttons - the lock indicator in the windscreen confirms that locking has been completed by starting to flash, see page 45.

All doors and the tailgate must be closed before the car can be locked - otherwise the car is not locked.

i NOTE

On cars with automatic transmission, the gear selector must be set in the **P** position - otherwise the car cannot be locked or the alarm armed.

Unlocking

Unlocking takes place when a hand grasps a door handle or the tailgate's rubberised pressure plate is actuated - open the door or tailgate as normal.

i NOTE

The door handles normally register a hand that takes hold of the handle, but with thick gloves on or after a very quick hand movement a second attempt may be required, or with the glove taken off.

Unlocking with the key blade



Hole for key blade - to loosen the cover.

If central locking cannot be activated with the PCC, e.g. if the batteries are discharged, then the left-hand front door can be opened with the PCC's detachable key blade (see page 48)

To access the lock cylinder, the door handle's plastic cover must be removed - this is also done with the key blade:

1. Press the key blade approx. 1 cm straight up into the hole on the underside of the door handle/cover - do not prize.
 - > The plastic cover loosens automatically by means of the torque when the blade



Keyless drive*

is pushed straight up and into the opening.

- Then insert the key blade in the lock cylinder and unlock the door.
- Refit the plastic cover after unlocking.

i NOTE

When the driver's door is unlocked using the key blade and is opened, the alarm is triggered. It is switched off by inserting the PCC in the ignition switch, see page 64.

Key memory² – driver's seat and door mirrors

PCC memory function

If several people each with a PCC approach the car, then the settings for seat and mirrors are implemented for the person who opens the driver's door.

After the driver's door has been opened by person A with PCC-A, but person B with PCC-B shall drive, the settings can be changed in three ways:

- Standing by the driver's door, or sitting behind the steering wheel, person B

presses their PCC's unlock button, see page 45.

- Select one of three possible memories for seat adjustment with seat button 1-3, see page 81.
- Adjust seat and mirrors manually, see page 81 and 103.

Lock settings

The Keyless function can be adapted by indicating in the menu system **MY CAR** which doors shall be unlocked, under **Car settings** → **Lock settings** → **Keyless entry** - there select between **All doors unlock**, **Any door**, **Doors on same side** and **Both front doors**.

For a description of the menu system, see page 202.

Antenna location

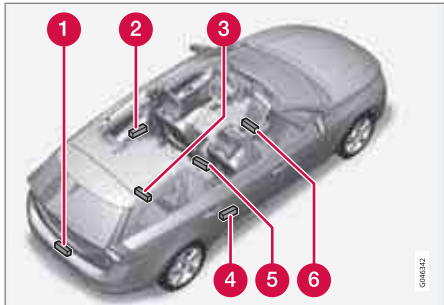

The keyless system has a number of integrated antennae located around the car:

- 1 Rear bumper, centre
- 2 Door handle, left rear
- 3 Cargo area, central and furthest in under the floor
- 4 Door handle, right rear
- 5 Centre console, under the rear section
- 6 Centre console, under the front section.

² Only in combination with power driver's seat and power mirrors.

* Option/accessory, for more information, see Introduction.



02 Locks and alarm

Keyless drive*



WARNING

People with pacemaker operations should not come closer than 22 cm to the keyless system's antennae with their pacemaker. This is to prevent interference between the pacemaker and the keyless system.

02



Locking/unlocking

From the outside

The remote control key can lock/unlock all doors and the tailgate simultaneously. Different sequences for unlocking can be selected, see "Unlocking with the remote control key" page 46.

In order that the lock sequence can be activated, the driver's door must be closed - if any of the other doors or the tailgate is open, then it/they is/are locked and the alarm is activated only when it/they are closed. With the Key-less* system all the doors and tailgate must be closed.

i NOTE

Be aware of the risk of locking the remote control key in the car.

If it is not possible to lock/unlock with the remote control key, the battery may be discharged - lock or unlock the left-hand front door with the detachable key blade, see page 48.

i NOTE

Remember that the alarm is triggered when the door is opened after being unlocked with the key blade - the alarm is switched off when the remote control key is inserted into the ignition switch.

! WARNING

Be aware of the risk of being locked in the car when it is locked from the outside using the remote control key - it is then not possible to open any of the doors from the inside with the door controls. Read more about this in the section "Deadlocks" later on.

Automatic relocking

If none of the doors or the tailgate is opened within 2 minutes of unlocking, all are locked again automatically. This function reduces the risk that the car is left unlocked unintentionally. (For cars with alarm, see page 63.)

Manual locking

In certain situations the car must be lockable manually, e.g. in the event of power failure.

The left-hand front door can be locked with its lock cylinder and the remote control key's detachable key blade, see page 54.

Other doors do not have lock cylinders and instead have lock knobs on each door's end face which must be re-turned - then they are mechanically locked/blocked against opening from the outside. The doors can still be opened from the inside.

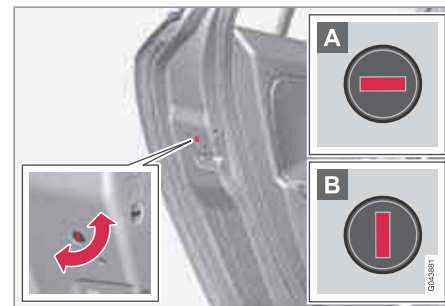

Manual locking of the door. Not to be mixed up with child safety locks, see page 62.

- Use the remote control key's detachable key blade to turn the knob, see page 48.
- A** The door is blocked against opening from the outside.
- B** The door can be opened from both the outside and the inside.



Locking/unlocking

NOTE

- A door's knob control only locks that particular door - not all doors simultaneously.
- A manually locked rear door with an activated manual child safety lock cannot be opened from either the outside or the inside, see page 62. A rear door that is locked in this way can only be unlocked with the remote control key or central locking button.

From the inside

Central locking



Central locking.

All of the doors and the tailgate can be locked or unlocked simultaneously using the central

locking button on the driver's door and the passenger door*.

- Press one side of the button to lock - the other side to unlock.

Unlocking

A door can be unlocked from the inside in two different ways:

- Press the central locking button .

Press and hold (at least 4 seconds) to also open all the side windows* simultaneously.

- Pull the door handle and open the door - the door is unlocked and opened in one operation.

Lamp in lock button

Central locking is available in two variants - the lamp in the central locking button for the driver's door has different meanings dependent on the variant.

With central locking button only in the driver's door, other doors have no button:

- Illuminated lamp means that all doors are locked.

With central locking button on both front doors and electric lock button in each rear door:

- Illuminated lamp means that only that particular door is locked. When all buttons are illuminated all doors are locked.

Locking

- Press the central locking button - all closed doors are locked.

Press and hold (at least 2 seconds) to also close all the side windows and the sunroof* simultaneously.

Lock button* rear doors



The button's lamp illuminates when the door is locked.

The rear door lock buttons only lock their respective rear door.

To unlock the door:

- Pull the door handle - the door is unlocked and opened.

Global opening

Press and hold the central locking button (at least 4 seconds) to also open all the win-



Locking/unlocking

dows simultaneously - for example, to quickly ventilate the passenger compartment during hot weather.

Automatic locking

The doors and tailgate are locked automatically when the car starts to move.

The function can be activated/deactivated in the menu system **MY CAR** under **Settings** → **Car settings** → **Lock settings** → **Automatic door locking**. For a description of the menu system, see page 202.

Glovebox

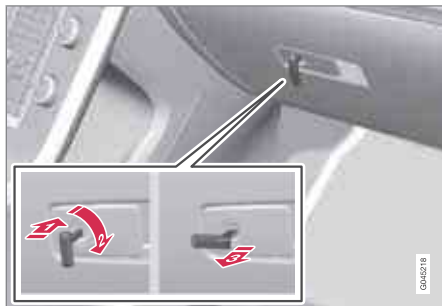

The glovebox can only be locked/unlocked using the remote control key's detachable key blade. For information on the key blade, see page 48.

Locking the glovebox:

- ➊ Insert the key blade in the glovebox lock cylinder.
- ➋ Turn the key blade 90 degrees clockwise. The keyhole is horizontal in the locked position.
- ➌ Pull out the key blade.

- Unlock by carrying this out in reverse order.

For information on privacy locking, see page 49.

Tailgate

Manual opening



Rubber plate with electrical contact.

The tailgate is held closed by an electrical lock. To open:

1. Push down gently on the wider of the two rubberised pressure plates under the outer handle - the lock is released.
2. Lift the outside handle in order to fully open the tailgate.



IMPORTANT

- Minimal force is required to release the rear hatch lock - just gently press the rubberised panel.
- Do not place the lift force on the rubber panel when opening the rear hatch - lift the handle. Using too much force may damage the electrical contact for the rubber panel.



Locking/unlocking

Unlocking with the remote control key



The alarm for the tailgate can be disarmed* and the tailgate unlocked on its own by using the remote control key's button.

The lock indicator on the instrument panel stops flashing in order to show that not all of the car is locked and the alarm's* level and movement sensors and the sensors for opening the tailgate are disconnected.

The doors remain locked and armed.

- The tailgate is unlocked, but remains closed - press lightly on the rubberised pressure plate under the outer handle and lift the tailgate.

If the tailgate is not opened within 2 minutes then it is relocked and the alarm is re-armed.

Unlocking the car from inside



To unlock the tailgate:

- Press the lighting panel button (1).
 - > The tailgate is unlocked and can be opened within 2 minutes (if the car is locked from the inside).

Locking with the remote control key

- Press the remote control key's button for locking, , see page 45.
 - > The lock indicator on the instrument panel starts flashing, which means that the car is locked and the alarm* has been activated.

Deadlocks*¹

Deadlocks means that all door handles are mechanically disengaged, which prevents doors being opened from the inside.

The deadlocks are activated with the remote control key and are set after an approximately 10 second delay after the doors have been locked.

NOTE

If a door is opened within the delay time then the sequence is interrupted and the alarm is deactivated.

The car can only be unlocked from a deadlock state with the remote control key. The front left door can also be unlocked with the detachable key blade.

WARNING

Do not allow anyone to remain in the car without first deactivating the deadlocks in order to avoid the risk of anyone being locked in.

¹ Only in combination with alarm.

* Option/accessory, for more information, see Introduction.



Locking/unlocking

Temporary deactivation



Active menu options are indicated with a cross.

- 1 MY CAR
- 2 OK MENU
- 3 TUNE knob control
- 4 EXIT

If someone is going to stay in the car but the doors must be locked from the outside, then the deadlocks function can be temporarily switched off. This is carried out as follows:

1. Access the menu system **MY CAR** under **Settings** → **Car settings** → **Reduced Guard** (for a detailed description of the menu system, see page 202).
2. Select **Activate once**.

> The instrument panel display shows the message **Reduced guard** See **manual** and the deadlocks function is switched off when the car is locked.

or

- Select **Ask when exiting**.

> Each time the engine is switched off the centre console display screen shows the message **Activate Reduced Guard until engine has started again?** followed by the alternatives **Confirm with OK** and **Cancel with EXIT**.

If the deadlocks function shall be switched off

- Press **OK/MENU** and lock the car. (Note that the alarm's movement and tilt detectors* are switched off at the same time, see page 64.)
 - > The next time the engine is started, the system is reset to zero and the instrument panel display shows the message **Full guard** at which the deadlocks function and the alarm's movement and tilt detectors are re-engaged.

If the locking system shall not be changed

- Press **EXIT** and lock the car.

NOTE

- Remember that the alarm is activated when the car is locked.
- If any of the doors are opened from the inside then the alarm is triggered.

02



Child safety locks

Manual blocking of the rear doors

The child safety locks prevent children from opening a rear door from the inside.

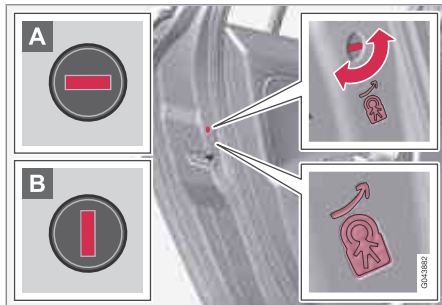

With child safety locks. Not to be mixed up with manual door locks, see page 57.

The child safety locks are located on the trailing edge of the rear doors and are only accessible when the doors are open.

To activate/deactivate the child safety locks:

- Use the remote control key's detachable key blade to turn the knob - see page 48.

- A** The door is blocked against opening from the inside.
- B** The door can be opened from both the outside and the inside.

WARNING

Each rear door has two knob controls - do not mix up the child safety lock with the mechanical door lock.

NOTE

- A door's knob control only blocks that particular door - not both rear doors simultaneously.
- Cars with an electric child safety lock do not have a manual child lock.

Electrical locking of the rear doors* and power windows



Control panel driver's door.

The child safety locks can be activated/deactivated in all key positions higher than **0** - see page 78. Activation/deactivation can be performed up to 2 minutes after switching off the engine, provided that no door is opened.

To activate the child safety locks:

1. Start the engine or choose a key position higher than **0**.
2. Press the button in the driver's door control panel.
 - > The information display shows the message **Rear child locks Activated** and the button's lamp illuminates - the locks are active.

When the electric child safety lock is active then the rear:

- windows can only be opened with the driver's door control panel
- doors cannot be opened from inside.

The current setting is stored when the engine is switched off - if the child safety locks are activated at engine shutdown, the function will remain activated the next time the engine is started.



Alarm*

General

Activated alarm is triggered if:

- a door, the bonnet or the tailgate is opened
- a movement is detected in the passenger compartment (if fitted with a movement detector*)
- the car is raised or towed away (if fitted with a tilt detector*)
- the battery's cable is disconnected
- the siren is disconnected.

If there is a fault in the alarm system, the information display shows a message. In which case, contact a workshop - an authorised Volvo workshop is recommended.

i NOTE

The movement sensors trigger an alarm in the event of movement in the passenger compartment - air currents are also registered. For this reason the alarm is triggered if the car is left with a window or the sunroof open or if the passenger compartment heater is used.

To avoid this: Close the window/sunroof when leaving the car. If the car's integrated passenger compartment heater (or a portable electric heater) shall be used - direct the airflow from the air vents so that they are not pointing upwards in the passenger compartment.

i NOTE

Do not attempt to repair or modify alarm system components. All such attempts could affect the terms of insurance.

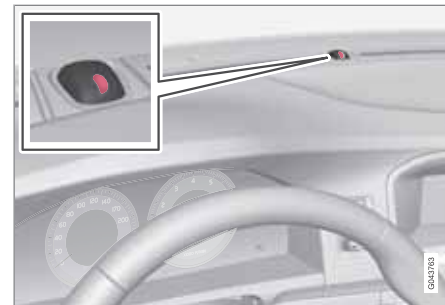
Alarm indicator

Same LED as lock indicator, see page 45.

A red LED on the instrument panel indicates the alarm system's status:

- LED not lit – Alarm not armed
- The LED flashes once every other second – Alarm is armed
- The LED flashes rapidly after disarming the alarm (and until the remote control key is inserted in the ignition switch and key position I is selected) – Alarm has been triggered.

Arming the alarm

- Press the remote control key lock button.

Deactivate the alarm

- Press the remote control key unlock button.



Alarm*

Deactivating a triggered alarm

- Press the remote control key unlock button or insert the remote control key in the ignition switch.

Other alarm functions

Automatic re-arming of the alarm

This function prevents the car being left with the alarm disarmed unintentionally.

If the car is unlocked with the remote control key (and the alarm is disarmed) but none of the doors or the tailgate is opened within 2 minutes, then the alarm is automatically re-armed. The car is relocked at the same time.

Remote control key not working

If the alarm cannot be deactivated with the remote control key, e.g. if the key's battery is discharged - the car can be unlocked, disarmed and the engine started as follows:

1. Open the driver's door with the detachable key blade - see page 54.
 - > The alarm is triggered, the alarm indicator flashes rapidly and the siren sounds.



2. Insert the remote control key in the ignition switch.
 - > The alarm is deactivated and the alarm indicator goes out.
3. Start the engine.

Alarm signals

When the alarm is triggered, the following happens:

- A siren sounds for 30 seconds or until the alarm is switched off. The siren has its own battery and works independently of the car battery.
- The direction indicators flash for 5 minutes or until the alarm is switched off.

Reduced alarm level

To avoid accidental triggering of the alarm - e.g. if a dog is left in a locked car or during transport on a car train or car ferry - temporarily deactivate the movement and tilt detectors.

The procedure is the same as with the temporary disengaging of deadlocks, see page 60.



Instruments and controls.....	68
Volvo Sensus	77
Key positions.....	78
Seats.....	80
Steering wheel.....	85
Lighting.....	86
Wipers and washing.....	98
Windows, rearview and door mirrors.....	101
Compass*	106
Power sunroof*.....	107
Alcolock*.....	109
Starting the engine.....	113
Starting the engine – Flexifuel.....	118
Starting the engine – external battery.....	120
Gearboxes.....	121
DRIVE Start/Stop*.....	127
All-wheel drive – AWD*.....	134
Foot brake.....	135
Parking brake.....	137
HomeLink® *.....	141



G041142

03

YOUR DRIVING ENVIRONMENT

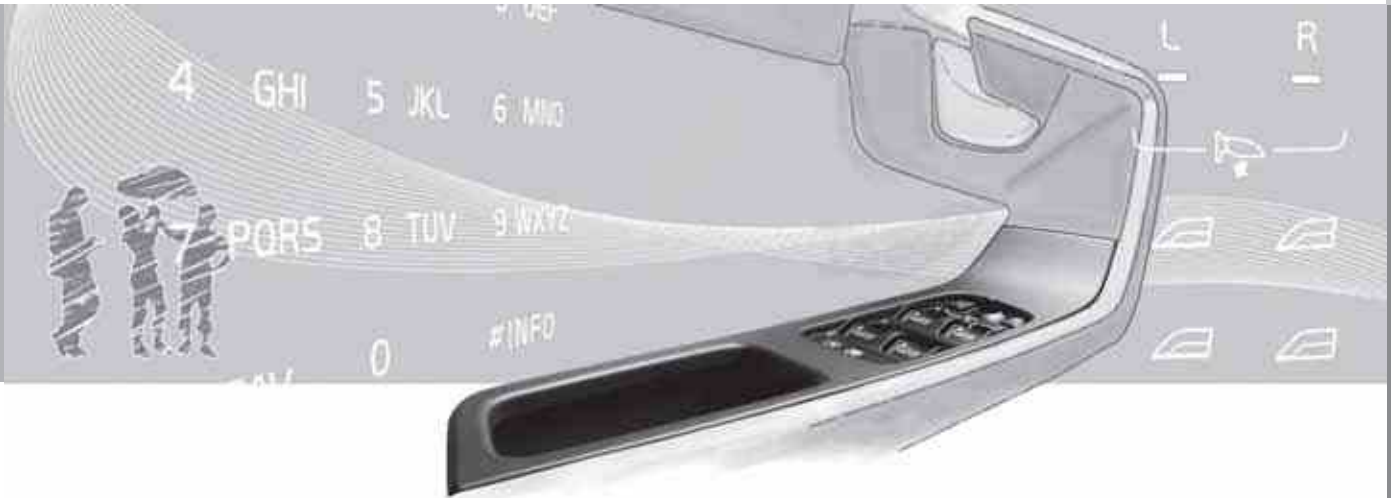



03 Your driving environment

Instruments and controls

Instrument overview

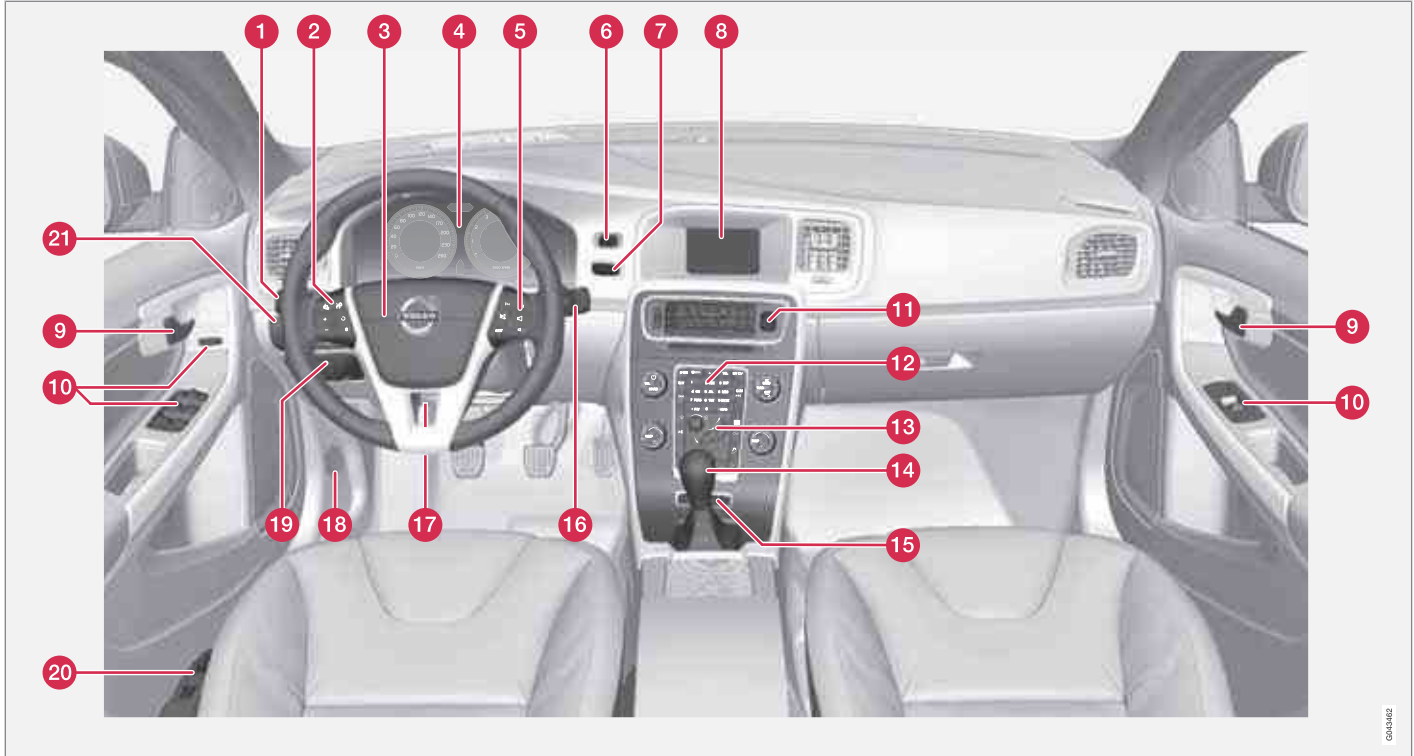

Left-hand drive.

030302



Instruments and controls

	Function	Page
1	Menus and messages, direction indicators, main/dipped beam, trip computer	87, 92, 200, 224
2	Cruise control	152, 154
3	Horn, airbags	20, 85
4	Combined instrument panel	71, 75
5	Menu, audio and phone control	202, 236, 262, 238
6	START/STOP ENGINE button	113
7	Ignition switch	78
8	Display for infotainment and menus	202, 235, 238
9	Door handle	–
10	Control panel	58, 62, 101, 103
11	Hazard warning flashers	92

	Function	Page
12	Control for infotainment and menu control	202, 235, 238
13	Control panel for climate control	213
14	Gear selector	121
15	Controls for active chassis (Four-C)*	226
16	Wipers and washing	98, 99
17	Steering wheel adjustment	85
18	Bonnet opener	328
19	Parking brake	137
20	Seat adjustment*	81
21	Headlamp control, opener for fuel filler flap and tailgate	59, 86, 287



03 Your driving environment

Instruments and controls

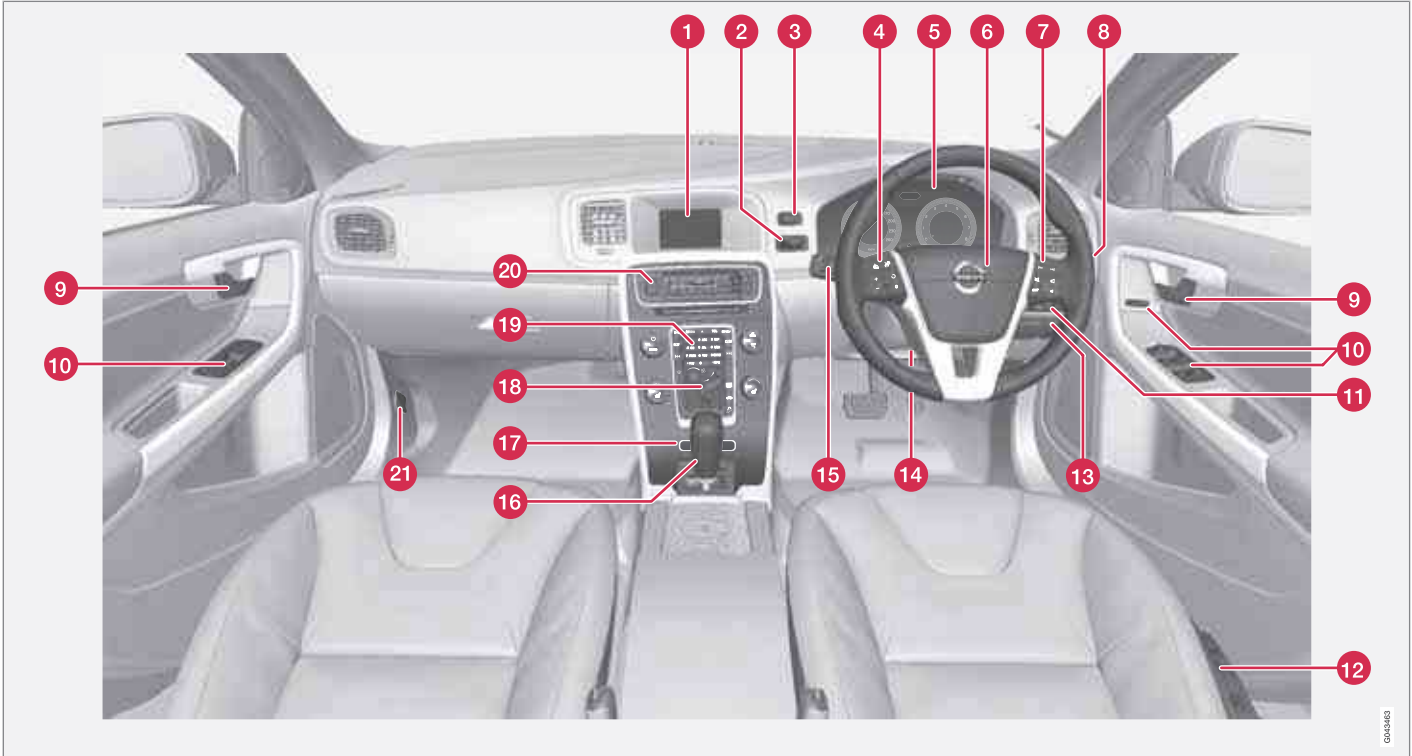

Right-hand drive.

000000



Instruments and controls

	Function	Page
1	Display for infotainment and menus	202, 235, 238
2	Ignition switch	78
3	START/STOP ENGINE button	113
4	Cruise control	152, 154
5	Combined instrument panel	71, 75
6	Horn, airbags	20, 85
7	Menu, audio and phone control	202, 236, 262, 238
8	Wipers and washing	98, 99
9	Door handle	–
10	Control panel	58, 62, 101, 103
11	Headlamp control, opener for fuel filler flap and tailgate	59, 86, 287
12	Seat adjustment*	81

	Function	Page
13	Parking brake	137
14	Steering wheel adjustment	85
15	Menus and messages, direction indicators, main/dipped beam, trip computer	87, 92, 200, 224
16	Gear selector	121
17	Controls for active chassis (Four-C)*	226
18	Control panel for climate control	213
19	Control for infotainment and menu control	202, 235, 238
20	Hazard warning flashers	92
21	Bonnet opener	328

Information displays

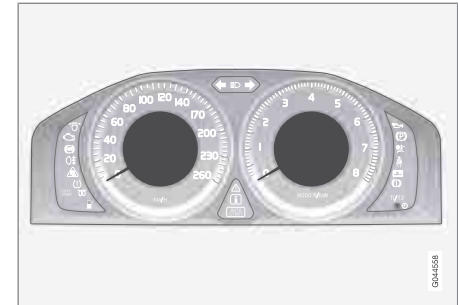

The combined instrument panel's information displays show information on some of the car's functions, e.g. cruise control, trip computer and messages. The information is shown with text and symbols.

There are further descriptions under the functions that use the information displays.

Instruments and controls

Meters

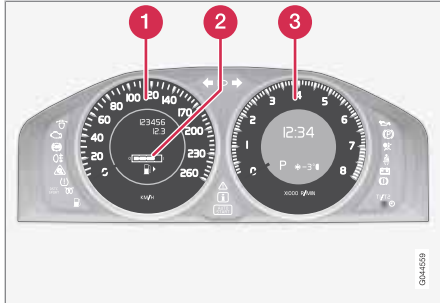

Meters in the combined instrument panel.

- 1 Speedometer
- 2 Fuel gauge. See also Trip computer, page 224, and Refuelling, page 287.
- 3 Tachometer. The meter indicates engine speed in thousands of revolutions per minute (rpm).

Indicator and warning symbols

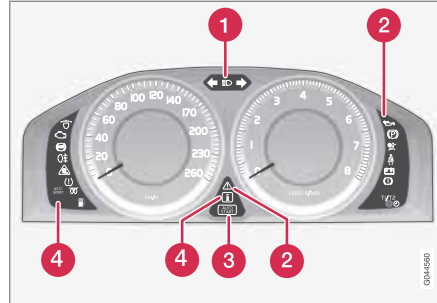

Indicator and warning symbols.

- 1 Main beam and direction indicator symbol
- 2 warning symbols¹
- 3 Symbol for DRIVE - Start/Stop*, see page 127
- 4 Indicator symbols

Functionality check

All indicator and warning symbols illuminate in key position II or when the engine is started. When the engine has started, all the symbols should go out except the parking brake symbol, which only goes out when the brake is disengaged.

If the engine does not start or if the functionality check is carried out in key position II then all symbols go out after 5 seconds except the symbol for faults in the car's emissions system and the symbol for low oil pressure.

Indicator symbols

Symbol	Specification
	ABL fault
	Emissions system
	ABS fault
	Rear fog lamp on
	Stability system
	Stability system, sport mode
	Engine preheater (diesel)
	Low level in fuel tank
	Information, read display text

¹ For certain engine variants, the symbol for low oil pressure is not used. Warnings are made via display text. For information on checking the oil level, see page 329.



Instruments and controls

Symbol	Specification
	Main beam On
	Left-hand direction indicators
	Right-hand direction indicators
	DRIVE - Start/Stop*, the engine auto-stopped, see page 127
	Tyre pressure system*, see page 319

ABL fault

The symbol illuminates if a fault has arisen in the ABL function (Active Bending Lights).

Emissions system

If the symbol illuminates then it may be due to a fault in the car's emissions system. Drive to a workshop for checking. Volvo recommends that you seek assistance from an authorised Volvo workshop.

ABS fault

If this symbol illuminates then the system is not working. The car's regular brake system continues to work, but without the ABS function.

1. Stop the car in a safe place and turn off the engine.

2. Restart the engine.
3. If the symbol remains illuminated, drive to a workshop to have the ABS system checked. Volvo recommends that you seek assistance from an authorised Volvo workshop.

Rear fog lamp on

This symbol illuminates when the rear fog lamp is on. There is only one fog lamp. It is located on the driver's side.

Stability system

A flashing symbol indicates that the stability system is operating. If the symbol illuminates with constant glow then there is a fault in the system.

Stability system, Sport mode

Sport mode allows for a more active driving experience. The system then detects whether the accelerator pedal, steering wheel movements and cornering are more active than in normal driving and then allows controlled skidding of the rear section up to a certain level before it intervenes and stabilises the car.

Engine preheater (diesel)

This symbol illuminates during engine preheating. Preheating takes place mostly due to low temperature.

Low level in fuel tank

When the symbol illuminates the level in the fuel tank is low, refuel as soon as possible.

Information, read display text

When one of the car's systems does not behave as intended, this information symbol illuminates and a text appears on the information display. The message text is cleared with the **OK** button, see page 200, or it disappears automatically after a time (time depending on which function is indicated). The information symbol can also illuminate in conjunction with other symbols.

NOTE

When a service message is shown, the symbol and message are cleared using the **OK** button, or disappear automatically after a time.

Main beam On

The symbol illuminates when main beam is on and with main beam flash.

Left/right-hand direction indicators

Both direction indicator symbols flash when the hazard warning flashers are used.

DRIVE - Start/Stop*

The symbol shines when the engine is auto-stopped.

Tyre pressure system

The symbol illuminates in the event of low tyre pressure, or if a fault arises in the tyre pressure system.

* Option/accessory, for more information, see Introduction.



Instruments and controls

Warning symbols

Symbol	Specification
	Low oil pressure ^A
	Parking brake applied
	Airbags – SRS
	Seatbelt reminder
	Alternator not charging
	Fault in brake system
	Warning

^A For certain engine variants, the symbol for low oil pressure is not used. Warnings are made via display text, see pages 329 and 331.

Low oil pressure

If this symbol illuminates during driving then the engine's oil pressure is too low. Stop the engine immediately and check the engine oil level, top up if necessary. If the symbol illuminates and the oil level is normal, contact a workshop. Volvo recommends that you seek assistance from an authorised Volvo workshop.

Parking brake applied

This symbol illuminates with a constant glow when the parking brake is applied. The symbol flashes during application, and then changes over to a constant glow.

A flashing symbol means that a fault has arisen. Read the message on the information display.

Airbags – SRS

If this symbol remains illuminated or illuminates while driving, it means a fault has been detected in the seatbelt buckle, SRS, SIPS, or IC systems. Drive immediately to a workshop to have the system checked. Volvo recommends that you seek assistance from an authorised Volvo workshop.

Seatbelt reminder

This symbol illuminates if someone in a front seat has not put on their seatbelt or if someone in a rear seat has taken off their seatbelt.

Alternator not charging

This symbol illuminates during driving if a fault has occurred in the electrical system. Visit a workshop. Volvo recommends that you seek assistance from an authorised Volvo workshop.

Fault in brake system

If this symbol illuminates, the brake fluid level may be too low. Stop the car in a safe place

and check the level in the brake fluid reservoir, see page 333.

If the brake and ABS symbols illuminate at the same time, there may be a fault in the brake force distribution system.

1. Stop the car in a safe place and turn off the engine.
2. Restart the engine.
 - If both symbols extinguish, continue driving.
 - If the symbols remain illuminated, check the level in the brake fluid reservoir, see page 333. If the brake fluid level is normal but the symbols are still illuminated, the car can be driven, with great care, to a workshop to have the brake system checked. Volvo recommends that you seek assistance from an authorised Volvo workshop.



WARNING

If the brake fluid is under the **MIN** level in the brake fluid reservoir, do not drive further before topping up the brake fluid.

The loss of brake fluid must be investigated by a workshop. Volvo recommends that you contact an authorised Volvo workshop.



Instruments and controls

WARNING

If the brake and ABS symbols are illuminated at the same time, there is a risk that the rear end will skid during heavy braking.

Warning

The red warning symbol illuminates when a fault has been indicated which could affect the safety and/or driveability of the car. An explanatory text is shown on the information display at the same time. The symbol remains visible until the fault has been rectified but the text message can be cleared with the **OK** button, see page 200. The warning symbol can also illuminate in conjunction with other symbols.

Action:

1. Stop in a safe place. Do not drive the car further.
2. Read the information on the information display. Implement the action in accordance with the message in the display. Clear the message using the **OK** button.

Reminder – doors not closed

If one of the doors, the bonnet² or tailgate is not closed properly then the information or warning symbol illuminates together with an explanatory text message in the combined instrument

panel. Stop the car in a safe place as soon as possible and close the door, bonnet or boot lid, whichever is open.

 If the car is driven at a speed lower than approx. 7 km/h then the information symbol illuminates.

 If the car is driven at a speed higher than approx. 7 km/h then the warning symbol illuminates.

Trip meter

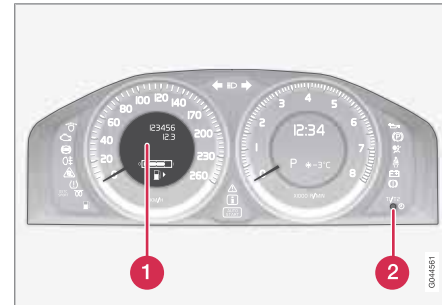

Trip meter and controls.

- 1 Display for trip meter
- 2 Controls for switching between trip meters T1 and T2, as well as resetting the trip meters

The meters are used to measure short distances. The distance is shown in the display.

One short press on the control switches between the two trip meters T1 and T2. A long press (more than 2 seconds) resets the currently displayed trip meter.

Clock

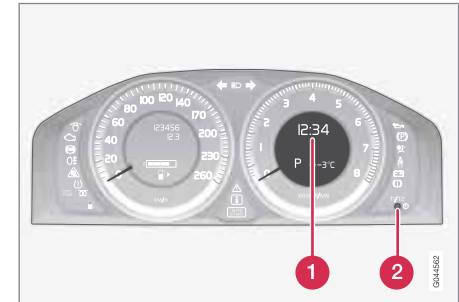

Clock and setting knob.

- 1 Display for showing the time
- 2 Controls for setting the clock

Turn the knob clockwise/anticlockwise to set the clock. Turn first to the end position and then turn past/over the end position a further approx. 1 mm - a "click" sounds and is felt in

² Only cars with alarm*.



03 Your driving environment

Instruments and controls

the button. Each "click" scrolls 1 minute. In order to change quickly - hold in the "click position".

In connection with a message the clock can be temporarily replaced by a symbol, see page 200.

Setting the clock in MY CAR

In addition to the previous manual/mechanical method the clock can also be set in the menu group **MY CAR**, for more information see page 202.



1. Locate **Settings** → **System options** → **Time**.
2. The cursor is located in the first box for Hour: Press **OK** - the box is activated.
3. Turn **TUNE** to set the correct hour and press **OK** - the box is deactivated.

4. Turn **TUNE** to select the box for Minute (A) and press **OK** - the box is activated (B).
5. Turn **TUNE** to set the correct minute and press **OK** - the box is deactivated.
6. Turn **TUNE** to select the box for **OK** and press **OK** - the setting is complete.

The menu option **Settings** → **System options** → **Time format** selects the 24h or 12h system (AM/PM).

RSI*

The function RSI (Road Sign Identification) helps the driver to see road signs containing information on current speed, that a motorway or road is starting/ending and when overtaking is prohibited. For detailed information on RSI, see page 148.



General

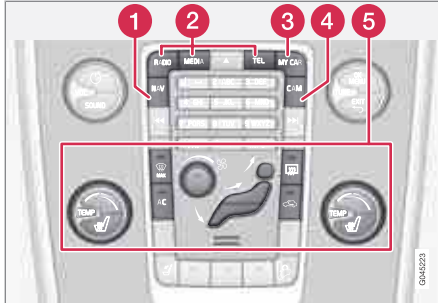

Control panel in centre console

- ➊ Navigation* - **NAV**, see separate owner's manual (Road and Traffic Information System - RTI).
- ➋ Infotainment (**RADIO, MEDIA, TEL***), see page 234.
- ➌ Car settings - **MY CAR**, see page 202.
- ➍ Park assist camera - **CAM***, see page 191.
- ➎ Climate control, see page 210.

Volvo Sensus is the car's operating system, the heart of your personal Volvo experience. Volvo Sensus combines and presents many functions in several of the car's systems on the centre console TV screen. With Volvo Sensus

the car can be personalised by means of an intuitive user interface. Settings can be made in Car settings, Infotainment, Climate, etc.

With the centre console buttons and controls or the steering wheel's right-hand keypad* functions can be activated or deactivated and many different settings can be made.

With a press on **MY CAR** all settings related to the driving and control of the car are presented, such as City Safety, Locks and alarm, setting the clock, etc.

With a press on the respective function: **RADIO, MEDIA, TEL***, **NAV*** and **CAM*** other sources, systems and functions can be activated, e.g. AM, FM1, CD, DVD*, TV*, Bluetooth*, navigation* and park assist camera*.

For more information on all functions/systems, see the respective section in the owner's manual.

Key positions

Insert and remove the remote control key



Ignition switch with remote control key extracted/inserted.

i NOTE

For cars with the Keyless* function the key does not need to be inserted into the ignition switch but can be stored in e.g. a pocket. For more information on Keyless functions - see page 53.

Insert the key

1. Hold the end of the remote control key with the detachable key blade and insert the key in the ignition switch.
2. Then press the key in the lock up to its end position.

! IMPORTANT

Foreign objects in the ignition switch may jeopardise the function or destroy the lock.

Do not press the remote control key incorrectly turned - Hold the end with the detachable key blade, see page 48.

Withdraw the key

- Push the remote control key, allow it to eject, then pull it out from the ignition switch.

Functions at different levels

In order to enable the use of a limited number of functions with the engine switched off, the car's electrical system can be set in 3 different levels (key positions) - **0**, **I** and **II** - with the remote control key. Throughout this owner's manual these levels are described using the denomination "key positions".

The following table shows the functions available in each key position/level.

Level	Functions
0	<ul style="list-style-type: none"> • Odometer, clock and temperature gauge are illuminated. • Power seats can be adjusted. • The audio system can be used for a limited time - see page 234.
I	<ul style="list-style-type: none"> • Sunroof, power windows, 12 V socket in the passenger compartment, RTI, phone, ventilation fan and wind-screen wipers can be used.
II	<ul style="list-style-type: none"> • The headlamps come on. • Warning/indicator lamps illuminate for 5 seconds. • Several other systems are activated. However, heating in seat cushions and the rear window can only be activated after the engine has been started. <p>This key position consumes a lot of current from the starter battery and should therefore be avoided!</p>

**Key positions****Choosing key position/level****Key position 0**

- Unlock the car - this means that the car's electrical system is at level **0**.

Key position I

- With the remote control key fully inserted into the ignition switch¹ - Briefly press **START/STOP ENGINE**.

i NOTE

To reach level **I** or **II** **without** starting the engine - do **not** depress the brake/clutch pedal when these key positions are due to be selected.

Key position II

- With the remote control key fully inserted into the ignition switch¹ - Give a long² press on **START/STOP ENGINE**.

Back to key position 0

- To return to key position **0** from position **II** and **I** - Briefly press on **START/STOP ENGINE**.

Audio system

For information on the audio system's functions with remote control key removed - see page 234.

Starting and stopping the engine

For information about starting/switching off the engine - see page 113.

Towing

For important information about the remote control key during towing - see page 304.

¹ Not necessary for cars with the Keyless* function.

² Approx. 2 seconds.

Seats

Front seats



- 1 Lumbar support adjustment, turn the wheel¹.
- 2 Forward/backward: lift the handle to adjust the distance to the steering wheel and pedals. Check that the seat is locked after changing position.
- 3 Raise/lower* front edge of seat cushion, pump up/down.
- 4 Adjust backrest rake, turn the wheel.
- 5 Raise/lower the seat, pump up/down.
- 6 Control panel for power seat*.

¹ Also applies to power seat.

WARNING

Adjust the position of the driver's seat before setting off, never while driving. Make sure that the seat is in locked position in order to avoid personal injury in the event of sudden braking or an accident.

Lowering the front seat backrest

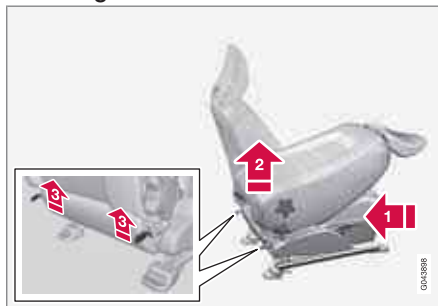

The passenger seat backrest can be folded forward to make room for long loads.

- 1 Move the seat as far back/down as possible.
- 2 Adjust the backrest to an upright position.

- 3 Lift the catches on the rear of the backrest and fold it forward.

4. Push the seat forward so that the head restraint "locks" in under the glovebox.

Raising takes place in reverse order.

WARNING

Grasp the backrest and make sure that it is properly locked after being folded up in order to avoid personal injury in the event of sudden braking or an accident.



Seats

Power seat*



- 1 Front edge of seat cushion up/down
- 2 Seat forward/backward and up/down
- 3 Backrest rake

The power front seats have overload protection which is tripped if a seat is blocked by an object. If this happens, go to key position I or 0 and wait a short time before adjusting the seat again.

Only one movement (forward/back/up/down) can be made at a time.

Preparations

The seats can be adjusted for a certain time after unlocking the door with the remote con-

trol key without the key in the ignition switch. Seat adjustment is normally made in key position I and can always be made when the engine is running.

Seat with memory function*

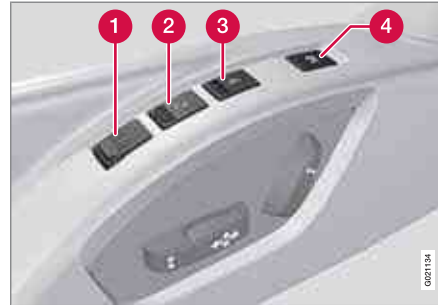

Store setting

- 1 Memory button
- 2 Memory button
- 3 Memory button
- 4 Button for storing settings

1. Adjust the seat and the door mirrors.

2. Hold the button depressed to store settings while depressing one of the memory buttons.

Using a stored setting

Hold one of the memory buttons depressed until the seat and the door mirrors stop. If you release the button then the movement of the seat will stop.

Key memory* in remote control key²

All remote control keys can be used by different drivers to store the settings for the driver's seat and door mirrors³. Proceed as follows:

- Adjust the seat as you want it.
- Lock the car by pressing the lock button on the remote control key that you normally

² For key memory for Keyless function, see page 55.

³ Only if the car is equipped with power seat with memory and retractable power door mirrors.



Seats

use. This stores the positions of the seat and door mirrors in the remote control key's memory⁴.

- Unlock the car (by pressing the unlock button on the **same** remote control key) and open the driver's door. The driver's seat and door mirrors will automatically adopt the positions that are stored in the remote control key's memory (if the seat has been moved since you locked the car).

The key memory can be activated/deactivated in the menu system **MY CAR** under **Settings** → **Car settings** → **Car key memory**. For a description of the menu system, see page 202.

Emergency stop

If the seat accidentally begins to move, press one of the setting buttons for the seat or memory buttons in order to stop the seat.

Restarting to reach the seat position stored in the key memory is performed by pressing the unlock button on the remote control key. The driver's door must then be open.

WARNING

Risk of crushing! Make sure that children do not play with the controls. Check that there are no objects in front of, behind or under the seat during adjustment. Ensure that none of the backseat passengers will be trapped.

Heated seats

For heated seats, see page 215.

Rear seats

Head restraint, centre seat, rear



Adjust the head restraint according to passenger height so that the whole of the back of the

head is covered if possible. Slide it up as required.

To lower the head restraint again, the button (located in the centre between the backrest and head restraint, see illustration) must be pressed in while the head restraint is pressed down carefully.

Manual lowering of the outer head restraints, rear seat



Pull the locking handle closest to the head restraint to fold the head restraint forward.

The head restraint is moved back manually until a "click" can be heard.

⁴ This setting does not affect settings that have been stored in the power seat's memory function.



Seats

! WARNING

The head restraints must be in locked position after being raised.

Lowering the rear seat backrest

! IMPORTANT

There must be no objects on the rear seat when the backrest is to be folded down. The seat belts must not be connected either. Otherwise there is a risk of damaging the rear seat upholstery.

The triple-section backrest can be folded in different ways.

i NOTE

The front seats may need to be pushed forwards, and/or the backrests adjusted upwards, in order that the rear backrests can be folded forward fully.

- The left-hand section can be folded separately.
- The centre section can be folded separately.
- The right-hand section can only be folded together with the centre section.

- If the entire backrest is to be folded then the different sections should be folded separately.

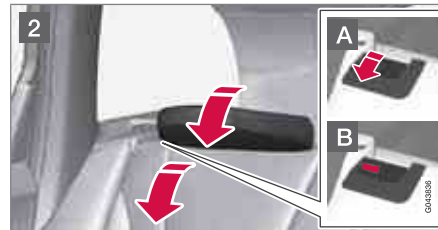

- 1 If the centre backrest is being lowered - fold and adjust the centre backrest's head restraint downwards, see page 82.
- 2 The outer head restraints are lowered automatically when the outer backrests are lowered. Pull up the backrest's locking handle **A** while folding the backrest forward at the same time. A red indicator on

the lock catch **B** shows that the backrest is no longer locked in place.

i NOTE

When the backrests have been lowered the head restraints must be moved forward slightly so as not to make contact with the seat cushion.

Raising takes place in reverse order.

i NOTE

When the backrest has been raised, the red indicator should no longer be showing. If it is still showing then the backrest is not locked in place.

! WARNING

Check that the backrests and head restraints in the rear seats are firmly locked after raising.



Seats

Electrical lowering of the rear seat's outer head restraints*



1. The remote control key must be in position **I** or **II**.
2. Press the button to lower the rear outer head restraints to improve rearward visibility.

WARNING

Do not lower the outer head restraints if there are any passengers using of the outer seats.

Move the head restraint back manually until a click is heard.

WARNING

The head restraints must be in locked position after being raised.



Steering wheel

Adjusting

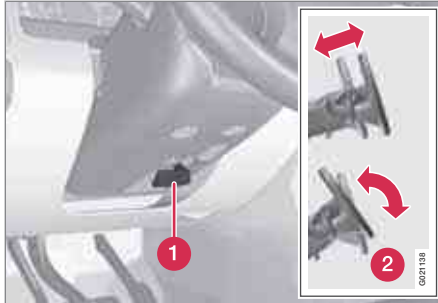

Adjusting the steering wheel.

- 1 Lever - releasing the steering wheel
- 2 Possible steering wheel positions

The steering wheel can be adjusted for both height and depth:

1. Pull the lever towards you to release the steering wheel.
2. Adjust the steering wheel to the position that suits you.
3. Push back the lever to fix the steering wheel in place. If the lever is stiff, press the steering wheel lightly at the same time as you push the lever back.

WARNING

Adjust and secure the steering wheel before driving.

With speed related power steering* the level of steering force can be adjusted, see page 226.

Keypads*



Keypads in the steering wheel.

- 1 Cruise control, see page 152
Adaptive cruise control, see page 154
- 2 Audio and phone control, see page 235.

Horn



Horn.

Press the centre of the steering wheel to signal.



Lighting

Headlamp control

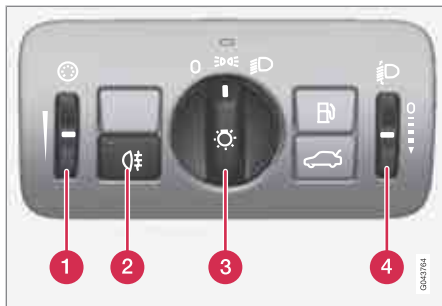

Overview, headlamp control.

- 1 Thumbwheel for adjusting display and instrument lighting
- 2 Rear fog lamp
- 3 Headlamp control
- 4 Thumbwheel¹ for headlamp levelling

Headlamp control with AUTO mode

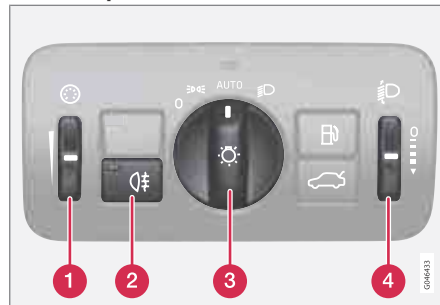

Overview, headlamp control.

- 1 Thumbwheel for adjusting display and instrument lighting
- 2 Rear fog lamp
- 3 Headlamp control
- 4 Thumbwheel¹ for headlamp levelling

Instrument lighting

Different display and instrument lighting is switched on depending on key position, see page 78.

The display lighting is automatically subdued in darkness - the sensitivity is set with the thumbwheel.

The intensity of the instrument lighting is adjusted with the thumbwheel.

Headlamp levelling

The load in the car changes the vertical alignment of the headlamp beam, which could dazzle oncoming motorists. Avoid this by adjusting the height of the beam. Lower the beam if the car is heavily laden.

1. Leave the engine running, or have the car's electrical system in key position I.
2. Roll the thumbwheel up/down to raise/lower beam alignment.

Cars with active Xenon headlamps* have automatic headlamp levelling and are therefore not equipped with the thumbwheel.

¹ Not available for cars equipped with active Xenon headlamps*.



Lighting

Main/dipped beam



Headlamp control and stalk switch.

- Position for main beam flash
- Position for main beam

Position	Specification
0	Dipped beam ^A /Dipped beam off. Main beam can be activated ^A . Main beam flash operates in this position.
☰☑☒	Position/parking lamps
☰☑	Dipped beam Main beam can be activated. Main beam flash operates in this position.

^A Applies to certain markets.

Headlamp control with AUTO mode



Headlamp control and stalk switch.

- Position for main beam flash
- Position for main beam



Position	Specification
0	Dipped beam off. Main beam flash operates in this position.
☰☑☒	Position/parking lamps



03 Your driving environment

Lighting

03

Position	Specification
	<p>Dipped beam^A/Dipped beam off in good light conditions. The "Tunnel detection*" function activates dipped beam in poor light conditions.</p> <p>The function for "Main beam with automatic activation*" can be used.</p> <p>Main beam flash operates in this position.</p>
	<p>Dipped beam</p> <p>Main beam can be activated.</p> <p>Main beam flash operates in this position.</p>

^A Applies to certain markets.

Volvo recommends that **AUTO** mode is used, as long as the traffic situation or weather conditions are not unfavourable for the function for "Main beam with automatic activation*".

Main beam flash

Move the stalk switch gently towards the steering wheel to the position for main beam flash.



Main beam comes on until the stalk switch is released.

Dipped beam

When the engine is started, dipped beam is activated automatically² if the headlamp control is in position . If necessary, automatic dipped beam for this position can be deactivated by a workshop. Volvo recommends that you contact an authorised Volvo workshop.

In position  dipped beam is always switched on when the engine is running or when key position **II** is active.

Main beam

Main beam can be activated when the headlamp control is in position  ^P or . Activate/deactivate main beam by moving the stalk switch towards the steering wheel to the end position and release. Alternatively, the main beam can be deactivated by a light press of the stalk switch toward the steering wheel.

When main beam has been activated the symbol  illuminates in the combined instrument panel.

Main beam with automatic activation - AHB*

Main beam with automatic activation (Active High Beam - AHB) is a function which uses a camera sensor at the top edge of the windscreen to detect the headlamp beams of oncoming traffic or the rear lights of vehicles in front, and then switches from main beam to dipped beam. The lights are switched back to main beam a second or so after the camera sensor no longer detects any such light.

In cars with this function the headlamp control has another design, see page 87.

This function can be activated when the headlamp control is in position **AUTO**. For activation to take place, the engine must have been running for at least 20 seconds and the speed of the car must be 20 km/h or higher.

² Applies to certain markets, for headlamp control without **AUTO** mode.

* Option/accessory, for more information, see Introduction.



Lighting





Light switch in position **AUTO**.

Activate/deactivate AHB by moving the left-hand stalk switch towards the steering wheel to the end position and release. Deactivation when main beam is on means that the lights switch directly to dipped beam.





Headlamp control and stalk switch.

When AHB has been activated the symbol  illuminates in the combined instrument panel's display. When main beam has been activated the  symbol also illuminates in the combined instrument panel.

 **NOTE**

Keep the windscreen surface in front of the camera sensor clean from ice, snow, mist and dirt.

Do not attach or fit anything to the windscreen in front of the camera sensor, as this could reduce or prevent the function of one or more camera-dependent systems.

If the message **AHB temporary unavailable** is shown in the combined instrument panel's display then you have to switch manually between main and dipped beam. However, the headlamp control may nevertheless be in position **AUTO**. The same applies if the message **Windscreen Sensors blocked** and the  symbol are shown. The  symbol goes out when these messages are shown.

AHB may be temporarily unavailable e.g. in situations with dense fog or heavy rain. When AHB becomes available again, or the windscreen sensors are no longer covered, the

message goes out and the  symbol illuminates.

 **WARNING**

AHB is an aid for using optimum light composition when conditions are favourable.

The driver always bears responsibility for manually switching between main and dipped beam when traffic situations or weather conditions so require.



03 Your driving environment

Lighting

! IMPORTANT

Examples of when manual switching between main and dipped beam may be required:

- In heavy rain or dense fog
- In snow flurries or slush
- In moonlight
- When driving in poorly lit built-up areas
- When the traffic ahead has weak lighting
- If there are pedestrians on or beside the road
- If there are highly reflective objects such as signs in the vicinity of the road
- When the lighting from oncoming traffic is obscured by e.g. a crash barrier
- When there is traffic on connecting roads
- On the brow of a hill or in a hollow
- In sharp bends.

For more information on the limitations of the camera sensor, see page 178.

Tunnel detection*

In cars with rain sensor* the rain sensor detects the changed light conditions when the car is

e.g. driven into a tunnel, and dipped beam is activated within a second in markets without automatic dipped beam. Dipped beam is deactivated approx. 20 seconds after the car has been driven out of the tunnel. Note! - The headlamp control must be in **AUTO** position for tunnel detection to work.

Active Xenon headlamps - ABL*



Headlamp pattern with function deactivated (left) and activated (right) respectively.

If the car is equipped with active Xenon headlamps Active Bending Lights - ABL the light from the headlamps follows the steering wheel movement in order to provide maximum lighting in bends and junctions and so provide increased safety.

The function is activated automatically when the car is started. In the event of a fault in the function the  symbol illuminates in the combined instrument panel at the same time as the information display shows an explanatory text and a further illuminated symbol.

Symbol	Display	Specification
	Headlamp failure Service required	The system is disengaged. Visit a workshop if the message remains. Volvo recommends that you contact an authorised Volvo workshop.

The function is only active in twilight or darkness and only when the car is moving.

The function³ can be deactivated/activated in the menu system **MY CAR** under **My V60** →

³ Activated on delivery from the factory.

* Option/accessory, for more information, see Introduction.

Lighting

Active Bending Lights or under **Settings** → **Car settings** → **Light settings** → **Active Bending Lights**. For a description of the menu system, see page 203.

For headlamp pattern adjustment, see page 94.

Auxiliary lamps*

If the car has auxiliary lamps, the driver can use the **MY CAR** menu system to choose whether they should be deactivated or switched on/off simultaneously with the main beam⁴, see page 204.

Position/parking lamps



Headlamp control in position for position/parking lamps.

Turn the headlamp control to the position for position/parking lamps (number plate lighting is illuminated at the same time).

When it is dark outside and the tailgate is opened the rear position lamps illuminate to alert traffic behind. This takes place irrespective of what position the headlamp control is in or what key position the car's electrical system is in.

Brake lights

The brake light automatically comes on during braking. For information on the Emergency brake lights and automatic hazard warning flashers, see page 135.

Rear fog lamp

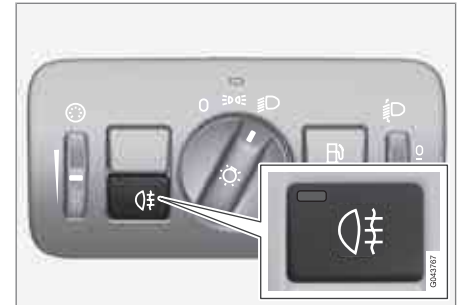

Button for rear fog lamp.

The rear fog lamp consists of one rear lamp and can only be switched on in combination with main/dipped beam.

Press the button for On/Off. The rear fog lamp indicator symbol  on the combined instrument panel and the light in the button illuminate when the rear fog lamp is switched on.

The rear fog lamp is switched off automatically when the engine is switched off.



NOTE

Regulations for using rear fog lamps vary between different countries.

⁴ Auxiliary lamps must be connected to the electrical system by a workshop. Volvo recommends that you contact an authorised Volvo workshop.

Lighting

Hazard warning flashers



Button for hazard warning flashers.

Press the button to activate the hazard warning flashers. Both direction indicator symbols in the combined instrument panel flash when the hazard warning flashers are in use.

The hazard warning flashers are activated automatically when the car has been braked so suddenly that the emergency brake lights have been activated at a speed below 10 km/h. The hazard warning flashers remain on when the car has stopped and are deactivated automatically when the car is driven off again or the button is depressed. For more information on Emergency brake lights and automatic hazard warning flashers, see page 135.

Direction indicators/flashers



Direction indicators/flashers.

Short flash sequence

➔ Move the stalk switch up or down to the first position and release. The direction indicators flash three times. The function can be activated/deactivated in the menu system **MY CAR** under **Settings** → **Car settings** → **Light settings** → **Triple indicator**. For a description of the menu system, see page 203.

Continuous flash sequence

➔ Move the stalk switch up or down to the outer position.

The stalk switch remains in its position and is moved back manually, or automatically by the steering wheel movement.

Direction indicator symbols

For direction indicator symbols, see page 72.

Interior lighting



Controls in roof console for the front reading lamps and passenger compartment lighting.

- ➊ Reading lamp, left-hand side
- ➋ Reading lamp, right-hand side
- ➌ Interior lighting

All lighting in the passenger compartment can be switched on and off manually within 30 minutes from when:

- the engine has been switched off and the car's electrical system is in key position **0**
- the car has been unlocked but the engine has not been started.



Lighting

Front roof lighting

The front reading lamps are switched on or off by pressing the relevant button in the roof console.

Rear roof lighting



Rear roof lighting.

The lamps are switched on or off by pressing each respective button.

Courtesy lighting

Courtesy lighting (and passenger compartment lighting) is switched on and off respectively when a side door is opened or closed.

Glovebox lighting

Glovebox lighting is switched on and off respectively when the lid is opened or closed.

Vanity mirror

The lighting for the vanity mirror, see page 229, is switched on and off respectively when the cover is opened or closed.

Lighting, cargo area

The lighting in the cargo area is switched on and off respectively when the tailgate is opened or closed.

Automatic lighting

The switch for passenger compartment lighting has three positions for the lighting in the passenger compartment:

- **Off** – right-hand side pressed in, automatic lighting deactivated.
- **Neutral position** – automatic lighting activated.
- **On** – left-hand side pressed in, passenger compartment lighting switched on.

Neutral position

When the button is in neutral position the passenger compartment lighting is switched on and off automatically in accordance with the following.

The passenger compartment lighting is switched on and remains on for 30 seconds if:

- the car is unlocked with the remote control key or key blade, see pages 45 or 48
- the engine has been switched off and the car's electrical system is in key position **0**.

Passenger compartment lighting is switched off when:

- the engine is started
- the car is locked.

The passenger compartment lighting comes on and remains on for two minutes if one of the doors is open.

If any lighting is switched on manually and the car is locked then it will be switched off automatically after two minutes.

Mood lights

When the normal passenger compartment lighting is switched off and the engine is running, a number of LEDs illuminate, including one in the ceiling lighting, in order to provide a low-light and enhance the mood while driving. This lighting goes out for a little while after the normal passenger compartment lighting when the car is locked.



Lighting

Home safe light duration

Some of the exterior lighting can be kept switched on to work as home safe lighting after the car has been locked.

1. Remove the remote control key from the ignition switch.
2. Move the left-hand stalk switch toward the steering wheel to the end position and release it. The function can be activated in the same way as with main beam flash, see page 87.
3. Get out of the car and lock the door.

When the function is activated, dipped beam, parking lamps, door mirror lamps, number plate lighting, interior roof lamps and courtesy lighting are switched on.

The length of time for which the home safe lighting should be kept on can be set in the menu system **MY CAR** under **Settings → Car settings → Light settings → Home safe light duration**. For a description of the menu system, see page 203.

Approach light duration

Approach lighting is switched on with the remote control key, see page 45, and is used to switch on the car's lighting at a distance.

When the function is activated with the remote control, parking lamps, door mirror lamps, number plate lighting, interior roof lamps and courtesy lighting are switched on.

The length of time for which the approach lighting should be kept on can be set in the menu system **MY CAR** under **Settings → Car settings → Light settings → Approach light duration**. For a description of the menu system, see page 203.

Adjusting headlamp pattern

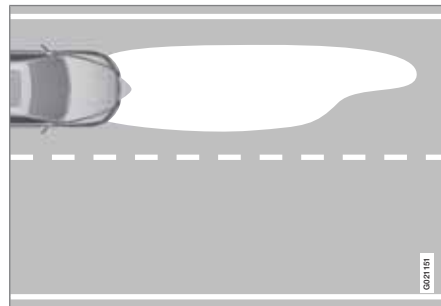

Headlamp pattern, left-hand traffic.

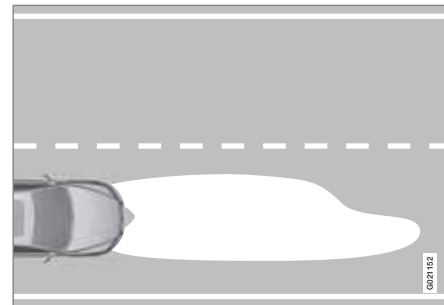

Headlamp pattern, right-hand traffic.

The headlamp pattern must be adjusted to avoid dazzling oncoming motorists and can be set for right or left-hand traffic. The correct pattern will also better illuminate the verge.

Active Xenon headlamps*

The car must be stationary with the engine running when the headlamp pattern is shifted between right and left-hand traffic.

1. Access the menu system **MY CAR** under **Settings → Car settings → Light settings**.
2. Select between **Temporary RH traffic** and **Temporary LH traffic**.

For a description of the menu system, see page 203



Halogen headlamps

The headlamp pattern for halogen headlamps is readjusted by masking the headlamp lens. The headlamp pattern may not be as good.

Masking the headlamps

1. Copy the A and B templates for left-hand drive cars or the C and D templates for right-hand drive cars with a scale of 1:1, see page 97:
 - A = LHD Right (left-hand drive, right lens)
 - B = LHD Left (left-hand drive, left lens)
 - C = RHD Right (right-hand drive, right lens)
 - D = RHD Left (right-hand drive, left lens)
2. Transfer the template to a self-adhesive waterproof material and cut it out.
3. Position the self-adhesive templates at the right distance from the edge of the headlamp lens using the illustration, see page 96, and the dimensions in the following list:
 - Template A: horizontal line approx. 80 mm, vertical line approx. 20 mm
 - Template B: horizontal line approx. 80 mm, vertical line approx. 4 mm
 - Template C: horizontal line approx. 120 mm, vertical line approx. 4 mm
 - Template D: horizontal line approx. 85 mm, vertical line approx. 15 mm



Lighting

Aligning the templates



Upper row: left-hand drive cars, templates A and B. Lower row: right-hand drive cars, templates C and D.

0903776

03



Lighting

Templates for halogen headlamps

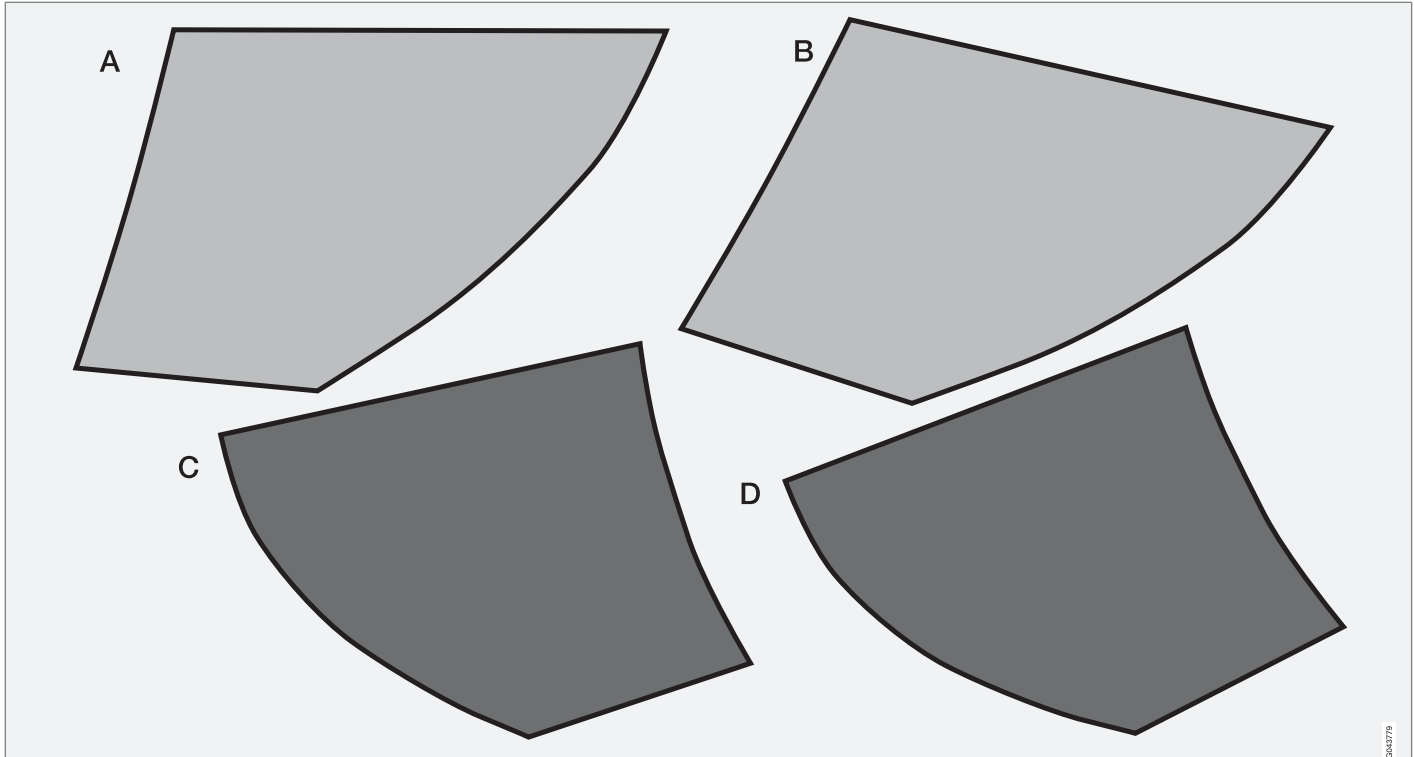

Wipers and washing

Windscreen wipers¹



Windscreen wipers and windscreen washers.

- 1** Rain sensor, on/off
- 2** Thumbwheel sensitivity/frequency

Windscreen wipers off

0 Move the stalk switch to position **0** to switch off the windscreen wipers.

Single sweep

Raise the stalk switch and release to make one sweep.

Intermittent wiping

INT Set the number of sweeps per time unit with the thumbwheel when intermittent wiping is selected.

Continuous wiping

The wipers sweep at normal speed.

The wipers sweep at high speed.

! IMPORTANT

Before activating the wipers during winter - ensure that the wiper blades are not frozen in and that any snow or ice on the windscreen (and rear window) is scraped away.

! IMPORTANT

Use plenty of washer fluid when the wipers are cleaning the windscreen. The windscreen must be wet when the windscreen wipers are operating.

Service position wiper blade

For cleaning the windscreen/wiper blades and replacement of wiper blades see see page 341 and 361.

Rain sensor*

The rain sensor automatically starts the windscreen wipers based on how much water it detects on the windscreen. The sensitivity of

the rain sensor can be adjusted using the thumbwheel.

When the rain sensor is activated a light in the button the rain sensor symbol is shown in the right-hand display in the combined instrument panel.

Activating and setting the sensitivity

When activating the rain sensor, the car must be running or the remote control key in position **I** or **II** while the windscreen wiper stalk switch must be in position **0** or in the position for a single sweep.

Activate the rain sensor by pressing the button

. The windscreen wipers make one sweep.

Press the stalk switch up for the wipers to make an extra sweep.

Turn the thumbwheel upward for higher sensitivity and downward for lower sensitivity. (An extra sweep is made when the thumbwheel is turned upward.)

Deactivate

Deactivate the rain sensor by pressing the button or move the stalk switch down to another wiper program.

¹ Replacing the wiper blades see page 341, service position, wiper blade see page 341 and filling washer fluid see page 343.



Wipers and washing

The rain sensor is automatically deactivated when the remote control key is removed from the ignition switch or five minutes after the engine has been switched off.

! IMPORTANT

The windscreen wipers could start and be damaged in an automatic car wash. Deactivate the rain sensor while the car is running or the remote control key is in position I or II. The symbol in the combined instrument panel and the lamp in the button go out.

Washing the headlamps and windows



Washing function.

Washing the windscreen

Move the stalk switch toward the steering wheel to start the windscreen and headlamp washers.

The windscreen wipers will make several more sweeps and the headlamps are washed once the stalk switch has been released.

Heated washer nozzles*

The washer nozzles are heated automatically in cold weather to prevent the washer fluid freezing solid.

High-pressure headlamp washing*

High-pressure headlamp washing consumes a large quantity of washer fluid. To save fluid, the headlamps are washed automatically at every fifth windscreen wash cycle.

Reduced washing

If only approx. 1 litre of washer fluid remains in the reservoir and the message that you should fill the washer fluid is shown in the combined instrument panel's display, then the supply of washer fluid to the headlamps is switched off. This is in order to prioritise cleaning the windscreen and the visibility through it.

Wiping and washing the rear window



- 1 Rear window wiper – intermittent wiping
- 2 Rear window wiper – continuous speed

Press the stalk switch forward (see the arrow in the illustration above) to initiate rear window washing and wiping.

i NOTE

The rear window wiper is equipped with overheating protection which means that the motor is switched off if it overheats. The rear window wiper works again after a cooling period (30 seconds or longer, depending on the heat in the motor and the outside temperature).



Wipers and washing

Wiper – reversing

Engaging reverse gear while the windscreen wipers are on initiates intermittent rear window wiping². The function stops when reverse gear is disengaged.

If the rear window wiper is already on at continuous speed, no change is made.



NOTE

On cars with rain sensor, the rear window wiper is activated with reversing, if the sensor is activated and it is raining.

² This function (intermittent wiping when reversing) can be deactivated. Visit a workshop. Volvo recommends that you contact an authorised Volvo workshop.



Windows, rearview and door mirrors

General

Laminated glass



The glass is reinforced which provides better protection against break-ins and improved sound insulation in the passenger compartment.

The windscreen and other windows* have laminated glass.

Water and dirt-repellent coating*



Windows are treated with a coating that improves the view in difficult

weather conditions. Maintenance, see page 362.



IMPORTANT

Do not use a metal ice scraper to remove ice from the windows. Use the defroster to remove ice from the mirrors, see page 104.

Heat-reflecting windscreen*

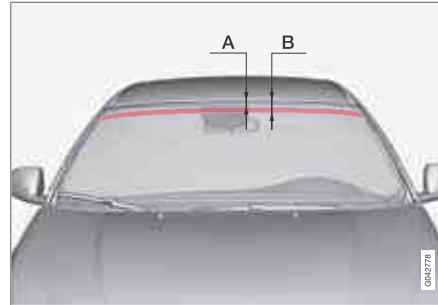

Areas where IR film is not applied.

	Dimensions
A	40 mm
B	80 mm

The windscreen is equipped with a heat-reflecting film (IR) that reduces the solar heat radiation into the passenger compartment.

The positioning of electronic equipment, such as a transponder, behind a glass surface with heat-reflecting film may affect its function and performance.

For the optimal function of electronic equipment, it should be positioned on the part of the

windscreen with no heat-reflecting film (see the highlighted area in the above illustration).

Power windows

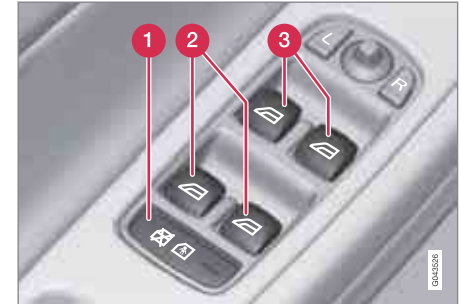

Driver's door control panel.

- 1 Switch for electric child safety locks* and disengaging rear power window buttons, see page 62.
- 2 Rear window controls
- 3 Front window controls



WARNING

Check that none of the rear seat passengers is in danger of becoming trapped in any way when closing the windows from the driver's door.



Windows, rearview and door mirrors

! WARNING

Make sure that children or other passengers are not in danger of becoming trapped in any way when closing the windows, in particular when the remote control key is used.

! WARNING

If there are children in the car - remember to always switch off the power supply to the power windows by selecting key position **0** and then take the remote control key with you when leaving the car. For information on key positions - see page 79.

Operating



Operating the power windows.

1 Operating without auto

2 Operating with auto

All power windows can be operated using the control panel for the driver's door - the control panels for the other doors can only each operate their respective power window. Only one control panel can be operated at a time.

In order for the power windows to be used the key position must be at least **I** - see page 78. The power windows can be operated for a few minutes after the engine has been switched off and after the remote control key has been removed - although not after a door has been opened.

Closing of the windows is stopped and the window is opened if anything prevents its movement. It is possible to override the pinch protection when closing has been interrupted, e.g. if there is ice forming. After two successive closing interruptions the pinch protection will be forced and the automatic function deactivated for a short while, now it is possible to close by continually holding the button pulled up.

i NOTE

One way to reduce the pulsating wind noise when the rear windows are open is to also open the front windows slightly.

Operating without auto

Move one of the controls up/down gently. The power windows move up/down as long as the control is held in position.

Operating with auto

Move one of the controls up/down to the end position and release it. The window runs automatically to its end position.

Operating with the remote control key and central locking

To remotely operate the power windows from the outside with the remote control key or from inside with central locking, see pages 46 and 58.



Windows, rearview and door mirrors

Resetting

If the battery is disconnected then the function for automatic opening must be reset so that it can work correctly.

1. Gently raise the front section of the button to raise the window to its end position and hold it there for one second.
2. Release the button briefly.
3. Raise the front section of the button again for one second.

WARNING

Resetting must be carried out to ensure that pinch protection works.

Door mirrors



Door mirror controls.

Adjusting

1. Press the **L** button for the left-hand door mirror or the **R** button for the right-hand door mirror. The light in the button illuminates.
2. Adjust the position with the joystick in the centre.
3. Press the **L** or **R** button again. The light should no longer be illuminated.

WARNING

The mirror on the driver's side is the wide-angle type to provide optimal vision. Objects may appear further away than they actually are.

Storing the position¹

The mirror positions are stored in the key memory when the car has been locked with the remote control key. When the car is unlocked with the same remote control key the mirrors and the driver's seat adopt the stored positions when the driver's door is opened.

The function can be activated/deactivated in the menu system **MY CAR** under **Settings** → **Car settings** → **Car key memory** → **Personal settings in key memory**. For a description of the menu system, see page 203.

Angling the door mirror when parking¹

The door mirror can be angled down for the driver to view the side of the road when parking for example.

- Engage reverse gear and press the **L** or **R** button.

When reverse gear is disengaged the mirror automatically returns to its original position

¹ Only in combination with power seat with memory, see page 81.



03 Your driving environment

Windows, rearview and door mirrors

after approx. 10 seconds, or sooner by pressing the **L** and **R** button.

Automatic angling of the door mirror when parking¹

When reverse gear is engaged the door mirror is automatically angled down so that the driver can see the side of the road when parking for example. When reverse gear is disengaged the mirror automatically returns to its original position after a short time.

The function can be activated/deactivated in the menu system **MY CAR** under **Settings** → **Car settings** → **Side mirror settings** → **Tilt left mirror** or **Tilt right mirror**. For a description of the menu system, see page 203.

Automatic retraction when locking¹

When the car is locked/unlocked with the remote control key the door mirrors are automatically retracted/extended.

The function can be activated/deactivated in the menu system **MY CAR** under **Settings** → **Car settings** → **Side mirror settings** → **Fold mirrors**. For a description of the menu system, see page 203.

Resetting to neutral

Mirrors that have been moved out of position by an external force must be reset electrically to the neutral position for electric retracting/ extending to work correctly:

1. Retract the mirrors with the **L** and **R** buttons.
2. Fold them out again with the **L** and **R** buttons.
3. Repeat the above procedure as necessary.

The mirrors are now reset in neutral position.

Retractable power door mirrors*

The mirrors can be retracted for parking/driving in narrow spaces:

1. Depress the **L** and **R** buttons simultaneously (key position must be at least **I**).
2. Release them after approximately 1 second. The mirrors automatically stop in the fully retracted position.

Fold out the mirrors by pressing down the **L** and **R** buttons simultaneously. The mirrors automatically stop in the fully extended position.

Home safe and approach lighting

The light on the door mirrors illuminates when approach lighting or home safe lighting is selected, see page 94.

Rear window and door mirror defrosters

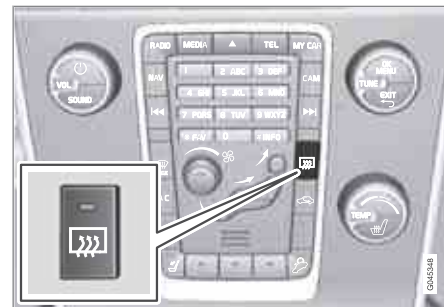

Use the defroster to quickly remove misting and ice from the rear window and the door mirrors.

One press of the button starts the heating. The light in the button indicates that the function is active. Disconnect the heating as soon as the ice/misting is cleared in order not to load the battery unnecessarily. However, the heating is switched off automatically after a certain time.

¹ Only in combination with power seat with memory, see page 81.

* Option/accessory, for more information, see Introduction.



Windows, rearview and door mirrors

The door mirrors and rear window are demisted/defrosted automatically if the car is started in an outside temperature lower than +9 °C. Automatic defrosting can be selected in the menu system **MY CAR** under **Settings** → **Climate settings** → **Automatic rear defroster**. Select between **On** or **Off**. For a description of the menu system, see page 203.

Interior rearview mirror



① Control for dimming

Manual dimming

Bright light from behind could be reflected in the rearview mirror and dazzle the driver. Use

dimming with the dimming control when lights from behind are distracting:

1. Use dimming by moving the control in towards the passenger compartment.
2. Return to normal position by moving the control towards the windscreen.

Automatic dimming*

Bright light from behind is automatically dimmed by the rearview mirror. The control is not available in mirrors with automatic dimming.

The compass* can only be specified for rearview mirrors with automatic dimming, see page 106.

Compass*

Operation



Rearview mirror with compass.

The upper right-hand corner of the rearview mirror has an integrated display that shows the compass direction in which the front of the car is pointing. Eight different directions are shown with English abbreviations: **N** (north), **NE** (north east), **E** (east), **SE** (south east), **S** (south), **SW** (south west), **W** (west) and **NW** (north west).

The compass is activated automatically when the car is started or in key position **II**, see page 78. To deactivate/activate the compass - press in the button on the underside of the mirror using a paper clip for example.

Calibration

The earth is divided into 15 magnetic zones. The compass is set for the geographic area to which the car was delivered. The compass

should be calibrated if the car is moved across several magnetic zones. Proceed as follows:

1. Stop the car in a large open area free from steel structures and high-voltage power lines.
2. Start the car.

NOTE

For optimum calibration - switch off all electrical equipment (climate control system, wipers etc.) and make sure that all doors are closed.

3. Hold the button on the underside of the rearview mirror depressed approx. 6 seconds (using a paper clip for example) until the character **C** is shown.

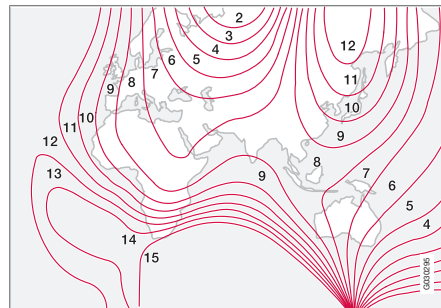

Magnetic zones.

4. Hold the button on the underside of the rearview mirror depressed approx. 3 seconds. The number of the current magnetic zone is shown.
5. Press the button repeatedly until the required magnetic zone (1-15) is shown. See the map of magnetic zones for the compass.
6. Wait until the display resumes showing the character **C**.
7. Drive slowly in a circle at a speed of no more than 10 km/h until a compass direction is shown in the display, indicating that calibration is complete. Then drive a further 2 circles to fine-tune calibration.
8. Repeat the above procedure as necessary.



Power sunroof*

General

The sunroof controls are located in the roof panel. The sunroof can be opened vertically at the rear edge and horizontally. Key position I or II is required for the sunroof to be opened.

Horizontal opening

Horizontal opening, backward/forward.

- ➊ Opening, automatic
- ➋ Opening, manual
- ➌ Closing, manual
- ➍ Closing, automatic

Opening

For maximum sunroof opening, move the control back to the position for automatic opening and release.

Open manually by pulling the control backwards to the point of resistance for manual opening. The sunroof moves to maximum open position as long as the button is kept depressed.

Closing

Close manually by pushing the control forwards to the point of resistance for manual closing. The sunroof moves to closed position as long as the button is kept depressed.

WARNING

Risk of crushing when sunroof is closed. The sunroof's pinch-protection function only operates during automatic closing, not manual.

Close automatically by pressing the control to the position for automatic closing and then release it.

The power supply to the sunroof is switched off by selecting key position 0 and removing the remote control key from the ignition switch.

WARNING

If there are children in the car:

Remember to always switch off the power supply to the sunroof by selecting key position 0 and then take the remote control key with you when leaving the car. For information on key positions - see page 79.

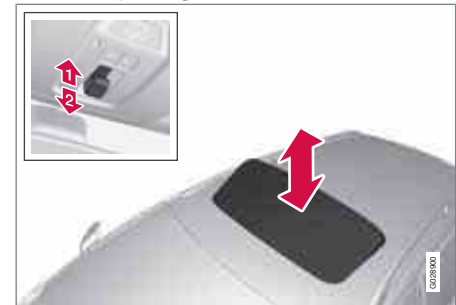
Vertical opening

Vertical opening, raised at the rear edge.

- ➊ Open by pressing the rear edge of the control upward.
- ➋ Close by pulling the rear edge of the control down.



03 Your driving environment

Power sunroof*

Closing using the remote control key or central locking button



One long press on the lock button closes the sunroof and all the windows, see pages 45 and 58. The doors and the tailgate are locked. To interrupt closing, press the lock button again.

WARNING

If the sunroof is closed using the remote control key, check that no one is in danger of becoming trapped in any way.

Sunscreen

The sunroof features a manual, sliding interior sunscreen. The sunscreen slides back automatically when the sunroof is opened. Grip the handle and slide the screen forward to close it.

Pinch protection

The sunroof's pinch protection function is triggered if it is blocked by an object during automatic closing. If blocked, the sunroof will stop and automatically open to the previous position.

Wind deflector



The sunroof has a wind deflector that is folded up when the sunroof is in the open position.



Alcolock*

General information on the alcolock

The alcolock's¹ function is to prevent the car from being driven by individuals under the influence of alcohol. Before the engine can be started the driver must take a breath test that verifies that he/she is not under the influence of alcohol. Alcolock calibration takes place in accordance with each market's limit value in force for driving legally.

WARNING

The Alcolock is an aid and does not exempt the driver from responsibility. It is always the responsibility of the driver to be sober and to drive the car safely.

Functions

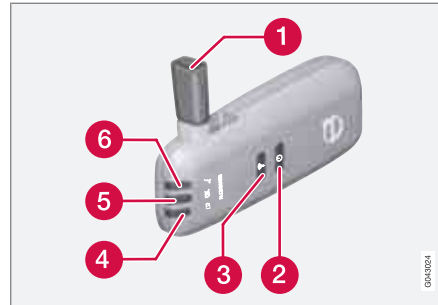

1. Nozzle for breath test.
2. Switch.
3. Transmission button.
4. Lamp for battery status.
5. Lamp for result of breath test.
6. Lamp indicates ready for breath test.

Operation

Battery

Alcolock indicator lamp (4) shows battery status:

Indicator lamp (4)	Battery status
Green flashing	Charging in progress
Green	Fully charged
Yellow	Semi-charged
Red	Discharged - fit the charger in the holder or connect the power supply cable from the glovebox.

NOTE

Store the Alcolock in its holder. This will keep the built-in battery fully charged and the Alcolock is activated automatically when the car is opened.

¹ Also called Alcoguard.



Alcolock*

Storage

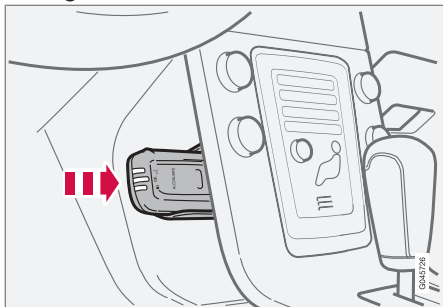

Handheld unit storage and charging station.

- The handheld alcolock unit is released by depressing it slightly in its holder and releasing it - it then springs out and can be removed from the holder.
- Replace the handheld unit in the holder by pushing it in until it engages.
- Store the handheld unit in the holder - this provides it with the best protection and keeps its batteries fully charged.

Before starting the engine

The Alcolock is activated automatically and is then ready for use when the car is opened.

1. When the indicator lamp (6) is green the Alcolock is ready for use.
2. Withdraw the Alcolock from its holder. If the Alcolock is outside the car when it is

unlocked then it must first be activated with the switch (2).

3. Fold up the nozzle (1), take a deep breath and blow with an even pressure until a "click" is heard after approx. 5 seconds. The result will be one of the alternatives in the following table **Result after breath test**.
4. If no message is shown then the transmission to the car may have failed - in which case, press the button (3) to transmit the result to the car manually.
5. Fold down the nozzle and refit the Alcolock in its holder.
6. Start the engine following an approved breath test within 5 minutes - otherwise it must be repeated.

Result after breath test

Indicator lamp (5) + Display text	Specification
Green lamp + Alcolock Approved test	Start the engine - no alcohol content measured.
Yellow lamp + Alcolock Approved test	Engine starting possible - measured alcohol content is above 0.1 promille but below the limit value in force ^A .
Red lamp + Disapproved test Wait 1 minute	Engine starting not possible - measured alcohol content is above the limit value in force ^A .

^A Limits vary between countries, so find out what limits apply. See also the section entitled General information on the Alcolock on page 109

i NOTE

After a completed period of driving, the engine can be restarted within 30 minutes without a new breath test.

**Alcolock*****To bear in mind****Before the breath test**

In order to obtain correct function and as accurate a measurement result as possible:

- Avoid eating or drinking approx. 5 minutes before the breath test.
- Avoid excess windscreen washing - the alcohol in the washer fluid may result in an incorrect measurement result.

Change of driver

In order to ensure that a new breath test is carried out in the event of a change of driver - depress the switch (2) and the send button (3) simultaneously for approx. 3 seconds. At which point the car returns to start inhibition mode and a new approved breath test is required before starting the engine.

Calibration and service

The Alcolock must be checked and calibrated at a workshop² every 12 months.

30 days before recalibration is necessary the display shows **Alcoguard Calibr. required**. If calibration is not carried out within these 30 days then normal engine starting will be blocked - only starting with the Bypass func-

tion will then be possible, see page 111 section Emergency situation.

The message can be cleared by pressing the send button (3) once. Otherwise it goes out on its own after approx. 2 minutes but then reappears each time the engine is started - only recalibration at a workshop² can clear the message permanently.

Cold or hot weather

The colder the weather the longer it takes before the Alcolock is ready for use:

Temperature (°C)	Maximum heating time (seconds)
+10 to +85	10
-5 to +10	60
-40 to -5	180

At temperatures below -20 °C or above +60 °C the Alcolock requires additional power supply. The display shows **Alcoguard insert power cable**. In which case, connect the power supply cable from the glovebox and wait until indicator lamp (6) is green.

In extremely cold weather the heating time can be reduced by taking the Alcolock indoors.

Emergency situation

In the event of an emergency situation or the Alcolock is out of order, it is possible to bypass the Alcolock in order to drive the car.

NOTE

All Bypass activation is logged and saved in memory, see page 8 in the section, Recording data.

After the Bypass function has been activated the display shows **Alcoguard Bypass enabled** the whole time while driving and can only be reset by a workshop².

The Bypass function can be tested without the error message being logged - in which case, carry out all the steps without starting the car. The error message is cleared when the car is locked.

When the Alcolock is installed, either the Bypass or Emergency function is selected as the bypassing option. This setting can be changed afterwards at a workshop².

² An authorised Volvo workshop is recommended.



03 Your driving environment

Alcolock*

Activating the Bypass function

- Depress and hold the left-hand stalk switch **OK** button and the button for hazard warning flashers simultaneously for approx. 5 seconds - the display first shows **Bypass activated Wait 1 minute** and then **Alcoguard Bypass enabled** - after which the engine can be started.

This function can be activated several times. The error message shown during driving can only be cleared at a workshop².

Activating the Emergency function

- Depress and hold the left-hand stalk switch **OK** button and the button for hazard warning flashers simultaneously for approx. 5 seconds - the display shows **Alcoguard Bypass enabled** and the engine can be started.

This function can be used once, after which a reset must be made at a workshop².

Symbols and display messages

In addition to the previously described messages, the combined instrument panel's display can also show the following:

Display text	Meaning/Action
Alcoguard Restart possible	The engine has been switched off for less than 30 minutes - engine starting possible without new test.
Alcoguard Service required	Contact a workshop ² .
Alcoguard No signal	Transmission failed - send manually with button (3) or take a new breath test.
Alcoguard Invalid test	Test failed - take a new breath test.
Alcoguard Blow longer	Blowing too short - blow for longer.
Alcoguard Blow softer	Blowing too hard - blow more gently.

Display text	Meaning/Action
Alcoguard Blow harder	Blowing too weak - blow harder.
Alcoguard wait Preheating	Heating not finished - wait for text Alcoguard Blow 5 seconds .

² An authorised Volvo workshop is recommended.

* Option/accessory, for more information, see Introduction.



Starting the engine

Petrol and diesel engines



Ignition switch with remote control key extracted/inserted, and **START/STOP ENGINE** button.

! IMPORTANT

Do not press in the remote control key incorrectly turned - Hold the end with the detachable key blade, see page 48.

1. Insert the remote control key in the ignition switch and press it in to its end position. Note that if the car is equipped with an alcolock then a breath test must first be approved before the engine can be started - see page 109.

2. Hold the clutch pedal fully depressed¹. (For cars with automatic gearbox - Depress the brake pedal.)
3. Press the **START/STOP ENGINE** button and then release it.

The starter motor works until the engine starts or until its overheating protection triggers.

! IMPORTANT

If the engine fails to start after 3 attempts - wait for 3 minutes before making a further attempt. Starting capacity increases if the battery is allowed to recover.

! WARNING

Never remove the remote control key from the ignition switch after starting the engine or when the car is being towed.

! WARNING

Always remove the remote control key from the ignition switch when leaving the car, and make sure that the key position is **0** - in particular if there are children in the car. For information on how this works - see page 79.

i NOTE

The idling speed can be noticeably higher than normal for certain engine types during cold starting. This is so that the emissions system can reach normal operating temperature as quickly as possible, which minimises exhaust emissions and protects the environment.

Keyless drive*

Follow steps 2–3 for starting petrol and diesel engines. For more information on Keyless drive - see page 53.

i NOTE

A prerequisite for the car to start is that one of the car's remote control keys with the Keyless drive* function is in the passenger compartment or cargo area.

! WARNING

Never remove the remote control key from the car while driving or during towing.

Stop the engine

To switch off the engine:

- Press **START/STOP ENGINE** - the engine stops.

¹ If the car is moving then it is enough to press the **START/STOP ENGINE** button to start the car.



Starting the engine

If the gear selector is not in **P** position or if the car is moving:

- Press twice on **START/STOP ENGINE** or hold the button depressed until the engine stops.

Steering lock

A mechanical noise can be perceived when the steering lock unlocks or locks.

- The steering lock unlocks when the remote control key is in the ignition switch² and the **START/STOP ENGINE** button is depressed.
- The steering lock locks when the driver's door is opened after the engine has been switched off.

Key positions

For information on the remote control key's different key positions - see page 78

Remote start - ERS*

General information on ERS

Remote start (ERS – Engine Remote Start) means that the car's engine can be started remotely using the remote control key. This is so that the passenger compartment can be warmed up/cooled down before departure.

The climate control starts with the same settings that were being used when the car was parked.

An ERS-started engine is activated for a maximum of 15 minutes, then it is switched off. After two ERS-activations the engine must be started in the normal way before ERS can be re-used.

The ERS option is only available on cars with automatic gearbox.

NOTE

Follow local/national rules/regulations on idling.

WARNING

To remote-start the engine, the following criteria must be met:

- The car must be supervised
- There must be no people or animals inside the car
- The car must not be parked in a closed, unventilated area - the exhaust gases may seriously injure humans and animals.

² Cars with Keyless drive must have a remote control key inside the passenger compartment.



Starting the engine

Operation



Remote control buttons for remote start.

- 1 Locking
- 2 Approach lighting
- 3 Information³

Remote starting the engine

Maximum distance for enabling remote starting of the engine is approx. 30 metres in unobstructed space - in addition, the car must be locked.

To remote start the engine:

1. Briefly press on the remote control key's lock button (1).
2. Follow this immediately afterwards with a long press - at least 2 seconds - on button (2).

If the conditions for ERS are fulfilled then the following takes place:

1. All direction indicators flash quickly several times.
2. The engine starts.
3. All direction indicators illuminate with a constant glow for 3 seconds to verify that the engine has started.

NOTE

After remote starting, the car continues to be locked but with the alarm deactivated.

With PCC⁴ key



The light indication for Approach lighting⁵ flashes several times when the button is pressed and then goes to constant glow if all criteria for ERS

have been fulfilled. However, this does not mean that ERS has started the engine.

To check whether ERS has started the engine, the user can press the Information button (3) - if the engine has started, there is a light indication on the button for Approach lighting (2).

Active functions

The following functions are activated with a remote started engine:

- Ventilation system
- Audio/video system.

Deactivated functions

The following functions are deactivated with a remote started engine:

- headlamps
- Position lamps
- Number plate lighting
- Windscreen wiper.

the engine is switched off

The following steps switch off an ERS-started engine:

- The remote control key's lock button (1) is depressed
- The car is unlocked
- A door is opened

³ Only on PCC key, see page 47.

⁴ Read about the PCC key on page 47.

⁵ Read about Approach lighting on page 46 and 94.



Starting the engine

- Accelerator pedal or brake pedal is depressed
- The gear selector is moved out of **P** position
- There is less than approx. 10 litres left in the fuel tank
- Active ERS time passes 15 minutes.

When an ERS-started engine is switched off, all direction indicators illuminate with a constant glow for 3 seconds.

Symbols and messages in the display

In situations where the ERS function fails or is interrupted, a symbol is shown on the instrument panel, supplemented by an explanatory message - Follow any recommendation given.

ERS function unavailable

Message	Specification
No remote start door open	ERS unavailable because a door/tailgate was not closed.
No remote start car not locked	ERS unavailable because the car was not locked.

Message	Specification
No remote start low battery	ERS unavailable due to low battery voltage. Charge the battery by starting the engine.
No remote start driver in car	ERS unavailable because someone was in the passenger compartment.
No remote start engine warning	ERS unavailable due to warning message from engine. Contact a workshop ^A .
No remote start gear not in P	ERS unavailable because gear selector was not in P position.
No remote start engine coolant	ERS unavailable due to error message from cooling system, see page 332.

Message	Specification
No remote start low fuel level	ERS unavailable because fuel level too low.
No remote start Max 2 starts	ERS unavailable because a maximum of 2 ERS activations in succession are allowed.

^A An authorised Volvo workshop is recommended.

Interrupted ERS function

Message	Specification
Remote start off low battery	ERS interrupted because battery voltage too low.
Remote start off low fuel level	ERS interrupted because fuel level too low.
Remote start off engine warning	ERS interrupted due to error message from engine. Contact a workshop ^A .

03



Starting the engine

Message	Specification
Remote start off gear not in P	ERS interrupted because gear selector is not in P position.
Remote start off driver in car	ERS interrupted because someone is in the passenger compartment.

^A An authorised Volvo workshop is recommended.



Starting the engine – Flexifuel

General information about starting with Flexifuel

The engine is started in the same way as in a petrol-engined car.

In the event of starting difficulties

If the engine does not start at the first start attempt:

- Make further attempts to start with the **START/STOP ENGINE** button.

If the engine still does not start

The outside temperature is lower than +5 °C:

1. Connect the engine block heater for at least 1 hour.
2. Make further attempts to start with the **START/STOP ENGINE** button.

! IMPORTANT

If the engine does not start despite repeated start attempts, you are recommended to contact an authorised Volvo workshop.

Engine block heater*



Electrical input to the engine block heater.

When the temperature is expected to be lower than -10 °C and the car has been refuelled with bioethanol E85, an engine block heater should be used for about 2 hours to facilitate the quick starting of the engine.

The lower the temperature, the longer the time required with the engine block heater. At -20 °C the heater should be used for approx. 3 hours.

Cars intended for E85 have an electric engine block heater*. Starting and driving with a pre-heated engine involves significantly lower emissions and reduced fuel consumption. For this reason you should aim to use the engine block heater throughout the winter months.

! **WARNING**

The engine block heater is powered by high voltage. Fault tracing and repair of an electric engine block heater and its electrical connections must only be carried out by a workshop - an authorised Volvo workshop is recommended.

i **NOTE**

Points to remember for carrying reserve fuel:

- In the event of stalling due to an empty fuel tank, bioethanol E85 from a reserve fuel can may make the engine difficult to start in extreme cold. This is avoided by filling the reserve fuel can with 95 octane petrol.

For more information on Flexifuel's bioethanol E 85 fuel, see page 289 and 384.



Starting the engine – Flexifuel

Fuel adaptation

Flexifuel engines can be driven on both 95 octane unleaded petrol and bioethanol E85. Both fuels are filled in the common fuel tank so that any variations of mixing ratios between these two fuels is possible.

If the fuel tank is filled with petrol after the car has been driven on bioethanol E85 (or vice versa) then the engine may run slightly unevenly for a time. For this reason it is important to allow the engine to accustom itself (adapt) to the new fuel mixture.

Adaptation takes place automatically when the car is driven for a short period at an even speed.

IMPORTANT

After the fuel mixture in the tank has been changed an adaptation should be made by driving at an even speed for about 15 minutes.

If the battery has been discharged or disconnected then a slightly longer period of driving is required for the adaptation as the memory for the electronics has been cleared.



Starting the engine – external battery

Jump starting

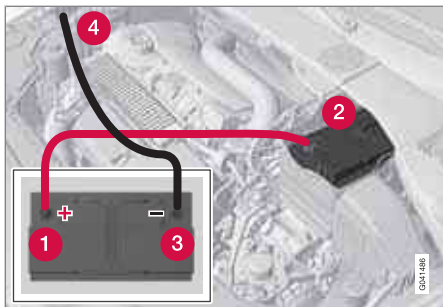

If the battery is flat then the car can be started with current from another battery.

When jump starting the car, the following steps are recommended to avoid short circuits or other damage:

1. Insert the remote control key in key position **0**, see page 78.
2. Check that the donor battery has a voltage of 12 V.
3. If the donor battery is installed in another car - switch off the donor car's engine and make sure that the two cars do not touch each other.

4. Connect one of the red jump lead's clamps to the donor battery's positive terminal (1).

! IMPORTANT

Connect the start cable carefully to avoid short circuits with other components in the engine compartment.

5. Open the clips on the front cover of the battery in your car and remove the cover, see page 345.
6. Connect the red jump lead's other clamp onto the car's positive terminal (2).
7. Connect one of the black jump lead's clamps to the donor battery's negative terminal (3).
8. Connect the other clamp to a grounding point, e.g. right-hand engine mounting at the top, the outer screw head (4).
9. Check that the jump lead clamps are affixed securely so that there are no sparks during the starting procedure.
10. Start the engine of the "donor car" and allow it to run a few minutes at a speed slightly higher than idle approx. 1500 rpm.
11. Start the engine in the car with the discharged battery.

! IMPORTANT

Do not touch the crocodile clips during the start procedure. There is a risk of sparks forming.

12. Remove the jump leads in reverse order - first the black and then the red.
 - > Make sure that none of the black jump lead's clamps comes into contact with the battery's positive terminal or the clamp connected to the red jump lead!

! WARNING

- The battery can generate oxyhydrogen gas, which is highly explosive. A spark can be formed if a jump lead is connected incorrectly, and this can be enough for the battery to explode.
- The battery contains sulphuric acid, which can cause serious burns.
- If sulphuric acid comes into contact with eyes, skin or clothing, flush with large quantities of water. If acid splashes into the eyes - seek medical attention immediately.

For more information on the car's battery - see page 344.



Gearboxes

! IMPORTANT

The operating temperature of the gearbox is checked in order to prevent damage to any of the drive system's components. In the event of a risk of overheating a warning symbol illuminates on the instrument panel combined with a text message - In which case, follow the recommendation given.

Manual gearbox



Gearshift pattern 5-speed gearbox.

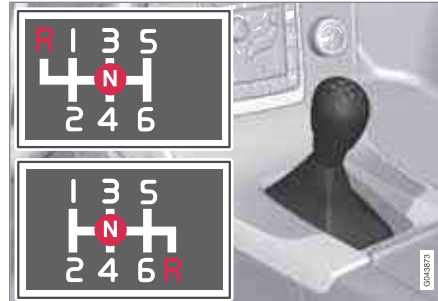

Gearshift pattern 6-speed gearbox.

The 6-speed box is available in two versions - reverse gear position differs between them. Look at the actual gearshift pattern imprinted on the gear lever.

- Depress the clutch pedal fully during each gear change.
- Take your foot off the clutch pedal between gear changes.

! WARNING

Always apply the parking brake when parking on a slope - leaving the car in gear is not sufficient to hold the car in all situation.

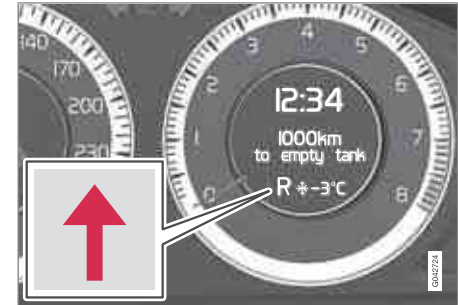
Gear indicator¹

An essential detail in connection with environmental driving is to drive in the right gear and change gear in time.

The driver is assisted by an indicator - GSI (Gear Shift Indicator) - which notifies the driver when it is most advantageous to engage the next higher or lower gear in order to obtain the lowest possible fuel consumption. However, taking into consideration characteristics such as performance and vibration-free running, it may be advantageous to change gear at a higher engine speed.

Indication is made with an up or down arrow in the combined instrument panel's right-hand display.

¹ Only manual gearbox for the D2 model.



Gearboxes

Reverse gear inhibitor

The reverse gear inhibitor hinders the possibility of mistakenly attempting to engage reverse gear during normal forward travel.

- Follow the gearing pattern printed on the gear lever and start from neutral position, **N** before moving it to **R** position.
- Only engage reverse gear when the car is stationary.

NOTE

With the upper variant of the shifting pattern for 6-speed gearbox (see previous illustration) - **first press down** the gear lever in the **N** position in order to engage reverse gear.

Automatic gearbox Geartronic*



D: Automatic gear positions. +/-: Manual gear positions.

The information display shows the position of the gear selector using the following indications: **P, R, N, D, S, 1, 2, 3, 4, 5** or **6**, see page 71.

Gear positions

Parking position - P

Select **P** when starting the engine or when the car is parked. The brake pedal must be depressed to disengage the gear selector from the **P** position.

The gearbox is mechanically blocked when the **P** position is engaged. Apply the parking brake as well, as a precaution - see page 137.

NOTE

The gear selector must be in **P** position to allow the car to be locked and alarmed.

IMPORTANT

The car must be stationary when position **P** is selected.

WARNING

Always apply the parking brake when parking on a slope - the automatic transmission's **P** position is not sufficient to hold the car in all situation.

Reverse position - R

The car must be stationary when **R** position is selected.

Neutral position - N

No gear is engaged and the engine can be started. Apply the parking brake if the car is stationary with the gear selector in **N** position.

Drive position - D

D is the normal driving position. Shifting up and down takes place automatically based on the level of acceleration and speed. The car must be stationary when the gear selector is moved to **D** position from **R** position.

**Geartronic – Manual gear positions (+/-)**

The driver can also change gear manually using the Geartronic automatic gearbox. The car engine-brakes when the accelerator pedal is released.

Manual gearshift mode is obtained by moving the lever to the side from **D** position to the end position at +/- . The information display shifts the indication from **D** to one of the figures 1 – 6, which is equivalent to the gear that is engaged just then, see page 71.

- Move the lever forwards towards + (plus) to change up a gear and release the lever, which returns to its rest position between + and –.

or

- Pull the lever back towards – (minus) to change down a gear and release it.

The manual gearshift mode (+/-) can be selected at any time while driving.

Geartronic automatically shifts down if the driver allows the speed to decrease lower than a level suitable for the selected gear, in order to avoid jerking and stalling.

To return to automatic driving mode:

- Move the lever to the side to the end position at **D**.

NOTE

If the gearbox has a Sport programme then the gearbox will only become manual after the lever has been moved forwards or backwards in its (-/+) position. The information display then shifts the indication from **S** to show which of the gears 1-6 is engaged.

Geartronic - Sport mode (S)²

The Sport programme provides sportier characteristics and allows higher engine speed for the gears. At the same time it responds more quickly to acceleration. During active driving, the use of a lower gear is prioritised, leading to a delayed upshift.

Sport mode is obtained by moving the lever to the side from **D** position to the end position at +/- . The information display shifts the indication from **D** to **S**.

Sport mode can be selected at any time while driving.

Geartronic - Winter mode

It can be easier to pull away on slippery roads if 3rd gear is engaged manually.

1. Depress the brake pedal and move the gear lever from **D** position to the end position at +/- - the instrument panel display shifts the indication from **D** to the figure 1.

2. Scroll up to gear 3 by pushing the lever forward towards + (plus) twice - the display shifts the indication from 1 to 3.
3. Release the brake and accelerate carefully.

The gearbox "winter mode" means that the car moves off with a lower engine speed and reduced engine power on the drive wheels.

Kick-down

When the accelerator pedal is pressed all the way to the floor (beyond the position normally regarded as full acceleration) a lower gear is immediately engaged. This is known as kick-down.

If the accelerator is released from the kick-down position, the gearbox automatically changes up.

Kick-down is used when maximum acceleration is needed, such as for overtaking.

Safety function

To prevent overrevving the engine, the gearbox control program has a protective downshift inhibitor which prevents the kick-down function.

² Only models D5 and T6.



03 Your driving environment

Gearboxes

Geartronic does not permit downshifting/kick-down which would result in an engine speed high enough to damage the engine. Nothing happens if the driver still tries to shift down in this way at high engine speed – the original gear remains engaged.

When kick-down is activated the car can change one or more gears at a time depending on engine speed. The car changes up when the engine reaches its maximum speed in order to prevent damage to the engine.

Mechanical gear selector inhibitor

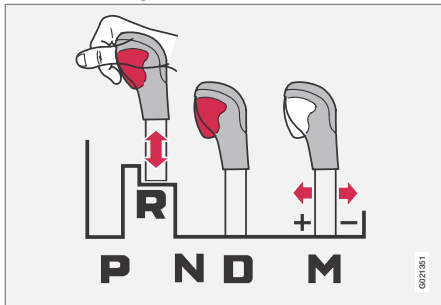

The gear selector can be moved forward and back freely between **N** and **D**. Other positions are locked with a latch that is released with the inhibitor button on the gear selector.

With the inhibitor button depressed the lever can be moved forwards or backwards between **P**, **R**, **N** and **D**.

Automatic gear selector inhibitor

The automatic gearbox has special safety systems:

Parking position (P)

Stationary car with engine running:

Keep your foot on the brake pedal when moving the gear selector to another position.

Electric gear inhibitor – Shiftlock Parking position (P)

To be able to move the gear selector from **P** to other gear positions, the brake pedal must be depressed and the remote control key must be in position **II**, see page 78.

Shiftlock – Neutral (N)

If the gear selector is in **N** position and the car has been stationary for at least 3 seconds (irrespective of whether the engine is running) then the gear selector is locked.

To be able to move the gear selector from **N** to other gear positions, the brake pedal must be depressed and the remote control key must be in position **II**, see page 78.

Deactivate automatic gear selector inhibitor



If the car cannot be driven, e.g. due to a flat battery, the gear selector must be moved from the **P** position so that the car can be moved.

- 1 Lift the rubber mat in the compartment behind the centre console and open the hatch.
- 2 Fully insert the key blade. Press the key blade down and hold (For information on the key blade, see page 48.)
- 3 Move the gear selector from the **P** position.



Gearboxes

Automatic gearbox Powershift*



D: Automatic gear positions. +/-: Manual gear positions.

Powershift is a 6-stage automatic gearbox that has double mechanical clutch discs in contrast to a conventional automatic gearbox. A conventional automatic gearbox has a hydraulic torque converter instead that transfers power from engine to gearbox.

Powershift transmission operates in the same way and has similar controls and functions as the Geartronic automatic transmission, described in the previous section.

Powershift or Geartronic?

In the event of uncertainty as to whether or not the car is equipped with Powershift transmis-

sion, this can be verified by checking the designation on the transmission's label under the bonnet - see page 370. The designation "MPS6" means that it is Powershift - transmission otherwise it is Geartronic automatic transmission.

HSA

The HSA (Hill Start Assist) function means that the pressure in the brake system remains for several seconds while the foot is moved from the brake pedal to the accelerator pedal before setting off or reversing uphill.

The temporary braking effect releases after several seconds or when the driver accelerates.

To bear in mind

The transmission's double clutch has overload protection that is activated if it becomes too hot, e.g. if the car is held stationary with the accelerator pedal on an uphill gradient for a long time.

Overheated transmission causes the car to shake and vibrate, and the warning symbol illuminates and the information display shows a message. The transmission can also overheat during slow driving in queues (10 km/h or

slower) on an uphill gradient, or with a trailer hitched. The transmission cools down when the car is stationary, with foot brake depressed and the engine running at idling speed.

Overheating during slow driving in queues can be avoided by driving in stages: Stop the car and wait with your foot on the brake pedal until there is a moderate distance to the traffic ahead, drive forward a short distance, and then wait another moment with your foot on the brake pedal.



IMPORTANT

Use the foot brake to hold the car stationary on an uphill gradient - do not hold the car with the accelerator pedal. The gearbox could then overheat.

For important information regarding Powershift transmission and towing - see page 304.

Text message and action

In some situations the display may show a message at the same time as a symbol is illuminated.



03 Your driving environment

Gearboxes

Symbol	Display	Driving characteristics	Action
	Transm. overheat brake to hold	Difficulty in maintaining even speed at constant engine speed.	Transmission overheated. Keep the car stationary using the foot brake. ^A
	Transm. overheat park safely	Significant pulling in the car's traction.	Transmission overheated. Park the car immediately in a safe manner. ^A
	Transm. cooling let engine run	No drive due to overheated gearbox.	Transmission overheated. For fastest cooling: Run the engine at idling speed with the gear lever in the N or P position until the message clears.

^A For fastest cooling: run the engine at idling speed with the gear lever in the **N** or **P** position, until the message clears.

The table shows three steps with an increased degree of seriousness should the transmission become too hot. In parallel with the display text the driver is also advised that the car's electronics are temporarily changing the driving characteristics. Follow the instructions on the information display where appropriate.

NOTE

The table's examples are no indication that the car is defective but instead show that a safety function has been activated intentionally to prevent damage to one of the car's components.

WARNING

If a warning symbol combined with the text **Transm. overheat park safely** is ignored then the heat in the gearbox may become so high that the power transmission between engine and gearbox is temporarily halted in order to prevent the clutch from malfunctioning - the car then loses drive and is stationary until gearbox temperature has cooled to an acceptable level.

For more possible display messages with their respective proposals for solutions concerning automatic transmission, see page 200.

A display text clears automatically after the action has been carried out or after one press on the indicator stalk **OK** button.



DRIVE Start/Stop*

Quieter and cleaner



Environmental care is one of Volvo Car Corporation's core values and it influences all of our operations. This target-orientation has resulted in the DRIVe vehicle series whose concept consists of an interaction between several separate energy-saving functions, all with the common purpose of reducing fuel consumption, which in turn contributes to reduced exhaust emissions.

General information on Start/Stop



The engine is switched off - it becomes quieter and cleaner....

Some engine and gearbox combinations come fitted with a Start and Stop function which engages in the event of e.g. stationary traffic or waiting at traffic lights - the engine is then switched off temporarily and restarts automatically when the journey is due to continue.

The Start/Stop function gives the driver the opportunity for a more active environmentally conscious way of driving the car by means of being able to allow the engine to stop automatically, whenever appropriate.

Manual or Automatic

Note that there are differences in the Start/Stop function depending on whether the gearbox is manual or automatic.

Function and operation

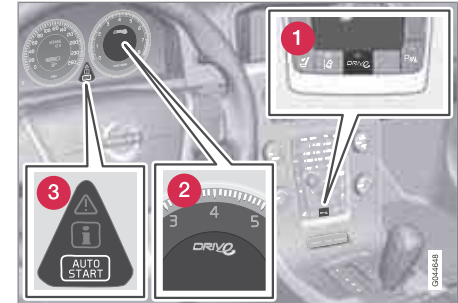

- 1 Start/Stop On/Off.
- 2 Illuminates briefly on activation and for text messages.
- 3 The engine is auto-stopped.

DRIVe The Start/Stop function is activated automatically when the engine is started with the key. The driver is alerted to the function by means of this symbol on the instrument panel illuminating briefly, the display text **Auto Start-Stop ON** is shown and the green lamp for the On/Off button illuminates.

All of the car's normal systems such as lighting, radio, etc. work as normal even with an engine that has stopped automatically, except that some equipment may have the function temporarily reduced, e.g. the climate control sys-



03 Your driving environment

DRIVE Start/Stop*

tem's fan speed or extremely high volume on the audio system.

Auto-stopping the engine

The following is required for the engine to auto-stop:

Conditions	M/A ^A
Declutch, set the gear lever in neutral position and release the clutch pedal - the engine is switched off.	M
Stop the car with the foot brake and then keep your foot on the pedal - the engine stops automatically.	A

A M = Manual gearbox, A = Automatic gearbox.



The **AUTO START** symbol on the information display illuminates as verification and reminder that the engine is has stopped automatically.

Auto-starting the engine

Conditions	M/A ^A
With the gear lever in neutral position: Depress the clutch pedal or press the accelerator pedal - the engine starts. Engage a suitable gear and continue the journey.	M
The following option is also available on a downhill gradient: Release the foot brake and let the car move off - the engine starts automatically when the speed exceeds normal walking pace.	M
Release the foot pressure on the foot brake - the engine starts automatically and the journey can continue.	A

A M = Manual gearbox, A = Automatic gearbox.

Start assistance HSA

The foot brake can also be released on an uphill gradient to start the engine automatically - the HSA function means that the car does not roll backwards.

HSA (Hill Start Assist) means that the pressure in the brake system remains temporarily available while the driver moves his/her foot from the brake pedal to the accelerator pedal for

driving off with the engine having stopped automatically. The temporary braking effect releases after a couple of seconds or when the driver accelerates.

There is more information available on HSA on page 125.

Deactivating the Start/Stop function



In certain situations, it may advisable to temporarily switch off the automatic Start/Stop function - this is carried out by pressing this button once, at which point the button's lamp goes out.

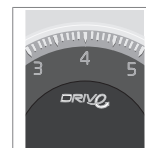

Disengaged Start/Stop function is indicated by the information display's symbol going out and the message **Auto Start-Stop OFF** being displayed for



about 5 seconds - while the button's lamp goes out at the same time.

The Start/Stop function is disengaged until it is reactivated with the button or until the next time the engine is started with the key.

* Option/accessory, for more information, see Introduction.



DRIVE Start/Stop*

Limitations

The engine does not auto-stop

Even if the Start/Stop function is activated, the engine does not stop automatically if:

Conditions	M/A ^A
the car has not achieved approx. 5 km/h (= fast walking pace) first after a key start or the last auto-stop.	M + A
the driver has opened the seat-belt's buckle.	M + A
the capacity of the battery is below the minimum permissible level.	M + A
the engine does not have normal operating temperature.	M + A
outside temperature is below freezing point or above approx. 30 °C.	M + A
the environment in the passenger compartment differs from the preset values - indicated by the ventilation fan running at a high speed.	M + A

Conditions	M/A ^A
the car is reversed.	M + A
battery temperature is below freezing point or above approx. 55 °C.	M + A
the driver makes greater steering wheel movements.	M + A
the exhaust system's particulate filter is full - the temporarily disengaged Start/Stop function is reactivated once an automatic cleaning cycle has been performed (see page 290).	M + A
the road is very steep.	M + A
a trailer is connected electrically to the car's electrical system.	M + A
the atmospheric air pressure is less than equivalent to 1500-2000 metres above sea level - the current air pressure varies with the prevailing weather conditions.	A
adaptive cruise control Queue Assist is activated.	A

Conditions	M/A ^A
the driver's door has been opened with the gear selector in D position.	A
the gear selector is moved out of the D position to S position ^B or "+/-".	A

A M = Manual gearbox, A = Automatic gearbox.
B Sport mode.

The engine auto-starts

An engine that has stopped automatically may restart in some cases without the driver having decided that the journey should continue. In the following cases the engine also starts automatically if the driver has not depressed the clutch pedal (manual gearbox) or takes his/her foot off the brake pedal (automatic gearbox):

Conditions	M/A ^A
Misting forms on the windows.	M + A
The environment in the passenger compartment deviates from the preset values.	M + A
The outside temperature falls below freezing point or exceeds approx. 30 °C.	M + A

03



03 Your driving environment

DRIVE Start/Stop*

Conditions	M/A ^A
There is a temporarily high current take-off or battery capacity drops below the lowest permissible level.	M + A
Repeated pumping of the brake pedal.	M + A
The car starts to roll - faster than the equivalent normal walking pace.	M
The driver's belt lock is opened with the gear selector in D or N position.	A
Steering wheel movements.	A
The gear selector is moved from the D position to "+/-" or R .	A
The driver's door is opened with the gear selector in D position - a "ping" sound and text message inform that the Start/Stop function is active.	A

A M = Manual gearbox, A = Automatic gearbox.

WARNING

Do not open the bonnet when the engine has stopped automatically - the engine may suddenly start automatically. First switch off the engine as normal using the **START/STOP ENGINE** button before opening the bonnet.

The engine does not auto-start

In the following cases the engine does not auto-start after having auto-stopped:

Conditions	M/A ^A
A gear is engaged without declutching - a display text prompts the driver to set the gear lever in neutral position in order to enable automatic starting.	M
The driver is unrestrained, the gear selector is in P position and the driver's door is open - a normal engine start must take place.	A
The gear selector is moved to P position - press the START/STOP ENGINE button to restart the engine. If the driver's door is opened before starting the engine with the START/STOP ENGINE button, the Start/Stop function is switched off.	A

A M = Manual gearbox, A = Automatic gearbox.

Involuntary engine stop with manual gearbox

In the event that a start-up fails and the engine stops, proceed as follows:

03



DRIVE Start/Stop*

1. Depress the clutch pedal again - the engine starts automatically.
2. In certain cases the gear lever must be set in neutral position. The information display then shows the text **Put gear in neutral**



More information and settings



The **MY CAR** menu system in the car includes instructions which explain parts of the DRIVE concept along with several possible settings and options - see page 203.

Text message







 In combination with this indicator lamp the Start/Stop function may display text messages on the information display for certain situations. For some of them there is a recommended action that should be performed. The following table shows some examples.

Symbol	Message	Info/Action	M/A ^A
	Auto Start-Stop ON	Illuminates for about 5 seconds after Start/Stop has been activated.	M + A
	Auto Start-Stop OFF	Illuminates for about 5 seconds after Start/Stop has been switched off.	M + A
	Auto Start-Stop serv. required	Start/Stop is not operational. Contact a workshop - an authorised Volvo workshop is recommended.	M + A





03 Your driving environment

DRIVE Start/Stop*

Symbol	Message	Info/Action	M/A ^A
	Engine management system	An automatic function check is carried out.	M + A
AUTO-STOP	Engine in Auto Start	The engine is ready to start automatically - waiting for the brake or clutch pedal to be depressed.	M
	Press Start button	The engine will not start automatically - start the engine as normal with the START/STOP ENGINE button.	M
	Depress clutch pedal to start	The engine is ready to auto-start - waiting for the clutch pedal to be depressed.	M
	Depress the foot brake to start	The engine is ready to auto-start - waiting for the brake pedal to be depressed.	M
	Press brake and clutch to start	The engine is ready to auto-start - waiting for the brake or clutch pedal to be depressed.	M
	Put gear in neutral	Gear is engaged without declutching - disengage and set the gear lever in neutral position.	M
AUTO-STOP	Engine in Auto Start	The engine is ready to start automatically - waiting for the brake pedal to be released.	A

* Option/accessory, for more information, see Introduction.

DRIVE Start/Stop*

Symbol	Message	Info/Action	M/A ^A
	Select P or N to start	Start/Stop has been deactivated - move the gear selector to N or P position and start the engine as normal with the START/STOP ENGINE button.	A
	Press Start button	The engine will not start automatically - start the engine as normal with the START/STOP ENGINE button and the gear selector in P or N .	A

A M = Manual gearbox, A = Automatic gearbox.

If a message does not go out following completion of the action then a workshop should be contacted - an authorised Volvo workshop is recommended.



03 Your driving environment

All-wheel drive – AWD*

All Wheel Drive is always available

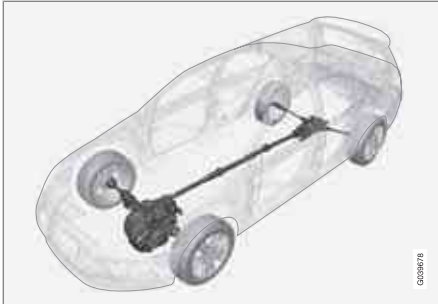

All Wheel Drive means that the car is driving all four wheels at the same time.

The power is automatically distributed between the front and rear wheels. An electronically controlled clutch system distributes the power to the wheels that have the best grip on the current road surface. This provides the best traction and prevents wheel spin. Under normal driving conditions, the majority of power is transmitted to the front wheels.

All Wheel Drive improves driving safety in rain, snow and icy conditions.



Foot brake

General

The car is equipped with two brake circuits. If one brake circuit is damaged then this will mean that the brakes engage at a deeper level and harder pressure on the pedal is needed to produce the normal braking effect.

The driver's brake pedal pressure is assisted by a brake servo.



WARNING

The brake servo only works when the engine is running.

If the brake is used when the engine is switched off then the pedal will feel stiff and more force must be used to brake the car.

In very hilly terrain or when driving with a heavy load the brakes can be relieved by using engine braking. Engine braking is most efficiently used if the same gear is used downhill as up.

For more general information on heavy loads on the car, see page 378.

Anti-lock braking system

The car is equipped with ABS (Anti-lock Braking System) which prevents the wheels from locking during braking. This means the ability to steer is maintained and it is easier to swerve to avoid a hazard for example. Vibration

may be felt in the brake pedal when this is engaged and this is normal.

A short test of the ABS system is made automatically after the engine has been started when the driver releases the brake pedal. A further automatic test of the ABS system may be made when the car reaches 10 km/h. The test may be experienced as pulses in the brake pedal.

Emergency brake lights and automatic hazard warning flashers

Emergency brake lights are activated to alert vehicles behind about sudden braking. The function means that the brake light flashes instead of - as in normal braking - shining with a constant glow.

Emergency brake lights are activated at speeds above 50 km/h if the ABS system is working and/or in the event of sudden braking. After the car's speed has been slowed below 10 km/h the brake light returns from flashing to the normal constant glow - while at the same time the hazard warning flashers are activated, and they flash until the driver changes engine speed with the accelerator pedal or they are deactivated with their button, see page 92.

Cleaning the brake discs

Coatings of dirt and water on the brake discs may result in delayed brake function. This delay is minimised by cleaning the brake linings.

Manual cleaning is advisable with wet road surfaces, prior to long-stay parking and after the car has been washed. Carry this out by braking gently during a short period while en route.

Emergency Brake Assistance

Emergency Brake Assistance EBA (Emergency Brake Assist) helps to increase brake force and so reduce braking distance. EBA detects the driver's braking style and increases brake force as necessary. The brake force can be reinforced up to the level when the ABS system is engaged. The EBA function is interrupted when the pressure on the brake pedal is reduced.



NOTE

When EBA is activated the brake pedal lowers slightly more than usual, depress (hold) the brake pedal as long as necessary. If the brake pedal is released then all braking ceases.

Maintenance

To keep the car as safe and reliable as possible, follow the Volvo service intervals as speci-



03 Your driving environment

Foot brake

fied in the Service and Warranty Booklet, see page 328.

! IMPORTANT

The wear on the brake system's components must be checked regularly.

Contact a workshop for information about the procedure or engage a workshop to carry out the inspection - an authorised Volvo workshop is recommended.

Symbols in the combined instrument panel

Symbol	Specification
	Constant glow – Check the brake fluid level. If the level is low, fill with brake fluid and check for the cause of the brake fluid loss.
	Constant glow for 2 seconds when the engine is started – There was a fault in the brake system's ABS function when the engine was last running.

! WARNING

If and illuminate at the same time, there may be a fault in the brake system.

If the level in the brake fluid reservoir is normal at this stage, drive carefully to the nearest workshop and have the brake system checked - an authorised Volvo workshop is recommended.

If the brake fluid is under the **MIN** level in the brake fluid reservoir, do not drive further before topping up the brake fluid.

The reason for the loss of brake fluid must be investigated.

03



Parking brake

General

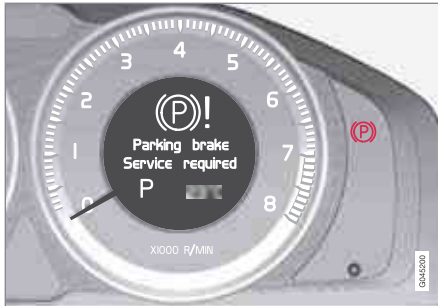

Function

A faint electric motor noise can be heard when the electrical parking brake is being applied. The noise can also be heard during the automatic function checking of the parking brake.

If the car is stationary when the parking brake is applied then it only acts on the rear wheels. If it is applied when the car is moving then the normal foot brake is used, i.e. the brake acts on all four wheels. Brake function changes over to the rear wheels when the car is almost stationary.

Low battery voltage

If the battery voltage is too low then the parking brake can neither be released nor applied. Connect a donor battery if the battery voltage is too low, see page 120.

Applying the parking brake



Parking brake control - apply.

1. Press the foot brake pedal down firmly.
2. Press the control.
 - > The combined instrument panel symbol  starts flashing - once there is a constant glow it is applied.
3. Release the foot brake pedal and make sure that the car is at a standstill position.
 - When parking the vehicle, always engage 1st gear (for manual gearbox) or put the gear selector in position **P** (for automatic gearbox).

In an emergency the parking brake can be applied when the vehicle is moving by depressing the control. When the control is released or

the accelerator pedal is depressed the braking is interrupted.

NOTE

In the event of emergency braking at speeds above 10 km/h a signal sounds during the braking procedure.

Parking on a hill

If the car is parked facing uphill:

- Turn the wheels **away from** the kerb.

If the car is parked facing downhill:

- Turn the wheels **towards** the kerb.

WARNING

Always apply the parking brake when parking on a slope - leaving the car in gear, or in **P** if it has automatic transmission, is not sufficient to hold the car in all situation.

Parking brake

Disengaging the parking brake



Parking brake control - release.

Cars with manual gearbox

Releasing manually

1. Insert the remote control key in the ignition switch.¹
2. Press the foot brake pedal down firmly.
3. Pull the control.
 - > The parking brake releases and the combined instrument panel symbol  goes out.

NOTE

The parking brake can also be released manually by depressing the clutch pedal instead of the brake pedal. Volvo recommends the use of the brake pedal.

Releasing automatically

1. Start the engine.
2. Engage 1st gear or reverse gear.
3. Ease up the clutch and depress the accelerator.
 - > The parking brake releases and the combined instrument panel symbol  goes out.

Cars with automatic gearbox

Releasing manually

1. Insert the remote control key in the ignition switch¹.
2. Press the foot brake pedal down firmly.
3. Pull the control.
 - > The parking brake releases and the combined instrument panel symbol  goes out.

Releasing automatically

1. Put the seatbelt on.
2. Start the engine.
3. Press the foot brake pedal down firmly.
4. Move the gear selector to position **D** or **R** and depress the accelerator.
 - > The parking brake releases and the combined instrument panel symbol  goes out.

NOTE

For safety reasons, the parking brake is only released automatically if the engine is running and the driver is wearing a seatbelt. The parking brake is released immediately on cars with automatic gearbox when the accelerator pedal is depressed and the gear selector is in position **D** or **R**.

Heavy load uphill

A heavy load, such as a trailer, can cause the car to roll backward when the parking brake is released automatically on a steep incline. Avoid this by depressing the control while driving off. Release the control when the engine achieves traction.

¹ For a car with the Keyless system: Press **START/STOP ENGINE**.



Parking brake

Replacing the brake linings

The rear brake linings must be replaced at a workshop due to the design of the electric

parking brake - an authorised Volvo workshop is recommended.

Symbols and messages in the display

Symbol	Message	Meaning/Action
(P)!	"Message"	Read the message on the information display.
		A flashing symbol indicates that the parking brake is applied. If the symbol flashes in any other situation then this means that a fault has arisen. Read the message on the information display.
	Park brake not fully released	A fault is preventing the parking brake from being released - Try to apply and release the brake. If the fault persists after a few attempts: Visit a workshop - an authorised Volvo workshop is recommended. Note: A warning signal sounds if the journey is continued with this error message.



03 Your driving environment

Parking brake

Symbol	Message	Meaning/Action
	Parking brake not applied	<p>A fault is preventing the parking brake from being applied - Try to release and apply the brake.</p> <p>If the fault persists after a few attempts: Visit a workshop - an authorised Volvo workshop is recommended.</p> <p>The message is also illuminated on cars with manual gearbox when the car is driven at low speed with the door open in order to alert the driver that the parking brake may have been unintentionally disengaged.</p>
	Parking brake Service required	<p>A fault has arisen - Try to apply and release the brake.</p> <p>If the fault persists after a few attempts: Visit a workshop - an authorised Volvo workshop is recommended.</p>

- If the car has to be parked before the fault has been rectified then the wheels must be turned as if parking on a hill and 1st gear engaged (manual gearbox) or the gear selector must be in position **P** (automatic gearbox).



General



HomeLink®¹ is a programmable remote control which can remotely control up to three different devices (e.g. garage door opener, alarm system, outdoor lighting and indoor lighting etc.) and in doing so replace their remote controls. For more information on HomeLink®, visit: www.homelink.com or ring 00 8000 466 354 65 (or premium rate phone number, +49 6838 907 277).

WARNING

- If HomeLink® is used to operate a garage door or gate, make sure that there is no-one in the vicinity of the door or gate while it is moving.
- The car should remain outside the garage while a garage door opener is being programmed.
- Do not use HomeLink® for any garage door that does not have safety stop and safety reverse.

Save the original remote controls for future programming (e.g. when changing to another car or for use in another vehicle). It is also recommended that the programming for the buttons is deleted when the car is sold. See the section "Resetting the HomeLink® buttons" on page 142.

Programming HomeLink®

NOTE

In certain vehicles the ignition must be switched on or in "accessory position" before HomeLink® can be programmed or used. If possible, fit new batteries in the remote control that shall be replaced by HomeLink® for faster programming and improved transmission of the radio signal. The HomeLink® buttons should be reset before programming. When this has been done HomeLink® is set in "learn mode" and ready for programming.

1. Aim the original remote control towards the HomeLink® button to be programmed and hold it 5-14 cm from the button. Do not obstruct the indicator lamp on HomeLink®.
2. Depress the button on the original remote control and the button to be programmed on HomeLink® simultaneously. Do not release the buttons until the indicator lamp has changed over from slow to rapid flashing. Both the buttons must be released when the indicator lamp flashes quickly.

¹ HomeLink and the HomeLink house symbol are registered trademarks of Johnson Controls, Inc.



HomeLink® *

3. **Depress the HomeLink® button being programmed, hold it depressed for 5 seconds and then release it.** Repeat if necessary until the garage door is activated. If the door is not activated, press the programmed HomeLink® button and hold it depressed and check the indicator lamp.

> **Constant glow:** The indicator lamp illuminates with a constant glow when the button is kept depressed, this indicates that the **programming is complete.**

The garage door, gate or similar should now be activated when the programmed HomeLink® button is depressed.

Glow not constant: The indicator lamp flashes quickly for approx. 2 seconds and then changes over to a constant glow. In which case, continue with the programming steps 4-6 in order to complete the programming of a device with rolling code (usually a garage door opener).

4. Locate the "programming button²" on the receiver for the garage door for example, normally located close to the antenna's bracket on the receiver.

5. Depress and release the receiver's "programming button". The button flashes for approx. 30 seconds and the next step must be carried out within this period.
6. While the receiver's "programming button" is still flashing, press the button on HomeLink® being programmed and hold it depressed for approx. 2 seconds and then release it. Repeat the press/hold/release sequence up to 3 times to conclude the programming.

Operation

When HomeLink® is fully programmed it can be used in place of the separate original remote controls.

Press the programmed button and hold it depressed until the garage door, alarm system, etc. is activated (may take several seconds). Naturally the original remote controls can still be used in parallel with HomeLink® if required.

NOTE

If the ignition is switched off, HomeLink® will work for 30 minutes after the driver's door has been opened.

If programming problems persist, contact HomeLink® on: www.homelink.com or ring 00 8000 466 354 65 (or premium rate phone number +49 6838 907 277).

Resetting the HomeLink® buttons

It is only possible to reset all of the HomeLink® buttons at the same time, not each button individually. However, individual buttons can be reprogrammed, see the following section "Programming individual buttons".

1. Depress the two outer buttons on HomeLink® and do not release until the indicator lamp starts to flash.
2. Release the buttons.
 - > HomeLink® is now set in so-called "learn mode" and is ready to be reprogrammed, see section "Programming HomeLink®" on page 141.

² Button designation and colour vary depending on manufacturer.

* Option/accessory, for more information, see Introduction.



Programming individual buttons

To reprogram an individual HomeLink® button, proceed as follows:

1. Depress the required button and **do not release**.
2. When the indicator lamp on HomeLink® starts to flash, after approx. 20 seconds, start with step 1 in section "Programming HomeLink®" on page 141.

For more information or to leave comments about HomeLink®, visit: www.homelink.com or ring 00 8000 466 354 65 (or premium rate phone number +49 6838 907 277).

DSTC – Stability and traction control system.....	146
Road sign information - RSI*	148
Speed limiter*.....	150
Cruise control*.....	152
Adaptive cruise control*.....	154
Distance Warning*.....	165
City Safety™.....	168
Collision Warning with Auto Brake & Pedestrian Protection*.....	173
Driver Alert System*.....	181
Driver Alert System - DAC*.....	182
Driver Alert System - LDW*.....	185
Park assist syst*.....	188
Park assist camera*.....	191
BLIS* – Blind Spot Information System.....	194



G000000

04

DRIVER SUPPORT

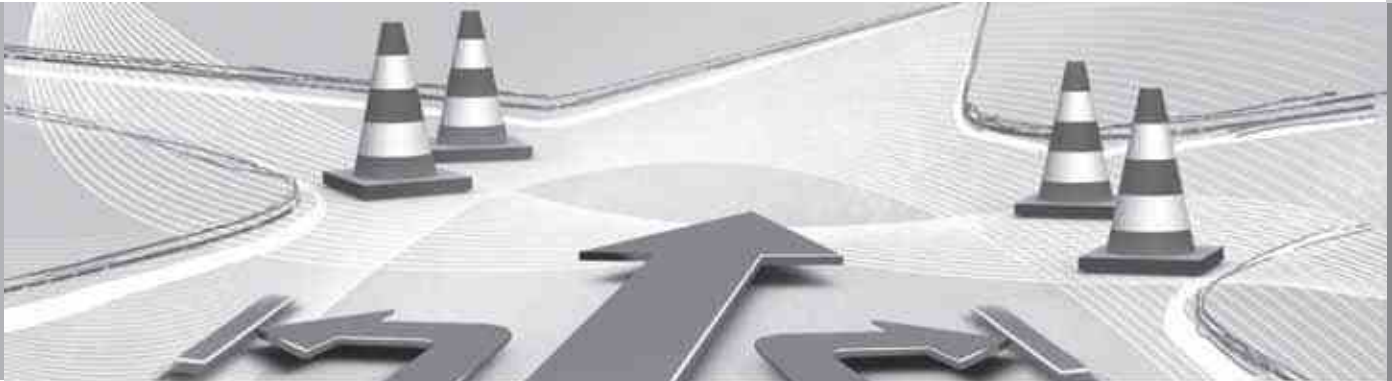



DSTC – Stability and traction control system

General information on DSTC

The stability and traction control system, DSTC (Dynamic Stability & Traction Control) helps the driver to avoid skidding and improves the car's traction.

The activation of the system during braking may be noticed as a throbbing sound. The car may accelerate slower than expected when the accelerator pedal is depressed.

Active Yaw Control

The function limits the driving and brake force of the wheels individually in order to stabilise the car.

Spin Control

The function prevents the driving wheels from spinning against the road surface during acceleration.

Traction control system

The function is active at low speed and transfers power from the driving wheel that is spinning to the one that is not.

Engine drag control - EDC

EDC (Engine Drag Control) prevents involuntary wheel locking, e.g. after shifting down or engine braking when driving in low gears on slippery road surfaces.

Involuntary wheel locking while driving can, amongst other things, impair the driver's ability to steer the car.

Corner Traction Control – CTC

CTC compensates for understeer and allows higher than normal acceleration in a bend without wheelspin on the inner wheel, e.g. on an arcing motorway entrance road to quickly reach the prevailing traffic speed.

Trailer Stability Assist* - TSA

The function serves to stabilise the car and trailer combination if it begins to snake, see page 303.



NOTE

The function is deactivated if the driver selects **Sport** mode.

Operation

Selection of level - Sport mode

The DSTC system is always activated - it cannot be deactivated.

However, the driver can select the **Sport** mode, which allows for a more active driving experience. In **Sport** mode the system detects whether the accelerator pedal, steering wheel movements and cornering are more active than

in normal driving and then allows controlled skidding with the rear section up to a certain level before it intervenes and stabilises the car.

If the driver stops a controlled skid by releasing the accelerator pedal then the DSTC system intervenes and stabilises the car.

With **Sport** mode, maximum traction is obtained if the car has become stuck, or when driving on a loose surface - e.g. sand or deep snow.

Proceed as follows to select **Sport** mode:

1. Press the centre console button **MY CAR** and search in the display screen's menu system and locate **My V60 → DSTC**. (For information on the menu system, see page 202).
2. Uncheck the box and back out of the menu system with **EXIT**.
 - > The system then allows a more sporty driving style.

The **Sport** mode is active until the driver deselects it or until the engine is switched off - after the engine is started the next time the DSTC system is back in its normal mode again.

* Option/accessory, for more information, see Introduction.

**DSTC – Stability and traction control system****Symbols and messages in the display**

Symbol	Message	Specification
	DSTC Temporarily OFF	DSTC system temporarily reduced due to excessive brake disc temperature. - The function is reactivated automatically when the brakes have cooled.
	DSTC Service required	DSTC system disengaged. <ul style="list-style-type: none"> • Stop the car in a safe place, switch off the engine and start it again. • Visit a workshop if the message remains - an authorised Volvo workshop is recommended.
 and 	"Message"	There is a message on the speedometer's display - Read it!
	Constant glow for 2 seconds.	System check when the engine is started.
	Flashing light.	DSTC system is being activated.
DSTC SPORT		Sport mode is activated.



04 Driver support

Road sign information - RSI*

General information on RSI



Examples of readable speed signs¹.

The Road sign information function (RSI – Road Sign Information) helps the driver to remember which road signs the car has passed through information on - among other things - the current speed, the start/end of a motorway or road, and when overtaking is prohibited.

If a sign for both a motorway/road for motorised traffic and a sign showing the maximum permitted speed are passed, RSI decides to show the sign symbol for maximum permitted speed.

WARNING

RSI does not work in all situations but is designed merely as a supplementary aid. The driver always bears ultimate responsibility for ensuring that the vehicle is driven safely and that applicable road traffic rules and regulations are followed.

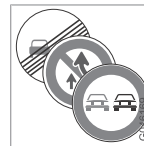

Together with the symbol for the current speed limit, a sign showing that overtaking is prohibited may also be displayed where appropriate.

Operation

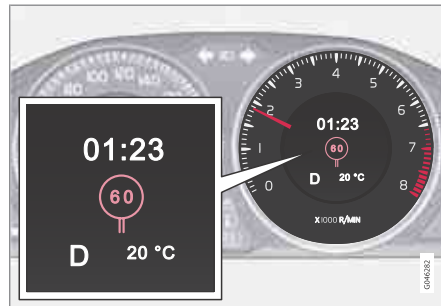

Recorded speed information.

When RSI has recorded a road sign with an imposed speed, the sign is displayed as a symbol on the instrument panel.

Additional signs

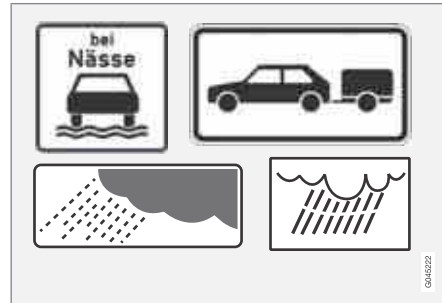

Examples of additional signs¹.

Sometimes different speed limits are signposted for the same road - an additional sign then indicates the circumstances under which the different speeds apply. The road section may be particularly susceptible to accidents in rain and/or fog, for example.

An additional sign relating to rain is displayed only if the windscreen wipers are in use.

¹ Road signs which are displayed in the instrument panel are dependent on the market - the illustration only shows a few examples.



Road sign information - RSI*

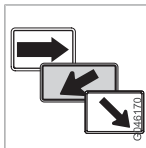

The speed applicable on an exit is indicated by means of an additional sign containing an arrow. The arrow is displayed under the symbol showing the speed.

Speed signs linked to this type of additional sign are displayed only if the driver is using the direction indicator.

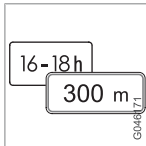
Limited distance or time of day

Some speeds are applicable only after a specific distance or at a certain time of day. The driver's attention is drawn to the situation by means of an empty frame under the symbol showing the speed.

Setting in MY CAR

Options in MY CAR.

The instrument panel's speed symbol display can be disabled. To deactivate the RSI function:

- Uncheck the option in **MY CAR Settings** → **Car settings** → **Road Sign Information** and go back by pressing **EXIT**, see page 203.

Speed warning

The driver can opt to receive a warning (Speed Alert) when the applicable speed limit is exceeded by 5 km/h or more. This warning is given by the symbol showing the applicable maximum speed temporarily flashing when this speed is exceeded.

To activate speed warning:

- Check speed warning in **MY CAR Settings** → **Car settings** → **Speed alert** and go back by pressing **EXIT**, see page 203.

Limitations

The RSI function's camera sensor is limited - just like the human eye. Find out more about this on page 178.

Signs which indirectly provide information on a prevailing speed limit, e.g. name signs for towns/districts, are not recorded by the RSI function.

Here are several examples of what can disrupt the function:

- Faded signs
- Signs positioned on bends
- Rotated or damaged signs
- Concealed or poorly positioned signs.
- Signs completely or partly covered with frost, snow and/or dirt.



Speed limiter*

General information on the speed limiter

A speed limiter (Speed Limiter) can be regarded as a reverse cruise control - the driver regulates the speed using the accelerator pedal but is prevented from accidentally exceeding a pre-selected/set speed by the speed limiter.

Operation

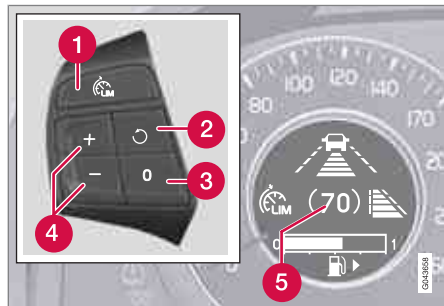

Steering wheel keypad and display.

- 1 Speed limiter - On/Off.
- 2 Standby mode ceases and stored speed resumes - each extra press gives +1 km/h.
- 3 Standby mode.

- 4 Activate and adjust the maximum speed (each press gives +/-5 km/h).
- 5 Stored maximum speed (in brackets = Standby mode).

Switch on and activate

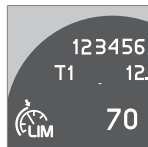

When the speed limiter is active the display will show its symbol in combination with the set maximum speed.

Selection and storage of the highest possible speed in the memory can be made both during a journey and while stationary.

While driving

1. Press the steering wheel button to switch on the speed limiter.
 - > The symbol for the speed limiter is illuminated on the instrument panel display.
2. When the car is moving at the desired highest possible speed: Press one of the steering wheel buttons or until the instrument panel display shows the desired maximum speed.
 - > The speed limiter is then active and the display (5) shows the maximum speed selected and the maximum speed stored in the memory.

When stationary

1. Press the steering wheel button to switch on the speed limiter.
2. Scroll with the button until the instrument panel display shows the desired maximum speed.
 - > The speed limiter is then active and the display (5) shows the maximum speed selected and the maximum speed stored in the memory.

Changing the speed

To change the stored speed:

- Adjust with short presses on or - every press gives +/- 5 km/h. The last presses made are stored in the memory.

To adjust +/- 1 km/h:

- Hold the button depressed and release when the instrument panel's display shows a point (5) at the desired maximum speed.

Temporary deactivation - standby mode

To temporarily deactivate the speed limiter and set it in standby mode:

- Press .
 - > The display shows the stored maximum speed in brackets (5) and the driver can

* Option/accessory, for more information, see Introduction.

**Speed limiter***

temporarily exceed the set maximum speed.

The speed limiter is re-activated by one press on  at which the display's brackets disappear and the car's maximum speed is again limited.

Temporary deactivation with the accelerator pedal

The speed limiter can also be set in standby mode with the accelerator pedal, e.g. for rapidly accelerating the car out of a situation:

- Depress the accelerator pedal fully.
 - > The display shows the stored maximum speed in brackets (5) and the driver can temporarily exceed the set maximum speed.



The speed limiter is automatically re-activated after the release of the accelerator pedal and the car's speed is slowed down to below the selected/stored maximum speed - the display's brackets disappear and the car's maximum speed is again limited.

Alarm for speed exceeded

On steep roads the engine braking effect may be inadequate and the selected maximum speed exceeded. The driver is alerted about this with an acoustic signal.



The signal is active until the driver has slowed to below the selected maximum speed.

NOTE

The alarm is only activated after 5 seconds if the speed has been exceeded by at least 3 km/h provided that none of the buttons  or  has been depressed during the last half minute.

Deactivate

To deactivate the speed limiter:

- Press the steering wheel button .
 - > The display's symbol for the speed limiter and the set speed (5) are cleared. The selected and stored speed are thus deleted from the memory and cannot be resumed with the  button.

The driver can then use the accelerator pedal to choose a speed without limitation.



Cruise control*

General information on CC

The cruise control (CC – Cruise Control) helps the driver maintain an even speed, resulting in a more relaxed driving on motorways and long, straight roads in regular traffic flows.

WARNING

The driver must always be observant with regard to the traffic conditions and intervene when the cruise control is not maintaining a suitable speed and/or suitable distance.

The driver always bears ultimate responsibility for ensuring that the vehicle is driven safely.

Operation

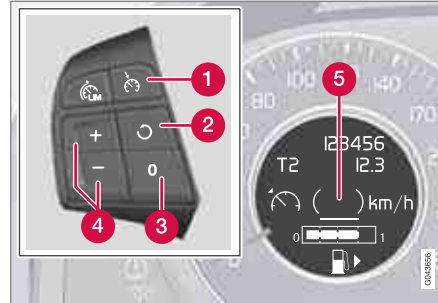

The steering wheel buttons and display in cars **with** speed limiter¹.

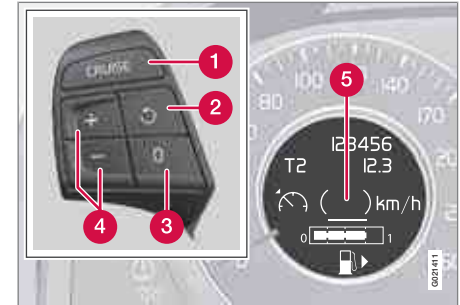

The steering wheel buttons and display in cars **without** speed limiter¹.

- 1** Cruise control - On/Off.
- 2** Standby mode ceases and the stored speed is resumed.
- 3** Standby mode
- 4** Activate and adjust the speed.
- 5** Selected speed (in brackets = Standby mode).

Activating and setting the speed

To enable cruise control:

- Press the steering wheel button (1).



¹ A Volvo dealer has updated information about what applies in each respective market.

* Option/accessory, for more information, see Introduction.

**Cruise control***

- > The symbol  illuminates in the display (5) and the brackets around (---) km/h show that cruise control is set in standby mode.

To activate cruise control:



- At the required speed - press the steering wheel button  or .
- > Current speed is stored in the memory - the display text (---) km/h changes to show the selected speed, e.g. **100 km/h**, without brackets.

NOTE

Cruise control cannot be engaged at speeds below 30 km/h.

Changing the speed

To change the stored speed:

- Press briefly on the steering wheel button,  or  - most recent presses are stored in memory.

A temporary increase in speed with the accelerator pedal, e.g. during overtaking, does not affect the cruise control setting - the car returns to the set speed when the accelerator pedal is released.

NOTE

If any of the Cruise Control buttons are held down for more than approx. 1 minute, it is blocked and disabled. To be able to reactivate Cruise Control, the car must be stopped and the engine restarted.

Temporary deactivation - standby mode

To temporarily disengage cruise control and set it in standby mode:

- Press the steering wheel button .
- > Set speed is shown in brackets in the display (5), e.g. **(100) km/h**.

Automatic standby mode

Cruise control is temporarily disengaged and set in standby mode if:

- wheels lose traction
- the foot brake is used
- speed falls below approx. 30 km/h
- the clutch pedal is depressed
- the gear selector is moved to neutral position (automatic gearbox)
- the driver maintains a speed higher than the set speed for longer than 1 minute.

The driver must then regulate the speed.

Resume set speed

Cruise control in standby mode is re-activated with one press on the steering wheel button  - the speed is then set to the last stored speed.

NOTE

A significant increase in speed may arise after the speed has been resumed with .

Deactivate

The cruise control is switched off with the steering wheel button (1) or by switching off the engine - the set speed is deleted from the memory and cannot be resumed with the  button.



Adaptive cruise control*

General information on ACC

The adaptive cruise control (ACC – Adaptive Cruise Control) helps the driver maintain a safe distance from the vehicle ahead. An adaptive cruise control provides a more relaxing driving experience on long journeys on motorways and long straight main roads in smooth traffic flows.

The driver sets the desired speed and time interval to the car in front. When the radar detector detects a slower vehicle in front of the car, the speed is automatically adapted to that. When the road is clear again the car returns to the selected speed.

If the adaptive cruise control is switched off or set to the standby mode and the car comes too close to a vehicle in front, then the driver is warned by Distance Warning (see page 165) about the short distance.

WARNING

The driver must always be observant with regard to the traffic conditions and intervene when the adaptive cruise control is not maintaining a suitable speed or suitable distance.

The adaptive cruise control cannot handle all traffic, weather and road conditions.

Read the whole of this section for information on the limitations of the adaptive cruise control. The driver must be familiar with this information before using the adaptive cruise control.

The driver always bears responsibility for maintaining the correct distance and speed, even when the adaptive cruise control is being used.

IMPORTANT

Maintenance of adaptive cruise control components must only be performed at a workshop - an authorised Volvo workshop is recommended.

Automatic gearbox

Cars with automatic gearbox have enhanced functionality with the adaptive cruise control's Queue Assistant, see page 159.

Function

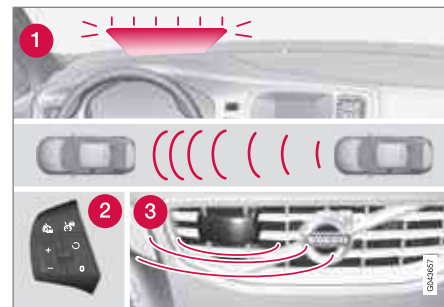

Function overview¹.

- 1** Warning lamp - braking by driver required
- 2** Steering wheel keypad
- 3** Radar sensor

Adaptive cruise control consists of a cruise control system and a coordinated spacing system.

¹ NOTE: The illustration is schematic - details may differ depending on car model.

**Adaptive cruise control*****! WARNING**

Adaptive cruise control is not a collision avoidance system. The driver must intervene if the system does not detect a vehicle in front.

The adaptive cruise control does not brake for humans or animals, and not for small vehicles such as bicycles and motorcycles. Nor for oncoming, slow or stationary vehicles and objects.

Do not use the adaptive cruise control, for example, in city traffic, in dense traffic, at junctions, on slippery surfaces, with a lot of water or slush on the road, in heavy rain/snow, in poor visibility, on winding roads or on slip roads.

The distance to the vehicle ahead is mainly measured by a radar sensor. Cruise control regulates the speed with acceleration and braking. It is normal for the brakes to emit a low sound when they are being used by the Adaptive cruise control.

! WARNING

The brake pedal moves when the cruise control brakes. Do not rest your foot under the brake pedal as it could become trapped.

The adaptive cruise control aims to follow the vehicle ahead in the same lane at a time interval set by the driver. If the radar sensor cannot see any vehicle in front then the car will instead maintain the cruise control's set speed. This also happens if the speed of the vehicle in front exceeds the cruise control's set speed.

The adaptive cruise control aims to control the speed in a smooth way. In situations that demand sudden braking the driver must brake himself/herself. This applies with large differences in speed, or if the vehicle in front brakes heavily. Due to limitations in the radar sensor, braking may come unexpectedly or not at all, see page 160.

The adaptive cruise control can be activated to follow another vehicle at speeds from 30 km/h² up to 200 km/h. If the speed falls below 30 km/h or if the engine speed becomes too low, the cruise control is set in standby mode at which automatic braking ceases - the driver must then take over himself/herself to maintain a safe distance to the vehicle ahead.

Warning lamp - braking by driver required

Adaptive cruise control has a braking capacity that is equivalent to more than 40% of the car's braking capacity.

If the car needs to be braked more heavily than cruise control capacity and the driver does not brake, then the cruise control uses the collision warning system's warning lamp and warning sound (see page 173) to alert the driver that immediate intervention is required.

i NOTE

The warning lamp may be difficult to notice in strong sunlight or when sunglasses are being worn.

! WARNING

Cruise control only warns of vehicles detected by the radar sensor. Consequently there may be no warning or it may be subject to a delay. Do not wait for a warning but brake when it is necessary.

Steep roads and/or heavy load

Bear in mind that the adaptive cruise control is primarily intended for use when driving on level road surfaces. It may have difficulty in keeping the correct distance from the vehicle ahead when driving on steep roads, with a heavy load or with a trailer - in which case, be extra attentive and ready to slow down.

² Queue Assistant (in cars with automatic gearbox) can operate in the range of 0-200 km/h, see page 159.



Adaptive cruise control*

Operation

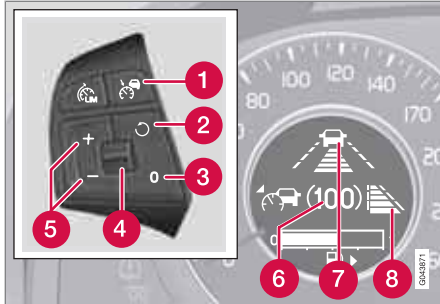

Steering wheel keypad and display in cars **with** Speed limiter³.

- 1 Cruise control - On/Off.
- 2 Standby mode ceases and stored speed resumes - each extra press gives +1 km/h.
- 3 Standby mode
- 4 Time interval - Increase/decrease.
- 5 Activate and adjust the speed (each press gives +/-5 km/h).
- 6 Selected speed (in brackets = Standby mode).

- 7 Time interval⁴ - On (during adjustment).
- 8 Time interval⁴ - On (after adjustment).

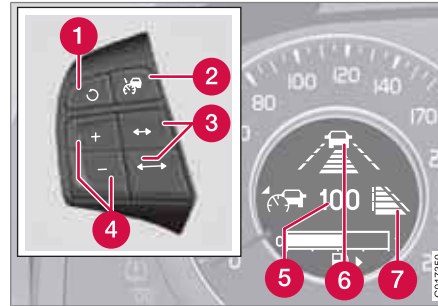

Steering wheel keypad and display in cars **without** Speed limiter³.

- 1 Standby mode ceases and the stored speed is resumed.
- 2 Cruise control - On/Off or Standby mode.
- 3 Time interval - Increase/decrease.
- 4 Activate and adjust the speed.
- 5 Selected speed (in brackets = Standby mode).

- 6 Time interval⁵ - On (during adjustment).
- 7 Time interval⁵ - On (after adjustment).

Activating and setting the speed

To set the Cruise control:

- Press the steering wheel button - the symbol illuminates in the display. The display's symbol (---) shows that the cruise control is set in standby mode.

To activate the Cruise control:

- At the desired speed - press the steering wheel button or .
- > The current speed is stored in the memory - the display's symbol (---) changes to show the selected speed, e.g. 100, without brackets.

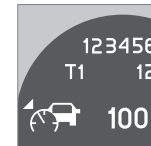

When the symbol changes to the radar sensor has detected a vehicle.

Only when the symbol (with car) is illuminated, is the **distance** to the vehicle in front regulated by the cruise control.

³ A Volvo dealer has updated information about what applies in each respective market.
⁴ The display shows either "dash" symbol [7] or [8] - they are never shown simultaneously.
⁵ The display shows either "dash" symbol [6] or [7] - they are never shown simultaneously.

**Adaptive cruise control*****Changing the speed**

To change the stored speed:

- Adjust with short presses on or - every press gives +/- 5 km/h. The last presses made are stored in the memory. If speed is increased using the accelerator pedal prior to pressing the , then it is the car's current speed when the button is pressed that is stored in the cruise control.
- In active mode the button has the same function as but results in a lower increase in speed: + 1 km/h.

**NOTE**

If any of the Cruise Control buttons are held down for more than approx. 1 minute, it is blocked and disabled. To be able to reactivate Cruise Control, the car must be stopped and the engine restarted.

In certain situations, cruise control cannot be activated. Then the display shows **Cruise control Unavailable**, see page 162.

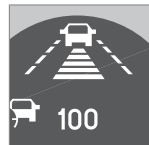
Set time interval

Different time intervals to the vehicle in front can be selected and shown in the display as 1-5 horizontal lines - the more lines the longer the time interval. One line corresponds to approx. 1 second

to the vehicle in front, 5 lines approx. 3 seconds.

To set/change the time interval:

- Increase or decrease with the steering wheel keypad's thumbwheel (or the buttons / for cars without Speed limiter).

At low speed, when the distances are short, the adaptive cruise control increases the time interval slightly.

The adaptive cruise control allows the time interval to vary noticeably in certain situations in order to allow the car to follow the vehicle in front smoothly and comfortably.

Note that small intervals only allow the driver a short time to react and take action if any unforeseen traffic problem should arise.

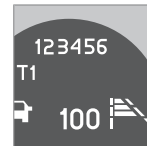

The number of lines for the selected time interval is shown during the setting itself and for several seconds afterwards. Then a smaller scale version of the symbol is shown to the right of the display. The same symbol is also shown when Distance Warning is activated, see page 165.

**NOTE**

Only use the time intervals permitted by local traffic regulations.

If Cruise Control does not appear to react when activated, this may be because the time distance to the car in front is preventing an increase in speed.

The higher the speed the longer the calculated distance in metres for a given time interval.

Temporary deactivation - standby mode

To temporarily disengage Cruise control and set it in standby mode:

- Press the steering wheel button .
- > Set speed is shown in brackets in the display, e.g. (100).



Adaptive cruise control*

Keypad without Speed limiter*

To temporarily disengage Cruise control and set it in standby mode:

- Press the steering wheel button .

Standby mode due to driver intervention

Cruise control is temporarily disengaged and set in standby mode if:

- the foot brake is used
- the clutch pedal is depressed for longer than 1 minute⁶
- the gear selector is moved to **N** position (automatic gearbox)
- the driver maintains a speed higher than the set speed for longer than 1 minute.

The driver must then regulate the speed.

A temporary increase in speed with the accelerator pedal, e.g. during overtaking, does not affect the cruise control setting - the car returns to the last stored speed when the accelerator pedal is released.

Automatic standby mode

The Adaptive cruise control is dependent on other systems, e.g.. DSTC (see page 146). If

any of these systems stop working then cruise control is automatically deactivated.

In the event of automatic deactivation a signal will sound and the message **Cruise control Cancelled** is shown in the display. The driver must then intervene and adapt the speed and distance to the vehicle ahead.

An automatic deactivation can be due to:

- engine speed is too low/high
- speed falls below 30 km/h⁷
- wheels lose traction
- brake temperature is high
- the radar sensor is covered e.g. by wet snow or heavy rain (radar waves blocked).

Resume set speed

Cruise control in standby mode is re-activated with one press on the steering wheel button  - the speed is then set to the last stored speed.

NOTE

A significant increase in speed may arise after the speed has been resumed with .

Overtaking another vehicle

When the car is following another vehicle and the driver indicates an imminent overtake with the direction indicator⁸, the Cruise control helps to briefly accelerate the car towards the vehicle in front.

The function is active at speeds above 70 km/h.





WARNING

Be aware that this function can be activated in more situations other than during overtaking, e.g. when a direction indicator is used to indicate a change of lane or exit to another road - the car will then accelerate briefly.

Deactivate

Keypad with Speed limiter

Adaptive cruise control is deactivated with the steering wheel button . The set speed is cleared and cannot be resumed with the  button.

Keypad without Speed limiter

With a short press on the steering wheel button  the cruise control is set in standby mode.

⁶ Disengaging and selecting a higher or lower gear does not involve standby mode.

⁷ Does not apply to a car with Queue Assistant - it manages right down to stationary.

⁸ On left flash only in left-hand drive car, or right flash in right-hand drive car.

**Adaptive cruise control***

With a further short press the cruise control is deactivated. The set speed is cleared and cannot be resumed with the  button.

Queue Assistant

In cars with automatic gearbox Adaptive cruise control is supplemented with the Queue Assistant function (also referred to as "Queue Assist").

Queue Assistant has the following functions:

- Extended speed range - also below 30 km/h and at standstill
- Change of target
- Automatic braking ceases when stationary
- Automatic activation parking brake.

Note that the lowest programmable speed for the cruise control is 30 km/h - even though the cruise control is capable of following another vehicle down to a standstill, a lower speed **cannot** be selected.

Extended speed range**NOTE**

In order to activate the cruise control the driver's door must be closed and the driver must be wearing the seatbelt.

With automatic gearbox the cruise control can follow another vehicle within the range of 0-200 km/h.

NOTE

Activation of the cruise control below 30 km/h requires a vehicle in front within a reasonable distance.

For shorter stops in connection with inching in slow traffic or at traffic lights driving is automatically resumed if the stops do not exceed about 3 seconds - if it takes longer before the car in front starts moving again then the cruise control is set in standby mode with automatic braking. The driver must then re-activate the cruise control in one of the following ways:

- Press the steering wheel button .
- or
- Depress the accelerator pedal.
- > The cruise control will then resume following the vehicle in front.

NOTE

Queue Assist can hold the car stationary for a maximum of 4 minutes - then the parking brake is applied and Cruise Control is disengaged.

- The driver has to release the parking brake before the cruise control can be reactivated.

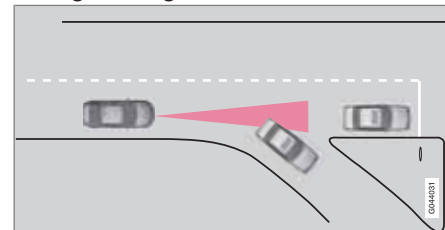
Change of target

If the target vehicle in front suddenly turns then there may be stationary traffic in front.

When the cruise control is following another vehicle at speeds **below** 30 km/h and changes target from a moving to a stationary vehicle, the cruise control will slow down for the stationary vehicle.



Adaptive cruise control*

WARNING

When the cruise control is following another vehicle at speeds **in excess of 30 km/h** and the target is changed from a moving vehicle to a stationary vehicle, the cruise control will ignore the stationary vehicle and instead select the stored speed.

- The driver must intervene him/herself and brake.

Automatic standby mode with change of target

Cruise control is disengaged and set in standby mode:

- when the speed is below 5 km/h and cruise control is not sure whether the target object is a stationary vehicle or some other object, e.g. a speed bump.
- when the speed is below 5 km/h and the vehicle in front turns off so the cruise control no longer has a vehicle to follow.

Termination of automatic braking at a standstill

In certain situations Queue Assist automatically interrupts braking when stationary. This means that the brakes are released and the car may start to roll - the driver must therefore intervene and brake the car himself/herself in order to maintain its position.

Queue Assist releases the foot brake and sets cruise control in standby mode in the following situations:

- the driver puts his/her foot on the brake pedal
- the parking brake is applied
- the gear selector is moved to **P, N or R** position
- the driver sets the cruise control in standby mode.

Automatic activation parking brake

In some situations Queue Assist applies the parking brake in order to keep the car stationary.

This takes place if:

- the driver opens the door or takes off his/her seatbelt
- DSTC is changed from **Normal** to **Sport** mode
- Queue Assist has held the car stationary for more than 4 minutes
- the engine is switched off
- the brakes have overheated.

The radar sensor and its limitations

The radar sensor is used - apart from by Adaptive cruise control - by the following functions as well:

- Collision Warning with Auto Brake, see page 173
- Distance Warning, see page 165.

The function of the radar sensor is to detect cars or larger vehicles in the same direction, in the same lane.

Modification of the radar sensor could result in it being illegal to use.

**Adaptive cruise control*****WARNING**

The driver must always be observant with regard to the traffic conditions and intervene when the adaptive cruise control is not maintaining a suitable speed or suitable distance.

The adaptive cruise control cannot handle all traffic, weather and road conditions.

Read the whole of this section for information on the limitations of the adaptive cruise control. The driver must be familiar with this information before using the adaptive cruise control.

The driver always bears responsibility for maintaining the correct distance and speed, even when the adaptive cruise control is being used.

WARNING

Accessories or other objects such as auxiliary lamps must not be installed in front of the grille.

WARNING

Adaptive cruise control is not a collision avoidance system. The driver must intervene if the system does not detect a vehicle in front.

The adaptive cruise control does not brake for humans or animals, and not for small vehicles such as bicycles and motorcycles. Nor for oncoming, slow or stationary vehicles and objects.

Do not use the adaptive cruise control, for example, in city traffic, in dense traffic, at junctions, on slippery surfaces, with a lot of water or slush on the road, in heavy rain/snow, in poor visibility, on winding roads or on slip roads.

The capacity of the radar sensor to detect vehicles in front is reduced significantly:

- if the radar sensor becomes blocked and cannot detect other vehicles e.g. in heavy rain or slush, or if other objects have collected in front of the radar sensor.

NOTE

Keep the area in front of the radar sensor clean - see "Maintenance" on page 176.

- if the speed of vehicles in front is significantly different from your own speed.

Examples where the cruise control does not work optimally

The radar sensor has a limited field of vision. In some situations another vehicle is not detected, or the detection is made later than expected.

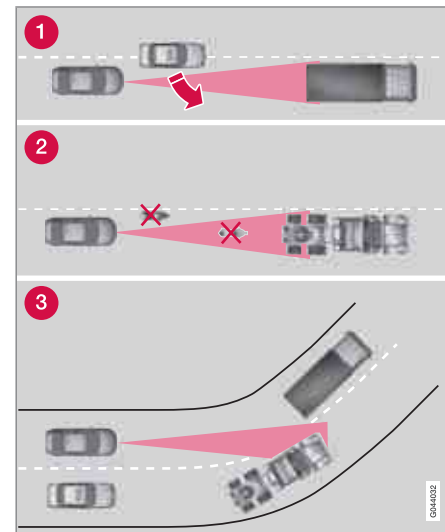

ACC field of vision.



Adaptive cruise control*

- 1 Sometimes the radar sensor is late at detecting vehicles at close distances, e.g. a vehicle that drives in between the car and vehicles in front.
- 2 Small vehicles, such as motorcycles, or vehicles not driving in the centre of the lane can remain undetected.
- 3 In bends the radar sensor may detect the wrong vehicle or lose a detected vehicle from view.

Fault tracing and action

If the display shows the message **Radar blocked** See manual this means that the radar signals from the radar sensor are blocked and that vehicles in front of the car could not be detected.

This means that in addition to the Adaptive Cruise Control, Distance Warning and Collision

Warning with Auto Brake functions are not operating either.

The following table presents possible causes for a message being shown along with the appropriate action.

Cause	Action
The radar surface in the grille is dirty or covered with ice or snow.	Clean the radar surface in the grille from dirt, ice and snow.
Heavy rain or snow blocking the radar signals.	No action. Sometimes the radar does not work during heavy rain or snowfall.
Water or snow from the road surface swirls up and blocks the radar signals.	No action. Sometimes the radar does not work on a very wet or snowy road surface.
The radar surface has been cleaned but the message remains.	Wait. It could take several minutes for the radar to sense that it is no longer blocked.

Symbols and messages in the display

Symbol	Message	Specification
		Standby mode or active mode without detected vehicle.
		Active mode with detected vehicle to which cruise control adapts the speed.

* Option/accessory, for more information, see Introduction.

**Adaptive cruise control***

Symbol	Message	Specification
		Time interval activated, during adjustment.
		Time interval activated, after adjustment.
	DSTC Normal to enable Cruise	Adaptive cruise control cannot be activated until the Stability and Traction Control system (DSTC) has been set in Normal mode - see page 146.
	Cruise control Cancelled	Adaptive cruise control has been deactivated - the driver has to regulate the speed.
	Cruise control Unavailable	Adaptive cruise control cannot be activated. This could be due to: <ul style="list-style-type: none"> • brake temperature is high • the radar sensor is blocked by e.g. wet snow or rain.
	Radar blocked See manual	Adaptive cruise control temporarily disengaged. <ul style="list-style-type: none"> • The radar sensor is blocked and cannot detect other vehicles. For example, in the event that heavy rain or if slush has collected in front of the radar sensor. Read about the limitations of the radar sensor, see page 160.
	Cruise control Service required	Adaptive cruise control disengaged. <ul style="list-style-type: none"> • Contact a workshop - an authorised Volvo workshop is recommended.



04 Driver support

Adaptive cruise control*

Symbol	Message	Specification
	Press Brake To hold + acoustic alarm (Only with Queue Assistant)	The car is stationary and the cruise control will release the foot brake to allow the parking brake to take over and hold the car, but a fault in the parking brake means the car will shortly begin to roll. <ul style="list-style-type: none">• The driver must brake himself/herself. The message remains and the alarm sounds until the driver depresses the brake pedal or uses the accelerator pedal.
	Below 30 km/h Only following (Only with Queue Assistant)	Shown with attempts to activate the cruise control at speeds below 30 km/h without a vehicle in front within the activation distance (approx. 30 metres).

04



Distance Warning*

General

Distance Warning (Distance Alert) is a function that informs the driver about the time interval to vehicles in front.

Distance Warning is active at speeds above 30 km/h and only reacts to vehicles driving in front of the car, in the same direction. No distance information is provided for oncoming, slow or stationary vehicles.

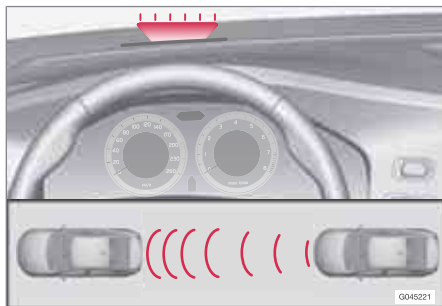

Orange warning lamp¹.

An orange warning lamp in the windscreen illuminates with a constant glow if the distance to the vehicle in front is shorter than the set time interval.

NOTE

Distance warning is deactivated during the time the adaptive cruise control is active.

WARNING

Distance warning only reacts if the distance to the vehicle ahead is shorter than the pre-set value - the speed of the driver's vehicle is not affected.

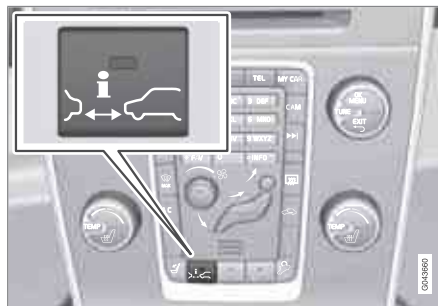
Operation

Press the button in the centre console to switch the function on or off. The function is switched on if one lamp is illuminated in the button.

Some combinations of the selected equipment leave no vacant space for a button in the centre console - in which case the function is handled by the car's menu system **MY CAR** under **Settings** → **Car settings** → **Warning distance**. For a description of the menu system - see page 202.

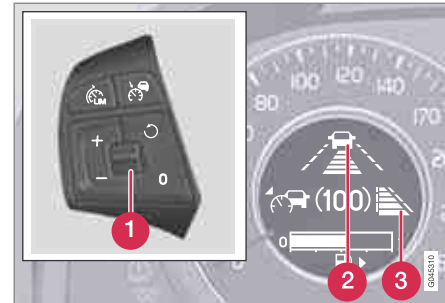
Set time interval

Controls and display for time interval.

- 1 Time interval - Increase/decrease. Press up to increase, down to decrease.
- 2 Time interval² - On (during adjustment).
- 3 Time interval² - On (after adjustment).

¹ NOTE: The illustration is schematic - details may vary depending on car model.

² The display shows either "dash" symbol [2] or [3] - they are never shown simultaneously.



Distance Warning*



Different time intervals to the vehicle in front can be selected and shown in the display as 1-5 horizontal lines - the more lines the longer the time interval. One line corresponds to

approximately 1 second to the vehicle in front, 5 lines approximately 3 seconds.

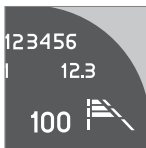

The number of lines for the selected time interval is shown during the setting itself and for several seconds afterwards. Then a smaller scale version of the symbol is shown to the right of the display.

The same symbol is also shown when adaptive cruise control is activated.

NOTE

The higher the speed, the longer the calculated distance in metres for a specific time interval.

The set time interval is also used by the adaptive cruise control function, see page 156.

Only use the time interval that is allowed in accordance with local traffic regulations.

Limitations

The function uses the same radar sensor as adaptive cruise control and the collision warning system. For more information on the radar sensor and its limitations, see page 160.

NOTE

Strong sunlight, reflections or strong variations in light intensity, as well as wearing sunglasses, could mean that the warning light in the windscreen cannot be seen.

Poor weather or winding roads could affect the radar sensor's capacity to detect vehicles in front.

The size of other vehicles could also affect detection capacity, e.g. motorcycles. This could mean that the warning lamp illuminates at a shorter distance than the setting or that the warning is temporarily absent.

Extremely high speeds can also cause the lamp to illuminate at a shorter distance than that set due to limitations in sensor range.



Distance Warning*

Symbols and messages in the display

Symbol	Message	Specification
		Set time interval, during adjustment.
		Set time interval, after adjustment.
	Radar blocked See manual	Distance Warning temporarily disengaged. The radar sensor is blocked and cannot detect other vehicles, e.g. in the event of heavy rain or if slush has collected in front of the radar sensor. Read about the limitations of the radar sensor, see page 160.
 	Collision warn. Service required	Distance Warning and Collision Warning with Auto Brake fully or partially disengaged. Visit a workshop if the message remains - an authorised Volvo workshop is recommended.

04

* Option/accessory, for more information, see Introduction.



City Safety™

General

City Safety™ is a function for helping the driver to avoid a collision when driving in queues, amongst other things, when changes in the traffic ahead, combined with a lapse in attention, could lead to an incident.

The function is active at speeds under 50 km/h and it helps the driver by automatically braking the car in the event of imminent risk of collision with vehicles in front, should the driver not react in time by braking and/or steering away.

City Safety™ is activated in situations where the driver should have started braking earlier, which is why it cannot help the driver in every situation.

City Safety™ is designed to be activated as late as possible in order to avoid unnecessary intervention.

City Safety™ must not be used as an excuse for the driver to change his/her driving style. If the driver solely relies on City Safety™ to do the braking, there will be a collision sooner or later.

The driver or passengers normally only notice City Safety™ if a situation arises where the car is extremely close to being in a collision.

If the car is also equipped with a Collision Warning function with Auto Brake*, these two systems complement each other. For more information on Collision Warning function with Auto Brake, see page 173.



IMPORTANT

Maintenance and replacement of City Safety™ components must only be performed by a workshop - an authorised Volvo workshop is recommended.



WARNING

City Safety™ does not engage in all driving situations or traffic, weather or road conditions.

City Safety™ does not react to vehicles driving in a different direction from the car, to small vehicles, motorcycles and bicycles or to humans and animals.

City Safety™ can prevent collision at a speed difference of less than 15 km/h - at a higher speed difference, it is only possible to reduce collision speed. In order to obtain full brake function, the driver must depress the brake pedal.

Never wait for City Safety™ to engage. The driver always bears responsibility for maintaining the proper distance and speed.

Function



Laser sensor transmitter and receiver window¹.

City Safety™ detects the traffic in front of the car with a laser sensor fitted in the top edge of the windscreen. If there is an imminent risk of collision, City Safety™ will automatically brake the car, which may be experienced as sudden braking.

If the speed difference is 4-15 km/h in relation to the vehicle in front then City Safety™ can completely prevent a collision.

City Safety™ activates a short, sharp braking and stops the car in normal circumstances, just behind the vehicle in front. For most drivers this is well outside normal driving style and may be experienced as being uncomfortable.

¹ NOTE: The illustration is schematic - details may vary depending on car model.

* Option/accessory, for more information, see Introduction.



City Safety™

If the difference in speed between the vehicles is greater than 15 km/h then City Safety™ may not prevent the collision on its own. To obtain full brake force, the driver must depress the brake pedal. This could then make it possible to prevent a collision, even at speed differences above 15 km/h.

When the function is activated and brakes, the instrument panel display shows a message to the effect that the function is/has been active.

i NOTE

The brake lights come on when City Safety™ brakes the car.

Operation**i NOTE**

The City Safety™ function is always enabled after the engine has been started via key position **I** and **II** (see page 78 on key positions).

On and Off

In certain situations, it may be advisable to disable City Safety™, e.g. where leafy branches could sweep over the bonnet and/or windscreen.

After starting the engine City Safety™ can be deactivated as follows:

- Using **MY CAR** on the centre console display screen with its menu system, search and locate **Settings** → **Car settings** → **Driver support systems** → **City Safety**.

Select the **Off** option. For more information on the menu system **MY CAR**, see page 202.

However, the function will be enabled the next time the engine is started, regardless of whether the system was enabled or disabled when the engine was switched off.

⚠ WARNING

The laser sensor also transmits laser light when City Safety™ is disabled manually.

To enable City Safety™ again:

- Follow the same procedure as for disabling, but select the **On** option.

Limitations

The sensor in City Safety™ is designed to detect cars and other large vehicles in front of the car irrespective of whether it is day or night.

However, the sensor has limitations and has poorer functionality - or none at all - in e.g. heavy snowfall or rain, dense fog, dust storms or snow flurries. Mist, dirt, ice or snow on the windscreen may disrupt the function.

Low-hanging objects, e.g. a flag/pennant for projecting load, or accessories such as auxiliary lamps and bull bars that are higher than the bonnet limit the function.

The laser light from the sensor in City Safety™ measures how the light is reflected. The sensor cannot detect objects with low reflection capacity. The rear sections of the vehicle generally reflect the light sufficiently thanks to the number plate and rear light reflectors.

On slippery road surfaces the braking distance is extended, which may reduce the capacity of City Safety™ to avoid a collision. In such situations the ABS and DSTC systems will provide best possible braking force with maintained stability.

When your own car is reversing, City Safety™ is temporarily deactivated.

City Safety™ is not activated at low speeds - under 4 km/h, which is why the system does not intervene in situations where a vehicle in front is being approached very slowly, e.g. when parking.

Driver commands are always prioritised, which is why City Safety™ does not intervene in situations where the driver is steering or accelerating in a clear manner, even if a collision is unavoidable.



04 Driver support

City Safety™

When City Safety™ has prevented a collision with a stationary object the car remains stationary for a maximum of 1.5 seconds. If the car is braked for a vehicle in front that is moving, then speed is reduced to the same speed as that maintained by the vehicle in front.

On a car with manual gearbox the engine stops when City Safety™ has stopped the car, unless the driver manages to depress the clutch pedal beforehand.

NOTE

- Keep the windscreen surface in front of the laser sensor free from ice, snow and dirt (see the illustration for sensor location, page 168).
- Do not affix or mount anything on the windscreen in front of the laser sensor
- Remove ice and snow from the bonnet - snow and ice must not exceed a height of 5 cm.

Fault tracing and action

If the message **Windscreen Sensors blocked** is shown on the instrument panel display, it indicates that the laser sensor is blocked and cannot detect vehicles in front of the car. This means that City Safety™ is not operational.

The **Windscreen Sensors blocked** message is not shown for all situations in which the laser sensor is blocked. The driver must therefore be diligent about keeping the windscreen and area in front of the laser sensor clean.

The following table presents possible causes for the message being shown, along with suggestions for appropriate action.

Cause	Action
The windscreen surface in front of the laser sensor is dirty or covered with ice or snow.	Clean the windscreen surface in front of the sensor from dirt, ice and snow.
The laser sensor field of vision is blocked.	Remove the blocking object.

IMPORTANT

If there are cracks, scratches or stone chips in the windscreen in front of either of the laser sensor's "windows" and they cover a surface of approx. 0.5 x 3.0 mm (or larger), then a workshop must be contacted for repair or replacement of the windscreen (see the illustration for sensor location, page 168) - an authorised Volvo workshop is recommended.

Failure to take action may result in reduced performance for City Safety™.

To avoid the risk of reducing City Safety™ performance the following also applies:

- Before replacing a windscreen, contact an authorised Volvo workshop to verify that the correct windscreen is ordered and fitted. Using the wrong windscreen may result in the City Safety function failing to operate or operating incorrectly.
- The same type or Volvo-approved windscreen wipers must be fitted during replacement.



Laser sensor

The City Safety™ function includes a sensor which transmits laser light. Contact a qualified workshop in the event of a fault or if the laser sensor needs servicing - an authorised Volvo workshop is recommended.



WARNING

Never look into the laser sensor (which emits spreading invisible laser radiation) at a distance of 100 mm or closer with magnifying optics such as a magnifying glass, microscope, lens or similar optical instruments - this would involve a risk of eye injury (the illustration on page 168 shows sensor location).

For more information on the laser sensor, see page 9.







Symbols and messages in the display

In conjunction with automatic braking by the City Safety™ system, one or more symbols may illuminate on the instrument panel and a message may appear on its display.

A text message can be acknowledged by briefly pressing the **OK** button on the direction indicator stalk.



City Safety™

Symbol	Message	Meaning/Action
 	Auto braking by City Safety	City Safety™ is braking or has automatically braked.
 	Windscreen Sensors blocked	The laser sensor is temporarily non-operational because something is blocking it. <ul style="list-style-type: none">• Remove the object blocking the sensor and/or clean the windscreen in front of the sensor. Read about the limitations of the laser sensor, see page 169.
 	City Safety Service required	City Safety™ is not operational. <ul style="list-style-type: none">• Visit a workshop if the message remains - an authorised Volvo workshop is recommended.



Collision Warning with Auto Brake & Pedestrian Protection*

General

"Collision Warning with Auto Brake & Pedestrian Detection" is an aid to assist the driver when there is a risk of colliding with a pedestrian or vehicle in front that is stationary or moving in the same direction.

Collision Warning with Auto Brake & Pedestrian Detection is activated in situations where the driver should have started braking earlier, which is why it cannot help the driver in every situation.

Collision Warning with Auto Brake & Pedestrian Detection is designed to be activated as late as possible in order to avoid unnecessary intervention.

Collision Warning with Auto Brake & Pedestrian Detection may prevent a collision or reduce the collision speed.

Collision Warning with Auto Brake & Pedestrian Detection must not be used as an excuse for the driver to change his/her driving style. If the driver solely relies on Collision Warning with Auto Brake to do the braking, there will be a collision sooner or later.

Two system levels

Depending on how the car equipped, the Collision Warning with Auto Brake & Pedestrian Detection function may appear in two variants: **Level 1** and **Level 2**.

Level 1

The driver is merely warned of occurring obstacles by means of visual and acoustic signals - no automatic braking intervenes, the driver must himself brake.

Level 2

The driver is warned of occurring obstacles by means of visual and acoustic signals - the car is braked automatically if the driver himself does not act within a reasonable time.

IMPORTANT

Maintenance of components included in Collision Warning with Auto Brake & Pedestrian Detection must only be carried out in a workshop - an authorised Volvo workshop is recommended.

Function

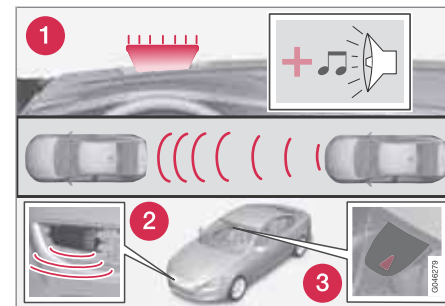

Function overview¹.

- 1** Audio-visual warning signal in the event of a collision risk.
- 2** Radar sensor²
- 3** Camera sensor

Collision Warning with Auto Brake executes three steps in the following order:

1. **Collision warning**
2. **Brake support²**
3. **Auto Brake²**

¹ NOTE: The illustration is schematic - details may vary depending on car model.

² With system Level 2 only.



Collision Warning with Auto Brake & Pedestrian Protection*

The collision warning system and City Safety™ complement each other. For more information on City Safety™, see page 168.

1 - Collision warning

The driver is first warned of a potentially imminent collision.

The collision warning system detects pedestrians, stationary vehicles as well as vehicles driving in the same direction in front of the car.

If there is a risk of collision with a pedestrian or a vehicle, the driver's attention is attracted with a flashing red warning signal (no. [1] in the illustration on page 173) and an acoustic signal.

2 - Brake support²

If the risk of collision has increased further after the collision warning then the brake support is activated.

This means that the brake system is prepared for rapid braking by applying the brakes lightly, which may feel like a slight jolt.

If the brake pedal is depressed sufficiently quickly then full brake function is implemented.

Brake support also reinforces the driver's braking if the system considers that the braking is not sufficient to avoid a collision.

3 - Auto Brake²

The automatic brake function is activated last.

If in this situation the driver has not yet started to take evasive action and the risk of collision is imminent then the automatic braking function is deployed - this takes place irrespective of whether or not the driver brakes. Braking then takes place with full brake force in order to reduce collision speed, or with limited brake force if it is sufficient to avoid a collision.



WARNING

The collision warning system does not engage in all driving situations or traffic, weather or road conditions. The collision warning system does not react to vehicles driving in another direction to the car or to animals.

Warning only activated in the event of a high risk for collision. This section "Function" and the section "Limitations" inform about limitations that the driver must be aware of before using the Collision Warning system with Auto Brake.

Warnings and brake interventions for pedestrians are switched off at vehicle speeds exceeding 80 km/h.

Warnings and brake interventions for pedestrians do not work in darkness and tunnels - not even when streetlights are lit.

The auto-brake function can prevent a collision or reduce collision speed. To ensure full brake performance, the driver should always depress the brake pedal - even when the car auto-brakes.

Never wait for a collision warning. The driver is always responsible that the correct distance and speed are maintained - even when the collision warning system with auto-brake is used.

² With system Level 2 only.

* Option/accessory, for more information, see Introduction.



Collision Warning with Auto Brake & Pedestrian Protection*

Detection of pedestrians

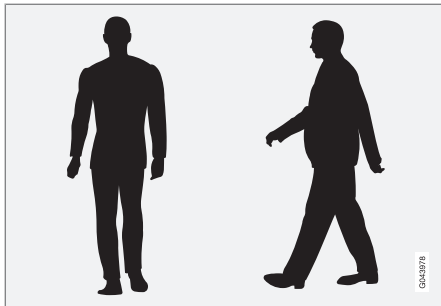

Optimal examples of what the system regards as pedestrians with clear body contours.

Optimal performance of the system requires that the system function that detects pedestrians receives as unambiguous information as possible about the contours of the body - this implies the opportunity to identify the head, arms, shoulders, legs, upper and lower body combined with a normal human pattern of movement.

If large parts of the body are not visible to the camera then the system cannot detect a pedestrian.

- In order for a pedestrian to be detected he/she must appear full-length and have a height of at least 80 cm.
- The system cannot detect a pedestrian carrying larger items.
- The camera sensor's ability to see pedestrians at dusk and dawn is limited - just like the human eye.
- The camera sensor's capacity to detect pedestrians is deactivated when driving in darkness and tunnels - even when street-lights are lit.

WARNING

Collision Warning with Auto Brake & Pedestrian Detection is an assistance tool.

This function cannot detect all pedestrians in all situations and it cannot see e.g. partially obscured pedestrians, people in clothing that hides the contours of the body or pedestrians shorter than 80 cm.

- The driver is always responsible that the vehicle is driven properly and with a safety distance adapted to the speed.

Operation

Settings are made from **MY CAR** via the centre console display screen and menu system. For information on how the menu system is used, see page 202.

NOTE

The Brake Support and Auto Brake functions are always enabled - they cannot be deactivated.

On and Off

To select whether the collision warning system should be switched on or off:

- Use the menu system **MY CAR** via the centre console display to search for **Settings → Car settings → Driver support systems → Collision Warning** - there, select **On** or **Off**.

An activated function is tested every time the engine is started by briefly illuminating the separate lights for the warning lamp (no. [1] in the illustration on page 173).

When starting the engine, the setting that was selected when the engine was switched off is obtained automatically.



Collision Warning with Auto Brake & Pedestrian Protection*

Activating/deactivating warning signals

The warning lamp (no. [1] in the illustration on page 173) is activated automatically when the engine is started if Collision Warning is enabled.

The warning sound can be activated/deactivated separately:

- Select **On** or **Off** in the menu system **MY CAR** under **Settings** → **Car settings** → **Driver support systems** → **Collision Warning** → **Warning sound**.

Set warning distance

The warning distance regulates the distance at which the visual and acoustic warnings are deployed.

- Select one of the options from **Long**, **Normal** or **Short** in the menu system **MY CAR** under **Settings** → **Car settings** → **Driver support systems** → **Collision Warning** → **Warning distance**.

The warning distance determines the system's sensitivity. Warning distance **Long** provides an earlier warning. First test with **Long** and if this setting produces too many warnings, which could be perceived as irritating in certain sit-

uations, then change to warning distance **Normal**.

Only use warning distance **Short** in exceptional cases, e.g. for dynamic driving.

NOTE

When the adaptive cruise control is in use the warning lamp and warning sound will be used by the cruise control even if the collision warning system is switched off.

The collision warning system warns the driver in the event of a risk of a collision, but the function cannot shorten driver reaction time.

In order for the collision warning system to be effective, always drive with the Distance Alert set at time interval 4 – 5. see page 165.

NOTE

Even if the warning distance has been set to **Long** warnings could be perceived as being late in certain situations, e.g. when there are large differences in speed or if vehicles in front brake heavily.

WARNING

No automatic system can guarantee 100 % correct function in all situations. Therefore, never test the Auto Brake system by driving at people or vehicles - this may cause severe damage and injury and risk lives.

Checking settings

The settings required can be controlled on the centre console display screen. Search with the menu system **MY CAR** under **Settings** → **Car settings** → **Driver support systems** → **Collision Warning**, see page 202.

Maintenance

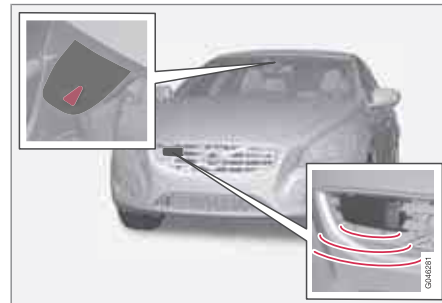

Camera and radar sensor³.

³ NOTE: The illustration is schematic - details may vary depending on car model.

* Option/accessory, for more information, see Introduction.

**Collision Warning with Auto Brake & Pedestrian Protection***

For the sensors to work correctly, they must be kept clear of dirt, ice and snow, and be cleaned regularly with water and car shampoo.

NOTE

Dirt, ice and snow covering the sensors will reduce their function and may prevent measurement.

Limitations

Collision Warning with Auto Brake and Pedestrian Detection is active from approx. 4 km/h.

The visual warning signal (no. [1] in the illustration on page 173) may be difficult to notice in the event of strong sunlight, reflections, when sunglasses are being worn or if the driver is not looking straight ahead. The warning sound should therefore always be activated.

On slippery road surfaces the braking distance is extended, which may reduce the capacity to avoid a collision. In such situations the ABS and DSTC systems will provide best possible braking force with maintained stability.

NOTE

The visual warning signal can be temporarily disengaged in the event of high passenger compartment temperature caused by strong sunlight for example. If this occurs then the warning sound is activated even if it is deactivated in the menu system.

- Warnings may not appear if the distance to the vehicle in front is small or if steering wheel and pedal movements are large, e.g. a very active driving style.

WARNING

Warnings and brake interventions could be implemented late or not at all if the traffic situation or external influences mean that the radar or camera sensor cannot detect a pedestrian or a vehicle in front correctly.

The sensor system has a limited range for pedestrians and the system therefore provides effective warnings and brake interventions at vehicle speeds up to 50 km/h. For stationary or slow-moving vehicles, warnings and brake interventions are effective at vehicle speeds up to 70 km/h.

Warnings for stationary or slow-moving vehicles could be disengaged due to darkness or poor visibility.

Warnings and brake interventions for pedestrians are switched off at vehicle speeds exceeding 80 km/h.

The collision warning system uses the same radar sensors as adaptive cruise control. For more information on the radar sensor and its limitations, see page 178.

If warnings are perceived as being too frequent or disturbing then the warning distance can be reduced. This then leads to the system providing a warning at a later stage, which reduces the total number of warnings; see the section "Set warning distance" on page 176.



Collision Warning with Auto Brake & Pedestrian Protection*

Collision Warning with Auto Brake is temporarily deactivated with reverse gear engaged.

Collision Warning with Auto Brake is not activated at low speeds - under 4 km/h, which is why the system does not intervene in situations where the car is approaching a vehicle in front very slowly, e.g. when parking.

In situations where the driver demonstrates active, aware driving behaviour, a collision warning may be postponed slightly in order to keep unnecessary warnings to a minimum.

When Auto Brake has prevented a collision with a stationary object the car remains stationary for a maximum of 1.5 seconds. If the car is braked for a vehicle in front that is moving, then speed is reduced to the same speed as that maintained by the vehicle in front.

On a car with manual gearbox the engine stops when Auto Brake has stopped the car, unless the driver manages to depress the clutch pedal beforehand.

Camera sensor limitations

The car's camera sensor is also used - as well as by Collision Warning with Auto Brake - by the functions:

- Automatic main/dipped beam dimming - see page 88
- Road sign information - see page 148

- Driver Alert Control – see page 182
- Lane Departure Warning – see page 185.

NOTE

Keep the windscreen surface in front of the camera sensor clean from ice, snow, mist and dirt.

Do not attach or fit anything to the windscreen in front of the camera sensor, as this could reduce or prevent the function of one or more camera-dependent systems.

The camera sensors have limitations similar to the human eye, i.e. they "see" worse in darkness, heavy snowfall or rain and in thick fog for example. Under such conditions the functions of camera-dependent systems could be significantly reduced or temporarily disengaged.

Strong oncoming light, reflections in the carriageway, snow or ice on the road surface, dirty road surfaces or unclear lane markings could also significantly reduce camera sensor function when it is used to scan the carriageway and detect pedestrians and other vehicles.

The field of vision of the camera sensor is limited, which is why pedestrians and vehicles cannot be detected in some situations, or they are detected later than anticipated.

During very high temperatures the camera is temporarily switched off for about 15 minutes

after the engine is started in order to protect camera functionality.

Fault tracing and action

If the display shows the message **Windscreen Sensors blocked** then this means that the camera sensor is blocked and cannot detect pedestrians, vehicles or road markings in front of the car.

At the same time, this means that - besides Collision Warning with Auto Brake - the Automatic main/dipped beam dimming, Road sign information, Driver Alert Control and Lane Departure Warning functions will not have full functionality either.

The following table presents possible causes for a message being shown along with the appropriate action.

**Collision Warning with Auto Brake & Pedestrian Protection***

Cause	Action
The windscreen surface in front of the camera is dirty or covered with ice or snow.	Clean the windscreen surface in front of the camera from dirt, ice and snow.
Thick fog, heavy rain or snow means that the camera does not work sufficiently well.	No action. At times the camera does not work during heavy rain or snowfall.

Cause	Action
The windscreen surface in front of the camera has been cleaned but the message remains.	Wait. It may take several minutes for the camera to measure the visibility.

Cause	Action
Dirt has appeared between the inside of the windscreen and the camera.	Visit a workshop to have the windscreen inside the camera cover cleaned - an authorised Volvo workshop is recommended.

04



Symbols and messages in the display

Symbol	Message	Specification
	Collis'n warning OFF	Collision warning system switched off. Shown when the engine is started. The message clears after about 5 seconds or after one press of the OK button.
	Collision warn. Unavailable	The collision warning system cannot be activated. Shown when the driver attempts to activate the function. The message clears after about 5 seconds or after one press of the OK button.
	Auto braking was activated	Auto Brake has been active. The message clears after one press of the OK button.





Collision Warning with Auto Brake & Pedestrian Protection*

Symbol	Message	Specification
	Wind-screen Sensors blocked	<p>The camera sensor is temporarily disengaged.</p> <p>Shown in the event of snow, ice or dirt on the windscreen for example.</p> <ul style="list-style-type: none">• Clean the windscreen surface in front of the camera sensor. <p>Read about the limitations of the camera sensor, see page 178.</p>
	Radar blocked See manual	<p>Collision Warning with Auto Brake is temporarily disengaged.</p> <p>The radar sensor is blocked and cannot detect other vehicles. For example, in the event of heavy rain or if slush has collected in front of the radar sensor.</p> <p>Read about the limitations of the radar sensor, see page 160.</p>
	Collision warn. Service required	<p>Collision Warning with Auto Brake is fully or partially disengaged.</p> <ul style="list-style-type: none">• Visit a workshop if the message remains - an authorised Volvo workshop is recommended.

**Driver Alert System*****General information on Driver Alert System**

The Driver Alert System is intended to assist drivers whose driving ability is deteriorating or who are inadvertently leaving the lane they are driving on.

The Driver Alert System consists of different functions which can either be switched on at the same time or individually:

- Driver Alert Control – DAC, see page 182.
- Lane Departure Warning – LDW, see page 185.

A switched-on function is set in standby mode and is not activated automatically until speed exceeds 65 km/h.

The function is deactivated again when speed decreases to below 60 km/h.

Both functions use a camera which is dependent on the lane having side markings painted on each side.

**WARNING**

The Driver Alert System does not work in all situations but is instead only intended to be of supplementary assistance.

The driver always has ultimate responsibility that the car is driven safely.



Driver Alert System - DAC*

General information on DAC

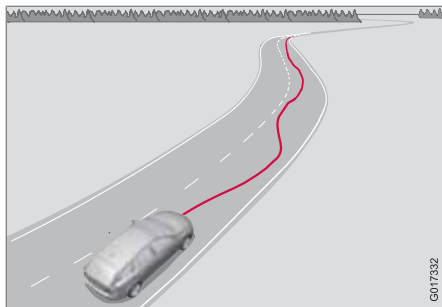

The DAC (Driver Alert Control) function is intended to attract the driver's attention when he/she starts to drive less consistently, e.g. if he/she becomes distracted or starts to fall asleep.

A camera detects the side markings painted on the carriageway and compares the section of the road with the driver's steering wheel movements. The driver is alerted if the vehicle does not follow the carriageway evenly.

i NOTE

The camera sensor has certain limitations, see page 178.

The objective for DAC is to detect slowly deteriorating driving ability and it is primarily intended for major roads. The function is not intended for city traffic.

In some cases driving ability is not affected despite driver fatigue. In which case there may not be any warning issued for the driver. For this reason it is always important to stop and take a break in the event of any signs of driver fatigue, irrespective of whether or not DAC issues a warning.

i NOTE

The function must not be used to extend a driving stint. Always plan breaks at regular intervals and ensure that you are fully rested.

Limitation

In some cases the system may issue a warning despite driving ability not deteriorating, for example:

- if the driver tests the LDW function.
- in strong side winds.
- on rutted road surfaces.

Operation

Some settings are made from the centre console display screen and its menu system. For information on how the menu system is used, see page 202.

The current status of Driver Alert can be checked on the trip computer display with the thumbwheel on the left-hand stalk switch.



- 1** Thumbwheel. Turn until the display shows **Driver Alert**. On the second row the options **Driver Alert Standby <65 km/h**, **Driver Alert**

Unavailable or level mark  can be shown.

- 2** **OK** confirms or clears a warning in the memory.

**Driver Alert System - DAC*****On/Off**

To set Driver Alert in standby mode:

- Search on the centre console's display screen with its **MY CAR** menu system and locate **Car settings** → **Driver support systems** → **Driver Alert** and tick the box.
- No tick in the box: Function disengaged.

Function

Driver Alert is activated when speed exceeds 65 km/h and remains active as long as the speed is over 60 km/h.

The display shows a level mark with 1-5 bars, where a low number of bars indicates inconsistent driving style. Many bars indicates stable driving.

If the vehicle is driven inconsistently then the driver is alerted by an acoustic signal as well as the text message **Driver Alert Time for a break**. The warning is repeated after a time if driving ability does not improve.

**WARNING**

An alarm should be taken very seriously, as a sleepy driver is often not aware of his/her own condition.

In the event of an alarm or a feeling of tiredness; stop the car in a safe manner as soon as possible and rest.

Studies have shown that it is equally as dangerous to drive while tired as it is under the influence of alcohol.





Symbols and messages in the display

Symbol	Message	Specification
	Driver Alert OFF	The function is disengaged.
	Driver Alert Standby <65 km/h	The function is set in standby mode due to speed being lower than 65 km/h.
	Driver Alert Unavailable	The carriageway does not have clear side markings or the camera sensor is temporarily disengaged. Read about the limitations of the camera sensor, see page 178.
	Driver Alert	The function analyses the driver's driving style. The number of bars can vary in the range 1-5, where a low number of bars indicates inconsistent driving ability. A high number of bars indicates stable driving.



04 Driver support

Driver Alert System - DAC*

Symbol	Message	Specification
	Driver Alert Time for a break	The vehicle has been driven inconsistently - the driver is alerted by an acoustic warning signal + text.
	Windscreen Sensors blocked	The camera sensor is temporarily disengaged. Shown in the event of snow, ice or dirt on the windscreen for example. <ul style="list-style-type: none">• Clean the windscreen surface in front of the camera sensor. Read about the limitations of the camera sensor, see page 178.
 	Driver Alert Sys Service required	The system is disengaged. <ul style="list-style-type: none">• Visit a workshop if the message remains - an authorised Volvo workshop is recommended.

04



Driver Alert System - LDW*

General information on - LDW

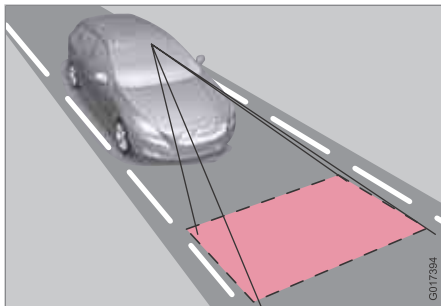

The LDW (Lane Departure Warning) function is intended to reduce the risk of so-called single-vehicle accidents – accidents where, in certain situations, the vehicle leaves the carriageway and is in danger of driving either into a ditch or into oncoming traffic.

LDW consists of a camera that detects the side markings painted on the carriageway. The driver is alerted by an acoustic signal if the vehicle crosses a side marking.

Operation and function



The function is switched on or off by means of a switch on the centre console. An indicator lamp in the button illuminates when the function is switched on.

The trip computer display shows **Lane Depart Warn Standby <65 km/h** when the function is in standby mode due to speed being below 65 km/h.

The LDW function is activated automatically from standby mode after the camera has scanned in the carriageway's side markings and speed exceeds 65 km/h. The trip computer display then shows **Lane Depart Warn Available**.

If the camera can no longer detect the carriageway's side markings the display shows **Lane Depart Warn Unavailable**.

If speed decreases to below 60 km/h then the function resumes standby mode and the display shows **Lane Depart Warn Standby <65 km/h**.

If the vehicle crosses the left or right-hand side marking of the carriageway without due cause then the driver is alerted by an acoustic signal.

No warning is given in the following situations:

- Direction indicators activated
- The driver has his/her foot on the brake pedal¹
- In the event of the accelerator pedal being depressed rapidly¹
- In the event of rapid steering wheel movements¹
- In the event of a sudden turn so that the car rolls.

The camera sensor also has certain limitations. For more information, see page 178.

¹ A warning is still given when Increased sensitivity is selected, see page 187.



04 Driver support

Driver Alert System - LDW*

NOTE

The driver is only warned once each time the wheels cross a line. So there is no acoustic alarm when there is a line between the car's wheels.

Symbols and messages in the display

Symbol	Message	Specification
	Lane departure warning ON/Lane departure warning OFF	The function is switched on/off. Shown at switch-on/off. The text disappears after 5 seconds.
	Lane Depart Warn Standby <65 km/h	The function is set in standby mode due to speed being lower than 65 km/h.
	Lane Depart Warn Unavailable	The carriageway does not have clear side markings or the camera sensor is temporarily disengaged. Read about the limitations of the camera sensor, see page 178.
	Lane Depart Warn Available	The function scans the carriageway's side markings.

* Option/accessory, for more information, see Introduction.



Driver Alert System - LDW*

Symbol	Message	Specification
	Windscreen Sensors blocked	<p>The camera sensor is temporarily disengaged.</p> <p>Shown in the event of snow, ice or dirt on the windscreen for example.</p> <ul style="list-style-type: none"> • Clean the windscreen surface in front of the camera sensor. <p>Read about the limitations of the camera sensor, see page 178.</p>
 	Driver Alert Sys Service required	<p>The system is disengaged.</p> <ul style="list-style-type: none"> • Visit a workshop if the message remains - an authorised Volvo workshop is recommended.

04

Personal preferences

Settings are made from the centre console's display screen via the menu system in **MY CAR**. From there, search and locate **Settings** → **Car settings** → **Driver support systems** → **Lane Departure Warning**. For information on how the menu system is used - see page 202.

Select from the options:

- **On at start-up** - The function enters standby mode every time the engine is

started. Otherwise the same value as when the engine was switched off is obtained.

- **Increased sensitivity** - The sensitivity increases, an alarm is triggered earlier and fewer limitations apply.

* Option/accessory, for more information, see Introduction.



Park assist syst*

General

Parking assistance is used as an aid to parking. An acoustic signal as well as symbols on the centre console's display screen indicate the distance to the detected obstacle.

Parking assistance sound level can be adjusted during the ongoing acoustic signal using the centre console's **VOL** knob or in the car's menu system **MY CAR** - see page 202.

Parking assistance is available in two variants:

- Rear only
- Both front and rear.

NOTE

When a towbar is configured with the car's electrical system, the protrusion of the towbar is included when the function measures the parking space.

WARNING

- Parking assistance does not relinquish the driver's own responsibility during parking.
- The sensors have blind spots where obstacles cannot be detected.
- Be aware of e.g. people or animals near the car.

Function



The system is automatically activated when the engine is started - the switch's On/Off lamp is illuminated. If parking assistance is switched off with the button, the lamp goes out.

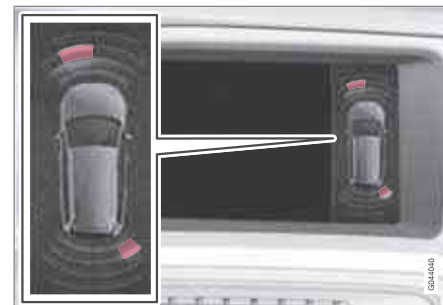

Display screen view - showing an obstacle left front and right rear.

The centre console's display screen shows an overview of the relationship between the car and detected obstacle.

Marked sectors show which of the four sensor(s) detected an obstacle. The closer to the car symbol a selected sector box is, the shorter the distance between the car and a detected obstacle.

The frequency of the signal increases the shorter the distance to an obstacle, in front of or behind the car. Other sound from the audio system is muted automatically.

When the distance is within 30 cm the tone is constant and the active sensor's field nearest the car is filled in. If the detected obstacle is within the distance for the constant tone both



Park assist syst*

behind and in front of the car, then the tone sounds alternately from the loudspeakers.

! IMPORTANT

Certain objects e.g. chains, thin glossy poles or low barriers may be in the "signal shadow" and are then temporarily not detected by the sensors - the pulsating tone may then unexpectedly stop instead of changing over to the expected constant tone.

- In which case, pay extra attention and manoeuvre/reposition the car particularly slowly or stop the current parking manoeuvre - there may be a high risk of damage to vehicles or other objects since the sensors are unable to function optimally.

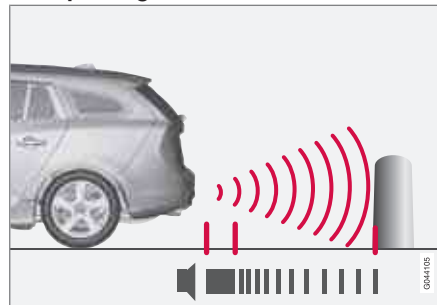
Rear parking assistance

The distance covered to the rear of the car is about 1.5 metres. The acoustic signal for obstacles behind comes from one of the rear loudspeakers.

Rear parking assistance is activated when reverse gear is engaged.

The system must be deactivated when reversing with a trailer or bike carrier on the towbar or similar - otherwise they would trigger the sensors.

i NOTE

Rear parking assistance is deactivated automatically when towing a trailer if Volvo genuine trailer wiring is used.

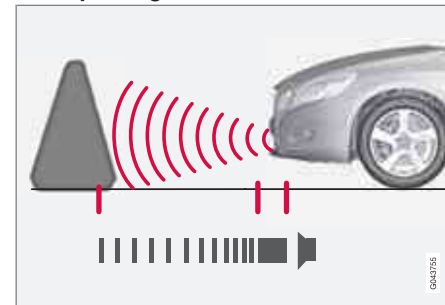
Front parking assistance

The distance covered in front of the car is about 0.8 metres. The acoustic signal for obstacles in front comes from one of the front loudspeakers.

Front parking assistance is active up to 15 km/h. The lamp in the button is illuminated in order to indicate that the system is activated. When the speed is below 10 km/h the system is reactivated.

i NOTE

Front parking assistance is deactivated when the parking brake is applied or **P** mode is selected in a car with an automatic gearbox.



Park assist syst*

! IMPORTANT

When fitting auxiliary lamps: Remember that they must not obscure the sensors – the auxiliary lamps could then be detected as obstacles.

Fault indicator

i If the information symbol illuminates with constant glow and the information display shows **Park assist syst Service required** then parking assistance is disengaged.

! IMPORTANT

In certain conditions the parking assistance system may produce incorrect warning signals that are caused by external audio frequencies that emit the same ultrasonic frequencies that the system works with.

Examples of such sources include horns, wet tyres on asphalt, pneumatic brakes and exhaust noises from motorcycles etc.

Cleaning the sensors



Sensor location, front.



Sensor location, rear.

The sensors must be cleaned regularly to ensure that they work properly. Clean them with water and car shampoo.

i NOTE

Dirt, ice and snow covering the sensors may cause incorrect warning signals.



Park assist camera*

General

The parking camera is an assist system and is activated when reverse gear is engaged (can be changed in the settings menu, see page 202).

The camera image is shown on the centre console's screen.

i NOTE

When a towbar is configured with the car's electrical system, the protrusion of the towbar is included when the function measures the parking space.

! WARNING

- The parking camera serves as an aid. It does not relieve the driver of responsibility when reversing.
- The camera has blind spots, where obstacles cannot be detected.
- Be aware of people and animals in the vicinity of the car.

Function and operation



CAM button location.

The camera shows what is behind the car and if something appears from the sides.

The camera shows a wide area behind the car and part of the bumper and any towbar.

Objects on the screen may appear to tilt slightly - this is normal.

i NOTE

Objects on the display screen may be closer to the car than they appear to be on the screen.

If another view is active the parking camera system takes over automatically and the camera image is displayed on the screen.

When reverse gear is engaged two unbroken lines are shown graphically which illustrate where the car's rear wheels will roll with the current steering wheel angle, this facilitates tight parking, reversing into tight spaces and for hitching a trailer. The car's approximate external dimensions are illustrated by means of two dashed lines. These help lines can be switched off in the settings menu.

If the car is also equipped with parking assistance sensors* then their information is displayed graphically as coloured fields in order to illustrate the distance to detected obstacles, see page 188.

The camera is active approx. 5 seconds after reverse gear has been disengaged or until the car's speed exceeds 10 km/h.



Camera location next to the opening handle.



Park assist camera*

Light conditions

The camera image is adjusted automatically according to prevailing light conditions. Because of this, the image may vary slightly in brightness and quality. Poor light conditions can result in a slightly reduced image quality.

NOTE

Keep the camera lens clear of dirt, snow and ice to ensure optimum function. This is particularly important in poor light.

Park assist lines

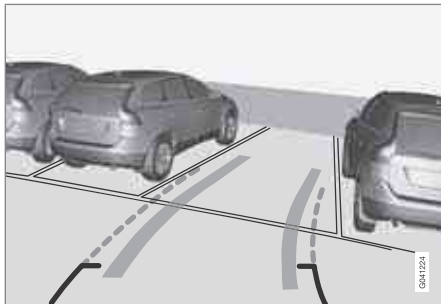

Examples of how the park assist lines can be displayed for the driver.

The lines on the screen are projected as if they were at ground level behind the car and are directly related to steering wheel movement,

which shows the driver the path the car will take, even when turning.

NOTE

- When reversing with a trailer which is not connected electrically to the car, the lines on the display show the route the car will take - not the trailer.
- The screen shows no lines when a trailer is connected electrically to the car's electrical system.
- The parking camera is deactivated automatically when towing a trailer if a Volvo genuine trailer cable is used.

IMPORTANT

Bear in mind that the screen only shows the area behind the car - pay attention to the sides and front of the car when manoeuvring during reversing.

Boundary lines

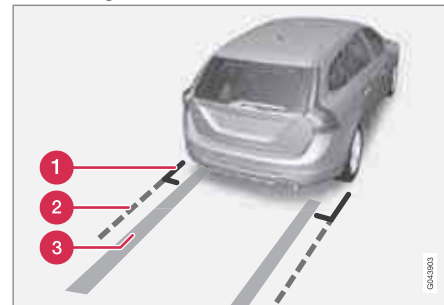

The system's lines.

- 1 Boundary line, 30 cm zone backwards from the car
- 2 Boundary line, free reversing zone
- 3 "Wheel tracks"

The unbroken line (1) frames in a zone that is within about 30 cm from the bumper.

The dashed line (2) frames in a zone up to about 1.5 m back from the bumper. It is also the limit of the car's most protruding parts, such as door mirrors and corners - also during turning.

The wide "wheel tracks" (3) between the side lines indicate where the wheels will roll and can extend about 3.2 m back from the bumper if no obstacle is in the way.

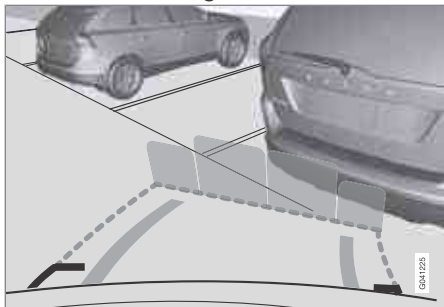
**Park assist camera*****Cars with reversing sensors***

Coloured areas (x 4, one per sensor) show distance.

If the car is also equipped with parking assistance sensors (see page 188) the distance indication will be more precise and the coloured areas show which of the 4 sensors is/are registering an obstacle.

The colour of the areas changes with decreasing distance to the obstacle - from yellow to orange to red.

Colour / paint	Distance (metres)
Yellow	1.5–
Orange	0.3–1.5
Red	0–0.3

Settings

Press **OK/MENU** when a camera view is shown. Make the settings as desired.

Miscellaneous

- The default setting is that the camera is activated when reverse gear is engaged.
- One press on **CAM** activates the camera even if reverse gear is not engaged.
- Change between normal and zoomed image by turning **TUNE** or by pressing **CAM**.
- If the car has more cameras* installed then the camera in use is changed by turning **TUNE**.

Limitations**NOTE**

A bike carrier or other accessory mounted on the rear of the car could obscure the camera's view.

Pay attention to the possibility that, even if it only looks like a relatively small part of the image is obscured, it could be a relatively large sector that is hidden from view. Obstacles could thereby go undetected until they are very close to the car.

To bear in mind

- Keep the camera lens free from dirt, ice and snow.
- Clean the camera lens regularly with luke-warm water and car shampoo - take care not to scratch the lens.



BLIS* – Blind Spot Information System

General information on BLIS

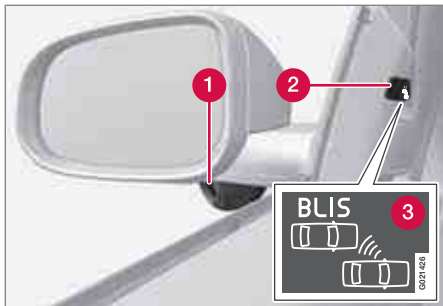

Rearview mirror with BLIS function¹.

- 1 BLIS camera
- 2 Indicator lamp
- 3 BLIS symbol

BLIS is an information system based on camera technology that under certain conditions can help the driver to notice vehicles moving in the same direction as the host vehicle in the so-called "blind spot".

WARNING

The system is a supplement to, not a replacement for, a safe driving style and use of the rearview mirrors. It can never replace the driver's attention and responsibility. The responsibility for changing lanes safely always rests with the driver.

The system is designed to work most effectively when driving in dense traffic on multi-lane highways.

When a camera (1) has detected a vehicle inside the blind spot zone the indicator lamp (2) illuminates with a constant glow.

NOTE

The lamp illuminates on the side of the car where the system has detected the vehicle. If the car is overtaken on both sides at the same time then both lamps illuminate.

BLIS advises the driver with a message if a fault arises in the system. If for example the system's cameras are obscured then the BLIS indicator lamp flashes and a message is shown on the information display. In such cases, check and clean the lenses.

If necessary, the system can be switched off temporarily, see the section "Activate/deactivate".

Blind spots

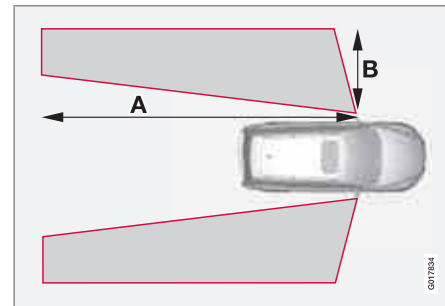

A = approx. 9.5 m and B = approx. 3.0 m.

¹ NOTE: The illustration is schematic - details may vary depending on car model.

**BLIS* – Blind Spot Information System****Activate/deactivate**

Button for activating/deactivating.

BLIS is activated when the engine is started. The indicator lamps in the door panels flash three times when BLIS is activated.

The system can be deactivated/activated after starting the engine with one press on the **BLIS** button.

Some combinations of the selected equipment leave no vacant space for a button in the centre console - in which case the function is handled by the car's menu system **MY CAR** under **Settings → Car settings → BLIS**. (For a description of the menu system - see page 202).

When BLIS is deactivated, the lamp in the button goes out and a message is shown in the instrument panel display.

When BLIS is activated the light in the button illuminates, a new text message is shown on the display and the indicator lamps in the door panels flash 3 times. Press the **OK** button to delete the text message. (For a description of messages - see page 200).

When BLIS operates

The system operates when the car is driven at a speed above 10 km/h.

Overtaking

The system is designed to react if:

- you overtake another vehicle at a speed of up to 10 km/h faster than the other vehicle
- you are overtaken by a vehicle travelling up to 70 km/h faster than you are travelling.

WARNING

BLIS does not work in sharp bends.

BLIS does not work when the car is reversing.

A wide trailer coupled to the car can conceal other vehicles in adjacent lanes. It can prevent the vehicle in the screened area from being detected by BLIS.

Daylight and darkness

In daylight the system reacts to the shape of the surrounding vehicles. The system is designed to detect motor vehicles such as cars, trucks, buses and motorcycles.

In darkness the system reacts to the headlamps of surrounding vehicles. If the headlamps of surrounding vehicles are not switched on then the system does not detect the vehicles. This means for example that the system does not react to a trailer without headlamps which is towed behind a car or truck.

WARNING

The system does not react to cyclists or moped riders.

The BLIS cameras have limitations similar to those of the human eye, i.e. they do not "see" as well e.g. in heavy snowfall, against strong light or in thick fog.



BLIS* – Blind Spot Information System

Cleaning

In order to work most effectively the BLIS camera lenses must be clean. The lenses can be cleaned with a soft cloth or damp sponge. Clean the lenses carefully so that they are not scratched.

! IMPORTANT

The lenses are electrically heated to melt ice or snow. If necessary, brush snow away from the lenses.

Messages on the display

Message	Specification
Blind-spot info system ON	The BLIS system is activated.
Blind spot syst. Service required	Blind spot syst. disengaged - contact a workshop.
Blind spot syst. Camera blocked	The BLIS camera is blocked by dirt, snow or ice - clean the lenses.

Message	Specification
Blind spot syst. Reduced function	Reduced function in the data transmission between the BLIS system's camera and the car's electrical system. The camera resets itself when the data transmission between the BLIS system's camera and the car's electrical system returns to normal.
Blind-spot info system OFF	The BLIS system is deactivated.

! IMPORTANT

Repair of the BLIS system components must only be performed by a workshop - an authorised Volvo workshop is recommended.

Limitations

In some situations the BLIS indicator lamp may illuminate despite there being no other vehicle within the blind spot.

i NOTE

If the BLIS indicator lamp illuminates on isolated occasions despite there being no other vehicle within the blind spot then this does not mean that a fault has arisen in the system.

In the event of a fault in the BLIS system the display shows the text **Blind spot syst. Service required**.

The following illustrations show examples of situations where the BLIS indicator lamp may illuminate even if there is no other vehicle within the blind spot.

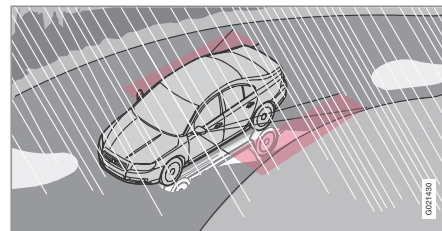

Reflection from shiny wet road surface.

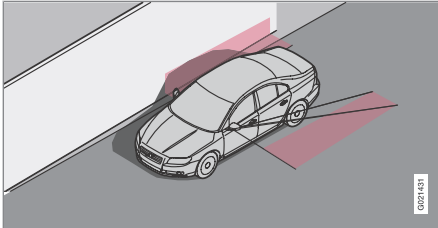
**BLIS* – Blind Spot Information System**

Own shadow on large light smooth surface, e.g. noise barrier or concrete road surface.

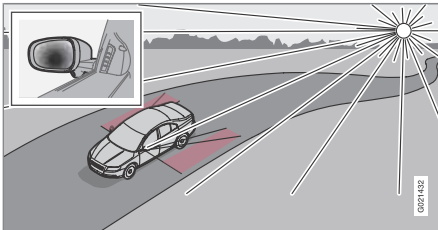

Low stationary sunlight shining into the camera.

Menus and messages.....	200
Menu source MY CAR.....	202
Climate control.....	210
Fuel-driven engine block heater and passenger compartment heater*	220
Additional heater*.....	223
Trip computer.....	224
Adapting driving characteristics.....	226
Comfort inside the passenger compartment.....	227



05

COMFORT AND DRIVING PLEASURE



Menus and messages

Combined instrument panel

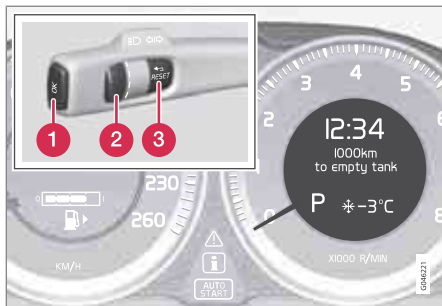

Information display and controls for menus.

- 1 **OK** – access to message list and message confirmation.
- 2 Thumbwheel – browse between menu options.
- 3 **RESET** – reset the active function. Used in certain cases to select/activate a function, see the explanation under each respective function.

The menus shown on the information displays in the combined instrument panel are controlled with the left-hand stalk switch. The menus shown depend on key position, see page 78. If a message appears then this must

be acknowledged with **OK** for the menus to be shown.

Menu overview

Some of the following menu options require the function and hardware to be installed in the car.

- km to empty tank
- I/100km average
- I/100km instantaneous
- km/h average speed
- km/h current speed¹
- Engine oil level Wait...*
- Tyre pressure Calibration*
- Park heat timer --:-- ---*²
- Direct start Park heat ON*³
- Additional heat auto ON*
- Lane Depart Warn *
- Driver Alert *

Message



Text message in the information display.

When a warning, information or indicator symbol illuminates, a corresponding message appears on the information display. An error message is stored in a memory list until the fault has been rectified.

Press **OK** to acknowledge and browse between the messages.

¹ Only certain markets.

² Programming is only possible when the engine is switched off.

³ Cannot be selected when the additional heater is operating.



Menus and messages

 NOTE

If a warning message appears while you are using the trip computer, the message must be read (press **OK**) before the previous activity can be resumed.

Message	Specification
Stop safely ^A	Stop and switch off the engine. Serious risk of damage - consult a workshop ^B .
Stop engine ^A	Stop and switch off the engine. Serious risk of damage - consult a workshop ^B .
Service urgent ^A	Contact a workshop ^B to check the car immediately.
Service required ^A	Contact a workshop ^B to check the car as soon as possible.
See manual ^A	Read the owner's manual.
Book time for maintenance	Time to book regular service - contact a workshop ^B .

Message	Specification
Time for regular maintenance	Time for regular service - contact a workshop ^B . The timing is determined by the number of kilometres driven, number of months since the last service, engine running time and oil grade.
Maintenance overdue	If the service intervals are not followed then the warranty does not cover any damaged parts - contact a workshop ^B .
Transmission oil Change needed	Contact a workshop ^B to check the car as soon as possible.
Transmission performance low	The gearbox cannot handle full capacity. Drive carefully until the message clears ^C . If shown repeatedly - contact a workshop ^B .

Message	Specification
Transmission hot Reduce speed	Drive more smoothly or stop the car in a safe manner. Disengage the gear and run the engine at idling speed until the message clears ^C .
Transmission hot Stop safely	Critical fault. Stop the car immediately in a safe manner and contact a workshop ^B .
Temporarily OFF ^A	A function has been temporarily switched off and is reset automatically while driving or after starting again.
Low battery Power save mode	The audio system is switched off to save energy. Charge the battery.

A Part of message, shown together with information on where the problem has arisen.

B An authorised Volvo workshop is recommended.

C For more messages concerning automatic transmission, see page 125.



Menu source MY CAR

General information on MY CAR



Many of the car's functions are handled in this menu source, such as setting the clock, door mirrors and locks.

Navigation in the menus is carried out using buttons on the centre console or with the steering wheel's right-hand keypad.

Certain functions are standard, others are optional - the range also varies depending on the market.

Operation

Centre console controls



Centre console controls for menu navigation.

- 1 Press **MY CAR** to open the menus under **MY CAR**.
- 2 Press **OK MENU** to select/tick in the highlighted menu option or to store the selected function in the memory.
- 3 Turn the **TUNE** knob to scroll up/down among the menu options.
- 4 **EXIT**

EXIT functions

Depending on the function the cursor is on when **EXIT** is pressed, and on the menu level, one of the following occurs:

- phone call is rejected
- current function is interrupted
- input characters are deleted
- most recent selections are undone
- leads up in the menu system

Short and long presses can also produce varying results.

A long press leads to the highest menu level (Main source view), from where all of the car's functions/menu sources can be accessed - see also page 236.



Menu source MY CAR

Steering wheel keypad*

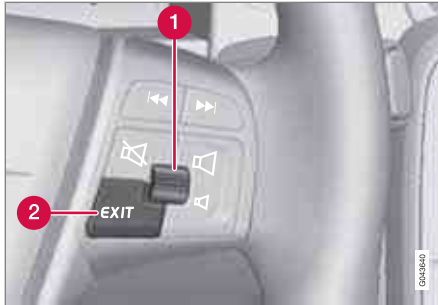

The keypad may vary depending on market.

- 1 Turn the thumbwheel knob to scroll up/down among the menu options.
- 1 Press the thumbwheel to select/tick in the highlighted menu option or to store the selected function in the memory.
- 2 EXIT (see heading "EXIT functions" page 202).

Search paths

Current menu level is shown at the top right of the centre console display screen. Search paths to the menu system functions are described in this manual in the following form:

Settings → Car settings → Lock settings → Doors unlock → Driver door, then all.

The following is an example of how a function can be accessed and adjusted using the steering wheel keypad:

1. Press the centre console button **MY CAR**.
2. Scroll to the desired menu, e.g. **Settings**, with the thumbwheel (1) and then **press** the thumbwheel - a submenu opens.
3. Scroll to the desired menu, e.g. **Car settings** and press the thumbwheel - a submenu opens.
4. Scroll to **Lock settings** and press the thumbwheel - a new submenu opens.
5. Scroll to **Doors unlock** and press the thumbwheel - a submenu of selectable functions opens.
6. Choose between the options **All doors** and **Driver door**, then all and press the thumbwheel - a cross is marked in the option's empty box.
7. Exit the programming by backing out of the menus incrementally with short presses on **EXIT** (2) or with one long press.

The procedure is the same as with the centre console's buttons - see page 202: **OK MENU** (2), **EXIT** (4) and the **TUNE** knob (3).

MY CAR

The following options are available in menu source **MY CAR**:



- My V60
- DRiVe*
- Support systems
- Settings

Menu source MY CAR

My V60



MY CAR → My V60

The display screen shows a grouping of all of the car's driver support systems - these can be activated or deactivated here.

My DRIVE*

Parts of Volvo's DRIVE concept are described here, amongst other things.

- **Start/Stop**
- **Eco driving guide**

For more information - see page 127.

Driver support system

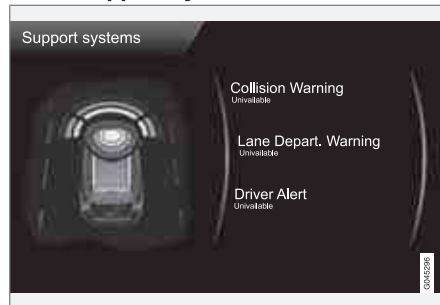

MY CAR → Support systems

The display screen shows a summary of the current status of the car's driver support systems.

Setup - menus

The menus are structured as follows:

Menu level 1	
Menu level 2	p. x
Menu level 3	
Menu level 4	

Shown here are the 4 first menu levels under **MY CAR → Settings**. Some menus have further submenus - these are then described in detail in their respective sections.

When selecting whether a function should be activated/**On** or deactivated/**Off** a square is displayed:

On: Selected square.

Off: Empty square.

- Select **On/Off** with **OK** - then back out of the menu with **EXIT**.

Car settings	
Car key memory	p. 81 and 103
On	
Off	



Menu source MY CAR

Lock settings Automatic door locking On Off Doors unlock All doors Driver door, then all Keyless entry All doors Any door Doors on same side Both front doors	p. 46, 55 and 59
Reduced Guard Activate once Ask when exiting	p. 60 and 64
Side mirror settings Fold mirrors Tilt left mirror Tilt right mirror	p. 103

Light settings Door lock confirmation light On Off Unlock confirmation light On Off	p. 44
Approach light duration Off 30 sec 60 sec 90 sec	p. 46 and 94
Home safe light duration 30 sec 60 sec 90 sec	p. 94

Triple indicator On Off	p. 92
Temporary LH traffic On Off	p. 94
or Temporary RH traffic On Off	
Active bending lights On Off	p. 90
Auxiliary lights On Off	p. 91



05 Comfort and driving pleasure

Menu source MY CAR

<p>Tyre pressure system*</p> <p>Warns if tyre pressure is too low</p> <p>Calibrate tyre pressure</p>	p. 319	<p>Collision Warning</p> <p>On</p> <p>Off</p> <p>Warning distance</p> <p>Long</p> <p>Normal</p> <p>Short</p> <p>Warning sound</p> <p>On</p> <p>Off</p>	p. 173	<p>DSTC</p> <p>On</p> <p>Off</p>	p. 146
<p>Steering wheel force</p> <p>Low</p> <p>Medium</p> <p>High</p>	p. 226	<p>Lane Departure Warning</p> <p>On</p> <p>Off</p> <p>On at start-up</p> <p>On</p> <p>Off</p> <p>Increased sensitivity</p> <p>On</p> <p>Off</p>	p. 185	<p>City Safety</p> <p>On</p> <p>Off</p>	p. 9 and 168
<p>Reset car settings</p> <p>All menus in Car settings are given original factory settings.</p>		<p>BLIS</p> <p>On</p> <p>Off</p>		<p>Distance Alert</p> <p>On</p> <p>Off</p>	p. 194
<p>Driver support systems</p>		<p>Driver Alert</p> <p>On</p> <p>Off</p>		<p>System options</p>	p. 165
				<p>Time</p> <p>The instrument panel clock is set here.</p>	p. 182

05



Menu source MY CAR

Time format 12 h 24 h	p. 75
Screen saver On Off The TV screen's current content fades out after a period of inactivity and is replaced by a blank screen if this option is selected. The current screen content returns if any of the TV screen's buttons or controls are actuated.	p. 202
Language Selects language for menu texts.	
Show help text On Off Explanatory text for the display screen's current content is shown with this option selected.	

Distance and fuel units MPG (UK) MPG (US) km/l l/100km	p. 224
Temperature unit Celsius Fahrenheit Selects the unit for the display of outside temperature and setting of the climate control system.	
Volume levels Voice output volume Front park assist volume Rear park assist volume Phone ringing volume	
Reset system options All menus in System options are given original factory settings.	
Voice settings	

Voice tutorial

This menu option + **OK** provides spoken information about how the system works.



Menu source MY CAR

Voice command list

Phone commands

Phone

Phone call contact

Phone dial number

Navigation commands

Navigation

Navigation repeat instruction

Navigation go to address

General commands

Help

Cancel

Voice tutorial

The menu options under **Phone commands** show several examples of available voice commands - only with a Bluetooth®-enabled mobile phone installed. For more

and detailed information - see page 262.

The menu options under **Navigation commands** show several examples of available voice commands - only with Volvo's navigation system RTI* installed.

Voice user setting

Default setting

User 1

User 2

Here there is the option to create a second user profile - an advantage if more than one person shall use the car/system regularly.

Default setting gives factory settings.

Voice training

User 1

User 2

With **Voice training** the voice recognition system is taught to recognise the driver's voice and pronunciation. A number of phrases are presented on the screen for the driver to read aloud. When the system has learnt how the driver talks, the presentation of the phrases stops. Following which e.g. **User 1** can be selected in **Voice user setting** in order that the system shall listen to the right user.

Voice output volume

A volume control appears on the screen - at which point, proceed as follows:

1. Adjust the volume with the thumbwheel.
2. Test-listen using **OK**.
3. Use **EXIT** to store the setting and the menu is switched off.



Menu source MY CAR

<p>Voice POI list</p> <p>Edit list</p> <p>The number of facilities is extensive and varies depending on market. Maximum 30 favourite facilities can be stored in this list.</p> <p>Menu option Voice POI list is only shown if Volvo's navigation system RTI* is installed. For more information on Facilities and Voice recognition - see the Navigation system's owner's manual.</p>		<p>Automatic blower adjustment p. 210</p> <p>Normal</p> <p>High</p> <p>Low</p> <p>Recirculation timer</p> <p>On</p> <p>Off</p> <p>Automatic rear defroster</p> <p>On</p> <p>Off</p> <p>Interior air quality system</p> <p>On</p> <p>Off</p> <p>Reset climate settings</p> <p>All menus in Climate settings are given original factory settings.</p>		<p>Number of keys p. 44</p> <p>VIN number p. 370</p> <p>DivX® VOD code p. 255</p> <p>Bluetooth software version in car p. 261</p> <p>Map and software version*</p> <p>Only in cars with Volvo GPS navigator - see separate manual.</p>	
<p>Audio settings</p>	p. 235	<p>Favourites (FAV)</p>	p. 239		
<p>Climate settings</p>		<p>Volvo On Call</p> <p>Described in a separate manual.</p>			
<p>Information</p>					



Climate control

General

Climate control

The car is equipped with electronic climate control. The climate control system cools or heats as well as dehumidifies the air in the passenger compartment.

i NOTE

The air conditioning system (AC) can be switched off, but to ensure the best possible climate comfort in the passenger compartment and to prevent the windows from misting, it should always be on.

Actual temperature

The temperature you select corresponds to the physical experience with reference to factors such as air speed, humidity and solar radiation etc. in and around the car.

The system includes a sun sensor which detects on which side the sun is shining into the passenger compartment. This means¹ that the temperature can differ between the right and left-hand air vents despite the controls being set for the same temperature on both sides.

¹ Only applies to ECC.

Sensor location

- The sun sensor is located on the top side of the dashboard.
- The temperature sensor for the passenger compartment is located below the climate control panel.
- The outside temperature sensor is located on the door mirror.
- The humidity sensor* is located by the interior rearview mirror.

i NOTE

Do not cover or block the sensors with clothing or other objects.

Side windows and sunroof*

To ensure that the air conditioning works optimally, the side windows, and sunroof* if specified, should be closed.

Misting windows

Remove misting on the insides of the windows by primarily using the defroster function.

To reduce the risk of misting, keep the windows clean and use window cleaner.

Temporary shut-off of the air conditioning

When the engine requires full power, e.g. for full acceleration or driving uphill with a trailer, the air conditioning can be temporarily switched off. There may then be a temporary increase in temperature in the passenger compartment.

Condensation

In warm weather, condensation from the air conditioning may drip under the car. This is normal.

Ice and snow

Remove ice and snow from the climate control system air intake (the grille between the bonnet and the windscreen).

Total airing function

The function opens/closes all side windows simultaneously and can be used for example to quickly air the car during hot weather, see page 58.

Passenger compartment filter

All air entering the car's passenger compartment is cleaned with a filter. This must be replaced at regular intervals. Follow the Volvo Service Programme for the recommended replacement intervals. If the car is used in a

* Option/accessory, for more information, see Introduction.



Climate control

severely contaminated environment, it may be necessary to replace the filter more often.

i NOTE

There are different types of passenger compartment filter. Make sure that the correct filter is fitted.

Clean Zone Interior Package (CZIP)*

This option keeps the passenger compartment clear of allergy and asthma inducing substances. For more information on CZIP, see the brochure included with the purchase of the car.

The following is included:

- An enhanced fan function that means that the fan starts when the car is opened with the remote control key. The fan fills the passenger compartment with fresh air. The function starts when required and is disengaged automatically after a time or when one of the passenger compartment doors is opened. The amount of time the fan runs is reduced gradually due to reduced need up until the car is 4 years old.
- The air quality system IAQS is a fully automatic system that cleans the air in the passenger compartment from contaminants such as particles, hydrocarbons, nitrous oxides and ground-level ozone.

i NOTE

To keep the CZIP standard in cars with CZIP the IAQS filter must be changed after 15 000 km or once per year depending on whichever occurs first. However, up to 75 000 km over 5 years. In cars without CZIP and where the customer does not want to keep the CZIP standard the IAQS filter must be changed at a regular service.

Use of tested materials in the interior equipment.

The materials have been developed in order to minimise the quantity of dust in the passenger compartment and they contribute to making the passenger compartment easier to keep clean. The carpets in both the passenger compartment and the cargo area are removable and easy to remove and clean. Use cleaning agents and car care products recommended by Volvo, see page 363.

Menu settings

It is possible to activate/deactivate or change the default settings for four of the climate control system's functions via the centre console. For general information about menu navigation, see page 203:

- Fan speed in automatic mode*, see page 216.
- Recirculation timer for passenger compartment air, see page 217.
- Automatic rear window defrosting, see page 104.
- Air quality system IAQS*, see page 217

The climate control system's functions can be reset to the default settings via the menu system in **MY CAR** and this is carried out under: **Settings** → **Climate settings** → **Reset climate settings**.

Air distribution

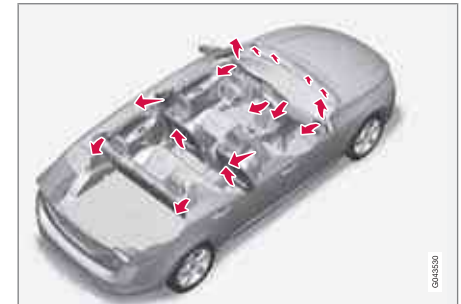

The incoming air is divided between a number of different vents in the passenger compartment.



05 Comfort and driving pleasure

Climate control

Air distribution is fully automatic in **AUTO** mode*.

If necessary it can be controlled manually, see page 219.

Air vents in the dashboard



- A** Open
- B** Closed

- C** Lateral airflow
- D** Vertical airflow

Aim the outer vents at the side windows to remove misting.

Air vents in the door pillars

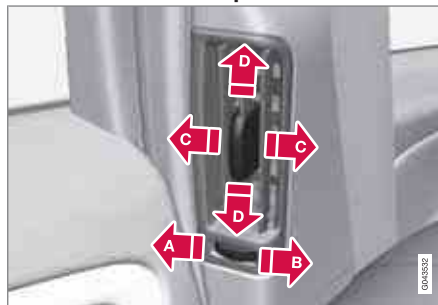

- A** Closed
- B** Open
- C** Lateral airflow
- D** Vertical airflow

Aim the vents at the windows to remove misting in cold weather.

Aim the vents into the passenger compartment to maintain a comfortable climate in the rear seat in hot weather.

i NOTE

Remember that small children may be sensitive to air flows and draughts.



Climate control

Electronic climate control, ECC*

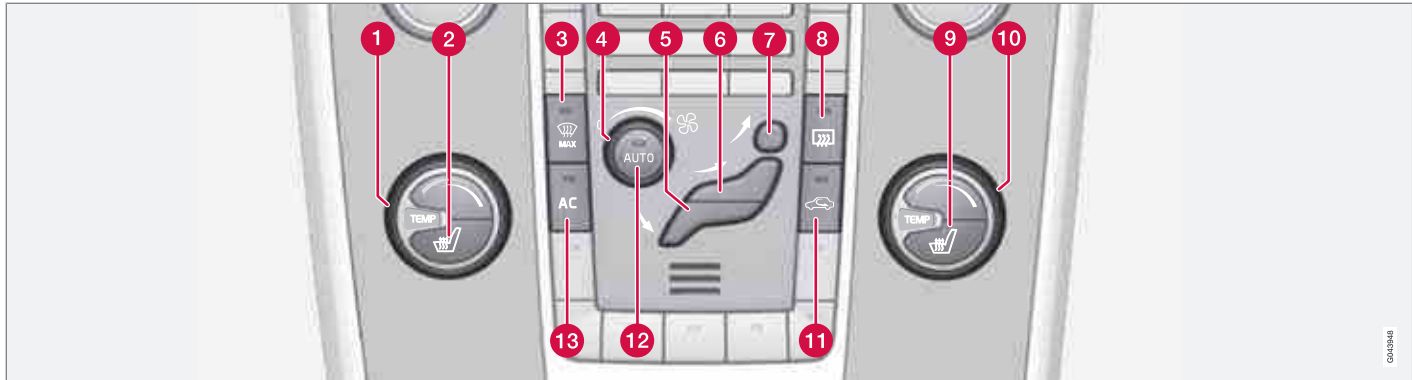

- | | | |
|--|--|---|
| 1 Temperature control, left-hand side | 6 Air distribution - air vent instrument panel | 10 Temperature control, right-hand side |
| 2 Electrically heated front seat, left-hand side | 7 Air distribution - defroster windscreen | 11 Recirculation |
| 3 Max. defroster | 8 Rear window and door mirror defrosters, see page 104 | 12 AUTO |
| 4 Fan | 9 Electrically heated front seat, right-hand side | 13 AC -- Air conditioning on/off |
| 5 Air distribution - ventilation floor | | |



Climate control

Electronic Temperature Control, ETC

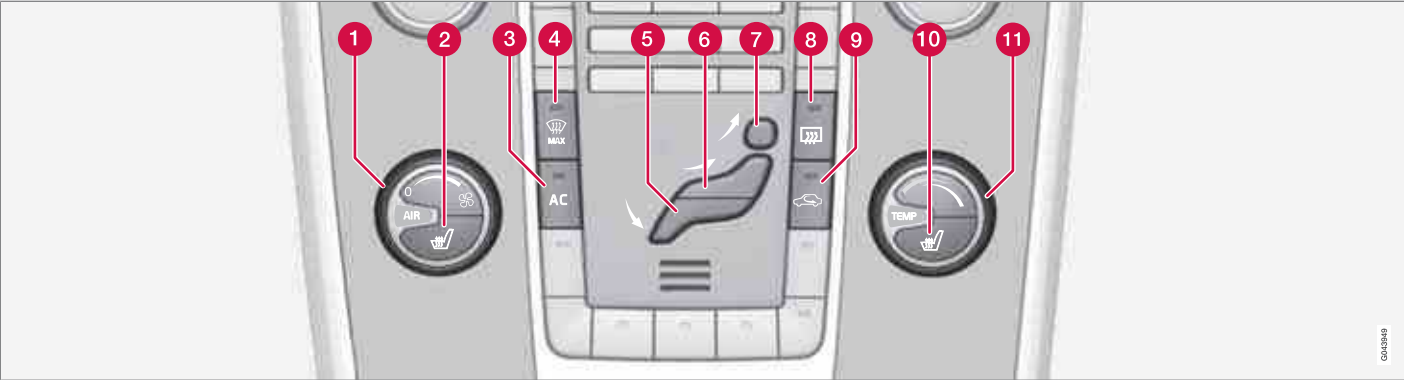

- 1** Fan
- 2** Electrically heated front seat, left-hand side
- 3** AC -- Air conditioning on/off
- 4** Max. defroster
- 5** Air distribution - ventilation floor
- 6** Air distribution - air vent instrument panel
- 7** Air distribution - defroster windscreen
- 8** Rear window and door mirror defrosters, see page 104
- 9** Recirculation
- 10** Electrically heated front seat, right-hand side
- 11** Temperature control

06103919



Climate control

Operating the controls

Heated seats*

Front seats



Current heat level is shown in the centre console TV screen.



One press on the button gives the highest heat level - three orange lamps illuminate in the centre console TV screen (see figure above).

Press the button twice for a lower heat level – two orange lamps illuminate in the TV screen.

Press the button three times for the lowest heat level – one orange lamp illuminates in the TV screen.

Press the button four times to switch off the heat – no lamps illuminate.

WARNING

The heated seat should not be used by people who find it difficult to perceive temperature increase because of sensory loss or for any reason have difficulty in managing to use the control of the heated seat. Otherwise, burn injuries may arise.

Rear seat²



Press the button once for the highest heat level – three lamps illuminate.

Press the button twice for a lower heat level – two lamps illuminate.

Press the button three times for the lowest heat level – one lamp illuminates.

Press the button four times to switch off the heat – no lamps illuminate.

Fan

NOTE

If the fan is fully switched off then the air conditioning is not engaged - which can cause a risk of misting on the windows.

Fan knob for ECC*



Turn the knob to increase or decrease fan speed. If **AUTO** is selected then fan speed is regulated automatically. The previously set fan speed is disengaged.

² Not included if 2-stage booster cushion is selected.



Climate control

Fan knob for ETC



Turn the knob to increase or decrease fan speed.

Air distribution

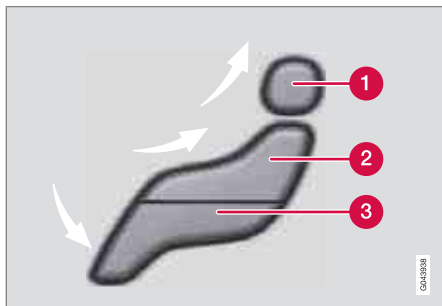

- 1 Air distribution - defroster windscreen
- 2 Air distribution - air vent instrument panel
- 3 Air distribution - ventilation floor

The figure consists of three buttons. When pressing the buttons the corresponding figure is illuminated in the TV screen (see figure below) and an arrow in front of each part of the

figure shows the air distribution that is selected. For more information on air distribution, see page 219.



The selected air distribution is shown in the centre console TV screen.

AUTO¹



The Auto function automatically regulates temperature, air conditioning, fan speed, recirculation, and air distribution.

If you select one or more manual functions, the other functions continue to be controlled automatically. All manual settings are disengaged

when **AUTO** is pressed. The TV screen shows **AUTO CLIMATE**.

Fan speed in automatic mode can be set in the menu system **MY CAR** under: **Settings** → **Climate settings** → **Automatic blower adjustment**. Choose between **Low**, **Normal** or **High**:

- **Low** - Automatic fan control. Low airflow is prioritised.
- **Normal** - Automatic fan control.
- **High** - Automatic fan control. A more intense airflow is prioritised.

For a description of the menu system, see page 203.

Temperature control



The temperature can be adjusted with the knob. For ECC* the temperature for the driver's side and the passenger side can be set separately.

When the car is started, the most recent setting is resumed.

¹ Only applies to ECC.



Climate control

 **NOTE**

Heating or cooling cannot be hastened by selecting a higher/lower temperature than the actual temperature required.

AC – Air conditioning on/off

When the lamp in the **AC** button illuminates, the air conditioning is controlled by the system's automatic function. This way, incoming air is cooled and dehumidified.

When the lamp in the **AC** button is switched off the air conditioning is disconnected. Other functions are still controlled automatically. When the max. defroster function is activated the air conditioning is switched on automatically, so that the air is dehumidified at the maximum setting.

Max. defroster

Used to quickly remove misting and ice from the windscreen and side windows. Air flowing to the windows. The light in the defroster button illuminates when the function is active.

The following also takes place in order to provide maximum dehumidification in the passenger compartment:

- the air conditioning is automatically engaged
- recirculation and the air quality system are automatically disengaged.

 **NOTE**

The noise level increases as the fan is operating at max.

When the defroster is switched off the climate control returns to the previous settings.

Recirculation**Recirculation**

When recirculation is engaged the orange lamp in the button illuminates. The function is selected to shut out bad air, exhaust gases etc. from the passenger compartment. The air in the passenger compartment is recirculated, i.e. no outside air is taken into the car when this function is activated.

 **IMPORTANT**

If the air in the car recirculates for too long, there is a risk of misting on the insides of the windows.

Timer

With the timer function activated the system will exit manually activated recirculation mode according to a time that depends on the outside temperature. This reduces the risk of ice, misting and bad air. Activate/deactivate the function in the menu system **MY CAR** under **Settings → Climate settings → Recirculation timer**. For a description of the menu system, see page 203.

 **NOTE**

When max. defroster is selected, recirculation is always deactivated.

Air quality system IAQS*

The air quality system separates gases and particles to reduce the levels of odours and pollution in the passenger compartment. If the outside air is contaminated then the air intake is closed and the air is recirculated.

Activate/deactivate the function in the menu system **MY CAR** under **Settings → Climate**



Climate control

settings → Interior air quality system. For a description of the menu system, see page 203.

NOTE

The air quality sensor should always be engaged in order to obtain the best air in the passenger compartment.

Recirculation is limited in cold weather to avoid misting.

If the insides of the windows start misting up, disengage the air quality sensor, and the defroster functions for the windscreen, the side and the rear windows should also be used to demist the windows.









Cars with Eco Start/Stop DRIVE*

With an auto-stopped engine certain equipment has its function temporarily reduced, e.g. climate control fan speed. For more information, see page 127.



Climate control

Air distribution table

	Air distribution	Use		Air distribution	Use
	Air to windows. Some air flows from the air vents. The air is not recirculated. Air conditioning is always engaged.	to remove ice and misting quickly.		Air to the floor and windows. Some air flows from the dashboard air vents.	to ensure comfortable conditions and good demisting in cold or humid weather.
	Air to windscreen, via defroster vent, and side windows. Some air flows from the air vents.	to prevent misting and icing in a cold and humid climate, (not at too low fan speed to enable this).		Air to floor and from dashboard air vents.	in sunny weather with cool outside temperatures.
	Airflow to windows and from dashboard air vents.	to ensure good comfort in warm, dry weather.		Air to floor. Some air flows to the dashboard air vents and windows.	to direct heat or cold to the floor.
	Airflow to the head and chest from the dashboard air vents.	to ensure efficient cooling in warm weather.		Airflow to windows, from dashboard air vents and to the floor.	to provide cooler air along the floor or warmer air higher up in cold weather or hot, dry weather.

Fuel-driven engine block heater and passenger compartment heater*

Fuel-driven heater

General information about the parking heater

The parking heater heats the engine and passenger compartment and can be started directly or with the timer.

Two different times can be selected using the timer. Here, time refers to the time when the car is heated and ready. The car's electronic system calculates when heating should be started based on the outside temperature.

The heater cannot start if the outside temperature exceeds 15 °C. At -5 °C or lower the maximum running time of the parking heater is 50 minutes.

WARNING

The car must be outdoors when the parking heater is used.

NOTE

When the parking heater is active there may be smoke from the right-hand wheel housing, which is perfectly normal.

Refuelling

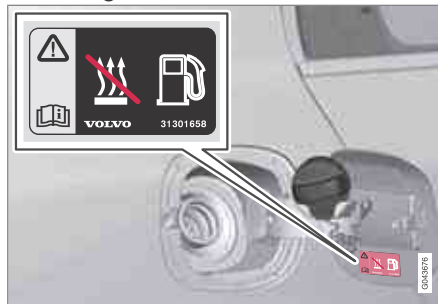

Warning label on fuel filler flap.

WARNING

Fuel which spills out can be ignited. Switch off the fuel-driven heater before starting to refuel.

Check the information display to see that the parking heater is switched off. When it is running, the information display shows **Park heat ON**.

Parking on a hill

If the car is parked on a steep hill, the front of the car should point downhill to ensure that there is a supply of fuel to the parking heater.

Battery and fuel

If the battery has insufficient charge or the fuel level is too low, the parking heater will be switched off automatically and a message appears on the information display. Acknowledge the message by pressing the indicator stalk **OK** button once, see page 221.

IMPORTANT

Repeated use of the parking heater combined with short journeys may discharge the battery and impair starting.

The car should be driven for the same time as the heater is used to ensure that the car's battery is recharged adequately to replace the energy consumed by the heater when it is used on a regular basis.



Fuel-driven engine block heater and passenger compartment heater*

Operation

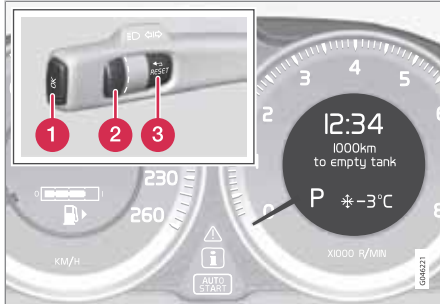



- 1 **OK** button
- 2 Thumbwheel
- 3 **RESET** - resets/selects



For more information on the information display and **OK**, see page 200.





Symbols and display messages

 When one of the timer's settings or **Direct start** is activated, the information symbol in the combined instrument panel illuminates while the information display shows an explanatory text and a further illuminated symbol. The table shows symbols and display texts that appear.

 **NOTE**

 - Figure 2 in the symbol means the second climate control system in the car, where the normal climate control system is the first. The figure 2 has nothing to do with **TIMER 1** or **TIMER 2**.

Symbol	Display	Specification
	Fuel heater ON	The heater is switched on and running.
	Timer is set for Fuel heater	The heater's timer is activated after the remote control key has been removed from the ignition switch and leaving the car - the engine and passenger compartment are heated at the set time.

Symbol	Display	Specification
 	Heater stopped Batt. save mode	The heater has been stopped by the car's electronics in order to facilitate starting the engine.
 	Heater unavailable. Low fuel level	Setting the heater is not possible due to fuel level being too low (approx. 7 litres) - this is in order to facilitate starting the engine as well as approx. 50 km driving.
	Park heater Service required	Heater not working. Contact a workshop for repair. Volvo recommends that you contact an authorised Volvo workshop.



Fuel-driven engine block heater and passenger compartment heater*

A display text clears automatically after a time or after one press on the indicator stalk **OK** button.

Direct start and immediate stop

1. Scroll with the thumbwheel to **Direct start Park heat**.
2. Press **RESET** to select between **ON** and **OFF**.

ON: Parking heater switched on manually or with programmed timer.

OFF: Parking heater switched off.

Following the direct start of the heater it will be activated for 50 minutes.

Heating of the passenger compartment will begin as soon as the engine coolant has reached the correct temperature.

NOTE

The car can be started and driven while the parking heater is running.

Setting the timer

The time when the car shall be used and heated is specified with the timer.

Select between **TIMER 1** and **TIMER 2**.

NOTE

The timer can only be programmed when the remote control key is in key position **I**, see page 78 - programming must therefore be carried out before starting the engine.

1. Scroll with the thumbwheel to **Park heat timer 1**.
2. Briefly press **RESET** to move to the flashing hours setting.
3. Select the required hour using the thumbwheel.
4. Briefly press **RESET** to move to the flashing minutes setting.
5. Select the required minute using the thumbwheel.
6. Briefly press **RESET** to confirm the setting.
7. Press **RESET** to activate the timer.

After setting **Park heat timer 1** a second start time can be programmed with **Park heat timer 2** by scrolling to it with the thumbwheel.

Set the alternative time in the same way as **Park heat timer 1**.

Deactivating a timer-started heater

A timer-started heater can be switched off manually before the set time has elapsed. Proceed as follows:

1. Press **OK**.
2. Use the thumbwheel to scroll to the text **Park heat timer 1** or **2**.
 - > The text **ON** flashes on the display.
3. Press **RESET**.
 - > The text **OFF** is shown with a constant glow and the heater is switched OFF.

A timer-started heater can be switched off in accordance with the instructions in the section "Direct start and immediate stop", see page 222.

Clock/timer

The heater's time is connected to the car's clock.

NOTE

All timer programming will be cleared if the car's clock is reset.



Additional heater*

General information about the additional heater

In cold climate zones¹ an additional heater may be required to obtain the correct operating temperature in the engine and to obtain sufficient heating in the passenger compartment.

Fuel-driven additional heater

A fuel-driven additional heater is fitted in cars with diesel engines.

The heater starts automatically when extra heat is required when the engine is running.

The heater is switched off automatically when the correct temperature is reached or when the engine is switched off.

i NOTE

When the additional heater is active there may be smoke from the right-hand wheel housing which is perfectly normal.

Auto mode or shutdown

The additional heater's automatic start sequence can be switched off if required.

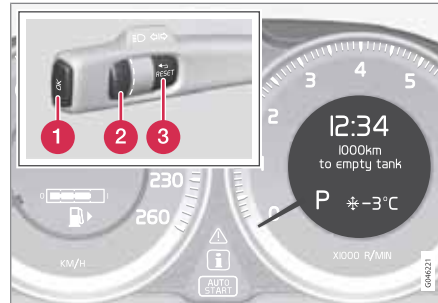

- 1** OK button
- 2** Thumbwheel
- 3** RESET button

1. Before starting the engine: Select key position **I**, see page 78.
2. Scroll with the thumbwheel to **Additional heat auto**.
3. Press **RESET** to select between **ON** and **OFF**.

i NOTE

The menu options are only visible in key position **I** - any adjustments must therefore be made before starting the engine.

Passenger compartment heater*

If the additional heater is supplemented with timer function then it can be used as a fuel-driven passenger compartment heater, see page 220.

Electric additional heater

Cars with certain petrol engines² have an electric additional heater integrated into the car's climate control system.

In a semi-cold¹ climate zone diesel-driven cars have an electric additional heater instead of a fuel-driven version.

The heater cannot be controlled manually but is instead activated automatically after the engine has been started in outside temperatures below 14 °C and is switched off after the set passenger compartment temperature has been reached.

¹ An authorised Volvo dealer has information regarding the geographical areas concerned.

² An authorised Volvo dealer has information regarding the engines concerned.



Trip computer

General

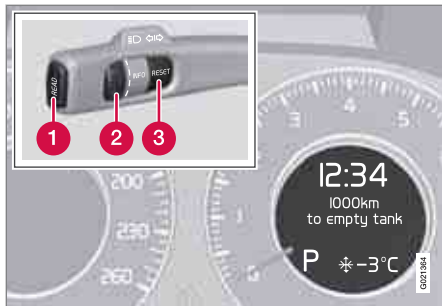

Information display and controls.

- 1 **OK** - confirms.
- 2 Thumbwheel – browse between menus and options in the trip computer list.
- 3 **RESET** – resets.

The trip computer's menu is in a variable loop. One of the menu options is a blank display - it also marks the beginning/end of the loop.

Functions

i NOTE

If a warning message appears when the trip computer is used then the message must first be acknowledged before the trip computer can be reactivated. Acknowledge the warning message by pressing **OK**.

To change unit for distance and speed - go to **MY CAR → Settings → System options → Distance and fuel units**, see page 202.

Average speed

Average speed is calculated from the last resetting. Reset using **RESET**.

Instantaneous

Current fuel consumption is calculated every second. The information on the display is updated every couple of seconds. When the car is stationary, "----" appears on the display.

Average

Average fuel consumption is calculated from the last resetting. Reset using **RESET**.

i NOTE

There may be a slight error in the reading if a fuel-driven supplementary and/or parking heater* has been used.

Km to empty tank

The calculation is based on the average fuel consumption over the last 30 km and the remaining driveable fuel quantity. The display shows the approximate distance that can be driven with the fuel quantity remaining in the tank.

An economic driving style generally results in a longer driving distance. For more information on how fuel consumption can be influenced, see page 11.

No guaranteed range remains when the display shows "---- **km to empty tank**". Refuel as soon as possible.

i NOTE

There may be a slight error in the reading if the driving style has been changed.

Resetting

1. Select --- **km/h average speed** or --.- **l/100km average**.

**Trip computer**

2. Press and hold **RESET** for approx. 1 second to reset the selected function. If **RESET** is kept depressed for at least 3 three seconds then Average speed and Average are reset simultaneously.

Current speed*¹

The instrument panel display changes to show current speed in mph (miles per hour) if the speedometer is graduated in km/h. If the speedometer is graduated in mph then the display changes to km/h.

¹ Only certain markets.



Adapting driving characteristics

Active chassis - Four-C*

Active chassis, Four-C (Continuously Controlled Chassis Concept), regulates the characteristics of the shock absorbers so that the car's driving characteristics can be adjusted. There are three settings: **Comfort**, **Sport** and **Advanced**.

Comfort

This setting means that the car is perceived as being more comfortable on rough and uneven road surfaces. Shock absorption is soft and the movement of the body is smooth and gentle.

Sport

This setting means that the car is perceived as being more sporty and is recommended for more active driving. Steering response is faster than in the Comfort mode. Shock absorption is harder and the body follows the road in order to reduce rolling during cornering.

Advanced

This setting is only recommended on very even and smooth road surfaces.

The shock absorbers are optimised for maximum roadholding and rolling in bends is further minimised.

Operation



Chassis settings.

Use the buttons in the centre console to change setting. The setting in use when the engine is switched off is activated next time the engine is started.

Speed related power steering*

Steering force increases with the speed of the car to give the driver enhanced sensitivity. The steering is firmer and more immediate on motorways. Steering is light and requires no extra effort when parking and at low speed.

The driver can choose between three different levels of steering force for road responsiveness or steering sensitivity. Go to the menu system **MY CAR** and locate **Settings** → **Car settings**

→ **Steering wheel force** and select **Low**, **Medium** or **High**.

For a description of the menu system, see page 202. This menu cannot be accessed while the car is in motion.



Comfort inside the passenger compartment

Storage spaces

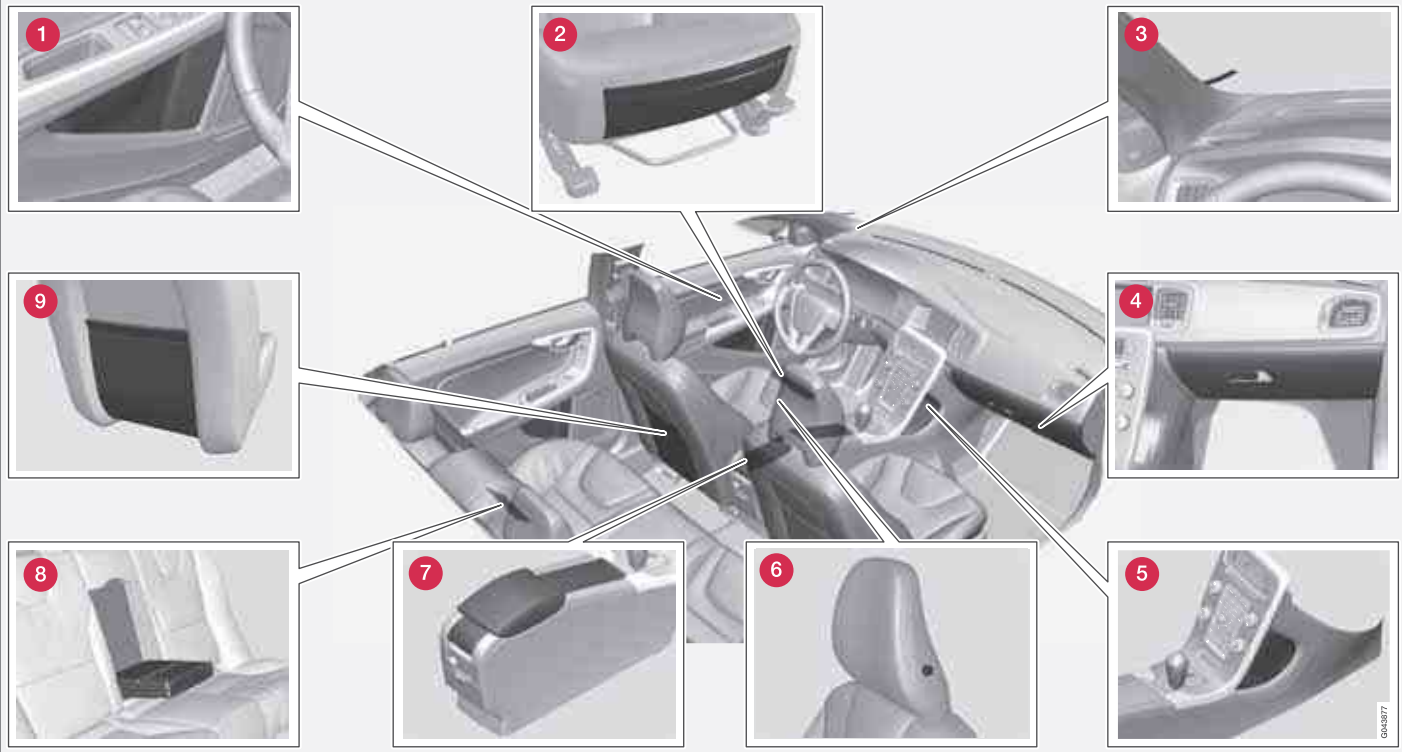



Comfort inside the passenger compartment

- 1 Storage compartment in door panel
- 2 Storage pocket* on front edge of front seat cushions
- 3 Ticket clip
- 4 Glovebox
- 5 Storage compartment
- 6 Jacket holder
- 7 Storage compartment, cup holder
- 8 Cup holder* in armrest, rear seat
- 9 Storage pocket

Jacket holder

The jacket holder is only designed for light clothing.

WARNING

Keep loose objects such as mobile phones, cameras, remote controls for accessories, etc. in the glove compartment or other compartments. Otherwise they may injure people in the car in the event of sudden braking or a collision.

Tunnel console

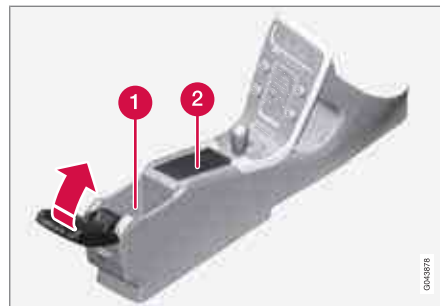

- 1 Storage compartment (e.g. for CDs) and USB*/AUX input under the armrest.
- 2 Includes cup holder for driver and passenger. (If ashtray and cigarette lighter are specified then there is a cigarette lighter in the 12 V socket for the front seat, see page 229, and a detachable ashtray in the cup holder.)

Cigarette lighter and ashtray*

The ashtray in the tunnel console is detached by lifting the tray straight up.

Activate the lighter by pushing in the button. The button pops out when the lighter is hot. Pull out the lighter and light a cigarette on the heated coils.

Glovebox



The owner's manual and maps can be kept here for example. There are also holders for pens on the inside of the lid. The glovebox can be locked using the key blade, see pages 48 and 59.

Inlay mats*

Volvo supplies specially manufactured inlay mats.

WARNING

Before setting off check that the inlaid mat in the driver area is firmly affixed and secured in the pins in order to avoid getting caught adjacent to and under the pedals.



Comfort inside the passenger compartment

Vanity mirror



Vanity mirror with lighting.

The light illuminates automatically when the cover is lifted.

12 V socket



12 V socket in tunnel console, front seat.



12 V socket in tunnel console, rear seat.

The electrical socket can be used for various accessories designed for 12 V, e.g. TV screens, music players and mobile phones. For the

socket to supply current, the remote control key must be in at least key position I, see page 78.

WARNING

Always leave the plug in the socket when the socket is not in use.

NOTE

Optional equipment and accessories - e.g. TV screens, music players and mobile phones - which are connected to one of the passenger compartment's 12V electrical sockets, could be activated by the climate control system, even when the remote control key has been removed or when the car is locked, for example, when the parking heater is activated at a preset time.

For this reason remove the plugs from the electrical sockets for optional equipment or accessories when not in use because the battery could be drained in the event of such an occurrence!



Comfort inside the passenger compartment

IMPORTANT

Max. socket is 10 A (120 W) if one socket is used at a time. If both sockets in the tunnel console are used simultaneously, 7.5 A (90 W) per socket is applicable.

If the compressor for emergency puncture repair is connected to one of the two sockets, no other current consumer must be connected to the other one.

NOTE

The compressor for temporary emergency puncture repair has been tested and approved by Volvo. For information on the use of Volvo's recommended temporary emergency puncture repair (TMK), see page 321.

Electrical socket in cargo area*

For more information, see page 293.



General information on infotainment.....	234
Radio.....	245
Media player.....	252
External audio source via AUX/USB* input.....	256
Media Bluetooth®*	259
Bluetooth® handsfree*.....	262
Voice recognition* mobile phone.....	271
TV*.....	275
Remote control*	279



06

INFOTAINMENT SYSTEM





06 Infotainment system

General information on infotainment

General

The infotainment system consists of radio, media player, TV* and the facility to communicate with mobile phone*. Information is presented on a 5 or 7-inch* colour screen in the upper section of the centre console. Functions can be controlled via buttons in the steering wheel, in the centre console under the colour screen or via a remote control*. A mobile phone can also be controlled with voice recognition in certain cases.

If the Infotainment System is active when the engine is switched off then it is automatically activated the next time the key is inserted into key position **I** or higher, and it continues with the same source (e.g. radio) as before the engine was switched off (the driver's door must be closed on cars with Keyless systems*).

The infotainment system can be used for 15 minutes at a time without the remote control key being in the ignition switch by pressing the On/Off button.

When the car is being started the infotainment system is switched off temporarily and continues when the engine has started.

NOTE

Remove the remote control key from the ignition switch if the infotainment system is used when the engine is switched off. This is to avoid discharging the battery unnecessarily.

Dolby, Pro Logic

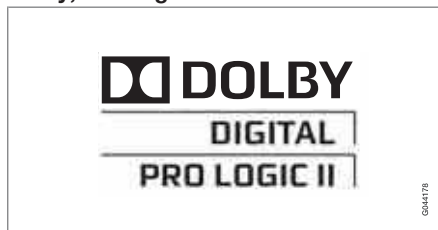

Made under license from Dolby Laboratories. Dolby, Pro Logic and the double-D symbol are trademarks of Dolby Laboratories.

Audyssey MultEQ¹

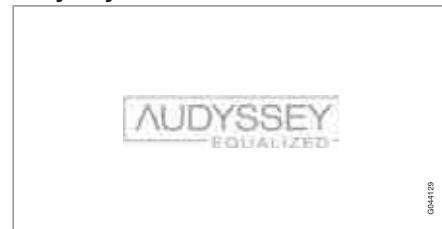

The Audyssey MultEQ system has been used in the development and tuning of the sound to ensure a world-class sound experience.

¹ Only applies to Premium Sound Multimedia.

* Option/accessory, for more information, see Introduction.



General information on infotainment

Overview



- 1 AUX² and USB³ inputs for external audio sources (e.g. iPod®)
- 2 Steering wheel keypad (with*/without thumbwheel).
- 3 TV screen. The TV screen is available in two sizes: 5 and 7-inch. The manual shows a 7-inch TV screen.
- 4 Centre console control panel

² Only applies to Performance
³ Does not apply to Performance

Operating the system

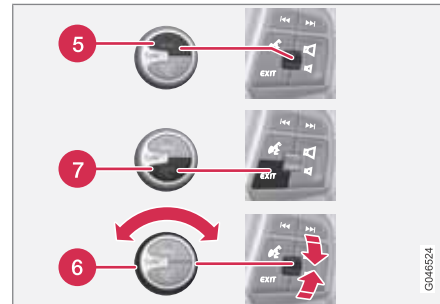
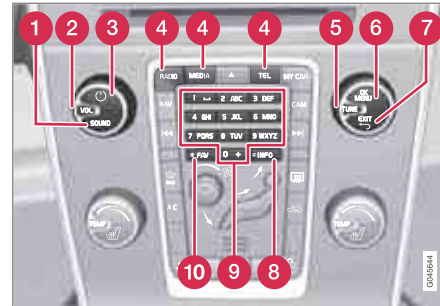

Steering wheel keypad as alternative to controls in the centre console.

- 1 **SOUND** - press for access to audio settings (bass, treble, etc.). For more information, see page 240.
- 2 **VOL** - turn to raise or lower the volume.
- 3 **ON/OFF/MUTE** - **short press** starts the system and **long press** (until the screen is off) switches off. Note that the whole of the Sensus system (including navigation* and phone functions*) starts/switches off at the same time. Briefly press to mute the sound (MUTE) or restore the sound if it had been switched off.
- 4 **Main sources** - press to select the main source (e.g. **RADIO**, **MEDIA**). Last active source is shown (e.g. **FM1**). If you are in **MEDIA** or **TEL** and press the main source button then a shortcut menu is shown with commonly used menu options.
- 5 **OK/MENU** - Press to accept options in menus. Leads to menu view in selected source (e.g. **RADIO** or **MEDIA**). Arrow to the right of the screen is shown when there are underlying menus.
- 6 **TUNE** - turn to scroll among disc tracks/folders, radio and TV* stations, phone contacts* or navigate through options on the TV screen.

* Option/accessory, for more information, see Introduction.



06 Infotainment system

General information on infotainment

- 7 EXIT - short press** leads upwards in the menu system, interrupts current function, interrupts/rejects phone calls or erases entered characters. **Long press** leads to normal view, or if you are in normal view to the highest menu level, see Main source view page 236.
- 8 INFO** - If more information than can be shown on the screen is available, press the **INFO** button to see the remaining information.
- 9** Preset buttons, input of numbers and letters.
- 10 FAV** – shortcut to a favourite setting. The button can be programmed for a commonly used function in AM, FM, etc. For more information, see page 239.

Steering wheel keypad

The steering wheel keypad can be used as an alternative to the buttons in the centre console. The keypad is available in three different versions depending on the options and the equipment level of the car.

Keypad with thumbwheel*

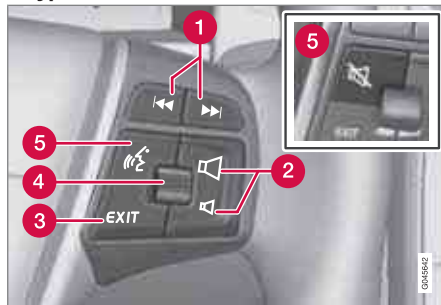

- 1 Short presses** scroll between disc tracks or preset radio stations⁴. A **long press** fast-winds disc tracks or searches for the next available radio station.
- 2** Volume - press to raise or lower the audio volume.
- 3 EXIT - short press** leads upwards in the menu system, interrupts current function, interrupts/rejects phone calls or erases entered characters. **Long press** leads to normal view, or if you are in normal view to the highest menu level, see Main source view page 236.

- 4 OK/MENU/TUNE - Press** to accept options in menus. Leads to the menu view in the selected source (e.g. **RADIO** or **MEDIA**). Arrow to the right of the screen is shown when there are underlying menus. **Turn** to scroll among disc tracks/folders, radio and TV* stations, phone contacts* or navigate through options on the TV screen.
- 5 Without voice recognition⁵** - press to switch off the radio/media audio (MUTE) or restore the audio if it has been switched off. **With voice recognition⁶** - Voice recognition (for Bluetooth®-connected mobile phone and navigation system*).

Main source view

A long press on **EXIT** on the steering wheel keypad* leads to normal view. If you are in normal view and give a long press on **EXIT** then it is possible to access the same main source buttons that are in the centre console:



NAV - Volvo's navigation system (RTI)*, is described in a separate owner's manual.



RADIO - AM, FM, DAB*





⁴ Does not apply to DAB.

⁵ Applies to cars without navigation.

⁶ Only cars with navigation.



General information on infotainment

	MEDIA - CD, DVD, AUX, USB*, Bluetooth [®] *, TV*.
	TEL - Bluetooth [®] handsfree*
	MY CAR - Car settings, see page 202.
	CAM - Park Assist Camera*, see page 191

fast-winds disc tracks or searches for the next available radio station.

- 2** Volume - press to raise or lower the audio volume.

Keypad without thumbwheel

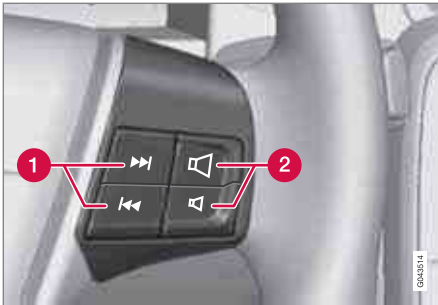

- 1** **Short presses** scroll between disc tracks or preset radio stations⁷. A **long press**

⁷ Does not apply to DAB.



General information on infotainment

Menus

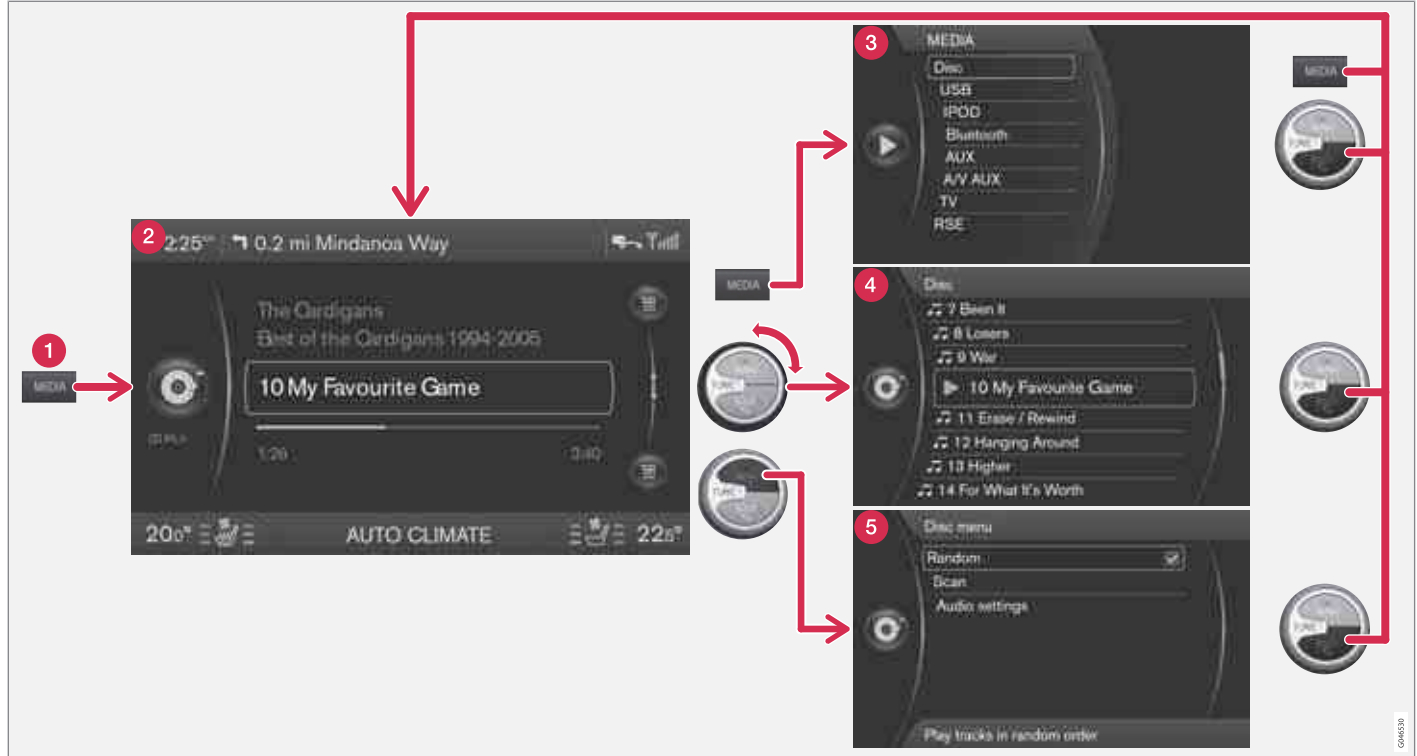

The example shows navigation to different functions when a disc is played back. (1) Main source button, (2) Normal view, (3) Shortcut view, (4) Quick view, (5) Menu view

GM0530



General information on infotainment

Select main source by pressing a main source button (1) (**RADIO, MEDIA, TEL**). To navigate in the source's menus, use the controls for **TUNE, OK/MENU** or **EXIT**.

Use **TUNE** to scroll in the menu, select the highlighted menu bar with **OK/MENU** or go back with **EXIT**. In some cases it is possible to access a shortcut menu by pressing the active source's main source button (1).

For Menu overview, see page 241.

NOTE

If the car is equipped with a steering wheel keypad with a thumbwheel⁸, these can be used instead of the controls in the centre console (**TUNE, OK/MENU, EXIT**), see page 236.

Views in the TV screen

For each main source there are four basic types of views:

- **Normal view (2)** - normal mode for the source
- **Shortcut menu (3)** - shows commonly used menu options in the main sources **TEL** and **MEDIA** (accessed by pressing the active source's main source button (1)).

- **Quick view (4)** - fast mode when **TUNE** is turned, e.g. for changing disc tracks, radio station, etc.
- **Menu view (5)** - for menu navigation (accessed by pressing **OK/MENU**).

The views have different appearances depending on the source, in-car equipment, settings, etc.

Pop-up menu⁸ video and TV*

Press **OK/MENU** when a video file is being played back or TV* is being shown in order to access the pop-up menu.

FAV - store a preset



The **FAV** button can be used to store functions that are used frequently so that the function

can be started simply by pressing **FAV**. You can select a favourite (e.g. **Equalizer**) for each function as follows:

In **RADIO** mode:

- AM
- FM1/FM2
- DAB1*/DAB2*

In **MEDIA** mode:

- DISC
- USB*
- iPod*
- Bluetooth*
- AUX
- TV*

It is also possible to select and store a favourite for **MY CAR, CAM*** and **NAV***. Favourites can also be selected and stored under **MY CAR**. For more information on the menu system **MY CAR**, see page 202.

To store a function in the **FAV** button:

1. Select a main source (e.g. **RADIO, MEDIA**).
2. Select a wavelength or source (**AM, Disc, etc.**).

⁸ Only applies when playing back videos or displaying TV*.



General information on infotainment



3. Press and hold the **FAV** button until the "favourites menu" is shown.
4. Turn **TUNE** to select an option from the list and press **OK/MENU** to save.
 - > When the main source (e.g. **RADIO**, **MEDIA**) is active the stored function is available via a short press on **FAV**.

General audio settings

Press **SOUND** to access the audio settings menu (**Bass**, **Treble**, etc.). Scroll forward with **SOUND** or **OK/MENU** to your selection (e.g. **Treble**).

Adjust the setting by turning **TUNE** and save the setting with **OK/MENU**.

Continue pressing **SOUND** or **OK/MENU** to access other options:

- **Surround**⁹ - Can be set to the On/Off position. When On is selected, the system selects the setting for optimal sound reproduction. Normally DPLII and  then appear in the TV screen. If the recording is made with Dolby Digital technology then playback will take place with this setting,  then appears in the TV screen.

When Off is selected, 3-channel stereo is available.

- **Bass** - Bass level.
- **Treble** - Treble level.
- **Fader** - Balance between the front and rear speakers.
- **Balance** - Balance between the left and right-hand speakers.
- **Subwoofer**⁹ - Bass speaker level.
- **DPL II centre level**³ **channel centre level**⁹ - Volume for centre speaker.
- **DPL II surround level**^{9, 10} - Level for surround.

Advanced audio settings

Equalizer¹¹

The volume level can be adjusted separately for different wavelengths.

1. Press **OK/MENU** to access **Audio settings** and select **Equalizer**.
2. Select wavelength by turning **TUNE** and confirm with **OK/MENU**.

3. Adjust the audio settings by turning **TUNE** and confirm with **OK/MENU**. Continue in the same way with other wavelengths you want to change.
4. When you have finished with audio settings, press **EXIT** to confirm and return to normal view.

For general information on menu navigation, see page 238 and menu overview, see page 241.

Sound stage⁹

The sound experience can be optimised for the driver's seat, both front seats or the rear seat. If there are passengers in both the front and rear seats then the option recommended is; both front seats. The options can be selected under **Audio settings** → **Sound stage**.

For general information on menu navigation, see page 238 and menu overview, see page 241.

Audio volume and automatic volume control

The audio system compensates for disrupting noises in the passenger compartment by increasing the volume in relation to the speed

⁹ Only Premium Sound Multimedia.

¹⁰ Only when Surround is activated.

¹¹ Not Performance.



General information on infotainment

of the car. The compensation level can be set to low, medium, high or off. Select the level under **Audio settings** → **Volume compensation**.

For general information on menu navigation, see page 238 and menu overview, see page 241.

External audio source audio volume

If an external audio source (e.g. an MP3 player or iPod®) is connected to the AUX input then the audio source that is connected can have a different volume than the audio system's internal volume (e.g. radio). Correct this by adjusting the volume of the input:

1. Press the **MEDIA** button and turn **TUNE** to **AUX** and wait a few seconds or press **OK/MENU**.
2. Press **OK/MENU** and then turn **TUNE** to **AUX input volume**. Confirm with **OK/MENU**.
3. Turn **TUNE** to adjust the volume for the AUX input.

NOTE

If the external audio source's volume is too high or too low, the quality of the sound may deteriorate. The audio quality may also be impaired if the player is charged while the infotainment system is in AUX mode. In which case, avoid charging the player via the 12 V socket.

Optimum sound reproduction

The audio system is pre-calibrated for optimum sound reproduction by means of digital signal processing.

This calibration takes into account loudspeakers, amplifiers, passenger compartment acoustics, listener position etc. for each combination of car model and audio system.

There is also a dynamic calibration that takes into account the position of the volume control, radio reception and vehicle speed.

The controls explained in these operating instructions, e.g. **Bass**, **Treble** and **Equalizer**, are only intended for the user to be able to adapt the sound reproduction according to personal taste.

Menu overview

Menus RADIO

Main menu AM AM menu

Show presets¹²

Scan

Audio settings¹³

Sound stage¹⁴

Equalizer¹⁵

Volume compensation

Reset all audio settings

Main menu FM1/FM2 FM menu

TP

Show radio text

Show presets¹²

Scan

News settings

¹²Only applies to High Performance Multimedia and Premium Sound Multimedia.

¹³The menu options for audio settings are the same for all audio sources.

¹⁴Only applies to Premium Sound Multimedia.

¹⁵Does not apply to Performance.



General information on infotainment

Advanced settings

REG

Alternative frequency

EON

Set TP favourite

PTY settings

Reset all FM settings

Audio settings¹⁶

Main menu DAB1*/DAB2*

DAB menu

Ensemble learn

PTY filtering

Turn off PTY filtering

Show radio text

Show presets¹²

Scan

Advanced settings

DAB linking

DAB band

Sub channels

Show PTY text

Reset all DAB settings

Audio settings¹⁶

Menus MEDIA

Main menu CD Audio

Disc menu

Random

Scan

Audio settings¹⁶

Main menu CD/DVD¹² Data

Disc menu

Play/Pause

Stop

Random

Repeat folder

Change subtitles

Change audio track

Scan

Audio settings¹⁶

Main menu DVD¹² Video

DVD Video Menu

DVD disc menu

Play/Pause/Continue

Stop

Subtitles

Audio tracks

Advanced settings

Angle

DivX® VOD code

Audio settings¹⁶

Main menu iPod¹⁵

iPod menu

Random

Scan

Audio settings¹⁶

Main menu USB¹⁵

USB menu

Play/Pause

¹⁶For submenus, see "Main menu AM".

¹²Only applies to High Performance Multimedia and Premium Sound Multimedia.

¹⁵Does not apply to Performance.



General information on infotainment

Stop
 Random
 Repeat folder
 Select USB device
 Change subtitles
 Change audio track
 Scan
 Audio settings¹⁶

Main menu Media Bluetooth¹⁵ Bluetooth menu

Random
 Change device
 Remove Bluetooth device
 Scan
 Bluetooth software version in car
 Audio settings¹⁶

Main menu AUX AUX menu

AUX input volume
 Audio settings¹⁶

Main menu TV* TV menu

Select country
 Reorganise presets
 Autostore
 Scan
 Audio settings¹⁶

Pop-up menu¹⁷ video and TV*

Press **OK/MENU** when a video file is being played back or TV* is being shown in order to access the pop-up menu.

Image settings
 Source menu¹⁸
 DVD disc menu¹⁹
 DVD disc TOP menu¹⁹

Menus TEL

Main menu Bluetooth® handsfree¹⁵ Phone menu

All calls
 All calls
 Missed calls
 Answered calls
 Dialed calls
 Call duration
 Phone book
 Search
 New contact
 Speed dials
 Receive vCard
 Memory status
 Clear phone book
 Change phone
 Remove Bluetooth device

¹⁶For submenus, see "Main menu AM".

¹⁵Does not apply to Performance.

¹⁷Only applies when playing back videos or displaying TV*.

¹⁸What is shown in the pop-up menu for the source menu depends on what is being played back or displayed, it can be e.g. CD/DVD data menu or USB menu.

¹⁹Only applies to DVD video discs.





General information on infotainment

Phone settings

Discoverable

Sounds and volume

Download phone book

Bluetooth software version in
car

Call options

Auto answer

Voicemail number

Disconnect phone



Radio

General

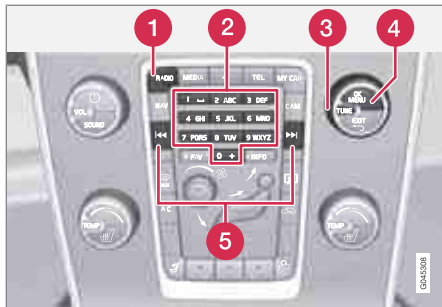

Centre console, controls for radio functions.

- 1 **RADIO** button for selecting the wavelength (AM, FM1, FM2, DAB1*, DAB2*).
- 2 Station presets (0-9)
- 3 Select the desired frequency/station or navigate in the radio menu by turning **TUNE**.
- 4 Confirm your selection or go to the radio menu by pressing **OK/MENU**.
- 5 Hold in the button for next/previous available station. Short press for preset.

i NOTE

If the car is equipped with a steering wheel keypad* and/or remote control* then in many cases these can be used instead of the buttons in the centre console. For a description of the steering wheel keypad, see page 236. For a description of the remote control, see page 279.

Menus

The menus in **RADIO** are controlled from the centre console and the steering wheel keypad*. For general information on menu navigation, see page 238 and menu overview, see page 241.

Radio AM/FM

Tuning

i NOTE

The reception is dependent both on how good the signal strength and signal quality are. The transmission may be disturbed by various factors such as tall buildings or the transmitter being far away. Coverage level can also vary depending on where in the country you are located.

Automatic tuning

1. Press **RADIO**, turn **TUNE** until the desired wavelength (**AM**, **FM1** etc.) is shown, press **OK/MENU**.
2. Hold in **◀◀** / **▶▶** in the centre console (or in the steering wheel keypad*). The radio searches for the next/previous available station.

Station list¹

The radio automatically compiles a list of the strongest FM stations whose signals it is currently receiving. This enables you to find a station when you drive into an area where you do not know the radio stations and their frequencies.

To go to the list and select a station:

1. Select the desired wavelength (**FM1** or **FM2**).
2. Turn **TUNE** one step in either direction. This displays the list of all stations in the area. The currently tuned station is indicated with enlarged text in the list.
3. Turn **TUNE** again in either direction to select a station from the list.
4. Confirm your selection with **OK/MENU**.

¹ Does not apply to Performance.



Radio

NOTE

- The list only shows the frequencies of stations that are currently being received, **not** a complete list of all radio frequencies on the selected wavelength.
- If the signal from the currently received station is weak, this may prevent the radio from updating the station list. If this occurs, press the **#INFO** button (while the station list is shown in the display screen) in order to change to manual tuning and set a frequency. If the station list is no longer shown, turn **TUNE** one step in either direction to show the list again, and press **#INFO** to switch.

The list disappears from the TV screen after a few seconds.

If the station list is no longer shown, turn **TUNE** one step in either direction and press the **#INFO** button in the centre console to change to manual tuning (or to return from manual tuning to the function for "Station list").

Manual tuning

The preset from the factory is that the radio shows the station list of the strongest stations

in the area when you turn **TUNE** (see the section "Station list", page 245). When the station list is shown, press the **#INFO** button in the centre console to change to manual tuning. This allows you to select a frequency from the list of all available radio frequencies in the selected wavelength. In other words, if turn **TUNE** one step in a manual search the frequency is changed from e.g. 93.3 to 93.4 MHz, etc.

To manually select a station:

1. Press the **RADIO** button, turn **TUNE** until the desired wavelength (**AM**, **FM1** etc.) is shown, press **OK/MENU**.
2. Turn **TUNE** to select a frequency.

NOTE

The preset from the factory is that the radio automatically searches for the stations in the area where you are driving (see previous section "Station list" above).

But if you have changed over to manual tuning (by pressing the **#INFO** button in the centre console when the station list was shown), then the radio remains set in the function for manual tuning the next time you switch on the radio. To change back to the function for "Station list", turn **TUNE** one step (to show the complete list of stations) and press the button **#INFO**.

Note that if you press **#INFO** when the station list is not shown then **INFO** is activated. For more information on this function, see page 235.

Preset

10 presets can be stored per wavelength (**AM**, **FM1** etc.).

The stored presets are selected using the preset buttons.

1. Tune into a station (see "Tuning", page 245).
2. Hold in one of the preset buttons for a few seconds, the sound disappears during this



Radio

time and returns when the station is stored. The preset button can now be used.

A list of pre-selected channels can be shown² in the TV screen. The function is activated/deactivated in FM/AM mode under **FM menu** → **Show presets** or **AM menu** → **Show presets**.

RDS functions

RDS (Radio Data System) links FM transmitters into a network. An FM transmitter in such a network sends information that gives an RDS radio the following functions:

- Automatically switches to a stronger transmitter if reception in the area is poor.
- Searches for programme type, such as traffic information or news.
- Receives text information on current radio programme.



NOTE

Some radio stations do not use RDS or only some if its functionality.

If a required programme type is located the radio can switch stations interrupting the audio source currently in use. For example, if the CD

player is in use, it is paused. The interrupting transmission is played at a preset volume, see page 249. The radio returns to the previous audio source and volume when the set programme type is no longer broadcast.

The programme functions alarm (**ALARM!**), traffic information (**TP**), news (**NEWS**), and programme types (**PTY**) interrupt one another in order of priority, where alarm has the highest priority and programme types has the lowest. For additional settings of programming interruptions (**EON Distant** and **EON Local**), see the section "Enhanced Other Networks – EON" below. Press **EXIT** to return to the interrupted audio source, press the **OK/MENU** to clear the message.

Alarm

This function is used to warn of serious accidents and catastrophes. The alarm cannot be temporarily interrupted or deactivated. The message **ALARM!** appears on the TV screen when an alarm message is transmitted.

Traffic information – TP

This function allows traffic information sent within a set station's RDS network to break through. The **TP** symbol indicates that the function is activated. If the preset station can

send traffic information then this is shown by **TP** glowing brightly in the TV screen, otherwise **TP** will be grey.

- Activate/deactivate in FM mode under **FM menu** → **TP**.

Enhanced Other Networks – EON

This function is useful in urban areas with many regional radio stations. It allows the distance between the car and the radio station transmitter to determine when programme functions should interrupt the current audio source.

- Activate/deactivate in FM mode by selecting one of the options under **FM menu** → **Advanced settings** → **EON**:
- **Local** – interrupts only if the radio station transmitter is close.
- **Distant**³ – interrupts if the station transmitter is far away, even if there is a lot of static.

TP from selected station/all stations

The radio can only interrupt for traffic information from the selected station or all stations within the RDS network.

- Go in FM mode to **FM menu** → **Advanced settings** → **Set TP favourite** to change.

² Only applies to High Performance Multimedia and Premium Sound Multimedia.

³ Factory settings.



Radio

News

This function allows news broadcasts sent within a set station's RDS network to break through. The **NEWS** symbol indicates that the function is active.

- Activate/deactivate in FM mode under **FM menu** → **News settings** → **News**.

News from selected station/all stations

The radio can only interrupt for news from the selected station or all stations in the RDS network.

- Go in FM mode to **FM menu** → **News settings** → **Set news favourite** to change.

Programme types – PTY

The PTY function can be used to select one or more programme types, such as pop music and serious classic. The PTY symbol indicates that the function is active. This function allows programme types broadcast within a set station's RDS network to break through.

1. Activate in FM mode by first selecting the programme types under **FM menu** → **Advanced settings** → **PTY settings** → **Select PTY**.

2. Then the PTY function must be activated under **FM menu** → **Advanced settings** → **PTY settings** → **Receive traffic bulletins from other networks**.

An indicator is shown in the TV screen when PTY is activated.

Deactivation of the PTY function is performed in FM mode under **FM menu** → **Advanced settings** → **PTY settings** → **Receive traffic bulletins from other networks**. Selected programme types (PTY) are not reset.

Resetting and removing PTY are performed under **FM menu** → **Advanced settings** → **PTY settings** → **Select PTY** → **Clear all**.

PTY search

This function searches the entire wavelength for the selected programme type.

1. In FM mode select one or more PTY under **FM menu** → **Advanced settings** → **PTY settings** → **Select PTY**.
2. Go to **FM menu** → **Advanced settings** → **PTY settings** → **Seek PTY**.

To finish searching, press **EXIT**.

- To continue searching for another broadcast of the selected programme types, press on **⏮** or **⏭**.

Display of programme type

The programme type of the current station can be shown on the TV screen.

- Activate/deactivate in FM mode under **FM menu** → **Advanced settings** → **PTY settings** → **Show PTY text**.

Radio text⁴

Some RDS stations transmit information on programme content, artists, etc. This information can be shown on the TV screen.

- Activate/deactivate in FM mode under **FM menu** → **Show radio text**.

Automatic frequency update – AF

The function selects the strongest transmitter for the set station. In order to find a strong transmitter the function may, in exceptional cases, need to search the entire FM wavelength.

- Activate/deactivate in FM mode under **FM menu** → **Advanced settings** → **Alternative frequency**.

⁴ Only cars with 7-inch screen



Regional radio programmes – REG

This function causes the radio to continue with a regional transmitter even if its signal strength is low. The symbol **REG** shows that the function is active.

- Activate/deactivate in FM mode under **FM menu** → **Advanced settings** → **REG**.

Resetting RDS functions

All radio settings can be reset to the original factory settings.

- The reset is carried out in FM mode under **FM menu** → **Advanced settings** → **Reset all FM settings**.

Volume control, programme types

The interrupting programme types, e.g. **NEWS** or **TP**, are heard at the volume selected for each respective programme type. If the volume level is adjusted during the programme interruption, the new level is saved until the next programme interruption.

Scan wavelength

The function automatically searches for available channels and takes into account any programme type filtering. When a station is found, it is played for approx. 10 seconds before scanning is resumed. When a station is playing back it can be saved as a preset in the usual way, see the section Preset, page 246.

- To start scanning go in FM/AM mode to **FM menu** → **Scan** or **AM menu** → **Scan**.

NOTE

Scanning stops if a station is saved.

Radio system - DAB*

General

DAB (Digital Audio Broadcasting) is a digital broadcasting system for radio. This system supports DAB, DAB+ and DMB.

NOTE

Coverage for DAB is not available in all locations. If there is no coverage then the message **No reception** is shown in the display screen.

Service and Ensemble

- **Service** - Channel, radio channel (only audio services are supported by the system).
- **Ensemble** - A collection of radio channels on the same frequency.

Storing channel groups (Ensemble learn)

When the vehicle is moved to a new broadcasting area, programming of existing channel groups in the area may be necessary.

Programming of channel groups creates an updated list of all available channel groups. The list is not updated automatically.

Programming is carried out in the menu system in DAB mode under **DAB menu** → **Ensemble learn**. Programming can also take place as follows:

1. Turn **TUNE** one step in either direction.
 - > **Ensemble learn** is shown in the list of available channel groups.
2. Press **OK/MENU**.
 - > New programming is started.

Programming can be cancelled with **EXIT**.

Navigation in channel group list (Ensemble)

To navigate in and access the channel group list turn **TUNE**. The name of the Ensemble is shown in the upper part of the TV screen. When switching to the new Ensemble the name changes to the new one.

- **Service** - Shows channels irrespective of the channel group to which they are allocated. The list can also be filtered using the selection of programme type (**PTY filtering**), see below.



Radio

Scanning

The function automatically searches the current wavelength for strong stations. When a station is found, it is played for approx. 10 seconds before scanning is resumed. When a station is playing back it is saved as a preset in the usual way. For more information on presets, see "Preset" below.

- Go in DAB mode to **DAB menu** → **Scan** to start scanning.

NOTE

Scanning stops if a station is saved.

Scanning can also be selected in DAB-PTY mode. In which case only channels of the pre-selected programme type are played.

Programme type (PTY)

Various types of radio programmes can be selected using the programme type function. There are a number of different programme types which also include different programme categories. After selecting a programme type, navigation only takes place within the channels that are broadcasting that type.

Programme type is selected in DAB mode under **DAB menu** → **PTY filtering**. Exit this mode as follows:

- Press **EXIT**.
 - > An indicator is shown in the TV screen when PTY is activated.

In certain cases DAB radio will exit PTY mode when DAB to DAB linking (see below) is implemented.

Preset

10 station presets can be stored per wavelength. DAB has 2 memories for presets: **DAB1** and **DAB2**. Storage of presets is made by means of a long press on the desired preset button, for more information see page 246. The stored presets are selected using the preset buttons.

A preset contains one channel but no sub-channels. If a subchannel is being played and a preset is saved then only the main channel is registered. This is because subchannels are temporary. At the next attempt to retrieve the preset, the channel which contained the sub-channel will be played. The preset is not dependent on the channel list.

A list of pre-selected channels can be shown⁵ in the TV screen. The function is activated/deactivated in DAB mode under **DAB menu** → **Show presets**.

NOTE

The audio system's DAB system does not support all functions available in the DAB standard.

Radio text

Some radio stations transmit information on programme content, artists, etc. This information is shown on the TV screen.

The function is deactivated/activated in DAB mode under **DAB menu** → **Show radio text**.

NOTE

Only one of the functions "**Show radio text**" and "**Show presets**" can be activated at a time. If one of them is activated when the other is already activated, then the previously activated function is deactivated automatically. Both functions can be deactivated.

⁵ Only applies to High Performance Multimedia and Premium Sound Multimedia.



Advanced settings

DAB to DAB link

DAB to DAB linking means that the DAB radio can go from one channel with poor or no reception to the same channel in another channel group with better reception. There may be a certain delay when changing channel group. There may be a period of silence between the current channel no longer being available to the new channel becoming available.

The function can be activated/deactivated in DAB mode under **DAB menu → Advanced settings → DAB linking**.

Wavelength

DAB can be transmitted on two⁶ wavelengths:

- **Band III** - covers most areas.
- **LBand** - available only in a few areas.

By selecting for example **Band III** on its own, channel programming takes place more quickly than if both **Band III** and **LBand** have been selected. It is not certain that all channel groups will be found. Wavelength selection does not affect the stored memories.

Wavelengths can be deactivated/activated in DAB mode under **DAB menu → Advanced settings → DAB band**.

⁶ Not all areas/countries use both wavelengths.

Subchannel

Secondary components are usually named subchannels. These are temporary and can contain e.g. translations of the main programme into other languages.

If one or more subchannels are broadcast then the **∨** symbol is shown to the left of the channel name in the TV screen. A subchannel is indicated by the - symbol appearing to the left of the channel name in the TV screen.

Press **▶▶** to access the subchannels.

Subchannels can only be accessed on the selected main channel and not on any other channel without selecting it.

Display of subchannels can be deactivated/activated in DAB mode under **DAB menu → Advanced settings → Sub channels**

Programme type text

Some radio stations broadcast information about programme type and programme category, for information on Programme types – PTY, see page 248. This information is shown on the TV screen.

The function is activated/deactivated in DAB mode under **DAB menu → Advanced settings → Show PTY text**.

Resetting the DAB settings

All DAB settings can be reset to the original factory settings.

- The reset is carried out in DAB mode under **DAB menu → Advanced settings → Reset all DAB settings**.



06 Infotainment system

Media player

CD/DVD¹ functions

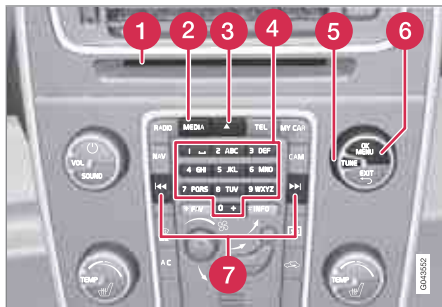

Centre console control panel.

- 1 Disc insert and eject slot
- 2 **MEDIA** button, activates last active media source. If you are already in a media source and press the **MEDIA** button then a short-cut menu is shown for commonly used menu options.
- 3 Disc eject
- 4 Input of numbers and letters.
- 5 Select the disc tracks/folders, or navigate through menu options by turning **TUNE**.

6 Confirm your selection or go to the menu for the selected media source by pressing **OK/MENU**.

7 Fast forward/reverse and change disc track or chapter².

The media player supports and can play the following main types of discs and files:

- Pre-recorded CD discs (CD Audio).
- Burned CD discs with audio and/or video files¹.
- Pre-recorded DVD video discs¹.
- Burned DVD discs¹ with audio and/or video files.

For more information about the supported formats, see page 255.

NOTE

If the car is equipped with a steering wheel keypad* and/or remote control* then in many cases these can be used instead of the buttons in the centre console. For a description of the steering wheel keypad, see page 236. For a description of the remote control, see page 279.

Menus

The menus in **MEDIA** are controlled from the centre console and the steering wheel keypad*. For general information on menu navigation, see page 238 and menu overview, see page 241.

Starting playback of a disc

Press the **MEDIA** button, turn **TUNE** until **Disc** is shown, press **OK/MENU**. If there is a disc in the media player then the disc starts playing back automatically, otherwise **Insert disc** is shown in the TV screen. Then insert a disc, with text side up. The disc starts to play back automatically.

If a disc with audio/video files is inserted into the player then the disc's folder structure needs to be loaded. Depending on the quality of the disc and the quantity of information there may be a certain delay before playback starts.

Disc eject

A disc remains in the ejected position for about 12 seconds, after which it is inserted back into the player for safety reasons.

Pause

When the volume is reduced entirely or **MUTE** is pressed, the media player is paused. When the volume is increased or **MUTE** is pressed

¹ Only applies to High Performance Multimedia and Premium Sound Multimedia.

² Only applies to DVD discs.



Media player

again, the media player starts. It is also possible to pause via the menu system³, press **OK/MENU**, select **Play/Pause**.

Playback and navigation**CD audio discs**



Turn **TUNE** to access the disc's playlist and navigate in the list. Use **OK/MENU** to confirm the selection of the disc track and start playback. Press **EXIT** to cancel and exit the playlist. A long press on **EXIT** leads to the playlist's root level.

Disc tracks can also be changed by pressing on **◀◀** / **▶▶** on the centre console or the steering wheel keypad*.

Burned discs audio/video files¹

Turn **TUNE** to access the disc's playlist/folder structure and navigate in the list/structure. Use **OK/MENU** to confirm either selection of sub-folder or start of playback of the selected audio/video file. Press **EXIT** to either stop and exit the playlist or go up (back) in the folder structure. A long press on **EXIT** leads to the playlist's root level.

Audio/video files can also be changed by pressing **◀◀** / **▶▶** on the centre console or the steering wheel keypad*.

Audio files have the symbol , video files¹ have the symbol  and folders have the symbol .

When playback of a file is complete the playback of the other files (of the same type) in that particular folder continues. Change⁴ of folder takes place automatically when all the files in the current folder have been played back. The system automatically detects and changes setting when a disc containing only audio files or only video files is loaded into the media player and then plays back these files. However, the system does not change setting if a disc containing a mixture of audio and video files is loaded into the media player, but instead the player continues to play back the previous file type.

NOTE

A video film is only shown when the car is stationary. When the car is moving at a speed of over about 8 km/h no picture is shown and **No visual media available while driving** appears on the display screen, although the audio is heard during this time. The picture is shown again as soon as the car's speed falls below about 6 km/h.

NOTE

Some audio files that are copy-protected by record companies or privately copied audio files cannot be loaded by the player.

DVD video discs¹

For playback of DVD video discs, see page 254.

Fast forward/reverse

Hold in the buttons **◀◀** / **▶▶** to fast forward/rewind. Audio files are fast forwarded/rewound at one speed, while video files are fast forwarded/rewound at several speeds. Repeatedly press the buttons **◀◀** / **▶▶** to increase the fast

³ Does not apply to CD Audio

¹ Only applies to High Performance Multimedia and Premium Sound Multimedia.

⁴ If Repeat folder is activated then this does not take place.



Media player

forward/rewind speed for video files. Release the button to return to viewing at normal speed.

Scan⁵

This function plays the first ten seconds of each disc track/audio file. To scan:

1. Press **OK/MENU**
2. Turn **TUNE** to **Scan**
 - > The first 10 seconds of each disc track or audio file are played.
3. Cancel the scan with **EXIT**, the disc track or audio file being played back will continue playing.

Random⁵

This function plays the tracks in random order. To listen to the tracks in random order:

1. Press **OK/MENU**
2. Turn **TUNE** to **Random**
3. Press **OK/MENU** to activate/deactivate the function.

Disc tracks/audio files can be changed by pressing **⏮** / **⏭** on the centre console or the steering wheel keypad*.

Repeat folder⁶

This function makes it possible to play files in a folder over and over again. When the last file has been played out, playback of the first file starts again.

1. Press **OK/MENU**
2. Turn **TUNE** to **Repeat folder**
3. Press **OK/MENU** to activate/deactivate the function.

Playback of DVD video discs¹

Playback

When playing back a DVD video disc a disc menu may appear on the display screen. The disc menu gives access to additional functions and settings, such as selecting subtitles, language and scene selection.



NOTE

A video film is only shown when the car is stationary. When the car is moving at a speed of over about 8 km/h no picture is shown and **No visual media available while driving** appears on the display screen, although the audio is heard during this time. The picture is shown again as soon as the car's speed falls below about 6 km/h.

Navigation in the DVD video disc's menu

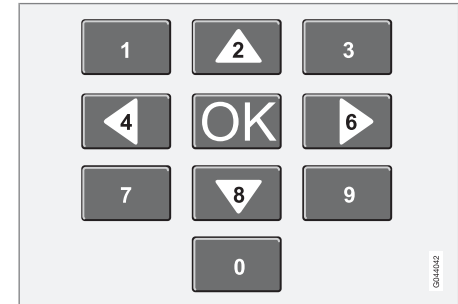

Navigation in the DVD video disc's menu is performed using the number keys in the centre console as illustrated above.

⁵ Does not apply to DVD video discs.

⁶ Only applies to audio/video files on burned discs or USB.

¹ Only applies to High Performance Multimedia and Premium Sound Multimedia.

**Media player****Changing chapter or title**

Turn **TUNE** to access the list of chapters and navigate through them (if the film is being played back then it is paused). Press **OK/MENU** to select the chapter, this also leads back to the original position (if the film was being played back then it is restarted). Press **EXIT** to access the title list.

Titles are selected in the title list by turning **TUNE** and the selection is confirmed with **OK/MENU**, this also leads back to the chapter list. Press **OK/MENU** to activate the selection and return to the start position. Use **EXIT** to cancel the selection and this leads back to the original position (without any selection being made).

The chapter can also be changed by pressing on **◀◀** / **▶▶** on the centre console or the steering wheel keypad*.

Advanced settings⁷**Angle**

If the DVD video disc supports it, the function can be used to choose from which camera position a particular scene should be shown. Go in disc mode to **Disc menu** → **Advanced settings** → **Angle**.

DivX® Video On Demand

The media player can be registered in order to play DivX VOD type files from burned discs or USB. The code for registration can be found in the menu system **MY CAR Settings** →

Information → **DivX® VOD code**. For general information on menus, see under **MY CAR**, see page 202.

For more information visit www.divx.com/vod.

Picture settings⁷

You can adjust the settings (when the car is stationary) for brightness and contrast.

1. Press **OK/MENU** and select **Image settings**, confirm with **OK/MENU**.
2. Turn **TUNE** to the adjustment option and confirm with **OK/MENU**.
3. Adjust the setting by turning **TUNE** and confirm with **OK/MENU**.

To return to the settings list, press the **OK/MENU** or **EXIT**.

The picture settings can be reset to factory settings with the **Reset** option.

Compatible file formats

The media player can play back a variety of file types and is compatible with the formats in the following table.

NOTE

Dual format, double-sided discs (DVD Plus, CD-DVD format) are thicker than regular CD discs and therefore playback cannot be guaranteed and malfunction may arise.

If a CD contains a mixture of MP3 and CDDA tracks, all MP3s will be ignored.

Audio format ^A	CD audio, mp3, wma
Audio format ^B	CD audio, mp3, wma, aac, m4a
Video format ^C	CD video, DVD video, divx, avi, asf

^A Applies to Performance.

^B Does not apply to Performance.

^C Only applies to High Performance Multimedia and Premium Sound Multimedia.

⁷ Applies to High Performance Multimedia and Premium Sound Multimedia.



External audio source via AUX/USB* input

General

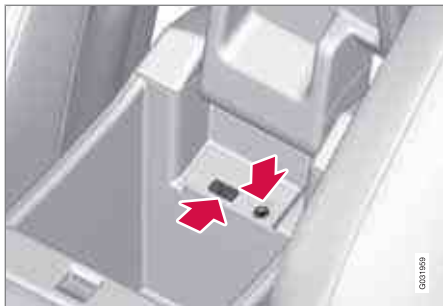

Connection points for external audio sources.

An external audio source, e.g. an iPod® or MP3 player, can be connected to the audio system via any of the connections in the centre console. An audio source connected to the USB input can then be handled¹ with the car's audio controls. A device connected via the AUX input cannot be controlled via the car.

i NOTE

If the car is equipped with a steering wheel keypad* and/or remote control* then in many cases these can be used instead of the buttons in the centre console. For a description of the steering wheel keypad, see page 236. For a description of the remote control, see page 279.

An iPod® or MP3 player with rechargeable batteries is recharged (when the ignition is on or the engine is running) if the device is plugged into the USB connection.

To connect the audio source:

1. Press **MEDIA**, turn **TUNE** to the desired audio source **USB**, **iPod** or **AUX**, press **OK/MENU**.
 - > If USB is selected then **Connect USB** is shown in the TV screen.
2. Connect your audio source to one of the connections in the centre console's storage compartment (see previous illustration).

The text **Reading USB** is shown in the TV screen when the system is loading the storage media's file structure. Depending on the file

structure and number of files there may be some delay before loading is finished.

i NOTE

The system supports most iPod® models produced in 2005 or later.

i NOTE

To prevent damage to the USB connection, this is shut off if the USB connection is short-circuited or if a connected USB unit is taking too much power (this may happen if the unit connected does not meet the USB standard). The USB connection is reactivated automatically the next time the ignition is turned on, unless the fault persists.

Menus

The menus in **MEDIA** are controlled from the centre console and the steering wheel keypad*. For general information on menu navigation, see page 238 and menu overview, see page 241.



¹ Only applies to the media source connected via the USB connection.





External audio source via AUX/USB* input

Playback and navigation²

Turn **TUNE** to access the playlist/folder structure and navigate in the list/structure. Use **OK/MENU** to either confirm selection of subfolder or start of playback of the selected audio/video file. Press **EXIT** to either stop and exit the playlist or go up (back) in the folder structure. A long press on **EXIT** leads to the playlist's root level.

Audio/video files can also be changed by pressing  /  on the centre console or the steering wheel keypad*.

Audio files have the symbol  , video files³ have the symbol  and folders have the symbol .

When playback of a file is complete the playback of the other files (of the same type) in that particular folder continues. Change⁴ of folder takes place automatically when all the files in the current folder have been played back. The system automatically detects and changes setting when a device containing only audio files or only video files is connected to the USB port and then it plays back these files. However, the system does not change setting if a

device containing a mixture of audio and video files is connected to the USB port, but instead the player continues to play back the previous file type.

Fast forward/reverse²

See page 253.

Scan²

See page 254.

Random²

See page 254.

Search function²

The keypad on the control panel in the centre console can be used to find a filename in the current folder.

The search function is accessed either by turning **TUNE** (to access the folder structure) or by pressing one of the letter keys. As a letter or character in a search string is entered you get closer to your search target.

Start playback of a file by pressing **OK/MENU**.

Repeat folder⁵

See page 254.

Pause

When the volume is reduced entirely or MUTE is pressed, the media player is paused. When the volume is increased or MUTE is pressed again, the media player starts. It is also possible to pause via the menu system⁶, press **OK/MENU**, select **Play/Pause**.

Audio sources

USB memory

To facilitate the use of a USB memory stick, only store music files on it. It takes a lot longer for the system to load storage media that contains anything other than compatible music files.

² Only applies to USB and iPod®.

³ Applies to High Performance Multimedia and Premium Sound Multimedia.

⁴ If Repeat folder is activated then this does not take place.

⁵ Only applies to USB.

⁶ Does not apply to iPod®



06 Infotainment system

External audio source via AUX/USB* input

NOTE

The system supports mobile media compliant with USB 2.0 and the FAT32 file system and can handle 1000 folders with a maximum of 254 subfolders/files in every folder. The top level, which can handle up to 1000 subfolders/files, is an exception to this.

NOTE

When using a longer model USB memory stick the use of a USB adapter cable is recommended. This is to avoid mechanical wear to the USB input and the connected USB memory stick.

USB hub

It is possible to connect a USB hub to the USB connection and thereby connect multiple USB devices simultaneously. Selection of USB device is made in **USB** mode under **USB menu** → **Select USB device**.

MP3 player

Many MP3 players have their own file systems that are not supported by the audio system. For use in the system, an MP3 player must be set in **USB Removable device/Mass Storage Device mode**.

iPod®

An iPod® is charged and supplied with power by the USB connection* via the player's connection cable.

NOTE

The system only supports the playback of audio files from iPod®.

NOTE

When an iPod® is used as audio source, the car's infotainment system has a menu structure that is similar to the iPod® player's own menu structure.

Compatible file formats via the USB connection

Audio and video files in the following table are supported by the system for playback via the USB connection.

Audio format	mp3, wma, aac, m4a
Video format ^A	divx, avi, asf

^A Only applies to High Performance Multimedia and Premium Sound Multimedia.

* Option/accessory, for more information, see Introduction.



Media Bluetooth®*

General

The car's media player is equipped with Bluetooth®¹ and can wirelessly play streaming audio files from external devices with Bluetooth®, such as mobile phones and PDAs. Navigation and control of the sound can be carried out via the centre console buttons or via the steering wheel keypad*. In some external devices it is also possible to change tracks from the device.

To play back the audio the car's media player must first be set in **Bluetooth** mode.

NOTE

The Bluetooth® media player must support the Audio/Video Remote Control Profile (AVRCP) and Advanced Audio Distribution Profile (A2DP). The player should use AVRCP version 1.3, A2DP 1.2. Otherwise some functions may not work.

Not all mobile phones and external media players available in the market are fully compatible with the Bluetooth® function in the car's media player. Volvo recommends that you contact an authorised Volvo dealer or visit www.volvocars.com for information on compatible phones and external media players.

NOTE

The car's media player can only play the audio files via the Bluetooth® function.

Menus

The menus in **MEDIA** are controlled from the centre console and the steering wheel keypad*. For general information on menu navigation, see page 238 and menu overview, see page 241.

Overview

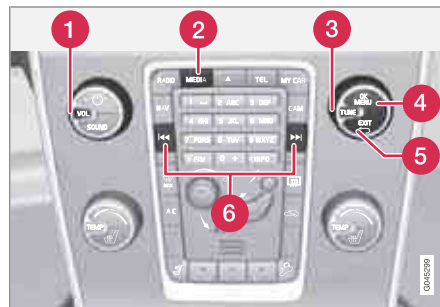

Centre console control panel.

- 1 **VOL** – volume
- 2 **MEDIA** button. Last active source (e.g. iPod®) is activated automatically. If a

source is activated and you press **MEDIA** then a shortcut menu is shown with commonly used menu options.

- 3 Navigate in the menu by turning **TUNE**.
- 4 Confirm your selection or go to the menu by pressing **OK/MENU**.
- 5 **EXIT** - leads up in the menu system, stops the function in progress.
- 6 **Short presses** are used to scroll between audio files. **Long presses** are used to fast forward and rewind audio files.

NOTE

If the car is equipped with a steering wheel keypad* and/or remote control* then in many cases these can be used instead of the buttons in the centre console. For a description of the steering wheel keypad, see page 236. For a description of the remote control, see page 279.

¹ Applies to High Performance, High Performance Multimedia and Premium Sound Multimedia.



Media Bluetooth®*

Getting started

Connect an external Bluetooth® device

A maximum of ten external devices can be registered. The connection is made in the same way as for the phone, see Connect an external Bluetooth® device, page 263.

Automatic connection



When the Bluetooth® function is active and the last external device connected is in range it is connected automatically. When the infotainment system searches for the last device connected its name is shown in the TV screen. To connect to another device, press **EXIT**. Connect a new external device, see "Change to another external device" below.

Change to another external device

It is possible to change a connected device with another device if there are several devices in the car. However, the device must first have been paired, see "Connect an external Bluetooth® device" above. To change to another device:

1. Press **MEDIA**, turn **TUNE** until **Bluetooth** is shown, press **OK/MENU**.

2. Check that the external device is searchable/visible via Bluetooth®, see the manual for the external device.
3. Press **OK/MENU**.
4. Turn **TUNE** to **Change device**, and confirm with **OK/MENU**.
 - > After a while, the external device's name is shown in the TV screen. If several external devices have been paired then these are also shown.
5. Select the device to be connected by turning **TUNE** and confirm with **OK/MENU**.
 - > Connection of the external device takes place.

Change audio file by pressing  /  on the centre console or the steering wheel keypad*.

Disconnecting the device

Automatic disconnection takes place if the external device moves out of the infotainment system's range. For more information on connection, see page 260.

Remove the connected device



1. Press Bluetooth mode on **OK/MENU**.
2. Turn **TUNE** to **Remove Bluetooth device** and confirm with **OK/MENU**.

3. Select the device to be removed by turning **TUNE**, and confirm with **OK/MENU**.
 - > A prompt asking whether or not you want to remove the connection is shown in the TV screen.
4. Press **OK/MENU** to confirm.

EXIT cancels.

Random²

This function plays back the audio files on the external device in random order. Activate/deactivate the random function in Bluetooth mode under **Bluetooth menu** → **Random**.

Change audio file by pressing  /  on the centre console or the steering wheel keypad*.

Scanning of audio files in external device²

This function play backs the first ten seconds of each audio file. Activate/deactivate the function in Bluetooth mode under **Bluetooth menu** → **Scan**.

Cancel scanning with **EXIT**.

² Not supported by all mobile phones.

* Option/accessory, for more information, see Introduction.

**Media Bluetooth®*****Version information Bluetooth®**

The car's current Bluetooth® version can be seen in Bluetooth mode under **Bluetooth** menu → **Bluetooth software version in car**.



06 Infotainment system

Bluetooth® handsfree*

General

A mobile phone equipped with Bluetooth® can be connected wirelessly to the Infotainment system¹. The infotainment system then works handsfree, with the option to control a range of the mobile phone's functions remotely. The microphone used is located by the driver's sun visor (2). The mobile phone can be operated by its own keys irrespective of whether or not it is connected.

NOTE

Only a selection of mobile phones are fully compatible with the handsfree function. Volvo recommends that you seek assistance from an authorised Volvo dealer or visit www.volvocars.com for information on compatible phones.

Menus

The menus in **TEL** are controlled from the centre console and the steering wheel keypad*. For general information on menu navigation, see page 238 and menu overview, see page 241.

Overview



System overview

- 1** Mobile phone
- 2** Microphone
- 3** Steering wheel keypad
- 4** Centre console control panel

Phone functions, controls overview

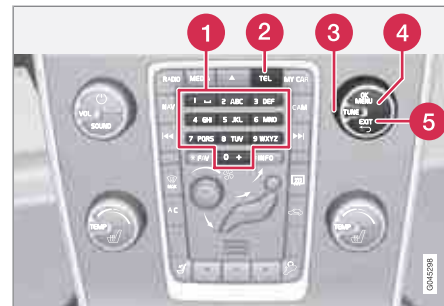

Centre console control panel.

- 1** Number and letter buttons
- 2** **TEL** button activates/searches last connected phone. If a phone is already connected, and **TEL** is pressed, a shortcut menu is shown with commonly used menu options for the phone.
- 3** **TUNE** - Turn in normal view to the right to access the phone book, and to the left for the call register for all calls; also used for navigation among the options on the TV screen.

¹ Applies to High Performance, High Performance Multimedia and Premium Sound Multimedia.

* Option/accessory, for more information, see Introduction.

**Bluetooth® handsfree***

- 4 Accept incoming calls, confirm your selection or go to the Phone menu by pressing **OK/MENU**.
- 5 **EXIT** - Cancels/rejects phone calls, deletes input characters, leads up in the menu system and cancels the current function.

i NOTE

If the car is equipped with a steering wheel keypad* and/or remote control* then in many cases these can be used instead of the buttons in the centre console. For a description of the steering wheel keypad, see page 236. For a description of the remote control, see page 279.

Remember**Activate**

A short press on **TEL** activates/searches last connected phone. If a phone is already connected, and **TEL** is pressed, a shortcut menu is shown with commonly used menu options for the phone. The  symbol indicates that a phone is connected.

Connect an external Bluetooth® device

A maximum of ten external devices can be registered. Registration is performed once per device. After registration the device no longer needs to be activated as visible/searchable.

It is possible to have two Bluetooth® devices connected simultaneously. One phone and one media device, which it is possible to switch between, see page 264 or see page 260. It is also possible to use the phone while streaming audio files from a connected device.

Connecting an external device takes place in different ways depending on whether or not the device has been connected previously.

To connect a device for the first time, follow the connection alternatives below.

There are two possible ways of connecting devices, either search for the external device from the car, or search for the car from the external device. If one option does not work then try with the other.

Alternative 1 - search for the external device via the car's menu system

1. Make the external device searchable/visible via Bluetooth®, see the external device's manual or www.volvocars.com.
2. Press **TEL**.
 - > The car searches for previously connected devices.
3. Activate Bluetooth® in the car. Press **OK/MENU**, select **Add phone** or **Change**

phone if another phone is already connected.

If one or more devices have already been connected then these are also shown. Select the device you want to connect and press **OK/MENU**.

- > The menu option is shown on the TV screen.
4. Check that the external device's Bluetooth® function is switched on and press **OK/MENU**.
 - > The car searches for external devices in the vicinity. The search takes approximately 30 seconds. The external devices detected are specified with their respective Bluetooth® name in the TV screen. The handsfree function's Bluetooth® name is shown in the external device as **My Volvo Car**.
 5. Turn **TUNE** to select one of the external devices shown on the car's TV screen and confirm with **OK/MENU**.
 6. Enter the series of numbers (PIN code) that is shown on the car's TV screen via the mobile phone's keypad and press the mobile phone's button to confirm the selection.

The external device is now connected to the car and can be controlled from the car.

* Option/accessory, for more information, see Introduction.



Bluetooth® handsfree*

If connecting the phone is not successful: Press **EXIT** and connect in accordance with Alternative 2.

If connecting the media device is not successful: Connect in accordance with Alternative 2.

Alternative 2 - search for the car via the external device

1. Press **TEL**.
If an external device is already connected, disconnect it.
> The car searches for previously connected devices.
2. Make the car searchable/visible via Bluetooth®. Press **OK/MENU**, select **Phone settings** → **Discoverable**.
3. Search for the car with the external device's Bluetooth® function, see the manual for the external device.
4. Select **My Volvo Car** in the list of devices detected in your external device.
5. Enter a PIN code of your choice in the external device via the external device's keypad when prompted for a PIN. Then enter the same PIN code via the car's keypad.
6. Choose to connect to **My Volvo Car** from the external device.

When the connection is established, the external device's Bluetooth® name is shown in the car's TV screen. Now the external device can be controlled from the car.

Automatic connection

When the handsfree function is active and the last mobile phone connected is in range it is connected automatically. If the last connected mobile phone is not available then the system will try to connect a mobile phone that was paired earlier. When the audio system searches for the last phone connected its name is shown in the TV screen.

Manual connection

If you want to change the connected mobile phone, go in phone mode → **Phone menu** → **Change phone**.

Change to another external device

It is possible to change a connected device with another device if there are several devices in the car. However, the device must first have been registered to the car, see Connect an external Bluetooth® device. To change to another device:

1. Check that the external device is searchable/visible via Bluetooth®, see the manual for the external device.

2. Press **TEL** and then select **Change phone**.
> The car searches for previously connected devices. The external devices detected are specified with their respective Bluetooth® name in the TV screen.
3. Select the device to be connected by turning **TUNE** and confirm with **OK/MENU**.
> Connection of the external device takes place.

To call

1. Make sure that the  symbol appears at the top of the TV screen and that the handsfree function is in phone mode.
2. Dial either the desired number or speed dial number, see page 269. Or in normal view turn **TUNE** to the right to access the phone book, and to the left for the call register for all calls. For information on the phone book, see page 266.
3. Press **OK/MENU**.

The call is interrupted with **EXIT**.

Disconnecting the mobile phone

Automatic disconnection takes place if the mobile phone moves out of the audio system's range. The connection to the mobile phone can be manually broken in phone mode under

* Option/accessory, for more information, see Introduction.

**Bluetooth® handsfree***

Phone menu → Disconnect phone. For more information on connection, see page 263.

The handsfree function is deactivated when the engine is switched off and the door is opened².

When the mobile phone has been disconnected an ongoing call can be continued by using the mobile phone's built-in microphone and speaker.

i NOTE

Even when your mobile phone has been manually disconnected, some mobile phones may automatically couple up to the last handsfree unit connected, e.g. when a new call begins.

Remove the device

A connected mobile phone can be deregistered and removed. This is performed in phone mode under **Phone menu → Remove Bluetooth device.**

Making and receiving calls**Incoming call**

- Press **OK/MENU** to answer the call, even if the audio system is in e.g. **RADIO** or **MEDIA** mode.

Refuse or end with **EXIT**.

Automatic answer

The automatic answer function means that calls are accepted automatically.

- Activate/deactivate in phone mode under **Phone menu → Call options → Auto answer.**

In call menu

Press **OK/MENU** during an ongoing call to access the following functions:

- **Mute** - audio system microphone is muted.
- **Mobile phone** - the call is transferred from handsfree to the mobile phone. For some mobile phones the connection is interrupted. This is normal. The handsfree function asks if you want to reconnect.
- **Dial number** - option to call a third party using the number keys (current call set in standby).

Call lists

The call lists are copied to the handsfree function at each new connection and are then updated during the connection. In normal view, turn to the left with **TUNE** to see the call register for **All calls**.

In phone mode it is possible to see all the call lists under **Phone menu → All calls:**

- **All calls**
- **Missed calls**
- **Answered calls**
- **Dialled calls**
- **Call duration**

i NOTE

Certain mobile phones show a list of the last dialled numbers in reverse order.

Voice mailbox

In normal view a speed dial number for the voice mailbox can be programmed in and then accessed later via a long press on **1**.

Voice mailbox number is changed in phone mode under **Phone menu → Call options → Voicemail number → Change number.** If

² Only Keyless Drive.



Bluetooth® handsfree*

there is no number stored then this menu can be reached with one long press on **1**.

Audio settings

Phone call volume

The phone call volume can only be changed during a call. Use the steering wheel keypad* or turn the **VOL** control.

Audio system volume

Providing there is no ongoing call taking place, the audio system volume is controlled as usual by turning **VOL**.

If an audio source is active during an incoming call then it can be muted automatically. Activate/deactivate in phone mode under **Phone menu** → **Phone settings** → **Sounds and volume** → **Mute radio/media**.

Ring volume

In phone mode go to **Phone menu** → **Phone settings** → **Sounds and volume** → **Ring volume** and adjust by turning **VOL**. Press **OK/MENU** to hear the audio volume. Press **EXIT** to save.

Ring signals

The handsfree function has integrated ring signals that can be selected in phone mode under **Phone menu** → **Phone settings** → **Sounds and volume** → **Ring signals** → **Ring signal 1** etc.

NOTE

For some mobile phones, the ringtone on the phone connected will not be switched off when one of the inbuilt signals for the handsfree system is used.

In order to select the connected phone's ring signal³, go in phone mode to **Phone menu** → **Phone settings** → **Sounds and volume** → **Ring signals** → **Mobile phone ring signal**.

Phone book

There are two phone books. These are merged into one in the car and are displayed as a single phone book in the car.

- The car downloads the mobile phone's phone book and only displays this phone book when the mobile phone from which

this phone book was downloaded is connected.

- The car also has a built-in phone book. This contains all the contacts stored in the car irrespective of which phone was connected when saving them. These contacts are visible for all users, regardless of the mobile phone that is connected to the car. If a contact is saved in the car then the symbol  is shown in front of the contact in the phone book.

NOTE

Changes made from the car to a record in the mobile phone's telephone book will result in a new record in the car's telephone book, i.e. changes will not be saved to the phone. From the car, this will now look like you have double records, with different icons. Note also that when a shortcut number is saved or a change to a contact is made, this will result in a new record in the car's phone book.

All use of the phone book requires that the  symbol appears at the top of the TV screen and that the handsfree function is in phone mode.

³ Not supported by all mobile phones.

* Option/accessory, for more information, see Introduction.



Bluetooth® handsfree*

The audio system stores a copy of the phone book from each paired mobile phone. The phone book can be copied automatically to the audio system during each connection.

- Activate/deactivate the function in phone mode under **Phone menu** → **Phone settings** → **Download phone book**.

If the phone book contains a ringing caller's contact information then this is shown in the TV screen.

Quick search for contacts

In normal view turn **TUNE** to the right to obtain a list of contacts. Turn **TUNE** to select and press **OK/MENU** to call.

Under the name of the contact is the phone number that is selected by default. If the symbol > appears to the right of the contact then there are several phone numbers stored for the contact. Press **OK/MENU** to show the numbers. Change and dial a number other than that selected by default by turning **TUNE**. Press **OK/MENU** to dial.

Search in the list of contacts by using the centre console's keypad to key in the start of the contact's name (see "Character table keypad in centre console" for button functions).

The list of contacts can also be accessed from normal view by pressing and holding the button on the centre console's keypad with the letter

that the contact searched for starts with. For example, a long press on the button for **6** gives instant access to that part of the list where the contacts with the letter **M** are located.

Character table keypad in centre console

Key	Function
1	Space ., - ? @ : ; / () 1
2 ABC	A B C Å Ä Æ À Ç 2
3 DEF	D E F È É 3
4 GHI	G H I ì 4
5 JKL	J K L 5
6 MNO	M N O Ö Ø Ñ Ò 6
7 PQRS	P Q R S ß 7
8 TUV	T U V Ü Û 8
9 WXYZ	W X Y Z 9
* FAV	Shift between upper and lower case letter.

Key	Function
0 +	+ 0 p w
#INFO	# *

Searching for contacts

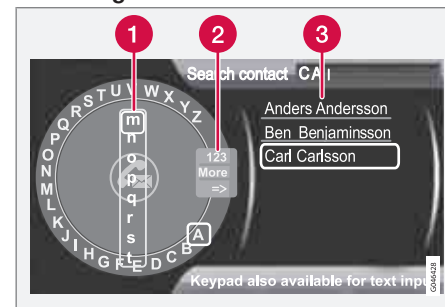

Search contacts using the text wheel.

- 1 Character list
- 2 Changing the input mode (see table below)
- 3 Phone book

To search for or edit a contact, go in phone mode to **Phone menu** → **Phone book** → **Search**.



06 Infotainment system

Bluetooth® handsfree*

i NOTE

There is no text wheel for High Performance, so **TUNE** cannot be used there to input characters: only the digit and letter buttons on the control panel in the centre console can be used for this.

1. Turn⁴ **TUNE** to the desired letter, press **OK/MENU** to confirm. The number and letter buttons on the control panel in the centre console can also be used.
2. Continue with the next letter and so on. The result of the search is shown in the phone book (3).
3. To change the input mode to numbers or special characters, or to go to the phone book, turn **TUNE** to one of the options (see explanation in the table below) in the list for changing the input mode (2), press **OK/MENU**.

123/ ABC	Change between letters and numbers with OK/MENU .
More	Change to special characters with OK/MENU .
=>	Leads to the phone book (3). Turn TUNE to select a contact, press OK/MENU to see the saved numbers and other information.

A short press on **EXIT** deletes an input character. A long press on **EXIT** will clear all entered characters.

By pressing a number key in the centre console when the text wheel is shown (see illustration above), a new character list (1) appears in the TV screen. Continue repeatedly pressing the number key to the desired letter and then release. Continue with the next letter and so on. When a button is depressed the entry is confirmed when another button is depressed.

To enter a number, hold in the corresponding number key.

New contact

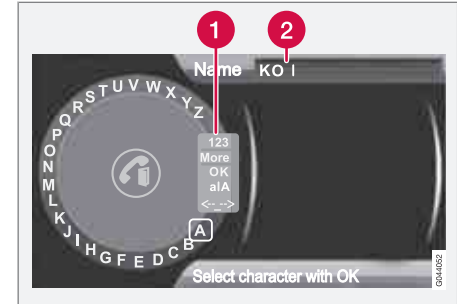

Entering letters for New contact.

- 1 Changing the input mode (see table below)
- 2 Input field

New contacts can be added in phone mode under **Phone menu** → **Phone book** → **New contact**.

i NOTE

There is no text wheel for High Performance, so **TUNE** cannot be used there to input characters: only the digit and letter buttons on the control panel in the centre console can be used for this.

⁴ Only applies to High Performance Multimedia and Premium Sound Multimedia.

* Option/accessory, for more information, see Introduction.



Bluetooth® handsfree*

1. When the **Name** row is selected, press **OK/MENU** to reach the input mode (illustration above).
2. Turn⁴ **TUNE** to the desired letter, press **OK/MENU** to confirm. The number and letter buttons on the control panel in the centre console can also be used.
3. Continue with the next letter and so on. The name entered is shown in the input field (2) in the TV screen.
4. To change the input mode to numbers, special characters, change between uppercase/lowercase letters, etc., turn **TUNE** to one of the options (see explanation in the table below) in the list (1) and then press **OK/MENU**.

When the name has been fully entered, select **OK** in the list on the TV screen (1) and press **OK/MENU**. Now continue with the telephone number in the same way as above.

When the telephone number has been entered, press **OK/MENU** and select a telephone number type (**Mobile phone**, **Home**, **Work** or **General**). Press **OK/MENU** to confirm.

When all details have been filled in, select **Save contact** in the menu to save the contact.

123/ ABC	Change between letters and numbers with OK/MENU .
More	Change to special characters with OK/MENU .
OK	Save and go back to Add contact with OK/MENU .
a A	Change between uppercase and lowercase letters with OK/MENU .
<-- --> _	Press OK/MENU , the cursor moves to the input field (2) at the top of the TV screen. The cursor can now be moved, with TUNE , to the appropriate place to e.g. insert new letters or delete with EXIT . To be able to insert new letters first go back to the input mode, by pressing OK/MENU .

Speed dial numbers

Use phone mode to add speed dial numbers under **Phone menu** → **Phone book** → **Speed dial**.

Dialling with speed dial numbers can be performed in phone mode using the number keys on the keypad in the centre console, by press-

ing a number key and then pressing **OK/MENU**. If there is no contact stored on the speed dial number then an option is shown to save a contact to the selected speed dial number.

Receiving a vCard

It is possible to receive a vCard to the car's phone book from other mobile phones (other than the one currently connected to the car). In order to allow this the car is set to visible mode for Bluetooth®. The function is activated in phone mode under **Phone menu** → **Phone book** → **Receive vCard**.

Memory status

Memory status of the car's phone book and the connected mobile phone's phone book can be seen in phone mode under **Phone menu** → **Phone book** → **Memory status**.

Delete phone book

The car's phone book can be deleted, this is carried out in phone mode under **Phone menu** → **Phone book** → **Clear phone book**.

⁴ Only applies to High Performance Multimedia and Premium Sound Multimedia.



Bluetooth® handsfree*



NOTE

Deleting the car's telephone book only deletes contacts in the car's telephone book. Contacts in the mobile phone's phone book are not deleted.

Version information Bluetooth®

The car's current Bluetooth® version can be seen in phone mode under **Phone menu** → **Phone settings** → **Bluetooth software version in car**.



Voice recognition* mobile phone

General

The infotainment system's voice recognition¹ allows the driver to voice-activate certain functions in a Bluetooth®-connected mobile phone or in Volvo's navigation system - RTI (Road and Traffic Information System).

NOTE

- The information in this section describes the use of voice commands to control a **mobile phone connected using Bluetooth®**. For detailed information on using a mobile phone connected using Bluetooth® with the car's Infotainment system see page 262.
- The Volvo navigation system RTI (Road and Traffic Information System) has a separate user manual which contains more information on voice control and voice commands to control that system.

Voice commands offer convenience and help the driver to avoid being distracted, and instead concentrate on driving and focus attention on the road and traffic conditions.

WARNING

The driver always holds overall responsibility for driving the vehicle in a safe manner and complying with all applicable rules of the road.

The voice recognition system allows the driver to voice-activate certain functions of a Bluetooth®-connected mobile phone and in Volvo's navigation system - RTI (Road and Traffic Information System), while the driver can keep his/her hands on the wheel at the same time. The input data are in dialogue form with spoken commands from the user and verbal replies from the system. The voice recognition system uses the same microphone as the Bluetooth® handsfree system (see illustration on page 262) and the voice recognition system's replies come via the car's speakers.

Language



Language list.

Voice recognition is not possible for all languages. Languages available for voice recognition are marked with an icon in the language list - . Changing the language is performed in the menu system **MY CAR**, see page 204.

¹ Only applies to vehicles equipped with Volvo's navigation system - RTI (Road and Traffic Information System).



Voice recognition* mobile phone

Remember



Steering wheel keypad.

- 1 Button for voice recognition

To activate the system

Before voice commands to a mobile phone can be used the mobile phone must be paired and connected via Bluetooth® handsfree. If a telephone command is given and no mobile phone is paired, then the system will provide information about this. For information on pairing and connecting a mobile phone, see page 263.

- Press the button for voice recognition (1) in order to activate the system and initiate a dialogue with voice commands. The system will then display commonly used commands in the TV screen in the centre console.

Keep the following things in mind when you use the voice recognition system:

- For a command - speak after the tone, with normal voice at normal speed.
- Do not speak while the system is replying (the system cannot understand commands during this time).
- The car's doors, windows and sunroof* must be closed.
- Avoid background noise in the passenger compartment.

NOTE

If the driver is unsure of which command to use, he (she) can say "Help" - the system then responds with a few different commands which can be used in the current situation.

Voice commands can be disabled by:

- saying "Cancel"
- not speaking
- a long press on the steering wheel button for Voice recognition
- Press **EXIT** or another main source button (e.g. **MEDIA**).

Help functions for voice recognition

- **Instructions:** A function that helps you get familiar with the system and the procedure for giving commands.
- **Voice training:** A function that enables the voice recognition system to learn to know your voice and your accent. The function provides an opportunity to voice train two user profiles.

The help functions can be accessed by pressing the **MY CAR** button on the control panel in the centre console and then turning **TUNE** to the desired menu option.

Instructions

The instructions can be started in two ways:

NOTE

This instruction and voice training can only be started when the car is parked.

- Press the button for Voice recognition and say "Voice instructions".
- Activate the instructions in the menu system **MY CAR** under **Settings** → **Voice settings** → **Voice tutorial**. For a description of the menu system, see page 202.

The instructions are divided into 3 lessons, which take around 5 minutes in total to complete. The system starts with the first lesson.



Voice recognition* mobile phone

To skip a lesson and go to the next one, press the button for voice recognition and say "Next". Go back to the previous lesson by saying "Previous".

Exit the instructions by means of a long press on the button for voice recognition.

Voice training

The system displays up to fifteen phrases for you to say. Voice training can be started in the menu system **MY CAR** under **Settings** →

Voice settings → **Voice training**. Choose between **User 1** or **User 2**. For a description of the menu system, see page 202.

After voice training has been completed, remember to set your user profile under **Voice user setting**.

Additional settings in MY CAR

- **User setting** - Two user profiles can be set, the function is activated in the menu system **MY CAR** under **Settings** → **Voice settings** → **Voice user setting**. Choose between **User 1** or **User 2**. For a description of the menu system, see page 202.
- **Voice volume** - Can be changed in the menu system **MY CAR** under **Settings** → **Voice settings** → **Voice output volume**. For a description of the menu system, see page 202.

Using voice commands

The driver initiates a dialogue with the voice commands by pressing the button for voice recognition (see illustration on page 272).

Once a dialogue has been started, commonly used commands will be shown in the TV screen. Greyed-out text or text within brackets is not included in the spoken command.

When the driver becomes accustomed to the system, he/she can speed up the command dialogue and skip the prompts from the system, by briefly pressing the button for voice recognition.

Commands can be given in several ways

The command "Phone call contact" can be pronounced as e.g.:

- "Phone > Call contact" - Say "Phone", wait for the system's reply, and then continue by saying "Call contact."
- or
- "Phone call contact" - Say the whole command in one sequence.

Quick commands

Quick commands for the phone can be found in the menu system **MY CAR** under **Settings** → **Voice settings** → **Voice command list** → **Phone commands** and **General commands**.

For a description of the menu system, see page 202.

Dial a number

The system understands the numbers **0** (zero) to **9** (nine). These numbers can be pronounced individually, in groups of several numbers at a time, or the whole number all at once. Numbers greater than **9** (nine) cannot be handled by the system, e.g. **10** (ten) or **11** (eleven) are not possible.

The following is an example of a dialogue with voice commands. The system's reply will vary depending on the situation.

The user starts the dialogue by saying:

Phone > call number

or

Phone call number

System reply

Number?

User action

Start saying the numbers (as individual units, i.e. six-eight-seven, etc.) in the phone number. If you say several numbers and pause, the system will repeat them, and then say "Continue".

Continue to say the numbers. When finished, finish the command by saying "Call".

- You can also change the number by saying the commands "Correct" (which deletes



Voice recognition* mobile phone

the last spoken group of numbers) or "Delete" (which deletes the whole spoken phone number).

Dialling from the call register

The following dialogue allows you to make a phone call from one of your mobile phone's call registers.

The user starts the dialogue by saying:

Phone > call from the call register

or

Phone call from the call register

Continue by responding to the system's prompts.

Call a contact

The following dialogue allows you to call your pre-defined contacts in the mobile phone.

The user starts the dialogue by saying:

Phone > call contact

or

Phone call contact

Continue by responding to the system's prompts.

Consider the following when you call a contact:

- If there are several contacts with similar names, they will be presented in the dis-

play in the numbered rows and the system prompts you to select a row number.

- If there are more rows in the list than can be displayed simultaneously, saying "Down" allows you to scroll down in the list (and saying "Up" allows you to scroll up in the list).

Calling voice mailbox

The following dialogue allows you to call your voice mailbox to check if you have received any messages. The phone number for your voice mailbox must be registered in the Bluetooth® function, see page 265.

The user starts the dialogue by saying:

Phone > call voice mailbox

or

Phone call voice mailbox

Continue by responding to the system's prompts.



TV*

General

NOTE

This system only supports TV transmissions in countries which transmit signals in mpeg-2 format and follow the DVB-T standard. The system does not support TV transmissions in mpeg-4 format or analogue transmissions.

NOTE

The TV picture is only shown when the car is stationary. When the car is moving at a speed over about 6 km/h the picture disappears. **No visual media available while driving** appears on the display screen, although the audio is heard during this time. The picture reappears when the car has stopped.

Cars with RSE do not shut off the rear screens.

NOTE

The reception is dependent both on how good the signal strength and signal quality are. The transmission may be disturbed by various factors such as tall buildings or the TV transmitter being far away. Coverage level can also vary depending on where in the country you are located.

IMPORTANT

A TV licence is required for this product in some countries.

Menus

The menus in **MEDIA** are controlled from the centre console and the steering wheel keypad*. For general information on menu navigation, see page 238 and menu overview, see page 241.

Overview

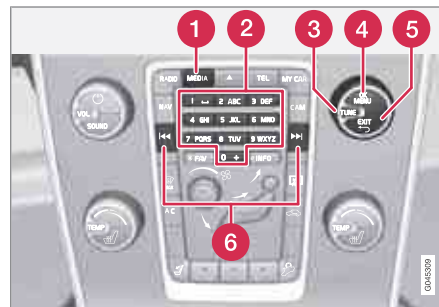

Centre console control panel.

- 1 MEDIA** button. Last active source (e.g. iPod® or TV) is activated. If a source is activated and you press **MEDIA** then a short-

cut menu is shown with commonly used menu options.

- 2** Station presets, numeric input.
- 3** Navigate in channel lists or menus by turning **TUNE**.
- 4** Confirm your selection or go to the menu by pressing **OK/MENU**.
- 5 EXIT** - leads up in the menu system, stops the function in progress.
- 6** The next available channel is shown by pressing **◀▶** / **▶▶**.

NOTE

If the car is equipped with a steering wheel keypad* and/or remote control* then in many cases these can be used instead of the buttons in the centre console. For a description of the steering wheel keypad, see page 236. For a description of the remote control, see page 279.



TV*

Watch TV

- Press **MEDIA**, turn **TUNE** until **TV** is shown in the TV screen, press **OK/MENU**.
 - > A search starts and after a short while the most recently used channel is shown.

Changing channel

It is possible to change channel as follows:

- Turn **TUNE**, a list of all available channels in the area is shown. If any of these channels is already saved as a preset then its preset number is shown to the right of the channel name. Continue turning **TUNE** to reach the desired channel and press **OK/MENU**.
- By pressing the preset buttons (0-9).
- Via a short press on the **◀◀** / **▶▶** buttons the next available channel in the area is shown.

NOTE

If the car has been moved within the country, for example, from one city to another, it is not certain that the presets are available at the new location as the frequency range may have changed. In which case, carry out a new search and save a new preset list, see the function "Save the available TV channels as presets", page 277.

NOTE

If no reception is available on the preset buttons, it may be because the car is at a location other than where the scan of TV channels was run, for example, if the car was driven from Germany to France. A new selection of country and a new search may then need to be carried out.

Searching TV channels/Preset list

1. Press TV mode on **OK/MENU**.
2. Turn **TUNE** to **TV menu** and press **OK/MENU**.
3. Turn **TUNE** to **Select country** and press **OK/MENU**.
 - > If one or more countries have previously been selected then they are shown in a list.
4. Turn **TUNE** to either **Other countries** or one of the previously selected countries. Press **OK/MENU**.
 - > A list of all available countries is shown.
5. Turn **TUNE** to the desired country (e.g. Sweden) and press **OK/MENU**.
 - > An automatic scan for available TV channels starts, this scan takes a little while. During this time the figure for each channel found and added as a pre-

set is shown. When the scan is complete a message is shown and the picture is shown. A preset list (max. 30 presets) has now been created and is available. To change channel, see page 276.

The scan and preset storage can be cancelled with **EXIT**.

Channel management

The preset list can be edited. You can change the order of the channels that are shown in the preset list. A TV channel can have more than one place in the preset list. The TV channel positions can also vary in the preset list.

To change the order in the preset list, go in TV mode to **TV menu** → **Reorganise presets**.

1. Turn **TUNE** to the channel you want to move in the list and confirm with **OK/MENU**.
 - > The selected channel is highlighted.
2. Turn **TUNE** to the new location in the list and confirm with **OK/MENU**.
 - > The channels change places with each other.

After the preset channels (max. 30) come all the other channels available in the area. It is pos-



TV*

sible to move a channel up to a place in the preset list.

Save the available TV channels as presets

If the car has been moved within the country, for example, from one city to another, it is not certain that the presets are available at the new location as the frequency range may have changed. In which case, carry out another scan and save a new preset list.

1. Press TV mode on **OK/MENU**.
2. Turn **TUNE** to **TV menu** and press **OK/MENU**.
3. Turn **TUNE** to **Autostore** and press **OK/MENU**.
 - > An automatic scan for available TV channels starts, this scan takes a little while. During this time the figure for each channel found and added as a preset is shown. When the scan is complete a message is shown and the picture is shown. A preset list (max. 30 presets) has now been created and is available. To change channel, see page 276.

Scanning the TV channels

This function automatically scans through the frequency range for all channels available in the



area where you are. When a channel is found, it is shown for approx. 10 seconds before scanning is resumed. Scanning is stopped with **EXIT**, then the channel that you just watched continues to be shown. Scanning does not affect the preset list.

Activate scanning in TV mode under **TV menu** → **Scan**.

Teletext

It is possible to read Teletext. Follow these steps:

1. Press the  button on the remote control.
2. Enter the page number (3 digits) with the number keys (0-9) to select page.
 - > The page is shown automatically.

Enter new page number, or press the remote control buttons  /  to go to the next page.

Return to TV screen with **EXIT** or by pressing the  button on the remote control.

It is also possible to control the teletext with the coloured buttons on the remote control.

Information about the current programme

Press the **INFO** button in order to display the information about the current programme, the next programme and its start time. If the **INFO** button is pressed once more then additional information on the current programme can sometimes be displayed, such as start and end times and a brief description of the current programme. For more information on the **INFO** button, see page 235.

To return to the TV picture, wait several seconds or press **EXIT**.

Picture settings

The settings for brightness and contrast can be adjusted. For more information, see page 255.

The reception is lost

If the reception for the TV channel that is being shown disappears then the picture will freeze. Shortly after this a message appears informing that the reception has been lost for the current TV channel, and a new search for the channel continues. When the reception returns the display of the TV channel starts immediately. It is possible to change channel at any time when the message is shown.

If the message **Reception lost, searching** is shown then this is because the system has





TV*

detected that there is no reception for all TV channels. One possible reason may be that a border has been crossed and that the system is set to the wrong country. In which case, change to the right country in accordance with "Searching TV channels/Preset list", see page 276.



Remote control*

General*



1 Corresponds to **TUNE** in the centre console.

The remote control can be used for all functions in the infotainment system. The remote control's buttons have the same functions as the buttons in the centre console or steering wheel keypad*.

When using the remote control, first press the remote control's button $L \begin{matrix} F \\ \text{TV} \\ R \end{matrix}$ to position **F**.

Then aim the remote control at the IR receiver, which is located to the right of the **INFO** button (see page 235) in the centre console.

**WARNING**

Keep loose objects such as mobile phones, cameras, remote controls for accessories, etc. in the glove compartment or other compartments. Otherwise they may injure people in the car in the event of sudden braking or a collision.

**NOTE**

Do not expose the remote control to direct sunlight (e.g. on the instrument panel) - otherwise problems may arise with the batteries.

functions

Key	Function
$L \begin{matrix} F \\ \text{TV} \\ R \end{matrix}$	F = Front TV screen
NAV	Change to navigation*
RADIO	Change to radio source (AM , FM1 etc.)
MEDIA	Change to media source (Disc , TV* etc.)
TEL	Change to Bluetooth® hands-free*
	Scroll/fast rewind, change track/song.
	Play/pause
	Stop
	Scroll/fast forward, change track/song.
DVD MENU	Menu
EXIT	To previous, cancels function, deletes input characters



06 Infotainment system

Remote control*

Key	Function
▲ ▼	Navigate up/down
◀ ▶	Navigate right/left
OK MENU	Confirm selection or go to the menu system for the selected source
🔊	Volume, decrease
🔊	Volume, increase
0-9	Preset channels, number and letter input
FAV *	Shortcuts for favourite setting.
INFO #	Information about the current programme, song, etc. Also used when there is more information available than can be shown in the TV screen.
💬	Selection of language for soundtrack

Key	Function
☐	Subtitles, selection of language for text
☰	Teletext*, On/Off

Replacing the battery in the remote control

NOTE

Battery life is normally 1-4 years and depends on how much the remote control is used.

The remote control is powered by four batteries of the AA/LR6 type.

Take along extra batteries for a long journey.

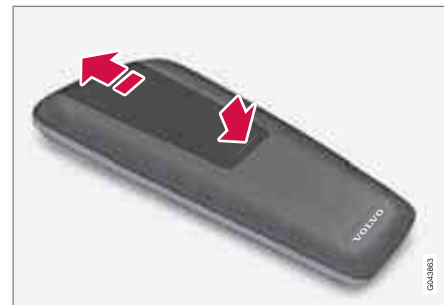

1. Push down the catch on the battery cover and slide the battery cover in the direction of the infrared lens.
2. Remove the used batteries, turn the new batteries in accordance with the symbols in the battery compartment and fit them.
3. Refit the cover.

NOTE

Be sure to dispose of the exhausted batteries in an environmentally safe manner.



Recommendations during driving.....	284
Refuelling.....	287
Fuel.....	288
Loading.....	292
Cargo area.....	295
Driving with a trailer.....	298
Towing and recovery.....	304



07

DURING YOUR JOURNEY





Recommendations during driving

General

Economical driving

Driving economically means driving smoothly while thinking ahead and adjusting your driving style and speed to the prevailing conditions.

- Drive in the highest gear possible, adapted to the current traffic situation and road - lower engine speeds result in lower fuel consumption.
- Avoid driving with open windows.
- Avoid sudden unnecessary acceleration and heavy braking.
- Remove unnecessary items from the car - the greater the load the higher the fuel consumption.
- Use engine braking to slow down, when it can take place without risk to other road users.
- A roof load and ski box increase air resistance, leading to higher fuel consumption - remove the load carriers when not in use.
- Do not run the engine to operating temperature at idling speed, but rather drive with a light load as soon as possible - a cold engine consumes more fuel than a warm one.
- A car with D2, D3, D4 or D5 engine in combination with a 6-speed manual gearbox is started in 2nd gear.

For more information and further advice, see the pages 12 and 384.



WARNING

Never switch off the engine while moving, such as downhill, this deactivates important systems such as the power steering and brake servo.

Driving in water

The car can be driven through water at a maximum depth of 25 cm at a maximum speed of 10 km/h. Extra caution should be exercised when passing through flowing water.

During driving in water, maintain a low speed and do not stop the car. When the water has been passed, depress the brake pedal lightly and check that full brake function is achieved. Water and mud for example can make the brake linings wet resulting in delayed brake function.

- Clean the electric contacts of the electric engine block heater and trailer coupling after driving in water and mud.
- Do not let the car stand with water over the sills for any long period of time - this could cause electrical malfunctions.



IMPORTANT

Engine damage can occur if water enters the air filter.

In depths greater than 25 cm, water could enter the transmission. This reduces the lubricating ability of the oils and shortens the service life of these systems.

In the event of the engine stalling in water, do not try restart - tow the car from the water to a workshop - an authorised Volvo workshop is recommended. Risk of engine breakdown.

Engine, gearbox and cooling system

Under special conditions, for example hard driving in hilly terrain and hot climate, there is a risk that the engine and drive system may overheat - in particular with a heavy load.

For information about overheating when driving with a trailer, see page 298.

- Remove any auxiliary lamps from in front of the grille when driving in hot climates.
- If the temperature in the engine's cooling system is too high the instrument panel's warning symbol is illuminated and there is a text message displayed there **High engine temp Stop safely** - stop the car in a safe way and allow the engine to run at idling speed for several minutes to cool down.



Recommendations during driving

- If the text message **High engine temp Stop engine** or **Coolant level low, Stop engine** is shown then the engine must be switched off after stopping the car.
- In the event of overheating in the gearbox a built-in protection function is activated which, amongst other things, illuminates the instrument panel's warning symbol and there is a text message displayed there **Transmission hot Reduce speed** or **Transmission hot Stop safely** - follow the recommendation given and lower the speed and stop the car in a safe way and allow the engine to run at idling speed for a few minutes to allow the gearbox to cool down.
- If the car overheats, the air conditioning may be switched off temporarily.
- Do not turn the engine off immediately you stop after a hard drive.

NOTE

It is normal for the engine's cooling fan to operate for a while after the engine has been switched off.

Open tailgate



WARNING

Do not drive with the tailgate open. Toxic exhaust fumes could be drawn into the car through the cargo area.

Do not overload the battery

The electrical functions in the car load the battery to varying degrees. Avoid using the key position **II** when the engine is switched off. Instead use the **I** mode - which uses less power.

Also, be aware of different accessories that load the electrical system. Do not use functions which use a lot of power when the engine is switched off. Examples of such functions are:

- ventilation fan
- headlamps
- windscreen wiper
- audio system (high volume).

If the battery voltage is low the information display shows the text **Low battery Power save mode**. The energy-saving function then shuts down certain functions or reduces certain functions such as the ventilation fan and/or audio system.

- In which case, charge the battery by starting the engine and then running it for at

least 15 minutes - battery charging is more effective during driving than running the engine at idling speed while stationary.

Before a long journey

- Check that the engine is working normally and that fuel consumption is normal.
- Make sure that there are no leaks (fuel, oil or other fluid).
- Check all bulbs and tyre tread depths.
- Carrying a warning triangle is a legal requirement in certain countries.

Winter driving

Check the following in particular before the cold season:

- The engine coolant must contain at least 50% glycol. This mixture protects the engine against frost erosion down to approximately -35°C . To achieve optimum antifreeze protection, different types of glycol must not be mixed.
- The fuel tank must be kept filled to prevent condensation.
- Engine oil viscosity is important. Oils with lower viscosity (thinner oils) facilitate starting in cold weather and also reduce fuel consumption while the engine is cold. For more information on suitable oils, see page 379.



Recommendations during driving

IMPORTANT

Low viscosity oil must not be used for hard driving or in hot weather.

- The condition of the battery and charge level must be inspected. Cold weather places great demands on the battery and its capacity is reduced by the cold.
- Use washer fluid to avoid ice forming in the washer fluid reservoir.

To achieve optimum roadholding Volvo recommends using winter tyres on all wheels if there is a risk of snow or ice.

NOTE

The use of winter tyres is a legal requirement in certain countries. Studded tyres are not permitted in all countries.

Slippery driving conditions

Practise driving on slippery surfaces under controlled conditions to learn how the car reacts.



Refuelling

Refuelling

Opening/closing the fuel filler flap



Open the fuel filler flap using the button on the lighting panel - the flap opens when the button is released.

 The arrow on the information display's symbol reminds which side of the car the fuel filler cap is located.

- Close the fuel filler flap by pressing it in until a click confirms that it is closed.

Opening the fuel filler flap manually

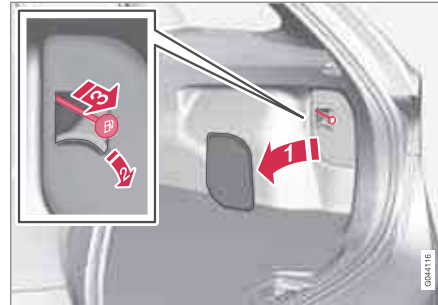

The fuel filler flap can be opened manually when electric opening from the passenger compartment is not possible.

1. Open/remove the side hatch in the cargo area (same side as fuel filler flap).
2. Expand/open a perforated section in the isolation and locate a green cord with handle.
3. Pull the cord gently straight back until the fuel filler flap folds out with a "click".

 **IMPORTANT**

Pull the wire gently - minimal force is required to disengage the hatch lock.

Opening/closing the fuel cap



The fuel filler cap can be attached onto the flap.

A certain overpressure may arise in the tank in the event of high outside temperatures. Open the cap slowly.

- After refuelling - refit the cap and turn it until one or more clicking sounds are heard.

Filling up with fuel

- Do not overfill the tank but fill until the pump nozzle cuts out.

 **NOTE**

Excess fuel in the tank can overflow in hot weather.



Fuel

General information on fuel

Fuel of a lower quality than that recommended by Volvo must not be used as engine power and fuel consumption is negatively affected.

WARNING

Always avoid inhaling fuel vapour and getting fuel splashes in the eyes.

In the event of fuel in the eyes, remove any contact lenses and rinse the eyes in plenty of water for at least 15 minutes and seek medical attention.

Never swallow fuel. Fuels such as petrol, bioethanol and mixtures of them and diesel are highly toxic and could cause permanent injury or be fatal if swallowed. Seek medical attention immediately if fuel has been swallowed.

WARNING

Fuel which spills onto the ground can be ignited.

Switch off the fuel-driven heater before starting to refuel.

Never carry an activated mobile phone when refuelling. The ring signal could cause spark build-up and ignite petrol fumes, leading to fire and injury.

IMPORTANT

Mixing different types of fuel or the use of fuel not recommended invalidates Volvo's guarantees, and any associated service agreement. This applies to all engines. NOTE: It does not apply to cars with engines that are adapted to run on ethanol fuel (E85).

NOTE

Extreme weather conditions, driving with a trailer or driving at high altitudes in combination with fuel grade are factors that could affect the car's performance.

Catalytic converters

The purpose of the catalytic converters is to purify exhaust gases. They are located close to the engine so that operating temperature is reached quickly.

The catalytic converters consist of a monolith (ceramic or metal) with channels. The channel walls are lined with a thin layer of platinum/rhodium/palladium. These metals act as catalysts, i.e. they participate in and accelerate a chemical reaction without being used up themselves.

Lambda-sond™ oxygen sensor

The Lambda-sond is part of a control system intended to reduce emissions and improve fuel economy.

An oxygen sensor monitors the oxygen content of the exhaust gases leaving the engine. This value is fed into an electronic system that continuously controls the injectors. The ratio of fuel to air directed to the engine is continuously adjusted. These adjustments create optimal conditions for efficient combustion, and together with the three-way catalytic converter reduce harmful emissions (hydrocarbons, carbon monoxide and nitrous oxides).

Petrol

Petrol must fulfil the EN 228 standard. Most engines can be run with octane ratings of 95 and 98 RON. Only in exceptional cases should 91 RON be used.

- 95 RON can be used for normal driving.
- 98 RON is recommended for optimum performance and minimum fuel consumption.

When driving in temperatures above +38 °C, fuel with the highest possible octane rating is recommended for optimum performance and fuel economy.

**Fuel****! IMPORTANT**

- Always refuel with unleaded petrol so as not to damage the catalytic converter.
- Do not use additives not recommended by Volvo.

Bioethanol E85

Do not modify the fuel system or its components, and do not replace components with parts that are not specifically designed for use with bioethanol.

! WARNING

Methanol must not be used. A decal on the inside of the fuel filler flap shows the correct alternative fuel.

The use of components not designed for bioethanol engines could cause fire, injury or engine damage.

Reserve fuel can

The reserve fuel can should be filled with petrol, see the NOTE box, page 118.

! IMPORTANT

Make sure the reserve fuel can is securely fastened and that its cap is sealed.

! WARNING

Ethanol is sensitive to sparks, and explosive gases could form in the reserve fuel can if it is refuelled with ethanol.

Diesel

Only use diesel fuel from well-known producers. Never use diesel of dubious quality. Diesel should fulfil the EN 590 or JIS K2204 standards. Diesel engines are sensitive to contaminants in the fuel, such as excessively high volumes of sulphur particles for example.

At low temperatures (-6 °C to -40 °C), a paraffin precipitate may form in the diesel fuel, which may lead to ignition problems. Special diesel fuel designed for low temperatures around freezing point is available from the major oil companies. This fuel is less viscous at low temperatures and reduces the risk of paraffin precipitate.

The risk of condensation in the fuel tank is reduced if the tank is kept well filled. When

refuelling, check that the area around the fuel filler pipe is clean. Avoid spilling fuel onto the paintwork. Wash off any spillage with detergent and water.

! IMPORTANT

Only ever use fuel that fulfils the European diesel standard.

The sulphur content must be a maximum of 50 ppm.

! IMPORTANT

Diesel type fuels that must not be used:

- Special additives
- Marine diesel fuel
- Heating oil
- FAME¹ (Fatty Acid Methyl Ester) and vegetable oil.

These fuels do not fulfil the requirements in accordance with Volvo recommendations and generate increased wear and engine damage that is not covered by the Volvo warranty.

Empty tank

The design of the fuel system in a diesel engine means that if the vehicle runs out of fuel, the

¹ Diesel fuel may contain a certain amount of FAME, but further amounts must not be added.



Fuel

tank may need to be vented in the workshop in order to restart the engine after fuelling.

Once the engine has stopped due to fuel starvation, the fuel system needs a few moments to carry out a check. Do this before starting the engine, once the fuel tank has been filled with diesel:

1. Insert the remote control key in the ignition switch and push it in to the end position (see page 78).
2. Press the **START** button **without** depressing the brake and/or clutch pedal.
3. Wait approx. 1 minute.
4. To start the engine: Depress the brake and/or clutch pedal and then press the **START** button again.

NOTE

Before filling with fuel in the event of fuel shortage:

- Stop the car on as flat/level ground as possible - if the car is tilting there is a risk of air pockets in the fuel supply.

Draining condensation from the fuel filter

The fuel filter separates condensation from the fuel. Condensation can disrupt engine operation.

The fuel filter must be drained at the intervals specified in the Service and Warranty Booklet or if you suspect that the car has been filled with contaminated fuel.

IMPORTANT

Certain special additives remove the water separation in the fuel filter.

Diesel particle filter (DPF)

Diesel cars are equipped with a particle filter, which results in more efficient emission control. The particles in the exhaust gases are collected in the filter during normal driving. So-called "regeneration" is started in order to burn away the particles and empty the filter. This requires the engine to have reached normal operating temperature.

Regeneration of the filter is automatic and normally takes 10-20 minutes. It may take a little longer at a low average speed. Fuel consumption may increase slightly during regeneration.

Regeneration in cold weather

If the car is frequently driven short distances in cold weather then the engine does not reach normal operating temperature. This means that regeneration of the diesel particle filter does not take place and the filter is not emptied.

When the filter has become approximately 80% full of particles, a warning triangle on the instrument panel illuminates, and the message **Soot filter full** See manual is shown on the instrument panel display.

Start regeneration of the filter by driving the car until the engine reaches normal operating temperature, preferably on a main road or motorway. The car should then be driven for approximately 20 minutes more.

NOTE

A smaller reduction of engine power may be noticed temporarily during regeneration.

When regeneration is complete the warning text is cleared automatically.

Use the parking heater* in cold weather so that the engine reaches normal operating temperature more quickly.

IMPORTANT

If the filter fills up with particles then it can be difficult to start the engine and the filter will be incapable of functioning. Then there is a risk that the filter will have to be replaced.



Fuel consumption and emissions of carbon dioxide

Fuel consumption figures may change if the car is equipped with extra equipment that affects the car's weight. See information on weights page 373 and table page 384.

The manner in which the car is driven, and other non-technical factors can also affect fuel consumption.

Consumption is higher and power output lower for fuel with an octane rating of 91 RON.



NOTE

Extreme weather conditions, driving with a trailer or driving at high altitudes in combination with fuel grade are factors that could affect the car's performance.



Loading

General information on loading

Payload depends on the car's kerb weight. The total of the weight of the passengers and all accessories reduces the car's payload by a corresponding weight. For more detailed information on weights, see page 373.



The tailgate is opened via a button on the lighting panel or the remote control key, see page 59.

WARNING

The car's driving characteristics change depending on the weight and distribution of the load.

To bear in mind when loading

- Position the load firmly against the rear seat's backrest.

Note that objects must not prevent the function of the WHIPS system for the front seats if any of the rear seat's backrests is folded down, see page 27.

- Centre the load.
- Heavy objects should be placed as low as possible. Avoid placing heavy loads on lowered backrests.
- Cover sharp edges with something soft to avoid damaging the upholstery.

- Secure all loads to the load retaining eyelets with straps or web lashings.

WARNING

A loose object weighing 20 kg can, in a frontal collision at a speed of 50 km/h, carry the impact of an item weighing 1000 kg.

WARNING

The protection provided by the inflatable curtain in the headlining may be compromised or eliminated by high loads.

- Never load cargo above the backrest.

WARNING

Always secure the load. During heavy braking the load may otherwise shift, causing injury to the car's occupants.

Cover sharp edges and sharp corners with something soft.

Switch off the engine and apply the parking brake when loading/unloading long items. Otherwise you may accidentally knock the gear lever or gear selector with the load into a drive position - and the car could then move off.

Front seat

The passenger seat backrest can also be folded for an extra long load, see page 80.

Roof load

Using load carriers

To avoid damaging the car and for maximum possible safety while driving, the load carriers designed by Volvo are recommended.

Carefully follow the installation instructions supplied with the carriers.

- Check periodically that the load carriers and load are properly secured. Lash the load securely with retaining straps.
- Distribute the load evenly over the load carriers. Put the heaviest objects at the bottom.
- The size of the area exposed to the wind, and therefore fuel consumption, increase with the size of the load.
- Drive gently. Avoid quick acceleration, heavy braking and hard cornering.

WARNING

The car's centre of gravity and driving characteristics are altered by roof loads. For information on maximum permitted roof load, including load carriers and any space box, see page 373.



Lowering the rear seat backrest

To simplify loading in the cargo area, the rear seat backrest can be folded down, see page 82.

Load retaining eyelets

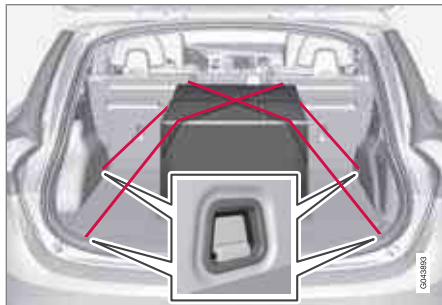

The folding load retaining eyelets are used to fasten straps in order to anchor items in the cargo area.

WARNING

Hard, sharp and/or heavy objects that are loose or protrude could cause injury during heavy braking.

Always secure large and heavy objects with a seatbelt or cargo retaining straps.

Bag holder*



Bag holder under folding hatch in the floor.

The bag holder keeps carrier bags in place and prevents them from overturning and spreading their contents across the cargo area.

1. Fold up the holder, which is part of the floor hatch.
2. Fasten the bags with strap and secure the carrying handle in the hooks.

12 V electrical socket*



Lower the cover to access the electrical socket.

- The socket also provides voltage when the remote control key is not in the ignition switch.

IMPORTANT

Max. power takeoff is 10 A (120 W).

NOTE

Remember that using the electrical socket with the engine switched off involves the risk of discharging the car's battery.



Loading



NOTE

The compressor for temporary emergency puncture repair has been tested and approved by Volvo. For information on the use of Volvo's recommended temporary emergency puncture repair (TMK), see page 321.



Cargo area

Safety net*



Storage space, safety net cassettes.

A rollable safety net comprising two cassettes has a storage space under the cargo area floor hatch.

Securing the net cassettes



The two-part safety net cassette is secured on the rear of the backrest. The narrowest cassette is secured on the left-hand side (seen from the tailgate).

1. Fold the rear seat's backrest forward, see page 83.
2. Align the cassette's anchor rails in front of the backrest attachment lugs **1**.
3. Slide the cassette into the attachment lugs **2**.
4. Fold back and lock the backrests.
 - Removing the cassettes takes place in reverse order.

Using the safety net

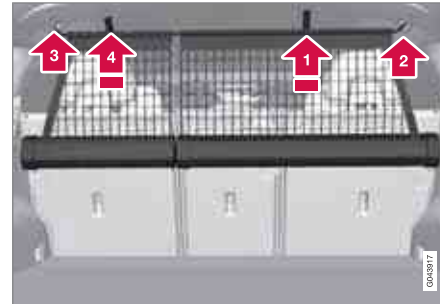

Pull the net up from the cassettes. The net is self-locking after about 1 minute if the rear seat's backrests are raised.

- 1** Pull up the right-hand section of the net using its strap.
 - 2** Insert the rod in the mounting on the right-hand side and then press it forward – the rod locks in with a click.
 - 3** Pull out the rod's telescope section and click it in on the other side.
 - 4** Pull up the left-hand safety net and hook it into the rod.
- Folding up takes place in reverse order.

The net can also be used when the rear seat's backrests are folded forward.

Removing the net cassettes

1. Roll the safety nets into the cassettes in accordance with the procedure in the section entitled "Using the safety net", but in reverse.
2. Fold the whole backrest forward.
3. Slide the cassettes out until they loosen from the anchor rails.

Store the cassettes in their compartment under the cargo area floor hatch.



Cargo area

WARNING

Loads in the cargo area must be firmly secured, even if the safety net is correctly fitted.

Safety net combined with cargo cover



Puller-straps for raising the net.

The safety net can also be raised from the rear seat when the cargo cover is extended.

Follow the procedure in the section entitled "Using the safety net". The straps for raising are located by the arrows.

Safety grille*

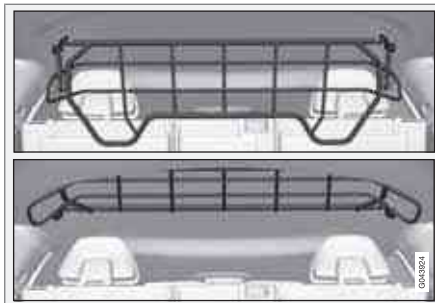

A safety grille prevents loads or pets from being thrown forward in the passenger compartment in the event of sudden braking.

Folding up

Take hold of the bottom of the safety grille and pull back/up.

IMPORTANT

The safety grille cannot be folded up or down when a cargo cover is fitted.

Fitting/removal

The safety grille is normally permanently installed in the car because it can easily be folded

up in the roof and so be out of the way if a longer cargo area is required. However, if desired, the safety grille can be dismantled and removed from the car.

For information about the tools required and methods for fitting/removal, see the installation instructions¹ that were included with the initial purchase.

For safety reasons, the safety grille must always be correctly fastened and secured when being refitted.

Cargo cover*

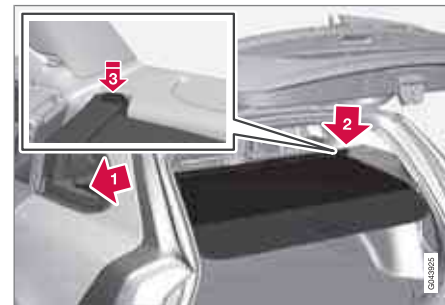

Pull the cargo cover over the load and hook it into the recesses at the cargo area's rear posts.

¹ Installation instructions no. 30756681.

* Option/accessory, for more information, see Introduction.

**!** **IMPORTANT**

The safety grille cannot be folded up or down when the cargo cover is fitted.

Attaching the cargo cover

- 1** ▶ Move one end piece of the cover into the recess on the side panel.
- 2** ▶ Move the other end piece into the corresponding recess.
- 3** ▶ Press both sides in. A "click" should be audible and the red marking should disappear.
 - > Check that both end pieces are locked.

Removing the cargo cover

1. Press in one end piece button and lift it out.
2. Carefully angle the cover up/out and the other end piece loosens automatically.

Lowering the cargo cover's rear sealing disc

In its rolled-in position, the cargo cover's rear sealing disc protrudes horizontally into the cargo area when it is fitted.

- Pull the sealing disc back gently, free from its support shelves, and lower.



Driving with a trailer

General

Payload depends on the car's kerb weight. The total of the weight of the passengers and all accessories, e.g. towbar, reduces the car's payload by a corresponding weight. For more detailed information on weights, see page 373.

If the towing bracket is mounted by Volvo, then the car is delivered with the necessary equipment for driving with a trailer.

- The car's towing bracket must be of an approved type.
- If the towbar is retrofitted, check with your Volvo dealer that the car is fully equipped for driving with a trailer.
- Distribute the load on the trailer so that the weight on the towing bracket complies with the specified maximum towball load.
- Increase the tyre pressure to the recommended pressure for a full load. For tyre pressure label location, see page 317.
- The engine is loaded more heavily than usual when driving with a trailer.
- Do not tow a heavy trailer when the car is brand new. Wait until it has been driven at least 1000 km.
- The brakes are loaded much more than usual on long and steep downhill slopes. Downshift to a lower gear and adjust your speed.

- For safety reasons, the maximum permitted speed for the car when coupled with a trailer should not be exceeded. Follow the regulations in force for the permitted speeds and weights.
- Maintain a low speed when driving with a trailer up long, steep ascents.
- Avoid driving with a trailer on inclines of more than 12%.

Trailer cable

An adapter is required if the car's towing bracket has 13 pin electrics and the trailer has 7 pin electrics. Use an adapter cable approved by Volvo. Make sure the cable does not drag on the ground.

Direction indicators and brake lights on the trailer

If any of the trailer's lamps for direction indicators are broken, then the combined instrument panel's symbol for direction indicators flashes faster than normal and the display shows the text **Bulb fail - Ind. signal trailer**.

If any of the trailer's lamps for the brake light are broken then the **Bulb fail - Stop lamp trailer** text is shown.

Level control*

The rear shock absorbers maintain a constant height irrespective of the car's load (up to the maximum permissible weight). When the car is

stationary the rear of the car lowers slightly, which is normal.

Trailer weights

For information on Volvo's permitted trailer weights, see page 374.



NOTE

The stated maximum permitted trailer weights are those permitted by Volvo. National vehicle regulations can further limit trailer weights and speeds. Towbars can be certified for higher towing weights than the car can actually tow.



WARNING

Follow the stated recommendations for trailer weights. Otherwise, the car and trailer may be difficult to control in the event of sudden movement and braking.

Manual gearbox

Overheating

When driving with a trailer in hilly terrain in a hot climate there may be a risk of overheating.

- Do not run the engine at higher revolutions than 4500 rpm (diesel engines: 3500 rpm) - otherwise the oil temperature may become too high.

**Driving with a trailer****Diesel engine 5-cyl**

- In the event of a risk of overheating the optimal speed for the engine is 2300-3000 rpm for optimal circulation of the coolant.

Automatic gearbox**Overheating**

When driving with a trailer in hilly terrain in a hot climate there may be a risk of overheating.

- An automatic gearbox selects the optimum gear related to load and engine speed.
- In the event of overheating a warning symbol illuminates on the instrument panel combined with a text message - follow the recommendation given.

Steep inclines

- Do not lock the automatic transmission in a higher gear than the engine "can cope with" - it is not always a good idea to drive at a high gear with low engine revolutions.

IMPORTANT

See also the specific information on slow driving with trailer for cars with the Powershift automatic transmission on page 125.

Parking on a hill

1. Depress the foot brake.

2. Activate the parking brake.
3. Move the gear selector to position **P**.
4. Release the foot brake.
 - Move the gear selector to park position **P** when parking an automatic car with a hitched trailer. Always use the parking brake.
 - Block the wheels with chocks when parking a car with hitched trailer on a hill.

Starting on a hill

1. Depress the foot brake.
2. Move the gear selector to driving position **D**.
3. Release the parking brake.
4. Release the foot brake and start driving off.

Towing bracket

If the car is equipped with a detachable towbar, the installation instructions for the loose section must be followed carefully, see page 301.

WARNING

If the car is fitted with a Volvo detachable towbar:

- Follow the installation instructions carefully.
- The detachable section must be locked with the key before setting off.
- Check that the indicator window shows green.

Important checks

- The towbar's towball must be cleaned and greased regularly.

NOTE

If a towball hitch with vibration damper is used, it is not necessary to grease the towball.



Driving with a trailer

Storing the detachable towbar



Towbar storage space.

! IMPORTANT

Always remove the towbar after use and store it in the appointed location in the car.

Specifications

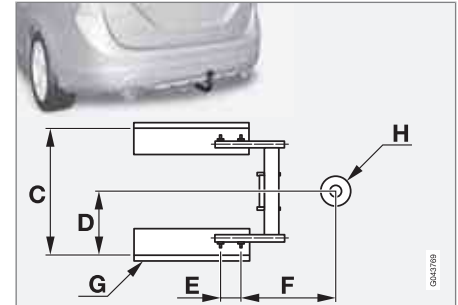
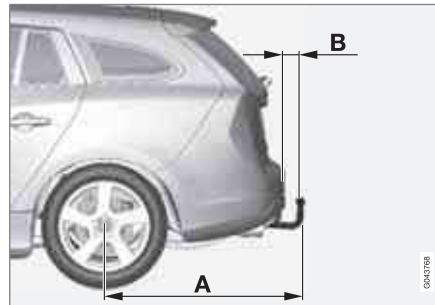

Dimensions, mounting points (mm)

A	998
B	80
C	854
D	427
E	109
F	282
G	Side member
H	Ball centre



Driving with a trailer

Attaching the towbar



- 1 Remove the protective cover by first pressing in the catch **1** and then pulling the cover straight back **2**.



- 2 Ensure that the mechanism is in the unlocked position by turning the key clockwise.



- 3 The indicator window must show red.



- 4 Insert the towbar until you hear a click.



- 5 The indicator window must show green.



- 6 Turn the key anticlockwise to locked position. Remove the key from the lock.



Driving with a trailer



7 Check that the towbar is secure by pulling it up, down and back.

! WARNING

If the towbar is not fitted correctly then it must be detached and reattached in accordance with the previous instructions.

! IMPORTANT

Only grease in the ball for the towing hitch, the remainder of the towbar should be clean and dry.



8 Safety cable.

! WARNING

Be sure to attach the trailer's safety cable to the correct place.

Removing the towbar



1 Insert the key and turn it clockwise to the unlocked position.



2 Push in the locking wheel  and turn it anticlockwise  until you hear a click.



3 Turn the locking wheel down fully, until it comes to a stop. Hold it in this position while pulling the towbar rearward and upward.

! WARNING

Secure the towbar safely if it is stored in the car, see page 300.



Driving with a trailer



- 4 Push the protective cover until it snaps tight.

Trailer Stability Assist - TSA*

The TSA system (Trailer Stability Assist) serves to stabilise the car and trailer combination if it begins to snake.

The TSA function is part of the **DSTC** system (Dynamic Stability and Traction Control), see page 146.

Function

The snaking phenomenon can occur with any car/trailer combination. Normally, snaking occurs at extremely high speeds. But, there is a risk of it occurring at lower speeds (70-90 km/h) if the trailer is overloaded or the load is improperly distributed, e.g. too far back.

In order for snaking to occur, there must be a triggering factor, e.g.:

- Car with trailer subjected to a sudden and powerful side wind.
- Car with trailer drives on an uneven road surface or in a pothole.
- Sweeping steering wheel movements.

Operation

If snaking has started, it could be difficult or even impossible to suppress. This makes the car/trailer combination difficult to control and there is a risk that you could, for example, end up in the wrong lane or leave the carriageway.

TSA system continually monitors car movements, particularly lateral movements. If snaking is detected, the front wheels are individually braked. This serves to stabilise the car/trailer combination. This is often enough to help the driver regain control of the car.

If snaking is not eliminated the first time the TSA system comes into action, the car/trailer combination is braked with all wheels and engine power is reduced. Once snaking has been gradually suppressed and the car/trailer combination is once again stable, the TSA system stops regulating and the driver once again has full control of the car.

Miscellaneous

The TSA system can engage within the speed interval 60 to 160 km/h.

NOTE

TSA function is switched off if the driver selects **Sport** mode, see page 146.

TSA may fail to engage if the driver uses severe steering wheel movements to try to rectify the snaking because in such a situation the TSA system cannot determine whether it is the trailer or the driver that is causing the snaking.

 The **DSTC** symbol in the combined instrument panel flashes when the TSA is working.



Towing and recovery

Towing

Find out the statutory maximum speed limit for towing before towing begins.

1. Unlock the steering lock by inserting the remote control key in the ignition switch and giving a long press on the **START/ STOP ENGINE** button - key position **II** is activated, see page 78 for more information on key positions.
2. The remote control key must remain in the ignition switch while the car is being towed.
3. Keep the towline taut when the towing vehicle reduces speed by holding your foot gently pressed on the brake pedal - thereby avoiding unnecessary jerking.
4. Be prepared to brake to stop.

WARNING

- Check that the steering lock is unlocked before towing.
- The remote control key must be in key position **II** - in position **I** all airbags are deactivated.
- Never remove the remote control key from the ignition switch when the car is being towed.

WARNING

The brake servo and power steering do not work when the engine is switched off - the brake pedal needs to be depressed about 5 times more heavily and the steering is considerably heavier than normal.

Manual gearbox

Prior to towing:

- Move gear lever into neutral and release the parking brake.

Automatic gearbox Geartronic

IMPORTANT

Note that the car must always be towed with the wheels rolling forward.

- Cars with automatic gearbox must not be towed at speeds above 80 km/h or further than 80 km.

Prior to towing:

- Move the gear selector to position **N** and release the parking brake.

Automatic gearbox Powershift

The model with Powershift transmission should not be towed as it is dependent on the engine running in order to receive sufficient

lubrication. If towing still has to take place, the route must be as short as possible and then with very low speed.

In the event of uncertainty as to whether or not the car is equipped with Powershift transmission, this can be verified by checking the designation on the transmission's label under the bonnet - see page 370. The designation "MPS6" means that it is Powershift - transmission otherwise it is Geartronic automatic transmission.

IMPORTANT

Avoid towing.

- However, the car can be towed for a short distance at low speed to move it from a dangerous position - not further than 10 km and not faster than 10 km/h. Note that the car must always be towed with the wheels rolling forward.
- In the event of moving a longer distance than 10 km, the car must be transported with the drive wheels raised from the road - professional recovery is recommended.

Prior to towing:

- Move the gear selector to position **N** and release the parking brake.



Towing and recovery

Jump starting

Do not tow the car to bump start the engine. Use a donor battery if the battery is discharged and the engine does not start, see page 120.

! IMPORTANT

The catalytic converter may be damaged during attempts to tow-start the engine.

Towing eye

The towing eye is screwed into a threaded socket behind a cover on the right-hand side of the bumper, front or rear.

Attaching the towing eye

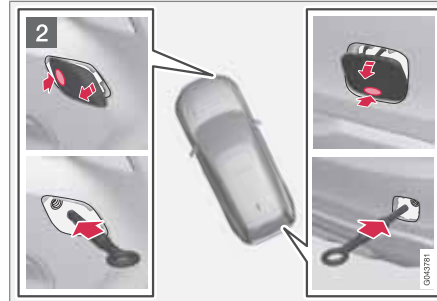

- 1 Take out the towing eye that is located under the floor hatch in the cargo area.
- 2 The cover for the towing eye's attachment point is available in two variants which must be opened in different ways:
 - Open the variant with a recess using a coin or similar inserted in the recess, turning it outwards. Then turn out the cover completely and remove it.
 - The second variant has a marking along one side or in a corner: Press the marking with a finger and fold out the opposite side/corner at the same time using a coin or similar - the cover turns around its axis and can then be removed.

Screw the towing eye right in up to its flange. Turn in the towing eye firmly e.g. using the wheel wrench.

After use, unscrew the towing eye and return it to its place.

Finish by refitting the cover onto the bumper.

! IMPORTANT

The towing eye is only designed for towing on roads - **not** for pulling the car unstuck or out of a ditch. Call a recovery service for recovery assistance.

i NOTE

On certain cars with towbar fitted the towing eye cannot be attached in the rear bracket. Attach the towrope in the towbar.

For this reason it is advisable to store the detachable towbar's towball in the car.



Towing and recovery

Recovery

Call a recovery service for recovery assistance.



IMPORTANT

Note that the car must always be transported with the wheels rolling forward.

- An All Wheel Drive car (AWD) with raised front suspension must not be towed at speeds above 70 km/h. It should not be towed further than 50 km.



General	310
Changing wheels	314
Tyre pressure	317
Warning triangle and first-aid kit*	318
Tyre pressure monitoring (TPMS)*	319
Emergency puncture repair (TMK)	321

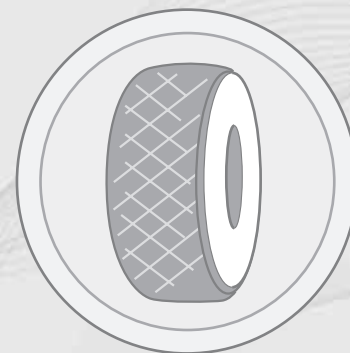

08

WHEELS AND TYRES

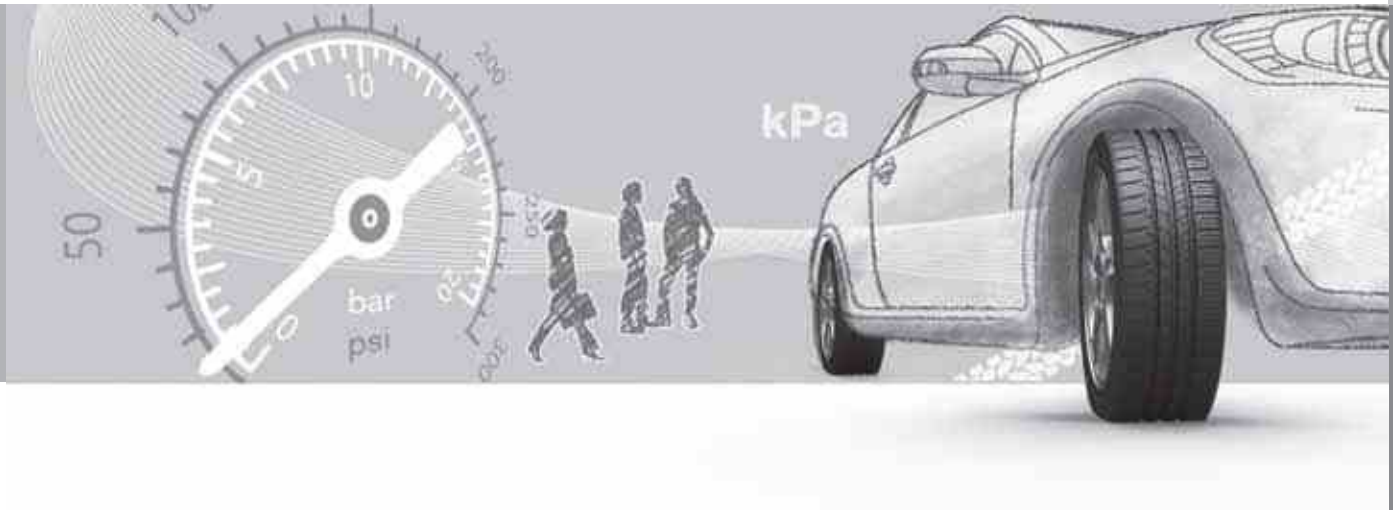



General

Driving characteristics

Tyres greatly affect the car's driving characteristics. The type of tyre, dimensions, tyre pressure and speed rating are important for how the car performs.

Direction of rotation

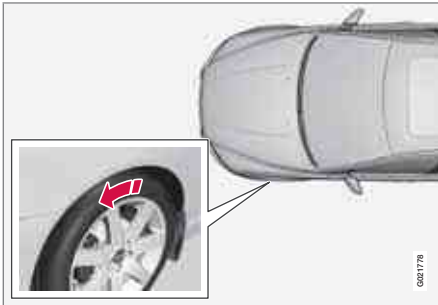

The arrow shows the tyre's direction of rotation.

Tyres with a tread pattern which are designed to only turn in one direction have the direction of rotation marked with an arrow. The tyre must always rotate in the same direction throughout its lifespan. Tyres should only be switched between front and rear positions, never between left and right-hand sides, or vice versa. If the tyres are fitted incorrectly, the car's braking characteristics and capacity to force rain and slush out of the way are adversely affected.

Tyres with the greatest tread depth should always be fitted to the rear of the car (to decrease the risk of skidding).

i NOTE

Ensure that tyres of the same type and dimensions, and also the same make, are fitted to all four wheels.

Follow the recommended tyre pressures specified in the tyre pressure table, see page 388.

Tyre care

Tyre age

All tyres older than 6 years old should be checked by an expert even if they seem undamaged. Tyres age and decompose, even if they are hardly ever or never used. The function can therefore be affected. This applies to all tyres that are stored for future use. Examples of external signs which indicate that the tyre is unsuitable for use are cracks or discoloration.

New tyres



Tyres are perishable. After a few years they begin to harden at the same time as the friction capacity/characteristics gradually deteriorate. For this reason, aim to get as fresh tyres as possible when you replace them. This is especially important with regard to winter tyres. The last four digits in the sequence mean the week and year of manufacture. This is the tyre's DOT marking (Department of Transportation), and this is stated with four digits, for example 1510. The tyre in the illustration was manufactured in week 15 of 2010.

Summer and winter tyres

When summer and winter wheels are changed the wheels should be marked with which side of the car they were mounted on, for example **L** for left and **R** for right.



General

Wear and maintenance

The correct tyre pressure results in more even wear, see page 317. Driving style, tyre pressure, climate and road condition affect how quickly your tyres age and wear. To avoid differences in tread depth and to prevent wear patterns arising, the front and rear wheels can be switched with each other. A suitable distance for the first change is approx. 5000 km and then at 10 000 km intervals. Volvo recommends that you contact an authorised Volvo workshop for checking if you are uncertain about tread depth. If significant differences in wear (>1 mm difference in tread depth) between tyres have already occurred, the least worn tyres must always be placed on the rear. Understeer is normally easier to correct than oversteer, and leads to the car continuing forwards in a straight line rather than having the rear end skidding to one side, resulting in possible complete loss of control over the car. This is why it is important for the rear wheels never to lose grip before the front wheels.

Wheels should be stored lying down or hanging up - and not standing up.

WARNING

A damaged tyre can lead to loss of control of the car.

Tyres with tread wear indicators



Tread wear indicators.

Tread wear indicators are narrow treadless bands across the width of the tread. On the side of the tyre are the letters **TWI** (Tread Wear Indicator). When the tyre's tread depth is down to 1.6 mm, the tread depth will be level in height with the tread wear indicators. Change to new tyres as soon as possible. Remember that tyres with little tread depth provide very poor grip in rain and snow.

Rims and wheel bolts

IMPORTANT

The wheel bolts must be tightened to 140 Nm. Overtightening can damage the nuts and the bolts.

Only use rims that are tested and approved by Volvo and which are Volvo genuine accessories. Check the torque with a torque wrench.

Locking wheel bolts*

Locking wheel bolts* can be used on both aluminium and steel rims. Under the cargo area floor there is space for the sleeve for the lockable wheel bolts.

Tools



Located under the cargo area floor are the car's towing eye, jack* and wheel wrench*. There is also space for the sleeve for the lockable wheel bolts.

* Option/accessory, for more information, see Introduction.



General

Jack*

The original jack should only be used for changing to the spare wheel. The jack's thread must always be well greased.

Tools - returning into place

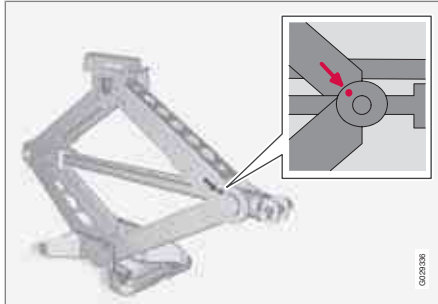

The tools and jack* must be returned to their correct places after use. The jack needs to be cranked together to the correct position in order to have space.

IMPORTANT

The tools and jack* must be stored in the intended location in the car's cargo area when not in use.

Winter tyres

Volvo recommends winter tyres with particular dimensions. Tyre dimensions are dependent on engine variant. When driving on winter tyres, the correct type of tyres must be fitted to all four wheels.

NOTE

Volvo recommends that you consult a Volvo dealer about which wheel rim and tyre types are most suitable.

Studded tyres

Studded winter tyres should be run in gently for 500-1000 km so the studs settle properly into the tyres. This gives the tyre, and especially the studs, a longer service life.

NOTE

The legal provisions for the use of studded tyres vary from country to country.

Tread depth

Road conditions with ice, slush and low temperatures place considerably higher demands on tyres than summer conditions. Volvo therefore recommends not to drive on winter tyres that have a tread depth of less than 4 millimetres.

Using snow chains

Snow chains may only be used on the front wheels (also applies to all-wheel drive cars).

Never drive faster than 50 km/h with snow chains. Avoid driving on bare ground as this wears out both the snow chains and tyres.

WARNING

Use Volvo genuine snow chains or equivalent chains designed for the car model, and tyre and rim dimensions. In the event of uncertainty Volvo recommends that you consult an authorised Volvo workshop. The wrong snow chains may cause serious damage to your car and lead to an accident.

Specifications

The car has whole vehicle approval. This means that certain combinations of wheels and tyres are approved. For the permissible combinations, see page 388

Wheel (rim) dimensions

Wheels (rims) have a designation of dimensions, for example: 7Jx16x50.

7	Rim width in inches
J	Rim flange profile



General

16	Rim diameter in inches
50	Off-set in mm (distance from wheel centre to wheel contact surface against the hub)

Tyre dimensions

The dimensions are stated on all car tyres.
Example of designation: 215/55R16 97W.

215	Tyre width (mm)
55	Ratio between tyre wall height and tyre width (%)
R	Radial ply
16	Rim diameter in inches (")
97	Codes for the maximum permitted tyre load, tyre load index (LI)
W	Speed rating for maximum permitted speed, speed rating (SS). (In this case 270 km/h).

Load index

Each tyre has a certain capacity to carry a load, a load index (LI). The car's weight determines the load capacity required of the tyres. Mini-

um permitted index is specified in the table, see page 388.

Speed ratings

Each tyre can withstand a certain maximum speed, a speed rating (Speed Symbol; SS).

Tyre speed class must at least correspond with the car's top speed. Minimum permitted speed rating is specified in the table, see page 388.

The only exception to these conditions is winter tyres (both those with metal studs and those without), where a lower speed rating may be used. If such a tyre is chosen, the car must not be driven faster than the speed rating of the tyre (for example, class Q can be driven at a maximum of 160 km/h).

Traffic regulations determine how fast a car can be driven, not the speed rating of the tyres.

 **NOTE**

It is the maximum permitted speed that is stated in the table.

Q	160 km/h (used only on winter tyres)
T	190 km/h
H	210 km/h

V	240 km/h
W	270 km/h
Y	300 km/h

 **WARNING**

The car must be fitted with tyres which have the same or a higher load index (LI) and speed rating (SS) than specified. If a tyre with too low a load index or speed rating is used, it may overheat.



Changing wheels

Spare wheel*

The following instructions are applicable **only if a spare wheel has been purchased as an optional extra with the car**. If the car does not have a spare wheel, see page 321 for information on temporary tyre sealing (TMK).

The spare wheel (Temporary spare) is only intended for use temporarily and must be replaced by an ordinary wheel as soon as possible. The car's handling may be altered by the use of the spare wheel. The spare wheel is smaller than the normal wheel. The car's ground clearance is affected accordingly. Pay attention to high kerbs and do not machine wash the car. If the spare wheel is fitted on the front axle, you cannot use snow chains at the same time. On all-wheel drive cars the drive on the rear axle can be disconnected. The spare wheel must not be repaired. The correct tyre pressure for the spare wheel is stated in the tyre pressure table, see page 388.

! IMPORTANT

Never drive faster than 80 km/h with a spare wheel on the car.

! IMPORTANT

The car must never be driven fitted with more than one temporary spare wheel.

The spare wheel is supplied in a bag which must be placed on the cargo area floor in the cargo area and be secured with straps.

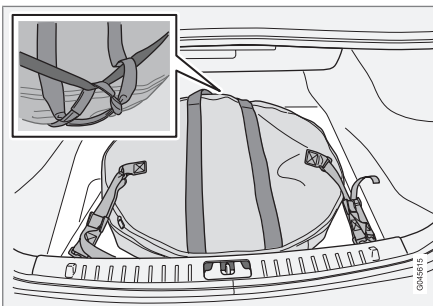

Cars with two load retaining eyelets.

Turn the handle on the spare wheel bag in towards the rear seat. Attach the sewn-in tensioning strap hooks in the load retaining eyelets. Attach the long strap into one of the load retaining eyelets, run the strap around the spare wheel and through the lower handle. Tighten the short tensioning strap onto the long one. Attach the second load retaining eyelet and tighten.

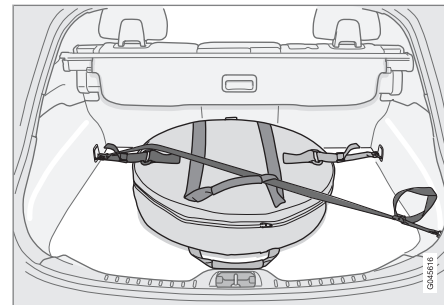

Cars with four load retaining eyelets.

Turn the handle on the spare wheel bag out towards you. Attach the sewn-in tensioning strap hooks in the front load retaining eyelets. Attach the long strap into one of the front load retaining eyelets, run the strap diagonally over the spare wheel and through the upper handle. Tighten the short tensioning strap onto the long one. Attach the rear load retaining eyelet and tighten.

Taking out the spare wheel

1. Loosen the straps, lift out the spare wheel from the cargo area and remove it from the spare wheel bag.
2. Fold up the cargo area floor.
3. Lift the tools and jack out from the foam block.

* Option/accessory, for more information, see Introduction.



Changing wheels

Removing

Set up the warning triangle, see page 318 if a wheel must be replaced at a busy location. The car and jack* must be on a firm horizontal surface.

1. Apply the parking brake and engage reverse gear, or position **P** if the car has an automatic gearbox.

WARNING

Check that the jack is not damaged, that the threads are thoroughly lubricated and that it is free from dirt.

NOTE

Volvo recommends only using the jack* that belongs to the car model in question, which is indicated on the jack's label.

The label also indicates the jack's maximum lift capacity at a specified minimum lifting height.

2. Take out the jack*, wheel wrench* and removal tool for wheel covers* located under the cargo floor in the cargo area. If another jack is selected, see page 328.
3. Place chocks in front of and behind the wheels which will remain on the ground.

Use heavy wooden blocks or large stones for example.

4. Cars with steel rims have removable wheel covers. Use the removal tool to hook in and pull off any full-wheel wheel covers. Alternatively, the wheel covers can be pulled away by hand.

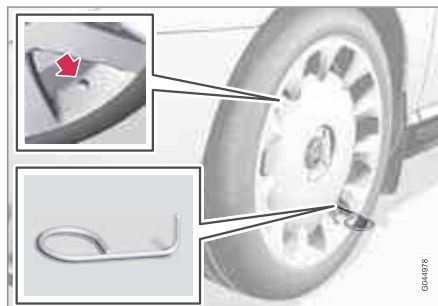

5. Screw together the towing eye with the wheel wrench* until the stop position as illustrated below.



IMPORTANT

The towing eye must be screwed into all threads in the wheel bolt wrench.

6. Loosen the wheel bolts $\frac{1}{2}$ -1 turn anticlockwise with the wheel wrench.

WARNING

Never position anything between the ground and the jack, nor between the jack and the car's jacking point.

7. There are two jacking points on each side of the car. There is a recess in the plastic cover at each point. Crank the foot of the



Changing wheels

jack down so it is pressed squarely on the ground.

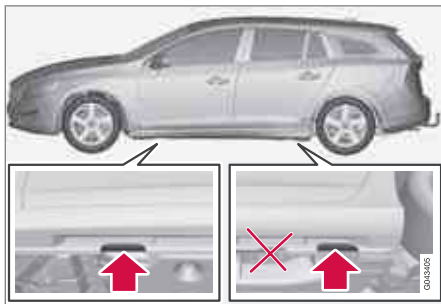

! IMPORTANT

The ground must be firm, smooth and level.

8. Lift the car so that the wheel is free. Remove the wheel bolts and lift off the wheel.

Installation

1. Clean the contact surfaces between wheel and hub.
2. Put on the wheel. Tighten the wheel bolts thoroughly.

3. Lower the car so that the wheels cannot rotate.



4. Tighten the wheel bolts crosswise. It is important that the wheel bolts are tightened properly. Tighten to 140 Nm. Check the torque with a torque wrench.
5. Refit any full wheel covers.

i NOTE

The wheel cover outlet for the valve must be positioned over the valve on the wheel rim during fitting.

! WARNING

Never crawl under the car when it is raised on the jack.

Passengers must leave the car when it is raised on the jack.

Park the car so that passengers have the car - or preferably a crash barrier - between them and the road.

i NOTE

The car's regular jack is designed only for use occasionally and for a short time, such as when changing a wheel with a punctured tyre, switching between summer tyres and winter tyres, etc. Only the jack belonging to the specific model is to be used to jack up the car. If the car is to be jacked up more often, or for a longer time than is required just to change a wheel, use of a garage jack is recommended. In this instance, follow the instructions for use that come with the equipment.



Tyre pressure

Tyre pressure



The tyre pressure decal on the driver's side door pillar (between frame and rear door) shows which pressures the tyres should have at different loads and speed conditions. This is also specified in the tyre pressure table, see page 388.

- Tyre pressure for the car's recommended tyre dimension
- ECO pressure¹

i NOTE

Temperature differences change the tyre pressure.

Fuel economy, ECO pressure

At speeds under 160 km/h, the general tyre pressure is recommended (applies for both full load and light load) in order to obtain optimum fuel economy.

Checking the tyre pressure

The tyre pressures must be checked every month.

Check tyre pressures on cold tyres. "Cold tyres" means the tyres are the same temperature as the ambient temperature. After several kilometres of driving, the tyres warm up and the pressure increases.

Inadequate tyre pressure increases fuel consumption, shortens tyre lifespan and impairs the car's roadholding. Driving on tyres with tyre pressure that is too low could result in the tyres overheating and being damaged. Tyre pressure affects travelling comfort, road noise and steering characteristics.

i NOTE

Tyre pressure decreases over time, this is a natural phenomenon. Tyre pressure also varies depending on ambient temperature.

¹ ECO pressure results in improved fuel economy.



Warning triangle and first-aid kit*

Warning triangle

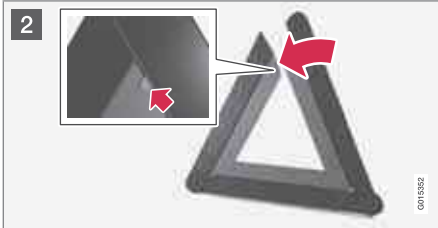
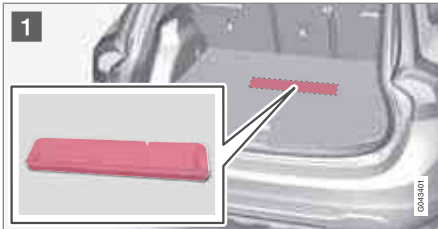

- 1 Lift the floor hatch and take out the warning triangle.
- 2 Take the warning triangle from the case, fold out and assemble the two loose sides.
- 3 Fold out the warning triangle's support legs.

Follow the regulations for the use of a warning triangle. Position the warning triangle in a suitable place with regard to traffic.

Ensure the warning triangle and its case are properly secured in the cargo area after use.

i **NOTE**

If the car has been locked with privacy locking then the boot lid/tailgate and floor hatch cannot be opened, see page 49.

First aid kit*



A case with first aid equipment is located under the floor in the cargo area.



Tyre pressure monitoring (TPMS)*

General

TPMS (Tyre Pressure Monitoring System)* warns the driver when the pressure is too low in one or more of the car's tyres. It uses sensors located inside the air valve in each wheel. When the car is driven at about 40 km/h the system detects the tyre pressure. If the pressure is too low then a warning lamp  on the instrument panel illuminates and a message is shown on the display.

Only factory fitted wheels are equipped with TPMS sensors in the valves.

If wheels without TPMS sensors are used then **Tyre press. syst Service required** will be shown every time the car is driven faster than 40 km/h for more than 10 minutes.

Always check the system after changing a wheel in order to ensure that replacement wheels work with the system.

For information on correct tyre pressures, see page 388.

The system does not replace normal tyre maintenance.

IMPORTANT

If a fault should arise in the tyre pressure system a warning lamp  on the instrument panel will illuminate and a message will be shown. This can be for various reasons, e.g. fitting a wheel not equipped with a sensor adapted for Volvo's tyre pressure monitoring system.

Adjusting tyre pressure monitoring

Tyre pressure monitoring can be adjusted in order to follow Volvo's tyre pressure recommendations, when driving with a heavy load for example.

NOTE

The engine must not be running when the tyres are calibrated.

The settings are made with the control in the centre console, see page 203.

1. Inflate the tyres to the required pressure and select key position **I** or **II**.
2. Select the menu system **MY CAR** to open the menus to **Settings** → **Tyre pressure**
3. Select **Calibrate tyre pressure**.
4. Press **OK**.

5. Start the car and drive at least at 40 km/h for a total of at least 1 minute and check that the message disappears.
 - > Calibration is complete.

Rectifying low tyre pressure

If a message for low tyre pressure is shown in the display:

1. Check the tyre pressure in all four tyres.
2. Inflate the tyre(s) to the correct pressure.
3. Drive at least at 40 km/h for a total of at least 1 minute and check that the message disappears.

Deactivating/activating tyre pressure monitoring

NOTE

The engine must not be running when tyre pressure monitoring is activated/deactivated.

The settings are made with the control in the centre console, see page 203.

1. Select key position **I** or **II**.
2. Select the system **MY CAR** to open the menus to **Car settings** → **Tyre pressure**
3. Select **Tyre pressure system** and press **OK**.

* Option/accessory, for more information, see Introduction.



Tyre pressure monitoring (TPMS)*

- > A **X** is shown in the display if the system is activated, the option disappears if the system is deactivated.

Recommendations

- Volvo recommends that TPMS sensors are fitted to all wheels on the car.
- Volvo recommends that sensors are not moved between different wheels.

WARNING

When inflating a tyre equipped with TPMS, hold the nozzle of the pump directly against the valve to avoid damaging the valve.

Driveable punctured tyres*

If Self Supporting run flat Tyres (SST)* have been selected then the car is also equipped with TPMS.

This type of tyre has a specially reinforced side wall that makes continued driving possible to a limited extent despite the tyre losing all or some of its pressure. These tyres are fitted on a special rim. (Normal tyres can also be fitted to this rim).

If an SST tyre loses tyre pressure then the yellow TPMS lamp on the instrument panel illuminates and a message is shown in the text panel. If this occurs, reduce speed to

max. 80 km/h. The tyre must be replaced as soon as possible.

Drive carefully, in some cases it can be difficult to see which tyre is faulty. In order to establish which tyre needs attention, check all four tyres.

WARNING

SST tyres should only be fitted by individuals with expertise on SST tyres.

SST tyres must only be fitted together with TPMS.

After a fault message on low tyre pressure has been shown, do not drive faster than 80 km/h.

Maximum driving distance to tyre change is 80 km.

Avoid hard driving such as sudden braking or turning.

SST tyres must be replaced if they are damaged or punctured.



Emergency puncture repair (TMK)

General



Emergency puncture repair (TMK; Temporary Mobility Kit) is used to seal a puncture and check and adjust tyre pressure. It consists of a compressor and a bottle with sealing fluid. The kit works as a temporary repair. The sealing fluid bottle must be replaced before its expiration date and after use.

The sealing fluid effectively seals tyres punctured in the tread.

NOTE

The emergency puncture repair kit is only intended for sealing tyres with a puncture in the tread.

The emergency puncture repair kit has limited capacity to seal tyres which have punctures in

the wall. Do not seal tyres with the emergency puncture repair kit if they have larger slits, cracks or similar damage.

Connect the compressor to one of the car's 12 V sockets, see pages 229 and 293. Choose the electrical socket that is nearest the punctured tyre.

IMPORTANT

If the compressor for emergency puncture repair is connected to one of the two sockets in the tunnel console, see page 229, no other current consumer must be connected to the other one.

NOTE

The compressor for temporary emergency puncture repair has been tested and approved by Volvo.

Location of the emergency puncture repair kit

Set up the warning triangle if a tyre is being sealed in a trafficked location. The emergency puncture repair kit is located under the floor in the cargo area, see page 318.

WARNING

You should not drive faster than 80 km/h after the emergency tyre repair kit has been used. Volvo recommends that you visit an authorised Volvo workshop for inspection of the sealed tyre (maximum driving distance is 200 km). The staff there can determine whether or not the tyre can be repaired or if it needs to be replaced.

Overview

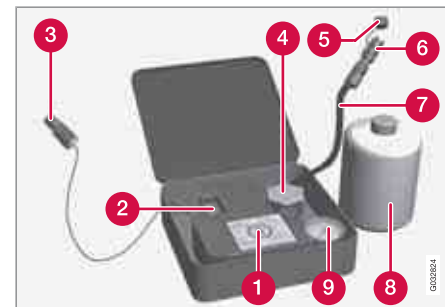

- 1 Label, maximum permitted speed
- 2 Switch
- 3 Cable
- 4 Bottle holder (orange cap)
- 5 Protective cap



Emergency puncture repair (TMK)

- 6 Pressure reducing valve
- 7 Air hose
- 8 Sealing fluid bottle
- 9 Pressure gauge

Sealing punctured tyres

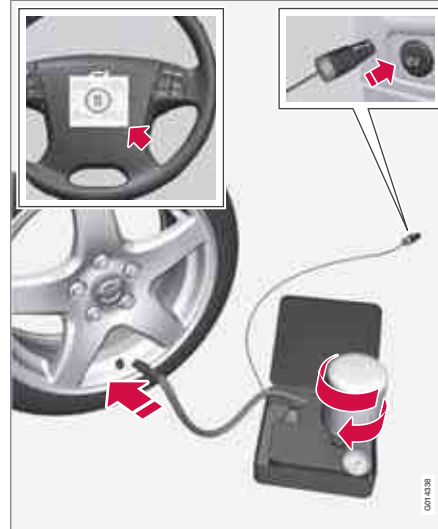

For information on the function of the parts, see preceding illustration.

1. Open the lid of the emergency puncture repair kit.
2. Detach the label for maximum permitted speed and affix it to the steering wheel.

! WARNING

The sealing fluid can irritate the skin. In the case of contact with skin, wash away the fluid with soap and water.

3. Check that the switch is in position **0** and locate the cable and the air hose.

i NOTE

Do not break the bottle's seal before use. The seal is broken automatically when the bottle is screwed in.

4. Unscrew the orange cap and unscrew the bottle's stopper.
5. Screw the bottle into its holder.

! WARNING

Do not unscrew the bottle, it is equipped with a reverse catch to prevent leakage.

6. Unscrew the wheel's dust cap and screw in the air hose valve connection to the bottom of the thread on the tyre's air valve.
7. Plug the cable into the 12 V socket and start the car.



Emergency puncture repair (TMK)

NOTE

If the compressor is connected to one of the two 12 V sockets, in the tunnel console, no other current consumer must be connected to the other one.

WARNING

Do not leave children in the car without supervision when the engine is running.

8. Flick the switch to position I.

WARNING

Never stand next to the tyre when the compressor is running. If cracks or unevenness arise then the compressor must be switched off immediately. The journey should not be continued. Contacting an authorised tyre centre is recommended.

NOTE

When the compressor starts, the pressure can increase up to 6 bar but the pressure drops after approximately 30 seconds.

9. Inflate the tyre for 7 minutes.

IMPORTANT

Risk of overheating. The compressor must not run for more than 10 minutes.

10. Switch off the compressor to check the pressure on the pressure gauge. Minimum pressure is 1.8 bar and maximum 3.5 bar. (Release air with the pressure reducing valve if the tyre pressure is too high.)

WARNING

If the pressure is below 1.8 bar then the hole in the tyre is too big. The journey should not be continued. Contacting an authorised tyre centre is recommended.

11. Switch off the compressor and unplug the cable from the 12 V socket.
12. Detach the hose from the tyre valve and fit the valve cap.
13. As soon as possible, drive approximately 3 km at a maximum speed of 80 km/h so that the sealing fluid can seal the tyre.

Rechecking the repair and pressure

1. Reconnect the equipment.

2. Read the tyre pressure on the pressure gauge.
 - If it is below 1.3 bar then the tyre is insufficiently sealed. The journey should not be continued. Contact a tyre centre.
 - If the tyre pressure is higher than 1.3 bar, the tyre must be inflated to the pressure specified in accordance with the tyre pressure table, see page 388 (1 bar=100 kPa). Release air using the pressure reducing valve if the tyre pressure is too high.

WARNING

Do not unscrew the bottle, it is equipped with a reverse catch to prevent leakage.

3. Make sure the compressor is switched off. Detach the air hose and cable. Refit the dust cap.

NOTE

The sealing fluid bottle and the hose must be replaced after use. Volvo recommends that this replacement is performed by an authorised Volvo workshop.



Emergency puncture repair (TMK)

WARNING

Check the tyre pressure regularly.

Volvo recommends that you drive to the nearest authorised Volvo workshop for the replacement/repair of the damaged tyre. Advise the workshop that the tyre contains sealing fluid.

WARNING

You should not drive faster than 80 km/h after the emergency tyre repair kit has been used. Volvo recommends that you visit an authorised Volvo workshop for inspection of the sealed tyre (maximum driving distance is 200 km). The staff there can determine whether or not the tyre can be repaired or if it needs to be replaced.

Inflating the tyres

The car's original tyres can be inflated by the compressor.

1. The compressor must be switched off. Make sure that the switch is in position **0** and locate the cable and air hose.
2. Unscrew the wheel's dust cap and screw in the air hose valve connection to the bottom of the thread on the tyre's air valve.

WARNING

Inhaling car exhaust fumes can result in danger to life. Never leave the engine running in sealed areas or areas that lack sufficient ventilation.

WARNING

Do not leave children in the car without supervision when the engine is running.

3. Connect the cable to one of the car's 12 V sockets and start the car.
4. Start the compressor by flicking the switch to position **I**.

IMPORTANT

Risk of overheating. The compressor must not run for more than 10 minutes.

5. Inflate the tyre to the pressure specified in accordance with the tyre pressure table, see page 388. (Release air using the pressure reducing valve if the tyre pressure is too high.)
6. Switch off the compressor. Detach the air hose and cable.
7. Refit the dust cap.

Replacing the sealing fluid canister

Replace the bottle when the expiration date has passed. Treat the old bottle as environmentally hazardous waste.

WARNING

The bottle contains 1.2-Ethanol and natural rubber-latex.

Harmful if ingested. Could result in allergic reaction in the event of skin contact.

Avoid contact with the skin and eyes.

Store out of the reach of children.



Engine compartment.....	328
Lamps.....	335
Wiper blades and washer fluid.....	341
Battery.....	344
Fuses.....	350
Car care.....	361



09

MAINTENANCE AND SERVICE

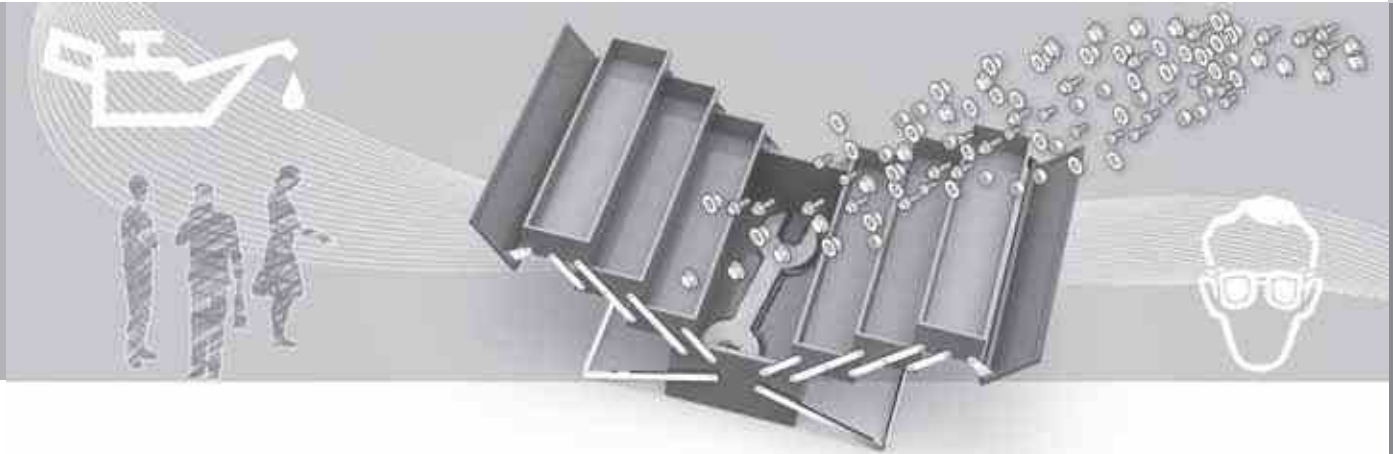



Engine compartment

General

Volvo service programme

To keep the car as safe and reliable as possible, follow the Volvo service programme as specified in the Service and Warranty Booklet. Volvo recommends engaging an authorised Volvo workshop to perform the service and maintenance work. Volvo workshops have the personnel, special tools and service literature to guarantee the highest quality of service.

! IMPORTANT

For the Volvo warranty to apply, check and follow the instructions in the Service and Warranty Booklet.

Check regularly

Check the following oils and fluids at regular intervals, e.g. when refuelling:

- Coolant
- Engine oil
- Power steering fluid
- Washer fluid

! WARNING

Remember that the radiator fan (located at the front of the engine compartment, behind the radiator) may start automatically some after the engine has been switched off.

Always have the engine cleaned by a workshop. There is a risk of fire if the engine is hot.

Raising the car

i NOTE

Volvo recommends only using the jack that belongs to the car model in question. If a jack is selected other than the one recommended by Volvo, follow the instructions for use supplied with the equipment.

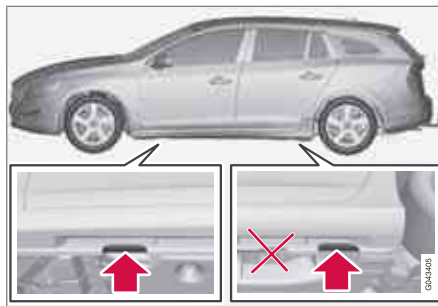

If the car is raised with a workshop jack; position the jack against the front edge on the engine's subframe.

Do not damage the splashguard under the engine. Ensure that the workshop jack is positioned so that the car cannot slide off the jack. Always use axle stands or similar.

If you raise the car using a two-pillar workshop lift, ensure that the front and rear lift arms are fixed under the lifting points. See preceding illustration.

Opening and closing the bonnet



The handle for bonnet opening is always on the left-hand side.



Engine compartment

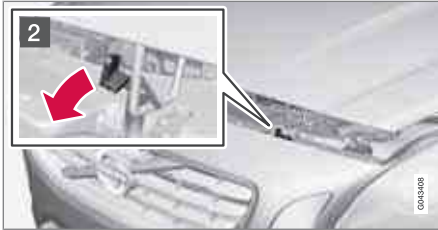

- 1 Turn the handle about 20-25 degrees clockwise. You will hear when the catch releases.
- 2 Move the catch to the left and open the bonnet. (The catch hook is located between the headlamp and grille, see illustration.)

WARNING

Check that the bonnet locks properly when closed.

Engine compartment, overview

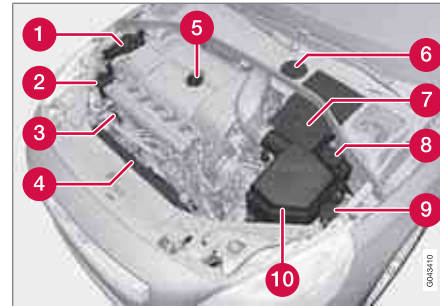

The appearance of the engine compartment may vary depending on engine variant.

- 1 Coolant expansion tank
- 2 Power steering fluid reservoir
- 3 Engine oil dipstick¹
- 4 Radiator
- 5 Filling engine oil
- 6 Reservoir for brake and clutch fluid (located on the driver's side)
- 7 Battery
- 8 Relay and fuse box

- 9 Filling washer fluid
- 10 Air filter

WARNING

The ignition system has very high voltage and output. The voltage in the ignition system is highly dangerous. The remote control key must always be in **0** position when work is being done in the engine compartment, see page 78.

Do not touch the spark plugs or ignition coil when the remote control key is in **II** position or when the engine is hot.

Checking the engine oil



¹ Engines with electronic oil level sensor have no dipstick (5-cyl. diesel).



Engine compartment

Volvo recommends Castrol oil products.

When driving under adverse conditions, see page 378.

! IMPORTANT

In order to fulfil the requirements for the engine's service intervals all engines are filled with a specially adapted synthetic engine oil at the factory. The choice of oil has been made very carefully with regard to service life, starting characteristics, fuel consumption and environmental impact.

An approved engine oil must be used in order that the recommended service intervals can be applied. Only use a prescribed grade of oil for both filling and oil change, otherwise you will risk affecting service life, starting characteristics, fuel consumption and environmental impact.

Volvo Car Corporation disclaims all warranty liability if engine oil of the prescribed grade and viscosity is not used.

Volvo recommends that oil changes are carried out at an authorised Volvo workshop.

Volvo uses different systems for warning of low/high oil level or low/high oil pressure. Certain variants have an oil pressure sensor, and then the lamp for oil pressure is used. Other variants have an oil level sensor, and then the

driver is informed via the warning symbol in the centre of the instrument unit as well as by display texts. Certain models have both variants. Contact a Volvo dealer for more information.

Change the engine oil and oil filter in accordance with the intervals specified in the Service and Warranty Booklet.

Using oil of a higher than specified grade is permitted. If the car is driven in adverse conditions, Volvo recommends using an oil of a higher grade, see page 378.

For capacities, see page 379 and onwards.

Engine with oil dipstick²



Dipstick and filler pipe.

Checking the oil level in a new car is especially important before the first scheduled oil change.

Volvo recommends checking the oil level every 2 500 km. The most accurate measurements are made on a cold engine before starting. The measurement will be inaccurate if taken immediately after the engine is switched off. The dipstick will indicate that the level is too low because the oil has not had time to flow down into the oil sump.

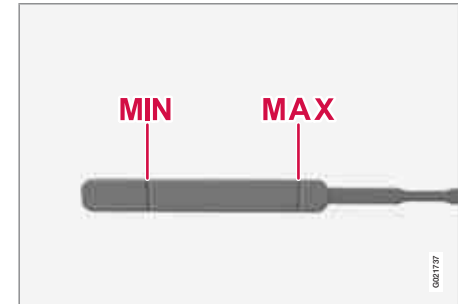

The oil level must be between the **MIN** and **MAX** marks.

Measurement and filling if required

1. Ensure that the car is level. After switching off the engine it is important to wait

² Only applies to petrol and 4-cyl. diesel.



Engine compartment

5 minutes to allow the oil time to run back to the sump.

2. Pull up and wipe the dipstick.
3. Re-insert the dipstick.
4. Pull it out and check the level.
5. If the level is close to **MIN** then 0.5 litres should be added. If the level is significantly below, then an additional amount is required.
6. If required, check the level again, do it after driving a short distance. Then repeat steps 1 - 4.

WARNING

Never fill above the **MAX** mark. The level should never be above **MAX** or below **MIN** as this could lead to engine damage.

WARNING

Do not spill oil onto the hot exhaust manifold due to the risk of fire.

Engine with electronic oil level sensor³

Filler pipe.⁴

You do not need to take action with respect to the engine oil level before a message is shown in the display, see the illustration below.

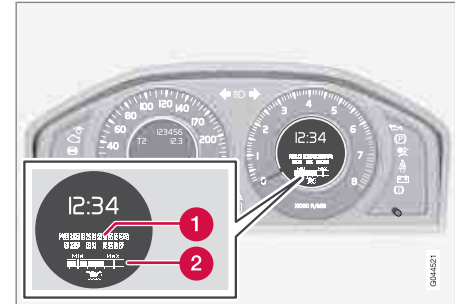

Message and graph in the display.

- 1 Message
- 2 Engine oil level

The oil level is checked using the electronic oil level gauge with the thumbwheel when the engine is switched off, see page 200.

WARNING

If the message **Oil service required** is shown, visit a workshop. The oil level may be too high.

³ Only applies to 5-cyl. diesel.

⁴ Engines with electronic oil level sensor have no dipstick (5-cyl. diesel).



Engine compartment

! IMPORTANT

In the event of the message **Oil level low Refill 0.5 Ltr**, only fill with 0.5 litres.

i NOTE

The oil level is only detected by the system during driving. The system cannot directly detect changes when the oil is filled or drained. The car must be driven about 30 km before the oil level display is correct.

! WARNING

Do not fill more oil if filling level (3) or (4) appears as shown in the illustration below. The level must never be above **MAX** or below **MIN**, as this could lead to engine damage.

! WARNING

Do not spill oil onto the hot exhaust manifold due to the risk of fire.

Measuring the oil level

If the oil level needs to be checked then it should be carried out in accordance with the sequence below.

1. Activate key position **II**, see page 78.
2. Rotate the thumbwheel on the left-hand stalk switch to position **Engine oil level Wait....**
 - > You will then see information displayed about the engine oil level.

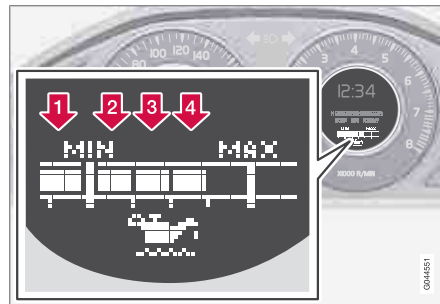

The figures 1-4 represent filling level. Do not fill more oil if filling level (3) or (4) is shown. Recommended filling level is 4.

Coolant

Checking the level and topping up



When topping up the coolant, follow the instructions on the packaging. It is important that the mixture of coolant concentrate and water is correct for the prevailing weather conditions. Never top up with water only. The risk of freezing increases with both too little and too much coolant concentrate.

! WARNING

Coolant can be very hot. If the coolant requires topping up when the engine is at operating temperature, unscrew the expansion tank cap slowly to gently release the overpressure.



Engine compartment

For capacities and for standards regarding water quality, see page 381.

Check the coolant regularly

The level must lie between the **MIN** and **MAX** marks on the expansion tank. If the system is not filled sufficiently, high temperatures could occur, causing a risk of damage to the engine.



IMPORTANT

- A high content of chlorine, chlorides and other salts may cause corrosion in the cooling system.
- Always use coolant with anti-corrosion agent as recommended by Volvo.
- Ensure that the coolant mixture is 50% water and 50% coolant.
- Mix the coolant with approved quality tap water. In the event of any doubt about water quality, used ready-mixed coolant in accordance with Volvo recommendations.
- When changing coolant/replacing cooling system components, flush the cooling system clean with approved quality tap water or flush with ready-mixed coolant.
- The engine must only be run with a well-filled cooling system. Otherwise, temperatures that are too high may occur resulting in the risk of damage (cracks) in the cylinder head.

Brake and clutch fluid

Checking the level

Brake and clutch fluid have a common reservoir. The level must be between the **MIN** and **MAX** marks that are visible inside the reservoir. Check the level regularly.

Change the brake fluid every other year or at every other regular service.

For capacities and recommended fluid grade, see page 381. The fluid should be changed annually on cars driven in conditions requiring hard, frequent braking, such as driving in mountains or tropical climates with high humidity.



WARNING

If the brake fluid is under the **MIN** level in the brake fluid reservoir, do not drive further before topping up the brake fluid. Volvo recommends that the reason for the loss of brake fluid is investigated by an authorised Volvo workshop.



Engine compartment

Filling

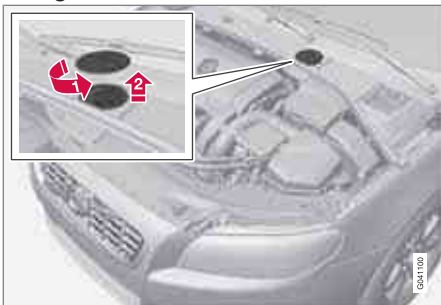

Brake fluid reservoir location.

The fluid reservoir is protected under the cover over the cold zone in the engine compartment. The round cover must be removed first before the reservoir cap can be reached.

1. Turn and open the cover located on the covering.
2. Unscrew the reservoir cap and fill the fluid. The level must be between the **MIN** and **MAX** marks, which are located on the inside of the reservoir.

IMPORTANT

Do not forget to refit the cap.

Power steering fluid

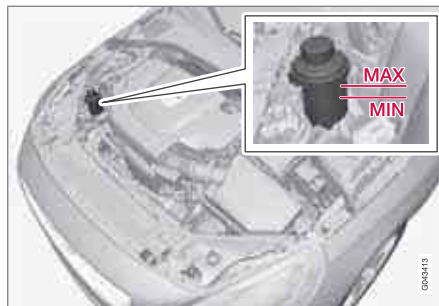

IMPORTANT

Keep the area around the power steering fluid reservoir clean when checking. The cover must not be opened.

Check the level frequently. The fluid does not require changing. The fluid level must be between the **MIN** and **MAX** marks. For capacities and recommended fluid grade, see page 381.

NOTE

If a fault should arise in the power steering system or if the engine is switched off and the car must be towed, it can still be steered.

Air conditioning system

Troubleshooting and repair

The air conditioning system contains fluorescent tracing agents. Use ultraviolet light when looking for leaks.

Volvo recommends that you contact an authorised Volvo workshop.

WARNING

The air conditioning system contains pressurised refrigerant R134a. This system must only be serviced and repaired by an authorised workshop.



Lamps

General

All bulbs are specified, see page 339. The following list contains locations of bulbs and other light sources that are specialised or unsuitable for changing except at a workshop:

- Active Xenon headlamps - ABL (Xenon lamps)
- Direction indicators, door mirrors
- Approach lighting, door mirrors
- Courtesy lighting
- Glovebox lighting
- General interior lighting in the roof
- Reading lamps
- Side position, position lamps rear
- Brake light
- LED lights, general

! WARNING

On cars with Xenon headlamps, the replacement of Xenon lamps must be carried out at a workshop - an authorised Volvo workshop is recommended. Working with Xenon lamps demands extreme caution because the headlamp is equipped with a high voltage unit.

! WARNING

The car's electrical system must be in key position **0** when replacing bulbs, see page 78

! IMPORTANT

Never touch the glass part of the bulbs with your fingers. Grease and oils from your fingers are vaporised by the heat, coating the reflector and then causing damage.

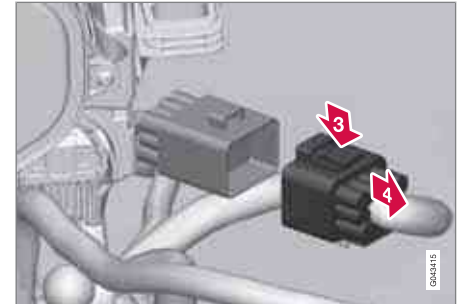
Headlamps front

All of the headlamp bulbs are replaced via the engine compartment. Loosen and remove the whole headlamp.

Removing the headlamp

1. Set the car's electrical system in key position **0**, see page 78:
2. (First illustration)
 - 1** Pull out the headlamp's locking pins.
 - 2** Release the headlamp by alternately tilting and pulling it out.

! IMPORTANT

Do not pull the electrical cable, only the connector.



Lamps

- (Second illustration)
 - Detach the headlamp connector by pressing down the clip with your thumb.
 - At the same time, guide out the connector with your other hand.
- Lift out the headlamp and place it on a soft surface to avoid scratching the lens.
- Replace the bulb in question.

Securing the headlamp

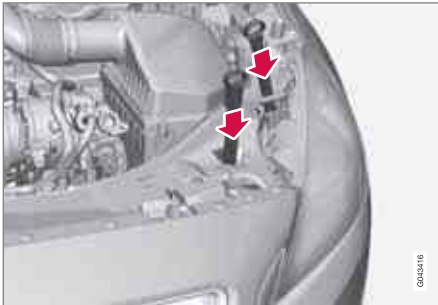

- Plug in the connector, a clicking sound should be heard.
- Reinstall the headlamp and locking pins. The short pin is fitted closest to the grille. Check that they are correctly inserted.
- Check the lighting.

The headlamp must be mounted and the connector correctly installed before the lighting is switched on or the remote control key is inserted into the ignition switch.

Removing the cover

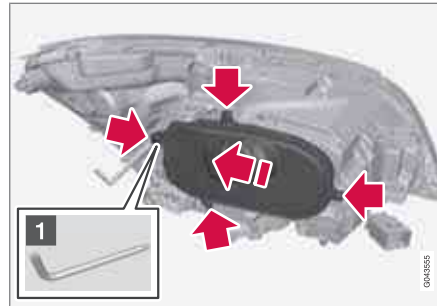

Before starting to replace a bulb, see page 335.

- Unscrew the cover's four screws with the tool (1) in the tool kit, see page 310. They should not be detached completely. (3 - 4 turns are sufficient.)

! IMPORTANT

Use the tool in the toolkit to remove and attach this correctly.

- Slide the cover to one side.
- Remove the cover.

Reinstall the cover in reverse order.

Dipped beam, halogen

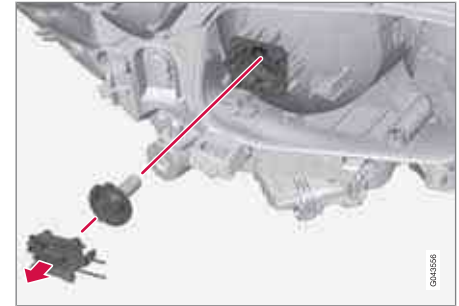

- Detach the headlamp, see page 335.
- Remove the cover.
- Unplug the connector from the bulb.
- Detach the bulb by pulling it straight out.
- The guide pin on the lamp should be straight up when it is fitted and a clicking sound should be heard when it clicks into place.

Reinstall the parts in reverse order.



Lamps

Main beam, Halogen



1. Detach the headlamp.
2. Remove the cover, see page 336
3. Detach the bulb by turning anticlockwise and then pulling straight out
4. Unplug the connector from the bulb.
5. Replace the bulb and align it in the socket and turn clockwise in order to secure it. It can be secured in one position.

Reinstall the parts in reverse order.

Extra main beam, ABL headlamps*



1. Detach the headlamp.
2. Remove the cover, see page 336.
3. Detach the bulb by turning anticlockwise and then pulling straight out
4. Unplug the connector from the bulb.
5. Replace the bulb and align it in the socket and turn clockwise in order to secure it. It can only be secured in one position.

Reinstall the parts in reverse order.

Direction indicators

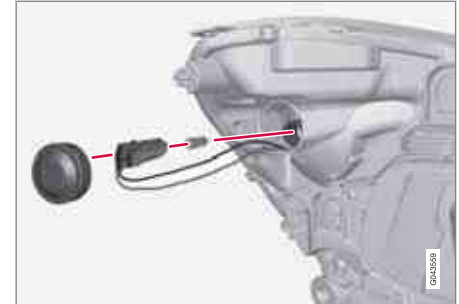

1. Detach the headlamp.
2. Detach the cover by pulling it straight out.
3. Pull the bulb holder in order to extract the bulb.
4. Press and simultaneously turn the bulb to detach it.

Reinstall the parts in reverse order.



Lamps

Lamp housing, rear



The reversing, fog and direction indicator bulbs in the rear lamp cluster are replaced from inside the cargo area.

1. Open the panel.
2. Remove the insulation that is fitted in front of the bulb holder by pulling it straight out.
3. Press down the catch and pull out the bulb holder.
4. Remove the blown bulb by pressing it in and turning anticlockwise.
5. Fit a new bulb, press down and turn clockwise.
6. Press down the catch when the bulb holder is refitted.

7. Refit the insulation and panel.

NOTE

If an error message remains after the broken bulb has been replaced then we recommend that you visit an authorised Volvo workshop.

Location of rear bulbs



Lamp lens, right-hand side

- 1 Brake light (LED)
- 2 Direction indicators
- 3 Reversing lamp
- 4 Rear fog lamp (driver's side)

Number plate lighting



1. Remove the screws with a screwdriver.
2. Carefully detach the whole lamp housing and withdraw it.
3. Replace the bulb.
4. Refit the whole lamp housing and screw it into place.



Lamps

Lighting, cargo area



1. Insert a screwdriver and gently prize so that the lamp housing comes loose.
2. Replace the bulb.
3. Check that the bulb illuminates and press back the lamp housing.

Vanity mirror lighting

Removal of lamp lens

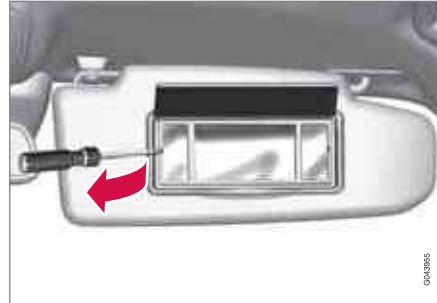

1. Insert a screwdriver under the lamp lens and gently prize up the lug on the edge.
2. Carefully detach and lift aside the lamp lens.
3. Use needle-nose pliers to pull the bulb straight out to the side and replace with a new one. Note! - Do not pinch hard with the pliers. Otherwise the lamp lens could then be crushed.

Attaching the lamp lens

1. Refit the lamp lens.
2. Press it into place.

Specification, bulbs

Lighting	W ^A	Type
Dipped beam, halogen	55	H7 LL
Main beam, Halogen	65	H9
Extra main beam, ABL	65	H9
Front direction indicators	21	HY21W
Courtesy lighting front	3	T10 Socket W2.1x9.5d
Glovebox lighting	5	Socket SV8.5 Length 43 mm
Vanity mirror lighting	1.2	T5 Socket W2x4.6d
Cargo area lighting	5	Socket SV8.5 Length 43 mm
Number plate lighting	5	C5W LL
Direction indicators, rear	21	PY21W SV
-	-	-



Lamps

Lighting	W ^A	Type
Reversing lamp	21	P21W LL
Rear fog lamp	21	H21W LL

^A Watt



Wiper blades and washer fluid

Wiper blades

Service position



Wiper blades in service position.

In order to change, clean or lift the wiper blades (for scraping off ice from the windshield, for example) they must be in service position.

! IMPORTANT

Before placing the wiper blades in the service position, make sure that they are not frozen down.

1. Insert the remote control key in the ignition switch¹ and briefly press the **START/STOP ENGINE** button to set the car's elec-

trical system to key position **I**. (For detailed information on key positions, see page 78.)

2. Briefly press the **START/STOP ENGINE** button again to set the car's electrical system in key position **0**.
3. Within 3 seconds, move the right stalk switch up and hold it in position for approx. 1 second.
 - > The wipers then move to standing straight up.

The wipers return to their starting position when you briefly press the **START/STOP ENGINE** button to set the car's electrical system to key position **I** (or when the car is started).

! IMPORTANT

If the wiper arms in service position have been folded up from the windshield, they must be folded back down onto the windshield before the wipers are allowed to return to their starting position. This is to avoid scraping the paint on the bonnet.

i NOTE

Once the wiper arms have been in service position, the wipers must be activated and deactivated before service position can be used again.

Replacing the wiper blades

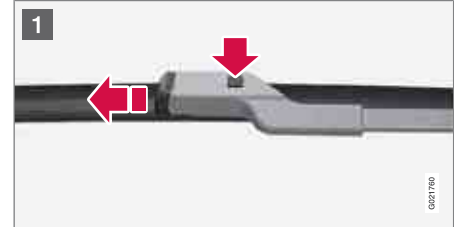

¹ Not necessary in cars with Keyless function.



Wiper blades and washer fluid

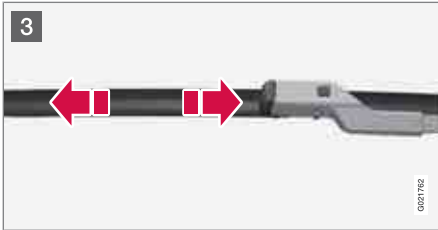

- 1 Fold up the wiper arm when it is in service position. Press the button located on the wiper blade mounting and pull straight out parallel with the wiper arm.
- 2 Slide in the new wiper blade until a "click" is heard.
- 3 Check that the blade is firmly installed.
- 4 Fold the wiper arm back towards the windscreen.

The wipers return from service position to their starting position when you briefly press the **START/STOP ENGINE** button to set the car's electrical system to key position I (or when the car is started).

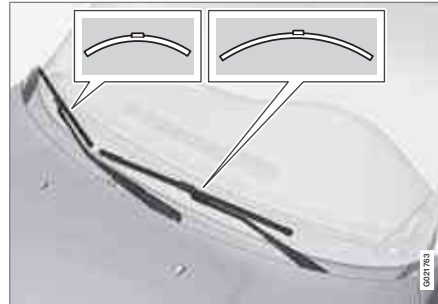

NOTE
The wiper blades are different lengths. The blade on the driver's side is longer than the blade on the passenger side.

Replacing the wiper blades, rear window

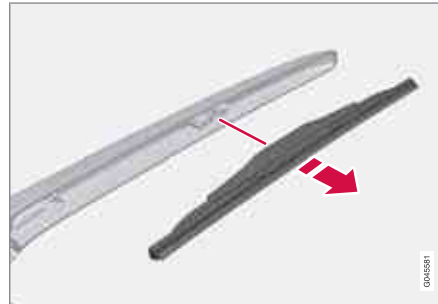

1. Fold out the wiper arm.
2. Grip the inner section of the blade (by the arrow).
3. Turn anticlockwise to use the blade's end position against the wiper arm as a lever to detach the blade more easily.
4. Press the new wiper blade into position. Check that it is firmly installed.
5. Lower the wiper arm.

Cleaning

For cleaning wiper blades and windscreen, see page 361 and onwards.

IMPORTANT
Check the wiper blades regularly. Neglected maintenance shortens the service life of the wiper blades.

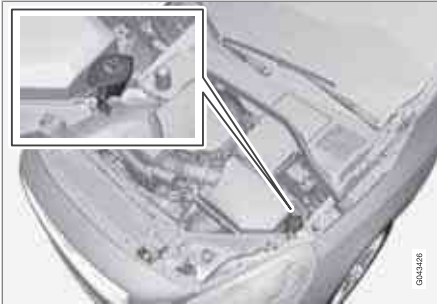
**Wiper blades and washer fluid****Filling washer fluid**

The windscreen and headlamp washers share a common reservoir.

! IMPORTANT

Use washer fluid with antifreeze during the winter to avoid freezing in the pump, reservoir and hoses.

For capacities, see page 381.



Battery

Operation

The service life and function of the battery is influenced by factors such as the number of starts, discharging, driving style, driving conditions, climatic conditions etc.

- Never disconnect the battery when the engine is running.
- Check that the cables to the battery are correctly connected and properly tightened.



WARNING

- The battery can generate oxyhydrogen gas, which is highly explosive. A spark can be formed if a jump lead is connected incorrectly, and this can be enough for the battery to explode.
- The battery contains sulphuric acid, which can cause serious burns.
- If sulphuric acid comes into contact with eyes, skin or clothing, flush with large quantities of water. If acid splashes into the eyes - seek medical attention immediately.



NOTE

The life of the battery is shortened if it becomes discharged repeatedly.

The life of the battery is affected by several factors, including driving conditions and climate. Battery starting capacity decreases gradually with time and therefore needs to be recharged if the car is not used for a longer time or when it is only driven short distances. Extreme cold further limits starting capacity.

To maintain the battery in good condition, at least 15 minutes of driving/week is recommended or that the battery is connected to a battery charger with automatic trickle charging.

A battery that is kept fully charged has a maximum service life.



IMPORTANT

Never use a quick charger to charge the battery.



IMPORTANT

If the following instruction is not observed then the energy saving function for infotainment may be temporarily disengaged, and/or the message in the information display about the main battery's state of charge may be temporarily inapplicable, following the connection of an external battery or battery charger:





- The negative battery terminal on the car's main battery must **never** be used for connecting an external battery or battery charger - only the **car chassis** may be used as the grounding point.

See the section "Start assistance" - for a description of how the cable clamps must be attached.



Battery

Symbols on the battery

	Use protective goggles.
	Further information in the owner's manual.
	Store the battery out of the reach of children.
	The battery contains corrosive acid.

	Avoid sparks and naked flames.
	Risk of explosion.
	Must be taken for recycling.

i **NOTE**
An expended battery must be recycled in an environmentally responsible manner - it contains lead.

Replacing the main battery

Removal

First of all: Take the remote control key from the ignition switch and wait at least 5 minutes before any electrical connections are touched - this is because the car's electrical system needs to store the necessary information to control modules.





Battery



- 2 Release the rubber moulding so that the rear cover is free.
- 3 Remove the rear cover by screwing one quarter turn and lifting it away.

WARNING

Connect and remove the positive and negative cables in the correct order.



- 4
 - 1 Detach the black negative cable.
 - 2 Detach the red positive cable.
 - 3 Detach the ventilation hose from the battery.
 - 4 Loosen the screw holding the battery clamp.
- 5 Move the battery to the side and lift it up.

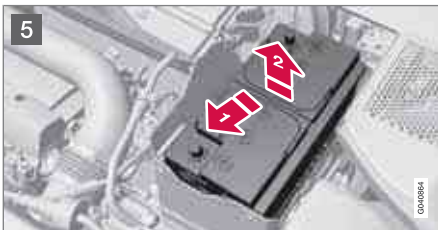

- 1 Open the clips on the front cover and remove the cover.

Cross-stay on the R-Design*

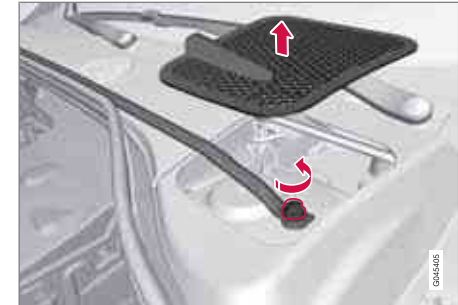

Cross-stay and plenum chamber cover.

Cars with R-Design have a cross-stay that must be removed before the main battery can be replaced.

1. Remove the plenum chamber covers on the right and left-hand sides. Prize carefully with a plastic knife or similar.
2. Loosen and remove the screws (one on the right and one on the left-hand side) that hold the cross-stay.
3. Remove the cross-stay.
 - > Now the main battery can be removed in accordance with the previous section.
- Fitting the cross-stay takes place in the reverse order.



Battery

NOTE

Tighten the screws to 30 Nm. Check the torque with a torque wrench.

Fitting

1. Lower the battery into the battery box.
2. Move the battery inward and to the side until it reaches the rear edge of the box.
3. Tighten the clamp that holds the battery.
4. Connect the ventilation hose.
 - > Check that it is correctly connected to both battery and outlet in the body.
5. Connect the red positive cable.
6. Connect the black negative cable.
7. Press in the rear cover. (See Removal.)

8. Fit the rubber moulding. (See Removal.)
9. Align the front cover and secure it with the clips. (See removal.)

For more information on the car's main battery - see page 391.

Eco Start/Stop DRIVE*

Cars with the Start/Stop function are equipped with two 12 V batteries - one extra powerful battery for starting and one support battery that helps during the Eco Start/Stop DRIVE function's starting sequence.

For more information on Start/Stop - see page 127.

For more information on the car's main battery - see page 120 and 391.

Battery	Start	Support
Cold start capacity ^A , CCA (A)	760	180
Size ^B , L×W×H (mm)	278×175×190	150×90×130
Capacity (Ah)	70	10

^A In accordance with the SAE standard.

^B Largest possible size.

IMPORTANT

When replacing batteries in cars with the Start/Stop function, the AGM¹ type batteries must be fitted.

¹ Absorbed Glass Mat



Battery

NOTE

- The higher the current take-off in the car (extra cooling/heating, etc.) the more the batteries must be charged = increased fuel consumption.
- When the capacity of the battery has fallen below the lowest permissible level then the Start/Stop function is disengaged.

Temporarily reduced Start/Stop function due to high current take-off means:

- The engine starts automatically² without the driver depressing the clutch pedal (manual gearbox).
- The engine starts automatically without the driver lifting his/her foot off the foot brake pedal (automatic gearbox).

Location of the batteries

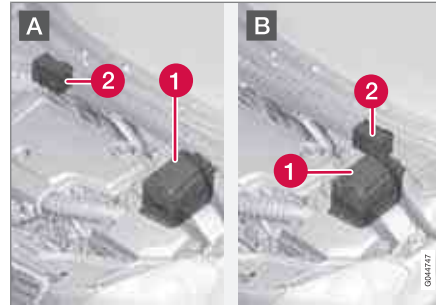

A: Left-hand drive car. B: Right-hand drive car. 1. Battery for starting³ 2. Support battery.

The support battery normally requires no more service than the normal battery that is used for starting. A workshop should be contacted in the event of questions or problems - an authorised Volvo workshop is recommended.

IMPORTANT

If the following instruction is not observed then the Start/Stop function may temporarily cease to work after the connection of an external battery or battery charger:

- The negative battery terminal on the car's main battery must **never** be used for connecting an external battery or battery charger - only the **car chassis** may be used as the grounding point.

See the section "Start assistance" - for a description of how the cable clamps must be attached.

² Automatic starting can only take place if the gear lever is in neutral position.

³ The battery for starting is described in detail on page 345.

**NOTE**

If the battery has become so discharged that everything is "black" and in principle the car does not have all the normal electrical functions and the engine is subsequently started using an external battery or battery charger, then the Start/Stop function will be activated. It will then be possible for the engine to be auto-stopped but in the event of an auto-stop the Start/Stop function may fail to auto-start the engine due to inadequate capacity in the battery.

The battery must first be charged in order to ensure a successful auto-start after an auto-stop. At an outside temperature of +15 °C the battery needs to be charged for at least 1 hour. At a lower outside temperature a charging time of 3-4 hours is recommended. The recommendation is that the battery is charged using an external battery charger.

If this is not possible then the recommendation is to temporarily deactivate the Start/Stop function until the battery has been adequately recharged.

For more information about recharging the battery, see the section "Battery" in the chapter "Maintenance and service".



Fuses

General

All electrical functions and components are protected by a number of fuses in order to protect the car's electrical system from damage by short circuiting or overloading.

If an electrical component or function does not work, it may be because the component's fuse was temporarily overloaded and failed. If the same fuse fails repeatedly then there is a fault in the circuit. Volvo recommends that you visit an authorised Volvo workshop for checking.

Changing

1. Look in the fuse diagram to locate the fuse.
2. Pull out the fuse and check from the side to see whether the curved wire has blown.
3. If this is the case, replace it with a new fuse of the same colour and amperage.



WARNING

Never use a foreign object, or a fuse with an amperage higher than that specified when replacing a fuse. This could cause significant damage to the electrical system and possibly lead to fire.

Location, fuse boxes

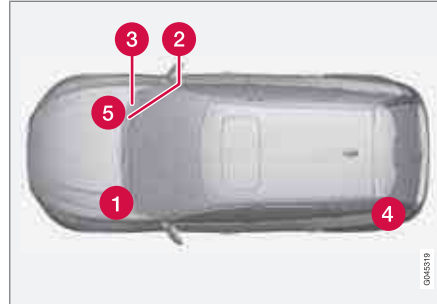

Central electrical unit locations in a left-hand drive car. In a right-hand drive car the central electrical units under the glovebox change sides.

- 1 Engine compartment
- 2 Under the glovebox
- 3 Under the glovebox
- 4 Cargo area under the cargo floor
- 5 Engine compartment cold zone (only Start/Stop*)



Fuses

Engine compartment

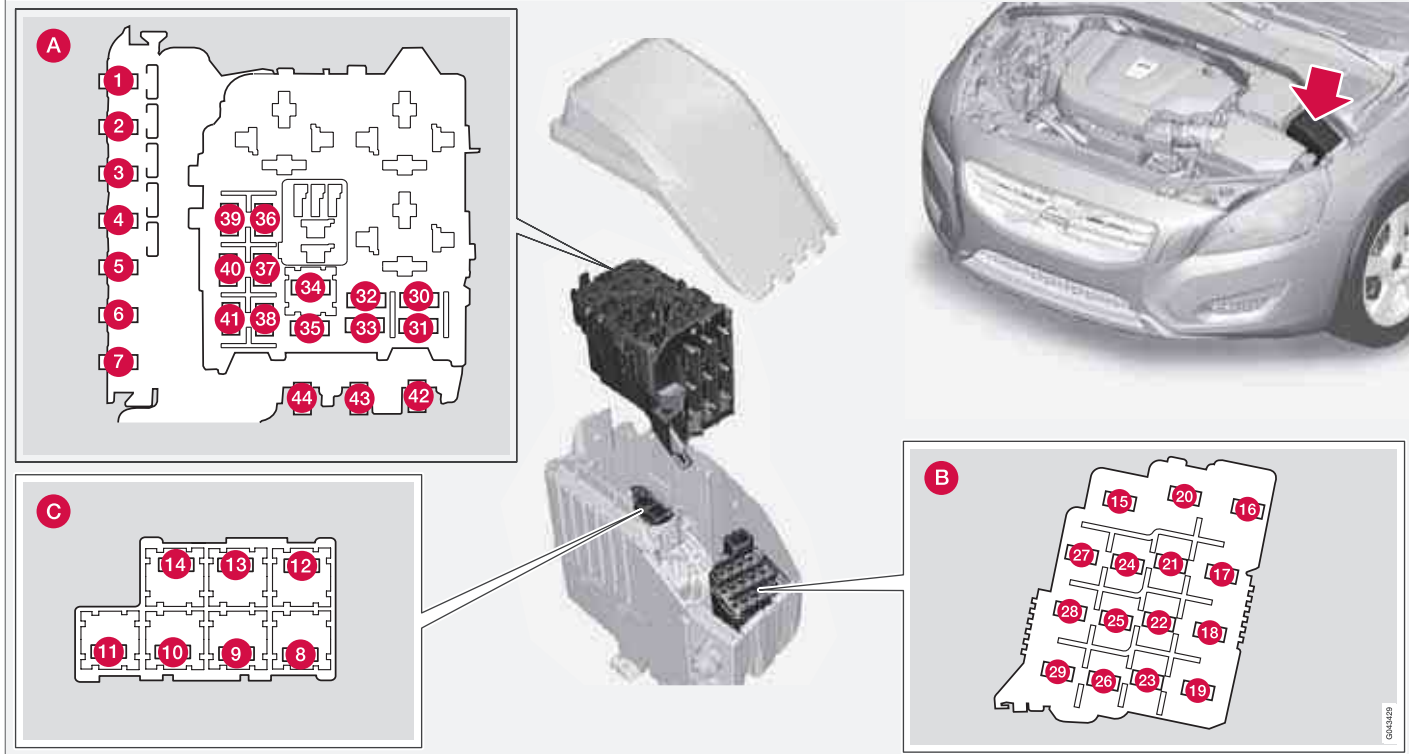

0000029



Fuses

General fuses, engine compartment

On the inside of the cover there are tweezers that facilitate the procedure for the removal and fitting of fuses.

Positions (see preceding illustration)

- A** Engine compartment, upper
- B** Engine compartment, front
- C** Engine compartment, lower

These fuses are all located in the engine compartment box. The fuses in (C) are located under (A).

On the inside of the cover is a label that shows the location of the fuses.

- Fuses 1-7 and 42-44 are of the "Midi Fuse" type and must only be replaced by a workshop¹.
- Fuses 8-15 and 34 are of the "JCASE" type and should be replaced by a workshop¹.
- Fuses 16-33 and 35-41 are of the "Mini Fuse" type.

	Function	A
1	Primary fuse for the central electronic module (CEM) with fuse box B under the glovebox ^A	50
2	Primary fuse for the central electronic module (CEM) with fuse box B under the glovebox	50
3	Primary fuse for central electrical unit in cargo area ^A	60
4	Primary fuse for central electrical unit in passenger compartment with fuse box A under the glovebox ^A	60
5	Primary fuse for central electrical unit in passenger compartment with fuse box A under the glovebox ^A	60
6	-	-
7	PTC element, air preheater ^{*A}	100
8	Headlamp washers [*]	20
9	Windscreen wipers	30

	Function	A
10	Parking heater [*]	25
11	Ventilation fan ^A	40
12	-	-
13	ABS pump	40
14	ABS valves	20
15	-	-
16	Headlamp levelling [*] ; Active Xenon headlamps - ABL [*]	10
17	Primary fuse for the central electronic module (CEM) with fuse box B under the glovebox	20
18	ABS	5
19	Speed related power steering [*]	5
20	Engine control module; Transmission control module; Airbags	10
21	Heated washer nozzles [*]	10

¹ An authorised Volvo workshop is recommended.



Fuses

	Function	A
22	-	-
23	Headlamp control	5
24	-	-
25	-	-
26	-	-
27	Internal relay coils	5
28	Auxiliary lamps*	20
29	Horn	15
30	Relay coil in main relay for engine management system; Engine control module (5, 6-cyl. petrol)	10
31	Transmission control module	15
32	Solenoid clutch A/C (not 5-cyl. diesel); Coolant pump (5-cyl. diesel Start/Stop)	15

	Function	A
33	Relay coil in relay for solenoid clutch A/C (not 5-cyl. diesel); Relay coil in relay for coolant pump (5-cyl. diesel Start/Stop); Relay coils in central electrical unit in engine compartment cold zone (Start/Stop)	5
34	Start relay ^A	30
35	Ignition coils (4-cyl. petrol); Glow control module (5-cyl. diesel)	10
	Ignition coils (5, 6-cyl. petrol); Capacitor (6-cyl.)	20
36	Engine control module (petrol)	10
	Engine control module (diesel)	15

	Function	A
37	Valves (1.6 l petrol); Mass air flow sensor (1.6 l petrol) Mass air flow sensor (D4162T); Control valve, fuel flow (D4162T)	10
	Mass air flow sensor (5-cyl. diesel, 6-cyl.); Control valves (5-cyl. diesel); Injectors (5, 6-cyl. petrol); Engine control module (5-cyl. petrol, 6-cyl.)	15
38	Solenoid clutch A/C (5, 6-cyl.); Valves, Engine control module (6-cyl.) Solenoids (6-cyl. without turbo); Actuator motors, intake manifold (6-cyl. without turbo); Mass air flow sensor (4-cyl. 2.0 l petrol, 5-cyl. petrol); Oil level sensor (5-cyl. diesel) Coolant pump (D4162T)	10
39	Lambda-sonds (4-cyl. petrol); Lambda-sond (diesel); Control module, radiator roller cover (manual 5-cyl. 2.0 l diesel)	10
	EVAP valve (5, 6-cyl. petrol); Lambda-sonds (5, 6-cyl. petrol)	15

* Option/accessory, for more information, see Introduction.





Fuses

	Function	A
40	Coolant pump (1.6 l petrol Start/Stop, 5-cyl. petrol Start/Stop); Crankcase ventilation heater (5-cyl. Petrol); Oil pump automatic gearbox (5-cyl. petrol Start/Stop)	10
	Diesel filter heater	20
41	Control module, radiator roller cover (5-cyl. petrol)	5
	Crankcase ventilation heater (5-cyl. diesel); Oil pump automatic gearbox (5-cyl. diesel Start/Stop)	10
42	Glow plugs (diesel)	70
43	Cooling fan (4-cyl., 5-cyl. petrol)	60
	Cooling fan (6-cyl., 5-cyl. diesel)	80
44	Electro-hydraulic power steering	100

^A For cars with the Start/Stop function this fuse location is empty - see instead page 359.



Fuses

Under the glovebox

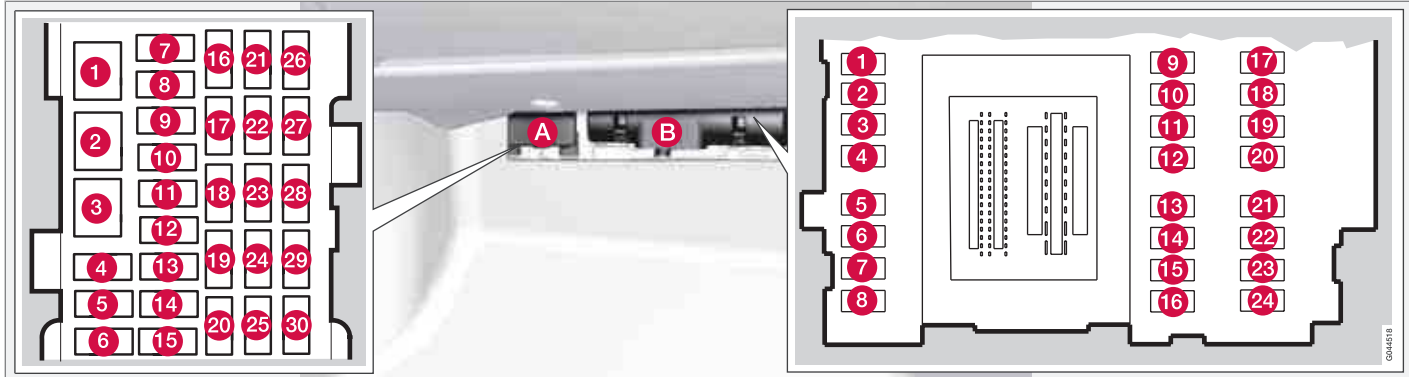

Positions

On the inside of the cover is a label that shows the location of the fuses in fuse box A.

Box A	Function	A
1	Primary fuse for audio control module*; Primary fuse for fuses 16-20: Infotainment	40
2	-	-
3	-	-

Box A	Function	A
4	-	-
5	-	-
6	Door handle (Keyless*)	5
7	-	-
8	Control panel, driver's door	20
9	Control panel, front passenger door	20

Box A	Function	A
10	Control panel, rear passenger door, right	20
11	Control panel, rear passenger door, left	20
12	Keyless*	7.5
13	Power seat driver's side*	20
14	Power seat passenger side*	20

* Option/accessory, for more information, see Introduction.





09 Maintenance and service

09

Fuses

Box A	Function	A
15	-	-
16	Infotainment control module	5
17	Audio control unit (amplifier)* Digital radio*; TV*	10
18	Audio	15
19	Telematics*; Bluetooth*	5
20	-	-
21	Sunroof*; Interior lighting roof; Climate sensor*; Damper motors, air intake	5
22	12 V socket, tunnel console	15
23	Seat heating, rear right*	15
24	Seat heating, rear left*	15
25	-	-
26	Seat heating (passenger side)	15
27	Seat heating (driver's side)	15

Box A	Function	A
28	Parking assistance*; Parking camera*; Towbar control module * BLIS*	5
29	AWD control module*	15
30	Active chassis Four-C*	10

Box B	Function	A
1	Rear window wiper	15
2	-	-
3	Interior lighting; Driver's door control panel, power windows; Power seats, front*; Remote controlled garage door opener*	7.5
4	Information display (DIM)	5
5	Adaptive cruise control, ACC*; collision warning system*	10
6	Interior lighting; Rain sensor	7.5
7	Steering wheel module	7.5

Box B	Function	A
8	Central locking system, fuel filler flap	10
9	Rear window washer	15
10	Windscreen washers	15
11	Unlocking, tailgate	10
12	Folding head restraint*	10
13	Fuel pump	20
14	Movement detector alarm*; Climate panel	5
15	Steering lock	15
16	Siren alarm*; Data link connector OBDII	5
17	-	-
18	Airbags	10
19	Collision warning system*	5
20	Accelerator pedal sensor, PTC element air preheater*; Dimming, interior rearview mirror*; Seat heating, rear*	7.5



Fuses

Box B	Function	A
21	-	-
22	Brake light	5
23	Sunroof*	20
24	Immobiliser	5





Fuses

Cargo area

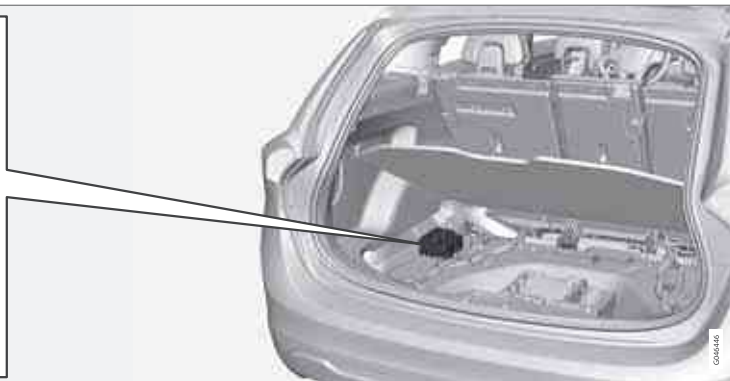
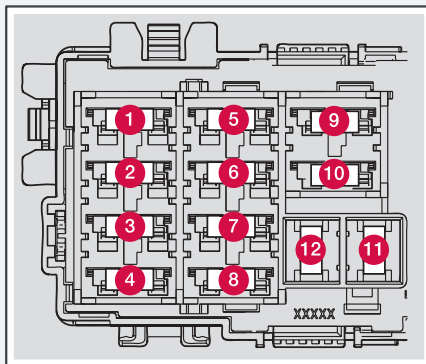

Positions

	Function	A
1	Electric parking brake, left	30
2	Electric parking brake, right	30
3	Rear window defroster	30
4	Trailer socket 2*	15

	Function	A
5	-	-
6	12 V socket, cargo area	15
7	-	-
8	-	-

	Function	A
9	-	-
10	-	-
11	Trailer socket 1*	40
12	-	-



Engine compartment, cold zone - Start/Stop*

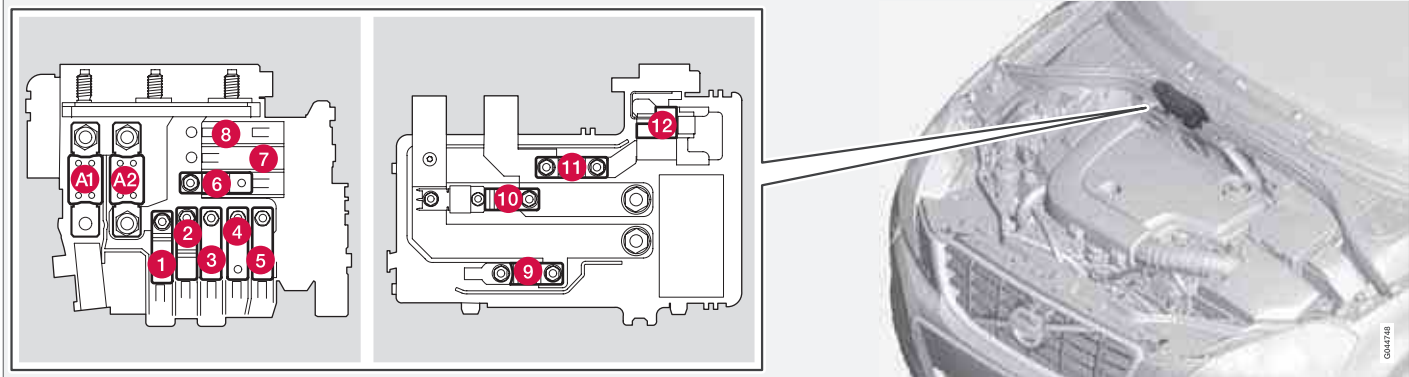

Location of fuses for the Start/Stop function.

- Fuses A1 and A2 are of the "MEGA Fuse" type and must only be replaced by a workshop².
- Fuses 1-11 are of the "Midi Fuse" type and must only be replaced by a workshop².
- Fuse 12 is of the "Mini Fuse" type.

For more information on Start/Stop - see page 127.

Positions

	Function	A
A1	Main fuse for central electrical unit in the engine compartment	175

	Function	A
A2	Main fuse for central electronic module (CEM) with fuse box B under the glovebox, central electrical unit in passenger compartment with fuse box A under the glovebox, central electrical unit in cargo area	175
1	PTC element, air preheater*	100

² An authorised Volvo workshop is recommended.



Fuses

	Function	A
2	Primary fuse for the central electronic module (CEM) with fuse box B under the glovebox	50
3	Primary fuse for central electrical unit in passenger compartment with fuse box A under the glovebox	60
4	Primary fuse for central electrical unit in passenger compartment with fuse box A under the glovebox	60
5	Primary fuse for central electrical unit in cargo area	60
6	Ventilation fan	40
7	-	-
8	-	-
9	Start relay	30
10	Internal diode	50

	Function	A
11	Support battery	70
12	Central electronic module (CEM) - reference voltage support battery; Charging point support battery	15



Washing the car

Wash the car as soon as it becomes dirty. Wash the car in a car wash with oil separator. Use car shampoo.

- Remove bird droppings from the paintwork as soon as possible. Bird droppings contain chemicals that affect and discolour paintwork very quickly. An authorised Volvo workshop is recommended for the removal of any discoloration.
- Hose down the underbody.
- Rinse the whole car until the loose dirt has been removed in order to reduce the risk of scratches from washing. Do not spray directly onto the locks.
- If necessary, use cold degreasing agent on very dirty surfaces. Note that the surfaces must not then be warmed up by the sun!
- Wash using a sponge, car shampoo and plenty of lukewarm water.
- Clean the wiper blades with a lukewarm soap solution or car shampoo.
- Use cold degreasing agent on very dirty surfaces.
- Dry the car using a clean, soft chamois or a water scraper. If you avoid allowing water droplets to dry in strong sunlight then the risk of water stains that may need to be polished away is reduced.

WARNING

Always have the engine cleaned by a workshop. There is a risk of fire if the engine is hot.

IMPORTANT

Dirty headlamps have impaired functionality. Clean them regularly, when refuelling for example.

Do not use any corrosive cleaning agents but use water and a non-scratching sponge instead.

NOTE

Outside lighting such as headlamps, fog lamps and rear lamps may temporarily have condensation on the inside of the lens. This is normal, all exterior lighting is designed to withstand this. Condensation is normally vented out of the lamp housing when the lamp has been switched on for a time.

Cleaning the wiper blades

Asphalt, dust and salt residue on wiper blades, as well as insects, ice etc. on the windscreen, impair the service life of wiper blades.

For cleaning:

- Set the wiper blades in service position, see page 341.

NOTE

Wash the wiper blades and windscreen regularly with lukewarm soap solution or car shampoo.

Do not use any strong solvents.

Automatic car washes

An automatic car wash is a simple and quick way of washing the car, but it cannot reach everywhere. Handwashing the car is recommended for achieving optimum results.

NOTE

During the first few months a new car must only be handwashed. This is because the paintwork is more sensitive when it is new.

High-pressure washing

When using high-pressure washing, use sweeping movements and make sure that the nozzle does not come closer than 30 cm to the surface of the car (the distance applies to all exterior parts). Do not spray directly onto the locks.



Car care

Testing the brakes

WARNING

Always test the brakes after washing the car, including the parking brake, to ensure that moisture and corrosion do not attack the brake linings and reduce braking performance.

Lightly depress the brake pedal now and then when driving long distances in rain or slush. The heat from the friction causes the brake linings to warm up and dry. Do the same thing after starting in very damp or cold weather.

Exterior plastic, rubber and trim components

A special cleaning agent available from Volvo dealers is recommended for the cleaning and care of coloured plastic parts, rubber and trim components, such as glossy trim mouldings. When using such a cleaning agent the instructions must be followed carefully.

IMPORTANT

Avoid waxing and polishing on plastic and rubber.

When using degreasant on plastic and rubber, only rub with light pressure if it is necessary. Use a soft washing sponge.

Polishing glossy trim mouldings could wear away or damage the glossy surface layer.

Polishing agent that contains abrasive must not be used.

Rims

Only use rim cleaning agent recommended by Volvo.

Strong rim cleaning agents can damage the surface and cause stains on chrome-plated aluminium rims.

Polishing and waxing

Polish and wax the car if the paintwork is dull or to give the paintwork extra protection.

The car does not need to be polished until it is at least one year old. However, the car can be waxed during this time. Do not polish or wax the car in direct sunlight.

Wash and dry the car thoroughly before you begin polishing or waxing. Clean off asphalt and tar stains using tar remover or white spirit.

More stubborn stains can be removed using fine rubbing paste designed for car paintwork.

Polish first with a polish and then wax with liquid or solid wax. Follow the instructions on the packaging carefully. Many preparations contain both polish and wax.

IMPORTANT

Only paint treatment recommended by Volvo should be used. Other treatment such as preserving, sealing, protection, lustre sealing or similar could damage the paintwork. Paintwork damage caused by such treatments is not covered by Volvo warranty.

Water-repellent coating*



Never use products such as car wax, degreaser or similar on glass surfaces as this could ruin their water-repellent properties.

Take care when cleaning so as not to damage the glass surface.

To avoid damaging glass surfaces when removing ice – only use plastic ice scrapers.

There is natural wear of the water-repellent coating.

Treatment with a special finishing agent available from Volvo dealers is recommended in



order to maintain the water-repellent properties. This should be used first after three years and then each year.

Rustproofing – inspection and maintenance

The car received a thorough and complete rustproofing at the factory. Parts of the body are made of galvanised sheet metal. The underbody is protected by a wear-resistant anti-corrosion compound. A thin, penetrating rustproofing fluid was sprayed into the exposed members, cavities, closed sections and side doors.

Under normal conditions the rustproofing does not require treatment for approximately 12 years. After this period, it should be treated at three-year intervals. Volvo recommends that you engage an authorised Volvo workshop for assistance if the car needs further treatment.

Dirt and road salt can lead to corrosion so it is important to keep the car clean. The car's rustproofing needs to be checked regularly and touched-up if necessary in order for it to be maintained.

Cleaning the interior

Only use cleaning agents and car care products recommended by Volvo. Clean regularly and follow the instructions included with the car care product.

Vacuuming is important prior to using cleaning agents.

Carpets and cargo area

Remove inlaid carpets for separate cleaning of the floor carpet and the inlaid carpets. Use a vacuum cleaner to remove dust and dirt.

Each inlay mat is secured with pins.

- Take hold of the inlay mat at each pin and lift the mat straight up.

Fit the inlay mat in place by pressing it in at each pin.



WARNING

Before setting off check that the inlaid mat in the driver area is firmly affixed and secured in the pins in order to avoid getting caught adjacent to and under the pedals.

A special textile cleaner is recommended for stains on the floor mat after vacuuming. Floor mats should be cleaned with agents recommended by your Volvo dealer!

Stains on fabric upholstery and roof upholstery

A special fabric cleaning agent, available from authorised Volvo dealers, is recommended to avoid impairing the fire retardant qualities of the upholstery.



IMPORTANT

Sharp objects and Velcro may damage the fabric upholstery.

Treating stains on leather upholstery

Volvo's leather upholstery is chromium-free and is treated to preserve its original appearance.

Leather upholstery ages and acquires a beautiful patina over time. The leather is refined and processed so that it retains its natural characteristics. It is given a protective coating, but regular cleaning is required in order to maintain both characteristics and appearance. Volvo offers a comprehensive product for the cleaning and treatment of leather upholstery which, when used in accordance with the instructions, preserves the leather's protective coating. After a period of use the natural appearance of the leather will nevertheless emerge, depending more or less on the surface texture of the leather. This is a natural maturing of the leather and shows that it is a natural product.



Car care

To achieve best results Volvo recommends cleaning and the application of protective cream once to four times per year (or more if necessary). The Volvo Leather Care kit is available from your Volvo dealer.

! IMPORTANT

- Certain items of coloured clothing (for example, jeans and suede garments) may stain the upholstery.
- Never use strong solvents. Such products may damage fabric, vinyl and leather upholstery.

Washing instructions for leather upholstery

1. Pour the leather cleaner on the dampened sponge and squeeze out a strong foam.
2. Work the dirt away with gentle circular movements.
3. Dab accurately with the sponge on the stains. Allow the sponge to absorb the stain. Do not rub.
4. Wipe off with soft paper or a cloth and allow the leather to dry completely.

Protective treatment of leather upholstery

1. Pour a small amount of the protective cream on the felted cloth and massage in a thin layer of cream with gentle circular movements on the leather.
2. Allow the leather to dry for 20 minutes before use.

The leather has now been given improved protection against stains and improved UV protection.

Washing instructions for the leather steering wheel

- Remove dirt and dust with a soft pre-moistened sponge and neutral soap.
- Leather needs to breathe. Never cover the leather steering wheel with protective plastic.
- Use natural oils. Volvo's leather care agents are recommended for best results.

If the steering wheel has stains:

Group 1 (ink, wine, coffee, milk, sweat and blood)

- Use a soft cloth or sponge. Mix a 5% ammonia solution. (For blood stains, use a solution of 2 dl water and 25g salt.)

Group 2 (fats, oils, sauces and chocolate)

1. Same procedure as group 1.
2. Polish with an absorbent paper or cloth.

Group 3 (dry dirt, dust)

1. Use a soft brush to remove the dirt.
2. Same procedure as group 1.

Treating stains on interior plastic, metal and wood parts

A fibrillated fibre or microfibre cloth, lightly moistened with water, available from Volvo dealers, is recommended for cleaning interior parts and surfaces.

Do not scrape or rub stains. Never use strong stain removers. A special cleaning agent available from Volvo dealers can be used for more difficult cleaning.

Cleaning seatbelts

Use water and a synthetic detergent. A special textile cleaning agent is available from your Volvo dealer. Make sure the seatbelt is dry before allowing it to retract.

Touching up minor paintwork damage

Paint is an important part of the car's rust-proofing and should therefore be checked regularly. To avoid the onset of rust, damaged paintwork should be rectified immediately. The most common types of paintwork damage are stone chips, scratches, and marks on the edges of wings, doors and bumpers.

Materials

- primer¹ - for e.g. plastic-clad bumpers there are special adhesive primers available in spray cans
- base coat and clear coat - are available in spray cans or as touch-up pens/sticks²
- masking tape
- fine sand paper¹.

Colour code (Paint code)

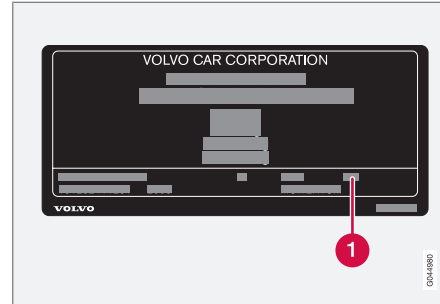

- 1** Code for car's colour

It is important that the correct colour is used. For product decal location, see page 370.

Repairing minor paint damage such as stone chips and scratches

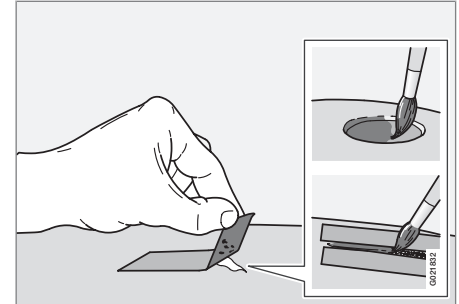

Before work is started, the car must be clean and dry as well as at a temperature above 15 °C.

1. Apply a piece of masking tape over the damaged surface. Then remove the tape to remove any loose paint.

If the damage has reached down to a metal surface (sheet steel), it is preferable to use a primer. In the event of damage to a plastic surface, an adhesive primer should be used for better results - spray into the spray can's cap and brush thinly.

¹ If required.

² Follow the instructions that are included with the package for the touch-up pen/stick.



Car care

2. A light sanding with very fine abrasive material can be performed locally before painting if necessary (e.g. if there are rough edges). Clean the surface thoroughly and allow to dry.
3. Stir the primer well and apply using a fine brush, matchstick or similar. Finish with base coat and clear coat once the primer has dried.
4. For scratches, proceed as above, but mask around the damaged area to protect the undamaged paintwork.



NOTE

If the stone chip has not penetrated down to the metal and an undamaged layer of paint remains in place, fill in with base coat and clear coat as soon as the surface has been cleaned.



Type designations.....	370
Dimensions and weights.....	372
Engine specifications.....	376
Engine oil.....	378
Fluids and lubricants.....	381
Fuel.....	384
Wheel and tyres, dimensions and pressure	388
Electrical system.....	391
Type approval.....	392
Symbols in the display.....	404



10

SPECIFICATIONS

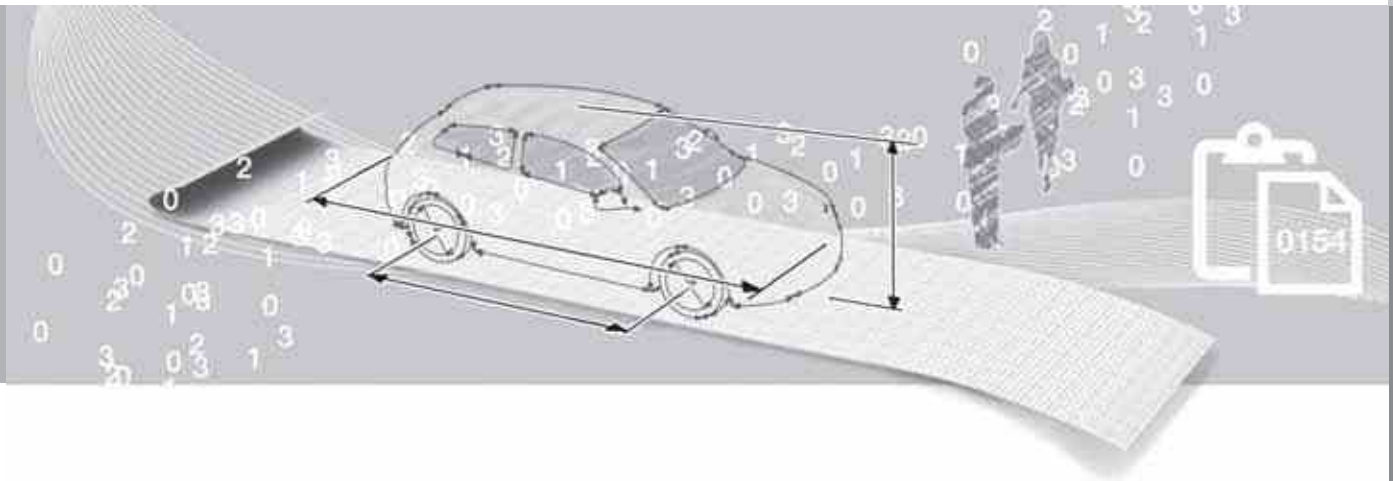

Type designations

Label location

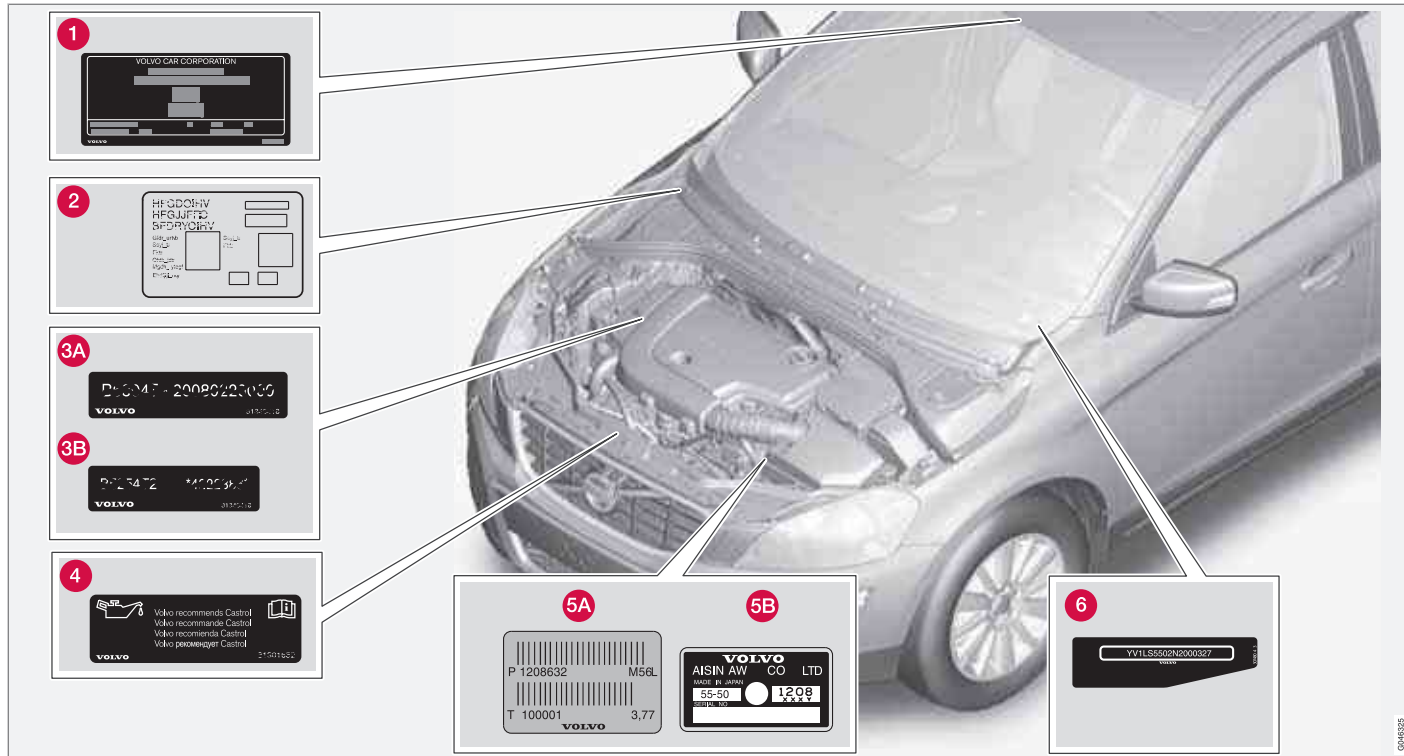

Type designations

Knowing the car's type designation, vehicle identification and engine numbers can facilitate all contact with an authorised Volvo dealer regarding the car and when ordering spare parts and accessories.

- 1 Type designation, vehicle identification number, maximum permissible weights, codes for colour and upholstery and type approval number. The label is visible when the right rear door is opened.
- 2 Label for parking heater.
- 3 Engine code and engine serial number.
 - A 6-cyl.
 - B 4-cyl / 5-cyl
- 4 Label for engine oil.
- 5 Gearbox type designation and serial number.
 - A Manual gearbox
 - B Automatic gearbox
- 6 Car's identification number. (VIN Vehicle Identification Number)

Further information on the car is presented in the registration document.

i NOTE

The labels shown in the owner's manual are not provided as exact reproductions of those in the car. The purpose is to show their approximate appearance and location in the car. The information that applies to your car in particular is available on the label in question in your car.

Dimensions and weights

Dimensions

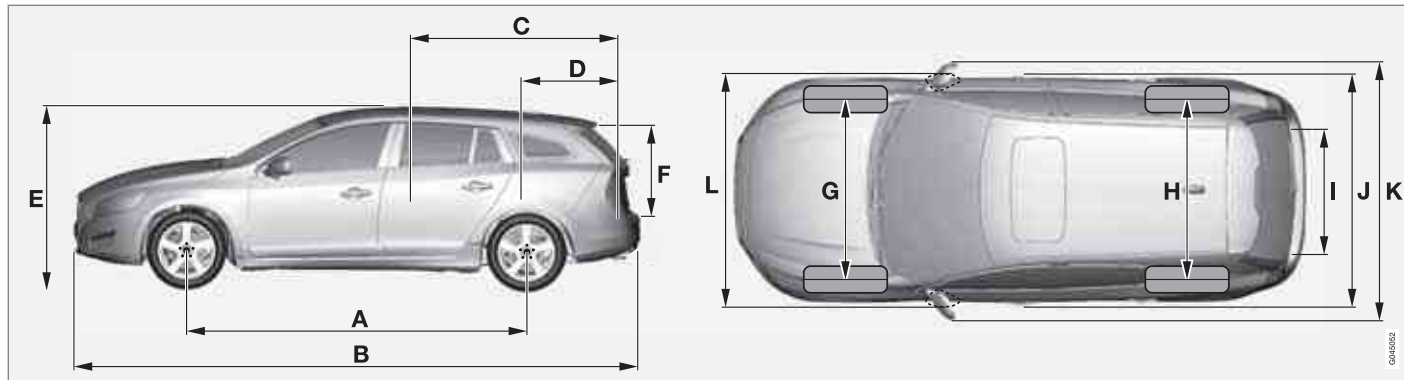

	Dimensions	mm
A	Wheelbase	2776
B	Length	4628
C	Load length, floor, folded rear seat	1749
D	Load length, floor	978
E	Height	1484
F	Load height	658

	Dimensions	mm
G	Front track	1588 ^A 1578 ^B
H	Rear track	1585 ^A 1575 ^B
I	Load width, floor	1082
J	Width	1865

	Dimensions	mm
K	Width including door mirrors	2097
L	Width including folded-in door mirrors	1899

A with 16" wheel
B with 17" wheel

Dimensions and weights

Weights

Kerb weight includes the driver, the fuel tank 90% full and all fluids.

The weight of passengers and accessories, and towball load (when a trailer is hitched, see table page 374) influences the payload and is not included in the kerb weight.

Permitted max. load = Gross vehicle weight - Kerb weight.

NOTE

The documented kerb weight applies to cars in the standard version - i.e. a car without extra equipment or accessories. This means that for every accessory added the loading capacity of the car is reduced correspondingly by the weight of the accessory.

Examples of accessories that reduce loading capacity are the Kinetic/Momentum/Summum equipment levels, as well as other accessories such as Towbar, Load carriers, Space box, Audio system, Auxiliary lamps, GPS, Fuel-driven heater, Safety grille, Carpets, Cargo cover, Power seats, etc.

Weighing the car is a certain way of ascertaining the kerb weight of your own particular car.

WARNING

The car's driving characteristics change depending on how heavily it is loaded and how the load is distributed.

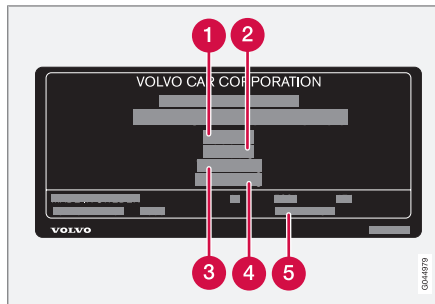

For information on decal location, see page 370.

- 1 Max. gross vehicle weight
- 2 Max. train weight (car+trailer)
- 3 Max. front axle load
- 4 Max. rear axle load
- 5 Equipment level

Max. load: See registration document.

Max. roof load: 75 kg.

Dimensions and weights

Towing capacity and towball load

Engine	Engine code ^A	Gearbox	Max. weight braked trailer (kg)	Max. towball load (kg)
T3	B4164T3	Manual, MMT6	1600	75
T3	B4164T3	Automatic, MPS6	1600	75
T4 ^B	B4164T	Manual, MMT6	1600	75
T4 ^B	B4164T	Automatic, MPS6	1600	75
T4 ^C	B5204T8	Automatic, TF-80SD	1800	90
T4F	B4164T2	Manual, MMT6	1600	75
T4F	B4164T2	Automatic, MPS6	1600	75
T5	B4204T7	Manual, MMT6	1800	90
T5	B4204T7	Automatic, MPS6	1800	90
T5 ^C	B5204T9	Automatic, TF-80SC	1800	90
T5 ^C	B5254T12	Automatic, TF-80SC	1800	90
T6 AWD	B6304T4	Automatic, TF-80SC	1800	90
D2	D4162T	Manual, MMT6	1300	75
D2	D4162T	Automatic, MPS6	1300	75
D3	D5204T7	Manual, M66	1600	75
D3	D5204T7	Automatic, TF-80SD ^E	1600	75

Dimensions and weights

Engine	Engine code ^A	Gearbox	Max. weight braked trailer (kg)	Max. towball load (kg)
D4	D5204T3	Manual, M66	1600	75
D4	D5204T3	Automatic, TF-80SC ^D	1600	75
D4	D5204T3	Automatic, TF-80SD ^E	1600	75
D4 AWD	D5244T17	Automatic, TF-80SC	1800	90
D5	D5244T11	Manual, M66	1600	75
D5	D5244T15	Automatic, TF-80SC	1800	90
D5 AWD	D5244T15	Automatic, TF-80SC	1800	90

^A Engine code, component and serial number can be read on the engine, see page 370.

^B DRIVE for certain markets.

^C Only certain markets.

^D Without Start/Stop.

^E With Start/Stop.

Max. weight unbraked trailer (kg)	Max. towball load (kg)
750	50

Engine specifications

Engine specifications



NOTE

Not all engines are available in all markets.

Engine	Engine code ^A	Output (kW/rpm)	Output (hp/rpm)	Torque (Nm/rpm)	No. of cylinders	Bore (mm)	Stroke (mm)	Swept volume (litres)	Compression ratio
T3	B4164T3	110/5700	150/5700	240/1600-4000	4	79	81.4	1.596	10.0:1
T4 ^B	B4164T	132/5700	180/5700	240/1600-5000	4	79	81.4	1.596	10.0:1
T4 ^C	B5204T8	132/5000	180/5000	300/2700-4200	5	81.0	77	1.984	10.5:1
T4F	B4164T2	132/5700	180/5700	240/1600-5000	4	79	81.4	1.596	10.0:1
T5	B4204T7	177/5500	240/5500	320/1800-5000	4	87.5	83.1	1.999	10.0:1
T5 ^C	B5204T9	157/6000	213/6000	300/2700-5000	5	81.0	77	1.984	10.5:1
T5 ^C	B5254T12	187/5400	254/5400	360/1800-4200	5	83.0	92.3	2.497	9.5:1
T6	B6304T4	224/5600	304/5600	440/2100-4200	6	82.0	93.2	2.953	9.3:1
D2	D4162T	84/3600	115/3600	270/1750-2500	4	75	88.3	1.560	16.0:1
D3	D5204T7	100/3500	136/3500	350/1500-2250	5	81.0	77	1.984	16.5:1
D4	D5204T3	120/3500	163/3500	400/1500-2750	5	81.0	77	1.984	16.5:1
D4 AWD	D5244T17	120/4000	163/4000	420/1500-2500	5	81.0	93.2	2.400	16.5:1

Engine specifications

Engine	Engine code ^A	Output (kW/rpm)	Output (hp/rpm)	Torque (Nm/rpm)	No. of cylinders	Bore (mm)	Stroke (mm)	Swept volume (litres)	Compression ratio
D5	D5244T11 ^D	158/4000	215/4000	420/1500–3250	5	81.0	93.15	2.400	16.5:1
D5	D5244T15 ^E	158/4000	215/4000	440/1500-3000	5	81.0	93.15	2.400	16.5:1

^A Engine code, component and serial number can be read on the engine, see page 370.

^B DRIVE for certain markets.

^C Only certain markets.

^D Manual gearbox

^E Automatic gearbox

Engine oil

Adverse driving conditions

Adverse driving conditions can lead to abnormally high oil temperature or oil consumption. Below are some examples of adverse driving conditions.

Check the oil level more frequently for long journeys:

- towing a caravan or trailer
- in mountainous regions
- at high speeds
- in temperatures colder than $-30\text{ }^{\circ}\text{C}$ or hotter than $+40\text{ }^{\circ}\text{C}$

The above also apply to shorter driving distances at low temperatures.

Choose a fully synthetic engine oil for adverse driving conditions. It provides extra protection for the engine.

Volvo recommends Castrol oil products.



IMPORTANT

In order to fulfil the requirements for the engine's service intervals all engines are filled with a specially adapted synthetic engine oil at the factory. The choice of oil has been made very carefully with regard to service life, starting characteristics, fuel consumption and environmental impact.

An approved engine oil must be used in order that the recommended service intervals can be applied. Only use a prescribed grade of oil for both filling and oil change, otherwise you will risk affecting service life, starting characteristics, fuel consumption and environmental impact.

Volvo Car Corporation disclaims all warranty liability if engine oil of the prescribed grade and viscosity is not used.

Volvo recommends that oil changes are carried out at an authorised Volvo workshop.

Engine oil

Engine oil grade

Engine	Engine code ^A	Recommended oil grade	Volume, incl. oil filter (litres)
T6	B6304T4	Oil grade: ACEA A5/B5 Viscosity: SAE 0W-30	approx. 6.8
D4	D5204T3		approx. 5.9
D4 AWD	D5244T17		approx. 5.9
D3	D5204T7		approx. 5.9
D5	D5244T11 ^B		approx. 5.9
D5	D5244T15 ^C		approx. 5.9
T5	B4204T7	Oil grade: ACEA A5/B5 Viscosity: SAE 5W-30 When driving under adverse conditions, use ACEA A5/B5 SAE 0W-30.	approx. 5.4
D2	D4162T		approx. 3.8
T3	B4164T3	Certified and factory-filled oil: Oil grade WSS-M2C925-A options for service: Oil grade: ACEA A5/B5 Viscosity: SAE 5W-30	approx. 4.1
T4 ^D	B4164T		approx. 4.1
T4F	B4164T2		approx. 4.1

Engine oil

Engine	Engine code ^A	Recommended oil grade	Volume, incl. oil filter (litres)
T4 ^E	B5204T8	Oil grade: ACEA A5/B5 Viscosity: SAE 0W-30	approx 5.5
T5 ^E	B5204T9		approx 5.5
T5 ^E	B5254T12		approx 5.5

^A Engine code, component and serial number can be read on the engine, see page 370.

^B Manual gearbox

^C Automatic gearbox

^D DRIVE for certain markets.

^E Only certain markets.

For filling engine oil, see page 329.

Fluids and lubricants

Coolant

Prescribed grade: Coolant recommended by Volvo mixed with 50% water¹, see the packaging.

Engine ^A		Volume (litres)
T5	B4204T7	10.5
D2	D4162T ^D	
D2	D4162T ^E	11.1
T4 ^B	B5204T8	8.9
T5 ^B	B5204T9	
T5 ^B	B5254T12	
T6	B6304T4	
D4	D5204T3	
D4 AWD	D5244T17	
D3	D5204T7	
D5	D5244T15	
D5	D5244T11	

Engine ^A		Volume (litres)
T3	B4164T3 ^D	9.2
T4 ^C	B4164T ^D	
T4F	B4164T2 ^D	
T3	B4164T3 ^E	9.8
T4 ^C	B4164T ^E	
T4F	B4164T2 ^E	

^A Engine code, component and serial number can be read on the engine, see page 370.

^B Only certain markets.

^C DRiVE for certain markets.

^D Manual gearbox

^E Automatic gearbox

¹ Water quality must fulfil the standard STD 1285.1.

10 Specifications

Fluids and lubricants

Other fluids and lubricants

Manual gearbox	Volume (litres)	Prescribed transmission fluid
MMT6	1.7	BOT 350M3
M66	1.9	

Automatic gearbox	Volume (litres)	Prescribed transmission fluid
MPS6	7.3	BOT 341
TF-80SC	7.0	AW1
TF-80SD	7.0	AW1

Fluid	System	Volume (litres)	Prescribed grade
Brake fluid	Brake system	0.6	DOT 4+
Power steering fluid	Power steering	-	WSS M2C204-A2 or equivalent product.
Washer fluid	Cars with headlamp washing	5.4	Washer fluid recommended by Volvo - with frost protection during cold weather and below freezing point.
	Cars without headlamp washing	4.0	
Fuel	Petrol engine	approx. 67	Petrol: see page 288
	Diesel engine	approx. 67	Diesel: see page 289







Fluids and lubricants

**NOTE**







Under normal driving conditions, the gear-box oil does not need to be changed during its service life. However, this may be necessary under adverse driving conditions, see page 381.

Fuel







CO₂ emissions and fuel consumption

							
		CO ₂		CO ₂		CO ₂	
T3	man	174	7.5	119	5.1	139	6.0
T3	aut	230	9.9	137	5.9	171	7.4
T4 ^A	man	202	8.7	125	5.4	153	6.6
T4 ^A	aut	230	9.9	137	5.9	171	7.4
T4 ^{FB}	man	219 (212 ^C)	9.5 (12.9 ^C)	129 (124 ^C)	5.6 (7.5 ^C)	162 (156 ^C)	7.0 (9.5 ^C)
T4 ^{FB}	aut	238 (223 ^C)	10.2 (13.6 ^C)	135 (135 ^C)	5.8 (8.2 ^C)	173 (167 ^C)	7.5 (10.2 ^C)
T5	man	261	11.2	143	6.1	186	8.0
T5	aut	269	11.5	148	6.3	192	8.2
T6 AWD	aut	346	14.8	175	7.5	237	10.2
D2	man	137	5.2	109	4.1	119	4.5

Fuel

							
		CO ₂		CO ₂		CO ₂	
D2	aut	134	5.1	111	4.2	119	4.5
D3	man	138	5.2	108	4.1	119	4.5
D3	aut	187	7.1	127	4.8	149	5.7
D4	man	138	5.2	108	4.1	119	4.5
D4 ^D	aut	214	8.1	127	4.8	159	6.0
D4 ^E	aut	187	7.1	127	4.8	149	5.7
D4 AWD	aut	226	8.6	137	5.2	169	6.4
D5	man	148	5.6	104	4.0	120	4.6

Fuel

							
		CO ₂		CO ₂		CO ₂	
D5	aut	221	8.5	128	4.9	162	6.2
D5 AWD	aut	226	8.6	137	5.2	169	6.4

A DRIVE for certain markets.



B Flexifuel engines can be driven on both 95 octane unleaded petrol and bioethanol E85. Both fuels are filled in the common fuel tank so that any variations of mixing ratios between these two fuels is possible. For more information, see page 119.

C E85

D Without Start/Stop.

E With Start/Stop.

Explanation

	gram/km
	litre/100 km
	Urban driving

	Extra-urban driving
	Combined driving

 NOTE

If the consumption and emission data is missing then it is included in the enclosed supplement.

Fuel consumption and emissions of carbon dioxide

Fuel consumption and emission values in the table above are based on specific EU cycles¹, that apply to cars with kerb weight in the basic version and without extra equipment. The car's weight may increase depending on equipment. This, as well as how heavily the car is loaded, increases fuel consumption and carbon dioxide emissions.

¹ Official fuel consumption figures are based on two standardised driving cycles in a laboratory environment ("EU driving cycles") all in accordance with EU Directive 80/1268/EEC (Euro 4), EU Regulation no 692/2008 (Euro 5) and UN ECE Regulation no 101. The regulations cover the driving cycles for urban driving and extra-urban driving. - Urban driving - the measurement starts with cold starting the engine. The driving is simulated. - Extra-urban driving - the car is accelerated and braked at speeds between 0 and 120 km/h. The driving is simulated. - A car with D2, D3, D4 or D5 engine and 6-speed manual gearbox is started in 2nd gear. The combined driving value given in the table is a combination of urban driving and extra-urban driving, in accordance with applicable legislation. CO₂ emissions - the exhaust gases are collected in order to calculate the carbon dioxide emissions during the two driving cycles. These are then analysed and give the value for CO₂ emissions.

Fuel

There are several reasons for increased fuel consumption compared with the table's values. Examples of this are:

- The driver's driving style.
- If the customer has specified wheels larger than those fitted as standard on the model's basic version, then resistance increases.
- High speed results in increased wind resistance.
- Fuel quality, road and traffic conditions, weather and the condition of the car.

Even a combination of the above-mentioned examples can result in significantly improved consumption. For further information, please refer to the regulations referred to¹.

Large deviations in fuel consumption may arise in a comparison with the EU driving cycles¹ which are used in the certification of the car and on which the consumption figures in the table are based.

To bear in mind

Tips that the driver can use in order to reduce consumption:

- Drive gently and avoid unnecessary acceleration as well as braking too hard.
- Drive with the correct air pressure in the tyres and check this regularly - select ECO tyre pressure for best results, see the tyre pressure table on page 388.
- Choice of tyres can affect fuel consumption - seek advice on suitable tyres from a dealer.

See further information and more advice on pages 12 and 284.

See page 288 for general information on fuel.

¹ Official fuel consumption figures are based on two standardised driving cycles in a laboratory environment ("EU driving cycles") all in accordance with EU Directive 80/1268/EEC (Euro 4), EU Regulation no 692/2008 (Euro 5) and UN ECE Regulation no 101. The regulations cover the driving cycles for urban driving and extra-urban driving. - Urban driving - the measurement starts with cold starting the engine. The driving is simulated. - Extra-urban driving - the car is accelerated and braked at speeds between 0 and 120 km/h. The driving is simulated. - A car with D2, D3, D4 or D5 engine and 6-speed manual gearbox is started in 2nd gear. The combined driving value given in the table is a combination of urban driving and extra-urban driving, in accordance with applicable legislation. CO₂ emissions - the exhaust gases are collected in order to calculate the carbon dioxide emissions during the two driving cycles. These are then analysed and give the value for CO₂ emissions.

Wheel and tyres, dimensions and pressure

Approved tyre pressures

Engine	Tyre size	Speed (km/h)	Load, 1 - 3 persons		Max. load		ECO pressure ^A
			Front (kPa) ^B	Rear (kPa)	Front (kPa)	Rear (kPa)	Front/rear (kPa)
T3 (B4164T3) T4 (B4164T) ^C T4F (B4164T2) D2 (D4162T)	205/60 R 16	0 - 160	230	230	260	260	260
	215/55 R 16	160 +	260	240	280	260	-
	215/50 R 17						
	235/45 R 17						
	235/40 R 18						
	235/45 R 17 SST	0 - 160	230	230	260	260	260
160 +		260	260	280	280	-	
T6 (B6304T4)	215/55 R 16	0 - 160	230	230	260	260	260
	235/45 R 17	160 +	280	240	300	260	-
	215/50 R 17	0 - 160	240	240	260	260	260
	235/40 R 18	160 +	300	240	320	280	-
	235/45 R 17 SST	0 - 160	230	230	260	260	260
		160 +	280	280	300	300	-

Wheel and tyres, dimensions and pressure

Engine	Tyre size	Speed (km/h)	Load, 1 - 3 persons		Max. load		ECO pressure ^A
			Front (kPa) ^B	Rear (kPa)	Front (kPa)	Rear (kPa)	Front/rear (kPa)
T4 (B5204T8) ^D	215/55 R 16	0 - 160	230	230	260	260	260
T5 (B5204T9) ^D	215/50 R 17	160 +	260	240	280	260	-
T5 (B4204T7)	235/45 R 17						
T5 (B5254T12) ^D	235/40 R 18						
D4 (D5204T3)	235/45 R 17 SST	0 - 160	230	230	260	260	260
D3 (D5204T7)		160 +	260	260	280	280	-
D5 (D5244T11)							
D5 (D5244T15) ^E							

Wheel and tyres, dimensions and pressure

Engine	Tyre size	Speed (km/h)	Load, 1 - 3 persons		Max. load		ECO pressure ^A
			Front (kPa) ^B	Rear (kPa)	Front (kPa)	Rear (kPa)	Front/rear (kPa)
D4 AWD (D5244T17) D5 AWD (D5244T15)	215/55 R 16	0 - 160	230	230	260	260	260
	235/45 R 17	160 +	260	240	280	260	-
	215/50 R 17	0 - 160	240	240	260	260	260
	235/40 R 18	160 +	280	240	300	260	-
	235/45 R 17 SST	0 - 160	230	230	260	260	260
		160 +	260	260	280	280	-
Temporary Spare Tyre		max. 80	420	420	420	420	-

A Economical driving.

B In certain countries there is the "bar" unit beside the SI unit "Pascal": 1 bar = 100 kPa.

C DRiVe for certain markets.

D Only certain markets.

E FWD



NOTE

All engines, tyres or combinations of these are not always available in all markets.

Electrical system

Electrical system

The car has a voltage-regulated AC alternator. The electrical system is single-pole and uses the chassis and engine casing as a conductor.

The battery capacity is dependent upon the equipment level in the vehicle.

IMPORTANT

If the battery is replaced, replace it with a battery of the same cold start capacity and reserve capacity as the original (see the decal on the battery).

10

Battery

Engine	Voltage (V)	Cold start capacity, CCA - Cold Cranking Amperes (A)	Reserve capacity (minutes)
Petrol (Ethanol)	12	520–800	100–160
Diesel	12	700–800	135–160
Petrol/Diesel with Start/Stop function	12	760 ^A	135

^A Battery type AGM (Absorbed Glass Mat) must be used in cars with the Start/Stop function.

NOTE

- The battery's container size should be consistent with the original battery's dimensions.
- The battery's height is different depending on size.

Eco Start/Stop DRIVE*

For information on batteries in cars with Eco Start/Stop DRIVE, see page 347.



Type approval

Remote control key system

Lock system, standard

Country	
EU, China	 <p>Comendral FCC ID: K325997402264 IC: 2577-299442264 CZ: 2009-19-0074 CET8777C0306R TRC/LP/2009/22 CMI ID: 20090-1126 Complies with EIA Standards D801782 TA-2009490 RLV/RTT06-348 Made in Cz</p>

Keyless lock system (Keyless drive)

Country	
EU	 <p>Comendral SIVK 4 9265</p>
Korea	 <p>Comendral SIE-SVK 49268 Made in Cz</p>

Country	
China	 <p>Comendral DMK4 9209 CET87631D/0808R TRC/LP/2009/200908 CMI ID: 20090-1121 Complies with IDA Standards D801782 TA-2009490 Made in Cz</p>
Hong Kong	 <p>Comendral SIVK4 9209</p>

Sensors, tyre pressure monitoring - TPMS (Tyre Pressure Monitoring System)*

Country	
Brazil	 <p>MADE IN BRAZIL ANATEL 0032-1-54129 01) 07884476554857</p>

Radar system

Country	
Singapore	<p>Complies with IDA standards DA105753</p> <p>IDA: Infocomm Development Authority of Singapore.</p>
Brazil	 <p>MADE IN BRAZIL ANATEL 0032-1-54129 01) 07884476554857</p>

Type approval



Bluetooth®

Declaration of Conformity (Declaration of Conformity)

Country	
Countries in the EU:	 <p>Exporting country: Japan Manufacturer: Alpine Electronics Inc. Type of equipment: Bluetooth® device For further information visit http://ec.europa.eu/enterprise/rte/faq.htm #informing</p>

Type approval

Country

		ALPINE ELECTRONICS, INC. <small>20-1 Yonemae Appochohri Bunkyo-ku, Fuchu-shi 183-0292 Japan Phone: (81)281-364111 Fax: (81)281-364600</small>
DECLARATION of CONFORMITY		
<p>We, Alpine Electronics, Inc. of the above address, hereby declare, at our sole responsibility, that the following product conforms to the Essential Requirements of the Radio and Telecommunications Terminal Equipment Directive 1999/5/EC in accordance with the tests conducted to the appropriate requirements of the relevant standards, as listed herewith.</p>		
Product	: Bluetooth Module	
Model/ Type Number	: IAM 2.1 BT PWB EU	
Directive and Standards used	: Radio : EN 300 328 V1.7.1: 2006-01	
	: EMC : EN 301 489-1 V1.3.2: 2008-04	
	EN 301 489-1 V1.8.1: 2008-04	
	ISO7637-2: 2004	
	: Safety : IEC 60065 Ed.7: 2001 + Amd.1: 2005	
	EN 60065: 2002 + Amd.1: 2006	
Year of affixing CE marking	: 2009	
Signature	: 	
Name	: Shinichi Asuke	
Date	: November 12, 2009	
		0043092

Czech Republic: Alpine Electronics, Inc. tímto prohlašuje, že tento **Bluetooth**® Module je ve shodě se základními požadavky a dalšími příslušnými ustanoveními směrnice 1999/5/ES.

Denmark: Undertegnede Alpine Electronics, Inc. erklærer herved, at følgende udstyr **Bluetooth**® Module overholder de væsentlige krav og øvrige relevante krav i direktiv 1999/5/EF.

Germany: Hiermit erklärt Alpine Electronics, Inc., dass sich das Gerät **Bluetooth**® Module in Übereinstimmung mit den grundlegenden Anforderungen und den übrigen einschlägigen Bestimmungen der Richtlinie 1999/5/EG befindet.

Type approval

Country	
Estonia:	Käesolevaga kinnitab Alpine Electronics, Inc. seadme Bluetooth ® Module vastavust direktiivi 1999/5/EÜ põhinõuetele ja nimetatud direktiivist tulenevatele teistele asjakohastele sätetele.
UK	Hereby, Alpine Electronics, Inc., declares that this Bluetooth ® Module is in compliance with the essential requirements and other relevant provisions of Directive 1999/5/EC.
Spain:	Por medio de la presente Alpine Electronics, Inc. declara que el Bluetooth ® Module cumple con los requisitos esenciales y cualesquiera otras disposiciones aplicables o exigibles de la Directiva 1999/5/CE.
Greece:	ΜΕ ΤΗΝ ΠΑΡΟΥΣΑ Alpine Electronics, Inc. ΔΗΛΩΝΕΙ ΟΤΙ Bluetooth ® Module ΣΥΜΜΟΡΦΩΝΕΤΑΙ ΠΡΟΣ ΤΙΣ ΟΥΣΙΩΔΕΙΣ ΑΠΑΙΤΗΣΕΙΣ ΚΑΙ ΤΙΣ ΛΟΙΠΕΣ ΣΧΕΤΙΚΕΣ ΔΙΑΤΑΞΕΙΣ ΤΗΣ ΟΔΗΓΙΑΣ 1999/5/EK.
France:	Par la présente Alpine Electronics, Inc. déclare que l'appareil Bluetooth ® Module est conforme aux exigences essentielles et aux autres dispositions pertinentes de la directive 1999/5/CE.
Italy:	Con la presente Alpine Electronics, Inc. dichiara che questo Bluetooth ® Module è conforme ai requisiti essenziali ed alle altre disposizioni pertinenti stabilite dalla direttiva 1999/5/CE.
Latvia:	Ar šo Alpine Electronics, Inc. deklarē, ka Bluetooth ® Module atbilst Direktīvas 1999/5/EK būtiskajām prasībām un citiem ar to saistītajiem noteikumiem.
Lithuania:	Šiuo Alpine Electronics, Inc. deklaruoja, kad šis Bluetooth ® Module atitinka esminius reikalavimus ir kitas 1999/5/EB Direktyvos nuostatas.
Netherlands:	Hierbij verklaart Alpine Electronics, Inc. dat het toestel Bluetooth ® Module in overeenstemming is met de essentiële eisen en de andere relevante bepalingen van richtlijn 1999/5/EG.
Malta:	Hawnhekk, Alpine Electronics, Inc., jiddikjara li dan Bluetooth ® Module jikkonforma mal-htigijiet essenzjali u ma provvedimenti oħrajn relevanti li hemm fid-Dirrettiva 1999/5/EC.
Hungary:	Alulírott, Alpine Electronics, Inc. nyilatkozom, hogy a Bluetooth ® Module megfelel a vonatkozó alapvető követelményeknek és az 1999/5/EC irányelv egyéb előírásainak.

Type approval

Country	
Poland:	Niniejszym Alpine Electronics, Inc. oświadcza, że Bluetooth ® Module jest zgodny z zasadniczymi wymogami oraz pozostałymi stosownymi postanowieniami Dyrektywy 1999/5/EC.
Portugal:	Alpine Electronics, Inc. declara que este Bluetooth ® Module está conforme com os requisitos essenciais e outras disposições da Directiva 1999/5/CE.
Slovenia:	Alpine Electronics, Inc. izjavlja, da je ta Bluetooth ® Module v skladu z bistvenimi zahtevami in ostalimi relevantnimi določili direktive 1999/5/ES.
Slovakia:	Alpine Electronics, Inc. týmto vyhlasuje, že Bluetooth ® Module spĺňa základné požiadavky a všetky príslušné ustanovenia Smernice 1999/5/ES.
Finland:	Alpine Electronics, Inc. vakuuttaa täten että Bluetooth ® Module tyyppinen laite on direktiivin 1999/5/EY oleellisten vaatimusten ja sitä koskevien direktiivin muiden ehtojen mukainen.
Sweden:	Härmed intygar Alpine Electronics, Inc. att denna Bluetooth ® Module står i överensstämmelse med de väsentliga egenskapskrav och övriga relevanta bestämmelser som framgår av direktiv 1999/5/EG.
Iceland:	Alpine Electronics, Inc. hereby certifies that this Bluetooth ® Module conforms to the essential characteristic requirements and other relevant regulations of directive 1999/5/EC.
Norway:	Alpine Electronics, Inc. erklærer herved at utstyret Bluetooth ® Module er i samsvar med de grunnleggende krav og øvrige relevante krav i direktiv 1999/5/EF.

Type approval

Country	
China:	<p>第十三条 进口和生产厂商在其产品的说明书或使用手册中，应刊印下述有关内容：</p> <ol style="list-style-type: none"> 1. 标明附件中所规定的技术指标和使用范围，说明所有控制、调整及开关等使用方法； <ul style="list-style-type: none"> ■ 使用频率：2.4 - 2.4835 GHz ■ 等效全向辐射功率(EIRP)：天线增益 < 10dBi 时：≤100 mW 或 ≤20 dBm ① ■ 最大功率谱密度：天线增益 < 10dBi 时：≤20 dBm / MHz (EIRP) ① ■ 载频容限：20 ppm ■ 杂散发射(辐射)功率(对应载波±2.5 倍信道带宽以外)： <ul style="list-style-type: none"> • ≤-36 dBm / 100 kHz (30 - 1000 MHz) • ≤-33 dBm / 100 kHz (2.4 - 2.4835 GHz) • ≤-40 dBm / 1 MHz (3.4 - 3.53 GHz) • ≤-40 dBm / 1 MHz (5.725 - 5.85 GHz) • ≤-30 dBm / 1 MHz (其它 1 - 12.75 GHz) 2. 不得擅自更改发射频率、加大发射功率(包括额外加装射频功率放大器)，不得擅自外接天线或改用其它发射天线； 3. 使用时不得对各种合法的无线电通信业务产生有害干扰；一旦发现有害干扰现象时，应立即停止使用，并采取措施消除干扰后方可继续使用； 4. 使用微功率无线电设备，必须忍受各种无线电业务的干扰或工业、科学及医疗应用设备的辐射干扰； 5. 不得在飞机和机场附近使用。

Type approval

Country	
Taiwan:	<p data-bbox="225 244 587 266">低效率電波輻射性電機管理辦法第十條</p> <p data-bbox="225 281 309 303">第十二條</p> <p data-bbox="225 318 1449 340">經型式認證合格之低功率射頻電機，非經許可，公司、商號或使用者均不得擅自 變更頻率、加大功率或變更原設計之特性及功能。</p> <p data-bbox="225 355 309 377">第十四條</p> <p data-bbox="225 392 1485 440">低功率射頻電機之使用不得影響飛航安全及干擾合法通信；經發現有干擾現象時，應立即停用，並改善至無干擾時方得繼續使用。前項合法通信，指依電信法規定 作業之無線電通信。低功率射頻電機須忍受合法通信或工業、科學及醫療用電波 輻射性電機設備之干擾。</p> <div data-bbox="225 454 368 600">The logo for CCAB (China Communications and Electronics Association) consists of three stylized, curved, overlapping shapes that resemble the letter 'C' or 'E'.</div> <p data-bbox="225 605 395 628">CCAB10LP0230T7</p>

Type approval

Country	
South Korea:	<p>제품 정보</p> <p>Volvo Car Korea 신청자 코드: N25-IAM2101V 제품 명: Bluetooth Audio Navigation Radio 모델 명: IAM2.1 산 날짜: March/2010 Alpine Electronics, Inc Made in Japan</p> <p>고객 정보</p> <p>Volvo Car Korea 볼보자동차코리아 서울시 용산구 한남 2 동 726-173 볼보빌딩 4 층 볼보자동차 고객센터 1588-1777 http://www.volvocars.com/kr</p> <p>사용자 주의사항</p> <p>※당해 무선설비는 전파혼신 가능성이 있으므로 인명안전과 관련된 서비스는 할 수 없습니다</p>

Type approval

Country	
Singapore:	<div data-bbox="225 244 370 393" style="border: 1px solid black; padding: 5px; width: fit-content;"><p data-bbox="252 311 343 364">Complies with IDA Standards DA100925X</p></div>
The United Arab Emirates:	<div data-bbox="225 418 665 781" style="border: 3px double black; padding: 10px; width: fit-content;"><p data-bbox="261 451 344 484">TRA</p><p data-bbox="261 498 639 532">REGISTERED No:</p><p data-bbox="261 552 464 585">0020557/09</p><p data-bbox="261 605 639 639">DEALER No:</p><p data-bbox="261 659 469 693">0014517/08</p></div>
Jordan:	<p data-bbox="225 807 1177 829">The product that contains the Bluetooth module is approved with the following certification number.</p> <p data-bbox="225 843 707 865">BT module certification number: TRC/LPD/2010/4.</p> <p data-bbox="225 879 582 901">BT module name: IAM2.1BT PWB EU</p>

Type approval

Country

South Africa:



10

Uruguay: This product contains URSEC approved transmitter [module name and model name (IAM2.1 BT PWB EU + BVJG905A, BVVE905A, BVLV905A)]



Type approval

Country	
Jamaica:	Approved for use in Jamaica SMA EI: IAM2.1
Thailand:	This telecommunication equipment conforms to NTC technical requirement.
Nigeria:	<div style="border: 1px solid black; padding: 5px; text-align: center;"> <p><u>Connection and use of this communications</u> equipment is permitted by the Nigerian <u>Communications Commission</u></p> </div>
Mexico:	<p>Warning</p> <p>"Este equipo opera a título secundario, consecuentemente, debe aceptar interferencias perjudiciales incluyendo equipos de la misma clase y puede no causar interferencias a sistemas operando a título primario."</p> <p>Bluetooth® module installation information</p> <p>This module board is to be installed only by the professional line operator and used only for car audio produced by ALPINE ELECTRONICS, INC. When this Bluetooth® Module Board is installed in the Car Audio, we shall consider the following points: 1. Since "IAM2.1 BT PWB US" owns its FCC ID/IC Number, we shall affix an exterior label on the outside of the product if the FCC ID is not visible. The exterior label shall use wording such as either "Contains Transmitter Module Board FCC ID: A269ZUA130 / IC: 700B-IAM2101" or "Contains FCC ID: A269ZUA130 / IC: 700B-IAM2101". 2. "IAM2.1 BT PWB US" complies with requirements of subsections 15.19(a)(3) in FCC Rules Part 15 Subpart C. The manual statement 15.19 (a)(3) is included in User Guide of the product.</p> <p>COFETEL No. RCPALIA10-0353</p>

Type approval

Country

Botswana:

BTA
REGISTERED No:
BTA/TA/2010/220

0044549

Croatia:





10

Symbols in the display

General







There are a variety of different symbols in the display in the car. The symbols are divided into warning, indicator and information symbols. Shown below are the most common symbols with their meanings and a reference to where in the manual further information can be found. For more information on symbols and text messages, see pages 72, 74 and 200.

 - Red warning symbol, illuminates when a fault has been indicated which could affect the safety and/or driveability of the car. At the same time an explanatory text is displayed in the information display.











 - Yellow information symbol, illuminates in combination with text in the information display, when a deviation in any of the car's systems has occurred. The yellow symbol information can also illuminate in combination with other symbols.

Symbols in the display





Indicator and warning symbols in the combined instrument panel

Symbol	Meaning	Page
	Low oil pressure	74
	Parking brake	74, 137, 139
	Airbags - SRS	19, 74
	Seatbelt reminder	16, 74
	Alternator not charging	74
	Fault in the brake system	74, 136
	Warning, safety mode	19, 30, 74, 75, 125



Indicator and information symbols in the combined instrument panel







Symbol	Meaning	Page
	Fault in the ABL system*	72, 90
	Emissions system	72
	Fault in the ABS system	72, 136
	Rear fog lamp on	72, 91
	Stability system, DSTC, Trailer stability assist	72, 147, 303
	Stability system, sport mode	72, 147
	Engine pre-heater (diesel)	72
	Low level in fuel tank	72, 221
	Information, read display text	72
	Main beam on	72, 90









Symbols in the display

Symbol	Meaning	Page
	Left-hand direction indicators	72
	Right-hand direction indicators	72
	DRIVE - Start/Stop*	72, 127, 131
	Tyre pressure system*	319





Other information symbols in the combined instrument panel

Symbol	Meaning	Page
	Adaptive cruise control*	152, 156, 162
	Adaptive cruise control*	162
	Adaptive cruise control*, Distance Warning* (Distance Alert)	162, 167



Symbol	Meaning	Page
	Adaptive cruise control*, Distance Warning* (Distance Alert)	162, 167
	Adaptive cruise control*	162
	Adaptive cruise control*, Distance Warning* (Distance Alert)	157, 165
	Adaptive cruise control*, Distance Warning* (Distance Alert)	157, 165
	Adaptive cruise control*	156
	Radar sensor*	162, 167, 179
	Start/Stop*, Adaptive cruise control*	131, 162

Symbol	Meaning	Page
	Speed limiter	150
	Camera sensor*, Laser sensor*	171, 179, 183, 186
	Auto Brake*, Distance Warning* (Distance Alert), City Safety™, Collision warning system*	167, 171, 179
	Fuel-driven engine block heater and passenger compartment heater*	221
	ABL system*	90
	Fuel filler flap, right-hand side	287
	Low battery	221
	(P)!	139

Symbols in the display

Symbol	Meaning	Page
	Rain sensor*	98
	Driver Alert System*	183
	Driver Alert System*, Lane Departure Warning*	183, 186
	Driver Alert System*, Lane Departure Warning*	186
	Driver Alert System*, Time for a break	183

Information symbols in the roof console display

Symbol	Meaning	Page
	Seatbelt reminder	18
	Airbag, passenger seat, activated	22, 23
	Airbag, passenger seat, deactivated	23



A

ACC – Adaptive cruise control.....	154	Air conditioning system		Audio volume	235
Active Bending Lights (ABL).....	90	repair.....	334	phone.....	266
Active chassis – FOUR-C.....	226	Air distribution.....	211, 219	phone/media player.....	266
Active Xenon headlamps.....	90	Air quality system IAQS	217	ring signal, phone.....	266
Adaptation.....	119	Air vents.....	212	speed/noise compensation.....	240
Adapting driving characteristics.....	226	Alarm.....	63	Auto	
Adaptive cruise control.....	154	alarm indicator.....	63	climate control settings.....	216
fault tracing.....	162	alarm signals.....	64	Automatic car washes.....	361
radar sensor.....	160	arming.....	63	Automatic gearbox.....	122
Additional heater (Diesel).....	223	checking the alarm.....	47	manual gear positions (Geartronic)....	123
Adjusting headlamp pattern.....	94	deactivate.....	63	towing and recovery.....	304
halogen headlamp.....	95	deactivating a triggered alarm.....	64	trailer.....	299
Adjusting the steering wheel.....	85	reduced alarm level.....	64	Automatic locking.....	59
Airbag		Alcolock.....	109	Automatic relocking.....	57
activating/deactivating, PACOS.....	22	Allergy and asthma inducing substances.	211	Auxiliary heater.....	223
driver's and front passenger side.....	20	All-wheel drive, AWD.....	134	AUX input.....	235, 256
key switch off.....	22	All Wheel Drive (AWD).....	134	AWD, All-wheel drive.....	134
AIRBAG	20	Approach light, duration.....	46, 94		
Airbag system	19	Audio		B	
Air conditioning.....	217	settings.....	240	Backrest.....	80
general.....	210	surround.....	234, 240	front seat, lowering.....	80
Air conditioning, AC.....	217	audio system	235	Backrest rear seat, lowering.....	83
		Audio system.....	234	Bag holder	293
		functions.....	240		
		overview.....	235		

B

Backrest.....	80
front seat, lowering.....	80
Backrest rear seat, lowering.....	83
Bag holder	293

- Battery..... 344, 391
 maintenance..... 344
 remote control 280
 remote control key/PCC..... 51
 start assistance..... 120
 symbols on the battery..... 345
 warning symbols..... 345
- Bioethanol E85..... 289
- Blind spot (BLIS)..... 194
- BLIS..... 194
- Bluetooth®
 handsfree 262
 media 259
 microphone off 265
 streaming audio 259
 transfer call to mobile 265
- Bonnet, opening..... 328
- Brake and clutch fluid..... 333
- Brake light..... 91
- Brakes..... 135
 anti-lock braking system, ABS..... 135
 brake light..... 91
 brake system..... 135
 electric parking brake..... 137
 Emergency Brake Assistance, EBA ... 135
 emergency brake lights..... 91
- filling brake fluid..... 334
 handbrake..... 137
 symbols in the combined instrument
 panel..... 136
- Bulbs, see Lighting..... 335
- [**
-
- Calls
 incoming..... 264
 operation..... 264
- Camera sensor..... 169, 178
- Car care..... 361
- Car care, leather upholstery..... 363
- Cargo area
 cargo cover..... 296
 lighting..... 93
 loading..... 292
 mounting points..... 293
 safety grille..... 296
 safety net..... 295
- Cargo cover..... 296
- Car upholstery..... 363
- Car wash..... 361
- Catalytic converter..... 288
 recovery..... 305
- CD 252
- Centre console..... 202
- Chassis settings..... 226
- Checking and topping up the coolant.... 332
- Checking the engine oil level..... 329
- Children..... 31
 child safety locks..... 38
 child seats and side airbags..... 24
 location in the car..... 31
 safety..... 31
- Child safety locks..... 62
- Child seat..... 31
- Child seats..... 31
 integrated two-stage booster cushion. 36
 ISOFIX fixture system for child seats. . 38
 recommended..... 32
 size classes for child seats with the ISO-
 FIX fixture system..... 38
 upper mounting points for child seats.. 41
- Cigarette lighter socket..... 228
- City Safety™..... 168

- Cleaning
- automatic car washes..... 361
 - car wash..... 361
 - rims..... 362
 - seatbelts..... 364
 - upholstery..... 363
- Clean Zone Interior Package (CZIP)..... 211
- Climate control..... 210
- general..... 210
 - sensors..... 210
- Clock, setting..... 75
- CO₂ emissions 384
- Collision..... 30
- Collision warning..... 173, 174
- Collision warning system
- radar sensor..... 160, 168, 173
- Collision Warning with Auto Brake*..... 173
- Colour code, paint..... 365
- Combined instrument panel..... 71, 200
- Comfort inside the passenger compartment..... 227
- Compass..... 106
- calibration..... 106
- Condensation in headlamps..... 361
- controls
- centre console 235
- Controls
- centre console..... 202
- Controls, lights..... 86
- Control symbols..... 72
- Cooling system..... 284
- Corner Traction Control 146
- Crash, see Collision..... 30
- Cruise control..... 152
- CZIP (Clear Zone Interior Package)..... 211
- D**
-
- DAB Radio..... 249
- Deadlock
- deactivation..... 60
 - temporary deactivation..... 61
- Deadlocks..... 60
- Defroster..... 217
- Diesel..... 289
- Diesel particle filter..... 290
- Dipstick, electronic..... 331
- Direction indicators..... 92
- Disengaging the gear selector inhibitor... 124
- Display lighting..... 86
- Distance Warning..... 165
- Dolby Surround Pro Logic II..... 234
- Door mirrors..... 103
- Driveable punctured tyres..... 320
- Driver Alert Control..... 182
- Driver Alert System..... 181
- Driving..... 284
- cooling system..... 284
 - with the tailgate open..... 285
 - with trailer..... 298
- Driving in water..... 284
- Driving with a trailer
- towball load..... 373
 - towing capacity..... 373
- DSTC, see also Stability control system.. 147
- DVD 252
- E**
-
- ECC, electronic climate control..... 213
- Economical driving..... 284

ECO pressure.....	317	Engine oil.....	329, 378	First aid equipment.....	318
Eco Start/Stop DRIVE.....	127	adverse driving conditions.....	378	First aid kit	318
Electrical socket.....	229	capacities.....	378	Flexifuel.....	118
cargo area.....	293	filter.....	329	adaptation.....	119
front seat.....	229	oil grade.....	378	Fluids, capacities.....	381
Electric parking brake.....	137	Engine specifications.....	376	Fluids and oils.....	381
low battery voltage.....	137	Environmental labelling, FSC, owner's		Fog lamps	
releasing automatically.....	138	manual.....	12	rear.....	91
releasing manually.....	138	Error messages		Foot brake.....	135
Emergency equipment		Adaptive Cruise Control.....	162	FOUR-C – Active chassis.....	226
warning triangle.....	318	Driver Alert Control.....	183	FSC, environmental labelling.....	12
Emergency puncture repair.....	321	Lane Departure Warning.....	186	Fuel.....	288
Emissions of carbon dioxide.....	291	see Messages and symbols.....	139, 162	fuel consumption.....	384
Engine		Error messages in BLIS.....	196	fuel economy.....	317
overheating.....	298	Error messages in Distance Alert.....	167	fuel filter.....	290
starting.....	113	ERS - Remote Start.....	114	Fuse box.....	350
Engine block heater.....	118	ETC, electronic temperature control	214	glovebox.....	355
fuel-driven.....	220	Expectant mothers, seatbelt.....	17	Fuses.....	350
Engine compartment		External dimensions.....	372	box in cargo area.....	358
coolant.....	332	F		changing.....	350
oil.....	329	Fan.....	215	cold zone.....	359
overview.....	329	Fault tracing for the camera sensor. 170, 178		general.....	350
power steering fluid.....	334			relay/fuse box in engine compartment	351
Engine drag control	146			Start/Stop.....	359

Fuse table	
fuses in engine compartment.....	352

G

Gearbox.....	121
automatic.....	122
manual.....	121
Gear selector inhibitor.....	124
Gear selector inhibitor, mechanical disengagement.....	124
Geartronic.....	123
Glass	
laminated/reinforced.....	101
Global opening.....	210
Glovebox.....	228
locking.....	59
Gross vehicle weight.....	373
GSI - Gear selector assistance.....	121

H

Handbrake.....	137
Hazard warning flashers.....	92

Headlamp levelling.....	86
Headlamp pattern, adjusting.....	94
Headlamp pattern adjustment	
Active Bending Lights	94
Headlamps.....	335
Head restraint	
centre seat, rear.....	82
lowering.....	82, 84
Heated washer nozzles.....	99
Heating.....	216
rearview and door mirrors.....	104
rear window.....	104
seats.....	215
Heat-reflecting windscreen.....	101
High engine temperature.....	298
High-pressure headlamp washing.....	99
HomeLink®	141
Home safe lighting.....	94
Hoot.....	85
Horn.....	85

I

IAQS – Interior Air Quality System.....	211
IC – Inflatable Curtain.....	26
Ignition keys.....	78
Immobiliser.....	45
Indicator lamps, PCC.....	47
Inflatable curtain.....	26
Information button, PCC.....	47
Information displays.....	71
Infotainment system	234
menus	238
overview	235
source buttons	235
voice control.....	271
Inlaid mats.....	228
Instrument lighting, see Lighting.....	86
Instrument overview	
left-hand drive.....	68
right-hand drive.....	70
Instruments and controls.....	68
Interior lighting, see Lighting.....	92
Interior rearview mirror.....	105
automatic dimming.....	105

Intermittent wiping..... 98
 iPod®, connection..... 256

K

Kerb weight..... 373
 Key..... 44
 Key blade..... 48
 Keyless drive..... 53, 113
 Keyless start (keyless drive)..... 53, 113
 Keypad in the steering
 wheel..... 85, 152, 203, 236
 Key positions..... 78

L

Labels..... 370
 Laminated glass..... 101
 Lamps, see Lighting..... 335
 Lane Departure Control..... 185
 Laser sensor..... 9
 Leather upholstery, washing instructions 363

Lighting..... 335
 Active Xenon headlamps..... 90
 approach light, duration..... 46, 94
 automatic lighting, passenger compart-
 ment..... 93
 bulbs, specifications..... 339
 controls..... 92
 display lighting..... 86
 headlamp levelling..... 86
 home safe lighting..... 94
 in passenger compartment..... 92
 instrument lighting..... 86
 main/dipped beam..... 87
 position/parking lamps..... 91
 rear fog lamp..... 91
 tunnel detection..... 90
 Lighting, bulb replacement..... 335
 bulb holder, rear, direction indicators. 338
 cargo area..... 339
 dipped beam halogen..... 336
 direction indicators..... 337
 main beam, Xenon lamp..... 337
 main beam halogen..... 337
 number plate lighting..... 338
 vanity mirror..... 339
 Light switches..... 86

Loading
 cargo area..... 292
 general..... 292
 mounting points..... 293
 roof load..... 292
 Lock confirmation 44
 Locking/unlocking
 inside..... 57
 tailgate..... 59
 Locks
 automatic locking..... 57
 locking..... 57
 unlocking..... 57
 Lubricants..... 381
 Lubricants, capacities..... 381

M

Main/dipped beam, see Lightning..... 87
 Main beam, automatic activation..... 88
 Maintenance
 rustproofing..... 363
 Making calls..... 264

Manual gearbox.....	121
GSI - Gear selector assistance.....	121
towing and recovery.....	304
Manual gear positions (Geartronic).....	123
Max. roof load	373
Media, Bluetooth®	259
media player	252
Memory function in seats.....	81
Menu navigation, Infotainment	238
Menus/functions.....	204
Menus and messages.....	200
Menu system MY CAR.....	202
Messages and symbols	
Adaptive Cruise Control.....	162
Collision Warning with Auto	
Brake.....	171, 179
Distance Alert.....	167
Driver Alert Control.....	183
Lane Departure Warning.....	186
Messages in BLIS.....	196
Messages in the combined instrument	
panel.....	200
Messages in the information display.....	147

Meters	
fuel gauge.....	72
speedometer.....	72
tachometer.....	72
Microphone.....	262
Misting.....	217
attending to the windows.....	210
condensation in headlamps.....	361
remove with the air vents.....	219
timer function.....	217
Mobile phone	
connect.....	263
handsfree.....	262
register phone.....	263
voice control.....	271
Mood lighting.....	93
MY CAR.....	202

O

Oil, see also Engine oil.....	378
Oil level low.....	329
Overheating.....	298
Owner's manual, environmental labelling..	12

P

PACOS.....	22
PACOS, switch.....	22
Paintwork	
colour code.....	365
damage and touch-up.....	365
Panel lighting.....	86
Panic function.....	46
Park assist camera.....	191
Parking assistance.....	188
parking assistance sensors.....	190
Parking brake.....	137
Parking heater.....	220
battery and fuel.....	220
parking on a hill.....	220
time setting.....	222
Passenger compartment.....	227
Passenger compartment filter.....	210
Passenger compartment heater	
fuel-driven.....	220
PCC – Personal Car Communicator	
functions.....	45
range.....	46, 47
Pedestrian protection.....	173

Petrol grade.....	288
Phone	
connect.....	263
handsfree.....	262
incoming calls.....	264
making calls.....	264
phone book.....	266
phone book, shortcut.....	266
receiving a call.....	265
register phone.....	263
voice control.....	271
Pinch protection, sunroof.....	108
Polishing.....	362
Position/parking lamps.....	91
Power seat.....	81
Powershift gearbox.....	125, 304
Power sunroof.....	107
Power windows.....	101
Privacy locking.....	49

Q

Queue Assist.....	159
Queue Assistant.....	159

R

Radar sensor.....	154
limitations.....	160
Radio	245
AM/FM	245
DAB	249
Rain sensor.....	98
Rear bulbs	
location.....	338
Rearview and door mirrors	
compass.....	106
door.....	103
electrically retractable.....	104
heating.....	104
interior.....	105
Rear window, defrosting.....	104
Recirculation.....	217
Recommendations during driving.....	284
Recommended child seats, table.....	32
Recovery.....	306
Refrigerant.....	334
Refuelling.....	287
fuel cap.....	287
fuel filler flap, electrical opening.....	287
fuel filler flap, manual opening.....	287
refuelling.....	287
Relay/fuse box: see Fuses.....	350
Remote control	279
battery replacement	280
Remote control, HomeLink®	
programmable	141
Remote control key.....	44
battery replacement.....	51
detachable key blade.....	48
functions.....	45
range.....	46
Remote control key system, type approval.....	392
Remote Start - ERS.....	114
Resetting the door mirrors.....	104
Resetting the power windows.....	103
Retractable power door mirrors.....	104
Reverse gear inhibitor.....	122
Rims	
cleaning.....	362
Road sign information.....	148
Roof load, max. weight	373
Rustproofing.....	363

S

Safety grille.....	296	SIPS bags.....	24	sunscreen.....	108
Safety mode.....	30	Soot filter.....	290	ventilation position.....	107
Safety net.....	295	Soot filter full.....	290	Sunscreen, sunroof.....	108
Seat, see Seats.....	80	Spare wheel.....	314	Surround.....	234, 240
Seatbelt		Spin control.....	146	Symbols.....	147
rear seat.....	18	Spin control function.....	146	indicator symbols.....	72
seatbelt tensioner.....	18	SST – Self Supporting run flat Tyres.....	320	warning symbols.....	72
Seatbelt reminder.....	18	Stability and traction control system.....	146	Symbols and messages	
Seatbelts.....	16	Stability system.....	146	Adaptive Cruise Control.....	162
Seats.....	80	Stains.....	363	Collision Warning with Auto	
head restraints, rear.....	82	Start assistance.....	120	Brake.....	171, 179
heating.....	215	Steering force, speed related.....	226	Distance Alert.....	167
lowering the front backrest.....	80	Steering force level, see Steering force...	226	Driver Alert Control.....	183
lowering the rear backrest.....	83	Steering lock.....	114	Lane Departure Warning.....	186
power seats.....	81	Steering wheel.....	85		
Securing loads (Loading).....	293	keypad.....	85, 152, 203, 236		
Sensus.....	77	keypad, adaptive cruise control.....	156		
Service position.....	341	steering wheel adjustment.....	85		
Service programme.....	328	Stone chips and scratches.....	365		
Set time interval.....	165	Storage spaces in the passenger compart- ment.....	227		
Side airbags.....	24	Sunroof			
Signal input, external.....	235, 256	opening and closing.....	107		
		pin protection.....	108		

T

Tailgate	
locking/unlocking.....	59
Temperature	
actual temperature.....	210
Temperature control.....	216
Timer.....	217
Total airing function.....	58, 210

Towbar
 detachable, attachment 301
 detachable, removal 302
 Towbar, see Towing equipment..... 299
 Towing..... 304
 towing eye..... 305
 Towing capacity..... 373
 Towing equipment..... 299
 specifications..... 300
 Towing eye..... 305
 TPMS – Tyre Pressure Monitoring..... 319
 Trailer..... 298
 cable..... 298
 driving with a trailer..... 298
 snaking..... 303
 Trailer stability assist 146
 Trailer Stability Assist..... 303
 Transmission..... 121
 Transponder..... 101
 Trip computer..... 224
 Trip meter..... 75
 Troubleshooting
 Adaptive Cruise Control..... 162
 TSA - trailer stability assist 146, 303

Tunnel detection..... 90
 TV..... 275
 Type approval, remote control key system..... 392
 Type designation..... 370
 Tyres
 direction of rotation..... 310
 driving characteristics..... 310
 maintenance..... 310
 pressure..... 317
 puncture repair..... 321
 specifications..... 312
 speed ratings..... 313
 tread wear indicators..... 311
 tyre pressure monitoring..... 319
 winter tyres..... 312

U

Unlocking
 from the inside..... 58
 from the outside..... 57
 USB, connection..... 256

V

Vanity mirror..... 93, 229
 Ventilation..... 211
 Vibration damper..... 299
 Voice control, mobile phone..... 271
 Volvo Sensus..... 77

W

Warning lamp
 adaptive cruise control..... 154
 collision warning system..... 176
 stability and traction control system. . 146
 Warning lamps
 airbags SRS..... 74
 alternator not charging..... 74
 fault in brake system..... 74
 low oil pressure..... 74
 parking brake applied..... 74
 seatbelt reminder..... 74
 warning..... 74
 Warning sound
 collision warning system..... 176
 Warning symbol, airbag system..... 19

Warning symbols.....	72	Windscreen washing.....	99
Warning triangle.....	318	Windscreen wipers.....	98
Washer fluid, filling.....	343	rain sensor.....	98
Washer nozzles, heated.....	99	Winter driving.....	285
Washers		Winter tyres.....	312
rear window.....	99	Wiper blades.....	341
washer fluid, filling.....	343	changing.....	341
windscreen.....	99	cleaning.....	342
Water and dirt-repellent coating.....	101	replacing, rear window.....	342
Water-repellent surface, cleaning.....	362	service position.....	341
Waxing.....	362	Wipers and washing.....	98
Weights			
kerb weight.....	373		
Wheels			
changing.....	315		
installation.....	316		
rims.....	311		
snow chains.....	312		
spare wheel.....	314		
Wheels and tyres.....	310		
Whiplash injury, WHIPS.....	27		
WHIPS			
child seat/booster cushion.....	27		
whiplash injury.....	27		
Windows, rearview and door mirrors.....	101		

