

2008 VOLVO S60



VOLVO OWNER'S MANUAL S60

1



Welcome to the worldwide family of Volvo owners. We hope that you will enjoy many years of safe driving in your Volvo, an automobile designed with your safety and comfort in mind. To help ensure your satisfaction with this vehicle, we encourage you to familiarize yourself with the equipment descriptions, operating instructions and maintenance requirements/recommendations in this manual. We also urge you and your passengers to wear seat belts at all times in this (or any other) automobile. And, of course, please do not operate a vehicle if you may be affected by alcohol, medication or any impairment that could hinder your ability to drive.

Your Volvo is designed to meet all applicable safety and emission standards, as indicated by the certification labels attached to the driver's door opening, and on the underside of the hood.

For further information please contact your retailer, or:

In the USA: Volvo Cars of North America, LLC
Customer Care Center
P.O. Box 914 Rockleigh, New Jersey 07647-0914
1-800-458-1552
www.volvocars.us



In Canada: Volvo Cars of Canada Corp.
National Customer Service
175 Gordon Baker Road
North York, Ontario M2H 2N7
1-800-663-8255
www.volvocanada.com

2007 © Volvo Car Corporation. All rights reserved.

2 Contents



00 Introduction

General information	6
Volvo and the environment	7
Important warnings	9

01 Safety

Occupant safety	12
Seat belts	14
Supplemental Restraint System	16
Front airbags	17
Occupant Weight Sensor (OWS)	21
Side impact (SIP) airbag	25
Volvo Inflatable Curtain (VIC)	26
Whiplash Protection System (WHIPS)	28
Child safety	30
Child restraint systems	32
Infant seats	34
Convertible seats	36
Booster cushions	39
ISOFIX lower anchors	40
Top tether anchors	42
Child restraint registration and recalls	43

02 Instruments and control

Instrument overview	46
Instrument panel	48
Instrument and warning symbols	49
Buttons in the center console	54
Steering wheel adjustment	56
Lighting panel	57
Fuel filler door-unlocking manually	59
Left-side steering wheel lever	60
Right-side steering wheel lever	61
Hazard warning flashers, door mirror defroster	63
Trip computer	64
Cruise control	66
Parking brake	68
12-volt sockets	69
Power windows	70
Mirrors	72

Power moonroof (option)	76
Home Link® Universal Transceiver (option)	78

3 Contents



03 Climate

Climate control systems - general information	84
Air distribution	85
Electronic Climate Control, ECC	86

04 Interior

Front seats	92
Interior lighting	97
Storage compartments	99
Rear seat and trunk	103
Spare wheel, tools and jack	106

05 Locks and alarm

Keys	110
Remote control	112
Locking and unlocking	115
Child safety locks	117
Alarm	118

4 Contents



06 Starting and driving

General information	122
Fuel requirements	124
Refueling	125
Starting the vehicle	127
Economical driving	129
Handling and road holding	130
Manual transmission	131
Automatic transmission (option)	132
All Wheel Drive (option)	136
Brake system	137
Stability system	139
Towing	141
Jump starting	143
Towing a trailer	144
Detachable trailer hitch	146
Load carriers (accessory)	147
Cold weather precautions	149
Before a long distance trip	150
Front/rear park assist (option/accessory)	151

07 Wheels and tires

General information	156
Tire inflation	158
Tire inflation pressure table -U.S. models	160
Tire inflation pressure table - Canadian models	161
Tire Pressure Monitoring System(TPMS) - U.S. models	162
Tire designations	164
Glossary of tire terminology	165
Vehicle loading	166
Uniform Tire Quality Grading	168
Snow chains, snow tires, studded tires	169
Temporary spare	170
Changing wheels	171
Tire rotation	174

08 Car care

Washing and cleaning the vehicle	178
Paint touch up	181

5 Contents





09 Maintenance and servicing

Volvo service	186
Maintaining your vehicle	187
Emission inspection readiness	188
Working on your vehicle	189
Hood and engine compartment	191
Engine oil	192
Fluids	195
Wiper blades	197
Battery	198
Replacing bulbs	201
Fuses	211



10 Audio

Introduction	222
Audio system HU-650 - overview	223
Audio system HU-850 - overview	224
Radio functions HU-650/HU-850	225
RBDS functions HU-650/HU-850	231
HU-650 - CD player	234
HU-850 - internal CD changer	235
External CD changer (option)	236
Dolby Surround Pro Logic II - HU-850 only	237
Audio systems - specifications	239



11 Specifications

Label information	242
Dimensions and weights	244
Capacities	246
Engine specifications	247
Bulbs	248
Electrical system	249
Three-way catalytic converter	250
Suspension	251
Volvo programs	252

5 -
cont. Contents



12 Index

Index [254](#)

6 Introduction



General information

Shiftlock

When your vehicle is parked, the gear selector is locked in the (P)ark position. To release the selector from this position, turn the ignition key to position II (or start the engine), depress the brake pedal, press the button on the front side of the gear selector and move the selector from (P)ark.

Keylock (automatic transmission)

When you switch off the ignition, the gear selector must be in the (P)ark position before the key can be removed from the ignition switch.

Anti-lock Brake System (ABS)

The ABS system in your vehicle performs a self-diagnostic test when the vehicle first reaches the speed of approximately 12 mph (20 km/h). The brake pedal will pulsate several times and a sound may be audible from the ABS control module. This is normal.

Fuel filler door

Press the button on the light switch panel when the car is at a standstill to open the fuel filler door.

Fuel filler cap

The fuel filler door, located on the right rear fender, is connected to your vehicle's central locking system. Press the button on the light switch panel (see illustration on [page 57](#)) when the vehicle is at a standstill to unlock the fuel filler door. Please note that the fuel filler door will remain unlocked until the vehicle begins to move forward. An audible

click will be heard when the fuel filler door relocks.

Points to keep in mind

- Before you operate your vehicle for the first time, please familiarize yourself with the new-engine oil consumption information on [page 193](#). You should also be familiar with the information in chapters one, two and eight of this manual.
- Information contained in the balance of the manual is extremely useful and should be read after operating the vehicle for the first time.
- The manual is structured so that it can be used for reference. For this reason, it should be kept in the vehicle for ready access.
- Do not export your Volvo to another country before investigating that country's applicable safety and exhaust emission requirements. In some cases it may be difficult or impossible to comply with these requirements. Modifications to the emission control system(s) may render your Volvo not certifiable for legal operation in the U.S., Canada and other countries.
- All information, illustrations and specifications contained in this manual are based on the latest product information available at the time of publication. Please note that some vehicles may be equipped differently, depending on special legal requirements. Optional equipment described in this manual may not be available in all markets.
- Volvo reserves the right to make model changes at any time, or to change specifications or design without notice and without incurring obligation.



WARNING

If your vehicle is involved in an accident, unseen damage may affect its drivability and safety.



Volvo and the environment



WARNING

CALIFORNIA proposition 65

Engine exhaust, some of its constituents, and certain vehicle components contain or emit chemicals known to the state of California to cause cancer, and birth defects or other reproductive harm. In addition, certain fluids contained in vehicles and certain products of component wear contain or emit chemicals known to the State of California to cause cancer, and birth defects or other reproductive harm.

Volvo is committed to the well being of its customers. As a natural part of this commitment, we care about the environment in which we all live. Caring for the environment means an everyday involvement in reducing our environmental impact. Volvo's environmental activities are based on a holistic view, which means we consider the overall environmental impact of a product throughout its complete life cycle. In this context, design, production, product use, and recycling are all important considerations. In production, Volvo has partly or completely phased out several chemicals including CFCs, lead chromates, asbestos, and cadmium; and reduced the number of chemicals used in our plants 50% since 1991.

Volvo was the first in the world to introduce into production a three-way catalytic converter with a Lambda sond, now called the heated oxygen sensor, in 1976. The current version of this highly efficient system reduces emissions of harmful substances (CO, HC, NOx) from the exhaust pipe by approximately 95-99% and the search to eliminate the remaining emissions continues. Volvo is the only automobile manufacturer to offer CFC-free retrofit kits for the air conditioning system of all models as far back as the 1975 model 240. Advanced electronic engine controls and cleaner fuels are bringing us closer to our goal. After Volvo vehicles and parts have fulfilled their use, recycling is the next critical step in completing the life cycle. The metal content is about 75% of the total weight of a vehicle, which makes

the vehicle among the most recycled industrial products. In order to have efficient and well-controlled recycling, dismantling information is available for all Volvo models. For Volvo, all homogeneous plastic parts weighing more than 3.4 oz. (100 grams) are marked with international symbols that indicate how the component is to be sorted for recycling. In addition to continuous environmental refinement of conventional gasoline-powered internal combustion engines, Volvo is actively looking at advanced technology alternative-fuel vehicles.

When you drive a Volvo, you become our partner in the work to lessen the car's impact on the environment. To reduce your vehicle's environmental impact, you can:

- Maintain proper air pressure in your tires. Tests have shown decreased fuel economy with improperly inflated tires.
- Follow the recommended maintenance schedule in your Warranty and Service Records Information booklet.
- Drive at a constant speed whenever possible.
- See a trained and qualified Volvo service technician as soon as possible for inspection if the check engine (malfunction indicator) light illuminates, or stays on after the vehicle has started.
- Properly dispose of any vehicle-related waste such as used motor oil, used batteries, brake pads, etc.
- When cleaning your vehicle, please use genuine Volvo car care products. All Volvo car care products are formulated to be environmentally friendly.

For additional information regarding the environmental activities in which Volvo Cars of North America, LLC and Volvo Car Corporation



Volvo and the environment

are involved, visit our Internet home page at: <http://www.volvocars.us>.

WARNING

Certain components of this vehicle such as air bag modules, seat belt pretensioners, adaptive steering columns, and button cell batteries may contain Perchlorate material. Special handling may apply for service or vehicle end of life disposal. See www.dtsc.ca.gov/hazardouswaste/perchlorate.



Important warnings

Accessory Installation

- We strongly recommend that Volvo owners install only genuine, Volvo-approved accessories, and that accessory installations be performed only by a trained and qualified Volvo service technician.
- Genuine Volvo accessories are tested to ensure compatibility with the performance, safety, and emission systems in your vehicle. Additionally, a trained and qualified Volvo service technician knows where accessories may and may not be safely installed in your Volvo. In all cases, please consult a trained and qualified Volvo service technician before installing any accessory in or on your vehicle.
- Accessories that have not been approved by Volvo may or may not be specifically tested for compatibility with your vehicle. Additionally, an inexperienced installer may not be familiar with some of your vehicle's systems.
- Any of your vehicle's performance and safety systems could be adversely affected if you install accessories that Volvo has not tested, or if you allow accessories to be installed by someone unfamiliar with your vehicle.
- Damage caused by unapproved or improperly installed accessories may not be covered by your new vehicle warranty. See your Warranty and Service Records Information booklet for more warranty information. Volvo assumes

no responsibility for death, injury, or expenses that may result from the installation of non-genuine accessories.

Driver distraction

- Driver distraction results from driver activities that are not directly related to controlling the vehicle in the driving environment. Your new Volvo is, or can be, equipped with many feature-rich entertainment and communication systems. These include hands-free cellular telephones, navigation systems, and multipurpose audio systems. You may also own other portable electronic devices for your own convenience. When used properly and safely, they enrich the driving experience. Improperly used, any of these could cause a distraction.
- For all of these systems, we want to provide the following warning that reflects the strong Volvo concern for your safety:
 - Never use these devices or any feature of your vehicle in a way that distracts you from the task of driving safely. Distraction can lead to a serious accident. In addition to this general warning, we offer the following guidance regarding specific newer features that may be found in your vehicle:
 - Never use a hand-held cellular telephone while driving. Some jurisdictions prohibit cellular telephone use by a driver while the vehicle is moving.
 - If your vehicle is equipped with a navigation system, set and make changes to your travel itinerary only with the vehicle parked.
 - Never program your audio system while the vehicle is moving. Program radio presets with the vehicle parked, and use your programmed presets to make radio use quicker and simpler.
 - Never use portable computers or personal digital assistants while the vehicle is moving.

A driver has a responsibility to do everything possible to ensure his or her own safety and the safety of passengers in the vehicle and others sharing the roadway. Avoiding distractions is part of that responsibility.



[Contents](#) | [Top of Page](#)

2008 VOLVO S60



VOLVO OWNER'S MANUAL S60

1



Welcome to the worldwide family of Volvo owners. We hope that you will enjoy many years of safe driving in your Volvo, an automobile designed with your safety and comfort in mind. To help ensure your satisfaction with this vehicle, we encourage you to familiarize yourself with the equipment descriptions, operating instructions and maintenance requirements/recommendations in this manual. We also urge you and your passengers to wear seat belts at all times in this (or any other) automobile. And, of course, please do not operate a vehicle if you may be affected by alcohol, medication or any impairment that could hinder your ability to drive.

Your Volvo is designed to meet all applicable safety and emission standards, as indicated by the certification labels attached to the driver's door opening, and on the underside of the hood.

For further information please contact your retailer, or:

In the USA: Volvo Cars of North America, LLC
Customer Care Center
P.O. Box 914 Rockleigh, New Jersey 07647-0914
1-800-458-1552
www.volvocars.us



In Canada: Volvo Cars of Canada Corp.
National Customer Service
175 Gordon Baker Road
North York, Ontario M2H 2N7
1-800-663-8255
www.volvocanada.com

2007 © Volvo Car Corporation. All rights reserved.

2 Contents



00 Introduction

General information	6
Volvo and the environment	7
Important warnings	9

01 Safety

Occupant safety	12
Seat belts	14
Supplemental Restraint System	16
Front airbags	17
Occupant Weight Sensor (OWS)	21
Side impact (SIP) airbag	25
Volvo Inflatable Curtain (VIC)	26
Whiplash Protection System (WHIPS)	28
Child safety	30
Child restraint systems	32
Infant seats	34
Convertible seats	36
Booster cushions	39
ISOFIX lower anchors	40
Top tether anchors	42
Child restraint registration and recalls	43

02 Instruments and control

Instrument overview	46
Instrument panel	48
Instrument and warning symbols	49
Buttons in the center console	54
Steering wheel adjustment	56
Lighting panel	57
Fuel filler door-unlocking manually	59
Left-side steering wheel lever	60
Right-side steering wheel lever	61
Hazard warning flashers, door mirror defroster	63
Trip computer	64
Cruise control	66
Parking brake	68
12-volt sockets	69
Power windows	70
Mirrors	72

Power moonroof (option)	76
Home Link® Universal Transceiver (option)	78

3 Contents



03 Climate

Climate control systems - general information	84
Air distribution	85
Electronic Climate Control, ECC	86

04 Interior

Front seats	92
Interior lighting	97
Storage compartments	99
Rear seat and trunk	103
Spare wheel, tools and jack	106

05 Locks and alarm

Keys	110
Remote control	112
Locking and unlocking	115
Child safety locks	117
Alarm	118

4 Contents



06 Starting and driving

General information	122
Fuel requirements	124
Refueling	125
Starting the vehicle	127
Economical driving	129
Handling and road holding	130
Manual transmission	131
Automatic transmission (option)	132
All Wheel Drive (option)	136
Brake system	137
Stability system	139
Towing	141
Jump starting	143
Towing a trailer	144
Detachable trailer hitch	146
Load carriers (accessory)	147
Cold weather precautions	149
Before a long distance trip	150
Front/rear park assist (option/accessory)	151

07 Wheels and tires

General information	156
Tire inflation	158
Tire inflation pressure table -U.S. models	160
Tire inflation pressure table - Canadian models	161
Tire Pressure Monitoring System(TPMS) - U.S. models	162
Tire designations	164
Glossary of tire terminology	165
Vehicle loading	166
Uniform Tire Quality Grading	168
Snow chains, snow tires, studded tires	169
Temporary spare	170
Changing wheels	171
Tire rotation	174

08 Car care

Washing and cleaning the vehicle	178
Paint touch up	181

5 Contents





09 Maintenance and servicing

Volvo service	186
Maintaining your vehicle	187
Emission inspection readiness	188
Working on your vehicle	189
Hood and engine compartment	191
Engine oil	192
Fluids	195
Wiper blades	197
Battery	198
Replacing bulbs	201
Fuses	211



10 Audio

Introduction	222
Audio system HU-650 - overview	223
Audio system HU-850 - overview	224
Radio functions HU-650/HU-850	225
RBDS functions HU-650/HU-850	231
HU-650 - CD player	234
HU-850 - internal CD changer	235
External CD changer (option)	236
Dolby Surround Pro Logic II - HU-850 only	237
Audio systems - specifications	239



11 Specifications

Label information	242
Dimensions and weights	244
Capacities	246
Engine specifications	247
Bulbs	248
Electrical system	249
Three-way catalytic converter	250
Suspension	251
Volvo programs	252

5 -
cont. Contents



12 Index

Index [254](#)

6 Introduction



General information

Shiftlock

When your vehicle is parked, the gear selector is locked in the (P)ark position. To release the selector from this position, turn the ignition key to position II (or start the engine), depress the brake pedal, press the button on the front side of the gear selector and move the selector from (P)ark.

Keylock (automatic transmission)

When you switch off the ignition, the gear selector must be in the (P)ark position before the key can be removed from the ignition switch.

Anti-lock Brake System (ABS)

The ABS system in your vehicle performs a self-diagnostic test when the vehicle first reaches the speed of approximately 12 mph (20 km/h). The brake pedal will pulsate several times and a sound may be audible from the ABS control module. This is normal.

Fuel filler door

Press the button on the light switch panel when the car is at a standstill to open the fuel filler door.

Fuel filler cap

The fuel filler door, located on the right rear fender, is connected to your vehicle's central locking system. Press the button on the light switch panel (see illustration on [page 57](#)) when the vehicle is at a standstill to unlock the fuel filler door. Please note that the fuel filler door will remain unlocked until the vehicle begins to move forward. An audible

click will be heard when the fuel filler door relocks.

Points to keep in mind

- Before you operate your vehicle for the first time, please familiarize yourself with the new-engine oil consumption information on [page 193](#). You should also be familiar with the information in chapters one, two and eight of this manual.
- Information contained in the balance of the manual is extremely useful and should be read after operating the vehicle for the first time.
- The manual is structured so that it can be used for reference. For this reason, it should be kept in the vehicle for ready access.
- Do not export your Volvo to another country before investigating that country's applicable safety and exhaust emission requirements. In some cases it may be difficult or impossible to comply with these requirements. Modifications to the emission control system(s) may render your Volvo not certifiable for legal operation in the U.S., Canada and other countries.
- All information, illustrations and specifications contained in this manual are based on the latest product information available at the time of publication. Please note that some vehicles may be equipped differently, depending on special legal requirements. Optional equipment described in this manual may not be available in all markets.
- Volvo reserves the right to make model changes at any time, or to change specifications or design without notice and without incurring obligation.

WARNING

If your vehicle is involved in an accident, unseen damage may affect its drivability and safety.



Volvo and the environment

WARNING

CALIFORNIA proposition 65

Engine exhaust, some of its constituents, and certain vehicle components contain or emit chemicals known to the state of California to cause cancer, and birth defects or other reproductive harm. In addition, certain fluids contained in vehicles and certain products of component wear contain or emit chemicals known to the State of California to cause cancer, and birth defects or other reproductive harm.

Volvo is committed to the well being of its customers. As a natural part of this commitment, we care about the environment in which we all live. Caring for the environment means an everyday involvement in reducing our environmental impact. Volvo's environmental activities are based on a holistic view, which means we consider the overall environmental impact of a product throughout its complete life cycle. In this context, design, production, product use, and recycling are all important considerations. In production, Volvo has partly or completely phased out several chemicals including CFCs, lead chromates, asbestos, and cadmium; and reduced the number of chemicals used in our plants 50% since 1991.

Volvo was the first in the world to introduce into production a three-way catalytic converter with a Lambda sond, now called the heated oxygen sensor, in 1976. The current version of this highly efficient system reduces emissions of harmful substances (CO, HC, NOx) from the exhaust pipe by approximately 95-99% and the search to eliminate the remaining emissions continues. Volvo is the only automobile manufacturer to offer CFC-free retrofit kits for the air conditioning system of all models as far back as the 1975 model 240. Advanced electronic engine controls and cleaner fuels are bringing us closer to our goal. After Volvo vehicles and parts have fulfilled their use, recycling is the next critical step in completing the life cycle. The metal content is about 75% of the total weight of a vehicle, which makes

the vehicle among the most recycled industrial products. In order to have efficient and well-controlled recycling, dismantling information is available for all Volvo models. For Volvo, all homogeneous plastic parts weighing more than 3.4 oz. (100 grams) are marked with international symbols that indicate how the component is to be sorted for recycling. In addition to continuous environmental refinement of conventional gasoline-powered internal combustion engines, Volvo is actively looking at advanced technology alternative-fuel vehicles.

When you drive a Volvo, you become our partner in the work to lessen the car's impact on the environment. To reduce your vehicle's environmental impact, you can:

- Maintain proper air pressure in your tires. Tests have shown decreased fuel economy with improperly inflated tires.
- Follow the recommended maintenance schedule in your Warranty and Service Records Information booklet.
- Drive at a constant speed whenever possible.
- See a trained and qualified Volvo service technician as soon as possible for inspection if the check engine (malfunction indicator) light illuminates, or stays on after the vehicle has started.
- Properly dispose of any vehicle-related waste such as used motor oil, used batteries, brake pads, etc.
- When cleaning your vehicle, please use genuine Volvo car care products. All Volvo car care products are formulated to be environmentally friendly.

For additional information regarding the environmental activities in which Volvo Cars of North America, LLC and Volvo Car Corporation



Volvo and the environment

are involved, visit our Internet home page at: <http://www.volvocars.us>.

WARNING

Certain components of this vehicle such as air bag modules, seat belt pretensioners, adaptive steering columns, and button cell batteries may contain Perchlorate material. Special handling may apply for service or vehicle end of life disposal. See www.dtsc.ca.gov/hazardouswaste/perchlorate.



Important warnings

Accessory Installation

- We strongly recommend that Volvo owners install only genuine, Volvo-approved accessories, and that accessory installations be performed only by a trained and qualified Volvo service technician.
- Genuine Volvo accessories are tested to ensure compatibility with the performance, safety, and emission systems in your vehicle. Additionally, a trained and qualified Volvo service technician knows where accessories may and may not be safely installed in your Volvo. In all cases, please consult a trained and qualified Volvo service technician before installing any accessory in or on your vehicle.
- Accessories that have not been approved by Volvo may or may not be specifically tested for compatibility with your vehicle. Additionally, an inexperienced installer may not be familiar with some of your vehicle's systems.
- Any of your vehicle's performance and safety systems could be adversely affected if you install accessories that Volvo has not tested, or if you allow accessories to be installed by someone unfamiliar with your vehicle.
- Damage caused by unapproved or improperly installed accessories may not be covered by your new vehicle warranty. See your Warranty and Service Records Information booklet for more warranty information. Volvo assumes

no responsibility for death, injury, or expenses that may result from the installation of non-genuine accessories.

Driver distraction

- Driver distraction results from driver activities that are not directly related to controlling the vehicle in the driving environment. Your new Volvo is, or can be, equipped with many feature-rich entertainment and communication systems. These include hands-free cellular telephones, navigation systems, and multipurpose audio systems. You may also own other portable electronic devices for your own convenience. When used properly and safely, they enrich the driving experience. Improperly used, any of these could cause a distraction.
- For all of these systems, we want to provide the following warning that reflects the strong Volvo concern for your safety:
 - Never use these devices or any feature of your vehicle in a way that distracts you from the task of driving safely. Distraction can lead to a serious accident. In addition to this general warning, we offer the following guidance regarding specific newer features that may be found in your vehicle:
 - Never use a hand-held cellular telephone while driving. Some jurisdictions prohibit cellular telephone use by a driver while the vehicle is moving.
 - If your vehicle is equipped with a navigation system, set and make changes to your travel itinerary only with the vehicle parked.
 - Never program your audio system while the vehicle is moving. Program radio presets with the vehicle parked, and use your programmed presets to make radio use quicker and simpler.
 - Never use portable computers or personal digital assistants while the vehicle is moving.

A driver has a responsibility to do everything possible to ensure his or her own safety and the safety of passengers in the vehicle and others sharing the roadway. Avoiding distractions is part of that responsibility.



[Contents](#) | [Top of Page](#)

2008 VOLVO S60

10 01 Safety



Occupant safety	12
Seat belts	14
Supplemental Restraint System	16
Front airbags	17
Occupant Weight Sensor (OWS)	21
Side impact (SIP) airbag	25
Volvo Inflatable Curtain (VIC)	26
Whiplash Protection System (WHIPS)	28
Child safety	30
Child restraint systems	32
Infant seats	34
Convertible seats	36
Booster cushions	39
ISOFIX lower anchors	40
Top tether anchors	42
Child restraint registration and recalls	43

11 01 Safety



12 01 Safety



Occupant safety

Volvo's concern for safety

Safety is the Volvo cornerstone. Our concern dates back to 1927 when the first Volvo rolled off the production line. Three-point seat belts (a Volvo invention), safety cages, and energy-absorbing impact zones were designed into Volvo vehicles long before it was fashionable or required by government regulation. We will not compromise our commitment

to safety. We continue to seek out new safety features and to refine those already in our vehicles. You can help. We would appreciate hearing your suggestions about improving automobile safety. We also want to know if you ever have a safety concern with your vehicle. Call us in the U.S. at: 800-458-1552 or in Canada at: 800-663-8255.

Occupant safety reminders

How safely you drive doesn't depend on how old you are but rather on:

- How well you see.
- Your ability to concentrate.
- How quickly you make decisions under stress to avoid an accident.

The tips listed below are suggestions to help you cope with the ever changing traffic environment.

- Never drink and drive.
- If you are taking any medication, consult your physician about its potential effects on your driving abilities.
- Take a driver-retraining course.
- Have your eyes checked regularly.
- Keep your windshield and headlights clean.
- Replace wiper blades when they start to leave streaks.
- Take into account the traffic, road, and weather conditions, particularly with regard to stopping distance.

Reporting safety defects in the U.S.

If you believe that your vehicle has a defect which could cause a crash or could cause injury or death, you should immediately inform the National Highway Traffic Safety Administration (NHTSA) in addition to notifying Volvo Cars of North America, LLC. If NHTSA receives similar complaints, it may open an investigation, and if it finds that a safety defect exists in a group of vehicles, it may order a recall and remedy campaign. However, NHTSA cannot become involved in individual problems between you, your retailer, or Volvo Cars of North America, LLC.

To contact NHTSA, you may either call the Auto Safety Hotline toll-free at 1-888-327-4236 (TTY: 1-800-424-9153) or write to: NHTSA, U.S. Department of Transportation, Washington D.C. 20590.

You can also obtain other information about motor vehicle safety from:

<http://www.safercar.gov>

Volvo strongly recommends that if your vehicle is covered under a service campaign, safety or emission recall or similar action, it should be completed as soon as possible. Please check with your local retailer or Volvo Cars of North America, LLC if your vehicle is covered under these conditions.

NHTSA can be reached at:

Internet: <http://www.nhtsa.gov>

Telephone: 1-888-DASH-2-DOT (1-888-327-4236).



Occupant safety

Reporting safety defects in Canada

If you believe your vehicle has a defect that could cause a crash or could cause injury or death, you should immediately

inform Transport Canada in addition to notifying Volvo Cars of Canada Corp.

To contact Transport Canada, call (800) 333-0510, or (613) 993-9851 if you are calling from the Ottawa region.



Seat belts

Using seat belts

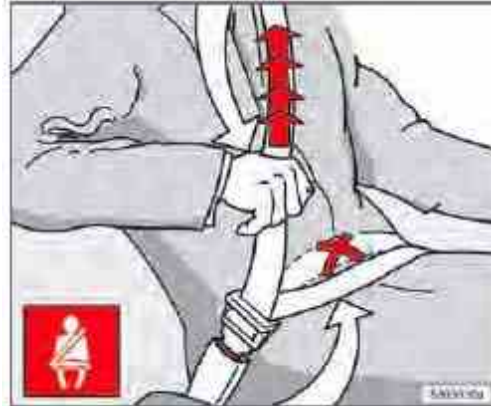

Adjusting the seat belt

Seat belts should always be worn by all occupants of your vehicle. Children should be properly restrained, using an infant, car, or booster seat determined by age, weight and height.

Volvo also believes that no child should sit in the front seat of a vehicle.

Most states and provinces make it mandatory for occupants of a vehicle to use seat belts.

Seat belt pretensioners

The seat belts are equipped with pretensioners that reduce slack in the belts. These pretensioners are triggered in situations where the airbags deploy. The front seat belts also include a tension reducing device which, in the event of a collision, limits the peak forces exerted by the seat belt on the occupant.

Buckling a seat belt

Pull the belt out far enough to insert the latch plate into the receptacle until a distinct click is heard. The seat belt retractor is normally "unlocked" and you can move freely, provided that the shoulder belt is not pulled out too far.

The retractor will lock up as follows:

- if the belt is pulled out rapidly
- during braking and acceleration
- if the vehicle is leaning excessively
- when driving in turns

When wearing the seat belt remember:

- The belt should not be twisted or turned.
- The lap section of the belt must be positioned low on the hips (not pressing against the abdomen).
- Make sure that the shoulder belt is rolled up into its retractor and that the shoulder and lap belts are taut.

Unbuckling the seat belt

To remove the seat belt, press the red section on the seat belt receptacle. Before exiting the vehicle, check that the seat

belt retracts fully after being unbuckled. If necessary, guide the belt back into the retractor slot.

Seat belt reminder

The seat belt reminder consists of an audible signal, an indicator light above the rearview mirror, and a symbol in the instrument panel that alert the driver that the seat belt is not properly fastened.



Seat belts

Seat belt use during pregnancy



The seat belt should always be worn during pregnancy. But it is crucial that it be worn in the correct way. The diagonal section should wrap over the shoulder then be routed between the breasts and to the side of the belly. The lap section should lay flat over the thighs and as low as possible under the belly. It must never be allowed to ride upward. Remove all slack from the belt and insure that it fits close to the body without any twists.

As a pregnancy progresses, pregnant drivers should adjust their seats and steering wheel such that they can easily maintain control of the vehicle as they drive (which means they must be able to easily operate the foot pedals and steering wheel). Within this context, they should strive to position the seat with as large a distance as possible between their belly and the steering wheel.

Child seats

Please refer to [page 34](#) for information on securing child seats with the seat belts.

Seat belt maintenance

Check periodically that the seat belts are in good condition. Use water and a mild detergent for cleaning. Check seat belt mechanism function as follows: attach the seat belt and pull rapidly on the strap.



WARNING

- Never use a seat belt for more than one occupant.
- Never wear the shoulder portion of the belt under the arm, behind the back or otherwise out of position. Such use could cause injury in the event of an accident.
- Seat belts lose much of their strength when exposed to violent stretching and should be replaced after any collision, even if they appear to be undamaged.
- Never repair the belt yourself; have this work done by an authorized Volvo service technician only.
- Any device used to induce slack into the shoulder belt portion of the three-point belt system will have a detrimental effect on the amount of protection available to you in the event of a collision.

- The seat back should not be tilted too far back. The shoulder belt must be taut in order to function properly.
- Do not use child safety seats or child booster cushions/backrests in the front passenger's seat. We also recommend that children who have outgrown these devices sit in the rear seat with the seat belt properly fastened.



Supplemental Restraint System

Supplemental Restraint System (SRS)

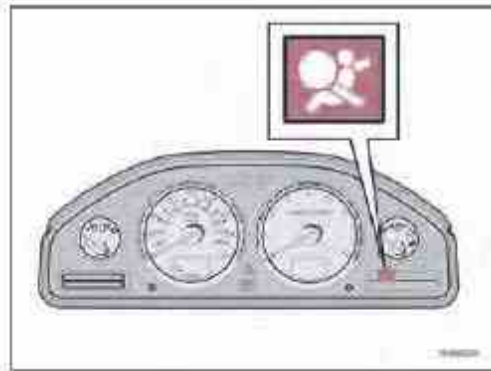

SRS warning light

As an enhancement to the three-point seat belts, your Volvo is equipped with a Supplemental Restraint System (SRS). Volvo's SRS consists of seat belt pretensioners, front airbags, side impact airbags, the occupant weight sensor, and inflatable curtains. All of these systems are monitored by the SRS control module. An SRS warning light in the instrument panel (see the illustration above) illuminates when the ignition key is turned to position I, II, or III, and will normally go out after approximately 7 seconds if no faults are detected in the system.

Where applicable, a text message will also be displayed when the SRS warning light illuminates. If this warning symbol is not functioning properly, the general warning symbol  illuminates and a text message will be displayed.

WARNING

- If the SRS warning light stays on after the engine has started or if it illuminates while you are driving, have the vehicle inspected by a trained and qualified Volvo service technician as soon as possible.

WARNING

- Never try to repair any component or part of the SRS yourself. Any interference in the system could cause malfunction and serious injury. All work on these systems should be performed by a trained and qualified Volvo service technician.

WARNING

If your vehicle has been subjected to flood conditions (e.g. soaked carpeting/standing water on the floor of the vehicle) or if your vehicle has become flood-damaged in any way, do not attempt to start the vehicle or put the key in the ignition before disconnecting the battery (see below). This may cause airbag deployment which could result in personal injury. Have the vehicle towed to a trained and qualified Volvo service technician for repairs.

Automatic transmission:

Before attempting to tow the vehicle, use the following procedure to override the shiftlock system to move the gear

selector to the neutral position:

- Switch off the ignition for at least 10 minutes and disconnect the battery
- Wait at least one minute.
- Insert the key in the ignition and turn it to position II.
- Press firmly on the brake pedal.
- Move the gear selector from (P)ark to the (N)eutral position. See [page 132](#) for information on manually overriding the shiftlock system.



Front airbags

The front airbag system

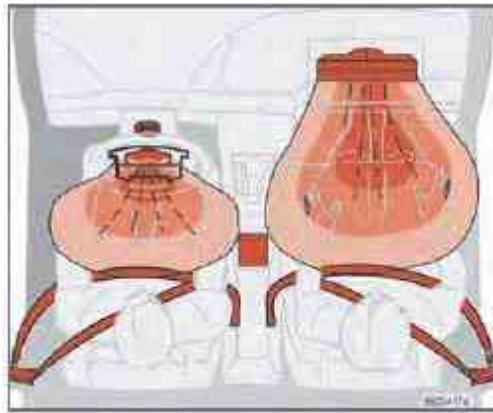

The front airbags supplement the three-point seat belts. For these airbags to provide the protection intended, seat belts must be worn at all times.

The front airbag system includes gas generators surrounded by the airbags, and deceleration sensors that activate the gas generators, causing the airbags to be inflated with nitrogen gas.

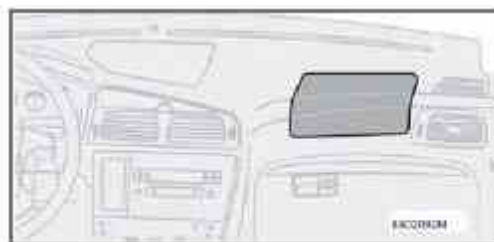

Passenger's side airbag—above glove compartment

As the movement of the seats' occupants compresses the airbags, some of the gas is expelled at a controlled rate to provide better cushioning. Both seat belt pretensioners also deploy, minimizing seat belt slack. The entire process, including inflation and deflation of the airbags, takes approximately one fifth of a second.

The location of the front airbags is indicated by "SRS AIRBAG" embossed on the steering wheel pad and above the glove compartment, and by decals on both sun visors and on the front and far right side of the dash.

- The driver's side front airbag is folded and located in the steering wheel hub.
- The passenger's side front airbag is folded behind a panel located above the glove compartment.

WARNING

- The airbags in the vehicle are designed to be a SUPPLEMENT to-not a replacement for-the three-point seat belts. For maximum protection, wear seat belts at all times. Be aware that no system can prevent all possible injuries that may occur in an accident.
- Never drive a vehicle with a steering wheel-mounted airbag with your hands on the steering wheel pad/airbag housing.
- The front airbags are designed to help prevent serious injury. Deployment occurs very quickly and with considerable force. During normal deployment and depending on variables such as seating position, one may experience abrasions, bruises, swellings, or other injuries as a result from deployment of one or both of the airbags.
- When installing any accessory equipment, make sure that the front airbag system is not damaged. Any interference in the system could cause malfunction.



Front airbags

Front airbag deployment

- Front airbag deployment
- The front airbags are designed to deploy during certain frontal or front-angular collisions, impacts, or decelerations, depending on the crash severity, angle, speed and object impacted. The airbags may also deploy in certain non-frontal collisions where rapid deceleration occurs.
- The SRS sensors, which trigger the front airbags, are designed to react to both the impact of the collision and the inertial forces generated by it, and to determine if the intensity of the collision is sufficient for the seat belt pretensioners and/or airbags to be deployed.

However, not all frontal collisions activate the front airbags.

- If the collision involves a nonrigid object (e.g., a snow drift or bush), or a rigid, fixed object at a low speed, the front airbags will not necessarily deploy.
- Front airbags do not normally deploy in a side impact collision, in a collision from the rear or in a rollover situation.
- The amount of damage to the bodywork does not reliably indicate if the airbags should have deployed or not.

NOTE

- Deployment of front airbags occurs only one time during an accident. In a collision where deployment occurs, the airbags and seat belt pretensioners activate. Some noise occurs and a small amount of powder is released. The release of the powder may appear as smoke-like matter. This is a normal characteristic and does not indicate fire.
- Volvo's front airbags use special sensors that are integrated with the front seat buckles. The point at which the airbag deploys is determined by whether or not the seat belt is being used, as well as the severity of the collision.
- Collisions can occur where only one of the airbags deploys. If the impact is less severe, but severe enough to present a clear injury risk, the airbags are triggered at partial capacity. If the impact is more severe, the airbags are triggered at full capacity.

Should you have questions about any component in the SRS system, please contact a trained and qualified Volvo service technician or Volvo Customer Support:

In the USA

Volvo Cars of North America, LLC
Customer Care Center
P.O. Box 914 Rockleigh, New Jersey 07647-0914

In Canada

Volvo Cars of Canada Corp.
National Customer Service
175 Gordon Baker Road
North York, Ontario M2H 2N7
1-800-663-8255
www.volvocanada.com



WARNING

- Do not use child safety seats or child booster cushions/backrests in the front passenger's seat. We also recommend that occupants under 4 feet 7 inches (140 cm) in height who have outgrown these devices sit in the rear seat with the seat belt fastened¹.
- Never drive with the airbags deployed. The fact that they hang out can impair the steering of your vehicle. Other safety systems can also be damaged.
- The smoke and dust formed when the airbags are deployed can cause skin and eye irritation in the event of prolonged exposure.

¹See also the Occupant Weight Sensor information on [page 21](#).



Front airbags



Airbag decal on outside of both sun visors



Airbag decal on the passenger's dashboard

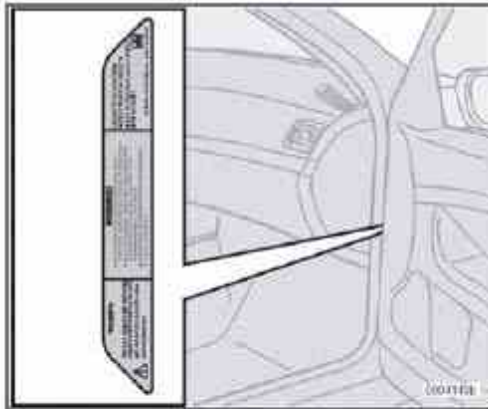

Airbag decal in the front passenger's door opening

WARNING

- Children must never be allowed in the front passenger's seat. Volvo recommends that ALL occupants (adults and children) shorter than 4 feet 7 inches (140 cm) be seated in the back seat of any vehicle with a passenger-side front airbag. See [page 30](#) for guidelines.
- Occupants in the front passenger's seat must never sit on the edge of the seat, sit leaning toward the instrument panel or otherwise sit out of position.
- The occupant's back must be as upright as comfort allows and be against the seat back with the seat belt properly fastened.
- Feet must be on the floor, e.g., not on the dash, seat or out of the window.



Front airbags

WARNING

- No objects or accessory equipment, e.g. dashboard covers, may be placed on, attached to, or installed near the air bag hatch (the area above the glove compartment) or the area affected by airbag deployment (see the illustration on [page 17](#)).
- There should be no loose articles, e.g. coffee cups, on the floor, seat, or dashboard area.
- Never try to open the airbag cover on the steering wheel or the passenger's side dashboard. This should only be done by a trained and qualified Volvo service technician.

Failure to follow these instructions can result in injury to the vehicle occupants.



Occupant Weight Sensor (OWS)

Disabling the passenger's side front airbag

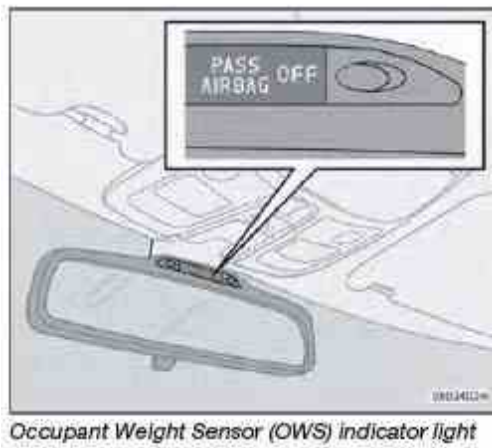

Volvo recommends that ALL occupants (adults and children) shorter than 4 feet 7 inches (140 cm) be seated in the rear seat of any vehicle with a passenger's side front airbag, and be properly restrained. Children should always be seated in child restraints appropriate for their size and weight. See also the child safety recommendations beginning on [page 30](#).

The Occupant Weight Sensor (OWS) is designed to meet the regulatory requirements of Federal Motor Vehicle Safety Standard (FMVSS) 208 and is designed to disable (will not inflate) the passenger's side front airbag under certain conditions.

The OWS works with sensors that are part of the front passenger's seat and seat belt. The sensors are designed to detect the presence of a properly seated occupant and determine if the passenger's side front airbag should be enabled (may inflate) or disabled (will not inflate).

The OWS will disable (will not inflate) the passenger's side front airbag when:

- the front passenger's seat is unoccupied, or has small/medium objects in the front seat,
- the system determines that an infant is present in a rear-facing infant seat that is installed according to the manufacturer's instructions,
- the system determines that a small child is present in a forward-facing child restraint that is installed according to the manufacturer's instructions,
- the system determines that a small child is present in a booster seat,
- a front passenger takes his/her weight off of the seat for a period of time,
- a child or a small person occupies the front passenger's seat.

The OWS uses a PASSENGER AIRBAG OFF indicator light which will illuminate and stay on to remind you that the passenger's side front airbag is disabled. The PASSENGER AIRBAG OFF indicator light is located in the overhead console, near the base of the rearview mirror.

NOTE

The PASSENGER AIRBAG OFF indicator lamp will illuminate for a short period of time when the ignition is turned on to confirm it is functional. When the front passenger's seat is not occupied (empty seat) or in the event that the passenger's side front airbag is enabled (may inflate), the PASSENGER AIRBAG OFF indicator lamp will be off.

However, if a fault is detected in the system:

- The PASSENGER AIRBAG OFF indicator light will stay on.
- The SRS warning light (see [page 16](#)) will come on and stay on.
- The message PASS. AIRBAG OFF SERVICE URGENT will be displayed in the information display.



Occupant Weight Sensor (OWS)

WARNING

- If a fault in the system is detected and indicated as explained on the previous page, be aware that the passenger's side front airbag will not deploy in the event of a collision.
- In this case, the safety systems and Occupant Weight Sensor should be inspected by a trained and qualified Volvo service technician as soon as possible.

WARNING

- Never try to open, remove, or repair any components in the OWS system. This could result in system malfunction. Maintenance or repairs should only be carried out by an authorized Volvo service technician.
- The front passenger's seat should not be modified in any way. This could reduce pressure on the seat cushion, which might interfere with the OWS system's function.

The OWS is designed to disable (will not inflate) the passenger's side front airbag when a rear facing infant seat, a forward-facing child restraint, or a booster seat is detected. The PASSENGER AIRBAG OFF indicator lamp will illuminate and stay on to remind you that the passenger's side front airbag is disabled (see the following table).

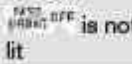
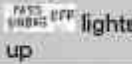
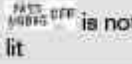
Passenger's seat occupancy status	OWS indicator light status	Passenger's side front airbag status
Seat unoccupied	OWS indicator light  is not lit	Passenger's side front airbag disabled
Seat occupied by low weight occupant/object ¹	OWS indicator light  lights up	Passenger's side front airbag disabled
Seat occupied by heavy occupant/object	OWS indicator light  is not lit	Passenger's side front airbag enabled

¹Volvo recommends that children always be properly restrained in appropriate child restraints in the rear seats.

In rare situations when the seat belt is not properly fastened, some child restraints may not be detected by the OWS because there is very little weight on the vehicle seat cushion. In these cases the passenger's side front airbag may be disabled, but the PASSENGER AIRBAG OFF indicator lamp will not be lit. Do not assume that the passenger's side front airbag is disabled unless the PASSENGER AIRBAG OFF indicator lamp is lit. Make sure the child restraint is properly installed (turn the vehicle off, remove the child restraint from the vehicle and reinstall the restraint following the child restraint manufacturer's instructions) and that the PASSENGER AIRBAG OFF indicator lamp is on, or move the child restraint to the rear seat.

The OWS is designed to enable (may inflate) the passenger's side front airbag anytime the system senses that a person of adult size is sitting properly in the front passenger's seat.

The PASSENGER AIRBAG OFF indicator lamp will be off and remain off.

If a person of adult size is sitting in the front passenger's seat, but the PASSENGER AIRBAG OFF indicator lamp is on, it is possible that the person isn't sitting properly in the seat. If this happens:

- Turn the vehicle off and ask the person to place the seatback in an upright position.



Occupant Weight Sensor (OWS)

- Have the person sit upright in the seat, centered on the seat cushion, with the person's legs comfortably extended.
- Restart the vehicle and have the person remain in this position for about two minutes. This will allow the system to detect that person and enable the passenger's frontal airbag.
- If the PASSENGER AIRBAG OFF indicator lamp remains on even after this, the person should be advised to ride in the rear seat.

This condition reflects limitations of the OWS classification capability. It does not indicate OWS malfunction.

Modifications

If you are considering modifying your vehicle in any way to accommodate a disability, for example by altering or adapting the driver's or front passenger's seat(s) and/or airbag systems, please contact Volvo at:

In the USA

Volvo Cars of North America, LLC
Customer Care Center
P.O. Box 914 Rockleigh, New Jersey 07647-0914
1-800-458-1552

In Canada

Volvo Cars of Canada Corp.
National Customer Service
175 Gordon Baker Road
North York, Ontario M2H 2N7
1-800-663-8255

WARNING

- No objects that add to the total weight on the seat should be placed on the front passenger's seat. If a child is seated in the front passenger's seat with any additional weight, this extra weight could cause the OWS system to enable the airbag, which might cause it to deploy in the event of a collision, thereby injuring the child.
- The seat belt should never be wrapped around an object on the front passenger's seat. This could interfere with the OWS system's function.
- The front passenger's seat belt should never be used in a way that exerts more pressure on the passenger than normal. This could increase the pressure exerted on the weight sensor by a child, and could result in the airbag being enabled, which might cause it to deploy in the event of a collision, thereby injuring the child.



Occupant Weight Sensor (OWS)

WARNING

Keep the following points in mind with respect to the OWS system. Failure to follow these instructions could adversely affect the system's function and result in serious injury to the occupant of the front passenger's seat:

- The full weight of the front seat passenger should always be on the seat cushion. The passenger should never lift him/herself off the seat cushion using the armrest in the door or the center console, by pressing the feet on the floor, by sitting on the edge of the seat cushion, or by pressing against the backrest in a way that reduces pressure on the

seat cushion. This could cause OWS to disable the front passenger's side airbag.

- Do not place any type of object on the front passenger's seat in such a way that jamming, pressing, or squeezing occurs between the object and the front seat, other than as a direct result of the correct use of the Automatic Locking Retractor/Emergency Locking Retractor (ALR/ELR) seat belt (see [page 31](#)).
- No objects should be placed under the front passenger's seat. This could interfere with the OWS system's function.



Side impact (SIPS) airbag

Side impact airbags - front seats only



Location of the side impact (SIPS) airbag

As an enhancement to the structural side impact protection built into your vehicle, the vehicle is also equipped with Side Impact Protection System (SIPS) airbags.

The SIPS airbag system is designed to help increase occupant protection in the event of certain side impact collisions. The SIPS airbags are designed to deploy only during certain side-impact collisions, depending on the crash severity, angle, speed and point of impact.



Components in the SIPS airbag system

NOTE

SIPS airbag deployment (one airbag) occurs only on the side of the vehicle affected by the impact. The airbags are not designed to deploy in all side impact situations.

Components in the SIPS airbag system

This SIPS airbag system consists of gas generators and side airbag modules built into the outboard sides of both front seat backrests.

WARNING

- The SIPS airbag system is a supplement to the structural Side Impact Protection System and the three-point seat belt system. It is not designed to deploy during collisions from the front or rear of the vehicle or in rollover situations.
- The use of seat covers on the front seats may impede SIPS airbag deployment.
- No objects, accessory equipment or stickers may be placed on, attached to or installed near the SIPS airbag system or in the area affected by SIPS airbag deployment.
- Never try to open or repair any components of the SIPS airbag system. This should be done only by a trained and qualified Volvo service technician.
- In order for the SIPS airbag to provide its best protection, both front seat occupants should sit in an upright position with the seat belt properly fastened.
- Failure to follow these instructions can result in injury to the occupants of the vehicle in the event of an accident.



Volvo Inflatable Curtain (VIC)

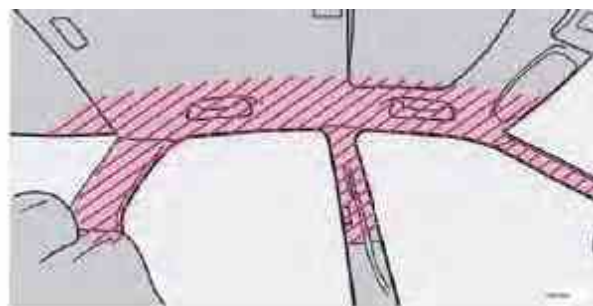
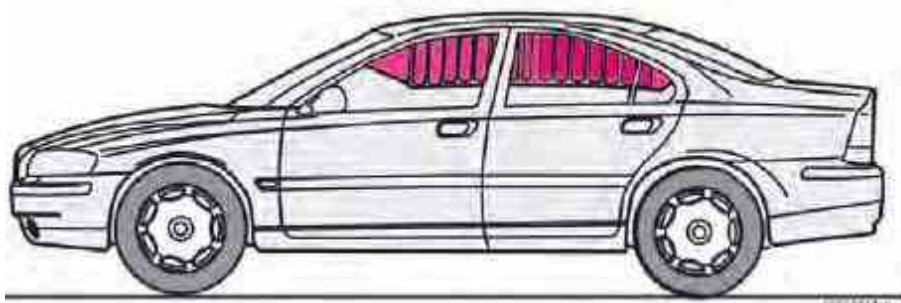

This system consists of inflatable curtains located along the sides of the roof liners, stretching from the center of both front side windows to the rear edge of the rear side door windows. It is designed to help protect the heads of the occupants of the front seats and the occupant of the outboard rear seating positions in certain side impact collisions.

In certain side impacts, both the Inflatable Curtain (VIC) and the Side Impact Airbag System (SIPS-bag) will deploy, whereas, in some cases, only the Inflatable Curtain (VIC) will deploy. In cases where both the VIC and the SIPS-bag deploy, this will occur simultaneously.

NOTE

If the inflatable curtain deploys, it remains inflated for approximately 3 seconds.

WARNING

- The VIC system is a supplement to the Side Impact Protection System. It is not designed to deploy during collisions from the front or rear of the vehicle or in rollover situations.
- Never try to open or repair any components of the VIC system. This should be done only by a trained and qualified Volvo service technician.
- Never hang heavy items from the ceiling handles. This could impede deployment of the Inflatable curtain.



Volvo Inflatable Curtain (VIC)

WARNING

In order for the VIC to provide its best protection, both front seat occupants and both outboard rear seat occupants should sit in an upright position with the seat belt properly fastened; adults using the seat belt and children using the proper child restraint system. Only adults should sit in the front seats. Children must never be allowed in the front passenger seat. See [page 30](#) for guidelines. Failure to follow these instructions can result in injury to the vehicle occupants in an accident.



Whiplash Protection System (WHIPS)

Whiplash Protection System (WHIPS) - front seats only

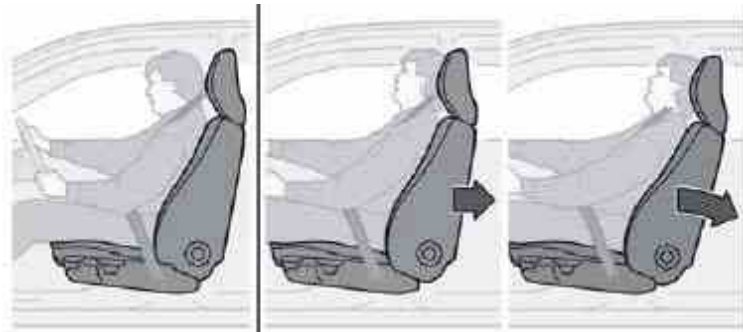

The WHIPS system consists of specially designed hinges and brackets on the front seat backrests designed to help absorb some of the energy generated in a collision from the rear (when the vehicle is "rear-ended").

In the event of a collision of this type, the hinges and brackets of the front seat backrests are designed to change position slightly to allow the backrest/head restraint to help support the occupant's head before moving slightly rearward. This movement helps absorb some of the forces that could result in whiplash.

WARNING

- The WHIPS system is designed to supplement the other safety systems in your vehicle. For this system to function properly, the three-point seat belt must be worn. Please be aware that no system can prevent all possible injuries that may occur in an accident.
- The WHIPS system is designed to function in certain collisions from the rear, depending on the crash severity, angle and speed.

WARNING

Occupants in the front seats must never sit out of position. The occupant's back must be as upright as comfort allows and be against the seat back with the seat belt properly fastened.



Whiplash Protection System (WHIPS)

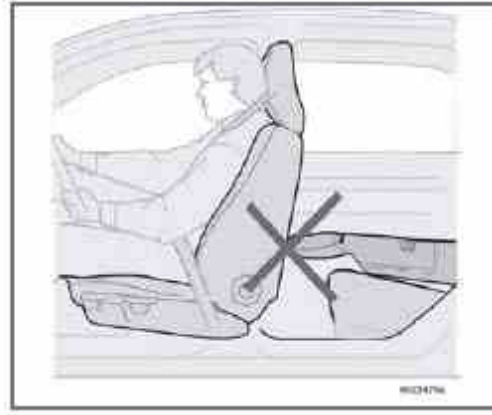
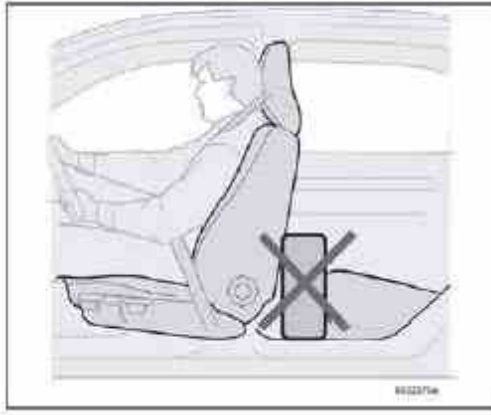

WARNING

- Boxes, suitcases, etc. wedged behind the front seats could impede the function of the WHIPS system.
- If the rear seat backrests are folded down, cargo must be secured to prevent it from sliding forward against the front seat backrests in the event of a collision from the rear. This could interfere with the action of the WHIPS system.
- If your vehicle has been involved in a rear-end collision, the front seat backrests must be inspected by a trained and qualified Volvo service technician, even if the seats appear to be undamaged. Certain components in the WHIPS system may need to be replaced.
- Do not attempt to service any component in the WHIPS system yourself.
- Any contact between the front seat backrests and the folded rear seat could impede the function of the WHIPS system. If the rear seat is folded down, the occupied front seats must be adjusted forward so that they do not touch the folded rear seat.



Child safety

Children should be seated safely

Volvo recommends the proper use of restraint systems for all occupants including children. Remember that, regardless of age and size, a child should always be properly restrained in a vehicle.

Your vehicle is also equipped with ISOFIX/LATCH attachments, which make it more convenient to install child seats.

Some restraint systems for children are designed to be secured in the vehicle by lap belts or the lap portion of a lap-shoulder belt. Such child restraint systems can help protect children in vehicles in the event of an accident only if they are used properly. However, children could be endangered in a crash if the child restraints are not properly secured in the vehicle. Failure to follow the installation instructions for your child restraint can result in your child striking the vehicle's interior in a sudden stop.

Holding a child in your arms is NOT a suitable substitute for a child restraint system. In an accident, a child held in a person's arms can be crushed between the vehicle's interior and an unrestrained person. The child could also be injured by striking the interior, or by being ejected from the vehicle during a sudden maneuver or impact. The same can also happen if the infant or child rides unrestrained on the seat. Other occupants should also be properly restrained to help reduce the chance of injuring or increasing the injury of a child.

All states and provinces have legislation governing how and where children should be carried in a vehicle. Find out the regulations existing in your state or province. Recent accident statistics have shown that children are safer in rear seating positions than front seating positions when properly restrained. A child restraint system can help protect a child

in a vehicle. Here's what to look for when selecting a child restraint system:

- It should have a label certifying that it meets applicable Federal Motor Vehicle Safety Standards (FMVSS 213) - or in Canada, CMVSS 213.
- Make sure the child restraint system is approved for the child's height, weight and development - the label required by the standard or regulation, or instructions for infant restraints, typically provide this information.
- In using any child restraint system, we urge you to carefully look over the instructions that are provided with the restraint. Be sure you understand them and can use the device properly and safely in this vehicle. A misused child restraint system can result in increased injuries for both the infant or child and other occupants in the vehicle.

When a child has outgrown the child safety seat, you should use the rear seat with the standard seat belt fastened. The best way to help protect the child here is to place the child on a cushion so that the seat belt is properly located on the hips (see the illustrations on [page 32](#)). Legislation in your state or province may mandate the use of a child seat or cushion in combination with the seat belt, depending on the child's age and/or size. Please check local regulations.

A specially designed and tested booster cushion (not available in Canada) can be obtained from your Volvo retailer for children weighing 33-80 lb. (15-36 kg) and 38-54 inches (97-137 cm) in height.



Child safety

WARNING

- Do not use child safety seats or child booster cushions/backrests in the front passenger's seat. We also recommend that children under 4 feet 7 inches (140 cm) in height who have outgrown these devices sit in the rear seat with the seat belt fastened.
- Keep vehicle doors and trunk locked and keep keys out of a child's reach. Unsupervised children could lock themselves in an open trunk and risk injury. Children should be taught not to play in vehicles.
- On hot days, the temperature in the vehicle interior can rise very quickly. Exposure to these high temperatures for even a short period of time can cause heat-related injury or death. Small children are particularly at risk.

Automatic Locking Retractor/Emergency Locking Retractor (ALR/ELR)

To make child seat installation easier, each seat belt (except for the driver's belt) is equipped with a locking mechanism to help keep the seat belt taut.

When attaching the seat belt to a child seat:

- Attach the seat belt to the child seat according to the child seat manufacturer's instructions.
- Pull the seat belt out as far as possible.
- Insert the seat belt latch plate into the buckle (lock) in the usual way.
- Release the seat belt and pull it taut around the child seat.

A sound from the seat belt retractor will be audible at this time and is normal.

The belt will now be locked in place.

This function is automatically disabled when the seat belt is unlocked and the belt is fully retracted.

WARNING

Do not use child safety seats or child booster cushions/backrests in the front passenger's seat. We also recommend that children who have outgrown these devices sit in the rear seat with the seat belt properly fastened.

Volvo's recommendations

Why does Volvo believe that no child should sit in the front seat of a vehicle? It's quite simple really. A front airbag is a very powerful device designed, by law, to help protect an adult.

Because of the size of the airbag and its speed of inflation, a child should never be placed in the front seat, even if he or she is properly belted or strapped into a child safety seat. Volvo has been an innovator in safety for over seventy-five years, and we'll continue to do our part. But we need your help. Please remember to put your children in the back seat, and buckle them up.

Volvo has some very specific recommendations:

- Always wear your seat belt.
- Airbags are a SUPPLEMENTAL safety device which, when used with a three-point seat belt can help reduce serious injuries during certain types of accidents. Volvo recommends that you do not disconnect the airbag system in your vehicle.
- Volvo strongly recommends that everyone in the vehicle be properly restrained.
- Volvo recommends that ALL occupants (adults and children) shorter than 4 feet 7 inches (140 cm) be seated in the back seat of any vehicle with a front passenger side airbag.

Drive safely!



Child restraint systems

Child restraints



Infant seat

There are three main types of child restraint systems: infant seats, convertible seats, and booster cushions. They are classified according to the child's age and size.

The following section provides **general information** on securing a child restraint using a three-point seat belt. Refer to [page 40](#) for information on securing a child restraint using ISOFIX lower anchors and/or top tether anchorages.

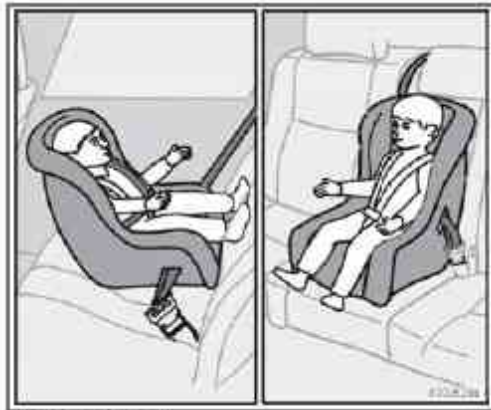

Convertible seat

WARNING

A child seat should never be used in the front passenger seat of any vehicle with a front passenger airbag - not even if the "Passenger airbag off" symbol near the rear-view mirror is illuminated (on vehicles equipped with Occupant Weight Sensor). If the severity of an accident were to cause the airbag to inflate, this could lead to serious injury or death to a child seated in this position.



Booster cushion

WARNING

Always refer to the child restraint manufacturer's instructions for detailed information on securing the restraint.



Child restraint systems

WARNING

- When not in use, keep the child restraint system secured or remove it from the passenger compartment to help prevent it from injuring passengers in the event of a sudden stop or collision.
- A small child's head represents a considerable part of its total weight and its neck is still very weak. Volvo recommends that children up to age 4 travel, properly restrained, facing rearward. In addition, Volvo recommends that children should ride rearward facing, properly restrained, as long as possible.



Infant seats

Securing an infant seat with a seat belt



Do not place the infant seat in the front passenger's seat

NOTE

Refer to [page 40](#) for information on securing a child restraint using ISOFIX lower anchors and/or top tether anchorages.

1. Place the infant seat in the rear seat of the vehicle.
2. Attach the seat belt to the infant seat according to the manufacturer's instructions.

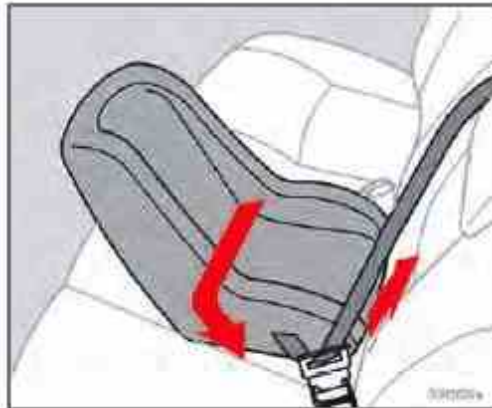

Positioning the seat belt through the infant seat

3. Fasten the seat belt by inserting the latch plate into the buckle (lock) until a distinct click is audible.

WARNING

- An infant seat must be in the rear-facing position only.
- The infant seat should not be positioned behind the driver's seat unless there is adequate space for safe installation.



Fasten the seat belt



WARNING

A child seat should never be used in the front passenger seat of any vehicle with a front passenger airbag - not even if the "Passenger airbag off" symbol near the rear-view mirror is illuminated (on vehicles equipped with Occupant Weight Sensor). If the severity of an accident were to cause the airbag to inflate, this could lead to serious injury or death to a child seated in this position.



Infant seats

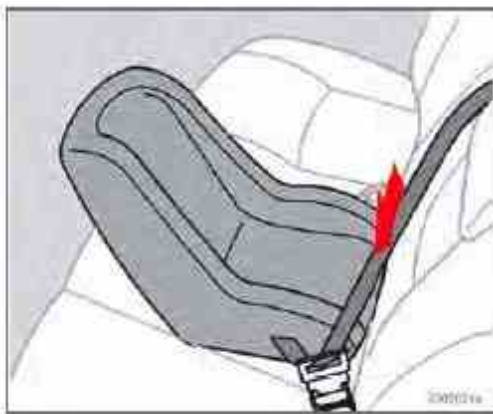

Pull out the shoulder section of the seat belt

4. Pull the shoulder section of the seat belt out as far as possible to activate the belt's automatic locking function.
5. Press the infant seat firmly in place, let the seat belt retract and pull it taut. A sound from the seat belt retractor's automatic locking function will be audible at this time and is normal. The seat belt should now be locked in place.



NOTE

The locking retractor will automatically release when the seat belt is unbuckled and allowed to retract fully.



Ensure that the seat is securely in place

6. Push and pull the infant seat to ensure that it is held securely in place by the seat belt.



WARNING

It should not be possible to move the child restraint more than 1 in. (2.5 cm) in any direction.

The infant seat can be removed by unbuckling the seat belt and letting it retract completely.



Convertible seats

Securing a convertible seat with a seat belt



Do not place the convertible seat in the front passenger's seat



NOTE

Refer to [page 40](#) for information on securing a child restraint using ISOFIX lower anchors and/or top tether anchorages.

Convertible seats can be used in either a forward or rearward-facing position, depending on the age and size of the child.

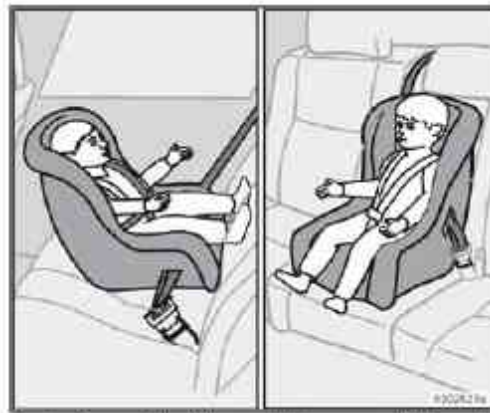

Route the seat belt through the convertible seat

WARNING

Always use a convertible seat that is suitable for the child's age and size. See the convertible seat manufacturer's recommendations.

1. Place the convertible seat in the rear seat of the vehicle.
2. Attach the seat belt to the convertible seat according to the manufacturer's instructions.

WARNING

- A small child's head represents a considerable part of its total weight and its neck is still very weak. Volvo recommends that children up to age 4 travel, properly restrained, facing rearward. In addition, Volvo recommends that children should ride rearward facing, properly restrained, as long as possible.
- Convertible child seats should be installed in the rear seat only.
- A rear-facing convertible seat should not be positioned behind the driver's seat unless there is adequate space for safe installation.



Convertible seats

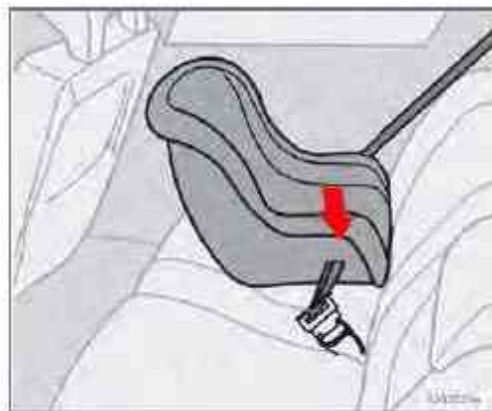

Fasten the seat belt

3. Fasten the seat belt by inserting the latch plate into the buckle (lock) until a distinct click is audible.
4. Pull the shoulder section of the seat belt out as far as possible to activate the belt's automatic locking function.

5. Press the convertible seat firmly in place, let the seat belt retract and pull it taut. A sound from the seat belt retractor's automatic locking function will be audible at this time and is normal. The seat belt should now be locked in place.



Pull out the shoulder section of the seat belt

i NOTE

The locking retractor will automatically release when the seat belt is unbuckled and allowed to retract fully.

6. Push and pull the convertible seat to ensure that it is held securely in place by the seat belt.

! WARNING

It should not be possible to move the child restraint more than 1 in. (2.5 cm) in any direction.

The convertible seat can be removed by unbuckling the seat belt and letting it retract completely.



Convertible seats



Ensure that the seat is securely in place

! WARNING

A child seat should never be used in the front passenger seat of any vehicle with a front passenger airbag - not even if the "Passenger airbag off" symbol near the rear-view mirror is illuminated (on vehicles equipped with Occupant Weight Sensor). If the severity of an accident were to cause the airbag to inflate, this could lead to serious injury or



Booster cushions

Securing a booster cushion



Position the child correctly on the booster cushion

1. Booster cushions are recommended for children who have outgrown convertible seats.
2. Place the booster cushion in the rear seat of the vehicle.
3. With the child properly seated on the booster cushion, attach the seat belt to or around the cushion according to the manufacturer's instructions.

Fasten the seat belt by inserting the latch plate into the buckle (lock) until a distinct click is audible.



Positioning the seat belt

4. Ensure that the seat belt is pulled taut and fits snugly around the child.



WARNING

- The hip section of the three-point seat belt must fit snugly across the child's hips, not across the stomach.
- The shoulder section of the three-point seat belt should be positioned across the chest and shoulder.
- The shoulder belt must never be placed behind the child's back or under the arm.



ISOFIX lower anchors

Using the ISOFIX lower child seat anchors

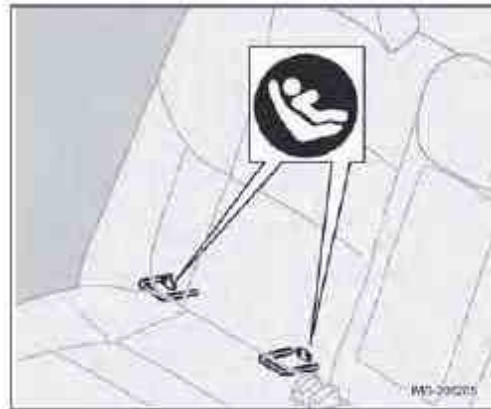

ISOFIX lower child restraint anchors

Lower anchors for ISOFIX-equipped child seats are located in the rear, outboard seats, hidden below the backrest cushions. Symbols on the seat back upholstery mark the anchor positions (see the illustration above).

To access the anchors:

1. Put the child restraint in position.
2. Kneel on the child restraint to press down the seat cushion and locate the anchors by feel.
3. Fasten the attachment on the child restraint's lower straps to the ISOFIX lower anchors.
4. Firmly tension the lower child seat straps according to the manufacturer's instructions.

WARNING

The ISOFIX lower child restraint anchors are only intended for use with child seats positioned in the outboard seating positions. These anchors are not certified for use with any child restraint that is positioned in the center seating position. When securing a child restraint in the center seating position, use only the vehicle's center seat belt.

NOTE

- The rear seat's center position is not equipped with ISOFIX lower anchors. When installing a child restraint in this position, attach the restraint's top tether strap (if it is so equipped) to the top tether anchorage point (see the information on [page 42](#)) and secure the restraint with the vehicle's center seat belt (see the information beginning on [page 36](#)).

WARNING

- Always follow your child seat manufacturer's installation instructions, and use both ISOFIX lower anchors and top tethers whenever possible.



ISOFIX lower anchors



Fasten the attachment correctly to the ISOFIX lower anchors

WARNING

- Be sure to fasten the attachment correctly to the anchor (see the illustration above). If the attachment is not correctly fastened, the child restraint may not be properly secured in the event of a collision.



Top tether anchors

Top tether anchors

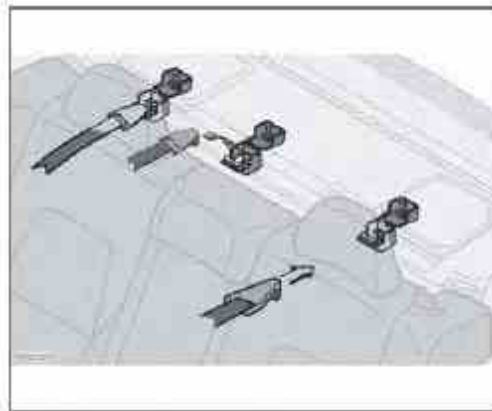

Top tether anchorage points

Your Volvo is equipped with child restraint top tether anchorages in all rear seat positions.

Using the top tether anchorages

1. Place the child restraint on the rear seat.
2. Route the top tether strap under the head restraint and fasten its attachment to the anchorage.

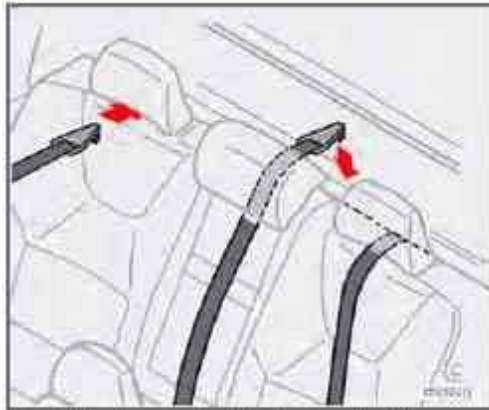

Route the strap under the head restraint

WARNING

Be sure to fasten the child tether attachment correctly to the anchor. If it is not correctly fastened, the child seat may not be properly restrained in the event of a collision.

3. Firmly tension the top tether strap according to the child restraint manufacturer's instructions. Tension the top tether strap only after the lower anchor straps or the seat belt have been firmly tensioned.

See [page 40](#) for on securing the child restraint to ISOFIX lower anchors.

WARNING

- Never route a top tether strap over the top or around the head restraint. It should always be routed under the head restraint.
- Child restraint anchorages are designed to withstand only those loads imposed by correctly fitted child restraints. Under no circumstances are they to be used for adult seat belts or harnesses. The anchorages are not able to withstand excessive forces on them in the event of collision if full harness seat belts or adult seat belts are installed to them. An adult who uses a belt anchored in a child restraint anchorage runs a great risk of suffering severe injuries should a collision occur.
- Do not install rear speakers that require the removal of the top tether anchors or interfere with the proper use of the top tether strap.



Child restraint registration and recalls

Registering a child restraint

Child restraints could be recalled for safety reasons. You must register your child restraint to be reached in a recall. To stay informed about child safety seat recalls, be sure to fill out and return the registration card that comes with new child restraints.

Child restraint recall information is readily available in both the U.S. and Canada. For recall information in the U.S., call the U.S. Government's Auto Safety Hotline at 1-800-424-9393. In Canada, visit Transport Canada's Child Safety website at <http://www.tc.gc.ca/roadsafety/childsafety/menu.htm>.



[Contents](#) | [Top of Page](#)

2008 VOLVO S60

44 02 Instruments and controls



Instrument overview	46
Instrument panel	48
Instrument and warning symbols	49
Buttons in the center console	54
Steering wheel adjustment	56
Lighting panel	57
Fuel filler door-unlocking manually	59
Left-side steering wheel lever	60
Right-side steering wheel lever	61
Hazard warning flashers, door mirror defroster	63
Trip computer	64
Cruise control	66
Parking brake	68
12-volt sockets	69
Power windows	70
Mirrors	72
Power moonroof (option)	76
Home Link® Universal Transceiver (option)	78

45 02 Instruments and controls



46 02 Instruments and controls



Instrument overview

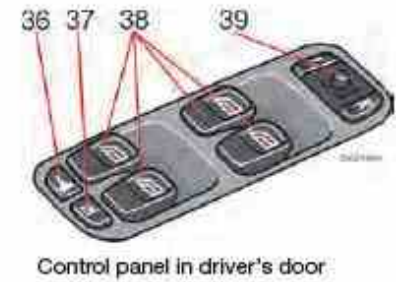
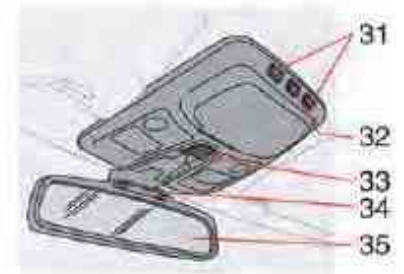
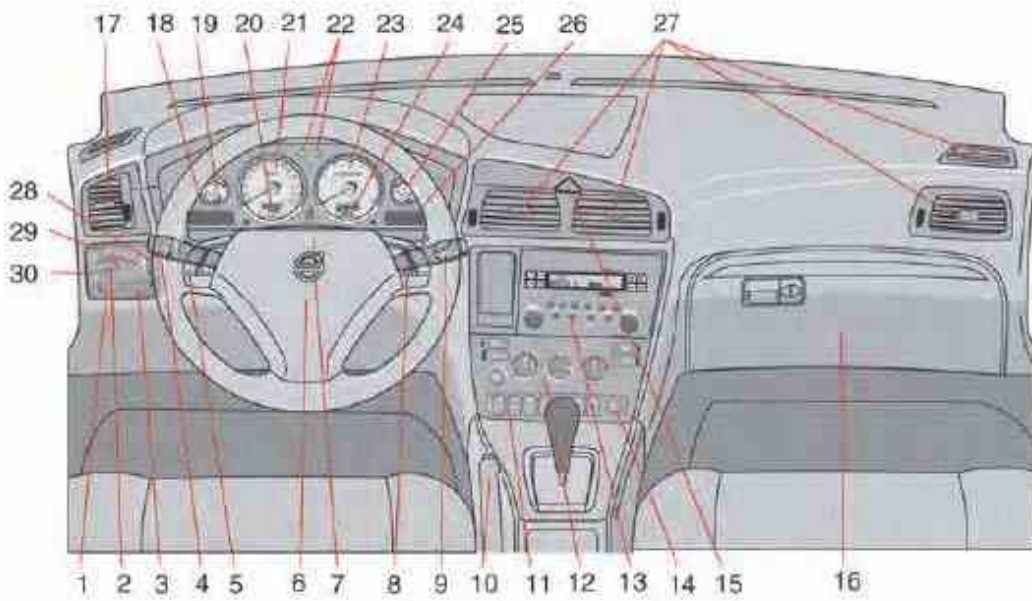

Instrument overview

1 Front fog lights	57
2 Headlights/Parking lights/switch for unlocking fuel filler door	57
3 Rear fog light	57
4 Turn signals/High/low beams	60
5 Cruise control	66
6 Horn	-
7 Instrument panel	48
8 Audio controls in steering wheel	229
9 Windshield wipers	61
10 Parking brake (hand brake)	68
11 Center console buttons	54
12 Climate control	84
13 Audio system	222
14 12-V socket	55, 69
15 Hazard warning flashers	63
16 Glove compartment	102
17 Panel vents	85
18 Text display	48
19 Temperature gauge	48
20 Odometer/Trip odometer/Cruise control indicator	48
21 Speedometer	48
22 Turn signal indicators	48
23 Tachometer	48
24 Ambient temperature/Clock/Selected gear indicator	48

25 Fuel gauge	48
26 Indicator and warning symbols	49
27 Panel vents	85
28 Instrument lighting	58
29 Not in use	
30 Lighting panel	57
31 Reading lights	97
32 Interior lighting	97
33 Moonroof control	76
34 Seat belt reminder	14
35 Rearview mirror	72
36 Lock button, for all doors	115
37 Cut-out button for rear seat power windows	71
38 Controls, power windows	70
39 Controls, door mirrors	74



Instrument panel

Instrument panel

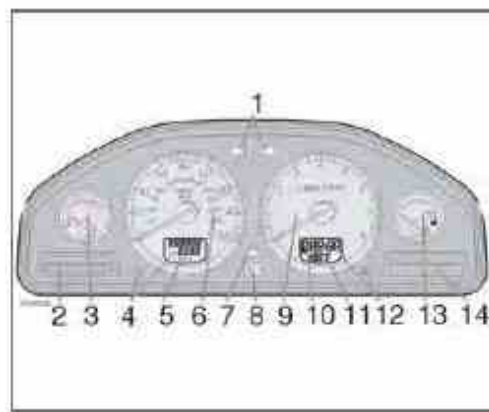

1. Turn signal indicators - right/left

2. Text window

The text window displays information and warning messages.

3. Temperature gauge

The pointer should be approximately midway on the gauge when driving. **Do not drive the vehicle if the warning light is on.** The text window will provide you with additional information.

If the engine temperature remains high, check coolant level - see [page 195](#).

4. Trip odometer

The trip odometers are used for measuring shorter distances. The right-hand digit gives tenth of a mile/kilometer. Press the button for more than 2 seconds to reset. Change between trip odometers 1 and 2 using one short press on the button.

5. Odometer

6. Speedometer

7. Warning symbol

8. High beam indicator

9. Tachometer

Indicates engine speed in thousands of revolutions per minute (rpm). Do not drive for long with the needle in the red section. The engine has an built-in function preventing excessively high engine speeds. When this function operates, you may discern some pulsation, which in that case is quite normal.

10. Gear and driving mode indicator

The currently selected driving mode is displayed here. If you use the optional Geartronic function on the automatic transmission, the currently selected gear will be displayed.

11. Ambient temperature gauge

This display indicates the air temperature outside your vehicle. A "snowflake" symbol in the text window is displayed when the temperature is in the range of 23 - 36 °F (-5 - +2 °C).

Please note that this symbol does not indicate a fault with your vehicle.

At low speeds or when the vehicle is not moving, the temperature readings may be slightly higher than the actual ambient temperature.

12. Clock/set button

Turn the button to set the clock.

13. Fuel gauge

See [page 246](#) for fuel tank volume. When the warning light in the gauge comes on, there are approximately 1.8 US gal. (8 liters) of fuel remaining in the tank. For more information on fuel level and consumption, see "Trip computer" on [page 64](#).

14. Indicator and warning symbols



Instrument and warning symbols

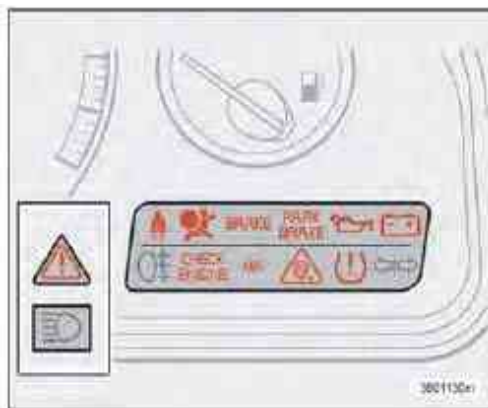

The indicator and warning symbols¹ light up when you turn the ignition key to the driving position (position II) before starting. This shows that the symbols are functioning. When the engine starts, all symbols go out. If the engine is not started within 5 seconds, all symbols except **CHECK ENGINE** and  go out. Certain symbols may not have their functions illustrated, depending on the vehicle's equipment. The symbol for the parking brake goes out when the parking brake is released.

¹On certain engines, the symbol for low oil pressure is not used. Instead, a text warning is provided in the information display, see also [page 52](#).

Warning symbol in the center of the instrument panel



This symbol shines as a red or yellow light depending on the severity of the discovered fault.

Red symbol - Stop the vehicle as soon as possible in a suitable location and read the message shown in the text window. The symbol and accompanying text will remain on until the fault has been corrected.

Yellow symbol - Follow the instructions shown in the text window. The text can be erased by pressing the READ button (see [page 52](#)), or will disappear automatically after two minutes.

When the message "TIME FOR REGULAR SERVICE" is displayed, the text can be erased and the yellow symbol light can be turned off by pressing the READ button. The text will disappear and the symbol light will go out automatically after two minutes.

Symbols in the instrument panel



Seat belt reminder

This symbol lights up to indicate that the driver has not fastened his/her seat belt.



Supplemental Restraint System SRS

If this light comes on while the vehicle is being driven, or remains on for longer than approximately 10 seconds after the vehicle has been started, the SRS system's diagnostic functions have detected a fault in a seat belt lock or pretensioner, a front airbag, side impact airbag, and/or an inflatable curtain. Have the system(s) inspected by a trained and qualified Volvo service technician as soon as possible.

BRAKE - Brake failure warning light

If the light comes on while driving or braking, stop immediately, open the hood and check the brake fluid level in the reservoir. See [page 196](#).



Canadian models are equipped with this warning light.



Instrument and warning symbols

If the BRAKE and ABS warning lights come on at the same time, this could indicate a fault in the brake system.

1. Stop the vehicle in a suitable place and switch off the engine.
2. Restart the engine.
3. If both warning lights go off, no further action is required.
4. If both lights are still on after the engine has been restarted, switch off the engine again and check the brake fluid level (see [page 196](#) for the location of the brake fluid reservoir).
5. If the brake fluid level is above the MIN mark, drive carefully to a trained and qualified Volvo service technician and have the brake system inspected.



WARNING

If the fluid level is below the MIN mark in the reservoir or if a "Brake failure - Service urgent" message is displayed in the text window: DO NOT DRIVE. Have the vehicle towed to a trained and qualified Volvo service technician and have the brake system inspected.

PARK BRAKE - Parking brake applied

This light will be on when the parking brake (hand brake) is applied. The parking brake lever is situated between the front seats. See also [page 68](#) for additional information.



Canadian models are equipped with this symbol.



Oil pressure warning light¹ If the light comes on while driving, stop the vehicle and then stop the engine

immediately and check the engine oil level. See [page 193](#). If the light stays on after restart, have the vehicle towed to the nearest trained and qualified Volvo service technician. After hard driving, the light may come on occasionally when the engine is idling. This is normal, provided it goes off when the engine speed is increased.



Generator warning light

If the light comes on while the engine is running, have the charging system checked.



Rear fog light

This light indicates that the fog light is on.

¹On certain engines, the symbol for low oil pressure is not used. Instead, a text warning is provided in the information display, see also [page 52](#).

CHECK ENGINE - Malfunction indicator light

On-Board Diagnostics II (OBDII): As you drive, a computer called "OBDII" monitors your vehicle's engine, transmission, electrical and emission systems. The CHECK ENGINE light will light up if the computer senses a condition that potentially may need correcting. When this happens, please have your vehicle checked by a trained and qualified Volvo service technician as soon as possible.

A CHECK ENGINE light may have many causes. Sometimes, you may not notice a change in your vehicle's behavior. Even so, an uncorrected condition could hurt fuel economy, emission cleanliness, and driveability. Extended driving without correcting the cause could even damage other components in your vehicle.



Canadian models are equipped with this warning light.



Anti-lock brake system ABS

If the warning light comes on, there is a malfunction of the ABS system (the standard braking system will still function). The vehicle should be driven to a trained and qualified Volvo service technician for inspection. See [page 137](#) for additional information.



Instrument and warning symbols



Dynamic Stability Traction Control (DSTC) system

This indicator light will flash when DSTC is actively working to stabilize the vehicle. See [page 139](#) for more detailed information.

Tire pressure monitoring light

See [page 162](#) for more information on this function.

Turn signal indicator - trailer(certain models)

If you are towing a trailer, this light will flash simultaneously with the turn signals on the trailer. If the light does not flash when signaling, neither the trailer's turn signals nor the vehicle's turn signals are functioning.



Instrument and warning symbols

Messages in the text window

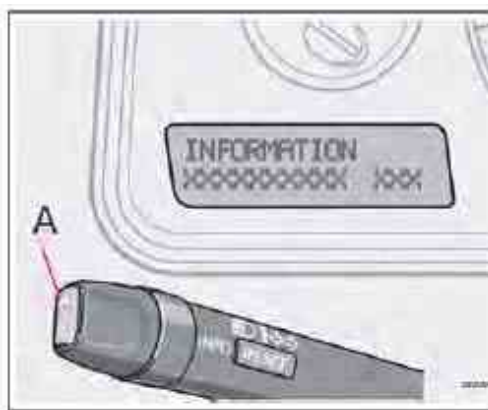

When a warning light in the instrument panel comes on, a message is also displayed in the text window. After you have read the message, you can erase it by pressing button A (see illustration).

NOTE

Certain messages cannot be erased until the condition has been corrected.

If a warning message is displayed when e.g. you are using the trip computer, this message must be erased before you can access the function of your choice. Press button A to erase the warning message.

You can scroll through the stored messages by pressing button A (see illustration). The text window can be cleared (the message will be returned to memory) by pressing button A again.



Instrument and warning symbols

Message	Meaning
STOP SAFELY	Stop the car in a safe place and switch off the engine to help prevent the risk of serious damage.
STOP ENGINE	Stop the car in a safe place and switch off the engine to help prevent the risk of serious damage.
SERVICE URGENT	Take your vehicle to a trained and qualified Volvo service technician for inspection immediately.
SEE MANUAL	Refer to your owner's manual. For additional information, please contact your Volvo retailer.
SERVICE REQUIRED	Take your vehicle to a trained and qualified Volvo service technician for inspection at your convenience (but preferably before the next scheduled maintenance service).
FIX NEXT SERVICE	Have the system affected inspected at the next scheduled maintenance service.
TIME FOR REGULAR SERVICE	This message will be displayed at 7,500 mile (12,000 km) intervals, after 750 hours of driving or after 12 months, whichever occurs first, to remind the driver that the service interval has been exceeded. The message will be displayed for 2 minutes each time the vehicle is started until reset by a trained and qualified Volvo service technician.
OIL LEVEL LOW - FILL OIL	Check the oil level and top up if necessary. See page 193.
OIL LEVEL LOW - STOP SAFELY	Stop as soon as possible and switch off the engine, check the oil level and top up if necessary. See page 193.
OIL LEVEL LOW - STOP ENGINE	Stop as soon as possible and switch off the engine, check the oil level and top up if necessary. See page 193.
OIL LEVEL LOW - SEE MANUAL	Stop as soon as possible and switch off the engine, check the oil level and top up if necessary. See page 193.
DSTC SPIN CONTROL OFF	The stability system's spin control function has been turned off. See page 138 for details.



Buttons in the center console

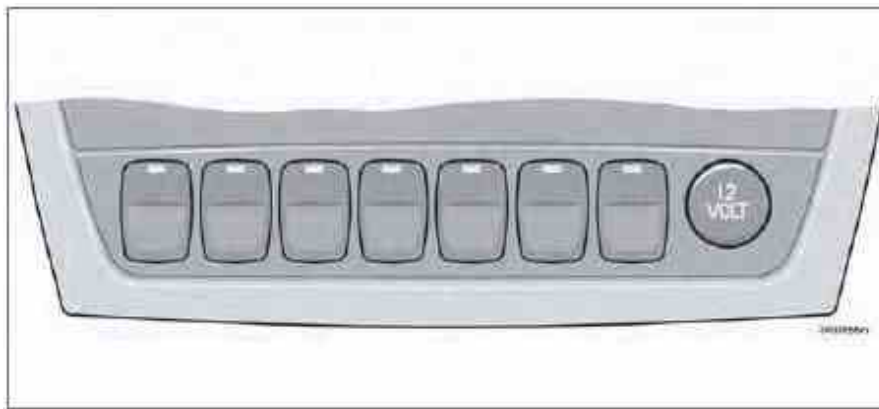

The positions of these buttons may vary, depending on the specifications of the vehicle.



Folding head restraints

This button is used to fold down the outboard rear head restraints. The ignition key must be in position I or II or the engine must be running.

NOTE

If the head restraints have been folded down, they must be returned to their original position manually. The head restraints should be in the upright position before the rear seat backrests are folded down.

WARNING

For safety reasons, no one should be allowed to sit in the outboard rear seat positions if the head restraints are folded

down. If these positions are occupied, the head restraints should be in the upright (fixed) position.



Valet lock (trunk lock)

Pressing this button locks the trunk, even if the doors are unlocked. The trunk will remain locked even if the



Buttons in the center console

doors are locked/unlocked using the master key or the remote control.

To use this function:

1. Turn the master key to position II.
2. Press the "Valet lock" button. An LED in the button will light up and "VALET LOCK ON" will be displayed in the text window to indicate that this function is activated.
3. The function can be turned off (deactivated) by turning the ignition key to position II and pressing the "Valet lock" button again (the LED in the button will go out and "VALET LOCK OFF" will be displayed in the text window).



Temporarily disconnecting the alarm sensors (option)

See [page 118](#) for more details.



12-volt socket

This 12- volt socket can be used to plug in certain accessories such as cellular telephones, etc. The ignition key must be in position 1 (or higher) for the auxiliary socket to function.

i NOTE

The auxiliary sockets can also be used for cigarette lighters, which are available at your Volvo retailer.



Front/rear park assist (option/accessory)

See [page 151](#) for more information on this function.

Active Bi-Xenon® headlights (ABL) - option



The beams of ABL headlights adjust laterally to help light up a curve according to movements of the steering wheel when the vehicle is turning. This function is activated automatically when the engine is started and can be deactivated/reactivated by pressing the button. The indicator light in the button is on when the function is activated. See also [page 57](#).



Steering wheel adjustment

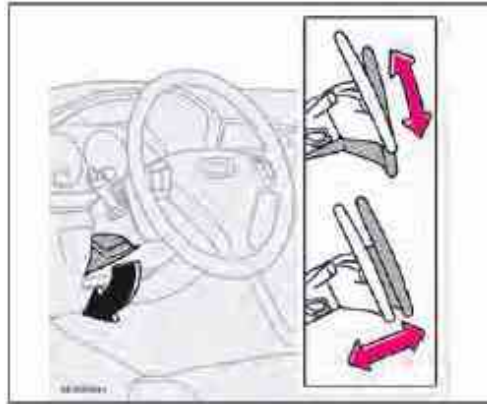

Both the height and the reach of the steering wheel can be adjusted to a comfortable position for the driver. Pull down the lever on the left of the steering column. Adjust the steering wheel to a suitable position and press the lever back into place to lock the steering wheel in the new position. Check that the steering wheel is locked in the new position.



WARNING

Never adjust the steering wheel while driving.



Lighting panel

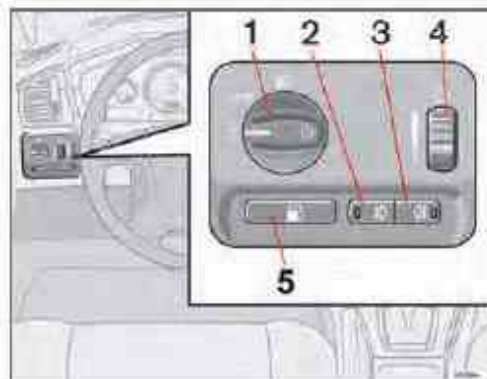

1. Headlight/parking light switch

2. Front fog lights
3. Rear fog light
4. Instrument panel lighting
5. Fuel filler door unlock button

Parking lights

The front and rear parking lights can be turned on even when the ignition is switched off.

- Turn switch 1 to position .

The license plate lights also illuminate when the parking lights are switched on.

Headlights

- Turn the ignition key to position II.
- The low beam headlights (daytime running lights) illuminate automatically, except when the light switch (1) is in position¹.

See [page 60](#) for information on switching between high and low beams.

NOTE

Active Bi-Xenon® headlights (option): Turn the headlight switch to position 0 to activate a daylight sensor, which automatically switches the low beams on or off, depending on ambient light conditions. When driving in daylight, the headlights will switch off and the daytime running lights will come on. In darkness, the daytime running lights will switch off and the Active Bi-Xenon® headlights will switch on.

¹On Canadian models, the daytime running lights will remain on with the light switch in this position.

Active Bi-Xenon® headlights (ABL) - option

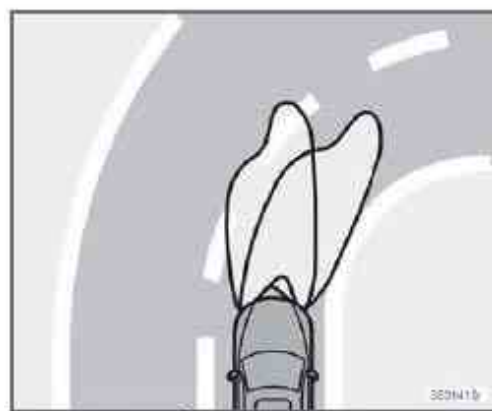

When the ABL function is activated, the headlight beams adjust laterally to help light up a curve according to movements of the steering wheel (see the right-pointing beam in the illustration above).

This function is activated automatically when the engine is started and can be deactivated/reactivated by pressing the ABL button (see [page 55](#)).



Lighting panel

Fog lights

Front fog lights (option)

The front fog lights can be used in combination with either the headlights or the parking lights.

- Turn the ignition key to position II.
- Press button 2 to turn on the front fog lights.

An indicator light in the button illuminates when the front fog lights are on.

Rear fog light

The single rear fog light is located in the driver's side tail light cluster. The rear fog light will only function in combination with the high/low beam headlights or the optional front fog lights.



- Turn the ignition key to position II.
- Press button 3 to turn on the rear fog light.

An indicator light in the button illuminates when the rear fog light is on.

NOTE

The rear fog light is considerably brighter than the normal tail lights and should be used only when conditions such as fog, rain, snow, smoke or dust reduce visibility for other vehicles to less than 500 ft. (150 meters).

Instrument panel lighting

The instrument panel lighting illuminates when the ignition key is in position II and the light switch (1) is in either position  or .

- Move the thumb wheel (4) up to increase brightness or down to decrease brightness.

Unlocking the fuel filler door

Press button 5 when the vehicle is at a standstill to unlock the fuel filler door. Please note that the fuel filler door will remain unlocked until the vehicle begins to move forward. An audible click will be heard when the fuel filler door relocks.

NOTE

If the fuel filler door does not unlock after the button has been pressed, drive the vehicle at a speed of at least 5 mph (8 km/h), stop the vehicle, and press the button again.

See the information below on unlocking the fuel filler door manually.



Fuel filler door-unlocking manually

Manually unlocking the fuel filler door

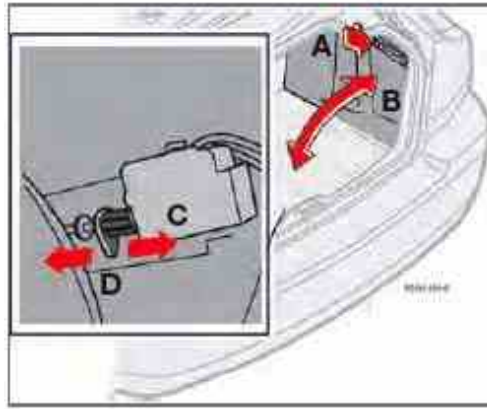

The electric motor that controls the fuel filler door locking mechanism is located on the inside of the rear fender on the passenger side of the vehicle, just behind the fuel filler door. To unlock this door manually:

- Turn the knob (A) 1/4 turn counterclockwise to release the cover panel (B).
- Fold down the cover panel to access the electric motor (C).

Press the catch (D) rearward to unlock the fuel filler door, or forward to lock the door.



Left-side steering wheel lever

Lever positions

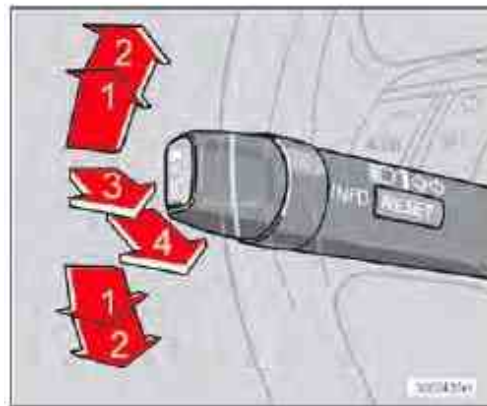

1. Turn signals, lane change position
2. Turn signals, position for normal turns
3. High beam flash
4. Toggle between high and low beams, Home Safe lighting

Turn signals

When turning

Move the lever as far up or down as possible (to position 2) to start the turn signals. The turn signals will be cancelled automatically by the movement of the steering wheel, or the lever can be returned to its initial position by hand.

When changing lanes

The driver can automatically flash the turn signals 3 times by:

- Moving the turn signal lever up or down to position 1 and releasing it.
- Moving the lever up or down to position 2 and immediately back to its original position.

NOTE

This automatic flashing sequence can be interrupted by immediately moving the lever in the opposite direction.

If the turn signal indicator flashes faster than normal, check for a burned-out turn signal bulb.

High/low beam headlights

Continuous high beams

- Turn the ignition key to position II.
- With the light switch (1) in position, (see [page 57](#)) pull the turn signal lever toward the steering wheel (position 4) to toggle between high and low beams (this also applies on models equipped with the optional Active Bi-Xenon® headlights).

High beam flash

- Turn the ignition key to position II.
- Pull the turn signal lever to position 3. The high beams will remain on until the lever is released.

Home safe lighting

When you leave your vehicle at night, you can make use of the home safe lighting function to illuminate the area in front of the vehicle.

- Remove the key from the ignition switch.
- Pull the direction indicator lever as far as possible towards the steering wheel (to position 4) and release it.
- Exit the vehicle and lock the doors.

The headlights and parking lights will illuminate and remain on for 30¹, 60 or 90 seconds. The time interval can be changed by a trained and qualified Volvo service technician.

¹Factory setting



Right-side steering wheel lever

Windshield wipers

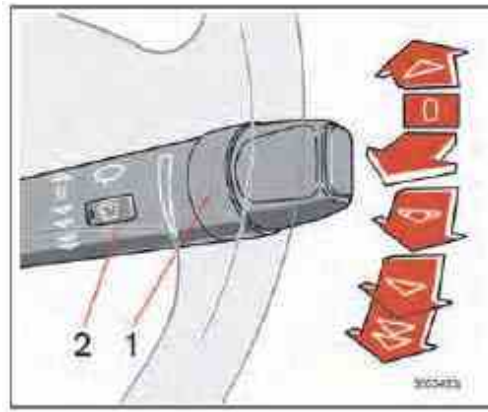

0 Windshield wipers off

If the lever is in the 0 position and you move it upwards, the wipers will sweep one stroke at a time for as long as you hold the lever up.

Intermittent wiper function

With the lever in this position, you can set the wiper interval by twisting the control ring 1 upward to increase wiper speed or downward to decrease the speed.

Headlight washer (certain models)

When the lever is pulled to wash the windshield, high pressure jets mounted in the bumper will spray the headlights.

- To conserve washer fluid in driving conditions where the windshield washers are used frequently, the headlights will only be washed once for every five times the windshield is washed within a 10-minute period.
- A short pull on the lever will wash the windshield only.
- When approximately 1 US quart (1 liter) remains in the washer fluid reservoir, the headlights will not be washed when the lever is pulled to conserve washer fluid for the windshield.

CAUTION

- Use ample washer fluid when washing the windshield. The windshield should be thoroughly wet when the wipers are in operation.
- Before using the wipers, ice and snow should be removed from the windshield. Be sure the wiper blades are not frozen in place.

Rain sensor (option)

The rain sensor automatically regulates wiper speed according to the amount of water on the windshield.

The **sensitivity** of the sensor can be adjusted by twisting ring 1 up (the wipers will sweep the windshield more frequently) or down (the wipers will sweep the windshield less frequently).

Activating the rain sensor

- Turn the ignition key to at least position I and put the windshield wiper lever in position 0.
- Press button 2.

An LED in the button will light up to indicate that the rain sensor is active.

Deactivating the rain sensor

- Press button 2.

or

- Move the windshield wiper lever **down** to another position.

Moving the lever up will not deactivate the rain sensor. Doing so will cause the wipers to sweep the windshield until the lever is released, at which time the wipers return to rain sensor mode.

62 02 Instruments and controls



Right-side steering wheel lever

CAUTION

The rain sensor should be deactivated when washing the vehicle in an automatic car wash, etc. If the rain sensor function is left on, the wipers will start inadvertently in the car wash and could be damaged.

 Continuous wiper function.

 Wipers operate at "high" speed.

63 02 Instruments and controls



Hazard warning flashers, door mirror defroster

Hazard warning flashers

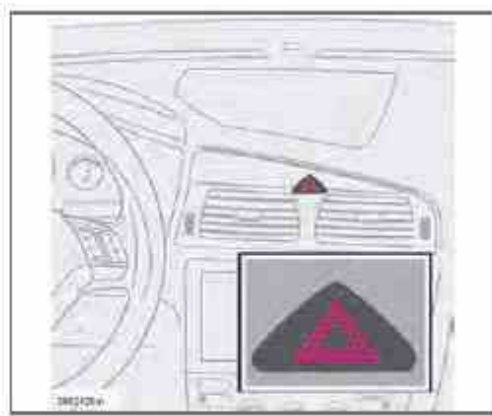

The four-way flasher should be used to indicate that the vehicle has become a traffic hazard. To activate the flashers, press the triangular button in the center dash. Press the button again to turn off the flashers.

NOTE

Regulations regarding the use of the hazard warning flasher may vary, depending on where you live.



Rear window and door mirror defroster

Press the switch to start heating the rear window and door mirrors to remove ice or condensation. An LED in the switch

will light up.

- A timer automatically switches off the heating after approximately 12 minutes. The LED will go out correspondingly.
- If the vehicle's speed is increased by using the accelerator pedal for more than 1 minute.



Trip computer



The trip computer stores information gathered from several systems in your vehicle and has four menus that can be displayed in the text window.

- Driving distance on current fuel reserve
- Average fuel consumption
- Current fuel consumption
- Average speed
- Current speed in mph (Canadian models only)
- DSTC (see [page 139](#) for detailed information)

NOTE

Warning messages from the vehicle's monitoring systems will override the trip computer function. If a warning message is displayed in the text window while you are using the trip computer, you must acknowledge the message by pressing button A. Press button A again to return to the trip computer function.

Trip computer controls and functions

The trip computer functions can be accessed by twisting INFO (B) one step at a time in either direction. Twisting a final time returns you to the original function.

The trip computer can be reset (current data will be erased from system memory) by pressing RESET (button C).

1. Driving distance on current fuel reserve

This function shows the approximate distance that can be driven on the fuel remaining in the tank. This calculation is based on average fuel consumption during the last 20 miles (30 km) of driving and the amount of fuel remaining in the tank when the reading was taken.

When the driving distance on current fuel reserve is less than 12 miles (20 km), "----" will be displayed in the text window.

2. Average fuel consumption

This value indicates fuel consumption since the last time the trip computer was reset (by pressing RESET, button C). When the engine is switched off, information on fuel consumption is stored and remains in system memory until the RESET (button C) is pressed again.

3. Current fuel consumption

This value indicates the current fuel consumption, based on readings taken once per second. When the vehicle is not moving, "----" will be displayed.

4. Average speed

This value indicates average speed since the last time the trip computer was reset (by pressing RESET, button C). When the engine is switched off, information on average speed is stored and remains in system memory until the RESET (button C) is pressed again.

5. Current speed in miles per hour (Canadian models only)

This function provides the driver with an instantaneous conversion of the vehicle's current speed from km/h to mph.

65 02 Instruments and controls



Trip computer

i NOTE

Trip computer readings may vary slightly depending on the circumference of the tires on the vehicle and driving style.

66 02 Instruments and controls



Cruise control

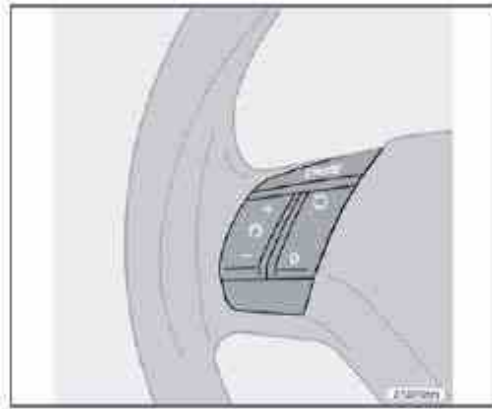

The cruise control panel is located on the left side of the steering wheel hub and may differ in appearance, depending on the model.

Engaging cruise control

Press the CRUISE button. CRUISE will be displayed in the information window in the instrument panel.

i NOTE

This does not set the vehicle's speed.

Setting speed

Press + or - to set the current speed. CRUISE-ON will be displayed in the information window in the instrument panel.

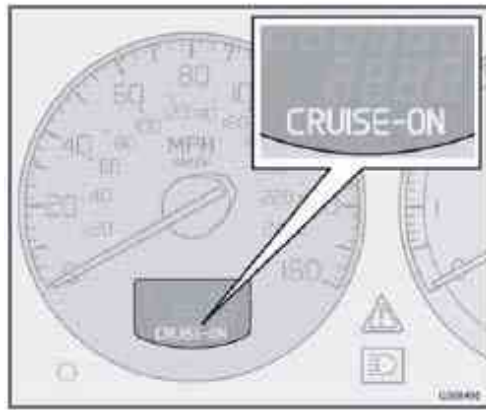

Increasing or decreasing speed

Use + or - in the following ways to increase or decrease the vehicle's speed

- Press and hold down + or - until the vehicle reaches the desired speed.
- Press + or - for approximately a half second and release the button to increase or decrease vehicle speed by approximately 1 mph (1.6 km/h).

NOTE

Cruise control will not function at speeds below approximately 20 mph (30 km/h).



Cruise control

Braking

- Cruise control is automatically disengaged when the brake pedal is depressed. The currently set speed is stored in memory.
- Pressing resume  will return the vehicle to the previously set speed.

Acceleration

Momentary acceleration, such as when passing another vehicle, does not affect cruise control operation. The vehicle will automatically return to the previously set speed when you release the accelerator pedal.

Disengaging cruise control

To disengage cruise control, press the CRUISE button. CRUISE or CRUISE-ON will no longer be displayed in the information window in the instrument panel.

NOTE

Cruise control is automatically disengaged if:

- the engine is switched off
- the gear selector is placed in (N)eutral
- the wheels start to spin or lock
- if an increase in speed is maintained for more than one minute
- if the vehicle's speed falls below approximately 20 mph (30 km/h).

Temporarily disengaging cruise control

- Press 0 to temporarily disengage cruise control. CRUISE will be displayed in the information window in the instrument panel.
- Press the brake pedal.

Press "resume"  to return to the previously set speed.

WARNING

Cruise control should not be used in heavy traffic or when driving on wet or slippery roads, or when driving on unpaved or uneven road surfaces. Cruise control may not maintain set speed on steep downgrades.



Parking brake

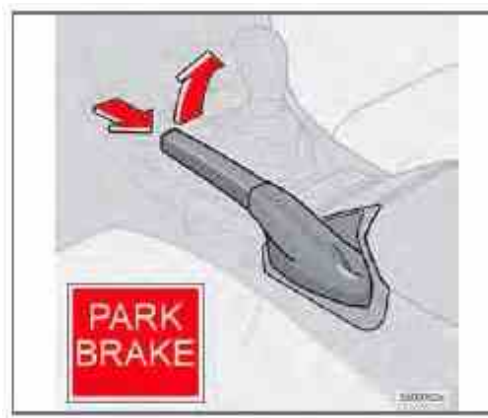

The parking brake lever is located between the front seats.

NOTE

The indicator light will light up even if the parking brake has only been partially applied.

When applying the parking brake

1. Press firmly on the brake pedal.
2. Pull the parking brake lever up firmly to its full extent.
3. Release the brake pedal and ensure that the vehicle is at a standstill.
4. If the vehicle rolls, the parking brake lever must be pulled more firmly.
5. When parking a vehicle always put the gear selector in first gear (for manual transmission) or P (for automatic transmission).

Parking on a hill

- If the vehicle is pointing uphill, turn the front wheels so that they point away from the curb.
- If the vehicle is pointing downhill, turn the front wheels so that they point toward the curb.

Releasing the parking brake

1. Press firmly on the brake pedal.

2. Pull the lever up slightly, press the button at the end of the lever and lower the lever completely.

WARNING

Pull up the parking brake lever up firmly to its full extent.



12-volt socket

Auxiliary sockets

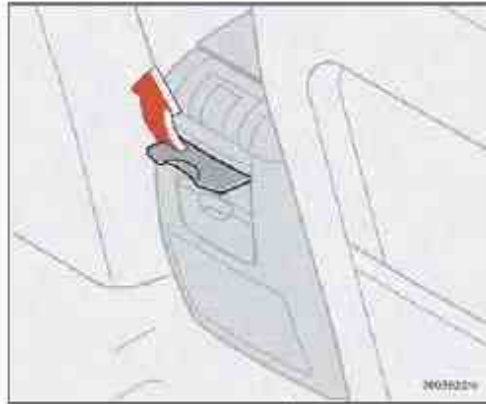

Auxiliary 12-volt socket (option in rear seat)

The 12-volt sockets can be used to plug in certain accessories such as cellular telephones, etc. The key must be in position I (or higher) for the auxiliary socket to function.

NOTE

The cover should be folded down when the auxiliary socket is not in use.

Cigarette lighter/ashtrays

The auxiliary sockets can also be used for cigarette lighters, which are available at your Volvo retailer.

Volvo vehicles in North America do not have an ashtray in the front seat as standard equipment. If you want to have an ashtray in the front seat, please contact your Volvo retailer.



Power windows

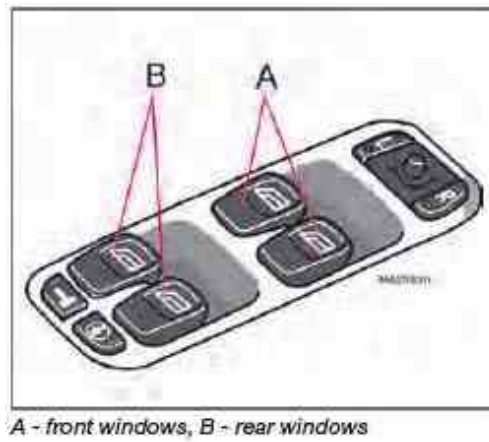

The power windows are controlled by buttons in the arm rests. The ignition switch must be ON¹ (ignition key in position I, II or the engine running) for the electrically operated windows to function.

To lower: Press down the front edge of the button to the first detent ("stop").

To raise: Lightly pull up the front edge of the button to the first detent ("stop").

¹The power windows will also function after the ignition has been switched off as long as neither of the front doors has been opened.

NOTE

To reduce buffeting wind noise if the rear windows are opened, also open the front windows slightly.

Auto up/down function (front doors only)

Either front door window can be opened or closed automatically.

Auto down

Press the front part of the button as far down as possible and release it immediately. To stop the window at any time, pull the button up.

Auto up

Pull the front part of the button up as far as possible and release it immediately. To stop the window at any time, press the button down.

NOTE

The electrically operated windows in the front seat have an overload protecting circuit breaker which reverses movement of the electrically operated windows to their starting points if they are obstructed in any way. Thereafter the windows will operate normally again.

WARNING

Always remove the ignition key when the vehicle is unattended.

Make sure that the windows are completely unobstructed before they are operated. Never leave children unattended in the vehicle.



Power windows

Cutout switch for rear windows

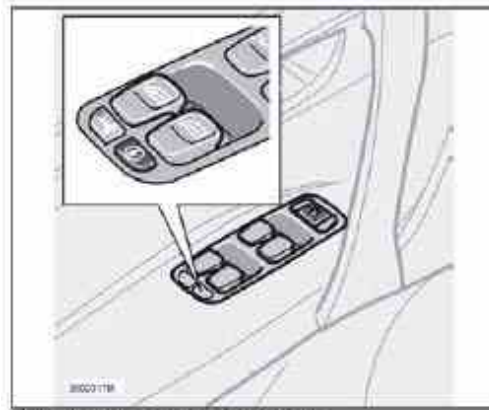

Cutout switch for rear windows

The electrically operated rear door windows can be disabled by a switch located on the driver's door (see illustration).

If the LED in the switch is OFF

The rear door windows can be raised or lowered with the buttons on the rear door armrests or with the buttons on the driver's door armrest.

If the LED in the switch is ON

The rear door windows can only be raised or lowered with the buttons on the driver's door armrest.

Power window on the front passenger's side



The control for the electrically operated window in the front passenger's seat operates that window only.

Power windows in the rear doors

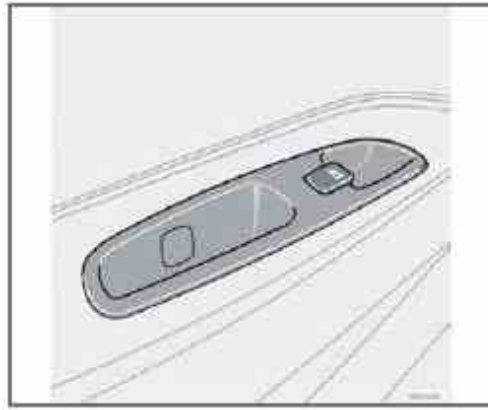

The rear door windows can be operated with the control on each door and the switch on the driver's door. If the LED in the switch for blocking electrically operated windows in the rear doors (located in the driver's door control panel) is on, the rear door windows can only be operated from the driver's door.



Mirrors

Rearview mirror

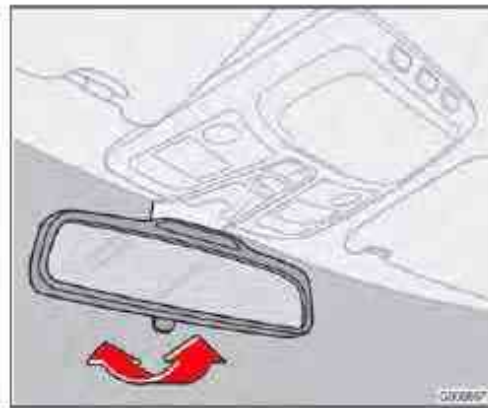

To reduce glare from the headlights of following vehicles, use the control to switch between the normal and night-driving positions.

- A. Normal position
- B. Night position, reduces glare from following headlights

Autodim function (option)

The autodim function reacts to headlights from following traffic and automatically reduces glare.

NOTE

This function is automatically switched off when the gear selector is placed in the Reverse position.

Rearview mirror with compass (option)

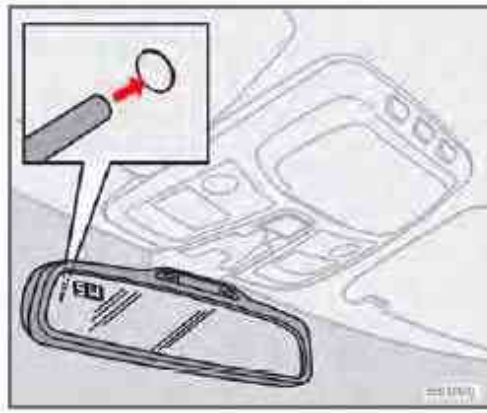

The upper left-hand corner of the rearview mirror has an integrated display that shows the compass direction toward which the car is pointing. Eight different directions can be displayed: N, NE, E, SE, S, SW, W and NW. The display shows your car's orientation with respect to true north.

If the compass is activated, it will be displayed automatically when the ignition is in position II or when the engine is running. The compass can be switched off or on by pressing the inset button on the rear side of the mirror (see the inset illustration). This can be done with straightened paperclip or similar



Mirrors

object. The button is recessed approximately 1 in. (2.5 cm) in the mirror.

Magnetic zones

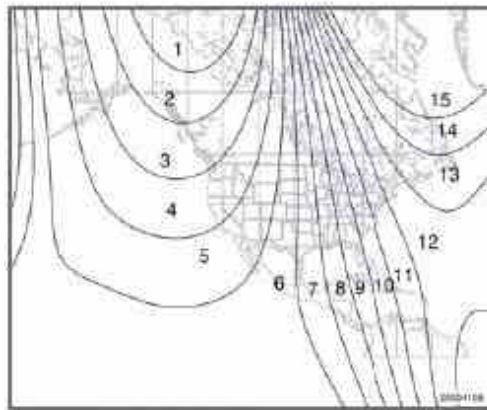

Selecting a magnetic zone

The earth is divided into 15 magnetic zones. The compass is initially set for the zone to which the car was delivered, and should always be adjusted if the car is driven to a new magnetic zone. To do so:

- Switch the ignition to position II.
- Press the button on the rear side of the mirror with straightened paperclip or similar object for approximately 3 seconds until ZONE is displayed. The number of the current magnetic zone will also be displayed.
- Press the button repeatedly until the number for the desired zone (1-15) is displayed.

After several seconds, the compass heading will again be displayed, and the change of magnetic zones is complete.



Mirrors

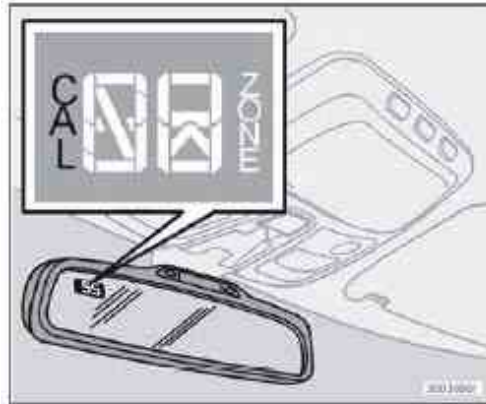

Calibrating the compass

Calibrating the compass

- Stop the car in a large, open area, away from traffic.
- Turn off as many electrical devices in the car as possible to avoid interference with the compass (e.g. audio system, etc).
- Using a pen or similar object, hold the button (1) depressed for at least 6 seconds. "CAL" will be displayed.
- Drive slowly in a circle at a maximum speed of 5 m.p.h. (8 km/h) until CAL is no longer displayed.

NOTE

This step can also be done by driving normally until CAL is no longer displayed.

Calibration is complete.

Power door mirrors

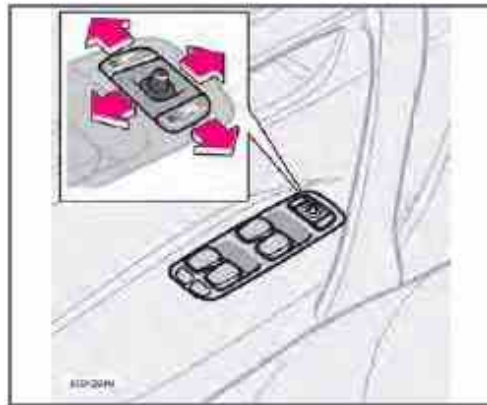

The mirror control switches are located on the driver's door armrest.

Driver's side

Press the L switch (an LED in the switch will light up) to activate the adjustment control and then use this control to adjust the driver's door mirror.

Passenger's door

Press the R switch (an LED in the switch will light up) and then use the adjustment control to adjust the passenger's door mirror.

After you have adjusted the mirror(s), press the L or R switch again (the LED will go out) to deactivate the adjustment control.



Mirrors

WARNING

The mirrors should always be adjusted prior to driving. Objects seen in the passenger's side wide-angle door mirror are closer than they appear to be.

Remote central locking and door mirror memory-option

If you lock the vehicle and later unlock it with the same remote control and open the driver's door, the door mirrors (and the driver's seat) will automatically move to the position they were in when you left the vehicle. This feature will work in the same way with all of the remote control transmitters (up to 3) that you use with your vehicle. This feature will not function if you lock your vehicle with the key.



Power moonroof (option)

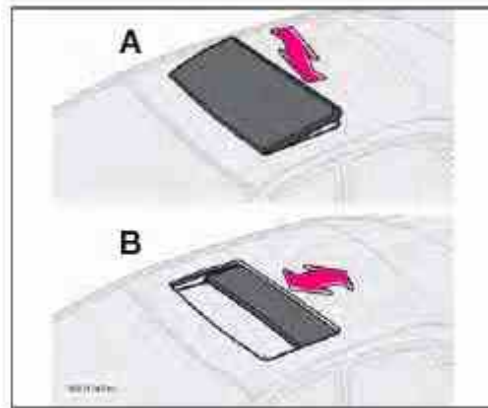

To operate the moonroof, turn the ignition key to position I or II, or start the engine. The moonroof can be operated in two ways:

- A. Tilt position
- B. Sliding moonroof

A. Tilt position

Open: With the moonroof closed, push up the rear edge of the switch (position 5 in the illustration below).

Close: Pull down and hold the rear edge of the switch (position 6 in the illustration below) until the moonroof has closed completely.

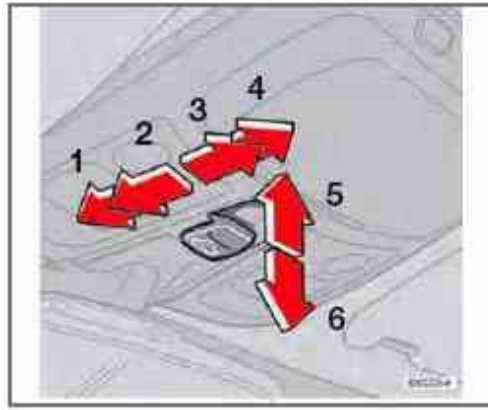

B. Sliding moonroof

Manual open: Pull the switch rearward to position 3 and hold it until the moonroof has opened to the position of your choice.

Auto open: Pull the switch as far back as possible (position 4) and release it to automatically slide open the moonroof to the "comfort"¹ position. Pull the switch rearward again to open the moonroof completely.

¹A position where the moonroof is not quite fully open, which helps alleviate "rumbling" wind noise.

Manual close: Push the switch to position 2 and hold it until the moonroof has closed completely or to the position of your choice.

Auto close: Push the switch forward as far as possible (position 1) and release it to automatically close the moonroof.

CAUTION

- Remove ice and snow before opening the moonroof.
- Do not operate the moonroof if it is frozen closed.
- Never place heavy objects on the moonroof.

WARNING

- Never open/close the moonroof if it is obstructed in any way when in operation.
- Never allow a child to operate the moonroof.
- Never extend any object or body part through the open moonroof, even if the vehicle's ignition is completely switched off.
- Never leave a child alone in a vehicle.



Power moonroof (option)

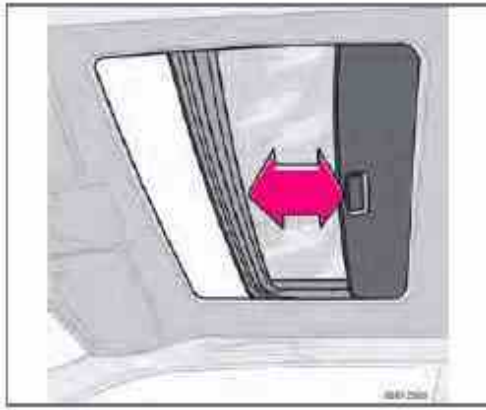

Sun visor

The optional moonroof also features a sliding sun visor. The visor slides open automatically when the moonroof is opened. The visor must be closed manually.



WARNING

The moonroof must never be obstructed in any way when in operation.



Home Link® Universal Transceiver (option)

Introduction

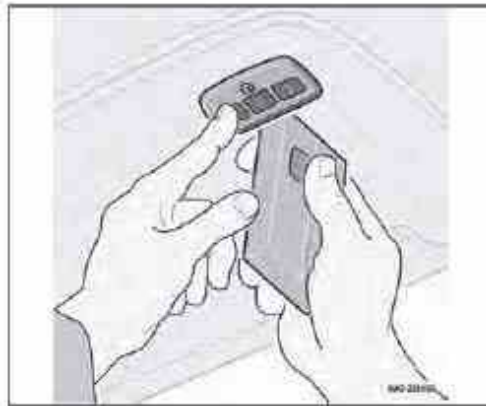

HomeLink¹ is a system that can be programmed to learn the codes of three different remote controlled-devices (for example, a garage door opener, remote lighting, entry gate). HomeLink's sun visor-mounted transceiver, powered by your car's electrical system, may then be used in place of your handheld remote controls. The HomeLink transceiver consists of three programmable buttons and an indicator light.

¹HomeLink is a registered trademark of Johnson Controls, Intl.



NOTE

- For your security, the HomeLink Universal Transceiver is designed to not function if you lock your car from the outside.

- Retain the original transmitter(s) for future programming procedures (for example, if you purchase a new vehicle).
- For your own security, erase all programmed buttons on the HomeLink Universal Transceiver when you sell your vehicle.
- Metallic sun protection films should not be used on any windows in a vehicle equipped with HomeLink Universal Transceiver. This could interfere with the transceivers function.

Operating the HomeLink Universal Transceiver

Once programmed, the HomeLink Universal Transceiver can be used in place of your handheld transmitters.

NOTE

The HomeLink universal transceiver will function for 30 minutes after the driver's door has been opened without switching on the vehicle's ignition.

Press the programmed HomeLink button to activate the garage door, driveway gate, security lightning, home security system etc.

Your original hand-held transmitters may, of course, be used at any time.

WARNING

- If you use HomeLink to open a garage door or gate, be sure no one is near the gate or door while it is in motion.
- Do not use the HomeLink Universal Transceiver with any garage door opener that lacks safety "stop" and "reverse" features as required by federal safety standards. (This includes any garage door opener model manufactured before April 1, 1982). A garage door opener that cannot "detect" an object, signalling the door to "stop" and "reverse" does not meet current federal safety standards. Using a garage door opener without these features increases the risk of serious injury or death. For more information on this matter, call toll-free 1-800-355-3515. (Internet: www.HomeLink.com).

Programming the transceiver for the first time (U.S. residents)

- For first time training, press and hold the two outer HomeLink buttons, releasing only when the HomeLink indicator light begins to flash after 20 seconds. (Do not perform this step when training the additional HomeLink buttons.)
- Position the hand-held transmitter 1-3 inches away from the HomeLink surface



Home Link® Universal Transceiver (option)

(located on your sun visor), keeping the HomeLink indicator light in view.

- Using both hands, simultaneously press and hold both the desired HomeLink button and hand held transmitter button. DO NOT release until the HomeLink indicator light flashes slowly and then rapidly. When the indicator light flashes rapidly, both buttons may be released. (The rapid flashing indicates successful training.)

NOTE

Some garage door openers may require you to replace step 3 with the "cycling" procedure noted in the "Programming the transceiver for the first time (Canadian residents)" section.

- Press and hold the trained HomeLink button and observe the indicator light.

If the indicator light is solid/continuous, training is complete and your device should activate when the HomeLink button is pressed and released.

- If the indicator light blinks rapidly for 2 seconds and then turns a solid/continuous light, proceed with the following training instructions for a rolling code device. A second person may make the following steps quicker and easier. Please use a ladder or other device. Do not stand on your vehicle to perform the next steps.

5. At the garage door opener receiver (motorhead unit) in the garage, locate the "learn" or "smart" button (usually near where the hanging antenna wire is attached to the unit). If there is difficulty locating the training button, reference the garage door opener's manual or contact us toll-free 1-800-355-3515 (Internet: www.HomeLink.com).

6. Press and release the "learn" or "smart" button (the name and color of the button may vary by manufacturer).

 **NOTE**

Once the button is pressed, there are 30 seconds in which to initiate the next step.

7. Return to the vehicle and firmly press and hold the trained HomeLink button for two seconds and release. Repeat the "press/hold/release" sequence up to 3 times to complete the training process.

To train additional HomeLink buttons, begin with step two.

Programming the transceiver for the first time (Canadian residents)

1. For first time training, press and hold the two outer HomeLink buttons releasing only when the HomeLink indicator light begins to flash after 20 seconds. (Do not perform this step when training the additional HomeLink buttons.)

2. Position the hand-held transmitter 1-3 inches (2.5-7.5 cm) away from the HomeLink surface (located on your) keeping the HomeLink indicator light in view.

3. Using both hands, simultaneously press and hold both the desired HomeLink button and hand held transmitter button. During programming, your handheld transmitter may automatically stop transmitting. Continue to press and hold the desired HomeLink button while you press and re-press ("cycle") your handheld transmitter every two seconds until the frequency signal has been learned. The indicator light will flash slowly and then rapidly after several seconds upon successful training. DO NOT release until the HomeLink indicator light flashes slowly and then rapidly. When the indicator light flashes rapidly, both buttons may be released. (The rapid flashing indicates successful training.)



Home Link® Universal Transceiver (option)

4. Press and hold the trained HomeLink button and observe the indicator light.

- If the indicator light is solid/continuous, training is complete and your device should activate when the HomeLink button is pressed and released.
- If the indicator light blinks rapidly for 2 seconds and then turns a solid/continuous light, proceed with the following training instructions for a rolling code device. A second person may make the following steps quicker and easier. Please use a ladder or other device. Do not stand on your vehicle to perform the next steps.

5. At the garage door opener receiver (motorhead unit) in the garage, locate the "learn" or "smart" button (usually near where the hanging antenna wire is attached to the unit). If there is difficulty locating the training button reference the garage door opener's manual or contact us.

6. Press and release the "learn" or "smart" button (the name and color of the button may vary by manufacturer).

NOTE



Once the button is pressed, there are 30 seconds in which to initiate the next step.

7. Return to the vehicle and firmly press and hold the trained HomeLink button for two seconds and release. Repeat the "press/hold/release" sequence up to 3 times to complete the training process.



NOTE

During programming, your hand-held transmitter may automatically stop transmitting. Continue to press and hold the desired HomeLink button while you press and repress ("cycle") your hand-held transmitter every two seconds until the frequency signal has been learned. The indicator light will flash slowly and then rapidly after several seconds upon successful training. If necessary, follow steps 5-7 to complete the training for a rolling code device.

To train additional HomeLink buttons, begin with step two.

Rolling Code Programming

Rolling code garage door openers that are "code-protected" and manufactured after 1996 may be determined by the following:

- Reference the garage door opener owner's manual for verification.
- The handheld transmitter appears to program the HomeLink Universal Transceiver but does not activate the garage door.
- Press and hold the trained HomeLink button. The garage door opener has the rolling code feature if the indicator light flashes rapidly and then turns solid after 2 seconds.

To train a garage door with the rolling code feature, follow these instructions (the aid of a second person may make the training quicker and easier):

1. Locate the training button on the garage door opener motor head unit. Exact location and color of the button may vary by garage door opener brand. If there is difficulty locating the training button, reference the garage door opener owner's manual or please visit our Web site at www.homelink.com.
2. Press the training button on the garage door opener motor head unit (which activates the "training light").



NOTE

Following step 2, there are 30 seconds in which to initiate step 3.

3. Firmly press and release the programmed HomeLink® button. Press and release the HomeLink button a second time to complete the training process. (Some garage door openers may require



Home Link® Universal Transceiver (option)

you to do this procedure a third time to complete the training.)

The garage door opener should now recognize the HomeLink Wireless Control System. The remaining two buttons may now be trained if this has not previously been done. Refer to the Programming portion of this text. The HomeLink Wireless Control System (once programmed) or the original handheld transmitter may be used to activate the garage door. In the event that there are still difficulties in programming the HomeLink Wireless Control System, please visit our Web site, www.homelink.com.

Reprogramming a Single HomeLink Button

To program a device to HomeLink using a HomeLink button previously trained, follow these steps:

1. Press and hold the desired HomeLink button. Do NOT release until step 4 has been completed.
2. When the indicator light begins to flash slowly (after 20 seconds), position the handheld transmitter 1 to 3 inches away from the HomeLink surface.
3. Press and hold the handheld transmitter button. The HomeLink indicator light will flash, first slowly and then rapidly.
4. When the indicator light begins to flash rapidly, release both buttons.

The previous device has now been erased and the new device can be activated by pushing the HomeLink button that has just been programmed. This procedure will not affect any other programmed HomeLink.

Erasing Channels

Individual buttons cannot be erased. However, to erase all three programmed buttons:

1. Press and hold the two outside buttons until the indicator light begins to flash (after 20 seconds).
2. Release both buttons.

The HomeLink® Wireless Control System is now in the training (learning) mode and can be programmed at any time following steps 2 through 4 in the Programming section.



[Contents](#) | [Top of Page](#)

2008 VOLVO S60

82 03 Climate



Climate control systems - general information [84](#)

Air distribution [85](#)

Electronic Climate Control, ECC [86](#)

83 03 Climate



84 03 Climate



Climate control systems - general information

Condensation on the inside of the windows

The defroster function should be used to remove fog or mist from the inside of the windows. Keeping the windows clean with a commercially available window washing spray will also help prevent fogging or misting.

Ice and snow

Always keep the air intake grille at the base of the windshield free of snow.

Cabin air filter

Replace the cabin air filter with a new one at the recommended intervals. Please refer to your Warranty and Service Records Information booklet, or consult a trained and qualified Volvo service technician for these intervals. The filter should be replaced more often when driving under dirty and dusty conditions. The filter cannot be cleaned and therefore should always be replaced with a new one.

Sensors

The sunlight sensor on the dashboard and passenger compartment temperature sensor in the ECC control panel should not be covered in any way as this could cause incorrect information to be sent to the ECC system.

Parking the vehicle in warm weather

If your vehicle has been parked in the sun in warm weather, opening the windows and moonroof (option) for several minutes before driving will help release the warm air from the passenger compartment. When the engine is running, close the windows and moonroof and use the recirculation function for several minutes to enable the air conditioning to cool the compartment as quickly as possible.

Windows and optional moonroof

The ECC system will function best if the windows and optional moonroof are closed. If you drive with the moonroof open, we recommend that you manually adjust the temperature and blower control (the LED in the AUTO switch should be off).

Acceleration

The air conditioning is momentarily disengaged during full-throttle acceleration.

Climate control maintenance

Special tools and equipment are required to maintain and carry out repairs on the climate system. Work of this type should only be done by a trained and qualified Volvo service technician.

Refrigerant

Volvo cares about the environment. The air conditioning system in your vehicle contains a CFC-free refrigerant - R134a (HFC134a). This substance will not deplete the ozone layer. The system contains 1.5 lbs (700 g) R134a and uses PAG oil.

Climate system blower

The climate system blower will be automatically switched off when the engine is not running (even if the ignition key is in position I or II) to avoid unnecessary battery drain. To activate the blower, turn the control to the desired setting.

Passenger compartment blower

Approximately 50 minutes after the ignition is turned off, the blower may come on automatically, and run for seven minutes, to remove condensation in the A/C evaporator.



Air distribution

Air distribution

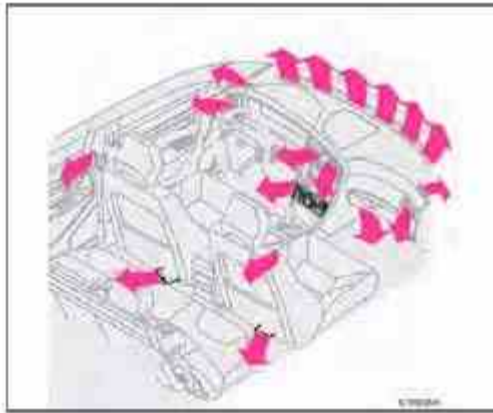

The incoming air is distributed through 14 ventilation points in the passenger compartment.

Air vents in the dash

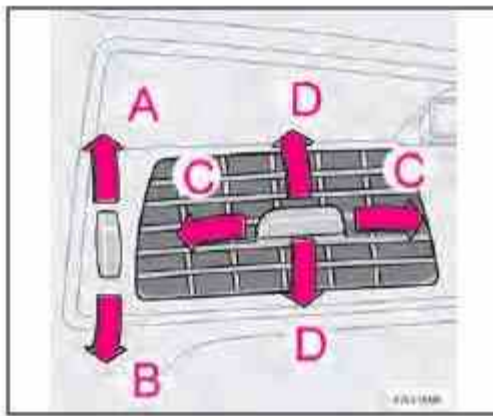

- A. Open
- B. Closed
- C. Horizontal air flow
- D. Vertical air flow

- Direct the outer air vents toward the side windows to defrost.
- In cold weather, close the air vents in the center of the dash to direct as much air as possible toward the windows.

Air vents in the door pillars

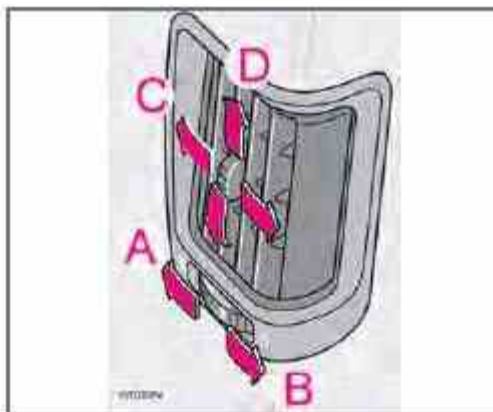

- A. Open
- B. Closed
- C. Horizontal air flow
- D. Vertical air flow

- Direct the outer air vents toward the side windows to defrost.
- In cold weather, close the air vents in the center of the dash to direct as much air as possible toward the windows.



Electronic climate control, ECC

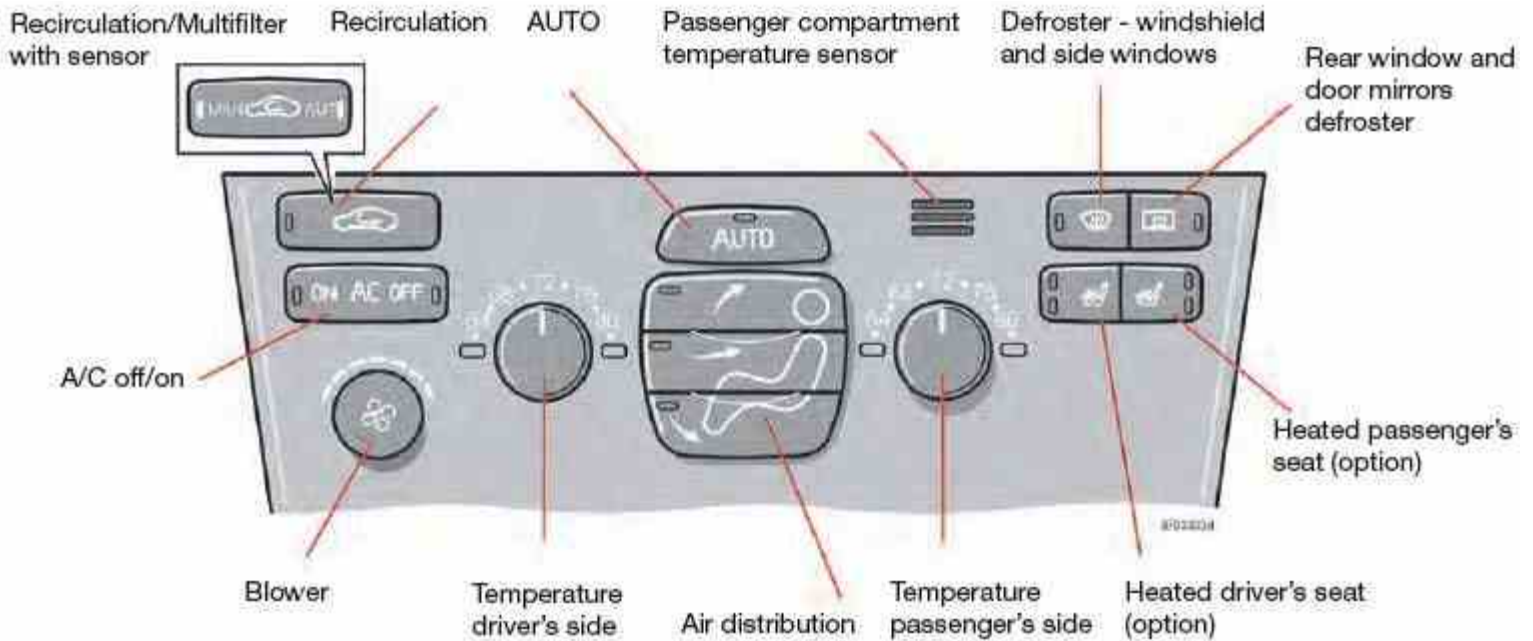

Electronic climate control, ECC



This function automatically regulates the Electronic Climate Control system so that the selected temperatures are maintained. The blower, heating, air distribution (air flow), air conditioning, and optional air quality sensor are controlled. If you prefer to manually set any of these functions, the remaining functions will still be controlled automatically. Pressing the AUTO button overrides any settings that were previously made manually.

Rear window and door mirror defrosters



This function defrosts/de-ices the rear window and door mirrors.

The LED in the switch will light up to indicate that the heating function is engaged. See page 63 for additional information on this function.

NOTE

Never use ice scrapers made of metal as they can easily scratch the mirror surface.



Temperature

These controls are used to individually set the temperature for both sides of the passenger compartment. Please note that the compartment will not be heated or cooled faster by setting the temperature higher or lower than necessary.

Set the control to the temperature you prefer.



Defroster

This function defrosts/de-ices the windshield and front side windows. The LED in the switch will light up to indicate that the defrost function is engaged.

- Blower speed increases automatically and the air conditioning will switch on (if not already on and if the passenger compartment blower is not turned off) to dehumidify the air in the passenger compartment.
- Recirculation will not function while defrost is engaged.
- The climate system will return to its previous settings when the defroster function is switched off.



Blower control

Turn the control clockwise to increase or counterclockwise to decrease the blower speed. Pressing the AUTO switch will automatically regulate blower speed and override manual adjustment.

Turning the blower control counterclockwise until an orange LED comes on will turn both the blower and the air conditioning off.

Air distribution



- Air flow to windows
- Air through panel vents
- Air through floor vents

Press **AUTO** to automatically regulate air flow or press any combination of the controls shown in the illustration to manually adjust air flow. An LED in the switch will light up if an air flow control has been pressed.



Electronic climate control, ECC



Heated front seats (option)

- Press the switch once for maximum seat heating. Both LEDs in the switch will be lit.
- Press the switch a second time for comfort heating. One LED in the switch will be lit.
- Press the switch a third time to turn the heating off completely. The LED will go off.

The seat heating for the passenger seat should be switched off when the seat is not occupied.



A/C - ON/OFF

Press the switch to turn the air conditioning on or off. The "ON" or "OFF" LED will light up to indicate if the system is switched on or off. Other functions will still be regulated automatically (if the **AUTO** switch is on).

- The air conditioning functions only at temperatures above 32 °F (0 °C).
- While the Defroster function is selected, the air conditioning is temporarily activated to dehumidify the air, even if you have manually switched the air conditioning off. This will only function if the blower is not switched off.



Recirculation

Press this switch to engage the recirculation function (air in the passenger compartment recirculates - no fresh air enters the compartment). The LED in the switch will light up to indicate that the function is engaged.

- Use this function if the outside air is contaminated with exhaust gases, smoke, etc or to heat/cool the vehicle quickly.
- Recirculation should not be used for more than 15 minutes. *If your windows begin to fog or mist, make sure that the*

recirculation function is switched off.

- Selecting **Defroster** automatically switches recirculation off.
- Timer mode activation: (vehicles with the Interior Air Quality system have no timer mode) Press and hold the recirculation button for at least 3 seconds to activate a recirculation timer mode. The amber LED in the recirculation button will flash 5 times to show that the timer mode is being activated. In timer mode, each time the recirculation button is pressed, the climate control system will recirculate the air in the passenger compartment for 5-12 minutes, depending on the outside air temperature, and then revert back to fresh air.
- Timer mode deactivation: Press and hold the recirculation button for 3 seconds. The amber LED in the recirculation button will illuminate steadily for 5 seconds to show a return to "normal" mode.
- In normal mode, when the recirculation button is pressed, the climate control system will recirculate the air in the passenger compartment until the recirculation button is pressed again.
- Timer mode memory: If the vehicle is turned off while timer mode is active, timer mode will still be active when the vehicle is restarted.



Interior air quality sensor (option)

Some vehicles are equipped with a multifilter and air quality sensor. The filter separates gases and particles, thereby reducing the amounts of odors and contaminants entering the vehicle. The air quality sensor detects increased levels of contaminants in the outside air. When the air quality sensor detects



Electronic climate control, ECC

contaminated outside air, the air intake closes and the air inside the passenger compartment is recirculated, i.e. no outside air enters the vehicle. The filter also cleans recirculated passenger compartment air.

When the ECC system is in the AUTO mode, the green LED will be on .

Operation

Press  to operate the air quality sensor (normal setting).

or

Select one of the following three functions by pressing  1, 2 or 3 times.

1. The AUT LED lights. The air quality sensor is now activated.
2. No LED lights. Recirculation is not activated unless needed to cool the passenger compartment in a warm climate.
3. The MAN LED lights. Recirculation is now activated.

Keep in mind the following

- Make it a rule to have the air quality sensor activated at all times.
- Recirculation is limited in cold climates to avoid fogging.
- If window fogging occurs, you should deactivate the air quality sensor.
- If fogging occurs, use the defroster functions for the windshield, side windows and rear window. See [page 63](#).

The filter should be changed at the intervals recommended in the service schedule. However, if the vehicle is used in a severely contaminated environment, it may be necessary to change the filter more frequently.



[Contents](#) | [Top of Page](#)

2008 VOLVO S60

90 04 Interior



- Front seats [92](#)
- Interior lighting [97](#)
- Storage compartments [99](#)
- Rear seat and trunk [103](#)
- Spare wheel, tools and jack [106](#)

91 04 Interior



92 04 Interior



Front seats

Manually adjusted front seats



1. Front-rear adjustment: lift the bar and move the seat to the position of your choice.

2. Raise/lower the front edge of the seat cushion (option): use the control to pump the front edge of the cushion up or down.

3. Raise/lower seat height: pump the seat up or down.
4. Lumbar support: turn the control for firmer or softer lumbar support.
5. Backrest tilt: turn the control to adjust the angle of the backrest.
6. Control panel for optional power seat (see [page 94](#) for more information).

WARNING

Do not adjust the seat while driving. The seat should be adjusted so that the brake pedal can be depressed fully. In addition, position the seat as far rearward as comfort and control allow.

Check that the seat is securely locked into position after adjusting.



Front seats

Folding the backrests in the front seat



The front passenger seat backrest can be folded to a horizontal position to make room for a long load. Fold the backrest as follows:

- Move the seat as far back as possible.
- Adjust the backrest to the upright position.
- Lift the catches on the rear of the backrest.
- Without releasing the catches, push the backrest forward.
- Move the seat as far forward as possible so that the head restraint slides under the glove compartment.

WARNING

Cover sharp edges on the load to help prevent injury to occupants. Secure the load to help prevent shifting during sudden stops.



Front seats

Power seat - (option on certain models)

Operation

Driver's seat: The seat can be adjusted if the ignition key is in position I, II or if the engine is running. It can also be adjusted as follows **with the ignition off:**

- Within several minutes after the driver's door has been unlocked from the outside, has been opened, and remains open.
- Within a short period if the driver's door has just been closed.
- Within a short period if the driver's door has not been opened after the ignition has been switched off.

Passenger seat: The seat can only be adjusted if the ignition key is in position I, II or if the engine is running.

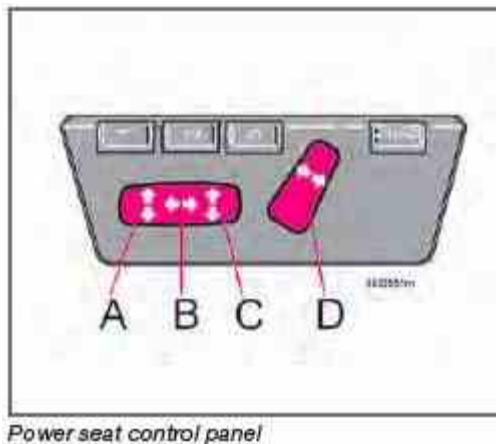

- A. Front edge of seat (raise/lower)
- B. Front - rear
- C. Rear edge of seat (raise/lower)
- D. Backrest tilt

Seat adjustment

If your Volvo is equipped with power seats, the following may be adjusted with the two switches at the side of the seat:

NOTE

The power seats have an overload protector that activates if a seat is blocked by any object. If this occurs, switch off the ignition (key in position 0) and wait for a short period before operating the seat again.

Emergency stop

If the seat accidentally begins to move, press any of the buttons to stop the seat.

Remote keyless entry system and the driver's seat

The remote control transmitter also controls the position of the electrically operated driver's seat in the following way:

1. Adjust the seat to your preferences.
2. When you leave your vehicle, lock it using the remote control.

The position of the seat is now stored in the remote control.

Automatic seat adjustment

To move the seat to the position in which you left it:

1. Unlock the driver's door with the same remote control (the one used to lock the doors)



Front seats

2. Open the driver's door within 2 minutes.

The driver's seat will automatically move to the position in which you left it.

NOTE

- The seat will move to this position even if someone else has moved it to a different seating position and locked the vehicle with a different remote control.
- This feature will work in the same way with all of the remote control transmitters (up to 3) that you use with your vehicle.
- This feature will not function if you lock your vehicle with the key.

WARNING

- Because the driver's seat can be adjusted with the ignition off, children should never be left unattended in the vehicle.
- Movement of the seat can be STOPPED at any time by pressing any button on the power seat control panel.
- Do not adjust the seat while driving. The seat should be adjusted so that the brake pedal can be depressed fully. In addition, position the seat as far rearward as comfort and control allow.
- The seat rails on the floor must not be obstructed in any way when the seat is in motion.

Programming the memory (option)

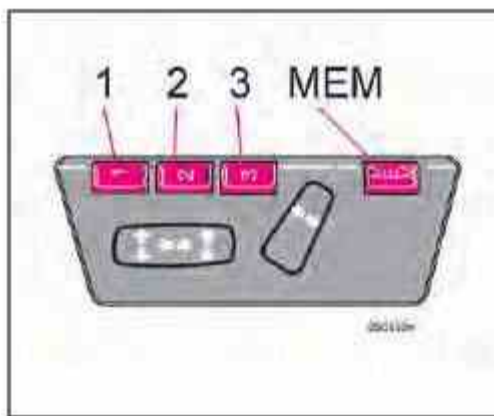

Three different seating and door mirror positions can be stored in the driver seat's memory.

The following example explains how button 1 can be programmed. Buttons 2 and 3 can be programmed in the same way.

To program (store) a seat position in button 1:

1. Move the seat to the desired position using the seat adjustment controls (see the previous page).
2. Press and hold down the MEM (memory) button.



Front seats

3. With the MEM button depressed, press button 1 briefly to store the seat's current position.

To move the seat to the position that it was in when button 1 was programmed:

Press and hold down button 1 until the seat stops moving.

As a safety precaution, the seat will stop automatically if the button is released before the seat has reached the preset position.



Interior lighting

Reading lights and courtesy light

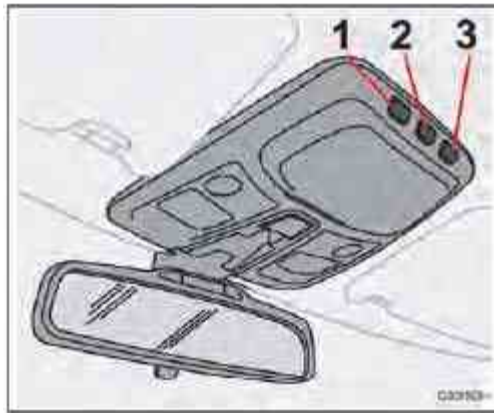

1. Driver's side front reading lamp
2. Courtesy lights
3. Passenger's side front reading lamp

The reading lights can be switched on or off by pressing buttons 1 or 3.

The courtesy lighting (including footwell lighting) can be turned on or off by pressing button 2. This also activates the automatic function.

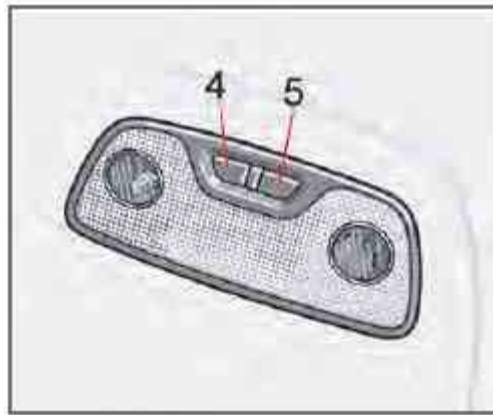

Rear reading lights

4. Driver's side rear reading light

5. Passenger's side rear reading light

The rear reading lights can be switched on and off by pressing buttons 4 or 5.

Automatic function

The reading lights and courtesy lights will switch off automatically approximately 10 minutes after the engine has been turned off. The lights can be turned off sooner by pressing the respective buttons.

The courtesy lights come on automatically¹ and remain on for approximately 30 seconds when:

- The vehicle has been unlocked from the outside with the remote control or key
- If the engine has been switched off and the ignition key has been turned to position 0

The courtesy lights will come on and remain on for approximately 10 minutes when:

- One of the doors is opened (assuming the courtesy lighting has not previously been switched off)

The courtesy lighting will go off when:

- The engine is started
- The vehicle is locked from the outside with the remote control or key

The automatic function can be disconnected by pressing button 2 for more than 3 seconds.

Briefly pressing the button again automatically reconnects the function.

The courtesy light timer periods can be changed. Contact a trained and qualified Volvo service technician.

¹This function is light dependent and is only activated in dark conditions.



Interior lighting

Vanity mirror

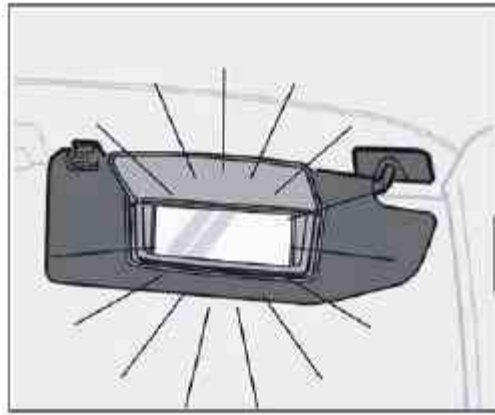

The light comes on when you open the cover.

Glove compartment lighting

The light in the glove compartment comes on or switches off when its door is opened or closed.



Storage compartments

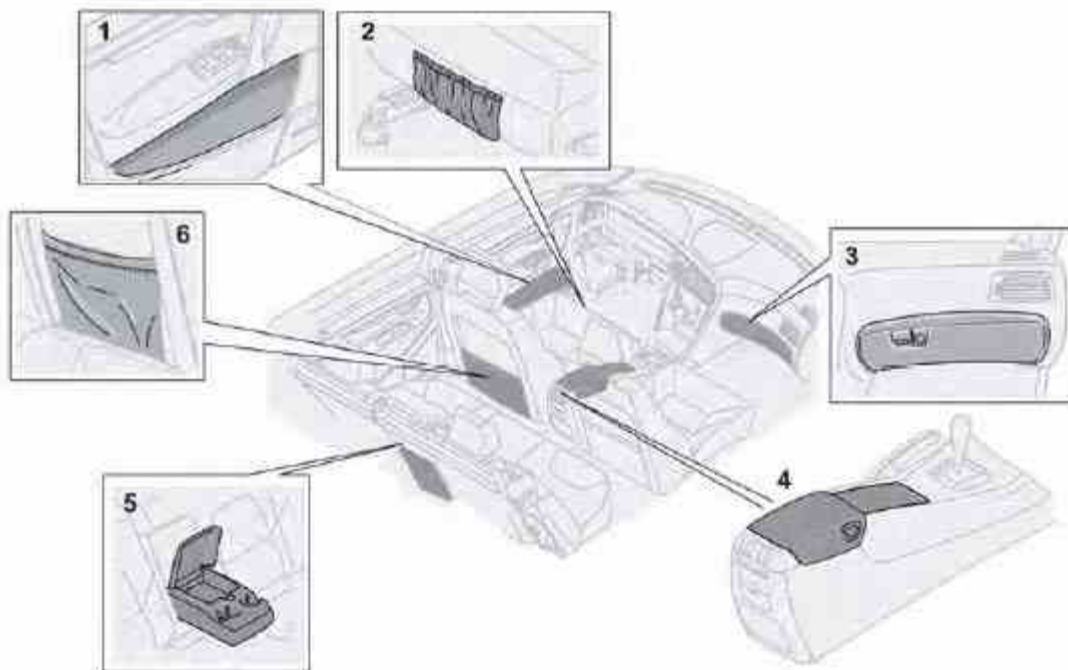

1. Storage compartment in door
2. Storage pocket in front edge of front seat
3. Glove compartment
4. Storage compartment and cup holders in center console (see [page 100](#) for more information)
5. Storage space and cup holders in rear seat armrest
6. Storage pocket in rear side of front seats



Storage compartments

WARNING

Packages on the rear window shelf can obscure vision and may become dangerous projectiles in the event of a sudden stop or an accident.

Anchor any heavy objects to help prevent them from moving during sudden stops.

Storage compartments in the center console

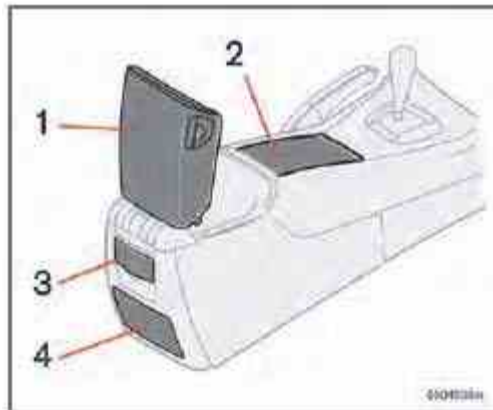

1. Storage compartment cover
2. Front storage compartment
3. 12-volt socket
4. Space for accessory ashtray

Cup holder for rear seat passengers

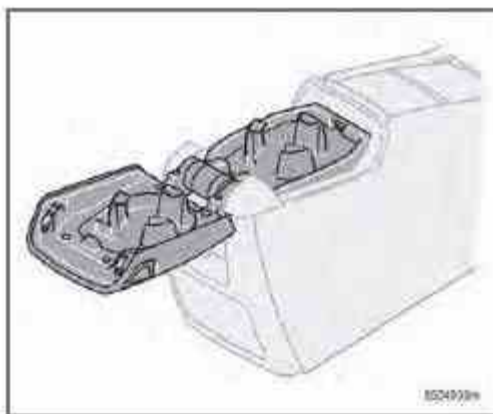

- To access the storage compartment, press the button on the left side of the armrest and fold the entire cover rearward.
- To open the rear seat cup holder, press the button on the right side of the armrest. Fold the upper section of the cover rearward.

The two sections of the cover can be closed separately.



Storage compartments

Cup holders in the center console

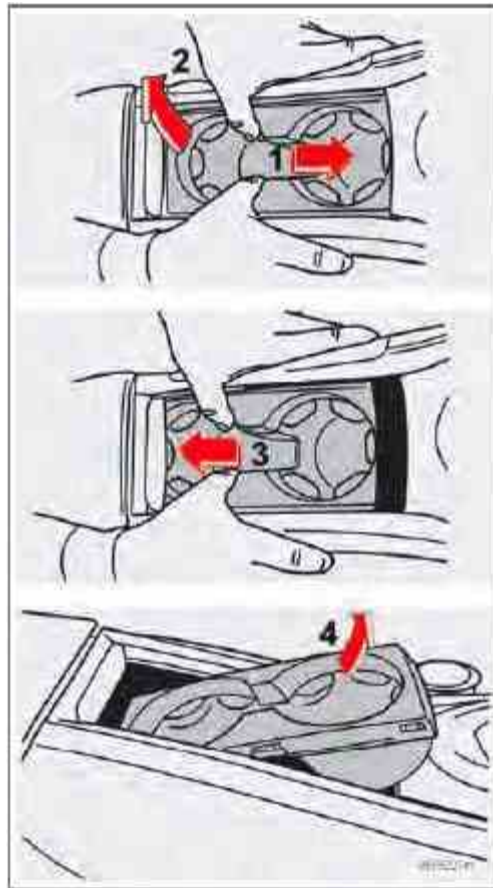

To remove the cup holders:

1. Press the cup holder forward (1), while lifting the rear edge (2).
2. Move the cup holder rearward (3), into the groove under the sliding cover.
3. Angle the front edge of the cup holder upward (4) and lift it out.

Return the cup holder to the storage space in the reverse order.



Storage compartments

Glove compartment

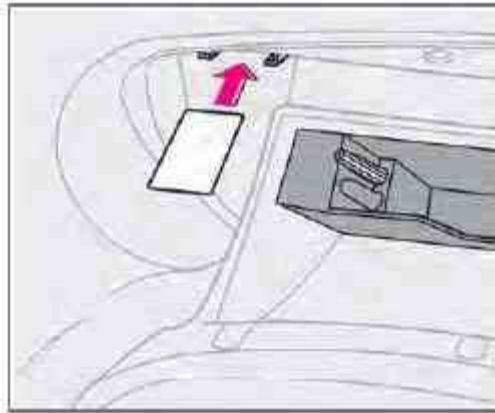

Card holder in glove compartment

The glove compartment can be used to store things such as the owner's manual, maps, pens, etc.

Jacket hanger

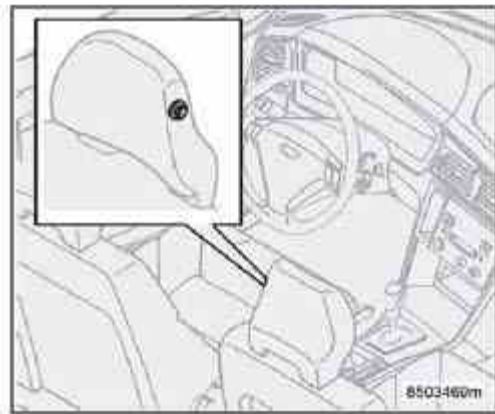

The jacket hanger is located on the inboard side of the front passenger's seat head restraint. It is only intended for hanging light garments.



Rear seat and trunk

Folding the rear seat backrest

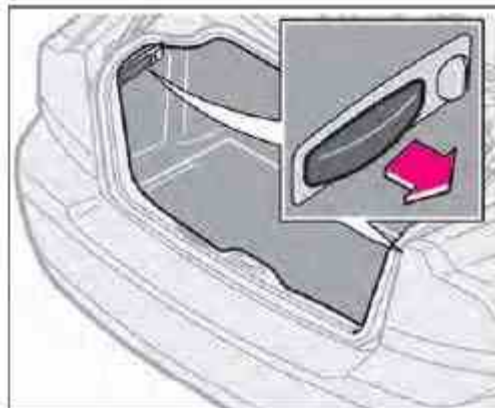

Backrest release handles in trunk

Both rear seat backrests can be folded down, together or individually to enable you to transport long objects.

Fold the rear seat backrests as follows:

1. Check first that the head restraint is folded down.
2. Pull the handle in the cargo compartment as shown in the illustration.
3. Fold the backrest down.

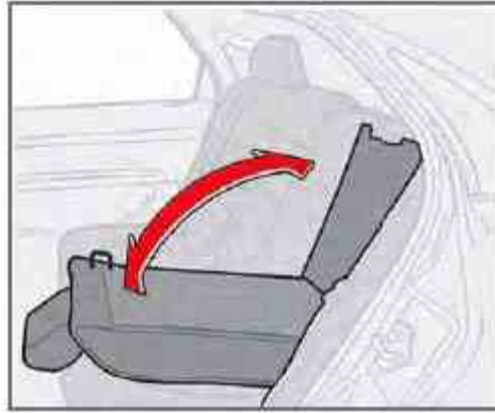

WARNING

Keep vehicle doors and the luggage compartment locked and keep keys out of a child's reach. Unsupervised children could lock themselves in an open trunk and risk injury. Children should be taught not to play in vehicles.

On hot days, the temperature in the trunk or vehicle interior can rise very quickly. Exposure of people to these high temperatures for even a short period of time can cause heat-related injury or death. Small children are particularly at risk.



WARNING

- When the backrest is returned to the upright position, check that it is properly locked in place. Return the head restraints to the upright position.
- Long loads should always be securely anchored to help avoid injury in the event of a sudden stop.
- Always turn the engine off and apply the parking brake when loading/unloading the vehicle.
- Place the transmission in the **P** position (automatic transmission) to help prevent inadvertent movement of the gear selector.
- The vehicle features a 60/40 split fold-down rear seat. This function is performed by handles inside the trunk, and also provides a means for children and adults to enter the passenger compartment in the event they become locked inside the trunk.
- Adults are advised to familiarize themselves with the operation and location of the release handles.
- To fold down the rear seats from inside the trunk, pull the release control handles located on either side of the trunk.



Rear seat and trunk

Carrying long loads (ski hatch)

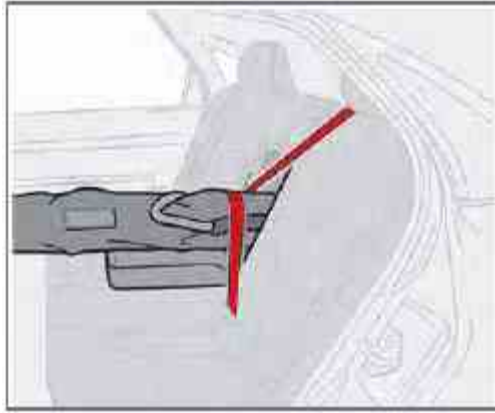

The center backrest cushion folds forward, allowing you to transport long, light cargo such as skis in the trunk of your vehicle. To lower the backrest:

1. Pull the right release control handle in the trunk to release the backrest (see [page 103](#)).
2. From the rear seat, fold down the right section of the backrest slightly.
3. Release the flap by pushing the catch (located on the rear side of the backrest) upward and pulling the flap forward.
4. Return the backrest to the upright position.

The cover on the rear seat armrest does not have hinges and should be removed before the ski hatch is used.

To remove:

1. Open the cover approximately 30°.
2. Pull it straight up.

To put in place:

1. Press the cover into the groove behind the upholstery.
2. Close the cover.

Grocery bag holder (option)

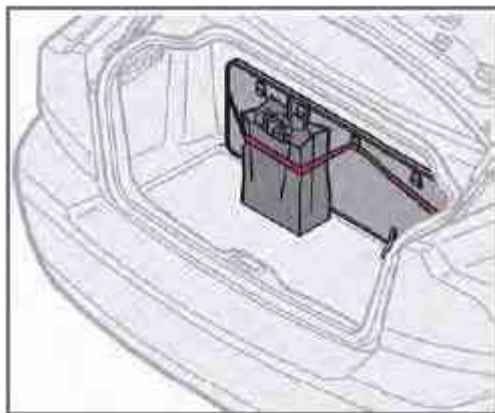

Open the trunk lid. Hang or secure your grocery bags using the tensioning straps or holders.



Rear seat and trunk

Center head restraints

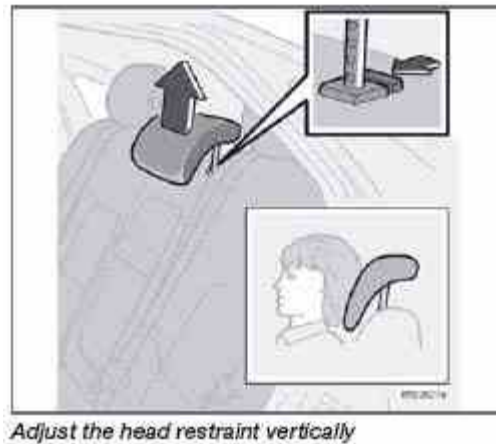

The center head restraint can be adjusted according to the passenger's height. The restraint should be carefully adjusted to support the occupant's head.

The head restraint can be raised by pulling straight up or lowered by pressing the catch at the base of the left head restraint support and pushing down.

WARNING

The center rear seat head restraint should only be in its lowest position when this seat is NOT occupied. When the center position is occupied, the head restraint should be correctly adjusted to the passenger's height.

106 04 Interior



Spare wheel, tools and jack

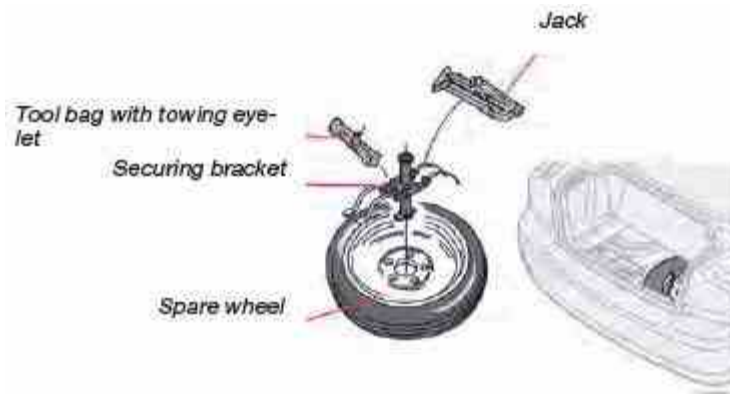

The spare wheel, jack and tool bag are located under the floor of the trunk. To access the spare tire:

1. Pull up the floor mats.
2. Remove the jack and tool bag.
3. Unscrew the spare wheel and lift it out.



WARNING

Make sure that the spare tire, jack and tool bag are properly secured with the securing bracket to help keep these components in place in the event of a sudden stop.

If the vehicle is equipped with a grocery bag holder:

1. Turn the two clips, which are located at the rear corner of the mat, 90°.
2. Pull the front of the floor mat back towards the trunk lid opening.
3. Lift the mat slightly and turn 90° to lift it out.
4. Lift the mat out of the trunk.
5. Unscrew the spare tire and lift it out.
6. Return and secure everything in reverse order.

See also [page 172](#) for more information on using the jack.



This page left intentionally blank.



2008 VOLVO S60

108 05 Locks and alarm



- Keys [110](#)
- Remote control [112](#)
- Locking and unlocking [115](#)
- Child safety locks [117](#)
- Alarm [118](#)

109 05 Locks and alarm



110 05 Locks and alarm



Keys



Two types of keys are provided with your vehicle; master keys and a service (valet) key. The master key, the remote control, and the central locking button may all be used to lock and unlock all of your vehicle's locks.

The service key will operate only the driver's door and the ignition switch. It is intended to help deter unwanted entry into the glove compartment and trunk.

- Turn the key once to unlock the **driver's door only**.
- Turn the key again (within 10 seconds) to unlock all doors and the trunk.
- One turn with the key towards lock in the drivers door locks all doors and the trunk.
- Use the switch on the driver's door armrest to lock/unlock the vehicle from the inside.

 **WARNING**

If the doors are locked while driving, this may hinder rapid access to the occupants of the vehicle in the event of an accident. (Also see information on "Child safety locks")

 **NOTE**

To help prevent accidentally locking the keys in the vehicle, the central locking system is designed to unlock the doors immediately if the key is left in the ignition switch, the vehicle is locked using the lock button on the door and the door is then closed. A sound from the lock will be audible at this time.

Please note that this function will not unlock the doors if the engine is running.

Immobilizer (start inhibitor)

Each of the keys supplied with your vehicle contains a coded transmitter. The code in the key is transmitted to an antenna in the ignition switch where it is compared to the code stored in the start inhibitor module. The vehicle will start only with a properly coded key.

Each key has a unique code, which your Volvo retailer uses if new keys are required. A maximum of six remote controls/keys can be programmed and used for one vehicle.

If you misplace a key, take the other keys to an authorized Volvo retailer for reprogramming as an antitheft measure.

111 05 Locks and alarm



Keys

NOTE

This device complies with part 15 of the FCC rules. Operation is subject to the following condition: (1) This device may not cause harmful interference, and (2) this device must accept any interference received, including interference that may cause undesired operation.

112 05 Locks and alarm



Remote control



Your vehicle is equipped with two coded remote control transmitters with integrated ignition keys called Key Integrated Remote (KIR). These transmitters use a radio frequency that will enable you to lock/unlock all doors and the trunk from a distance of 10-15 feet (3-5 meters).

The transmitters will also activate or allow "keyless" entry into the passenger compartment or the trunk. They will also activate or deactivate your vehicle's alarm system(s). The vehicle can also be locked/unlocked with the key.

If one of the transmitters is misplaced, a replacement can be purchased from your nearest authorized Volvo retailer for replacement.

Using the remote control

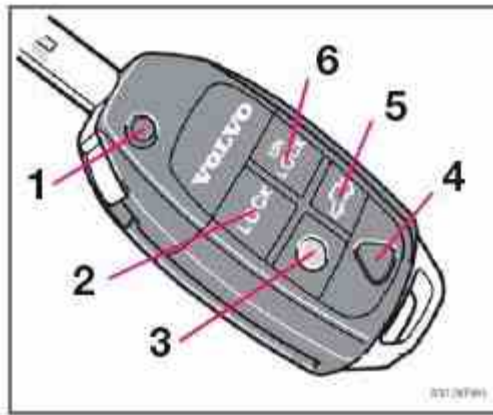

1. Fold key in/out
2. Lock
3. Approach lighting
4. "Panic" function
5. Open trunk
6. Unlock

Button 1: Press to extend the key. This button must also be pressed when the key is folded back into the slot in the side of the remote control unit.

Button 2 (Lock): Press once to lock all doors, and the trunk.

Button 3 (Approach lighting): Press this button when approaching the vehicle at night



Remote control

to light up the interior courtesy light, parking lights, and license plate lights.

Button 4 (Panic): See [page 118](#) for more information on this function.

Button 5 (Open trunk): Press this button twice within 3 seconds to pop open the trunk (without unlocking the other doors).

This function is not intended to open the trunk completely.

Button 6 (Unlock): Press this button once to unlock the driver's door only. Wait for at least 1 second and press the button again (within 10 seconds) to unlock all doors, and the trunk.

• FCC ID:LQNP2T-APU

This device complies with part 15 of the FCC rules. Operation is subject to the following conditions: (1) This device may not cause harmful interference, and (2) this device must accept any interference received, including interference that may cause undesired operation.

• Canadian 2306104388

Model 504 2927 by Donnelly

Operation is subject to the following conditions: (1) this device may not cause interference, and (2) this device must accept any interference, including interference that may cause undesired operation of the device.

- **Canadian 2306104388A**

Model 509 977 by Connaught Electronics

Operation is subject to the following conditions: (1) this device may not cause interference, and (2) this device must accept any interference, including interference that may cause undesired operation of the device.

NOTE

- If an airbag deploys, your vehicle's SRS control module will attempt to automatically unlock all doors.
- The keys may also be used to lock and unlock the doors, and to activate and deactivate the alarm system.
- To avoid leaving your keys in the vehicle, make a habit of always locking the vehicle with the remote control.
- If the key blade section of the remote is not fully folded out when starting the vehicle, the immobilizer function may make it impossible to start the engine.
- The vehicle can be locked even if a door is open. When the door(s) are closed, they will be locked. Please be aware that the keys could be locked in the car when this is done.

Automatic re-locking

If the doors are unlocked, the locks will automatically reengage (re-lock) and the alarm will rearm after 2 minutes unless a door or the trunk has been opened. This helps prevent the car from inadvertently being left unlocked.



Remote control

WARNING

Never use the transmitter to lock the doors from inside the vehicle.

Doing so would ACTIVATE:

- the break-in alarm, which would sound if one of the doors were opened
- the optional interior motion and inclination alarm sensors. Doing so would DEACTIVATE:
- the moonroof and interior courtesy light controls.
- the central locking buttons on the front door armrests, although the interior door handles would still function to allow occupants to leave the vehicle.

Disabled features would remain disabled until the remote is used again to unlock the vehicle.

In addition, locking an occupied vehicle would hinder rapid access to the occupants in an accident or emergency.

Replacing the battery in the remote control

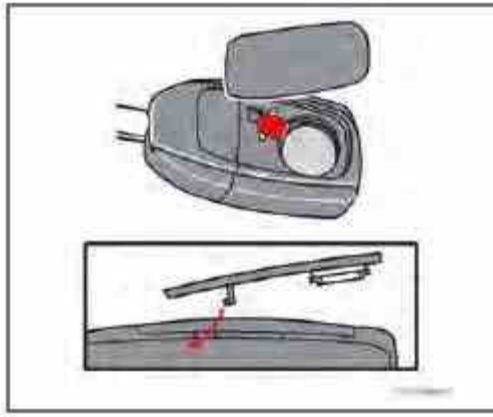

If the range of the transmitter is noticeably reduced, this indicates that the battery is weak and should be replaced.

To replace the battery

1. Carefully pry open the rear edge of the cover with a small screwdriver.
2. Insert a new 3-volt, CR2032 battery, with the battery's plus side up. Avoid touching the contact surfaces of the battery with your fingers.
3. Press the cover back into place. Ensure that the rubber seal is correctly positioned to help keep out moisture.

NOTE

The old battery should be disposed of properly at a recycling center or at your Volvo retailer.



Locking and unlocking

Locking and unlocking the vehicle from the inside

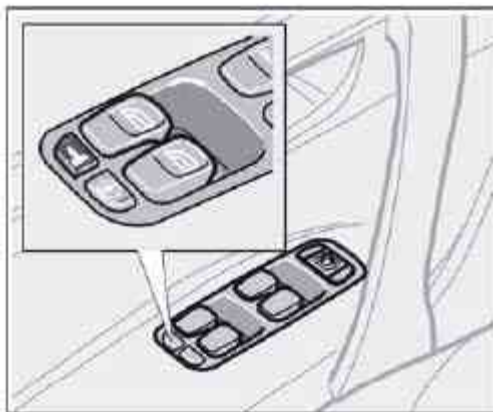

The button on the driver's door armrest can be used to lock or unlock all doors and the trunk, and to set the alarm.

Each door can also be locked with the lock button on the respective door and opened by pulling the door handle on the door.

Automatic locking

The function locks the doors automatically when the vehicle's speed exceeds approximately 5 mph (7 km/h). The doors

will then remain locked until a door is opened from the inside or if all of the doors are unlocked from the control panel in the driver's door.

This function can be activated/deactivated from the control panel in the driver's door.

Activating/deactivating automatic locking

1. Turn the ignition key to position I or II.
2. Press the READ button on the left-side steering wheel lever to erase any messages that may be displayed in the information display.
3. Depress the central locking button on the control panel until a new message about the locking status is displayed.

The message AUTOLOCK ON (the doors will be locked when the vehicle begins to move) or AUTOLOCK OFF will be displayed.

Unlocking the trunk lid with the master key



The master key should only be used to unlock the trunk lid in emergencies (if the remote control is not working or the vehicle is without power). Open the trunk lid as follows:

1. Insert the master key into the upper or lower part of the plug covering the lock.
2. Twist upward or downward to remove the plug.
3. Unlock the trunk lid.



Locking and unlocking

NOTE

If the trunk is opened with the master key, the alarm will sound. To turn off the alarm, unlock the driver's door with the master key.

Opening/locking the trunk lid with the remote control

Do as follows to unlock the trunk lid only:

1. Press the "Open trunk" button on the remote control twice.

2. Relock the trunk using the remote's "Lock" button.

i NOTE

If all doors are locked when you close the trunk lid, it locks automatically.

Opening the trunk from the inside (U.S. models only)

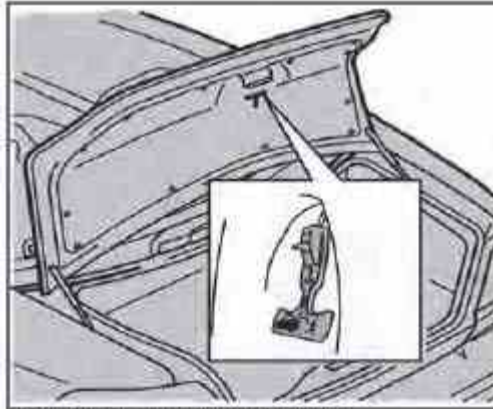

Opening the trunk from the inside

The S60 is equipped with a florescent handle on the inside of the trunk lid, which can be used in an emergency situation to open the trunk from the inside. *Pull the handle down to release the trunk lid.* **After use, the handle must be pushed back into its original position before the trunk can be closed.**

This handle is not intended to be used to anchor the trunk lid when long loads are being transported.

! WARNING

- Keep vehicle doors and trunk locked and keep keys out of a child's reach. Unsupervised children could lock themselves in an open trunk and risk injury. Children should be taught not to play in vehicles.
- On hot days, the temperature in the trunk or vehicle interior can rise very quickly. Exposure of people to these high temperatures for even a short period of time can cause heat-related injury or death. Small children are particularly at risk.



Child safety locks

Manual child safety locks - rear doors

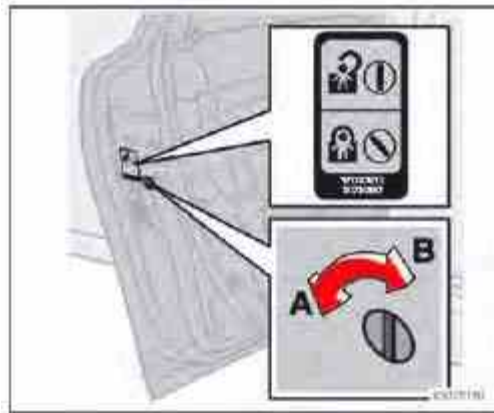

Control for child safety lock - left rear door

The controls are located on the rear door jambs. Use the ignition key or a screwdriver to adjust these controls.

A. The door cannot be opened from the inside. Normal operation from the outside.

B. The door lock functions normally.



Control for child safety lock - right rear door



WARNING

Remember, in the event of an accident, the rear seat passengers cannot open the doors from the inside with the buttons in position A.

The alarm is automatically armed whenever you lock your vehicle.

When armed, the alarm continuously monitors a number of points on the vehicle. The following conditions will set off the alarm:

- The hood is forced open.
- The trunk is forced open.
- A door is forced open.
- The ignition switch is tampered with.
- If there is movement in the passenger compartment (if the vehicle is equipped with the optional movement sensor).
- The vehicle is lifted or towed (if the vehicle is equipped with the optional inclination sensor).
- The battery is disconnected (while the alarm is armed).
- The siren is disconnected when the alarm is disarmed.

Arming the alarm

Press the LOCK button on the remote control, lock the vehicle using the key in the driver's door or press the central

lock button on the driver's door with the door open. One long flash of the turn signals will confirm that the alarm is armed.

Disarming the alarm

Press the UNLOCK button on the remote control or unlock the doors with the key.

Turning off (stopping) the alarm

If the alarm is sounding, it can be stopped by pressing the UNLOCK button on the remote control or by unlocking the driver's door with the key.



Alarm

Visual alarm signal

The visual alarm signal is given by flashing all turn signals and turning on the interior lighting for approximately 5 minutes.

Audible alarm signal

An audible alarm signal is given by a battery powered siren. One alarm cycle lasts for 25 seconds.

"Panic" button

In an emergency situation, this feature can be used to attract attention.

Activate the "panic" button by pressing the red button on the remote control (see illustration on [page 112](#)) for at least 3 seconds or by pressing this button twice within 3 seconds. The turn signals will flash, and the vehicle's horn will sound.

The function can be turned off by pressing any of the buttons on the remote control or will stop automatically after 25 seconds. When a button is pressed, there is a 5 second delay before the panic alarm is deactivated.

NOTE

This button will NOT unlock the vehicle.

Temporarily turning off the inclination and movement alarm sensor(s) - accessory



This button will only be found in vehicles equipped with the accessory inclination and/or movement sensors.

This device complies with part 15 of the FCC rules. Operation is subject to the following conditions: (1) This device may not cause harmful interference, and (2) this device must accept any interference received, including interference that may cause undesired operation.

Canadian IC: 4405A-DA5823

Movement sensor DA5823 by Dynex

Operation is subject to the following conditions: (1) this device may not cause interference, and (2) this device must accept any interference, including interference that may cause undesired operation of the device.

In certain situations it may be desirable to turn off the accessory inclination and movement alarm sensors if, for example, you drive your vehicle onto a ferry where the rocking of the boat could trigger the alarm or if a pet is left in the vehicle with the doors locked.

To temporarily turn off the inclination and movement alarm sensors from the alarm system:



Alarm

From the time the ignition key is turned from the Drive position (position II) until you lock the vehicle, you can press the button in the center console. The LED in the switch will light up and a message will be displayed in the text window to indicate that the sensors are disconnected.

The vehicle can then be locked in the usual way to set the alarm.

NOTE

- This function will not turn off the vehicle's standard alarm.
- The optional sensors are automatically reconnected to the alarm system the next time the vehicle is unlocked and then locked again.

LED alarm status signals

The status of the alarm system is indicated by the red LED at the top of the dash:

- LED off - the alarm is not armed
- LED flashes once per second - the alarm is armed
- LED flashes rapidly before the ignition is switched on - the alarm has been triggered
- **Fault in the alarm system:** If a fault has been detected in the alarm system, a message will be displayed in the text window. Contact a trained and qualified Volvo service technician.

Automatic re-lock/re-arm system

If the vehicle is unlocked with the remote, the vehicle will re-lock and the alarm will re-arm after 2 minutes unless a door or the trunk has been opened.



2008 VOLVO S60

120 06 Starting and driving



General information	122
Fuel requirements	124
Refueling	125
Starting the vehicle	127
Economical driving	129
Handling and road holding	130
Manual transmission	131
Automatic transmission (option)	132
All Wheel Drive (option)	136
Brake system	137
Stability system	139
Towing	141
Jump starting	143
Towing a trailer	144
Detachable trailer hitch	146
Load carriers (accessory)	147
Cold weather precautions	149
Before a long distance trip	150
Front/rear park assist (option/accessory)	151

121 06 Starting and driving



122 06 Starting and driving



General information

Engine oil

Although some oil consumption occurs during normal engine operation, more oil is consumed when the engine is new as the internal parts generate higher friction while wearing-in to each other. From the time the engine is new until the first service is performed, the oil consumption could be higher than normal. For this reason, it is especially important to check the oil every time you refuel your vehicle during this period. See [page 193](#).

Fuel requirements

Deposit control gasoline (detergent additives)

Volvo recommends the use of detergent gasoline to control engine deposits. Detergent gasoline is effective in keeping injectors and intake valves clean. Consistent use of deposit control gasolines will help ensure good drivability and fuel economy. If you are not sure whether the gasoline contains deposit control additives, check with the service station operator.

NOTE

Volvo does not recommend the use of external fuel injector cleaning systems.

Unleaded fuel

Each Volvo has a three-way catalytic converter and must use only unleaded gasoline. U.S. and Canadian regulations require that pumps delivering unleaded gasoline be labelled "UNLEADED". Only these pumps have nozzles which fit your vehicle's filler inlet. It is unlawful to dispense leaded fuel into a vehicle labelled "unleaded gasoline only". Leaded gasoline damages the three-way catalytic converter and the heated oxygen sensor system. Repeated use of leaded gasoline will lessen the effectiveness of the emission control system and could result in loss of emission warranty coverage. State and local vehicle inspection programs will make detection of misfueling easier, possibly resulting in emission test failure for misfueled vehicles.

NOTE

Some U.S. and Canadian gasolines contain an octane enhancing additive called methyl-cyclopentadienyl manganese tricarbonyl (MMT). If such fuels are used, your Emission Control System performance may be affected, and the Check Engine Light (malfunction indicator lamp) located on your instrument panel may light. If this occurs, please return your vehicle to a trained and qualified Volvo service technician for service.

Gasoline containing alcohol and ethers "Oxygenated fuels"

Some fuel suppliers sell gasoline containing "oxygenates" which are usually alcohols or ethers. In some areas, state or local laws require that the service pump be marked indicating use of alcohols or ethers. However, there are areas in which the pumps are unmarked. If you are not sure whether there is alcohol or ethers in the gasoline you buy, check with the service station operator. To meet seasonal air quality standards, some areas require the use of "oxygenated" fuel.

Volvo allows the use of the following "oxygenated" fuels; however, the octane ratings listed on this page must still be met.



General information

Alcohol - Ethanol: Fuels containing up to 10% ethanol by volume may be used. Ethanol may also be referred to as Ethyl alcohol, or "Gasohol".

Ethers - MTBE: Fuels containing up to 15% MTBE may be used.



Fuel requirements

Octane rating



Volvo recommends premium for best performance, but using 87 octane or above will not affect engine reliability.

Volvo engines are designed to achieve rated horsepower, torque, and fuel economy performance using premium 91 octane fuel.

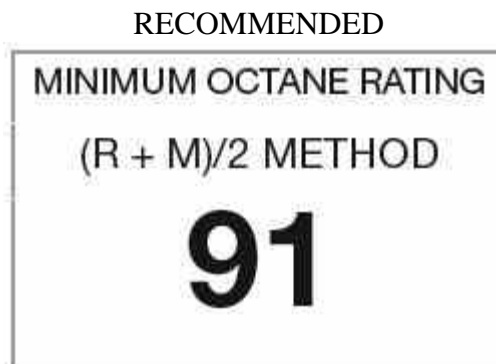

In demanding driving conditions, such as operating the vehicle in hot weather, towing a trailer, or driving for extended periods at higher altitudes than normal, it may be advisable to switch to higher octane fuel (91 or higher) or to change gasoline brands to fully utilize your engine's capacity, and for the smoothest possible operation.

NOTE

When switching to higher octane fuel or changing gasoline brands, it may be necessary to fill the tank more than once before a difference in engine operation is noticeable.

Fuel Formulations

Do not use gasoline that contains lead as a knock inhibitor, and do not use lead additives. Besides damaging the exhaust emission control systems on your vehicle, lead has been strongly linked to certain forms of cancer.

Many fuels contain benzene as a solvent. Unburned benzene has been strongly linked to certain forms of cancer. If you live in an area where you must fill your own gas tank, take precautions. These may include:

- standing upwind away from the filler nozzle while refueling

- refueling only at gas stations with vapor recovery systems that fully seal the mouth of the filler neck during refueling
- wearing neoprene gloves while handling a fuel filler nozzle.

Use of Additives

With the exception of gas line antifreeze during winter months, do not add solvents, thickeners, or other store-bought additives to your vehicle's fuel, cooling, or lubricating systems. Overuse may damage your engine, and some of these additives contain organically volatile chemicals. Do not needlessly expose yourself to these chemicals.



Refueling

WARNING

Carbon monoxide is a poisonous, colorless, and odorless gas. It is present in all exhaust gases. If you ever smell exhaust fumes inside the vehicle, make sure the passenger compartment is ventilated, and immediately return the vehicle to a trained and qualified Volvo service technician for correction.

WARNING

Driving with the trunk open: Driving with the trunk open could lead to poisonous exhaust gases entering the passenger compartment.

If the trunk must be kept open for any reason, proceed as follows:

- Close the windows
- Set the ventilation system control to air flow to floor, windshield and side windows and blower control to its highest setting.

Fuel filler door

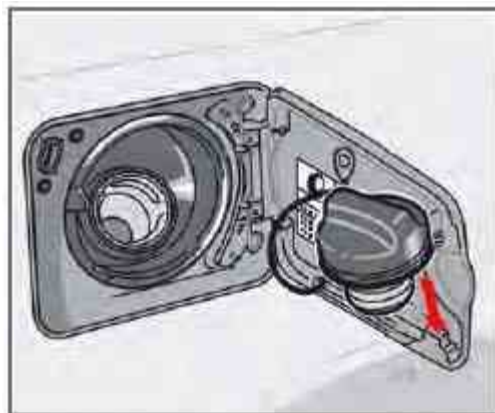

The fuel filler cap can be placed on the hook on the fuel filler door while refueling

Press the button on the light switch panel (see illustration on [page 57](#)) when the vehicle is at a standstill to unlock the fuel filler door. Please note that the fuel filler door will remain unlocked until the vehicle begins to move forward. An audible click will be heard when the fuel filler door relocks.

If you intend to leave your vehicle while it is being refueled, this feature enables you to lock the doors/trunk while

leaving the fuel filler door unlocked.

You can also keep the vehicle locked if you remain inside it during refueling. The central locking button does not lock the fuel filler door. Be sure the fuel filler door is not obstructed and is completely closed after refueling.

Open the fuel filler cap slowly during hot weather.

NOTE

During a transitional period, a small number of service stations may still have fuel nozzles that are not compatible with the fuel filler neck on vehicles equipped with the evaporative control system.

126 06 Starting and driving



Refueling

Refueling

The fuel tank is designed to accommodate possible expansion of the fuel in hot weather. See [page 246](#) for fuel tank volume. Be aware that the "usable" tank capacity will be somewhat less than the specified maximum. When the fuel level is low, such factors as ambient temperature, the fuel's "Reid vapor pressure" characteristics, and terrain can affect the fuel pump's ability to supply the engine with an adequate supply of fuel. Therefore, it is advisable to refuel as soon as possible when the needle nears the red zone, or when the fuel warning light comes on.

CAUTION

- Do not refuel with the engine running¹. Turn the ignition off or to position I. If the ignition is on, an incorrect reading could occur in the fuel gauge.
- After refueling, close the fuel filler cap by turning it clockwise until it clicks into place.¹
- Avoid overfilling the fuel tank. Do not press the handle on the filler nozzle more than one extra time. Too much fuel in the tank in hot weather conditions can cause the fuel to overflow. Overfilling could also cause damage to the emission control systems.
- Avoid spilling gasoline during refueling. In addition to causing damage to the environment, gasolines containing alcohol can cause damage to painted surfaces, which may not be covered under the New Vehicle Limited Warranty.
- Do not use gasolines containing methanol (methyl alcohol, wood alcohol). This practice can result in vehicle performance deterioration and can damage critical parts in the fuel system. Such damage may not be covered under the New Vehicle Limited Warranty.

¹If the fuel filler cap is not closed tightly or if the engine is running when the vehicle is refueled, the Check Engine Light (malfunction indicator lamp) may indicate a fault. However, your vehicle's performance will not be affected. Use only Volvo original or approved fuel filler caps.

127 06 Starting and driving



Starting the vehicle

Starting the engine

1. Fasten the seat belt.

WARNING

Before starting, check that the seat, steering wheel and mirrors are adjusted properly. Make sure the brake pedal can be depressed completely. Adjust the seat if necessary. See [pages 92 and 94](#).

2. Apply the parking brake (hand brake) if not already set. The gear selector (automatic transmission) is locked in the **(P)**ark position (**SHIFTLOCK**). Manual transmission: the clutch must be fully depressed.
3. Without touching the accelerator pedal, turn the ignition key¹ to the starting position. Allow the starter to operate for up to 10 seconds. Release the key as soon as the engine starts. If the engine fails to start, repeat this step.

¹If two of the keys to your vehicle are close together, e.g. on the same key ring, when you try to start the vehicle, this could cause interference in the immobilizer system and result in the vehicle not starting. If this should occur, remove one of the keys from the key ring before trying to start the vehicle again.

NOTE

- If the key blade section of the remote is not fully folded out when starting the vehicle, the immobilizer function may make it impossible to start the engine.
- After a cold start, idle speed may be noticeably higher than normal for a short period. This is done to help bring components in the emission control system to their normal operating temperature as quickly as possible, which enables them to control emissions and help reduce the vehicle's impact on the environment.
- To release the gear selector from the **P** position, the engine must be running (or the ignition key must be in position II) and the brake pedal must be depressed.
- Select the desired gear. The gear engages after a very slight delay which is especially noticeable when selecting R.

NOTE

Your vehicle is equipped with a **KEYLOCK** system (automatic transmission). When the engine is switched off, the gear selector must be in the **P** position before the key can be removed from the ignition switch.

When starting in cold weather, the transmission may shift up at slightly higher engine speeds than normal until the automatic transmission fluid reaches normal operating temperature.

WARNING

An extra mat on the driver's floor can cause the accelerator pedal to catch. Check that the movement of the accelerator pedal is not impeded. No more than one protective floor covering may be used at one time.

WARNING

Always place the gear selector in Park or in reverse on models with a manual transmission, and apply the parking brake before leaving the vehicle. Never leave the vehicle unattended with the engine running.

Always open garage doors fully before starting the engine inside a garage to ensure adequate ventilation. The exhaust gases contain carbon monoxide, which is invisible and odorless but very poisonous.



Starting the vehicle



Automatic transmission

The engine should be idling when you move the gear selector. Never accelerate until after you feel the transmission engage! Accelerating immediately after selecting a gear will cause harsh engagement and premature transmission wear.

Selecting P or N when idling at a standstill for prolonged periods of time will help prevent overheating of the automatic transmission fluid.

Do not race a cold engine immediately after starting.

Ignition switch and steering wheel lock

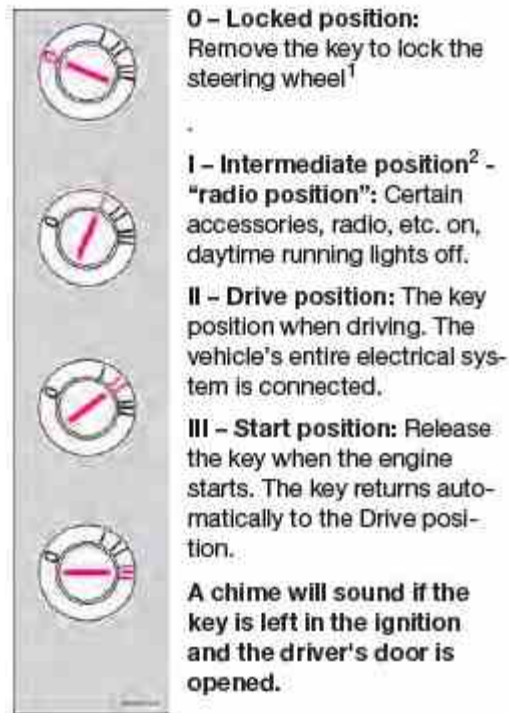

¹The gear selector must be in the (P)ark position (automatic transmission).

²Please be aware that leaving the key in this position will increase battery drain.



WARNING

Never turn the key to position O while driving or when the vehicle is being towed.

Steering wheel lock

The steering wheel lock might be under tension when the vehicle is parked.

Turn the steering wheel slightly to free the ignition key.

In order to help reduce vehicle theft, make sure the steering wheel lock is engaged before leaving the vehicle.



WARNING

Never switch off the ignition (turn the ignition key to position 0) or remove the key from the ignition switch while the vehicle is in motion. This could cause the steering wheel to lock, which would make the vehicle impossible to steer.



Economical driving

Economical driving conserves natural resources

Better driving economy may be obtained by thinking ahead, avoiding rapid starts and stops and adjusting the speed of your vehicle to immediate traffic conditions. Observe the following rules:

- Bring the engine to normal operating temperature as soon as possible by driving with a light foot on the accelerator pedal for the first few minutes of operation. A cold engine uses more fuel and is subject to increased wear.
- Whenever possible, avoid using the vehicle for driving short distances. This does not allow the engine to reach normal operating temperature.
- Drive carefully and avoid rapid acceleration and hard braking.
- Do not exceed posted speed limits.
- Avoid carrying unnecessary items (extra load) in the vehicle.
- Maintain correct tire pressure. Check tire pressure regularly (when tires are cold).
- Remove snow tires when threat of snow or ice has ended.
- Note that roof racks, ski racks, etc, increase air resistance and also fuel consumption.
- Avoid using automatic transmission kickdown feature unless necessary.
- However, at higher driving speeds, fuel consumption will be lower with the air conditioning on and the windows closed than with the air conditioning off and the windows open.
- Using the onboard trip computer's fuel consumption modes can help you learn how to drive more economically.

Other factors that decrease gas mileage are:

- Dirty air cleaner
- Dirty engine oil and clogged oil filter
- Dragging brakes
- Incorrect front end alignment. Some of the above mentioned items and others are checked at the standard Maintenance Service intervals.

NOTE

Vehicles equipped with automatic transmissions should use (D)rive as often as possible and avoid using "kickdown" to help improve fuel economy.

CAUTION

Drive slowly and carefully if going through standing water (i.e. flooded roadways, etc.). Damage to the engine could result if excess water is drawn in through the air intake system. Never drive the vehicle in water deeper than 1 foot (300 mm).



Handling and road holding

Weight distribution affects handling

At the specified curb weight your vehicle has a tendency to understeer, which means that the steering wheel has to be turned more than might seem appropriate for the curvature of a bend.

This ensures good stability and reduces the risk of rear wheel skid. Remember that these properties can alter with the vehicle load.

The heavier the load in the trunk (max. 220 lbs, 100 kg), the less the tendency to understeer.

Handling, roadholding

Vehicle load, tire design and inflation pressure all affect vehicle handling. Therefore, check that the tires are inflated to the recommended pressure according to the vehicle load. See "Tire pressure" section.

Loads should be distributed so that capacity weight or maximum permissible axle loads are not exceeded.

Speed-sensitive power steering (Option on certain models)

With this feature, the steering is most responsive at lower speeds to make parking, driving in city traffic, etc., easier. The effect of the power steering diminishes as you accelerate for greater stability at highway speeds.

Driving through water

The vehicle can be driven through water up to a depth of approximately 9 in. (25 cm), at a maximum speed of 6 mph (10 km/h).

Take particular care when driving through flowing water.

Clean the electrical connections for trailer wiring after driving in mud or water.

When driving through water, maintain low speed and do not stop in the water.



WARNING

After driving through water, press lightly on the brake pedal to ensure that the brakes are functioning normally. Water or mud can make the brake linings slippery, resulting in delayed braking effect.



CAUTION

- Engine damage will occur if water is drawn into the air cleaner.
- If the vehicle is driven through water deeper than 9 in (25 cm), water may enter the differential and the transmission. This reduces the oil's lubricating capacity and may shorten the service life of these components.
- Do not allow the vehicle to stand in water up to the door sills longer than absolutely necessary. This could result in electrical malfunctions.
- If the engine has been stopped while the car is in water, do not attempt to restart the engine. Have the car towed out of the water.



6-speed manual transmission (option on certain models)

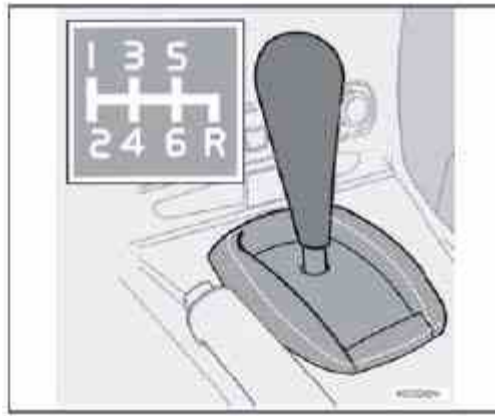

Depress the clutch pedal completely when changing gears¹.

Remove your foot from the clutch pedal while driving. The shift pattern should be followed.

Fifth and sixth gears should be used as often as possible to help improve fuel economy.

¹Clutch interlock

The clutch must be fully depressed before you can start your vehicle. If the clutch is not depressed, it will not be possible to start the engine.



WARNING

An extra mat on the driver's floor can cause the accelerator pedal and/or the clutch pedal to catch. Check that the movement of these pedals is not impeded. Not more than one protective floor covering may be used at one time.

Engaging reverse gear

Never engage R while the vehicle is moving.



CAUTION

Be careful to avoid inadvertently engaging reverse while moving forward.



Automatic transmission (option)

P (Park)

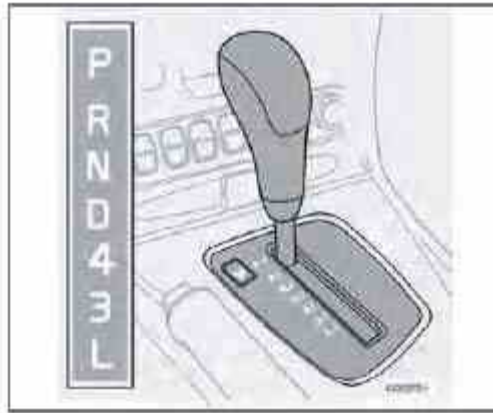

Use this position when starting the engine or parking the vehicle.

Never use P while the vehicle is in motion.

The parking brake should be set whenever the vehicle is parked.

The gear selector is mechanically locked in the P position (SHIFTLOCK). To release the gear selector from this position, the engine must be running (or the ignition key must be in position II) and the brake pedal must be depressed.



WARNING

Never leave the vehicle unattended when the engine is running. If, by mistake, the gear selector is moved from **P**, the vehicle may start moving.

R (Reverse)

Never engage R while the vehicle is moving.

N (Neutral)

Neutral - no gear engaged. Use the parking brake.

D (Drive)

D is the normal driving position and should be used as often as possible to help improve fuel economy. The vehicle should not be moving when shifting from **R** to the **D** position.

4 (Intermediate gear)

The transmission will shift automatically between gears 4, 3, 2 or 1 from this position. The transmission cannot shift up to **D** from fourth gear.

3 (Intermediate gear)

The transmission will shift automatically between gears 3, 2 and 1 from this position. The transmission cannot shift up to fourth gear or **D** from third gear.

L (Low gears)

The transmission is locked in gears 1 and 2 when the selector is in this position.

i NOTE

Gears 4, 3, or L can be used if you are driving in a mountainous area, towing a trailer or to increase engine braking effect.

The transmission has a built-in limiter designed to help prevent excessive engine speeds (high rpm) when gears 4, 3 or L are selected.



Automatic transmission (option)

W - Winter/Wet driving mode - enhanced vehicle traction

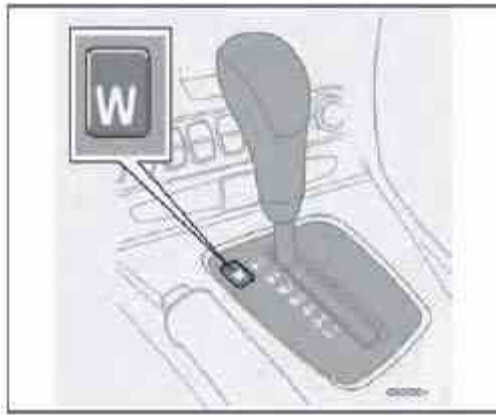

- Mode W will only function if the gear selector is in the **D** position.
- Press the button at the base of the gear selector to engage/disengage this driving mode (see illustration).
- When the W driving mode is engaged, this is displayed in the instrument panel (see [page 48](#)).
- This mode may be selected for starting/moving off on slippery roads.)

Shift gate positions

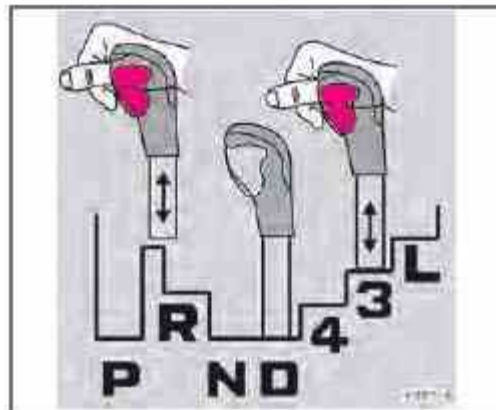

The gear selector can be moved freely between **N** and **D**.

Depressing the button on the front of the gear selector knob enables you to move the gear selector to positions P, R, N, D, 4, 3 and L.

"Kickdown"

Automatic shift to a lower gear (kickdown) is achieved by depressing the accelerator pedal fully and briskly. An upshift will occur when approaching the top speed for a particular gear or by releasing the accelerator pedal slightly.

Kickdown can be used for maximum acceleration or when passing at highway speeds.

Cold starts

When driving before the engine has reached its normal operating temperature, the transmission will shift up at slightly higher engine speeds to heat the three-way catalytic converter as quickly as possible.

Automatic transmission - adaptive system

The automatic transmission is controlled by an adaptive control system that constantly monitors the way in which the transmission functions. It senses and adapts each gear shift for optimal performance.



Automatic transmission (option)

P Park

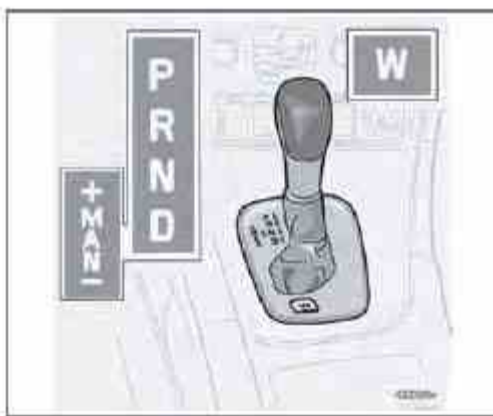

Use this position when starting the engine or parking the vehicle.

Never use P while the vehicle is in motion.

The parking brake should also be set whenever the vehicle is parked.

The gear selector is mechanically locked in the P position (SHIFTLOCK). To release the gear selector from this position, the engine must be running (or the ignition key must be in position II) and the brake pedal must be depressed.



WARNING

Never leave the vehicle unattended when the engine is running. If, by mistake, the gear selector is moved from P, the vehicle may start moving.

R (Reverse)

Never engage R while the vehicle is moving.

N (Neutral)

Neutral - no gear engaged. Use the parking brake.

D (Drive)

D is the normal driving position and should be used as often as possible to help improve fuel economy. The vehicle should not be moving when shifting from **R** to the **D** position.

Shift gate positions

You can move the gear selector freely between the **MAN** and **D** positions while driving.

Depress the button on the front of the gear selector knob to move between the R, N, D, and P positions.



Automatic transmission (option)

Manual shifting

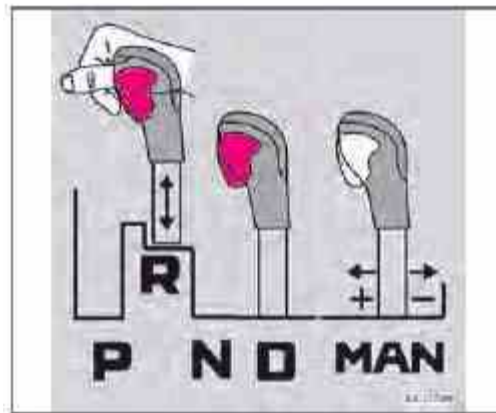

Shift gate positions

You can move the gear selector freely between the **MAN** and **D** positions to select forward gears while driving. Gears 3, 4, 5, and 6 (where applicable) have a "lock-up" function which reduces engine speed and helps save fuel.

i NOTE

Reverse, Neutral, and Park cannot be selected in Geartronic mode.

The currently selected gear will be displayed in the instrument panel (see [page 48](#)).

- To access the **MAN** shifting position from **D**, move the gear selector to the left to **MAN**.
- To return to the **D** position from **MAN**, move the gear selector to the right.

While driving

If you select the **MAN** position while driving, the gear that was being used in the **D** position will also initially be selected in **MAN** position.

- Move the gear selector forward (toward "+") to shift to a higher gear or rearward (toward "-") to shift to a lower gear.
- If you hold the gear selector toward "-", the transmission will downshift one gear and will utilize the braking power of the engine. If the current speed is too high for using a lower gear, the downshift will not occur until the speed has decreased enough to allow the lower gear to be used.

- If you slow down to a very low speed, the transmission will automatically shift down.
- When starting in the **MAN** position, 3rd gear is the highest gear that may be selected.

NOTE

Kickdown does not function when the transmission is in the manual shift (Geartronic) mode. The gear selector must be in the D position.

Kickdown

Automatic shift to a lower gear (kickdown) is achieved by depressing the accelerator pedal fully and briskly. An upshift will occur when approaching the top speed for a particular gear or by releasing the accelerator pedal slightly.

Kickdown can be used for maximum acceleration or when passing at highway speeds.

Kickdown does not function when the transmission is in the manual shift (Geartronic) mode.

W - Winter/Wet driving mode - enhanced vehicle traction

Please refer to the information on [page 133](#).



All Wheel Drive (option)

All Wheel Drive (AWD) - general information

Your Volvo can be equipped with permanent All Wheel Drive, which means that power is distributed automatically between the front and rear wheels. Under normal driving conditions, most engine's power is directed to the front wheels. However, if there is any tendency for the front wheels to spin, an electronically controlled coupling distributes power to the wheels that have the best traction.

Tire dimensions

Volvo recommends that you always drive on tires of the same brand, size, construction (radial), tread pattern, load-, speed-, traction-, temperature-, and treadwear rating. Never drive on mixed tires, except for brief periods when the temporary spare tire is in use.

Always use properly inflated tires of correct dimensions. Tire size and inflation pressures are shown on the tire inflation pressure placards, located on the driver's side B-pillar (the structural member at the side of the vehicle, at the rear of the driver's door opening), or on the inside of the fuel filler door on Canadian models.

Temporary Spare

The temporary spare tire is for temporary, low-speed, short-distance use only. Replace it with a full-sized tire as soon as possible. Do not drive on the temporary spare at speeds above 50 mph (80 km/h) or for distances greater than 50 miles (80 km).

Never install snow chains on a temporary spare.



Brake system

BRAKE Brake circuit malfunction

The brake system is a hydraulic system consisting of two master cylinders and two separate brake circuits. If a problem should occur in one of these circuits, it is still possible to stop the vehicle with the other brake circuit.

If the brake pedal must be depressed farther than normal and requires greater foot pressure, the stopping distance will be longer.

A warning light in the instrument panel will light up to warn the driver that a fault has occurred.

If this light comes on while driving or braking, stop immediately and check the brake fluid level in the reservoir.

NOTE

Press the brake pedal hard and maintain pressure on the pedal - do not pump the brakes.

WARNING

If the fluid level is below the MIN mark in the reservoir or if a "Brake failure - Service urgent" message is displayed in the text window: DO NOT DRIVE. Have the vehicle towed to a trained and qualified Volvo service technician and have the brake system inspected.

NOTE

When the vehicle is at a standstill and the engine is idling, e.g. at a traffic light and the brake pedal is depressed, the pedal may go down slightly. This is a normal function of the power-assisted brake system.

Power brakes function only when the engine is running

The power brakes utilize vacuum pressure which is only created when the engine is running. Never let the vehicle roll to a stop with the engine switched off.

If the power brakes are not working, the brake pedal must be pressed approximately four times harder than usual to make up for the lack of power assistance. This can happen for example when towing your vehicle or if the engine is switched off when the vehicle is rolling. The brake pedal feels harder than usual.

Water on brake discs and brake pads affects braking

Driving in rain and slush or passing through an automatic car wash can cause water to collect on the brake discs and pads. This will cause a delay in braking effect when the pedal is depressed. To avoid such a delay when the brakes are needed, depress the pedal occasionally when driving through rain, slush etc. This will remove the water from the brakes. Check that brake application feels normal. This should also be done after washing or starting in very damp or cold weather.

Severe strain on the brake system

The brakes will be subject to severe strain when driving in mountains or hilly areas or towing. Vehicle speed is usually slower, which means that the cooling of the brakes is less efficient than when driving on level roads. To reduce the strain on the brakes, shift into a lower gear and let the engine help with the braking. Do not forget that, if you are towing a trailer, the brakes will be subjected to a greater than normal load.



Anti-lock brakes (ABS)

If the warning lamp lights up there is a malfunction of the ABS system



Brake system

(the standard braking system will however function) and the vehicle should be driven cautiously to a trained and qualified Volvo service technician for inspection. The Anti-lock Braking System (ABS) helps to improve vehicle control (stopping and steering) during severe braking conditions by limiting brake lockup. When the system "senses" impending lockup, braking pressure is automatically modulated in order to help prevent lockup, which could lead to a skid.

The system performs a self-diagnostic test when the engine is started and when the vehicle first reaches a speed of approximately 12 mph (20 km/h). The brake pedal will pulsate several times and a sound may be audible from the ABS control module. This is normal.

To obtain optimal effect from the ABS system, constant pressure should be kept on the brake pedal. Do not pump the brake pedal.

The switching of the ABS modulator will be audible and the brake pedal will pulsate during braking. Please be aware that ABS does not increase the absolute braking potential of the vehicle. While control will be enhanced, ABS will not shorten stopping distances on slippery surfaces.

ABS with EBD (Electronic Brake Force Distribution)

EBD is an integrated part of the ABS system. EBD regulates the hydraulic pressure to the rear brakes to help provide optimal braking capacity. The brake pedal will pulsate during braking, which is normal.

If the BRAKE and ABS warning lights come on at the same time, this could indicate a fault in the brake system.

1. Stop the vehicle in a suitable place and switch off the engine.
2. Restart the engine.
3. If both warning lights go off, no further action is required.
4. If both lights are still on after the engine has been restarted, switch off the engine again and check the brake fluid level (see [page 196](#) for the location of the brake fluid reservoir).



WARNING

If the fluid level is below the MIN mark in the reservoir or if a "Brake failure - Service urgent" message is displayed in the text window: DO NOT DRIVE. Have the vehicle towed to a trained and qualified Volvo service technician and have the brake system inspected.

5. If the brake fluid level is above the MIN mark, drive carefully to a trained and qualified Volvo service technician and have the brake system inspected.

Emergency Brake Assistance (EBA)

The EBA function is designed to provide full brake effect immediately in the event of sudden, hard braking. The system is activated by the speed with which you depress the brake pedal.

NOTE

- When the EBA system is activated, the brake pedal will go down and pressure in the brake system immediately increases to the maximum level. You must maintain full pressure on the brake pedal in order to utilize the system completely. There will be no braking effect if the pedal is released. EBA is automatically deactivated when the brake pedal is released.
- When the vehicle has been parked for some time, the brake pedal may sink more than usual when the engine is started. This is normal and the pedal will return to its usual position when it is released.



Stability system

Dynamic Stability Traction Control (DSTC)

The stability system consists of a number of functions designed help reduce wheel spin, counteract skidding, and to generally help improve directional stability.

NOTE

A pulsating sound will be audible when the system is actively operating and is normal.

Traction control (TC)

This function is designed to help reduce wheel spin by transferring power from a drive wheel that begins to lose traction to the wheel on the opposite side of the vehicle (on the same axle).

TC is most active at low speeds.

This is one of the DSTC's permanent functions and cannot be switched off.

Spin control (SC)

The spin control function is designed to help prevent the drive wheels from spinning while the vehicle is accelerating.

Under certain circumstances, such as when driving with snow chains, or driving in deep snow or loose sand, it may be advisable to temporarily switch off this function for maximum tractive force.

Temporarily switching off Spin control

1. Turn the thumb wheel (1) on the left-side steering wheel lever until the DSTC menu is displayed.
2. Hold down the RESET button (2) to toggle between DSTC SPIN CONTROL ON or OFF.

Active Yaw Control (AYC)

This function helps maintain directional stability, for example when cornering, by braking one or more of the wheels if the vehicle shows a tendency to skid or slide laterally.)

WARNING

The car's handling and stability characteristics will be altered if the DSTC system functions have been disabled.



Controls on the left-side steering wheel lever

NOTE

- The message DSTC SPIN CONTROL OFF indicates that the stability system's spin control function has temporarily been switched off.
- The stability control indicator light will illuminate and remain on until spin control has been reactivated.
- DSTC ON indicates that all system functions are active.
- The spin control function is automatically enabled each time the engine is started.



Stability system

DSTC-related messages in the text window

- "TRACTION CONTROL TEMPORARILY OFF" - The system has been temporarily switched off due to high brake temperature and will automatically switch on again when the brakes have cooled.
- "ANTI SKID SERVICE REQUIRED" - the system has been automatically disengaged due to a fault. A trained and qualified Volvo service technician should check the system.

Symbols in the instrument panel

The Stability Control indicator light

 This light indicates different conditions, depending on how it illuminates.

The Stability Control indicator light illuminates for approximately 2 seconds

This indicates that the system is performing a self-diagnostic test when the ignition is switched on.

The Stability Control indicator light flashes

This indicates that the stability system is actively functioning to help counteract wheel spin and/or a skid.

The Stability Control indicator light glows steadily

"ANTI SKID SERVICE REQUIRED" will be displayed in the text window at the same time.

A fault is indicated in the stability system.

1. Stop the vehicle in a safe place and switch off the engine.
2. Restart the engine.

3. If the indicator light goes out, the fault was temporary and no further action is required.
4. If the indicator light remains on, drive to an authorized Volvo workshop as soon as possible to have the system checked.

The Stability Control indicator light glows steadily

If "DSTC SPIN CONTROL OFF" is displayed in the text window at the same time, this is a reminder that spin control has been disabled by the driver.

The warning symbol

 **The warning symbol glows steadily yellow**

The system has been temporarily switched off due to high brake temperature. "TRACTION CONTROL TEMPORARILY OFF" will be displayed. The system will automatically switch on again when the brakes have cooled.

WARNING

The stability system is intended to help improve driving safety. It supplements, but can never replace, the driver's judgement and responsibility when operating the vehicle. Speed and driving style should always be adapted to traffic and road conditions.



Towing

Emergency towing

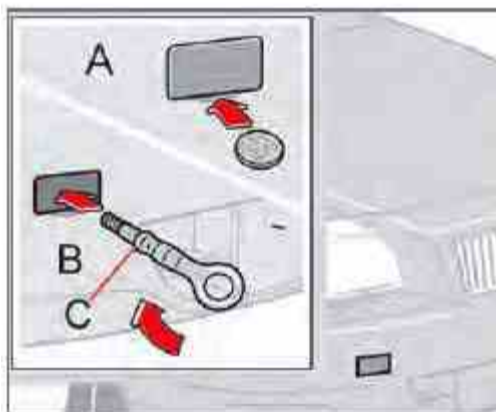

Front towing eyelet

The towing eyelet is located in the tool bag, under the floor of the trunk, with the spare tire. This eyelet must be screwed into the positions provided on the right sides of either the front or rear bumper (B, see illustrations).

To attach the towing eyelet:

- A. Use a coin to pry open the lower edge of the cover (A)¹.
- B. Screw the towing eyelet (C) in place, first by hand and then using the tire iron until it is securely in place.

After the vehicle has been towed, the eyelet should be removed and returned to the tool bag. Press the cover back into position.

¹The opening in the cover may vary.

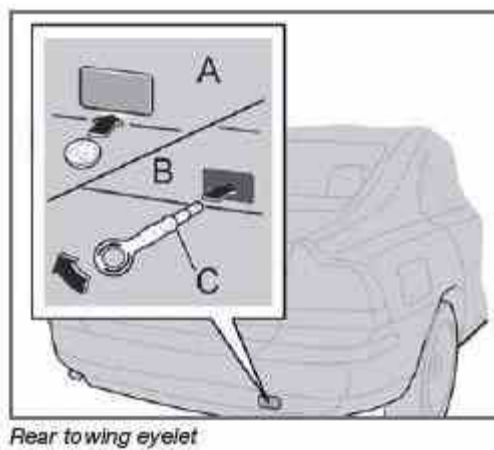

Precautions when the vehicle is in tow

- The steering wheel must be unlocked. Turn the ignition key to position I or II.
- The gear selector must be in position N.
- Maximum speed: 50 mph (80 km/h). Do not exceed the maximum allowable towing speed.
- Maximum distance with front wheels on ground: 50 miles (80 km).
- While the vehicle is being towed, try to keep the tow rope taut at all times.
- The vehicle should only be towed in forward direction.



Towing

CAUTION

- Please check with state and local authorities before attempting this type of towing, as vehicles being towed are subject to regulations regarding maximum towing speed, length and type of towing device, lighting, etc.
- If the vehicle's battery is dead, do not attempt to start the vehicle by pushing or pulling it as this will damage the three-way catalytic converter(s). The engine must be jump started using an auxiliary battery (see [page 143](#)).
- If the vehicle is being towed on a flat bed truck, the towing eyelets must not be used to secure the vehicle on the flat bed. Consult the tow truck operator.

WARNING

- Remember that the power brakes and power steering will not function when engine is not running. The braking and steering systems will function but the brake pedal pressure required is 3 - 4 times above normal and greater steering effort must be exerted.
- The towing eyelets must not be used for pulling another vehicle out of a ditch or for any similar purpose involving severe strain.
- Do not use the towing eyelets to pull the vehicle up onto a flat bed tow truck.

Towing vehicles with front wheel drive/All Wheel Drive

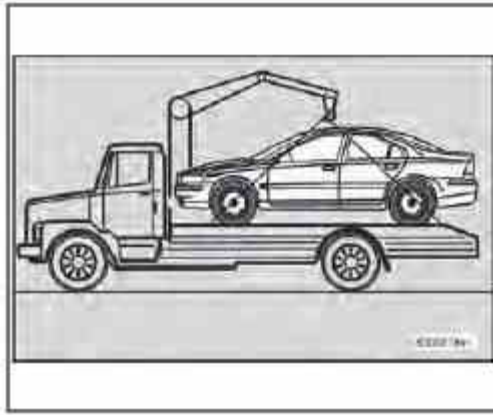

Volvo recommends the use of flat bed equipment.

If wheel lift equipment must be used, please use extreme caution to help avoid damage to the vehicle. **In this case, the vehicle should be towed with the rear wheels on the ground if at all possible.**

If it is absolutely necessary to tow the vehicle with the front wheels on the ground, please refer to the towing information on the previous page.

i CAUTION

- Sling-type equipment applied at the front will damage radiator and air conditioning lines.
- It is equally important not to use sling-type equipment at the rear or apply lifting equipment inside the rear wheels; serious damage to the rear axle may result.
- If the vehicle is being towed on a flat bed truck, the towing eyelets must not be used to secure the vehicle on the flat bed. Consult the tow truck operator.

! WARNING

Do not use the towing eyelets to pull the vehicle up onto a flat bed tow truck.



Jump starting

Jump starting

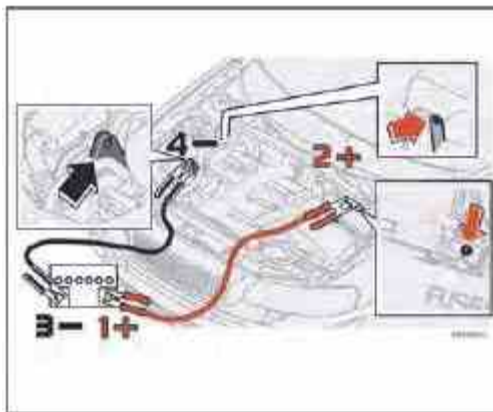

Follow these instructions to jump start your vehicle's dead battery or to jump start another vehicle's dead battery using your vehicle. Although your vehicle's battery is located under the floor of the trunk, jumper cables should be connected in the **engine compartment**, to the points shown in the illustrations.

If the 12-volt auxiliary battery to be used is in another vehicle, check that the vehicles are not touching to prevent premature completion of a circuit. Be sure to follow jump starting instructions provided for the other vehicle.

To jump start your vehicle:

1. Switch off the ignition.
2. First connect the auxiliary battery positive (+) terminal (1) to the positive (+) terminal in your vehicle's engine compartment (2), located under a small black plastic cover attached to the fuse box cover, marked with a "+" sign. Remove the cover on the main fuse box if necessary to access this terminal. Then connect the auxiliary battery's negative (-) terminal (3) to the ground point in your vehicle's engine compartment (4).
3. Start the engine in the assisting vehicle, then start the engine in the vehicle with dead battery.
4. After the engine has started, first remove the negative (-) terminal jumper cable. Then remove the positive (+) terminal jumper cable.

WARNING

PROPOSITION 65 WARNING!

Battery posts, terminals, and related accessories contain lead and lead compounds, chemicals known to the state of California to cause cancer and reproductive harm. Wash hands after handling.

WARNING

- Do not connect the jumper cable to any part of the fuel system or to any moving parts. Avoid touching hot manifolds.
- Never expose the battery to open flame or electric spark.
- Do not smoke near the battery.
- Batteries generate hydrogen gas, which is flammable and explosive.
- Battery fluid contains sulfuric acid. Do not allow battery fluid to contact eyes, skin, fabrics or painted surfaces. If contact occurs, flush the affected area immediately with water. Obtain medical help immediately if eyes are affected.
- Failure to follow the instructions for jump starting can lead to personal injury.



Towing a trailer

Volvo recommends the use of Volvo trailer hitches that are specially designed for the vehicle.

- Maximum trailer weight recommended by Volvo is:

Trailers without brakes: 1650 lbs (750 kg)

Trailers with brakes:

2" (50 mm) ball - 3300 lbs* (1500 kg), 1 7/8" (47 mm) ball - 2000 lbs (900 kg). Observe the legal requirements of the state/province in which the vehicles are

- All Volvo models are equipped with energy-absorbing shock-mounted bumpers. Trailer hitch installation should not interfere with the proper operation of this bumper system.

Trailer towing does not normally present any particular problems, but take into consideration:

- Increase tire pressure to recommended full. See section "Wheels and tires."
- When your vehicle is new, avoid towing heavy trailers during the first 620 miles (1000 km).
- Recommended hitch tongue load is:

Trailer weights **below** 2,650 lbs (1,200 kg) - 110lbs (50kg)

Trailer weights **above** 2,650 lbs (1,200 kg) - 165lbs (75kg)

- Maximum speed when towing a trailer: 50 mph (80 km/h).
- Engine and transmission are subject to increased loads. Therefore, engine coolant temperature should be closely watched when driving in hot climates or hilly terrain. Use a lower gear and turn off the air conditioner if the temperature gauge needle enters the red range.
- If the automatic transmission begins to overheat, a message will be displayed in the text window.
- Avoid overload and other abusive operation.
- Hauling a trailer affects handling, durability, and economy.
- It is necessary to balance trailer brakes with the towing vehicle brakes to provide a safe stop (check and observe state/local regulations).
- Do not connect the trailer's brake system directly to the vehicle's brake system.
- More frequent vehicle maintenance is required.
- Remove the ball and drawbar assembly when the hitch is not being used.
- Volvo recommends the use of synthetic engine oil when towing a trailer over long distances or in mountainous areas.

WARNING

- Bumper-attached trailer hitches must not be used on Volvos, nor should safety chains be attached to the bumper.
- Trailer hitches attaching to the vehicle rear axle must not be used.
- Never connect a trailer's hydraulic brake system directly to the vehicle brake system, nor a trailer's lighting system directly to the vehicle lighting system. Consult your nearest trained and qualified Volvo service technician for correct installation.
- When towing a trailer, the trailer's safety wire must be correctly fastened to the hole or hook provided in the trailer hitch on the vehicle. The safety wire should never be fastened to or wound around the drawbar ball.

NOTE

When parking the vehicle with a trailer on a hill, apply the parking brake before putting the gear selector in **P** (first/reverse gear on manual transmissions). Always follow the trailer manufacturer's recommendations for wheel chocking.

- When starting on a hill, put the gear selector in **D** before releasing the parking brake.
- If you use the manual (Geartronic) shift positions while towing a trailer, make sure



Towing a trailer

the gear you select does not put too much strain on the engine (using too high a gear).

- The drawbar assembly/trailer hitch may be rated for trailers heavier than the vehicle is designed to tow. Please adhere to Volvo's recommended trailer weights.

Leveling

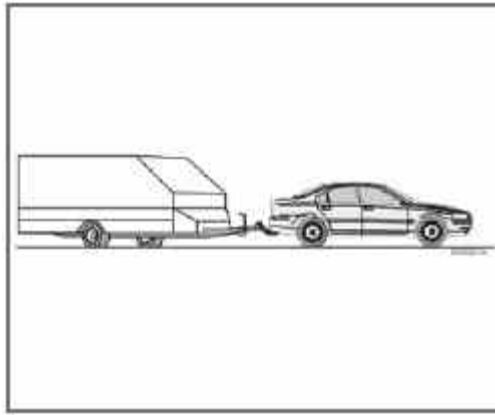

If your vehicle is equipped with automatic leveling, the rear suspension always retains the correct ride height regardless of the load. When the vehicle is stationary, the rear suspension lowers, which is normal.



Detachable trailer hitch

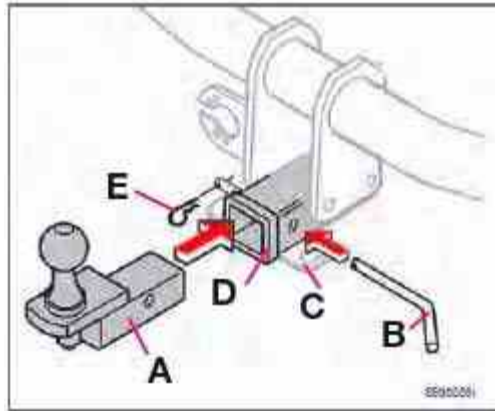

1. Ball holder
2. Locking bolt
3. Safety wire attachment
4. Hitch assembly
5. Cotter pin

Installing the ball holder

1. If necessary, remove the cotter pin from the locking bolt and slide the locking bolt out of the hitch assembly.
2. Slide the ball holder into the hitch assembly.
3. Align the hole in the ball holder with the one in the hitch assembly.
4. Slide the locking bolt through the hitch assembly/ball holder.
5. Insert the cotter pin in the hole at the end of the locking bolt.

Removing the ball holder

1. Remove the cotter pin from the locking bolt and slide the locking bolt out of the ball holder/hitch assembly.
2. Pull the ball holder out of the hitch assembly.

A cover for the hitch assembly can be purchased from your Volvo retailer.



Load carriers (accessory)

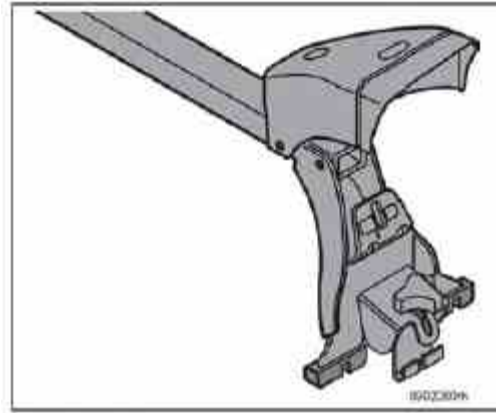

Load carriers are available as Volvo accessories. Observe the following points when in use:

- To avoid damaging your vehicle and to achieve maximum safety when driving, we recommend using the load carriers that Volvo has developed especially for your vehicle.
- Volvo-approved removable roof racks are designed to carry the maximum allowable roof load for this vehicle: 220 lbs (100 kg). For Non-Volvo roof racks, check the manufacturer's weight limits for the rack.
- Never exceed the rack manufacturer's weight limits and never exceed the maximum rated roof load of 220 lbs (100 kg).
- Avoid single-point loads. Distribute loads evenly.
- Place heavier cargo at the bottom of the load.
- Secure the cargo correctly with appropriate tie-down equipment.
- Check periodically that the load carriers and load are properly secured.
- Remember that the vehicle's center of gravity and handling change when you carry a load on the roof.
- The vehicle's wind resistance and fuel consumption will increase with the size of the load.
- Drive smoothly. Avoid rapid starts, fast cornering and hard braking.

Attaching load carriers

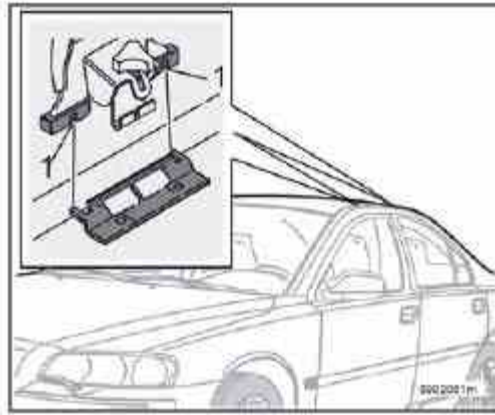

The attachment brackets for the load carriers are located under the roof molding.

1. Make sure that the load carriers are placed in the right direction. See the mark on the decal under the cover.
2. Press the guide lugs into the holes (1).
3. Carefully lower the opposite side of the load carrier to the roof.
4. Loosen the tightening wheel slightly. Slide the hook on the load carrier attachment into the attachment bracket under the roof molding.
5. Turn the tightening wheel to secure the load carrier in the attachment bracket.



Load carriers (accessory)

6. Repeat this procedure for the other load carrier attachments.
7. Check that the hooks on all four load carrier attachments are securely tightened in the respective attachment brackets on the roof of the vehicle.
8. Press down the covers.

Check periodically that the load carriers and load are properly secured.



Cold weather precautions

If you wish to check your vehicle before the approach of cold weather, the following advice is worth noting:

- Make sure that the engine coolant contains 50 percent antifreeze. Any other mixture will reduce freeze protection. This gives protection against freezing down to - 31°F (-35°C). See section "Coolant". **The use of "recycled" antifreeze is not approved by Volvo. Different types of antifreeze must not be mixed.**
- Volvo recommends using only genuine Volvo antifreeze in your vehicle's radiator. Your Volvo retailer stocks plenty of Volvo engine coolant to protect your vehicle during cold weather.
- Try to keep the **fuel tank** well filled - this prevents the formation of condensation in the tank. In addition, in extremely cold weather conditions it is worthwhile to add fuel line de-icer before refueling.
- The viscosity of the **engine oil** is important. Oil with low viscosity (thinner oil) improves cold-weather starting as

well as decreasing fuel consumption while the engine is warming up. For winter use, 5W-30 oil, particularly the synthetic type¹, is recommended. Be sure to use good quality oil but do not use cold-weather oil for hard driving or in warm weather. See section "Engine oil" for more information.

- The load placed on the **battery** is greater during the winter since the windshield wipers, lighting, etc. are used more often. Moreover, the capacity of the battery decreases as the temperature drops. In very cold weather, a poorly charged battery can freeze and be damaged. It is therefore advisable to check the state of charge more frequently and spray an antirust oil on the battery posts.
- Volvo recommends the use of **snow tires** on all four wheels for winter driving - see section "Wheels and tires."
- To prevent the **washer fluid reservoir** from freezing, add washer solvents containing antifreeze (see [page 195](#) for the location of the washer fluid reservoir). This is important since dirt is often splashed on the windshield during winter driving, requiring the frequent use of the washers and wipers. Volvo Washer Solvent should be diluted as follows:
 - **Down to 14° F (-10° C):** 1 part washer solvent and 4 parts water
 - **Down to 5° F (-15° C):** 1 part washer solvent and 3 parts water
 - **Down to 0° F (-18° C):** 1 part washer solvent and 2 parts water
 - **Down to -18° F (-28° C):** 1 part washer solvent and 1 part water
- Use Volvo Teflon Lock Spray in the locks.

¹Synthetic oil is not used when the oil is changed at the normal maintenance service intervals.

NOTE

Avoid the use of de-icing sprays as they can cause damage to the locks.

W - Winter/Wet driving mode - enhanced vehicle traction (automatic transmission)

- Mode W will only function if the gear selector is in the **D** position.
- Press the button at the base of the gear selector to engage/disengage this driving mode.
- An LED in the button will light up to indicate that W is engaged and this will also be displayed in the instrument panel (see [page 48](#)).
- This mode may be selected for starting/moving off on slippery roads.



Before a long distance trip

It is always worthwhile to have your vehicle checked by a trained and qualified Volvo service technician before driving long distances. Your retailer or service technician will also be able to supply you with bulbs, fuses, spark plugs and wiper blades for your use in the event that problems occur.

As a minimum, the following items should be checked before any long trip:

- Check that engine runs smoothly and that fuel consumption is normal.
- Check for fuel, oil, and fluid leakage.
- Check transmission oil level¹.
- Check condition of drive belts.
- Check state of the battery's charge.
- Examine tires carefully (the spare tire as well), and replace those that are worn. Check tire pressures.
- The brakes, front wheel alignment, and steering gear should be checked by a trained and qualified Volvo service technician only.
- Check all lights, including high beams.
- Reflective warning triangles are legal requirement in some countries.

- Have a word with your Volvo retailer if you intend to drive in countries where it may be difficult to obtain the correct fuel.
- Consider your destination. If you will be driving through an area where snow or ice are likely to occur, consider snow tires.

¹To prevent injury from contact with hot surfaces, do not inspect your vehicle's transmission fluid yourself. Have your vehicle's transmission fluid level inspected by a qualified Volvo service technician.



Front/rear park assist (option/accessory)

Front/rear park assist

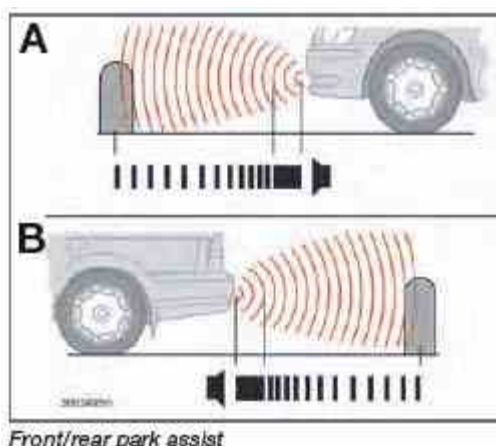

The park assist system is designed to assist you when driving into parking spaces, garages, etc. It utilizes four ultrasound sensors located in one or both bumpers to measure the distance to a vehicle, object, or a person who may be close to the front or rear of your vehicle.

Park assist is available in two versions:

- Rear bumper only
- Front and rear bumpers

WARNING

Park Assist is an information system, NOT a safety system. This system is designed to be a supplementary aid when parking the vehicle. It is not, however, intended to replace the driver's attention and judgement.

Function

The system is activated automatically when the vehicle is started. The indicator light in the button in the center console illuminates.

- The front park assist system is active from the time the engine is started until the vehicle exceeds a speed of approximately 10 mph (15 km/h). It is also active when the vehicle is backing up.
- Rear park assist is active when the engine is running and reverse gear has been selected.

Rear park assist

The distance monitored behind the vehicle is approximately 5 ft (1.5 m). The signal comes from the rear speakers.

The system must be deactivated when towing a trailer, carrying bicycles in a rear-mounted carrier, etc, which could trigger the rear park assist system's sensors.

NOTE

Rear park assist is deactivated automatically when towing a trailer if Volvo genuine trailer wiring is used.

Front park assist

The distance monitored in front of the vehicle is approximately 2.5 ft (0.8 m). The audible signal comes from the audio system's front speakers.

- It may not be possible to combine auxiliary headlights and front park assist since these lights could trigger the system's sensors.



Front/rear park assist (option/accessory)

Activating/deactivating park assist

The system is activated automatically when the vehicle is started.

- Press the Park assist button on the center console (see [page 55](#)) to temporarily deactivate the system(s). The indicator light in the button will go out when the system has been deactivated.
- Park assist will be automatically reactivated the next time the engine is started, or if the button is pressed (the indicator light in the button will illuminate).

NOTE

- Front park assist is disengaged automatically when the parking brake is applied.
- If the vehicle is equipped with front and rear park assist, both systems will be deactivated by pressing the button.

Audible signals from the park assist system

The Park Assist system uses an intermittent tone that pulses faster as you come close to an object, and becomes constant when you are within approximately 1 ft (30 cm) of an object in front of or behind the vehicle. If the volume of another source from the audio system is high, this will be automatically lowered.

If there are objects within this distance both behind and in front of the vehicle, the signal alternates between front and rear speakers.

Faults in the system



If the yellow warning symbol illuminates and **PARK ASSIST SERVICE REQUIRED** is shown on the information display, this indicates that the system is not functioning properly and has been disengaged. Consult a trained and qualified Volvo service technician.

CAUTION

In certain circumstances, the park assist system may give unexpected warning signals that can be caused by external

sound sources that use the same ultrasound frequencies as the system. This may include such things as the horns of other vehicles, wet tires on asphalt, pneumatic brakes, motorcycle exhaust pipes, etc. This does not indicate a fault in the system.



Front/rear park assist (option/accessory)

Cleaning the sensors

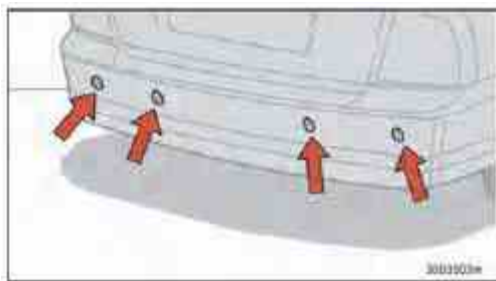

The sensors must be cleaned regularly to ensure that they work properly. Clean them with water and a suitable car washing detergent.

Ice and snow covering the sensors may cause incorrect warning signals.

NOTE

If the sensors are obstructed by e.g., dirt, snow, or ice, this could result in false warning signals from the park assist system.



2008 VOLVO S60

154 07 Wheels and tires



General information	156
Tire inflation	158
Tire inflation pressure table -U.S. models	160
Tire inflation pressure table -Canadian models	161
Tire Pressure Monitoring System(TPMS) - U.S. models	162
Tire designations	164
Glossary of tire terminology	165
Vehicle loading	166
Uniform Tire Quality Grading	168
Snow chains, snow tires, studded tires	169
Temporary spare	170
Changing wheels	171
Tire rotation	174

155 07 Wheels and tires



156 07 Wheels and tires



General information

Your vehicle is equipped with tires according to the vehicle's tire information placard on the B-pillar (the structural member at the side of the vehicle, at the rear of the driver's door opening), or on the inside of the fuel filler door on Canadian models.

The tires have good road holding characteristics and offer good handling on dry and wet surfaces. It should be noted however that the tires have been developed to give these features on snow/ice-free surfaces.

Certain models are equipped with "all-season" tires, which provide a somewhat higher degree of road holding on slippery surfaces than tires without the "all-season" rating. However, for optimum road holding on icy or snow-

covered roads, we recommend suitable winter tires on all four wheels.

When replacing tires, be sure that the new tires are the same size designation, type (radial) and preferably from the same manufacturer, on all four wheels. Otherwise there is a risk of altering the vehicle's roadholding and handling characteristics.

Storing wheels and tires

When storing complete wheels (tires mounted on rims), they should be suspended off the floor or placed on their sides on the floor.

Tires not mounted on rims should be stored on their sides or standing upright, but should not be suspended.



CAUTION

Tires should preferably be stored in a cool, dry, dark place, and should never be stored in close proximity to solvents, gasoline, oils, etc.

Tread wear indicator

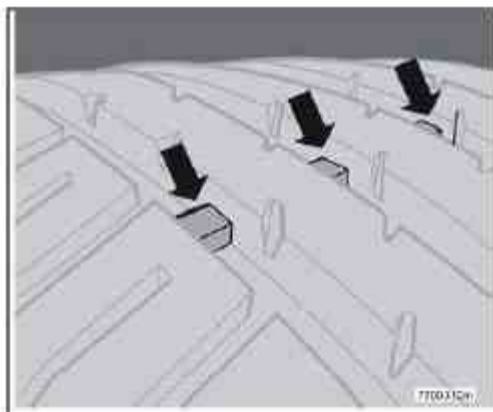

The tires have wear indicator strips running across or parallel to the tread. The letters TWI are printed on the side of the tire. When approximately 1/16" (1.6 mm) is left on the tread, these strips become visible and indicate that the tire should be replaced. Tires with less than 1/16" (1.6 mm) tread offer very poor traction.

When replacing worn tires, it is recommended that the tire be identical in type (radial) and size as the one being replaced. Using a tire of the same make (manufacturer) will prevent alteration of the driving characteristics of the vehicle.



General information



WARNING

The wheel and tire sizes for your Volvo are specified to meet stringent stability and handling requirements. Unapproved wheel/ tire size combinations can negatively affect your vehicle's stability and handling. Approved tire sizes are shown in the Tire inflation pressure tables on [pages 160 and 161](#).

Any damage caused by installation of unapproved wheel/tire size combinations will not be covered by your new

vehicle warranty. Volvo assumes no responsibility for death, injury, or expenses that may result from such installations.



New tires

Remember that tires are perishable goods. As of 2000, the manufacturing week and year will be indicated with 4 digits (e.g. 1502 means that the tire illustrated was manufactured during week 15 of 2002).

Tire age

Tires degrade over time, even when they are not being used. It is recommended that tires generally be replaced after 6 years of normal service. Heat caused by hot climates, frequent high loading conditions or Ultra Violet (U.V) exposure can accelerate the aging process.

You should replace the spare tire when you replace the other road tires due to the aging of the spare.

A tire's age can be determined by the DOT stamp on the sidewall (see the illustration above).

A tire with e.g., visible cracks or discoloration should be replaced immediately.

Improving tire economy:

- Maintain correct tire pressure. See the tire pressure tables on [pages 160 and 161](#).
- Drive smoothly: avoid fast starts, hard braking and tire screeching.
- Tire wear increases with speed.
- Correct front wheel alignment is very important.
- Unbalanced wheels impair tire economy and driving comfort.
- Tires must maintain the same direction of rotation throughout their lifetime.

When replacing tires, the tires with the most tread should be mounted on the rear wheels to reduce the chance of oversteer during hard braking.

Hitting curbs or potholes can damage the tires and/or wheels permanently.



Tire inflation

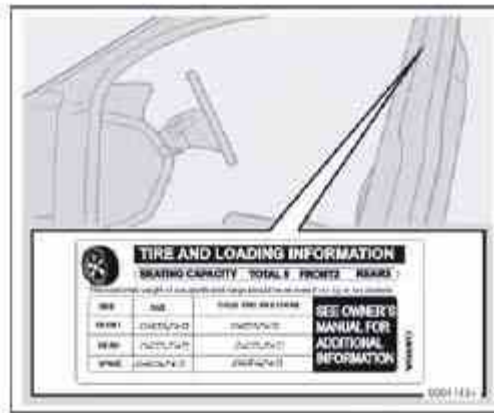

Tire inflation placards on U.S. models

Check tire inflation pressure regularly.

Tables listing the recommended inflation pressure for your vehicle can be found on [pages 160 and 161](#). A tire inflation pressure placard is also located on the driver's side B-pillar (the structural member at the side of the vehicle, at the rear of the driver's door opening). This placard indicates the designation of the factory-mounted tires on your vehicle, as well as load limits and inflation pressure.

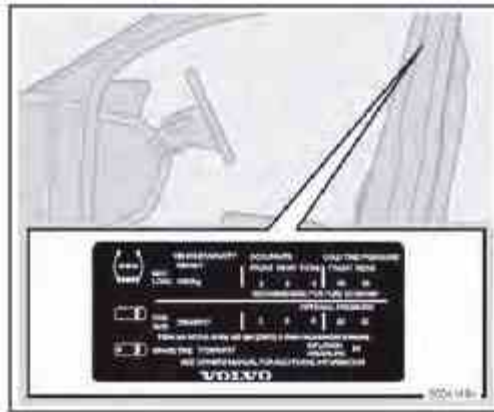

Tire inflation placard on Canadian models

i NOTE

The placards shown indicate inflation pressure for the tires installed on the vehicle at the factory only.

- Use a tire gauge to check the tire inflation pressure, including the spare, at least once a month and before long trips. You are strongly urged to buy a reliable tire pressure gauge, as automatic service station gauges may be inaccurate.
- Use the recommended cold inflation pressure for optimum tire performance and wear.
- Under-inflation or over-inflation may cause uneven treadwear patterns.

! WARNING

Under-inflation is the most common cause of tire failure and may result in severe tire cracking, tread separation, or "blowout," with unexpected loss of vehicle control and increased risk of injury.

Under-inflated tires reduce the load carrying capacity of your vehicle.

When weather temperature changes occur, tire inflation pressures also change. A 10-degree temperature drop causes a corresponding drop of 1 psi (7 kPa) in inflation pressure. Check your tire pressures frequently and adjust them to the proper pressure, which can be found on the vehicle's tire information placard or certification label.

Checking tire pressure

A certain amount of air seepage from the tires occurs naturally and tire pressure fluctuates with seasonal changes in temperature. Always check tire pressure regularly.

Cold tires

Inflation pressure should be checked when the tires are cold.



Tire inflation

The tires are considered to be cold when they have the same temperature as the surrounding (ambient) air.

This temperature is normally reached after the vehicle has been parked for at least 3 hours.

After driving a distance of approximately 1 mile (1.6 km), the tires are considered to be hot. If you have to drive farther than this distance to pump your tire(s), check and record the tire pressure first and add the appropriate air pressure when you get to the pump.

If checking tire pressure when the tire is hot, never "bleed" or reduce air pressure. The tires are hot from driving and it is normal for pressures to increase above recommended cold pressures. A hot tire at or below recommended cold inflation pressure could be significantly under-inflated.

To check inflation pressure:

1. Remove the cap from the valve on one tire, then firmly press the tire gauge onto the valve.
2. Add air to reach the recommended air pressure.
3. Replace the valve cap.
4. Repeat this procedure for each tire, including the spare.
5. Visually inspect the tires to make sure there are no nails or other objects embedded that could puncture the tire and cause an air leak.
6. Check the sidewalls to make sure there are no gouges, cuts, bulges or other irregularities.

NOTE

If you overfill the tire, release air by pushing on the metal stem in the center of the valve. Then recheck the pressure with your tire gauge.

Some spare tires require higher inflation pressure than the other tires. Consult the tire inflation tables on [pages 160 and 161](#), or see the inflation pressure placard.



Tire inflation pressure table - U.S. models

The following tire pressures are recommended by Volvo for your vehicle. Refer to the tire inflation placard for information specific to the tires installed on your vehicle at the factory.

Cold tire pressures up to five persons		
Tire size	Front, psi (kPa)	Rear, psi (kPa)
S60 195/65R15 205/55R16 215/55R16 235/45R17	35 (240)	35 (240)
235/40R18	39 (270)	39 (270)
Temporary spare tire T125/80R17	61 (420)	61 (420)

Load ratings

The load ratings in the tables above translate as follows:

91 = 1365 lbs (615 kg)

93 = 1433 lbs (650 kg)

99 = 1709 lbs (755 kg)

Speed ratings

The speed ratings in the tables translate as follows:

M = 81 mph (130 km/h)

V = 149 mph (240 km/h)

W = 168 mph (270 km/h)

See also [page 164](#) for an explanation of the designations on the sidewall of the tire.



Tire inflation pressure table - Canadian models

The following tire pressures are recommended by Volvo for your vehicle. Refer to the tire inflation placard for information specific to the tires installed on your vehicle at the factory.

Tire size	Cold tire pressures up to five persons psi (kPa)		Optional pressure up to three persons psi (kPa)	
	Front	Rear	Front	Rear
S60 195/65R15 205/55R16 215/55R16 235/45R17	38 (260)	38 (260)	32 (220)	32 (220)
235/40R18	39(270)	39(270)	35 (240)	35 (240)
Temporary spare tire T125/80R17	61 (420)	61 (420)	61 (420)	61 (420)



Tire Pressure Monitoring System (TPMS) - U.S. models

The tire pressure monitoring system uses sensors mounted in the tire valves to check inflation pressure levels. When the vehicle is moving at a speed of approximately 20 mph (30 km/h) or faster, these sensors transmit inflation pressure data to a receiver located in the vehicle.

USA - FCC ID: MRXTG315AM04¹

This device complies with part 15 of the FCC rules. Operation is subject to the following conditions: (1) This device may not cause harmful interference, and (2) this device must accept any interference received, including interference that may cause undesired operation.

¹On certain models, the FCC code is MRXTG315AM04

When low inflation pressure is detected, TPMS will light up the tire pressure warning light () (also referred to as a telltale) in the instrument panel, and will display a message in the text window. The wording of this message is determined by the degree of inflation pressure loss.

NOTE

If a fault occurs in TPMS, the tire pressure warning light will flash for approximately 1 minute and TIRE PRESS SYST SERVICE REQUIRED will be displayed.

Each tire, including the spare (if provided), should be checked monthly when cold and inflated to the inflation pressure recommended by the vehicle manufacturer on the vehicle placard or tire inflation pressure label. (If your vehicle has tires of a different size than the size indicated on the vehicle placard or tire inflation pressure label, you should determine the proper tire inflation pressure for those tires.)

As an added safety feature, your vehicle has been equipped with a tire pressure monitoring system (TPMS) that illuminates a low tire pressure telltale when one or more of your tires is significantly under-inflated. Accordingly, when the low tire pressure telltale illuminates, you should stop and check your tires as soon as possible, and inflate them to the proper pressure. Driving on a significantly under-inflated tire causes the tire to overheat and can lead to tire failure. Under-inflation also reduces fuel efficiency and tire tread life, and may affect the vehicle's handling and stopping ability.

Please note that the TPMS is not a substitute for proper tire maintenance, and it is the driver's responsibility to maintain correct tire pressure, even if under-inflation has not reached the level to trigger illumination of the TPMS low tire pressure telltale.

Your vehicle has also been equipped with a TPMS malfunction indicator to indicate when the system is not operating properly. The TPMS malfunction indicator is combined with the low tire pressure telltale. When the system detects a malfunction, the telltale will flash for approximately one minute and then remain continuously illuminated. This sequence will continue upon subsequent vehicle start-ups as long as the malfunction exists. When the malfunction indicator is illuminated, the system may not be able to detect or signal low tire pressure as intended. TPMS malfunctions may occur for a variety of reasons, including the installation of replacement or alternate tires or wheels on the vehicle that prevent the TPMS from functioning properly. Always check the TPMS malfunction telltale after replacing one or more tires or wheels on your vehicle to ensure that the replacement or alternate tires and wheels allow the TPMS to continue to function properly.



Tire Pressure Monitoring System (TPMS) - U.S. models

NOTE

TPMS indicates low tire pressure but does not replace normal tire maintenance. For information on correct tire pressure, please refer to the tables on [pages 160 and 161](#), or consult your Volvo retailer.

Erasing warning messages

When a low tire pressure warning message has been displayed, and the tire pressure warning light has come on:

- Use a tire pressure gauge to check the inflation pressure of all four tires.
- Re-inflate the tire(s) to the correct pressure (consult the tire pressure placard or the tables on [pages 160 and 161](#)).
- Drive the vehicle for several minutes at a speed of 20 mph (30 km/h) or faster.

This will erase the warning text and the warning light will go out.

WARNING

Incorrect inflation pressure could lead to tire failure, resulting in a loss of control of the vehicle.

Changing wheels with TPMS

Please note the following when changing or replacing the factory installed TPMS wheels/tires on the vehicle:

- Only the factory-mounted wheels are equipped with TPMS sensors in the valves.
- If the vehicle is equipped with a temporary spare tire, this tire does not have a TPMS sensor.
- If wheels without TPMS sensors are mounted on the vehicle, TIRE PRESS SYST SERVICE REQUIRED will be displayed each time the vehicle is driven above 25 mph (40 km/h) for 10 minutes or more.
- Once TPMS sensors are properly installed, the warning message should not reappear.
- Volvo recommends that TPMS sensors be fitted on all wheels used on the vehicle. Volvo does not recommend moving sensors back and forth between sets of wheels.

CAUTION

When inflating tires with TPMS valves, press the pump's mouthpiece straight onto the valve to help avoid bending or otherwise damaging the valve.



Tire designations

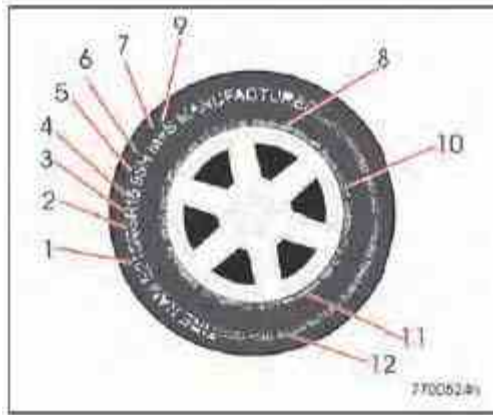

Federal law mandates that tire manufacturers place standardized information on the sidewall of all tires (see the illustration).

The following information is listed on the tire sidewall:

The tire designation (the following figures are examples of a tire designation):

1. **215**: the width of the tire (in millimeters) from sidewall edge to sidewall edge. The larger the number, the wider the tire.
2. **Å**: The ratio of the tire's height to its width.
3. **R**: Radial tire.
4. **15**: The diameter of the wheel rim (in inches).
5. **95**: The tire's load index. In this example, a load index of 95 equals a maximum load of 1521 lbs (690 kg).
6. **H**: The tire's speed rating, or the maximum speed at which the tire is designed to be driven for extended periods of time, carrying a permissible load for the vehicle, and with correct inflation pressure. For example, H indicates a speed rating of 130 mph (210 km/h).

i NOTE

This information may not appear on the tire because it is not required by law.

7. **M+S** or **M/S** = Mud and Snow

AT = All Terrain

AS = All Season

8. **U.S. DOT** Tire Identification Number (TIN): This begins with the letters "DOT" and indicates that the tire meets all federal standards. The next two numbers or letters are the plant code where it was manufactured, the next two are the tire size code and the last four numbers represent the week and year the tire was built. For example, the numbers 317 mean the 31st week of 1997. After 2000 the numbers go to four digits. For example, 2501 means the 25th week of 2001. The numbers in between are marketing codes used at the manufacturer's discretion. This information helps a tire manufacturer identify a tire for safety recall purposes.

9. **Tire Ply Composition and Material Used**: Indicates the number of plies indicates or the number of layers of rubber-coated fabric in the tire tread and sidewall. Tire manufacturers also must indicate the ply materials in the tire and the sidewall, which include steel, nylon, polyester, and others.

10. **Maximum Load**: Indicates the maximum load in pounds and kilograms that can be carried by the tire. Refer to the

vehicle's tire information placard or the safety certification label, located on the B-Pillar or the driver's door or on the inside of the fuel filler door on Canadian models, for the correct tire pressure for your vehicle.

11. Treadwear, Traction, and Temperature grades: See [page 168](#) for more information.

12. Maximum permissible inflation pressure: the greatest amount of air pressure that should ever be put in the tire. This limit is set by the tire manufacturer.



Glossary of tire terminology

Tire suppliers may have additional markings, notes or warnings such as standard load, radial tubeless, etc.

- **Tire information placard:** A placard showing the OE (Original Equipment) tire sizes, recommended inflation pressure, and the maximum weight the vehicle can carry.
- **Tire Identification Number (TIN):** A number on the sidewall of each tire providing information about the tire brand and manufacturing plant, tire size and date of manufacturer.
- **Inflation pressure:** A measure of the amount of air in a tire.
- **Standard load:** A class of P-metric or Metric tires designed to carry a maximum load at 35 psi [37 psi (2.5 bar) for Metric tires]. Increasing the inflation pressure beyond this pressure will not increase the tires load carrying capability.
- **Extra load:** A class of P-metric or Metric tires designed to carry a heavier maximum load at 41 psi [43 psi (2.9 bar) for Metric tires]. Increasing the inflation pressure beyond this pressure will not increase the tires load carrying capability.
- **kPa:** Kilopascal, a metric unit of air pressure.
- **PSI:** Pounds per square inch, a standard unit of air pressure.
- **B-pillar:** The structural member at the side of the vehicle behind the front door.
- **Bead area of the tire:** Area of the tire next to the rim.
- **Sidewall of the tire:** Area between the bead area and the tread.
- **Tread area of the tire:** Area of the perimeter of the tire that contacts the road when mounted on the vehicle.
- **Rim:** The metal support (wheel) for a tire or a tire and tube assembly upon which the tire beads are seated.
- **Maximum load rating:** a figure indicating the maximum load in pounds and kilograms that can be carried by the tire. This rating is established by the tire manufacturer.
- **Maximum permissible inflation pressure:** the greatest amount of air pressure that should ever be put in the tire. This limit is set by the tire manufacturer.
- **Recommended tire inflation pressure:** inflation pressure, established by Volvo, which is based on the type of tires that are mounted on a vehicle at the factory. This inflation pressure is affected by the number of occupants in the vehicle, the amount of cargo, and the speed at which the vehicle will be driven for a prolonged period. This information can be found on the tire inflation placard(s) located on the driver's side B-pillar or on the inside of the fuel filler door on Canadian models, and in the tire inflation table in this chapter.
- **Cold tires:** The tires are considered to be cold when they have the same temperature as the surrounding (ambient) air. This temperature is normally reached after the vehicle has been parked for at least 3 hours.



Vehicle loading

Properly loading your vehicle will provide maximum return of vehicle design performance.

Before loading your vehicle, familiarize yourself with the following terms for determining your vehicle's weight ratings, with or without a trailer, from the vehicle's Federal/ Canadian Motor Vehicle Safety Standards (FMVSS/CMVSS) label, and the vehicle's tire information placard:

Curb weight

The weight of the vehicle including a full tank of fuel and all standard equipment. It does not include passengers, cargo, or optional equipment.

Capacity weight

All weight added to the curb weight, including cargo and optional equipment. When towing, trailer hitch tongue load is also part of cargo weight.

NOTE

NOTE: For trailer towing information, please refer to the section "Towing a trailer" on [page 144](#).

Permissible axle weight

The maximum allowable weight that can be carried by a single axle (front or rear). These numbers are shown on the Federal/Canadian Motor Vehicle Safety Standards (FMVSS/CMVSS) label. The total load on each axle must never exceed its maximum permissible weight.

Gross vehicle weight (GVW)

The vehicle's curb weight + cargo + passengers.

NOTE

- The location of the various labels in your vehicle can be found on [page 243](#).
- A table listing important weight limits for your vehicle can be found on [page 245](#).

Steps for Determining Correct Load Limit

1. Locate the statement "the combined weight of occupants and cargo should never exceed XXX pounds" on your vehicle's placard.
2. Determine the combined weight of the driver and passengers that will be riding in your vehicle.
3. Subtract the combined weight of the driver and passengers from XXX kilograms or XXX pounds.
4. The resulting figure equals the available amount of cargo and luggage load capacity. For example, if the "XXX" amount equals 1400 lbs. and there will be five 150 lb. passengers in your vehicle, the amount of available cargo and luggage load capacity is 650 lbs. (1400-750 (5 x 150) = 650 lbs.)
5. Determine the combined weight of luggage and cargo being loaded on the vehicle. That weight may not safely exceed the available cargo and luggage load capacity calculated in Step 4.
6. If your vehicle will be towing a trailer, load from your trailer will be transferred to your vehicle. Consult this manual¹ to determine how this reduces the available cargo and luggage load capacity of your vehicle.

¹See "Towing a trailer" on [page 144](#).



Vehicle loading



WARNING

- Exceeding the permissible axle weight, gross vehicle weight, or any other weight rating limits can cause tire overheating resulting in permanent deformation or catastrophic failure.
- Do not use replacement tires with lower load carrying capacities than the tires that were original equipment on the vehicle because this will lower the vehicle's GVW rating. Replacement tires with a higher limit than the originals do not increase the vehicle's GVW rating limitations.

168 07 Wheels and tires



Uniform Tire Quality Grading

ALL PASSENGER VEHICLE TIRES MUST CONFORM TO FEDERAL SAFETY REQUIREMENTS IN ADDITION TO THESE GRADES

Quality grades can be found, where applicable, on the tire sidewall between the tread shoulder and maximum section width. For example:

Treadwear 200 Traction AA Temperature A

TREADWEAR

The treadwear grade is a comparative rating based on the wear rate of the tire when tested under controlled conditions on a specified government test course. For example, a tire graded 150 would wear one and one half (1 1/2) times as well on the government course as a tire graded 100. The relative performance of tires depends upon the actual conditions of their use, however, and many depart significantly from the norm due to variation in driving habits, maintenance practices and differences in road characteristics and climate.

TRACTION

The traction grades, from highest to lowest, are AA, A, B, and C, as measured under controlled conditions on specified government test surfaces of asphalt and concrete. A tire marked C may have poor traction performance.



WARNING

The traction grade assigned to this tire is based on braking (straight-ahead) traction tests and is not a measure of cornering (turning) traction.

TEMPERATURE

The temperature grades are AA (the highest), A, B, and C, representing the tire's resistance to the generation of heat and its ability to dissipate heat when tested under controlled conditions on a specified indoor laboratory test wheel. Sustained high temperature can cause the material of the tire to degenerate and reduce tire life, and excessive temperature can lead to sudden tire failure. The grade C corresponds to a minimum level of performance that all passenger vehicle tires must meet under the Federal Motor Safety Standard No. 109. Grades B and A represent higher levels of performance on the laboratory test wheel than the minimum required by law.



WARNING

The temperature grade for this tire is established for a tire that is properly inflated and not overloaded. Excessive speed, under-inflation, or excessive loading, either separately or in combination, can cause heat buildup and tire failure.



Snow chains, snow tires, studded tires

Snow chains

Snow chains can be used on your Volvo with the following restrictions:

- Snow chains should be installed on front wheels only. Use only Volvo approved snow chains.
- If accessory, aftermarket or "custom" tires and wheels are installed and are of a size different than the original tires and wheels, chains in some cases CANNOT be used. Sufficient clearances between chains and brakes, suspension and body components must be maintained.
- Some strap-on type chains will interfere with brake components and therefore CANNOT be used.
- All Wheel Drive models: Snow chains should only be installed on the front wheels. Only chains adapted for AWD models should be used.

Consult your Volvo retailer for additional snow chain information.



CAUTION

- Check local regulations regarding the use of snow chains before installing.
- Always follow the chain manufacturer's installation instructions carefully. Install chains as tightly as possible and retighten periodically.
- Never exceed the chain manufacturer's specified maximum speed limit. (Under no circumstances should you exceed 31 mph (50 km/h)).
- Avoid bumps, holes or sharp turns when driving with snow chains.
- The handling of the vehicle can be adversely affected when driving with chains. Avoid fast or sharp turns as well as locked wheel braking.

Snow tires, studded tires¹

Tires for winter use:

- Owners who live in or regularly commute through areas with sustained periods of snow or icy driving conditions are strongly advised to fit suitable winter tires to help retain the highest degree of traction.
- It is important to install winter tires on all four wheels to help retain traction during cornering, braking, and accelerating. Failure to do so could reduce traction to an unsafe level or adversely affect handling.
- Do not mix tires of different design as this could also negatively affect overall tire road grip.
- Winter tires wear more quickly on dry roads in warm weather. They should be removed when the winter driving season has ended.
- Studded tires should be run-in 300-600 miles (500-1000 km) during which the vehicle should be driven as smoothly as possible to give the studs the opportunity to seat properly in the tires. The tires should have the same rotational direction throughout their entire lifetime.

¹Where permitted



NOTE



Temporary spare

The spare tire in your vehicle is called a "Temporary Spare".

Recommended tire pressure (see the placard on the B-pillar or on the fuel filler door) should be maintained irrespective of which position on the vehicle the temporary spare tire is used on.

In the event of damage to this tire, a new one can be purchased from your Volvo retailer.

WARNING

Current legislation prohibits the use of the "Temporary Spare" tire other than as a temporary replacement for a punctured tire. It must be replaced as soon as possible by a standard tire. Road holding and handling may be affected with the "Temporary Spare" in use.

CAUTION

The vehicle must not be driven with wheels of different dimensions or with a spare tire other than the one that came with the vehicle. The use of different size wheels can seriously damage your vehicle's transmission.



Changing wheels

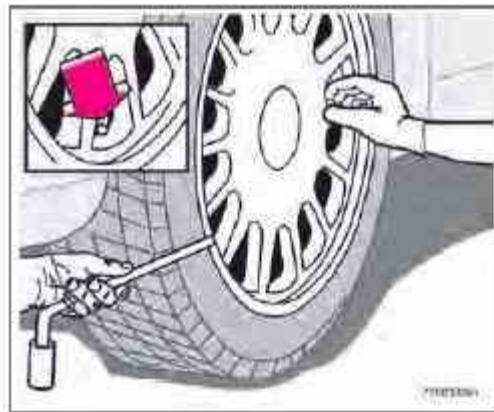

Insert flat end of lug wrench and turn/pull straight out

The spare wheel is located under the carpet on the trunk floor. The jack and crank are secured in the wheel recess.

There are two jack attachment points on each side of the vehicle (see illustration on next page).

To change a wheel:

1. Engage the parking brake.
2. Put the gear selector in P (automatic transmission) or reverse (manual transmission).

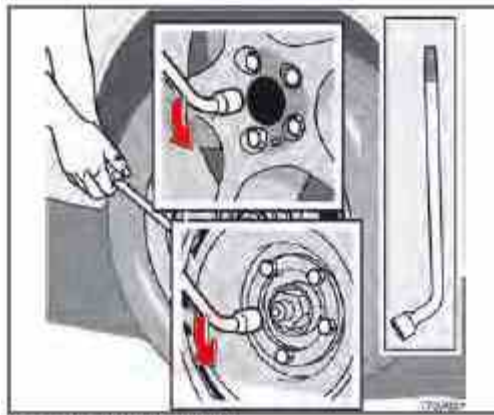

Loosen the wheel bolts

3. Remove the wheel cap (where applicable) using the lug wrench in the tool bag.

4. With the vehicle still on the ground, use the lug wrench to loosen the wheel bolts 1/2 - 1 turn by exerting downward pressure. Turn the bolts counterclockwise to loosen.

i CAUTION

- The vehicle must not be driven with wheels of different dimensions or with a spare tire other than the one that came with the vehicle. The use of different size wheels can seriously damage your vehicle's transmission.
- Correct tightening torque on wheel bolts must be observed. The wheel bolts should never be greased or lubricated. The extended, chromed wheel bolts must not be used with steel rims, as they make it impossible to fit the hub caps.
- Locking wheel bolts can be used on both aluminum and steel wheels. If hub caps are used on steel wheels, the locking wheel bolt should be mounted in the hole as far from the tire's inflation valve as possible. It would otherwise not be possible to mount the hub cap on the wheel.



Changing wheels

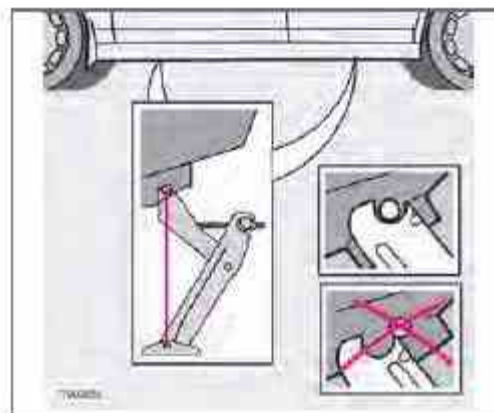

Attaching the jack

1. Position the jack correctly on the bar in the attachment (see the illustration) and crank while simultaneously guiding the base of the jack to the ground. The base of the jack must be flat on a level, firm, non-slippery surface. Before raising the vehicle, check that the jack is still correctly positioned in the attachment.

2. Raise the vehicle until the wheel to be changed is lifted off the ground.

3. Unscrew the wheel bolts completely and carefully remove the wheel so as not to damage the threads on the studs.

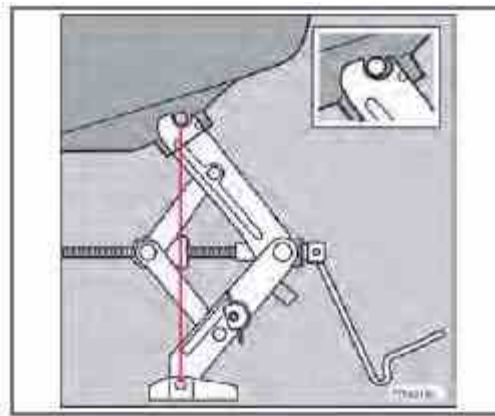

Jack on certain models

i NOTE

To avoid excessive wear and the necessity of rebalancing, mark and reinstall wheels in the same location and position as before removal. To lessen the chance of imbalance, each wheel hub is equipped with a guide stud to ensure that a removed wheel can be reinstalled in its original position (as when changing over to winter tires/wheels).



Installing the wheel

1. Clean the contact surfaces on the wheel and hub.
2. Lift the wheel and place it on the hub.
3. Install the wheel bolts and tighten hand-tight. Using the lug wrench, tighten crosswise until all bolts are snug.
4. Lower the vehicle to the ground and alternately tighten the bolts crosswise to 102 ft. lbs. (140 Nm).
5. Install the wheel cap (where applicable).



Changing wheels

! WARNING

- The jack must correctly engage the bar in the jack attachment. The vehicle's weight must not rest on the jack

attachment. See illustration "*Attaching the jack*".

- Be sure the jack is on a firm, level, non-slippery surface.
- Never allow any part of your body to be extended under a vehicle supported by a jack.
- Use the jack intended for the vehicle when replacing a wheel. For any other job, use stands to support the side of the vehicle being worked on.
- Apply the parking brake and put the gear selector in the **(P)**ark position (or reverse on manual transmissions).
- Block the wheels standing on the ground, use rigid wooden blocks or large stones.
- The jack should be kept well-greased and clean, and should not be damaged.
- No objects should be placed between the base of jack and the ground, or between the jack and the attachment bar on the vehicle.



Tire rotation

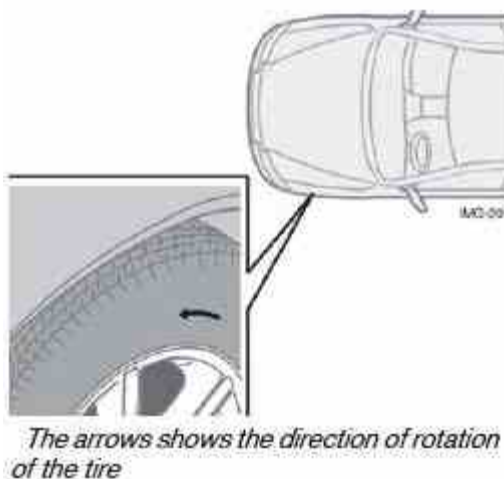

Summer and winter tires

- When switching between summer and winter tires, mark the tires to indicate where they were mounted on the car, e.g., LF = left front, RR = right rear
- Tires with tread designed to roll in only one direction are marked with an arrow on the sidewall.
- Incorrectly mounted tires impair the car's braking properties and ability to force aside rain, snow and slush.
- The tires with the most tread should always be at the rear (to reduce the risk of skidding).
- Contact a Volvo workshop if you are unsure about the tread depth.

Tire rotation

Your vehicle has no recommended tire rotation. The following information is intended to help you understand why.

Tread set

As a tire ages and the rubber cures, front and rear tires set at different angles. Therefore, if tires are rotated, the tread will eventually set at an angle that is a compromise. Even if ride, handling, and road noise may still seem acceptable, they may not be optimal. Further, tires that are rotated, but not on a regular basis, may actually cause more tire noise, faster tire wear, and unpleasant changes in steering feel and vehicle handling.

A tire that can fully adapt to its position will provide better steering feel, lower tire noise, and better fuel economy.

Braking stability performance

Your vehicle is driven mainly by the front tires, which will wear faster. This can be beneficial. Having more tread on the rear tires will help reduce oversteer. Oversteer is when a vehicle wants to keep turning because of momentum and

dynamic forces on its suspension.

Suspension wear diagnostics

Every suspension needs periodic inspection and maintenance. A tire's wear pattern can be an aid in detecting a suspension problem. Each tire, if left in place, tells a story about the suspension. Tire rotation, on the other hand, could make suspension wear harder to detect. Early detection is very important, because suspension problems can make tire wear worse.

If you do rotate your tires...

Please follow the tire manufacturer's recommendations, as outlined in the tire manufacturer's tire warranty pamphlet.



This page left intentionally blank.



2008 VOLVO S60

176 08 Car care



Washing and cleaning the vehicle [178](#)

Paint touch up [181](#)

177 08 Car care



178 08 Car care



Washing and cleaning the vehicle

Washing the vehicle

- The vehicle should be washed at regular intervals since dirt, dust, insects and tar spots adhere to the paint and may cause damage. It is particularly important to wash the vehicle frequently in the wintertime to prevent corrosion, when salt has been used on the roads.
- When washing the vehicle, do not expose it to direct sunlight. Use lukewarm water to soften the dirt before you wash with a sponge, and plenty of water, to avoid scratching.
- Bird droppings: Remove from paintwork as soon as possible. Otherwise the finish may be permanently damaged.
- A detergent can be used to facilitate the softening of dirt and oil.
- A water-soluble grease solvent may be used in cases of sticky dirt. However, use a wash place equipped with a drainage separator.
- Dry the vehicle with a clean chamois and remember to clean the drain holes in the doors and rocker panels.
- Tar spots can be removed with kerosene or tar remover after the vehicle has been washed.
- A stiff-bristle brush and lukewarm soapy water can be used to clean the wiper blades. Frequent cleaning of the windshield and wiper blades improves visibility considerably and also helps prolong the service life of the wiper blades.
- Wash off the dirt from the underside (wheel housings, fenders, etc.).
- In areas of high industrial fallout, more frequent washing is recommended.

CAUTION

During high pressure washing, the spray mouthpiece must never be closer to the vehicle than 13" (30 cm). Do not

spray into the locks.

When washing or steam cleaning the engine, avoid spraying water or steam directly on the electrical components or toward the rear side of the engine.

Dirt, snow, etc., on the headlights can reduce lighting capacity considerably. Clean the headlights regularly, for example when refueling.

- Always close the moonroof and sun shade before washing your vehicle.
- Never use abrasive cleaning agents on the moonroof.
- Never use wax on the rubber seals around the moonroof.

- After cleaning the engine, the spark plug wells should be inspected for water and blown dry if necessary.

Suitable detergents: Special vehicle washing detergents should be used. A suitable mixture is about 2.5 fl. oz. (8.5 cl) of detergent to 2.6 US gal. (10 liters) of warm water. After washing with a detergent the vehicle should be well rinsed with clean water.

Exterior components

Volvo recommends the use of special cleaning products, available at your Volvo retailer, for cleaning colored plastic, rubber, or ornamental components such as chromed strips on the exterior of your vehicle. The instructions for using these products should be followed carefully. Solvents or stain removers should not be used.

CAUTION

- Avoid waxing or polishing plastic or rubber components
- Polishing chromed strips can wear away or damage the surface
- Polishes containing abrasive substances should not be used

NOTE

When washing the vehicle, remember to remove dirt from the drain holes in the doors and sills



Washing and cleaning the vehicle

WARNING

When the vehicle is driven immediately after being washed, apply the brakes several times in order to remove any moisture from the brake linings.

Engine cleaning agents should not be used when the engine is warm. This constitutes a fire risk.

Automatic washing - simple and quick

- We do NOT recommend washing your vehicle in an automatic wash during the first six months (because the paint will not have hardened sufficiently).
- An automatic wash is a simple and quick way to clean your vehicle, but it is worth remembering that it may not be as thorough as when you yourself go over the vehicle with sponge and water. Keeping the underbody clean is most

important, especially in the winter. Some automatic washers do not have facilities for washing the underbody.

- Before driving into an automatic vehicle wash, make sure that side view mirrors, auxiliary lamps, etc, are secure, and that any antenna(s) are retracted or removed. Otherwise there is risk of the machine dislodging them.

Exterior lighting

Condensation may form temporarily on the inside of the lenses of exterior lights such as headlights, fog lights, or tail lights. This is normal and the lights are designed to withstand moisture. Normally, condensation will dissipate after the lights have been on for a short time.

Polishing and waxing

- Normally, polishing is not required during the first year after delivery, however, waxing may be beneficial.
- Before applying polish or wax the vehicle must be washed and dried. Tar spots can be removed with kerosene or tar remover. Difficult spots may require a fine rubbing compound.
- After polishing use liquid or paste wax.
- Several commercially available products contain both polish and wax.
- Waxing alone does not substitute for polishing a dull surface.
- A wide range of polymer-based vehicle waxes can be purchased today. These waxes are easy to use and produce a long-lasting, high-gloss finish that protects the bodywork against oxidation, road dirt and fading.
- Do not polish or wax your vehicle in direct sunlight (the surface of the vehicle should not be warmer than 113° F (45° C)).



CAUTION

Volvo does not recommend the use of long-life or durable paint protection coatings, some of which may claim to prevent pitting, fading, oxidation, etc. These coatings have not been tested by Volvo for compatibility with your vehicle's clear coat. Some of them may cause the clear coat to soften, crack, or cloud. Damage caused by application of paint protection coatings may not be covered under your vehicle's paint warranty.



Washing and cleaning the vehicle

Cleaning the upholstery

Fabric

Clean with soapy water or a detergent. For more difficult spots caused by oil, ice cream, shoe polish, grease, etc., use a clothing/fabric stain remover. Consult your Volvo retailer.

Interior plastic components

Cleaning interior plastic components should be done with a cleaning agent specially designed for this purpose. Consult your Volvo retailer.

Alcantera™ suede-like material

Suede-like upholstery can be cleaned with a soft cloth and mild soap solution.

Leather care

Volvo's leather upholstery is manufactured with a protectant to repel soiling. Over time, sunlight, grease and dirt can break down the protection. Staining, cracking, scuffing, and fading can result.

Volvo offers an easy-to-use, non-greasy leather care kit formulated to clean and beautify your vehicle's leather, and to renew the protective qualities of its finish. The cleaner removes dirt and oil buildup. The light cream protectant

restores a barrier against soil and sunlight.

Volvo also offers a special leather softener that should be applied after the cleaner and protectant. It leaves leather soft and smooth, and reduces friction between leather and other finishes in the vehicle.

Volvo recommends cleaning, protecting and conditioning your vehicle's leather two to four times a year. Ask your Volvo retailer about Leather Care Kit 951 0251 and Leather Softener 943 7429.

Cleaning leather upholstery

1. Pour leather cleaner on a damp sponge and squeeze it until the cleaner foams.
2. Apply the foam to the stain by moving the sponge with circular movements.
3. Dampen the stain thoroughly with the sponge. Let the sponge absorb the stain, do not rub.
4. Dry the stain with soft paper towels or a towel, and allow the leather to dry completely.

Protecting leather upholstery

1. Put a small amount of protectant cream on a cloth and apply a thin coating of cream to the upholstery with light circular movements.
2. Allow the leather to dry for 20 minutes. This will help the leather resist staining and protect against sunlight's harmful UV rays.

CAUTION

- Under no circumstances should gasoline, naphtha or similar cleaning agents be used on the plastic or the leather since these can cause damage.
- Take extra care when removing stains such as ink or lipstick since the coloring can spread.
- Use solvents sparingly. Too much solvent can damage the seat padding.
- Start from the outside of the stain and work toward the center.
- Sharp objects (e.g. pencils or pens in a pocket) or velcro fasteners on clothing may damage the textile upholstery.
- Clothing that is not colorfast, such as new jeans or suede garments, may stain the upholstery.

Chromed wheels: Clean chrome-plated wheels using the same detergents used for the body of the vehicle. Aggressive wheel-cleaning agents can permanently stain chrome-plated wheels.

Cleaning the seat belts

Clean only with lukewarm water and a mild soap solution.



Paint touch up

Cleaning floor mats

The floor mats should be vacuumed or brushed clean regularly, especially during winter when they should be taken out for drying. Spots on textile mats can be removed with a mild detergent.

Bear in mind

- Take extra care when removing stains such as ink or lipstick since the coloring can spread.
- Use solvents sparingly. Too much solvent can damage the seat padding.
- Start from the outside of the stain and work toward the center.

Paint damage requires immediate attention to avoid rusting. Make it a habit to check the finish regularly - when washing the vehicle for instance. Touch-up if necessary.

Paint repairs require special equipment and skill. Contact a trained and qualified Volvo service technician for any extensive damage.

Color code



Model plate with paint color code¹

Make sure you have the right color. When ordering touch-up paint from your Volvo retailer, use the paint code indicated on the model plate (1 in the illustration above).

¹The model plate is located on the passenger's side center door pillar.

Minor stone chips and scratches

Material:

- Primer - can
- Paint - touch-up pen
- Brush
- Masking tape
- If the stone chip has not gone down to the bare metal and an undamaged color coat remains, you can add paint immediately after removing dirt.

NOTE

When touching up the vehicle, it should be clean and dry. The surface temperature should be above 60° F (15° C).

Minor scratches on the surface

Minor scratches can be repaired by using Volvo touch-up paint. If the stone chip has not penetrated down to the metal and an undamaged layer of paint remains, the touch-up paint can be applied as soon as the spot has been cleaned.



Paint touch up

Deep scratches



1. Place a strip of masking tape over the damaged surface. Pull the tape off so that any loose flakes of paint adhere to it.
2. Thoroughly mix the primer and apply it with a small brush. When the primer surface is dry, the paint can be applied using a brush. Mix the paint thoroughly; apply several thin paint coats and let dry after each application.
3. If there is a longer scratch, you may want to protect surrounding paint by masking it off.



This page left intentionally blank.



2008 VOLVO S60

184 09 Maintenance and servicing



Volvo service	186
Maintaining your vehicle	187
Emission inspection readiness	188
Working on your vehicle	189
Hood and engine compartment	191
Engine oil	192
Fluids	195
Wiper blades	197
Battery	198
Replacing bulbs	201
Fuses	211

185 09 Maintenance and servicing



186 09 Maintenance and servicing



Volvo service

Maintenance service

Periodic maintenance will help keep your vehicle running well. Your Warranty and Service Records Information booklet provides a comprehensive maintenance schedule up to 150,000 miles (240,000 km) of vehicle service. This maintenance program contains inspections and services necessary for the proper function of your vehicle, and includes components that affect vehicle emissions. The maintenance services contain several checks that require special instruments and tools and therefore must be performed by a qualified technician. Volvo advises you to follow the service program outlined in this booklet. To keep your Volvo in top condition, specify time-tested and proven Genuine Volvo Parts and Accessories.

The Federal Clean Air Act - U.S.

The Federal Clean Air Act requires vehicle manufacturers to furnish written instructions to the ultimate purchaser to assure the proper servicing and function of the components that control emissions. These services, which are listed in the

"Warranty and Service Records Information booklet," are not covered by the warranty. You will be required to pay for labor and material used.

Maintenance services

Your Volvo passed several major inspections before it was delivered to you, in accordance with Volvo specifications. The maintenance services outlined in the Warranty and Service Records Information booklet, many of which will positively affect your vehicle's emissions, should be performed as indicated. It is recommended that receipts for vehicle emission services be retained in case questions arise concerning maintenance.

Inspection and service should also be performed anytime a malfunction is observed or suspected.

Vehicle Event Data (Black Box)

Your vehicle's driving and safety systems employ computers that monitor, and share with each other, information about your vehicle's operation. One or more of these computers may store what they monitor, either during normal vehicle operation or in a crash or near-crash event. Stored information may be read and used by:

- Volvo Car Corporation
- service and repair facilities
- law enforcement or government agencies
- others who may assert a legal right to know, or who obtain your consent to know such information.

Applicable warranties

In accordance with applicable U.S. and Canadian regulations, the following list of warranties is provided.

- New Car Limited Warranty
- Parts and Accessories Limited Warranty
- Corrosion Protection Limited Warranty
- Seat Belt and Supplemental Restraint Systems Limited Warranty
- Emission Design and Defect Warranty
- Emission Performance Warranty

These are the Federal warranties; other warranties are provided as required by state/provincial law. Refer to your separate Warranty and Service Records Information booklet for detailed information concerning each of the warranties.



Maintaining your vehicle

Owner maintenance

Periodic maintenance requirements and intervals are described in your vehicle's Warranty and Service Records Information booklet.

The following points can be carried out between the normally scheduled maintenance services.

Each time the vehicle is refueled:

- Check the engine oil level
- Clean the windshield, windshield wipers, headlights, and tail lights

Monthly:

- Check cold tire pressure in all tires. Inspect the tires for wear.

- Check that engine coolant and other fluid levels are between the indicated " min" and "max" markings.
- Clean interior glass surfaces with a glass cleaner and soft paper towels.
- Wipe driver information displays with a soft cloth.
- Visually inspect battery terminals for corrosion. Corrosion may indicate a loose terminal connector, or a battery near the end of its useful service life. Consult a trained and qualified Volvo service technician for additional information.

As needed:

- Wash the vehicle, including the undercarriage, to reduce wear that can be caused by a buildup of dirt, and corrosion that can be caused by salt residues.
- Clean leaves and twigs from air intake vents at the base of the windshield, and from other places where they may collect.

i NOTE

Complete service information for qualified technicians is available online for purchase or subscription at www.volvotechinfo.com.



Emission inspection readiness

What is an Onboard Diagnostic System (OBD II)?

OBD II is part of your vehicle's computerized engine management system. It stores diagnostic information about your vehicle's emission controls. It can light the Check Engine light (MIL) if it detects an emission control "fault." A "fault" is a component or system that is not performing within an expected range. A fault may be permanent or temporary. OBD II will store a message about any fault.

How do states use OBD II for emission inspections?

Many states connect a computer directly to a vehicle's OBD II system. The inspector can then read "faults." In some states, this type of inspection has replaced the tailpipe emission test.

How can my vehicle fail OBD II emission inspection?

Your vehicle can fail OBD II emission inspection for any of the following reasons.

- If your Check Engine (MIL) light is lit, your vehicle may fail inspection.
- If your vehicle's Check Engine light was lit, but went out without any action on your part, OBD II will still have a recorded fault. Your vehicle may pass or fail, depending on the inspection practices in your area.
- If you had recent service that required disconnecting the battery, OBD II diagnostic information may be incomplete and "not ready" for inspection. A vehicle that is not ready may fail inspection.

How can I prepare for my next OBD II emission inspection?

- If your Check Engine (MIL) light is lit - or was lit but went out without service, have your vehicle diagnosed and, if necessary, serviced by a qualified Volvo technician.
- If you recently had service for a lit Check Engine light, or if you had service that required disconnecting the battery, a period of driving is necessary to bring the OBD II system to "ready" for inspection. A half-hour trip of mixed stop-and-go/highway driving is typically needed to allow OBD II to reach readiness. Your Volvo retailer can provide you with more information on planning a trip.
- Maintain your vehicle in accordance with your vehicle's maintenance schedule.



Working on your vehicle

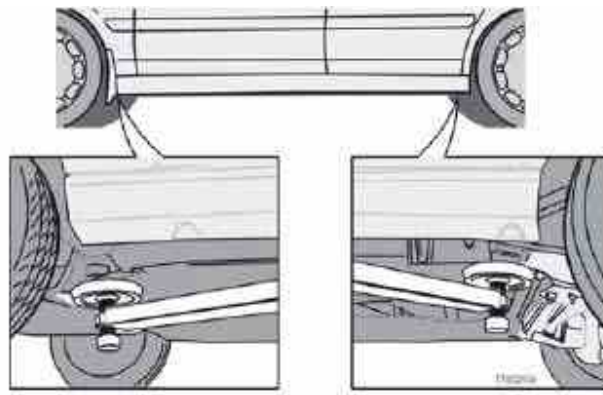

Note the following before you begin working on your vehicle

Battery

- Ensure that the battery cables are correctly connected and tightened.
- Never disconnect the battery when the engine is running (e.g. when replacing the battery).
- Never use a fast charger to charge the battery. The battery cables should be disconnected when recharging.
- The battery contains acid that is both corrosive and poisonous. It is important that the battery is handled in an environmentally friendly way. Let your Volvo dealer assist you.

Hoisting the vehicle

If a garage jack is used to lift the vehicle, the two jack attachments points should be used. They are specially reinforced to bear the weight of the vehicle. A garage jack can also be placed under the front of the engine support frame. Take care not to damage the splash guard under the engine. Ensure that the jack is positioned so that the vehicle cannot slide off it. Always use axle stands or similar structures.

If a two-post hoist is used to lift the vehicle, the front and rear lift arm pads should be centered under the reinforced lift plates on the inboard edge of the sill rail (see illustration).



Working on your vehicle

WARNING

The vehicle ignition system has very high voltage!

The voltage in the ignition system is dangerous! Do not touch spark plugs, ignition cables or the ignition coil when the engine is running or the ignition is switched on!

The ignition should be switched off when:

- Conducting engine tests.
- Replacing parts in the ignition system, such as spark plugs, ignition coil, distributor, ignition cables, etc.

Belt check

Check the belt regularly to make sure it is in good condition and is clean. A worn or dirty belt can cause poor cooling and low alternator output as well as impair the operation of the power steering and the air conditioning unit.



The drive belt is equipped with a self-tensioning mechanism and requires no adjustment between changes.



WARNING

The engine must not be running when this check is performed.

Check coolant level

The cooling system must be filled with coolant and not leak to operate at maximum efficiency. Check the coolant level regularly. The level should be between the "MAX" and "MIN" marks on the expansion tank. The check should be made with particular thoroughness when the engine is new or when the cooling system has been drained.

Do not remove the filler cap other than for topping up with coolant. Frequent removal may prevent coolant circulation between the engine and the expansion tank during engine warm up and cooling.

Changing coolant

Normally, the coolant does not need to be changed. If the system must be drained, consult a trained and qualified Volvo service technician.



NOTE

Do not top off with water only. This reduces the rust-protective and antifreeze qualities of the coolant and has a lower boiling point. It can also cause damage to the cooling system if it should freeze. Top off with Volvo Genuine Coolant/Antifreeze only (a 50/50 mix of water and antifreeze)



CAUTION

The cooling system must always be kept filled to the correct level. If it is not kept filled, there can be high local temperatures in the engine which could result in damage. Different types of antifreeze/coolant may not be mixed.



WARNING

Never remove the radiator cap while the engine is warm. Wait until the vehicle cools.



Hood and engine compartment

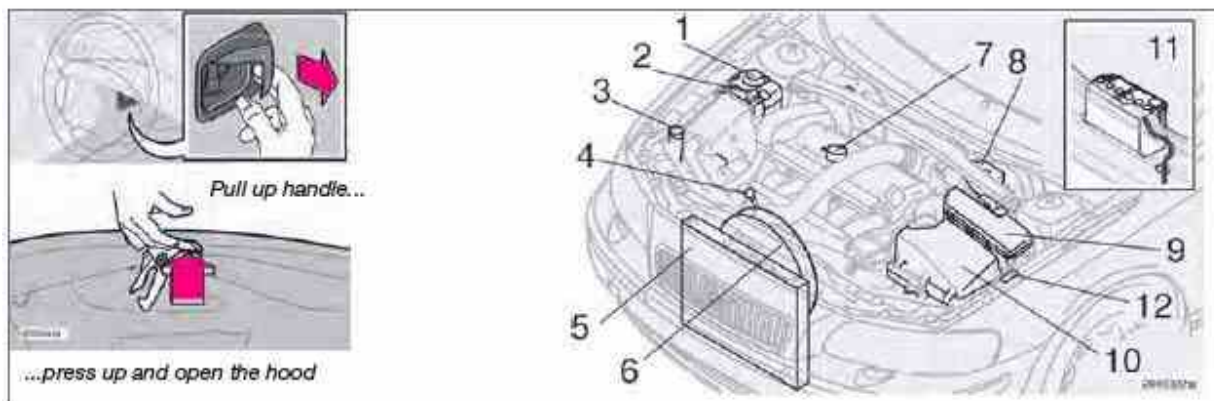

Opening the hood

1. Pull the lever located under the left side of the dash to release the hood lock.
2. Lift the hood slightly.
3. Press up the release control located under the front edge of the hood (at the center) and lift.



WARNING

Check that the hood locks properly when closed!

Engine compartment

1. Expansion tank - coolant
2. Power steering fluid reservoir
3. Washer fluid reservoir
4. Dipstick - engine oil
5. Radiator
6. Cooling fan
7. Oil filler cap - engine
8. Clutch/brake fluid reservoir
9. Relay/fuse box
10. Air cleaner
11. Battery (in trunk)
12. Data plate



WARNING

The cooling fan (6) may start or continue to operate (for up to 6 minutes) after the engine has been switched off.



Engine oil

Oil specifications

Engine oil must meet the minimum ILSAC specification GF-3, API SL, or ACEA A1/B1. Lower quality oils may not offer the same fuel economy, engine performance, or engine protection.

Volvo recommends Castrol.

Depending on your driving habits, premium or synthetic oils may provide superior fuel economy and engine protection. Consult your Volvo retailer or a trained and qualified Volvo service technician for recommendations on premium or synthetic oils.

Oil additives must not be used.

i NOTE

Synthetic oil is not used when the oil is changed at the normal maintenance services. This oil is only used at customer request, at additional charge. Please consult a trained and qualified Volvo service technician.

Oil viscosity (stable ambient temperatures)

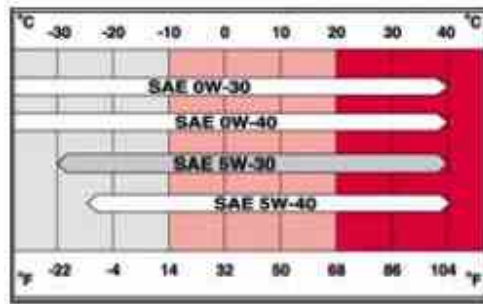

Operation in hot climates

When temperatures exceed 104° F (40° C) in your area, Volvo recommends, for the protection of your engine, that you use a heavier weight oil, such as such as SAE 5W-40 or 0W-40. See the viscosity chart.

Operation in temperate climates

Incorrect viscosity oil can shorten engine life. Under normal use when temperatures do not exceed 104° F (40° C), SAE 5W-30 will provide good fuel economy and engine protection. See the viscosity chart.

Extreme engine operation

Synthetic oils meeting SAE 0W-30 or 0W-40 and complying with oil quality requirements are recommended for driving in areas of sustained temperature extremes (hot or cold), when towing a trailer over long distances, and for prolonged driving in mountainous areas.



Engine oil



American Petroleum Institute (API) symbol

American Petroleum Institute (API) symbol

The API Service Symbol "donut" is divided into three parts:

The upper section describes the oil's performance level.

- The center identifies the oil's viscosity.
- The lower section indicates whether the oil has demonstrated energy-conserving properties in a standard test in comparison to a reference oil.

NOTE

Volvo uses different systems to indicate a low oil level or pressure. Some models have an oil pressure sensor, in which case a warning symbol (see [page 50](#)) is used to indicate low oil pressure. Other models have an oil level sensor, in which case the driver is alerted by the warning symbol in the center of the instrument panel and a text in the information display. Some models use both systems. Contact a trained and qualified Volvo service technician for more information.

Changing engine oil and oil filter

See the previous page for oil specifications and [page 246](#) for oil volumes. Refer to the Warranty and Service Records Information booklet for information on the oil change intervals.

NOTE

- Volvo does not recommend the use of oil additives.
- Synthetic oil is not used when the oil is changed at the normal maintenance intervals except at owner request and at additional charge. Please consult a trained and qualified Volvo service technician.

Checking and adding oil

The oil level should be checked every time the vehicle is refueled. This is especially important during the period up to the first scheduled maintenance service.

- The vehicle should be parked on a level surface when the oil is checked.
- **If the engine is warm**, wait for at least 10- 15 minutes after the engine has been switched off before checking the oil.

Checking the oil

1. Pull out the dipstick and wipe it with a lint-free rag.
2. Reinsert the dipstick, pull it out, and check the oil level.
3. Add oil if necessary. If the level is close to the MIN mark, add approximately 1 US quart (1 liter) of oil.
4. Run the engine until it reaches normal operating temperature.
5. Switch off the engine and wait for at least 10-15 minutes and recheck the oil level. If necessary, add oil until the level is near the mark.



Engine oil

CAUTION

- Not checking the oil level regularly can result in serious engine damage if the oil level becomes too low.
- Never fill oil above the MAX mark. This could cause an increase in oil consumption.
- Not checking the oil level regularly can result in serious engine damage if the oil level becomes too low.
- Always add oil of the same type and viscosity as already used.



WARNING

Do not allow oil to spill onto or come into contact with hot exhaust pipe surfaces.

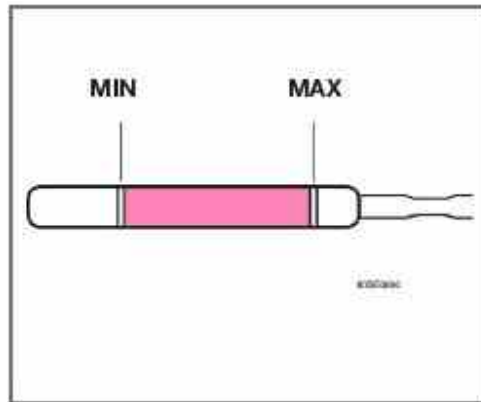

Fluids

Washer fluid reservoir

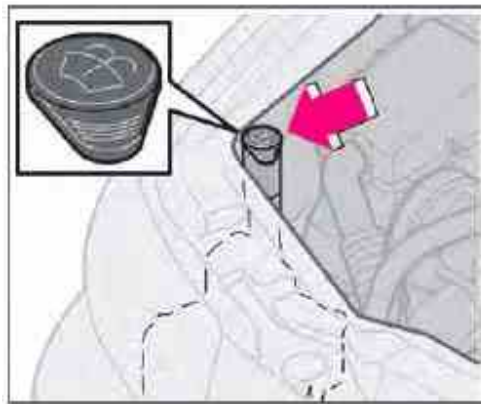

Washer fluid reservoir

The washer fluid reservoir is located in the engine compartment and holds approx. 6.8 US qts (6.4 liters).

During cold weather, the reservoir should be filled with windshield washer solvent containing antifreeze.

Changing coolant

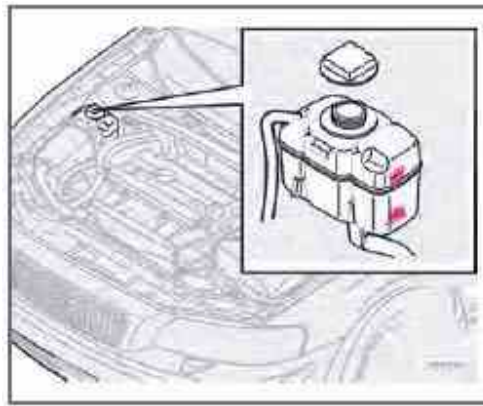

Coolant reservoir

Normally, the coolant does not need to be changed. If the system must be drained, consult a trained and qualified Volvo service technician.

NOTE

Do not top off with water only. This reduces the rust-protective and antifreeze qualities of the coolant and has a lower boiling point. It can also cause damage to the cooling system if it should freeze. Top off with Volvo Genuine Coolant/Antifreeze only (a 50/50 mix of water and antifreeze)

CAUTION

The cooling system must always be kept filled to the correct level. If it is not kept filled, there can be high local temperatures in the engine which could result in damage. Different types of antifreeze/coolant may not be mixed.

Check coolant regularly!

WARNING

- Never remove the radiator cap while the engine is warm. Wait until the vehicle cools.
- If it is necessary to top up the coolant when the engine is warm, unscrew the expansion tank cap slowly so that the overpressure dissipates.



Fluids

Clutch and brake fluid reservoir

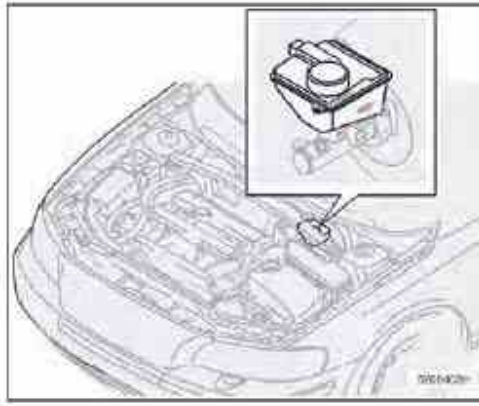

The clutch and brake fluid should always be above the MIN mark on the side of the reservoir. Check, without removing the cap, that there is sufficient fluid in the reservoir.

Fluid type: DOT 4+ boiling point >536 °F (280 °C), P/N 9437433.

Replace: Every second year or 30,000 miles (48,000 km). The fluid should be replaced once a year or every 15,000 miles (24,000 km) when driving under extremely hard conditions (mountain driving, etc.).

Always entrust brake fluid changing to a trained and qualified Volvo service technician.

Power steering fluid reservoir

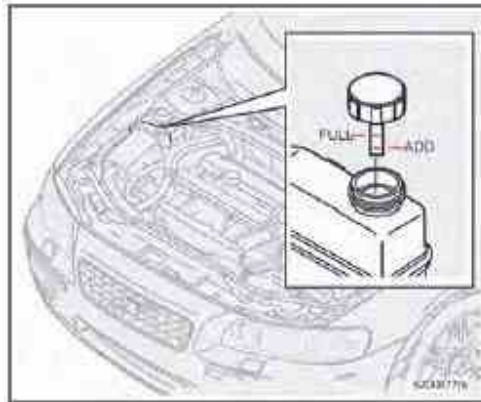

The fluid level should always be between the ADD and FULL marks.

Fluid type: Volvo synthetic power steering fluid (Pentosin CHF 11S) P/N 1161529 or equivalent.

Replace: No fluid change required.

NOTE

If a problem should occur in the power steering system or if the vehicle has no electrical current and must be towed, it is still possible to steer the vehicle. However, keep in mind that greater effort will be required to turn the steering wheel.



Wiper blades

Windshield wiper blades

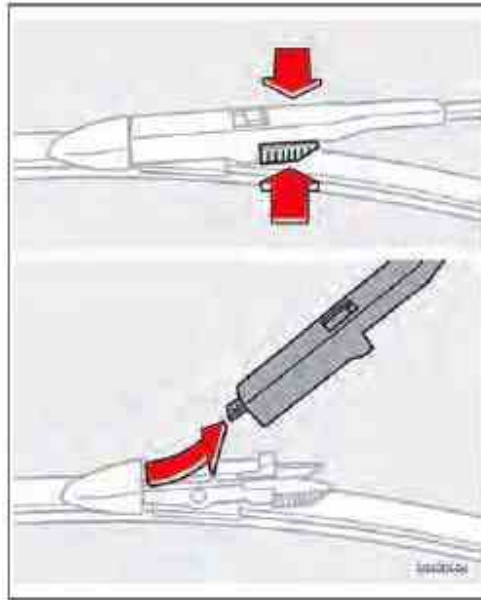

1. Lift the wiper arm off the windshield.
2. Press in the catches.
3. Pull out the wiper blade.
4. Insert a new wiper blade and ensure that it is firmly in place.

The driver's side wiper blade is longer than the one on the passenger's side.

i NOTE

Keeping the windshield and wiper blades clean helps improve visibility and prolongs the service life of the wiper blades. See [page 178](#) for washing instructions.



Battery

Battery maintenance

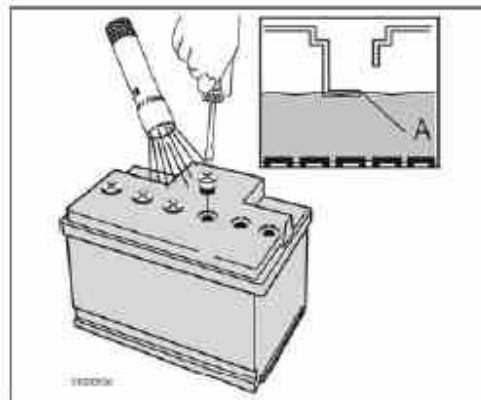

Two types of battery may be used and are fully interchangeable

The battery in your vehicle is located under the floor of the trunk.

Driving habits and conditions, climate, the number of starts, etc. all affect the service life and function of the battery. In order for your battery to perform satisfactorily, keep the following in mind:

- Check the fluid level in each cell in the battery every 24 months or every 15,000¹ miles (24,000 km), whichever is sooner. The fluid should be at the level shown in the illustrations above (A)². Do not overfill.

¹More frequently in warm climates.

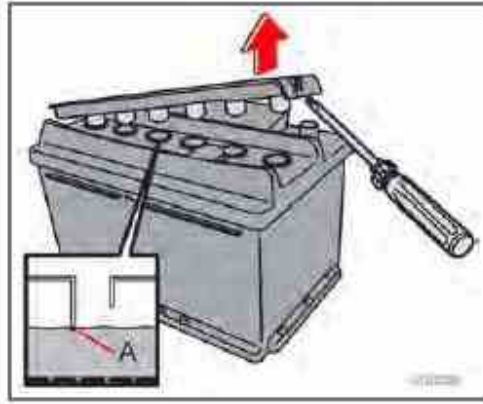

- Use a screw driver to open the caps or cover and a flashlight to inspect the level.
- If necessary, add distilled water. The level should never be above the indicator (A).
- The fluid level should be checked if the battery has been recharged.
- After inspection, be sure the cap over each battery cell or the cover is securely in place.
- Check that the battery cables are correctly connected and properly tightened. Route ventilation hose through opening in floor (see [page 199](#))

²The level indicator inside the battery could be designed in various ways. See illustrations.

- Never disconnect the battery when the engine is running, for example when changing the battery.
- The battery should be disconnected from the vehicle when a battery charger is used directly on the battery.
- However, if the battery is being charged via the connecting points in the engine compartment (see [page 199](#)), the battery must be connected.



WARNING

PROPOSITION 65 WARNING!

Battery posts, terminals, and related accessories contain lead and lead compounds, chemicals known to the state of California to cause cancer and reproductive harm. Wash hands after handling.



WARNING

- Never expose the battery to open flame or electric spark.
- Do not smoke near the battery.
- Battery fluid contains sulfuric acid. Do not allow battery fluid to contact eyes, skin, fabrics or painted surfaces. If contact occurs, flush the affected area immediately with water. Obtain medical help immediately if eyes are affected.



Battery

NOTE

Used batteries should be properly disposed of at a recycling station or similar facility, or taken to your Volvo retailer.

Symbols:



Replacing the battery

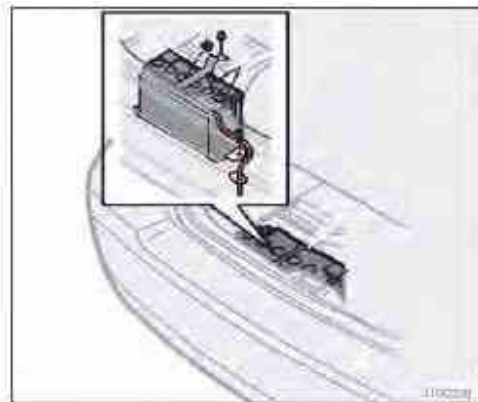

Ventilation hose

1. Switch off the ignition and remove the key.
2. Wait at least 5 minutes after switching off the ignition before disconnecting the battery so that all information in the vehicle's electrical system can be stored in the control modules.

3. Remove the bolts on the retaining bracket over the battery and lift out the bracket.
4. Fold up the plastic cover over the negative (ground) battery terminal. or unscrew the cover over the battery.
5. Disconnect the negative cable.



Battery

6. Lift off the plastic cover if necessary and disconnect the positive cable
7. Pull the ventilation hose from the battery.
8. Lift out the old battery.

Installing a new battery

1. Put a new battery into place.
2. Put the lower retaining bracket in place and retighten the bolt.
3. Reconnect the positive cable.
4. Press the cover for the positive battery terminal into place and fold down the lid of the plastic cover.
5. Connect the negative (ground) cable and fold down the plastic cover if applicable.
6. Be sure that the ventilation hose is securely connected to the battery and that the other end of the hose is properly routed through the ventilation opening in the floor of the battery compartment.
7. Reinstall the retaining bracket over the battery and retighten the nuts.



WARNING

Ventilation hose:

- The battery generates hydrogen gas, which is flammable and explosive. The battery is fitted with a ventilation hose which vents hydrogen gas out of the battery compartment through a ventilation opening in the bottom of this compartment. If the battery must be replaced, it is essential that the ventilation hose is properly connected to the battery and that it is routed through the ventilation opening provided (see illustration).
- Be sure the ventilation hose is free of debris.
- Only use replacement batteries equipped with a ventilation hose. Consult a trained and qualified Volvo service technician.



NOTE

After the battery has been disconnected or replaced, lock and unlock the vehicle with the central locking system's remote control to reactivate such features as the power windows, moonroof, courtesy lighting, etc.



Replacing bulbs

When replacing bulbs, keep the following points in mind:

- Never touch the glass of bulbs with your fingers. Grease and oils from your fingers vaporize in the heat and will leave a deposit on the reflector, which will damage it.
- The optional Active Bi-Xenon® headlight bulbs contain trace amounts of mercury. These bulbs should always be disposed of by an authorized Volvo retailer.
- The following bulbs should only be replaced by an authorized Volvo service technician:
 - Active Bi-Xenon® headlights,
 - Courtesy (dome) lighting,
 - Reading lights,
 - Glove compartment lights
 - Turn signals and courtesy lights in the side door mirrors
 - High-mounted brake lights
 - Diodes in the rear tail lights

Replacing bulbs at the front of the vehicle

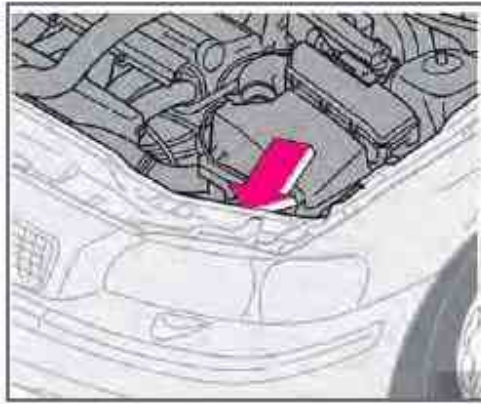

All front bulbs (except the optional front fog lights) are replaced from the engine compartment.



WARNING

Active Bi-Xenon® headlights (option) - due to the high voltage used by these headlights, these bulbs should only be replaced by a trained and qualified Volvo service technician.

Location of the bulbs in the headlight housing

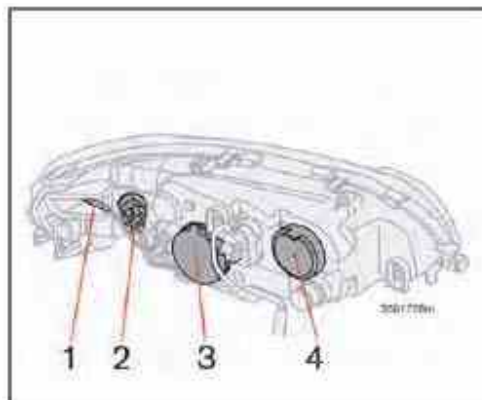

1. Side marker light
2. Turn signal
3. Low beam headlight/parking light (halogen headlights)
4. High beam headlight, parking light (Active Bi-Xenon® headlights)

Certain models may have a plastic tube that may hinder access to the bulbs. This tube can be broken off and discarded.

i NOTE

If you encounter difficulty when changing a bulb, please contact a Volvo workshop.



Replacing bulbs

Low beam headlight

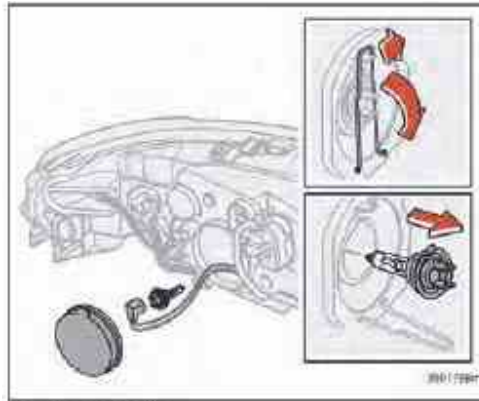

Low beam bulb

(Halogen headlights)

Removing the defective bulb:

1. Switch off the headlights and turn the ignition switch to position 0.
2. Remove the plastic cover.
3. Disconnect the wiring connector.
4. Loosen the retaining spring by first moving it to the right and then moving it outward and downward, out of the way.
5. Pull out the defective bulb.

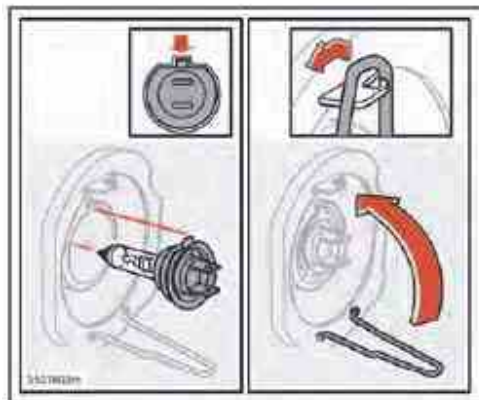

Installing the new bulb:

1. Insert the new bulb, without touching the glass, with the guide lug upward. The bulb will only seat properly in this position.
2. Move the retaining spring and push it slightly to the left until it seats properly.

3. Reconnect the wiring connector.

4. Reinstall the plastic cover.

NOTE

If the vertical aim of your headlights needs to be adjusted for any reason (e.g., towing a trailer for extended periods), this should be done by a trained and qualified Volvo service technician.



Replacing bulbs

High beam headlight

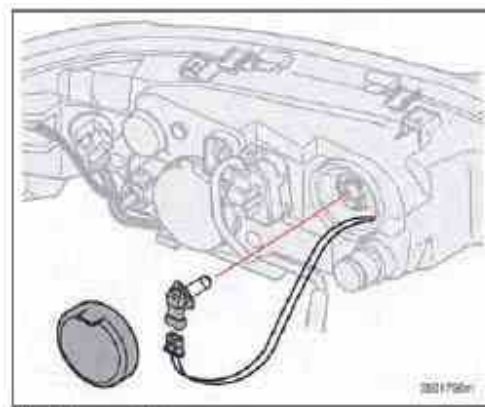

High beam bulb

(Halogen headlights)

Removing the defective bulb:

1. Switch off the headlights and turn the ignition switch to position 0.
2. Remove the cover to access the bulb assembly.
3. Turn the bulb counterclockwise and pull it out.
4. Disconnect the wiring connector by pressing the lock tab out and pulling.
5. Twist the bulb counterclockwise, and pull it out of the holder.

Installing the new bulb:

1. Connect the wiring connector to the new bulb until it clicks into place.
2. Insert the bulb into the headlight housing and turn it until it is securely in place.
3. Press the cover back into place.



Replacing bulbs

Parking light

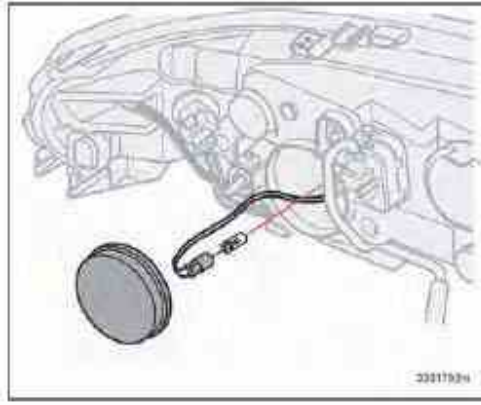

(Halogen headlights)

Removing the defective bulb:

1. Switch off the headlights and turn the ignition switch to position 0.
2. Remove the plastic cover of the low beam headlight assembly. Pull out the parking light holder.
3. Pull the bulb out of the holder.

Installing the new bulb:

1. Press a new bulb into the holder
2. Reinsert the bulb and holder into place.
3. Reinstall the plastic cover.

Parking light.

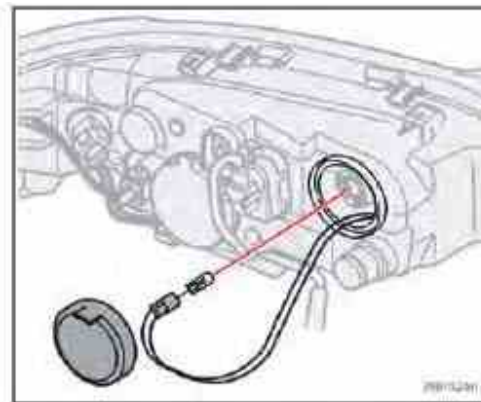

(Active Bi-Xenon® headlights)

Removing the defective bulb:

1. Switch off the headlights and turn the ignition switch to position 0.
2. Remove the plastic cover of the high beam headlight assembly. Pull out the parking light holder.
3. Pull the bulb out of the holder.

Installing the new bulb:

1. Press a new bulb into the holder
2. Reinsert the bulb and holder into place.

3. Reinstall the plastic cover.

Turn signal, driver's side

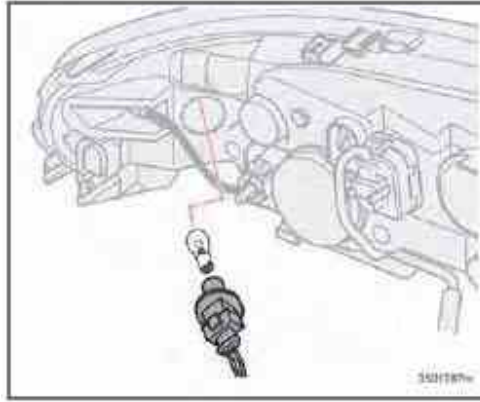

Removing the defective bulb:

1. Switch off the headlights and turn the ignition switch to position 0.
2. Pull out the bulb holder by twisting it counterclockwise.
3. Remove the bulb from the holder by pressing it in and turning it counterclockwise.

Installing the new bulb:

1. Insert the new bulb into the holder by pressing it in and turning it clockwise.



Replacing bulbs

2. Reinsert the bulb holder in the headlight housing and twist it clockwise until it seats properly.

Turn signal, passenger's side

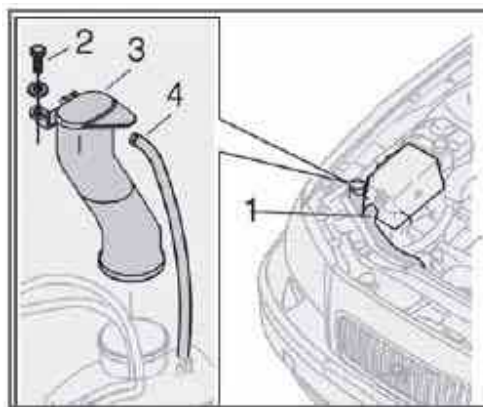

1. Switch off the headlights and turn the ignition switch to position 0.
2. Remove radiator pipe (1) from the box.
3. Remove filler pipe screw (2).
4. Pull the filler pipe (3) straight up.

5. Remove vent hose (4) from filler pipe.

Installing the new bulb:

1. Replace the bulb (same procedure as the driver's side bulb).
2. Ensure that the seal between the washer fluid reservoir and the filler pipe is correctly positioned.
3. Press the filler pipe (3) back into position.
4. Press the vent hose (4) into place on the filler pipe.
5. Reinstall and tighten the filler pipe screw (2).
6. Reinstall the radiator pipe to the box (1).



Replacing bulbs

Side marker light

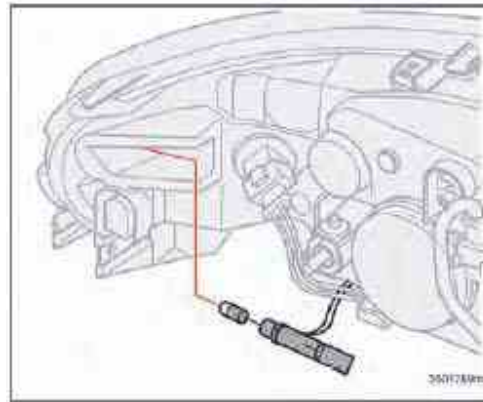

Side marker light

1. Turn the lamp holder counterclockwise and pull it out.
2. Pull out the defective bulb and insert a new one.
3. Reinsert the lamp holder and turn it clockwise until it seats properly.



Replacing bulbs

Front fog lights (option)

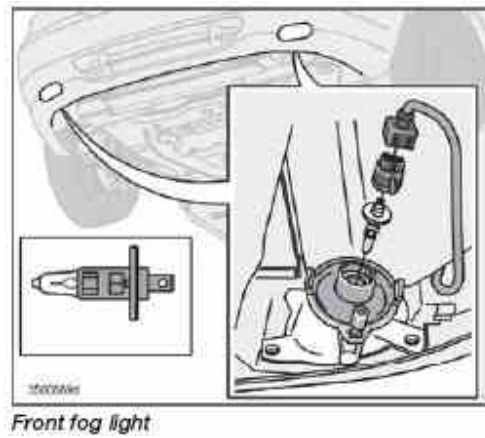

Removing the defective bulb:

1. Switch off the headlights and turn the ignition switch to position 0.
2. Turn the bulb holder slightly counterclockwise.
3. Pull out and remove the bulb.

Installing the new bulb:

1. Insert the new bulb (it can only be inserted in one position).
2. Reinsert the bulb holder and turn it clockwise. "TOP" must be upward.



Replacing bulbs

Replacing bulbs in the tail light cluster

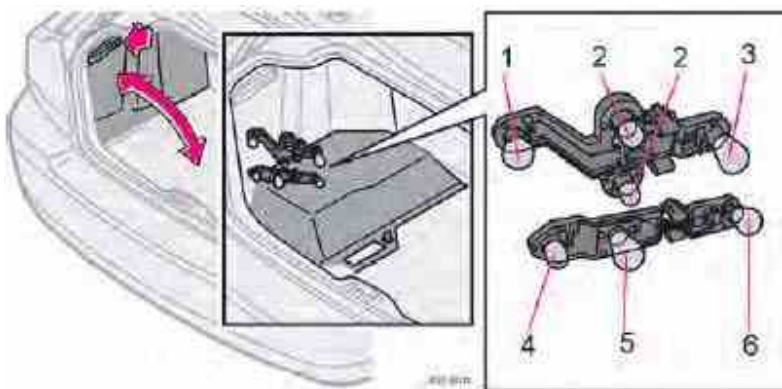

Location of bulbs

1. Brake light
2. Parking light (left side)
3. Fog light (one side)
4. Side marker lamp
5. Turn signal
6. Back up light

All bulbs in the tail light cluster can be replaced from inside the trunk.

1. Switch off all lights and turn ignition key to position 0.
2. Unlock and fold down the side panel to access the bulbs.

The bulbs are located in two separate bulb holders, an upper and a lower. Each bulb holder has a locking pin.

Replace bulbs in the upper and lower bulb holders as follows:

1. To ease the work: disconnect the cable from the bulb holder.
2. Press the catches together and pull out the holder.

3. Replace the bulb.
4. Reconnect the cable.
5. Close and secure the side panel.

NOTE

If the message indicating a burned out bulb remains in the information display after the bulb has been replaced, consult a trained and qualified Volvo service technician.

High level brake light

These bulbs are of a special type. We recommend that you ask a trained and qualified Volvo service technician to replace this bulb.



Replacing bulbs

License plate lights

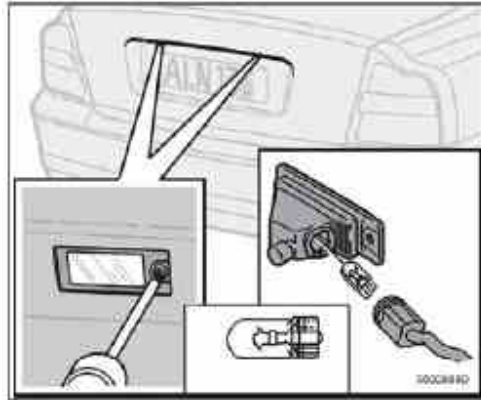

1. Switch off the ignition.
2. Loosen the screws with a torx screwdriver.
3. Carefully pull out the lamp housing.
4. Turn the bulb holder counterclockwise and pull it out.
5. Pull out the defective bulb and insert a new one.
6. Reinsert the bulb holder into the housing and turn it clockwise.
7. Reinstall the housing and screw it in place.

Door step courtesy lights

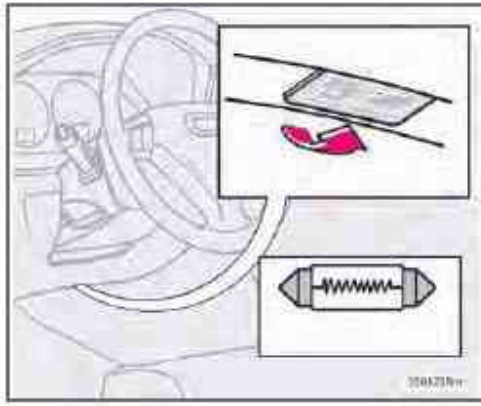

The door step courtesy lights are located under the dash on the driver's and passenger's sides. To replace a bulb:

1. Carefully insert a screwdriver and pry out the lens.
2. Replace the defective bulb.
3. Reinstall the lens.

Trunk lights

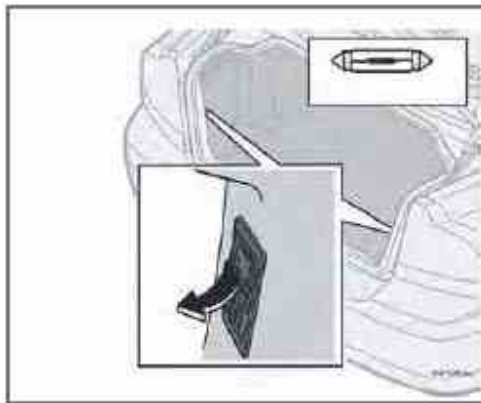

1. Carefully insert a screwdriver and pry out the lens.
2. Pry out the bulb and replace it.
3. Press the lens back into place.



Replacing bulbs

Vanity mirror

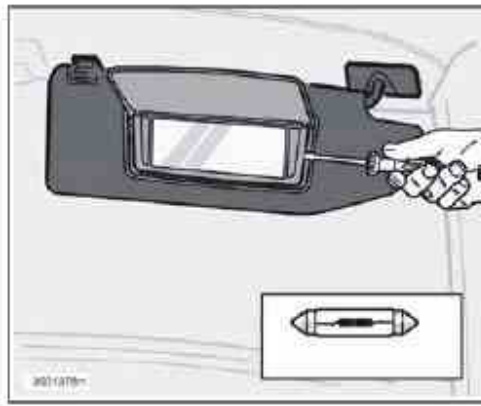

1. Carefully insert a screwdriver and pry out the lens.
2. Pry out the defective bulb and replace it.
3. Carefully press the lower edge of the lens onto the four tabs and press the upper edge of the lens into place.

i NOTE

Other bulbs may be difficult for you to replace yourself. Let a trained and qualified Volvo service technician replace these bulbs if necessary.



Fuses

Replacing fuses

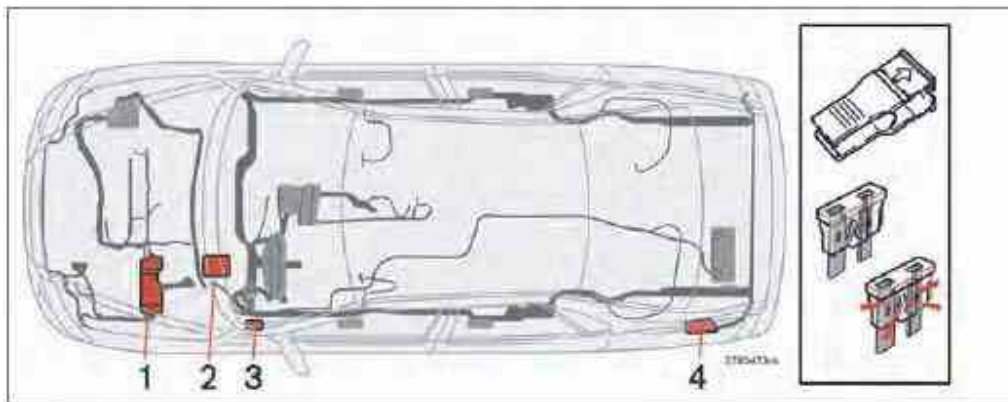

If an electrical component fails to function, it is possible that a fuse has blown.

Fuses are located in four different places:

1. Relays/fuse box in the engine compartment
2. Fuse box in the passenger compartment, behind plastic cover
3. Fuse box in the passenger compartment, on the edge of the dashboard
4. Fuse box in the cargo area

A label on the inside of each cover indicates the amperage and the electrical components that are connected to each fuse.

The easiest way to see if a fuse is blown is to remove it. Pull the fuse straight out. If a fuse is difficult to remove, you will find a special fuse removal tool (and several extra fuses) in the passenger compartment fuse box on the driver's end of dashboard. From the side, examine the curved metal wire (see the illustration above) to see if it is broken. If so, put in a new fuse of the **same color and amperage** (written on the fuse). Spare fuses are stored in the fuse box in the passenger compartment. If fuses burn out repeatedly, have the electrical system inspected by a trained and qualified Volvo service technician.

WARNING

Never use metal objects or fuses with higher amperage than those stated on the following pages. Doing so could seriously damage or overload the vehicle's electrical system.



Fuses

Relay/Fuse box in the engine compartment

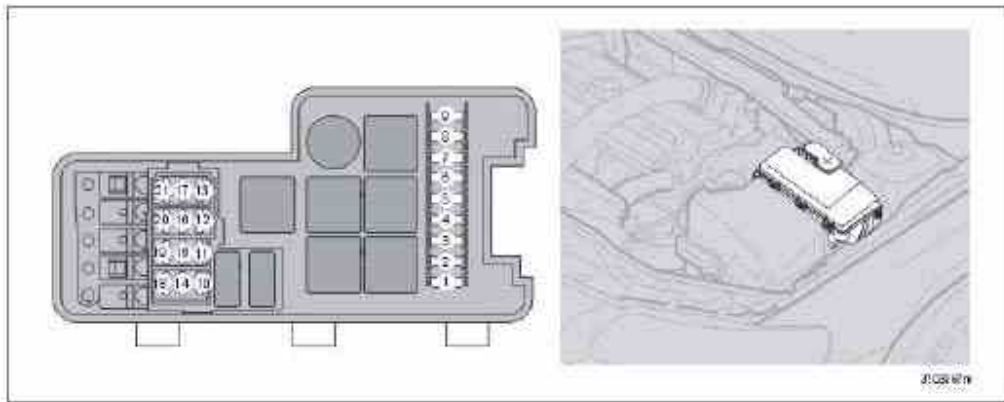

When replacing fuses, be sure to replace a blown fuse with a new one of the same color and amperage (written on the fuse).

Fuses in the engine compartment

Fuses in the engine compartment

No.		A
1	ABS	30
2	ABS	30
3	Headlight washers (certain models)	35

No.		A
4	-	
5	Auxiliary lights (option)	20
6	Starter motor relay	35
7	Windshield wipers	25
8	Fuel pump	15
9	-)	
10	Ignition coils, engine control module	20

No.		A
11	Throttle pedal sensor, A/C compressor, e-box fan	10
12	Engine control module, fuel injectors, mass airflow sensor	15
13	Throttle housing control module	10
14	Heated oxygen sensor	20
15	Crankcase ventilation heater, solenoid valves	10



Fuses

No.		A
16	Driver's side low beam headlight	20
17	Passenger's side low beam headlight	20
18	-	
19	Engine control module feed, engine relay	5
20	Parking lights	15
21	-	

214 09 Maintenance and servicing



Fuses

Fuse box in the passenger compartment, behind the plastic cover

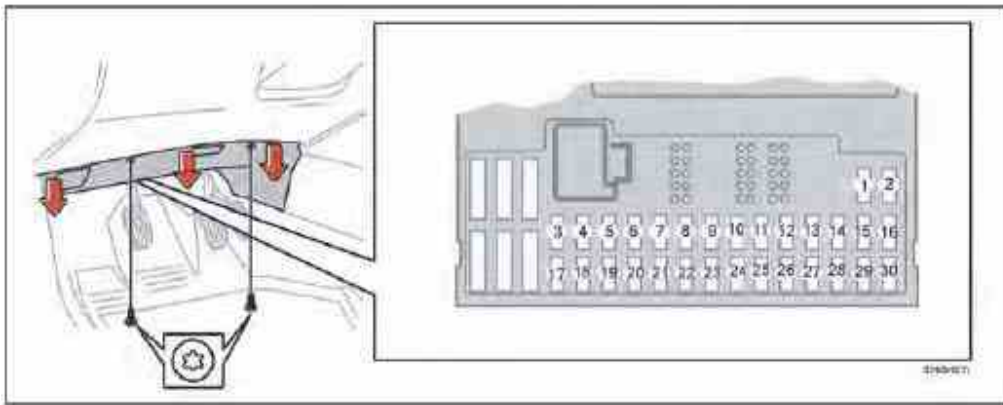

This fuse box is located behind the plastic cover below the steering wheel. When replacing a blown fuse, be sure to replace it with a new one of the same color and amperage (written on the fuse).

No.		A
1	Heated passenger's seat (option)	15
2	Heated driver's seat (option)	15

No.		A
3	Horn	15
4	-	-
5	-	-
6	-	-
7	-	-
8	Alarm siren	5

No.		A
9	Break light switch feed	5
10	Instrument panel, climate system, power driver's seat (option)	10
11	12-volt sockets - front and rear seats	15
12	-	-
13	-	-

215 09 Maintenance and servicing



Fuses

No.		A
14	-	
15	ABS, DSTC	5
16	Power steering, Active Bi-Xenon® headlights (option)	10
17	Driver's side front foglight (option)	7.5
18	Passenger's side front foglight (option)	7.5
19	-	-
20	-	-
21	Transmission control module, reverse gear block (M66)	10
22	Driver's side high beam	10
23	Passenger's side high beam	10
24	-	-
25	-	-
26	-	-
27	-	-
28	Power passenger's seat (option), audio system	5

No.		A
29	-	-
30	-	-
31	-	-
32	-	-
33	Vacuum pump	20
34	Windshield washer pump	15
35	-	-
36	-	-



Fuses

Fuse box on the edge of the dashboard

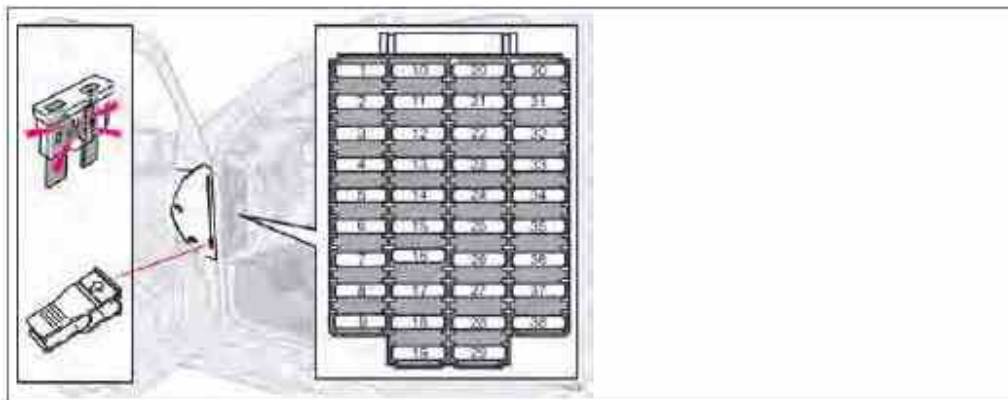

Fuses are located inside the access panel on the edge of the dashboard. There are also a number of spare fuses.

No.		A
1	Power driver's seat (option)	25
2	Power passenger's seat (option)	25
3	Climate system blower	30
4	Control module - front passenger's door	25

No.		A
5	Control module - driver's door	25
6	Ceiling lighting, upper electrical control module	10
7	Moon roof (option)	15
8	Ignition switch, SRS system, engine control module, immobilizer	7,5

No.		A
9	Onboard diagnostics, headlight switch, steering wheel angle sensor, steering wheel control module	5
10	Audio system	20
11	Audio system amplifier	30
12	Navigation system display (option)	10
13-38	-	



Fuses

Fuses in the trunk

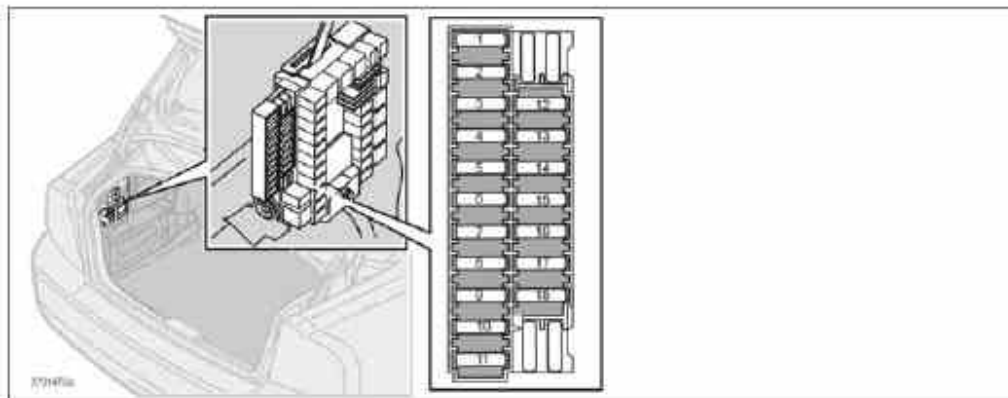

The fuses in the cargo area are located behind the panel on the driver's side of the cargo compartment. When replacing a blown fuse, be sure to replace it with a new one of the same color and amperage (written on the fuse).

No.		A
1	Backup lights	10
2	Parking lights, foglights, cargo area lighting, license plate lighting, brake lights	20
3	Accessory control module	15

No.		A
4	-	
5	Rear Electronic Module	10
6	CD-changer (option), Navigation system (option)	7,5
7	Trailer wiring (30-feed)	15
8	12-volt socket - cargo area	15
9	Rear passenger's side door - power window, power window cutout function	20

No.		A
10	Rear driver's side door - power window, power window cutout function	20
11		-
12	-	
13	-	
14	-	
15	-	
16	-	



Fuses

No.		A
17	Accessory audio	5
18	-	
19	Folding head restraints	15
20	Trailer wiring (15-feed)	20
21	-	
22	-	
23	All Wheel Drive	7.5
24	Four-C chassis system (option)	15
25	-	
26	Park assist (option)	5
27	Main fuse: trailer wiring, Four-C, park assist, All Wheel Drive	30
28	Central locking system	15
29	Driver's side trailer lighting: parking lights, turn signal	25
30	Passenger's side trailer lighting: parking light, brake light, fog light, turn signal	25
31	Main fuse: fuses 37 and 38	40

No.		A
32	-	
33	-	
34	-	
35	-	
36	-	
37	Heated rear window	20
38	Heated rear window	20



This page left intentionally blank.



2008 VOLVO S60

220 10 Audio



Introduction	222
Audio system HU-650 - overview	223
Audio system HU-850 - overview	224
Radio functions HU-650/HU-850	225
RBDS functions HU-650/HU-850	231
HU-650 - CD player	234
HU-850 - internal CD changer	235
External CD changer (option)	236
Dolby Surround Pro Logic II - HU-850 only	237
Audio systems - specifications	239

221 10 Audio



222 10 Audio



Introduction

The audio system in your vehicle is operated with the buttons and knobs in the system's front panel. Certain functions, such as adjusting the volume, changing radio stations or tracks on a CD, etc, can also be controlled with the optional steering wheel-mounted keypad.

The audio system is available in two versions:

HU-650

Features: AM/FM radio, single-disc CD player, 4x25W output, six¹ speakers.

HU-850

Features: AM/FM radio, integrated 6-disc CD changer, 4x50W or 4x70W output plus 25W Dolby Pro Logic II, eleven speakers.

Compact disc care

- Keep the discs clean. Wipe them with a soft, clean, lint-free cloth, working from the center outwards. If necessary, dampen the cloth with a neutral soap solution. Dry thoroughly before using.
- Never use cleaning spray or antistatic liquid. Use only cleaners specifically made for CDs.
- Use discs of the correct size only (3.5" discs should never be used).
- The discs should conform to the norms EN60908 (IEC60908). CDR discs can cause listening problems due to the quality of the disc or recording equipment used.
- Do not put tape or labels on the disc itself.
- Volvo does not recommend the use of plastic outer rings on the disc.
- Condensation may occur on discs/optical components of the changer in cold winter weather. The disc can be dried with a clean, lint-free cloth. Optical components in the CD changer may, however, take up to one hour to dry off.
- Never attempt to play a disc which is damaged in any way.
- When not in use, the discs should be stored in their covers. Avoid storing discs in excessive heat, direct sunlight or dusty locations.

¹T5 and 2.5T/2.5T AWD with the Premium package): eight speakers



Audio system HU-650 - overview

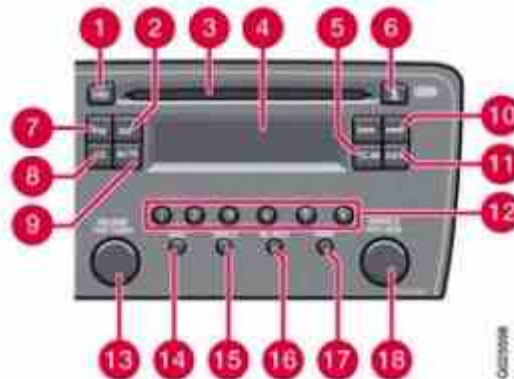

1. CD random play
2. AM (select AM1 or AM2)
3. CD slot
4. Display
5. Scan function (automatically search for radio stations)
6. CD eject
7. FM (select FM1, FM2, FM3)
8. CD player
9. AUTO - automatically search for radio stations

10. Navigation buttons (seek/change radio station or CD track)
 11. Exit (exit the menu)
 12. Buttons for selecting stored radio stations/ discs in optional CD changer
 13. On/off - press Volume - turn
 14. Bass (press to release control and turn to adjust)
 15. Treble (press to release control and turn to adjust)
 16. Balance (left/right) - press to release control and turn to adjust
 17. Fader (front/rear) - press to release control and turn to adjust
 18. Source/Menu
- Press to open main menu
Turn to select FM, AM, CD, CD changer (option), or AUX (option)



Audio system HU-850 - overview



1. CD random play
2. AM (select AM1 or AM2)
3. CD slot
4. Display
5. 3-channel stereo
6. 2-channel stereo
7. Dolby Surround Pro Logic II
8. CD eject
9. FM (select FM1, FM2, FM3)

10. CD player
11. AUTO - automatically search for radio stations
12. Navigation buttons (seek/change radio station or CD track)
13. Exit (exit the menu)
14. Scan function (automatically search for radio stations)
15. On/off - press Volume - turn
16. Buttons for selecting stored radio stations/discs in optional CD changer
17. Bass (press to release control and turn to adjust)
18. Treble (press to release control and turn to adjust)
19. Balance (left/right) - press to release control and turn to adjust
20. Fader (front/rear) - press to release control and turn to adjust
21. Source/Menu
Press to open main menu
Turn to select FM, AM, CD, CD changer (option), or AUX (option)



Radio functions HU-650/HU-850

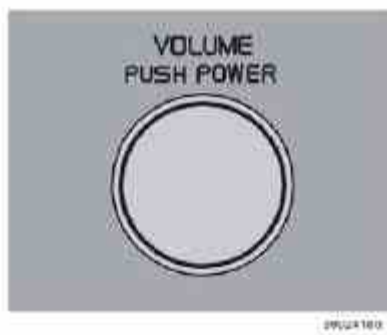

Switch on/off

Press the knob to switch on or turn off the radio.

Volume control

Turn the knob clockwise to increase volume. Volume control is electronic and does not have an end stop. If you have a key pad in the steering wheel, increase or decrease the volume with the + or - buttons.

Volume control - ALARM

If a CD is playing when the radio receives an alarm bulletin (available in certain areas only), the CD player enters pause mode. The bulletin is broadcast at the volume selected for this type of message.

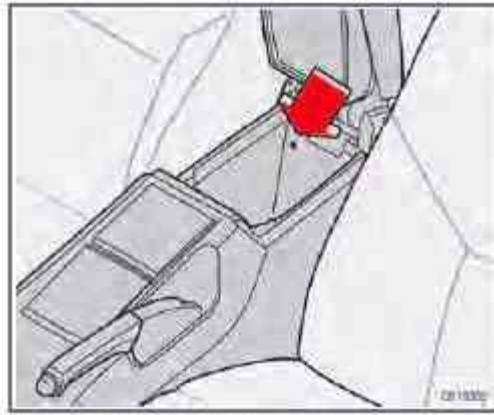

Auxiliary (AUX) 3.5 mm connector port

After the bulletin has been completed, the audio system reverts to the originally selected sound.

AUX connector (option)

The AUX (auxiliary) port can be used to connect external devices such as an mp3 player.

Turn the SOURCE control (see the illustration on [page 223 or 224](#)) to choose AUX.

If the player is being charged through a 12-volt socket while it is connect to the AUX port, sound quality may be impaired.



Radio functions HU-650/HU-850

The volume of the external sound source AUX may be different from the volume of the internal sound sources such as the CD player or the radio.

To change the AUX volume level:

1. While playing the radio or a CD, lower the audio volume to about one-quarter.
2. Switch to AUX mode on the audio system.
3. Connect the headphone output from your music player to the AUX input using a cable with a stereo 3.5mm miniplug at both ends.
4. Set your music player's headphone volume to three-quarters using the player's volume controls.
5. Press SOURCE, turn the SOURCE knob, select ADVANCED MENU and press SOURCE again.
6. Press the SOURCE knob, turn to AUDIO SETTINGS and press SOURCE.
7. Press the SOURCE knob, turn to AUX INPUT and press SOURCE.
8. Turn the volume knob to raise or lower the AUX Input Volume until you hear music at a comfortable level.
9. If there is distortion, lower your music player's headphone volume until the distortion goes away.
10. Finally, exit the menu and adjust the audio volume to a comfortable level.



Radio functions HU-650/HU-850

Sound settings



Optimal sound reproduction

The audio system is calibrated for optimal sound reproduction through the use of digital signal processing. This calibration takes into account the speakers, amplifier, cabin acoustics, the seating position of the listener, etc., for each combination of vehicle and audio system. There is also dynamic calibration that takes into account the setting of the volume control, radio reception, and the vehicle's speed. The sound settings described in this manual, such as **BASS**, **TREBLE**, and **EQUALIZER** are only intended to enable the user to adapt sound reproduction to his/her personal preferences.

Bass

Adjust the bass by pressing the button to extend the control and turning it to the left (less bass) or to the right (more bass). A "detent" indicates "equalized" bass. Press the button back in when you have made the adjustment.

Treble

Adjust the treble by pressing the button to extend the control and turning it to the left (less treble), or to the right (more treble). A "detent" indicates "equalized" treble. Press the button back in when you have made the adjustment.

Fader - Balance front/rear

Adjust front/rear speaker balance by pressing the button to extend the control and turning it to the left (more sound from the rear speakers) or to the right (more sound from the front speakers). A "detent" indicates "equalized" balance. Press the button back in when you have made the adjustment.

Balance right/left

Adjust left/right speaker balance by pressing the button to extend the control, and turning it to the left (more sound from the left speakers) or to the right (more sound from the right speakers). A "detent" indicates "equalized" balance. Press the button back in when you have made the adjustment.

MID EQ level

This function is used to fine-tune the balance of sound in the speakers. To set the level:

1. Press **SOURCE**.
2. Turn the **SOURCE** knob, select **ADVANCED MENU** and press **SOURCE**.
3. Turn the **SOURCE** knob, select **AUDIO SETTINGS** and press **SOURCE**.
4. Turn the **SOURCE** knob, select **MID EQ LEVEL** and press **SOURCE**.

5. Turn the **SOURCE** knob, select the desired level and press **SOURCE**.

6. Press **EXIT**.



Radio functions HU-650/HU-850

Selecting a sound source

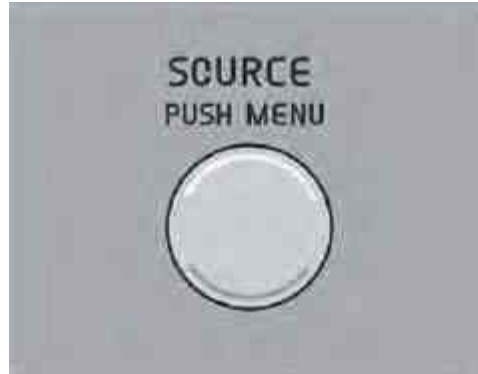

The sound source (e.g. AM, FM, etc.) can be selected in two ways:

- Use the sound source buttons (see the illustration below).
- Turn the **SOURCE** knob (see illustration above) to select a sound source (AM1, AM2, FM1, FM2, FM3, or CD). Press the knob to select the AM or FM band of your choice.

The sound source selected will be shown in the display.

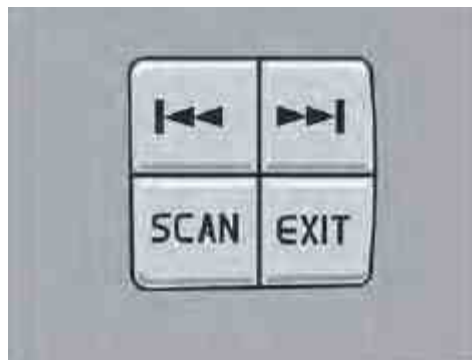

Scan



Press the **SCAN** button to start the station scan function. When a station is found, scanning stops for approximately 10 seconds, after which scanning will continue.

Press the **SCAN** or **SOURCE** button when a station has been found if you would like to listen to that station and to discontinue the scan function.

Station seek up/down

Press  or  to start the seek function. The radio seeks the next audible station and tunes it in. Repeat the procedure to continue the seek function.

Manual station search

Press **[<<]** or **[>>]** and hold it down. MAN will be shown in the display. The radio scans slowly in the selected direction and will increase the scanning speed after a few seconds. Release the button when the desired frequency appears in the display.

The frequency can be fine-tuned by short presses on the **[<<]** or **[>>]** keys.

The system will remain in manual search mode for 5 seconds after the button is released, after which it will return to seek mode.



Radio functions HU-650/HU-850

Steering wheel key pad (option)

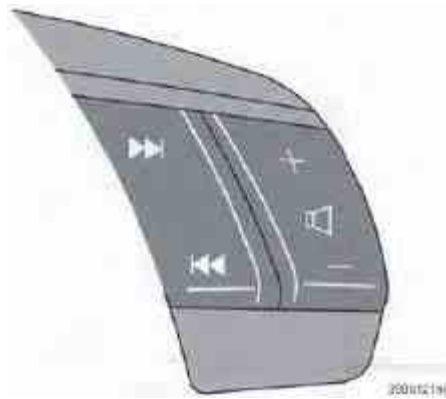

If the vehicle is equipped with the key pad in the steering wheel press the right or left arrow to switch between preset stations.

Storing stations



To store a selected station under one of the station setting buttons 1-6:

1. Tune to the desired station.
2. Press the button under which the station is to be stored and keep it depressed. The audio system sound will be interrupted for a few seconds and STORED will appear in the display. The station is now stored.

A total of 30 stations can be stored; 6 stations each in AM1, AM2, FM1, FM2, and FM3.

Storing stations automatically



This function automatically searches for and stores up to 10 strong AM or FM stations in a separate memory. If more than ten stations are found, the ten strongest ones are stored. This function is especially useful in areas in which you are not familiar with radio stations or their frequencies.

To use the AUTO function:

1. Select radio mode using the AM or FM buttons, or by turning the SOURCE knob.
2. Start the search by pressing AUTO for more than 2 seconds.
3. AUTO appears in the display and a number of stations with strong signals

230 10 Audio



RBDS functions HU-650/HU-850

(max. 10) from the selected frequency band will be stored in the auto-store memory. If there are no stations with sufficient signal strength, NO STATION is displayed.

4. Press the AUTO button or the arrow keys on the optional steering wheel controls briefly to select the stored stations.

When the radio is in auto-store mode, AUTO is shown in the display. AUTO disappears when you return to the normal radio mode.

Return to the normal radio mode by pressing the AM, FM, or EXIT button.

To return to the Auto-store mode, press the AUTO button briefly.

231 10 Audio



RBDS functions HU-650/HU-850

Radio Broadcast Data System - RBDS

This feature, which may not be available in your area, functions only with FM broadcasts. The radio in your vehicle is equipped with an advanced system allowing information from broadcasters to be transmitted visually, as text, together with the audio signal. This information is then decoded by the radio and made available for several new and unique features.

The RBDS or Radio Broadcast Data System operates in the FM band only, and the information transmitted is supplied exclusively by participating broadcasters. Volvo has no control over the accuracy of the data or information.

Coverage by local broadcasters may be limited at this time, but as the technology and benefits grow, you will find the radio in your vehicle is equipped to take advantage of this system.

PI (Program Information) Seek:

When an FM station has been stored as a preset, the radio also stores RBDS program information if it is available. When the preset is selected at a later time, the radio tries to access updated program information. In weak signal areas, there may be a delay before the station becomes audible. During this delay, "PI seek" will be displayed and there will be no sound.

PI seek can be interrupted by pressing EXIT.

Radio text

Certain RBDS stations broadcast program information, which can be shown in the display. The text will be shown twice in the display.

To start this function:

Press the FM button for several seconds.

To deactivate this function:

Press FM briefly.

Station information will be shown twice in the display.

Alarm

Alarms bulletins are transmitted automatically by certain RBDS stations. The function cannot be deactivated.

"Alarm!" is shown in the radio display when an alarm message is sent. The function is used to warn motorists of serious accidents, etc.

Program type/station format -PTY

The PTY function allows you to find stations whose programs suit your taste. Use the PTY function to select among the different station formats shown in the list.

To select a station format:

1. Select radio mode using the FM button, or by turning the SOURCE knob.
2. Turn the SOURCE knob, select PTY and press SOURCE.
3. Turn the SOURCE knob, select a station format from the list and press SOURCE to confirm the selected station format. The PTY (station format) of the selected station is now shown in the display.



NOTE

Not all RBDS radio stations have PTY designations.

Station formats

Format	Display text
Off	PTY OFF
News	NEWS
Current affairs	AFFAIRS



RBDS functions HU-650/HU-850

Format	Display text
Information	INFO
Sports	SPORT
Education	EDUCATION
Drama	DRAMA
Art and culture	CULTURE
Science	SCIENCE
Entertainment	VARIED
Pop music	POP M
Rock music	ROCK M
Easy listening	EASY M
Light classics	LIGHT M
Classical music	CLASSICS
Other music	OTHER M
Weather	WEATHER
Finance	FINANCE
Religious programs	RELIGION
Travel	TRAVEL

Format	Display text
Leisure	LEISURE
Jazz music	JAZZ
Country music	COUNTRY
National music	NATION M
Oldies	"OLDIES"
Folk music	FOLK M
Documentary	DOCUMENT

Automatic Frequency update (AF)

The AF function tunes to the strongest transmitter for the current station, if that station supports alternative frequencies. AF is OFF by default.

To deactivate AF:

1. Select radio mode using the FM button, or by turning the SOURCE knob.
2. Press SOURCE.
3. Turn the SOURCE knob, select ADVANCED MENU and press SOURCE.
4. Turn the SOURCE knob, select RADIO SETTINGS and press SOURCE.
5. Turn the SOURCE knob, select AF ON/OFF (flashing text) and press SOURCE.
6. Press EXIT.

To reactivate the function, follow the procedure above and select AF ON in step 5.

Resetting RBDS functions

RBDS functions can be returned to their factory settings as follows:

1. Select radio mode using the FM button, or by turning the SOURCE knob.
2. Press SOURCE.

3. Turn the SOURCE knob, select ADVANCED MENU and press SOURCE.



RBDS functions HU-650/HU-850

4. Turn the SOURCE knob, select RESET TO DEFAULT and press SOURCE.

5. Press EXIT.

ASC - speed compensated volume

The audio system's volume is adjusted automatically according to the speed of the vehicle. There are three settings available: low, medium, or high.

To activate ASC:

1. Select radio mode using the FM button, or by turning the SOURCE knob.

2. Press SOURCE.

3. Turn the SOURCE knob, select ADVANCED MENU and press SOURCE.

4. Turn the SOURCE knob, select AUDIO SETTINGS and press SOURCE.

5. Turn the SOURCE knob, select ASC LEVEL (flashing text) and press SOURCE.

6. Turn the SOURCE knob to select LOW, MEDIUM, HIGH, or OFF and press SOURCE.

7. Press EXIT.

NOTE

Please be aware that there are certain RBDS menu selections, for example EON, TP search, News, etc, that may not be available in North America.



HU-650 - CD player



Starting the CD player

Please refer to the illustration on [page 223](#) for the location of the buttons referred to on this page.



1. Insert a disc into the player.

2. Press the CD button or turn the SOURCE knob to CD.

Changing tracks

Briefly press the  or  keys (or the corresponding keys on the optional steering wheel keypad) to skip to the previous or next track. The track number is shown in the display.

Fast forward/back

Press and hold down the  or  keys to search within a track or the entire disc. The search continues for as long as the buttons are held in.

 **NOTE**

The corresponding keys on the optional steering wheel keypad cannot be used for fast forward/back.

Random play

This function plays the tracks on a CD in random order (shuffle).

1. Select CD mode and press the RND button. RND is shown in the display as long as the function is activated.
2. Press RND again to stop random play.

Scan

This function plays the first 10 seconds of each track on the CD.

1. Press SCAN to start the function.
2. Press SCAN again or EXIT to stop the scan function and listen to an entire track.

CD eject

Press the button (no. 6 in the illustration on [page 223](#)) to eject the disc.

 **NOTE**

- For reasons of traffic safety, the ejected CD must be removed within 12 seconds or it will be automatically drawn back into the slot and the CD player will resume playing the most recently selected track.
- See [page 222](#) for information on caring for compact discs.



HU-850 - internal CD changer

Starting the CD changer

The HU-850 is equipped with an internal, 6-disc CD changer.

Please refer to the illustration on [page 224](#) for the location of the buttons referred to on this page.

To load discs into the changer:

1. Press the CD button or turn the SOURCE knob to CD.
2. Select an empty position by pressing one of the preset buttons. The display shows which positions are empty. LOAD DISC must be displayed before a disc is inserted into the player.
3. Insert a disc.



If there are discs in the player when CD mode is selected, the changer will resume playing the disc and track that were most recently played.

Selecting a disc position (number)



Use the station setting buttons 1-6 to select the disc to be played. The number of the disc and the track being played

are shown in the display.

Changing tracks

Briefly press the  or  keys (or the corresponding keys on the optional steering wheel keypad) to skip to the previous or next track. The track number is shown in the display.

Fast forward/back

Press and hold down the  or  keys to search within a track or the entire disc. The search continues for as long as the buttons are held in.

The corresponding keys on the optional steering wheel keypad cannot be used for fast forward/back.

Random play

This function plays the tracks on a CD in random order (shuffle).

- Select CD mode and press the RND button. RND is shown in the display as long as the function is activated. Random tracks from randomly selected discs will be played.
- Press RND again to stop random play.

Scan

This function plays the first 10 seconds of each track on the CD.

1. Press SCAN to start the function.
2. Press SCAN again or EXIT to stop the scan function and listen to an entire track.

Scan only works on the selected disc.

CD eject

This function makes it possible to eject a single disc, or to eject all of the discs in the changer.

- Press the eject button briefly to eject the disc that is currently playing.
- A longer press (more than 2 seconds) starts the process of ejecting all of the discs in the changer.

NOTE

The EJECT ALL function can only be used while the vehicle is at a standstill and will be cancelled if the vehicle begins to move.

For reasons of traffic safety, you have 12 seconds in which to remove the ejected disc. After that, the disc automatically reinserts into the player, and the CD player will resume playing the most recently selected track.

See [page 222](#) for information on caring for compact discs.



External CD changer (option)

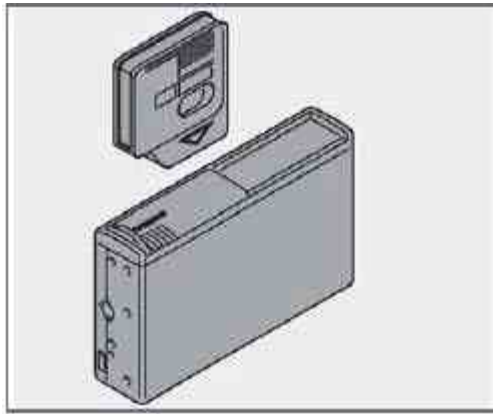

The optional 10-CD changer is mounted in the cargo compartment.

Please refer to the illustration on [pages 223 and 224](#) for the location of the buttons referred to on this page.

Turn the SOURCE knob to select the external CD changer.

To load discs into the changer:

1. Slide the cover on the CD change open.
2. Press the eject button on the CD changer.
3. Pull the magazine out of the changer and insert the disc(s).
4. Press the magazine back into the changer and slide the cover back into place.



If there are discs in the player when CD mode is selected, the changer will resume playing the disc and track that were most recently played.

Selecting a disc position (number)



Use the station setting buttons 1-6 to select the disc to be played. Continue to press button 6 to select discs 7-10.

The number of the disc and the track being played are shown in the display.

Changing tracks

Briefly press the  or  keys (or the corresponding keys on the optional steering wheel keypad) to skip to the previous or next track. The track number is shown in the display.

Fast forward/back

Press and hold down the  or  keys to search within a track or the entire disc. The search continues for as long as the buttons are held in.

The corresponding keys on the optional steering wheel keypad cannot be used for fast forward/back.

Random play

This function plays the tracks on a CD in random order (shuffle).

1. Select CD mode and press the RND button. RND is shown in the display as long as the function is activated. Random tracks from randomly selected discs will be played.
2. Press RND again to stop random play.

Scan

This function plays the first 10 seconds of each track on the CD.

1. Press SCAN to start the function.
2. Press SCAN or EXIT to stop the scan function and listen to an entire track.

Scan only works on the selected disc.

237 10 Audio



Dolby Surround Pro Logic II - HU-850 only

Dolby Surround Pro Logic II

Dolby Surround Pro Logic II is a further development of the previous version of the system and provides enhanced sound quality. The improved sound is particularly apparent to passengers in the rear seat.

Dolby Surround Pro Logic II, together with a center speaker in the dashboard, offers you a sound experience very close to a live performance. The normal left-right stereo channels are divided to left-center-right. In addition, surround sound is produced by the rear speakers. This surround sound mirrors the ambience of a concert hall.

NOTE

- Dolby Surround Pro Logic II is optimized for CD mode.
- When listening to FM radio stations, Dolby Surround Pro Logic II functions best in areas with strong reception. If reception is weak, selecting 2 or 3-channel stereo may provide better sound quality.
- 3 channel stereo is recommended for AM and FM broadcasts.

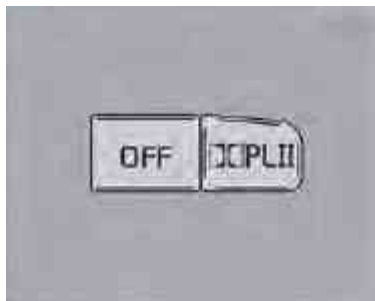

 Dolby Surround Pro Logic II and the Dolby icon are trademarks of Dolby Laboratories Licensing Corporation. Dolby Pro Logic II Surround System is manufactured under license from Dolby Laboratories Licensing Corporation.

Selecting Dolby Surround Pro Logic II

To select Dolby Surround Pro Logic II mode during CD playback, press "PL II". "Dolby Pro Logic II" is displayed. Press "OFF" to return to 2 channel stereo.

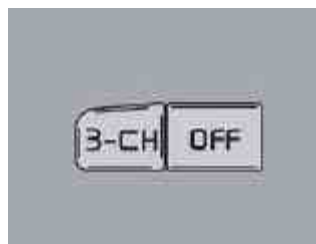

3 Channel stereo

To select 3 channel stereo mode press "3-CH". "3 ch" is displayed. Press "OFF" to return to 2 channel stereo.



Dolby Surround Pro Logic II - HU-850 only

Center level

This function is used to set the level of the center speaker in the dashboard. To set the level:

1. Press SOURCE.
2. Turn the SOURCE knob, select ADVANCED MENU and press SOURCE.
3. Turn the SOURCE knob, select AUDIO SETTINGS and press SOURCE.
4. Turn the SOURCE knob, select CENTER LEVEL and press SOURCE.
5. Turn the SOURCE knob, select the desired level and press SOURCE.
6. Press EXIT.

Surround level

This function is used to set the level of the of the rear speakers. To set the level:

1. Press SOURCE.
2. Turn the SOURCE knob, select ADVANCED MENU and press SOURCE.
3. Turn the SOURCE knob, select AUDIO SETTINGS and press SOURCE.
4. Turn the SOURCE knob, select SURROUND LEVEL and press SOURCE.
5. Turn the SOURCE knob, select the desired level and press SOURCE.
6. Press EXIT.



Audio systems - specifications

HU-650	
Output:	4x25 W
Impedance:	4 Ohm
Voltage required:	12 V, negative ground
External amplifier:	4x50 W or 4x75 W
Radio frequency range:	
AM:	530 - 1710 kHz
FM:	87.7 - 107.9 MHz
HU-850	
Output:	1x25 W center speaker
Impedance:	4 Ohm
Voltage required:	12 V, negative ground
External amplifier ¹ :	4x50 W or 4x75 W
Radio frequency range:	
AM:	530 - 1710 kHz
FM:	87.7 - 107.9 MHz

¹The HU-850 must be connected to an external amplifier.

NOTE

"Alarm!" is displayed when an alarm message is sent. The function is used to warn the driver of a serious accident or disaster situation.

NOTE

The optional supplementary amplifier (HU-850) may be mounted under the front passenger's seat. If the floor of the vehicle has become soaked for any reason, do not turn on the radio. This would cause damage to the amplifier. Contact a trained and qualified Volvo service technician.

Low battery voltage

If the level of battery voltage is low, a message will be displayed.

The vehicle's energy conservation function may switch off the audio system. Recharge the battery by starting the engine.



2008 VOLVO S60

240 11 Specifications



Label information	242
Dimensions and weights	244
Capacities	246
Engine specifications	247
Bulbs	248
Electrical system	249
Three-way catalytic converter	250
Suspension	251
Volvo programs	252

241 11 Specifications



242 11 Specifications



Label information

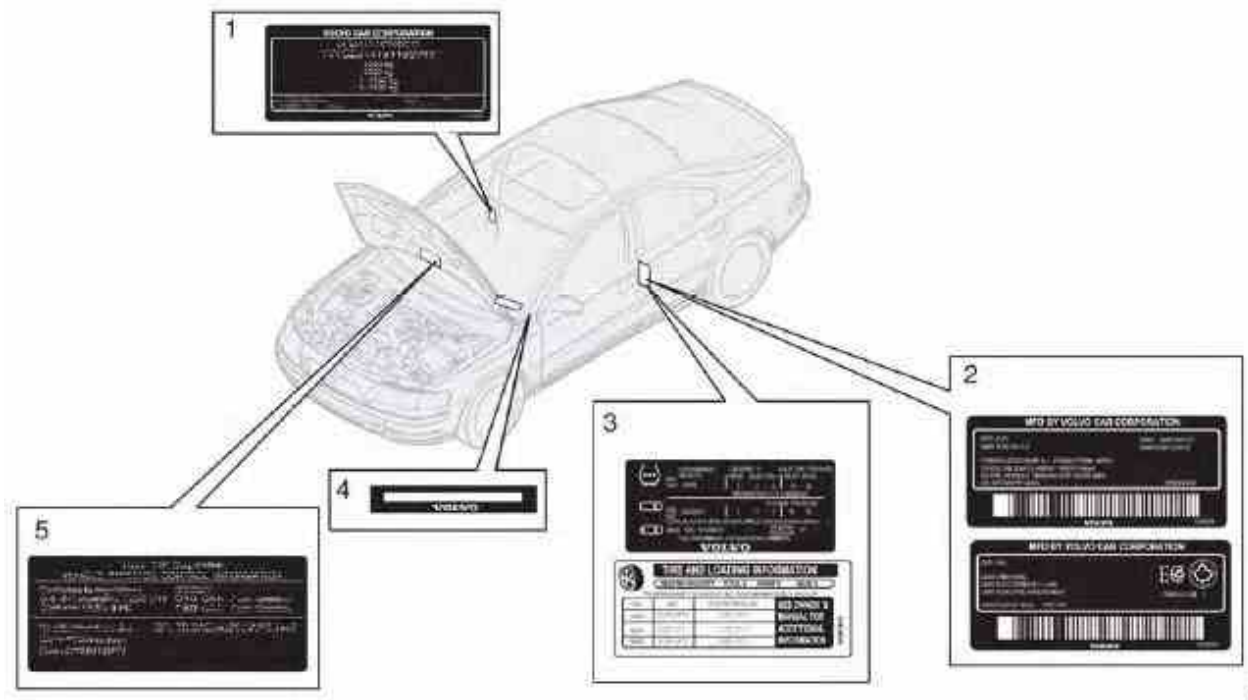

Label information

1. Model plate

Vehicle Identification Number (VIN). Codes for color and upholstery, etc.

2. Federal Motor Vehicle Safety Standards (FMVSS) specifications (USA) and Ministry of Transport (CMVSS) standards (Canada)

Your Volvo is designed to meet all applicable safety standards, as evidenced by the certification label on the facing side of the driver's door. For further information regarding these regulations, please consult your Volvo retailer.

3. Loads and Tire Pressures

The appearance of the decal will vary, depending on the market for which the vehicle is intended.

4. Vehicle Identification Number (VIN)

The VIN plate is located on the top left surface of the dashboard. The VIN is also stamped on the right hand door pillar.

The Vehicle Identification Number (VIN) should always be quoted in all correspondence concerning your vehicle with the retailer and when ordering parts.

5. Vehicle Emission Control Information/Vacuum hose routing

Your Volvo is designed to meet all applicable emission standards, as evidenced by the certification label on the underside of the hood. For further information regarding these regulations, please consult your Volvo retailer.



Dimensions and weights

Dimensions

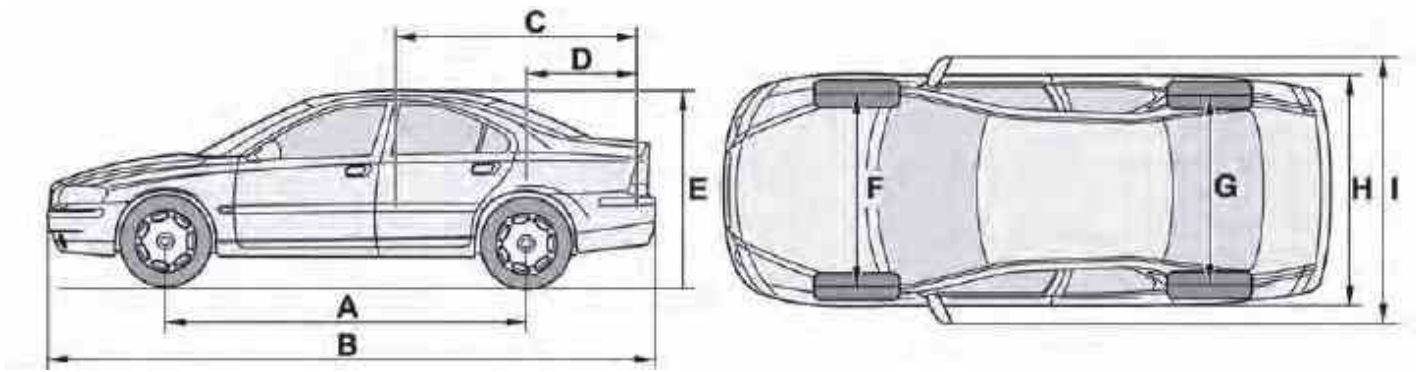

Position	Dimension	in. (mm)
A	Wheelbase	107 in. (272 cm)
B	Length	181 in. (460 cm)
C	Load length, floor, seatback down	85.4 in. (166 cm)
D	Load length, trunk	32.2 in. (82 cm)
E	Height	56.2 in. (143 cm)
F	Track, front	61.5 in. (156 cm)
G	Track, rear	60.6 in. (154 cm)
H	Width	71 in. (180 cm)
I	Width incl. door mirrors	81.5 in. (207 cm)

CAUTION

The maximum permissible axle loads and/ or the gross vehicle weight must not be exceeded.

WARNING

When adding accessories, equipment, luggage and other cargo to your vehicle, the total capacity weight must not be exceeded.



Dimensions and weights

Weights

AWD = All Wheel Drive

	USA	Canada
Gross vehicle weight¹		
5-cyl. turbo manual	4430 lbs	2010 kg
5-cyl. turbo automatic	4470 lbs	2030 kg
5-cyl turbo AWD automatic	4540 lbs	2060 kg
Capacity weight		
5-cyl. turbo	670 lbs	395 kg
5 cyl. turbo AWD	805 lbs	365 kg
Permissible axle weights, front¹		
5-cyl. turbo	2400 lbs	1090 kg
5-cyl. turbo AWD automatic	2420 lbs	1100 kg
Permissible axle weights, rear¹		
5-cyl., 5-cyl. turbo	2220 lbs	1010 kg
5-cyl. turbo AWD	2310 lbs	1050 kg
Curb weight		
5-cyl. turbo	3430-3505 lbs	1545-1580 kg
5-cyl. turbo AWD	3560-3595 lbs	1620-1640 kg

¹Permissible axle weight or gross vehicle weight must never be exceeded.

Max. loads

Max. roof load	220 lbs (100 kg)
Max. trailer weight:	
- without brakes	1650 lbs (750 kg)
- with brakes, 2" ball ¹	3300 lbs (1500 kg)
- with brakes, 1 7/8" ball	2000 lbs (900 kg)
Max. tongue weight:	165 lbs (75 kg)
Trailer weights below 2,650 lbs (1,200 kg)	110 lbs (50 kg)
Trailer weights above 2,650 lbs (1,200 kg)	165 lbs (75 kg)

¹When driving for prolonged periods at temperatures above 86 °F (30 °C), the maximum recommended weight is 2000 lbs (900 kg).

See also [page 144](#) for additional information.



WARNING

When adding accessories, equipment, luggage and other cargo to your vehicle, the total capacity weight must not be exceeded.



Capacities

Specifications and capacities

Category	Specification	Capacity
Fuel tank	Volvo engines are designed to achieve rated horsepower, torque, and fuel economy performance using premium 91 octane fuel. Volvo recommends premium for best performance, but using 87 octane or above will not affect engine reliability.	18 US gal. (68 liters).
Engine oil (with filter replacement) B5254T2 B5244T5	Engine oil must meet the minimum ILSAC specification GF-3, API SL, or ACEA A1/B1. Lower quality oils may not offer the same fuel economy, engine performance, or engine protection. Volvo recommends Castrol.	5.8 US qts. (5.5 liters). 1.3 US qts (1.2 liters) between MIN and MAX on dipstick
Automatic transmission oil (AW5)	JWS 3309 Different types of oil should never be mixed.	7.6 US qts. (7.2 liters)
Manual transmission oil (M66)	MTF 97309	2.1 US qts. (2.0 liters)
Coolant	Volvo original coolant/antifreeze	9.3 US qts (8.8 liters). The thermostat begins to open at 194°F (90°C).
Brake fluid	DOT 4+ boiling point >536°F (280°C).	0.69 US qts. (0.65 liters)
Power steering fluid	Volvo synthetic power steering fluid (Pentosin CHF 11S) P/N 1161529 or equivalent	0.9 US qts. (0.9 liters)
Washer fluid reservoir	Use washer fluid solvent in cold weather conditions.	6.8 US qts (6.4 liters)

NOTE

The transmission oil does not normally need to be changed during the service life of the vehicle. However, it may be necessary to replace the oil if the vehicle is often driven in areas of sustained temperature extremes (hot or cold), when towing a trailer over long distances, for prolonged driving in mountainous areas, or if the vehicle is often driven short distances in temperatures under 40°F (5°C).

Engine specifications

Engine designation	B5244T5	B5254T2
Output kW/rps hp/rpm	191/92 257/5500	154/83 208/5000
Torque Nm/rps ft. lbs./rpm	330/42-87 258/2100-5000	320/25-75 236/1500-4500
No. of cylinders	5	5
Displacement (liter/cu.in.)	2.4/146.5	2.52/153.8
Bore (in./mm)	3.19/81	3.19/81
Stroke (in./mm)	3.67/93.2	3.67/93.2
Compression ratio	8.5:1	9.0:1

Charge air cooler (Intercooler)

Turbocharged engines employ a turbo-compressor to force air into the engine inlet manifold and a charge air cooler to cool the compressed inlet air. The resulting increase in air flow raises pressure in the intake manifold and increases engine power over that developed by the normally-aspirated engine. The charge air cooler (which resembles a radiator) is located between the turbo-compressor and inlet manifold.

Fuel system

The engine is equipped with a multiport fuel injection system.



Bulbs

Bulb	Output	Type
Low beam headlight	55W	H7
Active Bi-Xenon® headlight (option)	35W	D2S
High beam headlight	55W	HB3
Brake light, back-up light, rear fog light	21W	BA15s
Turn signals front/rear (amber bulb)	21W	BAU15s
Rear parking lights/side marker lights	5W	BAY15d
Footwell lighting, trunk lighting, license plate lighting	5W	SV8.5
Vanity mirror	1.2W	SV5.5
Front parking lights/side marker lights	5W	W2.1X9.5d
Turn signal in door mirror (amber bulb)	5W	W2.1X9.5d
Front fog lights	55W	H11
Glove compartment lighting	3W	BA9



WARNING

Active Bi-Xenon® headlights (option) - due to the high voltage used by these headlights, these bulbs should only be replaced by an authorized Volvo service technician.



Electrical system

General information

12-volt system with voltage controlled generator. Single wire system in which the chassis and engine block are used as conductors, grounded on the chassis.

Battery

Voltage: 12 V

Cold start capacity (CCA): 600 A

Reserve capacity (RC): 115 min

Capacity (Ah): 70

If you must replace your battery, be sure to replace it with a battery of the same cold start capacity and reserve capacity as the original (See the decal on the battery).

Generator

Max. current: 140 A

Starter motor

Power: 1.4 kW

Spark plugs

P/N272313-8 or equivalent

Gap: 0.028-0.032 in. (0.7-0.8 mm)

Tightening torque: 22 ft. lbs. (30 Nm)

Firing order: 1-2-4-5-3.

Battery

Voltage	12 V	12 V	12 V
Cold start capacity (CCA)	590 A	600 A ¹	700 A ²
Reserve capacity (RC)	100 min	120 min	135 min
Capacity (Ah)	60	70	80

¹Models equipped with the High Performance audio system

²Models equipped with the Premium Sound audio system or the Volvo Navigation System

If the battery must be replaced, replace it with one with the same cold start capacity and reserve capacity as the original (see the decal on the battery).



WARNING

The distributor ignition system operates at very high voltages. Special safety precautions must be followed to prevent injury. Always turn the ignition off when:

Replacing distributor ignition components e.g. plugs, coil, etc.

Do not touch any part of the distributor ignition system while the engine is running. This may result in unintended movements and body injury.



WARNING

PROPOSITION 65 WARNING!

Battery posts, terminals, and related accessories contain lead and lead compounds, chemicals known to the state of California to cause cancer and reproductive harm. Wash hands after handling.



Three-way catalytic converter

Three-way catalytic converter - general information

- Keep your engine properly tuned. Certain engine malfunctions, particularly involving the electrical, fuel or distributor ignition systems, may cause unusually high three-way catalytic converter temperatures. Do not continue to operate your vehicle if you detect engine misfire, noticeable loss of power or other unusual operating conditions, such as engine overheating or backfiring. A properly tuned engine will help avoid malfunctions that could damage the three-way catalytic converter.
- Do not park your vehicle over combustible materials, such as grass or leaves, which can come into contact with the hot exhaust system and cause such materials to ignite under certain wind and weather conditions.
- Excessive starter cranking (in excess of one minute), or an intermittently firing or flooded engine can cause three-way catalytic converter or exhaust system overheating.

- Remember that tampering or unauthorized modifications to the engine, the Electronic Control Module, or the vehicle may be illegal and can cause three-way catalytic converter or exhaust system overheating.

This includes:

- Altering fuel injection setting or components.
- Altering emission system components or location or removing components.
- Repeated use of leaded fuel.



NOTE

Unleaded fuel is required for vehicles with three-way catalytic converters.

251 11 Specifications



Suspension

Rear suspension

Individual rear wheel suspension with longitudinal support arms, double link arms and track rods.

Front suspension

Spring strut suspension with integrated shock absorbers and control arms linked to the support frame. Power-assisted rack and pinion steering. Safety type steering column.

252 11 Specifications



Volvo programs

Volvo On Call Roadside Assistance

Your new Volvo comes with a four year ON CALL roadside assistance. Additional information, features, and benefits are described in a separate information package in your glove compartment.

If you have misplaced your package, dial:

In the U.S.A.:

1-800-638-6586 (1-800-63-VOLVO)

In Canada:

1-800-263-0475

Technician certification

In addition to Volvo factory training, Volvo supports certification by the National Institute for Automotive Service Excellence (A.S.E.). Certified technicians have demonstrated a high degree of competence in specific areas. Besides passing exams, each technician must also have worked in the field for two or more years before a certificate is issued. These professional technicians are best able to analyze vehicle problems and perform the necessary service procedures to keep your Volvo at peak operating condition.

253 11 Specifications



This page left intentionally blank.



[Contents](#) | [Top of Page](#)

2008 VOLVO S60

254-
259 12 Index



12-volt socket	
front	55
rear	69
A	
A/C (air conditioning)	88
ABS	50 , 137
Accessory Installation- Important Warning	9
Active Bi-Xenon® headlights (ABL)	57
Air conditioning	87
Air distribution	85 , 87 , 89
Air quality sensor	88
Air vents	85
Airbag system	16
Alarm	118
All Wheel Drive	136
towing	142
Anti-lock Brake System (ABS)	6 , 137
indicator light	50
Audio system	222
AUX port	225
CD changer	235
CD changer (external)	236
CD player	234
Dolby Surround Pro Logic II	237
PI seek	231
selecting a sound source	228
sound settings	227
storing radio stations	229
AUTO (climate control)	87
Automatic transmission	132
kickdown	133
AUX port	225
Average speed	64
AWD	136

B

Backrest, rear seat, folding	103
Battery	189
maintenance	198
replacing	199
specifications	249
Belt check	190
Black Box (Vehicle Event Data)	186
Blower (fan)	87
Brake circuit	137
Brake fluid	196
Brake system	49, 137
Bulbs	
list of	248
replacing	201
C	
Capacities, fluids	246
Capacity weight	166
Catalytic converter, three-way	250
CD changer	235
CD changer (external)	236
CD player	234
Central locking system - remote control	112
Changing a wheel	172
Changing coolant	190
Charge air cooler	247
Check Engine warning light	50
Child restraints	
recalls and registration	43
Child safety	30
child restraints	32
Child safety lock	117
Climate system	84
Clock reset button	48
Coat hanger	102
Cold weather precautions	149
Coolant	195
changing	190, 195
checking level of	190
Courtesy light	97
Cruise control	66
Cup holders	
center console	101
rear seat	100
Curb weight	166

Current fuel consumption	64
D	
Defroster	87
Detachable trailer hitch	146
Dimensions	244
Disabling the passenger's side front airbag	21
Door mirrors	
defroster	63
Driver distraction	9
Driving economically	129
Driving through water	130
Dynamic Stability and Traction Control (DSTC)	139
E	
Economical driving	129
Electrical system	249
Electrically operated moonroof	76
Emission inspection	188
Engine	
specifications	247
starting	127
Engine compartment	191
Engine oil	192
Environment	7
F	
Federal Clean Air Act	186
FIX NEXT SERVICE	53
Fog lights	
front	58
rear	58
Folding head restraints	54
Front airbags	17, 18, 21
Front park assist	151
Front seats	
folding backrests	93
manually operated	92
power operated	94
Front suspension	251
Fuel	122
Fuel filler cap	6, 125
Fuel filler door	125
Fuel Formulations	124
Fuel gauge	48

Fuel system	247
Fuses	211
G	
Gasoline	122
Geartronic	134, 135
manual shifting	135
Generator	249
Generator warning light	50
Glove compartment	102
Grocery bag holder	104
Gross vehicle weight (GVW)	166
H	
Handling	130
Hazard warning flashers	63
Head restraints	
center, rear	105
folding	54
Headlights	60
Heated front seats	88
High beam flash	60
High beam headlights	60
High beam indicator	48
Hoisting the car	189
Home safe lighting	60
Homelink® Universal Transceiver	78
Hood - opening	191
I	
Ignition switch	128
Immobilizer (start inhibitor)	110
Indicator and warning symbols	48
Inflatable Curtain	26
Inflation pressure table	
Canadian models	161
US models	160
Inflation pressure, checking	159
Information display, messages in	56
Inspection, preparing for	188
Instrument overview	46
Instrument panel	48
Interior lighting	97
J	
Jack	
location of	106
using	172

Jacket hanger	102
K	
Keylock	6, 127
Keys	110
Kickdown	132
L	
Label information	243
Leather care	180
Lighting panel	57
Load carriers	147
Locking steering wheel	128
Locking the car	115, 116
Long distance trips	150
Long loads - carrying	104
Low beam headlights	60
M	
Maintenance services	186
Maintenance, periodic	187
Malfunction indicator light	50
Moonroof	76
MP3 player, connecting	225
Multifilter with air quality sensor	88
O	
Occupant safety	12
Octane rating	124
Odometer	48
Oil pressure	50
Oil quality	192
Opening the trunk from the inside	116
Opening/locking the trunk	115
Owner maintenance	187
P	
P Park	132
Paint - color code	181
Park assist	151, 152, 153
Parking brake	68
warning light	50
Passenger's side front airbag, disabling	21
Permissible axle weight	166
PI seek	231
Polishing	179
Power moonroof	76
Power seat	94
Power steering fluid	196

Power steering, speed sensitive	130
Power windows	70
PROPOSITION 65 WARNING	249
R	
Radiator	191
Radio	225
Radio Broadcast Data System (RBDS)	231
Rain sensor - windshield wipers	61
Rear fog light	58
indicator light	50
Rear head restraints, folding	54
Rear park assist	151
Rear seat, folding backrests	103
Rear suspension	251
Rear window defroster	63
Recalls, child restraints	43
Recirculation	88
REDUCE SPEED	53
Refrigerant (A/C system)	84
Refueling	126
Registering child restraints	43
Remote control	112
Reporting safety defects	
Canada	13
USA	12
Roadholding	130
Roof racks (load carriers)	147
Rotating tires	174
S	
Safety defects, reporting	
Canada	13
USA	12
Seat belt	14
SEE MANUAL	53
Service	186
Service key	110
Service reminder	49
SERVICE REQUIRED	53
SERVICE URGENT	53
Shiftlock	6, 127
Side impact protection (SIPS) airbags	25
Ski hatch	104
Snow chains	169
Snow tires	169

Spare wheel	106
Speedometer	48
Stability systems	139
Start inhibitor (immobilizer)	110
Starting the car	127
Steering wheel lock	128
Stone chips, touching up	181
STOP ENGINE	53
Storage compartments	99, 100, 101, 102
Studded tires	169
Sun visor	77
Supplemental Restraint	
System (SRS) - warning light	49
Suspension	251
T	
Tachometer	48
Temperature control	87
Temperature gauge	48
Text window - messages	52
Three-way catalytic converter	250
TIME FOR REGULAR SERVICE	53
Tire designations	164
Tire economy, improving	157
Tire inflation	158
Tire inflation pressure table	
Canadian models	161
US models	160
Tire inflation pressure, checking	159
Tire Pressure Monitoring System	162
indicator light	51
Tires	
rotation	174
Towing - cars with All Wheel Drive	142
Towing a trailer	144
Towing the car	141
Trailer hitch - detachable	146
Trailer indicator lamp	51
Trailer towing	144
Transmission	
Geartronic	134, 135
Transmission - automatic	132
Tread wear indicator	156
Trip computer	64
Trip odometer	48

Trunk	
opening from the inside	116
unlocking/locking	115
Turn signals	60
U	
Uniform Tire Quality Grading	168
Unlocking the car	115
Unlocking the trunk	115
Upholstery, cleaning	180
V	
Valet key	110
Valet locking	54
Vanity mirror	98
Vehicle dimensions	244
Vehicle Event Data	186
Vehicle Identification Number (VIN)	243
Vehicle loading	166
VIN (Vehicle Identification Number)	243
Volvo and the environment	7
Volvo Customer Care Center, contacting	1
Volvo Inflatable Curtain	26
Volvo On Call Roadside Assistance	252
W	
Warranties	186
Washer fluid reservoir	191, 195
Washing the car	178
Water, driving through	130
Waxing	179
Weight distribution	130
Weights	245
Wheels	
changing	172
storing	156
Whiplash Protection System (WHIPS)	28
Windshield washer fluid reservoir	195
Windshield wipers	61
Winter/Wet driving mode	133, 149

