

2006 VOLVO S80



This manual deals with the operation and care of your Volvo.

Welcome to the world-wide family of Volvo owners. We trust that you will enjoy many years of safe driving in your Volvo, an automobile designed with your safety and comfort in mind. To help ensure your satisfaction with this vehicle, we encourage you to familiarize yourself with the equipment descriptions, operating instructions and maintenance requirements/recommendations in this manual. We also urge you and your passengers to wear seat belts at all times in this or any other automobile. And, of course, please do not operate a vehicle if you may be affected by alcohol, medication or any impairment that could hinder your ability to drive.

Your Volvo is designed to meet all applicable safety and emission standards, as evidenced by the certification labels attached to the driver's door opening and on the left wheel housing in the engine compartment.

For further information please contact your retailer, or:

In the USA:

Volvo Cars of North America

Customer Care Center

P.O. Box 914

Rockleigh, New Jersey 07647-0914

1-800-458-1552

<http://www.volvocars.us>

In Canada:

Volvo Cars of Canada Ltd.

National Customer Service

175 Gordon Baker Road

North York, Ontario M2H 2N7

1-800-663-8255

<http://www.volvocanada.com>

Contents

Contents

[Chapter 1 - Safety](#)

[Chapter 2 - Instruments, switches and controls](#)

[Chapter 3 - Climate control system](#)

[Chapter 4 - Interior](#)

[Chapter 5 - Keys, Locks, Alarm](#)

[Chapter 6 - Starting and driving](#)

[Chapter 7 - Wheels and tires](#)

[Chapter 8 - Maintenance/Serviceing](#)

[Chapter 9 - Specifications](#)

[Chapter 10 - Audio systems](#)

[HomeLink® Universal Transceiver \(option\)](#)

[Index](#)

[Back Cover](#)

© 2005 Volvo Cars of North America LLC.

General information

Shiftlock

When your car is parked, the gear selector is locked in the (P)ark position. To release the selector from this position, turn the ignition key to position II (or start the engine), depress the brake pedal, press the button on the front side of the gear selector and move the selector from (P)ark.

Keylock

This means that when you switch off the ignition, the gear selector must be in the (P)ark position before the key can be removed from the ignition switch.

Anti-lock Brake System (ABS)

The ABS system in your car performs a self-diagnostic test when the vehicle first reaches the speed of approximately 12 mph (20 km/h). The brake pedal will pulsate several times and a sound may be audible from the ABS control module. This is normal.

Fuel filler door

The fuel filler door, located on the right rear fender, is connected to your car's central locking system. Press the button on the light switch panel (see [page 34](#)) when the car is at a standstill to unlock the fuel filler door. Please note that the fuel filler door will remain unlocked until the car begins to move forward. An audible click will be heard when the fuel filler door relocks.

Fuel filler cap

After refueling, close the fuel filler cap by turning it clockwise until it *clicks* into place. If this cap is not closed tightly or if the engine is running when the car is refueled, the Malfunction Indicator Lamp ("Check Engine" light) may indicate a fault.

Warning!

If your vehicle is involved in an accident, unseen damage may affect your vehicle's driveability and safety.

Important

Before you operate your car for the first time, please familiarize yourself with the new-engine oil consumption information on [page 153](#). You should also be familiar with the information in chapters one, two and four of this manual.

Information contained in the balance of the manual is extremely useful and should be read after operating the vehicle for the first time.

The manual is structured so that it can be used for reference. For this reason, it should be kept in the car for ready access.

Do not export your Volvo to another country before investigating that country's applicable safety and exhaust emission requirements. In some cases it may be difficult or impossible to comply with these requirements. Modifications to the emission control system(s) may render your Volvo not certifiable for legal operation in the U.S., Canada and other countries.

All information, illustrations and specifications contained in this manual are based on the latest product information available at the time of publication. Please note that some vehicles may be equipped differently, depending on special legal requirements and that optional equipment described in this manual may not be available in all markets.

Volvo reserves the right to make model changes at any time, or to change specifications or design, without notice and without incurring obligation.

CALIFORNIA Proposition 65 Warning

WARNING! Engine exhaust, some of its constituents, and certain vehicle components contain or emit chemicals known to the state of California to cause cancer, and birth defects or other reproductive harm. In addition, certain fluids contained in vehicles and certain products of component wear contain or emit chemicals known to the State of California to cause cancer, and birth defects or other reproductive harm.

Volvo and the environment

Volvo is committed to the well being of its customers. As a natural part of this commitment, we care about the environment in which we all live. Caring for the environment means an everyday involvement in reducing our environmental impact.

Volvo's environmental activities are based on a holistic view, which means we consider the overall environmental impact of a product throughout its complete life cycle. In this context, design, production, product use, and recycling are all important considerations.

In production, Volvo has partly or completely phased out several chemicals including freons, lead chromates, naphthanates, asbestos, mercury and cadmium; and reduced the amount of chemicals used in our plants 50% since 1991.

In use, Volvo was the first in the world to introduce into production a three-way catalytic converter with a Lambda sond, now called oxygen sensor, in 1976. The current version of this highly efficient system reduces emissions of harmful substances (CO, HC, NOx) from the exhaust pipe by approximately 95% and the search to eliminate the remaining emissions continues. Volvo is the only automobile manufacturer to offer CFC-free retrofit kits for the air conditioning system for all models as far back as the M/Y 1975 240. Advanced electronic engine controls, refined purification systems and cleaner fuels are bringing us closer to our goal.

After Volvo cars and parts have fulfilled their use, recycling is the next critical step in completing the life cycle. The metal content is about 75% of the total weight of a car, which makes the car among the most recycled industrial products. In order to have efficient and well controlled recycling, many Volvo variants have printed dismantling manuals, indicating the weight and material of individual components. For Volvo, all homogeneous plastic parts weighing more than 1.7 oz. (50 grams) are marked with international symbols that indicate how the component is to be sorted for recycling.

In addition to continuous environmental refinement of conventional gasoline-powered internal combustion engines, Volvo is actively looking at advanced technology alternative-fuel vehicles.

When you drive a Volvo, you become our partner in the work to lessen the car's impact on the environment.

To reduce your vehicle's environmental impact, you can:

- Maintain proper air pressure in your tires. Tests have shown decreased fuel economy with improperly inflated tires
- Follow the recommended maintenance schedule in your Warranty and Service Records Information booklet.
- Drive at a constant speed
- See an authorized Volvo retailer as soon as possible for inspection if the check engine (malfunction indicator) lamp illuminates, or stays on after the vehicle has started
- Properly dispose of any vehicle related waste such as used motor oil, used batteries, brake pads, etc.
- When cleaning your car, use Volvo's own car care products, all of which have systematically been adapted to the environment.

PremAir®

On the surface of the radiator in the engine compartment, there is a special coating called PremAir®. PremAir® works as a catalytic converter, converting most of the ozone passing through the radiator into oxygen, thereby reducing harmful ground-level ozone.

PremAir is a registered trademark of Engelhard Corporation.



[Top of Page](#)

2006 VOLVO S80

Chapter 1 - Safety

pg. 1 Safety

[Occupant safety](#) 2

[Seat belts](#) 3

[Supplemental Restraint System \(SRS\)](#) 5

[Front airbags](#) 6

[Occupant Weight Sensor \(OWS\)](#) 9

[Side impact \(SIPS\) airbags](#) 12

[Volvo Inflatable Curtain \(VIC\)](#) 13

[Inspecting SRS system components](#) 14

[Whiplash Protection System \(WHIPS\)](#) 15

[Child safety](#) 17

pg. 2 Occupant safety

Volvo Concern for Safety

Safety is the Volvo cornerstone. Our concern dates back to 1927 when the first Volvo rolled off the production line. Three-point seat belts (a Volvo invention), safety cages, and energy-absorbing impact zones were designed into Volvo cars long before it was fashionable or required by government regulation. We will not compromise our commitment to safety. We continue to seek out new safety features and to refine those already in our cars. You can help. We would appreciate hearing your suggestions about improving automobile safety. We also want to know if you ever have a safety concern with your car. Call us in the U.S. at: 800-458-1552 or in Canada at: 800-663-8255.

Occupant safety

How safely you drive doesn't depend on how old you are but rather on:

- How well you see.
- Your ability to concentrate.
- How quickly you make decisions under stress to avoid an accident.

The tips listed below are suggestions to help you cope with the ever changing traffic environment.

- Never drink and drive.
- If you are taking any medication, consult your physician about its potential effects on your driving abilities.
- Take a driver-retraining course.

- Have your eyes checked regularly.
- Keep your windshield and headlights clean.
- Replace wiper blades when they start to leave streaks.
- Take into account the traffic, road, and weather conditions, particularly with regard to stopping distance.

Reporting Safety Defects in the U.S.

If you believe that your vehicle has a defect which could cause a crash or could cause injury or death, you should immediately inform the National Highway Traffic Safety Administration (NHTSA) in addition to notifying Volvo Cars of North America. If NHTSA receives similar complaints, it may open an investigation, and if it finds that a safety defect exists in a group of vehicles, it may order a recall and remedy campaign. However, NHTSA cannot become involved in individual problems between you, your retailer, or Volvo Cars of North America. To contact NHTSA, you may either call the Auto Safety Hotline toll free at 1-800-424-9393 (or 202-366-0123 in Washington, D.C. area) or write to: NHTSA, U.S. Department of Transportation, Washington D.C. 20590. You can also obtain other information about motor vehicle safety from the Hotline.

Volvo strongly recommends that if your vehicle is covered under a service campaign, safety or emission recall or similar action, it should be completed as soon as possible. Please check with your local retailer or Volvo Cars of North America, LLC. if your vehicle is covered under these conditions.

NHTSA can be reached at:

Internet : <http://www.nhtsa.dot.gov>

Telephone:

1-888-DASH-2-DOT (1-888-327-4236) (toll free)

1-800-424-9393 (toll free)

1-202-366-0123 (in Washington DC area)

pg. 3 Seat belts

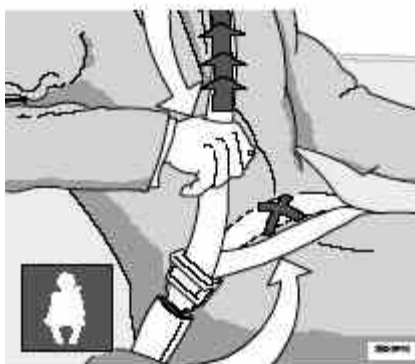

Adjusting the seat belt

Using seat belts

Volvo, the inventor of the three-point seat belt, urges you and all occupants of your vehicle to wear seat belts and ensure that children are properly restrained, using an infant, car, or booster seat determined by age, weight and height. Volvo also believes no child should sit in the front seat of a vehicle.

Most states and provinces make it mandatory for occupants of a vehicle to use seat belts.

Seat belt tensioners

The seat belts are equipped with tensioners that reduce slack in the belts. These tensioners are triggered in situations where the airbags deploy. The front seat belts also include a tension reducing device which, in the event of a collision, limits the peak forces exerted by the seat belt on the occupant.

Buckling a seat belt

Pull the belt out far enough to insert the latch plate into the receptacle until a distinct click is heard. The seat belt retractor is normally "unlocked" and you can move freely, provided that the shoulder belt is not pulled out too far.

The retractor will lock up as follows:

- if the belt is pulled out rapidly
- during braking and acceleration
- if the vehicle is leaning excessively
- when driving in turns

When wearing the seat belt remember:

- The belt should not be twisted or turned.
- The lap section of the belt must be positioned low on the hips (not pressing against the abdomen).
- Make sure that the shoulder belt is rolled up into its retractor and that the shoulder and lap belts are taut.

Unbuckling the seat belt

To remove the seat belt, press the red section on the seat belt receptacle. Before exiting the vehicle, check that the seat belt retracts fully after being unbuckled. If necessary, guide the belt back into the retractor slot.

Seat belt reminder

The seat belt reminder consists of an audible signal, an indicator light above the rearview mirror, and a symbol in the instrument panel that alert the driver and front seat passenger if their seat belts are not fastened.



Sample label on all seat belts with tensioners

Seat belt maintenance

Check periodically that the seat belts are in good condition. Use water and a mild detergent for cleaning. Check seat belt mechanism function as follows: attach the seat belt and pull rapidly on the strap.

WARNING!

- Never use a seat belt for more than one occupant.
- Never wear the shoulder portion of the belt under the arm, behind the back or otherwise out of position. Such use

could cause injury in the event of an accident.

- Seat belts lose much of their strength when exposed to violent stretching and should be replaced after any collision, even if they appear to be undamaged.
- Never repair the belt yourself; have this work done by an authorized Volvo service technician only.
- Any device used to induce slack into the shoulder belt portion of the three-point belt system will have a detrimental effect on the amount of protection available to you in the event of a collision.
- The seat back should not be tilted too far back. The shoulder belt must be taut in order to function properly.
- Do not use child safety seats or child booster cushions/backrests in the front passenger's seat. We also recommend that children who have outgrown these devices sit in the rear seat with the seat belt properly fastened.



Seat belt use during pregnancy

Seat belt use during pregnancy

The seat belt should always be worn during pregnancy. But it is crucial that it be worn in the correct way. The diagonal section should wrap over the shoulder then be routed between the breasts and to the side of the belly. The lap section should lay flat over the thighs and as low as possible under the belly. It must never be allowed to ride upward. Remove all slack from the belt and insure that it fits close to the body without any twists.

As a pregnancy progresses, pregnant drivers should adjust their seats and steering wheel such that they can easily maintain control of the vehicle as they drive (which means they must be able to easily operate the foot pedals and steering wheel). Within this context, they should strive to position the seat with as large a distance as possible between their belly and the steering wheel.

Child seats

Please refer to [page 21](#) for information on securing child seats with the seat belts.

pg. 5 Supplemental Restraint System (SRS)



SRS warning light

Supplemental Restraint System

As an enhancement to the three-point seat belts, your Volvo is equipped with a Supplemental Restraint System (SRS). Volvo's SRS consists of seat belt tensioners, front airbags, side impact airbags, the occupant weight sensor, and inflatable curtains. All of these systems are monitored by the SRS control module. An SRS warning light in the instrument panel (see the illustration above) illuminates when the ignition key is turned to position I, II, or III, and will

normally go out after approximately 7 seconds if no faults are detected in the system.

Where applicable, a text message will also be displayed when the SRS warning light illuminates. If this warning symbol is not functioning properly, the general warning symbol  illuminates and a text message will be displayed.

WARNING!

- If the SRS warning light stays on after the engine has started or if it illuminates while you are driving, have the vehicle inspected by a trained and qualified Volvo service technician as soon as possible.
- Never try to repair any component or part of the SRS yourself. Any interference in the system could cause malfunction and serious injury. All work on these systems should be performed by an authorized Volvo service technician.

WARNING!

If your vehicle has been subjected to flood conditions (e.g. soaked carpeting/standing water on the floor of the vehicle) or if your vehicle has become flood-damaged in any way, do not attempt to start the vehicle or put the key in the ignition before disconnecting the battery (see below). This may cause airbag deployment which could result in personal injury. Have the vehicle towed to a trained and qualified Volvo service technician for repairs.

Automatic transmission:

Before attempting to tow the vehicle, use the following procedure to override the shiftlock system to move the gear selector to the neutral position:

- Switch off the ignition for at least 10 minutes and disconnect the battery
- Wait at least one minute.
- Insert the key in the ignition and turn it to position II.
- Press firmly on the brake pedal.
- Move the gear selector from (P)ark to the (N)eutral position.

pg. 6 Front airbags

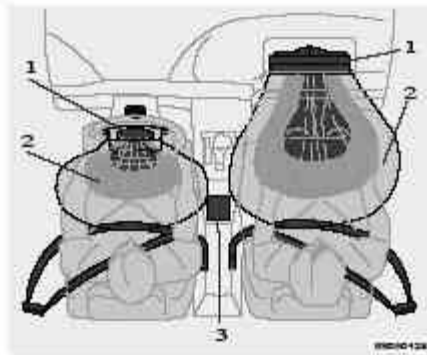

The front airbag system

The front airbags supplement the three-point seat belts. For these airbags to provide the protection intended, seat belts must be worn at all times.

The front airbag system includes gas generators (1) surrounded by the airbags (2) and a deceleration sensor (3) that activates the gas generators, causing the airbags to be inflated with nitrogen gas.

As the movement of the seats' occupants compresses the airbags, some of the gas is expelled at a controlled rate to provide better cushioning. Both seat belt tensioners also deploy, minimizing seat belt slack. The entire process,

including inflation and deflation of the airbags, takes approximately one fifth of a second.

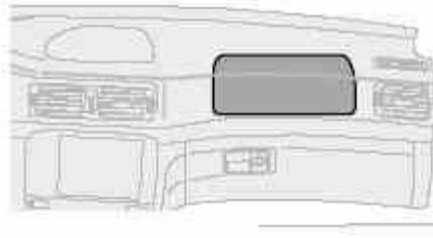

Passenger's side airbag - above glove compartment

The location of the front airbags is indicated by "SRS AIRBAG" embossed on the steering wheel pad and above the glove compartment, and by decals on both sun visors and on the front and far right side of the dash.

- The driver's side front airbag is folded and located in the steering wheel hub.
- The passenger's side front airbag is folded behind a panel located above the glove compartment.

WARNING!

- The airbags in the vehicle are designed to be a SUPPLEMENT to-not a replacement for-the three-point seat belts. For maximum protection, wear seat belts at all times. Be aware that no system can prevent all possible injuries that may occur in an accident.
- Never drive a vehicle with a steering wheel-mounted airbag with your hands on the steering wheel pad/airbag housing.
- The front airbags are designed to help prevent serious injury. Deployment occurs very quickly and with considerable force. During normal deployment and depending on variables such as seating position, one may experience abrasions, bruises, swellings, or other injuries as a result from deployment of one or both of the airbags.
- When installing any accessory equipment, make sure that the front airbag system is not damaged. Any interference in the system could cause malfunction.

pg. 7 Front airbags

Front airbag deployment

- The front airbags are designed to deploy during certain frontal or front-angular collisions, impacts, or decelerations, depending on the crash severity, angle, speed and object impacted. The airbags may also deploy in certain non-frontal collisions where rapid deceleration occurs.
- The SRS sensors, which trigger the front airbags, are designed to react to both the impact of the collision and the inertial forces generated by it, and to determine if the intensity of the collision is sufficient for the seat belt tensioners and/or airbags to be deployed.

However, not all frontal collisions activate the front airbags.

- If the collision involves a nonrigid object (e.g., a snow drift or bush), or a rigid, fixed object at a low speed, the front airbags will not necessarily deploy.
- Front airbags do not normally deploy in a side impact collision, in a collision from the rear or in a rollover situation.
- The amount of damage to the bodywork does not reliably indicate if the airbags should have deployed or not.

NOTE:

- Deployment of front airbags occurs only one time during an accident. In a collision where deployment occurs, the airbags and seat belt tensioners activate. Some noise occurs and a small amount of powder is released. The release of the powder may appear as smoke-like matter. This is a normal characteristic and does not indicate fire.

- Volvo's dual-threshold, dual-stage front airbags use special sensors that are integrated with the front seat buckles. The point at which the airbag deploys is determined by whether or not the seat belt is being used, as well as the severity of the collision.
- Collisions can occur where only one of the airbags deploys. If the impact is less severe, but severe enough to present a clear injury risk, the dual-stage airbags are triggered at 70% of their total capacity. If the impact is more severe, the dual-stage airbags are triggered at full capacity.

Should you have questions about any component in the SRS system, please contact a trained and qualified Volvo service technician or Volvo Customer Support:

In the USA:

Volvo Cars of North America
Customer Care Center
P.O. Box 914
Rockleigh, New Jersey 07647-0914
1-800-458-1552
<http://www.volvocars.us>

In Canada:

Volvo Cars of Canada Ltd.
National Customer Service
175 Gordon Baker Road
North York, Ontario M2H 2N7
1-800-663-8255
<http://www.volvocanada.com>

WARNING!

- Do not use child safety seats or child booster cushions/backrests in the front passenger's seat. We also recommend that occupants under 4 feet 7 inches (140 cm) in height who have outgrown these devices sit in the rear seat with the seat belt fastened¹.
- Never drive with the airbags deployed. The fact that they hang out can impair the steering of your vehicle. Other safety systems can also be damaged.
- The smoke and dust formed when the airbags are deployed can cause skin and eye irritation in the event of prolonged exposure.

¹ See also the Occupant Weight Sensor information on [page 9](#).



Airbag decal on outside of both sun visors



Airbag decal on the passenger's dashboard



SRS decal at far right of the passenger's dashboard

WARNING!

- No objects or accessory equipment, e.g. dashboard covers, may be placed on, attached to, or installed near the air bag hatch (the area above the glove compartment) or the area affected by airbag deployment (see the illustration on [page 6](#)).
- There should be no loose articles, e.g. coffee cups, on the floor, seat, or dashboard area.
- Never try to open the airbag cover on the steering wheel or the passenger's side dashboard. This should only be done by a trained and qualified Volvo service technician.

Failure to follow these instructions can result in injury to the vehicle occupants.

WARNING!

- No objects or accessory equipment, e.g. dashboard covers, may be placed on, attached to, or installed near the air bag hatch (the area above the glove compartment) or the area affected by airbag deployment (see the illustration on [page 6](#)).
- There should be no loose articles, e.g. coffee cups, on the floor, seat, or dashboard area.
- Never try to open the airbag cover on the steering wheel or the passenger's side dashboard. This should only be done by a trained and qualified Volvo service technician.

Failure to follow these instructions can result in injury to the vehicle occupants.

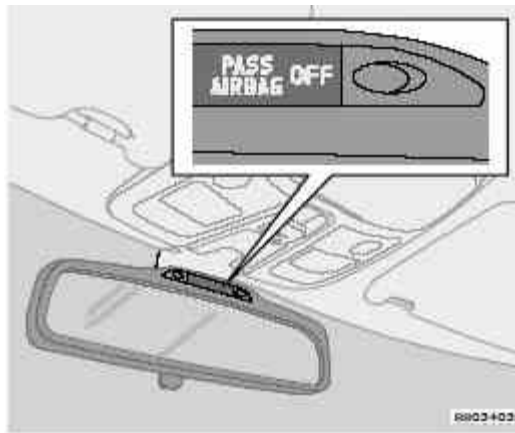

Occupant Weight Sensor (OWS) indicator light

Disabling the passenger's side front airbag

Volvo recommends that ALL occupants (adults and children) shorter than four feet seven inches (140 cm) be seated in the back seat of any vehicle with a front passenger side airbag, and be properly restrained for their size and weight. See also the child safety recommendations on [page 21](#).

The passenger's side front airbag is automatically enabled/disabled by the Occupant Weight Sensor (OWS), a system that monitors the weight of the person or object in the front passenger's seat. The system consists of a silicone-filled bag located under the padding in the front passenger's seat cushion, a control module located under this seat, and a seat belt tension sensor, located on the outboard side of the seat.



The OWS system continuously monitors the pressure on the front passenger's seat cushion and the tension applied to the seat belt. Based on this data, OWS assesses the weight of the occupant or object in the front passenger's seat. This information is transmitted to the SRS system control module, which enables or disables the passenger's side front airbag accordingly, as indicated in the table to the right.

If the system is functioning normally, the status of the front passenger's side airbag (enabled/ disabled) will be shown by the OWS indicator light as explained in the table to the right. The OWS indicator light is separate and in addition to the SRS warning light in the instrument panel.

NOTE: When the ignition is switched on, the OWS indicator light will go on for up to 10 seconds while the system performs a self-diagnostic test and then go out.

However, if a fault is detected in the system:

- The OWS indicator light will stay on
- The SRS warning light (see [page 5](#)) will come on and stay on
- The message PASS. AIRBAG OFF SERVICE URGENT will be displayed in the information display.

Passenger's Seat occupancy status	OWS Indicator light status	Passenger's side front airbag status
Seat unoccupied/ person or object weighing less than approx. 15 lbs (7 kg) on seat	OWS indicator light  is not lit	Passenger's side front airbag disabled
Seat occupied by a person or object weighing up to approx. 55-65 lbs (25-30 kg)	OWS indicator light  lights up	Passenger's side front airbag disabled
Seat occupied by a person or object weighing more than approx. 55-65 lbs (25-30 kg)	OWS indicator light  is not lit	Passenger's side front airbag enabled

(contd. on following page)

pg. 10 Occupant Weight Sensor (OWS)

WARNING!

If a fault in the system is detected and indicated as explained on the previous page, be aware that the passenger's side front airbag will not deploy in the event of a collision. In this case, the safety systems and Occupant Weight Sensor should be inspected by an authorized Volvo retailer as soon as possible.

Modifications

If you are considering modifying your vehicle in any way to accommodate a disability, for example by altering or adapting the driver's or front passenger's seat(s) and/or airbag systems, please contact Volvo at:

In the USA:

Volvo Cars of North America
 Customer Care Center
 P.O. Box 914
 Rockleigh, New Jersey 07647-0914
 1-800-458-1552

In Canada:

Volvo Cars of Canada Ltd.
 National Customer Service
 175 Gordon Baker Road
 North York, Ontario M2H 2N7
 1-800-663-8255

WARNING!

'No objects that add to the total weight on the seat should be placed on the front passenger's seat. If a child is seated in the front passenger's seat with any additional weight, this extra weight could cause the OWS system to enable the airbag, which might cause it to deploy in the event of a collision, thereby injuring the child. The seat belt should

never be wrapped around an object on the front passenger's seat. This could interfere with the OWS system's function. The front passenger's seat belt should never be used in a way that exerts more pressure on the passenger than normal. This could increase the pressure exerted on the weight sensor by a child, and could result in the airbag being enabled, which might cause it to deploy in the event of a collision, thereby injuring the child.

WARNING!

Never try to open, remove, or repair any components in the OWS system. This could result in system malfunction. Maintenance or repairs should only be carried out by an authorized Volvo service technician. The front passenger's seat should not be modified in any way. This could reduce pressure on the seat cushion, which might interfere with the OWS system's function.

pg. 11 Occupant Weight Sensor (OWS)

WARNING!

Keep the following points in mind with respect to the OWS system. Failure to follow these instructions could adversely affect the system's function and result in serious injury to the occupant of the front passenger's seat:

- The full weight of the front seat passenger should always be on the seat cushion. The passenger should never lift him/ herself off the seat cushion using the armrest in the door or the center console, by pressing the feet on the floor, by sitting on the edge of the seat cushion, or by pressing against the backrest in a way that reduces pressure on the seat cushion. This could cause OWS to disable the front passenger's side airbag.
- Do not place any type of object on the front passenger's seat in such a way that jamming, pressing, or squeezing occurs between the object and the front seat, other than as a direct result of the correct use of the ALR/ELR seat belt (see [page 21](#)).
- No objects should be placed under the front passenger's seat. This could interfere with the OWS system's function.



2006
VOLVO
S80

Chapter 2 - Instruments, switches and controls

pg. 23 Instruments, switches and controls

Interior	24
Exterior	25
Instruments	26
Instrument panel	27
Indicator and warning lights	28
Text information window	30
Switches in center console	31
Trip computer	32
Cruise control	33
Lighting panel	34
Manually unlocking the fuel filler door	35
Left-side steering wheel lever	36
Right-side steering wheel lever	37
Steering wheel adjustment/lock, ignition switch	38
Warning flashers, heated mirrors/rear window, heated front seats	39
Parking brake, auxiliary socket, ashtrays	40
Electrically operated windows	41
Vanity mirrors, Rearview/sideview mirrors	42
Power moonroof	43
Sun visor, sun blinds	44

pg. 24 Interior

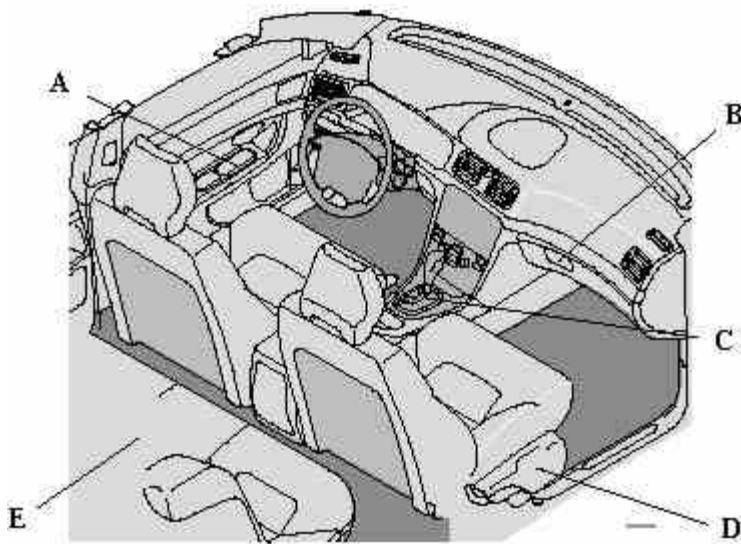

A

- Locking and unlocking the car [67](#)
- Alarm [69](#)
- Electrically operated windows [41](#)
- Sideview mirror controls [42](#)

B

- Glove compartment [57](#)

C

- Automatic transmission [78](#)
- Geartronic [80](#)
- Parking brake [40](#)
- Center console switches [31](#)

D

- Power seat adjustment [54](#)
- Heated seats (option) [39](#)
- Cleaning upholstery [135](#)

E

- Folding rear seat [60](#)
- Panel for long loads [58](#)
- Folding down head restraint [31](#)
- Adjusting center head restraint [61](#)
- Child safety locks [71](#)
- Integrated booster cushion [20](#)

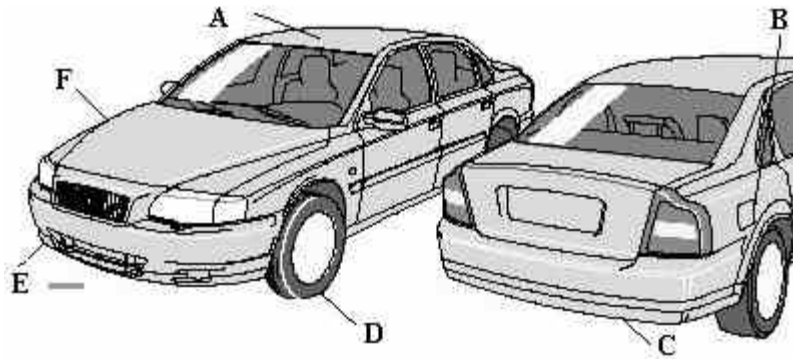

A	
Moonroof (option)	43
B	
Fuel filler door	76
Refuelling	76
Economical driving	84
C	
Replacing a back-up light	127
Replacing a brake light	127
Replacing a tail light	127
Replacing a turn signal	127
Replacing a rear fog light	127
Replacing license plate lights	129
D	
Tires	98
Wheels	98
Brake system	18
Spare tire	109
Changing wheels	110
E	
Replacing a high beam	126
Replacing a low beam	126
Replacing a parking light	126
Replacing a turn signal	126
Replacing a front fog light (option)	128
Replacing a headlight wiper	148
F	
Washing the car	133
Paint touch-up	132

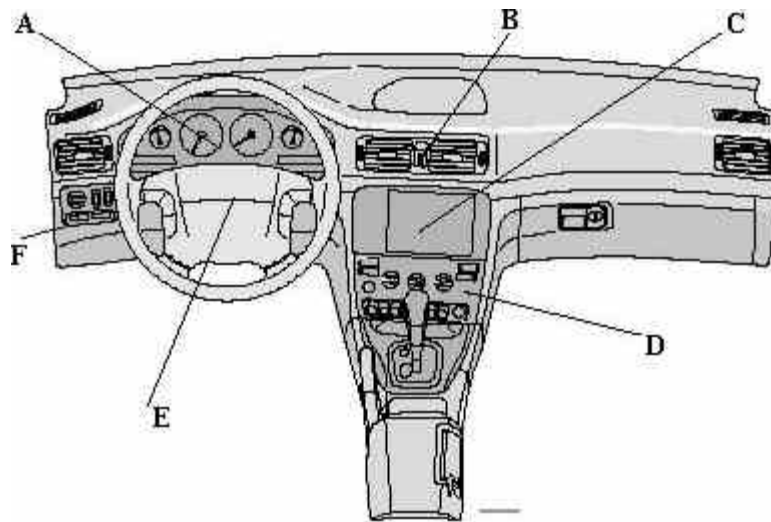

A	
Temperature gauge	27
Speedometer	27
Odometer	27
Trip odometer	27
Warning lights	27
Text window	30
Tachometer	27
Clock	27
Ambient temperature sensor	27
Fuel gauge	27
B	
Hazard warning flashers	39
C	
Audio system	157
D	
Electronic climate control	47
Heated seats (option)	39
Heated rear window/rearview mirrors	39
E	
Steering wheel adjustment	38
Airbag	4
Cruise control	33
Windshield wipers/washer	37
Turn signal lever	36
Trip computer	32
Audio system controls	158-159
F	
High/low beam headlights	34
Parking lights	34
Fog lights	34

Instrument panel lighting [34](#)

Button to unlock fuel filler door [34](#)

pg. 27 Instrument panel

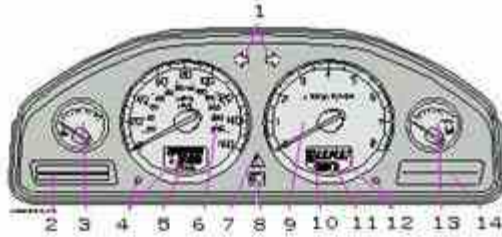

1 Turn signals

2 Text window

3 Temperature gauge

The pointer should be approximately midway on the gauge when driving.

Do not drive the car if the warning light is on. The text window will provide you with additional information.

If the engine temperature remains high, check coolant level - see [page 138](#).

4 Trip odometer/reset button

The trip odometer is used for measuring shorter distances. The last digit indicates 1/10 mile/kilometer. Press the button quickly to toggle between trip odometers 1 and 2. Hold in the button for more than 2 seconds to reset.

5 Odometer

6 Speedometer

7 General warning light (see [page 28](#)).

8 High beam indicator light

9 Tachometer

Indicates engine speed in thousands of rpm. Do not drive for long with the needle in the red section. The engine has an built-in function preventing too high an engine speed. When this function operates, you may discern some pulsation, which is normal.

10 Gear and driving mode indicator

The currently selected driving mode is displayed here. If you use the Geartronic function on the automatic transmission, the currently selected gear will be displayed.

11 Ambient temperature indicator

This sensor indicates the air temperature outside your car. A "snowflake" symbol in the text window is displayed when the temperature is in the range of 23 - 36° F (-5 - +2° C).

Please note that this symbol does not indicate a fault with your car.

At low speeds or when the car is not moving, the temperature readings may be slightly higher than the actual ambient temperature.

12 Clock/reset button

Turn the button to adjust the clock.

13 Fuel gauge

The fuel tank holds approximately 18 US gal. (68 liters).

A warning light in the gauge comes on there are approximately 1.8 US gal. (8 liters) of fuel remaining in the tank.

14 Indicator and warning lights

pg. 28 Indicator and warning lights

*The indicator and warning lights described on pages 28 and 29 should never stay on when driving**

When the ignition key is turned, all of the warning lights in the lower right-hand side of the instrument panel should go on to test the function of the bulbs. If a light does not go off after the engine has started, the system indicated should be inspected.

NOTE: The parking brake reminder light will not go off until the parking brake has been fully released.

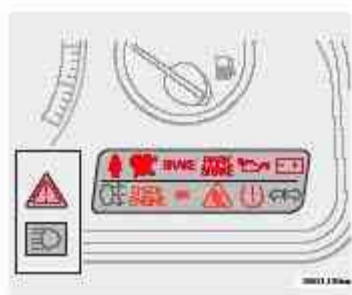

Warning lamp  in the center of the instrument panel

This lamp lights up **red** or **yellow** depending on the severity of the fault that has been detected.

Red symbol - Stop the vehicle as soon as possible in a suitable location and read the message shown in the text window. The symbol and accompanying text will remain on until the fault has been corrected.

Yellow symbol - Follow the instructions shown in the text window. The text can be erased by pressing the READ button (see [page 30](#)), or will disappear automatically after two minutes.

NOTE: When the message "TIME FOR REGULAR SERVICE" is displayed, the text can be erased and the yellow symbol light can be turned off by pressing the READ button. The text will disappear and the symbol light will go out automatically after two minutes.

BRAKE
Brake failure warning light
If the light comes on while driving or braking, stop immediately, open the hood and check the brake fluid level in the reservoir. See [page 142](#) for reservoir position and instructions.

Canadian models are equipped with this warning light: 

Park
Brake
Parking brake reminder light

This light will be on when the parking brake (hand brake) is applied. The parking brake lever is situated between the front seats.

Canadian models are equipped with this warning light: 



Oil pressure warning light

If the light comes on while driving, stop the car and then stop the engine immediately and check the engine oil level. See [page 144](#). If the light stays on after restart, have the car towed to the nearest authorized Volvo retailer. After hard driving, the light may come on occasionally when the engine is idling. This is normal, provided it goes off when the engine speed is increased.



Generator warning light

If the light comes on while the engine is running, have the charging system checked.

* Rear fog light, if used, and trailer turn signal, if towing a trailer, will go on while driving.

pg. 29 Indicator and warning lights



Rear fog light

This light indicates that the rear fog light is on.

CHECK ENGINE

Malfunction indicator lamp

On-Board Diagnostic II (OBDII): As you drive, a computer called "OBDII" monitors your car's engine, transmission, electrical and emission systems. The CHECK ENGINE light will light up if the computer senses a condition that potentially may need correcting. When this happens, please have your car checked by a Volvo retailer as soon as possible.

A CHECK ENGINE light may have many causes. Sometimes, you may not notice a change in your car's behavior. Even so, an uncorrected condition could hurt fuel economy, emission cleanliness, and driveability. Extended driving without correcting the cause could even damage other components in your car.

Canadian models are equipped with this warning light: 

NOTE: If the fuel filler cap is not closed tightly or if the engine is running when the car is refueled, the Malfunction Indicator Lamp may indicate a fault. However, your vehicle's performance will not be affected. Use only Volvo original or approved fuel filler caps.



Anti-lock Brake System ABS

If the warning light comes on, there is a malfunction of the ABS system (the standard braking system will however function). The vehicle should be driven to a Volvo retailer for inspection. See [page 97](#) for additional information.



Stability Traction Control (STC) system (option), or Dynamic Stability and Traction Control (DSTC) system (option)

This indicator light will flash with STC or DSTC is actively working to stabilize the car. See [pages 98-99](#) for more detailed information.



Turn signal indicator - trailer (certain models)

If you are towing a trailer, this light will flash simultaneously with the turn signals on the trailer. If the light does not flash when signaling, neither the trailer's turn signals nor the car's turn signals are functioning.

**Seat belt reminder**

This symbol lights up to indicate that the driver has not fastened his/her seat belt.

**Tire pressure warning light**

See [page 107](#) for more information on this function.

Supplemental Restraint System (SRS)

If this light comes on while the car is being driven, or remains on for longer than approximately 10 seconds after the car has been started, the SRS system's diagnostic functions have detected a fault in a seat belt lock or tensioner, a front airbag, side impact airbag, and/or an inflatable curtain. Have the system(s) inspected by a trained and qualified Volvo service technician as soon as possible.



[Contents](#) | [Top of Page](#)

2006
VOLVO
S80

Chapter 3 - Climate control system

pg. 45 Climate control system

Ventilation 46

Electronic Climate Control (ECC) 47

Climate control system - general information 50

Interior Air Quality system (option) 51

pg. 46 Ventilation

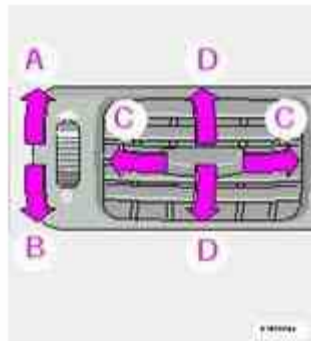

Air vents in dash

Air vents (dash)

A Open

B Closed

C Horizontal air flow

D Vertical air flow

Direct the outer air vents toward the side windows to demist.

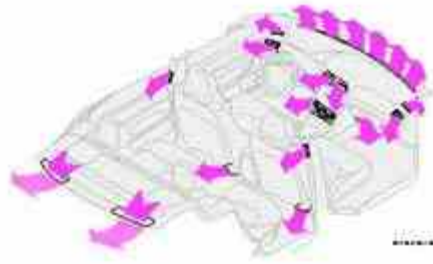

Air flow

The air that is drawn into the passenger compartment is distributed from 14 ventilation points.

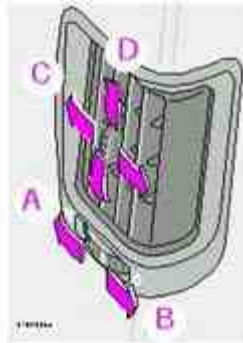

Air vents in door pillars

Air vents in door pillars

- A Open
- B Closed
- C Horizontal air flow
- D Vertical air flow

Direct the air vents toward the rear side windows to demist.

Direct the air vents toward the rear seat for the best heating/cooling effect.

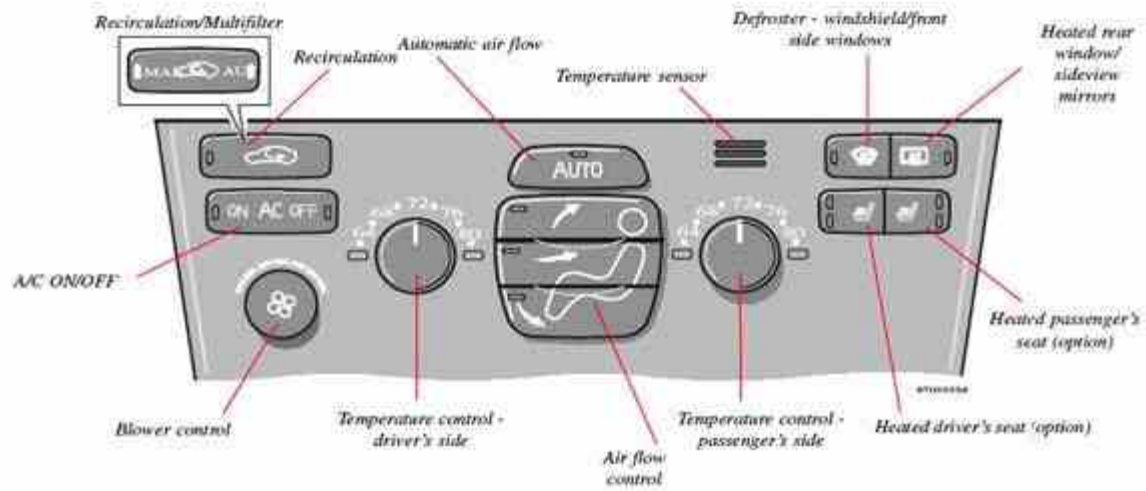

pg. 48 Electronic Climate Control (ECC)



AUTO

This function automatically regulates the Electronic Climate Control system so that the selected temperatures are maintained. The blower, heating, air distribution (air flow) and air conditioning are controlled. If you prefer to manually set any of these functions, the remaining functions will still be controlled automatically. Pressing the AUTO button overrides any settings that were previously made manually.



Temperature

These controls are used to individually set the temperature for both sides of the passenger compartment. Please note that the compartment will not be heated or cooled faster by setting the temperature higher or lower than necessary. Set the control to the temperature you prefer.



Defroster

This function demists/de-ices the windshield and front side windows. The LED in the switch will light up to indicate that the defrost function is engaged. Blower speed increases automatically and the air in the passenger compartment is dehumidified. Recirculation will not function while defrost is engaged.

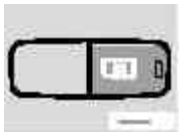

Heated rear window/sideview mirrors

This function demists/de-ices the rear window and sideview mirrors. The LED in the switch will light up to indicate

that the heating function is engaged. See [page 39](#) for additional information on this function.

CAUTION:

Never use ice scrapers made of metal as they can easily scratch the mirror surface.

pg. 49 Electronic Climate Control (ECC) - manual settings



Recirculation (see also [page 51](#))

Press this switch to engage the recirculation function (air in the passenger compartment recirculates - no fresh air enters the compartment). The LED in the switch will light up to indicate that the function is engaged.

- Use this function if the outside air is contaminated with exhaust gases, smoke, etc or to heat/cool the car quickly.
- Recirculation should not be used for more than 15 minutes. *If your windows begin to fog or mist, make sure that the recirculation function is switched off.*
- Selecting Defroster automatically switches recirculation off.
- **Timer mode activation:** (Cars with Interior Air Quality system have no timer mode) Press and hold the recirculation button for at least 3 seconds to activate a recirculation timer mode. The amber LED in the recirculation button will flash 5 times to show that the timer mode is being activated. In the time mode, each time the recirculation button is pressed, the climate control system will recirculate the air in the passenger compartment for 5 to 12 minutes, depending on the outside air and then revert back to fresh air.
- **Timer mode deactivation:** Press and hold the recirculation button for at least 3 seconds. The amber LED in the recirculation button will illuminate steadily for 5 seconds to show a return to "normal" mode.
- In normal mode, when the recirculation button is pressed, the climate control system will recirculate the air in the passenger compartment until the recirculation button is pressed again.
- **Timer mode memory:** If the car is turned off while timer mode is active, timer mode will still be active when the car is restarted.



Heated front seats (option)

Please see [page 39](#) for more information on this function.



Air flow to windows
Air from panel vents
Air through floor vents

Air flow

Press **AUTO** to automatically regulate air flow or press any combination of the controls shown in the illustration to manually adjust air flow. An LED in the switch will light up if an air flow control has been pressed.



Air conditioning ON/OFF

Press the switch to turn the air conditioning on or off. The "ON" or "OFF" LED will light up to indicate if the system is switched on or off. Other functions will still be regulated automatically (if the **AUTO** switch is on).

- The air conditioning functions only at temperatures above 32° F (0° C).
- While the **Defroster** function is selected, the air conditioning is temporarily activated to dehumidify the air, even if you have manually switched the air conditioning off. This will only function if the blower is *not* switched off.



Blower control

Turn the control clockwise to increase or counterclockwise to decrease the blower speed. Pressing the AUTO switch will automatically regulate blower speed and override manual adjustment.

NOTE: Turning the blower control counterclockwise as far as possible (an orange LED next to the control will light up) will turn both the blower and the air conditioning off.

pg. 50 Climate control system - general information

Condensation on the inside of the windows

Keeping the insides of the windows clean will help reduce the amount of condensation that forms on the windows. Use a commercial window cleaning agent to clean the windows.

Ice and snow

Always keep the air intake grille at the base of the windshield free of snow.

Cabin air filter

Replace the cabin air filter with a new one at the recommended intervals. Please refer to your Warranty and Service Records Information booklet, or consult your Volvo retailer for these intervals. The filter should be replaced more often when driving under dirty and dusty conditions. The filter cannot be cleaned and therefore should always be replaced with a new one.

Sensors

The sunlight sensor on the dashboard and passenger compartment temperature sensor in the ECC control panel should not be covered in any way as this could cause incorrect information to be sent to the ECC system.

Parking the car in warm weather

If your car has been parked in the sun in warm weather, opening the windows and sun roof (option) for several minutes before driving will help release the warm air from the passenger compartment. When the engine is running, close the windows and sun roof and use the recirculation function for several minutes to enable the air conditioning to cool the compartment as quickly as possible.

Windows and optional moonroof

The ECC system will function best if the windows and optional moonroof are closed. If you drive with the moonroof open, we recommend that you manually adjust the temperature and blower control (the LED in the AUTO switch should be off).

Acceleration

The air conditioning is momentarily disengaged during full-throttle acceleration.

Climate control maintenance

Special tools and equipment are required to maintain and carry out repairs on the climate system. Work of this type should only be done by a trained and qualified Volvo service technician.

Refrigerant

Volvo cares about the environment. The air conditioning system in your car contains a CFC-free refrigerant - R134a (HFC134a). This substance will not deplete the ozone layer. The system contains 2.2 lbs (1000 g) R134a and uses PAG oil.

Climate system blower

The climate system blower will be automatically switched off when the engine is not running (even if the ignition key is in position I or II) to avoid unnecessary battery drain. To activate the blower, turn the control to the desired setting.

Passenger compartment blower

Approximately 50 minutes after the ignition is turned off, the blower may come on automatically, and run for five minutes, to remove condensation in the A/C evaporator.

pg. 51 Interior Air Quality system (option)

Interior Air Quality system (option)

Some cars are equipped with a multifilter and air quality sensor. The filter separates gases and particles, thereby reducing the amounts of odors and contaminants entering the car. The air quality sensor detects increased levels of contaminants in the outside air. When the air quality sensor detects contaminated outside air, the air intake closes and the air inside the passenger compartment is recirculated, i.e. no outside air enters the car. The filter also cleans recirculated passenger compartment air. When the Air quality sensor is activated, the LED AUT comes on in the recirculation button 



Operation:

Press  to activate the Air quality sensor (normal setting).



Or select one of three functions by pressing 

1. Press  the LED *AUT* comes on.

The Air quality sensor is now activated.

2. Press  no LED is lighted.

Recirculation not activated.

3. Press  the LED *MAN* comes on. Recirculation is now activated. You can switch between these three functions by repeatedly pressing 

Keep the following in mind:

- Make it a rule to have the air quality sensor activated at all times.
- Recirculation is limited in cold climates to avoid misting up.
- If misting occurs, you should deactivate the Air quality sensor.
- If the windows mist up, you can also use the windshield and side window defroster functions. See [page 48](#).
- The filter should be changed at the intervals listed in the Warranty and Service Records Information booklet. However, if the car is used in a severely contaminated environment, it may be necessary to change the filter more frequently.

This page intentionally left blank.



[Contents](#) | [Top of Page](#)

2006
VOLVO
S80

Chapter 4 - Interior

pg. 53 Interior

[Front seats](#) 54

[Coat hanger](#) 55

[Interior lighting](#) 56

[Storage compartments](#) 57

[Storage compartments in center console, Long loads](#) 58

[Spare tire, Cargo net in trunk](#) 59

[Folding rear seat backrests](#) 60

[Center head restraint](#) 61

pg. 54 Front seats



1. Power seat control panel,
2. Lumbar support: turn for softer or firmer support

Electrically operated seats

Operation

Driver's seat:

The seat can be adjusted if the ignition key is in position I, II or if the engine is running.

It can also be adjusted as follows **with the ignition off**:

- Within 10 minutes after the driver's door has been unlocked from the outside and has been opened and remains open.
- Within 40 seconds, if the driver's door has just been closed.
- Within 40 seconds, if the driver's door has not been opened after the ignition has been switched off.

Passenger's seat:

The seat can only be adjusted if the ignition key is in position I, II or if the engine is running.

Electrically operated driver's seat controls

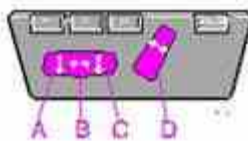

- A Front edge of seat (raise/lower)
- B Forward - rearward
- C Rear edge of seat (raise/lower)
- D Backrest tilt

WARNING!

- Because the driver's seat can be adjusted with the ignition off, children should never be left unattended in the car.
- Movement of the seat can be STOPPED at any time by pressing any button on the power seat control panel.
- Do not adjust the seat while driving. The seat should be adjusted so that the brake pedal can be depressed fully. In addition, position the seat as far rearward as comfort and control allow.
- The seat rails on the floor must not be obstructed in any way when the seat is in motion.



Programming the driver's seat memory (option)*

Three different seating and door mirror positions can be stored in the driver seat's memory.

The following example explains how button 1 can be programmed.

Buttons 2 and 3 can be programmed in the same way.

To program (store) a seat position in button 1:

1. Move the seat to the desired position using the seat adjustment controls (see the previous page).
2. Press and hold down the MEM (memory) button.

3. With the MEM button depressed, press button 1 briefly to store the seat's current position.

To move the seat to the position that it was in when button 1 was programmed:

Press and hold down button 1 until the seat stops moving.

As a safety precaution, the seat will stop automatically if the button is released before the seat has reached the preset position.

* This option is only available on the driver's seat.

pg. 55 Front seats, Coat hanger

Remote keyless entry system and the driver's seat

The remote control transmitter also controls the position of the electrically operated driver's seat in the following way:

1. Adjust the seat to your preferences.
2. When you leave your vehicle, lock it using the remote control.

The position of the seat is now stored in the remote control.

Automatic seat adjustment

To move the seat to the position in which you left it:

1. Unlock the driver's door with the same remote control (the one used to lock the doors).
2. Open the driver's door within 2 minutes.

The driver's seat will automatically move to the position in which you left it.

NOTE:

- The seat will move to this position even if someone else has moved it to a different seating position and locked the car with a different remote control.
- This feature will work in the same way with all of the remote control transmitters (up to 3) that you use with your vehicle.
- This feature will not function if you lock your vehicle with the key.

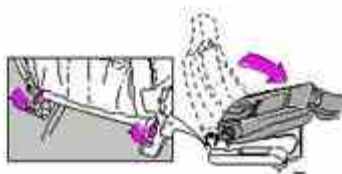

Folding front seat backrest

Folding front seat backrest

The passenger seat backrest can be folded down to the horizontal position for carrying long loads. To fold down the backrest:

- Move the seat as far rearward as possible

- Adjust the backrest tilt to the most upright position
- Lift the catches on the lower rear side of the backrest
- Without releasing the catches, push the backrest forward
- Move the seat as far forward as possible so that the head restraint slides under the glove compartment.

WARNING!

Cover sharp edges on the load to help prevent injury to occupants. Secure the load to help prevent shifting during sudden stops.

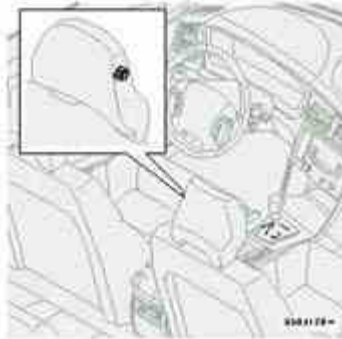

Coat hanger

Coat hanger

Use the coat hanger for light jackets, etc.

pg. 56 Interior lighting

Courtesy light



Front reading lights

Courtesy light

The courtesy light can be turned on or off by pressing the button. The light also has a timer function which turns the light (in dark conditions) on for 30 *seconds* if:

- You unlock the car from the outside with the key or remote control.
- You switch off the ignition (turn the key to position 0).

The courtesy light stays on for 10 *minutes* if one of the doors is left open after the car is unlocked.

The courtesy light switches off if:

- The engine is started.
- The car is locked from the outside with the key or remote control.

The interior courtesy light can be switched on or off at any time by pressing the center button in the panel above the rearview mirror. When switched on with the engine off, the light will stay on for 10 minutes. When switched on with the engine running, the light will stay on indefinitely. The light may be switched off at any time by pressing the center button a second time.

The courtesy light timer periods can be changed. Consult your Volvo retailer.

Overriding the Interior and Trunk Courtesy Lights

Normally if a car door is left open with the engine turned off, the interior courtesy light will stay on for 10 minutes. Normally, if the trunk is left open with the engine turned off, the trunk courtesy lights will stay on for 10 minutes. If a car door is left open or the interior courtesy lights are turned on while the engine is left running, the interior courtesy lights will stay on indefinitely. Likewise, if the trunk is left open while the engine is running, the trunk courtesy light will stay on indefinitely.

At times, you may wish to be assured that the courtesy lights will stay off regardless of door or trunk lid position. To switch off the interior and trunk courtesy lights indefinitely, press and hold the center button in the panel above the rearview mirror for 3 seconds. The courtesy lights will go off and remain off until the center button is pressed again.



Rear reading lights

Reading lights - front/rear

The reading lights can be switched on or off by pressing the respective buttons. These lights switch off automatically after 10 minutes if the engine is not running. If the engine is running, the lights stay on indefinitely. The lights can be switched off at any time by pressing the button.

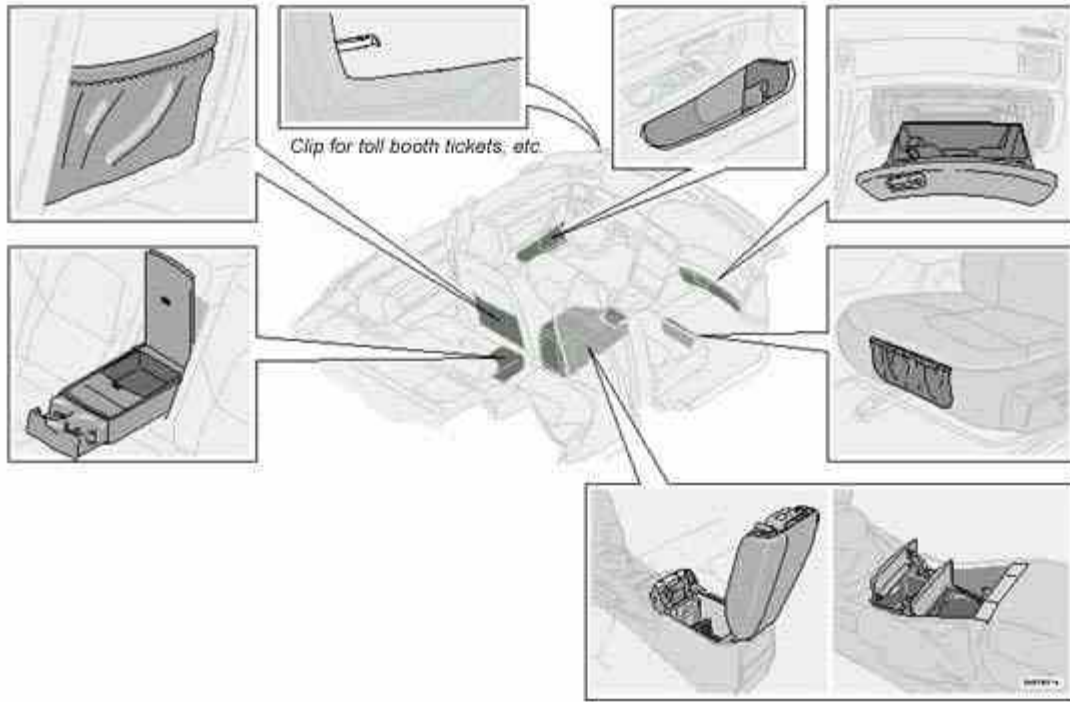

WARNING!
 Packages on the rear window shelf can obscure vision and may become dangerous projectiles in the event of a sudden stop or an accident.
 Anchor any heavy objects to help prevent them from moving during sudden stops.

pg. 58 Storage compartment in center console, Long loads

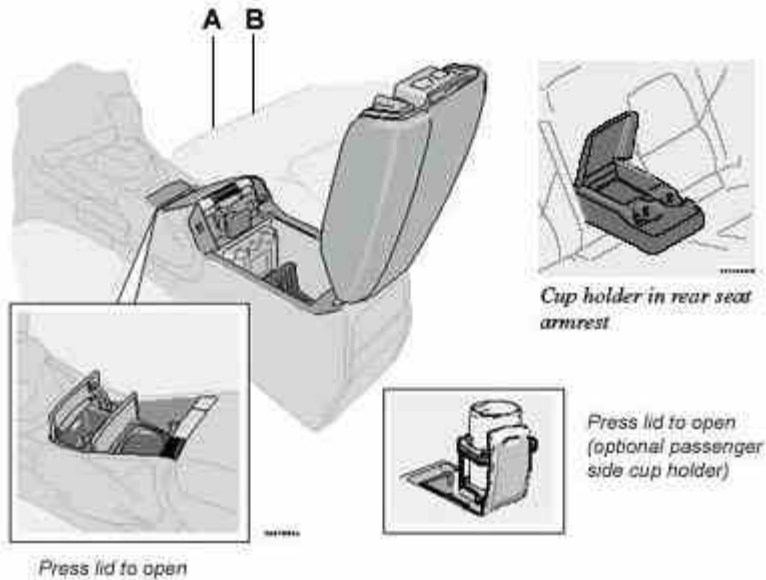

Storage compartment in center console/cup holders

- Press button A to pop open the cup holder.

- Press button B to open the storage space in the center console for cassettes, accessory coin holder, etc.

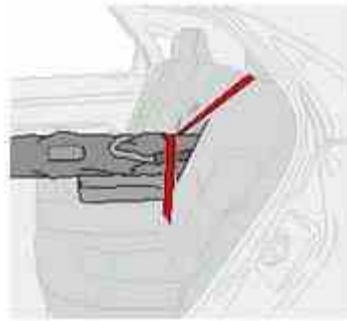

Secure long loads with the seat belt

Carry long loads

The center backrest cushion folds forward, allowing you to transport long, light cargo such as skis in the trunk of your car. To lower the backrest:

- Pull the left release control handle in the trunk to release the backrest (see [page 60](#)).
 - From the rear seat, fold down the left section of the backrest slightly*.
 - Release the flap by pushing the catch (located on the rear side of the backrest) upward and pulling the flap forward.
 - Return the backrest to the upright position.
- * If your car is equipped with the optional integrated child booster cushion, this cushion must be folded *down* before you fold down the backrest (see [page 15](#)).

pg. 59 Spare tire, Cargo net in trunk

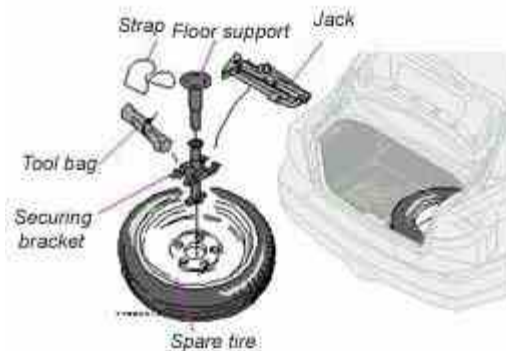

Spare tire

The spare tire, jack and tool bag are located under the floor of the trunk. To access the spare tire:

- Raise the rear edge of the trunk floor and fold it back toward the rear seat backrest.
- Lift out the trunk floor support (certain models) from the spare tire securing bracket.
- Release the strap to lift out the jack and tool bag.
- Unscrew the securing bracket and lift out the spare tire.

· To return the spare tire to the trunk, follow the reverse procedure.

WARNING!

Make sure that the spare tire, jack and tool bag are properly secured with the securing bracket and strap to help keep these components in place in the event of a sudden stop.

NOTE: See [page 116](#) for information on how the jack should be used.

Cargo net in the trunk

The cargo net in the trunk can be used to secure light objects. Pull the net out and slide the runner in the handle down into one of the two slots provided at the rear edge of the trunk. Use the release tab to release tension on the net while it is being placed around an object. Be sure the net is then pulled taut around the object.

The net can be retracted when not in use.

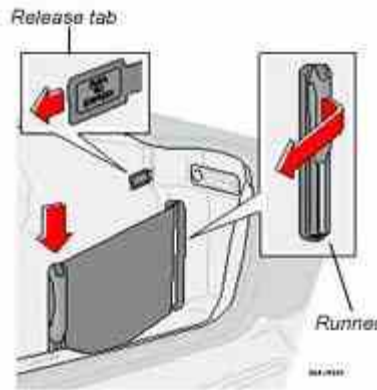

Cargo net in trunk

NOTE: If you have purchased the accessory plastic floor cover for the trunk, it may be necessary to cut notches in the rear edge of this cover so that the runner on the cargo net can be securely pressed into the slots provided.

WARNING!

Never use this net to secure sharp or heavy objects. In such cases, tie down the object using the cargo eyelets provided. Both rear seat backrests should be secured in the upright position when the cargo net is in use.

pg. 60 Folding rear seat backrests

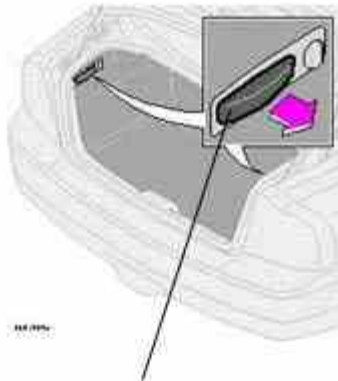

Backrest controls (on opposite sides of trunk)

Folding rear seat backrest

The rear seat backrest is split into two sections. Each section can be folded independently to allow you to transport long objects.

To fold down the backrest(s):

- Pull the release control handle(s) in the trunk to release the backrest(s) (see illustration above). If the outboard rear head restraints are folded down, they should be returned to the upright position before folding the backrest down. It may be necessary to manually adjust the center head restraint.
- Fold the backrest down.

WARNING!

All S80 cars feature 60/40 split fold-down rear seats. This function is performed by handles inside the trunk, and also provides a means for children and adults to enter the passenger compartment in the event they become locked inside the trunk.

Adults are advised to familiarize themselves with the operation and location of the release handles.

To fold down the rear seats from inside the trunk, pull the release control handles located on either side of the trunk.

WARNING!

- Keep vehicle doors and the luggage compartment locked and keep keys out of a child's reach. Unsupervised children could lock themselves in an open trunk and risk injury. Children should be taught not to play in vehicles.
- On hot days, the temperature in the trunk or vehicle interior can rise very quickly. Exposure of people to these high temperatures for even a short period of time can cause heat-related injury or death. Small children are particularly at risk.

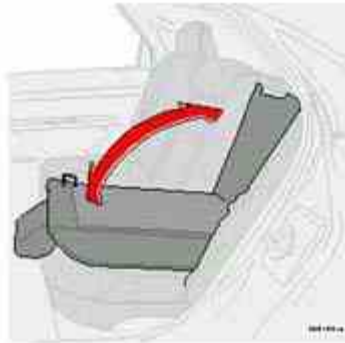

WARNING!

- When the backrest is returned to the upright position, check that it is properly locked in place. Return the head restraints to the upright position.
- Long loads should always be securely anchored to help avoid injury in the event of a sudden stop.
- Always turn the engine off and apply the parking brake when loading/unloading the vehicle.
- Place the transmission in the P (PARK) position to help prevent inadvertent movement of the gear selector.

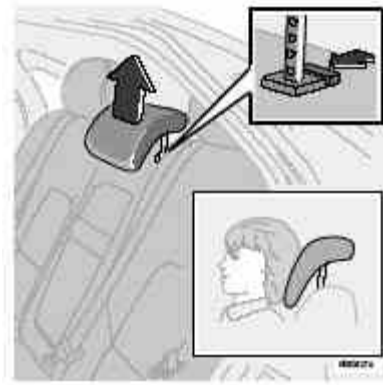

Adjust head restraint height

Center head restraint

The center head restraint can be adjusted according to the passenger's height. The restraint should be carefully adjusted to support the occupant's head.

The head restraint can be raised by pulling straight up or lowered by pressing the catch at the base of the left head restraint support and pushing down.

WARNING!

- Please note that the lowest head restraint position is only intended for use when the backrest is to be folded down, or when the seat is not occupied.
- The head restraint is intended to help protect the head/neck in a collision. Ensure that it is properly adjusted for the occupant of the seat.

pg. 62 This page intentionally left blank



[Contents](#) | [Top of Page](#)

2006
VOLVO
S80

Chapter 5 - Keys, Locks, Alarm

pg. 63 Keys, Locks, Alarm

[Keys, Immobilizer](#) 64

[Remote keyless entry system](#) 65

[Locking and unlocking the car](#) 67

[Alarm](#) 69

[Child safety locks - rear doors](#) 71

pg. 64 Keys, Immobilizer



Keys

Two types of keys are provided with your car; master keys and a service key. The master key, the remote control, and the central locking button may all be used to lock and unlock all of your car's locks.

The service key will operate only the driver's door and the ignition switch. It is intended to help deter unwanted entry into the glove compartment and trunk.

Turn the key once to unlock the driver's door only.

Turn the key again (within 10 seconds) to unlock all doors and the trunk.

One turn with the key towards lock in the drivers door locks all doors, trunk.

Use the switch on the front door armrests to lock/unlock the car from the inside.

WARNING!

If the doors are locked while driving, this may hinder rapid access to the occupants of the car in the event of an accident. (Also see information on "Child safety locks").

Note: To help prevent accidentally locking the keys in the car, the central locking system is designed to unlock the doors immediately if the key is left in the ignition switch, the car is locked using the lock button on the door and the door is then closed. **A sound from the lock will be audible at this time.**

Please note that this function will not unlock the doors if the engine is running.

Immobilizer (start inhibitor)

Each of the keys supplied with your car contains a coded transmitter. The code in the key is transmitted to an antenna in the ignition switch where it is compared to the code stored in the start inhibitor module. The car will start only with a properly coded key.

Each key has a unique code, which your Volvo retailer uses if new keys are required. A maximum of six remote controls/keys can be programmed and used for one car.

If you misplace a key, take the other keys to an authorized Volvo retailer for reprogramming as an antitheft measure. Turn the key once to unlock the driver's door only.

This device complies with part 15 of the FCC rules. Operation is subject to the following condition: (1) This device may not cause harmful interference, and (2) this device must accept any interference received, including interference that may cause undesired operation.

pg. 65 Remote keyless entry system

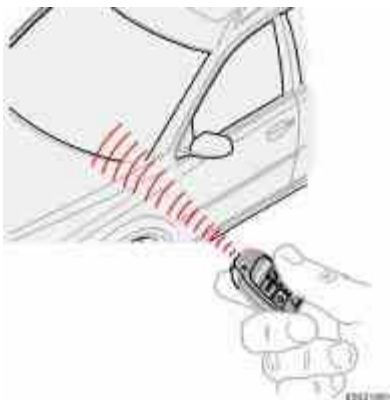

Remote keyless entry system

Your car is equipped with two coded remote control transmitters with integrated ignition keys called Key Integrated Remote (KIR). These transmitters use a radio frequency that will enable you to lock/unlock all doors and the trunk from a distance of 10-15 feet (3-5 meters).

The transmitters will also activate or allow "keyless" entry into the passenger compartment or the trunk. They will also activate or deactivate the vehicle's alarm system(s).

The car can also be locked/unlocked with the key.

If one of the transmitters is misplaced, contact your nearest authorized Volvo retailer for replacement.

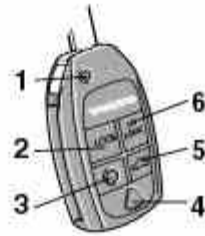

Buttons in remote control

*1 - Fold key in/out, 2 - Lock, 3 - Approach lighting,
4 - "Panic" function, 5 - Open trunk, 6- Unlock*

Using the remote control

Button 1: Press to extend the key. This button must also be pressed when the key is folded back into the slot in the side of the remote control unit.

Button 2 (Lock): Press once to lock all doors, and the trunk.

Button 3 (Approach lighting): Press this button when approaching the car at night to light up the interior courtesy light, parking lights, license plate lights and the lights in the sideview mirrors.

Button 4 (Panic): See [page 69](#) for more information on this function.

Button 5 (Open trunk): Press this button twice within 3 seconds to pop open the trunk (without unlocking the other doors).

Button 6 (Unlock): Press this button once to unlock the driver's door only. Wait for at least 1 second and press the button again (within 10 seconds) to unlock all doors, and the trunk.

NOTE:

- If the doors are unlocked with the remote, the locks will automatically reengage (re-lock) and the alarm will rearm after 2 minutes unless a door has been opened.
- The lock/unlock and alarm features can also be utilized by using the keys.

FCC ID:LQNP2T-APU

This device complies with part 15 of the FCC rules. Operation is subject to the following conditions: (1) This device may not cause harmful interference, and (2) this device must accept any interference received, including interference that may cause undesired operation.

Canadian 2306104388

Model 504 2927 by Donnelly

Operation is subject to the following conditions: (1) this device may not cause interference, and (2) this device must accept any interference, including interference that may cause undesired operation of the device.

Canadian 2306104388A

Model 509 977 by Connaught Electronics

Operation is subject to the following conditions: (1) this device may not cause interference, and (2) this device must accept any interference, including interference that may cause undesired operation of the device.

WARNING!

Never use the transmitter to lock the doors from inside the car.

Doing so would **ACTIVATE**:

- the break-in alarm, which would sound if one of the doors were opened.
- the interior motion and inclination alarm sensors, if equipped.

Doing so would **DEACTIVATE**:

- the moonroof and interior courtesy light controls.
- the central locking buttons on the front door armrests, although the interior door handles would still function to allow occupants to leave the car.

Disabled features would remain disabled until the remote were used again to unlock the car.

In addition, locking an occupied vehicle would hinder rapid access to the occupants in an accident or emergency.

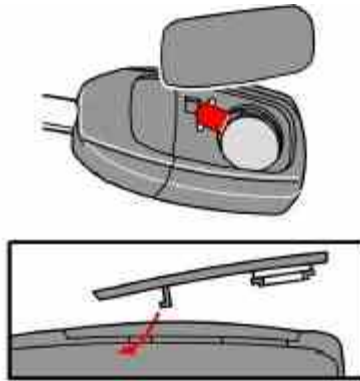

Remote keyless entry system - replacing batteries

If the range of the transmitter is noticeably reduced, this indicates that the battery is weak and should be replaced.

To replace the battery

- Remove the cover by carefully prying up its rear edge with a small screwdriver
- Replace the battery with a new 3-volt, CR 2032 battery. The battery should be inserted with the plus side upward. Avoid touching the contact surfaces of the battery with your fingers.
- Press the cover back into place. Ensure that the rubber seal seats correctly to help prevent moisture from entering the unit.

NOTE: The old battery should be disposed of properly at a recycling center or at your Volvo retailer.



Unlocking the trunk with the master key

Normally, the trunk should be locked and unlocked via the central locking system using the remote control or by using the key in the driver's door lock. The master key should be used only if it is not possible to unlock the trunk via the central locking system.

NOTE: Unlocking the trunk in this manner will cause the alarm to sound. See [page 69](#) for information on turning off the alarm. Unlocking the trunk this way will not unlock the other doors.

If, for any reason, it should be necessary to unlock the trunk with the master key:

- Press the key into the upper or lower edge of the cover over the lock in the trunk lid.
- Move the key upward or downward to remove the cover.
- Insert the master key in the lock and unlock the trunk.



Opening the trunk from the inside

Opening the trunk from the inside - (U.S. models only)

The car is equipped with a florescent handle on the inside of the trunk lid, which can be used in an emergency situation to open the trunk from the inside.

Pull the handle down to release the trunk lid.

After use, the handle must be pushed back into its original position before the trunk can be closed.

NOTE: This handle is not intended to be used to anchor the trunk lid when long loads are being transported.

WARNING!

- Keep vehicle doors and trunk locked and keep keys out of a child's reach. Unsupervised children could lock themselves in an open trunk and risk injury. Children should be taught not to play in vehicles.
- On hot days, the temperature in the trunk or vehicle interior can rise very quickly. Exposure of people to these high temperatures for even a short period of time can cause heat-related injury or death. Small children are



Central locking buttons

Central locking buttons

These buttons (located on the both front door armrests) can be used to lock/unlock all doors and the trunk and set the alarm.

The lock buttons on all doors can be used in the same way.

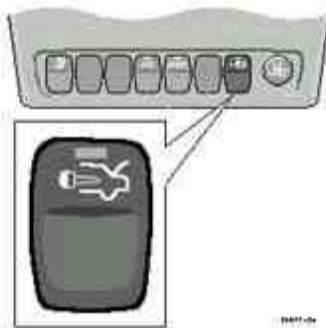

*Trunk lock button**

Valet security locking

The security locking feature of your car allow you to prevent unwanted access to your trunk and glove compartment, while still allowing a parking attendant to unlock, start, and relock the rest of your car. To prevent unwanted access to the trunk and glove compartment do the following:

- Give your service key to the parking attendant.
- Insert your master key into the glove compartment. Turn it 90 degrees clockwise and remove the key. The glove compartment cannot be unlocked with the service key.
- Insert your master key into the ignition and turn it to position II.
- Press the trunk lock button in the center console. An LED and a message in the text window will show that the trunk lock has be activated.
- Turn off the ignition and remove the master key.
- With the trunk lock activated, neither the service key nor the remote control will open the trunk.

The function can be turned off (deactivated) by turning the ignition key to position II and pressing the trunk lock

button again (the LED in the button will go out and VALET LOCK OFF" will be displayed in the text window).

* The position of this button may vary, depending on the specifications of your car.

pg. 69 Alarm

Alarm

The alarm is automatically armed whenever you lock your car.

When armed, the alarm continuously monitors a number of points on the car. The following conditions will set off the alarm:

- The hood is forced opened.
- The trunk is forced opened.
- A door is forced opened.
- The ignition switch is tampered with.
- If there is movement in the passenger compartment (if the car is equipped with the optional movement sensor).
- The car is lifted or towed (if the car is equipped with the optional inclination sensor).
- The battery is disconnected (while the alarm is armed).

Arming the alarm

Press the LOCK button on the remote control, lock the car using the key in the driver's door or press the central lock button on one of the front doors with the door open. One long flash of the turn signals will confirm that the alarm is armed.

Disarming the alarm

Press the UNLOCK button on the remote control or unlock the doors with the key.

Turning off (stopping) the alarm

If the alarm is sounding, it can be stopped by pressing the UNLOCK button on the remote control or by unlocking the driver's door with the key.

Visual alarm signal

The visual alarm signal is given by flashing all turn signals and turning on the interior lighting for approximately 5 minutes.

Audible alarm signal

An audible alarm signal is given by a battery powered siren. One alarm cycle lasts for 25 seconds.

"Panic" button

In an emergency situation, this feature can be used to attract attention.

Activate the "panic" button by pressing the red button on the remote control (see illustration on [page 65](#)) for at least 3 seconds or by pressing this button twice within 3 seconds. The turn signals will flash, and the car's horn will sound.

The function can be turned off by pressing any of the buttons on the remote control or will stop automatically after 25 seconds. When a button is pressed, there is a 5 second delay before the panic alarm is deactivated.

NOTE: This button will **NOT** unlock the car.

pg. 70 Alarm



The position of this button may vary, depending on the specifications of your car.

Temporarily turning off the inclination and movement alarm sensor(s) - accessory

This button will only be found in cars equipped with the accessory inclination and/or movement sensors.

FCC ID: MAYDA5823

This device complies with part 15 of the FCC rules. Operation is subject to the following conditions: (1) This device may not cause harmful interference, and (2) this device must accept any interference received, including interference that may cause undesired operation.

Canadian IC: 4405A-DA5823

Movement sensor DA5823 by Dynex

Operation is subject to the following conditions: (1) this device may not cause interference, and (2) this device must accept any interference, including interference that may cause undesired operation of the device.

In certain situations it may be desirable to turn off the optional inclination and movement alarm sensors if, for example, you drive your car onto a ferry where the rocking of the boat could trigger the alarm or if a pet is left in the car with the doors locked.

To temporarily turn off the inclination and movement alarm sensor from the alarm system:

From the time the ignition key is turned from the Drive position (position II) until you lock the car, you can press the button in the center console. The LED in the switch will light up and a message will be displayed in the text window to indicate that the sensors are disconnected.

The car can then be locked in the usual way to set the alarm.

NOTE:

- This function will not turn off the vehicle's standard alarm.
- The optional sensors are automatically reconnected to the alarm system the next time the car is unlocked and then locked again.

LED alarm status signals

The status of the alarm system is indicated by the red LED at the top of the dash:

- LED off - the alarm is not armed
- LED flashes once per second - the alarm is armed
- LED flashes rapidly before the ignition is switched on - the alarm has been triggered
- **Fault in the alarm system:** If a fault has been detected in the alarm system, a message will be displayed in the text window. Contact a Volvo retailer.

Automatic re-lock/re-arm function

If the car is unlocked with the remote, the car will re-lock and the alarm will re-arm after 2 minutes unless a door or the trunk has been opened.

pg. 71 Child safety locks - rear doors

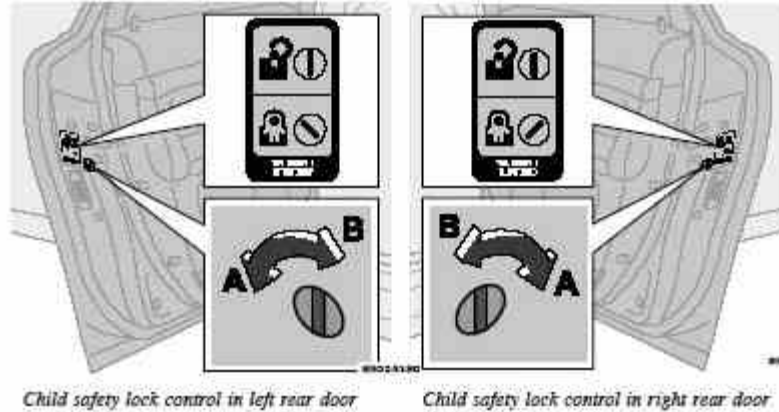

Child safety locks - rear doors

The controls are located on the rear door jambs. Use the ignition key or a screwdriver to adjust these controls.

A The door cannot be opened from the inside. Normal operation from the outside.

B The door lock functions normally.

WARNING!

Remember, in the event of an accident, the rear seat passengers cannot open the doors from the inside with the buttons in position A.

pg. 72 This page intentionally left blank.



[Contents](#) | [Top of Page](#)

2006
VOLVO
S80

Chapter 6 - Starting and driving

pg. 73 Starting and driving

<u>Fuel requirements</u>	<u>74</u>
<u>Refueling</u>	<u>76</u>
<u>Starting the engine</u>	<u>77</u>
<u>Automatic transmission - five speed</u>	<u>78</u>
<u>Automatic transmission (Geartronic)</u>	<u>80</u>
<u>Four-C active chassis system</u>	<u>82</u>
<u>Front/rear park assist</u>	<u>83</u>
<u>Driving economy</u>	<u>84</u>
<u>Points to remember</u>	<u>85</u>
<u>Roof racks/load carriers</u>	<u>86</u>
<u>Emergency towing</u>	<u>87</u>
<u>Vehicle towing information</u>	<u>88</u>
<u>Towing a trailer</u>	<u>89</u>
<u>Detachable trailer hitch</u>	<u>90</u>
<u>Jump starting</u>	<u>91</u>
<u>Winter driving</u>	<u>92</u>
<u>Long distance trips</u>	<u>93</u>
<u>Three-way catalytic converter</u>	<u>94</u>
<u>All Wheel Drive (AWD)</u>	<u>95</u>
<u>Brake system</u>	<u>96</u>
<u>Anti-lock Brake System (ABS)</u>	<u>97</u>
<u>STC/DSTC</u>	<u>98</u>

Fuel requirements

Octane rating

Volvo engines are designed for optimum performance on unleaded premium gasoline with an octane rating AKI of 91, or above. AKI (ANTI KNOCK INDEX) is an average of the Research Octane Number, RON, and the Motor Octane Number, MON. (RON + MON/2).

The minimum octane requirement is AKI 87 (RON 91).

Deposit control gasoline (detergent additives)

Volvo recommends the use of gasoline containing deposit control additives. These additives have shown to be effective in keeping injectors and intake valves clean. Consistent use of deposit control gasolines will help ensure good driveability and fuel economy. If you are not sure whether the gasoline contains deposit control additives, check with the service station operator.

Unleaded fuel

Each Volvo has a three-way catalytic converter and must use only unleaded gasoline. U.S. and Canadian regulations require that pumps delivering unleaded gasoline be labelled "UNLEADED". Only these pumps have nozzles which fit your car's filler inlet. It is unlawful to dispense leaded fuel into a vehicle labelled "unleaded gasoline only". Leaded gasoline damages the three-way catalytic converter and the heated oxygen sensor system. Repeated use of leaded gasoline will lessen the effectiveness of the emission control system and could result in loss of emission warranty coverage. State and local vehicle inspection programs will make detection of misfueling easier, possibly resulting in emission test failure for misfueled vehicles.

NOTE: Some U.S. and Canadian gasolines contain an octane enhancing additive called methyl-cyclopentadienyl manganese tricarbonyl (MMT). If such fuels are used, your Emission Control System performance may be affected, and the Check Engine light (malfunction indicator lamp) located on your instrument panel may light. If this occurs, please return your vehicle to an authorized Volvo retailer for service.

Gasoline containing alcohol and ethers

"Oxygenated fuels"

Some fuel suppliers sell gasoline containing "oxygenates" which are usually alcohols or ethers. In some areas, state or local laws require that the service pump be marked indicating use of alcohols or ethers. However, there are areas in which the pumps are unmarked. If you are not sure whether there is alcohol or ethers in the gasoline you buy, check with the service station operator. To meet seasonal air quality standards, some areas require the use of "oxygenated" fuel.

Volvo allows the use of the following "oxygenated" fuels; however, the octane ratings listed on this page must still be met.

Alcohol - Ethanol: Fuels containing up to 10% ethanol by volume may be used. Ethanol may also be referred to as Ethyl alcohol, or "Gasohol".

Ethers - MTBE: Fuels containing up to 15% MTBE may be used.

CAUTION!

Do not use gasolines containing methanol (methyl alcohol, wood alcohol). This practice can result in vehicle performance deterioration and can damage critical parts in the fuel system. Such damage may not be covered under the New Vehicle Limited Warranty.

Carbon Monoxide - Important Warning

Carbon monoxide is a poisonous, colorless, and odorless gas. It is present in all exhaust gases. If you ever smell exhaust fumes inside the vehicle, make sure the passenger compartment is ventilated, and immediately return the vehicle to your retailer for correction.

Fuel Formulations

Do not use gasoline that contains lead as a knock inhibitor, and do not use lead additives. Besides damaging the exhaust emission control systems on your car, lead has been strongly linked to certain forms of cancer. Many fuels contain benzene as a solvent. Unburned benzene has been strongly linked to certain forms of cancer. If you live in an area where you must fill your own gas tank, take precautions. These may include:

- standing upwind away from the filler nozzle while refueling
- refueling only at gas stations with vapor recovery systems that fully seal the mouth of the filler neck during refueling
- wear neoprene gloves while handling a fuel filler nozzle.

Use of Additives

With the exception of gas line antifreeze during winter months, do not add solvents, thickeners, or other store-bought additives to your car's fuel, cooling, or lubricating systems. Overuse may damage your engine, and some of these additives contain organically volatile chemicals. Do not needlessly expose yourself to these chemicals.

pg. 76 Refueling



Refueling

The fuel tank holds approximately 18 US gal. (68 liters) with sufficient volume left over to accommodate possible expansion of the fuel in hot weather. Be aware that the "usable" tank capacity will be somewhat less than the specified maximum. When the fuel level is low, such factors as ambient temperature, the fuel's "Reid vapor pressure" characteristics, and terrain can affect the fuel pump's ability to supply the engine with an adequate supply of fuel. Therefore, it is advisable to refuel as soon as possible when the needle nears the red zone, or when the fuel warning light comes on.

Fuel filler door

Press the button on the light switch panel (see illustration on [page 34](#)) when the car is at a standstill to unlock the fuel filler door. Please note that the fuel filler door will remain unlocked until the car begins to move forward. An audible click will be heard when the fuel filler door relocks.

If you intend to leave your car while it is being refueled, this feature enables you to lock the doors/trunk while leaving the fuel filler door unlocked.

You can also keep the car locked if you remain inside it during refueling. The central locking button does not lock the fuel filler door. Be sure the fuel filler door is not obstructed and is completely closed after refueling.

Open the fuel filler cap slowly during hot weather conditions.

NOTE: During a transitional period, a small number of service stations may still have fuel nozzles that are not compatible with the fuel filler neck on cars equipped with the evaporative control system. Please refer to [page 137](#) for

additional information.

WARNING!

Never carry a cell phone that is **switched on** while refueling your vehicle. If the phone rings, this may cause a spark that could ignite gasoline fumes, resulting in fire and injury.

CAUTION:

- Do not refuel with the engine running *. Turn the ignition off or to position I. If the ignition is on, an incorrect reading could occur in the fuel gauge.
- After refueling, close the fuel filler cap by turning it clockwise until it *clicks* into place *.
- Allow for fuel expansion by not overfilling the tank. Overfilling could also cause damage to the emission control systems.
- Avoid spilling gasoline during refueling. In addition to causing damage to the environment, gasolines containing alcohol can cause damage to painted surfaces, which may not be covered under the New Vehicle Limited Warranty.
- Do not use gasolines containing methanol (methyl alcohol, wood alcohol). This practice can result in vehicle performance deterioration and can damage critical parts in the fuel system. Such damage may not be covered under the New Vehicle Limited Warranty.

** If the fuel filler cap is not closed tightly or if the engine is running when the car is refueled, the Check Engine Light (malfunction indicator lamp) may indicate a fault.*

However, your vehicle's performance will not be affected. Use only Volvo original or approved fuel filler caps.

pg. 77 Starting the engine

Starting the engine

1. Fasten the seat belt.

WARNING!

Before starting, check that the seat, steering wheel and mirrors are adjusted properly. Make sure the brake pedal can be depressed completely. Adjust the seat if necessary. See [page 54](#).

2. Apply the parking brake, if not already set. The gear selector is locked in the (P)ark position (**SHIFTLOCK**).

3. **Without touching the accelerator pedal**, turn the ignition key* to the starting position. Allow the starter to operate for up to 5 seconds (turbo: 10 seconds). Release the key as soon as the engine starts. If the engine fails to start, repeat this step.

NOTE: On certain models, when the car is started, idle speed may be noticeably higher than normal for a short period, depending on the temperature of the engine.

This has been done to help bring components in the emission control system to their normal operating temperature as quickly as possible, which enables them to function normally.

For cold starts at altitudes above 6000 ft (1800 meters), depress the accelerator pedal halfway and turn the key to the starting position. Release the pedal slowly when the engine starts.

4. To release the gear selector from the (P)ark position, the engine must be running (or the ignition key must be in position II) and the brake pedal must be depressed. While keeping firm pressure on the brake pedal, release the parking brake.

5. Select the desired gear. The gear engages after a very slight delay which is especially noticeable when selecting R.

NOTE:

- Your car is equipped with a **KEYLOCK** system. When the engine is switched off, the gear selector must be in the **(P)**ark position before the key can be removed from the ignition switch.
 - When starting in cold weather, the transmission may shift up at slightly higher engine speeds than normal until the automatic transmission fluid reaches normal operating temperature.
-

CAUTION:

- The engine should be idling when you move the gear selector. Never accelerate until after you feel the transmission engage! Accelerating immediately after selecting a gear will cause harsh engagement and premature transmission wear.
- Selecting P or N when idling at a standstill for prolonged periods of time will help prevent overheating of the automatic transmission fluid.
- Do not race a cold engine immediately after starting. Oil flow may not reach some lubrication points fast enough to prevent engine damage.

WARNING!

- Always place the gear selector in Park and apply the parking brake before leaving the vehicle. Never leave the car unattended with the engine running.
- Always open the garage doors fully before starting the engine inside a garage to ensure adequate ventilation. The exhaust gases contain carbon monoxide, which is invisible and odorless but very poisonous.

* Your car is equipped with an electronic start inhibitor (immobilizer). The keys you received with your car are specially coded. The code in the key is transmitted to an antenna in the ignition switch where it is compared to the code stored in the start inhibitor module. The car can only be started if a properly coded key is used. If two of the keys to your car are close together, e.g., on the same key ring, when you try to start the car, this could cause interference in the immobilizer system and result in the car not starting. If this should occur, remove one of the keys from the key ring before trying to start the car again.

pg. 78 Automatic transmission - five speed

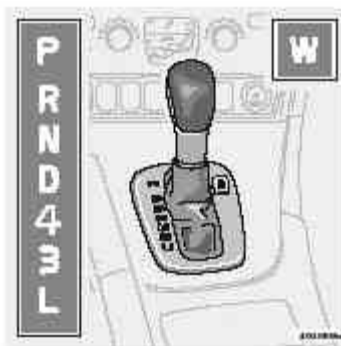

P (Park)

Use this position when starting the engine or parking the car.

Never use P while the car is in motion.

The parking brake should also be set whenever the car is parked.

The gear selector is mechanically locked in the P position (SHIFTLOCK). To release the gear selector from this position, the engine must be running (or the ignition key must be in position II) and the brake pedal must be depressed.

WARNING!

Never leave the car unattended when the engine is running. If, by mistake, the gear selector is moved from P, the car may start moving.

R (Reverse)

Never engage R while the car is moving.

N (Neutral)

Neutral - no gear engaged. Use the parking brake.

D (Drive)

D is the normal driving position and should be used as often as possible to help improve fuel economy. The car should not be moving when shifting from R to the D position.

4 (Intermediate gear)

The transmission will shift automatically between gears 4, 3, 2 or 1 from this position. **The transmission cannot shift up to (D)rive from fourth gear.**

3 (Intermediate gear)

The transmission will shift automatically between gears 3, 2 and 1 from this position. **The transmission cannot shift up to fourth gear or (D)rive from third gear.**

L (Low gears)

The transmission is locked in gears 1 and 2 when the selector is in this position.

NOTE:

- Gears 4, 3, or L can be used if you are driving in a mountainous area, towing a trailer or to increase engine braking effect.
- The transmission has a built-in limiter designed to help prevent excessive engine speeds (high rpm) when gears 4, 3, or L are selected.

pg. 79 Automatic transmission - five speed

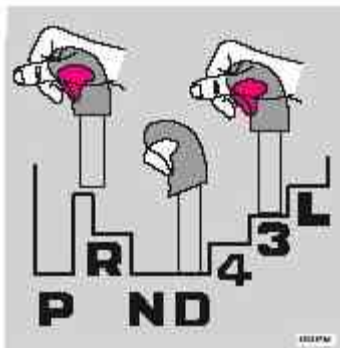
**Automatic transmission - shift gate positions**

The gear selector can be moved freely between N and D.

Depressing the button on the front of the gear selector knob enables you to move the gear selector to positions P, R, N, D, 4, 3 and L.

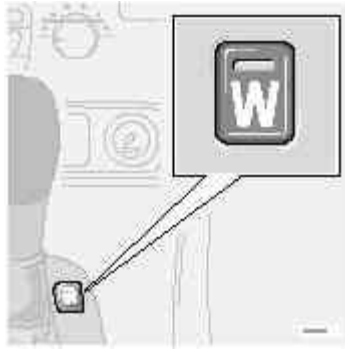

W Winter/Wet driving mode - enhanced vehicle traction

- Mode W will only function if the gear selector is in the (D)rive position.
- Press the button at the base of the gear selector to engage/disengage this driving mode (see illustration).
- An LED in the button will light up to indicate that **W** is engaged and this will also be displayed in the instrument panel (see [page 27](#)).
- This mode may be selected for starting/moving off on slippery roads.

Kickdown

Automatic shift to a lower gear (kickdown) is achieved by depressing the accelerator pedal fully and briskly. An upshift will occur when approaching the top speed for a particular gear or by releasing the accelerator pedal slightly. Kickdown can be used for maximum acceleration or when passing at highway speeds.

Cold starts

When driving before the engine has reached its normal operating temperature, the transmission will shift up at slightly higher engine speeds to heat the three-way catalytic converter as quickly as possible.

pg. 80 Automatic transmission (Geartronic)



P (Park)

Use this position when starting the engine or parking the car.

Never use P while the car is in motion.

The parking brake should also be set whenever the car is parked.

The gear selector is mechanically locked in the P position (SHIFTLOCK). To release the gear selector from this position, the engine must be running (or the ignition key must be in position II) and the brake pedal must be depressed.

WARNING!

Never leave the car unattended when the engine is running. If, by mistake, the gear selector is moved from P, the car may start moving.

R (Reverse)

Never engage R while the car is moving forward.

N (Neutral)

Neutral - no gear engaged. Use the parking brake.

D (Drive)

D is the normal driving position and should be used as often as possible to help improve fuel economy. The car should not be moving when shifting from R to the D position.

Kickdown

Automatic shift to a lower gear (kickdown) is achieved by depressing the accelerator pedal fully and briskly. An upshift will occur when approaching the top speed for a particular gear or by releasing the accelerator pedal slightly. Kickdown can be used for maximum acceleration or when passing at highway speeds. **Kickdown does not function when the transmission is in the manual shift (geartronic) mode (see next page).**

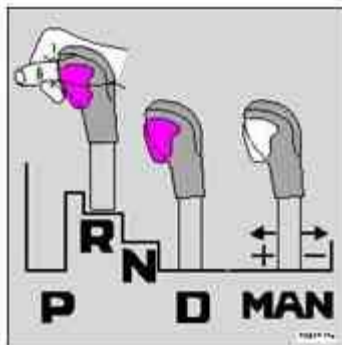

Shift gate positions

Automatic transmission - shift gate positions

You can move the gear selector freely between the (MAN)ual and (D)rive positions while driving. Depress the button on the front side of the gear selector knob to move between the R, N, D and P positions. **Please see the following page for information on using the Geartronic manual shift mode.**

pg. 81 Automatic transmission (Geartronic)

Manual shifting - Geartronic

You can move the gear selector freely between the (MAN)ual and (D)rive positions while driving. Gears 2, 3, 4 and 5 have a "lock-up" function which reduces engine speed and helps save fuel.

The currently selected gear will be displayed in the instrument panel (see [page 27](#)).

- To access the (MAN)ual shifting position from (D)rive, pull the gear selector back slightly from D and move it to the left to MAN.
- To return to the (D)rive position from MAN, move the gear selector to the right and push it forward to the (D)rive position.

While driving

If you select the (MAN)ual position while driving, the gear that was being used in the (D)rive position will also initially be selected in (MAN)ual position.

- Move the gear selector forward (toward "+") to shift to a higher gear or rearward (toward "-") to shift to a lower gear.
- If you hold the gear selector toward "-", the transmission will downshift one gear, and will utilize the braking power of the engine. If the current speed is too high for using a lower gear, the downshift will not occur until the speed has decreased enough to allow the lower gear to be used.

- If you slow down to a very low speed, the transmission will automatically shift down.
- When starting in the (MAN)ual position, 3rd gear is the highest gear that may be selected.

NOTE: Kickdown (see previous page) **does not function** when the transmission is in the manual shift (geartronic) mode. The gear selector must be in D (Drive) position.

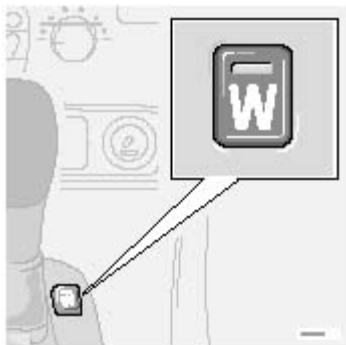

W Winter/Wet driving mode - enhanced vehicle traction

- Mode W will only function if the gear selector is in the (D)rive position.
- Press the button at the base of the gear selector to engage/disengage this driving mode. The position of this button may vary slightly on certain models.
- An LED in the button will light up to indicate that **W** is engaged and this will also be displayed in the instrument panel (see [page 27](#)).
- This mode may be selected for starting/moving off on slippery roads.

pg. 82 Four-C active chassis system

Four-C (option)

Your car can be optionally equipped with the Four-C (Continuously Controlled Chassis Concept) system.

This system is based on a number of sensors that continuously monitor factors such as the car's lateral and vertical movements, speed, and movements of the wheels. The sensors receive data up to 500 times per second, which is used to provide extremely fast and precise adjustment of each shock absorber. The system adjusts the stiffness of the shock absorbers approximately 100 times per second.

The button in the center console (see the illustration on [page 31](#)) can be used **at any time** to switch between the two driving modes: Comfort or Sport.

The system then adjusts the stiffness of the shock absorbers accordingly, for example when the type of road changes, or if the driver wishes to change driving style. This adjustment takes place instantaneously.

Comfort

The Comfort mode chassis setting offers the greatest amount of shock absorption and the softest ride. This mode is recommended for long-distance driving, or when driving in slippery conditions.

If Comfort mode was selected when the engine was switched off, this mode will be active when the engine is restarted.

Sport

An indicator lamp in the button will come on when this mode has been activated.

In Sport mode, shock absorption is stiffer to reduce the car's body sway during cornering and to provide more immediate steering response.

If this setting was selected when the engine was switched off, Sport mode will be active when the engine is restarted.

pg. 83 Front/rear park assist (option/accessory)

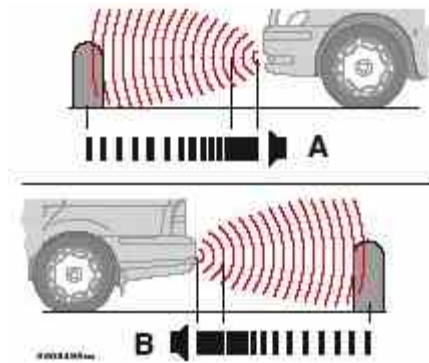

A - front (accessory as available), B - rear (option)

Front/rear park assist

The park assist system(s) are designed to assist you when driving into parking spaces, garages, etc. They utilize ultrasound sensors located in the bumpers to measure the distance to a vehicle or other object, or a person who may be close to the front or rear of the vehicle.

When is park assist active?

Front: the system is active from the time the engine is started until the car exceeds a speed of approximately 10 mph (15 km/h).

Rear: when the engine is running and reverse gear is selected.

NOTE:

- If the vehicle is equipped with front and rear park assist, both systems will either be activated or deactivated together. They cannot be used separately.
- The indicator light in the button (see the illustration on [page 31](#)) will light up to indicate that park assist system(s) are activated.

When park assist is actively working:

1. The audio system's volume will be reduced.
2. An intermittent signal will be audible from the speakers to indicate that you are approaching a person, object, parked vehicle, etc.

The signals begin when the distance between the bumper and the object is:

Rear: approximately 5 feet (1.5 meters)

Front: approximately 2.5 ft (0.8 meters)

3. At a distance of approximately 1 foot (30 cm), the signal will become constant.

Deactivating the system(s)

- Press the Park assist button on the center console (see [page 31](#)) to temporarily deactivate the system(s).
- The indicator light in the button will go out when the system(s) have been deactivated.
- If the vehicle is equipped with front and rear park assist, both systems will be deactivated by pressing the button.

NOTE:

It may be necessary to deactivate one or both of the park assist systems in certain cases.

- **Rear park assist:** towing a trailer, carrying bicycles in a rear-mounted carrier, etc, could trigger the rear park assist system's sensors.
- **Front park assist:** it may not be possible to combine auxiliary headlights and front park assist since these lights could trigger the system's sensors.

Faults in the system

If a fault should occur in the system, the LED in the button will be switched off and a message will be displayed in the text window.

Cleaning the sensors

For the system to function properly, the sensors in the front and/or rear bumpers should be kept clean. They can be cleaned with car washing detergent and a sponge.

WARNING!

These systems are designed to be a supplementary aid when parking the vehicle. They are not, however, intended to replace the driver's attention and judgement.

pg. 84 Driving economy

Economical driving conserves natural resources

Better driving economy may be obtained by thinking ahead, avoiding rapid starts and stops and adjusting the speed of your vehicle to immediate traffic conditions. Observe the following rules:

- Bring the engine to normal operating temperature as soon as possible by driving with a light foot on the accelerator pedal for the first few minutes of operation. A cold engine uses more fuel and is subject to increased wear.
- Whenever possible, avoid using the car for driving short distances. This does not allow the engine to reach normal operating temperature.
- Drive carefully and avoid rapid acceleration and hard braking.
- Do not exceed posted speed limits.
- Avoid carrying unnecessary items (extra load) in the car.
- Maintain correct tire pressure. Check tire pressure regularly (when tires are cold).
- Remove snow tires when threat of snow or ice has ended.
- Note that roof racks, ski racks, etc., increase air resistance and also fuel consumption.
- Avoid using automatic transmission kickdown feature unless necessary.
- Avoid using the air conditioning when it is not required. When engaged, the A/C compressor places an additional load on the engine. However, at higher driving speeds, fuel consumption will be lower with the air conditioning on and the windows closed than with the air conditioning off and the windows open.
- Using the onboard trip computer's fuel consumption modes can help you learn how to drive more economically.

Other factors that decrease gas mileage are:

- Dirty air cleaner
- Dirty engine oil and clogged oil filter
- Dragging brakes
- Incorrect front end alignment

Some of the above mentioned items and others are checked at the standard Maintenance Service intervals.

NOTE: Vehicles equipped with automatic transmissions should use (D)rive as often as possible and avoid using "kickdown" to help improve fuel economy.

Cooling system

The risk for engine overheating is greatest, especially in hot weather, when:

- Towing a trailer up steep inclines for prolonged periods at wide open throttle and low engine rpm.
- Stopping the engine suddenly after high speed driving (so-called "after-boiling" can occur).
- To avoid overheating, the following rules should be followed:

Do not drive for prolonged periods at engine speeds above 4500 rpm if you are towing a trailer in hilly terrain.

Reduce speed when towing a trailer up long, steep inclines. The risk of overheating can be reduced by switching off the air conditioning system for a short time.

- Do not let the engine idle unnecessarily for prolonged periods.
- Do not mount auxiliary lamps in front of the grill.

When the risk of overheating is imminent, or in the event of overheating (the temperature gauge goes repeatedly into, or stays continually in, the red section), the following precautions should be taken:

- Switch off the air conditioning system.
- Pull off the road, away from traffic, stop the car and put the gear selector into Park. **Do not stop the engine!**
- Switch the heater to full (maximum) position. Increase the engine speed to approx. 2000 rpm (twice idling speed) until the temperature begins to drop.
- If the warning light in the center of the instrument panel is red, and the message "Coolant level low stop engine" is displayed, switch off the engine as soon as possible.

WARNING!

Do not remove coolant expansion tank cap. The coolant will be extremely hot.

If necessary, see [page 138](#) for information on checking and topping-up the coolant level.



[Contents](#) | [Top of Page](#)

2006
VOLVO
S80

Chapter 7 - Wheels and tires

pg. 101 Wheels and tires

<u>General information</u>	<u>102</u>
<u>Tire inflation</u>	<u>104</u>
<u>Tire inflation pressure tables</u>	<u>106</u>
<u>Tire Pressure Monitoring System (TPMS)</u>	<u>107</u>
<u>Self supporting run flat tires</u>	<u>109</u>
<u>Tire designations</u>	<u>110</u>
<u>Glossary of tire terminology</u>	<u>111</u>
<u>Vehicle loading</u>	<u>112</u>
<u>Uniform Tire Quality Grading</u>	<u>113</u>
<u>Snow chains, snow tires, studded tires</u>	<u>114</u>
<u>Temporary spare</u>	<u>115</u>
<u>Changing a wheel</u>	<u>116</u>

pg. 102 Wheels and tires

General information

Your vehicle is equipped with tires according to the vehicle's tire information placard on the B-pillar (the structural member at the side of the vehicle, at the rear of the driver's door opening), or on the inside of the fuel filler door on Canadian models.

The tires have good road holding characteristics and offer good handling on dry and wet surfaces. It should be noted however that the tires have been developed to give these features on snow/ice-free surfaces.

Certain models are equipped with "all-season" tires, which provide a somewhat higher degree of road holding on slippery surfaces than tires without the "all-season" rating. However, for optimum road holding on icy or snow-covered roads, we recommend suitable winter tires on all four wheels.

When replacing tires, be sure that the new tires are the same size designation, type (radial) and preferably from the same manufacturer, on all four wheels. Otherwise there is a risk of altering the car's roadholding and handling

characteristics.



Tread wear indicator

Tread wear indicator

The tires have wear indicator strips running across or parallel to the tread. The letters TWI are printed on the side of the tire. When approximately 1/16" (1.6 mm) is left on the tread, these strips become visible and indicate that the tire should be replaced. Tires with less than 1/16" (1.6 mm) tread offer very poor traction.

When replacing worn tires, it is recommended that the tire be identical in type (radial) and size as the one being replaced. Using a tire of the same make (manufacturer) will prevent alteration of the driving characteristics of the vehicle.

New tires

Remember that tires are perishable goods. As of 2000, the manufacturing week and year will be indicated with 4 digits (e.g. 1502 means that the tire illustrated was manufactured during week 15 of 2002).

Storing wheels and tires

When storing complete wheels (tires mounted on rims), they should be suspended off the floor or placed on their sides on the floor. Tires not mounted on rims should be stored on their sides or standing upright, but should not be suspended.

CAUTION!

Tires should preferably be stored in a cool, dry, dark place, and should never be stored in close proximity to solvents, gasoline, oils, etc.

WARNING!

- The wheel and tire sizes for your Volvo are specified to meet stringent stability and handling requirements. Unapproved wheel/tire size combinations can negatively affect your vehicle's stability and handling. Approved tire sizes are shown in the Tire inflation pressure tables on [page 106](#).
- Any damage caused by installation of unapproved wheel/tire size combinations will not be covered by your new vehicle warranty. Volvo assumes no responsibility for death, injury, or expenses that may result from such installations.

pg. 103 Wheels and tires



Tire age

Tires degrade over time, even when they are not being used, which can affect their reliability and roadholding

characteristics. Therefore, all tires older than 6 years (including the spare tire and winter tires) should be inspected by a qualified technician, regardless of appearance or mileage. Heat caused by hot climates or frequent high loading conditions can accelerate the aging process.

A tire's age can be determined by the DOT stamp on the sidewall (see the illustration above).

A tire with e.g., visible cracks or discoloration should be replaced immediately.

Improving tire economy:

- Maintain correct tire pressure. See the tire pressure table on [page 106](#).
- Drive smoothly: avoid fast starts, hard braking and tire screeching.
- Tire wear increases with speed.
- Correct front wheel alignment is very important.
- Unbalanced wheels impair tire economy and driving comfort.
- Tires must maintain the same direction of rotation throughout their lifetime.
- When replacing tires, the tires with the most tread should be mounted on the rear wheels to reduce the chance of oversteer during hard braking.

Hitting curbs or potholes can damage the tires and/or wheels permanently.

pg. 104 Wheels and tires

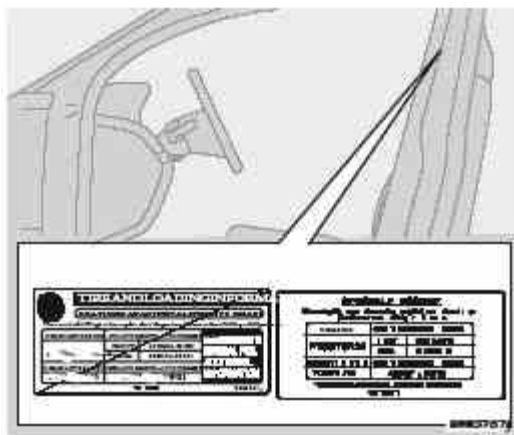

Tire inflation placards on U.S. models

Tire inflation

Check tire inflation pressure regularly.

A table listing the recommended inflation pressure for your vehicle can be found on [page 106](#). Tire inflation pressure placards are also located on the driver's side B-pillar (the structural member at the side of the vehicle, at the rear of the driver's door opening), or on the inside of the fuel filler door on Canadian models. These placards indicate the designation of the factory-mounted tires on your vehicle, as well as load limits and inflation pressure.

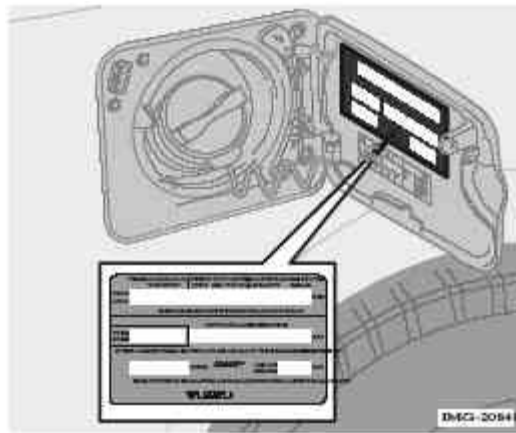

Tire inflation placard on Canadian models

NOTE: The placards shown indicate inflation pressure for the tires installed on the car at the factory only.

- Use a tire gauge to check the tire inflation pressure, including the spare, at least once a month and before long trips. You are strongly urged to buy a reliable tire pressure gauge, as automatic service station gauges may be inaccurate.
- Use the recommended cold inflation pressure for optimum tire performance and wear.
- Under-inflation or over-inflation may cause uneven treadwear patterns.

WARNING!

- Under-inflation is the most common cause of tire failure and may result in severe tire cracking, tread separation, or "blowout," with unexpected loss of vehicle control and increased risk of injury.
- Under-inflated tires reduce the load carrying capacity of your vehicle.

When weather temperature changes occur, tire inflation pressures also change. A 10-degree temperature drop causes a corresponding drop of 1 psi (7 kPa) in inflation pressure. Check your tire pressures frequently and adjust them to the proper pressure, which can be found on the vehicle's tire information placard or certification label.

Checking tire pressure

Cold tires

Inflation pressure should be checked when the tires are cold.

The tires are considered to be cold when they have the same temperature as the surrounding (ambient) air.

This temperature is normally reached after the car has been parked for at least 3 hours.

pg. 105 Wheels and tires

After driving a distance of approximately 1 mile (1.6 km), the tires are considered to be hot. If you have to drive farther than this distance to pump your tire(s), check and record the tire pressure first and add the appropriate air pressure when you get to the pump.

If checking tire pressure when the tire is hot, never "bleed" or reduce air pressure. The tires are hot from driving and it is normal for pressures to increase above recommended cold pressures. A hot tire at or below recommended cold inflation pressure could be significantly under-inflated.

To check inflation pressure:

1. Remove the cap from the valve on one tire, then firmly press the tire gauge onto the valve.
2. Add air to reach the recommended air pressure
3. Replace the valve cap.
4. Repeat this procedure for each tire, including the spare.
5. Visually inspect the tires to make sure there are no nails or other objects embedded that could puncture the tire and cause an air leak.
6. Check the sidewalls to make sure there are no gouges, cuts, bulges or other irregularities.

NOTE:

- If you overfill the tire, release air by pushing on the metal stem in the center of the valve. Then recheck the pressure with your tire gauge.
- Some spare tires require higher inflation pressure than the other tires. Consult the tire inflation table on [page 106](#) or see the inflation pressure placard.

pg. 106 Wheels and tires

Tire inflation pressure tables

Tire pressures recommended by Volvo for your vehicle. Refer to the tire inflation placard for information specific to the tires installed on your vehicle at the factory.

Cold tire pressure for vehicle loads up to 890 lbs (400 kg) ¹		
Tire size	Front, psi (kPa)	Rear, psi (kPa)
S80		
205/65R15	39 (270)	39 (270)
215/55R16	39 (270)	39 (270)
225/50R17	39 (270)	39 (270)
235/45R17 SSRFT ²	39 (270)	39 (270)
235/40R18	39 (270)	39 (270)
Temporary spare tire T125/80R17	61 (420)	61 (420)

¹ These weights include the weight of all occupants of the car plus cargo.

² Self supporting run flat tires. See [page 109](#) for more information.

Optional tire pressure. These inflation pressures may only be used when the vehicle is not fully loaded.

Optional cold tire pressure that may only be used for vehicle loads up to 495 lbs (225 kg). psi (kPa)		
Tire size	Front, psi (kPa)	Rear, psi (kPa)
S80		
205/65R15	32 (220)	30 (210)

215/55R16	32 (220)	30 (210)
225/50R17	32 (220)	30 (210)
235/45R17 RFT (SST)	-	-
235/40R18	35 (240)	35 (240)
Temporary spare tire T125/80R17	61 (420)	61 (420)

pg. 107 Wheels and tires

Tire Pressure Monitoring System (TPMS) - option on certain U.S. models only

The tire pressure monitoring system uses sensors mounted in the tire valves to check inflation pressure levels. When the vehicle is moving at a speed of 20 mph (30 km/h) or faster, these sensors transmit inflation pressure data to a receiver located in the vehicle.

USA - FCC ID: MRXTG315AM04

This device complies with part 15 of the FCC rules. Operation is subject to the following conditions: (1) This device may not cause harmful interference, and (2) this device must accept any interference received, including interference that may cause undesired operation.

WARNING!

The TPMS system uses a radio frequency of 315 MHz. Accessory electrical equipment using the same frequency could interfere with TPMS and should not be installed in the vehicle. Please consult your Volvo retailer, a qualified Volvo service technician, or the accessory equipment's supplier for further information

When low inflation pressure is detected, TPMS will light up the tire pressure warning light () (also referred to as a telltale) in the instrument panel, and will display a message in the text window. The wording of this message is determined by the degree of inflation pressure loss.

NOTE: If a fault occurs in TPMS, the tire pressure warning light will flash for approximately 1 minute and TIRE PRESS SYST SERVICE REQUIRED will be displayed.

Each tire, including the spare (if provided), should be checked monthly when cold and inflated to the inflation pressure recommended by the vehicle manufacturer on the vehicle placard or tire inflation pressure label. (If your vehicle has tires of a different size than the size indicated on the vehicle placard or tire inflation pressure label, you should consult the appropriate section of this owner's manual to determine the proper tire inflation pressure.) When the low tire pressure telltale is illuminated, one or more of your tires is significantly underinflated. You should stop and check your tires as soon as possible, and inflate them to the proper pressure. Driving on a significantly underinflated tire causes the tire to overheat and can lead to tire failure. Under-inflation also reduces fuel efficiency and tire tread life, and may affect the vehicle's handling and stopping ability. Your vehicle has also been equipped with a TPMS malfunction telltale to indicate when the system is not operating properly. When the malfunction telltale is illuminated, the system may not be able to detect or signal low tire pressure as intended. TPMS malfunctions may occur for a variety of reasons, including the installation of incompatible replacement tires on the vehicle. Always check the TPMS malfunction telltale after replacing one or more tires on your vehicle to ensure that the replacement tires are compatible with the TPMS.

NOTE: TPMS indicates low tire pressure but does not replace normal tire maintenance. For information on correct tire pressure, please refer to the table on [page 106](#), or consult your Volvo retailer.

Erasing warning messages

When a low tire pressure warning message has been displayed, and the tire pressure warning light has come on:

1. Use a tire pressure gauge to check the inflation pressure of all four tires.
2. Re-inflate the tire(s) to the correct pressure (consult the tire pressure placard or the table on [page 106](#)).
3. Drive the car for several minutes at a speed of 20 mph (30 km/h) or faster.

This will erase the warning text and the warning light will go out.

WARNING!

Incorrect inflation pressure could lead to tire failure, resulting in a loss of control of the vehicle.

(Contd. on following page)

pg. 108 Wheels and tires

Changing tires

- Only the factory-mounted wheels are equipped with TPMS sensors in the valves.
- If the vehicle is equipped with a temporary spare tire, this tire does not have a TPMS sensor.
- If winter wheels without TPMS sensors are mounted on the vehicle, TIRE PRESS SYST SERVICE REQUIRED will be displayed each time the vehicle is driven above 25 mph (40 km/h) for 10 minutes or more.
- Once TPMS sensors are properly installed, the warning message should not reappear.
- Volvo recommends that TPMS sensors be fitted on all wheels used on the vehicle. Volvo does not recommend moving sensors back and forth between sets of wheels.

CAUTION!

When inflating tires with TPMS valves, press the pump's mouthpiece straight onto the valve to help avoid bending or otherwise damaging the valve.

pg. 109 Wheels and tires

Self supporting run flat tires (option)

Certain models equipped with the Tire Pressure Monitoring System (TPMS) can also be equipped with self supporting run flat tires.

Tires of this type have specially reinforced sidewalls that make it possible to continue driving in the event of a drop in inflation pressure. Tires of this type are mounted on special rims.

NOTE: Self supporting run flat tires are only available in conjunction with TPMS.

If a self supporting run flat tire should lose inflation pressure, the yellow TPMS warning symbol () in the instrument panel lights up to alert the driver, and a message will be shown in the text window in the instrument panel.

If this occurs, reduce vehicle speed to a maximum of 50 mph (80 km/h). The vehicle can be driven approximately 50 miles (80 km), or somewhat farther if the vehicle is not heavily loaded. The tire should be replaced as soon as possible.

Hard braking and sudden steering maneuvers should be avoided.

In certain cases, it may be difficult to see which self supporting run flat tire is defective. To determine which tire is damaged, check the inflation pressure of all four tires.

WARNING!

- Only specially trained persons should mount self supporting run flat tires.
- If self supporting run flat tires are mounted, the vehicle must be equipped with a Tire Pressure Monitoring System.
- After a low pressure warning has been displayed, do not exceed 50 mph (80 km/h).
- Avoid severe cornering and hard braking, and minimize the distance traveled before replacing the self supporting run flat tire.
- Self supporting run flat tires cannot be repaired. They must be replaced if damaged or punctured.

pg. 110 Wheels and tires

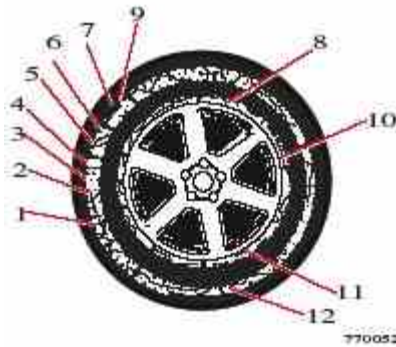

Tire designations

Federal law mandates that tire manufacturers place standardized information on the sidewall of all tires (see the illustration).

The following information is listed on the tire sidewall:

The tire designation (the following figures are examples of a tire designation):

1. 215: the width of the tire (in millimeters) from sidewall edge to sidewall edge. The larger the number, the wider the tire.
2. 65: The ratio of the tire's height to its width.
3. R: Radial tire.
4. 15: The diameter of the wheel rim (in inches).
5. 95: The tire's load index. In this example, a load index of 95 equals a maximum load of 1521 lbs (690 kg).
6. H: The tire's speed rating, or the maximum speed at which the tire is designed to be driven for extended periods of time, carrying a permissible load for the vehicle, and with correct inflation pressure. For example, H indicates a speed rating of 130 mph (210 km/h).

NOTE: This information may not appear on the tire because it is not required by law.

7. M+S or M/S = Mud and Snow, AT = All Terrain, AS = All Season

8. U.S. DOT Tire Identification Number (TIN): This begins with the letters "DOT" and indicates that the tire meets all federal standards. The next two numbers or letters are the plant code where it was manufactured, the next two are the tire size code and the last four numbers represent the week and year the tire was built. For example, the numbers 317 mean the 31st week of 1997. After 2000 the numbers go to four digits. For example, 2501 means the 25th week of 2001. The numbers in between are marketing codes used at the manufacturer's discretion. This information helps a tire manufacturer identify a tire for safety recall purposes.

9. Tire Ply Composition and Material Used: Indicates the number of plies indicates or the number of layers of rubber-coated fabric in the tire tread and sidewall. Tire manufacturers also must indicate the ply materials in the tire and the sidewall, which include steel, nylon, polyester, and others.

10. Maximum Load: Indicates the maximum load in pounds and kilograms that can be carried by the tire. Refer to the vehicle's tire information placard or the safety certification label, located on the B-Pillar or the driver's door or on the inside of the fuel filler door on Canadian models, for the correct tire pressure for your vehicle.

11. Treadwear, Traction, and Temperature grades: See [page 113](#) for more information.

12. Maximum permissible inflation pressure: the greatest amount of air pressure that should ever be put in the tire. This limit is set by the tire manufacturer.

pg. 111 Wheels and tires

Glossary of tire terminology

The tire suppliers may have additional markings, notes or warnings such as standard load, radial tubeless, etc.

Glossary of tire terminology

- **Tire information placard:** A placard showing the OE (Original Equipment) tire sizes, recommended inflation pressure, and the maximum weight the vehicle can carry.
- **Tire Identification Number (TIN):** A number on the sidewall of each tire providing information about the tire brand and manufacturing plant, tire size and date of manufacturer.
- **Inflation pressure:** A measure of the amount of air in a tire.
- **Standard load:** A class of P-metric or Metric tires designed to carry a maximum load at 35 psi [37 psi (2.5 bar) for Metric tires]. Increasing the inflation pressure beyond this pressure will not increase the tires load carrying capability.
- **Extra load:** A class of P-metric or Metric tires designed to carry a heavier maximum load at 41 psi [43 psi (2.9 bar) for Metric tires]. Increasing the inflation pressure beyond this pressure will not increase the tires load carrying capability.
- **kPa:** Kilopascal, a metric unit of air pressure.
- **PSI:** Pounds per square inch, a standard unit of air pressure.
- **B-pillar:** The structural member at the side of the vehicle behind the front door.
- **Bead area of the tire:** Area of the tire next to the rim.
- **Sidewall of the tire:** Area between the bead area and the tread.

- **Tread area of the tire:** Area of the perimeter of the tire that contacts the road when mounted on the vehicle.
- **Rim:** The metal support (wheel) for a tire or a tire and tube assembly upon which the tire beads are seated.
- **Maximum load rating:** a figure indicating the maximum load in pounds and kilograms that can be carried by the tire. This rating is established by the tire manufacturer.
- **Maximum permissible inflation pressure:** the greatest amount of air pressure that should ever be put in the tire. This limit is set by the tire manufacturer.
- **Recommended tire inflation pressure:** inflation pressure, established by Volvo, which is based on the type of tires that are mounted on a vehicle at the factory. This inflation pressure is affected by the number of occupants in the car, the amount of cargo, and the speed at which the vehicle will be driven for a prolonged period. This information can be found on the tire inflation placard(s) located on the driver's side B-pillar or on the inside of the fuel filler door on Canadian models, and in the tire inflation table in this chapter.
- **Cold tires:** The tires are considered to be cold when they have the same temperature as the surrounding (ambient) air. This temperature is normally reached after the car has been parked for at least 3 hours.

pg. 112 Wheels and tires

Vehicle loading

Properly loading your vehicle will provide maximum return of vehicle design performance.

Before loading your vehicle, familiarize yourself with the following terms for determining your vehicle's weight ratings, with or without a trailer, from the vehicle's Federal/Canadian Motor Vehicle Safety Standards (FMVSS/CMVSS) label, and the vehicle's tire information placard:

Curb weight

The weight of the vehicle including a full tank of fuel and all standard equipment. It does not include passengers, cargo, or optional equipment.

Capacity weight

All weight added to the curb weight, including cargo and optional equipment. When towing, trailer hitch tongue load is also part of cargo weight.

NOTE: For trailer towing information, please refer to the section "Towing a trailer" on [page 89](#).

Permissible axle weight

The maximum allowable weight that can be carried by a single axle (front or rear). These numbers are shown on the Federal/Canadian Motor Vehicle Safety Standards (FMVSS/CMVSS) label. The total load on each axle must never exceed its maximum permissible weight.

Gross vehicle weight (GVW)

The vehicle's curb weight + cargo + passengers.

NOTE:

- The location of the various labels in your vehicle can be found on [page 150](#).

- A table listing important weight limits for your vehicle can be found on [page 151](#).

Steps for Determining Correct Load Limit

- (1) Locate the statement "the combined weight of occupants and cargo should never exceed XXX pounds" on your vehicle's placard.
- (2) Determine the combined weight of the driver and passengers that will be riding in your vehicle.
- (3) Subtract the combined weight of the driver and passengers from XXX kilograms or XXX pounds.
- (4) The resulting figure equals the available amount of cargo and luggage load capacity. For example, if the "XXX" amount equals 1400 lbs. and there will be five 150 lb. passengers in your vehicle, the amount of available cargo and luggage load capacity is 650 lbs. (1400-750 (5 x 150) = 650 lbs.)
- (5) Determine the combined weight of luggage and cargo being loaded on the vehicle. That weight may not safely exceed the available cargo and luggage load capacity calculated in Step 4.
- (6) If your vehicle will be towing a trailer, load from your trailer will be transferred to your vehicle. Consult this manual¹ to determine how this reduces the available cargo and luggage load capacity of your vehicle.

WARNING!

- Exceeding the permissible axle weight, gross vehicle weight, or any other weight rating limits can cause tire overheating resulting in permanent deformation or catastrophic failure.
- Do not use replacement tires with lower load carrying capacities than the tires that were original equipment on the vehicle because this will lower the vehicle's GVW rating. Replacement tires with a higher limit than the originals do not increase the vehicle's GVW rating limitations.

¹ See "Towing a trailer" on [page 89](#).

pg. 113 Wheels and tires

Uniform tire quality grading

ALL PASSENGER VEHICLE TIRES MUST CONFORM TO FEDERAL SAFETY REQUIREMENTS IN ADDITION TO THESE GRADES

Quality grades can be found, where applicable, on the tire sidewall between the tread should and maximum section width. For example:

Treadwear 200 Traction AA Temperature A

TREADWEAR

The treadwear grade is a comparative rating based on the wear rate of the tire when tested under controlled conditions on a specified government test course. For example, a tire graded 150 would wear one and one half (1 1/2) times as well on the government course as a tire graded 100. The relative performance of tires depends upon the actual conditions of their use, however, and many depart significantly from the norm due to variation in driving habits, service practices and differences in road characteristics and climate.

TRACTION

The traction grades, from highest to lowest, are AA, A, B, and C, as measured under controlled conditions on specified

government test surfaces of asphalt and concrete. A tire marked C may have poor traction performance.

WARNING!

The traction grade assigned to this tire is based on braking (straight-ahead) traction tests and does not include cornering (turning) traction.

TEMPERATURE

The temperature grades are AA (the highest), A, B, and C, representing the tire's resistance to the generation of heat and its ability to dissipate heat when tested under controlled conditions on a specified indoor laboratory test wheel. Sustained high temperature can cause the material of the tire to degenerate and reduce tire life, and excessive temperature can lead to sudden tire failure. The grade C corresponds to a minimum level of performance that all passenger car tires must meet under the Federal Motor Safety Standard No. 109. Grades B and A represent higher levels of performance on the laboratory test wheel than the minimum required by law.

WARNING!

The temperature grade for this tire is established for a tire that is properly inflated and not overloaded. Excessive speed, under-inflation, or excessive loading, either separately or in combination, can cause heat buildup and possible tire failure.

pg. 114 Wheels and tires

Snow chains, snow tire, studded tires

Snow chains

Snow chains can be used on your Volvo with the following restrictions:

- Snow chains should be installed on front wheels only. Use only Volvo approved snow chains.
- If accessory, aftermarket or "custom" tires and wheels are installed and are of a size different than the original tires and wheels, chains in some cases CANNOT be used. Sufficient clearances between chains and brakes, suspension and body components must be maintained.
- Some strap-on type chains will interfere with brake components and therefore CANNOT be used.
- All Wheel Drive models: Snow chains should only be installed on the front wheels. Only chains adapted for AWD models should be used.

Consult your Volvo retailer for additional snow chain information.

CAUTION!

- Check local regulations regarding the use of snow chains before installing.
- Always follow the chain manufacturer's installation instructions carefully. Install chains as tightly as possible and retighten periodically.
- Never exceed the chain manufacturer's specified maximum speed limit. (Under no circumstances should you exceed 31 mph (50 km/h)).
- Avoid bumps, holes or sharp turns when driving with snow chains.
- The handling of the vehicle can be adversely affected when driving with chains. Avoid fast or sharp turns as well as

locked wheel braking.

Snow tires, studded tires¹

Tires for winter use:

- Owners who live in or regularly commute through areas with sustained periods of snow or icy driving conditions are strongly advised to fit suitable winter tires to help retain the highest degree of traction.
- It is important to install winter tires on all four wheels to help retain traction during cornering, braking, and accelerating. Failure to do so could reduce traction to an unsafe level or adversely affect handling.
- Do not mix tires of different design as this could also negatively affect overall tire road grip.
- Winter tires wear more quickly on dry roads in warm weather. They should be removed when the winter driving season has ended.
- Studded tires should be run-in 300-600 miles (500-1000 km) during which the car should be driven as smoothly as possible to give the studs the opportunity to seat properly in the tires. The tires should have the same rotational direction throughout their entire lifetime.

NOTE: Please consult state or provincial regulations restricting the use of studded winter tires before installing such tires.

¹ Where permitted

pg. 115 Wheels and tires

Temporary Spare

The spare tire in your car is called a "Temporary Spare".

Recommended tire pressure (see the placard on the B-pillar or on the fuel filler door) should be maintained irrespective of which position on the car the temporary spare tire is used on.

In the event of damage to this tire, a new one can be purchased from your Volvo retailer.

WARNING!

Current legislation prohibits the use of the "Temporary Spare" tire other than as a temporary replacement for a punctured tire. It must be replaced as soon as possible by a standard tire. Road holding and handling may be affected with the "Temporary Spare" in use. Do not exceed 50 mph (80 km/h). Do not drive farther than 50 miles (80 km) on a temporary spare tire.

CAUTION!

The car must not be driven with wheels of different dimensions or with a spare tire other than the one that came with the car. The use of different size wheels can seriously damage your car's transmission.

pg. 116 Changing wheels

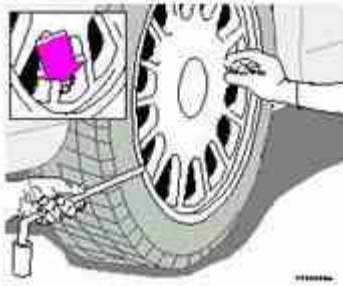

Insert flat end of lug wrench and turn/pull straight out

Changing wheels

The spare wheel is located under the carpet on the trunk floor. The jack and crank are secured in the wheel recess. There are two jack attachment points on each side of the car.

To change a wheel:

- Engage the parking brake.
- Put the gear selector in (P)ark.
- Remove the wheel cap (where applicable) using the lug wrench in the tool bag.
- With the car still on the ground, use the lug wrench to loosen the wheel bolts 1/2 -1 turn by exerting downward pressure. Turn the bolts counterclockwise to loosen.

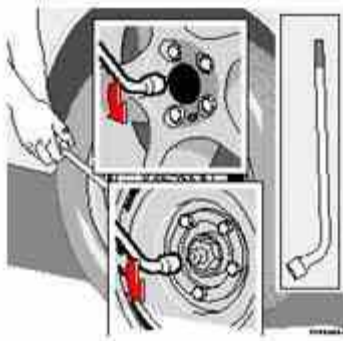

Loosen wheel bolts

- Position the jack on the bar in the attachment (A in the illustration below) and crank while simultaneously guiding the base of the jack to the ground. **The base of the jack must be flat on a level, firm, non-slippery surface. Before raising the car, check that the jack is still correctly positioned in the attachment.**
- Raise the vehicle until the wheel to be changed is lifted off the ground.
- Unscrew the wheel bolts completely and carefully remove the wheel so as not to damage the thread on the studs.

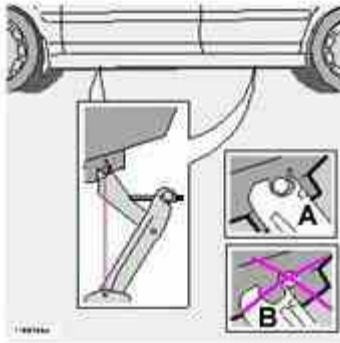

Attaching the jack

NOTE: To avoid excessive wear and the necessity of rebalancing, mark and reinstall wheels in the same location and position as before removal. To lessen the chance of imbalance, each wheel hub is equipped with a guide stud to ensure that a removed wheel can be reinstalled in its original position (as when changing over to winter tires/wheels).

pg. 117 Changing wheels

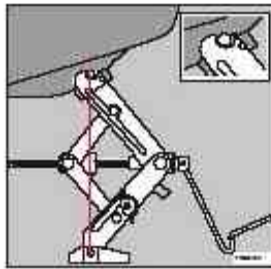

Jack for All Wheel Drive models

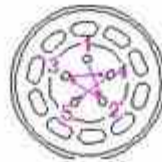

Correct tightening order for wheel bolts

Installing the wheel

- Clean the contact surfaces on the wheel and hub.
- Lift the wheel and place it on the hub.
- Install the wheel bolts and tighten hand-tight. Using the lug wrench, tighten crosswise (see illustration above) until all bolts are snug.
- Lower the vehicle to the ground and alternately tighten the bolts crosswise to 102 ft. lbs. (140 Nm).
- Install the wheel cap (where applicable).

WARNING!

- The jack must correctly engage the bar in the jack attachment (A). The car's weight must not rest on the jack

attachment (B). See illustration on [page 116](#).

- Be sure the jack is on a firm, level, non-slippery surface.
- Never allow any part of your body to be extended under a car supported by a jack.
- Use the jack intended for the car when replacing a wheel. For any other job, use stands to support the side of the car being worked on.
- Apply the parking brake and put the gear selector in the (P)ark position.
- Block the wheels standing on the ground, use rigid wooden blocks or large stones.
- The jack should be kept well-greased

CAUTION:

- Correct tightening torque on wheel bolts must be observed. The wheel bolts should never be greased or lubricated. The extended, chromed wheel bolts must not be used with steel rims, as they make it impossible to fit the hub caps.
- Locking wheel bolts can be used on both aluminum and steel wheels. If hub caps are used on steel wheels, the locking wheel bolt should be mounted in the hole as far from the tire's inflation valve as possible. It would otherwise not be possible to mount the hub cap on the wheel.

pg. 118

This page intentionally left blank.



[Contents](#) | [Top of Page](#)

2006
VOLVO
S80

Chapter 8 - Maintenance/Serviceing

pg. 119 Maintenance/Serviceing

Fuses 120

Replacing bulbs 125

Paint touch up 132

Washing the car 133

Cleaning the upholstery 135

Maintenance service, Warranty 136

Fuel/emissions systems 137

Drive belt, Coolant 138

Maintaining your car 139

Serviceing 141

Opening the hood, Engine compartment 142

Engine oil 143

Power steering/Brake fluid reservoirs 145

Replacing the battery 146

Battery maintenance 147

Replacing wiper blades 148

pg. 120 Fuses

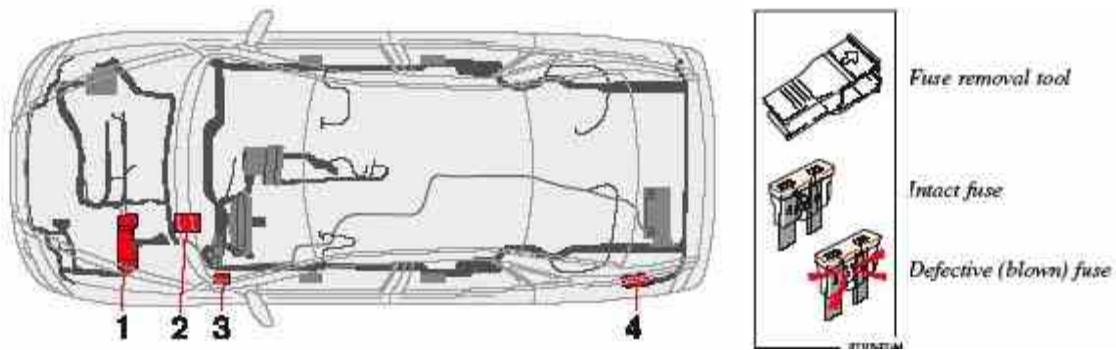

Replacing fuses

If an electrical component fails to function, it is likely that a fuse has blown due to a temporary circuit overload.

Fuses are located in four different places:

1. Relays/fuse box in the engine compartment
2. Fuse box in the passenger compartment, behind the plastic cover
3. Fuse box in the passenger compartment, on the edge of the dashboard
4. Fuse box in the trunk

A label on the inside of each cover indicates the amperage and the electrical components that are connected to each fuse.

The easiest way to see if a fuse is blown is to remove it. Pull the fuse straight out. If a fuse is difficult to remove, you will find a special fuse removal tool in the passenger compartment fuse box. From the side, examine the curved metal wire to see if it is broken. If so, put in a new fuse of the **same color and amperage** (written on the fuse). Spare fuses are stored in the fuse box in the passenger compartment. If fuses burn out repeatedly, have the electrical system inspected by an authorized Volvo retailer.

WARNING!

Never use fuses with higher amperage than those stated on the following pages. Doing so could overload the car's electrical system.

pg. 121 Fuses in the engine compartment

Relays/fuses in the engine compartment

When replacing fuses, be sure to replace a blown fuse with a new one of the **same color and amperage** (written on the fuse). Fuse amperage is also indicated on the inside of the fuse box cover. Fuses in positions marked X are replacement fuses.

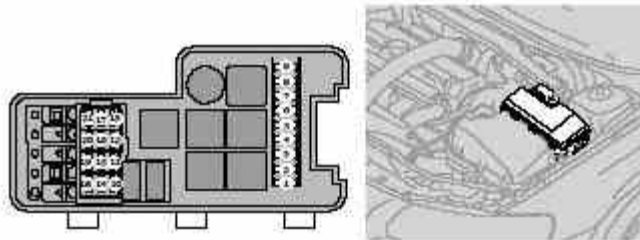

A - To open, press the plastic catches on the sides of the fuse box cover and lift.

Ordinary fuses

Location	Amperage
1 ABS	30A
2 ABS	30A
3	-
4	-
5 Auxiliary lights (option)	20A
6 Starter motor relay	35A
7 Windshield wipers	25A
8	-
9 Fuel pump	15A
10 Ignition coils, engine control module	20A
11 Throttle pedal sensor, A/C compressor, e-box fan	10A
12 Engine control module, fuel injectors, mass airflow sensor	15A
13 Throttle housing control module	10A
14 Heated oxygen sensor	20A
15 Crankcase ventilation heater, solenoid valves	10A
16 Driver's side low beam headlight	20A
17 Passenger's side low beam headlight	20A
18	-
19 Engine control module feed, engine relay	5A
20 Parking lights	15A
21	-

pg. 122 Fuses in the passenger compartment

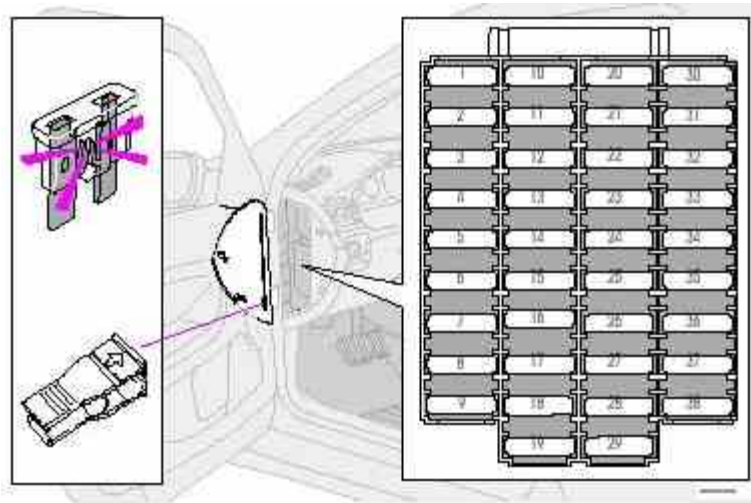

Fuse box on the edge of the dashboard

Fuses are located inside the access panel on the edge of the dashboard. When replacing a blown fuse, be sure to replace it with a new one of the **same color and amperage** (written on the fuse).

Location

Amperage

1	Power driver's seat (option)	25A
2	Power passenger's seat (option)	25A
3	Climate system blower	30A
4	Control module - front passenger's door	25A
5	Control module - driver's door	25A
6	Ceiling lighting, upper electrical control module	10A
7	Moon roof (option)	15A
8	Ignition switch, SRS system, engine control module, immobilizer	7.5A
9	Onboard diagnostics, headlight switch, steering wheel angle sensor, steering wheel control module	5A
10	Audio system	20A
11	Audio system amplifier	30A
12	Navigation system display (option)	10A
13	-	
14	-	
15	-	
16	-	
17	-	
18	-	
19	-	
20	-	
21	-	
22	-	
23	-	
24	-	
25	-	
26	-	
27	-	
28	-	
29	-	
30	-	
31	-	
32	-	
33	-	
34	-	
35	-	
36	-	
37	-	
38	-	

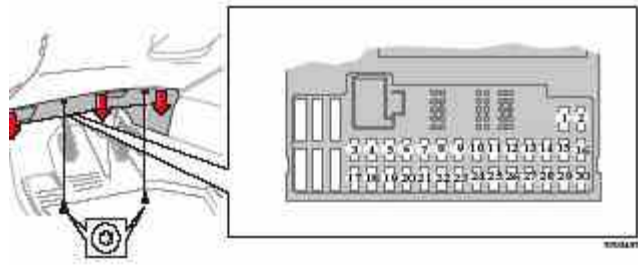

Fuse box in the passenger compartment, behind the plastic cover

This fuse box is located behind the plastic cover below the steering wheel. When replacing a blown fuse, be sure to replace it with a new one of the **same color and amperage** (written on the fuse).

Location	Amperage
1 Heated passenger's seat (option)	15A
2 Heated driver's seat (option)	15A
3 Horn	15A
4 -	
5 -	
6 -	
7 -	
8 Alarm siren	5A
9 Brake light switch feed	5A
10 Instrument panel, climate system, power driver's seat (option)	10A
11 12-volt sockets - front and rear seats	15A
12 -	
13 -	
14 Headlight wipers (certain models)	15A
15 ABS, STC/DSTC	5A
16 Power steering, Bi-Xenon headlights (option)	10A
17 Driver's side front foglight (option)	7.5A
18 Passenger's side front foglight (option)	7.5A
19 -	
20 -	
21 Transmission control module, reverse gear block (M66 gearbox)	10A
22 Driver's side high beam	10A
23 Passenger's side high beam	10A
24 -	
25 -	
26 -	
27 -	
28 Power passenger's seat (option), audio system	5A
29 -	
30 -	
31 -	
32 -	

33	Vacuum pump	20A
34	Washer pump - headlight wipers (certain models)	15A
35	-	
36	-	

pg. 124 Fuses in the trunk

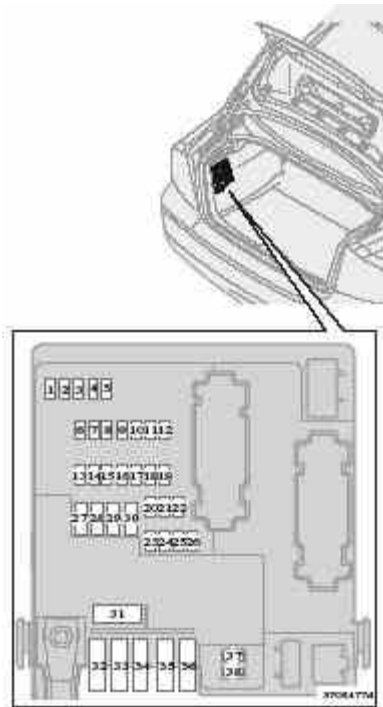

Fuses in the trunk

The fuses in the trunk are located behind the panel on the driver's side. When replacing a blown fuse, be sure to replace it with a new one of the **same color and amperage** (written on the fuse).

Ordinary fuses

Location	Amperage
1 Backup lights	10A
2 Parking lights, foglights, trunk lighting, license plate lighting, brake lights	20A
3 Accessory control module	15A
4 -	
5 Rear Electronic Module	10A
6 CD-changer (option), Navigation system (option)	7.5A
7 Trailer wiring (30-feed)	15A
8 12-volt socket - trunk	15A
9 Rear passenger's side door - power window, power window cut-out function	20A
10 Rear driver's side door - power window, power window cut-out function	20A
11 -	
12 -	

13	-	
14	-	
15	-	
16	-	
17	Accessory audio	5A
18	-	
19	Folding head restraints (option)	15A
20	Trailer wiring (15-feed)	20A
21	-	
22	-	
23	All Wheel Drive (option)	7.5A
24	Four-C chassis system (option)	15A
25	-	
26	Park assist (option)	5A
27	Main fuse: trailer wiring, Four-C, park assist, All Wheel Drive	30A
28	Central locking system	15A
29	Driver's side trailer lighting: parking lights, turn signal	25A
30	Passenger's side trailer lighting: parking light, brake light, fog light, turn signal	25A
31	Main fuse: fuses 37 and 38	40A
32	-	
33	-	
34	-	
35	-	
36	-	
37	Heated rear window	20A
38	Heated rear window	20A

pg. 125 Replacing bulbs

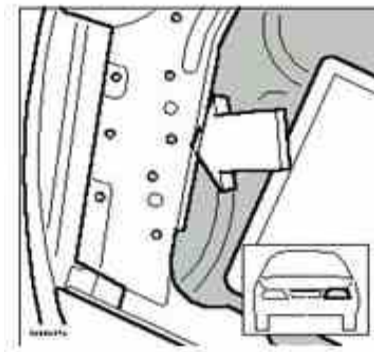

Replacing high/low beam headlight bulbs

The headlight bulbs must be replaced from the engine compartment.

CAUTION:

- Do not touch the glass on halogen bulbs with your fingers. Grease, oil or any other impurities can be carbonized onto the bulb and cause damage to the reflector.
- Be sure to use bulbs of the correct type and voltage.

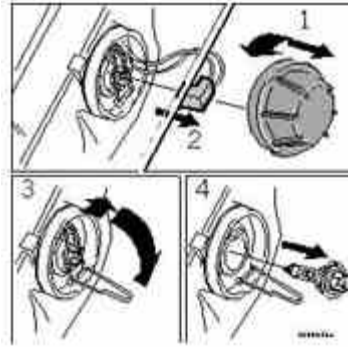

Removing a defective bulb

To remove a defective bulb:

- Switch off the ignition.
- Open the hood.
- Remove the plastic cover over the bulb (1) by turning it counterclockwise.
- Remove the connector (2).
- Loosen the retaining spring (3) by first moving it to the right and then moving it down, out of the way.
- Pull out the defective bulb. Note the position of the guide lug on the base of the bulb (4).

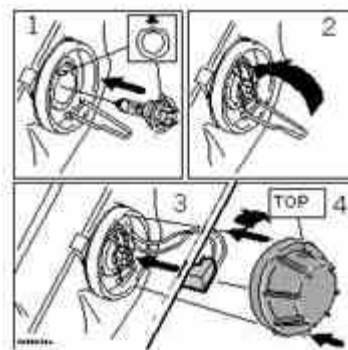

Installing a new bulb

Installing a new bulb:

- Insert the new bulb, without touching the glass, with the guide lug upward (1). The bulb will only seat properly in this position.
- Move the retaining spring up and push it slightly to the left until it seats properly (2).
- Press the connector into place on the bulb (3).
- Reinstall the plastic cover and turn it clockwise until it is correctly in place (4). "TOP" must be upward.

NOTE: If the vertical aim of your headlights needs to be adjusted for any reason (e.g., towing a trailer for extended periods), this should be done by an authorized Volvo retailer.

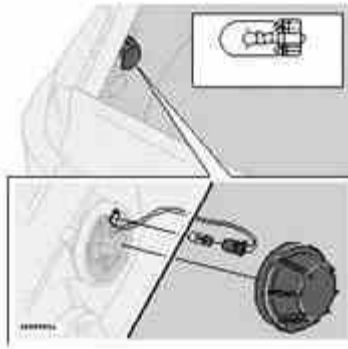

Front parking light

Front parking lights

- Switch off the ignition.
- Remove the plastic cover over the high beam bulb by turning it counterclockwise.
- Pull out the bulb and its socket. Replace the bulb.
- Press the bulb and its socket back into place.
- Switch on the ignition to test the bulb.
- Reinstall the plastic cover and turn it clockwise until it is correctly in place. "TOP" must be upward (see illustration on previous page).



Front turn signal

Front turn signals

- Switch off the ignition.
- Open the hood.
- Press down the retaining catch with a screwdriver and pull out the lamp housing.
- Press the retaining spring downward and pull the connector out of the lamp housing.
- Turn the bulb holder counterclockwise and remove it.
- Remove the defective bulb from the holder by first pressing it in slightly and then turning it counterclockwise.
- Install a new bulb in the holder and reinsert the bulb and holder in the lamp housing.

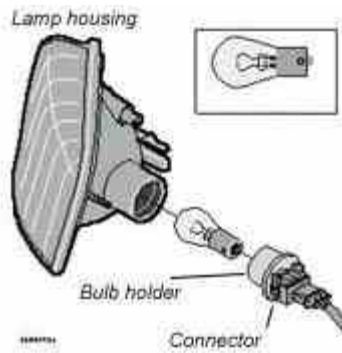

- Press the connector onto the bulb holder.
- Switch on the ignition to test the bulb.
- Press the lamp housing back into place on the fender. Be sure it seats properly.

pg. 127 Replacing bulbs

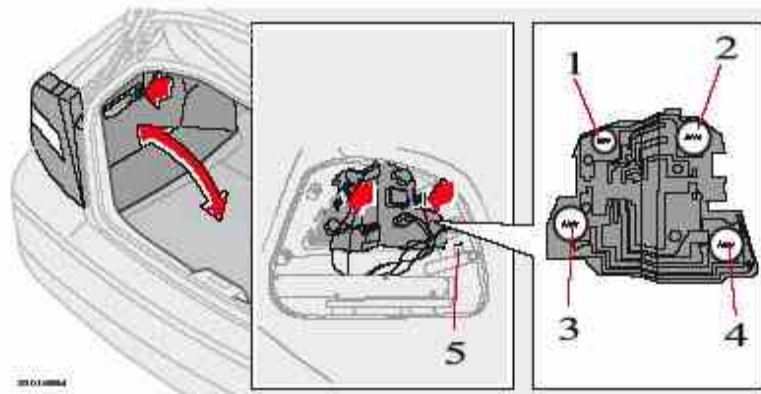

Tail lights

1. Tail light
2. Tail light/fog light (left side only)
3. Turn signal
4. Back-up light
5. Side marker light

NOTE: The brake lights are Light Emitting Diodes (LEDs), which must be replaced by an authorized Volvo workshop.

All tail light bulbs are accessed from inside the trunk.

- Switch off the ignition and open the trunk.
- Fold the covering panel inward to access the bulbs. When replacing right tail light bulbs, access is made easier if you pull out the cargo net in the trunk completely before folding down the panel.

The bulbs are located in a holder that is held in place by two retaining catches.

To replace bulbs 1-4:

- Press the retaining catches toward each other to release the bulb holder.
- Replace the defective bulb.

- Press the bulb holder back into place.
- Reconnect the wiring.
- Fold up and close the covering panel.

To replace bulb 5:

- Pull the bulb holder straight out of its retainer.
- Pull the bulb out of the holder.
- Press a new bulb into the holder.
- Press the bulb holder back into place.
- Fold up and close the covering panel.

NOTE: If the message indicating a burned out bulb remains in the information display after the bulb has been replaced, consult an authorized Volvo retailer or workshop.

pg. 128 Replacing bulbs

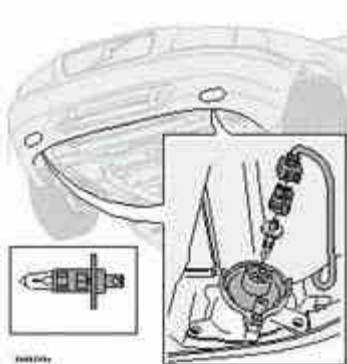

Front fog lights (option)

CAUTION:

Avoid touching the glass on the bulb with your fingers.

- Switch off the ignition.
- Turn the bulb holder slightly counterclockwise to release it.
- Replace the bulb. The shape of the foot of the bulb corresponds to the shape of the bulb holder.
- Reinstall the bulb holder by turning it slightly clockwise. "TOP" on the holder should be upward.



Vanity mirror lights

- Carefully insert a screwdriver and pry out the lens.
- Pry out the defective bulb and replace it.
- Carefully press the lower edge of lens onto the four tabs and press the upper edge of the lens into place.

pg. 129 Replacing bulbs

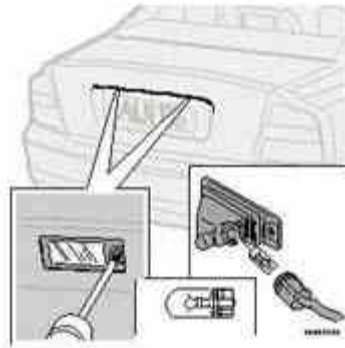

License plate lights

- Switch off the ignition.
- Loosen the screws with a torx screwdriver.
- Carefully pull out the lamp housing.
- Turn the bulb holder counterclockwise and pull it out.
- Pull out the defective bulb and insert a new one.
- Reinsert the bulb holder into the housing and turn it clockwise.
- Reinstall the housing and screw it in place.

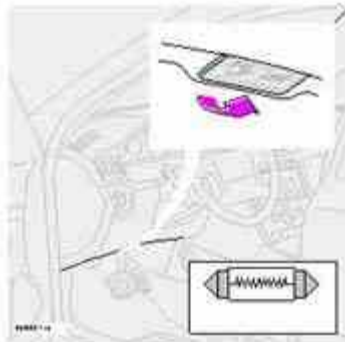

Door step courtesy lights

The door step courtesy lights are located under the dash on the driver's and passenger's sides. To replace a bulb:

- Carefully insert a screwdriver and pry out the lens.
- Replace the defective bulb.
- Reinstall the lens.

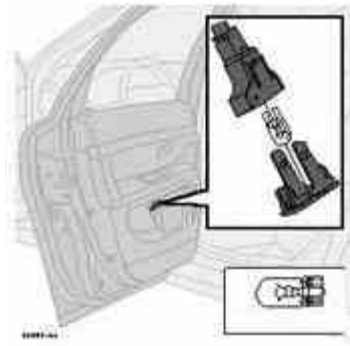

Rear door step lights

- Carefully insert a screwdriver and pry out the lens.
 - Disconnect the wiring from the lamp housing.
 - Remove the lens from the lamp housing by pressing the two side catches out.
 - Pull out the defective bulb and replace it.
 - Reinstall the lamp housing in the reverse order.
-



[Contents](#) | [Top of Page](#)

2006 VOLVO S80

Chapter 9 - Specifications

pg. 149 Specifications

[Label information](#) 150

[Dimensions and weights](#) 151

[Engine specifications](#) 152

[Oil/fluid specifications and volumes](#) 153

[Fuel system, distributor ignition system, suspension](#) 154

[Electrical system](#) 155

[On Call Roadside Assistance](#) 156

pg. 150 Label information

1 Vehicle Emission Control Information

Your Volvo is designed to meet all applicable emission standards, as evidenced by the certification label on the underside of the hood. For further information regarding these regulations, please consult your Volvo retailer.

2 Vacuum hose routing

(underside of hood)

3 Loads and Tire Pressures

(on inside of fuel filler door): Canadian models only.

4 Model plate

Vehicle Identification Number (VIN). Codes for color and upholstery, etc. The plate is located in the engine compartment, on the inside of the left front fender.

5 Vehicle Identification Number (VIN) *

The VIN plate is located on the top left surface of the dashboard. The VIN is also stamped on the right hand door pillar.

6 Federal Motor Vehicle Safety Standards (FMVSS) specifications (USA) and Ministry of Transport (CMVSS) standards (Canada)

Your Volvo is designed to meet all applicable safety standards, as evidenced by the certification label on the facing side of the driver's door. For further information regarding these regulations, please consult your Volvo retailer.

7 Child safety latch label

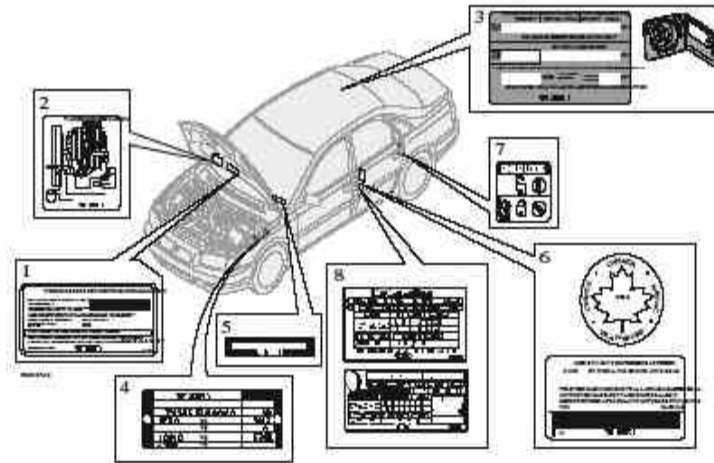

8 Loads and Tire Pressures - U.S. models only

Certain models will only have one decal, depending on the specifications of the vehicle.

* The Vehicle Identification Number (VIN) should always be quoted in all correspondence concerning your vehicle with the retailer and when ordering parts.

All specifications are subject to change without prior notice.

pg. 151 Dimensions and weights

Dimensions

Length	190.9 in. (485 cm)
Width	72.1 in. (183 cm)
Height	57.2 in. (145 cm)
Wheelbase	109.9 in. (279 cm)
Track, front	62.3 in. (158 cm)
Track, rear	61.4 in. (156 cm)
Turning circle (between curbs)	35.8 - 39 ft. (10.9 - 12 m)
Cargo capacity - trunk	14.2 cu. ft. (0.4 m ³)

Weights

AWD = All Wheel Drive USA		Canada
Gross vehicle weight (GVW)		
5 cyl. automatic	4560 lbs	-
5 cyl. automatic AWD	4760 lbs	2160 kg
Capacity weight *		
5 cyl. automatic	890 lbs	-

5 cyl. automatic AWD	890 lbs	400 kg
Curb weight		
5 cyl. automatic	3510-3550 lbs	-
5 cyl. automatic AWD	3690-3725 lbs	1680-1695 kg
Permissible axle weight, front		
5 cyl. automatic	2400 lbs	-
5 cyl. automatic AWD	2440 lbs	1110 kg
Permissible axle weight, rear		
5 cyl. automatic	2293 lbs	-
5 cyl. automatic AWD	2400 lbs	1090 kg
Max roof load	220 lbs	100 kg
Max trailer weight		
(w/o brakes)	1650 lbs	750 kg
Max trailer weight		
(with brakes)		
2" ball	3300 lbs **	1500 kg
1 7/8" ball	2000 lbs	900 kg
Max tongue weight ***	165 lbs	75 kg

WARNING!

When adding accessories, equipment, luggage and other cargo to your vehicle, the total loaded weight capacity of the vehicle must not be exceeded.

* The max permissible axle loads or the gross vehicle weight must not be exceeded.

** When driving for prolonged periods at temperatures above 86° F (30° C), the maximum recommended weight is 2000 lbs (900 kg).

*** See also section "Trailer towing"

All specifications are subject to change without prior notice.

pg. 152 Engine specifications

Engine specifications

Designation: Volvo B 5254 T2

Output	208 hp at 5000 rpm (154 kW/83 rps)
Max. torque	236 ft. lbs. at 1500-4500 rpm (320 Nm/25-75 rps)
Number of cylinders	5
Bore	3.27" (83 mm)
Stroke	3.67" (93.2 mm)
Displacement	2.5 liters
Compression ratio	9.0:1
Number of valves	20

Charge air cooler (Intercooler)

Turbocharged engines employ a turbo-compressor to force air into the engine inlet manifold and a charge air cooler to cool the compressed inlet air. The resulting increase in air flow raises pressure in the intake manifold and increases

engine power over that developed by the normally-aspirated engine. The charge air cooler (which resembles a radiator) is located between the turbo-compressor and inlet manifold.

All specifications are subject to change without prior notice.

pg. 153 Oil/fluid specifications and volumes

Engine oil

Type: Engine oil must meet the minimum ILSAC specification GF-3, API SL, or ACEA A1/B1.

Volume: 5.8 qts (5.5 liters)

Volume between MIN and MAX on dipstick: 1.3 US qts (1.2 liters)

Automatic transmission fluid

AW5: 7.6 US qts (7.2 liters), type: JWS 3309

Cooling system

Type: Positive pressure, closed system. The thermostat begins to open at 194 °F (90 °C).

Coolant: Volvo original coolant/antifreeze.

Volume: 9.5 US qts (9.0 liters)

Power steering fluid

Volvo synthetic power steering fluid (Pentosin CHF 11S) P/N 1161529 or equivalent.

Volume: 0.95 US qt (0.9 liter).

Brake fluid

DOT 4+ boiling point > 536°F (280° C) P/N 9437433

Volume: 0.6 US qt (0.6 liter)

Climate control system - refrigerant (R 134a)

Oil: PAG

Volume: 2.2 lbs (1000 g) R134a.

Fuel

Minimum octane requirement - AKI 87 (RON 91)

Fuel tank volume: 18 US gal. (68 liters) .

Washer fluid reservoir

Volume: 6 cyl: 4.7 US qts. (4.5 liters)

All specifications are subject to change without prior notice.

pg. 154 Fuel system, Distributor Ignition system, Suspension

Fuel system

The engine is equipped with a multiport fuel injection system.

Distributor ignition system

Firing order: 1-2-4-5-3

Distributor ignition setting: Not adjustable

Spark plugs: B 5254 T2: Champion RC8PYP 8 (or equivalent)

Spark plug gap: 0.028-0.032" (0.7-0.8 mm)

Tightening torque: 18.4 ft. lbs. (25 Nm)

WARNING!

The distributor ignition system operates at very high voltages. Special safety precautions must be followed to prevent injury. Always turn the ignition off when:

- Replacing distributor ignition components e.g. plugs, coil, etc.
- Do not touch any part of the distributor ignition system while the engine is running. This may result in unintended movements and body injury.

Front suspension

Spring strut suspension with integrated shock absorbers and control arms linked to the support frame. Power-assisted rack and pinion steering. Safety type steering column.

The alignment specifications apply to an unladen car but include fuel, coolant and spare wheel.

Rear suspension

Individual rear wheel suspension with longitudinal support arms, double link arms and track rods.

Vehicle loading

The tires on your Volvo should perform to specifications at all normal loads when inflated as recommended on the tire information label. The label is located on the inside of the fuel filler door and lists vehicle design limits. Do not load your car beyond the load limits indicated.

WARNING!

Improperly inflated tires will reduce tire life, adversely affect vehicle handling and can possibly lead to failure resulting in loss of vehicle control without prior warning.

All specifications are subject to change without prior notice.

pg. 155 Electrical system

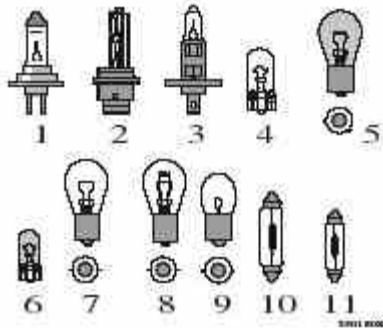

Bulbs

Bulb	Type	Socket
1. High/low beams	55W H7	
2. Bi-Xenon headlight (option)	35W D2R	
3. Front foglights	55W H1	

4. Front parking lights, rear side marker lights, rear footwell lighting	W5W	W2.1x9.5d
Front side marker lights	W3W	W2.1x9.5d
5. Front turn signals	PY21W	BAU 15s
6. Side turn signals (amber)	WY5W	W2.1x9.5d
7. Brake lights, backup lights, rear turn signals	P21W	BA15s
8. Rear foglight, parking light	P21/4W	BAZ15d
9. Rear parking light	R5W	BA15s
10. License plate lighting, front footwell lighting, trunk lighting	C5W	SV8.5
11. Vanity mirror	1.2W	SV5.5

WARNING!

Bi-Xenon headlights (option) - due to the high voltage used by these headlights, these bulbs should only be replaced by an authorized Volvo service technician.

Electrical system

12 Volt, negative ground.

Voltage-controlled generator. Single-wire system with chassis and engine used as conductors. Grounded on chassis.

Battery

Voltage: 12 Volt, capacity: 600 A/115 min. reverse capacity

The battery contains corrosive and poisonous acids. It is of the utmost importance that old batteries are disposed of correctly. Your Volvo retailer can assist you in this matter.

Generator

Rated output: max. current: 140 A

Starter motor:

Output: 1.7 kW

All specifications are subject to change without prior notice.

pg. 156 On Call Roadside Assistance



Volvo On Call Roadside Assistance

Your new Volvo comes with a four-year On Call Roadside Assistance program. Additional information, features, and benefits are described in a separate information package in your glove compartment.

If you have misplaced your package, dial:

In the U.S.A.

1-800-63-VOLVO (1-800-638-6586)

In Canada:

1-800-263-0475



Technician certification

In addition to Volvo factory training, Volvo supports certification by the National Institute for Automotive Excellence (A.S.E.). Certified technicians have demonstrated a high degree of competence in specific areas. Besides passing exams, each technician must also have worked in the field for two or more years before a certificate is issued. These professional technicians are best able to analyze vehicle problems and perform the necessary service procedures to keep your Volvo at peak operating condition.



[Contents](#) | [Top of Page](#)

2006
VOLVO
S80

Chapter 10 - Audio systems

pg. 157 Audio systems

[Introduction](#) [158](#)

[HU-650 overview](#) [159](#)

[HU-850 overview](#) [160](#)

[Audio functions HU-650/HU-850](#) [161](#)

[Radio functions HU-650/HU-850](#) [163](#)

[CD player HU-650](#) [168](#)

[Internal CD changer - HU-850](#) [169](#)

[External CD changer \(option\) - HU-650/HU-850](#) [170](#)

[Cassette deck HU-650](#) [171](#)

[Dolby Surround Pro Logic II HU-850](#) [172](#)

[Audio systems - specifications](#) [174](#)

[HomeLink® Universal Transceiver \(option\)](#) [175](#)

pg. 158 Introduction

The audio system in your car is operated with the buttons and knobs in the system's front panel. Certain functions, such as adjusting the volume, changing radio stations or tracks on a CD, etc. can also be controlled with the optional steering wheel-mounted keypad.

The audio system is available in two versions:

HU-650

Features: AM/FM radio, single-disc CD player, cassette player, 4x25W output, six speakers.

HU-850

Features: AM/FM radio, integrated 6-disc CD changer, 4x50W or 4x70W output plus 25W Dolby Pro Logic II, eleven speakers.

Compact disc care

- Keep the discs clean. Wipe them with a soft, clean, lint-free cloth, working from the center outwards. If necessary, dampen the cloth with a neutral soap solution. Dry thoroughly before using.
- Keep the discs clean. Wipe them with a soft, clean, lint-free cloth, working from the center outwards. If necessary, dampen the cloth with a neutral soap solution. Dry thoroughly before using.
- Never use cleaning spray or antistatic liquid. Use only cleaners specifically made for CDs.
- Use discs of the correct size only (3.5" discs should never be used). The discs should conform to the norms EN60908 (IEC60908).
- Do not put tape or labels on the disc itself.
- Volvo does not recommend the use of plastic outer rings on the disc.
- Condensation may occur on discs/optical components of the changer in cold winter weather. The disc can be dried with a clean, lint-free cloth. Optical components in the CD changer may, however, take up to one hour to dry off.
- Never attempt to play a disc which is damaged in any way.
- When not in use, the discs should be stored in their covers. Avoid storing discs in excessive heat, direct sunlight or dusty locations.

Cassettes

- Store cassettes in their cases.
- Do not touch the tape surface with your fingers.
- Tapes should not be exposed to direct sunlight or extreme temperatures.
- Keep tapes away from oil, grease and other contaminants.
- For optimal tape deck performance Volvo does not recommend the use of C-120 tapes.
- Take up slack using a pen or a pencil before inserting a cassette in the cassette slot.

Cassette cleaning

We recommend the use of the Volvo Cleaning Cassette available as a genuine Volvo accessory. Regular use improves sound quality, cleans vital parts and prevents tape tangle.

pg. 159 Audio system HU-650 - overview



1. On/off - press

- Volume - turn
- 2. Selector knob for:
Stored radio stations
Press to store a station
- CD changer - selecting disc (option)
- 3. Selector knob:
Radio _ FM, AM
Cassette
CD
CD changer (option)
Press to open the main menu.
- 4. Fader - press and turn
Balance - press to release the control, pull and turn to adjust
- 5. Exit (exit the menu)
- 6. Scan function (automatically search for radio stations)
- 7. Navigations buttons (seek/change radio station or CD track)
- 8. CD eject
- 9. CD slot
- 10. CD random play
- 11. FM
- 12. AM
- 13. CD player
- 14. Automatically search for radio stations
- 15. Bass - press and turn
Treble - press to release the control, pull and turn to adjust
- 16. Tape direction selector
- CD changer (option) - random play
- 17. Cassette opening
- 18. Cassette eject

pg. 160 Audio system HU-850 - overview

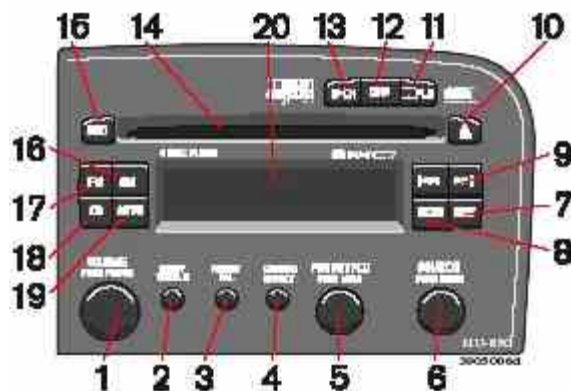

- 1. On/off - press
Volume - turn
- 2. Bass - press and turn
Treble - press to release the control, pull and turn to adjust
- 3. Fader - press and turn
Balance - press to release the control, pull and turn to adjust
- 4. Center volume - press and turn

Effect channel volume - press, pull and turn

5. Selector knob for:

Stored radio stations

CD - changer (option), selecting a disc

6. Source/Menu

Press to open main menu

Turn to select FM, AM, CD,

CD changer (option), selecting a disc

7. Exit (exit the menu)

8. Scan function (automatically search for radio stations)

9. Navigations buttons (seek/change radio station or CD track)

10. CD eject

11. Dolby Pro Logic II

12. 2 channel stereo

13 3 channel stereo

14. CD slot

15. CD random play

16. AM

17. FM

18. CD player

19. Automatically search for radio stations

20. Display

pg. 161 Audio functions HU-650/HU-850



Switch on/off

Press the knob to switch on or turn off the radio.

Volume control

Turn the knob clockwise to increase volume. Volume control is electronic and does not have an end stop. If you have a key pad in the steering wheel, increase or decrease the volume with the + or- buttons.

Volume control - ALARM

If a CD is playing when the radio receives an alarm bulletin (available in certain areas only), the CD player enters pause mode. The bulletin is broadcast at the volume selected for this type of message.

After the bulletin has been completed, the audio system reverts to the originally selected sound source (radio or CD), which is played at the volume that was selected for that source.

If the bulletin volume is adjusted while the bulletin is being broadcast, this new volume is saved and used for subsequent bulletins.

Bass

Adjust the bass by pressing the button to extend the control and turning it to the left (less bass) or to the right (more

bass). A "detent" indicates "equalized" bass. Press the button back in when you have made the adjustment.

Treble

Adjust the treble by pressing the button to extend the control, pulling it out as far as possible, and then turning it to the left (less treble) or to the right (more treble). A "detent" indicates "equalized" treble. Press the button back in when you have made the adjustment.



MID EQ level

This function is used to fine-tune the balance of sound in the speakers. To set the level:

1. Press SOURCE.
2. Turn the SOURCE knob, select ADVANCED MENU and press SOURCE.
3. Turn the SOURCE knob, select AUDIO SETTINGS and press SOURCE.
4. Turn the SOURCE knob, select MID EQ LEVEL and press SOURCE.
5. Turn the SOURCE knob, select the desired level and press SOURCE.
6. Press EXIT.

pg. 162 Radio functions HU-650/HU-850



Fader - Balance front/rear

Adjust front/rear speaker balance by pressing the button to extend the control and turning it to the left (more sound from the rear speakers) or to the right (more sound from the front speakers). A "detent" indicates "equalized" balance. Press the button back in when you have made the adjustment.

Balance right/left

Adjust left/right speaker balance by pressing the button to extend the control, pulling it out as far as possible and then turning it to the left (more sound from the left speakers) or to the right (more sound from the right speakers). A "detent" indicates "equalized" balance. Press the button back in when you have made the adjustment.

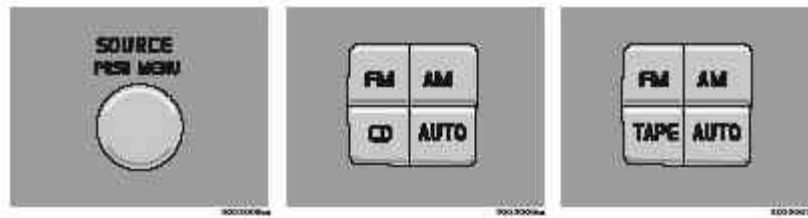

Selecting a sound source

The sound source (e.g. AM, FM, etc) can be selected in two ways:

- Use the sound source buttons (see the right illustrations above).
- Turn the SOURCE knob (see illustration above) to select a sound source (AM, FM, cassette, or CD). Press the knob to select the AM or FM band of your choice.

The sound source selected will be shown in the display.

pg. 163 Audio systems HU-650/HU-850

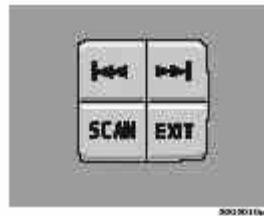



Scan



Press the SCAN button to start the station scan function. When a station is found, scanning stops for approximately 10 seconds, after which scanning will continue.

Press the SCAN or EXIT button when a station has been found if you would like to listen to that station and to discontinue the scan function.

Station seek up/down

Press  or  to start the seek function. The radio seeks the next audible station and tunes it in. Repeat the procedure to continue the seek function.

Manual station search

Press  or  and hold it down. MAN will be shown in the display. The radio scans slowly in the selected direction and will increase the scanning speed after a few seconds. Release the button when the desired frequency appears in the display.

The frequency can be fine-tuned by short presses on the  or  keys.

The system will remain in manual search mode for 5 seconds after the button is released, after which it will return to seek mode.



Audio system controls on the steering wheel

Steering wheel key pad (option)

If the vehicle is equipped with the key pad in the steering wheel press the right or left arrow to switch between preset stations.

pg. 164 Radio functions HU-650/HU-850



Storing stations

1. Tune to the desired station.
2. Press the knob. Choose a number by turning the knob. Press again to store the station.

Preset

To choose a preset station, turn button to the stored number. The currently selected station is displayed.



Storing stations automatically

This function automatically searches for and stores up to 10 strong AM or FM stations in a separate memory. If more than ten stations are found, the ten strongest ones are stored. This function is especially useful in areas in which you are not familiar with radio stations or their frequencies.

To use the AUTO function:

1. Select radio mode using the AM or FM buttons.
2. Start the search by pressing AUTO for more than 2 seconds.
3. AUTO appears in the display and a number of stations with strong (max. 10) from the selected frequency band will be stored in the auto-store memory. If there are no stations with sufficient signal strength, NO STATION is displayed.
4. Press the AUTO button or the arrow keys on the optional steering wheel controls briefly to select the stored stations.

When the radio is in auto-store mode, AUTO is shown in the display. AUTO disappears when you return to the normal radio mode.

Return to the normal radio mode by pressing the AM, FM, or EXIT button or turn the PRESET/CD knob.

To return to the Auto-store mode, press the AUTO button briefly.

pg. 165 Radio functions HU-650/HU-850

Radio Broadcast Data System - RBDS

This feature, which may not be available in your area, functions only with FM broadcasts. The radio in your car is equipped with an advanced system allowing information from broadcasters to be transmitted visually, as text, together with the audio signal. This information is then decoded by the radio and made available for several new and unique features.

The RBDS or Radio Broadcast Data System operates in the FM band only, and the information transmitted is supplied exclusively by participating broadcasters. Volvo has no control over the accuracy of the data or information.

Coverage by local broadcasters may be limited at this time, but as the technology and benefits grow, you will find the radio in your car is equipped to take advantage of this system.

PI (Program Information) Seek:

When an FM station has been stored as a preset, the radio also stores RBDS program information if it is available. When the preset is selected at a later time, the radio tries to access updated program information. In weak signal areas, there may be a delay before the station becomes audible. During this delay, "PI seek" will be displayed and there will be no sound.

PI seek can be interrupted by pressing EXIT.

Radio text

Certain RBDS stations broadcast program information, which can be shown in the display. The text will be shown twice in the display.

To start this function:

Press the FM button for several seconds.

To deactivate this function:

Press EXIT briefly.

Station information will be shown twice in the display.

Alarm

Alarms bulletins are transmitted automatically by certain RBDS stations. The function cannot be deactivated.

"Alarm!" is shown in the radio display when an alarm message is sent. The function is used to warn motorists of serious accidents, etc.

pg. 166 Radio functions HU-650/HU-850

Program type/station format -PTY

The PTY function allows you to find stations whose programs suit your taste. Use the PTY function to select among the different station formats shown in the list.

To select a station format:

1. Select radio mode using the FM button, or by turning the SOURCE knob.
2. Press the SOURCE knob, select PTY and press SOURCE.
3. Turn the SOURCE knob, select a station format from the list and press SOURCE to confirm the selected station format. The PTY (station format) of the selected station is now shown in the display.

NOTE: Not all RBDS radio stations have PTY designations.

Deactivate:

1. Select radio mode using the FM button and press the SOURCE knob.
2. Turn the SOURCE knob, select PTY and press SOURCE.
3. Turn the SOURCE knob, select PTY OFF and press SOURCE.
4. Press EXIT.

The PTY symbol in the display turns off and the radio returns to normal.

Program type	Display text
Off	PTY OFF
News	NEWS
Current affairs	AFFAIRS
Information	INFO
Sports	SPORT
Education	EDUCATION
Drama	DRAMA
Art and culture	CULTURE
Science	SCIENCE
Entertainment	VARIED
Pop music	POP M
Rock music	ROCK M
Easy listening	EASY M
Light classics	LIGHT M
Classical music	CLASSICS
Other music	OTHER M
Weather	WEATHER
Finance	FINANCE
Religious programs	RELIGION
Travel	TRAVEL
Leisure	LEISURE
Jazz music	JAZZ
Country music	COUNTRY

National music	NATION M
Oldies	"OLDIES"
Folk music	FOLK M
Documentary	DOCUMENT



[Contents](#) | [Top of Page](#)

2006 VOLVO S80

HomeLink® Universal Transceiver (option)

pg. 175 HomeLink® Universal Transceiver (option)

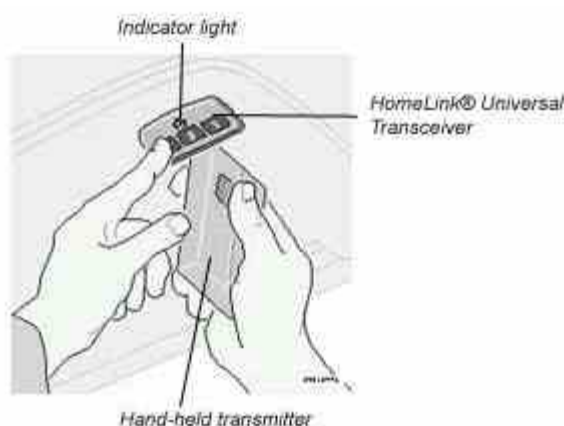

HomeLink® Universal Transceiver

HomeLink® is an advanced system that can be programmed to learn the codes of three different remote controlled-devices (e.g., garage door openers, remote lighting, entry door lock). HomeLink®'s sun visor-mounted transceiver, powered by your car's electrical system, may then be used in place of your hand-held remote controls.

NOTE: For your security, the HomeLink® Universal Transceiver is designed to **not** function if the car has been locked from the *outside*.

Programming the transceiver

1. The ignition switch must be turned to the "accessory" position (II) before programming the HomeLink® Universal Transceiver.
2. Begin by erasing all 3 factory default channels. Hold down the two outside buttons (buttons 1 and 3 in the illustration) on the HomeLink® Universal Transceiver for about 20 seconds, until HomeLink®'s indicator light begins to flash. Then release the buttons.
3. Hold your hand-held transmitter (garage door opener, for example) 2 to 5 in. (5 to 12 cm) away from the HomeLink® surface, keeping the indicator light in view. For placement questions, contact HomeLink® toll-free 1-800-355-3515 (Internet: www.HomeLink.com).
4. Using two hands, push and hold both your hand-held transmitter's button and the transceiver button you wish to program. The indicator light will flash first slowly, then rapidly. Rapid flashing tells you the HomeLink® button has been successfully programmed. Release both buttons.
5. If you are programming a rolling code-equipped device (e.g., garage door opener or entry door lock), refer to "Programming rolling codes" on the next page to complete the programming process.

Repeat steps 3 and 4 to program the other two transceiver buttons.

If, after several attempts, you are unable to successfully train the HomeLink® Universal Transceiver to learn your hand-held transmitter's signal, contact HomeLink® toll-free 1-800-355-3515 (Internet: www.HomeLink.com).

pg. 176 HomeLink® Universal Transceiver (option)

WARNING!

- If you use HomeLink® to open a garage door or gate, be sure no one is near the gate or door while it is in motion.
- Do not use the HomeLink® Universal Transceiver with any garage door opener that lacks safety "stop" and "reverse" features as required by federal safety standards. (This includes any garage door opener model manufactured before April 1, 1982) A garage door opener that cannot "detect" an object, signalling the door to "stop" and "reverse" does not meet current federal safety standards. Using a garage door opener without these features increases the risk of serious injury or death. For more information on this matter, call toll-free 1-800-355-3515 (Internet: www.HomeLink.com).

NOTE - Canadian residents:

During programming, your hand-held transmitter may automatically stop transmitting. To successfully train HomeLink®, continue to hold the HomeLink® button. At the same time, repeatedly press and hold your hand-held transmitter's button at *two-second intervals* until HomeLink® has learned your transmitter's code. The HomeLink® indicator light will flash first slowly, and then rapidly to indicate that the button has been successfully programmed.

Determining if your garage door uses a rolling code

Determine, in one of the following ways, if your garage door uses a rolling code system and is manufactured after 1996:

- Refer to the garage door opener owner's manual for verification.
- If your hand-held transmitter appears to program the HomeLink® Universal Transceiver but the programmed button does not activate the garage door, your garage door opener may have a rolling code.
- Press the programmed HomeLink® button. If the garage door opener has the rolling code feature, the HomeLink® indicator light flashes rapidly and then glows steadily after approximately 2 seconds.

To train a rolling code garage door opener, follow these instructions after programming the desired transceiver button according to "Programming the transceiver." The help of a second person may make training easier.

1. Locate the training button on the *garage door opener motor head unit*. The location and color of the training button may vary. If you encounter difficulty, refer to the garage door opener owner's manual or call toll-free 1-800-355-3515 (Internet: www.HomeLink.com).
2. Press the "training" button on the garage door opener motor head unit until the "training" light comes on.
3. Press and release the programmed HomeLink® button. Press and release the programmed HomeLink® button a *second* time to complete the training process.

Some garage door openers may require you to do this procedure a *third time* to complete the training.

The programmed button on your HomeLink® Universal Transceiver should now operate your garage door opener. The original hand-held transmitter can also be used, as desired, to operate the garage door.

The remaining two HomeLink® buttons can be programmed in the same way. In the event of any problems in

programming the HomeLink® Universal Transceiver, call toll-free 1-800-355-3515 (Internet: www.HomeLink.com).

Operating the HomeLink® Universal Transceiver

Once programmed, the HomeLink® Universal Transceiver can be used in place of hand-held transmitters.

To operate, the key must be turned to the "accessory" position (II) or the engine must be running. Press the programmed HomeLink® button to activate the garage door, driveway gate, security lighting, home security system, etc.

Your original hand-held transmitters may, of course, be used at any time.

pg. 177 HomeLink® Universal Transceiver (option)

Erasing programmed buttons

Individual buttons cannot be erased. To erase all three programmed buttons:

1. Turn the ignition key to the "accessory" position (II).
2. Hold down the two outside buttons on the HomeLink® Universal Transceiver for about 20 seconds, until HomeLink®'s indicator light begins to flash.
3. Release both buttons.

The HomeLink® buttons can be reprogrammed using the procedures described on the previous pages.

Reprogramming a single HomeLink® button

1. Press and hold the desired HomeLink® button. **Do not release** the button until step 3 has been completed.
2. When the indicator light begins to flash slowly (after approximately 20 seconds), position the hand-held transmitter 2 to 5 in. (5 to 12 cm) away from the HomeLink® surface.
3. Press and hold the hand-held transmitter button. The HomeLink® indicator light will flash first slowly, then rapidly. When the indicator light flashes rapidly, release both buttons.

The previously programmed device has now been erased and the new device can be activated by pressing the HomeLink® button that has just been programmed. This procedure will not affect any other programmed HomeLink® buttons.

NOTE:

- Retain the original transmitter(s) for future programming procedures (i.e., if you purchase a new car).
- For your own security, erase all programmed buttons on the HomeLink® Universal Transceiver when you sell your car.
- Metallic sun protection films should not be used on any windows in a car equipped with HomeLink® Universal Transceiver. This could interfere with the transceiver's function.



[Contents](#) | [Top of Page](#)

2006
VOLVO
S80

Index

pg. 179 Index

A

- [ABS.....97](#)
- [ABS - warning light.....29](#)
- [Active chassis system \(Four-C\).....82](#)
- [Adjusting the steering wheel.....38](#)
- [Air conditioning.....47, 48, 49, 51](#)
- [Air vents.....46](#)
- [Airbag, front.....6](#)
- [Alarm.....67, 68](#)
- [Alarm - "panic" function.....67](#)
- [All Wheel Drive \(AWD\) general information.....95](#)
- [Anti-lock Brake System \(ABS\).....97](#)
- [Anti-lock Brake System - warning light.....29](#)
- [Antifreeze.....92, 138](#)
- [Ashtrays.....40](#)
- [Audio systems.....157](#)
 - [_ CD player.....169](#)
 - [_ HU-650 - overview.....159](#)
 - [_ HU-850 - overview.....160](#)
 - [_ Specifications.....174](#)
- [Automatic car washing.....134](#)
- Automatic transmission
 - [_ five speed.....78](#)
 - [_ Geartronic.....80](#)
- [Auxiliary socket.....40](#)

B

- [Backrests, rear seat - folding.....60](#)
- [Battery.....92, 155](#)
 - [_ maintenance.....147](#)
 - [_ replacing.....146](#)
 - [_ ventilation hose.....146](#)

"Black box" (Vehicle Event Data).....	136
Blinds - rear/side rear windows.....	44
Booster cushion - integrated.....	20
Brake failure warning light	28
Brake fluid.....	145, 153
Brake system.....	96
Bulbs (list).....	155
Bulbs - replacing.....	125-131

C

Capacities (oils and fluids).....	149, 153
Cargo net in trunk.....	59
Cassette deck (HU-650).....	171
Catalytic converters - three-way.....	94, 95
Center console - switches.....	31
Center head restraint	61
Central locking buttons.....	67
Changing wheels.....	116, 117
Chassis setting	82
Child booster cushion	20
Child restraint anchorages	19
Child safety.....	17 -21
Child safety locks - rear doors.....	71
Child seat anchors ISOFIX	19
Climate controls.....	47, 48, 49, 51
Climate system - general information.....	50
Clock.....	27
Coat hanger.....	55
Cold weather driving.....	92
Combination filter.....	47, 51
Coolant.....	138, 153
Cooling system.....	84, 153
Courtesy light.....	56
Courtesy lights (front) - replacing.....	131
Courtesy lights - exterior.....	64
Cruise control.....	33
Cup holder - opening.....	58

D

Detachable trailer hitch - installing/removing.....	90
Dimensions.....	151
Direction indicators.....	36
Distributor ignition system.....	154
Door step courtesy lights - replacing.....	129
Doors and locks.....	64
Drive belt.....	138

Driving economy.....	84
Driving mode indicator.....	27
Driving mode W.....	79, 81
Driving with trunk open.....	85
Dynamic Stability Traction Control.....	98, 99

E

Economical driving.....	84
Electrical system.....	155
Electrical system - general information.....	85
Electrically operated front seats.....	54
Electrically operated moonroof.....	43
Electrically operated sideview mirrors.....	42
Electrically operated windows.....	41
Electronic Brake Force Distribution.....	97
Electronic Climate Control(ECC).....	47 - 51
Emergency towing.....	87, 88
Emergency warning flashers.....	39
Emission inspection readiness.....	140
Emissions systems.....	137
Engine - specifications.....	152
Engine - starting.....	77
Engine compartment.....	142
Engine oil.....	92, 143, 144, 153
Exterior courtesy lights.....	64
Exterior features - overview.....	25

F

Fog light - rear.....	29, 35
Folding passenger's seat backrest.....	55
Folding rear seat backrests	60
Four-C (active chassis system).....	82
Front airbags	6, 7, 8
Front airbags - SRS.....	9, 10, 11
Front airbags - SRS - warning light.....	29
Front courtesy lights - replacing.....	131
Front fog lights - replacing	128
Front reading lights.....	56
Front seats - adjusting.....	54
Front seats - heated.....	39
Front suspension.....	154
Fuel.....	74, 153
Fuel filler cap.....	76
Fuel filler door.....	76
Fuel filler door - unlocking manually.....	35
Fuel filler door - unlocking	34

[Fuel gauge.....27](#)
[Fuel requirements.....74](#)
[Fuel system.....137, 133, 154](#)
[Fuel/emissions systems.....137](#)
[Fuses.....120 - 124](#)

G

[Gas cap.....76](#)
[Gasoline.....74](#)
[Gear indicator.....27](#)
[Geartronic80](#)
[Generator.....155](#)
[Generator warning light.....28](#)
[Glossary of tire terminology.....111](#)

H

[Hand brake.....40](#)
[Handling.....85](#)
[Hazard warning flashers.....39](#)
[Head restraint - center rear.....61](#)
[Headlight bulbs - replacing.....125](#)
[Headlight flash.....36](#)
[Headlight wiper blades - replacing.....148](#)
[Headlights.....36](#)
[Heated front seats.....39](#)
[Heated rear window.....39](#)
[Heated sideview mirrors.....39](#)
[Heating.....47 - 49, 51](#)
[High beam flash.....36](#)
[High/low beam headlights.....36](#)
[Hoisting the car.....141](#)
[Home safe lighting.....36](#)
[HomeLink®175, 176, 176](#)
[Hood - opening.....142](#)

I

[Ignition switch.....38](#)
[Immobilizer \(start inhibitor\).....64, 77](#)
[Indicator lights.....28, 29](#)
[Inflatable curtain13](#)
[Inspecting SRS system components.....14](#)
[Instrument panel.....27](#)
[Instruments.....26](#)
[Integrated booster cushion 20](#)
[Interior Air Quality system51](#)
[Interior features - overview.....24](#)
[Interior lighting.....56](#)

[ISOFIX child seat anchors..... 19](#)

J

[Jack.....59, 116, 117](#)

[Jump starting.....91](#)

K

[Key - removing from ignition switch.....77](#)

[Keyless entry system.....65, 66](#)

[Keyless entry system - replacing batteries.....66](#)

[Keylock.....77](#)

[Keys.....64](#)

[Kickdown.....79, 80](#)

L

[Label information.....150](#)

[Laminated side windows.....134](#)

[LATCH/ISOFIX anchors..... 19](#)

[License plate lights - replacing.....129](#)

[Lifting the car.....141](#)

[Lighting panel.....34](#)

[Load carriers.....86](#)

[Locking and unlocking the car.....64](#)

[Locking steering wheel.....38](#)

[Long distance trip.....93](#)

[Long loads.....55](#)

[Low/high beam headlights.....36](#)

M

[Maintenance service.....136](#)

[Malfunction indicator lamp.....29](#)

[Mirrors.....42](#)

[Mirrors, sideview - memory function.....42](#)

[Moonroof.....43](#)

O

[Occupant Weight Sensor \(OWS\).....9, 10, 11](#)

[Octane rating.....74](#)

[Odometer.....27](#)

[Oil - engine.....92, 143, 144, 153](#)

[Oil pressure warning light 28](#)

[Opening the hood.....142](#)

[Opening the trunk from the inside.....67](#)

P

[Paint touch-up.....132](#)

[Panic function \(alarm\).....69](#)

[Park Assist.....83](#)

[Parking brake.....40](#)

[Parking brake reminder light.....28](#)

[Passenger's seat backrest - folding.....55](#)

[PI \(Program Information\) Seek.....165](#)

[Polishing.....134](#)

[Power moonroof.....43](#)

[Power seats.....54](#)

[Power steering - speed-sensitive.....85](#)

[Power steering fluid 145, 153](#)

[Power windows.....41](#)

R

[Radio.....159, 160](#)

[Radio Broadcast Data System - RBDS.....165](#)

[Rain sensor - windshield wipers.....37](#)

[Reading lights - front/rear 56](#)

[Rear door step lights - replacing.....129](#)

[Rear fog light.....29](#)

[Rear reading lights.....56](#)

[Rear seat backrests - folding.....60](#)

[Rear suspension.....154](#)

[Rear window - heated.....39](#)

[Rearview mirror.....42](#)

[Refrigerant.....50, 153](#)

[Refueling.....76](#)

[Remote keyless entry system.....65](#)

[Remote keyless entry system - replacing batteries.....66](#)

[Remote keyless entry system and sideview mirrors.....42](#)

[Remote keyless entry system and the driver's seat.....55](#)

[Replacing bulbs.....125-131](#)

[Replacing fuses.....120](#)

[Replacing the battery.....146](#)

[Replacing wiper blades.....148](#)

[Road assistance.....156](#)

[Roadholding.....85](#)

[Roof load - maximum.....151](#)

[Roof racks.....86](#)

[Run flat tires.....109](#)

S

[Safety locks - child.....71](#)

[Seat belt reminder.....3](#)

[Seat belts.....3, 4, 21](#)

[_use during pregnancy.....4](#)

[Seat belts - cleaning.....135](#)

[Seats - front.....54](#)

[Self supporting run flat tires.....109](#)

[Servicing.....141](#)

Shiftlock.....	77, 78, 80
Side impact airbag system (SIPS).....	12
Side marker lights - replacing.....	130
Side turn signals - replacing.....	130
Sideview mirrors.....	42
Sideview mirrors - heated.....	39
Sideview mirrors - memory function.....	42
Spare tire.....	59
Spark plugs.....	154
Specifications.....	152
Speed-sensitive power steering.....	85
SRS.....	8
SRS system components, inspecting.....	14
Stability Traction Control	98, 99
Start inhibitor (immobilizer).....	64, 77
Starting the engine.....	77
Steering wheel adjustment	38
Steering wheel lock.....	38
Storage compartment in center console.....	58
Storage compartments.....	57
Sun blinds.....	44
Supplemental Restraint System.....	29
Supplemental Restraint System (SRS).....	5
Suspension.....	154
Switches in center console	31
T	
Tachometer.....	27
Tail light bulbs - replacing	127
Temperature gauge.....	27
Text window.....	30
Three-way catalytic converters.....	94, 95
Tire Pressure Monitoring System	107
102 - 117	
Tires - changing.....	116, 116
Tool bag.....	59
Towing a trailer.....	89
Towing eyelet.....	87
Towing the car.....	87, 88
Trailer hitch, detachable - installing/removing.....	90
Trailer towing.....	89
Trailer weight - maximum.....	151
Transmission - automatic.....	81, 82
Transmission fluid (automatic).....	153
Trip computer.....	32

Trip odometer.....	27
Trunk - opening from the inside.....	67
Trunk - unlocking with master key.....	67
Trunk lights - replacing.....	130
Turn signal bulbs (front).....	126
Turn signals.....	36

U

Unlocking the trunk with key.....	67
Upholstery - cleaning.....	135
Seat belts.....	3

V

Vanity mirror lights - replacing.....	128
Vehicle Event Data	136
Vehicle Identification Number (VIN).....	150
Volvo Inflatable Curtain (VIC).....	13
Warning flashers.....	39
Washer fluid reservoir.....	153
Vehicle loading.....	154
Ventilation.....	46
Ventilation hose, battery	146
Volumes (oils and fluids)	153
Volvo On Call.....	156

W

Warning lights.....	28, 29
Warranty.....	136
Washer fluid reservoir.....	141
Washer fluid solvent.....	92
Washing the car.....	133, 134, 135
Water repellent glass.....	134
Waxing.....	134
Weight distribution.....	85
Weights.....	151
Wheels - changing.....	116, 117
Wheels and tires.....	102 - 117
Whiplash Protection System (WHIPS).....	15
Windows - electrically operated.....	41
Windshield washer solvent	92
Windshield wiper blades - replacing.....	148
Windshield wipers/washers.....	37
Winter driving.....	92
Winter/Wet driving mode.....	79, 81
Wiper blades - replacing.....	148



[Contents](#) | [Top of Page](#)

2006 VOLVO S80

Back Cover

Back Cover

Accessory Installation - Important Warning

- We strongly recommend that Volvo owners install only genuine, Volvo-approved accessories, and that accessory installations be performed only by the factory-trained technicians at your authorized Volvo retailer.
- Genuine Volvo accessories are tested to ensure compatibility with the performance, safety, and emission systems in your car. Additionally, your authorized Volvo retailer knows where accessories may and may not be safely installed in your Volvo. In all cases, please consult your authorized Volvo retailer before installing any accessory in or on your car.
- Accessories that have not been approved by Volvo may or may not be specifically tested for compatibility with your car. Additionally, an inexperienced installer may not be familiar with some of your car's systems.
- Any of your car's performance and safety systems could be adversely affected if you install accessories that Volvo has not tested, or if you allow accessories to be installed by someone unfamiliar with your car.
- Damage caused by unapproved or improperly installed accessories may not be covered by your new car warranty. See your Warranty and Service Records Information booklet for more warranty information. Volvo assumes no responsibility for death, injury, or expenses that may result from the installation of non-genuine accessories.

Driver Distraction

- Driver distraction results from driver activities that are not directly related to controlling the car in the driving environment. Your new Volvo is, or can be, equipped with many feature-rich entertainment and communication systems. These include hands-free cellular telephones, navigation systems, and multipurpose audio systems. You may also own other portable electronic devices for your own convenience. When used properly and safely, they enrich the driving experience. Improperly used, any of these could cause a distraction.
- For all of these systems, we want to provide the following warning that reflects the strong Volvo concern for your safety:
 - Never use these devices or any feature of your vehicle in a way that distracts you from the task of driving safely. Distraction can lead to a serious accident.
 - In addition to this general warning, we offer the following guidance regarding specific newer features that may be found in your vehicles:
 - Never use a hand-held cellular telephone while driving. Some jurisdictions prohibit cellular telephone use by a driver while the vehicle is moving.
 - If your car is equipped with a navigation system, set and make changes to your travel itinerary only with the vehicle parked.
 - Never program your audio system while the vehicle is moving. Program radio presets with the vehicle parked, and use your programmed presets to make radio use quicker and simpler.
 - Never use portable computers or personal digital assistants while the vehicle is moving.

A driver has a responsibility to do everything possible to ensure his or her own safety and the safety of passengers in

the vehicle and others sharing the roadway. Avoiding distractions is part of that responsibility.

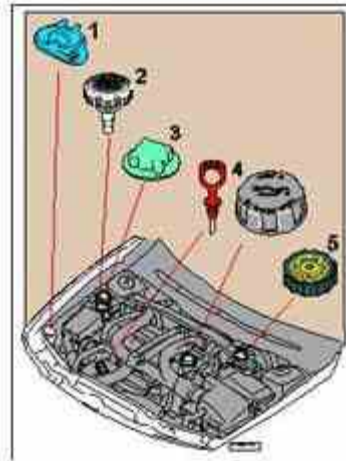

The following should be checked regularly: *

1 Washer fluid reservoir should be filled with water and solvent (wintertime: windshield washer anti-freeze). See [page 92](#).

2 Power steering - When cold, the level must not be above the COLD mark and when hot it must not be above the HOT mark. Top up if the level drops to the ADD mark with ATF fluid. See [page 145](#).

3 Coolant level should be between the expansion tank marks. Mixture: 50% anti-freeze and 50% water. See [page 138](#).

4 Engine oil level should be between the dipstick marks. The distance between the marks represents approx. 1.6 US qts (1.5 liters). See [page 143](#).

5 Brake fluid - check, without removing the cap, that the level is above the MIN mark. Use brake fluid DOT 4+. See [page 145](#).

* Engine oil should be checked each time the car is refuelled.



Octane rating, see [page 74](#).

Tire pressure, see label located on the rear edge of the right front door.

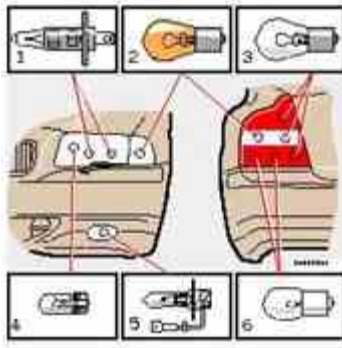

[Contents](#) | [Top of Page](#)