

# 2006 VOLVO S40

## Introduction



Welcome to the worldwide family of Volvo owners. We hope that you will enjoy many years of safe driving in your Volvo, an automobile designed with your safety and comfort in mind. To help ensure your satisfaction with this vehicle, we encourage you to familiarize yourself with the equipment descriptions, operating instructions and maintenance requirements/recommendations in this manual. We also urge you and your passengers to wear seat belts at all times in this (or any other) automobile. And, of course, please do not operate a vehicle if you may be affected by alcohol, medication or any impairment that could hinder your ability to drive.

Your Volvo is designed to meet all applicable safety and emission standards, as indicated by the certification labels attached to the driver's door opening, and on the underside of the hood.

For further information please contact your retailer, or:

**In the USA:** Volvo Cars of North America

Customer Care Center

P.O. Box 914 Rockleigh, New Jersey 07647-0914

1-800-458-1552

<http://www.volvocars.us>

**In Canada:** Volvo Cars of Canada Ltd.

Customer Care Center

175 Gordon Baker Road

North York, Ontario M2H 2N7

1-800-663-8255

<http://www.volvocanada.com>

2005 © Volvo Cars of North America, LLC

## Introduction

### General information

#### Shiftlock

When your car is parked, the gear selector is locked in the (P)ark position. To release the selector from this position, turn the ignition key to position II (or start the engine), depress the brake pedal, press the button on the front side of the gear selector and move the selector from (P)ark.

#### Keylock

When the ignition is switched off, the gear selector must be in the (P)ark position before the key can be removed from the ignition switch.

#### Anti-lock Brake System (ABS)

The ABS system in your car performs a self-diagnostic test when the vehicle first reaches the speed of approximately 12 mph (20 km/h). The brake pedal will pulsate several times and a sound may be audible from the ABS control module. This is normal.

#### Fuel filler door

Press the button on the light switch panel when the car is at a standstill to unlock the fuel filler door.

#### Fuel filler cap

After refueling, close the fuel filler cap by turning it clockwise until it clicks into place. If this cap is not closed tightly or if the engine is running when the car is refueled, the Malfunction Indicator Lamp ("Check Engine" light) may indicate a fault.

### Points to keep in mind

- Before you operate your vehicle for the first time, please familiarize yourself with the new-engine oil consumption information on [page 179](#). You should also be familiar with the information found in the chapters "Instruments and controls", and "Starting and driving".
- Information contained in the balance of the manual is extremely useful and should be read after operating the vehicle for the first time.
- The manual is structured so that it can be used for reference. For this reason, it should be kept in the vehicle for

ready access.

- Do not export your Volvo to another country before investigating that country's applicable safety and emission control requirements. In some cases it may be difficult or impossible to comply with these requirements. Modifications to the emission control system(s) may render your Volvo not certifiable for legal operation in the U.S., Canada and other countries.
- All information, illustrations and specifications contained in this manual are based on the latest product information available at the time of publication. Please note that some vehicles may be equipped differently, depending on special legal requirements. Optional equipment described in this manual may not be available in all markets.
- Volvo reserves the right to make model changes at any time, or to change specifications or design without notice and without incurring obligation.

**WARNING!**

If your vehicle is involved in an accident, unseen damage may affect its driveability and safety.

## Introduction

**WARNING!**

**CALIFORNIA proposition 65**

Engine exhaust, some of its constituents, and certain vehicle components contain or emit chemicals known to the state of California to cause cancer, and birth defects or other reproductive harm. In addition, certain fluids contained in vehicles and certain products of component wear contain or emit chemicals known to the State of California to cause cancer, and birth defects or other reproductive harm.

### Volvo and the environment

Volvo is committed to the well being of its customers. As a natural part of this commitment, we care about the environment in which we all live. Caring for the environment means an everyday involvement in reducing our environmental impact. Volvo's environmental activities are based on a holistic view, which means we consider the overall environmental impact of a product throughout its complete life cycle. In this context, design, production, product use, and recycling are all important considerations. In production, Volvo has partly or completely phased out several chemicals including freons, lead chromates, naphthanates, asbestos, mercury and cadmium; and reduced the amount of chemicals used in our plants 50% since 1991.

Volvo was the first in the world to introduce into production a three-way catalytic converter with a Lambda sond, now called the heated oxygen sensor, in 1976. The current version of this highly efficient system reduces emissions of harmful substances (CO, HC, NOx) from the exhaust pipe by approximately 95% and the search to eliminate the remaining emissions continues. Volvo is the only automobile manufacturer to offer CFC-free retrofit kits for the air conditioning system of all models as far back as the 1975 model 240. Advanced electronic engine controls, refined purification systems and cleaner fuels are bringing us closer to our goal. After Volvo cars and parts have fulfilled their use, recycling is the next critical step in completing the life cycle. The metal content is about 75% of the total weight of a car, which makes the car among the most recycled industrial products. In order to have efficient and well controlled recycling, many Volvo variants have printed dismantling manuals, indicating the weight and material of individual components. For Volvo, all homogeneous plastic parts weighing more than 1.7 oz. (50 grams) are marked with international symbols that indicate how the component is to be sorted for recycling. In addition to continuous environmental refinement of conventional gasoline-powered internal combustion engines, Volvo is actively looking at advanced technology alternative-fuel vehicles.

When you drive a Volvo, you become our partner in the work to lessen the car's impact on the environment. To reduce your vehicle's environmental impact, you can:

- Maintain proper air pressure in your tires. Tests have shown decreased fuel economy with improperly inflated tires.
- Follow the recommended maintenance schedule in your Warranty and Service Records Information booklet.

Drive at a constant speed whenever possible.

- See a trained and qualified Volvo service technician as soon as possible for inspection if the check engine (malfunction indicator) lamp illuminates, or stays on after the vehicle has started.
- Properly dispose of any vehicle-related waste such as used motor oil, used batteries, brake pads, etc.

## Introduction

- When cleaning your car, use Volvo's own car care products, all of which have systematically been adapted to the environment.

### **PremAir®**

The surface of the radiator in the engine compartment is treated with a special coating called Premair<sup>1</sup>. This coating works as a catalytic converter, converting most of the ground level ozone passing through the radiator into oxygen, thereby reducing harmful ground-level ozone.

1. PremAir is a registered trademark of Engelhard Corporation.

## Contents

### **Contents**

[Chapter 1 - Instrument overview](#)

[Chapter 2 - Safety](#)

[Chapter 3 - Instruments and controls](#)

[Chapter 4 - Climate](#)

[Chapter 5 - Interior](#)

[Chapter 6 - Locks and alarm](#)

[Chapter 7 - Starting and driving](#)

[Chapter 8 - Wheels and tires](#)

[Chapter 9 - Vehicle care](#)

[Chapter 10 - Maintenance and servicing](#)

[Chapter 11 - Audio](#)

[Chapter 12 - Specifications](#)

[Index](#)



# 2006 VOLVO S40

## Chapter 1 - Instrument overview

pg. 7 Instrument overview

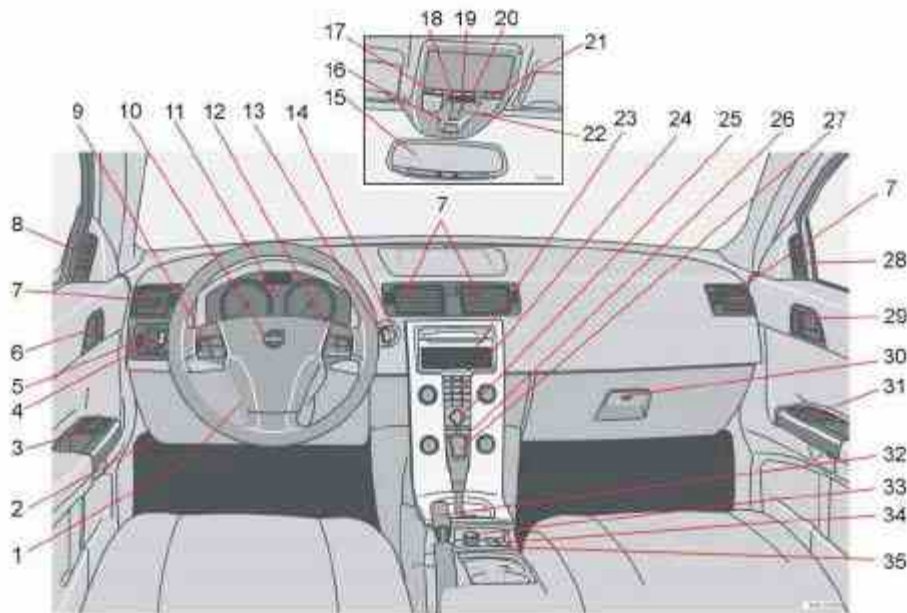

pg. 8 Instrument overview

1. Steering wheel adjustment
2. Hood opener
3. Controls in driver's door
4. Turn signals, high beams, trip computer
5. Lighting panel, fuel filler door opener
6. Central locking button, door open handle
7. Climate system air vents
8. Side window air vent
9. Cruise control
10. Horn, airbag
11. Main instrument panel
12. Audio controls (option)
13. Windshield wipers and washers, headlight washers (certain models)
14. Ignition key/start control
15. Rear-view mirror and optional compass
16. Seat belt reminder
17. Driver's side reading light
18. Movement detector (option), alarm

19. Courtesy lighting switch
20. Position for accessory switch
21. Passenger's side reading light
22. Moonroof control (option)
23. Display for climate control and audio systems
24. Audio system
25. Controls for audio system/personal settings
26. Climate control system
27. Gear selector
28. Side window air vent
29. Central locking button, door open handle
30. Glove compartment
31. Controls in passenger's door
32. Parking brake
33. 12-volt socket
34. Stability system STC/DSTC switch
35. Switch for optional equipment

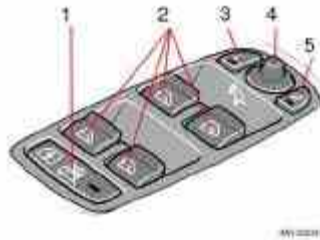

1. Power window lockout button
  2. Power windows
  3. Door mirror button, driver's side
  4. Door mirror adjustment control
  5. Door mirror button, passenger's side
- 



# 2006 VOLVO S40

## Chapter 2 - Safety

<a href="#">Occupant safety</a>	<a href="#">10</a>
<a href="#">Seat belts</a>	<a href="#">11</a>
<a href="#">Supplemental Restraint System - SRS</a>	<a href="#">14</a>
<a href="#">Front airbags</a>	<a href="#">15</a>
<a href="#">Occupant Weight Sensor - disabling the passenger's side front airbag</a>	<a href="#">18</a>
<a href="#">Side impact protection (SIPS) airbags</a>	<a href="#">21</a>
<a href="#">Volvo Inflatable Curtain (VIC)</a>	<a href="#">22</a>
<a href="#">Whiplash Protection System (WHIPS)</a>	<a href="#">23</a>
<a href="#">Collision status</a>	<a href="#">25</a>
<a href="#">Inspecting SRS system components</a>	<a href="#">26</a>
<a href="#">Child safety</a>	<a href="#">27</a>

pg. 10 Safety

### Occupant safety

#### Volvo's concern for safety

Safety is Volvo's cornerstone. Our concern dates back to 1927 when the first Volvo rolled off the production line. Three-point seat belts (a Volvo invention), safety cages, and energy-absorbing impact zones were designed into Volvo cars long before it was fashionable or required by government regulation.

We will not compromise our commitment to safety. We continue to seek out new safety features and to refine those already in our cars. You can help. We would appreciate hearing your suggestions about improving automobile safety.

We also want to know if you ever have a safety concern with your car. Call us in the U.S. at: 1-800-458-1552 or in Canada at: 1-800-663-8255.

#### Occupant safety reminders

How safely you drive doesn't depend on how old you are but rather on:

- How well you see.
- Your ability to concentrate.
- How quickly you make decisions under stress to avoid an accident. The following suggestions are intended to help you cope with the ever changing traffic environment.
- Never drink and drive.
- If you are taking any medication, consult your physician about its potential effects on your driving abilities.
- Take a driver-retraining course.

- Have your eyes checked regularly.
- Keep your windshield and headlights clean.
- Replace wiper blades when they start to leave streaks.
- Take into account the traffic, road, and weather conditions, particularly with regard to stopping distance.

### **Reporting safety defects in the U.S.**

If you believe that your vehicle has a defect which could cause a crash or could cause injury or death, you should immediately inform the National Highway Traffic Safety Administration (NHTSA) in addition to notifying Volvo Cars of North America. If NHTSA receives similar complaints, it may open an investigation, and if it finds that a safety defect exists in a group of vehicles, it may order a recall and remedy campaign. However, NHTSA cannot become involved in individual problems between you, your retailer, or Volvo Cars of North America. To contact NHTSA, you may either call the Auto Safety Hotline toll-free at 1- 800-424-9393 (or 202-366-0123 in Washington, D.C. area) or write to: NHTSA, U.S. Department of Transportation, Washington D.C. 20590. You can also obtain other information about motor vehicle safety from the Hotline.

Volvo strongly recommends that if your vehicle is covered under a service campaign, safety or emission recall or similar action, it should be completed as soon as possible. Please check with your local retailer or Volvo Cars of North America, LLC if your vehicle is covered under these conditions. NHTSA can be reached at:

<http://www.nhtsa.dot.gov>

or by phone at:

1-888-DASH-2-DOT (1-888-327- 4236) (toll free)

1-800-424-9393 (toll free)

1-202-366-0123 (in the Washington DC area)

pg. 11 Seat belts

## **Seat belts**

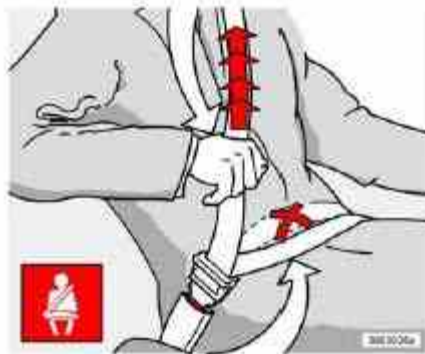

*Adjusting the seat belt*

### **Using seat belts**

Volvo, the inventor of the three-point seat belt, urges you and all occupants of your vehicle to wear seat belts and ensure that children are properly restrained, using an infant, car, or booster seat determined by age, weight and height. Volvo also believes no child should sit in the front seat of a vehicle.

Most states and provinces make it mandatory for occupants of a vehicle to use seat belts.

### **Seat belt tensioners**

The front and rear outboard seat belts are equipped with tensioners that reduce slack in the belts. These tensioners are triggered in situations where the airbags deploy. The front seat belts also include a tension reducing device which, in the event of a collision, limits the peak forces exerted by the seat belt on the occupant.



## Buckling a seat belt

Pull the belt out far enough to insert the latch plate into the receptacle until a distinct click is heard. The seat belt retractor is normally "unlocked" and you can move freely, provided that the shoulder belt is not pulled out too far. The retractor will lock up as follows:

- if the belt is pulled out rapidly
- during braking and acceleration
- if the vehicle is leaning excessively
- when driving in turns

## When wearing the seat belt remember:

- The belt should not be twisted or turned.
- The lap section of the belt must be positioned low on the hips (not pressing against the abdomen).
- Make sure that the shoulder belt is rolled up into its retractor and that the shoulder and lap belts are taut.

## Unbuckling the seat belt

- To remove the seat belt, press the red section on the seat belt receptacle. Before exiting the vehicle, check that the seat belt retracts fully after being unbuckled. If necessary, guide the belt back into the retractor slot.



*Sample label on all seat belts with tensioners*

### **WARNING!**

Never use a seat belt for more than one occupant. Never wear the shoulder portion of the belt under the arm, behind the back or otherwise out of position. Such use could cause injury in the event of an accident. As seat belts lose much of their strength when exposed to violent stretching, they should be replaced after any collision, even if they appear to be undamaged.

### **WARNING!**

- Never repair the belt yourself; have this work done by a trained and qualified Volvo service technician only.
- Any device used to induce slack into the shoulder belt portion of the three-point belt system will have a detrimental effect on the amount of protection available to you in the event of a collision.
- The seat back should not be tilted too far back. The shoulder belt must be taut in order to function properly.
- Do not use child safety seats or child booster cushions/backrests in the front passenger's seat. We also recommend that children who have outgrown these devices sit in the rear seat with the seat belt properly fastened.



### **Seat belt use during pregnancy**

The seat belt should always be worn during pregnancy. But it is crucial that it be worn in the correct way. The diagonal section should wrap over the shoulder then be routed between the breasts and to the side of the belly. The lap section should lay flat over the thighs and as low as possible under the belly. It must never be allowed to ride upward. Remove all slack from the belt and insure that it fits close to the body without any twists.

As a pregnancy progresses, pregnant drivers should adjust their seats and steering wheel such that they can easily maintain control of the vehicle as they drive (which means they must be able to easily operate the foot pedals and steering wheel). Within this context, they should strive to position the seat with as large a distance as possible between their belly and the steering wheel.

### **Child seats**

Please refer to [page 31](#) for information on securing child seats with the seat belts.

pg. 13 Seat belts

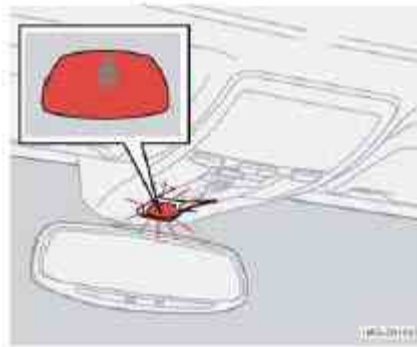

*Seat belt reminder light in ceiling console*

### **Seat belt reminder**

The seat belt reminder consists of an audible signal, an indicator light above the rearview mirror, and a symbol in the instrument panel (see [page 37](#)) that alert the driver and front seat passenger if their seat belts are not fastened.

**NOTE:** The function is active for a total of 6 minutes from the time the ignition is switched on.

#### **During the first minute:**

The seat belt reminder function only reacts if the driver has not fastened his/her seat belt.

- The indicator light above the mirror and the symbol in the instrument panel will light up and stay lit until the seat belt has been fastened.
- A chime will sound for 6 seconds. The frequency of the chiming increases with the speed of the car.

#### **After one minute has elapsed:**

The seat belt reminder reacts if the driver and/or the front seat passenger have not fastened their seat belts.

- The indicator light above the mirror and the symbol in the instrument panel will light up and stay lit until the seat belt(s) have been fastened, or until the remaining 5 minutes of the 6-minute cycle have elapsed.
- The chime will sound for 6 seconds, at 30-second intervals. The frequency of the chiming increases with the speed of the car.

After 6 minutes, the chime will no longer sound and the indicator lights will go out.

### Seat belt maintenance

Check periodically that the seat belts are in good condition. Use water and a mild detergent for cleaning. Check seat belt mechanism function as follows: attach the seat belt and pull rapidly on the strap.

## pg. 14 Supplemental Restraint System (SRS)

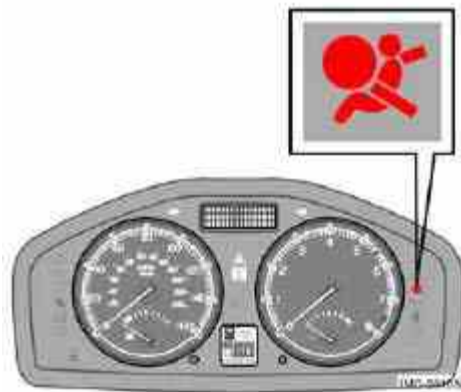

### Supplemental Restraint System

As an enhancement to the three-point seat belts, your Volvo is equipped with a Supplemental Restraint System (SRS). Volvo's SRS consists of seat belt tensioners, front airbags, side impact airbags, the occupant weight sensor, and inflatable curtains. All of these systems are monitored by the SRS control module. An SRS warning light in the instrument panel (see the illustration above) illuminates when the ignition key is turned to position I, II, or III, and will normally go out after approximately 7 seconds if no faults are detected in the system.

Where applicable, a text message will also be displayed when the SRS warning light illuminates.

If this warning symbol is not functioning properly, the general warning symbol  illuminates and a text message will be displayed.

### WARNING!

- If the SRS warning light stays on after the engine has started or if it illuminates while you are driving, have the vehicle inspected by a trained and qualified Volvo service technician as soon as possible.
- Never try to repair any component or part of the SRS yourself. Any interference in the system could cause malfunction and serious injury. All work on these systems should be performed by a trained and qualified Volvo service technician.

### WARNING!

If your vehicle has been subjected to flood conditions (e.g. soaked carpeting/ standing water on the floor of the vehicle) or if your vehicle has become flood damaged in any way, do not attempt to start the vehicle or put the key in the ignition before disconnecting the battery (see below). This may cause airbag deployment which could result in personal injury. Have the vehicle towed to a trained and qualified Volvo service technician for repairs.

### **Automatic transmission:**

Before attempting to tow the vehicle, use the following procedure to override the shiftlock system to move the gear selector to the neutral position:

- Switch off the ignition for at least 10 minutes and disconnect the battery
- Wait at least one minute.
- Insert the key in the ignition and turn it to position II.
- Press firmly on the brake pedal.
- Move the gear selector from (P)ark to the (N)eutral position. See [page 105](#) for information on manually overriding the shiftlock system.

### **Front airbags**

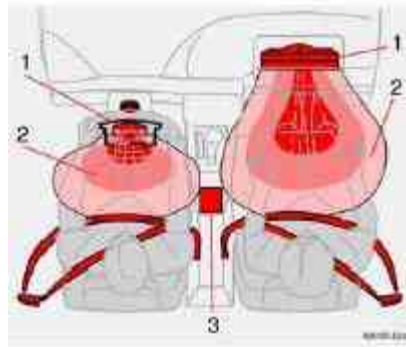

### **The front airbag system**

The front airbags supplement the three-point seat belts. For these airbags to provide the protection intended, seat belts must be worn at all times.

The front airbag system includes gas generators (1) surrounded by the airbags (2) and a deceleration sensor (3) that activates the gas generators, causing the airbags to be inflated with nitrogen gas.

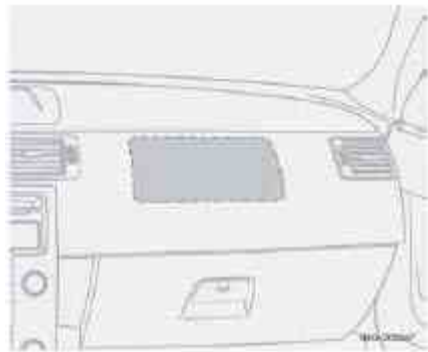

*Location of the passenger's side front airbag*

As the movement of the seats' occupants compresses the airbags, some of the gas is expelled at a controlled rate to provide better cushioning. Both seat belt tensioners also deploy, minimizing seat belt slack. The entire process, including inflation and deflation of the airbags, takes approximately one fifth of a second.

The location of the front airbags is indicated by "SRS AIRBAG" embossed on the steering wheel pad and above the glove compartment, and by decals on both sun visors and on the front and far right side of the dash.

- The driver's side front airbag is folded and located in the steering wheel hub.
- The passenger's side front airbag is folded behind a panel located above the glove compartment.

## **WARNING!**

- The airbags in the vehicle are designed to be a **SUPPLEMENT** to-not a replacement for-the three-point seat belts. For maximum protection, wear seat belts at all times. Be aware that no system can prevent all possible injuries that may occur in an accident.
- Never drive a vehicle with a steering wheel-mounted airbag with your hands on the steering wheel pad/airbag housing.
- The front airbags are designed to help prevent serious injury. Deployment occurs very quickly and with considerable force. During normal deployment and depending on variables such as seating position, one may experience abrasions, bruises, swellings, or other injuries as a result from deployment of one or both of the airbags.
- When installing any accessory equipment, make sure that the front airbag system is not damaged. Any interference in the system could cause malfunction.

### **Front airbag deployment**

- The front airbags are designed to deploy during certain frontal or front-angular collisions, impacts, or decelerations, depending on the crash severity, angle, speed and object impacted. The airbags may also deploy in certain non-frontal collisions where rapid deceleration occurs.
- The SRS sensors, which trigger the front airbags, are designed to react to both the impact of the collision and the inertial forces generated by it, and to determine if the intensity of the collision is sufficient for the seat belt tensioners and/or airbags to be deployed.

However, not all frontal collisions activate the front airbags.

- If the collision involves a nonrigid object (e.g., a snow drift or bush), or a rigid, fixed object at a low speed, the front airbags will not necessarily deploy.
- Front airbags do not normally deploy in a side impact collision, in a collision from the rear or in a rollover situation.
- The amount of damage to the bodywork does not reliably indicate if the airbags should have deployed or not.

### **NOTE:**

- Deployment of front airbags occurs only one time during an accident. In a collision where deployment occurs, the airbags and seat belt tensioners activate. Some noise occurs and a small amount of powder is released. The release of the powder may appear as smoke-like matter. This is a normal characteristic and does not indicate fire.
- Volvo's dual-threshold, dual-stage front airbags use special sensors that are integrated with the front seat buckles. The point at which the airbag deploys is determined by whether or not the seat belt is being used, as well as the severity of the collision.
- Collisions can occur where only one of the airbags deploys. If the impact is less severe, but severe enough to present a clear injury risk, the dual-stage airbags are triggered at 70% of their total capacity. If the impact is more severe, the dual-stage airbags are triggered at full capacity.

Should you have questions about any component in the SRS system, please contact a trained and qualified Volvo service technician or Volvo Customer Support:

### **In the USA**

Volvo Cars of North America

Customer Care Center

P.O. Box 914 Rockleigh, New Jersey 07647- 0914

1-800-458-1552

<http://www.volvocars.us>

## In Canada

Volvo Cars of Canada Ltd.  
National Customer Service  
175 Gordon Baker Road  
North York, Ontario M2H 2N7  
1-800-663-8255  
<http://www.volvocanada.com>

### WARNING!

- Do not use child safety seats or child booster cushions/backrests in the front passenger's seat. We also recommend that occupants under 4 feet 7 inches (140 cm) in height who have outgrown these devices sit in the rear seat with the seat belt fastened<sup>a</sup>.
- Never drive with the airbags deployed. The fact that they hang out can impair the steering of your vehicle. Other safety systems can also be damaged.
- The smoke and dust formed when the airbags are deployed can cause skin and eye irritation in the event of prolonged exposure.

a. See also the Occupant Weight Sensor information on [page 18](#).

pg. 17 Front airbags

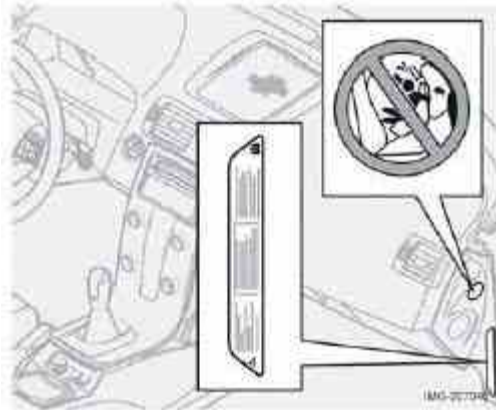

*Airbag decal on the far right end of the passenger's dashboard*



*Airbag decal on the outside of both sun visors*

### WARNING!

- Children must never be allowed in the front passenger's seat. Volvo recommends that ALL occupants (adults and children) shorter than 4 feet 7 inches (140 cm) be seated in the back seat of any vehicle with a passenger-side front

airbag. See [page 31](#) for guidelines.

- Occupants in the front passenger's seat must never sit on the edge of the seat, sit leaning toward the instrument panel or otherwise sit out of position.
- The occupant's back must be as upright as comfort allows and be against the seat back with the seat belt properly fastened.
- Feet must be on the floor, e.g., not on the dash, seat or out of the window.



*Airbag decal on passenger's side dashboard*

### **WARNING!**

- No objects or accessory equipment, e.g. dashboard covers, may be placed on, attached to, or installed near the air bag hatch (the area above the glove compartment) or the area affected by airbag deployment (see the illustration on [page 14](#)).
- There should be no loose articles, e.g. coffee cups, on the floor, seat, or dashboard area.
- Never try to open the airbag cover on the steering wheel or the passenger's side dashboard. This should only be done by a trained and qualified Volvo service technician.

Failure to follow these instructions can result in injury to the vehicle occupants.

pg. 18 Occupant Weight Sensor - disabling the passenger's side front airbag



*Occupant Weight Sensor (OWS) indicator light*

### **Disabling the passenger's side front airbag**

Volvo recommends that ALL occupants (adults and children) shorter than 4 feet 7 inches (140 cm) be seated in the back seat of any vehicle with a front passenger side airbag, and be properly restrained for their size and weight. See also the child safety recommendations on [page 31](#).



The passenger's side front airbag is automatically enabled/disabled by the Occupant Weight Sensor (OWS), a system that monitors the weight of the person or object in the front passenger's seat. The system consists of a silicone-filled bag located under the padding in the front passenger's seat Occupant Weight Sensor - disabling the passenger's side front airbag cushion, a control module located under this seat, and a seat belt tension sensor, located on the outboard side of the seat.

The OWS system continuously monitors the pressure on the front passenger's seat cushion and the tension applied to the seat belt. Based on this data, OWS assesses the weight of the occupant or object in the front passenger's seat. This information is transmitted to the SRS system control module, which enables or disables the passenger's side front airbag accordingly, as indicated in the table below.

If the system is functioning normally, the status of the front passenger's side airbag (enabled/disabled) will be shown by the OWS indicator light as explained in the table to the right. The OWS indicator light is separate and in addition to the SRS warning light in the instrument panel.

**NOTE:** When the ignition is switched on, the OWS indicator light will go on for up to 10 seconds while the system performs a self diagnostic test and then go out. However, if a fault is detected in the system:

- The OWS indicator light will stay on
- The SRS warning light (see [page 14](#)) will come on and stay on
- The message PASS. AIRBAG OFF SERVICE URGENT will be displayed in the information display.

Passenger's seat occupancy status	OWS indicator light status	Passenger's side front airbag status
Seat unoccupied/ person or object weighing less than approx.15 lbs (7 kg) on seat	OWS indicator light  is not lit	Passenger's side front airbag disabled
Seat occupied by a person or object weighing up to approx.55-65 lbs (25-30 kg)	OWS indicator light  lights up	Passenger's side front airbag disabled
Seat occupied by a person or object weighing more than approx. 55-65 lbs (25-30 kg)	OWS indicator light  is not lit	Passenger's side front airbag enabled

pg. 19 Occupant Weight Sensor - disabling the passenger's side front airbag

**WARNING!**

If a fault in the system is detected and indicated as explained on the preceding page, be aware that the passenger's side front airbag will not deploy in the event of a collision. In this case, the SRS system and Occupant Weight Sensor should be inspected by a trained and qualified Volvo service technician as soon as possible.

**Modifications**

If you are considering modifying your vehicle in any way to accommodate a disability, for example by altering or adapting the driver's or front passenger's seat(s) and/or airbag systems, please contact Volvo at:



## **In the USA**

Volvo Cars of North America  
Customer Care Center  
P.O. Box 914 Rockleigh, New Jersey 07647- 0914  
1-800-458-1552

## **In Canada**

Volvo Cars of Canada Ltd.  
National Customer Service  
175 Gordon Baker Road  
North York, Ontario M2H 2N7  
1-800-663-8255

### **WARNING!**

- Never try to open, remove, or repair any components in the OWS system. This could result in system malfunction. Maintenance or repairs should only be carried out by an a trained and qualified Volvo service technician.
- The front passenger's seat should not be modified in any way. This could reduce pressure on the seat cushion, which might interfere with the OWS system's function.

### **WARNING!**

- No objects that add to the total weight on the seat should be placed on the front passenger's seat. If a child is seated in the front passenger's seat with any additional weight, this extra weight could cause the OWS system to enable the airbag, which might cause it to deploy in the event of a collision, thereby injuring the child.
- The seat belt should never be wrapped around an object on the front passenger's seat. This could interfere with the OWS system's function.
- The front passenger's seat belt should never be used in a way that exerts more pressure on the passenger than normal. This could increase the pressure exerted on the weight sensor by a child, and could result in the airbag being enabled, which might cause it to deploy in the event of a collision, thereby injuring the child.

pg. 20 Occupant Weight Sensor - disabling the passenger's side front airbag

### **WARNING!**

Keep the following points in mind with respect to the OWS system. Failure to follow these instructions could adversely affect the system's function and result in serious injury to the occupant of the front passenger's seat:

- The full weight of the front seat passenger should always be on the seat cushion. The passenger should never lift him/herself off the seat cushion using the armrest in the door or the center console, by pressing the feet on the floor, by sitting on the edge of the seat cushion, or by pressing against the backrest in a way that reduces pressure on the seat cushion. This could cause OWS to disable the front, passenger's side airbag.
- Do not place any type of object on the front passenger's seat in such a way that jamming, pressing, or squeezing occurs between the object and the front seat, other than as a direct result of the correct use of the ALR/ELR seat belt (see [page 31](#)).
- No objects should be placed under the front passenger's seat. This could interfere with the OWS system's function.



2006  
VOLVO  
S40

Chapter 3 - Instruments and controls

pg. 33 Instruments and controls

<a href="#">Instrument panel</a>	<a href="#">34</a>
<a href="#">Indicator and warning symbols</a>	<a href="#">35</a>
<a href="#">Symbols on the left side of the instrument panel</a>	<a href="#">36</a>
<a href="#">Symbols on the right side of the instrument panel</a>	<a href="#">37</a>
<a href="#">Information display</a>	<a href="#">39</a>
<a href="#">Center console controls</a>	<a href="#">40</a>
<a href="#">Lighting panel</a>	<a href="#">41</a>
<a href="#">Left-side steering wheel lever</a>	<a href="#">42</a>
<a href="#">Trip Computer</a>	<a href="#">43</a>
<a href="#">Cruise control (option)</a>	<a href="#">44</a>
<a href="#">Right-side steering wheel lever</a>	<a href="#">46</a>
<a href="#">Rain Sensor</a>	<a href="#">47</a>
<a href="#">Steering wheel adjustment, Hazard warning flashers</a>	<a href="#">48</a>
<a href="#">Parking brake, 12 volt socket</a>	<a href="#">49</a>
<a href="#">Power windows</a>	<a href="#">50</a>
<a href="#">Mirrors</a>	<a href="#">52</a>
<a href="#">Power moonroof (option)</a>	<a href="#">54</a>
<a href="#">Personal settings</a>	<a href="#">56</a>
<a href="#">Home Link® Universal Transceiver (option)</a>	<a href="#">58</a>

pg. 34 Instrument panel

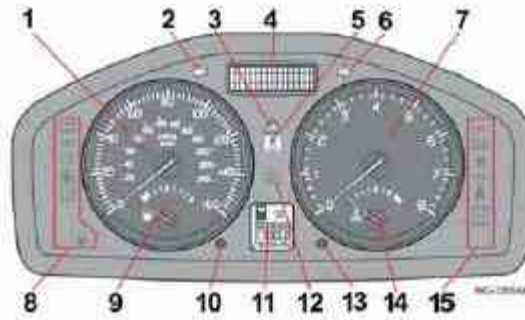

## 1. Speedometer

## 2. Turn signal, left

## 3. Warning symbol

See the next page for additional information.

## 4. Information display

The display presents information and warning messages, the ambient temperature, and the clock, etc. When the ambient temperature is between 23° and 36°F (-5° and +2°C), a snowflake symbol is shown in the display. This symbol serves as a warning for possible slippery road surfaces. Please note that this symbol does not indicate a fault with your car. At low speeds, or when the car is not moving, the temperature readings may be slightly higher than the actual ambient temperature.

## 5. Information symbol

See the next page for additional information.

## 6. Turn signal, right

## 7. Tachometer

The tachometer shows engine speed in thousands of revolutions per minute (rpm). Do not drive continuously with the needle in the red area of the dial, which indicates maximum allowable engine rpm range. Instead, shift to a higher gear or slow the vehicle down. The engine management system will automatically prevent excessively high engines speeds. This will be noticeable as a pronounced unevenness in engine speed.

## 8. Indicator and warning symbols

## 9. Fuel gauge

The fuel tank holds approximately 15.9 US gallons (60 liters)<sup>1</sup>. When a warning light in the gauge comes on, there are approximately 2.1 US gallons (8 liters) of fuel remaining in the tank.

## 10. Trip odometer reset button

The trip odometers are used to measure short distances. Press the button briefly to switch between the odometer for the car's total mileage and the two trip odometers, T1 and T2. A long press (more than 2 seconds) resets the currently selected trip odometer.

## 11. Function display

This window displays information on functions such as the odometer, trip odometers, optional rain sensor, and cruise control.

## 12. High beam indicator

## 13. Clock setting button

Turn the button to set the time.

## 14. Temperature gauge

The gauge indicates the temperature of the engine cooling system. If the temperature is abnormally high and the needle enters the red zone, a message is shown in the display. Bear in mind that auxiliary lamps in front of the air intake reduce the cooling capacity at high outside temperatures and high engine loads.

## 15. Indicator and warning symbols

1. Models with All Wheel Drive have a tank volume of 15 US gallons (57 liters).

Models with engine code 39 have a fuel tank capacity of 14 US gallons (53 liters). This code is the 6th and 7th digits from the left in your vehicle's VIN number. See [page 176](#) for the location of the VIN plate.

### pg. 35 Indicator and warning symbols

#### Function check

The indicator and warning symbols light up when you turn the ignition key to the driving position (position II) before starting. This shows that the symbols are functioning. When the engine starts, all symbols go out. If the engine is not started within 5 seconds, all of the symbols except CHECK ENGINE and  will go out. Certain symbols may not have their functions illustrated, depending on the car's equipment. The PARK BRAKE symbol will not go out until the parking brake has been released.

#### Symbols in the center of the instrument panel



#### Warning symbol

The red warning symbol lights up to indicate a fault that could affect the car's driveability. A text explaining the nature of the fault will also be shown in the information display. The symbol and accompanying text will remain on until the fault has been corrected. This symbol may also light up in combination with other indicator or warning symbols.

If the red warning symbol lights up:

1. Stop the car as soon as possible in a suitable location.

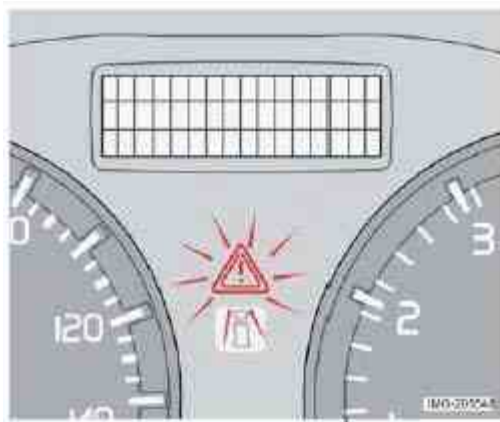

2. Read the message in the information display.

3. Follow the instructions provided, or contact a trained and qualified Volvo service technician.



#### Information symbol

The yellow information symbol lights up to alert the driver to a message in the information display. The message can be erased by pressing the READ button (see [page 39](#)), or will disappear automatically after two minutes.

When the message "TIME FOR REGULAR SERVICE" is displayed, the text can be erased and the information symbol light can be turned off by pressing the READ button. The text will disappear and the symbol light will go out.

automatically after two minutes. This symbol may also light up in combination with other indicator or warning symbols.

**NOTE:** The car can still be driven after the information symbol has come on. The car can be driven for 1-2 weeks after service-related information has been displayed.

pg. 36 Symbols on the left side of the instrument panel

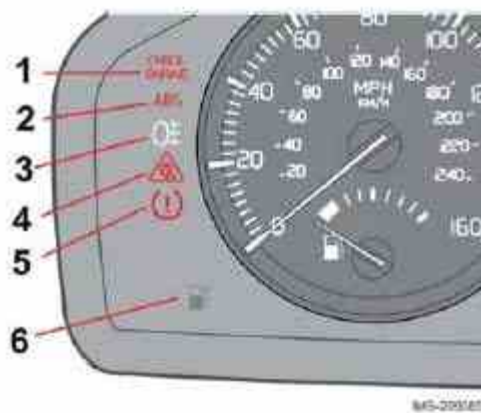

## Symbols - left side of instrument panel

### 1. Malfunction indicator light

**CHECK ENGINE** As you drive, a computer called On-Board Diagnostics II (OBDII) monitors your car's engine, transmission, electrical and emission systems. The CHECK ENGINE light will light up if the computer senses a condition that potentially may need correcting. When this happens, please have your car checked by a trained and qualified Volvo service technician as soon as possible.

A CHECK ENGINE light may have many causes. Sometimes, you may not notice a change in your car's behavior. Even so, an uncorrected condition could hurt fuel economy, emission controls, and driveability. Extended driving without correcting the cause could even damage other components in your car. Canadian models are equipped with this symbol . 

### 2. Anti-lock brake system (ABS)

**ABS** If the warning light comes on, there is a malfunction of the ABS system (the standard braking system will still function). The vehicle should be driven to a trained and qualified Volvo service technician for inspection. See [page 107](#) for additional information. Canadian models are equipped with this symbol . 

### 3. Rear fog light

 This symbol indicates that the rear fog light (located in the driver's side tail light cluster) is on.

### 4. Stability system STC or DSTC

 This indicator symbol flashes when the STC (Stability and Traction control system) or the DSTC (Dynamic Stability and Traction control system) is actively working to stabilize the car. See [page 109](#) for more detailed information.

### 5. Not in use

## 6. Fuel level warning light



When this light comes on, there are approximately 2.1 US gallons (8 liters) of fuel remaining in the tank.

pg. 37 Symbols on the right side of the instrument panel

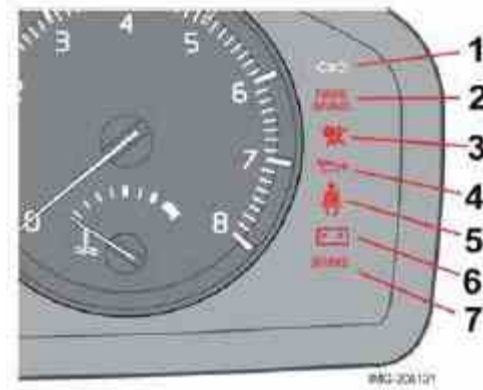

### Symbols - right side of instrument panel

#### 1. Turn signal indicator for trailer (certain models)

 If you are towing a trailer, this light will flash simultaneously with the turn signals on the trailer. If the light does not flash when signaling, one of the turn signals on the trailer or on the car are not functioning properly.

#### 2. Parking brake applied

 This light is on when the parking brake (hand brake) is applied. The parking brake lever is situated between the front seats.

Canadian models are equipped with this symbol .

#### 3. SRS warning light

 If this light comes on while the car is being driven, or remains on for longer than approximately 10 seconds after the car has been started, the SRS system's diagnostic functions have detected a fault in a seat belt lock or tensioner, a front airbag, side impact airbag, and/or an inflatable curtain. Have the system(s) inspected by a trained and qualified Volvo service technician as soon as possible.

#### 4. Oil pressure warning light

 If the light comes on while driving, stop the car, stop the engine immediately, and check the engine oil level. If the oil level is normal and the light stays on after restart, have the car towed to the nearest trained and qualified Volvo service technician. After hard driving, the light may come on occasionally when the engine is idling. This is normal, provided it goes off when the engine speed is increased.

#### 5. Seat belt reminder

This symbol (and the seat belt reminder light above the rear view mirror) will light up if either front seat



occupant has not buckled his/her seat belt. If the car is not moving, the symbols will go out after approximately 6 seconds.

## 6. Generator warning light



If the light comes on while the engine is running, have the charging system checked by a trained and qualified Volvo service technician.

## 7. Brake failure warning light

**BRAKE** If this light comes on while driving or braking, stop the car as quickly as possible in a safe place, open the hood, and check the brake fluid level in the reservoir. See [page 145](#) for the location of the reservoir.

pg. 38 Symbols on the right side of the instrument panel

Canadian models are equipped with this symbol .

### **WARNING!**

If the fluid level is below the MIN mark in the reservoir or if a "Brake failure - Service urgent" message is displayed in the information display: **DO NOT DRIVE**. Have the car towed to a trained and qualified Volvo service technician and have the brake system inspected.

**If the BRAKE and ABS warning lights come on at the same time, this could indicate a fault in the brake system.**

In this case:

1. Stop the car in a suitable place and switch off the engine.
2. Restart the engine.
3. If both warning lights go off, no further action is required and the car can be driven.
4. If both lights remain on after the engine has been restarted, switch off the engine again and check the brake fluid level. See [page 145](#) for the location of the reservoir.

## Door open warning

The driver will be alerted if one of the doors, the hood, or the trunk lid are open or ajar.

### At low speeds



If the car is moving at a speed of less than approximately 4 m.p.h. (7 km/h), the Information symbol in the instrument panel will light up and a message will be shown in the information display indicating which door(s), etc is not completely closed.

### At higher speeds



If the car is moving at a speed above approximately 4 m.p.h. (7 km/h), the Warning symbol in the instrument panel will light up and a message will be shown in the information display indicating which door(s), etc is not completely closed.

## Hood and trunk

If the hood and/or trunk lid is not completely closed, the Information symbol in the instrument panel will



light up and a message will be displayed, regardless of the vehicle's speed.

pg. 39 Information display

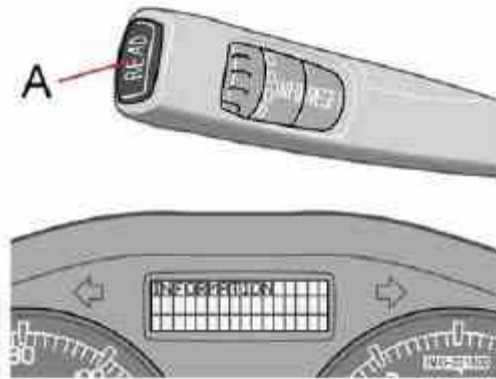

### Messages

When an indicator or warning light in the instrument panel comes on, a message is also shown in the information display. To read a message:

Press the READ button (A).

Pressing READ repeatedly enables you to scroll to any other messages that may be stored.

**NOTE:** If a message is displayed when e.g. you are using the trip computer, this message must be read before you can access the trip computer.

Message	Meaning
STOP SAFELY	Stop and switch off the engine to help prevent the risk of serious damage.
STOP ENGINE	Stop and switch off the engine to help prevent the risk of serious damage.
SERVICE URGENT	Take your car to a trained and qualified Volvo service technician for inspection immediately.
SEE MANUAL	Refer to your owner's manual. For additional information, please contact a trained and qualified Volvo service technician.
SERVICE REQUIRED	Take your car to a trained and qualified Volvo service technician for inspection as soon as possible (but preferably before the next scheduled maintenance service).
TIME FOR REGULAR SERVICE	This message is affected by the number of miles/km driven, by the number of months, or by the number of engine hours since the service reminder was reset at the most recent regularly scheduled service.

pg. 40 Center console controls



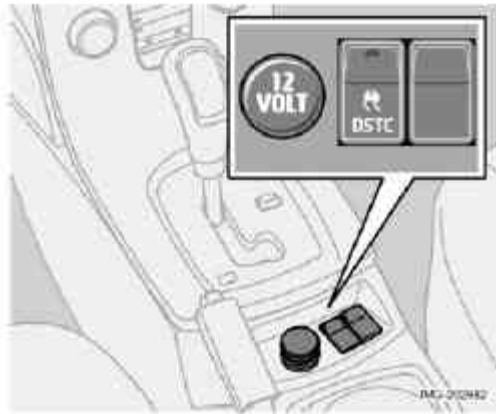

*12 volt socket, stability system, auxiliary equipment*

### **12 volt sockets**

The 12 volt sockets can be used to plug in certain accessories such as cellular telephones, etc. The key must be in position I (or higher) for the auxiliary socket to function. The auxiliary sockets can also be used for cigarette lighters, which are available at your Volvo retailer.

**NOTE:** The cover should be kept on when the auxiliary socket is not in use.

### **Stability system STC or DSTC**

The stability system - Stability and Traction Control (STC), or the optional Dynamic Stability and Traction Control (DSTC) - activate automatically when the car is started. In certain situations, it may be necessary to disable the system's anti-spin function, for example, while driving for a short period with tires of different dimensions.

#### **To disable the anti-spin function:**

Press the STC<sup>1</sup> or DSTC button for approximately one second. The indicator light in the button will go out, and STC/DSTC SPIN CONTROL OFF will be shown in the information display.

1. Models equipped with All Wheel Drive (AWD) have an integrated traction control function, and are not equipped with an STC button. DSTC is optional.

#### **WARNING!**

The car's handling and stability characteristics will be altered with the anti-spin function disabled.

**NOTE:** The anti-spin function will be automatically reactivated when the engine is started.

### **Auxiliary equipment**

The button to the right of the STC/DSTC button can be used for Volvo-installed optional or auxiliary equipment.

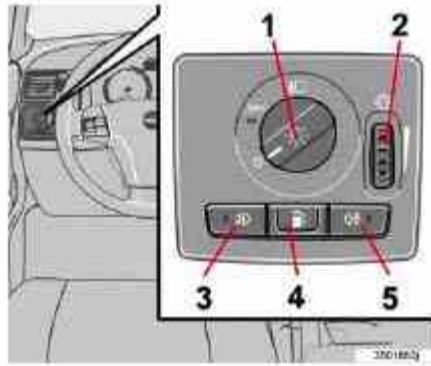

1. Headlight/parking light switch
2. Instrument panel lighting
3. Front fog lights
4. Fuel filler door unlock button
5. Rear fog light

### Parking lights

The front and rear parking lights can be turned on even when the ignition is switched off.

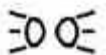
- Turn switch 1 to position .

The license plate lights also illuminate when the parking lights are switched on.

### Headlights

- Turn the ignition key to position II.
- The low beam headlights (daytime running lights) illuminate automatically, except when the light switch (1) is in position  1.

**NOTE:** See [page 42](#) for information on switching between high and low beams.

### Fog lights

#### Front fog lights (option)

The front fog lights can be used in combination with either the headlights or the parking lights.

- Turn the ignition key to position II.
- Press button 3 to turn on the front fog lights.

An indicator light in the button illuminates when the front fog lights are on.

#### Rear fog light



The single rear fog light is located in the driver's side tail light cluster.

The rear fog light will only function in combination with the high/low beam headlights or the optional front fog lights.

- Turn the ignition key to position II.
- Press button 5 to turn on the rear fog light. An indicator light in the button illuminates when the rear fog light is on.

**NOTE:** The rear fog light is considerably brighter than the normal tail lights and should be used only when conditions such as fog, rain, snow, smoke or dust reduce visibility for other vehicles to less than 500 ft. (150 meters).

## Instrument panel lighting

The instrument panel lighting illuminates when the ignition key is in position II and the light switch (1) is in either position  or  .

- Move the thumb wheel (2) up to increase brightness or down to decrease brightness.

## Unlocking the fuel filler door

With the ignition switched off, press button 4 to unlock the fuel filler door. Please note that the fuel filler door will remain unlocked until the car begins to move forward.

An audible click will be heard when the fuel filler door re-locks.

1. On Canadian models, the daytime running lights will remain on with the light switch in this position.

pg. 42 Left-side steering wheel lever

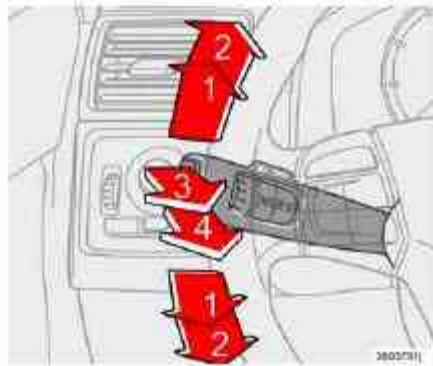

## Lever positions

1. Turn signals, lane change position
2. Turn signals, position for normal turns
3. High beam flash
4. Toggle between high and low beams, Home Safe lighting

## Turn signals

### When turning

Move the lever as far up or down as possible (to position 2) to start the turn signals. The turn signals will be cancelled automatically by the movement of the steering wheel, or the lever can be returned to its initial position by hand.

### When changing lanes

The driver can flash the turn signals by moving the turn signal lever up or down to position 1 and releasing it. The turn signals will flash three times and the lever will automatically return to its initial position.

**NOTE:** If the turn signal indicator flashes faster than normal, check for a burned-out turn signal bulb.

## High/low beam headlights

### Continuous high beams

- Turn the ignition key to position II.
- With the light switch (1) in position , (see [page 41](#)) pull the turn signal lever toward the steering wheel (position

4) to toggle between high and low beams.

### High beam flash

- Turn the ignition key to position II.
- Pull the turn signal lever to position 3. The high beams will remain on until the lever is released.

### Home safe lighting

When you leave your car at night, you can make use of the home safe lighting function to illuminate the area in front of the car.

- Remove the key from the ignition switch.
- Pull the direction indicator lever as far as possible towards the steering wheel (to position 4) and release it.
- Exit the car and lock the doors.

The headlights and parking lights will illuminate and remain on for 30<sup>1</sup>, 60 or 90 seconds. The time interval can be changed according to your preferences by using the Personal Settings function, see [page 56](#) for more information.

1. Factory setting

pg. 43 Trip Computer

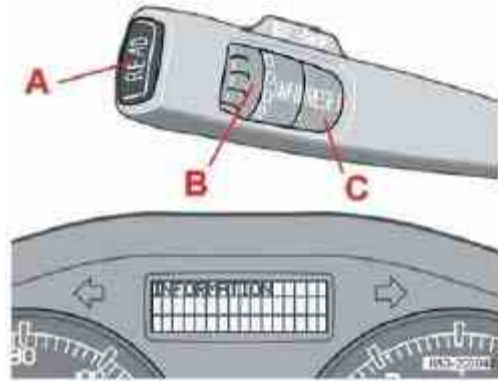

### Trip computer (option)

The trip computer stores information gathered from several systems in your car and has four menus (five on Canadian models) that can be shown in the information display.

- Driving distance on current fuel reserve
- Average fuel consumption
- Current fuel consumption
- Average speed

**NOTE:** Current speed in m.p.h. (Canadian models only)

**NOTE:** Warning messages from the car's monitoring systems will override the trip computer function. If a warning message is shown in the information display while you are using the trip computer, you must acknowledge the message by pressing the READ button (A). Press button A again to return to the trip computer function.

### Controls

The four trip computer functions (five on Canadian models) can be accessed by twisting INFO (B) one step at a time

in either direction. Twisting a fifth time (sixth time on Canadian models) returns you to the original function. The trip computer can be reset (average fuel consumption and average speed will be erased from system memory) by pressing RESET (C) for at least five seconds.

### **Driving distance on current fuel reserve**

This function shows the approximate distance that can be driven on the fuel remaining in the tank. This calculation is based on average fuel consumption during the last 20 miles (30 km) of driving and the amount of fuel remaining in the tank when the reading was taken. When the driving distance on current fuel reserve is less than 12 miles (20 km), "---" will be displayed in the information display.

### **Average fuel consumption**

This value indicates fuel consumption since the last time the trip computer was reset (by pressing RESET, button C). When the engine is switched off, information on fuel consumption is stored and remains in system memory until the RESET (button C) is pressed again.

### **Current fuel consumption**

This value indicates the current fuel consumption, based on readings taken once per second. When the car is not moving, "----" will be displayed.

### **Average speed**

This value indicates average speed since the last time the trip computer was reset (by pressing RESET, button C). When the engine is switched off, information on average speed is stored and remains in system memory until the RESET (button C) is pressed again.

### **Current speed in m.p.h. (Canadian models only)**

This function provides the driver with an instantaneous conversion of the car's current speed from km/h to m.p.h.

**NOTE:** Trip computer readings may vary slightly depending on the circumference of the tires on the car or on tire inflation.

pg. 44 Cruise control (option)



### **Cruise control**

The cruise control buttons are located on the left side of the steering wheel hub.

#### **Engaging the cruise control function**

1. Press the CRUISE button. CRUISE will appear in the function display in the center of the instrument panel.

**NOTE:** This does not set the vehicle's speed.

2. Press + or - to set the current speed. CRUISE ON will be displayed.

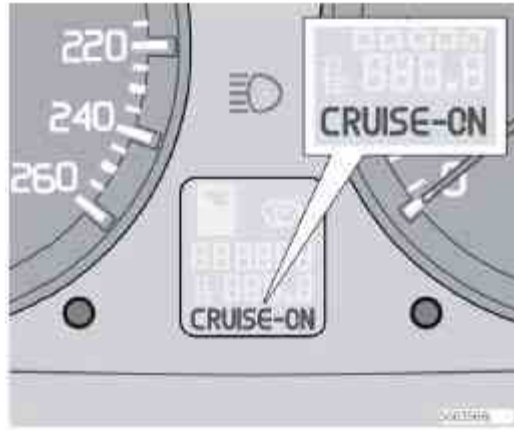

### **Increasing or decreasing speed**

Use + or - in the following ways to increase or decrease the vehicle's speed:

- Press and hold down + or - until the vehicle reaches the desired speed. This will become the set speed when the button is released.
- Press + or - for approximately a half second and release the button to increase or decrease vehicle speed by approximately 1 mph (1.6 km/h).

### **NOTE:**

- Cruise control will not function at speeds below 20 m.p.h. (30 km/h).
- Momentary acceleration, for less than 1 minute (e.g. when passing another car), does not affect cruise control operation. The car will automatically return to the previously set speed when the accelerator pedal is released.

### **Temporarily disengaging the cruise control**

Press 0 to temporarily disengage cruise control. CRUISE will appear in the function display. The currently set speed is stored in the system's memory.

### **Cruise control is also automatically disengaged:**

- If the speed drops below approximately 20 mph (30 km/h) when driving uphill.
- When the brake or clutch pedal is depressed.
- If the gear selector is moved to position N.
- During wheel spin or wheel lock-up.
- If the vehicle's speed is increased by using the accelerator pedal for more than 1 minute.

### **Returning to the set speed**



Press the button to resume the previously set speed.

pg. 45 Cruise control (option)

### **Disengaging cruise control**

Cruise control can also be disengaged by:

- Pressing the CRUISE button (CRUISE ON will no longer be shown in the function display).
- Putting the gear selector in (N)utral.

**WARNING!**

Cruise control should not be used in heavy traffic or when driving on wet or slippery roads. Cruise control may not maintain set speed on steep downgrades.

pg. 46 Right-side steering wheel lever

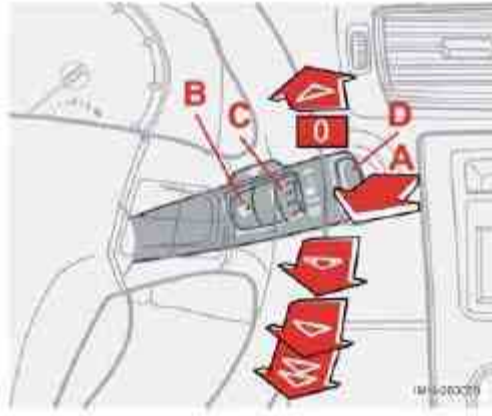

### Windshield wipers

- A. Windshield/headlight washers
- B. Rain sensor (option) - on/off
- C. Thumb wheel
- D. Used on wagon models only

### Windshield wipers off

 The windshield wipers are off when the lever is in position 0

### Manual wiper function

 From position 0, move the lever upward. The windshield wipers will sweep one stroke at a time for as long as the lever is held up.

### Intermittent wiper function

 With the lever in this position, you can set the wiper interval by moving the thumb wheel (C) upward to increase wiper speed or downward to decrease the speed.

### Continuous wiper function

 The wipers operate at "normal" speed.

 High speed wiper function.

### A - Windshield washers

Pull the lever toward the steering wheel and release it. The wipers will make 2-3 sweeps across the windshield after the lever has been released.

### CAUTION!

Use ample washer fluid when washing the windshield to avoid scratching the glass.

### Headlight washers (certain models)

When the lever has been pulled, high pressure jets mounted in the bumper will spray the headlights.

The following applies to conserve washer fluid (see [page 41](#) for information on the light switch positions):



### Low/high beam headlights on

The headlights will be washed the first time the windshield is washed. Thereafter, the headlights will only be washed once for every five times the windshield is washed within a 10-minute period.



### Parking lights on

- Optional Bi-Xenon headlights will be washed once for every five times the windshield is washed.
- Normal halogen headlights will not be washed.

pg. 47 Rain sensor

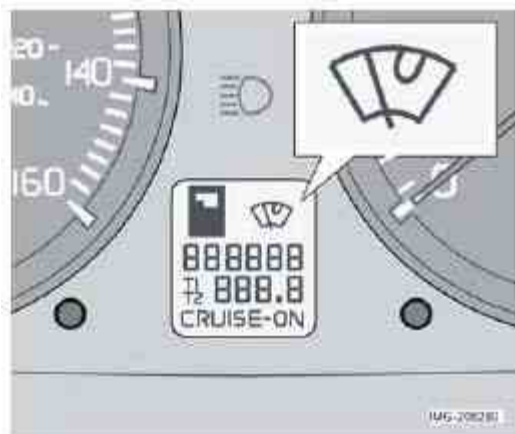

### B - Rain sensor (option)

The rain sensor regulates windshield wiper speed according to the amount of water on the windshield. The sensitivity of the rain sensor is adjusted by moving the thumb wheel (C in the illustration on the previous page) up (the wipers will sweep the windshield more frequently) or down (the wipers will sweep the windshield less frequently).

### On/Off

#### To activate the rain sensor:

1. Switch on the ignition.
2. Put the windshield wiper lever in position 0.
3. Press button B (see the illustration on the previous page). The rain sensor symbol will appear in the lower display.

#### The rain sensor can be deactivated by:

- Pressing button (B).
- or
- Moving the windshield wiper lever down. If the lever is moved up, the rain sensor function will remain activated.

### CAUTION!

The rain sensor should be deactivated when washing the car in an automatic car wash, etc. If the rain sensor function is left on, the wipers will start inadvertently in the car wash and could be damaged.



**The rain sensor is automatically deactivated:**

- When the key is removed from the ignition.
- Five minutes after the ignition is switched off if the key is left in the ignition.

**C - Thumb wheel**

The thumb wheel is used to set the wiper interval when intermittent wiping is selected, or the sensitivity to the amount of rain on the windshield when the rain sensor is selected. Move the wheel upward or downward to increase/decrease wiper speed when the intermittent function is selected, or to increase/decrease the optional rain sensor's sensitivity when the this function is activated.

**D - This button is used on wagon models only**

---



[Contents](#) | [Top of Page](#)

# 2006 VOLVO S40

## Chapter 4 - Climate

pg. 61 Climate

[General information](#) 62

[Manual climate control](#) 64

[Electronic climate control \(ECC\) - option](#) 66

[Air distribution](#) 69

pg. 62 General information

### **Air conditioning - A/C**

Your car is equipped with a climate control system that includes either manually adjustable air conditioning or optional Electronic Climate Control (ECC).

The air conditioning system can be switched off, but for optimal air quality in the passenger compartment and to prevent the windows from fogging, the air conditioning should be left on - even in cool weather.

**NOTE:** In warm weather, a small amount of water may accumulate under the car when it has been parked. This water is condensation from the A/C system and is normal.

### **Ice and snow**

Always keep the air intake grille at the base of the windshield free of snow.

### **Climate control maintenance**

Special tools and equipment are required to maintain and carry out repairs on the climate system. Work of this type should only be done by a trained and qualified Volvo service technician.

### **Refrigerant**

Volvo cares about the environment. The air conditioning system in your car contains a CFC-free refrigerant - R134a. This substance will not deplete the ozone layer. The system contains 1.2 lbs (530 g) R134a (HFC 134a), and uses PAG oil.

### **Passenger compartment filter**

Replace the cabin air filter with a new one at the recommended intervals. Please refer to your Warranty and Service Records Information booklet, or consult a trained and qualified Volvo service technician for these intervals. The filter should be replaced more often when driving under dirty and dusty conditions. The filter cannot be cleaned and therefore should always be replaced with a new one.

**NOTE:** There are different types of cabin air filters. Ensure that the correct type is installed.

### **Display**

The display above the climate control panel shows the climate settings that have been made.

## Personal settings

There are two functions in the climate system that can be set to your preferences:

- Blower speed to Auto mode (models with ECC only).
- Timer controlled recirculation of the air in the passenger compartment. For information about how to make these settings, see the Personal settings section on [page 57](#).

## Models equipped with ECC (option)

### Sensors

The sunlight sensor on the upper side of the dashboard and the passenger compartment temperature sensor, located behind the climate system control panel, should not be obstructed.

### Side windows and optional moonroof

The electronic climate control system will function best if the windows and moonroof are closed. If you drive with the windows or moonroof open, it may be preferable to manually adjust the temperature and blower control (the LED in the AUTO switch should be off).

### Acceleration

The air conditioning system is temporarily switched off during full throttle acceleration.

pg. 63 General information

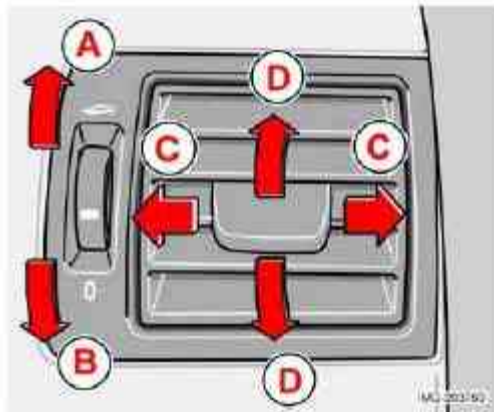

### Air vents in the dashboard

- A. Open
- B. Closed
- C. Horizontal air flow
- D. Vertical air flow

Direct the outer air vents toward the side windows to defrost.

pg. 64 Manual climate control



*Climate system control panel*

1. Blower speed
2. Recirculation
3. Defroster
4. Airflow controls
5. A/C - OFF/ON
6. Heated driver's seat
7. Heated front passenger's seat
8. Rear window and door mirror defrosters
9. Temperature selector

## Manual climate system functions

### 1. Blower speed



The blower speed can be increased or decreased by turning the knob. If the knob is turned

counterclockwise and the indicator light in the display goes out, the blower and the air conditioning are switched off. The display shows the blower symbol and OFF.

### 2. Recirculation



This function can be used to shut out exhaust fumes, smoke, etc from the passenger compartment. The

air in the passenger compartment is then recirculated, i.e. no air from outside the car is taken into the car when this function is activated. Recirculation (together with the air conditioning system) cools the passenger compartment more quickly in very warm weather. If the air in the car recirculates for too long, there is a risk of condensation forming on the insides of the windows, especially in winter.

### Timer

The timer function minimizes the risk of misting, or stale air when the recirculation function is selected. See [page 57](#) for information on setting the recirculation timer. Recirculation is always disengaged when you select Defroster (3).

### 3. Defroster



Directs airflow to the windshield and side windows and increases blower speed.

- Air flows to the windows at high blower speed.
- The LED in the defroster button lights up when this function is activated. The air conditioning system is controlled to provide maximum air dehumidification.

- The air is not recirculated.

pg. 65 Manual climate control

#### 4. Airflow controls



Press one of the three buttons in the illustration to activate the selected airflow. A symbol in the display

above the climate control panel and a lit LED in the selected button indicate that the manual function has been selected. With manually selected airflow both warm and cool air can be selected. The desired temperature is selected using control 9.

#### 5. A/C - On or Off



The air conditioning system is engaged when the ON LED is lit. The system is disengaged when the OFF

lights up. If Defroster (3) is activated the air conditioning is always engaged.

#### 6/7. Heated front seats (option)



**Maximum heating:** Press the button once - both LEDs light up.

**Reduced heating:** Press the button a second time - one LED lights up.

**Seat heating off:** Press the button a third time - no LEDs are lit.

#### 8. Heated rear window and door mirrors



Use this function to defrost the rear window and door mirrors.

#### 9. Temperature selector



The knob with the thermometer symbol is used to select cooling or heating for both the driver's and passenger's sides of the car.

pg. 66 Electronic climate control (ECC) - option



1. Auto - On/Off
2. Blower speed
3. Recirculation
4. Defroster
5. Airflow controls
6. A/C - ON/OFF
7. Heated driver's seat
8. Heated front passenger's seat
9. Rear window and door mirror defrosters
10. Temperature selector

## ECC functions

### 1. Auto -On/Off



The AUTO function automatically regulates climate control to maintain the desired temperature. The automatic function controls heating, air conditioning, blower speed, recirculation, and air distribution.

If you select one or more manual functions, the remaining functions continue to be controlled automatically. All manual settings are switched off when AUTO is switched on. AUTO CLIMATE is shown in the display.

### 2. Blower speed



The blower speed can be increased or decreased by turning the knob. The blower speed is regulated automatically if AUTO is selected. The previously set blower speed is disconnected.

**NOTE:** If the knob is turned counterclockwise and the blower indication in the display goes out, the blower and the air conditioning are switched off. The display shows the blower symbol and OFF.

### 3. Recirculation



This function can be used to shut out exhaust fumes, smoke, etc from the passenger compartment. The air in the passenger compartment is then recirculated, i.e. no air from outside the car is taken into the car when this function is activated.

If the air in the car recirculates for too long, there is a risk of condensation forming on the insides of the windows, especially in winter.

#### **Timer**

The timer function minimizes the risk of fogging, or stale air when the recirculation

pg. 67 Electronic climate control (ECC) - option

function is selected. See [page 57](#) for information on setting the recirculation timer.

#### **4. Defroster**



Directs airflow to the windshield and side windows and increases blower speed. The LED in the defroster button lights up when this function is activated. The air conditioning system is controlled to provide maximum air dehumidification. The air is not recirculated.

#### **5. Airflow controls**



Press one of the three buttons in the illustration to activate the selected airflow. A symbol in the display above the climate control panel and a lit LED in the selected button indicate that the manual function has been selected. With manually selected airflow both warm and cool air can be selected. See also the table on [page 69](#).

#### **6. Air conditioning On/Off**



The air conditioning system is controlled automatically by the system when the ON LED is lit to maintain the selected temperature. When OFF is selected and the OFF LED is lit, the air conditioning system is deactivated. Other functions are still controlled automatically. When Defroster (4) is selected, the air conditioning system is activated for maximum dehumidifying.

#### **7 and 8. Heated front seats (option)**



- Maximum heating:** Press the button once - both LEDs light up.
- Reduced heating:** Press the button a second time one LED lights up.
- Seat heating off:** Press the button a third time - no LEDs are lit.

**9. Rear window and door mirror defrosters**



Press to defrost the rear window and door mirrors.  
 The rear window and door mirrors are defrosted simultaneously if the switch is pressed once. The function is active if one LED is lit in the switch. The door mirrors are deactivated automatically after approximately 6 minutes. The rear windscreen is deactivated after approximately 12 minutes.

**10. Temperature selector**



The temperatures on the driver's and passenger's sides can be set separately using the knob (with the thermometer in it). The temperature can be set for both sides of the car when the ignition is switched on (both LEDs will be on), which means that a temperature setting will apply to both sides of the car.  
 To set the temperature on one side of the car:

- Press the knob once. The LED for one side of the car will light up. Turn the knob to adjust the temperature.

pg. 68 Electronic climate control (ECC) - option







- Press the knob a second time to set the temperature on the opposite side of the car.
- Press the knob a third time to set the temperature on both sides of the car at the same time.

**NOTE:** Selecting a temperature that is higher or lower than necessary will not heat or cool the passenger compartment faster.

pg. 69 Air distribution

	<b>Air distribution</b>	<b>Use:</b>
	Defroster. Air is not recirculated in this mode. Air conditioning is always engaged. There is a certain amount of airflow to the panel air vents.	Defrost/de-fog the windshield and front side windows.
	Air to windshield and front side windows. There is also a certain amount of airflow to the dashboard air vents.	Prevents fogging in cold or humid weather (blower speed should be moderate to high)



		
	Air to the windows and from dashboard air vents.	For good comfort in warm, dry weather.
	Airflow directed to the head and chest from the dashboard air vents.	To ensure efficient cooling in a warm weather.
	Air to the floor and windows. There is also a certain amount of airflow to the dashboard air vents.	For comfortable conditions and good defrosting in cold weather. Medium to high blower speed.
	Air to the floor and dashboard air vents.	For sunny weather with cool ambient temperatures.
	Air to the floor. There is a certain amount of airflow to the dashboard and window air vents.	To warm the feet.
	Airflow to the windows, dashboard air vents, and floor.	For cooler air toward the feet, or for warmer air toward the head and chest.

pg. 70 This page intentionally left blank



# 2006 VOLVO S40

## Chapter 5 - Interior

pg. 71 Interior

[Front seats](#) 72

[Interior lighting](#) 75

[Storage compartments](#) 76

[Rear seat](#) 78

[Trunk](#) 80

pg. 72 Front seats



### Manual seat adjustment

The driver's and passenger's seats can be adjusted in a number of ways to provide a comfortable driving and sitting position.

1. Forward-rearward: Pull the lever up and slide the seat to the position of your choice.
2. Use this control to raise or lower the front edge of the seat cushion.
3. Use this control to raise or lower the rear edge of the seat cushion.
4. Turn this knob (option on some passenger's seats) to adjust the firmness of the lumbar support.
5. Turn this knob to adjust the backrest tilt.

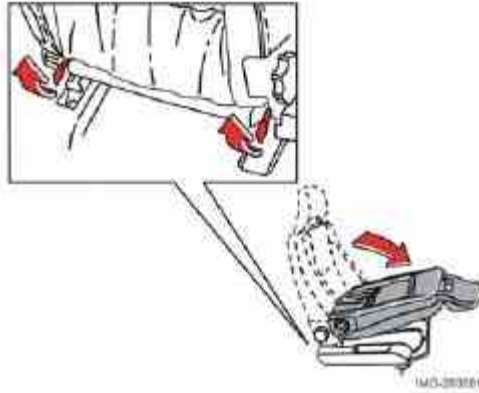

*Folding down the front seat backrest*

**WARNING!**

Do not adjust the seat while driving.  
 The seat should be adjusted so that the brake pedal can be depressed fully.  
 Position the seat as far rearward as comfort and control allow.

**Folding down the front seat backrests (certain models)**

The front passenger's seat backrest can be folded down to provide room for long loads.

To fold down the backrest:

1. Move the seat as far back as possible.
2. Adjust the backrest to the upright position.
3. Lift the catches on the rear of the backrest as shown in the illustration.
4. Without releasing the catches, push the backrest forward.
5. Move the seat as far forward as possible.

**WARNING!**

Cover sharp edges on the load to help prevent injury to occupants. Secure the load to help prevent shifting during sudden stops.

pg. 73 Front seats

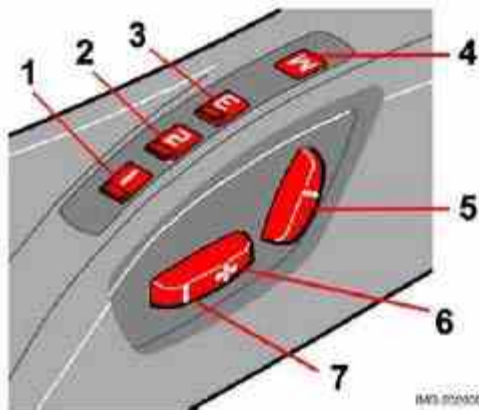

**Power seats**

The power driver's seat can be adjusted:

- If the ignition key is in position I or II.
- During a 10 minute period after the doors have been unlocked if the door remains open.
- If the door is closed and the ignition key is not yet in the ignition, or if the key is in position 0, the seat can be adjusted or during a period of 40 seconds. The power passenger's seat can only be adjusted if the ignition key is in position I or II, or if the engine is running.

### **Adjusting the seat**

Controls 5, 6, and 7 on the side of the seat can be used to make adjustments.

#### **5. Backrest tilt**

**6.** Move this section of the control up or down to raise/lower the rear section of the seat. Move the control forward to move the seat forward.

**7.** Move this section of the control up or down to raise/lower the front section of the seat. Move the control rearward to move the seat rearward.

**NOTE:**The power seats have an overload protector that activates if a seat is blocked by any object. If this occurs, switch off the ignition (key in position 0) and wait for approximately 20 seconds before operating the seat again.

### **Emergency stop**

If the seat inadvertently begins to move, press any of the buttons to stop the seat.

### **Programming the seat memory, driver's seat only (option)**

Three different seating positions can be stored in the seat's memory.

The following example explains how button 1 can be programmed. Buttons 2 and 3 can be programmed in the same way.

To program (store) a seat position in button 1:

1. Use controls 5, 6, and 7 to adjust the seat to the desired position.
2. Press and hold down the M (memory) button.
3. With the M button depressed, press button 1 to store the seat's current position.

To move the seat to the position that it was in when button 1 was programmed, press and hold down button 1 until the seat stops moving.

As a safety precaution, the seat will stop automatically if the button is released before the seat has reached the preset position.

### **Central locking system remote control and driver's seat memory**

The remote control transmitter can also be equipped with an optional function that controls the electrically operated driver's seat in the following way:

1. Adjust the seat to the desired position.
2. When you leave the car, lock it using the remote control.
3. The next time the driver's door is unlocked with the same remote control and the driver's door is opened, the

pg. 74 Front seats

driver's seat will automatically move to the position that it was in when the door was most recently locked with that remote control.

### **WARNING!**

Because the driver's seat can be adjusted with the ignition off, children should never be left unattended in the car. Movement of the seat can be STOPPED at any time by pressing any button on the power seat control panel. Do not adjust the seat while driving. The seat should be adjusted so that the brake pedal can be depressed fully. In addition, position the seat as far rearward as comfort and control allow. The seat rails on the floor must not be obstructed in any way when the seat is in motion.

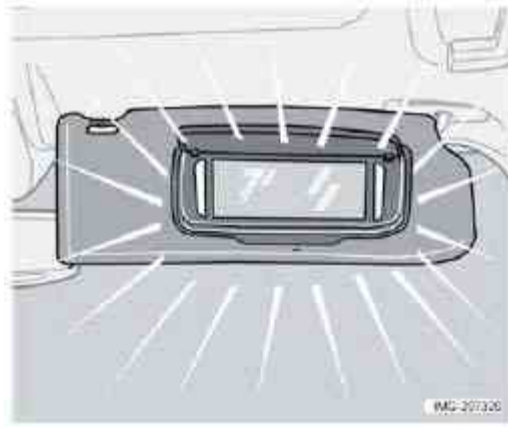

### **Vanity mirror**

Raise the cover to switch on the light.

pg. 75 Interior lighting

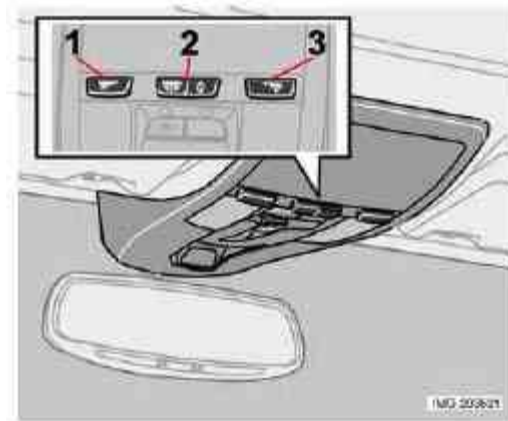

*1 - Driver's side reading light,  
2 - Courtesy lighting,  
3 - Passenger's side reading light*

### **Interior lighting**

The reading lights can be switched on and off by pressing buttons 1 or 3. The function selector (2) can be set to three positions:

- Press the left side of the switch: the interior courtesy lighting is always on.
- Neutral position: the interior courtesy lighting comes on when a door is opened, and is switched off 10 seconds after the door is closed.
- Press the right side of the button: the interior courtesy lighting is always off.

### **Courtesy lighting - automatic function**

The interior lighting has a built-in automatic function that switches on the courtesy lighting for 30 seconds when:

- the car is unlocked from the outside using the key or remote control
  - the engine is switched off and the ignition key is turned to the 0 position.
- The courtesy lighting lights up or remains on for 5 minutes when:
- one of the doors is opened and left open.
  - the courtesy lighting has not been switched off (the right side of button 2 depressed).

The automatic lighting goes out when:

- the engine is started
- the car is locked from the outside using the key or remote control.

If the courtesy lighting is not switched off manually, it will be turned off automatically 5 minutes after the engine has been switched off.

The courtesy lighting can be switched on or off within 30 minutes after the key has been turned to position 0 by pressing the left side of button 2.



*Rear reading lights (in ceiling)*

### **Rear reading lights**

The rear reading lights can be switched on or off by pressing the respective buttons. The reading lights can be switched on or off within 30 minutes after the engine has been switched off, or after a door has been opened or closed.

These lights switch off automatically 5 minutes after the engine has been switched off.

pg. 76 Storage compartments

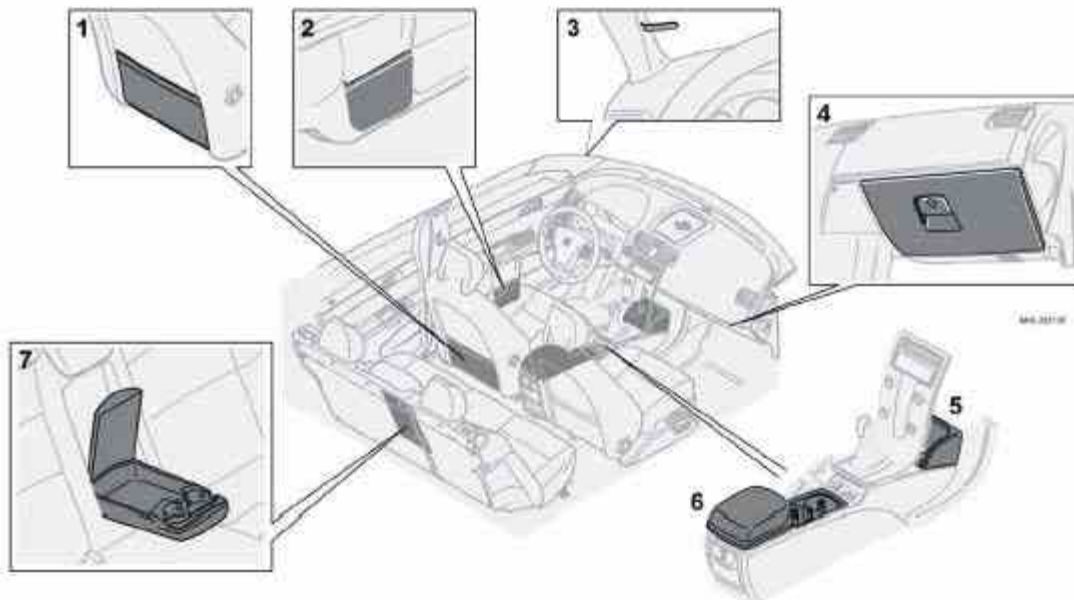

pg. 77 Storage compartments

1. Storage pocket (also on front side of seat cushion)
2. Compartment in door panel
3. Ticket clip
4. Glove compartment
5. Waste bin (accessory), located behind the center instrument panel
6. Storage compartment and cup holders
7. Storage compartment and cup holders.

**WARNING!**

Anchor any heavy objects to prevent them from moving during sudden stops.

Packages on the rear parcel shelf can obscure vision and may become dangerous projectiles in the event of a sudden stop or an accident.

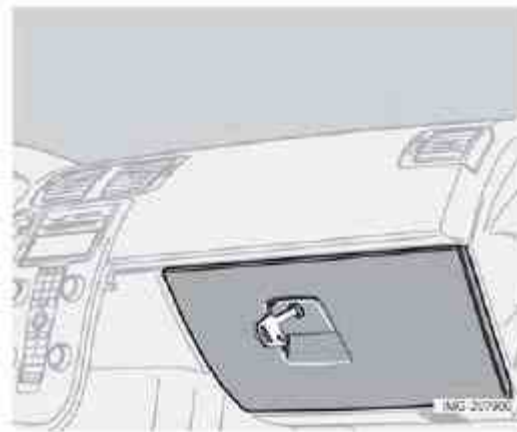

**Glove compartment**

The owners manual and maps can be stored here. There are also holders for coins, pens and fuel cards. The glove compartment can only be locked and unlocked using the detachable key blade from the central locking system's remote control. See the chapter "Locks and alarm" for further information about the key blade.

pg. 78 Rear seat



*Adjust the head restraint vertically*

**Rear seat head restraints**

Each of the rear seat head restraints can be adjusted vertically to suit the height of the passenger. The upper edge of

the head restraint should be on a level with the midpoint of the rear side of the passenger's head (see illustration).

- To raise: slide the head restraint up to the desired height.
- To lower: Press the catch at the base of the right support and press the head restraint down.
- To remove: Pull the head restraint up far as possible. Press the catch at the base of the right support and pull the head restraint out of its holders.

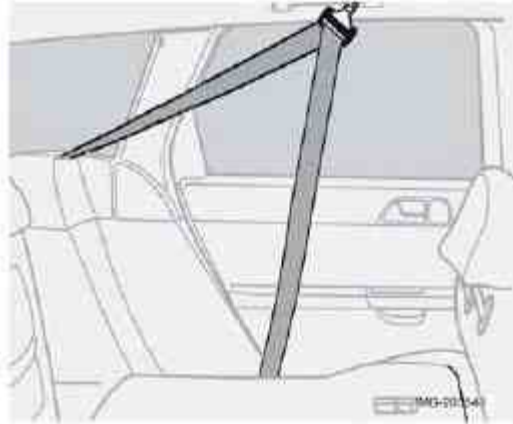

**NOTE:** When the seat backs are folded down, the head restraints may be damaged if they are not removed. The center head restraint must also be removed when transporting heavy loads.

### Folding down the rear seat backrests

Both sections of the rear seat backrest can be folded down, together or separately, to enable you to transport long objects. Before folding down the rear seat backrests, the outboard seat belts can be attached to the clothes hook as shown in the middle illustration. To fold down one or both sections:

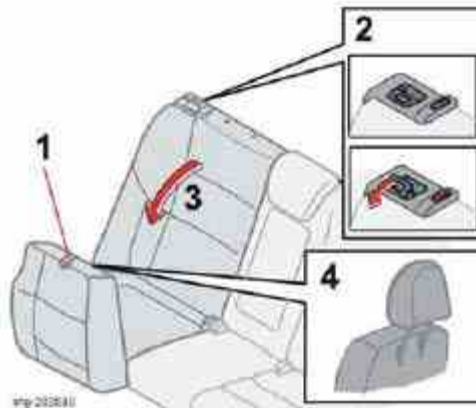

1. Grasp the rear edge of the seat cushions and pull it forward.
2. Pull the catch on the upper outboard edge of the backrest upward and forward to release the backrest lock. A red lock indicator is visible when the backrest is **not** locked in the upright position.
3. Fold the backrest down partially and remove the outer head restraints. Press the center head restraint down completely or remove it.

pg. 79 Rear seat

4. Place the head restraints in the plastic tubes, which are now accessible on the under side of the seat cushions.

**WARNING!**



The red lock indicator is **VISIBLE** when the backrest is **NOT** locked in position and **HIDDEN** when the backrest is correctly locked in place. When the backrest is in the upright position, it must always be correctly locked in place. When the rear seat is folded down, do not place heavy objects against the backs of the front seats. This places a severe strain on the folded down backrest of the rear seat. Be sure to secure cargo. Cargo must not be stacked higher than the top of seat backs. This will reduce the possibility of luggage, etc. becoming projectiles during sudden maneuvers, rapid braking or an accident.

pg. 80 Trunk

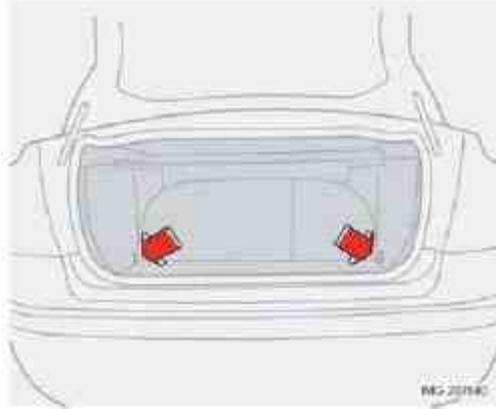

### Load anchoring eyelets

The eyelets in the trunk can be used to fasten accessory load and lashing straps, load nets, and other load anchors.

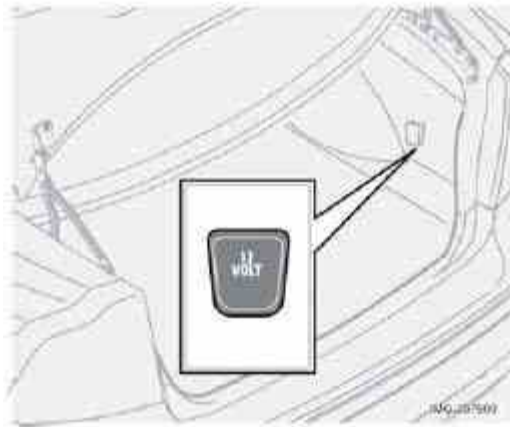

### Auxiliary 12 volt socket (option)

Fold down the lid to use the socket.

- Using the 12 volt socket while the engine is not running drains the vehicle's battery.
- If the ignition is switched off and a device drawing more than 0.1A is connected to a socket, a battery alert will be shown in the driver information display.
- The cover should be kept on when the auxiliary socket is not in use.
- Maximum current from the socket is 15A.



**Grocery bag holder (option)**

The grocery bag holder keeps bags in place and prevents them from tipping over and spilling their contents in the trunk.

---



[Contents](#) | [Top of Page](#)

# 2006 VOLVO S40

## Chapter 6 - Locks and alarm

pg. 81 Locks and alarm

[Remote control and key blade](#) 82

[Valet locking](#) 85

[Remote control battery](#) 86

[Locking and unlocking](#) 87

[Locking the glove compartment, Child safety locks](#) 88

[Alarm](#) 89

pg. 82 Remote control and key blade

### Remote controls

Two remote controls that also function as ignition keys are provided with your car. The remote controls contain detachable metal key blades for manually locking or unlocking the driver's door and the glove compartment.

USA - FCC ID: LTQVO315TX

This device complies with part 15 of the FCC rules. Operation is subject to the following conditions: (1) This device may not cause harmful interference, and (2) this device must accept any interference received, including interference that may cause undesired operation.

Canada - IC: 3659AVO315TX

Operation is subject to the following conditions: (1) this device may not cause interference, and (2) this device must accept any interference, including interference that may cause undesired operation of the device.

### Loss of a remote control

If either of the remote controls is lost, the other must be taken with the car to a trained and qualified Volvo service technician. As an anti-theft measure, the code of the lost remote control must be erased from the system. Each key blade has a unique code, which is used if new key blades are required. A maximum of six remote controls/key blades can be programmed and used for one car.

### Immobilizer (start inhibitor)

Each of the keys supplied with your car contains a coded transponder. The code in the key is transmitted to an antenna in the ignition switch where it is compared to the code stored in the start inhibitor module. The car will start only with

a properly coded key. If you misplace a key, take the other keys to a trained and qualified Volvo service technician for reprogramming as an antitheft measure.

USA - FCC ID: LTQWFS 125VO

This device complies with part 15 of the FCC rules. Operation is subject to the following condition: (1) This device may not cause harmful interference, and (2) this device must accept any interference received, including interference that may cause undesired operation.

Canada - IC: 3659A-WFS125VO

Operation is subject to the following conditions: (1) this device may not cause interference, and (2) this device must accept any interference, including interference that may cause undesired operation of the device.

### CAUTION!

Never use force on the narrow section of the remote control - this is where the transponder is located. The car cannot be started if the transponder is damaged.

pg. 83 Remote control and key blade

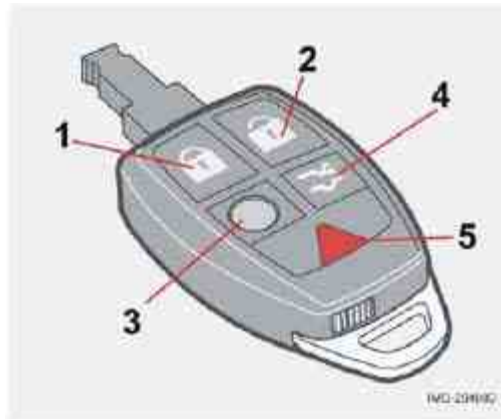

### Remote control functions

1. **Lock** - Press the Lock button on the remote once to lock all doors and the trunk. The turn signals will flash once to confirm locking.
2. **Unlock** - Press the Unlock button on the remote once to unlock the driver's door. The turn signals will flash twice to confirm unlocking.  
After a short pause, press the Unlock button a second time within 10 seconds to unlock the other doors and the trunk.  
A long press (at least two seconds) opens all side windows.

### NOTE:

- The turn signals flash to confirm that the vehicle has been correctly locked/ unlocked with the remote control. When locking the vehicle, the turn signals will flash a confirmation only if all the doors are securely closed and locked. Flashing confirmation for locking and unlocking may be customized in the vehicle's Personal settings menu. See [page 56](#) for more information.
- The two-step unlocking function can be changed so that one press of the Unlock button unlocks all of the doors and the trunk. See Personal settings on [page 56](#) for more information.
- **Automatic relocking:** If the doors are unlocked, the locks will automatically reengage (re-lock) and the alarm will

rearm after 2 minutes unless a door or the trunk has been opened.

- **Automatic locking:** When the car starts to move, the doors and trunk can be locked automatically. This feature can be turned on or off, see Personal settings on [page 56](#) for more information.

- Airbag deployment will automatically attempt to unlock the doors.

3. **Approach lighting** - As you approach the car:

Press the yellow button on the remote control to light the interior lighting, position/parking lamps, license plate lighting and the lights in the door mirrors (option). These lights will switch off automatically after 30, 60 or 90 seconds. See the Personal settings on [page 56](#) for information about adjusting the time setting.

4. **Unlock trunk**- Press the button once to disarm the alarm system and unlock only the trunk. After closing, the trunk will not automatically relock. Press Lock to relock it and rearm the alarm.

5. **Panic alarm:** - This button can be used to attract attention during emergency situations.

To activate the panic alarm, press and hold the red button for at least 3 seconds or press it twice within 3 seconds. The turn signals and horn will be activated. The panic alarm will stop automatically after 30 seconds. To deactivate, wait approximately 5 seconds and press the red button again.

**NOTE:** This button will NOT unlock the car.

pg. 84 Remote control and key blade

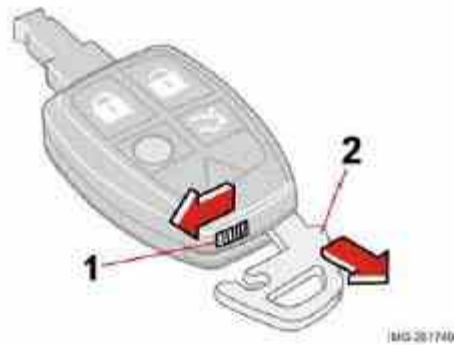

*Removing the key blade*

### **Key blade**

The key blade can be removed from the remote control. When removed, the key blade can be used as follows:

- To lock/unlock the driver's door
- To lock/unlock the glove compartment (see [page 87](#))
- For valet locking (see the explanation in below)

### **Removing the key blade**

Slide the spring loaded catch (1 in the illustration shown) to the side and pull the key blade (2) out of the remote control.

### **Reinserting the key blade in the remote control**

- Hold the remote control with the pointed end down.
- Carefully slide the key blade into its groove.
- Gently press the key blade in the groove until it clicks into place.

### **Unlocking the doors with the detached key blade**

- Insert the key blade as far as possible in the driver's door lock. Turn the key blade clockwise approximately one-

quarter turn to unlock the driver's door only.

**NOTE:**

After unlocking the driver's door with the key blade, opening the door will trigger the alarm. To disable the alarm:

- Press the Unlock button on the remote control, or insert the key in the ignition switch.

**Locking the doors with the detached key blade**

- Lock the rear doors and the front passenger's door by pressing the lock button on each door.
- Turn the key blade one-quarter turn counter-clockwise to lock the driver's door.

**NOTE:** This does not arm the alarm or lock the trunk.

pg. 85 Valet locking

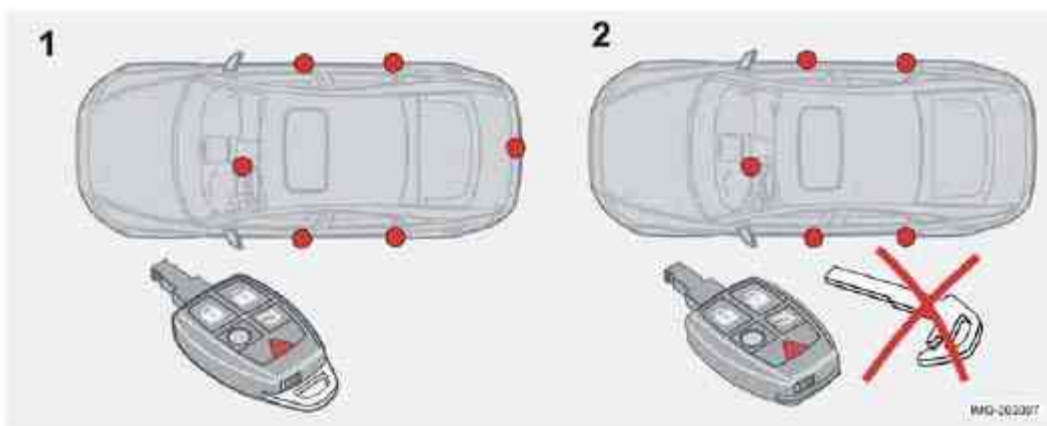

1. Normal locking/unlocking points 2. Locking/unlocking points with valet locking activated

**Valet or service locking**

By utilizing the remote control with the key blade removed, the valet locking feature enables you to block access to the trunk and glove compartment for e.g. valet parking or when the car is brought to the retailer for service.

**With the valet locking function activated:**

- The vehicle's doors can be locked or unlocked
- The engine can be started
- The glove compartment cannot be unlocked
- Access to the trunk is blocked (the trunk lid cannot be unlocked or opened, and the rear seat backrests are locked in the upright position)

**Activating the valet locking function**

1. Remove the key blade from the remote control.
2. Turn the key blade 180° clockwise in the glove compartment lock to lock the glove compartment and disconnect the trunk lock from the central locking system. (A message appears in the information display.)
3. Lock the rear seat backrests in the upright position by inserting the key blade into the locks located on the upper outboard edge of the backrests.

**Passenger's side:** Turn the key counterclockwise to lock the backrest.

**Driver's side:** Turn the key clockwise to lock the backrest.

4. Give the parking attendant or service personnel only the remote control (with the key blade removed).

**Deactivating the valet locking function**

Turn the key blade 180° counterclockwise in the glove compartment lock to deactivate valet locking, and use the key blade to unlock the rear seat backrests.

## pg. 86 Remote control battery

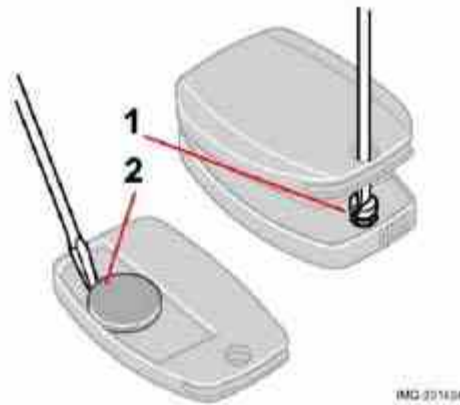

### Weak battery in the remote control

When the battery begins to lose its charge, the Information symbol in the instrument panel (see [page 35](#)) lights up and REMOTE BATTERY LOW VOLTAGE is shown in the information display.

### Replacing the battery in the remote control

If the range of the transmitter is noticeably reduced, this indicates that the battery (type CR 2032, 3V) is weak and should be replaced. To replace the battery:

1. Remove the key blade.
2. Place the remote control with the keypad downward. Remove the screw (1) using a small slotted screwdriver.
3. Remove the cover.
4. Note how the + and - sides of the battery are positioned on the inside of the cover. The plus side of the new battery (marked on the battery) must face downward.

### CAUTION!

When replacing the battery, avoid touching the electrical circuitry in the other half of the remote control.

5. Pry out (2) and replace the battery. Avoid touching the battery and its contact surfaces with your fingers.
6. Press the cover back into place and tighten the screw.
7. Reinsert the key blade in the remote control.

**NOTE:** The old battery should be disposed of properly at a recycling center or by a trained and qualified Volvo service technician.

## pg. 87 Locking and unlocking

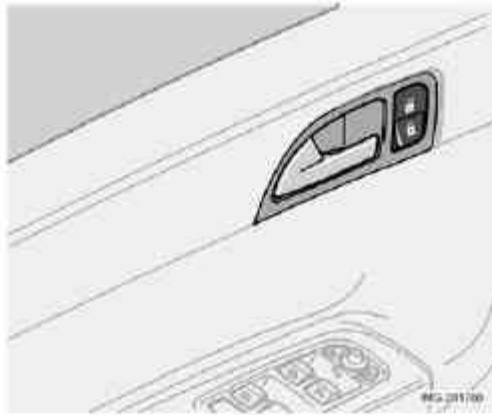

### **Locking/unlocking the car from the inside**

The switches near the door opening handles on the driver's and front passenger's doors can be used to lock or unlock all doors and the trunk, and to set the alarm.

- **Unlocking:**

Press in the upper section in the lock button. A long press (at least two seconds) also opens all the side windows.

- **Locking:**

Press in the lower section of the lock button.

### **NOTE:**

- The doors cannot be opened by pulling up the lock button.
- Each door can also be locked manually using the lock button on that particular door. This applies only if the car has not been locked from the outside.
- The doors can also be unlocked (and the door opened) by pulling the handle in the door twice.

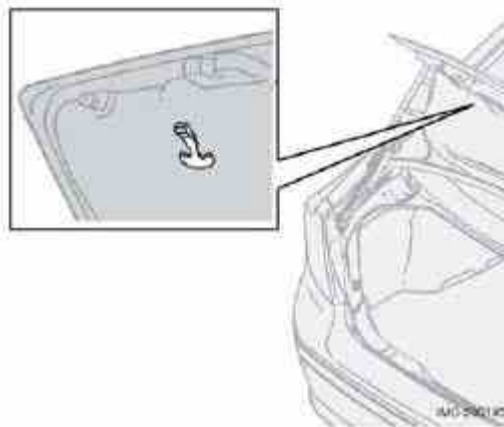

*Opening the trunk from the inside*

### **Opening the trunk from the inside**

#### **U.S. models only**

The car is equipped with a florescent handle on the inside of the trunk lid, which can be used in an emergency situation to open the trunk from the inside.

Pull the handle down to release the trunk lid. After use, the handle must be pushed back into its original position before the trunk can be closed.



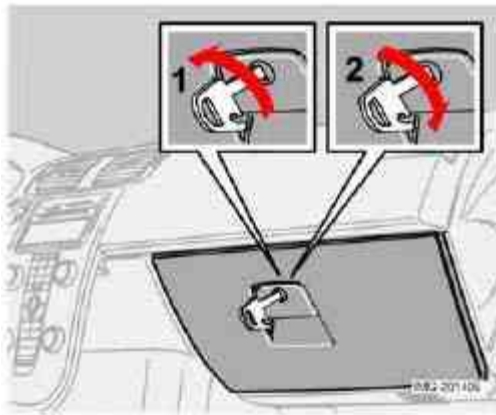

### Locking the glove compartment

The glove compartment can only be locked and unlocked using the detachable key blade on the remote control. See [page 84](#) for information on removing the key blade from the remote control.

- Unlock the glove compartment by turning the key a quarter of a turn (90°) counterclockwise. The key slot is vertical when the glove compartment is unlocked.
- Lock the glove compartment by turning the key a quarter of a turn (90°) clockwise. The key slot is horizontal when the glove compartment is locked.

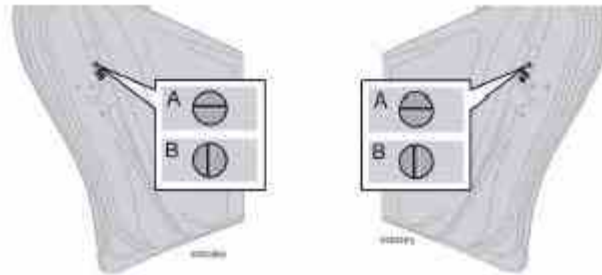

### Manual child safety locks, rear doors

The controls are located on the rear inside edges of the doors, and are only accessible when the doors are open. Use the ignition key blade or a screwdriver to turn the control.

- A. The door cannot be opened from the inside when the slot in the control is in the horizontal position. The door can be opened from the outside.
- B. The door can be opened from the inside when the slot in the control is in the vertical position.

pg. 89 Alarm

### The alarm system

The alarm is automatically armed whenever the car is locked with the remote control, or if a front lock button is depressed.

When armed, the alarm continuously monitors a number of points on the car. The following conditions will trigger the alarm:

- The hood is forced open.
- The trunk is forced open.
- A door is forced open.
- The ignition switch is tampered with
- An attempt is made to start the car with a non-approved key (a key not coded to the car's ignition).
- If there is movement in the passenger compartment (if the car is equipped with the optional movement sensor).

- The car is lifted or towed (if the car is equipped with the optional inclination sensor)
- The battery is disconnected (while the alarm is armed).
- The siren is disconnected when the alarm is disarmed.

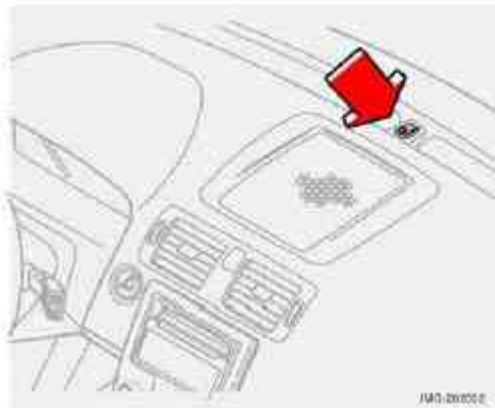

*Alarm indicator light*

### **The alarm indicator light**

The status of the alarm system is indicated by the indicator light on at the top of the dashboard (see illustration):

- Indicator light off - the alarm is not armed
- The indicator light flashes every two seconds - the alarm is armed
- The indicator light flashes rapidly before the ignition is switched on - the alarm has been triggered. The message "ALARM TRIGGERED, CHECK CAR" will also be displayed.
- **Fault in the alarm system:** If a fault has been detected in the alarm system, a message will be shown in the information display. Contact a trained and qualified Volvo service technician to have the alarm system inspected and repaired if necessary.

### **Arming the alarm**

Press the LOCK button on the remote control, or press the central lock button on one of the front doors with the door open. One long flash of the turn signals will confirm that the alarm is armed.

### **Disarming the alarm**

Press the UNLOCK button on the remote control or insert the key in the ignition to disarm the alarm. Two short flashes from the car's direction indicators confirm that the alarm has been deactivated and that all doors are unlocked.

### **Turning off (stopping) the alarm**

If the alarm is sounding, it can be stopped by pressing the UNLOCK button on the remote control or by inserting the key in the ignition switch.

### **Audible/visual alarm signal**

An audible alarm signal is given by a battery powered siren. The alarm cycle lasts for 30 seconds.

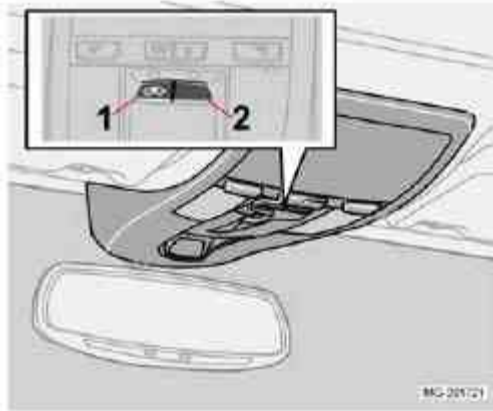

1. Disconnecting the sensors. 2. Not in use

The visual alarm signal is given by flashing all turn signals and turning on the interior lighting for approximately 5 minutes.

### **Temporarily turning off the accessory alarm sensor(s)**

In certain situations it may be desirable to turn off the accessory inclination and movement alarm sensors if, for example, you drive your vehicle onto a ferry where the rocking of the boat could trigger the alarm or if a pet is left in the vehicle with the doors locked.

1. Turn the ignition key to position II and then back to position 0 and remove it from the ignition switch.
2. Press the button (1). The LED in the button will remain on for one minute after the key has been removed from the ignition switch or until the car is locked.

### **Important**

- The accessory sensors are automatically reconnected to the alarm system the next time the vehicle is unlocked and then locked again.
- This function will not turn off the vehicle's standard alarm.

U,S.A. FCC ID: MAYDA 5823(3)

This device complies with part 15 of the FCC rules. Operation is subject to the following conditions: (1) This device may not cause harmful interference, and (2) this device must accept any interference received, including interference that may cause undesired operation.

Canada IC: 4405A-DA 5823(3)

Movement sensor DA5823 by Dynex Operation is subject to the following conditions: (1) this device may not cause interference, and (2) this device must accept any interference, including interference that may cause undesired operation of the device.



2006  
VOLVO  
S40

Chapter 7 - Starting and driving

pg. 91 Starting and driving

<a href="#">General information</a>	<a href="#">92</a>
<a href="#">Fuel requirements</a>	<a href="#">95</a>
<a href="#">Ignition switch and steering wheel lock</a>	<a href="#">98</a>
<a href="#">Starting the vehicle</a>	<a href="#">99</a>
<a href="#">Manual transmission, 5-speed</a>	<a href="#">101</a>
<a href="#">Manual transmission, 6-speed</a>	<a href="#">102</a>
<a href="#">Automatic transmission - Geartronic</a>	<a href="#">103</a>
<a href="#">Shiftlock override</a>	<a href="#">105</a>
<a href="#">All Wheel Drive (option)</a>	<a href="#">106</a>
<a href="#">Brake system</a>	<a href="#">107</a>
<a href="#">Stability system</a>	<a href="#">109</a>
<a href="#">Rear park assist (accessory)</a>	<a href="#">111</a>
<a href="#">Towing</a>	<a href="#">112</a>
<a href="#">Jump starting</a>	<a href="#">114</a>
<a href="#">Towing a trailer</a>	<a href="#">115</a>
<a href="#">Detachable trailer hitch</a>	<a href="#">117</a>
<a href="#">Transporting loads</a>	<a href="#">118</a>

pg. 92 General information

**Economical driving conserves natural resources**

Better driving economy may be obtained by thinking ahead, avoiding rapid starts and stops and adjusting the speed of your vehicle to immediate traffic conditions.

Observe the following rules:

- Bring the engine to normal operating temperature as soon as possible by driving with a light foot on the accelerator

pedal for the first few minutes of operation. A cold engine uses more fuel and is subject to increased wear.

- Whenever possible, avoid using the vehicle for driving short distances. This does not allow the engine to reach normal operating temperature.
- Drive carefully and avoid rapid acceleration and hard braking.
- Use the transmission's (D)rive position as often as possible and avoid using kickdown.
- Do not exceed posted speed limits.
- Avoid carrying unnecessary items (extra load) in the vehicle.
- Maintain correct tire pressure. Check tire pressure regularly (when tires are cold).
- Remove snow tires when threat of snow or ice has ended.
- Note that roof racks, ski racks, etc, increase air resistance and also fuel consumption.
- At highway driving speeds, fuel consumption will be lower with the air conditioning on and the windows closed than with the air conditioning off and the windows open.
- Using the onboard trip computer's fuel consumption modes can help you learn how to drive more economically.

#### **Other factors that decrease gas mileage are:**

- Dirty air cleaner
- Dirty engine oil and clogged oil filter
- Dragging brakes
- Incorrect front end alignment

Some of the above mentioned items and others are checked at the standard maintenance intervals.

#### **Weight distribution affects handling**

At the specified curb weight your vehicle has a tendency to understeer, which means that the steering wheel has to be turned more than might seem appropriate for the curvature of a bend. This ensures good stability and reduces the risk of rear wheel skid. Remember that these properties can alter with the vehicle load. The heavier the load in the cargo area, the less the tendency to understeer.

#### **WARNING!**

**Driving with the trunk open:** Driving with the trunk open could lead to poisonous exhaust gases entering the passenger compartment. If the trunk must be kept open for any reason, proceed as follows:

Close the windows

Set the ventilation system control to air flow to floor, windshield and side windows and the blower control to its highest setting.

#### **CAUTION!**

Drive slowly and carefully if going through standing water (i.e. flooded roadways, etc.). Damage to the engine could result if excess water is drawn in through the air intake system. Never drive the vehicle in water deeper than 18 inches (48 cm).

pg. 93 General information

#### **Handling, roadholding**

Vehicle load, tire design and inflation pressure all affect vehicle handling. Therefore, check that the tires are inflated to the recommended pressure according to the vehicle load. See the "Tire pressure" section. Loads should be distributed so that capacity weight or maximum permissible axle loads are not exceeded.

#### **Cold weather precautions**

If you wish to check your vehicle before the approach of cold weather, the following advice is worth noting:

- Make sure that the engine coolant contains 50 percent antifreeze. Any other mixture will reduce freeze protection. This gives protection against freezing down to -31°F (-35°C). See section "Coolant". The use of "recycled" antifreeze

is not approved by Volvo. Different types of antifreeze must not be mixed.

- Volvo recommends using only genuine Volvo antifreeze in your vehicle's radiator.
- Try to keep the fuel tank well filled - this prevents the formation of condensation in the tank. In addition, in extremely cold weather conditions it is worthwhile to add fuel line de-icer before refueling.
- The viscosity of the engine oil is important. Oil with low viscosity (thinner oil) improves cold-weather starting as well as decreasing fuel consumption while the engine is warming up. For winter use, 5W-30 oil, particularly the synthetic type<sup>1</sup>, is recommended. Be sure to use good quality oil but do not use cold-weather oil for hard driving or in warm weather. See [page 179](#) for more information.
- The load placed on the battery is greater during the winter since the windshield wipers, lighting, etc. are used more often. Moreover, the capacity of the battery decreases as the temperature drops. In very cold weather, a poorly charged battery can freeze and be damaged. It is therefore advisable to check the state of charge more frequently and spray an anti-rust oil on the battery posts.
- Volvo recommends the use of snow tires on all four wheels for winter driving - see the chapter "Wheels and tires."
- To prevent the washer fluid reservoir from freezing, add washer solvents containing antifreeze (see [page 145](#) for the location of the washer fluid reservoir). This is important since dirt is often splashed on the windshield during winter driving, requiring the frequent use of the washers and wipers. Volvo Washer Solvent should be diluted as follows: Down to 14° F (-10° C): 1 part washer solvent and 4 parts water, Down to 5° F (-15° C): 1 part washer solvent and 3 parts water, Down to 0° F (-18° C): 1 part washer solvent and 2 parts water, Down to -18° F (-28° C): 1 part washer solvent and 1 part water.
- Use Volvo Teflon Lock Spray in the locks.

**NOTE:** Avoid using de-icing sprays as they can cause damage to the locks.

1. Synthetic oil is not used when the oil is changed at the normal maintenance intervals except at owner request and at additional charge.

### **Conserving electrical current**

Keep the following in mind to help minimize battery drain:

- When the engine is not running, avoid turning the ignition key to position II. Many electrical systems (the audio

#### pg. 94 General information

system, the optional navigation system, power windows, etc) will function with the ignition key in position I. This position reduces drain on the battery.

- Please keep in mind that using systems, accessories, etc that consume a great deal of current when the engine is not running could result in the battery being completely drained.
- The optional 12 volt socket in the trunk provides electrical current even with the ignition switched off, which drains the battery.

**NOTE:** If the ignition is switched on, a warning message will be displayed in the text window in the instrument panel when the battery charge is low.

An energy conserving function designed into the vehicle's electrical system will switch off certain functions or reduce the load on the battery by, e.g., reducing the audio system's volume.

### **Before a long distance trip**

It is always worthwhile to have your vehicle checked by a trained and qualified Volvo service technician before driving long distances. Your retailer will also be able to supply you with bulbs, fuses, spark plugs and wiper blades for your use in the event that problems occur.

As a minimum, the following items should be checked before any long trip:

- Check that engine runs smoothly and that fuel consumption is normal.
- Check for fuel, oil, and fluid leakage

- Have the transmission oil level checked<sup>2</sup>.
- Check condition of drive belts.
- Check state of the battery's charge.
- Examine tires carefully (the spare tire as well), and replace those that are worn. Check tire pressures.
- The brakes, front wheel alignment, and steering gear should be checked by a trained and qualified Volvo service technician only.
- Check all lights, including high beams.
- Reflective warning triangles are legally required in some states/provinces.
- Have a word with a trained and qualified Volvo service technician if you intend to drive in countries where it may be difficult to obtain the correct fuel.
- Consider your destination. If you will be driving through an area where snow or ice are likely to occur, consider snow tires.

2. To prevent injury from contact with hot surfaces, do not inspect your vehicle's transmission fluid yourself. Have your vehicle's transmission fluid level inspected by a trained and qualified Volvo service technician.

## pg. 95 Fuel requirements

### **Octane rating**

Volvo engines are designed for optimum performance on unleaded premium gasoline with an AKI octane rating of 91 or above. AKI (ANTI KNOCK INDEX) is an average of the Research Octane Number, RON, and the Motor Octane Number, MON.  $((RON + MON)/2)$ . The minimum octane requirement is AKI 87 (RON 91).

### **Deposit control gasoline (detergent additives)**

Volvo recommends the use of detergent gasoline to control engine deposits. Detergent gasoline is effective in keeping injectors and intake valves clean. Consistent use of deposit control gasolines will help ensure good driveability and fuel economy. If you are not sure whether the gasoline contains deposit control additives, check with the service station operator.

**NOTE:** Volvo does not recommend the use of store-bought fuel injector cleaning additives.

### **Unleaded fuel**

Each Volvo has a three-way catalytic converter and must use only unleaded gasoline. U.S. and Canadian regulations require that pumps delivering unleaded gasoline be labelled "UNLEADED". Only these pumps have nozzles which fit your vehicle's filler inlet. It is unlawful to dispense leaded fuel into a vehicle labelled "unleaded gasoline only". Leaded gasoline damages the three-way catalytic converter and the heated oxygen sensor system. Repeated use of leaded gasoline will lessen the effectiveness of the emission control system and could result in loss of emission warranty coverage. State and local vehicle inspection programs will make detection of misfueling easier, possibly resulting in emission test failure for misfueled vehicles.

**NOTE:** Some U.S. and Canadian gasolines contain an octane enhancing additive called methyl-cyclopentadienyl manganese tricarbonyl (MMT). If such fuels are used, your Emission Control System performance may be affected, and the Check Engine Light (malfunction indicator lamp) located on your instrument panel may light. If this occurs, please return your vehicle to a trained and qualified Volvo service technician for maintenance.

### **Gasoline containing alcohol and ethers**

Some fuel suppliers sell gasoline containing "oxygenates" which are usually alcohols or ethers. In some areas, state or local laws require that the service pump be marked indicating use of alcohols or ethers. However, there are areas in which the pumps are unmarked. If you are not sure whether there is alcohol or ethers in the gasoline you buy, check with the service station operator. To meet seasonal air quality standards, some areas require the use of "oxygenated" fuel. Volvo allows the use of the following "oxygenated" fuels; however, the octane ratings listed on this page must still be met.

**Alcohol - Ethanol:** Fuels containing up to 10% ethanol by volume may be used. Ethanol may also be referred to as Ethyl alcohol, or "Gasohol". **Ethers - MTBE:** Fuels containing up to 15% MTBE may be used.

## Fuel Formulations

Do not use gasoline that contains lead as a knock inhibitor, and do not use lead additives. Besides damaging the exhaust emission control systems on your vehicle, lead has been strongly linked to certain forms of cancer. Many fuels contain benzene as a solvent. Unburned benzene has been strongly linked to certain forms of cancer. If you live in an area where you must fill your own gas tank, take precautions.

These may include:

- standing upwind away from the filler nozzle while refueling

pg. 96 Fuel requirements (contd.)

- refueling only at gas stations with vapor recovery systems that fully seal the mouth of the filler neck during refueling
- wearing neoprene gloves while handling a fuel filler nozzle.

### **WARNING!**

Carbon monoxide is a poisonous, colorless, and odorless gas. It is present in all exhaust gases. If you ever smell exhaust fumes inside the vehicle, make sure the passenger compartment is ventilated, and immediately return the vehicle to your retailer for correction.

## Use of Additives

With the exception of fuel line antifreeze during winter months, do not add solvents, thickeners, or other store-bought additives to your vehicle's fuel, cooling, or lubricating systems. Overuse may damage your engine, and some of these additives contain organically volatile chemicals. Do not needlessly expose yourself to these chemicals.

## Fuel filler door

Press the button on the light switch panel (see the illustration on [page 41](#)) **with the ignition switched off** to unlock the fuel filler door. Please note that the fuel filler door will remain unlocked until the vehicle begins to move forward. An audible click will be heard when the fuel filler door relocks.

If you intend to leave your vehicle while it is being refueled, this feature enables you to lock the doors/trunk while leaving the fuel filler door unlocked.

You can also keep the vehicle locked if you remain inside it during refueling. The central locking button does not lock the fuel filler door.

Be sure the fuel filler door is not obstructed and is completely closed after refueling.

**Open the fuel filler cap slowly during hot weather.**

## Refueling

The fuel tank is designed to hold approximately 15.9 US gallons (60 liters)<sup>1</sup> with sufficient volume left over to accommodate possible expansion of the fuel in hot weather. Be aware that the "usable" tank capacity will be somewhat less than the specified maximum. When the fuel level is low, such factors as ambient temperature, the fuel's "Reid vapor pressure" characteristics, and terrain can affect the fuel pump's ability to supply the engine with an adequate supply of fuel. Therefore, it is advisable to refuel as soon as possible when the needle nears the red zone, or when the fuel warning light comes on.

1. Models with All Wheel Drive have a tank volume of 15 US gallons (57 liters).

Models with engine code 39 have a fuel tank capacity of 14 US gallons (53 liters). This code is the 6th and 7th digits from the left in your vehicle's VIN number. See [page 176](#) for the location of the VIN plate.

pg. 97 Fuel requirements



## CAUTION!

Do not refuel with the engine running<sup>a</sup>. Turn the ignition off or to position I. If the ignition is on, an incorrect reading could occur in the fuel gauge

After refueling, close the fuel filler cap by turning it clockwise until it clicks into place.

Allow for fuel expansion by not overfilling the tank. Overfilling could also cause damage to the emission control systems.

Avoid spilling gasoline during refueling. In addition to causing damage to the environment, gasolines containing alcohol can cause damage to painted surfaces, which may not be covered under the New Vehicle Limited Warranty.

Do not use gasolines containing methanol (methyl alcohol, wood alcohol). This practice can result in vehicle performance deterioration and can damage critical parts in the fuel system. Such damage may not be covered under the New Vehicle Limited Warranty.

a. If the fuel filler cap is not closed tightly or if the engine is running when the vehicle is refueled, the Check Engine Light (malfunction indicator lamp) may indicate a fault. However, your vehicle's performance will not be affected. Use only Volvo original or approved fuel filler caps.

## pg. 98 Ignition switch and steering wheel lock

### 0 - Locked position



Remove the key to lock the steering wheel<sup>1</sup>. Never turn the key to position 0 while driving or when the vehicle is being towed.

**NOTE:** A ticking sound may be audible if the key is turned to a position between 0 and I. To stop this sound, turn the key to position II and back to position 0.

### I - Intermediate position<sup>2</sup>



Certain accessories, radio, etc. on, daytime running lights off

1. The gear selector must be in the Park position.
2. Please be aware that leaving the key in this position will increase battery drain.

### II - Drive position



The key's position when driving. The vehicle's entire electrical system is activated.

### III - Start position



Release the key when the engine starts. The key returns automatically to the Drive position. A chime will sound if the key is left in the ignition and the driver's door is opened.

### Steering wheel lock

When the key is removed from the ignition, the steering wheel locks so that it cannot be turned. If the front wheels are hard up against a curb, the steering wheel lock may be under too much tension to unlock. If so, the key will turn in the ignition switch but the car will not start. At the same time, a message "Steering locked" will appear in the driver information text display.

If this happens:

1. Remove the key from the ignition.
2. Turn the steering wheel slightly and hold it to relieve pressure on the lock mechanism. Reinsert the key. The steering should immediately unlock. If not, try again.

**NOTE:** In order to help reduce vehicle theft, make sure the steering wheel lock is engaged before leaving the vehicle.

### WARNING!

Never switch off the ignition (turn the ignition key to position 0) or remove the key from the ignition switch while the vehicle is in motion. This could cause the steering wheel to lock, which would make the vehicle impossible to steer.

pg. 99 Starting the vehicle

### Starting the vehicle

#### To start the engine:

1. Fasten the seat belt.

### WARNING!

Before starting, check that the seat, steering wheel and mirrors are adjusted properly. Make sure the brake pedal can be depressed completely. Adjust the seat if necessary.

2. Apply the parking brake if not already set. The gear selector (automatic transmission) is locked in the (P)ark position (SHIFTLOCK). See also [page 103](#).

**Manual transmission:** the clutch must be fully depressed.

3. Without touching the accelerator pedal, turn the ignition key to the starting position. Allow the starter to operate for up to 10 seconds. Release the key as soon as the engine starts. If the engine fails to start, repeat this step.

#### Autostart (T5 turbo with automatic transmission only)

This function makes it possible to start the vehicle without holding the key in position III. Turn the key to position III and release it. The starter motor will then operate automatically (for up to ten seconds) until the engine starts.

#### NOTE:

On certain models, when the vehicle is started, idle speed may be noticeably higher than normal for a short period, depending on the temperature of the engine. This has been done to help bring components in the emission control system to their normal operating temperature as quickly as possible, which enables them to function normally.

- For cold starts at altitudes above 6000 ft. (1800 meters), depress the accelerator pedal halfway and turn the key to

the starting position. Release the pedal slowly when the engine starts.

4. To release the gear selector from the (P)ark position, the engine must be running (or the ignition key must be in position II) and the brake pedal must be depressed.

5. Select the desired gear. On models with an automatic transmission, the gear engages after a very slight delay which is especially noticeable when selecting R.

**NOTE:**

- **Immobilizer:** If two of the keys to your vehicle are close together, e.g., on the same key ring when you try to start the vehicle, this could cause interference in the immobilizer system and result in the vehicle not starting. If this should occur, remove one of the keys from the key ring before trying to start the vehicle again.
- **Keylock:** Your vehicle is equipped with a keylock system. When the engine is switched off, the gear selector must be in the (P)ark position before the key can be removed from the ignition switch.
- When starting in cold weather, the automatic transmission may shift up at slightly higher engine speeds than normal until the automatic transmission fluid reaches normal operating temperature.
- Do not race a cold engine immediately after starting. Oil flow may not reach some lubrication points fast enough to prevent engine damage.

**WARNING!**

Volvo's floor mats are specially manufactured for your car. They must be firmly secured in the clips on the floor so that they cannot slide and become trapped under the pedals on the driver's side.

pg. 100 Starting the vehicle

**CAUTION!**

Automatic transmission: The engine should be idling when you move the gear selector. Never accelerate until after you feel the transmission engage! Accelerating immediately after selecting a gear will cause harsh engagement and premature transmission wear. Selecting P or N when idling at a standstill for prolonged periods of time will help prevent overheating of the automatic transmission fluid.

**WARNING!**

Always place the gear selector in Park and apply the parking brake before leaving the vehicle. Never leave the vehicle unattended with the engine running.

Always open garage doors fully before starting the engine inside a garage to ensure adequate ventilation. The exhaust gases contain carbon monoxide, which is invisible and odorless but very poisonous.

pg. 101 Manual transmission, 5-speed

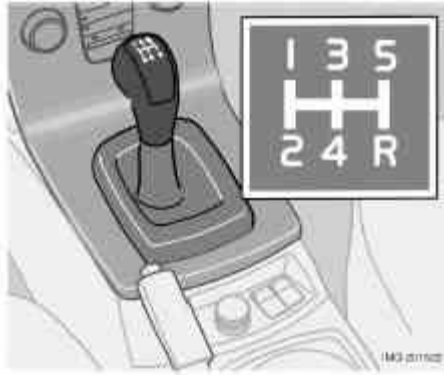

### **5-speed manual transmission (option on certain models)**

Depress the clutch pedal completely when changing gears<sup>1</sup>.  
Remove your foot from the clutch pedal while driving. The shift pattern should be followed.  
Overdrive (5th gear) should be used as often as possible to help improve fuel economy.

1. Clutch interlock The clutch must be fully depressed before you can start your car. If the clutch is not depressed, it will not be possible to start the engine.

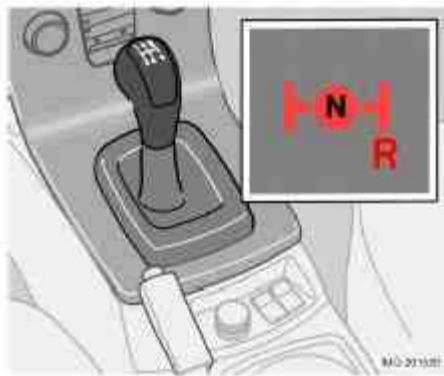

### **Engaging reverse gear, 5-speed transmission**

Reverse gear should only be engaged from a complete stop.

#### **CAUTION!**

Never shift into reverse while moving forward.

#### **WARNING!**

An extra mat on the driver's floor can cause the accelerator, brake, and/or clutch pedal to catch. Check that the movement of these pedals is not impeded. Not more than one protective floor covering may be used at one time.



### **6-speed manual transmission (option on certain models)**

Depress the clutch pedal completely when changing gears<sup>1</sup>.

Remove your foot from the clutch pedal while driving. The shift pattern should be followed. Overdrive (5th and 6th gears) should be used as often as possible to help improve fuel economy.

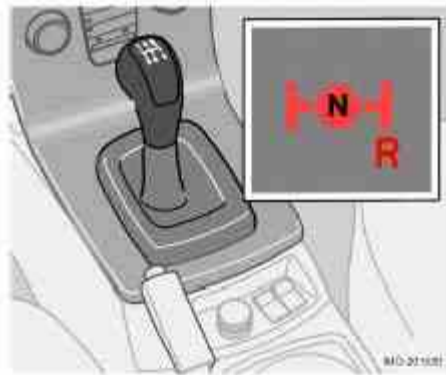

### **Engaging reverse gear, 6-speed transmission**

Reverse gear should only be engaged from a complete stop.

**NOTE:** Reverse gear is electronically blocked and cannot be selected if the vehicle is moving at a speed of approximately 13 mph (20 km/h).

#### **CAUTION!**

Never shift into reverse while moving forward.

#### **WARNING!**

An extra mat on the driver's floor can cause the accelerator, brake, and/or clutch pedal to catch. Check that the movement of these pedals is not impeded. Not more than one protective floor covering may be used at one time.

1. Clutch interlock The clutch must be fully depressed before you can start your car. If the clutch is not depressed, it will not be possible to start the engine.

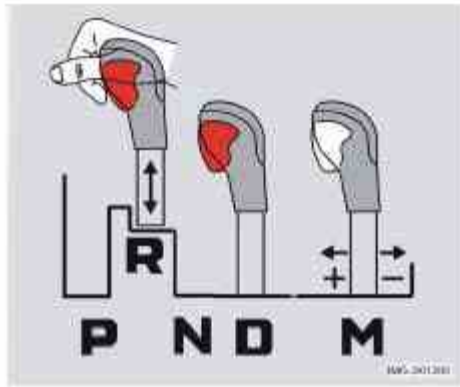

### Shift gate positions

Depress the button on the front of the gear selector knob to move the selector between the R, N, D, and P positions. The gear selector can be moved freely between the Geartronic (manual shifting) and (D)rive positions while driving.

### Gear selector positions

#### P - Park

Select the **P** position when starting or parking.

In **P**, the transmission is mechanically blocked (Shiftlock). Always apply the parking brake when parking.

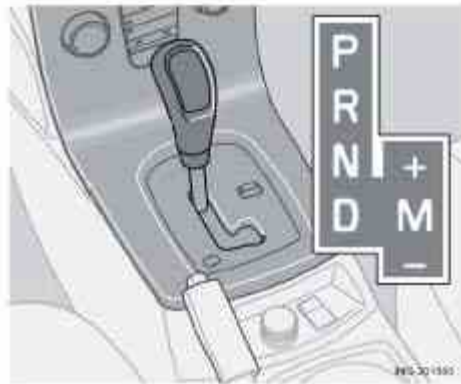

### CAUTION!

The car must be stationary when selecting position **P**.

#### R - Reverse

The car must be stationary when shifting to position **R**.

#### N - Neutral

**N** is the neutral position. The engine can be started, but no gear is selected. Apply the parking brake when the car is stationary with the gear selector in **N**.

**NOTE:** If the gear selector is in the Neutral position and the car has been at a standstill for at least 3 seconds (regardless of whether the engine is running or not), the gear selector will be locked in Neutral.

In order to move the gear selector to another position:

- Turn the ignition key to position II (if the engine is not already running)
- Depress the brake pedal
- Move the gear selector to the desired position

## **D - Drive**

**D** is the normal driving position. The car automatically shifts between the various forward gears, based on the level of acceleration and speed. The car must be at a standstill when shifting to position **D** from position **R**

## **Manual shifting - Geartronic**

The manual shifting mode (Geartronic) can be selected at any time, including while the car is moving.

- To access the **(M)**anual shifting position from **(D)**rive, move the gear selector to the right to **M**.
- To return to the **(D)**rive position from **M**, move the gear selector to the left.

## pg. 104 Automatic transmission - Geartronic

### **While driving**

- If you select the **M** position while driving, the gear that was being used in the **(D)**rive position will also initially be selected in **M** position.
- Move the gear selector forward (toward "+") to shift to a higher gear or rearward (toward "-") to shift to a lower gear.
- If you hold the gear selector toward "-", the transmission will downshift one gear at a time and will utilize the braking power of the engine. If the current speed is too high for using a lower gear, the downshift will not occur until the speed has decreased enough to allow the lower gear to be used.
- If you slow to a very low speed, the transmission will automatically shift down.

### **W - Winter/Wet driving mode - enhanced vehicle traction**

Mode **W** reduces torque at the wheels, which helps improve traction when starting off on a slippery surface.

Press the button near the base of the gear selector to engage/disengage this driving mode.

- A "W" will be displayed in the instrument panel when Winter/Wet driving mode is engaged.
- Mode **W** will only function if the gear selector is in the **(D)**rive position.

Once underway, turn off mode **W** to improve vehicle performance and fuel economy.

### **Cold starts (turbo engines)**

When driving before the engine has reached its normal operating temperature, the transmission will shift up at slightly higher engine speeds to heat the three-way catalytic converter as quickly as possible.

### **Kickdown**

Automatic shift to a lower gear (kickdown) is achieved by depressing the accelerator pedal fully and briskly. An upshift will occur when approaching the top speed for a particular gear or by releasing the accelerator pedal slightly. Kickdown can be used for maximum acceleration or when passing at highway speeds.

**NOTE:** The gear selector must be in the **D** (Drive) position for kickdown to function.

## pg. 105 Shiftlock override

### **Overriding the shiftlock system**

Shiftlock prevents the gear selector from being moved out of Park unless the ignition key is in position **II** and the brake pedal is depressed.

In certain cases it may be necessary to move the gear selector from the Park position manually, for example if the battery is discharged.

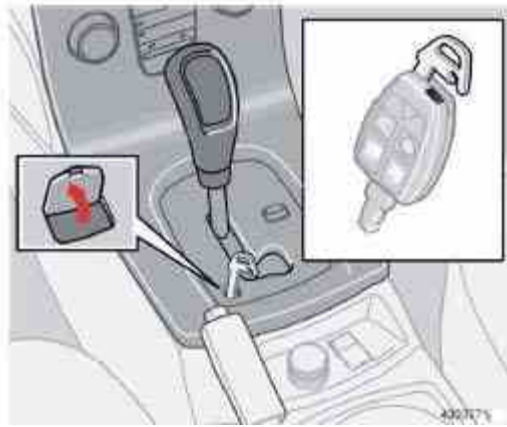

*Overriding the shiftlock system*

**Manually overriding the Shiftlock system:**

1. Apply the parking brake.
  2. Depress the brake pedal.
  3. There is a small cover behind P-R-N-D on the gear selector panel. Open the rear edge of the panel.
  4. Insert the key blade (see [page 84](#)) or a screwdriver into the opening and press it down until it bottoms and move the gear selector out of the P position.
- 



[Contents](#) | [Top of Page](#)



**2006  
VOLVO  
S40**

**Chapter 8 - Volvo Service**

pg. 119 Wheels and tires

<a href="#"><u>General information</u></a>	<a href="#"><u>120</u></a>
<a href="#"><u>Tire inflation</u></a>	<a href="#"><u>122</u></a>
<a href="#"><u>Tire inflation pressure tables</u></a>	<a href="#"><u>124</u></a>
<a href="#"><u>Tire designations</u></a>	<a href="#"><u>125</u></a>
<a href="#"><u>Glossary of tire terminology</u></a>	<a href="#"><u>126</u></a>
<a href="#"><u>Vehicle loading</u></a>	<a href="#"><u>127</u></a>
<a href="#"><u>Uniform Tire Quality Grading</u></a>	<a href="#"><u>128</u></a>
<a href="#"><u>Temporary Spare</u></a>	<a href="#"><u>130</u></a>
<a href="#"><u>Wheel nuts</u></a>	<a href="#"><u>131</u></a>
<a href="#"><u>Tire rotation</u></a>	<a href="#"><u>132</u></a>
<a href="#"><u>Changing a wheel</u></a>	<a href="#"><u>133</u></a>

pg. 120 General information

**General information**

Your vehicle is equipped with tires according to the vehicle's tire information placard on the B-pillar (the structural member at the side of the vehicle, at the rear of the driver's door opening), or on the inside of the fuel filler door on Canadian models.

The tires have good road holding characteristics and offer good handling on dry and wet surfaces. It should be noted however that the tires have been developed to give these features on snow/ice-free surfaces.

Certain models are equipped with "all-season" tires, which provide a somewhat higher degree of road holding on slippery surfaces than tires without the "all-season" rating. However, for optimum road holding on icy or snow-covered roads, we recommend suitable winter tires on all four wheels.

When replacing tires, be sure that the new tires are the same size designation, type (radial) and preferably from the same manufacturer, on all four wheels. Otherwise there is a risk of altering the car's roadholding and handling characteristics.

**Storing wheels and tires**

When storing complete wheels (tires mounted on rims), they should be suspended off the floor or placed on their sides

on the floor.

Tires not mounted on rims should be stored on their sides or standing upright, but should not be suspended.

**CAUTION!**

Tires should preferably be stored in a cool, dry, dark place, and should never be stored in close proximity to solvents, gasoline, oils, etc.

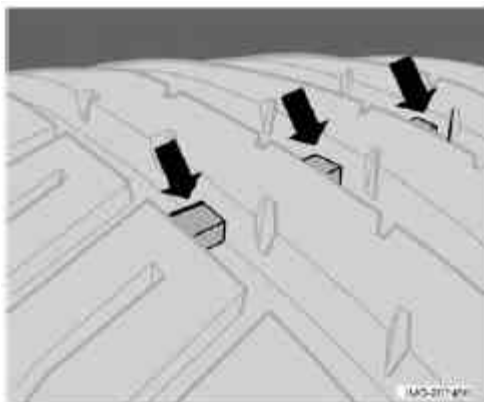

*Tread wear indicator*

**Tread wear indicator**

The tires have wear indicator strips running across or parallel to the tread. The letters TWI are printed on the side of the tire. When approximately 1/16" (1.6 mm) is left on the tread, these strips become visible and indicate that the tire should be replaced. Tires with less than 1/16" (1.6 mm) tread offer very poor traction.

When replacing worn tires, it is recommended that the tire be identical in type (radial) and size as the one being replaced. Using a tire of the same make (manufacturer) will prevent alteration of the driving characteristics of the vehicle.

**WARNING!**

- The wheel and tire sizes for your Volvo are specified to meet stringent stability and handling requirements. Unapproved wheel/tire size combinations can negatively affect your vehicle's stability and handling. Approved tire sizes are shown in the Tire inflation pressure tables on [page 124](#).
- Any damage caused by installation of unapproved wheel/tire size combinations will not be covered by your new vehicle warranty. Volvo assumes no responsibility for death, injury, or expenses that may result from such installations.

pg. 121 General information



**New tires**

Remember that tires are perishable goods. As of 2000, the manufacturing week and year (Department of Transportation (DOT) stamp) will be indicated with 4 digits (e.g. 1502 means that the tire illustrated was manufactured during week 15 of 2002).

## Tire age

Tires degrade over time, even when they are not being used, which can affect their reliability and roadholding characteristics. Therefore, all tires older than 6 years (including the spare tire and winter tires) should be inspected by a qualified technician, regardless of appearance or mileage. Heat caused by hot climates or frequent high loading conditions can accelerate the aging process.

A tire's age can be determined by the DOT stamp on the sidewall (see the illustration above).

A tire with e.g., visible cracks or discoloration should be replaced immediately.

## Improving tire economy:

- Maintain correct tire pressure. See the tire pressure table on [page 124](#).
- Drive smoothly: avoid fast starts, hard braking and tire screeching.
- Tire wear increases with speed.
- Correct front wheel alignment is very important.
- Unbalanced wheels impair tire economy and driving comfort.
- Tires must maintain the same direction of rotation throughout their lifetime.
- When replacing tires, the tires with the most tread should be mounted on the rear wheels to reduce the chance of oversteer during hard braking.
- Hitting curbs or potholes can damage the tires and/or wheels permanently.

pg. 122 Tire inflation

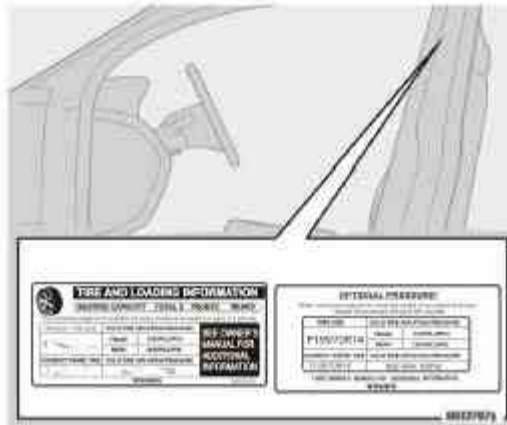

*Tire inflation placards on U.S. models*

## Tire inflation

Check tire inflation pressure regularly.

A table listing the recommended inflation pressure for your vehicle can be found on [page 124](#). Tire inflation pressure placards are also located on the driver's side B-pillar (the structural member at the side of the vehicle, at the rear of the driver's door opening), or on the inside of the fuel filler door on Canadian models. These placards indicate the designation of the factory-mounted tires on your vehicle, as well as load limits and inflation pressure.

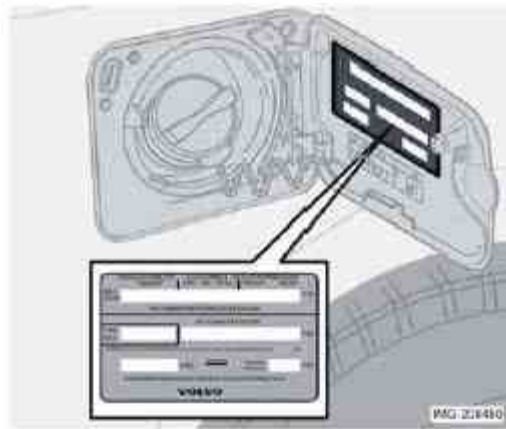

*Tire inflation placard on Canadian models*

**NOTE:** The placards shown indicate inflation pressure for the tires installed on the car at the factory only.

- Use a tire gauge to check the tire inflation pressure, including the spare, at least once a month and before long trips. You are strongly urged to buy a reliable tire pressure gauge, as automatic service station gauges may be inaccurate.
- Use the recommended cold inflation pressure for optimum tire performance and wear.
- Under-inflation or over-inflation may cause uneven treadwear patterns.

**WARNING!**

- Under-inflation is the most common cause of tire failure and may result in severe tire cracking, tread separation, or "blowout," with unexpected loss of vehicle control and increased risk of injury.
- Under-inflated tires reduce the load carrying capacity of your vehicle.

When weather temperature changes occur, tire inflation pressures also change. A 10- degree temperature drop causes a corresponding drop of 1 psi (7 kPa) in inflation pressure. Check your tire pressures frequently and adjust them to the proper pressure, which can be found on the vehicle's tire information placard or certification label.

**Checking tire pressure**

**Cold tires**

Inflation pressure should be checked when the tires are cold.

**The tires are considered to be cold when they have the same temperature as the surrounding (ambient) air.**

This temperature is normally reached after the car has been parked for at least 3 hours.

pg. 123 Tire inflation

After driving a distance of approximately 1 mile (1.6 km), the tires are considered to be hot. If you have to drive farther than this distance to pump your tire(s), check and record the tire pressure first and add the appropriate air pressure when you get to the pump.

If checking tire pressure when the tire is hot, never "bleed" or reduce air pressure. The tires are hot from driving and it is normal for pressures to increase above recommended cold pressures. A hot tire at or below recommended cold inflation pressure could be significantly under-inflated.

**To check inflation pressure:**

1. Remove the cap from the valve on one tire, then firmly press the tire gauge onto the valve.

2. Add air to reach the recommended air pressure
3. Replace the valve cap.
4. Repeat this procedure for each tire, including the spare.
5. Visually inspect the tires to make sure there are no nails or other objects embedded that could puncture the tire and cause an air leak.
6. Check the sidewalls to make sure there are no gouges, cuts, bulges or other irregularities.

**NOTE:**

- If you overfill the tire, release air by pushing on the metal stem in the center of the valve. Then recheck the pressure with your tire gauge.
- Some spare tires require higher inflation pressure than the other tires. Consult the tire inflation table on [page 124](#) or see the inflation pressure placard.

pg. 124 Tire inflation pressure tables

Tire pressures recommended by Volvo for your vehicle. Refer to the tire inflation placard for information specific to the tires installed on your vehicle at the factory.

Tire size	Cold tire pressure for vehicle loads up to 800 lbs (365 kg) <sup>a</sup> psi (kPa)	
	Front	Rear
195/65R15 <sup>b</sup> 91V	36 (250)	36 (250)
205/55R16 91V	36 (250)	36 (250)
205/50R17 93V Extra load	36 (250)	36 (250)
215/45R18 93W Extra load	36 (250)	36 (250)
Temporary spare tire T125/85R16 99M	61 (420)	61 (420)

- a. These weights include the weight of all occupants of the car plus cargo.
- b. 15" wheels should only be used on models with non-turbo engines, and with 15" front brakes. Consult your Volvo retailer.

Optional tire pressure. These inflation pressures may only be used when the vehicle is not fully loaded.

Tire size	Optional cold tire pressure that may only be used for vehicle loads up to 495 lbs (225 kg). psi (kPa)	
	Front	Rear
195/65R15 91V	30 (210)	30 (210)
205/55R16 91V	30 (210)	30 (210)
205/50R17 93V Extra load	35 (240)	32 (220)
215/45R18 93W Extra load	35 (240)	32 (220)
Temporary spare tire T125/85R16 99M	61 (420)	61 (420)

**Load ratings**

The load ratings in the tables above translate as follows:

91 = 1365 lbs (615 kg), 93 = 1433 lbs (650 kg), 99 = 1709 lbs (755 kg).

## Speed ratings

The speed ratings in the tables translate as follows:

M = 81 mph (130 km/h), V = 149 mph (240 km/h)

See also [page 125](#) for an explanation of the designations on the sidewall of the tire.

## pg. 125 Tire designations

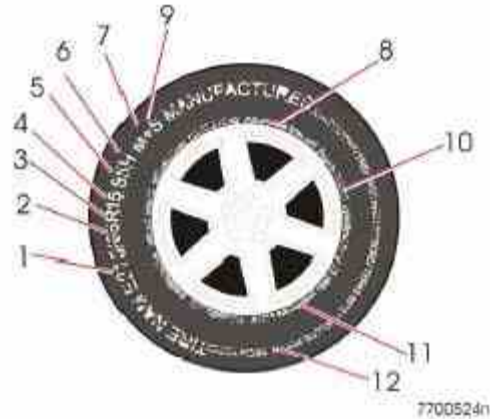

## Tire designations

Federal law mandates that tire manufacturers place standardized information on the sidewall of all tires (see the illustration).

The following information is listed on the tire sidewall:

The tire designation (the following figures are examples of a tire designation):

1. **215**: the width of the tire (in millimeters) from sidewall edge to sidewall edge. The larger the number, the wider the tire.
2. **65**: The ratio of the tire's height to its width.
3. **R**: Radial tire.
4. **15**: The diameter of the wheel rim (in inches).
5. **95**: The tire's load index. In this example, a load index of 95 equals a maximum load of 1521 lbs (690 kg).
6. **H**: The tire's speed rating, or the maximum speed at which the tire is designed to be driven for extended periods of time, carrying a permissible load for the vehicle, and with correct inflation pressure. For example, H indicates a speed rating of 130 mph (210 km/h).

**NOTE:** This information may not appear on the tire because it is not required by law.

7. **M+S** or **M/S** = Mud and Snow, **AT** = All Terrain, **AS** = All Season

8. **U.S. DOT Tire Identification Number (TIN):** This begins with the letters "DOT" and indicates that the tire meets all federal standards. The next two numbers or letters are the plant code where it was manufactured, the next two are the tire size code and the last four numbers represent the week and year the tire was built. For example, the numbers 317 mean the 31st week of 1997. After 2000 the numbers go to four digits. For example, 2501 means the 25th week of

2001. The numbers in between are marketing codes used at the manufacturer's discretion. This information helps a tire manufacturer identify a tire for safety recall purposes.

**9. Tire Ply Composition and Material Used:** Indicates the number of plies indicates or the number of layers of rubber-coated fabric in the tire tread and sidewall. Tire manufacturers also must indicate the ply materials in the tire and the sidewall, which include steel, nylon, polyester, and others.

**10. Maximum Load:** Indicates the maximum load in pounds and kilograms that can be carried by the tire. Refer to the vehicle's tire information placard or the safety certification label, located on the B-Pillar or the driver's door or on the inside of the fuel filler door on Canadian models, for the correct tire pressure for your vehicle.

**11. Treadwear, Traction, and Temperature grades:** See [page 128](#) for more information.

**12. Maximum permissible inflation pressure:** the greatest amount of air pressure that should ever be put in the tire. This limit is set by the tire manufacturer.

## pg. 126 Glossary of tire terminology

The tire suppliers may have additional markings, notes or warnings such as standard load, radial tubeless, etc.

- **Tire information placard:** A placard showing the OE (Original Equipment) tire sizes, recommended inflation pressure, and the maximum weight the vehicle can carry.
- **Tire Identification Number (TIN):** A number on the sidewall of each tire providing information about the tire brand and manufacturing plant, tire size and date of manufacturer.
- **Inflation pressure:** A measure of the amount of air in a tire.
- **Standard load:** A class of P-metric or Metric tires designed to carry a maximum load at 35 psi [37 psi (2.5 bar) for Metric tires]. Increasing the inflation pressure beyond this pressure will not increase the tires load carrying capability.
- **Extra load:** A class of P-metric or Metric tires designed to carry a heavier maximum load at 41 psi [43 psi (2.9 bar) for Metric tires]. Increasing the inflation pressure beyond this pressure will not increase the tires load carrying capability.
- **kPa:** Kilopascal, a metric unit of air pressure.
- **PSI:** Pounds per square inch, a standard unit of air pressure.
- **B-pillar:** The structural member at the side of the vehicle behind the front door.
- **Bead area of the tire:** Area of the tire next to the rim.
- **Sidewall of the tire:** Area between the bead area and the tread.
- **Tread area of the tire:** Area of the perimeter of the tire that contacts the road when mounted on the vehicle.
- **Rim:** The metal support (wheel) for a tire or a tire and tube assembly upon which the tire beads are seated.
- **Maximum load rating:** a figure indicating the maximum load in pounds and kilograms that can be carried by the tire. This rating is established by the tire manufacturer.
- **Maximum permissible inflation pressure:** the greatest amount of air pressure that should ever be put in the tire. This limit is set by the tire manufacturer.
- **Recommended tire inflation pressure:** inflation pressure, established by Volvo, which is based on the type of tires that are mounted on a vehicle at the factory. This inflation pressure is affected by the number of occupants in the car, the amount of cargo, and the speed at which the vehicle will be driven for a prolonged period. This information can be found on the tire inflation placard(s) located on the driver's side B-pillar or on the inside of the fuel filler door on Canadian models, and in the tire inflation table in this chapter.
- **Cold tires:** The tires are considered to be cold when they have the same temperature as the surrounding (ambient) air. This temperature is normally reached after the car has been parked for at least 3 hours.

## pg. 127 Vehicle loading

### Vehicle loading

Properly loading your vehicle will provide maximum return of vehicle design performance.

Before loading your vehicle, familiarize yourself with the following terms for determining your vehicle's weight ratings, with or without a trailer, from the vehicle's Federal/ Canadian Motor Vehicle Safety Standards (FMVSS/CMVSS) label, and the vehicle's tire information placard:

### **Curb weight**

The weight of the vehicle including a full tank of fuel and all standard equipment. It does not include passengers, cargo, or optional equipment.

### **Capacity weight**

All weight added to the curb weight, including cargo and optional equipment. When towing, trailer hitch tongue load is also part of cargo weight.

**NOTE:** For trailer towing information, please refer to the section "Towing a trailer" on [page 115](#).

### **Permissible axle weight**

The maximum allowable weight that can be carried by a single axle (front or rear). These numbers are shown on the Federal/Canadian Motor Vehicle Safety Standards (FMVSS/CMVSS) label. The total load on each axle must never exceed its maximum permissible weight.

### **Gross vehicle weight (GVW)**

The vehicle's curb weight + cargo + passengers.

### **NOTE:**

- The location of the various labels in your vehicle can be found on [page 176](#).
- A table listing important weight limits for your vehicle can be found on [page 177](#).

### **Steps for Determining Correct Load Limit**

- (1) Locate the statement "the combined weight of occupants and cargo should never exceed XXX pounds" on your vehicle's placard.
- (2) Determine the combined weight of the driver and passengers that will be riding in your vehicle.
- (3) Subtract the combined weight of the driver and passengers from XXX kilograms or XXX pounds.
- (4) The resulting figure equals the available amount of cargo and luggage load capacity. For example, if the "XXX" amount equals 1400 lbs. and there will be five 150 lb. passengers in your vehicle, the amount of available cargo and luggage load capacity is 650 lbs. (1400-750 (5 x 150) = 650 lbs.)
- (5) Determine the combined weight of luggage and cargo being loaded on the vehicle. That weight may not safely exceed the available cargo and luggage load capacity calculated in Step 4.
- (6) If your vehicle will be towing a trailer, load from your trailer will be transferred to your vehicle. Consult this manual<sup>1</sup> to determine how this reduces the available cargo and luggage load capacity of your vehicle.

#### **WARNING!**

- Exceeding the permissible axle weight, gross vehicle weight, or any other weight rating limits can cause tire overheating resulting in permanent deformation or catastrophic failure.
- Do not use replacement tires with lower load carrying capacities than the tires that were original equipment on the vehicle because this will lower the vehicle's GVW rating. Replacement tires with a higher limit than the originals do not increase the vehicle's GVW rating limitations.

1. See "Towing a trailer" on [page 115](#).

pg. 128 Uniform Tire Quality Grading

### **Uniform Tire Quality Grading**

**ALL PASSENGER VEHICLE TIRES MUST CONFORM TO FEDERAL SAFETY REQUIREMENTS IN**



## ADDITION TO THESE GRADES

Quality grades can be found, where applicable, on the tire sidewall between the tread shoulder and maximum section width. For example:

**Treadwear 200 Traction AA Temperature A**

### TREADWEAR

The treadwear grade is a comparative rating based on the wear rate of the tire when tested under controlled conditions on a specified government test course. For example, a tire graded 150 would wear one and one half (1 1/2) times as well on the government course as a tire graded 100. The relative performance of tires depends upon the actual conditions of their use, however, and many depart significantly from the norm due to variation in driving habits, maintenance practices and differences in road characteristics and climate.

### TRACTION

The traction grades, from highest to lowest, are AA, A, B, and C, as measured under controlled conditions on specified government test surfaces of asphalt and concrete. A tire marked C may have poor traction performance. The traction grade assigned to this tire is based on braking (straight-ahead) traction tests and is not a measure of cornering (turning) traction.

#### **WARNING!**

The traction grade assigned to this tire is based on braking (straight-ahead) traction tests and is not a measure of cornering (turning) traction.

### TEMPERATURE

The temperature grades are AA (the highest), A, B, and C, representing the tire's resistance to the generation of heat and its ability to dissipate heat when tested under controlled conditions on a specified indoor laboratory test wheel. Sustained high temperature can cause the material of the tire to degenerate and reduce tire life, and excessive temperature can lead to sudden tire failure. The grade C corresponds to a minimum level of performance that all passenger vehicle tires must meet under the Federal Motor Safety Standard No. 109. Grades B and A represent higher levels of performance on the laboratory test wheel than the minimum required by law.

#### **WARNING!**

The temperature grade for this tire is established for a tire that is properly inflated and not overloaded. Excessive speed, under-inflation, or excessive loading, either separately or in combination, can cause heat buildup and tire failure.

pg. 129 Snow chains, snow tire, studded tires

### Snow chains

Snow chains can be used on your Volvo with the following restrictions:

- Snow chains should be installed on front wheels only. Use only Volvo approved snow chains.
- If accessory, aftermarket or "custom" tires and wheels are installed and are of a size different than the original tires and wheels, chains in some cases CANNOT be used. Sufficient clearances between chains and brakes, suspension and body components must be maintained.
- Some strap-on type chains will interfere with brake components and therefore CANNOT be used.
- **All Wheel Drive models:** Snow chains should only be installed on the front wheels. Only chains adapted for AWD models should be used.

Consult your Volvo retailer for additional snow chain information.

#### **CAUTION!**

- Check local regulations regarding the use of snow chains before installing.
- Always follow the chain manufacturer's installation instructions carefully. Install chains as tightly as possible and retighten periodically.
- Never exceed the chain manufacturer's specified maximum speed limit. (Under no circumstances should you exceed 31 mph
- (50 km/h).
- Avoid bumps, holes or sharp turns when driving with snow chains.
- The handling of the vehicle can be adversely affected when driving with chains. Avoid fast or sharp turns as well as locked wheel braking.

## **Snow tires, studded tires<sup>1</sup>**

### **Tires for winter use:**

- Owners who live in or regularly commute through areas with sustained periods of snow or icy driving conditions are strongly advised to fit suitable winter tires to help retain the highest degree of traction.
- It is important to install winter tires on all four wheels to help retain traction during cornering, braking, and accelerating. Failure to do so could reduce traction to an unsafe level or adversely affect handling.
- Do not mix tires of different design as this could also negatively affect overall tire road grip.
- Winter tires wear more quickly on dry roads in warm weather. They should be removed when the winter driving season has ended.
- Studded tires should be run-in 300-600 miles (500-1000 km) during which the car should be driven as smoothly as possible to give the studs the opportunity to seat properly in the tires. The tires should have the same rotational direction throughout their entire lifetime.

**NOTE:** Please consult state or provincial regulations restricting the use of studded winter tires before installing such tires.

1. Where permitted

pg. 130 Temporary Spare

### **Temporary spare**

The spare tire in your vehicle is called a "temporary spare".

Recommended tire pressure (see the placard on the B-pillar or on the fuel filler door) should be maintained irrespective of which position on the car the temporary spare tire is used on.

In the event of damage to this tire, a new one can be purchased from your Volvo retailer.

### **WARNING!**

Current legislation prohibits the use of the "temporary spare" tire other than as a temporary replacement for a punctured tire. It must be replaced as soon as possible by a standard tire. Road holding and handling may be affected with the "temporary spare" in use. Do not exceed 50 m.p.h. (80 km/h). Do not drive farther than 50 miles (80 km) on a temporary spare tire.

### **CAUTION!**

The car must not be driven with wheels of different dimensions or with a spare tire other than the one that came with the car. The use of different size wheels can seriously damage your car's transmission.

pg. 131 Wheel nuts

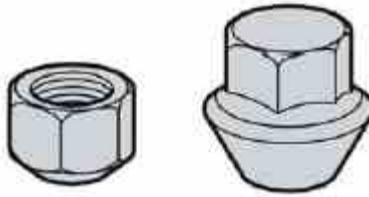

*Low and high wheel nuts*

### **Wheel nuts**

There are two different types of wheel nut, depending on whether the wheels are steel or aluminum.

#### **Steel rims - low nut**

Steel rims are normally secured using the low type of nut, although steel rims may also use the high type.

#### **WARNING!**

Never use the short type of nut for aluminium wheels. This could cause the wheel to come loose.

#### **Aluminum wheels - high nut**

Only the high type of nut can be used for aluminum wheels. This is considerably different from other types of nut because it has a rotating conical thrust washer.

**NOTE:** This nut can also be used on steel wheels.

#### **Lockable wheel nut**

If steel wheels with lockable wheel nuts are used in combination with wheel covers, the lockable wheel nut must be fitted to the stud nearest the air valve. The wheel cover cannot otherwise be installed on the wheel.

pg. 132 Tire rotation

### **Tire rotation**

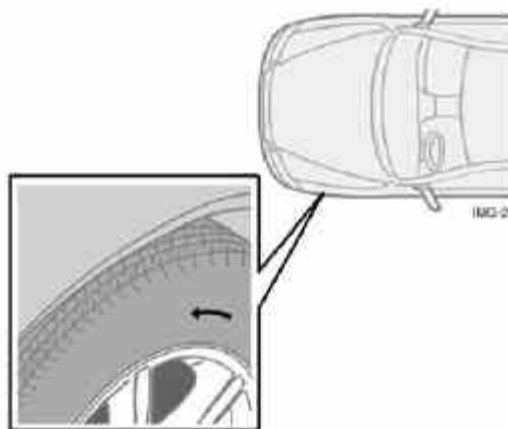

*The arrow shows the direction of rotation of the tire*

### **Summer and winter tires**

- When switching between summer and winter tires, mark the tires to indicate where they were mounted on the car, e.g. LF = left front, RR = right rear

- Tires with tread designed to roll in only one direction are marked with an arrow on the sidewall.
- Incorrectly mounted tires impair the car's braking properties and ability to force aside rain, snow and slush.
- The tires with the most tread should always be at the rear (to reduce the risk of skidding).
- Contact a Volvo workshop if you are unsure about the tread depth.

pg. 133 Changing a wheel

## Changing a wheel

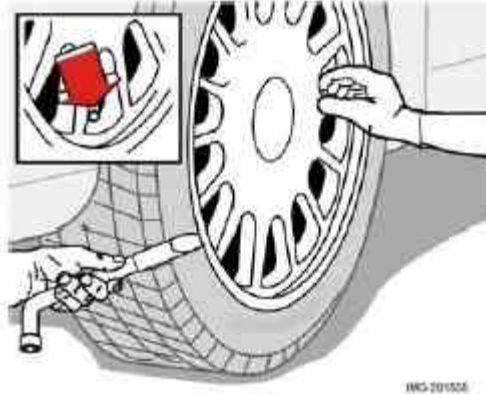

The spare tire, jack, and crank are located under the carpet on the floor of the trunk.

To change a tire:

1. Engage the parking brake.
2. Put the gear selector in (P)ark.
3. Block the wheels that are on the ground with wooden blocks or large stones.
4. Remove the wheel cap (where applicable) using the lug wrench in the tool bag.

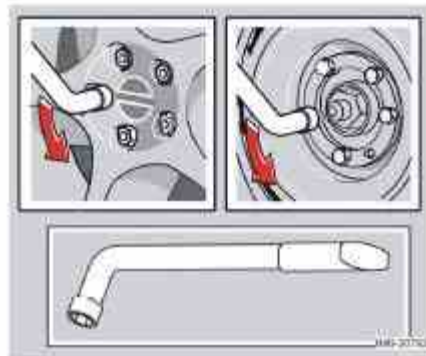

5. With the car still on the ground, use the lug wrench to loosen the wheel nuts 1/2 - 1 turn by exerting downward pressure. Turn the nuts counterclockwise to loosen.
6. There are two jack attachment points on each side of the car. Position the jack correctly in the attachment (see illustration above) and crank while simultaneously guiding the base of the jack to the ground. The base of the jack must be flat on a level, firm, non-slippery surface. Before raising the car, check that the jack is still correctly positioned in the attachment.

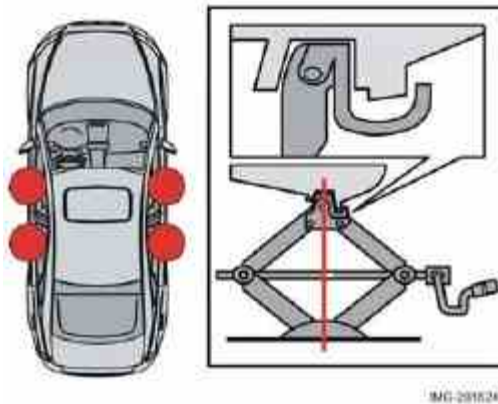

7. Raise the vehicle until the wheel to be changed is lifted off the ground.
8. Unscrew the wheel bolts completely and carefully remove the wheel so as not to damage the threads on the studs.

pg. 134 Changing a wheel

**WARNING!**

The jack must correctly engage the jack attachment.  
 Be sure the jack is on a firm, level, non-slippery surface.  
 Never allow any part of your body to be extended under a car supported by a jack.  
 Use the jack intended for the car when changing a tire. For any other job, use stands to support the car.  
 Apply the parking brake and put the gear selector in the (P)ark position.  
 Block the wheels standing on the ground, use rigid wooden blocks or large stones.  
 The jack should be kept well-greased.

**Installing the wheel**

1. Clean the contact surfaces on the wheel and hub.
2. Lift the wheel and place it on the hub.
3. Install the wheel nuts and tighten hand-tight. Using the lug wrench, tighten crosswise until all nuts are snug.
4. Lower the vehicle to the ground and alternately tighten the bolts crosswise to 62 ft. lbs. (85 Nm).

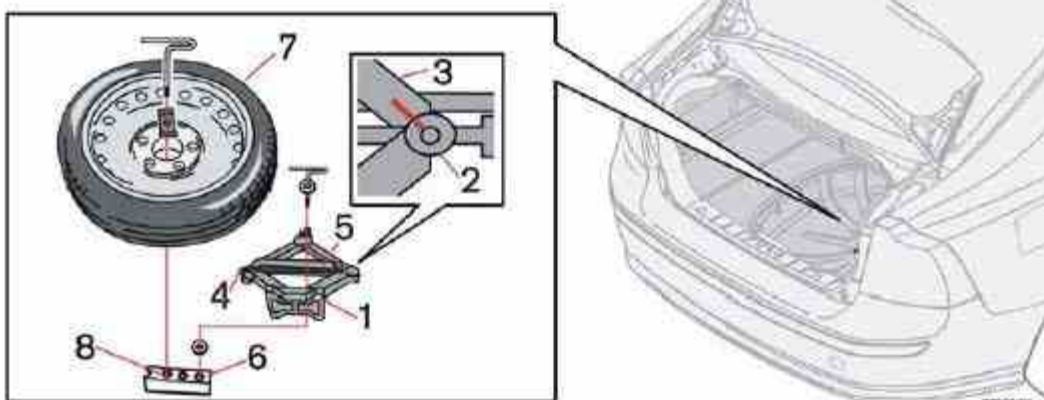

*Returning jack and spare wheel to storage space*

5. Install the wheel cap (where applicable).

**Returning the jack and spare wheel to the storage space**

1. Crank the jack (1) down approximately halfway until the mark on the washer (2) aligns with the mark on the jack's

- arm (3).
2. Place the jack in the storage space. Fold in the jack's crank (4) and place the lug wrench (5) on the jack.
  3. Screw the jack's retaining pin into hole 6 so that it holds the jack securely in place.
  4. Place the spare wheel (7) over the jack.
  5. Insert the spare wheel's retaining pin through the center hole in the spare wheel so that it aligns with hole 8. Screw the retaining pin into hole 8 so that it holds the spare wheel securely in place.
- 



[Contents](#) | [Top of Page](#)

**2006  
VOLVO  
S40**

**Chapter 9 - Vehicle care**

pg. 135 Vehicle care

[Washing and cleaning the car](#) **136**

[Paint touch up](#) **139**

pg. 136 Washing and cleaning the car

**Washing and cleaning the car**

**Washing the car**

The following points should be kept in mind when washing and cleaning the car:

- The car should be washed at regular intervals since dirt, dust, insects and tar spots adhere to the paint and may cause damage. To help prevent corrosion, it is particularly important to wash the car frequently in the wintertime.
- Avoid washing your car in direct sunlight. Doing so may cause detergents and wax to dry out and become abrasive. To avoid scratching, use lukewarm water to soften the dirt before you wash with a soft sponge, and plenty of sudsy water.
- **Bird droppings:** Remove from paint work as soon as possible. Otherwise the finish may be permanently damaged.
- A detergent can be used to facilitate the softening of dirt and oil.
- A water-soluble grease solvent may be used in cases of sticky dirt. However, use a wash place equipped with a drainage separator.
- Dry the car with a clean chamois and remember to clean the drain holes in the doors and rocker panels.
- Tar spots can be removed with kerosene or tar remover after the car has been washed.
- A stiff-bristle brush and lukewarm soapy water can be used to clean the wiper blades. Frequent cleaning improves visibility considerably.
- Wash off the dirt from the underside (wheel housings, fenders, etc).
- In areas of high industrial fallout, more frequent washing is recommended.
- After cleaning the engine, the spark plug wells should be inspected for water and blown dry if necessary.

**Exterior plastic components**

Cleaning exterior plastic components should be done with a cleaning agent specially designed for this purpose. Solvents or stain removers should not be used. Consult your Volvo retailer.

**NOTE:** When washing the car, remember to remove dirt from the drain holes in the doors and sills.

**CAUTION!**

During high pressure washing, the spray mouthpiece must never be closer to the vehicle than 13" (30 cm). Do not spray into the locks.

When washing or steam cleaning the engine, avoid spraying water or steam directly on the electrical components or toward the rear side of the engine. Special moonroof cautions:  
Always close the moonroof and sun shade before washing your vehicle.  
Never use abrasive cleaning agents on the moonroof.  
Never use wax on the rubber seals around the moonroof.

### **Automatic washing - simple and quick**

- We do NOT recommend washing your car in an automatic wash during the first six months (because the paint will not have hardened sufficiently).
- An automatic wash is a simple and quick way to clean your car, but it is worth remembering that it may not be as thorough as when you yourself go over the car with sponge and water. Keeping the underbody clean is most important,

pg. 137 Washing and cleaning the car

especially in the winter. Some automatic washers do not have facilities for washing the underbody.

#### **CAUTION!**

Before driving into an automatic carwash, turn off the optional rain sensor to avoid damaging the windshield wipers. Make sure that side view mirrors, auxiliary lamps, etc, are secure, and that any antenna(s) are retracted or removed. Otherwise there is risk of the machine dislodging them.

#### **WARNING!**

When the car is driven immediately after being washed, apply the brakes several times in order to remove any moisture from the brake linings.  
Engine cleaning agents should not be used when the engine is warm. This constitutes a fire risk.

### **Polishing and Waxing**

- Normally, polishing is not required during the first year after delivery, however, waxing may be beneficial.
- Before applying polish or wax the vehicle must be washed and dried. Tar spots can be removed with kerosene or tar remover. Difficult spots may require a fine rubbing compound.
- After polishing use liquid or paste wax.
- Several commercially available products contain both polish and wax.
- Waxing alone does not substitute for polishing a dull surface.
- A wide range of polymer-based waxes can be purchased today. These waxes are easy to use and produce a long-lasting, high-gloss finish that protects the bodywork against oxidation, road dirt and fading.
- Do not polish or wax your vehicle in direct sunlight (the surface of the vehicle should not be warmer than 113° F (45° C)).

#### **CAUTION!**

Volvo does not recommend the use of long-life or durable paint protection coatings, some of which may claim to prevent pitting, fading, oxidation, etc. These coatings have not been tested by Volvo for compatibility with your vehicle's clear coat. Some of them may cause the clear coat to soften, crack, or cloud. Damage caused by application of paint protection coatings may not be covered under your vehicle's paint warranty.

pg. 138 Washing and cleaning the car

### **Upholstery care Fabric**



- Clean with soapy water or a detergent. For more difficult spots caused by oil, ice cream, shoe polish, grease, etc., use a clothing/fabric stain remover. Consult your Volvo retailer.

### **Interior plastic components**

- Cleaning interior plastic components should be done with a cleaning agent specially designed for this purpose. Consult your Volvo retailer. **Alcantera™ suede-like material**
- Suede-like upholstery can be cleaned with a soft cloth and mild soap solution.

### **Leather care**

Volvo's leather upholstery is manufactured with a protectant to repel soiling. Over time, sunlight, grease and dirt can break down the protection. Staining, cracking, scuffing, and fading can result.

Volvo offers an easy-to-use, non-greasy leather care kit formulated to clean and beautify your vehicle's leather, and to renew the protective qualities of its finish. The cleaner removes dirt and oil buildup. The light cream protectant restores a barrier against soil and sunlight.

Volvo also offers a special leather softener that should be applied after the cleaner and protectant. It leaves leather soft and smooth, and reduces friction between leather and other finishes in the vehicle.

Volvo recommends cleaning, protecting and conditioning your vehicle's leather two to four times a year. Ask your Volvo retailer about Leather Care Kit 951 0251 and Leather Softener 943 7429.

#### **CAUTION!**

- Under no circumstances should gasoline, naphtha or similar cleaning agents be used on the plastic or the leather since these can cause damage.
- Take extra care when removing stains such as ink or lipstick since the coloring can spread.
- Use solvents sparingly. Too much solvent can damage the seat padding.
- Start from the outside of the stain and work toward the center.
- Sharp objects (e.g. pencils or pens in a pocket) or Velcro fasteners on clothing may damage the textile upholstery.

### **Cleaning the seat belts**

Clean only with lukewarm water and a mild soap solution.

### **Cleaning floor mats**

The floor mats should be vacuumed or brushed clean regularly, especially during winter when they should be taken out for drying. Spots on textile mats can be removed with a mild detergent. For best protection in winter, Volvo recommends the use of Volvo rubber floor mats. Consult your Volvo retailer.

pg. 139 Paint touch up

### **Touching up minor paint damage**

Paint damage requires immediate attention to avoid rusting. Make it a habit to check the finish regularly - when washing the vehicle for instance. Touch-up if necessary. Paint repairs require special equipment and skill. Contact your Volvo retailer for any extensive damage. Minor scratches can be repaired by using Volvo touch-up paint.

### **Color code**

When ordering touch-up paint from your Volvo retailer, make sure you have the right color. Use the paint code indicated on the model plate. The plate is located on the passenger's side center door pillar.

### **Minor stone chips and scratches**

Material:

- Primer - can
- Paint - touch-up pen
- Brush
- Masking tape

**NOTE:** When touching up the vehicle, it should be clean and dry. The surface temperature should be above 60° F (15° C).

If the stone chip has not penetrated down to the metal and an undamaged layer of paint remains, the touch-up paint can be applied as soon as the spot has been cleaned.

VOLVOCARCORP.MADEIN	
kg	1
kg	2
1- kg	3
2- kg	4

*Paint color code*

### Deep scratches

1. Place a strip of masking tape over the damaged surface. Pull the tape off so that any loose flakes of paint adhere to it.
2. Thoroughly mix the primer and apply it with a small brush. When the primer surface is dry, the paint can be applied using a brush. Mix the paint thoroughly; apply several thin paint coats and let dry after each application.
3. If there is a longer scratch, you may want to protect surrounding paint by masking it off.



pg. 140 This page intentionally left blank



**2006  
VOLVO  
S40**

**Chapter 10 - Maintenance and servicing**

pg. 141 Maintenance and servicing

[Volvo maintenance](#) [142](#)

[Maintaining your car](#) [143](#)

[Hood and engine compartment](#) [145](#)

[Engine oil](#) [146](#)

[Fluids](#) [147](#)

[Wiper blades](#) [149](#)

[Battery](#) [150](#)

[Bulbs](#) [152](#)

[Replacing front bulbs](#) [153](#)

[Replacing tail light bulbs](#) [156](#)

[Replacing interior bulbs](#) [157](#)

[Fuses](#) [158](#)

pg. 142 Volvo maintenance

**Volvo maintenance**

Volvo advises you to follow the maintenance program outlined in the Warranty and Service Records Information booklet. This maintenance program contains inspections and services necessary for the proper function of your vehicle. The maintenance services contain several checks that require special tools and training, and therefore must be performed by a qualified technician. To keep your Volvo in top condition, specify time-tested and proven Genuine Volvo Parts and Accessories.

**The Federal Clean Air Act - U.S**

The Federal Clean Air Act requires vehicle manufacturers to furnish written instructions to the ultimate purchaser to assure the proper servicing and function of the components that control emissions. These services, which are listed in the "Warranty and Service Records Information" booklet, are not covered by the warranty. You will be required to pay for labor and material used.

**Maintenance**

Your Volvo passed several major inspections before it was delivered to you, in accordance with Volvo specifications. The maintenance procedures outlined in the Warranty and Service Records Information booklet, many of which will positively affect your vehicle's emissions, should be performed as indicated. It is recommended that receipts for vehicle emission maintenance be retained in case questions arise concerning maintenance. Inspection and maintenance should also be performed anytime a malfunction is observed or suspected.

### **Applicable warranties - U.S./Canada**

In accordance with applicable U.S. and Canadian regulations, the following list of warranties is provided.

- New Vehicle Limited Warranty
- Parts and Accessories Limited Warranty
- Corrosion Protection Limited Warranty
- Seat Belt and Supplemental Restraint Systems Limited Warranty
- Emission Design and Defect Warranty
- Emission Performance Warranty

These are the federal warranties; other warranties are provided as required by state/provincial law. Refer to your separate Warranty and Service Records Information booklet for detailed information concerning each of the warranties.

### **Periodic maintenance helps minimize emissions**

Periodic maintenance will help keep your vehicle running well. Your Warranty and Service Records Information booklet provides a comprehensive periodic maintenance schedule up to 150,000 miles (240,000 km) of vehicle maintenance. The schedule includes components that affect vehicle emissions. This page describes some of the emission-related components.

### **Vehicle Event Data (Black Box)**

Your vehicle's driving and safety systems employ computers that monitor, and share with each other, information about your vehicle's operation. One or more of these computers may store what they monitor, either during normal vehicle operation or in a crash or near-crash event. Stored information may be read and used by:

- Volvo Car Corporation
- service and repair facilities
- law enforcement or government agencies
- others who may assert a legal right to know, or who obtain your consent to know such information.

pg. 143 Maintaining your car

### **Owner maintenance**

Periodic maintenance requirements and intervals are described in your vehicle's Warranty and Service Records Information booklet.

The following points can be carried out between the normally scheduled maintenance services.

#### **Each time the car is refueled:**

- Check the engine oil level
- Clean the windshield, windshield wipers, headlights, and tail lights

#### **Monthly:**

- Check cold tire pressure in all tires. Inspect the tires for wear.
- Check that engine coolant and other fluid levels are between the indicated "min" and "max" markings.
- Clean interior glass surfaces with a glass cleaner and soft paper towels.
- Wipe driver information displays with a soft cloth.
- Visually inspect battery terminals for corrosion. Corrosion may indicate a loose terminal connector, or a battery near the end of its useful service life. Consult your Volvo retailer for additional information.

**As needed:**

- Wash the car, including the undercarriage, to reduce wear that can be caused by a buildup of dirt, and corrosion that can be caused by salt residues.
- Clean leaves and twigs from air intake vents at the base of the windshield, and from other places where they may collect.

**NOTE:**

Complete service information for qualified technicians is available online for purchase or subscription at [www.volvotechinfo.com](http://www.volvotechinfo.com).

pg. 144 Maintaining your car

**Emission inspection readiness****What is an Onboard Diagnostic System (OBD II)?**

OBD II is part of your vehicle's computerized engine management system. It stores diagnostic information about your vehicle's emission controls. It can light the Check Engine light (MIL) if it detects an emission control "fault." A "fault" is a component or system that is not performing within an expected range. A fault may be permanent or temporary. OBD II will store a message about any fault.

**How do states use OBD II for emission inspections?**

Many states connect a computer directly to a vehicle's OBD II system. The inspector can then read "faults." In some states, this type of inspection has replaced the tailpipe emission test.

**How can my vehicle fail OBD II emission inspection?**

Your vehicle can fail OBD II emission inspection for any of the following reasons.

- If your Check Engine (MIL) light is lit, your vehicle may fail inspection.
- If your vehicle's Check Engine light was lit, but went out without any action on your part, OBD II will still have a recorded fault. Your vehicle may pass or fail, depending on the inspection practices in your area.
- If you had recent service that required disconnecting the battery, OBD II diagnostic information may be incomplete and "not ready" for inspection. A vehicle that is not ready may fail inspection.

**How can I prepare for my next OBD II emission inspection?**

- If your Check Engine (MIL) light is lit - or was lit but went out without service, have your vehicle diagnosed and, if necessary, serviced by a qualified Volvo technician.
- If you recently had service for a lit Check Engine light, or if you had service that required disconnecting the battery, a period of driving is necessary to bring the OBD II system to "ready" for inspection. A half-hour trip of mixed stop-and-go/ highway driving is typically needed to allow OBD II to reach readiness. Your Volvo retailer can provide you with more information on planning a trip.
- Maintain your vehicle in accordance with your vehicle's maintenance schedule.

pg. 145 Hood and engine compartment

**Hood and engine compartment**

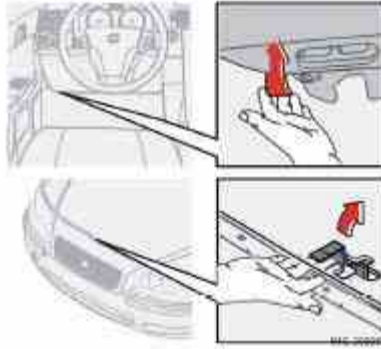

## Opening the hood

To open the hood:

- Pull the lever located under the left side of the dash to release the hood lock.
- Lift the hood slightly.
- Press up the release control located under the front edge of the hood (at the center) up to the right, and lift the hood.

### **WARNING!**

Check that the hood locks engage properly when closed.

## Engine compartment

1. Cooling system expansion tank
2. Power steering fluid reservoir
3. Dipstick - engine oil
4. Radiator
5. Cooling fan
6. Washer fluid reservoir
7. Engine oil filler cap
8. Brake/clutch fluid reservoir
9. Battery
10. Relay/fuse box
11. Air cleaner

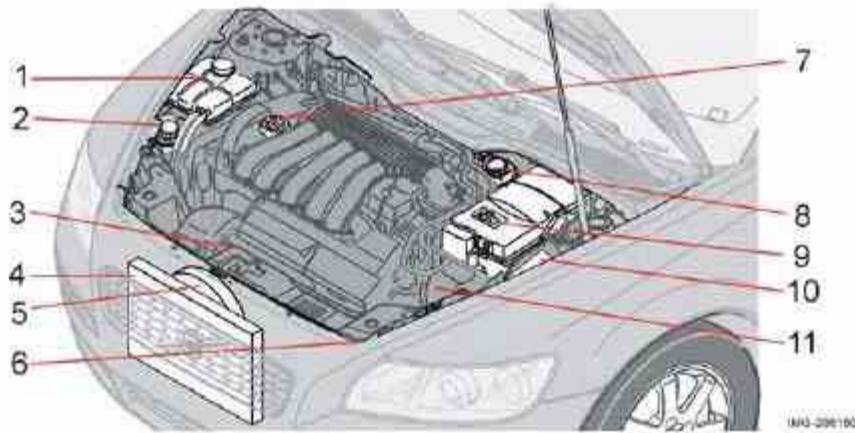

### **WARNING!**

The cooling fan may start or continue to operate (for up to 6 minutes) after the engine has been switched off.

pg. 146 Engine

### Changing engine oil and oil filter

See [page 179](#) for oil specifications. Refer to the Warranty and Service Records Information booklet for information on the oil change intervals.

#### NOTE:

- Volvo does not recommend the use of oil additives.
- Synthetic oil is not used when the oil is changed at the normal maintenance intervals except at owner request and at additional charge. Please consult your Volvo retailer.

### Checking and adding oil

The oil level should be checked every time the vehicle is refueled. This is especially important during the period up to the first scheduled maintenance service.

#### CAUTION!

Not checking the oil level regularly can result in serious engine damage if the oil level becomes too low. Always add oil of the same type and viscosity as already used.

- The car should be parked on a level surface when the oil is checked.

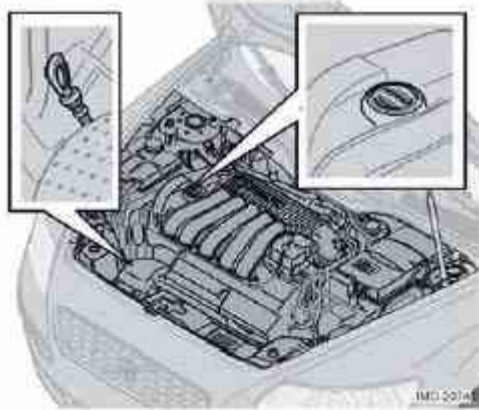

*Location of dipstick and oil filler cap*

- **If the engine is warm**, wait for at least 10-15 minutes after the engine has been switched off before checking the oil.

### Checking the oil

1. Pull out the dipstick and wipe it with a lint-free rag.
2. Reinsert the dipstick, pull it out, and check the oil level.
3. Add oil if necessary. If the level is close to the MIN mark, add approximately 1 US quart (1 liter) of oil.
4. Run the engine until it reaches normal operating temperature.

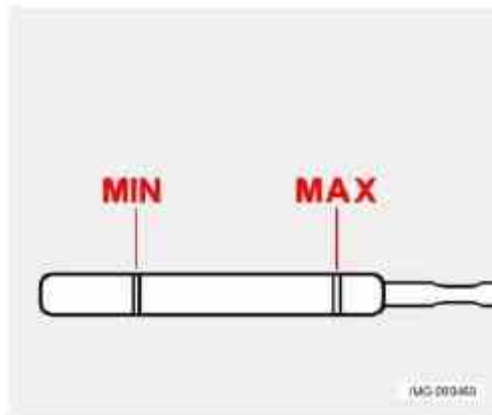

5. Switch off the engine and wait for at least 10-15 minutes and recheck the oil level. If necessary, add oil until the level is near the Max mark.

### CAUTION!

- Not checking the oil level regularly can result in serious engine damage if the oil level becomes too low.
- Oil that is lower than the specified quality can damage the engine.
- Always add oil of the same type and viscosity as already used.
- Never fill oil above the MAX mark. This could cause an increase in oil consumption.

### WARNING!

Do not allow oil to spill onto or come into contact with hot exhaust pipe surfaces.

pg. 147 Fluids



*Washer fluid reservoir*

### Washer fluid

The washer fluid reservoir is located in the engine compartment and holds approximately 6.8 US qts (6.5 liters). During cold weather, the reservoir should be filled with windshield washer solvent containing antifreeze.



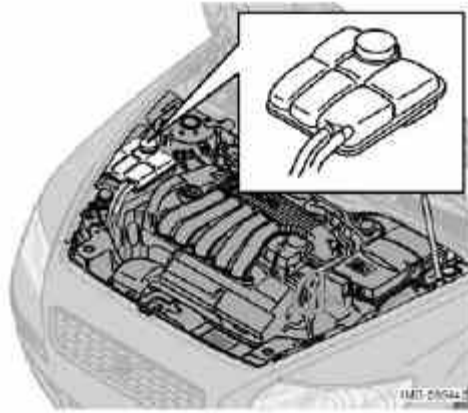

*Coolant reservoir*

### **Coolant**

Normally, the coolant does not need to be changed. If the system must be drained, consult your Volvo retailer.

**NOTE:** Do not top off with water only. This reduces the rust-protective and antifreeze qualities of the coolant and has a lower boiling point. It can also cause damage to the cooling system if it should freeze. Top off with Volvo Genuine Coolant/Antifreeze only (a 50/50 mix of water and antifreeze).

### **CAUTION!**

The cooling system must always be kept filled to the correct level, and the level must be between the MIN and MAX marks. If it is not kept filled, there can be high local temperatures in the engine which could result in damage. Different types of antifreeze/coolant may not be mixed. Check coolant regularly!

### **WARNING!**

Never remove the radiator cap while the engine is warm. Wait until the vehicle cools. If it is necessary to top off the coolant when the engine is warm, unscrew the expansion tank cap slowly so that the over-pressure dissipates.

pg. 148 Fluids

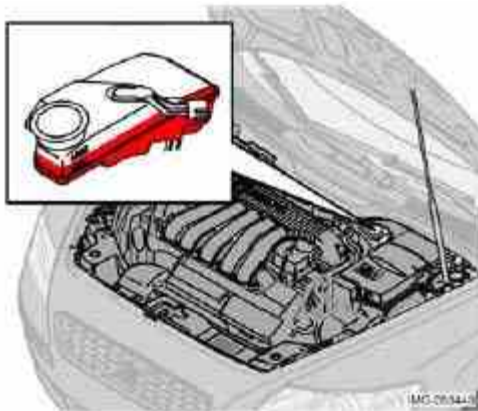

*Brake fluid reservoir*

### **Brake fluid**

The brake fluid should always be between the MIN and MAX marks on the side of the reservoir. Check, without

removing the cap, that there is sufficient fluid in the reservoir.

**Fluid type:** DOT 4+ boiling point >536°F (280°C), P/N 9437433

**Replace:** The fluid should be replaced according to the intervals specified in the Warranty and Service Records Information booklet. When driving under extremely hard conditions (mountain driving, etc), it may be necessary to replace the fluid more often. Consult your Volvo retailer. Always entrust brake fluid changing to a trained and qualified Volvo service technician.

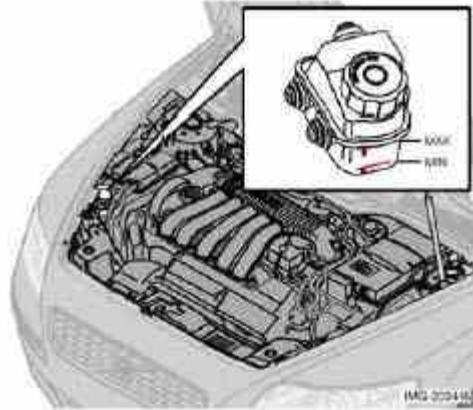

*Power steering fluid reservoir*

### **Power steering fluid**

The fluid level should always be between the MIN and MAX marks.

**Fluid type:** Volvo power steering fluid or equivalent.

**Replace:** No fluid change required

### **WARNING!**

If a problem should occur in the power steering system or if the vehicle has no electrical current and must be towed, it is still possible to steer the vehicle.

However, keep in mind that greater effort will be required to turn the steering wheel.

pg. 149 Wiper blades

### **Wiper blades**

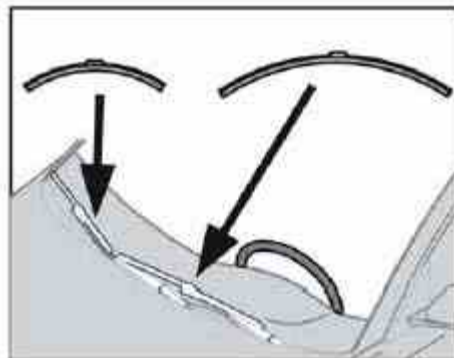

## Replacing windshield wiper blades

1. Fold out the wiper arm and fold out the wiper blade at a 90° angle to the wiper arm.
2. Pull off the wiper blade from the attachment, straight to the side.
3. Slide in a new wiper blade at a 90° angle to the wiper arm.
4. Fold in the wiper blade under the metal plate and fold the wiper arm down.

### NOTE:

The wiper blades are different lengths. The blade on the driver's side is longer than the one on the passenger's side.

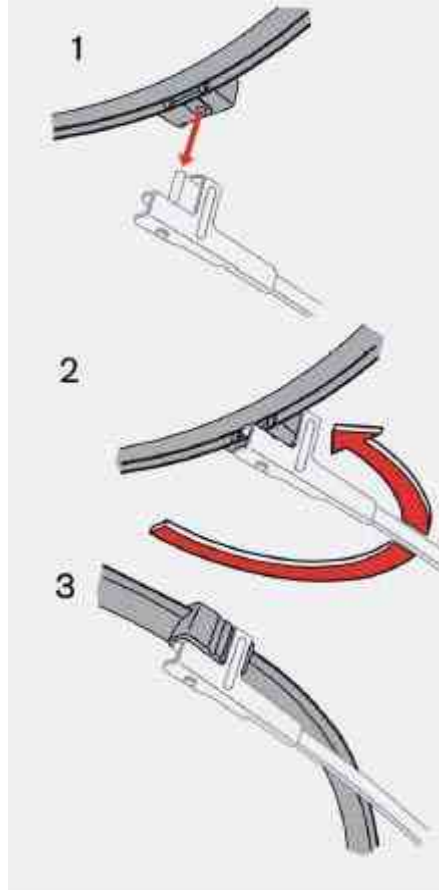

pg. 150 Battery

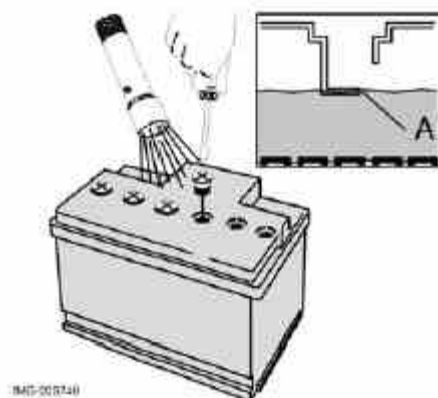

**Battery maintenance**

Driving habits and conditions, climate, the number of starts, etc. all affect the service life and function of the battery. In order for your battery to perform satisfactorily, keep the following in mind:

- Check the fluid level in each cell in the battery every 24 months or every 15,000<sup>1</sup> miles (24,000 km), whichever is sooner. The fluid should be at the level shown in the illustration above (A). Do not overfill.
- Use a screw driver to open the caps and a flashlight to inspect the level.
- If necessary, add distilled water. The level should never be above the indicator (A).
- The fluid level should be checked if the battery has been recharged.
- After inspection, be sure the cap over each battery cell is securely in place.
- Check that the battery cables are correctly connected and properly tightened.
- Never disconnect the battery when the engine is running, or when the key is in the ignition. This could damage the vehicle's electrical system.
- The battery should be disconnected from the vehicle when a battery charger is used directly on the battery.

1. More frequently in warm climates.

### **WARNING!**

### **PROPOSITION 65 WARNING!**

Battery posts, terminals, and related accessories contain lead and lead compounds, chemicals known to the state of California to cause cancer and reproductive harm. Wash hands after handling.



Wear protection goggles.



See the owner's manual for additional information.



Keep away from children.



Corrosive.



No smoking, no open flames, no sparks.



Risk of explosion.

### **Battery replacement**

1. Switch off the ignition and remove the key.
2. Unscrew the cover over the battery.
3. Wait at least 5 minutes after switching off the ignition before disconnecting the battery so that all information in the vehicle's electrical system can be stored in the control modules.

4. Remove the cover and unscrew the front side of the battery box using a screwdriver.
5. Disconnect the battery negative (ground)
6. Release the clamp holding the battery.
7. Disconnect the positive cable and lift out the battery.

Install the new battery in the reverse order.

**WARNING!**

Never expose the battery to open flame or electric spark.

Do not smoke near the battery.

Battery fluid contains sulfuric acid. Do not allow battery fluid to contact eyes, skin, fabrics or painted surfaces. If contact occurs, flush the affected area immediately with water. Obtain medical help immediately if eyes are affected.



[Contents](#) | [Top of Page](#)

# 2006 VOLVO S40

## Chapter 11 - Audio

pg. 163 Audio

[Audio functions](#) 164

[Radio functions](#) 166

[CD player/CD changer \(option\)](#) 170

[Compact disc care](#) 172

[Audio menu settings and selections](#) 173

pg. 164 Audio functions

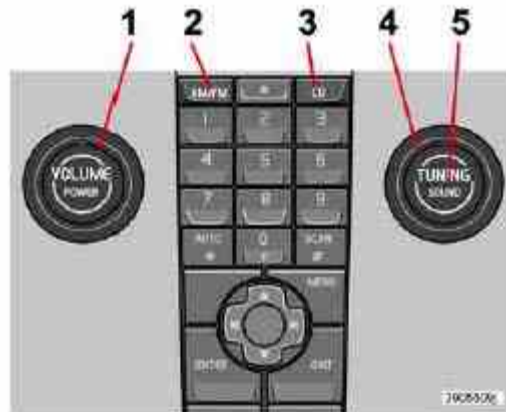

### Audio system controls

1. VOLUME dial
2. AM/FM1/FM2 selection
3. CD player button
4. TUNING dial
5. SOUND button

### Volume

Use the volume dial (1) or the buttons in the optional steering wheel keypad to adjust the volume level. The volume

level is also adjusted automatically according to the vehicle's speed, see [page 165](#) for more information on this function.



*Optional steering wheel keypad*

### **Steering wheel keypad (option)**

The four buttons on the steering wheel keypad can be used to control the audio system. The steering wheel keypad can be used to adjust volume, shift between preset stations and change CD tracks. Press one of the two left-hand buttons briefly to change to the next/previous preset radio station, or to go to the next/previous track on a CD. Press and hold down these buttons to search within a track on a CD.

### **Daytime/twilight display**

In daylight the information is displayed against a light background. In darkness it is displayed against a dark background.

### **Sound source**

A sound source can be selected by pressing AM/FM (2) or CD (3). Press AM/FM repeatedly to toggle between FM1, FM2, and AM. The currently selected sound source will be shown in the display.

### **Sound settings**

- Press SOUND (5). Press this button repeatedly until you come to the setting that you wish to change.
3. Turn the TUNING dial (4) to make the desired setting.

The following settings can be made:

BASS-set the bass level

TREBLE-set the treble level

BALANCE-set the left/right sound balance

FADER-set the front/rear sound balance

SUBWOOFER (accessory)-set the level for the subwoofer (bass speaker)

CENTER<sup>1</sup>-make settings for the center speaker

SURROUND<sup>1</sup>-make settings for surround sound

1. Premium Sound system only

### **Subwoofer (accessory)**

To switch the subwoofer on or off:

- Press MENU followed by ENTER.
- Select *AUDIO SETTINGS* and press ENTER.
- Select SUBWOOFER and press ENTER.

## Surround sound

Surround settings are used to balance sound levels throughout the vehicle. Surround settings for FM and CD are stored separately.

### NOTE:

- Dolby Surround Pro Logic II is only available on the Premium Sound system.
- When listening to FM radio stations, Dolby Surround Pro Logic II functions best in areas with strong reception. If reception is weak, selecting 2 or 3-channel stereo may provide better sound quality.

The Dolby symbol will be appear in the display when Dolby Pro Logic II is activated. There are three alternative settings:

- *Pro Logic II*
- *3-channel*
- *Off (normal 2-channel stereo)*

### Activating/deactivating Surround sound

- Press MENU followed by ENTER.
- Select *AUDIO SETTINGS* in the menu and press ENTER.
- Select Surround FM or Surround CD and press ENTER.
- Select *Pro logic II, 3-channel stereo* or *Off* and press ENTER.

### Equalizer Front/Rear

This function is used to fine-tune the sound from the front and rear speakers separately.

**NOTE:** This function is only available on certain sound systems.

To adjust the equalizer settings:

- Press MENU followed by ENTER.
- Select AUDIO SETTINGS in the menu and press ENTER.
- Select Equalizer Front/Rear and press ENTER.

The column in the display indicates the level for the current frequency.

- Adjust the level with the Tuning dial (4), or use the Up/Down arrows. Additional frequencies can be selected with the Right/Left arrows.
- Save the settings by pressing ENTER or exit without saving by pressing EXIT.

### ASC - speed compensated volume

The audio system's volume is adjusted automatically according to the speed of the vehicle. There are three settings available, which determine the level of volume compensation:

- Low
- Medium\*
- High



\* Default setting.

To set the level of speed compensation:

- Press MENU followed by ENTER.
- Select *AUDIO SETTINGS* in the menu and press ENTER.
- Select *ASC* in the menu and press ENTER.
- Select *Low*, *Medium*, or *High* and press ENTER.

pg. 166 Radio functions



### Radio function controls

1. AM/FM1/FM2 selection
2. Station preset buttons
3. TUNING dial for selecting radio stations
4. SCAN
5. MENU NAVIGATION CONTROL-press the up or down arrow keys to scroll in a menu, or the keys on the left/right sides of the control to search for or change radio stations/CD tracks
6. EXIT-press to cancel a menu selection or a selected function
7. AUTO-search for and store the strongest radio stations in the area in which you are driving

### Searching for stations

There are two ways to manually tune a radio station:

- Turn the TUNING dial (3) to the desired frequency.
- Press the left or right arrow key on the MENU NAVIGATION CONTROL and hold it down. The radio scans slowly in the selected direction and will increase the scanning speed after a few seconds. Release the button when the desired frequency appears in the display.

The frequency can be fine-tuned by short presses on the left/right arrow keys.

### Storing preset stations

Manually storing a station

- Tune to the desired station.
- Press and hold the preset button under which the station is to be stored. The audio system sound will be interrupted for a few seconds and STATION STORED will appear in the display.

**NOTE:** A total of 30 stations can be stored; 10 stations each in AM, FM1 and FM2.

### **Automatically storing a station**

Pressing AUTO (7) automatically searches for and stores up to ten strong AM or FM stations in a separate memory. If more than ten stations are found, the ten strongest ones are stored. This function is especially useful in areas in which you are not familiar with radio stations or their frequencies.

To use the AUTO function:

- Select a waveband using the AM/FM button (1).
- Start the search by pressing AUTO until AUTO STORING appears in the display.
- When the search is completed, AUTO STORING will no longer be displayed. If there are no stations with sufficient signal strength, NO ST FOUND is displayed.

The auto-stored stations can be selected using the preset buttons (2).

Press EXIT (6) to terminate the automatic storing function.

When the radio is in auto-store mode, AUTO is shown in the display. AUTO disappears when you return to normal radio mode, which can be done by briefly pressing AM/FM (1), EXIT (6), or AUTO (7).

## pg. 167 Radio functions

To return to the Auto-store mode, press the AUTO button briefly and select a stored station by pressing one of the preset buttons (2).

### **Saving auto-stored stations in the preset memory**

An auto-stored station can be saved in the memory for manually preset stations.

- Press AUTO (7) briefly.

*Auto* is displayed.

Press one of the preset buttons (2) under which the station is to be stored. Hold down the button until *STATION STORED* is displayed.

The radio will then exit auto-store mode and the stored station can be selected by pressing the preset button.

### **Scanning**

SCAN (4) automatically searches through the selected waveband for strong AM or FM stations. When the radio finds a station, that station will be played for approximately 8 seconds, after which scanning resumes.

### **Activating/deactivating SCAN**

- Select radio mode using the AM/FM button (2).
- Press SCAN to activate the function. *SCAN* is shown in the display.
- Press the SCAN or EXIT button to deactivate the scan function and listen to the selected station.

### **Storing a station found with SCAN**

A station can be stored as a preset while the SCAN function is activated.

- Press one of the preset buttons (2) under which the station is to be stored. Hold down the button until *STATION STORED* is displayed.

The SCAN function will be deactivated and the station can be selected by pressing the preset button.

### **Radio Broadcast Data System - RBDS**

This feature, which may not be available in your area, functions only with FM broadcasts. The radio in your car is equipped with an advanced system allowing information from broadcasters to be transmitted visually, as text, together with the audio signal. This information is then decoded by the radio and made available for several new and unique features.

**The RBDS or Radio Broadcast Data System operates in the FM band only, and the information transmitted is supplied exclusively by participating broadcasters.**

Volvo has no control over the accuracy of the data or information.

Coverage by local broadcasters may be limited at this time, but as the technology and benefits grow, you will find the radio in your car is equipped to take advantage of this system.

### **PI (Program Information) seek**

When an FM station has been stored as a preset, the radio also stores RBDS program information if it is available. When the preset is selected at a later time, the radio tries to access updated program information. In weak signal areas, there may be a delay before the station becomes audible. During this delay, there will be no sound.

PI seek can be interrupted by pressing EXIT.

### **Radio text**

Certain RBDS stations broadcast program information, which can be shown in the display.

To start this function:

1. Select FM1 or FM2 and press the MENU button.
2. Press ENTER.
3. Select RADIOTEXT in the menu and press ENTER.

pg. 168 Radio functions

To deactivate this function, select RADIOTEXT again and press ENTER.

### **Alarm**

Alarms bulletins are transmitted automatically by certain RBDS stations. The function cannot be deactivated.

"Alarm!" is shown in the radio display when an alarm message is sent. The function is used to warn motorists of serious accidents, etc.

### **Program type/station format - PTY**

The PTY function allows you to find stations whose programs suit your taste. Use the PTY function to select among the different station formats shown in the list.

To show the format of the current station:

- Select FM1 or FM2 and press the MENU button.
- Press ENTER.
- Select PTY from the menu and press ENTER.
- Select SHOW PTY and press ENTER. The PTY (program type) of the selected station is now shown in the display.

**NOTE:** Not all RBDS radio stations have PTY designations.

### **Station formats**

Switch off/deactivate (Clear all PTY)

News  
Information  
Sports  
Talk  
Rock  
Classic rock  
Adult hits  
Soft rock  
Top 40  
Country  
Oldies  
Soft  
Nostalgia  
Jazz  
Classical  
Rhythm and Blues  
Soft R&B  
Language  
Religious music  
Religious talk  
Personality  
Public  
College  
Weather

### **Search for a specific station format**

This function enables you to search for a certain station format by searching through the entire FM waveband.

- Select FM1 or FM2 and press the MENU button.
- Press ENTER.
- Select PTY and press ENTER.
- Choose SELECT PTY and press ENTER.
- Press ENTER for one or more of the listed station formats. Once you have selected all the desired types, select EXIT to exit the PTY list.
- Select SEARCH PTY and press ENTER. If the radio finds a station with the selected format, it will tune to this station.

If you would like to continue searching, press the left or right arrow on the MENU NAVIGATION control.

If no stations with the selected station format are found, the radio resumes its previous frequency.

pg. 169 Radio functions

### **Automatic frequency update - AF**

The AF function ensures that one of the strongest available transmitters for a radio station is used. This function is only available on RBDS stations. To activate this function:

- Select FM1 or FM2 and press the MENU button.
- Press ENTER
- Select ADVANCED RADIO SETTINGS in the menu and press ENTER.
- Select AF and press ENTER.

To deactivate this function, select AF and press ENTER.

## Resetting RBDS functions

This function restores all radio settings to the original factory settings.

- Select FM1 or FM2 and press the MENU button.
- Press ENTER.
- Select ADVANCED RADIO SETTINGS in the menu and press ENTER.
- Select RESET ALL in the menu and press ENTER.

Press ENTER again to confirm your selection.

pg. 170 CD player/CD changer (option)

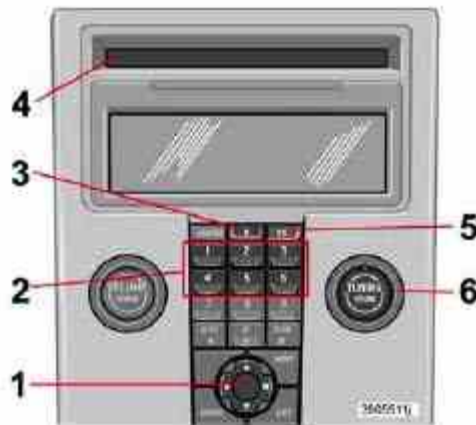

## CD function controls

1. MENU NAVIGATION CONTROL - press the up or down arrow keys to scroll in a menu, or the keys on the left/right sides of the control to change CD tracks/fast forward/back
2. Buttons for selecting a disc in the optional CD changer
3. CD eject button
4. CD slot
5. CD player button
6. TUNING dial for selecting tracks on a CD

## Playing a CD

### *Single CD player*

Start the CD player by pressing the CD button (5) and inserting a disc in the slot (4). If there is already a disc inserted, it will begin to play.

### *CD changer*

The CD changer can hold up to six discs.

- Press the CD button.
- Select an empty position using the 1-6 buttons or the up/down keys on the MENU NAVIGATION control. The display shows which positions are empty.
- Insert a disc into the slot (4).

**NOTE:** Ensure that INSERT DISC is displayed before inserting a disc.

## Changing tracks

Press the left or right arrow keys on the MENU NAVIGATION control to skip to the previous or next track.

**NOTE:** The TUNING dial (6) (turn clockwise to go to the next track, or counterclockwise to go to the previous track) or the optional steering wheel keypad can also be used for this purpose.

## Fast forward/back

Press and hold down the left or right arrows keys in the MENU NAVIGATION control (or the corresponding keys on the optional steering wheel keypad) to search within a track or the whole disc. The search continues for as long as the buttons are held down.

## Random play

This function plays the tracks on a CD (or on all of the CDs if the vehicle is equipped with the optional CD changer) in random order (shuffle).

- Select CD (5) and press the MENU button.
- Press ENTER.
- Select RANDOM from the menu and press ENTER.
- CD changer only: Select SINGLE DISC or ALL DISCS for the CD changer to randomly choose from one or all discs.

RND (or RND ALL for the CD changer) is shown in the display for as long as the function is activated. Press the right arrow key on the MENU NAVIGATION control (1) to select the next random track.

**NOTE:** CD changer only - you can only select the next random track on the current disc.

pg. 171 CD player/CD changer (option)

- Press the EXIT button to stop random play.

## Disc text (CD changer only)

Certain CDs contain information about the disc, such as the titles of the tracks, etc. This information can be shown in the display by activating the DISCTEXT function.

- Press MENU. Select the menu for relevant sound source and press ENTER.
- Select DISCTEXT in the menu and press ENTER.
- If information is stored on the disc, it will now appear in the display. To deactivate this function, select DISCTEXT in the menu and press ENTER.

## Scan

This function plays the first 10 seconds of each track on the CD.

- Press SCAN.
- Press EXIT to stop the scan function and listen to an entire track.

## CD eject

### *Single CD player*

Press the eject button (3) to eject the disc.

### *CD changer*

This function makes it possible to eject a single disc, or to eject all of the discs in the changer.

- Press the eject button (3) briefly to eject the disc that is currently playing.
- A longer press (more than two seconds) starts the process of ejecting all of the discs in the changer.

## **NOTE:**

- The EJECT ALL function can only be used while the vehicle is at a standstill and will be cancelled if the vehicle begins to move.

**NOTE:** For reasons of traffic safety, the ejected CD must be removed within 12 seconds or it will be automatically drawn back into the slot and the CD player will enter pause mode. Press the CD button to restart the disc.

pg. 172 CD player/CD changer (option)

## **Compact disc care**

### **Keep the following in mind when playing/handling compact discs**

- Use CD standard EN 60908 discs only. Discs not meeting this standard may cause problems with system (poor sound). CD-R discs can cause listening problems due to the quality of the disc or recording equipment used.
- Keep the discs clean. Wipe them with a soft, clean, lint-free cloth, working from the center outward. If necessary, dampen the cloth with a neutral soap solution. Dry thoroughly before using.
- Never use cleaning spray or antistatic liquid. Use only cleaners specifically made for CDs.
- Use discs of the correct size only (3.5" discs should never be used).
- Do not put tape or labels on the disc itself. They could become stuck in the player.
- Volvo does not recommend the use of plastic outer rings on the disc.
- Condensation may occur on discs/ optical components of the changer in cold winter weather. The disc can be dried with a clean, lint-free cloth. Optical components in the CD changer may, however, take up to one hour to dry off.
- Never attempt to play a damaged CD.
- When not in use, the discs should be stored in their covers. Avoid storing discs in excessive heat, direct sunlight or dusty locations.

pg. 173 Audio menu settings and selections

## **Audio menu settings and selections**

### **NOTE:**

All alternatives marked \* can be selected or set to On or Off by navigating to the alternative in the menu and pressing Enter.

### **FM1/FM2 menu**

1. PTY
  - 1.1. SELECT PTY
    - 1.1.1. CLEAR ALL PTY
    - 1.1.2. The available program types are listed here
  - 1.2. SEARCH PTY
  - 1.3. SHOW PTY ON/OFF (default)\*
2. RADIOTEXT ON/OFF (default)\*
3. ADVANCED RADIO SETTINGS
  - 3.1. AF ON/OFF (default)\*
  - 3.2. RESET All
4. AUDIO SETTINGS
  - 4.1. SURROUND FM (Premium sound system only)
    - 4.1.1. Dolby Pro Logic II\*
    - 4.1.2.3 Channel\*
    - 4.1.3. OFF (default)\*
  - 4.2. SURROUND CD
    - 4.2.1. Dolby Pro Logic II (default)\*

- 4.2.2.3 Channel\*
- 4.2.3. OFF\*
- 4.3. SUBWOOFER ON (default)/OFF\* (accessory)
- 4.4. EQUALIZER FRONT (certain audio systems)
- 4.5. EQUALIZER REAR (certain audio systems)
- 4.6. Auto. volume control (speed compensated volume)
  - 4.6.1. Low\*
  - 4.6.2. Medium (default)\*
  - 4.6.3. High\*
- 4.7. RESET ALL

### **AM menu**

- 1. 1. AUDIO SETTINGS
  - 1.1. SURROUND FM (Premium sound system only)
    - 1.1.1. Dolby Pro Logic II\*
    - 1.1.2. 3 Channel\*
    - 1.1.3. OFF (default)\*
  - 1.2. SURROUND CD (Premium sound system only)
    - 1.2.1. Dolby Pro Logic II (default)\*
      - 1.2.2.3 Channel\*
      - 1.2.3. Off\*
  - 1.3. SUBWOOFER ON (default)/OFF\* (accessory)
  - 1.4. EQUALIZER FRONT (certain audio systems)
  - 1.5. EQUALIZER REAR (certain audio systems)
  - 1.6. Auto. volume control (speed compensated volume)
    - 1.6.1. Low\*
    - 1.6.2. Medium (default)\*
    - 1.6.3. High\*
  - 1.7. RESET ALL

### **CD menu**

- 1. RANDOM\*
- 2. AUDIO SETTINGS
  - 2.1. SURROUND FM (Premium sound system only)
    - 2.1.1. Dolby Pro Logic II\*
    - 2.1.2. 3 Channel\*
    - 2.1.3. Off (default)\*
  - 2.2. SURROUND CD (Premium sound system only)
    - 2.2.1. Dolby Pro Logic II (default)\*
      - 2.2.2. 3 Channel\*
      - 2.2.3. Off\*

pg. 174 Audio menu settings and selections

- 2.3. SUBWOOFER ON (default)/OFF\* (accessory)
- 2.4. EQUALIZER Front (certain audio systems)
- 2.5. EQUALIZER Rear (certain audio systems)
- 2.6. Auto. volume control (speed compensated volume)
  - 2.6.1. Low\*
  - 2.6.2. Medium (default)\*
  - 2.6.3. High\*
- 2.7. RESET ALL



## CD changer menu

1. RANDOM
    - 1.1. Off (default)\*
    - 1.2. Single Disc\*
    - 1.3. All Discs\*
  2. DISC TEXT ON/OFF (default)\*
  3. AUDIO SETTINGS
    - 3.1. SURROUND FM (Premium sound system only)
      - 3.1.1. Dolby Pro Logic II\*
      - 3.1.2.3 Channel\*
      - 3.1.3. Off (default)\*
    - 3.2. SURROUND CD (Premium sound system only)
      - 3.2.1. Dolby Pro Logic II (default)\*
      - 3.2.2. 3 Channel\*
      - 3.2.3. Off\*
    - 3.3. SUBWOOFER ON (default)/OFF\* (accessory)
    - 3.4. EQUALIZER Front (certain audio systems)
    - 3.5. EQUALIZER Rear (certain audio systems)
    - 3.6. Auto. volume control (speed compensated sound)
      - 3.6.1. Low\*
      - 3.6.2. Medium (default)\*
      - 3.6.3. High\*
    - 3.7. RESET ALL
- 



# 2006 VOLVO S40

## Chapter 12 - Specifications

pg. 175 Specifications

[Label information](#) 176

[Dimensions and weights](#) 177

[Fuel, oils, and fluids](#) 178

[Engine oil](#) 179

[Engine specifications](#) 180

[Electrical system](#) 181

[Three-way catalytic converter](#) 182

[Volvo programs](#) 183

pg. 176 Label information

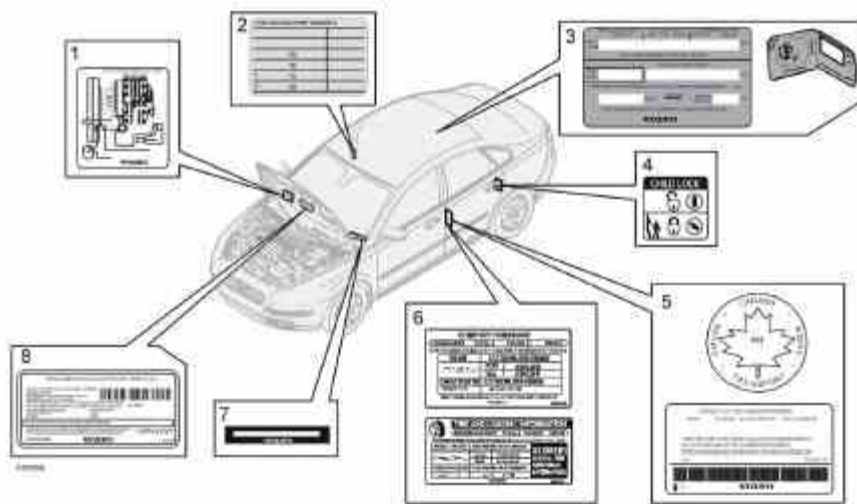

**1. Vacuum hose routing** (underside of hood)

**2. Model plate**

Vehicle Identification Number (VIN).

Codes for color and upholstery, etc. The label is located on the passenger's side center door pillar.

### 3. Loads and Tire Pressures

(on inside of fuel filler door): Canadian models only.

### 4. Child safety lock

This information is stamped on the rear inside edges of the doors.

### 5. Federal Motor Vehicle Safety Standards (FMVSS) specifications (USA) and Ministry of Transport (CMVSS) standards (Canada)

Your Volvo is designed to meet all applicable safety standards, as evidenced by the certification label on the facing side of the driver's door. For further information regarding these regulations, please consult your Volvo retailer.

### 6. Loads and Tire Pressures U.S. models only

Certain models will only have one decal, depending on the specifications of the vehicle.

### 7. Vehicle Identification Number (VIN)<sup>1</sup>

The VIN plate is located on the top left surface of the dashboard. The VIN is also stamped on the right hand door pillar.

### 8. Vehicle Emission Control Information

Your Volvo is designed to meet all applicable emission standards, as evidenced by the certification label on the underside of the hood. For further information regarding these regulations, please consult your Volvo retailer.

1. The Vehicle Identification Number (VIN) should always be quoted in correspondence concerning your vehicle with the retailer and when ordering parts.

## pg. 177 Dimensions and weights

### Dimensions and weights

#### Dimensions

<b>Length</b>	175.9 in. (447 cm)
<b>Width</b>	69.7 in. (177 cm)
<b>Height</b>	57.2 in. (145 cm)
<b>Wheelbase</b>	103.9 in. (264 cm)
<b>Front track</b>	60.4/60.9 in. (154/155 cm)
<b>Rear track</b>	60.3/60.8 in. (153/154 cm)
<b>Turning circle</b>	34.9 ft. (10.6 m)
<b>Cargo capacity</b>	31.2 cu. ft. (883 liters) <sup>1</sup>

1. 38.4 cu. ft. (1088 liters) with the front passenger's seat backrest folded down (certain models only).

<b>Category</b>	<b>USA</b>	<b>Canada</b>
<b>Gross vehicle weight</b>	FWD <sup>1</sup> : 4320 lbs	1960 kg
	FWD Turbo: 4320 lbs	1960 kg
	AWD <sup>2</sup> Turbo: 4450 lbs	2020 kg
<b>Capacity weight</b>	FWD: 800 lbs	365 kg
	AWD: 800 lbs	365 kg
<b>Permissible axle weight, front</b>	FWD: 2380 lbs	1080 kg
	FWD Turbo: 2380 lbs	1080 kg
	AWD Turbo: 2420 lbs	1100 kg

<b>Permissible axle weight, rear</b>	FWD: 2130 lbs	970 kg
	FWD Turbo: 2130 lbs	970 kg
	AWD Turbo: 2200 lbs	1000 kg
<b>Curb weight</b>	FWD: 3170 - 3285 lbs	1440 - 1500 kg
	AWD: 3405 - 3455 lbs	1550 - 1575
<b>Max. roof load</b>	All models: 165 lbs	All models: 75 kg
<b>Max. trailer weight (w/o brakes)</b>	All models: 1540 lbs	All models: 700 kg
<b>Max. trailer weight (with brakes)</b>	All models: 2000 lbs	All models: 900 kg
<b>Max. tongue weight</b>	All models: 165 lbs	All models: 75 kg

1. FWD = Front Wheel Drive
2. AWD = All Wheel Drive

### CAUTION!

The maximum permissible axle loads and/or the gross vehicle weight must not be exceeded.

### WARNING!

When adding accessories, equipment, luggage and other cargo to your vehicle, the total capacity weight must not be exceeded.

pg. 178 Fuel, oils, and fluids

## Specifications and capacities

Category	Specification	Capacity
Fuel tank	Octane rating: Unleaded premium gasoline with an octane rating AKI of 91, or above. The minimum octane requirement is AKI 87 (RON 91).	15.9 US gallons (60 liters) Models with All Wheel Drive have a tank volume of 15 US gallons (57 liters). Models with engine code 39 have a fuel tank capacity of 14 US gallons (53 liters). This code is the 6th and 7th digits from the left in your vehicle's VIN number. See <a href="#">page 176</a> for the location of the VIN plate.
Engine oil (with filter replacement)	See <a href="#">page 179</a> for information on engine oil specifications.	6.1 US quarts (5.8 liters)
Automatic transmission JWS oil		8.19 US quarts (7.75 liters)
Manual transmission oil	MTF 97309-10	2.2 US quarts (2.1 liters) - non-turbo models 2.1 US quarts (2.0 liters) - turbo models
Coolant	Volvo original coolant/antifreeze (50/50 mixture of water and anti-freeze)	9 US quarts (8.5 liters) - models with automatic transmission 8.5 US quarts (8.0 liters) - models with manual transmission
Brake fluid	DOT 4+ boiling point >536°F (280°C), P/N 9437433	0.63 US quarts (0.6 liters)
Power steering	WSS M2C204-A or equivalent	1.3 US quarts (1.2 liters) - system and reservoir combined

fluid  
 Washer fluid Use washer fluid solvent in cold weather reservoir conditions. 6.8 US quarts (6.5 liters)  
 Air conditioning Refrigerant - R134a system 1.2 lbs. (530 grams)

pg. 179 Engine oil

**Oil specifications**  
 Engine oil must meet the minimum ILSAC specification GF-3, API SL, or ACEA A1/B1. Lower quality oils may not offer the same fuel economy, engine performance, or engine protection.

Volume: 6.1 US qts (5.8 liters).

Volume between the MIN and Max marks on the dipstick: approximately 1.7 US qts (1.6 liters).

Volvo recommends  .

Depending on your driving habits, premium or synthetic oils may provide superior fuel economy and engine protection. Consult your Volvo retailer for recommendations on premium or synthetic oils.

**Oil additives must not be used.**

**NOTE:** Synthetic oil is not used when the oil is changed at the normal service intervals. This oil is only used at customer request, at additional charge. Please consult your Volvo retailer.

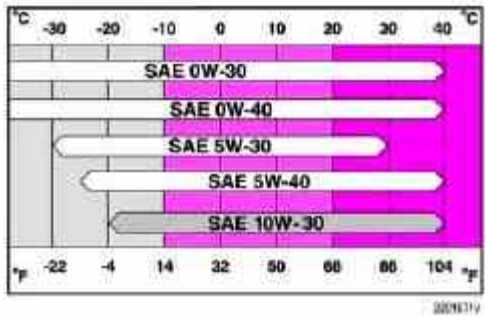

**Oil viscosity (stable ambient temperatures)**

**Operation in hot climates**

When temperatures exceed 86° F (30° C) in your area, Volvo recommends, for the protection of your engine, that you use a heavier weight oil, such as SAE 10W-30. See the viscosity chart.

**Operation in temperate climates**

Incorrect viscosity oil can shorten engine life. Under normal use when temperatures do not exceed 86° F (30° C), SAE 5W-30 will provide good fuel economy and engine protection. See the viscosity chart.



American Petroleum Institute (API) symbol

### Extreme engine operation

Synthetic oils meeting SAE 10W-30 and complying with oil quality requirements are recommended for driving in areas of sustained temperature extremes (hot or cold), when towing a trailer over long distances, and for prolonged driving in mountainous areas.

### American Petroleum Institute (API) symbol

The API Service Symbol "donut" is divided into three parts:

- The upper section describes the oil's performance level.
- The center identifies the oil's viscosity.
- The lower section indicates whether the oil has demonstrated energy-conserving properties in a standard test in comparison to a reference oil.

### pg. 180 Engine specifications

Engine designation	B5244S4	B5244S7	B5254T3
Output			
kW/rps	125/100	125/100	162/83
hp/rpm	168/6000	168/6000	218/5000
Torque			
Nm/rps	230/73	230/73	320/25-80
ft. lbs./rpm	170/4400	170/4400	236/1500-4800
No. of cylinders	5	5	5
Displacement (liters/cubic inches)	2.44/148.6	2.44/148.6	2.52/153.8
Bore (mm/in.)	83/3.27	83/3.27	83/3.27
Stroke (mm/in.)	90/3.54	90/3.54	93.2/3.67
Compression ratio	10.3:1	10.3:1	9.0:1
Spark plugs			
type	Volvo kit no. 30650843	Volvo kit no. 30650843	Volvo kit no. 30650379
gap inches/mm	(3x) 0.024 ± 0.004 in./0.6 ± 0.1mm	(3x) 0.024 ± 0.004 in./0.6 ± 0.1mm	0.027in./0.7mm
tightening torque ft. lbs./Nm	22.5 ft. lbs./30 Nm	22.5 ft. lbs./30 Nm	22.5 ft. lbs./30 Nm

### Charge air cooler (Intercooler)

Turbocharged engines employ a turbocompressor to force air into the engine inlet manifold and a charge air cooler to cool the compressed inlet air. The resulting increase in air flow raises pressure in the intake manifold and increases engine power over that developed by the normally-aspirated engine. The charge air cooler (which resembles a radiator) is located between the turbo-compressor and inlet manifold.

### Fuel system

The engine is equipped with a multiport fuel injection system.

### pg. 181 Electrical system

### General information

12-volt system with voltage controlled generator. Single wire system in which the chassis and engine block are used as

conductors, grounded on the chassis.

## Bulbs

Please refer to [page 152](#) for a list of the bulbs used in your car.

## Battery

Voltage	12 V	12 V	12 V
Cold start capacity (CCA)	520 A	600 A*	700 A**
Reserve capacity (RC)	100 min	120 min	150 min

If the battery must be replaced, replace it with one with the same cold start capacity and reserve capacity as the original (see the decal on the battery).

\* Cars equipped with the High Performance audio system

\*\* Cars equipped with the Premium Sound audio system and/or the Volvo Navigation system

Generator <sup>1</sup> maximum current 120/150 A

Starter motor output 1.4/1.9 kW

1. Dependent on engine type

pg. 182 Three-way catalytic converter

## Three-way catalytic converter - general information

- Keep your engine properly tuned. Certain engine malfunctions, particularly involving the electrical, fuel or distributor ignition systems, may cause unusually high three-way catalytic converter temperatures. Do not continue to operate your vehicle if you detect engine misfire, noticeable loss of power or other unusual operating conditions, such as engine overheating or backfiring. A properly tuned engine will help avoid malfunctions that could damage the three-way catalytic converter.
- Do not park your vehicle over combustible materials, such as grass or leaves, which can come into contact with the hot exhaust system and cause such materials to ignite under certain wind and weather conditions.
- Excessive starter cranking (in excess of one minute), or an intermittently firing or flooded engine can cause three-way catalytic converter or exhaust system overheating.
- Remember that tampering or unauthorized modifications to the engine, the Engine Control Module, or the vehicle may be illegal and can cause three-way catalytic converter or exhaust system overheating. This includes:
  - Altering fuel injection settings or components.
  - Altering emission system components or location or removing components.
  - Repeated use of leaded fuel.

**NOTE:** Unleaded fuel is required for vehicles with three-way catalytic converters.

pg. 183 Volvo programs

## Volvo On Call Roadside Assistance

Your new Volvo comes with a four year ON CALL roadside assistance. Additional information, features, and benefits are described in a separate information package in your glove compartment. If you have misplaced your package, dial:  
In the U.S.A. 1-800-638-6586 (1-800-63-VOLVO)  
In Canada: 1-800-263-0475

## Technician certification

In addition to Volvo factory training, Volvo supports certification by the National Institute for Automotive Service Excellence (A.S.E.). Certified technicians have demonstrated a high degree of competence in specific areas. Besides passing exams, each technician must also have worked in the field for two or more years before a certificate is issued.

These professional technicians are best able to analyze vehicle problems and perform the necessary maintenance procedures to keep your Volvo at peak operating condition.



[Contents](#) | [Top of Page](#)



# 2006 VOLVO S40

## Index

pg. 185-188 Index

### Numerics

12 volt socket, in trunk	<a href="#">80</a>
12 volt socket, rear seat	<a href="#">49</a>
12 volt sockets	<a href="#">40</a>

### A

ABS (anti-lock brake system)	<a href="#">2</a>
Active yaw control - AYC	<a href="#">109</a>
Airbag system	<a href="#">14</a>
Alarm	<a href="#">89, 90</a>
All Wheel Drive	<a href="#">106</a>
Antifreeze	<a href="#">147</a>
Anti-lock Brake System (ABS)	<a href="#">2, 36</a>
Approach lighting	<a href="#">56, 83</a>
ASC - speed compensated volume, audio system	<a href="#">165</a>
Audio system - introduction	<a href="#">164</a>
Audio system menus, list of	<a href="#">173, 174</a>
Autolock	<a href="#">56</a>
Automatic transmission - Geartronic	<a href="#">103, 104</a>
Auxiliary equipment	<a href="#">40</a>
AWD	<a href="#">106</a>

### B

Backrests, rear seat	<a href="#">78</a>
Battery drain - avoiding	<a href="#">93</a>
Battery maintenance	<a href="#">150</a>
Battery replacement	<a href="#">151</a>
Battery replacement, remote control	<a href="#">86</a>
Battery, conserving electrical current	<a href="#">93</a>
Battery, specifications	<a href="#">181</a>
Bi-Xenon headlights	<a href="#">153</a>
Black box (Vehicle Event Data)	<a href="#">142</a>
Booster cushion	<a href="#">28</a>
Brake fluid	<a href="#">148</a>

Bulbs	<a href="#">152</a>
<b>C</b>	
Capacities, fluids	<a href="#">178</a>
Catalytic converter, three-way	<a href="#">182</a>
CD player	<a href="#">170</a>
Central locking system, remote controls	<a href="#">82</a>
Changing a tire	<a href="#">133</a>
Changing oil	<a href="#">146</a>
Charge air cooler	<a href="#">180</a>
Child restraint anchorages	<a href="#">30</a>
Child safety	<a href="#">27</a>
Child safety locks	<a href="#">88</a>
Clock setting button	<a href="#">34</a>
Cold weather precautions	<a href="#">93</a>
Collision status	<a href="#">25</a>
Compact disc care	<a href="#">172</a>
Compass in rearview mirror	<a href="#">52</a>
Coolant	<a href="#">147</a>
Courtesy lighting	<a href="#">75</a>
Cruise control	<a href="#">44</a>
<b>D</b>	
Dimensions	<a href="#">177</a>
Disabling the passenger's side front airbag	<a href="#">18</a>
Display, instrument panel	<a href="#">34</a>
Door mirrors	<a href="#">53</a>
Door open warning	<a href="#">42</a>
Driving after a collision	<a href="#">25</a>
DSTC	<a href="#">40</a>
<b>E</b>	
Economical driving	<a href="#">92</a>
Electrical current - conserving	<a href="#">93</a>
Electrical system	<a href="#">181</a>
Electronic Brake Force Distribution (EBD)	<a href="#">108</a>
Emission inspection readiness	<a href="#">144</a>
Engine compartment	<a href="#">145</a>
Engine oil, changing	<a href="#">146</a>
Engine specifications	<a href="#">180</a>
Environment	<a href="#">3</a>
Equalizer, audio system	<a href="#">165</a>
<b>F</b>	
Federal Clean Air Act	<a href="#">142</a>
Flash, high beam	<a href="#">42</a>
Floor mats	<a href="#">99</a>
Floor mats, cleaning	<a href="#">138</a>

Fog lights	<a href="#">41</a>
Front airbags	<a href="#">15, 16</a>
Front fog light, replacing	<a href="#">155</a>
Front fog lights	<a href="#">41</a>
Front seats, manual adjustment	<a href="#">72</a>
Front seats, power	<a href="#">73</a>
Fuel filler cap	<a href="#">2</a>
Fuel filler door	<a href="#">2, 96</a>
Fuel filler door, unlocking	<a href="#">41</a>
Fuel gauge	<a href="#">34</a>
Fuel requirements	<a href="#">95</a>
Fuel system	<a href="#">180</a>
Fuel tank capacity	<a href="#">96</a>
Fuse box in the passenger compartment, accessing	<a href="#">160</a>
Fuses	<a href="#">158</a>
Fuses in the engine compartment	<a href="#">159</a>
Fuses in the passenger compartment	<a href="#">161</a>
<b>G</b>	
Gasoline	<a href="#">95</a>
Geartronic (manual shifting)	<a href="#">103</a>
Generator	<a href="#">181</a>
Generator warning light	<a href="#">37</a>
Glossary of tire terminology	<a href="#">126</a>
Glove compartment	<a href="#">77</a>
Glove compartment, locking	<a href="#">88</a>
Grocery bag holder (option)	<a href="#">80</a>
<b>H</b>	
Hazard warning flashers	<a href="#">48</a>
Head restraints, rear seat	<a href="#">78</a>
Headlight housing, removing	<a href="#">153</a>
Headlight washers	<a href="#">46</a>
Headlights	<a href="#">41</a>
High beam bulb, replacing	<a href="#">154</a>
High beam flash	<a href="#">42</a>
High beam headlights	<a href="#">42</a>
High beam indicator	<a href="#">34</a>
Home safe lighting	<a href="#">42, 56</a>
Hood, opening	<a href="#">145</a>
<b>I</b>	
Immobilizer	<a href="#">82, 99</a>
Indicator and warning symbols	<a href="#">34</a>
Inflatable Curtain	<a href="#">22</a>
Inflation pressure tables	<a href="#">124</a>
Information display	<a href="#">34</a>

Information display, messages in	<a href="#">39</a>
Information symbol	<a href="#">34, 35</a>
Inspection readiness	<a href="#">144</a>
Instrument overview	<a href="#">7</a>
Instrument panel	<a href="#">34</a>
Instrument panel lighting	<a href="#">41</a>
Interior lighting	<a href="#">75</a>
ISOFIX/LATCH anchors	<a href="#">28</a>
<b>J</b>	
Jack, positioning correctly	<a href="#">133</a>
Jump starting	<a href="#">114</a>
<b>K</b>	
Key blade	<a href="#">84</a>
Keylock	<a href="#">2, 99</a>
Kickdown	<a href="#">104</a>
<b>L</b>	
Label information	<a href="#">176</a>
LATCH anchors	<a href="#">28</a>
License plate lighting, replacing	<a href="#">157</a>
Lighting panel	<a href="#">41</a>
Loading the vehicle	<a href="#">127</a>
Long distance trips	<a href="#">94</a>
Low beam bulb, replacing	<a href="#">153</a>
Low beam headlights	<a href="#">42</a>
<b>M</b>	
Maintenance	<a href="#">142</a>
Malfunction indicator light	<a href="#">36</a>
Manual front seat adjustment	<a href="#">72</a>
Manual shifting (Geartronic)	<a href="#">103</a>
Manual transmission	<a href="#">101</a>
Mirror, rearview	<a href="#">52</a>
Mirrors, door-mounted	<a href="#">53</a>
Moonroof	<a href="#">54</a>
<b>O</b>	
OBD II	<a href="#">144</a>
Occupant safety	<a href="#">10</a>
Occupant Weight Sensor (OWS), disabling front passenger's side airbag	<a href="#">18</a>
Octane rating	<a href="#">95</a>
Oil pressure warning light	<a href="#">37</a>
Oil, changing	<a href="#">146</a>
On Call Roadside Assistance	<a href="#">183</a>
Onboard Diagnostic System (OBD II)	<a href="#">144</a>
Opening the hood	<a href="#">145</a>
Opening the trunk from the inside	<a href="#">87</a>

## **P**

Paint touch up	<a href="#">139</a>
Parking lights, instrument	<a href="#">41</a>
Panic alarm, central locking system remote control	<a href="#">83</a>
Parking assist	<a href="#">111</a>
Parking brake	<a href="#">49</a>
Parking light bulb, replacing	<a href="#">154</a>
Parking lights	<a href="#">41</a>
Passenger's side front airbag, disabling	<a href="#">18</a>
Personal settings	<a href="#">56</a>
PI (Program Information) seek	<a href="#">167</a>
Polishing	<a href="#">137</a>
Power door mirrors	<a href="#">53</a>
Power front seats	<a href="#">73</a>
Power moonroof	<a href="#">54</a>
Power steering fluid	<a href="#">148</a>
Power windows	<a href="#">50</a>
PremAir ®	<a href="#">4</a>
Program Information seek	<a href="#">167</a>
Program type, audio system	<a href="#">168</a>
PROPOSITION 65 WARNING	<a href="#">150</a>

## **R**

Radio Broadcast Data System - RBDS	<a href="#">167</a>
Radio station formats	<a href="#">168</a>
Radio text	<a href="#">167</a>
Rain sensor	<a href="#">47</a>
Reading lights, rear	<a href="#">75</a>
Rear fog light	<a href="#">41</a>
Rear park assist	<a href="#">111</a>
Rear reading lights	<a href="#">75</a>
Rear seat backrests, folding down	<a href="#">78</a>
Rear seat head restraints	<a href="#">78</a>
Rearview mirror	<a href="#">52</a>
Rearview mirror with compass (option)	<a href="#">52</a>
Refueling	<a href="#">96</a>
Remote control functions	<a href="#">83</a>
Remote control, battery replacement	<a href="#">86</a>
Remote controls, central locking system	<a href="#">82</a>
Removing a wheel	<a href="#">133</a>
Replacing fuses	<a href="#">158</a>
Reporting safety defects	<a href="#">10</a>
Restraint anchorages	<a href="#">30</a>

## **S**

Safety defects, reporting	<a href="#">10</a>
---------------------------	--------------------

Safety locks, child	<a href="#">88</a>
Seat belt maintenance	<a href="#">13</a>
Seat belt reminder	<a href="#">13, 37</a>
Seat belts	<a href="#">11</a>
SEE MANUAL	<a href="#">39</a>
SERVICE REQUIRED	<a href="#">39</a>
Shiftlock	<a href="#">2</a>
Shiftlock override	<a href="#">105</a>
Side impact protection (SIPS) airbags	<a href="#">21</a>
Side marker light, replacing	<a href="#">155</a>
Speedometer	<a href="#">34</a>
Spin control - SC	<a href="#">109</a>
SRS warning light	<a href="#">37</a>
Stability system	<a href="#">40, 109, 110</a>
Start inhibitor (immobilizer)	<a href="#">82</a>
Station formats	<a href="#">168</a>
STC	<a href="#">40, 109</a>
Steering wheel adjustment	<a href="#">48</a>
Steering wheel lock	<a href="#">98</a>
Stone chips, paint touch-up	<a href="#">139</a>
STOP ENGINE	<a href="#">39</a>
STOP SAFELY	<a href="#">39</a>
Storage compartments	<a href="#">76</a>
Storing wheels and tires	<a href="#">120</a>
Sunroof (moonroof)	<a href="#">54</a>
<b>T</b>	
Tachometer	<a href="#">34</a>
Tail light bulb holder, removing	<a href="#">156</a>
Technician certification	<a href="#">183</a>
Temperature gauge	<a href="#">34</a>
Three-way catalytic converter	<a href="#">182</a>
TIME FOR REGULAR SERVICE	<a href="#">39</a>
Tire inflation pressure tables	<a href="#">124</a>
Tire rotation	<a href="#">132</a>
Tires, changing	<a href="#">133</a>
Tires, general information	<a href="#">120</a>
Tires, storing	<a href="#">120</a>
Traction control - TC	<a href="#">109</a>
Transmission, automatic	<a href="#">103, 104</a>
Tread wear indicator	<a href="#">121</a>
Trip computer	<a href="#">43</a>
Trip odometer	<a href="#">34</a>
Trunk	<a href="#">80</a>
Trunk lighting, replacing	<a href="#">157</a>

Trunk, limiting access to	<a href="#">85</a>
Trunk, opening from the inside	<a href="#">87</a>
Turn signal bulb, replacing	<a href="#">155</a>
<b>U</b>	
Uniform Tire Quality Grading	<a href="#">128</a>
Unlock (personal settings)	<a href="#">56</a>
Unlocking the fuel filler door	<a href="#">41</a>
<b>V</b>	
Valet locking	<a href="#">85</a>
Vanity mirror	<a href="#">74</a>
Vanity mirror lighting, replacing	<a href="#">157</a>
Vehicle Event Data	<a href="#">142</a>
Vehicle Identification Number	<a href="#">176</a>
Vehicle loading	<a href="#">127</a>
Volvo and the environment	<a href="#">3</a>
Volvo Customer Care Center, contacting	<a href="#">1</a> , <a href="#">16</a> , <a href="#">19</a>
Volvo Inflatable Curtain	<a href="#">22</a>
Volvo maintenance	<a href="#">142</a>
Volvo On Call Roadside Assistance	<a href="#">183</a>
<b>W</b>	
W Winter/Wet driving mode	<a href="#">104</a>
Warning flashers	<a href="#">48</a>
Warning symbol	<a href="#">34</a> , <a href="#">35</a>
Warranties	<a href="#">142</a>
Washer fluid	<a href="#">147</a>
Washing the car	<a href="#">136</a>
Waxing	<a href="#">137</a>
Weight distribution	<a href="#">92</a>
Weights	<a href="#">177</a>
Wheel nuts	<a href="#">131</a>
Wheels, removing	<a href="#">133</a> , <a href="#">134</a>
Wheels, storing	<a href="#">120</a>
Whiplash Protection System (WHIPS)	<a href="#">23</a>
Windshield washer fluid	<a href="#">147</a>
Windshield wiper blades	<a href="#">149</a>
Windshield wipers	<a href="#">46</a>
Winter/Wet driving mode	<a href="#">104</a>
Wiper blades	<a href="#">149</a>

