

# 2005 VOLVO S60



## Introduction



Welcome to the world-wide family of Volvo owners. We trust that you will enjoy many years of safe driving in your Volvo, an automobile designed with your safety and comfort in mind. To help ensure your satisfaction with this vehicle, we encourage you to familiarize yourself with the equipment descriptions, operating instructions and maintenance requirements/recommendations in this manual. We also urge you and your passengers to wear seat belts at all times in this (or any other) automobile. And, of course, please do not operate a vehicle if you may be affected by alcohol, medication or any impairment that could hinder your ability to drive.

Your Volvo is designed to meet all applicable safety and emission standards, as evidenced by the certification labels attached to the driver's door opening and on the left wheel housing in the engine compartment.

**For further information please contact your retailer, or:**

**In the USA:**

Volvo Cars of North America  
Customer Care Center  
P.O. Box 914  
Rockleigh, New Jersey 07647-0914  
800-458-1552  
<http://www.volvocars.us>

**In Canada:**

Volvo Cars of Canada Ltd.  
National Customer Service  
175 Gordon Baker Road  
North York, Ontario M2H 2N7  
800-663-8255  
<http://www.volvocanada.com>

## General Information

**Shiftlock (automatic transmission)**

When your car is parked, the gear selector is locked in the (P)ark position. To release the selector from this position, turn the ignition key to position II (or start the engine), depress the brake pedal, press the button on the front side of the gear selector and move the selector from (P)ark.

**Keylock (automatic transmission)**

When you switch off the ignition, the gear selector must be in the (P)ark position before the key can be removed from the ignition switch.

**Anti-lock Brake System (ABS)**

The ABS system in your car performs a self-diagnostic test when the vehicle first reaches the speed of approximately 12 mph (20 km/h). The brake pedal will pulsate several times and a sound may be audible from the ABS control module. This is normal.

**Fuel filler door**

The fuel filler door, located on the right rear fender, is connected to your car's central locking system. Press the button on the light switch panel (see illustration on [page 34](#)) when the car is at a standstill to unlock the fuel filler door. Please note that the fuel filler door will remain unlocked until the car begins to move forward. An audible click will be heard when the fuel filler door relocks.

**Fuel filler cap**

After refueling, close the fuel filler cap by turning it clockwise until it clicks into place. If this cap is not closed tightly or if the engine is running when the car is refueled, the Malfunction Indicator Lamp ("Check Engine" light) will illuminate.

**Important information**

Before you operate your car for the first time, please familiarize yourself with the new-engine oil consumption information on [page 84](#). You should also be familiar with the information in chapters one, two and four of this manual. Information contained in the balance of the manual is extremely useful and should be read after operating the vehicle for the first time.

The manual is structured so that it can be used for reference. For this reason, it should be kept in the car for ready access.

Do not export your Volvo to another country before investigating that country's applicable safety and exhaust emission requirements. In some cases it may be difficult or impossible to comply with these requirements. Modifications to the

emission control system(s) may render your Volvo not certifiable for legal operation in the U.S., Canada and other countries.

All information, illustrations and specifications contained in this manual are based on the latest product information available at the time of publication. Please note that some vehicles may be equipped differently, depending on special legal requirements. Optional equipment described in this manual may not be available in all markets. Volvo reserves the right to make model changes at any time, or to change specifications or design without notice and without incurring obligation.

 **WARNING!**

**CALIFORNIA Proposition 65 Warning!**

Engine exhaust, some of its constituents, and certain vehicle components contain or emit chemicals known to the state of California to cause cancer, and birth defects or other reproductive harm. In addition, certain fluids contained in vehicles and certain products of component wear contain or emit chemicals known to the State of California to cause cancer, and birth defects or other reproductive harm.

 **WARNING!**

If your vehicle is involved in an accident, unseen damage may affect your vehicle's driveability and safety.

## Volvo and the environment

Volvo is committed to the well being of its customers. As a natural part of this commitment, we care about the environment in which we all live. Caring for the environment means an everyday involvement in reducing our environmental impact.

Volvo's environmental activities are based on a holistic view, which means we consider the overall environmental impact of a product throughout its complete life cycle. In this context, design, production, product use, and recycling are all important considerations.

In production, Volvo has partly or completely phased out several chemicals including freons, lead chromates, naphthanates, asbestos, mercury and cadmium; and reduced the amount of chemicals used in our plants 50% since 1991. Volvo was the first in the world to introduce into production a three-way catalytic converter with a Lambda sond, now called oxygen sensor, in 1976. The current version of this highly efficient system reduces emissions of harmful substances (CO, HC, NOx) from the exhaust pipe by approximately 95% and the search to eliminate the remaining emissions continues. Volvo is the only automobile manufacturer to offer CFC-free retrofit kits for the air conditioning system of all models as far back as the 1975 model 240. Advanced electronic engine controls, refined purification systems and cleaner fuels are bringing us closer to our goal.

After Volvo cars and parts have fulfilled their use, recycling is the next critical step in completing the life cycle. The metal content is about 75% of the total weight of a car, which makes the car among the most recycled industrial products. In order to have efficient and well controlled recycling, many Volvo variants have printed dismantling manuals, indicating the weight and material of individual components.

For Volvo, all homogeneous plastic parts weighing more than 1.7 oz. (50 grams) are marked with international symbols that indicate how the component is to be sorted for recycling.

In addition to continuous environmental refinement of conventional gasoline-powered internal combustion engines, Volvo is actively looking at advanced technology alternative-fuel vehicles.

When you drive a Volvo, you become our partner in the work to lessen the car's impact on the environment.

To reduce your vehicle's environmental impact, you can:

- Maintain proper air pressure in your tires. Tests have shown decreased fuel economy with improperly inflated tires.
- Follow the recommended maintenance schedule in your Warranty and Service Records Information booklet.

Drive at a constant speed.

- See an authorized Volvo retailer as soon as possible for inspection if the check engine (malfunction indicator) lamp illuminates, or stays on after the vehicle has started.
- Properly dispose of any vehicle-related waste such as used motor oil, used batteries, brake pads, etc.
- When cleaning your car, use Volvo's own car care products, all of which have systematically been adapted to the environment.

### PremAir®

On the surface of the radiator in the engine compartment, there is a special coating called PremAir®. PremAir® works as a catalytic converter, converting most of the ground level ozone passing through the radiator into oxygen, thereby reducing harmful ground-level ozone.

PremAir is a registered trademark of Engelhard Corporation.

## Instruments, switches and controls

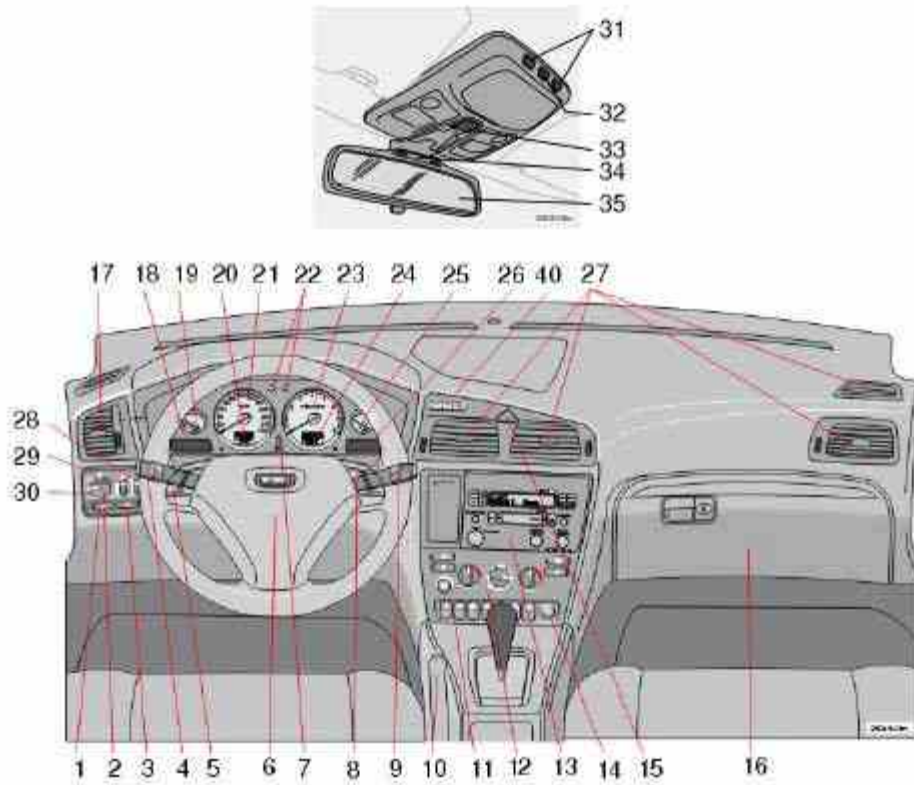

|  | Page                |
|--|---------------------|
| 1. Front fog lights  | <a href="#">34</a>  |
| 2. Headlights/Parking lights/switch for unlocking fuel filler door | <a href="#">34</a>  |
| 3. Rear fog light  | <a href="#">35</a>  |
| 4. Turn signals/High/low beams                                     | <a href="#">36</a>  |
| 5. Cruise control  | <a href="#">40</a>  |
| 6. Horn  | <a href="#">iv</a>  |
| 7. Instrument panel  | <a href="#">26</a>  |
| 8. Audio controls in steering wheel                                | <a href="#">179</a> |
| 9. Windshield wipers   | <a href="#">37</a>  |

|   |                        |
|---|------------------------|
| 10. Parking brake (hand brake)                        | <a href="#">42</a>     |
| 11. Center console switches                           | <a href="#">31</a>     |
| 12. Climate control                                   | <a href="#">49</a>     |
| 13. Audio system                                      | <a href="#">173</a>    |
| 14. 12 V socket                                       | <a href="#">42</a>     |
| 15. Hazard warning flashers                           | <a href="#">38</a>     |
| 16. Glove compartment                                 | <a href="#">68</a>     |
| 17. Panel vents                                       | <a href="#">51</a>     |
| 18. Text window                                       | <a href="#">30</a>     |
| 19. Temperature gauge                                 | <a href="#">26</a>     |
| 20. Odometer/ Trip odometer/Cruise control indicator  | <a href="#">26/ 40</a> |
| 21. Speedometer                                       | <a href="#">26</a>     |
| 22. Turn signal indicators                            | <a href="#">26</a>     |
| 23. Tachometer  | <a href="#">26</a>     |
| 24. Ambient temperature/Clock/Selected gear indicator | <a href="#">26</a>     |
| 25. Fuel gauge  | <a href="#">26</a>     |
| 26. Indicator and warning symbols                     | <a href="#">27</a>     |
| 27. -   | -                      |
| 28. Panel vents                                       | <a href="#">51</a>     |
| 29. Instrument lighting                               | <a href="#">34</a>     |
| 30. Lighting panel                                    | <a href="#">34</a>     |
| 31. Reading lights                                    | <a href="#">64</a>     |
| 32. Interior lighting                                 | <a href="#">64</a>     |
| 33. Moonroof control                                  | <a href="#">47</a>     |
| 34. Seat belt reminder                                | <a href="#">iv</a>     |
| 35. Rearview mirror                                   | <a href="#">45</a>     |
| 36. Lock button, for all doors                        | <a href="#">77</a>     |
| 37. Blocking rear seat power windows                  | <a href="#">43</a>     |
| 38. Controls, power windows                           | <a href="#">43</a>     |
| 39. Controls, sideview mirrors                        | <a href="#">45</a>     |
| 40. Four-C active chassis system (R-models only)      | <a href="#">97</a>     |

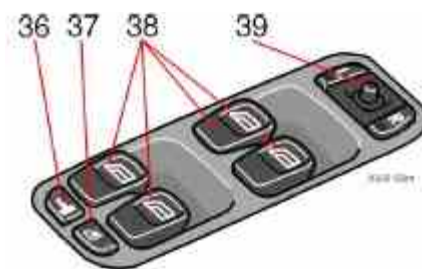

*Control panel in the driver's door (controls 36-39).*

# Contents

[Safety](#)

[Instruments and controls](#)

[Climate control](#)

[Interior](#)

[Locks and alarm](#)

[Starting and driving](#)

[Wheels and tires](#)

[Car care](#)

[Maintenance and service](#)

[Specifications](#)

[Audio](#)

[Index](#)

[Back Cover](#)



[Contents](#) | [Top of Page](#)

# 2005 VOLVO S60

## Safety

### pg. 1 Safety

|   |                    |
|---|--------------------|
| Seat belts  | <a href="#">2</a>  |
| Airbags (Supplemental Restraint System)                             | <a href="#">4</a>  |
| Side airbags (SIPS airbags)   | <a href="#">12</a> |
| Inflatable Curtain (IC)   | <a href="#">14</a> |
| Inspection of airbags, inflatable curtains and seat belt tensioners | <a href="#">15</a> |
| WHIPS   | <a href="#">16</a> |
| Child safety  | <a href="#">18</a> |
| Occupant safety, Reporting safety defects                           | <a href="#">24</a> |

### pg. 2 Safety

#### **Seat belts**

Not wearing a seat belt is like believing "It'll never happen to me!" Volvo, the inventor of the three-point seat belt, urges you and all occupants of your car to wear seat belts and ensure that children are properly restrained, using an infant, car or booster seat determined by age, weight and height. Volvo also believes no child should sit in the front seat of a car.

**NOTE:** Legislation in your state or province may mandate seat belt usage. Additionally, most states and provinces have already made it mandatory for occupants of a car to use seat belts.

So, urging you to "buckle up" is not just our recommendation - legislation in your state or province may mandate seat belt usage. The few seconds it takes to buckle up may one day allow you to say, "It's a good thing I was wearing my seat belt."

**NOTE:** A chime will sound several times if the driver has not fastened his/her seat belt.

The seat belts are equipped with tensioners that reduce slack in the seat belts. These tensioners are triggered in situations where the airbags deploy.

The front seat belts also include a tension reducing device which, in the event of a collision, limits the peak forces exerted by the seat belt on the occupant.

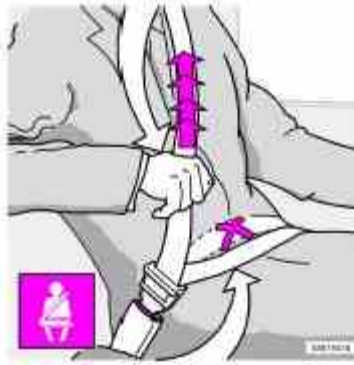

*Extending the lap belt*

### **To buckle a seat belt:**

Pull the belt out far enough to insert the latch plate into the receptacle until a distinct click is heard. The seat belt retractor is normally "unlocked" and you can move freely, provided that the shoulder belt is not pulled out too far. The retractor will lock up as follows:

- if the belt is pulled out rapidly
- during braking and acceleration
- if the vehicle is leaning excessively
- when driving in turns

For the seat belt to provide maximum protection in the event of an accident, it must be worn correctly. When wearing the seat belt remember:

- The belt should not be twisted or turned.
- The lap belt must be positioned low on the hips (not pressing against the abdomen).

Make sure that the shoulder belt is rolled up into its retractor and that the shoulder and lap belts are taut.

Before exiting the car, check that the seat belt retracts fully after being unbuckled.

If necessary, guide the belt back into the retractor slot.

### **Child seats:**

Please refer to [page 23](#) for information on securing child seats with the seat belts.



### **During pregnancy**

Pregnant women should always wear seat belts. Remember that the belt should always be positioned in such a way as to avoid any possible pressure on the abdomen. The lap portion of the belt should be located low, as shown in the above illustration.



## ⚠ WARNING!

### Seat belts:

- Never use a seat belt for more than one occupant. Never wear the shoulder portion of the belt under the arm, behind the back or otherwise out of position. Such use could cause injury in the event of an accident. As seat belts lose much of their strength when exposed to violent stretching, they should be replaced after any collision, even if they appear to be undamaged.
- Never repair the belt on your own; have this work done by an authorized Volvo retailer only.
- Any device used to induce slack into the shoulder belt portion of the three-point belt system will have a detrimental effect on the amount of protection available to you in the event of a collision.
- The seat back should not be tilted too far back. The shoulder belt must be taut in order to function properly.
- Do not use child safety seats or child booster cushions/backrests in the front passenger's seat. We also recommend that children who have outgrown these devices sit in the rear seat with the seat belt properly fastened.



*Sample label found on all seat belts with tensioners*

## Airbags (Supplemental Restraint System)



### Driver's side airbag

As an enhancement to the three-point seat belt system, your Volvo is equipped with a Supplemental Restraint System (SRS) to complement the three-point seat belt system. The inflatable airbag is installed folded up in the center of the steering wheel. The wheel is embossed with SRS.

**⚠ WARNING!**

Never drive an SRS equipped car with your hands on the steering wheel pad/airbag housing.

**⚠ WARNING!**

As its name implies, SRS is designed to be a SUPPLEMENT to - not a replacement for - the three-point belt system. For maximum protection, wear seat belts at all times. Be aware that no system can prevent all possible injuries that may occur in an accident.

When installing any accessory equipment, make sure that the SRS system is not damaged. Do not attempt to service any component of the SRS yourself. Attempting to do so may result in serious personal injury. If a problem arises, take your car to the nearest authorized Volvo retailer for inspection as soon as possible.

pg. 5 Safety



**Passenger side airbag**

The airbag on the front passenger side is folded up in a compartment above the glove compartment. The panel is embossed SRS.

**⚠ WARNING!**

No objects, accessory equipment or stickers may be placed on, attached to, or installed near the SRS cover in the center of the steering wheel, the SRS cover above the glove compartment or the area affected by airbag deployment.

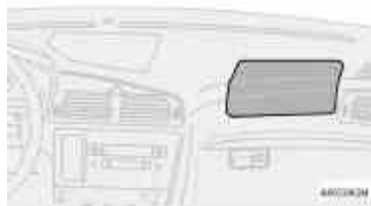

*Passenger side airbag - location*

pg. 6 Safety

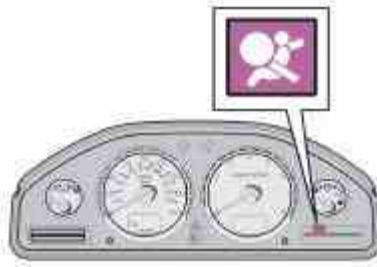

### Safety system warning light in the instrument panel

A self-diagnostic system incorporated in the sensor monitors certain safety system components. A check is performed on components such as seat belt locks, SRS, SIPS, and/or the VIC system. If a fault is detected, the warning light will illuminate. The light is included in the warning/indicator light cluster in the instrument panel. Normally, the safety system warning lamp should light up when the ignition key is turned to positions I, II or III and should go out after approximately 7 seconds or when the engine is started. Check that this light is functioning properly every time the vehicle is started.

#### **WARNING!**

If the SRS warning light stays on after the engine has started or if it comes on while you are driving, drive the car to the nearest authorized Volvo retailer for inspection as soon as possible.

pg. 7 Safety

#### **WARNING!**

Children must never be allowed in the front passenger's seat. Volvo recommends that ALL occupants (adults and children) shorter than 4 feet 7 inches (140 cm) be seated in the back seat of any vehicle with a front passenger-side airbag. See [page 23](#) for guidelines.

Occupants in the front passenger's seat must never sit on the edge of the seat, sit leaning toward the instrument panel or otherwise sit out of position. The occupant's back must be as upright as comfort allows and be against the seat back with the seat belt properly fastened.

Feet must be on the floor, e.g. not on the dash, seat or out of the window.

No objects or accessory equipment, e.g. dash covers, may be placed on, attached to, or installed near the SRS hatch (the area above the glove compartment) or the area affected by airbag deployment (see illustration on [page 4 and 5](#)).

There should be no loose articles, e.g. coffee cups, on the floor, seat or dash area.

Never try to open the SRS cover on the steering wheel or the passenger side dash. This should only be done by an authorized Volvo service technician.

Failure to follow these instructions can result in injury to the vehicle occupants

pg. 8 Safety



SRS text on outside of both sun visors.



SRS text on inside of both sun visors.



SRS text on passenger's dash.



SRS text at the end of the dash.

**NOTE:** Deployment of SRS components occurs only one time during an accident. In a collision where deployment occurs, the airbags and seat belt tensioners activate. Some noise occurs and a small amount of powder is released. The release of the powder may appear as smoke-like matter. This is a normal characteristic and does not indicate fire.

**NOTE:** Volvo's dual-threshold, dual-stage airbags use special sensors that are integrated with the front seat buckles. The point at which the airbag deploys is determined by whether or not the seat belt is being used, as well as the severity of the collision. Collisions can occur where only one of the airbags deploys.

If the impact is less severe, but severe enough to present a clear injury risk, the dual-stage airbags are triggered at just 70% of their total capacity. If the impact is more severe, the dual-stage airbags are triggered at full capacity.

**⚠ WARNING!**

Do not use child safety seats or child booster cushions/backrests in the front passenger's seat. We also recommend that occupants under 4 feet 7 inches (140 cm) in height who have outgrown these devices sit in the rear seat with the seat belt fastened.

Never drive with the airbags deployed. The fact that they hang out can impair the steering of your car. Other safety systems can also be damaged. The smoke and dust formed when the airbags are deployed can cause skin and eye irritation in the event of prolonged exposure.

**NOTE:** The information on this page does not pertain to the Side Impact Protection System airbags.

**When are the airbags deployed?**

The SRS system is designed to deploy during certain frontal or front-angular collisions, impacts, or decelerations, depending on the crash severity, angle, speed and object impacted. The SRS sensor is designed to react to both the

impact of the collision and the inertial forces generated by it and to determine if the intensity of the collision is sufficient for the seat belt tensioners or airbags to be deployed.

If the airbags have been deployed, we recommend the following:

- Have the car towed to an authorized Volvo retailer. Never drive with the airbags deployed.
- Have an authorized Volvo retailer replace the SRS system components.
- Use only new, Genuine Volvo Parts when replacing SRS components (airbags, seat belts, tensioners, etc.).

### **When are the airbags NOT deployed?**

Not all frontal collisions activate the SRS system. If the collision involves a nonrigid object (e.g., a snow drift or bush), or a rigid, fixed object at a low speed, the SRS system will not necessarily deploy. Front airbags do not normally deploy in a side impact collision, in a collision from the rear or in a rollover situation. The amount of damage to the bodywork does not reliably indicate if the airbags should have deployed or not.

### **Seat belts - the heart of the Volvo safety system**

The heart of the Volvo safety system is the three-point seat belt (a Volvo invention)! In order for the SRS system to provide the protection intended, seat belts must be worn at all times by everyone in the car. **The SRS system is a supplement to the seat belts.**

#### **WARNING!**

Never drive with the airbags deployed. The fact that they hang out can impair the steering of your car. Other safety systems can also be damaged. The smoke and dust formed when the airbags are deployed can cause skin and eye irritation in the event of prolonged exposure.

pg. 10 Safety

#### **WARNING!**

If your car has been subjected to flood conditions (e.g. soaked carpeting/standing water on the floor of the vehicle) or if your car has become flood-damaged in any way, do not attempt to start the vehicle or put the key in the ignition before disconnecting the battery (see below). This may cause airbag deployment which could result in personal injury. **Have the car towed to an authorized Volvo retailer for repairs.**

#### **Automatic transmission:**

Before attempting to tow the car, use the following procedure to override the shiftlock system to move the gear selector to the neutral position.

- Switch off the ignition for at least 10 minutes and disconnect the battery
- Wait at least one minute
- Insert the key in the ignition and turn it to position II
- Press firmly on the brake pedal.
- Move the gear selector from **(P)**ark to the **(N)**eutral position.

There is no maintenance to perform on the SRS yourself. The month and year shown on the decal on the door pillar indicate when you should contact your Volvo retailer for specific servicing or replacement of airbags and seat belt tensioners. This service must be performed by an authorized Volvo retailer.

Should you have any questions about the SRS system, please contact your authorized Volvo retailer or Volvo Customer Support.:

**In the USA:**

Volvo Cars of North America, LLC.  
Customer Care Center  
P.O. Box 914  
Rockleigh, New Jersey 07647-0914  
800-458-1552

**In Canada:**

Volvo Cars of Canada Ltd.  
National Customer Service  
175 Gordon Baker Road  
North York, Ontario M2H 2N7  
800-663-8255

pg. 11 Safety

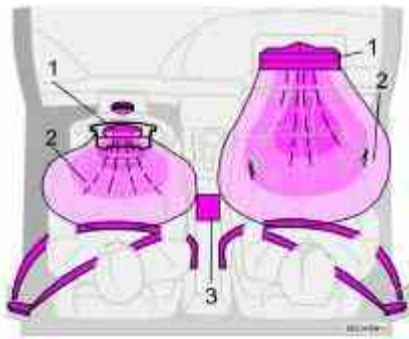
**Front airbag (SRS) system**

As an enhancement to the three-point seat belt system, your Volvo is equipped with a Supplemental Restraint System (SRS). The Volvo SRS consists of an airbag (2) on both the driver's and passenger's sides and seat belt tensioners in both front door pillars. The system is designed to supplement the protection provided by the three-point seat belt system. All three rear seat belts are also equipped with tensioners.

The SRS system is indicated by the "SRS" embossed on the steering wheel pad and above the glove compartment, and by decals on both sun visors and on the front and far right side of the dash.

The airbags are folded and located in the steering wheel hub and above the glove compartment.

**Deployment:** The SRS airbags are designed to deploy during certain frontal or front-angular collisions, impacts, or decelerations, depending on the crash severity, angle, speed and object impacted. The airbags may also deploy in certain non-frontal collisions where rapid deceleration occurs.

The airbag system includes gas generators (1) surrounded by the airbags (2) and front seat belt tensioners for both of the front seats. To deploy the system, the sensor (3) activates the gas generators causing the airbags to be inflated with nitrogen gas.

As the movement of the seats' occupants compresses the airbags, some of the gas is expelled at a controlled rate to provide better cushioning. Both seat belt tensioners also deploy, minimizing any seat belt slack. The entire process, including inflation and deflation of the airbags, takes approximately two-tenths of a second.

**⚠ WARNING!**

The SRS is designed to help prevent serious injury. Deployment occurs very quickly and with considerable force. During normal deployment and depending on variables such as seating position, one may experience abrasions,

bruises, swellings, or other injuries as a result of airbag(s) deployment.

**Never** try to repair any part of the SRS or SIPS bag systems yourself. Any interference in the system could cause malfunction and serious injury. All work on these systems should be performed by an authorized Volvo retailer.

pg. 12 Safety

## Side airbags (SIPS airbags)



*SIPS airbag\**

### SIPS airbag (front seats only)

As an enhancement to the structural Side Impact Protection System built into your car, the car is also equipped with Side Impact Protection System (SIPS) airbags. The SIPS airbag system consists of airbag modules built into the sides of both front seat backrests, wires and gas generators/sensor units (see illustration on next page).



The SIPS airbag system is designed to help increase occupant protection in the event of certain side impact collisions. The SIPS airbags are designed to deploy only during certain side-impact collisions, depending on the crash severity, angle, speed and point of impact. SIPS airbag deployment (one airbag) occurs only on the side of the vehicle affected by the impact. The airbags are not designed to deploy in all side impact situations.

\*A SIPS airbag warning decal is also located at the end of the instrument panel on the driver's side of the car.

### **⚠ WARNING!**

- The SIPS airbag system is a supplement to the Side Impact Protection System and the three-point seat belt system. It is not designed to deploy during collisions from the front or rear of the car or in rollover situations.
- The use of seat covers on the front seats may impede SIPS airbag deployment.
- No objects, accessory equipment or stickers may be placed on, attached to or installed near, the SIPS airbag system or in the area affected by SIPS airbag deployment (see illustration above).

- Never try to open or repair any components of the SIPS airbag system. This should be done only by an authorized Volvo service technician.

- In order for the SIPS airbag to provide its best protection, both front seat occupants should sit in an upright position with the seat belt properly fastened.

- Failure to follow these instructions can result in injury to the occupants of the vehicle in the event of an accident.

pg. 13 Safety

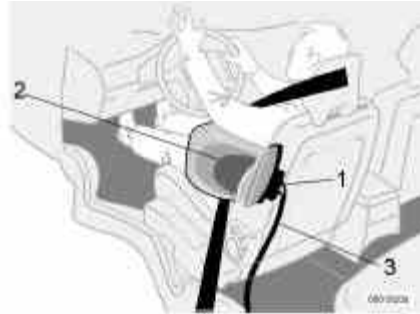

### **The SIPS airbag system**

This system consists of a gas generator (1), the side airbags (2), and electronic sensors/cables (3).



[Contents](#) | [Top of Page](#)



# 2005 VOLVO S60

## Instruments and controls

### pg. 25 Instruments and controls

|  |                    |
|--|--------------------|
| Instrument panel   | <a href="#">26</a> |
| Indicator and warning symbols  | <a href="#">27</a> |
| Switches in the center console   | <a href="#">31</a> |
| Steering wheel adjustment  | <a href="#">33</a> |
| Lighting panel   | <a href="#">34</a> |
| Lighting panel, Manually unlocking the fuel filler door                            | <a href="#">35</a> |
| Turn signals   | <a href="#">36</a> |
| Windshield wipers/washer   | <a href="#">37</a> |
| Hazard warning flashers, rear window/sideview mirror defroster, heated front seats | <a href="#">38</a> |
| Trip computer (option)   | <a href="#">39</a> |
| Cruise control   | <a href="#">40</a> |
| Parking brake, electric socket/cigarette lighter                                   | <a href="#">42</a> |
| Electrically operated windows  | <a href="#">43</a> |
| Rearview mirror/sideview mirrors   | <a href="#">45</a> |
| Power moonroof (option)  | <a href="#">47</a> |

### pg. 26 Instruments and controls

## Instrument panel

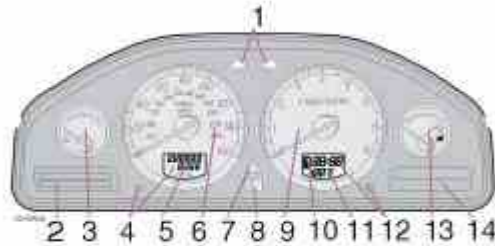

### 1. Turn signal indicators - right/left

### 2. Text window

The text window displays information and warning messages.

### 3. Temperature gauge

The pointer should be approximately midway on the gauge when driving. **Do not drive the car if the warning light is on.** The text window will provide you with additional information. If the engine temperature remains high, check

coolant level - see [page 139](#).

#### 4. Trip odometer

The trip odometers are used for measuring shorter distances. The right-hand digit gives tenth of a mile/kilometer. Press the button for more than 2 seconds to reset. Change between trip odometers 1 and 2 using one short press on the button.

#### 5. Odometer

#### 6. Speedometer

#### 7. Warning symbol

#### 8. High beam indicator

#### 9. Tachometer

Indicates engine speed in thousands of revolutions per minute (rpm). Do not drive for long with the needle in the red section. The engine has an built-in function preventing excessively high engine speeds. When this function operates, you may discern some pulsation, which in that case is quite normal.

#### 10. Gear and driving mode indicator

The currently selected driving mode is displayed here. If you use the optional Geartronic function on the automatic transmission, the currently selected gear will be displayed.

#### 11. Ambient temperature gauge

This display indicates the air temperature outside your car. A "snowflake" symbol in the text window is displayed when the temperature is in the range of 23 - 36° F (-5 - +2° C).

Please note that this symbol does not indicate a fault with your car.

At low speeds or when the car is not moving, the temperature readings may be slightly higher than the actual ambient temperature.

#### 12. Clock/set button

Turn the button to set the clock.

#### 13. Fuel gauge

The fuel tank holds approximately:

**Front wheel drive, non-turbo models -:** 18.5 US gals (70 liters)

**All turbo models -:** 18 US gals (68 liters)

When a warning light in the gauge comes on, there are approximately 1.8 US gal. (8 liters) of fuel remaining in the tank.

#### 14. Indicator and warning symbols

pg. 27 Instruments and controls

## Indicator and warning symbols

The indicator and warning symbols light up when you turn the ignition key to the driving position (position II) before starting. This shows that the symbols are functioning. When the engine starts, all symbols go out. If the engine is not started within 5 seconds, all symbols except **CHECK ENGINE** and  go out. Certain symbols may not have their functions illustrated, depending on the car's equipment. The symbol for the parking brake goes out when the parking brake is released.

## Warning symbol in center of dashboard

This symbol shines as a red or yellow light depending on the severity of the discovered fault.

**Red symbol** - Stop the car as soon as possible in a suitable location and read the message shown in the text window.

**Yellow symbol** - Follow the instructions shown in the text window.

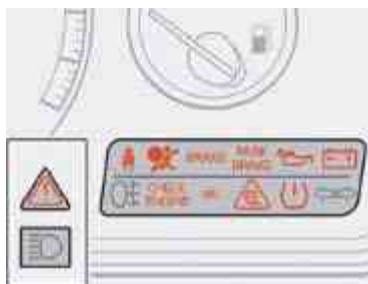

### **Anti-lock brake system ABS**

If the warning light comes on, there is a malfunction of the ABS system (the standard braking system will still function). The vehicle should be driven to a Volvo retailer for inspection. See [page 99](#) for additional information.

### **Stability Traction Control (STC)\* system or Dynamic Stability Traction Control (DSTC) system\*\***

This indicator light will flash when STC or DSTC is actively working to stabilize the car. See [page 100](#) for more detailed information.

### **BRAKE Brake failure warning light**

If the light comes on while driving or braking, stop immediately, open the hood and check the brake fluid level in the reservoir. See [page 140](#) for reservoir position and [page 143](#) for instructions.

 Canadian models are equipped with this warning light:

**If the BRAKE and ABS warning lights come on at the same time, this could indicate a fault in the brake system.**

- Stop the car in a suitable place and switch off the engine.
- Restart the engine.
- If both warning lights go off, no further action is required.
- If both lights are still on after the engine has been restarted, switch off the engine again and check the brake fluid level (see [page 140](#) for the location of the brake fluid reservoir).

\* Standard on all models except the T5 turbo.

\*\* Standard on the T5 turbo, option on all other models.

## Indicator and warning symbols (cont'd)

### **WARNING!**

If the fluid level is below the MIN mark in the reservoir or if a "Brake failure - Service urgent" message is displayed in the text window: **DO NOT DRIVE**. Have the car towed to an authorized Volvo retailer and have the brake system inspected.

- 
- If the brake fluid level is above the MIN mark, drive carefully to an authorized Volvo retailer and have the brake system inspected.

pg. 29 Instruments and controls

### **Supplemental Restraint System SRS**

If the light comes on (or stays on after the vehicle has started), the SRS diagnostic system has detected a fault. Drive to an authorized Volvo retailer for an inspection of the system. See the SRS section for more information.

### **Generator warning light**

If the light comes on while the engine is running, have the charging system checked.

### **Seat belt reminder**

This symbol lights up to indicate that the driver has not fastened his/her seat belt.

### **Tire pressure monitoring light**

See [page 118](#) for more information on this function.

### **PARK BRAKE Parking brake applied**

This light will be on when the parking brake (hand brake) is applied. The parking brake lever is situated between the front seats.

 Canadian models are equipped with this symbol.

### **Rear fog light**

This light indicates that the fog light is on.

### **Turn signal indicator - trailer (certain models)**

If you are towing a trailer, this light will flash simultaneously with the turn signals on the trailer. If the light does not flash when signaling, neither the trailer's turn signals nor the car's turn signals are functioning.

### **Oil pressure warning light**

**If the light comes on while driving, stop the car and then stop the engine immediately and check the engine oil level.** See [page 142](#). R-models are also equipped with an oil level warning system. If the light stays on after restart, have the car towed to the nearest authorized Volvo retailer. After hard driving, the light may come on occasionally when the engine is idling. This is normal, provided it goes off when the engine speed is increased.

### **CHECK ENGINE Malfunction indicator light**

On-Board Diagnostic II (OBDII): As you drive, a computer called "OBDII" monitors your car's engine, transmission, electrical and emission systems. The CHECK ENGINE light will light up if the computer senses a condition that potentially may need correcting. When this happens, please have your car checked by a Volvo retailer as soon as possible.

A CHECK ENGINE light may have many causes. Sometimes, you may not notice a change in your car's behavior. Even so, an uncorrected condition could hurt fuel economy, emission cleanliness, and driveability. Extended driving without correcting the cause could even damage other components in your car.

 Canadian models are equipped with this warning light.

---

### Messages in the text window

When a warning light in the instrument panel comes on, a message is also displayed in the text window. After you have read the message, you can erase it by pressing button A (see illustration).

**NOTE:** Certain messages cannot be erased until the condition has been corrected.

If a warning message is displayed when e.g. you are using the trip computer this message must be erased before you can access the function of your choice. Press button A to erase the warning message.

You can scroll through the stored messages by pressing button A (see illustration). The text window can be cleared (the message will be returned to memory) by pressing button A again.



| <b>Message</b>                  | <b>Meaning:</b>   |
|---------------------------------|---|
| STOP SAFELY:                    | Stop and switch off the engine - to help prevent serious risk of damage.  |
| STOP ENGINE:                    | Stop and switch off the engine - to help prevent serious risk of damage.  |
| SERVICE URGENT:                 | Take your car to an authorized Volvo retailer for inspection as soon as possible.   |
| SEE MANUAL:                     | Refer to your owner's manual. For additional information, please contact your Volvo retailer.   |
| SERVICE REQUIRED:               | Take your car to an authorized Volvo retailer for inspection at your convenience (but preferably before the next scheduled maintenance service).  |
| FIX NEXT SERVICE:               | Have the system affected inspected at the next scheduled maintenance service.   |
| TIME FOR REGULAR SERVICE:       | This light will come on at 7,500 mile (12,000 km) intervals, after 750 hours of driving or after 12 months, whichever occurs first, to remind the driver that the service interval has been exceeded. The light will stay on for 2 minutes after start until reset by the servicing retailer. |
| 1) OIL LEVEL LOW - FILL OIL*    | Check the oil level and top up if necessary. See <a href="#">page 141</a>   |
| 2) OIL LEVEL LOW - STOP SAFELY* | Stop as soon as possible and switch off the engine, check the oil level and top up if necessary. See <a href="#">page 141</a>   |
| 2) OIL LEVEL LOW - STOP ENGINE* | Stop as soon as possible and switch off the engine, check the oil level and top up if necessary. See <a href="#">page 141</a>   |
| 2) OIL LEVEL LOW                | Stop as soon as possible and switch off the engine, check the oil level and top up if necessary. See  |

- SEE [page 141](#)  
MANUAL\*

\* These messages apply to R-line models only.

- 1) Yellow warning symbol, see [page 27](#).
- 2) Red warning symbol, see [page 27](#).

pg. 31 Instruments and controls

## Switches in the center console



*The positions of these buttons may vary, depending on the specifications of the vehicle*



**Four-C active chassis system (option)** Please see [page 97](#) for information on adjusting the active chassis settings.



### Stability Traction Control (STC)/Dynamic Stability Traction Control (DSTC) (option)

Press this switch for at least half a second to turn the Spin Control (SC) function of the STC/DSTC system on or off. An LED in the switch will light up to indicate that the system is on. See [page 100](#) for more information on STC/DSTC. The SC function should be switched off if you, for any reason, temporarily have to drive with tires of different dimensions (e.g., spare tire).

#### **R-models only:**

The Active Yaw Control function can be deactivated. See [page 100](#) for more information.

**Note:** To help reduce the risk that the SC function is turned off inadvertently, the switch must be held in for at least half a second to disable this function. "STC/DSTC SPIN CONTROL OFF" will be displayed in the text window.

This function will be automatically reactivated when the engine is restarted.

#### **⚠ WARNING!**

Please be aware that the car's handling characteristics may be affected if the Spin Control function is switched off.



### Folding head restraints

This button is used to fold down the outboard rear head restraints. The ignition key must be in position I or II or the engine must be running.

**NOTE:** If the head restraints have been folded down, they must be returned to their original position manually. The head restraints should be in the upright position before the rear seat backrests are folded down.

### **WARNING!**

For safety reasons, no one should be allowed to sit in the outboard rear seat positions if the head restraints are folded down. If these positions are occupied, the head restraints should be in the upright (fixed) position.

pg. 32 Instruments and controls



### Valet lock (trunk lock)

Pressing this switch locks the trunk, even if the doors are unlocked. The trunk will remain locked even if the doors are locked/unlocked using the **master** key or the remote control.

To use this function:

- Turn the master key to position II.
- Press the "Valet lock" button. An LED in the button will light up and "VALET LOCK ON" will be displayed on the text window to indicate that this function is activated.
- The function can be turned off (deactivated) by turning the ignition key to position II and pressing the "Valet lock" button again (the LED in the button will go out and "VALET LOCK OFF" will be displayed in the text window).



### Temporarily disconnecting the alarm sensors (option)

See [page 81](#) for more details.



### 12 volt socket

This 12 volt socket can be used to plug in certain accessories such as cellular telephones, etc. The ignition key must be in position 1 (or higher) for the auxiliary socket to function.

**NOTE:** The auxiliary sockets can also be used for cigarette lighters, which are available at your Volvo retailer.

pg. 33 Instruments and controls

## Steering wheel adjustment

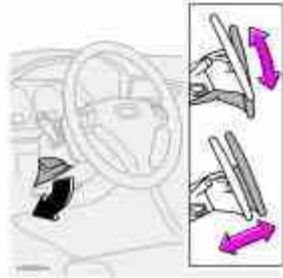

Both the height and the reach of the steering wheel can be adjusted to a comfortable position for the driver. Pull down the lever on the left of the steering column. Adjust the steering wheel to a suitable position and press the lever back into place to lock the steering wheel in the new position. Check that the steering wheel is locked in the new position.

### **⚠ WARNING!**

Never adjust the steering wheel while driving.

pg. 34 Instruments and controls

## Lighting panel

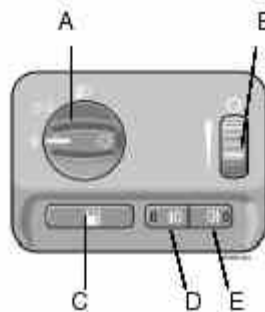

### **A - Headlights and parking lights**

0 All lighting off.

### **Models with daytime running lights:**

Low beam headlights will automatically come on if the ignition key is in position II. Front and rear parking lights and license plate lights will also be on. Volvo recommends the use of daytime running lights. If, however, you would prefer to have these lights turned off (USA only), please consult your Volvo retailer. Please note that the use of daytime running lights is mandatory in Canada.

**NOTE:** Bi-Xenon headlights (option): Turn the headlight switch to position 0 to activate a daylight sensor, which automatically switches the low beams on or off, depending on ambient light conditions. When driving in daylight, the headlights will switch off and the daytime running lights will come on. In darkness, the daytime running lights will switch off and the Bi-Xenon headlights will switch on.



 Parking lights on. **The parking lights should be switched off when you leave the car to help avoid battery drain.**

 Headlights, parking lights, license plate lights and instrument panel illumination are on if the ignition key is in position II.

If the headlight switch is in this position, all lights will go out when the ignition is switched off.

The headlight switch must be in this position before the high beams will function (this also applies on models equipped with the optional Bi-Xenon headlights).

Switch from high to low beams and vice versa by pulling the turn signal switch lever on the left side of steering column toward you.

### **B - Instrument lighting**

Move the thumb wheel up to increase brightness or down to decrease brightness. There is also an instrument panel illumination sensor (see illustration on [page 52](#)) which automatically adjusts the level of illumination.

The symbols have maximum illumination in daylight (only the background lighting can be adjusted). At night, both the symbol light and background lighting can be adjusted.

### **C - Unlocking the fuel filler door**

Press this button when the car is at a standstill to unlock the fuel filler door. Please note that the fuel filler door will remain unlocked until the car begins to move forward. An audible click will be heard when the fuel filler door relocks.

See also [page 86](#).

**NOTE:** If the fuel filler door does not unlock after the button has been pressed, please see [page 35](#) for information on manually unlocking this door.

### **D - Front fog lights \***

The front fog lights will function only in combination with the low beam headlights.

An LED in the switch indicates when the front fog lights are on.

\* Standard on T5, R models/accessory on the other models.

These lights will be automatically switched off the next time the car is started.



# 2005 VOLVO S60

## Climate control

pg. 49 Climate control

|   |                    |
|---|--------------------|
| Climate control systems - general information     | <a href="#">50</a> |
| Air distribution                                  | <a href="#">51</a> |
| Electronic climate control, ECC                   | <a href="#">52</a> |
| Manual climate control with air conditioning, A/C | <a href="#">56</a> |

pg. 50 Climate control

## Climate control systems - general information

### Condensation on the inside of the windows

Keeping the insides of the windows clean will help reduce the amount of condensation that forms on the windows. Use a commercial window cleaning agent to clean the windows.

### Ice and snow

Always keep the air intake grille at the base of the windshield free of snow.

### Cabin air filter

Replace the cabin air filter with a new one at the recommended intervals. Please refer to your Warranty and Service Records Information booklet, or consult your Volvo retailer for these intervals. The filter should be replaced more often when driving under dirty and dusty conditions. The filter cannot be cleaned and therefore should always be replaced with a new one.

### Sensors

The sunlight sensor on the dashboard and passenger compartment temperature sensor in the ECC control panel should not be covered in any way as this could cause incorrect information to be sent to the ECC system.

### Parking the car in warm weather

If your car has been parked in the sun in warm weather, opening the windows and moonroof (option) for several minutes before driving will help release the warm air from the passenger compartment. When the engine is running, close the windows and moonroof and use the recirculation function for several minutes to enable the air conditioning to cool the compartment as quickly as possible.

### Windows and optional moonroof

The ECC system will function best if the windows and optional moonroof are closed. If you drive with the moonroof open, we recommend that you manually adjust the temperature and blower control (the LED in the AUTO switch should be off).

### Acceleration

The air conditioning is momentarily disengaged during full-throttle acceleration.

## Climate control maintenance

All maintenance on the climate control systems should be carried out by an authorized Volvo service technician only.

## Refrigerant

Volvo cares about the environment. The air conditioning system in your car contains a CFC-free refrigerant - R134a(HFC134a). This substance will not deplete the ozone layer. The system contains 2.2 lbs (1000 g) R134a and uses PAG oil.

## Passenger compartment blower

Approximately 50 minutes after the ignition is turned off, the blower may come on automatically, and run for seven minutes, to remove condensation in the A/C evaporator.

pg. 51 Climate control

## Air distribution

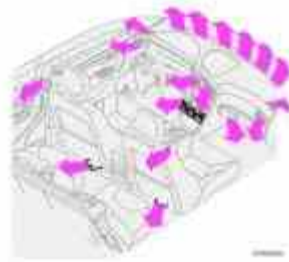

## Air distribution

The incoming air is distributed through 14 ventilation points in the passenger compartment.

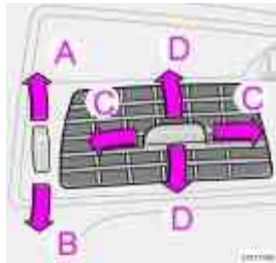

## Air vents in the dash

A Open

B Closed

C Horizontal air flow

D Vertical air flow

- Direct the outer air vents toward the side windows to defrost.
- In cold weather, close the air vents in the center of the dash to direct as much air as possible toward the windows.

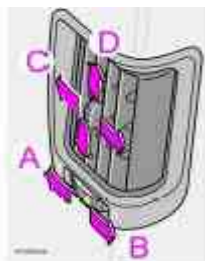

## Air vents in the door pillars

- A Open
- B Closed
- C Horizontal air flow
- D Vertical air flow

- Direct the outer air vents toward the side windows to defrost.
- In cold weather, close the air vents in the center of the dash to direct as much air as possible toward the windows.

pg. 52 Climate control

## Electronic climate control, ECC

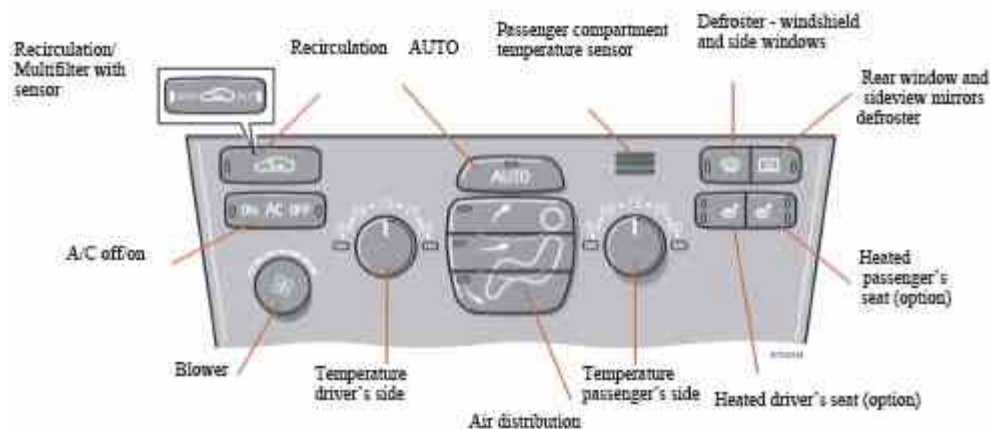

pg. 53 Climate control

## Electronic climate control, ECC (contd)



### AUTO

**This function automatically regulates the Electronic Climate Control system so that the selected temperatures are maintained. The blower, heating, air distribution (air flow) and air conditioning are controlled. If you prefer to manually set any of these functions, the remaining functions will still be controlled automatically. Pressing the AUTO button overrides any settings that were previously made manually.**



### Rear window and sideview mirror defrosters

This function defrosts/de-ices the rear window and sideview mirrors. The LED in the switch will light up to indicate that the heating function is engaged. See [page 38](#) for additional information on this function.

**Never use ice scrapers made of metal as they can easily scratch the mirror surface.**



## Temperature

These controls are used to individually set the temperature for both sides of the passenger compartment. Please note that the compartment will not be heated or cooled faster by setting the temperature higher or lower than necessary.

Set the control to the temperature you prefer.



### Defroster

This function defrosts/de-ices the windshield and front side windows. The LED in the switch will light up to indicate that the defrost function is engaged. Blower speed increases automatically and the air in the passenger compartment is dehumidified. Recirculation will not function while defrost is engaged.



### Blower control

Turn the control clockwise to increase or counterclockwise to decrease the blower speed. Pressing the AUTO switch will automatically regulate blower speed and override manual adjustment.

**NOTE:** Turning the blower control counter-clockwise until an orange LED comes on will turn both the blower and the air conditioning off.

pg. 54 Climate control

## Electronic climate control, ECC (contd)



Air flow to windows  
Air through panel vents  
Air through floor vents

### Air distribution

Press AUTO to automatically regulate air flow or press any combination of the controls shown in the illustration to manually adjust air flow. An LED in the switch will light up if an air flow control has been pressed.



### Heated front seats (option)

- Press the switch once for maximum seat heating. Both LEDs in the switch will be lit.
- Press the switch a second time for comfort heating. One LED in the switch will be lit.
- Press the switch a third time to turn the heating off completely. The LED will go off.

The seat heating for the passenger seat should be switched off when the seat is not occupied.



### A/C - ON/OFF

Press the switch to turn the air conditioning on or off. The "ON" or "OFF" LED will light up to indicate if the system is switched on or off. Other functions will still be regulated automatically (if the **AUTO** switch is on).

- The air conditioning functions only at temperatures above 32° F (0° C).
- While the Defroster function is selected, the air conditioning is temporarily activated to dehumidify the air, even if you have manually switched the air conditioning off. This will only function if the blower is not switched off.



### Recirculation

Press this switch to engage the recirculation function (air in the passenger compartment recirculates - no fresh air enters the compartment). The LED in the switch will light up to indicate that the function is engaged.

- Use this function if the outside air is contaminated with exhaust gases, smoke, etc or to heat/cool the car quickly.
- Recirculation should not be used for more than 15 minutes. *If your windows begin to fog or mist, make sure that the recirculation function is switched off.*
- Selecting **Defroster** automatically switches recirculation off.
- Timer mode activation: (Cars with the Interior Air Quality system have no timer mode) Press and hold the recirculation button for at least 3 seconds to activate a recirculation timer mode. The amber LED in the recirculation button will flash 5 times to show that the timer mode is being activated. In timer mode, each time the recirculation button is pressed, the climate control system will recirculate the air in the passenger compartment for 5-12 minutes, depending on the outside air temperature, and then revert back to fresh air.
- Timer mode deactivation: Press and hold the recirculation button for 3 seconds. The amber LED in the recirculation button will illuminate steadily for 5 seconds to show a return to "normal" mode.

pg. 55 Climate control

## Electronic climate control, ECC (contd)

- In normal mode, when the recirculation button is pressed, the climate control system will recirculate the air in the passenger compartment until the recirculation button is pressed again.
- Timer mode memory: If the car is turned off while timer mode is active, timer mode will still be active when the car is restarted.



### Interior air quality sensor (option)

Some cars are equipped with a multifilter and air quality sensor. The filter separates gases and particles, thereby reducing the amounts of odors and contaminants entering the car. The air quality sensor detects increased levels of contaminants in the outside air. When the air quality sensor detects contaminated outside air, the air intake closes and the air inside the passenger compartment is recirculated, i.e. no outside air enters the car. The filter also cleans recirculated passenger compartment air.

When the ECC system is in the AUTO mode, the green LED will be on .

### Operation

Press  to operate the air quality sensor (normal setting).

Or:

Select one of the following three functions by pressing  1, 2 or 3 times.

1. The AUT LED lights. The air quality sensor is now activated.
2. No LED lights. Recirculation is not activated unless needed to cool the passenger compartment in a warm climate.
3. The MAN LED lights. Recirculation is now activated.

**Keep in mind the following:**

- Make it a rule to have the air quality sensor activated at all times.
- Recirculation is limited in cold climates to avoid fogging.
- If window fogging occurs, you should deactivate the air quality sensor.
- If fogging occurs, use the defroster functions for the windshield, side windows and rear window. See [page 53](#).
- The filter should be changed at the intervals recommended in the service schedule. However, if the car is used in a severely contaminated environment, it may be necessary to change the filter more frequently.

pg. 56 Climate control

## Manual climate control with air conditioning, A/C

- You must turn the blower knob (from the 0 position) to activate the air conditioning.
- Use the air conditioning at low temperatures to dehumidify incoming air.

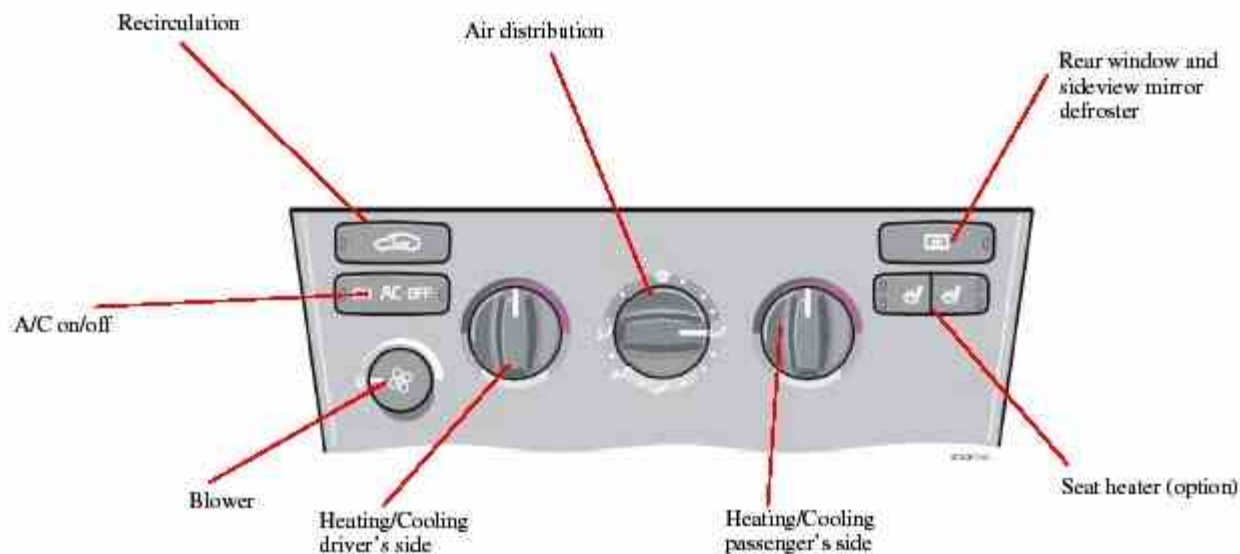

pg. 57 Climate control

## Manual climate control with air conditioning, A/C (contd)



### A/C - ON/OFF

The air conditioning function is engaged by pressing ON and disengaged by pressing OFF.

When you select Defroster , the air conditioning is automatically engaged if the fan is not set to position 0.



### **Blower**

Blower speed can be increased or decreased by turning the knob. If the knob is set to 0, the air conditioning function is automatically disengaged.



### **Temperature**

Turn the control to set the temperature for the driver's and passenger's sides of the car. For cooler air, the air conditioning function must be engaged.



### **Rear window and sideview mirror defrosters**

This function defrosts/de-ices the rear window and sideview mirrors. The LED in the switch will light up to indicate that the heating function is engaged. See [page 38](#) for additional information on this function.

**Never use ice scrapers made of metal as they can easily scratch the mirror surface.**



### **Heated front seats (option)**

- Press the switch once for maximum seat heating. Both LEDs in the switch will be lit.
- Press the switch a second time for comfort heating. One LED in the switch will be lit.
- Press the switch a third time to turn the heating off completely. The LED will go off.

The seat heating for the passenger seat should be switched off when the seat is not occupied.

pg. 58 Climate control

## **Manual climate control with air conditioning, A/C (contd)**





### **Recirculation**

Recirculation can be used to shut out stale air, exhaust, etc. from the passenger compartment. The air in the passenger compartment is then recirculated, i.e. no air from outside the car is taken into the car when this function is activated. Recirculation (together with the air conditioning system) cools the passenger compartment more quickly in warm weather.

If you allow the air in the car to recirculate, there is a risk of icing and fogging, especially in winter. The timer function minimizes the risk of ice, misting and stale air.

Activate the timer function as follows:

- Press  for more than 3 seconds. The LED flashes for 5 seconds. The air recirculates in the car for 3-12 minutes depending on the outside temperature.
- The timer function is activated each time you press .

To switch off the timer function:







- Press  again for more than 3 seconds. The LED lights for 5 seconds to confirm your selection.

Recirculation is always disconnected when you select  Defroster.



### Air distribution

Use the air distribution control positions (marked with dots) between the different symbols to fine-tune air distribution for maximum comfort.

| Air distribution  | Use  |
|---|--|
|  Air through front and rear air vents.  | When you want good cooling in warm weather.                              |
|  Air to windows. Air is not recirculated in this position. Air conditioning is always connected. There is a certain amount of airflow to the air vents. | When you want to remove ice and fog from the windshield.                 |
|  Air to both floor and windows. There is a certain amount of airflow to the air vents.  | When you want comfortable conditions and good demisting in cold weather. |
|  Air to floor. There is a certain amount of airflow to the air vents and the defroster vents for the windshield and side windows.                      | When you want to warm your feet.   |
|  Air to floor and air vents.  | In sunny weather with cool outside temperature.                          |



# 2005 VOLVO S60

## Interior

pg. 59 Interior

|                             |                    |
|-----------------------------|--------------------|
| Front seats                 | <a href="#">60</a> |
| Interior lighting           | <a href="#">64</a> |
| Floor mats                  | <a href="#">65</a> |
| Storage compartments        | <a href="#">66</a> |
| Rear seat and trunk         | <a href="#">69</a> |
| Spare wheel, tools and jack | <a href="#">71</a> |

pg. 60 Interior

## Front seats

### Manually adjusted front seats

1. Front-rear adjustment: lift the bar and move the seat to the position of your choice.
2. Raise/lower the front edge of the seat cushion (option): use the control to pump the front edge of the cushion up or down.
3. Raise/lower seat height: pump the seat up or down
4. Lumbar support: turn the control for firmer or softer lumbar support.
5. Backrest tilt: turn the control to adjust the angle of the backrest.
6. Control panel for optional power seat (see [page 62](#) for more information).

### WARNING!

- Do not adjust the seat while driving. The seat should be adjusted so that the brake pedal can be depressed fully. In addition, position the seat as far rearward as comfort and control allow.
- Check that the seat is securely locked into position after adjusting.



pg. 61 Interior

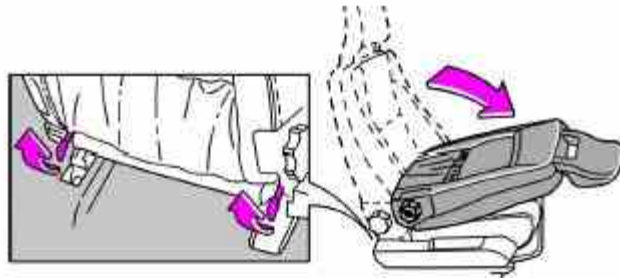

### Folding the backrests in the front seat

The front passenger seat backrest can be folded to a horizontal position to make room for a long load. Fold the backrest as follows:

- Move the seat as far back as possible.
- Adjust the backrest to the upright position.
- Lift the catches on the rear of the backrest.
- Without releasing the catches, push the backrest forward.
- Move the seat as far forward as possible so that the head restraint slides under the glove compartment.

### ⚠ WARNING!

Cover sharp edges on the load to help prevent injury to occupants. Secure the load to help prevent shifting during sudden stops.

pg. 62 Interior

## Front seats (Contd)

**Power seat - (option on certain models)**

### Operation

**Driver's seat:** The seat can be adjusted if the ignition key is in position I, II or if the engine is running. It can also be adjusted as follows **with the ignition off:**

- Within approximately 4 minutes after the driver's door has been unlocked from the outside and has been opened and remains open.
- Within 40 seconds, if the driver's door has just been closed.
- Within 40 seconds, if the driver's door has not been opened after the ignition has been switched off.

**Passenger seat:** The seat can only be adjusted if the ignition key is in position I, II or if the engine is running.

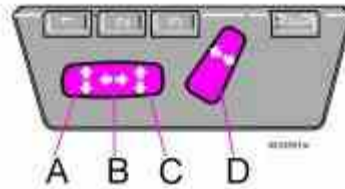

*Power seat control panel*

### **Seat adjustment**

If your Volvo is equipped with power seats, the following may be adjusted with the two switches at the side of the seat:

- A - Front edge of seat (raise/lower)
- B - Front-rear
- C - Rear edge of seat (raise/lower)
- D - Backrest tilt

**NOTE!** The power seats have an overload protector that activates if a seat is blocked by any object. If this occurs, switch off the ignition (key in position 0) and wait about 20 seconds before operating the seat again.

**Please refer to the following page for information on programming the memory function in the driver's seat.**

### **Remote keyless entry system and the driver's seat**

The remote control transmitter also controls the position of the electrically operated driver's seat in the following way:

1. Adjust the seat to your preferences.
2. When you leave your vehicle, lock it using the remote control.

The position of the seat is now stored in the remote control.

### **Automatic seat adjustment**

To move the seat to the position in which you left it:

1. Unlock the driver's door with the same remote control (the one used to lock the doors)
2. Open the driver's door within 2 minutes. The driver's seat will automatically move to the position in which you left it.

### **NOTE:**

- The seat will move to this position even if someone else has moved it to a different seating position and locked the car with a different remote control.
- This feature will work in the same way with all of the remote control transmitters (up to 3) that you use with your vehicle.

**NOTE:** This feature will not function if you lock your vehicle with the key.

## **⚠ WARNING!**

Because the driver's seat can be adjusted with the ignition off, children should never be left unattended in the car.

Movement of the seat can be STOPPED at any time by pressing any button on the power seat control panel.

Do not adjust the seat while driving. The seat should be adjusted so that the brake pedal can be depressed fully. In addition, position the seat as far rearward as comfort and control allow.

The seat rails on the floor must not be obstructed in any way when the seat is in motion.

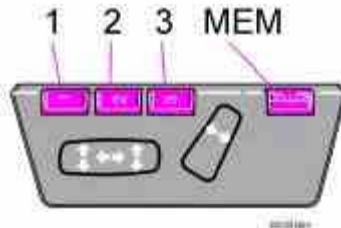

### **Programming the memory (option)**

Three different seating and door mirror positions can be stored in the driver seat's memory.

The following example explains how button 1 can be programmed. Buttons 2 and 3 can be programmed in the same way.

To program (store) a seat position in button 1:

1. Move the seat to the desired position using the seat adjustment controls (see the previous page).
2. Press and hold down the MEM (memory) button.
3. With the MEM button depressed, press button 1 briefly to store the seat's current position.

### **To move the seat to the position that it was in when button 1 was programmed:**

Press and hold down button 1 until the seat stops moving.

As a safety precaution, the seat will stop automatically if the button is released before the seat has reached the preset position.

pg. 64 Interior

## **Interior lighting**

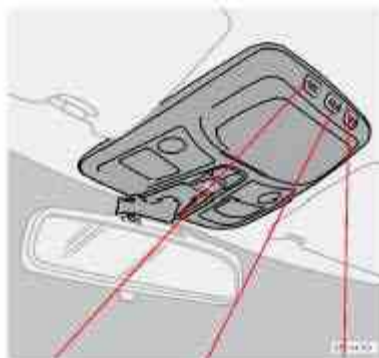

*Reading light Courtesy light Reading light*

### **Courtesy light**

The courtesy light can be turned on or off by pressing the center button. The light also has a timer function which turns

the light on for 30 seconds if:

- You unlock the car from the outside with the key or remote control.
- You switch off the ignition (turn the key to position 0).

The courtesy light stays on for 10 minutes if one of the doors is left open after the car is unlocked.

The courtesy light switches off if:

- The engine is started.
- The car is locked from the outside with the key or remote control.

The courtesy light can be switched off or on in all situations by briefly pressing the button.

When you switch the light on, it remains lit for 10 minutes.

You can disconnect the automatic function by pressing the courtesy light button for more than 3 seconds. Briefly pressing the courtesy light button again automatically reconnects the function.

The courtesy light timer periods can be changed. Contact your Volvo retailer.



*Rear reading lights*

### **Reading lights - front/rear**

The reading lights can be switched on or off by pressing the respective buttons. These lights switch off automatically after 10 minutes if the engine is not running. If the engine is running, the lights stay on indefinitely. The lights can be switched off at any time by pressing the button.



**Vanity mirror**

The light comes on when you open the cover.

**Floor mats**

Volvo offers floor mats specially manufactured for your car. They must be properly placed and secured in the mat clips.

 **WARNING!**

An extra mat on the driver's floor can cause the accelerator pedal to catch. Check that the movement of the accelerator pedal is not impeded. No more than one protective floor covering may be used at one time.



[Contents](#) | [Top of Page](#)

# 2005 VOLVO S60

## Locks and alarm

pg. 73 Locks and alarm

|                       |                    |
|-----------------------|--------------------|
| Keys                  | <a href="#">74</a> |
| Remote controls       | <a href="#">75</a> |
| Locking and unlocking | <a href="#">77</a> |
| Child safety lock     | <a href="#">79</a> |
| Alarm                 | <a href="#">80</a> |

pg. 74 Locks and alarm

## Keys and remote controls



### Keys

Two types of keys are provided with your car; master keys and a service (valet) key. The master key, the remote control, and the central locking button may all be used to lock and unlock all of your car's locks.

The service key will operate only the driver's door and the ignition switch. It is intended to help deter unwanted entry into the glove compartment and trunk.

- Turn the key once to unlock the **driver's door only**.



- Turn the key again (within 10 seconds) to unlock all doors and the trunk.
- One turn with the key towards lock in the drivers door locks all doors, trunk.
- Use the switch on the driver's door armrest to lock/unlock the car from the inside.

**⚠ WARNING!**

If the doors are locked while driving, this may hinder rapid access to the occupants of the car in the event of an accident. (Also see information on "Child safety locks")

**NOTE:** To help prevent accidentally locking the keys in the car, the central locking system is designed to unlock the doors immediately if the key is left in the ignition switch, the car is locked using the lock button on the door and the door is then closed. A sound from the lock will be audible at this time.

*Please note that this function will not unlock the doors if the engine is running.*

**Immobilizer (start inhibitor)**

Each of the keys supplied with your car contains a coded transmitter. The code in the key is transmitted to an antenna in the ignition switch where it is compared to the code stored in the start inhibitor module. The car will start only with a properly coded key.

If you misplace a key, take the other keys to an authorized Volvo retailer for reprogramming as an antitheft measure.

**NOTE:** This device complies with part 15 of the FCC rules. Operation is subject to the following condition: (1) This device may not cause harmful interference, and (2) this device must accept any interference received, including interference that may cause undesired operation.

pg. 75 Locks and alarm



**Remote controls**

Your car is equipped with two coded remote control transmitters with integrated ignition keys called Key Integrated Remote (KIR). These transmitters use a radio frequency that will enable you to lock/unlock all doors and the trunk from a distance of 10-15 feet (3-5 meters). The transmitters will also activate or allow "keyless" entry into the passenger compartment or the trunk. They will also activate or deactivate your car's alarm system(s). The car can also be locked/unlocked with the key.

If one of the transmitters is misplaced, contact your nearest authorized Volvo retailer for replacement.



1 - Fold key in/out, 2 - Lock,  
3 - Approach lighting, 4 - "Panic" function,  
5 - Open trunk, 6 - Unlock

### Using the remote control

**Button 1:** Press to extend the key. This button must also be pressed when the key is folded back into the slot in the side of the remote control unit.

**Button 2(Lock):** Press once to lock all doors, and the trunk.

**Button 3(Approach light):** Press this button when approaching the car at night to light up the interior courtesy light, parking lights, license plate lights and the lights in the sideview mirrors.

**Button 4(Panic):** See [page 80](#) for more information on this function.

**Button 5(Open trunk):** Press this button **twice** within 3 seconds to pop open the trunk (without unlocking the other doors).

**Button 6(Unlock):** Press this button once to unlock the driver's door only. Wait for at least 1 second and press the button again (within 10 seconds) to unlock all doors, and the trunk.

### NOTE:

- Airbag deployment will automatically unlock the doors.
- The keys may also be used to lock and unlock the doors, and to activate and deactivate the alarm system.
- To avoid leaving your keys in the car, make a habit of always locking the car with the remote control.

### Automatic re-locking

If the doors are unlocked, the locks will automatically re-engage (re-lock) and the alarm will rearm after 2 minutes unless a door or the trunk has been opened.

pg. 76 Locks and alarm

---

FCC ID:LQNP2T-APU

This device complies with part 15 of the FCC rules. Operation is subject to the following conditions: (1) This device may not cause harmful interference, and (2) this device must accept any interference received, including interference that may cause undesired operation.

---

Canadian 2306104388

Model 504 2927 by Donnelly Operation is subject to the following conditions: (1) this device may not cause interference, and (2) this device must accept any interference, including interference that may cause undesired operation of the device.

---

Canadian 2306104388A

Model 509 977 by Connaught Electronics Operation is subject to the following conditions: (1) this device may not cause interference, and (2) this device must accept any interference, including interference that may cause undesired operation of the device.

---

## **⚠ WARNING!**

Never use the transmitter to lock the doors from inside the car

Doing so would **ACTIVATE**:

- the break-in alarm, which would sound if one of the doors were opened
- the optional interior motion and inclination alarm sensors.

Doing so would **DEACTIVATE**:

- the moonroof and interior courtesy light controls.
- the central locking buttons on the front door armrests, although the interior door handles would still function to allow occupants to leave the car.

Disabled features would remain disabled until the remote were used again to unlock the car.

In addition, locking an occupied vehicle would hinder rapid access to the occupants in an accident or emergency.

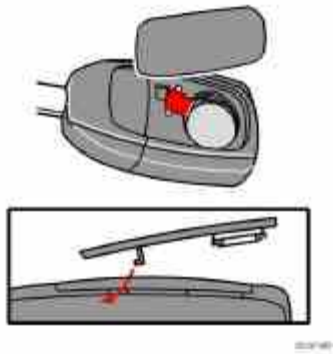

### **Replacing the battery in the remote control**

If the range of the transmitter is noticeably reduced, this indicates that the battery is weak and should be replaced.

#### **To replace the battery**

1. Carefully pry open the rear edge of the cover with a small screwdriver.
2. Insert a new 3-volt, CR2032 battery, with the battery's plus side up. Avoid touching the contact surfaces of the battery with your fingers.
3. Press the cover back into place. Ensure that the rubber seal is correctly positioned to help keep out moisture.

**Note:** The old battery should be disposed of properly at a recycling center or at your Volvo retailer.

## **Locking and unlocking**

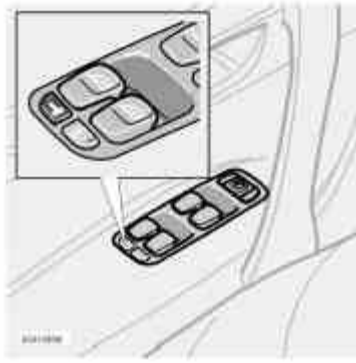

### **Locking and unlocking the car from the inside**

The switch on the driver's door armrest can be used to lock or unlock all doors and the trunk, and to set the alarm.

### **Opening/locking the trunk lid with the remote control**

Do as follows to unlock the trunk lid only:

- Press the "Open trunk" button on the remote control twice.
- Relock the trunk using the remote's "Lock" button.

If all doors are locked when you close the trunk lid, it locks automatically.



### **Unlocking the trunk lid with the master key**

The master key should only be used to unlock the trunk lid in emergencies (if the remote control is not working or the car is without power). Open the trunk lid as follows:

- Insert the master key into the upper or lower part of the plug covering the lock.
- Twist upward or downward to remove the plug.
- Unlock the trunk lid.

**NOTE:** If the trunk is opened with the master key, the alarm will sound. To turn off the alarm, unlock the driver's door with the master key.

## **Locking and unlocking (contd)**

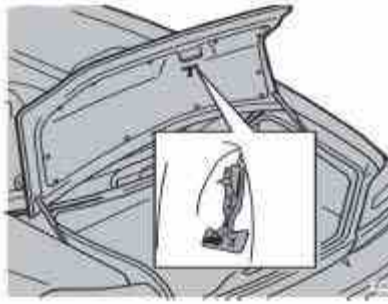

*Opening the trunk from the inside*

### **Opening the trunk from the inside (U.S. models only)**

The S60 is equipped with a fluorescent handle on the inside of the trunk lid, which can be used in an emergency situation to open the trunk from the inside. *Pull the handle down to release the trunk lid.* **After use, the handle must be pushed back into its original position** before the trunk can be closed.

This handle is not intended to be used to anchor the trunk lid when long loads are being transported.

### **⚠ WARNING!**

Keep vehicle doors and trunk locked and keep keys out of a child's reach. Unsupervised children could lock themselves in an open trunk and risk injury. Children should be taught not to play in vehicles.

On hot days, the temperature in the trunk or vehicle interior can rise very quickly.

Exposure of people to these high temperatures for even a short period of time can cause heat-related injury or death. Small children are particularly at risk.

## **Child safety lock**

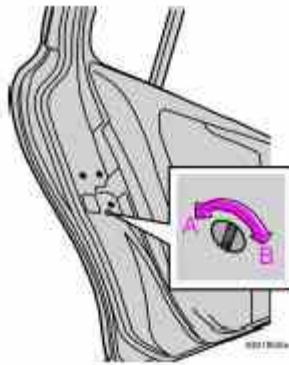

*Control for child safety lock - left rear door*

### **Manual child safety locks - rear doors**

The controls are located on the rear door jambs. Use the ignition key or a screwdriver to adjust these controls.

**A** The door cannot be opened from the inside. Normal operation from the outside.

**B** The door lock functions normally.

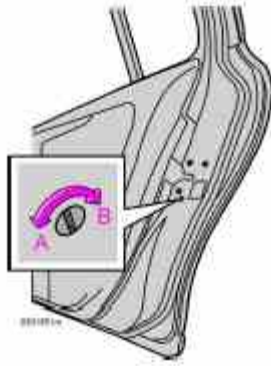

*Control for child safety lock - right rear door*

## **⚠ WARNING!**

Remember, in the event of an accident, the rear seat passengers cannot open the doors from the inside with the buttons in position A.

pg. 80 Locks and alarm

## **Alarm**

### **Alarm**

The alarm is automatically armed whenever you lock your car.

When armed, the alarm continuously monitors a number of points on the car. The following conditions will set off the alarm:

- The hood is forced open.
- The trunk is forced open.
- A door is forced open.
- The ignition switch is tampered with.
- If there is movement in the passenger compartment (if the car is equipped with the optional movement sensor).
- The car is lifted or towed (if the car is equipped with the optional inclination sensor).
- The battery is disconnected (while the alarm is armed).
- The siren is disconnected when the alarm is disarmed.

### **Arming the alarm**

Press the LOCK button on the remote control, lock the car using the key in the driver's door or press the central lock button on one of the front doors with the door open. One long flash of the turn signals will confirm that the alarm is armed.

### **Disarming the alarm**

Press the UNLOCK button on the remote control or unlock the doors with the key.

### **Turning off (stopping) the alarm**

If the alarm is sounding, it can be stopped by pressing the UNLOCK button on the remote control or by unlocking the driver's door with the key.

### **Visual alarm signal**

The visual alarm signal is given by flashing all turn signals and turning on the interior lighting for approximately 5

minutes.

### **Audible alarm signal**

An audible alarm signal is given by a battery powered siren. One alarm cycle lasts for 25 seconds.

### **"Panic" button**

In an emergency situation, this feature can be used to attract attention.

Activate the "panic" button by pressing the red button on the remote control (see illustration on [page 75](#)) for at least 3 seconds or by pressing this button twice within 3 seconds. The turn signals will flash, and the car's horn will sound.

The function can be turned off by pressing any of the buttons on the remote control or will stop automatically after 25 seconds. When a button is pressed, there is a 5 second delay before the panic alarm is deactivated.

**NOTE:** This button will NOT unlock the car.

pg. 81 Locks and alarm



### **Temporarily turning off the inclination and movement alarm sensor( s) - accessory**

This button will only be found in cars equipped with the accessory inclination and/or movement sensors.

---

FCC ID: MAYDA5823

This device complies with part 15 of the FCC rules. Operation is subject to the following conditions: (1) This device may not cause harmful interference, and (2) this device must accept any interference received, including interference that may cause undesired operation.

---

Canadian IC: 4405A-DA5823

Movement sensor DA5823 by Dynex

Operation is subject to the following conditions: (1) this device may not cause interference, and (2) this device must accept any interference, including interference that may cause undesired operation of the device.

---

In certain situations it may be desirable to turn off the optional inclination and movement alarm sensors if, for example, you drive your car onto a ferry where the rocking of the boat could trigger the alarm or if a pet is left in the car with the doors locked.

### **To temporarily turn off the inclination and movement alarm sensors from the alarm system:**

From the time the ignition key is turned from the Drive position (position II) until you lock the car, you can press the button in the center console. The LED in the switch will light up and a message will be displayed in the text window to indicate that the sensors are disconnected.

The car can then be locked in the usual way to set the alarm.

## NOTE:

- This function will not turn off the vehicle's standard alarm.
- The optional sensors are automatically reconnected to the alarm system the next time the vehicle is unlocked and then locked again.

### LED alarm status signals

The status of the alarm system is indicated by the red LED at the top of the dash:

- LED off - the alarm is not armed
- LED flashes once per second - the alarm is armed
- LED flashes rapidly before the ignition is switched on - the alarm has been triggered
- **Fault in the alarm system:** If a fault has been detected in the alarm system, a message will be displayed in the text window. Contact your Volvo retailer.

### Automatic re-lock/re-arm system

If the car is unlocked with the remote, the car will re-lock and the alarm will re-arm after 2 minutes unless a door or the trunk has been opened.

pg. 82 This page intentionally left blank.



[Contents](#) | [Top of Page](#)



# 2005 VOLVO S60

## Starting and driving

pg. 83 Starting and driving

|   |                     |
|---|---------------------|
| Engine oil                                | <a href="#">84</a>  |
| Refueling                                 | <a href="#">86</a>  |
| Starting the car                          | <a href="#">87</a>  |
| General information                       | <a href="#">89</a>  |
| Manual transmission                       | <a href="#">91</a>  |
| Automatic transmission (option)           | <a href="#">92</a>  |
| Geartronic (option)                       | <a href="#">94</a>  |
| All Wheel Drive (option)                  | <a href="#">96</a>  |
| Four-C active chassis system              | <a href="#">97</a>  |
| Brake system                              | <a href="#">98</a>  |
| Stability system                          | <a href="#">100</a> |
| Towing                                    | <a href="#">102</a> |
| Jump starting                             | <a href="#">104</a> |
| Towing a trailer                          | <a href="#">105</a> |
| Detachable trailer hitch - installing     | <a href="#">107</a> |
| Detachable trailer hitch - removing       | <a href="#">108</a> |
| Attaching load carriers                   | <a href="#">109</a> |
| Cold weather precautions                  | <a href="#">110</a> |
| Before a long distance trip               | <a href="#">111</a> |
| Front/rear park assist (option/accessory) | <a href="#">112</a> |

pg. 84 Starting and driving

## Engine Oil

Although some oil consumption occurs during normal engine operation, more oil is consumed when the engine is new as the internal parts generate higher friction while wearing-in to each other. From the time the engine is new until the first service is performed, the oil consumption could be higher than normal. For this reason, it is especially important to check the oil every time you refuel your car during this period. See [page 142](#).

### Fuel requirements

#### Octane rating

Volvo engines are designed for optimum performance on unleaded premium gasoline with an AKI octane rating of 91 or above. AKI (ANTI KNOCK INDEX) is an average of the Research Octane Number, RON, and the Motor Octane Number, MON. (RON + MON/2). The minimum octane requirement is AKI 87 (RON 91).

### **Deposit control gasoline (detergent additives)**

Volvo recommends the use of detergent gasoline to control engine deposits. Detergent gasoline is effective in keeping injectors and intake valves clean. Consistent use of deposit control gasolines will help ensure good driveability and fuel economy. If you are not sure whether the gasoline contains deposit control additives, check with the service station operator.

**NOTE:** Volvo does not recommend the use of external fuel injector cleaning systems.

### **Unleaded fuel**

Each Volvo has a three-way catalytic converter and must use only unleaded gasoline. U.S. and Canadian regulations require that pumps delivering unleaded gasoline be labelled "UNLEADED". Only these pumps have nozzles which fit your car's filler inlet. It is unlawful to dispense leaded fuel into a vehicle labeled "unleaded gasoline only". Leaded gasoline damages the three-way catalytic converter and the heated oxygen sensor system. Repeated use of leaded gasoline will lessen the effectiveness of the emission control system and could result in loss of emission warranty coverage. State and local vehicle inspection programs will make detection of misfueling easier, possibly resulting in emission test failure for misfueled vehicles.

**NOTE:** Some U.S. and Canadian gasolines contain an octane enhancing additive called methyl-cyclopentadienyl manganese tricarbonyl (MMT). If such fuels are used, your Emission Control System performance may be affected, and the Check Engine Light (malfunction indicator lamp) located on your instrument panel may light. If this occurs, please return your vehicle to an authorized Volvo retailer for service.

### **Gasoline containing alcohol and ethers**

"Oxygenated fuels"

Some fuel suppliers sell gasoline containing "oxygenates" which are usually alcohols or ethers. In some areas, state or local laws require that the service pump be marked indicating use of alcohols or ethers. However, there are areas in which the pumps are unmarked. If you are not sure whether there is alcohol or ethers in the gasoline you buy, check with the service station operator. To meet seasonal air quality standards, some areas require the use of "oxygenated" fuel.

Volvo allows the use of the following "oxygenated" fuels; however, the octane ratings listed on this page must still be met.

Alcohol - Ethanol: Fuels containing up to 10% ethanol by volume may be used. Ethanol may also be referred to as Ethyl alcohol, or "Gasohol".

Ethers - MTBE: Fuels containing up to 15% MTBE may be used.

pg. 85 Starting and driving

### **Carbon Monoxide - Important Warning**

Carbon monoxide is a poisonous, colorless, and odorless gas. It is present in all exhaust gases. If you ever smell exhaust fumes inside the vehicle, make sure the passenger compartment is ventilated, and immediately return the vehicle to your retailer for correction.

### **Fuel Formulations**

Do not use gasoline that contains lead as a knock inhibitor, and do not use lead additives. Besides damaging the exhaust emission control systems on your car, lead has been strongly linked to certain forms of cancer. Many fuels contain benzene as a solvent. Unburned benzene has been strongly linked to certain forms of cancer. If you live in an area where you must fill your own gas tank, take precautions. These may include:

- standing upwind away from the filler nozzle while refueling
- refueling only at gas stations with vapor recovery systems that fully seal the mouth of the filler neck during refueling

- wear neoprene gloves while handling a fuel filler nozzle.

### Use of Additives

With the exception of gas line antifreeze during winter months, do not add solvents, thickeners, or other store-bought additives to your car's fuel, cooling, or lubricating systems. Overuse may damage your engine, and some of these additives contain organically volatile chemicals. Do not needlessly expose yourself to these chemicals.

### **⚠ WARNING!**

Never carry a cell phone that is **switched on** while refueling your vehicle. If the phone rings, this may cause a spark that could ignite gasoline fumes, resulting in fire and injury.

pg. 86 Starting and driving



### Fuel filler door

Press the button on the light switch panel (see illustration on [page 34](#)) when the car is at a standstill to unlock the fuel filler door. Please note that the fuel filler door will remain unlocked until the car begins to move forward. An audible click will be heard when the fuel filler door relocks.

If you intend to leave your car while it is being refueled, this feature enables you to lock the doors/trunk while leaving the fuel filler door unlocked.

You can also keep the car locked if you remain inside during refueling. The central locking button does not lock the fuel filler door. Be sure the fuel filler door is not obstructed and is completely closed after refueling.

### Open the fuel filler cap slowly during hot weather.

**NOTE:** During a transitional period, a small number of service stations may still have fuel nozzles that are not compatible with the fuel filler neck on cars equipped with the evaporative control system.

### Refueling

The fuel tank holds approximately:

**Front wheel drive:** 18.5 US gals (70 liters)

**All turbo models:** 18 US gals (68 liters)

with sufficient volume left over to accommodate possible expansion of the fuel in hot weather. Be aware that the "usable" tank capacity will be somewhat less than the specified maximum. When the fuel level is low, such factors as ambient temperature, the fuel's "Reid vapor pressure" characteristics, and terrain can affect the fuel pump's ability to supply the engine with an adequate supply of fuel. Therefore, it is advisable to refuel as soon as possible when the needle nears the red zone, or when the fuel warning light comes on.

---

### CAUTION:

Do not refuel with the engine running \*. Turn the ignition off or to position I. If the ignition is on, an incorrect reading could occur in the fuel gauge

After refueling, close the fuel filler cap by turning it clockwise until it clicks into place\*.

Allow for fuel expansion by not overfilling the tank. Overfilling could also cause damage to the emission control systems. Avoid spilling gasoline during refueling. In addition to causing damage to the environment, gasolines containing alcohol can cause damage to painted surfaces, which may not be covered under the New Vehicle Limited Warranty.

Do not use gasolines containing methanol (methyl alcohol, wood alcohol). This practice can result in vehicle performance deterioration and can damage critical parts in the fuel system. Such damage may not be covered under the New Vehicle Limited Warranty.

---

\* If the fuel filler cap is not closed tightly or if the engine is running when the car is refueled, the Check Engine Light (malfunction indicator lamp) may indicate a fault. However, your vehicle's performance will not be affected. Use only Volvo original or approved fuel filler caps.

pg. 87 Starting and driving

## Starting the car

### Starting the engine

1. Fasten the seat belt.

#### **WARNING!**

Before starting, check that the seat, steering wheel and mirrors are adjusted properly. Make sure the brake pedal can be depressed completely. Adjust the seat if necessary. See [pages 60, 62](#).

2. Apply the parking brake (hand brake) if not already set. The gear selector (automatic transmission) is locked in the (P)ark position (**SHIFTLOCK**).

Manual transmission: the clutch must be fully depressed.

3. Without touching the accelerator pedal, turn the ignition key\* to the starting position. Allow the starter to operate for up to 10 seconds. Release the key as soon as the engine starts. If the engine fails to start, repeat this step.

**NOTE:** On certain models, when the car is started, idle speed may be noticeably higher than normal for a short period, depending on the temperature of the engine. This has been done to help bring components in the emission control system to their normal operating temperature as quickly as possible, which enables them to function normally.

For cold starts at altitudes above 6000 ft (1800 meters), depress the accelerator pedal halfway and turn the key to the starting position. Release the pedal slowly when the engine starts.

4. To release the gear selector from the (P)ark position, the engine must be running (or the ignition key must be in position II) and the brake pedal must be depressed.

5. Select the desired gear. The gear engages after a very slight delay which is especially noticeable when selecting R.

**NOTE:** Your car is equipped with a **KEYLOCK** system (automatic transmission). When the engine is switched off, the gear selector must be in the (P)ark position before the key can be removed from the ignition switch.

When starting in cold weather, the transmission may shift up at slightly higher engine speeds than normal until the automatic transmission fluid reaches normal operating temperature.

---

## CAUTION:

### Automatic transmission

The engine should be idling when you move the gear selector. Never accelerate until after you feel the transmission engage! Accelerating immediately after selecting a gear will cause harsh engagement and premature transmission wear. Selecting **P** or **N** when idling at a standstill for prolonged periods of time will help prevent overheating of the automatic transmission fluid.

### WARNING!

Always place the gear selector in Park or in reverse on models with a manual transmission, and apply the parking brake before leaving the vehicle. Never leave the car unattended with the engine running. Always open garage doors fully before starting the engine inside a garage to ensure adequate ventilation. The exhaust gases contain carbon monoxide, which is invisible and odorless but very poisonous

Do not race a cold engine immediately after starting.

\* If two of the keys to your car are close together, e.g., on the same key ring, when you try to start the car, this could cause interference in the immobilizer system and result in the car not starting. If this should occur, remove one of the keys from the key ring before trying to start the car again.

pg. 88 Starting and driving

## Starting the car (contd)

### Ignition switch and steering wheel lock

#### **0 - Locked position:**

Remove the key to lock the steering wheel\*.

### WARNING!

Never turn the key to position O while driving or when the car is being towed.

#### **I - Intermediate position\*\* - "radio position":**

Certain accessories, radio, etc. on, daytime running lights off.

**II - Drive position:** The key position when driving. The car's entire electrical system is connected.

**III - Start position:** Release the key when the engine starts. The key returns automatically to the Drive position.

**A chime will sound if the key is left in the ignition and the driver's door is opened.**



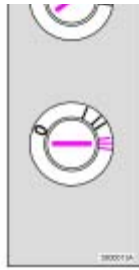

### Steering wheel lock

The steering wheel lock might be under tension when the car is parked. Turn the steering wheel slightly to free the ignition key.

**In order to help reduce car theft, make sure the steering wheel lock is engaged before leaving the car.**

#### **⚠ WARNING!**

Never switch off the ignition (turn the ignition key to position 0) or remove the key from the ignition switch while the car is in motion. This could cause the steering wheel to lock, which would make the car impossible to steer

\* The gear selector must be in the **(P)**ark position (automatic transmission).

\*\* Please be aware that leaving the key in this position will increase battery drain.

pg. 89 Starting and driving

## General information

### Economical driving conserves natural resources

Better driving economy may be obtained by thinking ahead, avoiding rapid starts and stops and adjusting the speed of your vehicle to immediate traffic conditions. Observe the following rules:

- Bring the engine to normal operating temperature as soon as possible by driving with a light foot on the accelerator pedal for the first few minutes of operation. A cold engine uses more fuel and is subject to increased wear.
- Whenever possible, avoid using the car for driving short distances. This does not allow the engine to reach normal operating temperature.
- Drive carefully and avoid rapid acceleration and hard braking.
- Do not exceed posted speed limits.
- Avoid carrying unnecessary items (extra load) in the car.
- Maintain correct tire pressure. Check tire pressure regularly (when tires are cold).
- Remove snow tires when threat of snow or ice has ended.
- Note that roof racks, ski racks, etc, increase air resistance and also fuel consumption.
- Avoid using automatic transmission kickdown feature unless necessary.
- However, at higher driving speeds, fuel consumption will be lower with the air conditioning on and the windows closed than with the air conditioning off and the windows open.
- Using the onboard trip computer's fuel consumption modes can help you learn how to drive more economically.

### Other factors that decrease gas mileage are:

- Dirty air cleaner
- Dirty engine oil and clogged oil filter
- Dragging brakes
- Incorrect front end alignment

Some of the above mentioned items and others are checked at the standard Maintenance Service intervals.

**NOTE:** Vehicles equipped with automatic transmissions should use **(D)**rive as often as possible and avoid using "kickdown" to help improve fuel economy.

 **WARNING!**

**Driving with the trunk open:** Driving with the trunk open could lead to poisonous exhaust gases entering the passenger compartment.

If the trunk must be kept open for any reason, proceed as follows

- Close the windows
- Set the ventilation system control to air flow to floor, windshield and side windows and blower control to its highest setting.

**CAUTION:** Drive slowly and carefully if going through standing water (i.e. flooded roadways, etc.). Damage to the engine could result if excess water is drawn in through the air intake system. Never drive the vehicle in water deeper than 1 foot (300 mm).

pg. 90 Starting and driving

## General information (contd)

### Weight distribution affects handling

At the specified curb weight your car has a tendency to understeer, which means that the steering wheel has to be turned more than might seem appropriate for the curvature of a bend.

This ensures good stability and reduces the risk of rear wheel skid. Remember that these properties can alter with the vehicle load.

The heavier the load in the trunk (max. 220 lbs, 100 kg), the less the tendency to understeer.

### Handling, roadholding

Vehicle load, tire design and inflation pressure all affect vehicle handling. Therefore, check that the tires are inflated to the recommended pressure according to the vehicle load. See "Tire pressure" section.

Loads should be distributed so that capacity weight or maximum permissible axle loads are not exceeded.

### Speed-sensitive power steering

(Option on certain models)

With this feature, the steering is most responsive at lower speeds to make parking, driving in city traffic, etc, easier. The effect of the power steering diminishes as you accelerate for greater stability at highway speeds.

pg. 91 Starting and driving

## Manual transmission



### 5-speed manual transmission

Depress the clutch pedal completely when changing gears\*.

Remove your foot from the clutch pedal while driving. The shift pattern should be followed.

Overdrive (5th gear) should be used as often as possible to help improve fuel economy.

#### \* Clutch interlock

The clutch must be fully depressed before you can start your car. If the clutch is not depressed, it will not be possible to start the engine.



### 6-speed manual transmission

(option on certain models)

Fifth and sixth gears should be used as often as possible to help improve fuel economy.

#### **⚠ WARNING!**

An extra mat on the driver's floor can cause the accelerator pedal and/or the clutch pedal to catch. Check that the movement of these pedals is not impeded. Not more than one protective floor covering may be used at one time.





## Engaging reverse gear

Never engage R while the car is moving.

## CAUTION:

Be careful to avoid inadvertently engaging reverse while moving forward.

pg. 92 Starting and driving

## Automatic transmission (option)

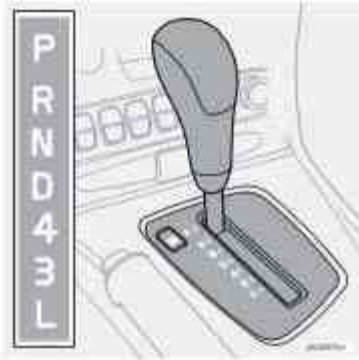

### Automatic transmission AW55- 50 (option)

#### **P Park**

Use this position when starting the engine or parking the car.

Never use **P** while the car is in motion.

The parking brake should be set whenever the car is parked.

The gear selector is mechanically locked in the **P** position (SHIFTLOCK). To release the gear selector from this position, the engine must be running (or the ignition key must be in position II) and the brake pedal must be depressed.

## **⚠ WARNING!**

Never leave the car unattended when the engine is running. If, by mistake, the gear selector is moved from **P**, the car may start moving.

#### **R (Reverse)**

Never engage **R** while the car is moving.

#### **N (Neutral)**

Neutral - no gear engaged. Use the parking brake.

#### **D (Drive)**

**D** is the normal driving position and should be used as often as possible to help improve fuel economy. The car should not be moving when shifting from **R** to the **D** position.

#### **4 (Intermediate gear)**

The transmission will shift automatically between gears 4, 3, 2 or 1 from this position. The transmission cannot shift up to (**D**)rive from fourth gear.

#### **3 (Intermediate gear)**

The transmission will shift automatically between gears 3, 2 and 1 from this position. The transmission cannot shift up to fourth gear or **(D)**rive from third gear.

### **L (Low gears)**

The transmission is locked in gears 1 and 2 when the selector is in this position.

**NOTE:** Gears 4, 3, or L can be used if you are driving in a mountainous area, towing a trailer or to increase engine braking effect.

The transmission has a built-in limiter designed to help prevent excessive engine speeds (high rpm) when gears 4, 3 or L are selected.

pg. 93 Starting and driving



### **W - Winter/Wet driving mode - enhanced vehicle traction**

- Mode W will only function if the gear selector is in the **(D)**rive position.
- Press the button at the base of the gear selector to engage/disengage this driving mode (see illustration).
- When the W driving mode is engaged, this is displayed in the instrument panel (see [page 26](#)).
- This mode may be selected for starting/moving off on slippery roads.

**NOTE:** R-models are not equipped with this button.

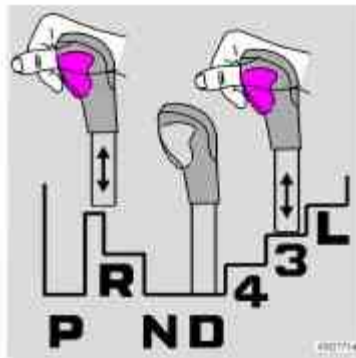

### **Automatic transmission AW55- 50 - shift gate positions**

The gear selector can be moved freely between **N** and **D**.

Depressing the button on the front of the gear selector knob enables you to move the gear selector to positions P, R, N, D, 4, 3 and L.

### **"Kickdown"**

Automatic shift to a lower gear (kickdown) is achieved by depressing the accelerator pedal fully and briskly. An upshift will occur when approaching the top speed for a particular gear or by releasing the accelerator pedal slightly.

Kickdown can be used for maximum acceleration or when passing at highway speeds.

### **Automatic transmission - adaptive system**

The automatic transmission is controlled by an adaptive system that constantly monitors the way in which the transmission functions. It senses and adapts each gear shift for optimal performance.

### **Cold starts**

When driving before the engine has reached its normal operating temperature, the transmission will shift up at a slightly higher engine speeds to heat the three-way catalytic converter as quickly as possible.

pg. 94 Starting and driving

## **Geartronic (option)**



### **P Park**

Use this position when starting the engine or parking the car.

**Never use P while the car is in motion.**

The parking brake should also be set whenever the car is parked.

**The gear selector is mechanically locked in the P position (SHIFTLOCK).** To release the gear selector from this position, the engine must be running (or the ignition key must be in position II) and the brake pedal must be depressed.

### **⚠ WARNING!**

Never leave the car unattended when the engine is running. If, by mistake, the gear selector is moved from P, the car may start moving.

### **R (Reverse)**

Never engage **R** while the car is moving.

### **N (Neutral)**

Neutral - no gear engaged. Use the parking brake.

### **D (Drive)**

D is the normal driving position and should be used as often as possible to help improve fuel economy. The car should not be moving when shifting from **R** to the **D** position.

### **Automatic transmission - adaptive system**

The automatic transmission is controlled by an adaptive control system that constantly monitors the way in which the transmission functions. It senses and adapts each gear shift for optimal performance. The system also monitors your particular driving style and adapts gear shifting accordingly.

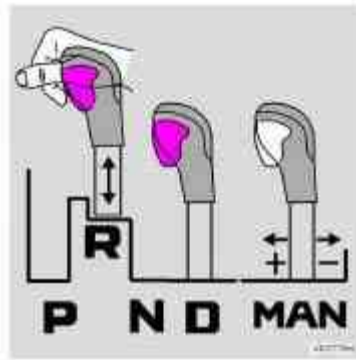

### Automatic transmission - shift gate positions

You can move the gear selector freely between the (MAN)ual and (D)rive positions while driving.

Depress the button on the front of the gear selector knob to move between the R, N, D, and P positions.

pg. 95 Starting and driving

### Manual shifting - Geartronic

You can move the gear selector freely between the (MAN)ual and (D)rive positions while driving. Gears 3, 4 and 5 have a "lock-up" function which reduces engine speed and helps save fuel.

The currently selected gear will be displayed in the instrument panel (see [page 26](#)).

- To access the (MAN)ual shifting position from (D)rive, move the gear selector to the left to **MAN**.
- To return to the (D)rive position from **MAN**, move the gear selector to the right.

### While driving

If you select the (MAN)ual position while driving, the gear that was being used in the (D)rive position will also initially be selected in (MAN)ual position.

- Move the gear selector forward (toward "+") to shift to a higher gear or rearward (toward "-") to shift to a lower gear.
- If you hold the gear selector toward "-", the transmission will downshift one gear and will utilize the braking power of the engine. If the current speed is too high for using a lower gear, the downshift will not occur until the speed has decreased enough to allow the lower gear to be used.
- If you slow down to a very low speed, the transmission will automatically shift down.
- When starting in the (MAN)ual position, 3rd gear is the highest gear that may be selected.

**NOTE:** Kickdown does not function when the transmission is in the manual shift (Geartronic) mode. The gear selector must be in the D(Drive) position.

### Kickdown

Automatic shift to a lower gear (kickdown) is achieved by depressing the accelerator pedal fully and briskly. An upshift will occur when approaching the top speed for a particular gear or by releasing the accelerator pedal slightly. Kickdown can be used for maximum acceleration or when passing at highway speeds.

**Kickdown does not function when the transmission is in the manual shift (Geartronic) mode.**

**W - Winter/Wet driving mode - enhanced vehicle traction**

Please refer to the information on [page 93](#).



### **Sport mode** (R-models only)

R-models are equipped with a (S)port button that can be used to engage/disengage the Sport shifting mode. An indicator light in the button will go on when Sport mode is engaged.

With Sport mode engaged, the transmission will shift up at higher rpm in first and second gears, and will also shift down at higher rpm for more immediate engine response during acceleration and deceleration.

pg. 96 Starting and driving

## **All Wheel Drive (option)**

### **All Wheel Drive (AWD) - general information**

Your Volvo can be equipped with permanent All Wheel Drive, which means that power is distributed automatically between the front and rear wheels. Under normal driving conditions, most engine's power is directed to the front wheels. However, if there is any tendency for the front wheels to spin, an electronically controlled coupling distributes power to the wheels that have the best traction.

### **Tire dimensions**

Volvo recommends that you always drive on tires of the same brand, size, construction (radial), tread pattern, load-, speed-, traction-, temperature-, and treadwear rating. Never drive on mixed tires, except for brief periods when the temporary spare tire is in use.

Always use properly inflated tires of correct dimensions. Tire size and inflation pressures are shown on the tire inflation pressure placards, located on the driver's side B-pillar (the structural member at the side of the vehicle, at the rear of the driver's door opening), or on the inside of the fuel filler door on Canadian models.

### **Temporary Spare**

The temporary spare tire is for temporary, low-speed, short-distance use only. Replace it with a full-size tire as soon as possible. Do not drive on the temporary spare at speeds above 50 mph (80 km/h) or for distances greater than 50 miles (80 km.)

Never install snow chains on a temporary spare.

pg. 97 Starting and driving

## **Four-C active chassis system**

### **Four-C active chassis**

The FOUR-C (Continuously Controlled Chassis Concept) active chassis system, consisting of Comfort and Sport modes, is available as an option.

**NOTE:**

The S60 R has a standard FOUR-C system consisting of Comfort, Sport, and Advanced sport modes. The buttons for controlling these driving modes are located in center instrument panel, above the ventilation system panel vents, see the illustration below. These buttons can be pressed at any time to change driving modes. An indicator light in the selected button will come on to indicate the driving mode that is currently selected.

This system is based on a number of sensors that continuously monitor factors such as the car's lateral and vertical movements, speed, and movements of the wheels. The sensors receive data up to 500 times per second, which is used to provide extremely fast and precise adjustment of each shock absorber. The system adjusts the stiffness of the shock absorbers approximately 100 times per second.



Use the button in the center console to switch between the driving modes Comfort and Sport. This can be done at any time.

**Comfort**

The Comfort mode chassis setting offers the greatest amount of shock absorption and the softest ride. This mode is recommended for long-distance driving, or when driving in slippery conditions. The indicator light in the button will be off when this mode is selected.

If Comfort mode was selected when the engine was switched off, this mode will still be active when the engine is restarted.

**Sport**

In this mode, shock absorption is stiffer to reduce the car's body sway during cornering and to provide more immediate steering response. The indicator light in the button will come on to indicate that Sport mode has been selected.

If this setting was selected when the engine was switched off, Sport mode will still be active when the engine is restarted.

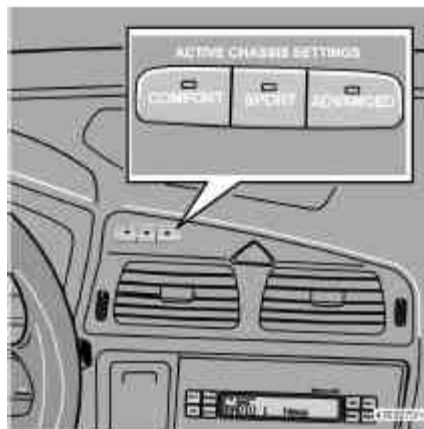

*S60 R buttons on the dashboard*

**Advanced Sport (S60R only)**

In this mode, movement of the shock absorbers is minimal, response from pressure on the throttle pedal is more direct, and body sway in curves or when cornering is sharply reduced.

If **Advanced sport mode** was selected when the engine was switched off, **Sport mode** will be active when the engine is restarted.

## Brake system

### **BRAKE Brake circuit malfunction**

The brake system is a hydraulic system consisting of two master cylinders and two separate brake circuits. If a problem should occur in one of these circuits, it is still possible to stop the car with the other brake circuit.

If the brake pedal must be depressed farther than normal and requires greater foot pressure, the stopping distance will be longer.

A warning light in the instrument panel will light up to warn the driver that a fault has occurred.

If this light comes on while driving or braking, stop immediately and check the brake fluid level in the reservoir.

**NOTE:** Press the brake pedal hard and maintain pressure on the pedal - do not pump the brakes.

### **WARNING!**

If the fluid level is below the MIN mark in the reservoir or if a "Brake failure - Service urgent" message is displayed in the text window: **DO NOT DRIVE.** Have the car towed to a Volvo retailer and have the brake system inspected.

**NOTE:** When the car is at a standstill and the engine is idling, e.g. at a traffic light and the brake pedal is depressed, the pedal may go down slightly. This is a normal function of the power-assisted brake system.

### **Power brakes function only when the engine is running**

The power brakes utilize vacuum pressure which is only created when the engine is running. Never let the vehicle roll to a stop with the engine switched off.

If the power brakes are not working, the brake pedal must be pressed approximately four times harder than usual to make up for the lack of power assistance. This can happen for example when towing your vehicle or if the engine is switched off when the vehicle is rolling. The brake pedal feels harder than usual.

### **Water on brake discs and brake pads affects braking**

Driving in rain and slush or passing through an automatic car wash can cause water to collect on the brake discs and pads. This will cause a delay in braking effect when the pedal is depressed. To avoid such a delay when the brakes are needed, depress the pedal occasionally when driving through rain, slush etc. This will remove the water from the brakes. Check that brake application feels normal. This should also be done after washing or starting in very damp or cold weather.

### **Severe strain on the brake system**

The brakes will be subject to severe strain when driving in mountains or hilly areas or towing. Vehicle speed is usually slower, which means that the cooling of the brakes is less efficient than when driving on level roads. To reduce the strain on the brakes, shift into a lower gear and let the engine help with the braking. Do not forget that, if you are towing a trailer, the brakes will be subjected to a greater than normal load.



### **Anti-lock brakes (ABS)**

If the warning lamp lights up there is a malfunction of the ABS system (the standard braking system will however function) and the vehicle should be driven cautiously to a Volvo retailer for inspection. The Anti-lock Braking System

(ABS) helps to improve vehicle control (stopping and steering) during severe braking conditions by limiting brake lockup. When the system "senses" impending lockup, braking pressure is automatically modulated in order to help prevent lockup, which could lead to a skid.

**The system performs a self-diagnostic test when the engine is started and when the vehicle first reaches a speed of approximately 12 mph (20 km/h).** The brake pedal will pulsate several times and a sound may be audible from the ABS control module. This is normal.

To obtain optimal effect from the ABS system, constant pressure should be kept on the brake pedal. Do not pump the brake pedal.

The switching of the ABS modulator will be audible and the brake pedal will pulsate during braking. Please be aware that ABS does not increase the absolute braking potential of the vehicle. While control will be enhanced, ABS will not shorten stopping distances on slippery surfaces.

### **ABS with EBD (Electronic Brake Force Distribution)**

EBD is an integrated part of the ABS system. EBD regulates the hydraulic pressure to the rear brakes to help provide optimal braking capacity. The brake pedal will pulsate during braking, which is normal.

If the BRAKE and ABS warning lights come on at the same time, this could indicate a fault in the brake system.

- Stop the car in a suitable place and switch off the engine.
- Restart the engine.
- If both warning lights go off, no further action is required.
- If both lights are still on after the engine has been restarted, switch off the engine again and check the brake fluid level (see [page 140](#) for the location of the brake fluid reservoir).

#### **WARNING!**

If the fluid level is below the MIN mark in the reservoir or if a "Brake failure - Service urgent" message is displayed in the text window: **DO NOT DRIVE**. Have the car towed to a Volvo retailer and have the brake system inspected.

- If the brake fluid level is above the MIN mark, drive carefully to an authorized Volvo retailer and have the brake system inspected.





# 2005 VOLVO S60

## Wheels and tires

pg. 113 Wheels and tires

|   |                     |
|---|---------------------|
| General information   | <a href="#">114</a> |
| Tire inflation pressure tables  | <a href="#">117</a> |
| Tire Pressure Monitoring System (TPMS) - option on certain U.S. models only | <a href="#">118</a> |
| Changing tires  | <a href="#">119</a> |
| Tire designations   | <a href="#">120</a> |
| Glossary of tire terminology  | <a href="#">121</a> |
| Vehicle loading   | <a href="#">122</a> |
| Uniform Tire Quality Grading  | <a href="#">123</a> |
| Snow chains, snow tires, studded tires                                      | <a href="#">124</a> |
| Temporary Spare   | <a href="#">125</a> |
| Changing wheels   | <a href="#">126</a> |

pg. 114 Wheels and tires

## General information

Your vehicle is equipped with tires according to the vehicle's tire information placard on the B-pillar (the structural member at the side of the vehicle, at the rear of the driver's door opening), or on the inside of the fuel filler door on Canadian models.

The tires have good road holding characteristics and offer good handling on dry and wet surfaces. It should be noted however that the tires have been developed to give these features on snow/ice-free surfaces.

Certain models are equipped with "all-season" tires, which provide a somewhat higher degree of road holding on slippery surfaces than tires without the "all-season" rating. However, for optimum road holding on icy or snow-covered roads, we recommend suitable winter tires on all four wheels.

When replacing tires, be sure that the new tires are the same size designation, type (radial) and preferably from the same manufacturer, on all four wheels. Otherwise there is a risk of altering the car's roadholding and handling characteristics.

**NOTE:** When storing wheel/tire assemblies (e.g. winter tires and wheels), either stand the assemblies upright, or suspend them off the ground. Laying wheel/tire assemblies on their sides for prolonged periods can cause wheel and/or tire damage.

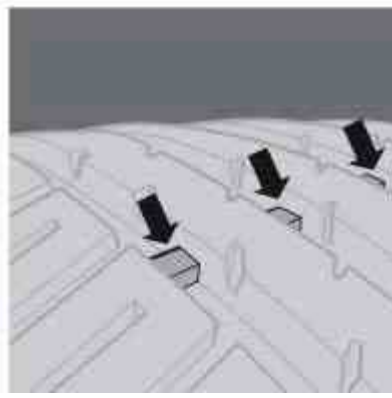

### Tread wear indicator

The tires have wear indicator strips running across or parallel to the tread. The letters TWI are printed on the side of the tire. When approximately 1/16" (1.6 mm) is left on the tread, these strips become visible and indicate that the tire should be replaced. Tires with less than 1/16" (1.6 mm) tread offer very poor traction.

When replacing worn tires, it is recommended that the tire be identical in type (radial) and size as the one being replaced. Using a tire of the same make (manufacturer) will prevent alteration of the driving characteristics of the vehicle.

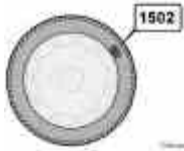

### — New tires

Remember that tires are perishable goods. As of 2000, the manufacturing week and year will be indicated with 4 digits (e.g. 1502 means that the tire illustrated was manufactured during week 15 of 2002).

### Improving tire economy:

- Maintain correct tire pressure. See the tire pressure table on [page 117](#).
- Drive smoothly: avoid fast starts, hard braking and tire screeching.
- Tire wear increases with speed.
- Correct front wheel alignment is very important.
- Unbalanced wheels impair tire economy and driving comfort.
- Tires must maintain the same direction of rotation throughout their lifetime.
- When replacing tires, the tires with the most tread should be mounted on the rear wheels to reduce the chance of oversteer during hard braking. Hitting curbs or potholes can damage the tires and/or wheels permanently.

pg. 115 Wheels and tires



*Tire inflation placards on US models*

## Tire inflation

Check tire inflation pressure regularly. A table listing the recommended inflation pressure for your vehicle can be found on [page 117](#). Tire inflation pressure placards are also located on the driver's side B-pillar (the structural member at the side of the vehicle, at the rear of the driver's door opening), or on the inside of the fuel filler door on Canadian models. These placards indicate the designation of the factory-mounted tires on your vehicle, as well as load limits and inflation pressure.

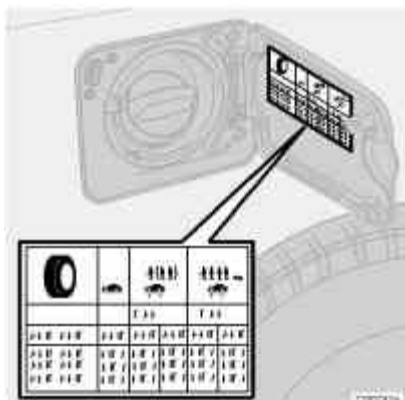

*Tire inflation placard on Canadian models*

**NOTE:** The placards shown indicate inflation pressure for the tires installed on the car at the factory only.

- Use a tire gauge to check the tire inflation pressure, including the spare, at least once a month and before long trips. You are strongly urged to buy a reliable tire pressure gauge, as automatic service station gauges may be inaccurate.
- Use the recommended cold inflation pressure for optimum tire performance and wear.
- Under-inflation or over-inflation may cause uneven treadwear patterns.

### **⚠ WARNING!**

- Under-inflation is the most common cause of tire failure and may result in severe tire cracking, tread separation, or "blowout," with unexpected loss of vehicle control and increased risk of injury.
- Under-inflated tires reduce the load carrying capacity of your vehicle.

When weather temperature changes occur, tire inflation pressures also change. A 10-degree temperature drop causes a corresponding drop of 1 psi (7 kPa) in inflation pressure. Check your tire pressures frequently and adjust them to the proper pressure, which can be found on the vehicle's tire information placard or certification label.

## Checking tire pressure

### Cold tires

Inflation pressure should be checked when the tires are cold.

**The tires are considered to be cold when they have the same temperature as the surrounding (ambient) air.**

This temperature is normally reached after the car has been parked for at least 3 hours.

### pg. 116 Wheels and tires

After driving a distance of approximately 1 mile (1.6 km), the tires are considered to be hot. If you have to drive farther than this distance to pump your tire(s), check and record the tire pressure first and add the appropriate air pressure when you get to the pump.

If checking tire pressure when the tire is hot, never "bleed" or reduce air pressure. The tires are hot from driving and it is normal for pressures to increase above recommended cold pressures. A hot tire at or below recommended cold inflation pressure could be significantly under-inflated.

### To check inflation pressure:

1. Remove the cap from the valve on one tire, then firmly press the tire gauge onto the valve.

2. Add air to reach the recommended air pressure.
3. Replace the valve cap.
4. Repeat this procedure for each tire, including the spare.
5. Visually inspect the tires to make sure there are no nails or other objects embedded that could puncture the tire and cause an air leak.
6. Check the sidewalls to make sure there are no gouges, cuts, bulges or other irregularities.

**NOTE:**

- If you overfill the tire, release air by pushing on the metal stem in the center of the valve. Then recheck the pressure with your tire gauge.
- Some spare tires require higher inflation pressure than the other tires. Consult the tire inflation table on [page 117](#) or see the inflation pressure placard.

pg. 117 Wheels and tires

**Tire inflation pressure tables**

Tire pressures recommended by Volvo for your vehicle. Refer to the tire inflation placard for information specific to the tires installed on your vehicle at the factory.

| Cold tire pressure for vehicle loads up to 890 lbs (400 kg) <sup>a</sup> |                  |                 |
|--|------------------|-----------------|
| Tire size  | Front, psi (kPa) | Rear, psi (kPa) |
| <b>S60</b>   |                  |                 |
| 195/65R15  |                  |                 |
| 205/55R16  |                  |                 |
| 215/55R16  | 38 (260)         | 38 (260)        |
| 235/45R17  |                  |                 |
| 235/45R17 SSRFT <sup>b</sup>   |                  |                 |
| 235/40R18  | 39 (270)         | 39 (270)        |
| Temporary spare tire   |                  |                 |
| T125/80R17   | 61 (420)         | 61 (420)        |
| <b>S60 R</b>   |                  |                 |
| 235/45R17  |                  |                 |
| 235/40R18  | 39 (270)         | 39 (270)        |
| Temporary spare tire   |                  |                 |
| T115/85R18   | 61 (420)         | 61 (420)        |

- a. These weights include the weight of all occupants of the car plus cargo.
- b. Self supporting run flat tires. See [page 119](#) for more information.

Optional tire pressure. These inflation pressures may only be used when the vehicle is not fully loaded.

| Optional cold tire pressure that may only be used for vehicle loads up to 495 lbs (225 kg). |                  |                 |
|---|------------------|-----------------|
| Tire size   | Front, psi (kPa) | Rear, psi (kPa) |
| <b>S60</b>  |                  |                 |
| 195/65R15   |                  |                 |
| 205/55R16   | 32 (220)         | 30 (210)        |
| 215/55R16   |                  |                 |
| 235/45R17   |                  |                 |
| 235/45R17 RFT (SST)   | -                | -               |
| Temporary spare tire  |                  |                 |
| T125/80R17  | 61 (420)         | 61 (420)        |
| <b>S60 R</b>  |                  |                 |
| 235/45R17   |                  |                 |
| 235/40R18   | 35 (240)         | 35 (240)        |
| Temporary spare tire  |                  |                 |
| T115/85R18  | 61 (420)         | 61 (420)        |

### Tire Pressure Monitoring System (TPMS) - option on certain U.S. models only

The tire pressure monitoring system uses sensors mounted in the tire valves to check inflation pressure levels. When the vehicle is moving at a speed of 20 mph (30 km/h) or faster, these sensors transmit inflation pressure data to a receiver located in the vehicle.

USA - FCC ID: MRXTG315AM04

This device complies with part 15 of the FCC rules. Operation is subject to the following conditions: (1) This device may not cause harmful interference, and (2) this device must accept any interference received, including interference that may cause undesired operation.

When low inflation pressure is detected, TPMS will light up the tire pressure warning light (  ) in the instrument panel, and will display a message in the text window. The wording of this message is determined by the degree of inflation pressure loss.

When the tire pressure monitoring system warning light is on, one or more of your tires is significantly under-inflated. You should stop and check your tires as soon as possible, and inflate them to the proper pressure as indicated on the vehicle's tire information placard.

Driving on a significantly under-inflated tire causes the tire to overheat and can lead to tire failure. Under-inflation also reduces fuel efficiency and tire tread life, and may affect the vehicle's handling and stopping ability. Each tire, including the spare, should be checked monthly when cold and set to the recommended inflation pressure as specified in the vehicle placard and owner's manual.

**NOTE:** TPMS indicates low tire pressure but does not replace normal tire maintenance. For information on correct tire pressure, please refer to the table on [page 117](#), or consult your Volvo retailer.

### Erasing warning messages

When a low tire pressure warning message has been displayed, and the tire pressure warning light has come on:

1. Use a tire pressure gauge to check the inflation pressure of all four tires.
2. Re-inflate the tire(s) to the correct pressure (consult the tire pressure placard or the table on [page 117](#)).
3. Drive the car for at least one minute at a speed of 20 mph (30 km/h) or faster.

This will erase the warning text and the warning light will go out.

 **WARNING!**

Incorrect inflation pressure could lead to tire failure, resulting in a loss of control of the vehicle.

pg. 119 Wheels and tires

### Changing tires

Please note the following when changing or replacing the factory installed TPMS wheels/tires on the vehicle: Only the factory-mounted wheels are equipped with TPMS sensors in the valves.

If the vehicle is equipped with a temporary spare tire, this tire does not have a TPMS sensor.

If, for example, winter wheels/tires are used that are not equipped with TPMS sensors, the message TIRE PRESSURE SYSTEM SERVICE REQUIRED will be displayed after the car has been driven for several minutes at approximately 35 mph (50 km/h) or faster.

This message will remain on until wheels with TPMS sensors are mounted on the vehicle and it has been driven for at least one minute at a speed of 20 mph (30 km/h) or faster.

TPMS valves can be fitted on winter wheels or full-size spare wheels/tires. Consult your Volvo retailer.

---

### CAUTION:

When inflating tires with TPMS valves, press the pump's mouthpiece straight onto the valve to help avoid bending or otherwise damaging the valve.

---

### Self supporting run flat tires (option)

Certain models equipped with the Tire Pressure Monitoring System (TPMS) can also be equipped with self supporting run flat tires. Tires of this type have specially reinforced sidewalls that make it possible to continue driving in the event of a drop in inflation pressure. Tires of this type are mounted on special rims.

**NOTE:** Self supporting run flat tires are only available in conjunction with TPMS. If a self supporting run flat tire should lose inflation pressure, the yellow TPMS warning symbol (  ) in the instrument panel lights up to alert the driver, and a message will be shown in the text window in the instrument panel.

If this occurs, reduce vehicle speed to a maximum of 50 mph (80 km/h). The vehicle can be driven approximately 50 miles (80 km), or somewhat farther if the vehicle is not heavily loaded. The tire should be replaced as soon as possible.

Hard braking and sudden steering maneuvers should be avoided.

In certain cases, it may be difficult to see which self supporting run flat tire is defective. To determine which tire is damaged, check the inflation pressure of all four tires.

---

### WARNING!

- Only specially trained persons should mount self supporting run flat tires.
- If self supporting run flat tires are mounted, the vehicle must be equipped with a Tire Pressure Monitoring System.
- After a low pressure warning has been displayed, do not exceed 50 mph (80 km/h).
- Avoid severe cornering and hard braking, and minimize the distance traveled before replacing the self supporting run flat tire.
- Self supporting run flat tires cannot be repaired. They must be replaced if damaged or punctured.

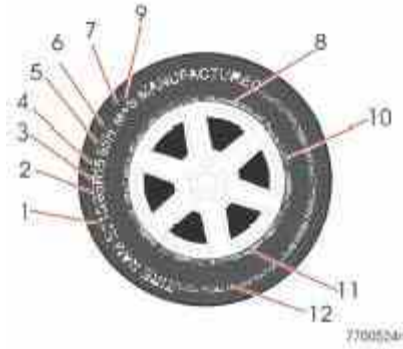

Federal law mandates that tire manufacturers place standardized information on the sidewall of all tires (see the illustration).

The following information is listed on the tire sidewall:

The tire designation (the following figures are examples of a tire designation):

1. 215: the width of the tire (in millimeters) from sidewall edge to sidewall edge. The larger the number, the wider the tire.
2. 65: The ratio of the tire's height to its width.
3. R: Radial tire.
4. 15: The diameter of the wheel rim (in inches).
5. 95: The tire's load index. In this example, a load index of 95 equals a maximum load of 1521 lbs (690 kg).
6. H: The tire's speed rating, or the maximum speed at which the tire is designed to be driven for extended periods of time, carrying a permissible load for the vehicle, and with correct inflation pressure. For example, H indicates a speed rating of 130 mph (210 km/h).

**NOTE:** This information may not appear on the tire because it is not required by law.

7. M+S or M/S = Mud and Snow, AT = All Terrain, AS = All Season

8. U.S. DOT Tire Identification Number (TIN): This begins with the letters "DOT" and indicates that the tire meets all federal standards. The next two numbers or letters are the plant code where it was manufactured, the next two are the tire size code and the last four numbers represent the week and year the tire was built. For example, the numbers 317 mean the 31st week of 1997. After 2000 the numbers go to four digits. For example, 2501 means the 25th week of 2001. The numbers in between are marketing codes used at the manufacturer's discretion. This information helps a tire manufacturer identify a tire for safety recall purposes.

9. Tire Ply Composition and Material Used: Indicates the number of plies indicates or the number of layers of rubber-coated fabric in the tire tread and sidewall. Tire manufacturers also must indicate the ply materials in the tire and the sidewall, which include steel, nylon, polyester, and others.

10. Maximum Load: Indicates the maximum load in pounds and kilograms that can be carried by the tire. Refer to the vehicle's tire information placard or the safety certification label, located on the B-Pillar or the driver's door or on the inside of the fuel filler door on Canadian models, for the correct tire pressure for your vehicle.

11. Treadwear, Traction, and Temperature grades: See [page 123](#) for more information.

12. Maximum permissible inflation pressure: the greatest amount of air pressure that should ever be put in the tire. This limit is set by the tire manufacturer.

## pg. 121 Wheels and tires

### Glossary of tire terminology

The tire suppliers may have additional markings, notes or warnings such as standard load, radial tubeless, etc.

### Glossary of tire terminology

- **Tire information placard:** A placard showing the OE (Original Equipment) tire sizes, recommended inflation pressure, and the maximum weight the vehicle can carry.
- **Tire Identification Number (TIN):** A number on the sidewall of each tire providing information about the tire brand and manufacturing plant, tire size and date of manufacturer.
- **Inflation pressure:** A measure of the amount of air in a tire.
- **Standard load:** A class of P-metric or Metric tires designed to carry a maximum load at 35 psi [37 psi (2.5 bar) for Metric tires]. Increasing the inflation pressure beyond this pressure will not increase the tires load carrying capability.
- **Extra load:** A class of P-metric or Metric tires designed to carry a heavier maximum load at 41 psi [43 psi (2.9 bar) for Metric tires]. Increasing the inflation pressure beyond this pressure will not increase the tires load carrying capability.
- **kPa:** Kilopascal, a metric unit of air pressure.
- **PSI:** Pounds per square inch, a standard unit of air pressure.
- **B-pillar:** The structural member at the side of the vehicle behind the front door.
- **Bead area of the tire:** Area of the tire next to the rim.
- **Sidewall of the tire:** Area between the bead area and the tread.
- **Tread area of the tire:** Area of the perimeter of the tire that contacts the road when mounted on the vehicle.
- **Rim:** The metal support (wheel) for a tire or a tire and tube assembly upon which the tire beads are seated.
- **Maximum load rating:** a figure indicating the maximum load in pounds and kilograms that can be carried by the tire. This rating is established by the tire manufacturer.
- **Maximum permissible inflation pressure:** the greatest amount of air pressure that should ever be put in the tire. This limit is set by the tire manufacturer.
- **Recommended tire inflation pressure:** inflation pressure, established by Volvo, which is based on the type of tires that are mounted on a vehicle at the factory. This inflation pressure is affected by the number of occupants in the car, the amount of cargo, and the speed at which the vehicle will be driven for a prolonged period. This information can be found on the tire inflation placard(s) located on the driver's side B-pillar or on the inside of the fuel filler door on Canadian models, and in the tire inflation table in this chapter.
- **Cold tires:** The tires are considered to be cold when they have the same temperature as the surrounding (ambient) air. This temperature is normally reached after the car has been parked for at least 3 hours.

## pg. 122 Wheels and tires

### Vehicle loading

Properly loading your vehicle will provide maximum return of vehicle design performance.

Before loading your vehicle, familiarize yourself with the following terms for determining your vehicle's weight ratings, with or without a trailer, from the vehicle's Federal/ Canadian Motor Vehicle Safety Standards (FMVSS/CMVSS) label, and the vehicle's tire information placard:

### Curb weight

The weight of the vehicle including a full tank of fuel and all standard equipment. It does not include passengers, cargo, or optional equipment.



## Capacity weight

All weight added to the curb weight, including cargo and optional equipment. When towing, trailer hitch tongue load is also part of cargo weight.

**NOTE:** For trailer towing information, please refer to the section "Towing a trailer" on [page 105](#).

## Permissible axle weight

The maximum allowable weight that can be carried by a single axle (front or rear). These numbers are shown on the Federal/Canadian Motor Vehicle Safety Standards (FMVSS/CMVSS) label. The total load on each axle must never exceed its maximum permissible weight.

## Gross vehicle weight (GVW)

The vehicle's curb weight + cargo + passengers.

### NOTE:

- The location of the various labels in your vehicle can be found on [page 162](#).
- A table listing important weight limits for your vehicle can be found on [page 164](#).

## Steps for Determining Correct Load Limit

- (1) Locate the statement "the combined weight of occupants and cargo should never exceed XXX pounds" on your vehicle's placard.
- (2) Determine the combined weight of the driver and passengers that will be riding in your vehicle.
- (3) Subtract the combined weight of the driver and passengers from XXX kilograms or XXX pounds.
- (4) The resulting figure equals the available amount of cargo and luggage load capacity. For example, if the "XXX" amount equals 1400 lbs. and there will be five 150 lb. passengers in your vehicle, the amount of available cargo and luggage load capacity is 650 lbs. (1400-750 (5 x 150) = 650 lbs.)
- (5) Determine the combined weight of luggage and cargo being loaded on the vehicle. That weight may not safely exceed the available cargo and luggage load capacity calculated in Step 4.
- (6) If your vehicle will be towing a trailer, load from your trailer will be transferred to your vehicle. Consult this manual<sup>1</sup> to determine how this reduces the available cargo and luggage load capacity of your vehicle.

### **WARNING!**

- Exceeding the permissible axle weight, gross vehicle weight, or any other weight rating limits can cause tire overheating resulting in permanent deformation or catastrophic failure.
- Do not use replacement tires with lower load carrying capacities than the tires that were original equipment on the vehicle because this will lower the vehicle's GVW rating. Replacement tires with a higher limit than the originals do not increase the vehicle's GVW rating limitations.

1. See "Towing a trailer" on [page 105](#) WARNING!

pg. 123 Wheels and tires

## Uniform Tire Quality Grading

**ALL PASSENGER VEHICLE TIRES MUST CONFORM TO FEDERAL SAFETY REQUIREMENTS IN**

## ADDITION TO THESE GRADES

Quality grades can be found, where applicable, on the tire sidewall between the tread shoulder and maximum section width. For example:

**Treadwear 200 Traction AA Temperature A**

### TREADWEAR

The treadwear grade is a comparative rating based on the wear rate of the tire when tested under controlled conditions on a specified government test course. For example, a tire graded 150 would wear one and one half (1 1/2) times as well on the government course as a tire graded 100. The relative performance of tires depends upon the actual conditions of their use, however, and many depart significantly from the norm due to variation in driving habits, service practices and differences in road characteristics and climate.

### TRACTION

The traction grades, from highest to lowest, are AA, A, B, and C, as measured under controlled conditions on specified government test surfaces of asphalt and concrete. A tire marked C may have poor traction performance.

#### **WARNING!**

The traction grade assigned to this tire is based on braking (straight-ahead) traction tests and is not a measure of cornering (turning) traction.

### TEMPERATURE

The temperature grades are AA (the highest), A, B, and C, representing the tire's resistance to the generation of heat and its ability to dissipate heat when tested under controlled conditions on a specified indoor laboratory test wheel. Sustained high temperature can cause the material of the tire to degenerate and reduce tire life, and excessive temperature can lead to sudden tire failure. The grade C corresponds to a minimum level of performance that all passenger vehicle tires must meet under the Federal Motor Safety Standard No. 109. Grades B and A represent higher levels of performance on the laboratory test wheel than the minimum required by law.

#### **WARNING!**

The temperature grade for this tire is established for a tire that is properly inflated and not overloaded. Excessive speed, under-inflation, or excessive loading, either separately or in combination, can cause heat buildup and tire failure.

pg. 124 Wheels and tires

### Snow chains

Snow chains can be used on your Volvo with the following restrictions:

- Snow chains should be installed on front wheels only. Use only Volvo approved snow chains.
- If accessory, aftermarket or "custom" tires and wheels are installed and are of a size different than the original tires and wheels, chains in some cases CANNOT be used. Sufficient clearances between chains and brakes, suspension and body components must be maintained.
- Some strap-on type chains will interfere with brake components and therefore CANNOT be used.
- All Wheel Drive models : Snow chains should only be installed on the front wheels. Only chains adapted for AWD models should be used.

**NOTE:** Consult your Volvo retailer for additional snow chain information.

---

**CAUTION:**

- Check local regulations regarding the use of snow chains before installing.
  - Always follow the chain manufacturer's installation instructions carefully. Install chains as tightly as possible and retighten periodically.
  - Never exceed the chain manufacturer's specified maximum speed limit. (Under no circumstances should you exceed 31 mph (50 km/h)).
  - Avoid bumps, holes or sharp turns when driving with snow chains.
  - The handling of the vehicle can be adversely affected when driving with chains. Avoid fast or sharp turns as well as locked wheel braking.
- 

**Snow tires, studded tires <sup>1</sup>****Tires for winter use:**

- Owners who live in or regularly commute through areas with sustained periods of snow or icy driving conditions are strongly advised to fit suitable winter tires to help retain the highest degree of traction.
  - It is important to install winter tires on all four wheels to help retain traction during cornering, braking, and accelerating. Failure to do so could reduce traction to an unsafe level or adversely affect handling.
  - Do not mix tires of different design as this could also negatively affect overall tire road grip.
  - Winter tires wear more quickly on dry roads in warm weather. They should be removed when the winter driving season has ended.
- 
- Studded tires should be run-in 300-600 miles (500-1000 km) during which the car should be driven as smoothly as possible to give the studs the opportunity to seat properly in the tires. The tires should have the same rotational direction throughout their entire lifetime.

**NOTE:** Please consult state or provincial regulations restricting the use of studded winter tires before installing such tires.

<sup>1</sup> Where permitted

pg. 125 Wheels and tires

**Temporary Spare**

The spare tire in your car is called a "Temporary Spare".

Recommended tire pressure (see the placard on the B-pillar or on the fuel filler door) should be maintained irrespective of which position on the car the temporary spare tire is used on.

In the event of damage to this tire, a new one can be purchased from your Volvo retailer.

** WARNING!**

Current legislation prohibits the use of the "Temporary Spare" tire other than as a temporary replacement for a punctured tire. It must be replaced as soon as possible by a standard tire. Road holding and handling may be affected with the "Temporary Spare" in use. Do not exceed 50 mph (80 km/h). Do not drive farther than 50 miles (80 km) on a temporary spare tire.

**CAUTION:**

The car must not be driven with wheels of different dimensions or with a spare tire other than the one that came with the car. The use of different size wheels can seriously damage your car's transmission.

---

---

## Changing wheels

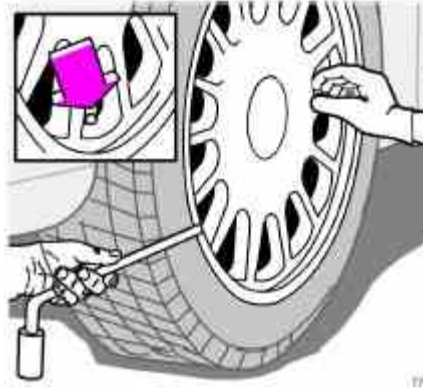

*Insert flat end of lug wrench and turn/pull straight out*

### Changing wheels

The spare wheel is located under the carpet on the trunk floor. The jack and crank are secured in the wheel recess.

There are two jack attachment points on each side of the car (see illustration on next page).

### To change a wheel:

- Engage the parking brake.
- Put the gear selector in (P)ark (automatic transmission) or reverse (manual transmission).

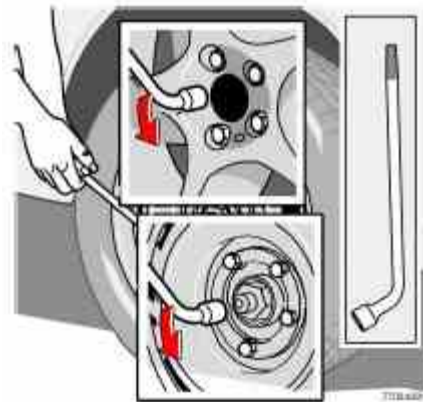

*Loosen the wheel bolts*

- Remove the wheel cap (where applicable) using the lug wrench in the tool bag.
- With the car still on the ground, use the lug wrench to loosen the wheel bolts 1/2 - 1 turn. Turn the bolts counterclockwise to loosen.

### CAUTION:

The car must not be driven with wheels of different dimensions or with a spare tire other than the one that came with the car. The use of different size wheels can seriously damage your car's transmission.

Correct tightening torque on wheel bolts must be observed. The wheel bolts should never be greased or lubricated. The extended, chromed wheel bolts must not be used with steel rims, as they make it impossible to fit the hub caps.

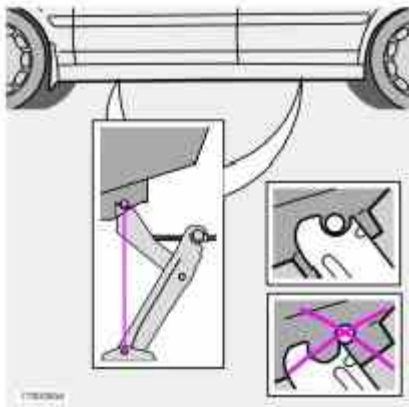

*Attaching the jack*

- Position the jack correctly on the bar in the attachment (see illustration above) and crank while simultaneously guiding the base of the jack to the ground. The base of the jack must be flat on a level, firm, non-slippery surface. Before raising the car, check that the jack is still correctly positioned in the attachment.
- Raise the vehicle until the wheel to be changed is lifted off the ground.
- Unscrew the wheel bolts completely and carefully remove the wheel so as not to damage the threads on the studs.

**NOTE:** To avoid excessive wear and the necessity of rebalancing, mark and reinstall wheels in the same location and position as before removal. To lessen the chance of imbalance, each wheel hub is equipped with a guide stud to ensure that a removed wheel can be reinstalled in its original position (as when changing over to winter tires/wheels).



### Installing the wheel

- Clean the contact surfaces on the wheel and hub.
- Lift the wheel and place it on the hub.
- Install the wheel bolts and tighten hand-tight. Using the lug wrench, tighten crosswise until all bolts are snug.
- Lower the vehicle to the ground and alternately tighten the bolts crosswise to 102 ft. lbs. (140 Nm).
- Install the wheel cap (where applicable).

### **⚠ WARNING!**

The jack must correctly engage the bar in the jack attachment. The car's weight must not rest on the jack attachment. See illustration "Attaching the jack" above.

Be sure the jack is on a firm, level, non-slippery surface.

Never allow any part of your body to be extended under a car supported by a jack. Use the jack intended for the car when replacing a wheel. For any other job, use stands to support the side of the car being worked on.

Apply the parking brake and put the gear selector in the (P)ark position (or reverse on manual transmissions).

Block the wheels standing on the ground, use rigid wooden blocks or large stones. The jack should be kept well-

greased.

pg. 128 This page intentionally left blank.



[Contents](#) | [Top of Page](#)

# 2005 VOLVO S60

## Car care

pg. 129 Car care

Washing and cleaning the car [130](#)

Paint touch up [133](#)

pg. 130 Car care

## Washing and cleaning the car

- The car should be washed at regular intervals since dirt, dust, insects and tar spots adhere to the paint and may cause damage. It is particularly important to wash the car frequently in the wintertime to prevent corrosion, when salt has been used on the roads.
- When washing the car, do not expose it to direct sunlight. Use lukewarm water to soften the dirt before you wash with a sponge, and plenty of water, to avoid scratching.
- Bird droppings: Remove from paintwork as soon as possible. Otherwise the finish may be permanently damaged.
- A detergent can be used to facilitate the softening of dirt and oil.
- A water-soluble grease solvent may be used in cases of sticky dirt. However, use a wash place equipped with a drainage separator.
- Dry the car with a clean chamois and remember to clean the drain holes in the doors and rocker panels.
- Tar spots can be removed with kerosene or tar remover after the car has been washed.
- A stiff-bristle brush and lukewarm soapy water can be used to clean the wiper blades. Frequent cleaning improves visibility considerably.
- Wash off the dirt from the underside (wheel housings, fenders, etc.).
- In areas of high industrial fallout, more frequent washing is recommended.

### CAUTION:

During high pressure washing, the spray mouthpiece must never be closer to the vehicle than 13" (30 cm). Do not spray into the locks.

When washing or steam cleaning the engine, avoid spraying water or steam directly on the electrical components or toward the rear side of the engine.

### Special moonroof cautions:

- Always close the moonroof and sun shade before washing your vehicle.
- Never use abrasive cleaning agents on the moonroof.
- Never use wax on the rubber seals around the moonroof.

- 
- After cleaning the engine, the spark plug wells should be inspected for water and blown dry if necessary.

**Suitable detergents:** Special car washing detergents should be used. A suitable mixture is about 2.5 fl. oz. (8.5 cl) of detergent to 2.6 US gal. (10 liters) of warm water. After washing with a detergent the car should be well rinsed with

clean water.

**Bumpers:** Wash the bumpers with the same cleaning agent used on the rest of the car. Never clean the bumpers with gasoline or paint thinner. Difficult spots can be removed with denatured alcohol. To avoid scratches, do not dry the bumpers with paper.

**NOTE:** When washing the car, remember to remove dirt from the drain holes in the doors and sills.

**⚠ WARNING!**

When the car is driven immediately after being washed, apply the brakes several times in order to remove any moisture from the brake linings.

Engine cleaning agents should not be used when the engine is warm. This constitutes a fire risk.

### **Automatic washing - simple and quick**

- We do NOT recommend washing your car in an automatic wash during the first six months (because the paint will not have hardened sufficiently).
- An automatic wash is a simple and quick way to clean your car, but it is worth remembering that it may not be as thorough as when you yourself go over the car with sponge and water. Keeping

pg. 131 Car care

the underbody clean is most important, especially in the winter. Some automatic washers do not have facilities for washing the underbody.

- Before driving into an automatic car wash, make sure that side view mirrors, auxiliary lamps, etc, are secure, and that any antenna(s) are retracted or removed. Otherwise there is risk of the machine dislodging them.

### **Polishing and Waxing**

- Normally, polishing is not required during the first year after delivery, however, waxing may be beneficial.
- Before applying polish or wax the car must be washed and dried. Tar spots can be removed with kerosene or tar remover. Difficult spots may require a fine rubbing compound.
- After polishing use liquid or paste wax.
- Several commercially available products contain both polish and wax.
- Waxing alone does not substitute for polishing a dull surface.
- A wide range of polymer-based car waxes can be purchased today. These waxes are easy to use and produce a long-lasting, high-gloss finish that protects the bodywork against oxidation, road dirt and fading.
- Do not polish or wax your car in direct sunlight (the surface of the car should not be warmer than 113° F (45° C)).

### **CAUTION:**

Volvo does not recommend the use of longlife or durable paint protection coatings, some of which may claim to prevent pitting, fading, oxidation, etc. These coatings have not been tested by Volvo for compatibility with your vehicle's clear coat. Some of them may cause the clear coat to soften, crack, or cloud. Damage caused by application of paint protection coatings may not be covered under your vehicle's paint warranty.

### **Mirrors with the water repellent glass coating (option)**

- Do not apply wax, degreasing agents, etc to this glass. This could damage the coating.
- Clean the glass surface with care to avoid scratching.
- Use only suitable plastic scrapers to remove ice or snow from the windows.



## **Cleaning the upholstery**

### **Fabric**

Clean with soapy water or a detergent. For more difficult spots caused by oil, ice cream, shoe polish, grease, etc., use a clothing/fabric stain remover.

### **Plastic**

The plastic in the upholstery can be cleaned with a soft cloth and mild soap solution.

### **Alcantera™ suede-like material**

Suede-like upholstery can be cleaned with a soft cloth and mild soap solution.

### **Leather care**

Volvo's leather upholstery is manufactured with a protectant to repel soiling. Over time, sunlight, grease and dirt can break down the protection. Staining, cracking, scuffing, and fading can result.

Volvo offers an easy-to-use, non-greasy leather care kit formulated to clean and beautify your vehicle's leather, and to renew the protective qualities of its finish. The cleaner removes dirt and oil buildup. The light cream protectant restores a barrier against soil and sunlight.

Volvo also offers a special leather softener that should be applied after the cleaner and protectant. It leaves leather soft and smooth, and reduces friction between leather and other finishes in the vehicle.

Volvo recommends cleaning, protecting and conditioning your vehicle's leather two to four times a year. Ask your Volvo retailer about Leather Care Kit 951 0251 and Leather Softener 943 7429.

---

### **CAUTION:**

- Under no circumstances should gasoline, naphtha or similar cleaning agents be used on the plastic or the leather since these can cause damage.
- Take extra care when removing stains such as ink or lipstick since the coloring can spread.
- Use solvents sparingly. Too much solvent can damage the seat padding.
- Start from the outside of the stain and work toward the center.
- Sharp objects (e.g. pencils or pens in a pocket) or velcro fasteners on clothing may damage the textile upholstery.

---

### **Cleaning the seat belts**

Clean only with lukewarm water and a mild soap solution.

### **Cleaning floor mats**

The floor mats should be vacuumed or brushed clean regularly, especially during winter when they should be taken out for drying. Spots on textile mats can be removed with a mild detergent.

### **Bear in mind**

- Take extra care when removing stains such as ink or lipstick since the coloring can spread.
- Use solvents sparingly. Too much solvent can damage the seat padding.
- Start from the outside of the stain and work toward the center.

# Paint touch up

Paint damage requires immediate attention to avoid rusting. Make it a habit to check the finish regularly - when washing the car for instance. Touch-up if necessary.

Paint repairs require special equipment and skill. Contact your Volvo retailer for any extensive damage.

Minor scratches can be repaired by using Volvo touch-up paint.

**NOTE:** When ordering touch-up paint from your Volvo retailer, use the paint code indicated on the model plate. The plate is located in the engine compartment.

## Color code

Make sure you have the right color. The color code number is on the data plate in the engine compartment.



## Minor stone chips and scratches

Material:

- Primer - can
- Paint - touch-up pen
- Brush
- Masking tape
- If the stone chip has not gone down to the bare metal and an undamaged color coat remains, you can add paint immediately after removing dirt.

**NOTE:** When touching up the car, it should be clean and dry. The surface temperature should be above 60° F (15° C).

## Minor scratches on the surface

If the stone chip has not penetrated down to the metal and an undamaged layer of paint remains, the touch-up paint can be applied as soon as the spot has been cleaned.

## Deep scratches

1. Place a strip of masking tape over the damaged surface. Pull the tape off so that any loose flakes of paint adhere to it.
2. Thoroughly mix the primer and apply it with a small brush.

When the primer surface is dry, the paint can be applied using a brush. Mix the paint thoroughly; apply several thin paint coats and let dry after each application.

3. If there is a longer scratch, you may want to protect surrounding paint by masking it off.



pg. 134 This page intentionally left blank.



[Contents](#) | [Top of Page](#)

# 2005 VOLVO S60

## Maintenance and service

pg. 135 Maintenance and service

|                             |                     |
|-----------------------------|---------------------|
| Volvo service               | <a href="#">136</a> |
| Working on your car         | <a href="#">138</a> |
| Hood and engine compartment | <a href="#">140</a> |
| Oils and fluids             | <a href="#">141</a> |
| Wiper blades                | <a href="#">145</a> |
| Battery                     | <a href="#">146</a> |
| Replacing bulbs             | <a href="#">149</a> |
| Fuses                       | <a href="#">156</a> |

pg. 136 Maintenance and service

## Volvo service

### Maintenance service

Volvo advises you to follow the service program outlined in the Warranty and Service Records Information booklet. This maintenance program contains inspections and services necessary for the proper function of your car. The maintenance services contain several checks which require special instruments and tools and therefore must be performed by a qualified technician. To keep your Volvo in top condition, specify time-tested and proven Genuine Volvo Parts and Accessories.

### The Federal Clean Air Act - U. S.

The Federal Clean Air Act requires vehicle manufacturers to furnish written instructions to the ultimate purchaser to assure the proper servicing and function of the components that control emissions. These services, which are listed in the "Warranty and Service Records Information booklet," are not covered by the warranty. You will be required to pay for labor and material used.

### Maintenance services

Your Volvo passed several major inspections before it was delivered to you, in accordance with Volvo specifications. The maintenance services outlined in the Warranty and Service Records Information booklet, many of which will positively affect your vehicle's emissions, should be performed as indicated. It is recommended that receipts for vehicle emission services be retained in case questions arise concerning maintenance.

Inspection and service should also be performed anytime a malfunction is observed or suspected.

[Page 137](#) provides more information about maintenance of emission-related components.

### Vehicle Event Data

Your vehicle's driving and safety systems employ computers that monitor, and share with each other, information

about your vehicle's operation. One or more of these computers may store what they monitor, either during normal vehicle operation or in a crash or near-crash event. Stored information may be read and used by:

- Volvo Car Corporation
- service and repair facilities
- law enforcement or government agencies
- others who may assert a legal right to know, or who obtain your consent to know such information.

### **Applicable warranties**

In accordance with applicable U.S. and Canadian regulations, the following list of warranties is provided

- New Car Limited Warranty
- Parts and Accessories Limited Warranty
- Corrosion Protection Limited Warranty
- Seat Belt and Supplemental Restraint Systems Limited Warranty
- Emission Design and Defect Warranty
- Emission Performance Warranty

These are the Federal warranties; other warranties are provided as required by state/provincial law. Refer to your separate Warranty and Service Records Information booklet for detailed information concerning each of the warranties.

pg. 137 Maintenance and service

### **Periodic maintenance helps minimize emissions**

Periodic maintenance will help keep your vehicle running well. Your Warranty and Service Records Information booklet provides a comprehensive periodic maintenance schedule up to 150,000 miles (240,000 km) of vehicle service. The schedule includes components that affect vehicle emissions. This page describes some of the emission-related components.

#### **Engine air filter**

The engine air filter cleans particles from air entering the engine. Replace the engine air filter cartridge with a new one every 37,500 miles (60,000 km) under normal driving conditions. Replace the cartridge more often when the vehicle is driven under dirty and dusty conditions. The cartridge cannot be cleaned, and should always be replaced with a new one.

#### **Fuel filter**

The fuel filter should be replaced at 105,000 miles (168,000 km). The filter is replaced as one complete unit. Replace more frequently if contaminated fuel is introduced into the tank, or if there is reason to suspect that this has occurred.

#### **Fuel system, including filler cap, tank, lines and connections**

The ability of the fuel system to contain hydrocarbons is dependent upon a leak-free system. Inspect fuel lines every 30,000 miles (48,000 km). Check for proper sealing of the fuel filler cap which contains "O" ring type seals.

**NOTE:** If the fuel filler cap is not closed tightly or if the engine is running when the car is refueled, the Check Engine light (Malfunction Indicator) may indicate a fault. However, your vehicle's performance will not be affected. Use only Volvo original or approved fuel filler caps.

#### **Timing belt**

For proper functioning of the engine and emission control systems, the timing belt and belt tensioner must be replaced every 105,000 miles (168,000 km). Engine damage will occur if the belt fails.

#### **PCV system**

(on turbocharged models)

The nipple in the intake manifold and the filter at the end of the PCV hose in the air cleaner should be inspected at 105,000 miles (168,000 km) and again at 150,000 miles (240,000 km).

### Spark plugs

The spark plugs should be replaced every 60,000 miles (96,000 km) under normal driving conditions. City driving or fast highway driving may necessitate replacement sooner.

Under normal driving conditions, spark plugs require no maintenance between replacement intervals. When installing new plugs, be sure to use the right type and to tighten them correctly. When changing the plugs, clean the terminals and rubber seals. Also check that the suppressor connectors are in good condition. Cracked or damaged connectors should be replaced.

pg. 138 Maintenance and service

## Working on your car

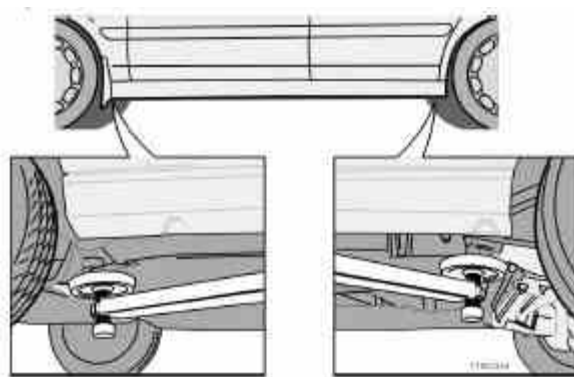

**Note the following before you begin working on your car:**

### Battery

- Ensure that the battery cables are correctly connected and tightened.
- Never disconnect the battery when the engine is running (e.g. when replacing the battery).
- Never use a fast charger to charge the battery. The battery cables should be disconnected when recharging.
- The battery contains acid that is both corrosive and poisonous. It is important that the battery is handled in an environmentally friendly way. Let your Volvo dealer assist you.

### Hoisting the car

If a garage jack is used to lift the car, the two jack attachments points should be used. They are specially reinforced to bear the weight of the car. A garage jack can also be placed under the front of the engine support frame. Take care not to damage the splash guard under the engine. Ensure that the jack is positioned so that the car cannot slide off it. Always use axle stands or similar structures.

If a two-post hoist is used to lift the car, the front and rear lift arm pads should be centered under the reinforced lift plates on the inboard edge of the sill rail (see illustration).

### **⚠ WARNING!**

The car ignition system has very high voltage!

The voltage in the ignition system is dangerous!

Do not touch spark plugs, ignition cables or the ignition coil when the engine is running or the ignition is switched on!

### The ignition should be switched off when:

- Conducting engine tests.
- Replacing parts in the ignition system, such as spark plugs, ignition coil, distributor, ignition cables, etc.

### **WARNING!**

Never try to repair any part of the SRS or SIPS bag systems yourself. Any interference in the system could cause malfunction and serious injury. Any work should only be performed by an authorized Volvo workshop.

pg. 139 Maintenance and service

### **Belt check**

Check the belt regularly to make sure it is in good condition and is clean. A worn or dirty belt can cause poor cooling and low alternator output as well as impair the operation of the power steering and the air conditioning unit.

**NOTE:** The drive belt is equipped with a self-tensioning mechanism and requires no adjustment between changes!

### **WARNING!**

The engine must not be running when this check is performed.

### **Check coolant level**

The cooling system must be filled with coolant and not leak to operate at maximum efficiency. Check the coolant level regularly. The level should be between the "MAX" and "MIN" marks on the expansion tank. The check should be made with particular thoroughness when the engine is new or when the cooling system has been drained.

Do not remove the filler cap other than for topping up with coolant. Frequent removal may prevent coolant circulation between the engine and the expansion tank during engine warm up and cooling.

### **Changing coolant**

Normally, the coolant does not need to be changed. If the system must be drained, consult your Volvo retailer.

**NOTE:** Do not top off with water only. This reduces the rust-protective and antifreeze qualities of the coolant and has a lower boiling point. It can also cause damage to the cooling system if it should freeze. Top off with Volvo Genuine Coolant/Antifreeze only (a 50/50 mix of water and antifreeze).

### **CAUTION:**

The cooling system must always be kept filled to the correct level. If it is not kept filled, there can be high local temperatures in the engine which could result in damage. Different types of antifreeze/coolant may not be mixed.

### **WARNING!**

Never remove the radiator cap while the engine is warm. Wait until the car cools.

pg. 140 Maintenance and service

## **Hood and engine compartment**

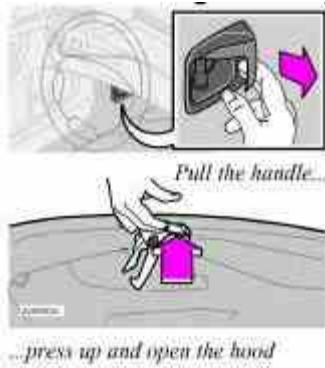

## Opening the hood

- Pull the lever located under the left side of the dash to release the hood lock.
- Lift the hood slightly.
- Press up the release control located under the front edge of the hood (at the center) and lift.

### **⚠ WARNING!**

Check that the hood locks properly when closed!

## Engine compartment

1. Expansion tank - coolant
2. Power steering fluid reservoir
3. Washer fluid reservoir
4. Dipstick - engine oil
5. Radiator
6. Cooling fan
7. Oil filler cap - engine
8. Clutch/brake fluid reservoir
9. Relay/fuse box
10. Air cleaner
11. Battery (in trunk)
12. Data plate

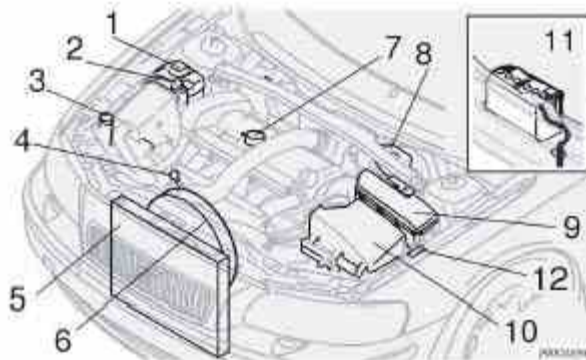

### **⚠ WARNING!**

The cooling fan (6) may start or continue to operate (for up to 6 minutes) after the engine has been switched off.



## Oils and fluids

### Oil quality

Engine oil must meet the minimum ILSAC specification GF-2, including ACEA A1, API SJ, SJ/CF and SJ/ Energy Conserving.

Your Volvo has been certified to standards using ILSAC oil specification GF-2 5W-30. Volvo recommends use of oil with a quality rating equal to or higher than ILSAC GF-2. Equivalent and better oils include ACEA A1, API SJ, SJ/CF, and SJ/Energy conserving. Lower quality oils may not offer the same fuel economy, engine performance, or engine protection.

Volvo Cars recommends Castrol.

Depending on your driving habits, premium or synthetic oils may provide superior fuel economy and engine protection. Consult your Volvo retailer for recommendations on premium or synthetic oils.

### Oil additives must not be used.

**NOTE:** Synthetic oil is not used when the oil is changed at normal maintenance services. This oil is only used at customer request, at additional charge. Please consult your Volvo retailer.

### Operation in hot climates

When temperatures exceed 86° F (30° C) in your area, Volvo recommends, for the protection of your engine, that you use a heavier weight oil, such as SAE 10W/30. See the viscosity chart below.

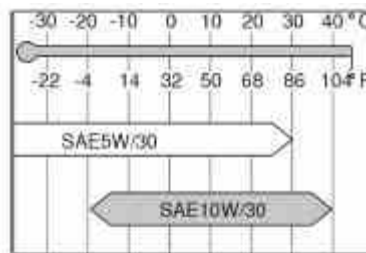

### Oil viscosity (stable ambient temperatures)

#### Operation in temperate climates

Incorrect viscosity oil can shorten engine life. Under normal use when temperatures do not exceed 86° F (30° C), SAE 5W/30 will provide good fuel economy and engine protection. See the viscosity chart above.

#### Extreme engine operation

Synthetic oils meeting SAE 10W/30 and complying with oil quality requirements are recommended for driving in areas of sustained temperature extremes (hot or cold), when towing a trailer over long distances, and for prolonged driving in mountainous areas.

#### Changing oil and oil filter

Oil and oil filter changes should be made at 7,500 mile (12,000 km) intervals.

#### Volvo does not recommend the use of oil additives.

**Synthetic oil is not used when the oil is changed at the normal maintenance service intervals.**



- The API Service Symbol "donut" is divided into three parts:
- The top half describes the oil's performance level.
- The center identifies the oil's viscosity.
- The bottom half tells whether the oil has demonstrated energy-conserving properties in a standard test in comparison to a reference oil.

pg. 142 Maintenance and service

## Oils and fluids (Contd)

### Checking the oil level

**The oil level should be checked every time the car is refueled. This is especially important during the period up to the first service.**

### CAUTION:

Not checking the oil level regularly can result in serious engine damage if the oil level becomes too low.

Park the car on a level surface and wait for at least 5 minutes after the engine has been switched off. Be sure the oil level is maintained between the upper and lower marks on the dipstick. Low oil level can cause internal damage to the engine and overfilling can result in high oil consumption. The distance between the dipstick marks represents approx. 1.6 US qt (1.5 liter). The oil should preferably be checked when cold, before the engine has been started.

**NOTE:** The engine must be stopped when checking the oil.

### ⚠ WARNING!

Do not allow oil to spill onto or come into contact with hot exhaust pipe surfaces.

### Adding oil (topping up)

- Add oil of the same kind as already used.
- Capacity (including filter): Normally-aspirated 5-cylinder engine - 5.8 US qts (5.5 liters). Turbo 5-cylinder engine - 6.1 US qts (5.8 liters).
- The oil filter should be replaced at every oil change.

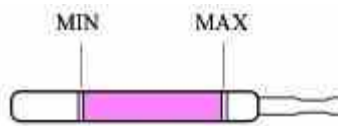

Approx. 1.6 US qt (1.5 liter)  
R-models: 1.3 (1.2 liter)

### R-models

R-models are equipped with an oil level warning system. If the engine oil level becomes too low, the warning light in the instrument panel will come on and a warning will be displayed in the text window.

If the yellow warning light in the instrument panel comes on and the text OIL LEVEL LOW/ FILL OIL is displayed, stop safely as soon as possible and add 1 qt (1 liter) of oil. Check the oil level with the dipstick before restarting the engine.

If the red warning light in the instrument panel comes on and the text OIL LEVEL LOW/STOP SAFELY-->STOP ENGINE-->SEE MANUAL is displayed, stop safely as soon as possible and add oil (not more than 1.6 qts (1.5 liters)). Check the oil level with the dipstick before restarting the engine. If no oil level is visible on the dipstick, do not start the engine. Have the car towed to an authorized Volvo workshop.

pg. 143 Maintenance and service

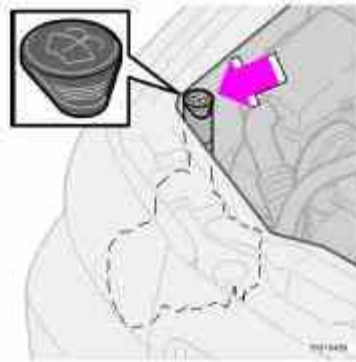

*Washer fluid reservoir*

### **Washer fluid reservoir**

The washer fluid reservoir is located in the engine compartment and holds approx. 6.8 US qts (6.4 liters) or 4.8 US qts (4.5 liters) on the S60 R.

During cold weather, the reservoir should be filled with windshield washer solvent containing antifreeze.

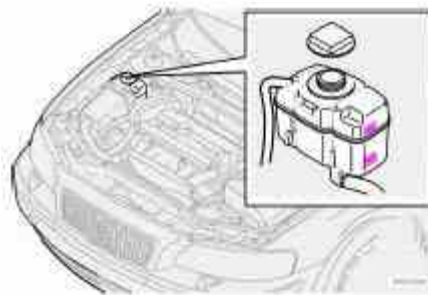

*Coolant reservoir*

### **Changing coolant**

Normally, the coolant does not need to be changed. If the system must be drained, consult your Volvo retailer.

**NOTE:** Do not top off with water only. This reduces the rust-protective and antifreeze qualities of the coolant and has a lower boiling point. It can also cause damage to the cooling system if it should freeze. Top off with Volvo Genuine Coolant/Antifreeze only (a 50/50 mix of water and antifreeze).

**CAUTION:**

The cooling system must always be kept filled to the correct level. If it is not kept filled, there can be high local temperatures in the engine which could result in damage. Different types of antifreeze/coolant may not be mixed. Check coolant regularly!

**⚠ WARNING!**

Never remove the radiator cap while the engine is warm. Wait until the car cools.

If it is necessary to top up the coolant when the engine is warm, unscrew the expansion tank cap slowly so that the overpressure dissipates.

pg. 144 Maintenance and service

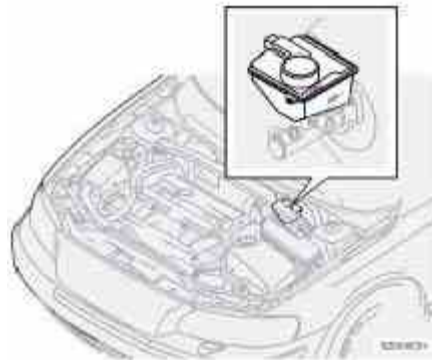
**Oils and fluids (Contd)****Clutch and brake fluid reservoir**

The clutch and brake fluid should always be above the MIN mark on the side of the reservoir. Check, without removing the cap, that there is sufficient fluid in the reservoir.

**Fluid type:** DOT 4+ boiling point > 536° F (280° C), P/N 9437433

**Replace:** Every second year or 30,000 miles (48,000 km). The fluid should be replaced once a year or every 15,000 miles (24,000 km) when driving under extremely hard conditions (mountain driving, etc.)

Always entrust brake fluid changing to an authorized Volvo retailer.

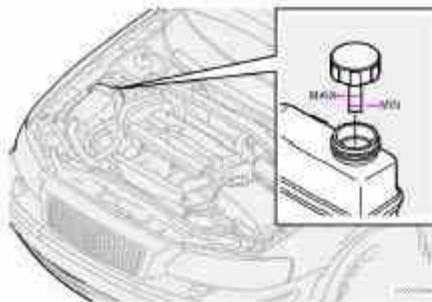
**Power steering fluid reservoir**

The fluid level should always be between the ADD and FULL marks.

**Fluid type:** Volvo synthetic power steering fluid (Pentosin CHF 11S) P/N 1161529 or equivalent.

**Replace:** No fluid change required

**NOTE:** If a problem should occur in the power steering system or if the car has no electrical current and must be towed, it is still possible to steer the car. However, keep in mind that greater effort will be required to turn the steering wheel.

---



[Contents](#) | [Top of Page](#)

# 2005 VOLVO S60

## Specifications

pg. 161 Specifications

|                               |                     |
|-------------------------------|---------------------|
| Label information             | <a href="#">162</a> |
| Dimensions and weights        | <a href="#">163</a> |
| Capacities                    | <a href="#">165</a> |
| Lubricants                    | <a href="#">166</a> |
| Cooling system                | <a href="#">166</a> |
| Three way catalytic converter | <a href="#">167</a> |
| Suspension                    | <a href="#">168</a> |
| Bulbs                         | <a href="#">169</a> |
| Electrical system             | <a href="#">170</a> |
| Engine specifications         | <a href="#">171</a> |

*All specifications are subject to change without prior notice.*

pg. 162 Specifications

## Label information

### 1 Vehicle Emission Control Information

Your Volvo is designed to meet all applicable emission standards, as evidenced by the certification label on the underside of the hood. For further information regarding these regulations, please consult your Volvo retailer.

### 2 Vacuum hose routing

(underside of hood)

### 3 Loads and Tire Pressures

(on inside of fuel filler door): Canadian models only.

### 4 Model plate

Vehicle Identification Number (VIN). Codes for color and upholstery, etc. The plate is located in the engine compartment, on the inside of the left front fender.

### 5 Vehicle Identification Number (VIN) \*

The VIN plate is located on the top left surface of the dashboard. The VIN is also stamped on the right hand door pillar.

### 6 Federal Motor Vehicle Safety Standards (FMVSS) specifications (USA) and Ministry of Transport (CMVSS) standards (Canada)

Your Volvo is designed to meet all applicable safety standards, as evidenced by the certification label on the facing

side of the driver's door. For further information regarding these regulations, please consult your Volvo retailer.

## 7 Child safety latch label

## 8. Loads and Tire Pressures - U.S. models only

Certain models will only have one decal, depending on the specifications of the vehicle.

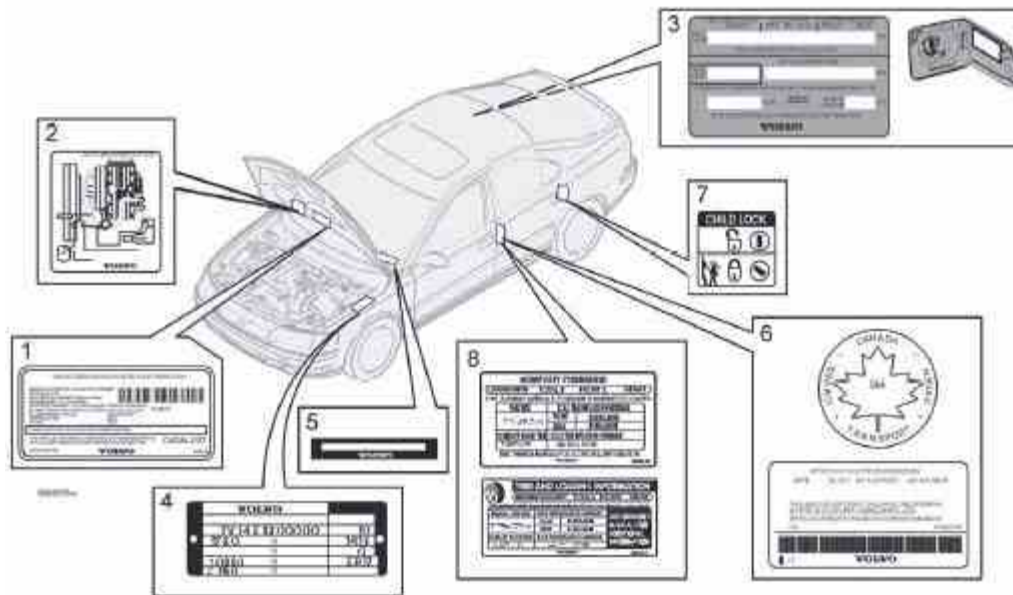

\*The Vehicle Identification Number (VIN) should always be quoted in all correspondence concerning your vehicle with the retailer and when ordering parts.

pg. 163 Specifications

## Dimensions and weights

### Dimensions

Length 180 in. (458 cm)

- S60R 181.7 in. (462 cm)

Width 71 in. (180 cm)

- S60R 71 in. (180 cm)

Height 56.2 in. (143 cm)

- S60R 55.7 in. (142 cm)

Wheelbase 107 in. (272 cm)

Front track 61.5 in. (156 cm)

Rear track 61.4 (156 cm)

Turning circle, between curbs 35.4- 38.7 ft. (10.8- 11.8 m)

Cargo capacity, trunk SAE V1 - 13.9 (394)

### Max. loads:

Max. roof load 220 lbs 100 kg

Max. trailer weight

**without** brakes 1650 lbs (750 kg)

**with** brakes 2" ball 3300 lbs (1500 kg)

1 7/ 8" ball 2000 lbs (900 kg)

Max. tongue weight 165 lbs (75 kg)

See also [page 105](#) for additional information

\* When driving for prolonged periods at temperatures above 86°F (30°C), the maximum recommended weight is 2000 lbs (900 kg).

**⚠ WARNING!**

When adding accessories, equipment, luggage and other cargo to your vehicle, the total capacity weight must not be exceeded.

pg. 164 Specifications

## Dimensions and weights (contd)

AWD = All Wheel Drive

| <b>Gross vehicle weight*</b>            | <b>USA</b>    | <b>Canada</b> |
|---|---------------|---------------|
| 5-cyl. manual                           | 4360 lbs      | 1980 kg       |
| 5-cyl. automatic                        | 4400 lbs      | 2000 kg       |
| 5-cyl. turbo manual                     | 4430 lbs      | 2010 kg       |
| 5-cyl. turbo automatic                  | 4470 lbs      | 2030 kg       |
| 5-cyl turbo AWD automatic               | 4540 lbs      | 2060 kg       |
| 5-cyl turbo AWD-R manual/automatic      | 4540 lbs      | 2060 kg       |
| <b>Capacity weight</b>                  |               |               |
| 5-cyl.                                  | 890 lbs       | 400 kg        |
| 5-cyl. turbo                            | 890 lbs       | 400 kg        |
| 5 cyl. turbo AWD                        | 820 lbs       | 375 kg        |
| 5 cyl. turbo AWD-R                      | 770 lbs       | 350 kg        |
| <b>Permissible axle weights, front*</b> |               |               |
| 5-cyl.                                  | 2330 lbs      | 1060 kg       |
| 5-cyl. turbo                            | 2400 lbs      | 1090 kg       |
| 5-cyl. turbo AWD automatic              | 2420 lbs      | 1100 kg       |
| 5-cyl. turbo AWD-R manual               | 2400 lbs      | 1090 kg       |
| 5-cyl. turbo AWD-R automatic            | 2420 lbs      | 1100 kg       |
| <b>Permissible axle weights, rear*</b>  |               |               |
| 5-cyl., 5-cyl. turbo                    | 2220 lbs      | 1010 kg       |
| 5-cyl. turbo AWD, AWD-R                 | 2310 lbs      | 1050 kg       |
| <b>Curb weight</b>                      |               |               |
| 5-cyl.                                  | 3245-3350 lbs | 1475-1520 kg  |
| 5-cyl. turbo                            | 3380-3450 lbs | 1540-1570 kg  |
| 5-cyl. turbo AWD                        | 3540-3575 lbs | 1610-1625 kg  |
| 5-cyl. turbo AWD-R                      | 3650-3710 lbs | 1675-1690 kg  |

\* Permissible axle weight or gross vehicle weight must never be exceeded.

pg. 165 Specifications



# Capacities

**Fuel tank** Front wheel drive, non-turbo models - 18.5 US gal. (70 liters)  
All turbo models - 18 US gal. (68 liters)

## Engine oil

B5244S 5.8 US qts. (5.5 liters)  
B5234T3 6.1 US qts. (5.8 liters)  
B5244T3 6.1 US qts. (5.8 liters)  
B5254T2 6.1 US qts. (5.8 liters)  
B5254T4 5.5 US qts (5.2 liters)

## Transmission oil

Manual (M 56) 2.2 US qts. (2.1 liters)  
Manual (M 66) 2.1 US qts. (2.0 liters)  
Automatic (AW 55-50) 7.6 US qts. (7.2 liters)

## Miscellaneous

Power steering 0.9 US qts. (0.9 liters)  
Windshield washer reservoir 4.8 US qts. (4.5 liters)  
Brake and clutch fluid 0.69 US qts. (0.65 liters)  
Air conditioning system 2.2 lbs. (1 kg) R 134a  
Windshield washer reservoir 6.8 US qts (6.4 liters)  
S60 R 4.8 US qts (4.5 liters)

Minimum octane requirement - AKI 87 (RON 91) unleaded fuel (See also [page 84](#))

pg. 166 Specifications

# Lubricants

## Engine oil

Meeting minimum ILSAC specification GF-2, including ACEA A1, API SJ, SJ/ CF and SJ/Energy Conserving.

**Oil additives must not be used.**

## Transmission

### Oil grade:

Manual: MTF 97309

Automatic: JWS 3309

Different types of oil should never be mixed.

## Power steering

**Grade:** Volvo synthetic power steering fluid (Pentosin CHF 11S) P/N 1161529 or equivalent.

## Brake fluid

Fluid type: DOT 4+ boiling point > 536°F (280° C)

# Cooling system

**Type** Positive pressure, closed system.

**Coolant** Volvo original coolant/antifreeze

**Volume** 5 cyl. non-turbo

8.5 US qts. (8.0 liters)

5 cyl. turbo

9.3 US qts (8.8 liters)

The thermostat begins to open at 194°F (90° C).

pg. 167 Specifications

## Three way catalytic converter

### Three-way catalytic converter cautions

- Keep your engine properly tuned. Certain engine malfunctions, particularly involving the electrical, fuel or distributor ignition systems, may cause unusually high three-way catalytic converter temperatures. Do not continue to operate your vehicle if you detect engine misfire, noticeable loss of power or other unusual operating conditions, such as engine overheating or backfiring. A properly tuned engine will help avoid malfunctions that could damage the three-way catalytic converter.
- Do not park your car over combustible materials, such as grass or leaves, which can come into contact with the hot exhaust system and cause such materials to ignite under certain wind and weather conditions.
- Excessive starter cranking (in excess of one minute), or an intermittently firing or flooded engine can cause three-way catalytic converter or exhaust system overheating.
- Remember that tampering or unauthorized modifications to the engine, the Electronic Control Module, or the vehicle may be illegal and can cause three-way catalytic converter or exhaust system overheating. This includes:
  - Altering fuel injection setting or components.
  - Altering emission system components or location or removing components.
  - Repeated use of leaded fuel.

**NOTE:** Unleaded fuel is required for cars with three-way catalytic converters.

pg. 168 Specifications

## Suspension

### Rear suspension

Individual rear wheel suspension with longitudinal support arms, double link arms and track rods.

### Front suspension

Spring strut suspension with integrated shock absorbers and control arms linked to the support frame. Power-assisted rack and pinion steering. Safety type steering column.

pg. 169 Specifications

## Bulbs

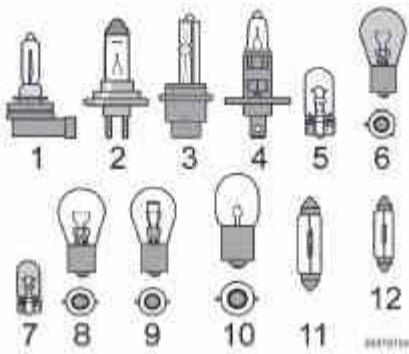

| <b>Bulbs</b>  | <b>Type</b> | <b>Socket</b> |
|---|-------------|---------------|
| 1. High beam  | H9 65W      |               |
| 2. Low beam   | H11 55W     |               |
| 3. Bi-Xenon headlight (option)  | D2R 35W     |               |
| 4. Front foglights  | H1 55       |               |
| 4. Front foglights (S60 R)  | H3 55W      |               |
| 5. Front parking lights, front side marker lights, rear footwell lighting, license plate lighting | W5W         | W2.1x9.5d     |
| 6. Front/rear turn signals (amber)  | PY21W       | BAU15s        |
| 7. Side turn signals  | WY5W        | W2.1x9.5d     |
| 8. Brake lights, backup lights, rear foglight   | P21W        | BA15s         |
| 9. Rear parking light   | P21/4W      | BAZ15d        |
| 10. Rear parking light  | R5W         | BA15s         |
| 10. Rear side marker light  | R10W        | BA15s         |
| 11. License plate lighting  | WW5         | SV8.5         |
| 11. Front footwell lighting, cargo area lighting  | C5W         | SV8.5         |
| 12. Vanity mirror   | 1.2W        | SV5.5         |

**⚠ WARNING!**

Bi-Xenon headlights (option) - due to the high voltage used by these headlights, these bulbs should only be replaced by an authorized Volvo service technician.

pg. 170 Specifications

## Electrical system

12-volt system with voltage controlled generator. Single wire system in which the chassis and engine block are used as conductors, grounded on the chassis.

### Battery

|                           |         |
|---------------------------|---------|
| Voltage                   | 12 V    |
| Cold start capacity (CCA) | 600 A   |
| Reserve capacity (RC)     | 115 min |

If you must replace your battery, be sure to replace it with a battery of the same cold start capacity and reserve capacity as the original (See the decal on the battery).

|                               |       |
|-------------------------------|-------|
| <b>Generator max. current</b> | 140 A |
|-------------------------------|-------|

|                             |                             |
|-----------------------------|-----------------------------|
| <b>Starter motor, power</b> | 1.4 kW                      |
| <b>Spark plugs</b>          | P/N272313-8 or equivalent   |
| - Gap                       | 0.028- 0.032 in. 0.7-0.8 mm |
| - Tightening torque         | 22 ft. lbs. (30 Nm)         |
| - Firing order              | 1-2-4-5-3                   |

**⚠ WARNING!**

The distributor ignition system operates at very high voltages. Special safety precautions must be followed to prevent injury. Always turn the ignition off when:

- Replacing distributor ignition components e.g. plugs, coil, etc.
- Do not touch any part of the distributor ignition system while the engine is running. This may result in unintended movements and body injury.

pg. 171 Specifications

## Engine specifications

|                                     | <b>B5244S</b>        | <b>B5244T5</b>      | <b>B5254T2</b>       | <b>B5254T4</b>       |
|-------------------------------------|----------------------|---------------------|----------------------|----------------------|
| Output (kW/rps)                     | 123/100              | 191/92              | 154/83               | 220/92*              |
| (hp/rpm)                            | 165/6000             | 257/5500            | 208/5000             | 300/5500*            |
| Torque (Nm/rps)                     | 225/75               | 330/42-87           | 320/25-75            | 400/31-95**          |
| (ft. lbs./rpm)                      | 166/4500             | 258/2100-5000       | 236/1500-4500        | 295/1950-5250**      |
| No. of cylinders                    | 5                    | 5                   | 5                    | 5                    |
| Bore (in/mm)                        | 3.27/83              | 3.19/81             | 3.19/81              | 3.27/83              |
| Stroke (in/mm)                      | 3.54/90              | 3.67/93.2           | 3.67/93.2            | 3.67/93.2            |
| Cylinder displacement, <sup>1</sup> | 2.44 (148.6 cu. in.) | 2.4 (146.5 cu. in.) | 2.52 (153.8 cu. in.) | 2.52 (153.8 cu. in.) |
| Compression ratio                   | 10.3:1               | 8.5:1               | 9.0:1                | 8.5:1                |

### Charge air cooler (Intercooler)

Turbocharged engines employ a turbo-compressor to force air into the engine inlet manifold and a charge air cooler to cool the compressed inlet air. The resulting increase in air flow raises pressure in the intake manifold and increases engine power over that developed by the normally-aspirated engine. The charge air cooler (which resembles a radiator) is located between the turbo-compressor and inlet manifold.

### Fuel system

The engine is equipped with a multiport fuel injection system.

\* Automatic transmission: 220 kW at 100 rps, 300 hp at 6000 rpm

\*\* Automatic transmission: 350Nm at 32-100 rps, 258 ft. lbs at 1850-6000 rpm

pg. 172 Specifications

## Volvo On Call Roadside Assistance

Your new Volvo comes with a four year ON CALL roadside assistance. Additional information, features, and benefits are described in a separate information package in your glove compartment.

If you have misplaced your package, dial:

In the U.S.A.

1-800-638-6586 (1-800-63-VOLVO)

In Canada:

1-800-263-0475

### **Technician certification**

In addition to Volvo factory training, Volvo supports certification by the National Institute for Automotive Excellence (A.S.E.). Certified technicians have demonstrated a high degree of competence in specific areas. Besides passing exams, each technician must also have worked in the field for two or more years before a certificate is issued. These professional technicians are best able to analyze vehicle problems and perform the necessary service procedures to keep your Volvo at peak operating condition.



[Contents](#) | [Top of Page](#)

# 2005 VOLVO S60

## Audio

pg. 173 Audio

|   |                     |
|---|---------------------|
| Introduction                              | <a href="#">174</a> |
| Audio system HU-650 - overview            | <a href="#">175</a> |
| Audio system HU-850 - overview            | <a href="#">176</a> |
| Radio functions HU-650/HU-850             | <a href="#">177</a> |
| RBDS functions HU-650/HU-850              | <a href="#">181</a> |
| HU-650 - CD player                        | <a href="#">184</a> |
| HU-850 - internal CD changer              | <a href="#">185</a> |
| External CD changer (option)              | <a href="#">186</a> |
| Dolby Surround Pro Logic II - HU-850 only | <a href="#">187</a> |
| Audio systems - specifications            | <a href="#">189</a> |
| HomeLink® Universal Transceiver (option ) | <a href="#">190</a> |

pg. 174 Audio

### Introduction

The audio system in your car is operated with the buttons and knobs in the system's front panel. Certain functions, such as adjusting the volume, changing radio stations or tracks on a CD, etc, can also be controlled with the optional steering wheel-mounted keypad.

The audio system is available in two versions:

#### HU-650

Features: AM/FM radio, single-disc CD player, 4x25W output, six speakers.

#### HU-850

Features: AM/FM radio, integrated 6-disc CD changer, 4x50W or 4x70W output plus 25W Dolby Pro Logic II, eleven speakers. A subwoofer mounted under the floor in the cargo area is available as an option. Consult your Volvo retailer.

### Compact disc care

- Before using a new disc for the first time, remove any burrs in the center/outer edge by running the stem of a pen or similar object around the hole/edge of the disc.
- Use high quality discs only.
- Keep the discs clean. Wipe them with a soft, clean, lint-free cloth, working from the center outwards. If necessary, dampen the cloth with a neutral soap solution. Dry thoroughly before using.
- Never use cleaning spray or antistatic liquid. Use only cleaners specifically made for CDs.
- Use discs of the correct size only (3.5" discs should never be used). The discs should conform to the norms EN60908 (IEC60908).
- Do not put tape or labels on the disc itself.

Volvo does not recommend the use of plastic outer rings on the disc.

- Condensation may occur on discs/optical components of the changer in cold winter weather. The disc can be dried with a clean, lint-free cloth. Optical components in the CD changer may, however, take up to one hour to dry off.
- Never attempt to play a disc which is damaged in any way.
- When not in use, the discs should be stored in their covers. Avoid storing discs in excessive heat, direct sunlight or dusty locations.

pg. 175 Audio

## Audio system HU-650 - overview



1. On/off - press Volume - turn
2. Buttons for selecting stored radio stations/discs in optional CD changer
3. Bass (press to release control and turn to adjust)
4. Treble (press to release control and turn to adjust)
5. Balance (left/right) - press to release control and turn to adjust
6. Fader (front/rear) - press to release control and turn to adjust
7. Source/Menu Press to open main menu  
Turn to select FM, AM, CD, CD changer (option)
8. Scan function (automatically search for radio stations)
9. Exit (exit the menu)
10. Navigation buttons (seek/change radio station or CD track)
11. CD eject
12. CD slot
13. CD random play
14. FM (select FM1, FM2, FM3)
15. AM (select AM1 or AM2)
16. CD player
17. AUTO - automatically search for radio stations
18. Display

pg. 176 Audio

## Audio system HU-850 - overview



1. On/off - press Volume - turn
2. Buttons for selecting stored radio stations/discs in optional CD changer
3. Bass (press to release control and turn to adjust)
4. Treble (press to release control and turn to adjust)
5. Balance (left/right) - press to release control and turn to adjust
6. Fader (front/rear) - press to release control and turn to adjust
7. Source/Menu Press to open main menu Turn to select FM, AM, CD, CD changer (option)
8. Scan function (automatically search for radio stations)
9. Exit (exit the menu)
10. Navigation buttons (seek/change radio station or CD track)
11. CD eject
12. Dolby Surround Pro Logic II
13. 2-channel stereo
14. 3-channel stereo
15. CD slot
16. CD random play
17. FM (select FM1, FM2, FM3)
18. AM (select AM1 or AM2)
19. CD player
20. AUTO - automatically search for radio stations
21. Display

pg. 177 Audio

## Radio functions HU-650/HU-850



### Switch on/off

Press the knob to switch on or turn off the radio.

### Volume control

Turn the knob clockwise to increase volume. Volume control is electronic and does not have an end stop. If you have a key pad in the steering wheel, increase or decrease the volume with the + or - buttons.



## Volume control - ALARM

If a CD is playing when the radio receives an alarm bulletin (available in certain areas only), the CD player enters pause mode. The bulletin is broadcast at the volume selected for this type of message.

After the bulletin has been completed, the audio system reverts to the originally selected sound.



## Sound settings

### Bass

Adjust the bass by pressing the button to extend the control and turning it to the left (less bass) or to the right (more bass). A "detent" indicates "equalized" bass. Press the button back in when you have made the adjustment.

### Treble

Adjust the treble by pressing the button to extend the control and turning it to the left (less treble), or to the right (more treble). A "detent" indicates "equalized" treble. Press the button back in when you have made the adjustment.

### Fader - Balance front/rear

Adjust front/rear speaker balance by pressing the button to extend the control and turning it to the left (more sound from the rear speakers) or to the right (more sound from the front speakers). A "detent" indicates "equalized" balance. Press the button back in when you have made the adjustment.

### Balance right/left

Adjust left/right speaker balance by pressing the button to extend the control, and turning it to the left (more sound from the left speakers) or to the right (more sound from the right speakers). A "detent" indicates "equalized" balance. Press the button back in when you have made the adjustment.

### MID EQ level

This function is used to fine-tune the balance of sound in the speakers. To set the level:

1. Press SOURCE.
2. Turn the SOURCE knob, select ADVANCED MENU and press SOURCE.
3. Turn the SOURCE knob, select AUDIO SETTINGS and press SOURCE.
4. Turn the SOURCE knob, select MID EQ LEVEL and press SOURCE.
5. Turn the SOURCE knob, select the desired level and press SOURCE.
6. Press EXIT.

## Radio functions HU-650/HU-850 (contd)



## Selecting a sound source

The sound source (e.g. AM, FM, etc.) can be selected in two ways:

- Use the sound source buttons (see the center illustration above).
- Turn the SOURCE knob (see illustration above) to select a sound source (AM1, AM2, FM1, FM2, FM3, or CD). Press the knob to select the AM or FM band of your choice.

The sound source selected will be shown in the display.





## Scan



Press the SCAN button to start the station scan function. When a station is found, scanning stops for approximately 10 seconds, after which scanning will continue.



Press the SCAN or SOURCE button when a station has been found if you would like to listen to that station and to discontinue the scan function.

## Station seek up/down

Press  or  to start the seek function. The radio seeks the next audible station and tunes it in. Repeat the procedure to continue the seek function.

## Manual station search

Press  or  and hold it down. MAN will be shown in the display. The radio scans slowly in the selected direction and will increase the scanning speed after a few seconds. Release the button when the desired frequency appears in the display.

The frequency can be fine-tuned by short presses on the  or  keys.

The system will remain in manual search mode for 5 seconds after the button is released, after which it will return to seek mode.

pg. 179 Audio



## Steering wheel key pad (option)

If the vehicle is equipped with the key pad in the steering wheel press the right or left arrow to switch between preset stations.



### Storing stations

To store a selected station under one of the station setting buttons 1-6:

1. Tune to the desired station.
  2. Press the button under which the station is to be stored and keep it depressed. The audio system sound will be interrupted for a few seconds and STORED will appear in the display. The station is now stored.
- A total of 30 stations can be stored; 6 stations each in AM1, AM2, FM1, FM2, and FM3.

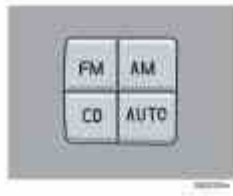

### Storing stations automatically

This function automatically searches for and stores up to 10 strong AM or FM stations in a separate memory. If more than ten stations are found, the ten strongest ones are stored. This function is especially useful in areas in which you are not familiar with radio stations or their frequencies.

To use the AUTO function:

1. Select radio mode using the AM or FM buttons, or by turning the SOURCE knob.
2. Start the search by pressing AUTO for more than 2 seconds.
3. AUTO appears in the display and a number of stations with strong signals (max. 10) from the selected frequency band will be

pg. 180 Audio

## Radio functions HU-650/HU-850 (contd)

stored in the auto-store memory. If there are no stations with sufficient signal strength, NO STATION is displayed.

4. Press the AUTO button or the arrow keys on the optional steering wheel controls briefly to select the stored stations.

When the radio is in auto-store mode, AUTO is shown in the display. AUTO disappears when you return to the normal radio mode.

Return to the normal radio mode by pressing the AM, FM, or EXIT button.

To return to the Auto-store mode, press the AUTO button briefly.

pg. 181 Audio

## RBDS functions HU-650/HU-850

## **Radio Broadcast Data System - RBDS**

This feature, which may not be available in your area, functions only with FM broadcasts. The radio in your car is equipped with an advanced system allowing information from broadcasters to be transmitted visually, as text, together with the audio signal. This information is then decoded by the radio and made available for several new and unique features.

The RBDS or Radio Broadcast Data System operates in the FM band only, and the information transmitted is supplied exclusively by participating broadcasters. Volvo has no control over the accuracy of the data or information.

Coverage by local broadcasters may be limited at this time, but as the technology and benefits grow, you will find the radio in your car is equipped to take advantage of this system.

### **PI (Program Information) Seek:**

When an FM station has been stored as a preset, the radio also stores RBDS program information if it is available. When the preset is selected at a later time, the radio tries to access updated program information. In weak signal areas, there may be a delay before the station becomes audible. During this delay, "PI seek" will be displayed and there will be no sound.

PI seek can be interrupted by pressing EXIT.

### **Radio text**

Certain RBDS stations broadcast program information, which can be shown in the display. The text will be shown twice in the display.

### **To start this function:**

Press the FM button for several seconds.

### **To deactivate this function:**

Press FM briefly.

Station information will be shown twice in the display.

### **Alarm**

Alarms bulletins are transmitted automatically by certain RBDS stations. The function cannot be deactivated.

"Alarm!" is shown in the radio display when an alarm message is sent. The function is used to warn motorists of serious accidents, etc.

pg. 182 Audio

## **Program type/station format -PTY**

The PTY function allows you to find stations whose programs suit your taste. Use the PTY function to select among the different station formats shown in the list.

To select a station format:

1. Select radio mode using the FM button, or by turning the SOURCE knob.
2. Turn the SOURCE knob, select PTY and press SOURCE.
3. Turn the SOURCE knob, select a station format from the list and press SOURCE to confirm the selected station format. The PTY (station format) of the selected station is now shown in the display.

**NOTE:** Not all RBDS radio stations have PTY designations.

Station formats

| <b>Format</b> | <b>Display text</b> |
|---------------|---------------------|
|---------------|---------------------|

|                    |           |
|--------------------|-----------|
| Off                | PTY OFF   |
| News               | NEWS      |
| Current affairs    | AFFAIRS   |
| Information        | INFO      |
| Sports             | SPORT     |
| Education          | EDUCATION |
| Drama              | DRAMA     |
| Art and culture    | CULTURE   |
| Science            | SCIENCE   |
| Entertainment      | VARIED    |
| Pop music          | POP M     |
| Rock music         | ROCK M    |
| Easy listening     | EASY M    |
| Light classics     | LIGHT M   |
| Classical music    | CLASSICS  |
| Other music        | OTHER M   |
| Weather            | WEATHER   |
| Finance            | FINANCE   |
| Religious programs | RELIGION  |
| Travel             | TRAVEL    |
| Leisure            | LEISURE   |
| Jazz music         | JAZZ      |
| Country music      | COUNTRY   |
| National music     | NATION M  |
| Oldies             | "OLDIES"  |
| Folk music         | FOLK M    |
| Documentary        | DOCUMENT  |



# 2005 VOLVO S60

## Index

pg. 195 Index

### A

|  |  |
|--|--|
| A/C (air conditioning)                   | <a href="#">54</a> , <a href="#">57</a>                      |
| ABS                                      | <a href="#">ii</a> , <a href="#">27</a> , <a href="#">99</a> |
| Adjustable steering wheel                | <a href="#">33</a>   |
| Air bags - dual threshold/stage          | <a href="#">8</a>  |
| Air distribution                         | <a href="#">51</a> , <a href="#">54</a> , <a href="#">58</a> |
| Air quality sensor                       | <a href="#">55</a>   |
| Air vents                                | <a href="#">51</a>   |
| Airbag - Side Impact (SIPS)              | <a href="#">12</a>   |
| Airbags                                  | <a href="#">4</a>  |
| Alarm                                    | <a href="#">73</a> , <a href="#">80</a>                      |
| All Wheel Drive                          | <a href="#">96</a>   |
| All Wheel Drive - towing                 | <a href="#">103</a>  |
| Anti-lock Brake System (ABS)             | <a href="#">ii</a> , <a href="#">27</a>                      |
| Approach lighting                        | <a href="#">36</a>   |
| Ashtray                                  | <a href="#">42</a>   |
| Audio                                    | <a href="#">173</a>  |
| AUTO (climate control)                   | <a href="#">53</a>   |
| Automatic Climate Control, ECC           | <a href="#">52</a>   |
| Automatic gearbox                        | <a href="#">89</a>   |
| Automatic transmission                   | <a href="#">92</a>   |
| Automatic transmission - adaptive system | <a href="#">93</a>   |
| Automatic transmission - kickdown        | <a href="#">93</a>   |
| Automatic transmission - Sport mode      | <a href="#">95</a>   |
| Average speed                            | <a href="#">39</a>   |
| AWD                                      | <a href="#">96</a>   |

### B

|                              |   |
|------------------------------|---|
| Back up light                | <a href="#">153</a>   |
| Backrest, rear seat, folding | <a href="#">69</a>  |
| Battery                      | <a href="#">138</a> , <a href="#">146</a> , <a href="#">170</a> |
| Battery - replacing          | <a href="#">147</a>   |
| Belt check                   | <a href="#">139</a>   |
| Blower (fan)                 | <a href="#">53</a> , <a href="#">57</a>                         |
| Booster cushion (integrated) | <a href="#">20</a>  |

|  |   |
|--|---|
| Brake circuit                                | <a href="#">98</a>                        |
| Brake fluid                                  | <a href="#">144</a>                       |
| Brake light                                  | <a href="#">153</a>                       |
| Brake system                                 | <a href="#">27</a> , <a href="#">98</a>   |
| Bulbs  | <a href="#">149</a>                       |
| <b>C</b>                                     |   |
| Capacities                                   | <a href="#">165</a>                       |
| Capacity weight                              | <a href="#">122</a>                       |
| Carbon Monoxide - Important Warning          | <a href="#">85</a>                        |
| Catalytic converter                          | <a href="#">167</a>                       |
| Ceiling lighting                             | <a href="#">155</a>                       |
| Central locking system - remote control      | <a href="#">75</a>                        |
| Changing coolant                             | <a href="#">139</a>                       |
| Changing oil and oil filter                  | <a href="#">141</a>                       |
| Changing wheels                              | <a href="#">126</a>                       |
| Check Engine warning light                   | <a href="#">29</a>                        |
| Child restraint anchorages                   | <a href="#">22</a>                        |
| Child safety                                 | <a href="#">18</a>                        |
| Child safety locks                           | <a href="#">79</a>                        |
| Child seat anchors                           | <a href="#">19</a>                        |
| Cigarette lighter                            | <a href="#">42</a>                        |
| Climate control systems -general information | <a href="#">50</a>                        |
| Clock  | <a href="#">26</a>                        |
| Coat hanger                                  | <a href="#">68</a>                        |
| Cold weather precautions                     | <a href="#">110</a>                       |
| Coolant                                      | <a href="#">143</a>                       |
| Coolant - changing                           | <a href="#">139</a> , <a href="#">143</a> |
| Coolant - checking level of                  | <a href="#">139</a>                       |
| Cooling system                               | <a href="#">166</a>                       |
| Courtesy light                               | <a href="#">64</a>                        |
| Cruise control                               | <a href="#">40</a>                        |
| Curb weight                                  | <a href="#">122</a>                       |
| Current fuel consumption                     | <a href="#">39</a>                        |
| <b>D</b>                                     |   |
| Defroster                                    | <a href="#">53</a>                        |
| Door mirror defroster                        | <a href="#">38</a>                        |
| Door mirrors                                 | <a href="#">32</a>                        |
| Driving economically                         | <a href="#">89</a>                        |
| DSTC   | <a href="#">31</a>                        |
| Dual-threshold airbags                       | <a href="#">8</a>                         |
| <b>E</b>                                     |   |
| ECC  | <a href="#">52</a>                        |
| Economical driving                           | <a href="#">89</a>                        |
| Electric socket                              | <a href="#">32</a> , <a href="#">42</a>   |

|                                 |                        |
|---------------------------------|------------------------|
| Electrical system               | <a href="#">170</a>    |
| Electrically operated moonroof  | <a href="#">47</a>     |
| Electrically operated windows   | <a href="#">43</a>     |
| Engine - starting               | <a href="#">87</a>     |
| Engine compartment              | <a href="#">140</a>    |
| Engine oil                      | <a href="#">141</a>    |
| Engine oil - checking           | <a href="#">142</a>    |
| Engine oil, capacity            | <a href="#">165</a>    |
| Engine specifications           | <a href="#">171</a>    |
| Environment                     | <a href="#">iii</a>    |
| <b>F</b>                        |                        |
| Federal Clean Air Act           | <a href="#">136</a>    |
| FIX NEXT SERVICE                | <a href="#">30</a>     |
| Floor mats                      | <a href="#">65</a>     |
| Fog lamp                        | <a href="#">29</a>     |
| Fog light, rear                 | <a href="#">153</a>    |
| Front fog light, changing       | <a href="#">152</a>    |
| Front fog lights                | <a href="#">34</a>     |
| Front park assist               | <a href="#">112</a>    |
| Front seat - backrest           | <a href="#">61</a>     |
| Front seats                     | <a href="#">60</a>     |
| Front seats - heated            | <a href="#">38</a>     |
| Front seats - manual adjustment | <a href="#">60</a>     |
| Front seats - power             | <a href="#">62</a>     |
| Front suspension                | <a href="#">168</a>    |
| Fuel                            | <a href="#">84</a>     |
| Fuel filler cap                 | <a href="#">ii, 86</a> |
| Fuel filler door                | <a href="#">ii, 86</a> |
| Fuel filler door - unlocking    | <a href="#">34</a>     |
| Fuel Formulations               | <a href="#">85</a>     |
| Fuel gauge                      | <a href="#">26</a>     |
| Fuel tank, capacity             | <a href="#">165</a>    |
| Fuses                           | <a href="#">156</a>    |
| <b>G</b>                        |                        |
| Gasoline                        | <a href="#">84</a>     |
| Gear position                   | <a href="#">91</a>     |
| Geartronic                      | <a href="#">94</a>     |
| Geartronic - kickdown           | <a href="#">95</a>     |
| Geartronic - manual shifting    | <a href="#">95</a>     |
| General information             | <a href="#">ii</a>     |
| Generator                       | <a href="#">170</a>    |
| Generator warning light         | <a href="#">29</a>     |
| Glossary of tire terminology    | <a href="#">121</a>    |
| Glove compartment               | <a href="#">68</a>     |



|                                 |  |
|---------------------------------|--|
| Grocery bag holder              | <a href="#">70</a>   |
| Gross vehicle weight (GVW)      | <a href="#">122</a>  |
| <b>H</b>                        |  |
| Handling                        | <a href="#">90</a>   |
| Hazard warning flashers         | <a href="#">38</a>   |
| Head restraint - center, rear   | <a href="#">70</a>   |
| Headlight flasher               | <a href="#">36</a>   |
| Headlight wiper blades          | <a href="#">145</a>  |
| Headlights                      | <a href="#">34</a>   |
| Heated front seats              | <a href="#">38</a> , <a href="#">54</a> , <a href="#">57</a> |
| High beam "flash"               | <a href="#">36</a>   |
| High beam indicator             | <a href="#">26</a>   |
| Hoisting the car                | <a href="#">138</a>  |
| HomeLink® Universal Transceiver | <a href="#">190</a>  |
| Hood - opening                  | <a href="#">140</a>  |
| <b>I</b>                        |  |
| Ignition switch                 | <a href="#">88</a>   |
| Immobilizer (start inhibitor)   | <a href="#">74</a>   |
| Indicator and warning symbols   | <a href="#">26</a> , <a href="#">27</a>                      |
| Inflatable Curtain              | <a href="#">14</a>   |
| Inflation pressure tables       | <a href="#">117</a>  |
| Inflation pressure, checking    | <a href="#">116</a>  |
| Instrument lighting             | <a href="#">34</a>   |
| Instrument panel                | <a href="#">26</a>   |
| Integrated booster cushion      | <a href="#">20</a>   |
| Interior                        | <a href="#">59</a>   |
| Interior lighting               | <a href="#">64</a>   |
| Introduction                    | <a href="#">i</a>  |
| ISOFIX/LATCH anchors            | <a href="#">19</a>   |
| <b>J</b>                        |  |
| Jack                            | <a href="#">127</a>  |
| Jack, location of               | <a href="#">71</a>   |
| Jump starting                   | <a href="#">104</a>  |
| <b>K</b>                        |  |
| Keylock                         | <a href="#">ii</a> , <a href="#">87</a>                      |
| Keys                            | <a href="#">73</a>   |
| Kickdown                        | <a href="#">93</a>   |
| <b>L</b>                        |  |
| LATCH (ISOFIX) anchors          | <a href="#">19</a>   |
| LED illumination                | <a href="#">36</a>   |
| Lighting panel                  | <a href="#">34</a>   |
| Load carriers                   | <a href="#">109</a>  |
| Locking steering wheel          | <a href="#">88</a>   |
| Locking the car                 | <a href="#">77</a>   |

|  |   |
|--|---|
| Locks  | <a href="#">73</a>                      |
| Long distance trips                          | <a href="#">111</a>                     |
| Long loads - carrying                        | <a href="#">70</a>                      |
| Low beam bulb                                | <a href="#">150</a>                     |
| Lubricants                                   | <a href="#">166</a>                     |
| <b>M</b>                                     |   |
| Maintenance service                          | <a href="#">136</a>                     |
| Malfunction indicator light                  | <a href="#">29</a>                      |
| Manual climate control with air conditioning | <a href="#">56</a>                      |
| Manual transmission                          | <a href="#">91</a>                      |
| Messages in the display                      | <a href="#">30</a>                      |
| Moonroof                                     | <a href="#">47</a>                      |
| Multifilter with air quality sensor          | <a href="#">55</a>                      |
| <b>O</b>                                     |   |
| Occupant safety                              | <a href="#">24</a>                      |
| Octane rating                                | <a href="#">84</a>                      |
| Odometer                                     | <a href="#">26</a>                      |
| Oil pressure                                 | <a href="#">29</a>                      |
| Oil quality                                  | <a href="#">141</a>                     |
| Oil viscosity                                | <a href="#">141</a>                     |
| Opening the trunk from the inside            | <a href="#">78</a>                      |
| Opening/locking the trunk                    | <a href="#">77</a>                      |
| <b>P</b>                                     |   |
| P Park                                       | <a href="#">92</a> , <a href="#">94</a> |
| Paint - color code                           | <a href="#">133</a>                     |
| Park assist                                  | <a href="#">112</a>                     |
| Parking brake                                | <a href="#">29</a> , <a href="#">42</a> |
| Parking light bulb, changing                 | <a href="#">151</a>                     |
| Parking lights                               | <a href="#">34</a>                      |
| Pen holder                                   | <a href="#">68</a>                      |
| Permissible axle weight                      | <a href="#">122</a>                     |
| Polishing                                    | <a href="#">131</a>                     |
| Power moonroof                               | <a href="#">47</a>                      |
| Power seat                                   | <a href="#">62</a>                      |
| Power steering fluid                         | <a href="#">144</a>                     |
| Power steering, speed sensitive              | <a href="#">90</a>                      |
| PremAir                                      | <a href="#">iii</a>                     |
| PROPOSITION 65 WARNING                       | <a href="#">104</a>                     |
| <b>R</b>                                     |   |
| Radiator                                     | <a href="#">140</a>                     |
| Radio  | <a href="#">177</a>                     |
| Rain sensor - windshield wipers              | <a href="#">37</a>                      |
| Reading lights                               | <a href="#">64</a>                      |
| Rear fog lights                              | <a href="#">35</a>                      |

|   |   |
|---|---|
| Rear park assist                          | <a href="#">112</a>                       |
| Rear seat, folding backrests              | <a href="#">69</a>                        |
| Rear suspension                           | <a href="#">168</a>                       |
| Rear window defroster                     | <a href="#">38</a> , <a href="#">57</a>   |
| Rearview mirror/door mirrors              | <a href="#">45</a>                        |
| Recirculation                             | <a href="#">54</a> , <a href="#">58</a>   |
| REDUCE SPEED                              | <a href="#">30</a>                        |
| Refrigerant (A/C system)                  | <a href="#">50</a>                        |
| Refueling                                 | <a href="#">83</a> , <a href="#">86</a>   |
| Remote control - central locking system   | <a href="#">75</a>                        |
| Replacing the battery                     | <a href="#">147</a>                       |
| Reporting safety defects                  | <a href="#">24</a>                        |
| Roadholding                               | <a href="#">90</a>                        |
| Roof racks (load carriers)                | <a href="#">109</a>                       |
| Run flat tires                            | <a href="#">119</a>                       |
| <b>S</b>                                  |   |
| Safety                                    | <a href="#">1</a>                         |
| Safety defects - reporting                | <a href="#">24</a>                        |
| Safety system warning light               | <a href="#">6</a>                         |
| Seat belt                                 | <a href="#">2</a>                         |
| Seat belt maintenance                     | <a href="#">24</a>                        |
| Seat belt reminder                        | <a href="#">45</a>                        |
| Seat belts (keeping child seats in place) | <a href="#">23</a>                        |
| SEE MANUAL                                | <a href="#">30</a>                        |
| Self supporting run flat tires            | <a href="#">119</a>                       |
| Service                                   | <a href="#">136</a>                       |
| Service key                               | <a href="#">74</a>                        |
| Service reminder                          | <a href="#">29</a>                        |
| SERVICE REQUIRED                          | <a href="#">30</a>                        |
| SERVICE URGENT                            | <a href="#">30</a>                        |
| Shiftlock                                 | <a href="#">ii</a> , <a href="#">87</a>   |
| Side airbags                              | <a href="#">12</a>                        |
| Side marker lamp                          | <a href="#">153</a>                       |
| Side marker light, changing               | <a href="#">152</a>                       |
| SIPS airbags                              | <a href="#">12</a>                        |
| Ski hatch                                 | <a href="#">70</a>                        |
| Snow chains                               | <a href="#">124</a> , <a href="#">126</a> |
| Snow tires                                | <a href="#">124</a>                       |
| Spare wheel                               | <a href="#">70</a>                        |
| Spark plugs                               | <a href="#">170</a>                       |
| Specifications                            | <a href="#">161</a>                       |
| Speedometer                               | <a href="#">26</a>                        |
| Sport mode                                | <a href="#">95</a>                        |
| SRS                                       | <a href="#">4</a>                         |

|   |                     |
|---|---------------------|
| Stability systems                                   | <a href="#">100</a> |
| Stability Traction Control (STC)                    | <a href="#">100</a> |
| Start inhibitor (immobilizer)                       | <a href="#">74</a>  |
| Starting the car                                    | <a href="#">87</a>  |
| STC   | <a href="#">31</a>  |
| Steering wheel adjustment                           | <a href="#">33</a>  |
| Steering wheel lock                                 | <a href="#">88</a>  |
| Stone chips, touching up                            | <a href="#">133</a> |
| STOP ENGINE   | <a href="#">30</a>  |
| Storage compartments                                | <a href="#">67</a>  |
| Studded tires                                       | <a href="#">124</a> |
| Sun visor   | <a href="#">47</a>  |
| Supplemental Restraint System (SRS)                 | <a href="#">4</a>   |
| Supplemental Restraint System (SRS) - warning light | <a href="#">29</a>  |
| Suspension  | <a href="#">168</a> |
| Switches in the center console                      | <a href="#">31</a>  |
| <b>T</b>  |                     |
| Tachometer  | <a href="#">26</a>  |
| Temperature control                                 | <a href="#">53</a>  |
| Temperature gauge                                   | <a href="#">26</a>  |
| Text window - messages                              | <a href="#">30</a>  |
| TIME FOR REGULAR SERVICE                            | <a href="#">30</a>  |
| Tire designations                                   | <a href="#">120</a> |
| Tires economy - improving                           | <a href="#">114</a> |
| Tires inflation                                     | <a href="#">115</a> |
| Tire inflation pressure tables                      | <a href="#">117</a> |
| Tire inflation pressure, checking                   | <a href="#">116</a> |
| Tire pressure monitoring system                     | <a href="#">29</a>  |
| Tire Pressure Monitoring System (TPMS)              | <a href="#">118</a> |
| Tire terminology, glossary of                       | <a href="#">121</a> |
| Tires - tread wear indicators                       | <a href="#">126</a> |
| Towing - cars with All Wheel Drive                  | <a href="#">103</a> |
| Towing a trailer                                    | <a href="#">105</a> |
| Towing the car                                      | <a href="#">102</a> |
| Trailer indicator lamp                              | <a href="#">29</a>  |
| Trailer towing                                      | <a href="#">105</a> |
| Transmission - automatic                            | <a href="#">92</a>  |
| Transmission - Geartronic                           | <a href="#">94</a>  |
| Transmission - manual                               | <a href="#">91</a>  |
| Tread wear indicator                                | <a href="#">114</a> |
| Trip computer                                       | <a href="#">39</a>  |
| Trip odometer                                       | <a href="#">26</a>  |
| Trunk   | <a href="#">69</a>  |
| Trunk - opening from the inside                     | <a href="#">78</a>  |

|                                       |   |
|---------------------------------------|---|
| Trunk - unlocking                     | <a href="#">77</a>                        |
| Turn signals, rear                    | <a href="#">153</a>                       |
| Turn signals                          | <a href="#">36</a>                        |
| Type designations                     | <a href="#">162</a>                       |
| <b>U</b>                              |   |
| Uniform Tire Quality Grading          | <a href="#">123</a> , <a href="#">127</a> |
| Unlocking the car                     | <a href="#">77</a>                        |
| Unlocking the trunk                   | <a href="#">77</a>                        |
| Use of Additives                      | <a href="#">85</a>                        |
| <b>V</b>                              |   |
| Valet key                             | <a href="#">74</a>                        |
| Vanity mirror                         | <a href="#">65</a>                        |
| Vanity mirror bulb, changing          | <a href="#">155</a>                       |
| Vehicle Identification Number (VIN)   | <a href="#">162</a>                       |
| Vehicle loading                       | <a href="#">122</a>                       |
| Vehicle weights                       | <a href="#">164</a>                       |
| VIN (Vehicle Identification Number)   | <a href="#">162</a>                       |
| Volvo and the environment             | <a href="#">iii</a>                       |
| <b>W</b>                              |   |
| W - Winter                            | <a href="#">93</a> , <a href="#">95</a>   |
| Warning light, safety systems         | <a href="#">6</a>                         |
| Warning symbol in center of dashboard | <a href="#">27</a>                        |
| Warranties                            | <a href="#">136</a>                       |
| Washer fluid reservoir                | <a href="#">140</a> , <a href="#">143</a> |
| Washing the car                       | <a href="#">130</a>                       |
| Waxing                                | <a href="#">131</a>                       |
| Weight distribution                   | <a href="#">90</a>                        |
| Weights                               | <a href="#">164</a>                       |
| WHIPS                                 | <a href="#">16</a>                        |
| Windshield washer fluid reservoir     | <a href="#">143</a>                       |
| Windshield wipers                     | <a href="#">37</a>                        |
| Winter/Wet driving mode               | <a href="#">110</a>                       |



# 2005 VOLVO S60

Back Cover

Back Cover

## Accessory Installation - Important Warning

- We strongly recommend that Volvo owners install only genuine, Volvo-approved accessories, and that accessory installations be performed only by the factory-trained technicians at your authorized Volvo retailer.
- Genuine Volvo accessories are tested to ensure compatibility with the performance, safety, and emission systems in your car. Additionally, your authorized Volvo retailer knows where accessories may and may not be safely installed in your Volvo. In all cases, please consult your authorized Volvo retailer before installing any accessory in or on your car.
- Accessories that have not been approved by Volvo may or may not be specifically tested for compatibility with your car. Additionally, an inexperienced installer may not be familiar with some of your car's systems.
- Any of your car's performance and safety systems could be adversely affected if you install accessories that Volvo has not tested, or if you allow accessories to be installed by someone unfamiliar with your car.
- Damage caused by unapproved or improperly installed accessories may not be covered by your new car warranty. See your Warranty and Service Records Information booklet for more warranty information. Volvo assumes no responsibility for death, injury, or expenses that may result from the installation of non-genuine accessories.

## Driver Distraction

- Driver distraction results from driver activities that are not directly related to controlling the car in the driving environment. Your new Volvo is, or can be, equipped with many feature-rich entertainment and communication systems. These include hands-free cellular telephones, navigation systems, and multipurpose audio systems. You may also own other portable electronic devices for your own convenience. When used properly and safely, they enrich the driving experience. Improperly used, any of these could cause a distraction.
- For all of these systems, we want to provide the following warning that reflects the strong Volvo concern for your safety:
  - Never use these devices or any feature of your vehicle in a way that distracts you from the task of driving safely. Distraction can lead to a serious accident. In addition to this general warning, we offer the following guidance regarding specific newer features that may be found in your vehicle:
    - Never use a hand-held cellular telephone while driving. Some jurisdictions prohibit cellular telephone use by a driver while the vehicle is moving.
    - If your car is equipped with a navigation system, set and make changes to your travel itinerary only with the vehicle parked.
    - Never program your audio system while the vehicle is moving. Program radio presets with the vehicle parked, and use your programmed presets to make radio use quicker and simpler.
    - Never use portable computers or personal digital assistants while the vehicle is moving.

A driver has a responsibility to do everything possible to ensure his or her own safety and the safety of passengers in the vehicle and others sharing the roadway. Avoiding distractions is part of that responsibility.

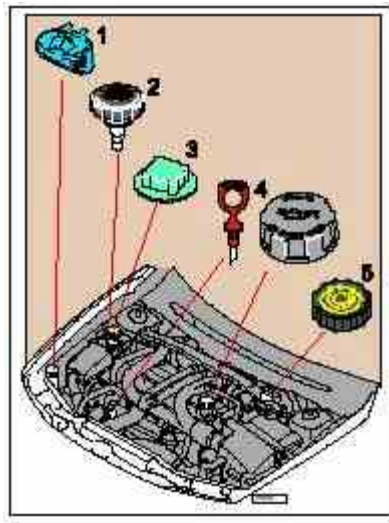

**The following should be checked regularly: \***

- 1 Washer fluid reservoir should be filled with water and solvent (wintertime: windshield washer anti-freeze). See [page 143](#).
- 2 Power steering- When cold, the level must not be above the COLD mark and when hot it must not be above the HOT mark. Top up if the level drops to the ADD mark with ATF fluid. See [page 144](#).
- 3 Coolant level should be between the expansion tank marks. Mixture: 50% anti-freeze and 50% water. See [page 143](#).
- 4 Engine oil level should be between the dipstick marks. The distance between the marks represents approx. 1.6 US qts (1.5 liters). See [page 141](#).
- 5 Brake fluid - check, without removing the cap, that the level is above the MIN mark. Use brake fluid DOT 4+. See [page 144](#).

**Fuel octane rating, see [page 84](#).**

**Tire pressure, see label located on the inside of the fuel tank cover.**

\* Engine oil should be check each time the car is refueled.

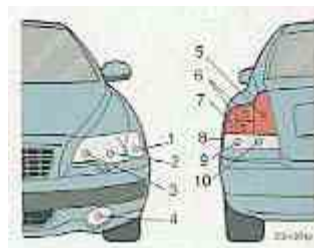

**Bulb no. Name**

- 1 Direction indicator/parking light
- 2 Low beam
- 3 High beam
- 4 Fog light (option)  
\*H3 on R-models
- 5 Fog light
- 6 Tail/parking light
- 7 Brake light
- 8 Side marker light
- 9 Direction indicator
- 10 Backup light

See [pages 149-155](#) for more information on replacing bulbs.

---



[Contents](#) | [Top of Page](#)