

# 2004 VOLVO S80

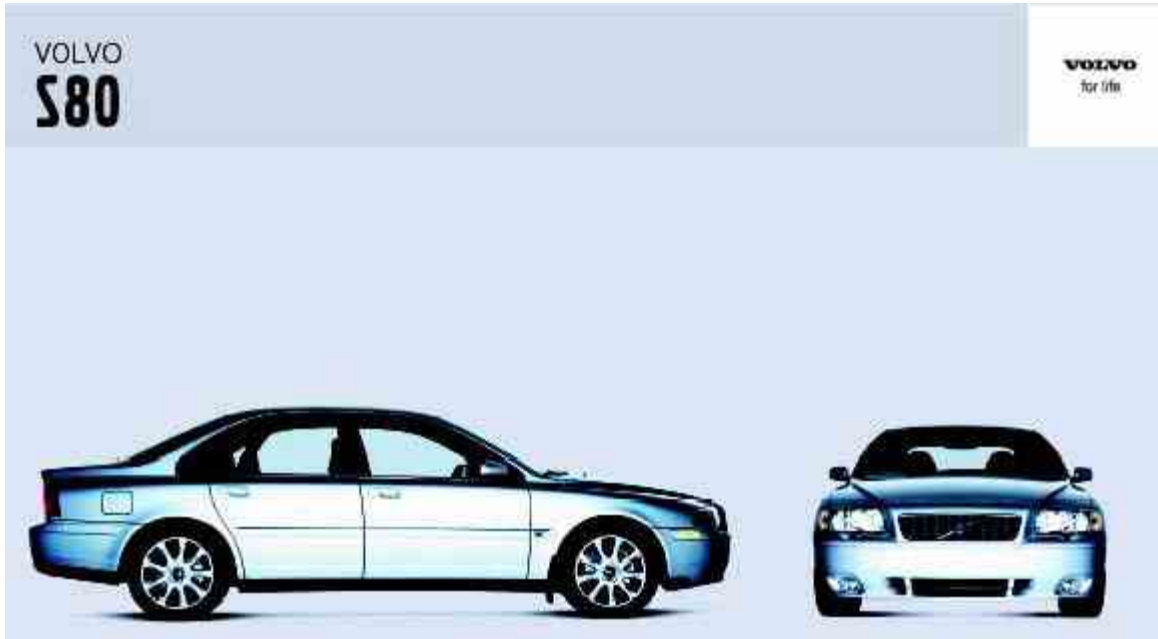

This manual deals with the operation and care of your Volvo.



Welcome to the world-wide family of Volvo owners. We trust that you will enjoy many years of safe driving in your Volvo, an automobile designed with your safety and comfort in mind. To help ensure your satisfaction with this vehicle, we encourage you to familiarize yourself with the equipment descriptions, operating instructions and maintenance requirements/recommendations in this manual. We also urge you and your passengers to wear seat belts at all times in this (or any other) automobile. And, of course, please do not operate a vehicle if you may be affected by alcohol, medication or any impairment that could hinder your ability to drive.

Your Volvo is designed to meet all applicable safety and emission standards, as evidenced by the certification labels attached to the driver's door opening and on the left wheel housing in the engine compartment.

**For further information please contact your retailer, or:**

In the USA:

In Canada:

Volvo Cars of North America  
Customer Relations  
P.O. Box 914  
Rockleigh, New Jersey 07647-0914  
800-458-1552

Volvo Cars of Canada Ltd.  
175 Gordon Baker Road  
North York, Ontario M2H 2N7

We also invite you to visit our Home Page on the Internet at:

<http://www.volvocars.com>

## Contents

### Contents

[Chapter 1 - Safety](#)

[Chapter 2 - Instruments, switches and controls](#)

[Chapter 3 - Climate control system](#)

[Chapter 4 - Interior](#)

[Chapter 5 - Keys, Locks, Alarm](#)

[Chapter 6 - Starting and driving](#)

[Chapter 7 - Wheels and tires](#)

[Chapter 8 - Maintenance/Serviceing](#)

[Chapter 9 - Specifications](#)

[Chapter 10 - Audio systems](#)

[HomeLink® Universal Transceiver \(option\)](#)

[Index](#)

[Back Cover](#)

© 2003 Volvo Cars of North America LLC.

## General information

### Shiftlock

When your car is parked, the gear selector is locked in the (P)ark position. To release the selector from this position, turn the ignition key to position II (or start the engine), depress the brake pedal, press the button on the front side of the gear selector and move the selector from (P)ark.

### Keylock

This means that when you switch off the ignition, the gear selector must be in the (P)ark position before the key can be removed from the ignition switch.

### Anti-lock Brake System (ABS)

The ABS system in your car performs a self-diagnostic test when the vehicle first reaches the speed of approximately 12 mph (20 km/h). The brake pedal will pulsate several times and a sound may be audible from the ABS control

module. This is normal.

### **Fuel filler door**

The fuel filler door, located on the right rear fender, is connected to your car's central locking system.

Press the button on the light switch panel (see [page 32](#)) when the car is at a standstill to unlock the fuel filler door. Please note that the fuel filler door will remain unlocked until the car begins to move forward. An audible click will be heard when the fuel filler door relocks.

### **Fuel filler cap**

After refueling, close the fuel filler cap by turning it clockwise until it *clicks* into place. If this cap is not closed tightly or if the engine is running when the car is refueled, the Malfunction Indicator Lamp ("Check Engine" light) may indicate a fault.

### **Warning!**

If your vehicle is involved in an accident, unseen damage may affect your vehicle's driveability and safety.

### **Important**

**Before you operate your car for the first time, please familiarize yourself with the new-engine oil consumption information on [page 122](#). You should also be familiar with the information in the chapters one, two and four of this manual.**

**Information contained in the balance of the manual is extremely useful and should be read after operating the vehicle for the first time.**

**The manual is structured so that it can be used for reference. For this reason, it should be kept in the car for ready access.**

**Do not export your Volvo to another country before investigating that country's applicable safety and exhaust emission requirements. In some cases it may be difficult or impossible to comply with these requirements. Modifications to the emission control system(s) may render your Volvo not certifiable for legal operation in the U.S., Canada and other countries.**

**All information, illustrations and specifications contained in this manual are based on the latest product information available at the time of publication. Please note that some vehicles may be equipped differently, depending on special legal requirements and that optional equipment described in this manual may not be available in all markets.**

**Volvo reserves the right to make model changes at any time, or to change specifications or design, without notice and without incurring obligation.**

### **CALIFORNIA Proposition 65 Warning**

**WARNING!** Engine exhaust, some of its constituents, and certain vehicle components contain or emit chemicals known to the state of California to cause cancer, and birth defects or other reproductive harm. In addition, certain fluids contained in vehicles and certain products of component wear contain or emit chemicals known to the State of California to cause cancer, and birth defects or other reproductive harm.

### **Volvo and the environment**

Volvo is committed to the well being of our customers. As a natural part of this commitment, we care about the environment in which we all live. Caring for the environment means an everyday involvement in reducing our

environmental impact.

Volvo's environmental activities are based on a holistic view, which means we consider the overall environmental impact of a product throughout its complete life cycle. In this context, design, production, product use, and recycling are all important considerations.

In production, Volvo has partly or completely phased out several chemicals including freons, lead chromates, naphthanates, asbestos, mercury and cadmium; and reduced the amount of chemicals used in our plants 50% since 1991.

In use, Volvo was the first in the world to introduce into production a three-way catalytic converter with a Lambda sond, now called oxygen sensor, in 1976. The current version of this highly efficient system reduces emissions of harmful substances (CO, HC, NOx) from the exhaust pipe by approximately 95% and the search to eliminate the remaining emissions continues. Volvo is the only automobile manufacturer to offer CFC-free retrofit kits for the air conditioning system for all models as far back as the M/Y 1975 240. Advanced electronic engine controls, refined purification systems and cleaner fuels are bringing us closer to our goal.

After Volvo cars and parts have fulfilled their use, recycling is the next critical step in completing the life cycle. The metal content is about 75% of the total weight of a car, which makes the car among the most recycled industrial products. In order to have efficient and well controlled recycling, many Volvo variants have printed dismantling manuals, indicating the weight and material of individual components. For Volvo, all homogeneous plastic parts weighing more than 1.7 oz. (50 grams) are marked with international symbols that indicate how the component is to be sorted for recycling.

In addition to continuous environmental refinement of conventional gasoline-powered internal combustion engines, Volvo is actively looking at advanced technology alternative-fuel vehicles.

When you drive a Volvo, you become our partner in the work to lessen the car's impact on the environment.

To reduce your vehicle's environmental impact, you can:

- Maintain proper air pressure in your tires. Tests have shown decreased fuel economy with improperly inflated tires
- Follow the recommended maintenance schedule in your Warranty and Service Records Information booklet.
- Drive at a constant speed
- See an authorized Volvo retailer as soon as possible for inspection if the check engine (malfunction indicator) lamp illuminates, or stays on after the vehicle has started.
- Properly dispose of any vehicle related waste such as used motor oil, used batteries, brake pads, etc.
- When cleaning your car, use Volvo's own car care products, all of which have systematically been adapted to the environment.

### **PremAir®**

On the surface of the radiator in the engine compartment, there is a special coating called PremAir®. PremAir® works as a catalytic converter, converting most of the ozone passing through the radiator into oxygen, thereby reducing harmful ground-level ozone.

For additional information regarding the environmental activities in which Volvo Cars of North America, LLC. and Volvo Car Corporation are involved, visit our Internet Home Page at:

<http://www.volvocars.com>



[Top of Page](#)

# 2004 VOLVO S80

## Chapter 1 - Safety

### pg. 1 Safety

Not wearing a seat belt is like believing "It'll never happen to me!" Volvo, the inventor of the three-point seat belt, urges you and all adult occupants of your car to wear seat belts and ensure that children are properly restrained, using an infant, car or booster seat determined by age, weight and height. Volvo also believes no child should sit in the front seat of a car.

**Fact:** In every state and province, some type of child-restraint legislation has been passed. Additionally, most states and provinces have already made it mandatory for occupants of a car to use seat belts.

So, urging you to "buckle up" is not just our recommendation - legislation in your state or province may mandate seat belt usage. The few seconds it takes to buckle up may one day allow you to say, "It's a good thing I was wearing my seat belt."

<a href="#"><u>Seat belts</u></a>	<a href="#"><u>2</u></a>
<a href="#"><u>Center head restraint</u></a>	<a href="#"><u>3</u></a>
<a href="#"><u>Front airbags (SRS)</u></a>	<a href="#"><u>4</u></a>
<a href="#"><u>Side impact airbags (SIPS)</u></a>	<a href="#"><u>8</u></a>
<a href="#"><u>Volvo Inflatable Curtain (VIC)</u></a>	<a href="#"><u>9</u></a>
<a href="#"><u>Whiplash Protection System (WHIPS)</u></a>	<a href="#"><u>10</u></a>
<a href="#"><u>Occupant safety</u></a>	<a href="#"><u>11</u></a>
<a href="#"><u>Child safety</u></a>	<a href="#"><u>12</u></a>
<a href="#"><u>Brake system</u></a>	<a href="#"><u>16</u></a>
<a href="#"><u>Anti-lock Brake System (ABS)</u></a>	<a href="#"><u>17</u></a>
<a href="#"><u>Stability Traction Control (STC)</u></a>	<a href="#"><u>18</u></a>
<a href="#"><u>Dynamic Stability and Traction Control (DSTC)</u></a>	<a href="#"><u>18</u></a>

### pg. 2 Seat belts

#### Seat belts

**Always fasten the seat belts before you drive or ride. A chime will sound several times if the driver has not fastened his seat belt.**

**To buckle:**

Pull the belt out far enough to insert the latch plate into the receptacle until a distinct click is heard. The seat belt retractor is normally "unlocked" and you can move freely, provided that the shoulder belt is not pulled out too far. The retractor will lock up as follows:

- if the belt is pulled out rapidly
- during braking and acceleration
- if the vehicle is leaning excessively
- when driving in turns

For the seat belt to provide maximum protection in the event of an accident, it must be worn correctly. When wearing the seat belt remember:

- The belt should not be twisted or turned.
- The lap belt must be positioned low on the hips (not pressing against the abdomen).

Make sure that the shoulder belt is rolled up into its retractor and that the shoulder and lap belts are taut.

The seat belts are equipped with tensioners that reduce slack in the seat belts. These tensioners are triggered in situations where the airbags deploy.

The front seat belts also include a tension reducing device which, in the event of a collision, limits the peak forces exerted by the seat belt on the occupant.

Before exiting the car, check that the seat belt retracts fully after being unbuckled.

If necessary, guide the belt back into the retractor slot.

**NOTE:** Legislation in your state or province may mandate seat belt usage.

*Adjusting shoulder belt*

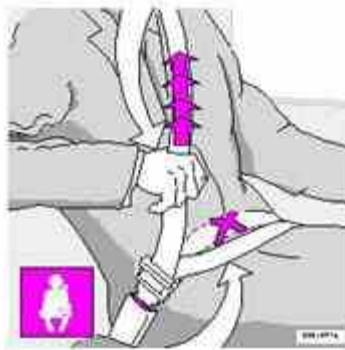

*Lap portion of the belt should sit low*

**Child seats:** Please refer to [page 14](#) for information on securing child seats with the seat belts.



## During pregnancy

Pregnant women should always wear seat belts. Remember that the belt should always be positioned in such a way as to avoid any possible pressure on the abdomen. The lap portion of the belt should be located low, as shown in the above illustration.

pg. 3 Seat belts, Center head restraint

### WARNING!

- Never use a seat belt for more than one occupant.
- Never wear the shoulder portion of the belt under the arm, behind the back or otherwise out of position. Such use could cause injury in the event of an accident.
- As the seat belts lose much of their strength when exposed to violent stretching, they should be replaced after any collision, even if they appear to be undamaged.
- Never repair the belt on your own; have this work done by an authorized Volvo retailer only.
- Any device used to induce slack into the shoulder belt portion of the three-point belt system will have a detrimental effect on the amount of protection available to you in the event of a collision.
- The seat back should not be tilted too far back. The shoulder belt must be taut in order to function properly.
- Do not use child safety seats or child booster cushions/backrests in the front passenger's seat. We also recommend that children who have outgrown these devices sit in the rear seat with the seat belt properly fastened.

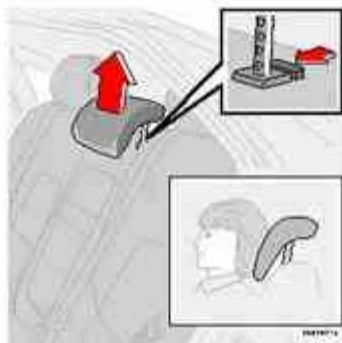

*Adjust head restraint height*

## Center head restraint

The center head restraint can be adjusted according to the passenger's height. The restraint should be carefully adjusted to support the occupant's head.

The head restraint can be **raised** by pulling straight up or **lowered** by pressing the catch at the base of the left head restraint support and pushing down.

### WARNING!

- Please note that the lowest head restraint position is only intended for use when the backrest is to be folded down, or when the seat is not occupied.
- The head restraint is intended to help protect the head/neck in a collision. Ensure that it is properly adjusted for the

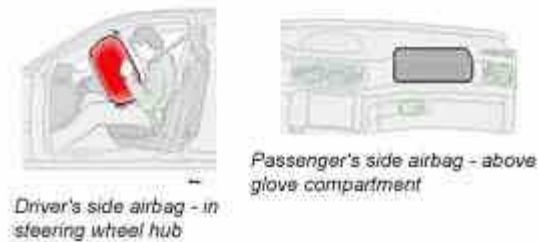

As an enhancement to the three-point seat belt system, your Volvo is equipped with a Supplemental Restraint System (SRS). The Volvo SRS consists of an airbag (2) on both the driver's and passenger's sides and seat belt tensioners in both front door pillars (4). The system is designed to supplement the protection provided by the three-point seat belt system. All three rear seat belts are also equipped with tensioners.

The SRS system is indicated by the "SRS" embossed on the steering wheel pad and above the glove compartment, and by decals on both sun visors and on the far right side of the dash.

The airbags are folded and located in the steering wheel hub and above the glove compartment. They are designed to deploy during certain frontal or front-angular collisions, impacts, or decelerations, depending on the crash severity, angle, speed and object impacted. The airbags may also deploy in certain non-frontal collisions where rapid deceleration occurs.

The airbag system includes gas generators (1) surrounded by the airbags (2) and front seat belt tensioners for both of the front seats (4). To deploy the system, the sensor (3) activates the gas generators causing the airbags to be inflated with nitrogen gas. As the movement of the seats' occupants compresses the airbags, some of the gas is expelled at a controlled rate to provide better cushioning. Both seat belt tensioners also deploy, minimizing any seat belt slack.

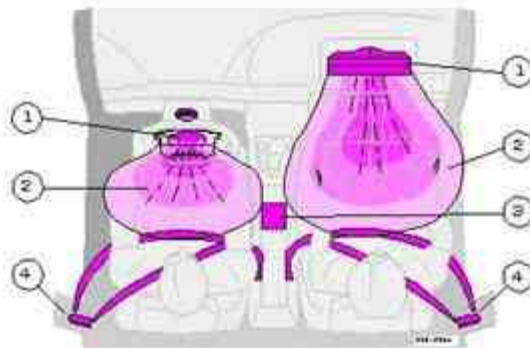

The entire process, including inflation and deflation of the airbags, takes approximately two-tenths of a second.

### **WARNING!**

- As its name implies, SRS is designed to be a **SUPPLEMENT** to - not a replacement for - the three-point belt system. For maximum protection, wear seat belts at all times. Be aware that no system can prevent all possible injuries that may occur in an accident.



- When installing any optional equipment, make sure that the SRS system is not damaged. Do not attempt to service any component of the SRS yourself. Attempting to do so may result in serious personal injury. If a problem arises, take your car to the nearest authorized Volvo retailer for inspection as soon as possible.

## pg. 5 Front airbags - SRS



A self-diagnostic system incorporated in the sensor monitors the SRS. This system does not, however, monitor the Side Impact Protection System (SIPS) airbags. If a fault is detected, the warning light will illuminate. The light is included in the warning/indicator light cluster in the instrument panel. Normally, the SRS warning lamp should light up when the ignition key is turned to positions I, II or III and should go out after 7 seconds or when the engine is started. Check that this light is functioning properly every time the car is started.

The following items are monitored by the self-diagnostic system:

- Sensor unit
- Cable harness
- Gas generator igniters

### **WARNING!**

- Never drive an SRS equipped car with your hands on the steering wheel pad / airbag housing.
- No objects, accessory equipment or stickers may be placed on, attached to or installed near the SRS cover in the center of the steering wheel, the SRS cover above the glove compartment or the area affected by airbag deployment.
- If the SRS warning light stays on after the engine has started or if it comes on while you are driving, drive the car to the nearest authorized Volvo retailer for inspection as soon as possible.



*Above: Sample label found on all tensioner-equipped seat belts. The label is sewn into the belt near its lower anchorage point*



*Above: Sample SRS service decal, which can be found on the edge of the left rear door*

There is no maintenance to perform on the SRS yourself. The month and year shown on the decal on the door pillar

indicate when you should contact your Volvo retailer for specific servicing or replacement of airbags and seatbelt tensioners. This service must be performed by an authorized Volvo retailer.

Should you have any questions about the SRS system, please contact your authorized Volvo retailer or Volvo Customer Support:

In the USA:

Volvo Cars of North America, LLC.  
Customer Relations  
P.O. Box 914  
Rockleigh, New Jersey 07647-0914  
800-458-1552

In Canada:

Volvo Cars of Canada Ltd.  
175 Gordon Baker Road  
North York, Ontario M2H 2N7

1-800-663-8255

pg. 6 Front airbags - SRS



SRS texts on outside of both sun visors



SRS texts on inside of both sun visors



SRS texts on the passenger's dash



SRS decals at far right of instrument panel

**WARNING!**

Do not use child safety seats or child booster cushions/backrests in the front passenger's seat. We also recommend that children under 4 feet 7 inches (140 cm) in height who have outgrown these devices sit in the rear seat with the

seat belt fastened.

**NOTE:** Deployment of SRS components occurs only one time during an accident. In a collision where deployment occurs, the airbags and seat belt tensioners activate. Some noise occurs and a small amount of powder is released. The release of the powder may appear as smoke-like matter. This is a normal characteristic and does not indicate fire.

**NOTE: Volvo's dual-threshold airbags** use special sensors that are integrated with the front seat buckles. The point at which the air bag deploys is determined by whether or not the seat belt is being used, as well as, the severity of the collision. Collisions can occur where only one of the airbags deploys.

**NOTE: Volvo's dual-stage airbags:** If the impact is less severe, but severe enough to present a clear injury risk, the dual-stage airbags are triggered at just 70% of its total capacity. If the impact is more severe, the dual-stage airbags are triggered with full capacity.

### **WARNING!**

- Children must never be allowed in the front passenger seat. Volvo recommends that ALL occupants (adults and children) shorter than 4 feet 7 inches (140 cm) be seated in the back seat of any vehicle with a front passenger-side front airbag. See [page 14](#) for guidelines.
- Occupants in the front passenger's seat must never sit on the edge of the seat, sit leaning toward the instrument panel or otherwise sit out of position. The occupant's back must be as upright as comfort allows and be against the seat back with the seat belt properly fastened.
- Feet must be on the floor, e.g. not on the dash, seat or out of the window.
- No objects or accessory equipment, e.g. dash covers, may be placed on, attached to or installed near the SRS hatch (the area above the glove compartment) or the area affected by airbag deployment (see illustration on [page 4](#)).
- There should be no loose articles, e.g. coffee cups, on the floor, seat or dash area.
- Never try to open the SRS cover on the steering wheel or the passenger side dash. This should only be done by an authorized Volvo service technician.
- Failure to follow these instructions can result in injury to the vehicle occupants.

## pg. 7 Front airbags - SRS

**NOTE:** The information on this page does not pertain to the Side Impact Protection System airbags.

### **When are the airbags deployed?**

The SRS system is designed to deploy during certain frontal or front-angular collisions, impacts, or decelerations, depending on the crash severity, angle, speed and object impacted. The SRS sensor is designed to react to both the impact of the collision and the inertial forces generated by it and to determine if the intensity of the collision is sufficient for the airbags to be deployed.

### **WARNING!**

The SRS is designed to help prevent serious injury. Deployment occurs very quickly and with considerable force. During normal deployment and depending on variables such as seating position, one may experience abrasions, bruises, swellings, or other injuries as a result of airbag(s) deployment.

If the airbags have been deployed, we recommend the following:

- Have the car towed to an authorized Volvo retailer. Never drive with the airbags deployed.
- Have an authorized Volvo retailer replace the SRS system components.
- Use only new, Genuine Volvo Parts when replacing SRS components (airbags, seat belts, tensioners, etc.).

### **When are the airbags NOT deployed?**

Not all frontal collisions activate the SRS system. If the collision involves a nonrigid object (e.g., a snow drift or bush), or a rigid, fixed object at a low speed, the SRS system will not necessarily deploy. Front airbags do not normally deploy in a side impact collision, in a collision from the rear or in a rollover situation. The amount of damage to the bodywork does not reliably indicate if the airbags should have deployed or not.

### **Seat belts - the heart of the Volvo safety system**

The heart of the Volvo safety system is the **three-point seat belt** (a Volvo invention)! In order for the SRS system to provide the protection intended, seat belts must be worn at all times by everyone in the car. **The SRS system is a supplement to the seat belts.**

#### **WARNING!**

If your car has been subjected to flood conditions (e.g. soaked carpeting/standing water on the floor of the vehicle) or if your car has become flood-damaged in any way, do not attempt to start the vehicle or put the key in the ignition before disconnecting the battery (see below). This may cause airbag deployment which could result in personal injury. Have the car towed to an authorized Volvo retailer for repairs.

#### **Automatic transmission:**

Before attempting to tow the car, use the following procedure to override the shiftlock system to move the gear selector to the neutral position.

- Switch off the ignition for at least 10 minutes and disconnect the battery
- Wait at least one minute
- Insert the key in the ignition and turn it to position II
- Press firmly on the brake pedal.
- Move the gear selector from (P)ark to the (N)eutral position.

#### **WARNING!**

Never drive with the airbags deployed. The fact that they hang out can impair the steering of your car. Other safety systems can also be damaged. The smoke and dust formed when the airbags are deployed can cause skin and eye irritation in the event of prolonged exposure.



*SIPS airbag \**

### **SIPS airbag (front seats only)**

As an enhancement to the structural Side Impact Protection System built into your car, the car is also equipped with Side Impact Protection System (SIPS) airbags. The SIPS airbag system consists of airbag modules built into the sides of both front seat backrests (1), wires (2) and gas generators/sensor units (3).

The SIPS airbag system is designed to help increase occupant protection in the event of certain side impact collisions. The SIPS airbags are designed to deploy only during certain side-impact collisions, depending on the crash severity, angle, speed and point of impact. The airbags are not designed to deploy in all side impact situations.

**NOTE:** SIPS airbag deployment (one airbag) occurs only on the side of the vehicle affected by the impact.

### **WARNING!**

- The SIPS airbag system is a supplement to the Side Impact Protection System and the three-point seat belt system. It is not designed to deploy during collisions from the front or rear of the car or in rollover situations.
- The use of seat covers on the front seats may impede SIPS airbag deployment.
- No objects, accessory equipment or stickers may be placed on, attached to or installed near, the SIPS airbag system or in the area affected by SIPS airbag deployment (see illustration below). Never try to open or repair any components of the SIPS airbag system. This should only be done by an authorized Volvo service technician.
- In order for the SIPS airbag to provide its best protection, both front seat occupants should sit in an upright position with the seat belt properly fastened.

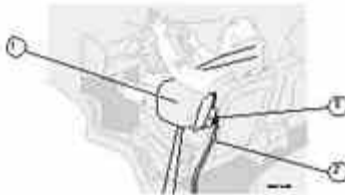

*1 - Airbag, 2 - wire, 3 - gas generator/sensor unit*

### **WARNING!**

- Never drive with the airbags deployed. The fact that they hang out can impair the steering of your car. Other safety systems can also be damaged. The smoke and dust formed when the airbags are deployed can cause skin and eye irritation in the event of prolonged exposure.
- If your car has been subjected to flood conditions (e.g. soaked carpeting/standing water on the floor of the

vehicle) or if your car has become flood-damaged in any way, do not attempt to start the vehicle or put the key in the ignition before disconnecting the battery. This may cause airbag deployment which could result in personal injury. Have the car towed to an authorized Volvo retailer for repairs.

\*A SIPS airbag warning decal is also located at the end of the instrument panel on the driver's side of the car.

## pg. 9 Volvo Inflatable curtain (VIC)

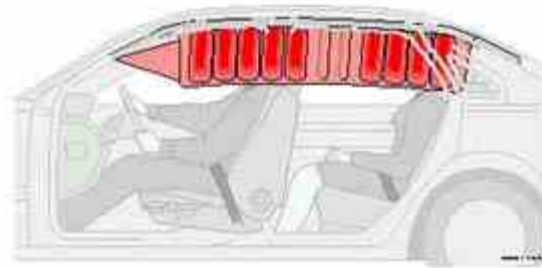

### Volvo Inflatable curtain (VIC)

This system consists of inflatable curtains located along the sides of the roof liners, stretching from the center of both front side windows to the rear edge of the rear side windows. It is designed to help protect the heads of the occupant of the front seat and the occupant of the outboard rear seat position in certain side impact collisions.

**NOTE:** IC system deployment occurs only on the side of the vehicle affected by the impact.

In certain side impacts, **BOTH** the Inflatable Curtain (IC) and the Side Impact Airbag System (SIPS-bag) will deploy, whereas, in some cases, **ONLY** the Inflatable Curtain (IC) will deploy. In cases where **BOTH** the IC and the SIPS-bag deploy, deployment will occur simultaneously.

If the inflatable curtain deploys, it remains inflated for approximately 3 seconds.

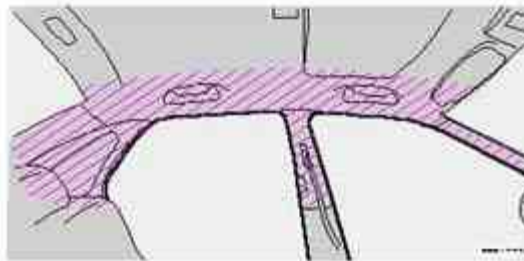

### WARNING!

- The IC system is a supplement to the Side Impact Protection System. It is not designed to deploy during collisions from the front or rear of the car or in rollover situations.
- Never try to open or repair any components of the IC system. This should only be done by an authorized Volvo service technician.
- The inflatable curtains are designed to deploy only during certain side-impact collisions, depending on the crash

severity, angle, speed and impact. The inflatable curtains are not designed to deploy in all side impact situations.

- In order for the IC to provide its best protection, both front seat occupants and both outboard rear seat occupants should sit in an upright position with the seat belt properly fastened; adults using the seat belt and children using the proper child restraint system. Only adults should sit in the front seats. Children must never be allowed in the front passenger seat. See [page 14](#) for guidelines. Failure to follow these instructions can result in injury to the vehicle occupants in an accident.



[Contents](#) | [Top of Page](#)

2004  
VOLVO  
S80

Chapter 2 - Instruments, switches and controls

pg. 19 Instruments, switches and controls

<u>Interior</u>	<u>22</u>
<u>Exterior</u>	<u>23</u>
<u>Instruments</u>	<u>24</u>
<u>Instrument panel</u>	<u>25</u>
<u>Indicator and warning lights</u>	<u>26</u>
<u>Text information window</u>	<u>28</u>
<u>Switches in center console</u>	<u>29</u>
<u>Trip computer</u>	<u>30</u>
<u>Cruise control</u>	<u>31</u>
<u>Light switch panel</u>	<u>32</u>
<u>Manually unlocking the fuel filler door</u>	<u>33</u>
<u>Turn signals, windshield wipers/washers</u>	<u>34</u>
<u>Steering wheel adjustment/lock, ignition switch</u>	<u>36</u>
<u>Warning flashers, heated mirrors/rear window/heated front seats</u>	<u>37</u>
<u>Parking brake, auxiliary socket, ashtrays</u>	<u>38</u>
<u>Electrically operated windows</u>	<u>39</u>
<u>Rearview/sideview/vanity mirrors</u>	<u>40</u>
<u>Power moonroof</u>	<u>41</u>
<u>Sun blinds</u>	<u>42</u>

pg. 22 Interior



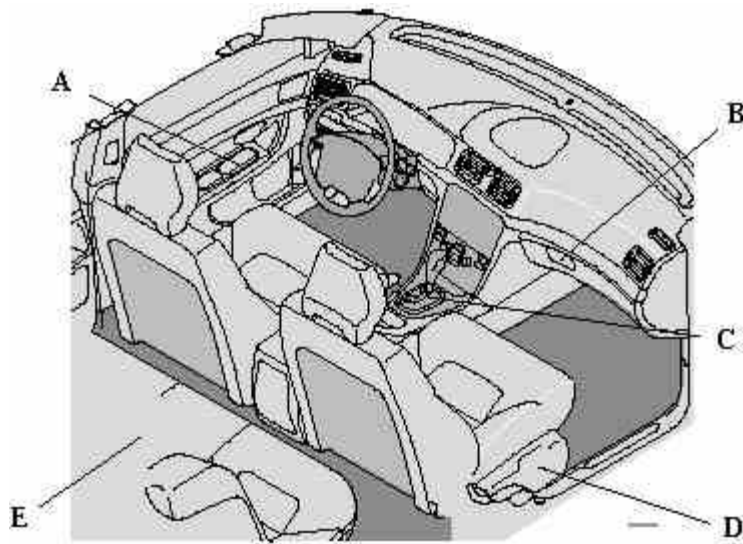

**A**

- Locking and unlocking the car [63/64](#)
- Alarm [65](#)
- Power windows [39](#)
- Sideview mirror controls [40](#)

**B**

- Glove compartment [55](#)

**C**

- Automatic transmission [74](#)
- Geartronic [76](#)
- Parking brake [38](#)
- Center console switches [29](#)

**D**

- Power seat adjustment [52](#)
- Heated seats (option) [37](#)
- Cleaning upholstery [115](#)

**E**

- Folding rear seat [58](#)
- Panel for long loads [56](#)
- Folding down head restraint [29](#)
- Adjusting center head restraint [3](#)
- Child safety locks [67](#)
- Integrated booster cushion [13](#)

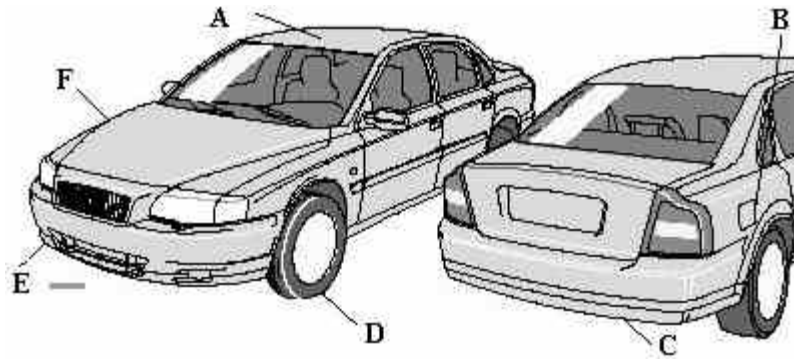

<b>A</b>	
Moonroof (option)	<a href="#">41</a>
<b>B</b>	
Fuel filler door	<a href="#">72</a>
Refuelling	<a href="#">72</a>
Economical driving	<a href="#">80</a>
<b>C</b>	
Replacing a back-up light	<a href="#">108</a>
Replacing a brake light	<a href="#">108</a>
Replacing a tail light	<a href="#">108</a>
Replacing a direction indicator	<a href="#">108</a>
Replacing a rear fog light	<a href="#">108</a>
Replacing license plate lights	<a href="#">110</a>
<b>D</b>	
Tires	<a href="#">94</a>
Wheels	<a href="#">94</a>
Brake system	<a href="#">16</a>
Spare tire	<a href="#">96</a>
Changing wheels	<a href="#">98</a>
<b>E</b>	
Replacing a high beam	<a href="#">106</a>
Replacing a low beam	<a href="#">106</a>
Replacing a parking light	<a href="#">107</a>
Replacing a direction indicator	<a href="#">107</a>
Replacing a front fog light (option)	<a href="#">109</a>
Replacing a headlight wiper	<a href="#">127</a>
<b>F</b>	
Washing the car	<a href="#">114</a>
Paint touch-up	<a href="#">113</a>

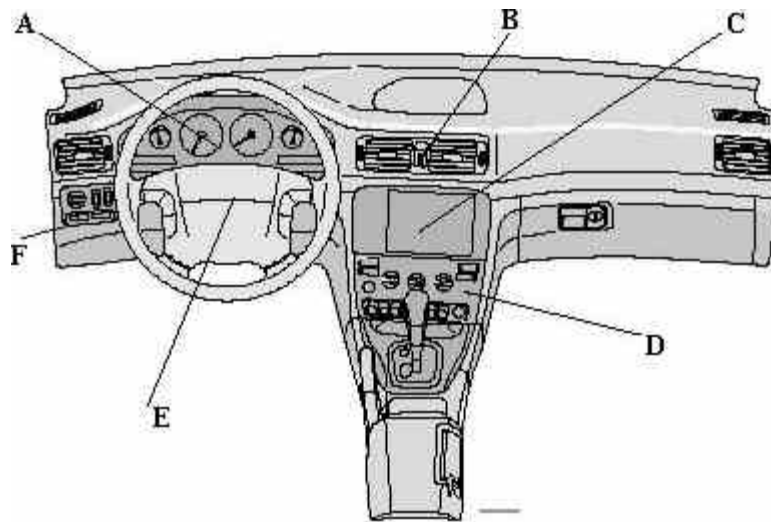

## A

Temperature gauge	<a href="#">25</a>
Speedometer	<a href="#">25</a>
Odometer	<a href="#">25</a>
Trip odometer	<a href="#">25</a>
Warning lights	<a href="#">25</a>
Text window	<a href="#">28</a>
Tachometer	<a href="#">25</a>
Clock	<a href="#">25</a>
Ambient temperature sensor	<a href="#">25</a>
Fuel gauge	<a href="#">25</a>

## B

Hazard warning flashers	<a href="#">37</a>
-------------------------	--------------------

## C

Audio system	<a href="#">137</a>
--------------	---------------------

## D

Electronic climate control	<a href="#">45</a>
Heated seats (option)	<a href="#">37</a>
Heated rear window/rearview mirrors	<a href="#">37</a>

## E

Steering wheel adjustment	<a href="#">36</a>
Airbag	<a href="#">4</a>
Cruise control	<a href="#">31</a>
Windshield wipers/washer	<a href="#">35</a>
Turn signal lever	<a href="#">34</a>
Trip computer	<a href="#">30</a>
Audio system controls	<a href="#">141</a>

## F

High/low beam headlights	<a href="#">32</a>
Parking lights	<a href="#">32</a>
Fog lights	<a href="#">32</a>

Instrument panel lighting [32](#)

Button to unlock fuel filler door [32](#)

pg. 25 Instrument panel

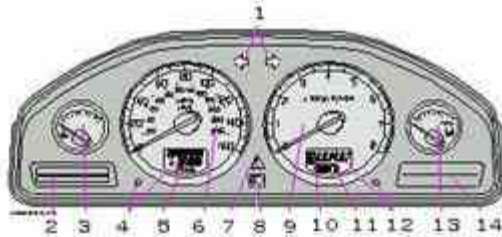

### 1 Turn signals

### 2 Text window

### 3 Temperature gauge

The pointer should be approximately midway on the gauge when driving.

**Do not drive the car if the warning light is on.** The text window will provide you with additional information.

If the engine temperature remains high, check coolant level - see [page 118](#).

### 4 Trip odometer/reset button

The trip odometer is used for measuring shorter distances. The last digit indicates 1/10 mile/kilometer. Press the button quickly to toggle between trip odometers 1 and 2. Hold in the button for more than 2 seconds to reset.

### 5 Odometer

### 6 Speedometer

### 7 General warning light (see [page 26](#)).

### 8 High beam indicator light

### 9 Tachometer

Indicates engine speed in thousands of rpm. Do not drive for long with the needle in the red section. The engine has an built-in function preventing too high an engine speed. When this function operates, you may discern some pulsation, which is normal.

### 10 Gear and driving mode indicator

The currently selected driving mode is displayed here. If you use the Geartronic function on the automatic transmission, the currently selected gear will be displayed.

### 11 Ambient temperature indicator

This sensor indicates the air temperature outside your car. A "snowflake" symbol in the text window is displayed when the temperature is in the range of 23 - 36° F (-5 - +2° C).

**Please note that this symbol does not indicate a fault with your car.**

At low speeds or when the car is not moving, the temperature readings may be slightly higher than the actual ambient temperature.

### 12 Clock/reset button

Turn the button to adjust the clock.

### 13 Fuel gauge

The fuel tank holds approximately 21.1 US gal. (80 liters).

When the warning light comes on there is approximately 1.8 US gal. (8 liters) of fuel remaining.

### 14 Indicator and warning lights

pg. 26 Indicator and warning lights

*The indicator and warning lights described on pages 26 and 27 should never stay on when driving\**

When the ignition key is turned, all of the warning lights in the lower right-hand side of the instrument panel should go on to test the function of the bulbs. If a light does not go off after the engine has started, the system indicated should be inspected.

**NOTE:** The parking brake reminder light will not go off until the parking brake has been fully released.



Warning lamp  in the center of the instrument panel

This lamp lights up **red** or **yellow** depending on the severity of the fault that has been detected.

**Yellow light:** Follow the instructions shown in the text window.

**Red light:** Stop the car as soon as possible in a suitable location and read the message shown in the text window.



#### Supplemental Restraint System (SRS)

If the light comes on (or stays on after the vehicle has started), the SRS diagnostic system has detected a fault. Drive to an authorized Volvo retailer for an inspection of the system. See the SRS section for more information.

#### BRAKE

##### Brake failure warning light

**If the light comes on while driving or braking, stop immediately, open the hood and check the brake fluid level in the reservoir.** See [page 124](#) for reservoir position and instructions.

Canadian models are equipped with this warning light: 

#### Park

##### Brake

##### Parking brake reminder light

This light will be on when the parking brake (hand brake) is applied. The parking brake lever is situated between the front seats.

Canadian models are equipped with this warning light: 



### Oil pressure warning light

If the light comes on while driving, stop the car and then stop the engine immediately and check the engine oil level. See [page 123](#). If the light stays on after restart, have the car towed to the nearest authorized Volvo retailer. After hard driving, the light may come on occasionally when the engine is idling. This is normal, provided it goes off when the engine speed is increased.



### Generator warning light

If the light comes on while the engine is running, have the charging system checked.

\* Rear fog light, if used, and trailer turn signal, if towing a trailer, will go on while driving.

pg. 27 Indicator and warning lights



### Rear fog light

This light indicates that the rear fog light is on.

## CHECK ENGINE

### Malfunction indicator lamp

**On-Board Diagnostic II (OBDII):** As you drive, a computer called "OBDII" monitors your car's engine, transmission, electrical and emission systems. The CHECK ENGINE light will light up if the computer senses a condition that potentially may need correcting. When this happens, please have your car checked by a Volvo retailer as soon as possible.

A CHECK ENGINE light may have many causes. Sometimes, you may not notice a change in your car's behavior. Even so, an uncorrected condition could hurt fuel economy, emission cleanliness, and driveability. Extended driving without correcting the cause could even damage other components in your car.

Canadian models are equipped with this warning light: 

**NOTE:** If the fuel filler cap is not closed tightly or if the engine is running when the car is refueled, the Malfunction Indicator Lamp may indicate a fault. However, your vehicle's performance will not be affected. Use only Volvo original or approved fuel filler caps.



### Anti-lock Brake System ABS

If the warning light comes on, there is a malfunction of the ABS system (the standard braking system will however function). The vehicle should be driven to a Volvo retailer for inspection. See [page 17](#) for additional information.



### Stability Traction Control (STC) system (option), or Dynamic Stability and Traction Control (DSTC) system (option)

This indicator light will flash with STC or DSTC is actively working to stabilize the car. See [pages 18-19](#) for more detailed information.



### **Turn signal indicator - trailer (certain models)**

If you are towing a trailer, this light will flash simultaneously with the turn signals on the trailer. If the light does not flash when signaling, neither the trailer's turn signals nor the car's turn signals are functioning.



### **Seat belt reminder**

This symbol lights up to indicate that the driver has not fastened his/her seat belt.

---



[Contents](#) | [Top of Page](#)

2004  
VOLVO  
S80

Chapter 3 - Climate control system

pg. 43 Climate control system

Ventilation 44

Electronic Climate Control (ECC) 45

Climate control system - general information 48

pg. 44 Ventilation

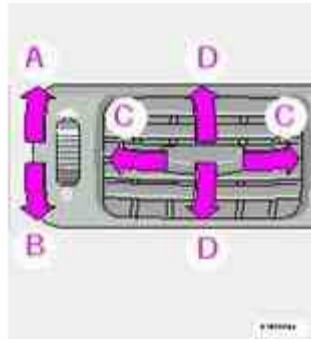

*Air vents in dash*

**Air vents (dash)**

- A Open
- B Closed
- C Horizontal air flow
- D Vertical air flow

Direct the outer air vents toward the side windows to demist.

In cold weather, close the air vents in the center of the dash to direct as much air as possible toward the windows.



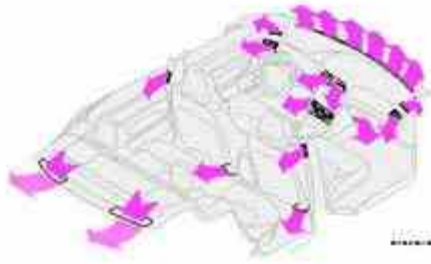

### **Air flow**

The air that is drawn into the passenger compartment is distributed from 14 ventilation points.

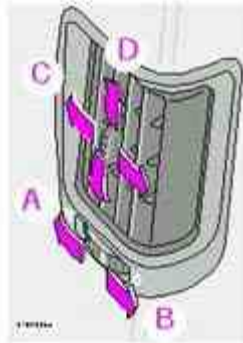

*Air vents in door pillars*

### **Air vents in door pillars**

- A Open
- B Closed
- C Horizontal air flow
- D Vertical air flow

Direct the air vents toward the rear side windows to demist.

Direct the air vents toward the rear seat for the best heating/cooling effect.

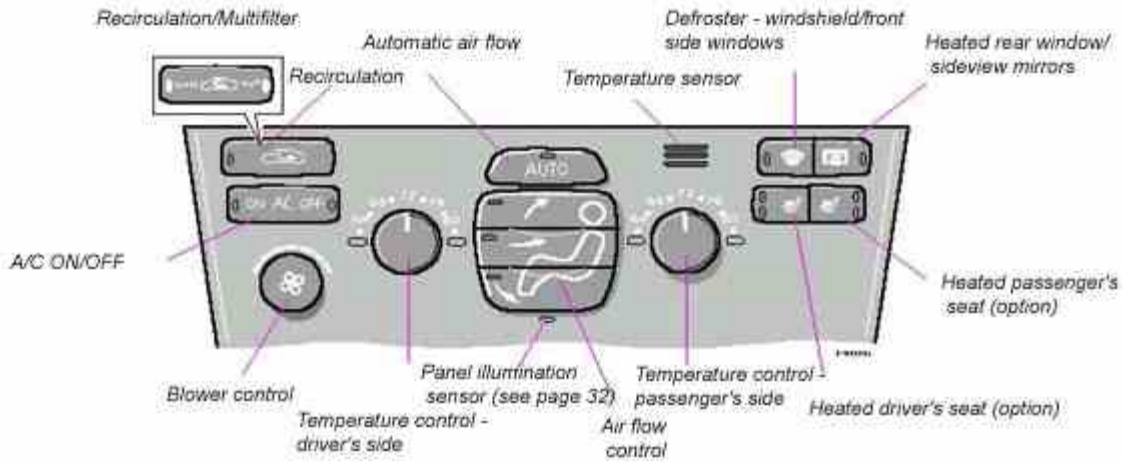

## pg. 46 Electronic Climate Control (ECC)



### AUTO

This function automatically regulates the Electronic Climate Control system so that the selected temperatures are maintained. The blower, heating, air distribution (air flow) and air conditioning are controlled. If you prefer to manually set any of these functions, the remaining functions will still be controlled automatically. Pressing the AUTO button overrides any settings that were previously made manually.



### Temperature

These controls are used to individually set the temperature for both sides of the passenger compartment. Please note that the compartment will not be heated or cooled faster by setting the temperature higher or lower than necessary. Set the control to the temperature you prefer.



### Defroster

This function demists/de-ices the windshield and front side windows. The LED in the switch will light up to indicate that the defrost function is engaged. Blower speed increases automatically and the air in the passenger compartment is dehumidified. Recirculation will not function while defrost is engaged.

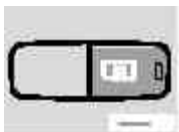

### Heated rear window/sideview mirrors

This function demists/de-ices the rear window and sideview mirrors. The LED in the switch will light up to indicate

that the heating function is engaged. See [page 37](#) for additional information on this function.

## CAUTION:

Never use ice scrapers made of metal as they can easily scratch the mirror surface.

pg. 47 Electronic Climate Control (ECC) - manual settings



### Recirculation (see also [page 49](#))

Press this switch to engage the recirculation function (air in the passenger compartment recirculates - no fresh air enters the compartment). The LED in the switch will light up to indicate that the function is engaged.

- Use this function if the outside air is contaminated with exhaust gases, smoke, etc or to heat/cool the car quickly.
- Recirculation should not be used for more than 15 minutes. *If your windows begin to fog or mist, make sure that the recirculation function is switched off.*
- Selecting Defroster automatically switches recirculation off.
- **Timer mode activation:** (Cars with Interior Air Quality system have no timer mode) Press and hold the recirculation button for at least 3 seconds to activate a recirculation timer mode. The amber LED in the recirculation button will flash 5 times to show that the timer mode is being activated. In the time mode, each time the recirculation button is pressed, the climate control system will recirculate the air in the passenger compartment for 5 to 12 minutes, depending on the outside air and then revert back to fresh air.
- **Timer mode deactivation:** Press and hold the recirculation button for at least 3 seconds. The amber LED in the recirculation button will illuminate steadily for 5 seconds to show a return to "normal" mode.
- In normal mode, when the recirculation button is pressed, the climate control system will recirculate the air in the passenger compartment until the recirculation button is pressed again.
- **Timer mode memory:** If the car is turned off while timer mode is active, timer mode will still be active when the car is restarted.



### Heated front seats (option)

Please see [page 37](#) for more information on this function.



### Air flow

Press **AUTO** to automatically regulate air flow or press any combination of the controls shown in the illustration to manually adjust air flow. An LED in the switch will light up if an air flow control has been pressed.



### Air conditioning ON/OFF

Press the switch to turn the air conditioning on or off. The "ON" or "OFF" LED will light up to indicate if the system is switched on or off. Other functions will still be regulated automatically (if the **AUTO** switch is on).

- The air conditioning functions only at temperatures above 32° F (0° C).
- While the **Defroster** function is selected, the air conditioning is temporarily activated to dehumidify the air, even if you have manually switched the air conditioning off. This will only function if the blower is *not* switched off.



### **Blower control**

Turn the control clockwise to increase or counterclockwise to decrease the blower speed. Pressing the AUTO switch will automatically regulate blower speed and override manual adjustment.

**NOTE:** Turning the blower control counterclockwise as far as possible (an LED next to the control will light up) will turn both the blower and the air conditioning off.

pg. 48 Climate control system - general information

### **Condensation on the inside of the windows**

Keeping the insides of the windows clean will help reduce the amount of condensation that forms on the windows. Use a commercial window cleaning agent to clean the windows.

### **Ice and snow**

Always keep the air intake grille at the base of the windshield free of snow.

### **Cabin air filter**

Replace the cabin air filter with a new one at the recommended intervals. Please refer to your Warranty and Service Records Information booklet, or consult your Volvo retailer for these intervals. The filter should be replaced more often when driving under dirty and dusty conditions. The filter cannot be cleaned and therefore should always be replaced with a new one.

### **Sensors**

The sunlight sensor on the dashboard and passenger compartment temperature sensor in the ECC control panel should not be covered in any way as this could cause incorrect information to be sent to the ECC system.

### **Parking the car in warm weather**

If your car has been parked in the sun in warm weather, opening the windows and sun roof (option) for several minutes before driving will help release the warm air from the passenger compartment. When the engine is running, close the windows and sun roof and use the recirculation function for several minutes to enable the air conditioning to cool the compartment as quickly as possible.

### **Windows and optional moonroof**

The ECC system will function best if the windows and optional moonroof are closed. If you drive with the moonroof open, we recommend that you manually adjust the temperature and blower control (the LED in the AUTO switch should be off).

### **Acceleration**

The air conditioning is momentarily disengaged during full-throttle acceleration.

### **ECC maintenance**

All maintenance on the climate control systems should be carried out by an authorized Volvo service technician only.

### Refrigerant

Volvo cares about the environment. The air conditioning system in your car contains a CFC-free refrigerant - R134a. This substance will not deplete the ozone layer. The system contains 2.2 lbs (1000 g) R134a and uses PAG oil.

### Passenger compartment blower

Approximately 50 minutes after the ignition is turned off, the blower may come on automatically, and run for five minutes, to remove condensation in the A/C evaporator.

pg. 49 Electronic Climate Control (ECC) - with Interior Air Quality system (option)





### Interior Air Quality system (option)

Some cars are equipped with a multifilter and air quality sensor. The filter separates gases and particles, thereby reducing the amounts of odors and contaminants entering the car. The air quality sensor detects increased levels of contaminants in the outside air. When the air quality sensor detects contaminated outside air, the air intake closes and the air inside the passenger compartment is recirculated, i.e. no outside air enters the car. The filter also cleans recirculated passenger compartment air. When the Air quality sensor is activated, the LED *AUT* comes on in the recirculation button



### Operation:

Press  to activate the Air quality sensor (normal setting). Or select one of three functions by pressing 

1. Press  the LED *AUT* comes on. The Air quality sensor is now activated.
2. Press  no LED is lighted. Recirculation not activated.
3. Press  the LED *MAN* comes on. Recirculation is now activated. You can switch between these three functions by repeatedly pressing 

### Keep the following in mind:

- Make it a rule to have the air quality sensor activated at all times.
- Recirculation is limited in cold climates to avoid misting up.
- If misting occurs, you should deactivate the Air quality sensor.
- If the windows mist up, you can also use the windshield and side window defroster functions. See [page 46](#).
- The filter should be changed at the intervals listed in the Warranty and Service Records Information booklet. However, if the car is used in a severely contaminated environment, it may be necessary to change the filter more frequently.

pg. 50

This page intentionally left blank.





2004  
VOLVO  
S80

Chapter 4 - Interior

pg. 51 Interior

[Front seats](#) 52

[Coat hanger](#) 53

[Interior lighting](#) 54

[Storage compartments](#) 55

[Storage compartments in center console](#) 56

[Spare tire, Cargo net in trunk](#) 57

[Folding rear seat backrests, Carrying long loads](#) 58

pg. 52 Front seats



**Electrically operated front seats**

From the time the driver's door is unlocked, the driver's seat can be adjusted *with the ignition off* during a **10 minute period, if the door remains opened**. If the door is closed, the seat can be adjusted for 40 seconds.

**1 - Power seat control panel**

**2 - Lumbar support**

Turn the control for softer or firmer lumbar support.

Move the seat as far rearward as possible for easiest access to the lumbar support control.

## Electrically operated seats with memory function (option)\*

*Power seat control panel*

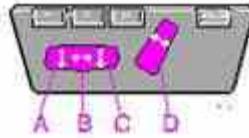

- A Front edge of seat (raise/lower)
- B Forward - rearward
- C Rear edge of seat (raise/lower)
- D Backrest tilt

### **WARNING!**

- Because the driver's seat can be adjusted with the ignition off, children should never be left unattended in the car.
- Movement of the seat can be STOPPED at any time by pressing any button on the power seat control panel.
- Do not adjust the seat while driving. The seat should be adjusted so that the brake pedal can be depressed fully. In addition, position the seat as far rearward as comfort and control allow.
- The seat rails on the floor must not be obstructed in any way when the seat is in motion.

### **Programming the memory**

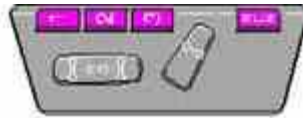

Three seat positions can be programmed. To program a seat position:

- 1 Adjust the seat to the desired position.
- 2 Hold down the MEM button.
- 3 While holding down the MEM button, press button 1 to program the current position of the seat.

Buttons 2 and 3 can be programmed in the same way.

To move the seat to a programmed position, press and hold down button 1, 2 or 3 until the seat moves to the preset position and stops.

**As a safety precaution, the seat will stop automatically if the button is released before the seat has reached the programmed position.**

**NOTE:** The seat has an overload protector which engages if an object blocks the movement of the seat. If this happens, remove the object and wait 20 seconds before operating the seat again.

\* This option is only available on the driver's seat.

## **Electrically operated seats - general information**

### **Adjusting the front seats:**



**Passengers's seat:** The passenger's seat can only be adjusted if the ignition key is in position I or II (see [page 36](#)).

**Driver's seat:** The driver's seat can be adjusted if the ignition key is in position I or II (see [page 36](#)). However, it can also be adjusted:

- Within 40 seconds after the ignition has been switched off (even if the key has been removed from the ignition switch).
- Within 40 seconds after the driver's door has been unlocked with the key or remote control and opened. The key does not have to be in the ignition switch during this period.

### **Remote keyless entry system and driver's seat**

The remote control transmitter also controls the electrically operated driver's seat in the following way:

- Adjust the seat to your preferences.
- When you leave your car, lock it using the remote control
- The next time you unlock the driver's door with the **same** remote control (the one you used to lock the doors with) *and open the driver's door*, the driver's seat will automatically move to the position in which you left it. The seat will move to this position even if someone else has adjusted it since you last unlocked the car with the same remote control.

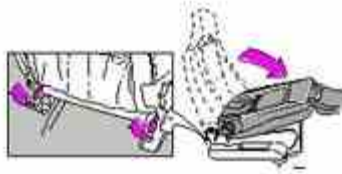

*Folding front seat backrest*

### **NOTE:**

- This feature will work in the same way with all of the remote control transmitters (up to 3) that you use with your car.
- This feature will not function if you lock your car with the key.

### **Folding front seat backrest**

The passenger seat backrest can be folded down to the horizontal position for carrying long loads. To fold down the backrest:

- Move the seat as far rearward as possible
- Adjust the backrest tilt to the most upright position
- Lift the catches on the lower rear side of the backrest
- Without releasing the catches, push the backrest forward
- Move the seat as far forward as possible

### **WARNING!**

Cover sharp edges on the load to help prevent injury to occupants. Secure the load to help prevent shifting during sudden stops.

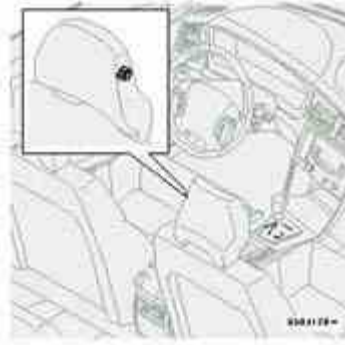

*Coat hanger*

### **Coat hanger**

Use the coat hanger for clothes of normal weight.

pg. 54 Interior lighting

*Courtesy light*



*Front reading lights*

### **Courtesy light**

The courtesy light can be turned on or off by pressing the button. The light also has a timer function which turns the light on for 30 *seconds* if:

- You unlock the car from the outside with the key or remote control.
- You switch off the ignition (turn the key to position 0).

The courtesy light stays on for 10 *minutes* if one of the doors is left open after the car is unlocked.

The courtesy light switches off if:

- The engine is started.
- The car is locked from the outside with the key or remote control.

The interior courtesy light can be switched on or off at any time by pressing the center button in the panel above the rearview mirror. When switched on with the engine off, the light will stay on for 10 minutes. When switched on with the engine running, the light will stay on indefinitely. The light may be switched off at any time by pressing the center button a second time.

The courtesy light timer periods can be changed. Consult your Volvo retailer.

### **Overriding the Interior and Trunk Courtesy Lights**

Normally if a car door is left open with the engine turned off, the interior courtesy light will stay on for 10 minutes. Normally, if the trunk is left open with the engine turned off, the trunk courtesy lights will stay on for 10 minutes. If a car door is left open or the interior courtesy lights are turned on while the engine is left running, the interior courtesy lights will stay on indefinitely. Likewise, if the trunk is left open while the engine is running, the trunk courtesy light will stay on indefinitely.

At times, you may wish to be assured that the courtesy lights will stay off regardless of door or trunk lid position. To switch off the interior and trunk courtesy lights indefinitely, press and hold the center button in the panel above the rearview mirror for 3 seconds. The courtesy lights will go off and remain off until the center button is pressed again.



*Rear reading lights*

### **Reading lights - front/rear**

The reading lights can be switched on or off by pressing the respective buttons. These lights switch off automatically after 10 minutes if the engine is not running. If the engine is running, the lights stay on indefinitely. The lights can be switched off at any time by pressing the button.

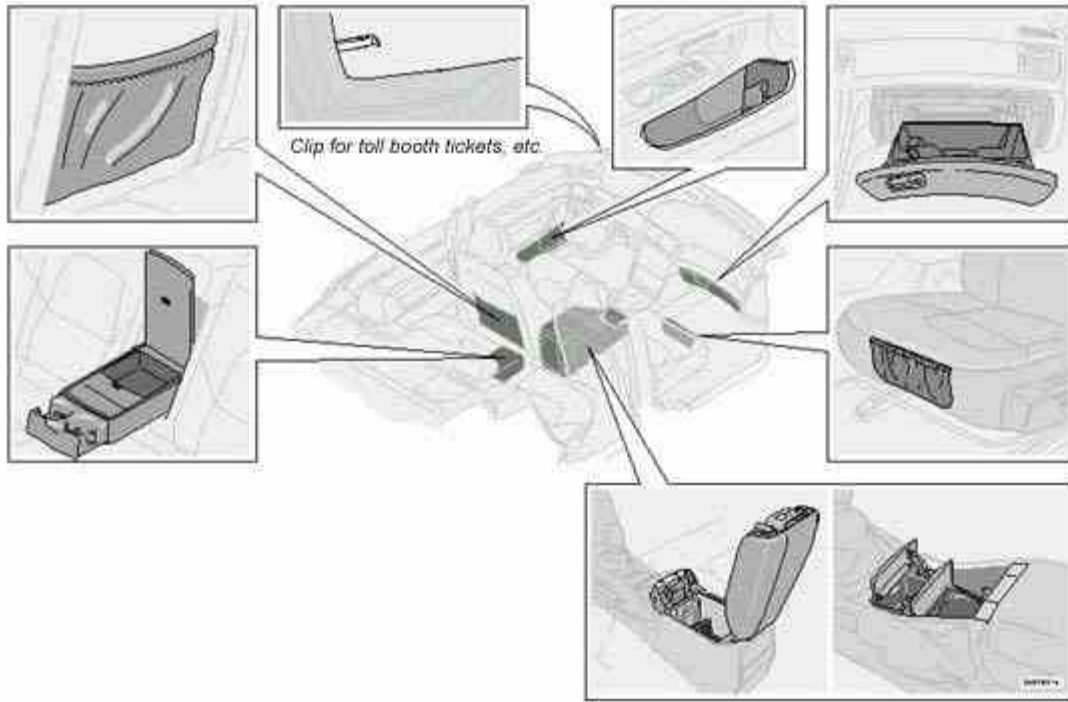

**WARNING!**  
 Packages on the rear window shelf can obscure vision and may become dangerous projectiles in the event of a sudden stop or an accident.  
 Anchor any heavy objects to help prevent them from moving during sudden stops.

pg. 56 Storage compartment in center console, Long loads

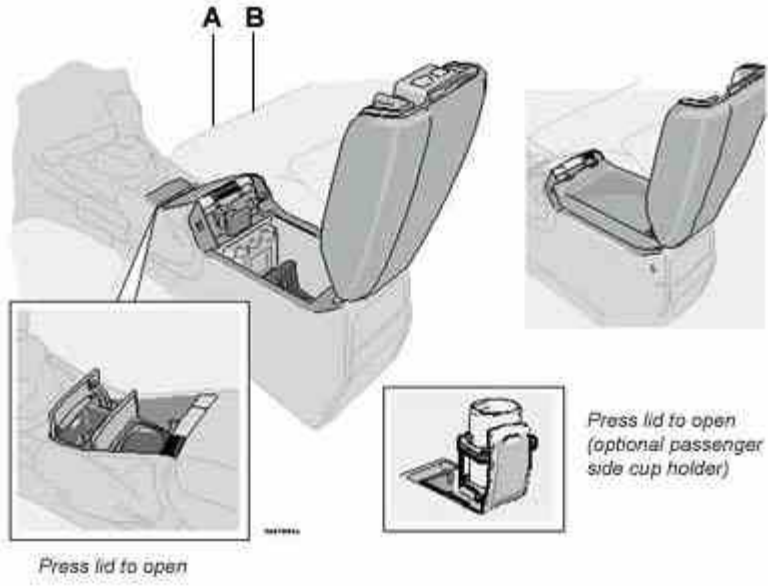

**Storage compartment in center console/cup holders**

- Press button A to pop open the cup holder.

- Press button B to open the storage space in the center console for cassettes, change holder, etc.

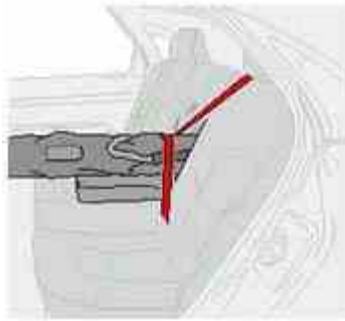

*Secure long loads with the seat belt*

### Carry long loads

The center backrest cushion folds forward, allowing you to transport long, light cargo such as skis in the trunk of your car. To lower the backrest:

- Pull the right release control handle in the trunk to release the backrest (see [page 54](#)).
  - From the rear seat, fold down the right section of the backrest slightly\*.
  - Release the flap by pushing the catch (located on the rear side of the backrest) upward and pulling the flap forward.
  - Return the backrest to the upright position.
- \* If your car is equipped with the optional integrated child booster cushion, this cushion must be folded *down* before you fold down the backrest (see [page 13](#)).

pg. 57 Spare tire, Cargo net in trunk

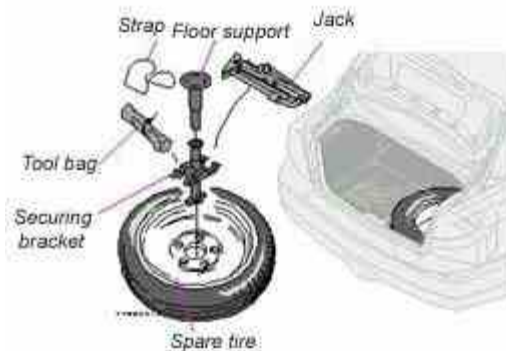

### Spare tire

The spare tire, jack and tool bag are located under the floor of the trunk. To access the spare tire:

- Raise the rear edge of the floor of the trunk and fold it back toward the rear seat backrest.
- Lift out the trunk floor support (certain models) from the spare tire securing bracket.
- Release the strap to lift out the jack and tool bag.
- Unscrew the securing bracket and lift out the spare tire.
- To return the spare tire to the trunk, follow the reverse procedure.

### **WARNING!**

Make sure that the spare tire, jack and tool bag are properly secured with the securing bracket and strap to help keep

these components in place in the event of a sudden stop.

**NOTE:** See [page 98](#) for information on how the jack should be used.

### Cargo net in the trunk

The cargo net in the trunk can be used to secure light objects. Pull the net out and slide the runner in the handle down into one of the two slots provided at the rear edge of the trunk. Use the release tab to release tension on the net while it is being placed around an object. Be sure the net is then pulled taut around the object.

The net can be retracted when not in use.

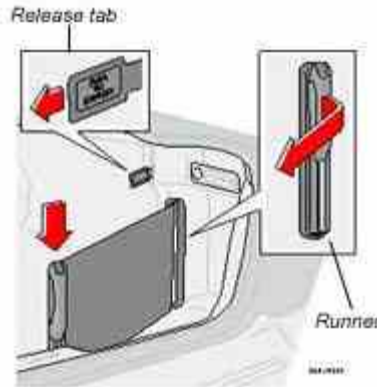

*Cargo net in trunk*

**NOTE:** If you have purchased the accessory plastic floor cover for the trunk, it may be necessary to cut notches in the rear edge of this cover so that the runner on the cargo net can be securely pressed into the slots provided.

### **WARNING!**

Never use this net to secure sharp or heavy objects. In such cases, tie down the object using the cargo eyelets provided. Both rear seat backrests should be secured in the upright position when the cargo net is in use.

pg. 58 Folding rear seat backrests, Carrying long loads

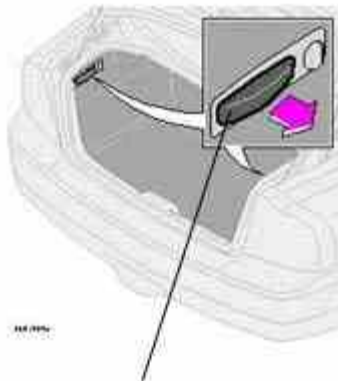

*Backrest controls (on opposite sides of trunk)*

### Folding rear seat backrest

The rear seat backrest is split into two sections. Each section can be folded independently to allow you to transport

long objects.

To fold down the backrest(s):

- Pull the release control handle(s) in the trunk to release the backrest(s) (see illustration above). If the outboard rear head restraints are folded down, they should be returned to the upright position before folding the backrest down. It may be necessary to manually adjust the center head restraint.
- Fold the backrest down.

**WARNING!**

All S80 cars feature 60/40 split fold-down rear seats. This function is performed by handles inside the trunk, and also provides a means for children and adults to enter the passenger compartment in the event they become locked inside the trunk.

Adults are advised to familiarize themselves with the operation and location of the release handles.

To fold down the rear seats from inside the trunk, pull the release control handles located on either side of the trunk.

**WARNING!**

- Keep vehicle doors and the luggage compartment locked and keep keys out of a child's reach. Unsupervised children could lock themselves in an open trunk and risk injury. Children should be taught not to play in vehicles.
- On hot days, the temperature in the trunk or vehicle interior can rise very quickly. Exposure of people to these high temperatures for even a short period of time can cause heat-related injury or death. Small children are particularly at risk.

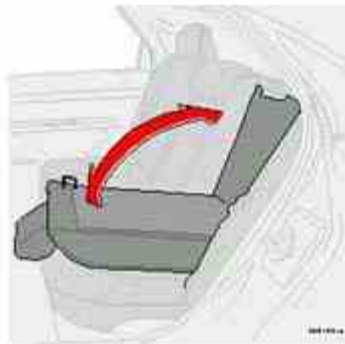

**WARNING!**

- When the backrest is returned to the upright position, check that it is properly locked in place. Return the head restraints to the upright position.
- Long loads should always be securely anchored to help avoid injury in the event of a sudden stop.
- Always turn the engine off and apply the parking brake when loading/unloading the vehicle.
- Place the transmission in the P (PARK) position to help prevent inadvertent movement of the gear selector.



# 2004 VOLVO S80

## Chapter 5 - Keys, Locks, Alarm

pg. 59 Keys, Locks, Alarm

[Keys, Exterior courtesy lights, Locking and unlocking the car](#) 60

[Remote keyless entry system](#) 61

[Unlocking the trunk with the master key, Central locking buttons, "Trunk lock" function](#) 63

[Alarm](#) 65

[Child safety locks - rear doors](#) 67

pg. 60 Keys, Exterior courtesy lights, Locking and unlocking the car



### Keys

Two keys are provided with your car; a master key and a service key. The master key, the remote control, and the central locking button may all be used to lock and unlock all of your car's locks.

The service key will operate only the driver's door and the ignition switch. It is intended to help deter unwanted entry into the glove compartment and trunk.

**Turn the key once** to unlock the driver's door only.

**Turn the key again (within 10 seconds)** to unlock all doors and the trunk.

One turn with the key towards lock in the drivers door locks all doors, trunk.



Use the switch on the front door armrests to lock/unlock the car from the inside.

**WARNING!**

If the doors are locked while driving, this may hinder rapid access to the occupants of the car in the event of an accident. (Also see information on "Child safety locks").

**Note:** To help prevent accidentally locking the keys in the car, the central locking system is designed to unlock the doors immediately if the key is left in the ignition switch, the car is locked using the lock button on the door and the door is then closed. **A sound from the lock will be audible at this time.**

*Please note that this function will not unlock the doors if the engine is running.*

**Immobilizer (start inhibitor)**

Each of the keys supplied with your car contains a coded transmitter. The code in the key is transmitted to an antenna in the ignition switch where it is compared to the code stored in the start inhibitor module. The car will start only with a properly coded key.

If you misplace a key, take the other keys to an authorized Volvo retailer for reprogramming as an antitheft measure.

---

This device complies with part 15 of the FCC rules. Operation is subject to the following condition: (1) This device may not cause harmful interference, and (2) this device must accept any interference received, including interference that may cause undesired operation.

---

**Exterior Courtesy lights**

**Home Safe System**

When you leave your car at night, you can make use of the courtesy lighting function:

- Remove the key from the ignition switch.
- Pull the direction indicator lever towards the steering wheel (as when using the headlight flasher function).
- Exit the car and lock the doors.

The headlights, parking lights, license plate lights and the lights in the sideview mirrors will now come on and remain on for 30, 60 or 90 seconds (the time interval is at your discretion and can be changed by an authorized Volvo retailer).

**Approach lighting**

When approaching the car at night, press the yellow button in the central locking remote control (see illustration on [page 61](#)). This lights up the interior courtesy light, parking lights, license plate lights and the lights in the sideview mirrors.

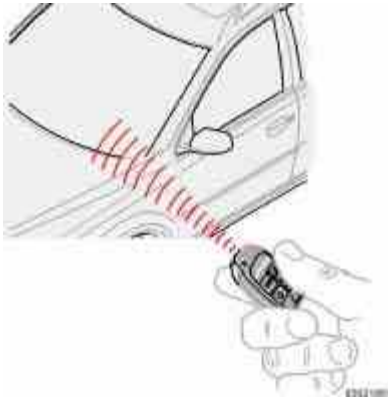

### Remote keyless entry system

Your car is equipped with two coded remote control transmitters with integrated ignition keys called Key Integrated Remote (KIR). These transmitters use a radio frequency that will enable you to lock/unlock all doors and the trunk from a distance of 10-15 feet (3-5 meters).

The transmitters will also activate or allow "keyless" entry into the passenger compartment or the trunk. They will also activate or deactivate the vehicle's alarm system(s).

The car can also be locked/unlocked with the key.

If one of the transmitters is misplaced, contact your nearest authorized Volvo retailer for replacement.

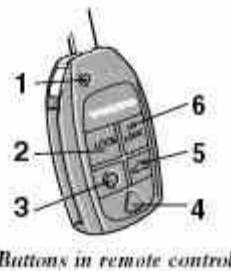

*Buttons in remote control*

*1 - Fold key in/out, 2 - Lock, 3 - Approach lighting,  
4 - "Panic" function, 5 - Open trunk, 6- Unlock*

### Using the remote control

**Button 1:** Press to extend the key. This button must also be pressed when the key is folded back into the slot in the side of the remote control unit.

**Button 2 (Lock):** Press once to lock all doors, and the trunk.

**Button 3 (Approach lighting):** Press this button when approaching the car at night to light up the interior courtesy light, parking lights, license plate lights and the lights in the sideview mirrors.

**Button 4 (Panic):** See [page 65](#) for more information on this function.

**Button 5 (Open trunk):** Press this button twice within 3 seconds to pop open the trunk (without unlocking the other doors).

**Button 6 (Unlock):** Press this button once to unlock the driver's door only. Wait for at least 1 second and press the button again (within 10 seconds) to unlock all doors, and the trunk.

**NOTE:**

- If the doors are unlocked with the remote, the locks will automatically reengage (re-lock) and the alarm will rearm after 2 minutes unless a door has been opened.
- The lock/unlock and alarm features can also be utilized by using the keys.

FCC ID:LQNP2T-APU

This device complies with part 15 of the FCC rules. Operation is subject to the following conditions: (1) This device may not cause harmful interference, and (2) this device must accept any interference received, including interference that may cause undesired operation.

Canadian 2306104388

Model 504 2927 by Donnelly

Operation is subject to the following conditions: (1) this device may not cause interference, and (2) this device must accept any interference, including interference that may cause undesired operation of the device.

Canadian 2306104388A

Model 509 977 by Connaught Electronics

Operation is subject to the following conditions: (1) this device may not cause interference, and (2) this device must accept any interference, including interference that may cause undesired operation of the device.

pg. 62 Remote keyless entry system

### **WARNING!**

Never use the transmitter to lock the doors from inside the car.

Doing so would **ACTIVATE**:

- the break-in alarm, which would sound if one of the doors were opened.
- the interior motion and inclination alarm sensors, if equipped.

Doing so would **DEACTIVATE**:

- the moonroof and interior courtesy light controls.
- the central locking buttons on the front door armrests, although the interior door handles would still function to allow occupants to leave the car.

Disabled features would remain disabled until the remote were used again to unlock the car.

In addition, locking an occupied vehicle would hinder rapid access to the occupants in an accident or emergency.

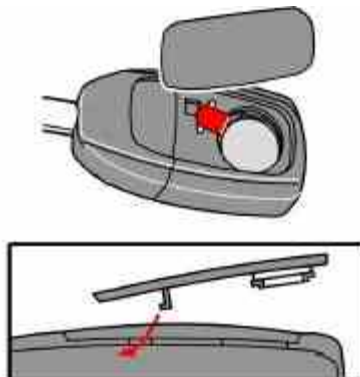

**Remote keyless entry system - replacing batteries**

If the range of the transmitter is noticeably reduced, this indicates that the battery is weak and should be replaced.

### To replace the battery

- Remove the cover by carefully prying up its rear edge with a small screwdriver
- Replace the battery with a new 3-volt, CR 2032 battery. The battery should be inserted with the plus side upward. Avoid touching the contact surfaces of the battery with your fingers.
- Press the cover back into place. Ensure that the rubber seal seats correctly to help prevent moisture from entering the unit.

**NOTE:** The old battery should be disposed of properly at a recycling center or at your Volvo retailer

pg. 63 Locking and unlocking the car



### Unlocking the trunk with the master key

Normally, the trunk should be locked and unlocked via the central locking system using the remote control or by using the key in the driver's door lock. The master key should be used only if it is not possible to unlock the trunk via the central locking system.

**NOTE: Unlocking the trunk in this manner will cause the alarm to sound. See [page 65](#) for information on turning off the alarm.** Unlocking the trunk this way will not unlock the other doors.

If, for any reason, it should be necessary to unlock the trunk with the master key:

- Press the key into the upper or lower edge of the cover over the lock in the trunk lid.
- Move the key upward or downward to remove the cover.
- Insert the master key in the lock and unlock the trunk.



*Opening the trunk from the inside*

### Opening the trunk from the inside - (U.S. models only)

The S80 is equipped with a florescent handle on the inside of the trunk lid, which can be used in an emergency situation to open the trunk from the inside.

*Pull the handle down to release the trunk lid.*

**After use, the handle must be pushed back into its original position before the trunk can be closed.**

**NOTE:** This handle is not intended to be used to anchor the trunk lid when long loads are being transported.

### WARNING!

- Keep vehicle doors and trunk locked and keep keys out of a child's reach. Unsupervised children could lock themselves in an open trunk and risk injury. Children should be taught not to play in vehicles.
- On hot days, the temperature in the trunk or vehicle interior can rise very quickly. Exposure of people to these high temperatures for even a short period of time can cause heat-related injury or death. Small children are particularly at risk.

pg. 64 Locking and unlocking the car



*Central locking buttons*

### Central locking buttons

These buttons (located on the both front door armrests) can be used to lock/unlock all doors and the trunk and set the alarm.

The lock buttons on all doors can be used in the same way.



*Trunk lock button\**

## **Valet security locking**

The security locking feature of your car allow you to prevent unwanted access to your trunk and glove compartment, while still allowing a parking attendant to unlock, start, and relock the rest of your car. To prevent unwanted access to the trunk and glove compartment do the following:

- Give your service key to the parking attendant.
- Insert your master key into the glove compartment. Turn it 90 degrees clockwise and remove the key. The glove compartment cannot be unlocked with the service key.
- Insert your master key into the ignition and turn it to position II.
- Press the trunk lock button in the center console. An LED and a message in the text window will show that the trunk lock has be activated.
- Turn off the car and remove the master key.
- With the trunk lock activated, neither the service key nor the remote control will open the trunk.

The function can be turned off (deactivated) by turning the ignition key to position II and pressing the trunk lock button again (the LED in the button will go out and VALET LOCK OFF" will be displayed in the text window).

\* The position of this button may vary, depending on the specifications of your car.

pg. 65 Alarm

## **Alarm**

The alarm is automatically armed whenever you lock your car.

When armed, the alarm continuously monitors a number of points on the car. The following conditions will set off the alarm:

- The hood is forced opened.
- The trunk is forced opened.
- A door is forced opened.
- The ignition switch is tampered with.
- If there is movement in the passenger compartment (if the car is equipped with the optional movement sensor).
- The car is lifted or towed (if the car is equipped with the optional inclination sensor).
- The battery is disconnected (while the alarm is set).

### **Arming the alarm**

Press the LOCK button on the remote control, lock the car using the key in the driver's door or press the central lock button on one of the front doors with the door open. One long flash of the turn signals will confirm that the alarm is armed.

### **Disarming the alarm**

Press the UNLOCK button on the remote control or unlock the doors with the key.

### **Turning off (stopping) the alarm**

If the alarm is sounding, it can be stopped by pressing the UNLOCK button on the remote control or by unlocking the driver's door with the key.

### **Visual alarm signal**

The visual alarm signal is given by flashing all turn signals and turning on the interior lighting for approximately 5 minutes.

### **Audible alarm signal**

An audible alarm signal is given by a battery powered siren. One alarm cycle lasts for 25 seconds.

## "Panic" function

In an emergency situation, this feature can be used to attract attention.

Activate the "panic" function by pressing the red button on the remote control (see illustration on [page 61](#)) for at least 3 seconds or by pressing this button twice within 3 seconds. The turn signals will flash, the interior lights will go on and the car's horn will sound.

**The function can be turned off by pressing any of the buttons on the remote control or will stop automatically after 25 seconds. When a button is pressed, there is a 5 second delay before the panic alarm is deactivated.**

**NOTE:** This button will **NOT** unlock the car.

pg. 66 Alarm



*The position of this button may vary, depending on the specifications of your car.*

## Temporarily disconnecting the alarm sensor(s) - accessory

This button will only be found in cars equipped with the optional inclination and/or movement sensors.

---

FCC ID: MAYDA5823

This device complies with part 15 of the FCC rules. Operation is subject to the following conditions: (1) This device may not cause harmful interference, and (2) this device must accept any interference received, including interference that may cause undesired operation.

---

Canadian IC: 4405A-DA5823

Movement sensor DA5823 by Dynex

Operation is subject to the following conditions: (1) this device may not cause interference, and (2) this device must accept any interference, including interference that may cause undesired operation of the device.

---

In certain situations it may be desirable to turn off the optional inclination and movement alarm sensors if, for example, you drive your car onto a ferry where the rocking of the boat could trigger the alarm or if a pet is left in the car with the doors locked.

## To temporarily turn off the inclination and movement alarm sensor from the alarm system:

From the time the ignition key is turned from the Drive position (position II) until you lock the car, you can press the button in the center console. The LED in the switch will light up and a message will be displayed in the text window to indicate that the sensors are disconnected.

The car can then be locked in the usual way to set the alarm.

## NOTE:

- This function will not turn off the vehicle's standard alarm.
- The optional sensors are automatically reconnected to the alarm system the next time the car is unlocked and then locked again.

### LED alarm status signals

The status of the alarm system is indicated by the red LED at the top of the dash:

- LED off - the alarm is not armed
- LED flashes once per second - the alarm is armed
- LED flashes rapidly before the ignition is switched on - the alarm has been triggered
- **Fault in the alarm system:** If a fault has been detected in the alarm system, a message will be displayed in the text window. Contact a Volvo retailer.

### Automatic re-lock/re-arm function

If the car is unlocked with the remote, the car will re-lock and the alarm will re-arm after 2 minutes unless a door or the trunk has been opened.

pg. 67 Child safety locks - rear doors

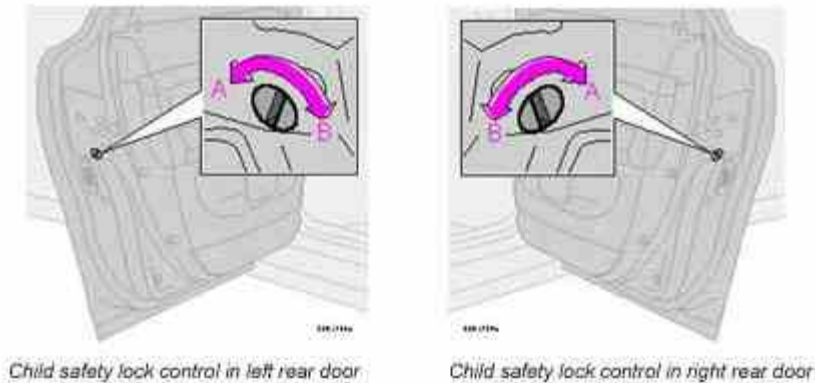

### Child safety locks - rear doors

The controls are located on the rear door jambs. Use a screwdriver to adjust these controls.

**A** The door cannot be opened from the inside. Normal operation from the outside.

**B** The door lock functions normally.

### WARNING!

Remember, in the event of an accident, the rear seat passengers cannot open the doors from the inside with the buttons in position A.

pg. 68

This page intentionally left blank.







2004  
VOLVO  
S80

Chapter 6 - Starting and driving

pg. 69 Starting and driving

<a href="#">Fuel requirements</a>	70
<a href="#">Refueling</a>	72
<a href="#">Starting the engine</a>	73
<a href="#">Automatic transmission</a>	74
<a href="#">Four-C active chassis system</a>	78
<a href="#">Rear Parking assistance</a>	79
<a href="#">Driving economy</a>	80
<a href="#">Points to remember</a>	81
<a href="#">Roof racks/load carriers</a>	82
<a href="#">Emergency towing</a>	83
<a href="#">Vehicle towing information</a>	84
<a href="#">Towing a trailer</a>	85
<a href="#">Jump starting</a>	88
<a href="#">Winter driving</a>	89
<a href="#">Long distance trips</a>	90
<a href="#">Three-way catalytic converter</a>	91

pg. 70 Fuel requirements

## Fuel requirements

### Octane rating

Volvo engines are designed for optimum performance on unleaded premium gasoline with an octane rating AKI of 91,

or above. AKI (ANTI KNOCK INDEX) is an average of the Research Octane Number, RON, and the Motor Octane Number, MON.  $(RON + MON)/2$ .

The minimum octane requirement is AKI 87 (RON 91).

### **Deposit control gasoline (detergent additives)**

Volvo recommends the use of gasoline containing deposit control additives. These additives have shown to be effective in keeping injectors and intake valves clean. Consistent use of deposit control gasolines will help ensure good driveability and fuel economy. If you are not sure whether the gasoline contains deposit control additives, check with the service station operator.

### **Unleaded fuel**

Each Volvo has a three-way catalytic converter and must use only unleaded gasoline. U.S. and Canadian regulations require that pumps delivering unleaded gasoline be labelled "UNLEADED". Only these pumps have nozzles which fit your car's filler inlet. It is unlawful to dispense leaded fuel into a vehicle labelled "unleaded gasoline only". Leaded gasoline damages the three-way catalytic converter and the heated oxygen sensor system. Repeated use of leaded gasoline will lessen the effectiveness of the emission control system and could result in loss of emission warranty coverage. State and local vehicle inspection programs will make detection of misfueling easier, possibly resulting in emission test failure for misfueled vehicles.

**NOTE:** Some U.S. and Canadian gasolines contain an octane enhancing additive called methyl-cyclopentadienyl manganese tricarbonyl (MMT). If such fuels are used, your Emission Control System performance may be affected, and the Check Engine light (malfunction indicator lamp) located on your instrument panel may light. If this occurs, please return your vehicle to an authorized Volvo retailer for service.

### **Gasoline containing alcohol and ethers**

#### **"Oxygenated fuels"**

Some fuel suppliers sell gasoline containing "oxygenates" which are usually alcohols or ethers. In some areas, state or local laws require that the service pump be marked indicating use of alcohols or ethers. However, there are areas in which the pumps are unmarked. If you are not sure whether there is alcohol or ethers in the gasoline you buy, check with the service station operator. To meet seasonal air quality standards, some areas require the use of "oxygenated" fuel.

Volvo allows the use of the following "oxygenated" fuels; however, the octane ratings listed on this page must still be met.

**Alcohol - Ethanol:** Fuels containing up to 10% ethanol by volume may be used. Ethanol may also be referred to as Ethyl alcohol, or "Gasohol".

**Ethers - MTBE:** Fuels containing up to 15% MTBE may be used.

---

### **CAUTION!**

Do not use gasolines containing methanol (methyl alcohol, wood alcohol). This practice can result in vehicle performance deterioration and can damage critical parts in the fuel system. Such damage may not be covered under the New Vehicle Limited Warranty.

pg. 71 Fuel requirements

### **Carbon Monoxide - Important Warning**

Carbon monoxide is a poisonous, colorless, and odorless gas. It is present in all exhaust gases. If you ever smell exhaust fumes inside the vehicle, make sure the passenger compartment is ventilated, and immediately return the vehicle to your retailer for correction.

### **Fuel Formulations**

Do not use gasoline that contains lead as a knock inhibitor, and do not use lead additives. Besides damaging the exhaust emission control systems on your car, lead has been strongly linked to certain forms of cancer.

Many fuels contain benzene as a solvent. Unburned benzene has been strongly linked to certain forms of cancer. If you live in an area where you must fill your own gas tank, take precautions. These may include:

- standing upwind away from the filler nozzle while refueling
- refueling only at gas stations with vapor recovery systems that fully seal the mouth of the filler neck during refueling
- wear neoprene gloves while handling a fuel filler nozzle.

### Use of Additives

With the exception of gas line antifreeze during winter months, do not add solvents, thickeners, or other store-bought additives to your car's fuel, cooling, or lubricating systems. Overuse may damage your engine, and some of these additives contain organically volatile chemicals. Do not needlessly expose yourself to these chemicals.

pg. 72 Refueling



### Refueling

The fuel tank is designed to hold approximately 21.1 US gal. (80 liters) with sufficient volume left over to accommodate possible expansion of the fuel in hot weather. Be aware that the "usable" tank capacity will be somewhat less than the specified maximum. When the fuel level is low, such factors as ambient temperature, the fuel's "Reid vapor pressure" characteristics, and terrain can affect the fuel pumps' ability to supply the engine with an adequate supply of fuel. Therefore, it is advisable to refuel as soon as possible when the needle nears the red zone, or when the fuel warning light comes on.

### Fuel filler door

Press the button on the light switch panel (see illustration on [page 32](#)) when the car is at a standstill to unlock the fuel filler door. Please note that the fuel filler door will remain unlocked until the car begins to move forward. An audible click will be heard when the fuel filler door relocks.

If you intend to leave your car while it is being refueled, this feature enables you to lock the doors/trunk while leaving the fuel filler door unlocked.

You can also keep the car locked if you remain inside it during refueling. The central locking button does not lock the fuel filler door. Be sure the fuel filler door is not obstructed and is completely closed after refueling.

### Open the fuel filler cap slowly during hot weather conditions.

**NOTE:** During a transitional period, a small number of service stations may still have fuel nozzles that are not compatible with the fuel filler neck on cars equipped with the evaporative control system. Please refer to [page 117](#) for additional information.

### **WARNING!**

Never carry a cell phone that is **switched on** while refueling your vehicle. If the phone rings, this may cause a spark that could ignite gasoline fumes, resulting in fire and injury.

## CAUTION:

- Do not refuel with the engine running \*. Turn the ignition off or to position I. If the ignition is on, an incorrect reading could occur in the fuel gauge.
- After refueling, close the fuel filler cap by turning it clockwise until it *clicks* into place \*.
- Allow for fuel expansion by not overfilling the tank. Overfilling could also cause damage to the emission control systems.
- Avoid spilling gasoline during refueling. In addition to causing damage to the environment, gasolines containing alcohol can cause damage to painted surfaces, which may not be covered under the New Vehicle Limited Warranty.
- Do not use gasolines containing methanol (methyl alcohol, wood alcohol). This practice can result in vehicle performance deterioration and can damage critical parts in the fuel system. Such damage may not be covered under the New Vehicle Limited Warranty.

*\* If the fuel filler cap is not closed tightly or if the engine is running when the car is refueled, the Check Engine Light (Malfunction Indicator Lamp) may indicate a fault. However, your vehicle's performance will not be affected. Use only Volvo original or approved fuel filler caps.*

pg. 73 Starting the engine

## Starting the engine

1. Fasten the seat belt.

### WARNING!

Before starting, check that the seat, steering wheel and mirrors are adjusted properly. Make sure the brake pedal can be depressed completely. Adjust the seat if necessary. See [page 52](#).

2. Apply the parking brake, if not already set. The gear selector is locked in the (P)ark position (**SHIFTLOCK**).
3. **Without touching the accelerator pedal**, turn the ignition key\* to the starting position. Allow the starter to operate for up to 5 seconds (turbo: 10 seconds). Release the key as soon as the engine starts. If the engine fails to start, repeat this step.

**NOTE:** On certain models, when the car is started, idle speed may be noticeably higher than normal for a short period, depending on the temperature of the engine.

This has been done to help bring components in the emission control system to their normal operating temperature as quickly as possible, which enables them to function normally.

For cold starts at altitudes above 6000 ft (1800 meters), depress the accelerator pedal halfway and turn the key to the starting position. Release the pedal slowly when the engine starts.

4. To release the gear selector from the (P)ark position, the engine must be running (or the ignition key must be in position II) and the brake pedal must be depressed. While keeping firm pressure on the brake pedal, release the parking brake.

5. Select the desired gear. The gear engages after a very slight delay which is especially noticeable when selecting R.

### NOTE:

- Your car is equipped with a **KEYLOCK** system. When the engine is switched off, the gear selector must be in the (P)ark position before the key can be removed from the ignition switch.

- When starting in cold weather, the transmission may shift up at slightly higher engine speeds than normal until the automatic transmission fluid reaches normal operating temperature.

### CAUTION:

- The engine should be idling when you move the gear selector. Never accelerate until after you feel the transmission engage! Accelerating immediately after selecting a gear will cause harsh gear engagement and premature transmission wear.
- Selecting P or N when idling at a standstill for prolonged periods of time will help prevent overheating of the automatic transmission fluid.
- Do not race a cold engine immediately after starting. Oil flow may not reach some lubrication points fast enough to prevent engine damage.

### WARNING!

- Always place the gear selector in Park and apply the parking brake before leaving the vehicle. Never leave the car unattended with the engine running.
- Always open the garage doors fully before starting the engine inside a garage to ensure adequate ventilation. The exhaust gases contain carbon monoxide, which is invisible and odorless but very poisonous.

\* Your car is equipped with an electronic start inhibitor (immobilizer). The keys you received with your car are specially coded. The code in the key is transmitted to an antenna in the ignition switch where it is compared to the code stored in the start inhibitor module. The car can only be started if a properly coded key is used. If two of the keys to your car are close together, e.g., on the same key ring, when you try to start the car, this could cause interference in the immobilizer system and result in the car not starting. If this should occur, remove one of the keys from the key ring before trying to start the car again.

pg. 74 Automatic transmission



### P (Park)

Use this position when starting the engine or parking the car.

**Never use P while the car is in motion.**

The parking brake should also be set whenever the car is parked.

**The gear selector is mechanically locked in the P position (SHIFTLOCK).** To release the gear selector from this position, the engine must be running (or the ignition key must be in position II) and the brake pedal must be depressed.

### WARNING!

Never leave the car unattended when the engine is running. If, by mistake, the gear selector is moved from P, the car may start moving.

---

### **R (Reverse)**

Never engage R while the car is moving forward.

### **N (Neutral)**

Neutral - no gear engaged. Use the parking brake.

### **D (Drive)**

D is the normal driving position and should be used as often as possible to help improve fuel economy. The car should not be moving when shifting from R to the D position.

### **3 (Intermediate gear)**

The transmission will shift automatically between gears 3, 2 or 1 from this position. **The transmission cannot shift up to (D)rive from third gear.**

### **2 (Intermediate gear)**

The transmission will shift automatically between gears 2 and 1 from this position. **The transmission cannot shift up to third gear from second gear.**

### **1 (Low gear)**

If you select this gear at speeds above 30 mph (50 km/h), the transmission will first shift to second gear and then to first gear at lower speeds.

**NOTE:** The intermediate and low gears can be used for:

- Driving in a mountainous area
- Towing a trailer
- Increasing the braking effect of the engine.
- The transmission has a built-in limiter designed to help prevent excessive engine speeds (high rpm) when gears 3, 2 or 1 are selected.

### **Kickdown**

Automatic shift to a lower gear (kickdown) is achieved by depressing the accelerator pedal fully and briskly. An upshift will occur when approaching the top speed for a particular gear or by releasing the accelerator pedal slightly. Kickdown can be used for maximum acceleration or when passing at highway speeds.

### **Automatic transmission - adaptive system**

The automatic transmission is controlled by an adaptive control system that constantly monitors the way in which the transmission functions. It senses and adapts each gear shift for optimal performance. The system also monitors your particular driving style and adapts gear shifting accordingly.

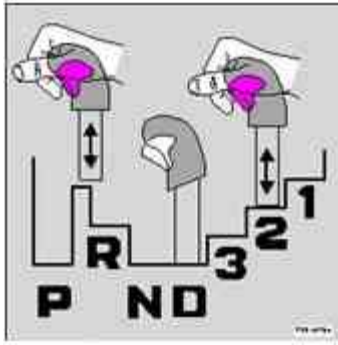

### Automatic transmission - shift gate positions

The gear selector can be moved freely between N and D.

Depressing the selector knob enables you to move the gear selector to positions P, R, N, D, 3, 2 and 1.

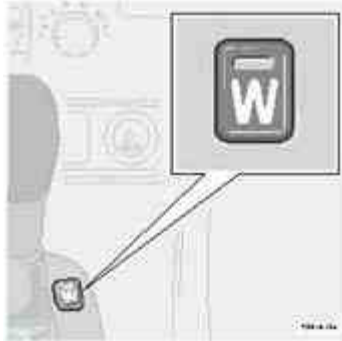

### W Winter/Wet driving mode - enhanced vehicle traction

- Mode W will only function if the gear selector is in the (D)rive position.
- Press the button at the base of the gear selector to engage/disengage this driving mode (see illustration).
- An LED in the button will light up to indicate that **W** is engaged and this will also be displayed in the instrument panel (see [page 25](#)).
- This mode may be selected for starting/moving off on slippery roads.

### Cold starts

When driving before the engine has reached its normal operating temperature, the transmission will shift up at slightly higher engine speeds to heat the three-way catalytic converter as quickly as possible.

pg. 76 Automatic transmission (Geartronic)



**P (Park)**



Use this position when starting the engine or parking the car.

**Never use P while the car is in motion.**

The parking brake should also be set whenever the car is parked.

**The gear selector is mechanically locked in the P position (SHIFTLOCK).** To release the gear selector from this position, the engine must be running (or the ignition key must be in position II) and the brake pedal must be depressed.

**WARNING!**

Never leave the car unattended when the engine is running. If, by mistake, the gear selector is moved from P, the car may start moving.

**R (Reverse)**

Never engage R while the car is moving forward.

**N (Neutral)**

Neutral - no gear engaged. Use the parking brake.

**D (Drive)**

D is the normal driving position and should be used as often as possible to help improve fuel economy. The car should not be moving when shifting from R to the D position.

**Kickdown**

Automatic shift to a lower gear (kickdown) is achieved by depressing the accelerator pedal fully and briskly. An upshift will occur when approaching the top speed for a particular gear or by releasing the accelerator pedal slightly. Kickdown can be used for maximum acceleration or when passing at highway speeds. **Kickdown does not function when the transmission is in the manual shift (geartronic) mode (see next page).**



*Shift gate positions*

**Automatic transmission - adaptive system**

The automatic transmission is controlled by an adaptive control system that constantly monitors the way in which the transmission functions. It senses and adapts each gear shift for optimal performance. The system also monitors your particular driving style and adapts gear shifting accordingly.

**Automatic transmission - shift gate positions**

You can move the gear selector freely between the (MAN)ual and (D)rive positions while driving. Depress the selector knob on the front side of the gear selector to move between the R, N, D and P positions. **Please see the following page for information on using the Geartronic manual shift mode.**

## Manual shifting - Geartronic

You can move the gear selector freely between the (MAN)ual and (D)rive positions while driving. Gears 2, 3, and 4 have a "lock-up" function which reduces engine speed and helps save fuel.

The currently selected gear will be displayed in the instrument panel (see [page 25](#)).

- To access the (MAN)ual shifting position from (D)rive, pull the gear selector back slightly from D and move it to the left to MAN.
- To return to the (D)rive position from MAN, move the gear selector to the right and push it forward to the (D)rive position.

## While driving

If you select the (MAN)ual position while driving, the gear that was being used in the (D)rive position will also initially be selected in (MAN)ual position.

- Move the gear selector forward (toward "+") to shift to a higher gear or rearward (toward "-") to shift to a lower gear.
- If you hold the gear selector toward "-", the transmission will downshift one gear, and will utilize the braking power of the engine. If the current speed is too high for using a lower gear, the downshift will not occur until the speed has decreased enough to allow the lower gear to be used.
- If you slow down to a very low speed, the transmission will automatically shift down.
- When starting in the (MAN)ual position, 3rd gear is the highest gear that may be selected.

**NOTE:** Kickdown (see previous page) **does not function** when the transmission is in the manual shift (geartronic) mode. The gear selector must be in D (Drive) position.

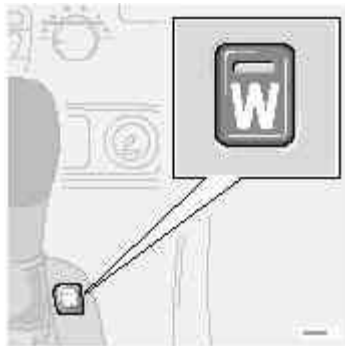

## W Winter/Wet driving mode - enhanced vehicle traction

- Mode W will only function if the gear selector is in the (D)rive position.
- Press the button at the base of the gear selector to engage/disengage this driving mode (see illustration).
- An LED in the button will light up to indicate that **W** is engaged and this will also be displayed in the instrument panel (see [page 25](#)).
- This mode may be selected for starting/moving off on slippery roads.

pg. 78 Four-C active chassis system

## Four-C (option)

Your car can be optionally equipped with the Four-C (Continuously Controlled Chassis Concept) system.

This system is based on a number of sensors that continuously monitor factors such as the car's lateral and vertical movements, speed, and movements of the wheels. The sensors receive data up to 500 times per second, which is used to provide extremely fast and precise adjustment of each shock absorber. The system adjusts the stiffness of the shock absorbers approximately 100 times per second.

The button in the center console (see the illustration on [page 29](#)) can be used **at any time** to switch between the two driving modes: Comfort or Sport.

The system then adjusts the stiffness of the shock absorbers accordingly, for example when the type of road changes, or if the driver wishes to change driving style. This adjustment takes place instantaneously.

### **Comfort**

The Comfort mode chassis setting offers the greatest amount of shock absorption and the softest ride. This mode is recommended for long-distance driving, or when driving in slippery conditions.

If Comfort mode was selected when the engine was switched off, this mode will be active when the engine is restarted.

### **Sport**

An indicator lamp in the button will come on when this mode has been activated.

In Sport mode, shock absorption is stiffer to reduce the car's body sway during cornering and to provide more immediate steering response.

If this setting was selected when the engine was switched off, Sport mode will be active when the engine is restarted.

pg. 79 Rear parking assistance (option)

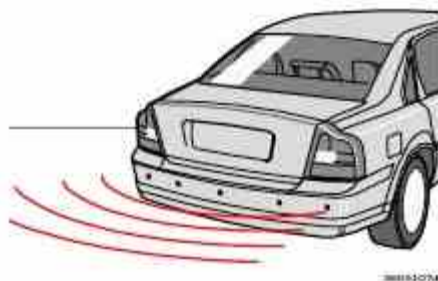

### **Rear Parking Assistance**

This system is used to assist you when backing into parking spaces, etc by providing an audible tone as you back up.

The system is automatically activated when you select reverse gear.

It utilizes ultrasound sensors located in the rear bumper to measure the distance to a vehicle or other object, or a person who may be behind the vehicle.

#### **When the system is active:**

1. The audio system's volume will be reduced.
2. An intermittent signal will be audible from the audio system's speakers to indicate that as you back up, you are approaching a person, object, parked vehicle, etc. The signals begin when the vehicle is at a distance of approximately 5 feet (1.5 meters) from an object/person, etc.
3. At a distance of approximately 1 foot (30 cm), the signal will become constant.

#### **Switching off the system**

Towing a trailer, carrying bicycles in a tailgate-mounted carrier, etc, could trigger the reverse warning system.

### To temporarily deactivate the system:

- Press the button in the center control panel (see illustration on [page 29](#)).
- The LED in the button will go out to indicate that the system is not in active mode.
- Press the button again to reactivate the system.

### Faults in the system

If a fault should occur in the system, the LED in the button will be switched off and a message will be displayed in the text window.

### Cleaning the sensors

For the system to function properly, the sensors should be kept clean. They can be cleaned with car washing detergent and a sponge.

#### **WARNING!**

This system is designed to be a supplementary aid when the vehicle is backing up. It is not, however, intended to replace the driver's attention and judgement.

pg. 80 Driving economy

### Economical driving conserves natural resources

Better driving economy may be obtained by thinking ahead, avoiding rapid starts and stops and adjusting the speed of your vehicle to immediate traffic conditions. Observe the following rules:

- Bring the engine to normal operating temperature as soon as possible by driving with a light foot on the accelerator pedal for the first few minutes of operation. A cold engine uses more fuel and is subject to increased wear.
- Whenever possible, avoid using the car for driving short distances. This does not allow the engine to reach normal operating temperature.
- Drive carefully and avoid rapid acceleration and hard braking.
- Do not exceed posted speed limits.
- Avoid carrying unnecessary items (extra load) in the car.
- Maintain correct tire pressure. Check tire pressure regularly (when tires are cold).
- Remove snow tires when threat of snow or ice has ended.
- Note that roof racks, ski racks, etc., increase air resistance and also fuel consumption.
- Avoid using automatic transmission kickdown feature unless necessary.
- Avoid using the air conditioning when it is not required. When engaged, the A/C compressor places an additional load on the engine. However, at higher driving speeds, fuel consumption will be lower with the air conditioning on and the windows closed than with the air conditioning off and the windows open.
- Using the onboard trip computer's fuel consumption modes can help you learn how to drive more economically.

Other factors that decrease gas mileage are:

- Dirty air cleaner
- Dirty engine oil and clogged oil filter
- Dragging brakes
- Incorrect front end alignment

Some of the above mentioned items and others are checked at the standard Maintenance Service intervals.

**NOTE:** Vehicles equipped with automatic transmissions should use (D)rive as often as possible and avoid using

"kickdown" to help improve fuel economy.

### Cooling system

The risk for engine overheating is greatest, especially in hot weather, when:

- Towing a trailer up steep inclines for prolonged periods at wide open throttle and low engine rpm.
- Stopping the engine suddenly after high speed driving (so-called "after-boiling" can occur).
- To avoid overheating, the following rules should be followed:

Do not drive for prolonged periods at engine speeds above 4500 rpm if you are towing a trailer in hilly terrain.

- Reduce speed when towing a trailer up long, steep inclines. The risk of overheating can be reduced by switching off the air conditioning system for a short time.
- Do not let the engine idle unnecessarily for prolonged periods.
- Do not mount auxiliary lamps in front of the grill.

When the risk of overheating is imminent, or in the event of overheating (the temperature gauge goes repeatedly into, or stays continually in, the red section), the following precautions should be taken:

- Switch off the air conditioning system.
- Pull off the road, away from traffic, stop the car and put the gear selector into Park. **Do not stop the engine!**
- Switch the heater to full (maximum) position. Increase the engine speed to approx. 2000 rpm (twice idling speed) until the temperature begins to drop.
- If the warning light in the center of the instrument panel is red, and the message "Coolant level lo stop engine" is displayed, switch off the engine as soon as possible.

#### **WARNING!**

Do not remove coolant expansion tank cap. The coolant will be extremely hot.

If necessary, see [page 118](#) for information on checking and topping-up the coolant level.



[Contents](#) | [Top of Page](#)

2004  
VOLVO  
S80

Chapter 7 - Wheels and tires

pg. 93 Wheels and tires

[General information, Wear indicator, Tire economy, Flat spots](#) 94

[Snow chains, Snow tires/studded tires](#) 95

[Inflation pressure, Spare tire](#) 96

[Uniform tire quality grading](#) 97

[Changing wheels](#) 98

pg. 94 Wheels and tires

### General information

**Your vehicle is equipped with tires according to the tire information label on the inside of the fuel filler door.**

The following is an **example** of a tire designation code: 225/55 R16

**225** = tire width in mm.

**55** = tire profile. This is the relationship (in percent) between the section height and width of the tire.

**R** = radial tires.

**16** = diameter in inches.

The tires have good road holding characteristics and offer good handling on dry and wet surfaces. It should be noted however that the tires have been developed to give these features on snow/icefree surfaces. **Certain models are equipped with "all-season" tires, which provide a somewhat higher degree of road holding on slippery surfaces than tires without the "all-season" rating.** However, for optimum road holding on icy or snow covered roads **we recommend suitable winter tires on all four wheels.** When replacing tires, be sure that the new tires are the same size designation, type (radial) and preferably from the same manufacturer, on all four wheels. Otherwise there is a risk of altering the car's roadholding and handling characteristics.

**NOTE:** When storing wheel/tire assemblies (e.g. winter tires and wheels), either stand the assemblies upright, or suspend them off the ground. Laying wheel/tire assemblies on their sides for prolonged periods can cause wheel and/or tire damage.

### Wear indicator

The tires have wear indicator strips running across or parallel to the tread. When approx. 1/16" (1.6 mm) is left on the

tread, these strips become visible and indicate that the tire should be replaced.

Tires with less than 1/16" (1.6 mm) tread have a very poor grip in rain or snow.

When replacing worn tires, it is recommended that the tire be identical in type (radial) and size as the one being replaced. Using a tire of the same make (manufacturer) will prevent alteration of the driving characteristics of the vehicle.

### **To improve tire economy:**

- Maintain correct tire pressure. See the tire pressure label on the inside of the fuel filler door.
- Drive smoothly: avoid fast starts, hard braking and tire screeching.
- Tire wear increases with speed.
- Correct front wheel alignment is very important.
- Unbalanced wheels impair tire economy and driving comfort.
- Volvo recommends rotating the tires every 7,500 miles (12,000 km). Tires should be rotated front-to-back/back-to-front only. Tires must maintain the same direction of rotation throughout their lifetime, and should never be rotated from one side of the vehicle to the other.
- Hitting curbs or potholes can damage the tires and/or wheels permanently.

### **Flat spots**

All tires become warm during use. After cooling, when the vehicle is parked, the tires have a tendency to distort slightly, forming flat spots. These flat spots can cause vibrations similar to the vibrations caused by unbalanced wheels. They do, however, disappear when the tire warms up. The degree to which flat spots form depends on the type of cord used in the tire. In cold weather, it takes longer for the tire to warm up and consequently longer for the flat spot to disappear.

---

### **CAUTION:**

The car must not be driven with wheels of different dimensions or with a spare tire other than the one that came with the car. The use of different size wheels can seriously damage your car's transmission.

pg. 95 Wheels and tires

### **Snow chains**

Snow chains can be used on your Volvo with the following restrictions:

- Snow chains should be installed on front wheels only. Use only Volvo approved snow chains.
- Special snow chains must be mounted on 215/55 R16, 225/55 R16 and 225/50 R17 tires. Consult your Volvo retailer.
- If accessory, aftermarket or "custom" tires and wheels are installed and are of a size different than the original tires and wheels, chains in some cases CANNOT be used. Sufficient clearances between chains and brakes, suspension and body components must be maintained.
- Some strap-on type chains will interfere with brake components and therefore CANNOT be used.

Consult your Volvo retailer for additional snow chain information.

---

### **CAUTION:**

- Check local regulations regarding the use of snow chains before installing.
- Always follow the chain manufacturer's installation instructions carefully. Install chains as tightly as possible and retighten periodically.
- Never exceed the chain manufacturer's specified maximum speed limit. (Under no circumstances should that limit be higher than 31 mph (50 km/h).
- Avoid bumps, holes or sharp turns when driving with snow chains.
- The handling of the vehicle can be adversely affected when driving with chains. Avoid fast or sharp turns as well as locked wheel braking.

## Snow tires, studded tires \*

### Tires for winter use:

**Owners who live in or regularly commute through areas with sustained periods of snow or icy driving conditions are strongly advised to fit suitable winter tires to help retain the highest degree of traction.**

It is important to install winter tires **on all four wheels** to help retain traction during cornering, braking, and accelerating. Failure to do so could reduce traction to an unsafe level or adversely affect handling. Do not mix tires of different design as this could also negatively affect overall tire road grip.

**Volvo recommends 215/55 R16 winter tires on all four wheels.**

Winter tires wear more quickly on dry roads in warm weather. They should be removed when the winter driving season has ended.

**Studded tires** should be run-in 300-600 miles (500-1000 km) during which the car should be driven as smoothly as possible to give the studs the opportunity to seat properly in the tires. The tires should have the same rotational direction throughout their entire lifetime. In other words, if you wish to rotate the wheels, make sure that the same wheels are always on the same side of the car.

**NOTE:** Please consult state or provincial regulations restricting the use of studded winter tires before installing such tires.

\* Where permitted.

pg. 96 Wheels and tires

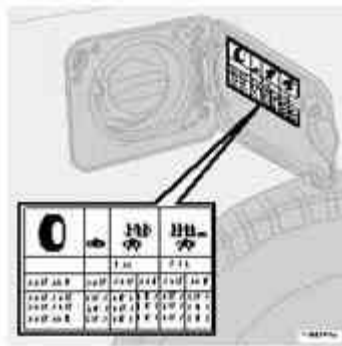

*Tire pressure label*

## Checking and correcting tire pressure

- Check the tire pressure regularly.
- The tire pressure should be corrected only when the tires are cold.
- With warm tires, correct only when the pressure is too low. The tire temperature rises after driving just a few miles.

## Vehicle loading

The tires on your Volvo will perform to specifications at all normal loads when inflated as recommended on the tire information label located on the inside of the fuel filler door\*. This label lists both tire and vehicle design limits. Do not load your car beyond the indicated limits.



### **Temporary Spare (certain models)**

The spare tire in your car is called a "Temporary Spare". It has the following designation: T125/80 R17.

Recommended tire pressure (see decal on fuel filler door) should be maintained irrespective of which position on the car the Temporary Spare tire is used on.

In the event of damage to this tire, a new one can be purchased from your Volvo retailer.

#### **WARNING!**

Current legislation prohibits the use of the "Temporary Spare" tire other than as a temporary replacement for a punctured tire. In other words, it must be replaced as soon as possible by a standard tire. Road holding and handling may be affected with the "Temporary Spare" in use. Do not exceed 50 mph (80 km/h). Do not drive farther than 50 miles (80 km) on a temporary spare tire.

#### **CAUTION:**

The car must not be driven with wheels of different dimensions or with a spare tire other than the one that came with the car. The use of different size wheels can seriously damage your car's transmission.

**NOTE:** Certain models may be equipped with a full-size spare tire. When used, it should be inflated to the same pressure as the tire it is replacing.

\* Please note that the tire information label indicates pressure for both comfort and fuel economy.

pg. 97 Wheels and tires

### **Uniform tire quality grading**

#### **ALL PASSENGER CAR TIRES MUST CONFORM TO FEDERAL SAFETY REQUIREMENTS IN ADDITION TO THESE GRADES**

Quality grades can be found, where applicable, on the tire sidewall between the tread should and maximum section width. For example:

**Treadwear 200 Traction AA Temperature A**

#### **TREADWEAR**

The treadwear grade is a comparative rating based on the wear rate of the tire when tested under controlled conditions on a specified government test course. For example, a tire graded 150 would wear one and one half (1 1/2) times as well on the government course as a tire graded 100. The relative performance of tires depends upon the actual conditions of their use, however, and many depart significantly from the norm due to variation in driving habits, service practices and differences in road characteristics and climate.

#### **TRACTION**

The traction grades, from highest to lowest, are AA, A, B, and C, as measured under controlled conditions on specified government test surfaces of asphalt and concrete. A tire marked C may have poor traction performance.

#### **WARNING!**

The traction grade assigned to this tire is based on braking (straight-ahead) traction tests and does not include cornering (turning) traction.

#### **TEMPERATURE**

The temperature grades are AA (the highest), A, B, and C, representing the tire's resistance to the generation of heat and its ability to dissipate heat when tested under controlled conditions on a specified indoor laboratory test wheel. Sustained high temperature can cause the material of the tire to degenerate and reduce tire life, and excessive

temperature can lead to sudden tire failure. The grade C corresponds to a minimum level of performance that all passenger car tires must meet under the Federal Motor Safety Standard No. 109. Grades B and A represent higher levels of performance on the laboratory test wheel than the minimum required by law.

**WARNING!**

The temperature grade for this tire is established for a tire that is properly inflated and not overloaded. Excessive speed, under-inflation, or excessive loading, either separately or in combination, can cause heat buildup and possible tire failure.

pg. 98 Changing wheels

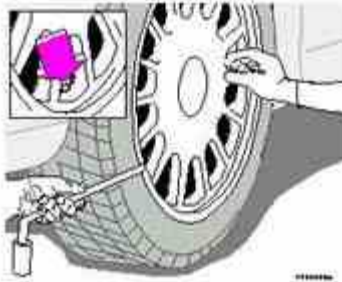

*Insert flat end of lug wrench and turn/pull straight out*

**Changing wheels**

The spare wheel is located under the carpet on the trunk floor. The jack and crank are secured in the wheel recess. There are two jack attachment points on each side of the car.

**To change a wheel:**

- Engage the parking brake.
- Put the gear selector in (P)ark.
- Remove the wheel cap (where applicable) using the lug wrench in the tool bag.
- With the car still on the ground, use the lug wrench to loosen the wheel bolts 1/2 1 turn by exerting downward pressure. Turn the bolts counterclockwise to loosen.

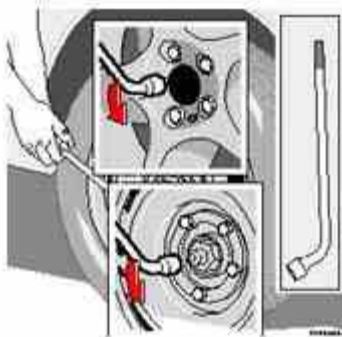

*Loosen wheel bolts*

- Position the jack on the bar in the attachment (A in the illustration below) and crank while simultaneously guiding the base of the jack to the ground. **The base of the jack must be flat on a level, firm, non-slippery surface. Before**

**raising the car, check that the jack is still correctly positioned in the attachment.**

- Raise the vehicle until the wheel to be changed is lifted off the ground.
- Unscrew the wheel bolts completely and carefully remove the wheel so as not to damage the thread on the studs.

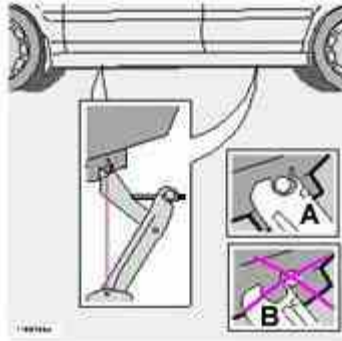

*Attaching the jack*

**NOTE:** To avoid excessive wear and the necessity of rebalancing, mark and reinstall wheels in the same location and position as before removal. To lessen the chance of imbalance, each wheel hub is equipped with a guide stud to ensure that a removed wheel can be reinstalled in its original position (as when changing over to winter tires/wheels).

pg. 99 Changing wheels



*Correct tightening order for wheel bolts*

### **Installing the wheel**

- Clean the contact surfaces on the wheel and hub.
- Lift the wheel and place it on the hub. Make sure that you align the wheel with the guide stud on the wheel hub prior to installation.
- Install the wheel bolts and tighten handtight. use the lug wrench, tighten crosswise(see illustration above) until all bolts are snug.
- Lower the vehicle to the ground and alternately tighten the bolts crosswise to 100 ft. lbs. (136 Nm).
- Install the wheel cap (where applicable).

### **WARNING!**

- The jack must correctly engage the bar in the jack attachment (A). The car's weight must not rest on the jack attachment (B). See illustration on [page 98](#).
- Be sure the jack is on a firm, level, non-slippery surface.
- Never allow any part of your body to be extended under a car supported by a jack.
- Use the jack intended for the car when replacing a wheel. For any other job, use stands to support the side of the car being worked on.
- Apply the parking brake and put the gear selector in the (P)ark position.

Block the wheels standing on the ground, use rigid wooden blocks or large stones.

- The jack should be kept well-greased.

---

**CAUTION:**

- The car must not be driven with wheels of different dimensions or with a spare tire other than the one that came with the car. The use of different size wheels can seriously damage your car's transmission.
- Correct tightening torque on wheel bolts must be observed. The wheel bolts should never be greased or lubricated. The extended, chromed wheel bolts must not be used with steel rims, as they make it impossible to fit the hub caps.

pg. 100

This page intentionally left blank.

---



[Contents](#) | [Top of Page](#)

2004  
VOLVO  
S80

Chapter 8 - Maintenance/Serviceing

pg. 101 Maintenance/Serviceing

Fuses 102

Replacing bulbs 106

Paint touch up 113

Washing the car 114

Cleaning the upholstery 115

Maintenance service, Warranty 116

Fuel/emissions systems 117

Drive belt, Coolant 118

Emissions maintenance 119

Washer fluid, Hoisting the car 120

Opening the hood, Engine compartment 121

Engine oil 122

Power steering/Brake fluid reservoirs 124

Battery maintenance 125

Replacing wiper blades 127

pg. 102 Fuses

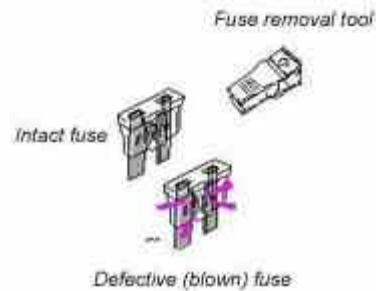

## Replacing fuses

If an electrical component fails to function, it is likely that a fuse has blown due to a temporary circuit overload.

The fuse boxes are located in three different places:

- A** - Relays/fuse box in the engine compartment
- B** - Fuse box in the passenger compartment
- C** - Relays/fuse box in the trunk

A label on the inside of each cover indicates the amperage and the electrical components that are connected to each fuse.

The easiest way to see if a fuse is blown is to remove it. Pull the fuse straight out. If a fuse is difficult to remove, you will find a special fuse removal tool in the passenger compartment fuse box. From the side, examine the curved metal wire to see if it is broken. If so, put in a new fuse of the **same color and amperage** (written on the fuse). Spare fuses are stored in the fuse box in the passenger compartment. If fuses burn out repeatedly, have the electrical system inspected by an authorized Volvo retailer.

### **WARNING!**

Never use fuses with higher amperage than those stated on the following pages. Doing so could overload the car's electrical system.

pg. 103 Fuses in the engine compartment

### **Relays/fuses in the engine compartment**

When replacing fuses, be sure to replace a blown fuse with a new one of the **same color and amperage** (written on the fuse).

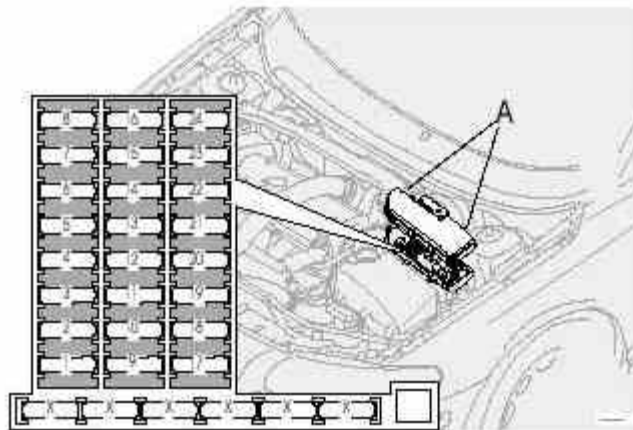

*A - To open, press the plastic catches on the rear side of the fuse box cover and lift.*

# Ordinary fuses

## Location Amperage

1	Accessories	25A
2	Auxiliary lamps (option)	20A
3		
4	Oxygen sensors	20A
5	Crankcase ventilation heater, solenoid valves	10A
6	Mass airflow sensor, engine control module, injectors	15A
7	Throttle module	10A
8	AC compressor, accelerator pedal position sensor, E-box fan	10A
9	Horn	15A
10	-	
11	AC compressor, ignition coils	20A
12	Brake light switch	5A
13	Windshield wipers	25A
14	ABS/STC/DSTC	30A
15	-	
16	Windshield washers, headlight wiper/washers (certain models)	15A
17	Low beam, right	10A
18	Low beam, left	10A
19	ABS/STC/DSTC	30A
20	High beam, left	15A
21	High beam, right	15A
22	Starter motor	25A
23	Engine control module	5A
24	-	

pg. 104 Fuses in the passenger compartment

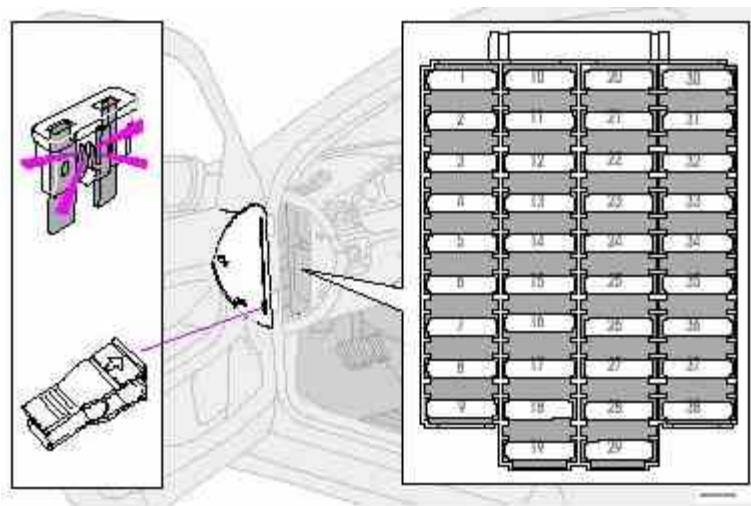

## Fuse box in the passenger compartment

This fuse box is located at the far left side of the instrument panel. Extra fuses and the fuse removal tool are also stored here. When replacing a blown fuse, be sure to replace it with a new one of the **same color and amperage** (written on the fuse).

<b>Location</b>	<b>Amperage</b>
1 Low beam headlights	15A
2 High beam headlights	20A
3 Power driver's seat	30A
4 Power passenger's seat	30A
5 Speed-dependent power steering, vacuum pump	15A
6 -	
7 Heated seat - front left (option)	15A
8 Heated seat - front right (option)	15A
9 ABS/STC/DSTC	5A
10 Daytime running lights	10A
11 Daytime running lights	10A
12 Headlight wipers (certain models)	15A
13 Electric socket 12 V	15A
14 Power passenger's seat	5A
15 Audio system, VNS	5A
16 Audio system	20A
17 Audio amplifier	30A
18 Front fog lights	15A
19 VNS display	10A
20 -	
21 Automatic transmission, shiftlock, extended D2 feed	10A
22 Direction indicators	20A
23 Headlight switch module, climate control system, onboard diagnostic connector, steering wheel lever modules	5A
24 Relay extended D1 feed: climate control system, power driver's seat, driver's info	10A
25 Ignition switch, relay starter motor, SRS, engine control module	10A
26 Climate control system blower	30A
27 -	
28 Electronic module - courtesy lighting	10A
29 -	
30 Left front/rear parking lights	7.5A
31 Right front/rear parking lights, license plate lights	7.5A
32 Central electrical module, vanity mirror lighting, power steering, glove compartment light, interior courtesy lighting	10A
33 Fuel pump	15A
34 Power moonroof	15A
35 Central locking system, power windows - left door mirror	25A
36 Central locking system, power windows - right door mirror	25A
37 Rear power windows	30A



\* Please be aware that if this fuse is not intact, or if it is removed, the alarm will sound.

pg. 105 Fuses in the trunk

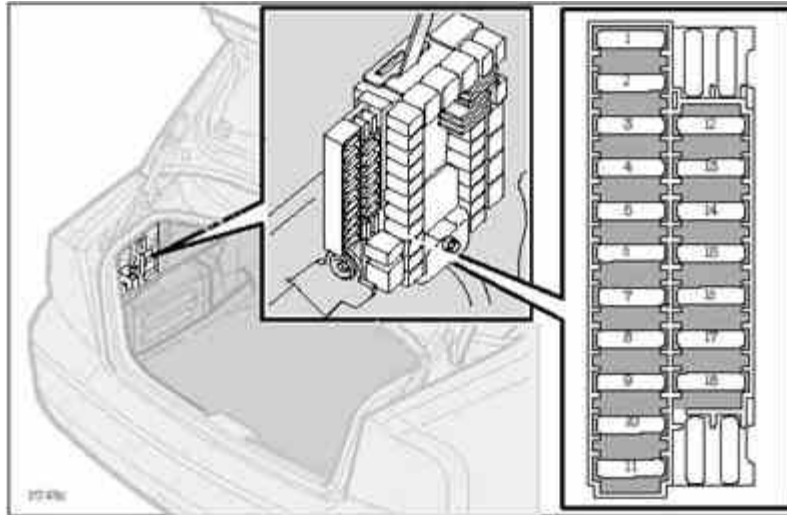

### Fuses in the trunk

The fuses in the trunk are located behind the left panel. When replacing a blown fuse, be sure to replace it with a new one of the **same color and amperage** (written on the fuse).

## Ordinary fuses

Location	Amperage
1 Rear electrical module, trunk lighting	10A
2 Rear fog light	10A
3 Brake lights (cars with trailer hitches only)	15A
4 Backup lights	10A
5 Rear window defroster, relay 15I - accessories	5A
6 Trunk release	10A
7 Folding rear head restraints	10A
8 Central locking rear doors/fuel filler door	15A
9 Trailer hitch (30 feed)	15A
10 CD changer, VNS	10A
11 Accessory control module (AEM)	15A
12 -	
13 -	
14 -	
15 Trailer hitch (15I feed)	20A
16 Electrical socket in trunk - accessories	15A
17 -	
18 -	

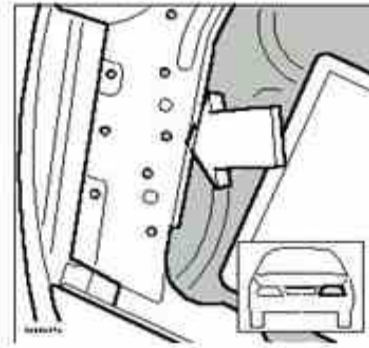

### Replacing high/low beam headlight bulbs

The headlight bulbs must be replaced from the engine compartment.

#### CAUTION:

- Do not touch the glass on halogen bulbs with your fingers. Grease, oil or any other impurities can be carbonized onto the bulb and cause damage to the reflector.
- Be sure to use bulbs of the correct type and voltage.

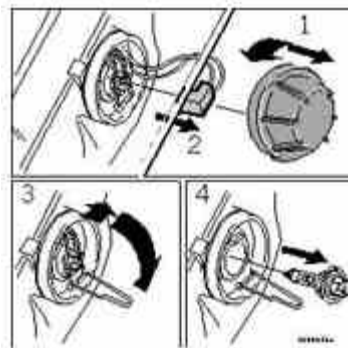

*Removing a defective bulb*

#### To remove a defective bulb:

- Switch off the ignition.
- Open the hood.
- Remove the plastic cover over the bulb (1) by turning it counterclockwise.
- Remove the connector (2).
- Loosen the retaining spring (3) by first moving it to the right and then moving it down, out of the way.
- Pull out the defective bulb. Note the position of the guide lug on the base of the bulb (4).

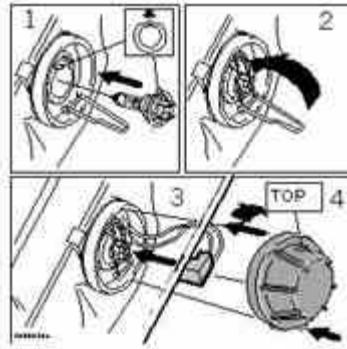

*Installing a new bulb*

### **Installing a new bulb:**

- Insert the new bulb, without touching the glass, with the guide lug upward (1). The bulb will only seat properly in this position.
- Move the retaining spring up and push it slightly to the left until it seats properly (2).
- Press the connector into place on the bulb (3).
- Reinstall the plastic cover and turn it clockwise until it is correctly in place (4). "TOP" must be upward.

**NOTE:** If the vertical aim of your headlights needs to be adjusted for any reason (e.g., towing a trailer for extended periods), this should be done by an authorized Volvo retailer.

pg. 107 Replacing bulbs

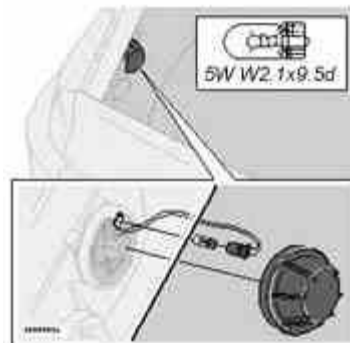

*Front parking light*

### **Front parking lights**

- Switch off the ignition.
- Remove the plastic cover over the high beam bulb by turning it counterclockwise.
- Pull out the bulb and its socket. Replace the bulb.
- Press the bulb and its socket back into place.
- Switch on the ignition to test the bulb.
- Reinstall the plastic cover and turn it clockwise until it is correctly in place. "TOP" must be upward (see illustration on previous page).

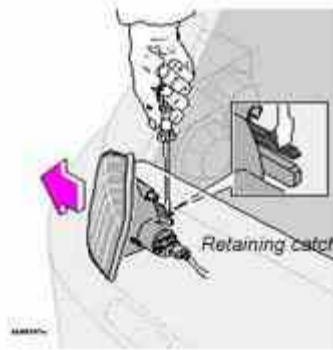

*Front direction indicator*

## Front direction indicators

- Switch off the ignition.
- Open the hood.
- Press down the retaining catch with a screwdriver and pull out the lamp housing.
- Press the retaining spring downward and pull the connector out of the lamp housing.
- Turn the bulb holder counterclockwise and remove it.
- Remove the defective bulb from the holder by first pressing it in slightly and then turning it counterclockwise.
- Install a new bulb in the holder and reinsert the bulb and holder in the lamp housing.

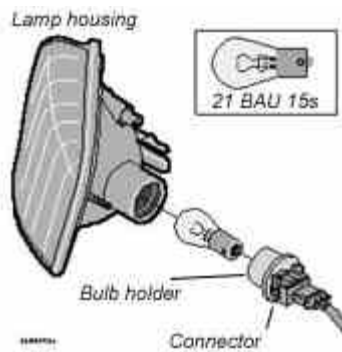

- Press the connector onto the bulb holder.
- Switch on the ignition to test the bulb.
- Press the lamp housing back into place on the fender. Be sure it seats properly.

pg. 108 Replacing bulbs

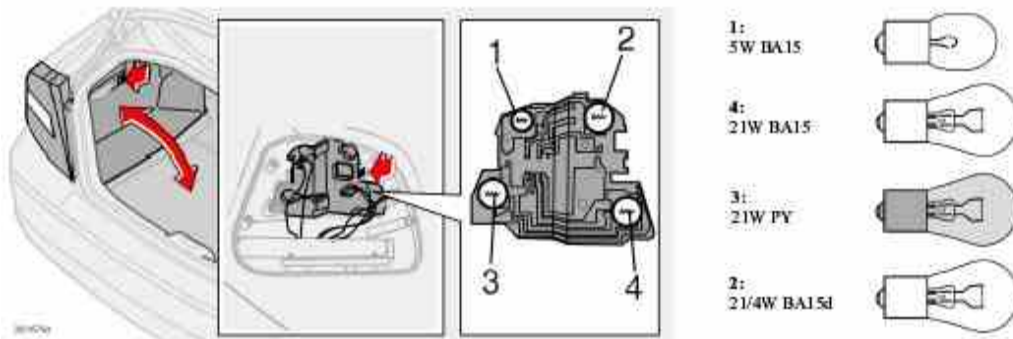

## Tail lights

1. Tail light
2. Tail light/fog light (left side only)
3. Direction indicator
4. Back-up light

All tail light bulbs are accessed from inside the trunk.

- Switch off the ignition and open the trunk.
- Fold the covering panel inward to access the bulbs. When replacing right tail light bulbs, access is made easier if you pull out the cargo net in the trunk completely before folding down the panel.

The bulbs are located in a holder that is held in place by two retaining catches.

### To replace a bulb in the *upper* holder:

- Disconnect the wiring from the bulb holder.
- Press the retaining catch upward to release the lower part of the holder.
- Press the retaining catch downward to release the upper part of the holder.
- Replace the defective bulb.
- Press the bulb holder back into place.
- Reconnect the wiring.
- Fold up and close the covering panel.

### To replace a bulb:

- Press the retaining catches toward each other to release the holder.
- Replace the defective bulb.
- Press the bulb holder back into place.
- Reconnect the wiring.
- Fold up and close the covering panel.

pg. 109 Replacing bulbs

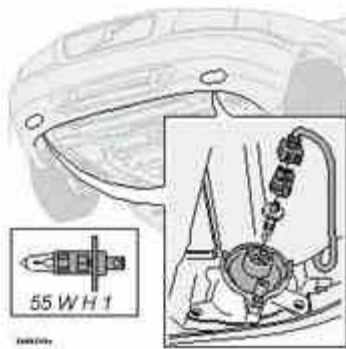

## Front fog lights (option)

**CAUTION:**

Avoid touching the glass on the bulb with your fingers.

- Switch off the ignition.
- Turn the bulb holder slightly counterclockwise to release it.
- Replace the bulb. The shape of the foot of the bulb corresponds to the shape of the bulb holder.
- Reinstall the bulb holder by turning it slightly clockwise. "TOP" on the holder should be upward.

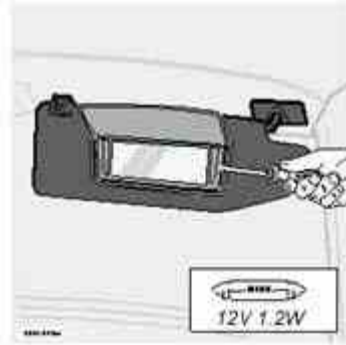

### Vanity mirror lights

- Carefully insert a screwdriver and pry out the lens.
- Pry out the defective bulb and replace it.
- Carefully press the lower edge of lens onto the four tabs and press the upper edge of the lens into place.

pg. 110 Replacing bulbs

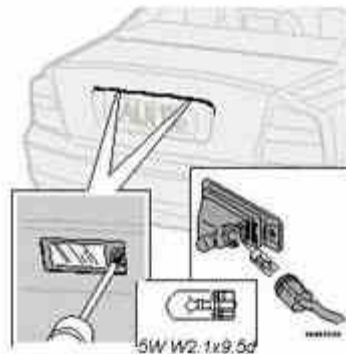

### License plate lights

- Switch off the ignition.
- Loosen the screws with a torx screwdriver.
- Carefully pull out the lamp housing.
- Turn the bulb holder counterclockwise and pull it out.
- Pull out the defective bulb and insert a new one.
- Reinsert the bulb holder into the housing and turn it clockwise.
- Reinstall the housing and screw it in place.

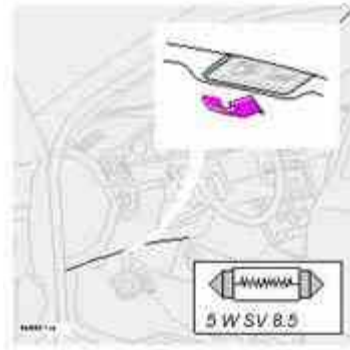

### **Door step courtesy lights**

The door step courtesy lights are located under the dash on the driver's and passenger's sides. To replace a bulb:

- Carefully insert a screwdriver and pry out the lens.
- Replace the defective bulb.
- Reinstall the lens.

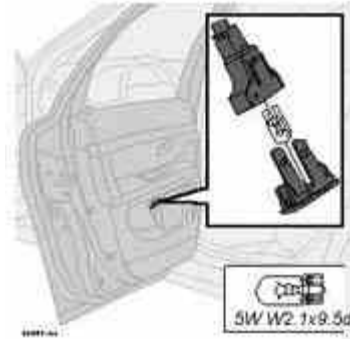

### **Rear door step lights**

- Carefully insert a screwdriver and pry out the lens.
- Disconnect the wiring from the lamp housing.
- Remove the lens from the lamp housing by pressing the two side catches out.
- Pull out the defective bulb and replace it.
- Reinstall the lamp housing in the reverse order.



# 2004 VOLVO S80

## Chapter 9 - Specifications

pg. 129 Specifications

[Label information](#) 130

[Dimensions and weights](#) 131

[Engine/transmission specifications](#) 132

[Oil/fluid specifications and volumes](#) 133

[Fuel system, distributor ignition system, suspension](#) 134

[Electrical system](#) 135

[On Call Roadside Assistance](#) 136

pg. 130 Label information

### **1 Vehicle Emission Control Information**

Your Volvo is designed to meet all applicable emission standards, as evidenced by the certification label on the underside of the hood. For further information regarding these regulations, please consult your Volvo retailer.

### **2 Vacuum hose routing**

(underside of hood)

### **3 Loads and Tire Pressures**

(on inside of fuel filler door)

### **4 Model plate**

Vehicle Identification Number (VIN). Codes for color and upholstery, etc. The plate is located in the engine compartment, on the inside of the left front fender.

### **5 Vehicle Identification Number (VIN) \***

The VIN plate is located on the top left surface of the dashboard. The VIN is also stamped on the right hand door pillar.

### **6 Federal Motor Vehicle Safety Standards (FMVSS) specifications (USA) and Ministry of Transport (CMVSS) standards (Canada)**

Your Volvo is designed to meet all applicable safety standards, as evidenced by the certification label on the facing side of the driver's door. For further information regarding these regulations, please consult your Volvo retailer.



## 7 Child safety latch label

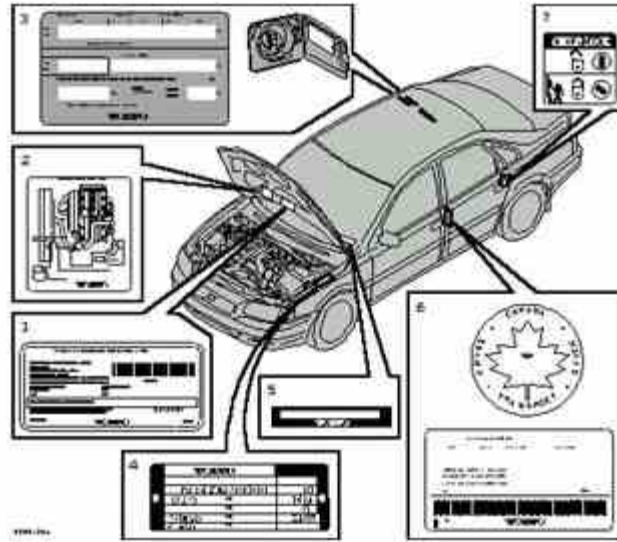

\* The Vehicle Identification Number (VIN) should always be quoted in all correspondence concerning your vehicle with the retailer and when ordering parts.

**All specifications are subject to change without prior notice.**

pg. 131 Dimensions and weights

### Dimensions

Length	189.8 in. (482 cm)
Width	72.1 in. (183 cm)
Height	57.2 in. (145 cm)
Wheelbase	109.9 in. (279 cm)
Track, front	62.3 in. (158 cm)
Track, rear	61.4 in. (156 cm)
Turning circle (between curbs)	35.8 - 39 ft. (10.9 - 12 m)
Cargo capacity - trunk	14.2 cu. ft. (0.4 m <sup>3</sup> )

### Weights

	USA	Canada
<b>Gross vehicle weight (GVW)</b>		
6 cyl.	4608 lbs	2090 kg
6 cyl. turbo	4670 lbs	2120 kg
<b>Capacity weight *</b>		
6 cyl.	890 lbs	400 kg
6 cyl. turbo	890 lbs	400 kg
<b>Curb weight</b>		
6 cyl.	3570-3600 Ibs	1620-1640 kg

6 cyl. turbo 3630-3665 lbs 1650-1665 kg

**Permissible axle weight, front**

6 cyl. 2491 lbs 1130 kg

**Permissible axle weight, rear**

6 cyl. 2293 lbs 1040 kg

**Max roof load** 220 lbs 100 kg

**Max trailer weight**

**(w/o brakes)** 1650 lbs 750 kg

**Max trailer weight**

**(with brakes)**

2" ball 3300 lbs \*\* 1500 kg

1 7/8" ball 2000 lbs 900 kg

**Max tongue weight** \*\*\* 165 lbs 75 kg

**WARNING!**

When adding accessories, equipment, luggage and other cargo to your vehicle, the total loaded weight capacity of the vehicle must not be exceeded.

\* The max permissible axle loads or the gross vehicle weight must not be exceeded.

\*\* When driving for prolonged periods at temperatures above 86° F (30° C), the maximum recommended weight is 2000 lbs (900 kg).

\*\*\* See also section "Trailer towing"

**All specifications are subject to change without prior notice.**

pg. 132 Engine/transmission specifications

**Engine specifications**

**Designation: Volvo B 6294 T**

Output 268 hp at 5200 rpm (200 KW/87 rps)

Max torque 280 ft. lbs. at 1800-5000 rpm (380 Nm at 35-83 rps)

Number of cylinders 6

Bore 3.27" (83 mm)

Stroke 3.54" (90 mm)

Displacement 2.92 liters (115 cu. in.)

Compression ratio 8.5:1

Number of valves 24

**Charge air cooler (Intercooler)**

Turbocharged engines employ a turbo-compressor to force air into the engine inlet manifold and a charge air cooler to cool the compressed inlet air. The resulting increase in air flow raises pressure in the intake manifold and increases engine power over that developed by the normally-aspirated engine. The charge air cooler (which resembles a radiator) is located between the turbo-compressor and inlet manifold.

**Designation: Volvo B 6294 S**

Output 194 hp at 5200 rpm (144 KW/87 rps)

Max. torque 207 ft. lbs. at 3900 rpm (280 Nm at 65 rps)

Number of cylinders	6
Bore	3.27" (83 mm)
Stroke	3.54" (90 mm)
Displacement	2.92 liters (115 cu. in)
Compression ratio	10.5:1
Number of valves	24

**All specifications are subject to change without prior notice.**

pg. 133 Oil/fluid specifications and volumes

### **Engine oil**

Meeting minimum ILSAC specification GF-2, including ACEA A1, API SJ, SJ/CF and SJ/Energy Conserving.

**Extra oil additives must not be used.**

**Volume:** (including filter):

Normally-aspirated 6-cylinder engine - 7.3 US qts (6.9 liters).

Turbo 6-cylinder engine - 7.3 US qts (6.9 liters).

### **Automatic transmission fluid**

Geartronic: ATF Dexron® III.

**Total Volume:** 7.9 US qts (7.5 liters).

### **Cooling system**

Type: Positive pressure, closed system. The thermostat begins to open at 194 °F (90 °C).

Coolant: Volvo original coolant/antifreeze.

**Volume:** Normally-aspirated 6-cylinder engine - 9.3 US qts (8.8 liters).

Turbo 6-cylinder engine - 10.1 US qts (9.6 liters).

### **Power steering fluid**

ATF fluid.

**Volume:** 6 cyl engine - 0.95 US qt (0.9 liter).

### **Brake fluid**

DOT 4+ boiling point > 536°F (280° C) P/N 9437433

**Volume:** 0.6 US qt (0.6 liter)

### **Climate control system - refrigerant (R 134a)**

Oil: PAG

**Volume:** 2.2 lbs (1000 g) R134a.

### **Fuel**

Minimum octane requirement - AKI 87 (RON 91)

**Volume (fuel tank):** 21.1 US gals (80 liters)

### **Washer fluid reservoir**

**Volume:** 6 cyl: 4.7 US qts. (4.5 liters)

**All specifications are subject to change without prior notice.**

pg. 134 Fuel system, Distributor ignition system, Suspension

## Fuel system

The engine is equipped with a multiport fuel injection system.

## Distributor ignition system

Firing order:	15-3-6-2-4
Distributor ignition setting:	Not adjustable
Spark plugs:	B 6284 T: P/N 271367-4 (or equivalent) B 6294 S: P/N 272371-8 (or equivalent)
Spark plug gap:	0.028-0.032" (0.7-0.8 mm)
Tightening torque:	18.4 ft. lbs. (25 Nm)

### WARNING!

The distributor ignition system operates at very high voltages. Special safety precautions must be followed to prevent injury. Always turn the ignition off when:

- Replacing distributor ignition components e.g. plugs, coil, etc.
- Do not touch any part of the distributor ignition system while the engine is running. This may result in unintended movements and body injury.

## Front suspension

Spring strut suspension with integrated shock absorbers and control arms linked to the support frame. Power-assisted rack and pinion steering. Safety type steering column.

The alignment specifications apply to an unladen car but include fuel, coolant and spare wheel.

Toe-in measured on the wheel rims: 2.3 mm +/- 0.8 mm

Toe-in measured on tire sides: 2.8 +/- 0.9 mm

## Rear suspension

Individual rear wheel suspension with longitudinal support arms, double link arms and track rods.

Toe-in measured on the tire sides: 1.9 mm +/- 1.9 mm

## Vehicle loading

The tires on your Volvo should perform to specifications at all normal loads when inflated as recommended on the tire information label. The label is located on the inside of the fuel filler door and lists vehicle design limits. Do not load your car beyond the load limits indicated.

### WARNING!

Improperly inflated tires will reduce tire life, adversely affect vehicle handling and can possibly lead to failure resulting in loss of vehicle control without prior warning.

**All specifications are subject to change without prior notice.**

pg. 135 Electrical system

## Bulbs

Bulb	US no.	Power	Socket
Headlights			

High beam	H7	55W	-
Low beam	H7	55W	-
Bi-Xenon headlights* (option)		35W	D2R
Front parking lights		5W	W 2.1x9.5d
Front direction indicators	-	21 W	BAU 15s
Front fog lights	H1	55 W	-
Side marker lights	-	3 W	W2.1x9.5d
Rear direction indicators	-	21W	PY
Tail lights	67	5W/4cp	BA 15
Brake lights	LED		
Backup lights	1156	21W	BA 15
Rear fog light	1156	21/4W	BA 15 d
License plate light	-	5 W	W 2.1x9.5d
Door step courtesy lights			
Front	-	5W	SV 8.5
Rear	-	5W	W 2.1x9.5d
Trunk lights	-	10 W	SV 8.5
Glove compartment light	-	2 W	BA 9s
Vanity mirror light(s)	-	12V 1.2 W	
Instrument lighting	-	3 W	W 2.1x9.5d
Rear ashtray	-	1.2 W	W 2x4.6d
Front courtesy lights	-	10 W	SV 8.5
Rear reading lights	-	5 W	W2.1x9.5d
Sideview mirror	-	5W	W2.1x9.5d

**WARNING!**

Bi-Xenon headlights (option) - due to the high voltage used by these headlights, these bulbs should only be replaced by an authorized Volvo service technician.

**Electrical system**

12 Volt, negative ground.

Voltage-controlled generator. Single-wire system with chassis and engine used as conductors. Grounded on chassis.

**Battery**

Voltage: 12 Volt, capacity: 600 A/115 min. reverse capacity

The battery contains corrosive and poisonous acids. It is of the utmost importance that old batteries are disposed of correctly. Your Volvo retailer can assist you in this matter.

**Generator**

Rated output: max. current: 140 A

**Starter motor:**

Output: 1.7 kW

**All specifications are subject to change without prior notice.**



### **Volvo On Call Roadside Assistance**

Your new Volvo comes with a four-year On Call Roadside Assistance program. Additional information, features, and benefits are described in a separate information package in your glove compartment.

If you have misplaced your package, dial:

#### **In the U.S.A.**

1-800-63-VOLVO (1-800-638-6586)

#### **In Canada:**

1-800-263-0475



### **Technician certification**

In addition to Volvo factory training, Volvo supports certification by the National Institute for Automotive Excellence (A.S.E.). Certified technicians have demonstrated a high degree of competence in specific areas. Besides passing exams, each technician must also have worked in the field for two or more years before a certificate is issued. These professional technicians are best able to analyze vehicle problems and perform the necessary service procedures to keep your Volvo at peak operating condition.



[Contents](#) | [Top of Page](#)

# 2004 VOLVO S80

## Chapter 10 - Audio systems

pg. 137 Audio systems

[HU-611 overview](#) [138](#)

[HU-801 overview](#) [139](#)

[Functions](#) [140](#)

[Specifications](#) [151](#)

[General information](#) [152](#)

[HomeLink® Universal Transceiver \(option\)](#) [153](#)

**NOTE:** The text on the face of the radio, describing the button functions, may vary slightly depending on which audio system you have in your car.

pg. 138 Audio system HU-611 - overview

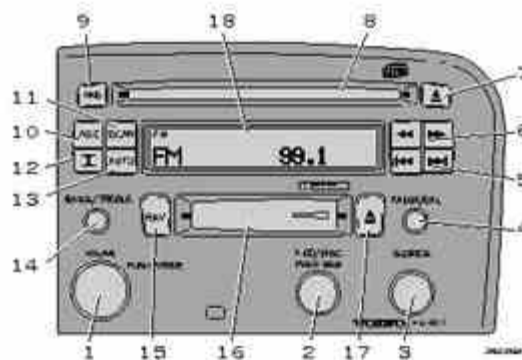

1. On/off - press  
Volume - turn
2. Selector knob for:  
Stored radio frequencies  
CD changer - selecting disc
3. Selector knob:  
Radio

- Cassette
- CD
- CD changer
- TV (option on certain models)
- 4. Fader - press and turn
- Balance - press, pull and turn
- 5. Radio - Station seek up/down
- Cassette - selecting next/previous track
- CD - Selecting next/previous track
- 6. Radio - Manual station selection
- Cassette - Fast winding forward/backward
- CD - Fast forwards/backward
- 7. CD eject
- 8. CD slot
- 9. CD random play
- 10. Active Sound Control (ON or OFF)
- 11. Scan function
- 12. Dolby B Noise Reduction
- 13. Automatic presetting of radio stations
- 14. Bass - press and turn
- Treble - press, pull and turn
- 15. Tape direction selector
- 16. Cassette opening
- 17. Cassette eject
- 18. Display

pg. 139 Audio system HU-801 - overview

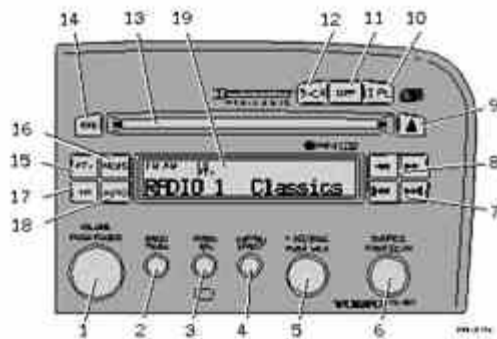

- 1. On/off - press
- Volume - turn
- 2. Bass - press and turn
- Treble - press, pull and turn
- 3. Fader - press and turn
- Balance - press, pull and turn
- 4. Center volume - press and turn
- Effect channel volume - press, pull and turn
- 5. Selector knob for:
- Stored radio frequencies
- CD - selecting disc



6. Selector knob:
  - Radio
  - Internal CD changer
  - CD
  - Station scan - press
  - TV (option on certain models)
  - External CD changer (option)
7. Radio - Station seek up/down
- CD - Selecting next/previous track
8. Radio - Manual station selection
- CD - Fast forward/backward
9. CD eject
10. Dolby Pro Logic - switching on
11. 2 channel stereo
- 12 3 channel stereo
13. CD slot
14. CD random play
15. Program type
16. News
17. Traffic information
18. Automatic presetting of radio stations
19. Display

pg. 140 Audio systems HU-611/HU-801



### **Switch on/off**

Press the knob to switch on or turn off the radio.

### **Volume control**

Turn the knob clockwise to increase volume. Volume control is electronic and does not have an end stop. If you have a key pad in the steering wheel, increase or decrease the volume with the + or- buttons.



### **Bass**

Adjust the bass by pressing the button to extend the control and turning it to the left (less bass) or to the right (more

bass). A "detent" indicates "equalized" bass. Press the button back in when you have made the adjustment.

### **Treble**

Adjust the treble by pressing the button to extend the control, pulling it out as far as possible, and then turning it to the left (less treble) or to the right (more treble). A "detent" indicates "equalized" treble. Press the button back in when you have made the adjustment.



### **Band selector**

Turn "SOURCE" knob to select FM or AM. The station and wavelength are displayed. You can also select cassette deck, CD or optional CD changer with this knob.

### **Active sound control (ASC)**

The ASC (Active Sound Control) automatically adapts volume to vehicle speed.

Press the ASC button (HU-611) or the PTY button (HU-801) for several seconds to switch this function ON or OFF. This function is included in the Advanced User Mode on the HU-801 equipped with this feature. "ASC ON" or "ASC OFF" will be shown in the display for several seconds.

pg. 141 Audio systems HU-611/HU-801



### **Fader - Balance front/rear**

Adjust front/rear speaker balance by pressing the button to extend the control and turning it to the left (more sound from the rear speakers) or to the right (more sound from the front speakers). A "detent" indicates "equalized" balance. Press the button back in when you have made the adjustment.

### **Balance right/left**

Adjust left/right speaker balance by pressing the button to extend the control, pulling it out as far as possible and then turning it to the left (more sound from the left speakers) or to the right (more sound from the right speakers). A "detent" indicates "equalized" balance. Press the button back in when you have made the adjustment.

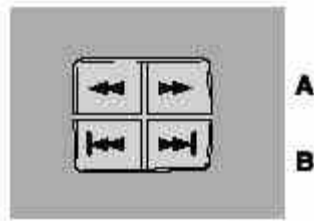

### A - Setting station

Press the left side of the button to select lower frequencies and the right side for higher frequencies. Set frequencies are displayed.

### B - Station seek up/down

Press the left side (lower frequency) or right side (higher frequency) of the button to start the seek function. The radio seeks the next audible station and tunes it in. Repeat the procedure to continue the seek function.



*Audio system controls on the steering wheel*

### Station seek up/down

If you have a key pad in the steering wheel press the right or left arrow to switch between preset stations.

### Scan function

Press the SCAN button (HU-611) or the SOURCE button (HU-801) to start the station scan function. When a station is found, scanning stops for several seconds, after which scanning will continue.

Press the SCAN or SOURCE button when a station has been found if you would like to listen to that station and to discontinue the scan function.

pg. 142 Audio systems HU-611/HU-801 - radio



### A - Automatic station preset

This function seeks and stores up to 10 strong AM or FM stations in a separate memory. This function is especially useful in areas where you are not familiar with the radio stations.

1. Press in the "AUTO" button for at least 2 seconds. A number of strong signal stations (max. 10) from the currently selected waveband are now stored automatically in the memory. An "A" and "AUTO" is displayed. If there is no station with sufficient signal strength "NO STATION" is displayed.
2. Turn "1-20/DISC" button if you wish to change to another of the auto-stored stations. Another auto-stored station is selected with each turn.



### Programming stations

1. Tune in the desired frequency.
2. Press the "1-20/DISC" button. Select a number by turning forwards or backwards. Press again to store the selected frequency and station.

### Preset

To choose a pre-set station, turn "1-20/DISC" button to the stored number. The currently selected station is displayed.

### Radio Data System (RDS, also referred to as RBDS) - HU-801 only

The HU-801 radio in your car is equipped with an advanced system allowing information from broadcasters to be transmitted visually, as text, together with the audio signal. This information is then decoded by the radio and made available for several new and unique features. **The RDS or Radio Data System operates in the FM band only, and the information transmitted is supplied exclusively by participating broadcasters.** Volvo has no control over the accuracy of the data or information. Please refer to the following pages regarding specific descriptions and operation of these functions.

Volvo was among the first to pioneer this technology throughout Europe and it is slowly making its way to North America. Coverage by local broadcasters may be limited at this time, but as the technology and benefits grow, you will find the radio in your car is equipped to take advantage of this system.

pg. 143 Audio systems HU-801 - radio



### Traffic information (TP) - HU-801 only

**This feature may not be apply in your area and only functions with FM broadcasts.**

Push the "TP" button for traffic information from RDS stations. "TP" is displayed when the function is connected. When the unit is in Cassette or CD mode, the FM radio function will seek in the background for a station with a strong signal broadcasting traffic information. If a cassette or CD are playing when the radio receives a traffic bulletin, that function is interrupted and the bulletin is broadcast with the volume pre-selected for traffic information. When the bulletin is finished the unit immediately returns to the previously set volume and continues playing the cassette or CD.

- Traffic information can only be heard when **TP** is displayed.
- If only TP is displayed, this indicates that no traffic information is being received at the time.
- If you do not wish to listen to an ongoing traffic bulletin, press the "TP" button. The TP function will remain active and the radio will continue to monitor traffic information.
- To turn the TP function off, press the **TP** button. TP is no longer shown in the display.



### News on/off - HU-801 only

**This feature may not be apply in your area and only functions with FM broadcasts.**

Press the "NEWS" button to activate the news function. The text NEWS is displayed. Press the "NEWS" button again if you want to switch off the function.

As soon as a news broadcast begins, the news program will interrupt the Cassette, CD or CD changer.

If you do not wish to listen to the news program, press the "NEWS" button again. The news function will remain active and the radio will continue to monitor news programs.

pg. 144 Audio systems HU-801 - radio

### Program types (HU-801 only)

Program type	Text displayed
News	News
Information	Inform
Sports	Sports
Talk	Talk
Rock	Rock
Classic rock	Cls_Rock
Adult hits	Adlt_Hit
Soft rock	Soft_Rck
Top 40	Top_40
Country	Country
Oldies	Oldies
Soft	Soft
Nostalgia	Nostalgia
Jazz	Jazz
Classical	Classicl
Rhythm and Blues	R_&_B
Soft Rhythm and Blues	Soft_R&B
Foreign language	Language
Religious music	Rel_Musc

Religious talk	Rel_Talk
Personality	Persnlty
Public	Public
College	College
-	
-	
-	
-	
-	
Weather	Weather

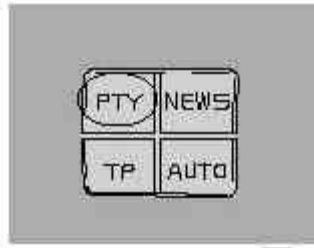

### **Program type - HU-801 only**

The PTY function enables you to select specific types of programs.

To search for a particular program type:

1. Press "PTY" button to initiate the function. The currently tuned station's program type is displayed.
2. Scroll through the list of program types by turning the "1-20/DISC" button.
3. When you have reached the program type you require press the "1-20/DISC" button to begin the search.
4. If the radio finds a station with the selected program type, it sets it. If the radio finds no station with the selected program type, it will return to its previous function. PTY is then in standby mode and remains so until a program of the selected type begins. The radio then changes to the station with the selected program type.
5. The PTY symbol is displayed until the radio finds the selected program type and as long as that program is being transmitted.
6. To manually deactivate this function, press the PTY button again. The PTY function is automatically deactivate after it is used once.

### **(certain models)**

This function can also be used in the CD mode.

Steps 1-4 are the same as described above.

5. If there is more than one station with the selected program type, you can select using , or the scan button. The PTY function is active until the radio finds the selected program type and as long as the selected station transmits that program type.
6. To return to standby mode, press PTY again. The CD will resume playing until the selected program type is sent again.
7. To deactivate PTY standby, press the PTY button again. The PTY symbol will turn off.

### **Volume of traffic information/news/PTY -HU- 801 only**

If you change the volume when the TP, PTY or NEWS function is active, the new volume setting will be stored automatically.





# 2004 VOLVO S80

## HomeLink® Universal Transceiver (option)

pg. 153 HomeLink® Universal Transceiver (option)

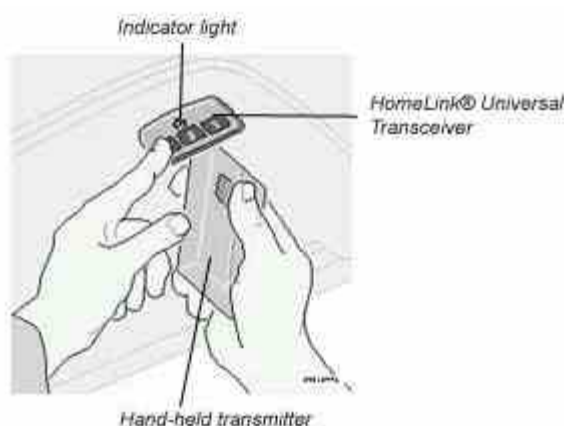

### HomeLink® Universal Transceiver

HomeLink® is an advanced system that can be programmed to learn the codes of three different remote controlled-devices (e.g., garage door openers, remote lighting, entry door lock). HomeLink®'s sun visor-mounted transceiver, powered by your car's electrical system, may then be used in place of your hand-held remote controls.

**NOTE:** For your security, the HomeLink® Universal Transceiver is designed to **not** function if the car has been locked from the *outside*.

### Programming the transceiver

1. The ignition switch must be turned to the "accessory" position (II) before programming the HomeLink® Universal Transceiver.
2. Begin by erasing all 3 factory default channels. Hold down the two outside buttons (buttons 1 and 3 in the illustration) on the HomeLink® Universal Transceiver for about 20 seconds, until HomeLink®'s indicator light begins to flash. Then release the buttons.
3. Hold your hand-held transmitter (garage door opener, for example) 2 to 5 in. (5 to 12 cm) away from the HomeLink® surface, keeping the indicator light in view. For placement questions, contact HomeLink® toll-free 1-800-355-3515 (Internet: [www.HomeLink.com](http://www.HomeLink.com)).
4. Using two hands, push and hold both your hand-held transmitter's button and the transceiver button you wish to program. The indicator light will flash first slowly, then rapidly. Rapid flashing tells you the HomeLink® button has been successfully programmed. Release both buttons.
5. If you are programming a rolling code-equipped device (e.g., garage door opener or entry door lock), refer to "Programming rolling codes" on the next page to complete the programming process.



Repeat steps 3 and 4 to program the other two transceiver buttons.

If, after several attempts, you are unable to successfully train the HomeLink® Universal Transceiver to learn your hand-held transmitter's signal, contact HomeLink® toll-free 1-800-355-3515 (Internet: [www.HomeLink.com](http://www.HomeLink.com)).

#### pg. 154 HomeLink® Universal Transceiver (option)

#### **WARNING!**

- If you use HomeLink® to open a garage door or gate, be sure no one is near the gate or door while it is in motion.
- Do not use the HomeLink® Universal Transceiver with any garage door opener that lacks safety "stop" and "reverse" features as required by federal safety standards. (This includes any garage door opener model manufactured before April 1, 1982) A garage door opener that cannot "detect" an object, signalling the door to "stop" and "reverse" does not meet current federal safety standards. Using a garage door opener without these features increases the risk of serious injury or death. For more information on this matter, call toll-free 1-800-355-3515 (Internet: [www.HomeLink.com](http://www.HomeLink.com)).

#### **NOTE - Canadian residents:**

During programming, your hand-held transmitter may automatically stop transmitting. To successfully train HomeLink®, continue to hold the HomeLink® button. At the same time, repeatedly press and hold your hand-held transmitter's button at *two-second intervals* until HomeLink® has learned your transmitter's code. The HomeLink® indicator light will flash first slowly, and then rapidly to indicate that the button has been successfully programmed.

#### **Determining if your garage door uses a rolling code**

Determine, in one of the following ways, if your garage door uses a rolling code system and is manufactured after 1996:

- Refer to the garage door opener owner's manual for verification.
- If your hand-held transmitter appears to program the HomeLink® Universal Transceiver but the programmed button does not activate the garage door, your garage door opener may have a rolling code.
- Press the programmed HomeLink® button. If the garage door opener has the rolling code feature, the HomeLink® indicator light flashes rapidly and then glows steadily after approximately 2 seconds.

**To train a rolling code garage door opener**, follow these instructions after programming the desired transceiver button according to "Programming the transceiver." The help of a second person may make training easier.

1. Locate the training button on the *garage door opener motor head unit*. The location and color of the training button may vary. If you encounter difficulty, refer to the garage door opener owner's manual or call toll-free 1-800-355-3515 (Internet: [www.HomeLink.com](http://www.HomeLink.com)).
2. Press the "training" button on the garage door opener motor head unit until the "training" light comes on.
3. Press and release the programmed HomeLink® button. Press and release the programmed HomeLink® button a *second* time to complete the training process.

Some garage door openers may require you to do this procedure a *third time* to complete the training.

The programmed button on your HomeLink® Universal Transceiver should now operate your garage door opener. The original hand-held transmitter can also be used, as desired, to operate the garage door.

The remaining two HomeLink® buttons can be programmed in the same way. In the event of any problems in

programming the HomeLink® Universal Transceiver, call toll-free 1-800-355-3515 (Internet: [www.HomeLink.com](http://www.HomeLink.com)).

### **Operating the HomeLink® Universal Transceiver**

Once programmed, the HomeLink® Universal Transceiver can be used in place of hand-held transmitters.

To operate, the key must be turned to the "accessory" position (II) or the engine must be running. Press the programmed HomeLink® button to activate the garage door, driveway gate, security lighting, home security system, etc.

Your original hand-held transmitters may, of course, be used at any time.

pg. 155 HomeLink® Universal Transceiver (option)

### **Erasing programmed buttons**

Individual buttons cannot be erased. To erase all three programmed buttons:

1. Turn the ignition key to the "accessory" position (II).
2. Hold down the two outside buttons on the HomeLink® Universal Transceiver for about 20 seconds, until HomeLink®'s indicator light begins to flash.
3. Release both buttons.

The HomeLink® buttons can be reprogrammed using the procedures described on the previous pages.

### **Reprogramming a single HomeLink® button**

1. Press and hold the desired HomeLink® button. **Do not release** the button until step 3 has been completed.
2. When the indicator light begins to flash slowly (after approximately 20 seconds), position the hand-held transmitter 2 to 5 in. (5 to 12 cm) away from the HomeLink® surface.
3. Press and hold the hand-held transmitter button. The HomeLink® indicator light will flash first slowly, then rapidly. When the indicator light flashes rapidly, release both buttons.

The previously programmed device has now been erased and the new device can be activated by pressing the HomeLink® button that has just been programmed. This procedure will not affect any other programmed HomeLink® buttons.

### **NOTE:**

- Retain the original transmitter(s) for future programming procedures (i.e., if you purchase a new car).
- For your own security, erase all programmed buttons on the HomeLink® Universal Transceiver when you sell your car.
- Metallic sun protection films should not be used on any windows in a car equipped with HomeLink® Universal Transceiver. This could interfere with the transceiver's function.



[Contents](#) | [Top of Page](#)

# 2004 VOLVO S80

## Index

pg. 157 Index

### A

[ABS.....17](#)  
[ABS - warning light.....27](#)  
[Accessory lights.....29](#)  
[Active chassis system \(Four-C\).....78](#)  
[Adjusting the steering wheel.....36](#)  
[Advanced User Mode \(AUM\) - radio.....145](#)  
[Air conditioning.....45- 49](#)  
[Air filter - engine.....119](#)  
[Air vents.....44](#)  
[Airbag \(SIPS\).....8](#)  
[Airbag \(SRS\).....4](#)  
[Alarm.....65, 66](#)  
[Alarm - "panic" function.....65](#)  
[ALR/ELR.....14](#)  
[Anti-lock Brake System \(ABS\).....17](#)  
[Anti-lock Brake System - warning light.....27](#)  
[Antifreeze.....89, 118](#)  
[Approach lighting.....60](#)  
[Ashtrays.....38](#)  
[Audio systems.....137](#)  
[\\_cassette deck.....148](#)  
[\\_CD player.....146](#)  
[\\_HU-611 - overview.....138](#)  
[\\_HU-801 - overview.....139](#)  
[\\_radio.....142](#)  
[\\_specifications.....151](#)  
[AUM \(Advanced User Mode\) - radio.....145](#)  
[Automatic car washing.....115](#)  
[Automatic Locking Retractor \(ALR\).....14](#)  
[Automatic transmission](#)

[Geartronic.....76, 77](#)  
[Kickdown.....76](#)  
[Automatic transmission - cold starts.....75](#)  
[Auxiliary socket.....29, 38](#)

## **B**

[Backrests, rear seat - folding.....58](#)  
[Battery.....89, 135](#)  
[Battery maintenance.....125 -126](#)  
[Replacing the battery.....126](#)  
[Ventilation hose.....126](#)  
[Blinds - rear/side rear windows.....42](#)  
[Booster cushion.....13, 15](#)  
[Booster cushion - integrated.....13](#)  
[Brake failure warning light .....26](#)  
[Brake fluid.....124, 133](#)  
[Brake system.....16](#)  
[Bulbs \(list\).....135](#)  
[Bulbs - replacing.....106-112](#)

## **C**

[Capacities \(oils and fluids\).....129, 133](#)  
[Cargo net in trunk.....57](#)  
[Catalytic converters - three-way.....91](#)  
[Center console - switches.....29](#)  
[Center head restraint - rear seat.....3](#)  
[Central locking buttons.....63](#)  
[Chains - winter driving.....95](#)  
[Changing wheels.....98, 99](#)  
[Chassis setting \(R-models\).....69 78](#)  
[Child booster cushion ..... 13, 15](#)  
[Child Restraint Anchorages ..... 12](#)  
[Child safety.....12 -15](#)  
[Child safety locks - rear doors.....67](#)  
[Climate controls.....45 - 49](#)  
[Climate system - general information.....48](#)  
[Clock.....25](#)  
[Coat hanger.....53](#)  
[Cold weather driving.....89](#)  
[Combination filter.....45, 49](#)  
[Coolant.....118, 133](#)  
[Cooling system.....80, 133](#)  
[Courtesy light.....54](#)  
[Courtesy lights \(front\) - replacing.....112](#)  
[Courtesy lights - exterior.....60](#)  
[Cruise control.....31](#)

[Cup holder - opening.....56](#)

## **D**

[Dimensions.....131](#)

[Direction indicator bulbs \(front\).....107](#)

[Direction indicators.....35](#)

[Distributor ignition system.....134](#)

[Door step courtesy lights - replacing.....110](#)

[Doors and locks.....60](#)

[Drive belt.....118](#)

[Driver's seat and remote keyless entry system.....53](#)

[Driving economy.....80](#)

[Driving mode indicator.....25](#)

[Driving mode W.....75, 77, 89](#)

[Driving with trunk open.....81](#)

## **E**

[Economical driving.....80](#)

[Electrical system.....135](#)

[Electrical system - general information.....81](#)

[Electrically operated front seats.....52](#)

[Electrically operated moonroof.....41](#)

[Electrically operated sideview mirrors.....40](#)

[Electrically operated windows.....39](#)

[Electronic Brake Force Distribution.....17](#)

[Electronic Climate Control\(ECC\).....45 - 49](#)

[Emergency Locking Retractor \(ELR\).....14](#)

[Emergency towing.....83, 84](#)

[Emergency warning flashers.....37](#)

[Emissions systems.....117](#)

[Engine - specifications.....132](#)

[Engine - starting.....73](#)

[Engine air filter.....119](#)

[Engine compartment.....121](#)

[Engine oil.....89, 122, 123, 133](#)

[Exterior courtesy lights.....60](#)

[Exterior features - overview.....23](#)

## **F**

[Fog light - rear.....27, 32](#)

[Fog lights - front.....32](#)

[Folding head restraints.....29](#)

[Folding passenger's seat backrest.....53](#)

[Folding rear seat backrests .....58](#)

[Four-C \(active chassis system\).....29, 78](#)

[Front airbags - SRS.....4-7](#)

[Front airbags - SRS - warning light.....26](#)

<a href="#">Front courtesy lights - replacing.....</a>	<a href="#">112</a>
<a href="#">Front fog lights.....</a>	<a href="#">32</a>
<a href="#">Front fog lights - replacing .....</a>	<a href="#">109</a>
<a href="#">Front reading lights.....</a>	<a href="#">54</a>
<a href="#">Front seats - adjusting.....</a>	<a href="#">52</a>
<a href="#">Front seats - heated.....</a>	<a href="#">37</a>
<a href="#">Front suspension.....</a>	<a href="#">134</a>
<a href="#">Fuel.....</a>	<a href="#">70, 133</a>
<a href="#">Fuel filler cap.....</a>	<a href="#">72</a>
<a href="#">Fuel filler door.....</a>	<a href="#">72</a>
<a href="#">Fuel filler door - unlocking manually.....</a>	<a href="#">33</a>
<a href="#">Fuel filter .....</a>	<a href="#">119</a>
<a href="#">Fuel gauge.....</a>	<a href="#">25</a>
<a href="#">Fuel requirements.....</a>	<a href="#">70</a>
<a href="#">Fuel system.....</a>	<a href="#">117, 119, 134</a>
<a href="#">Fuel/emissions systems.....</a>	<a href="#">117</a>
<a href="#">Fuses.....</a>	<a href="#">102 - 105</a>

## **G**

<a href="#">Gas cap.....</a>	<a href="#">72</a>
<a href="#">Gasoline.....</a>	<a href="#">70</a>
<a href="#">Gear indicator.....</a>	<a href="#">25</a>
<a href="#">Geartronic (automatic transmission).....</a>	<a href="#">76 - 77</a>
<a href="#">Generator.....</a>	<a href="#">135</a>
<a href="#">Generator warning light.....</a>	<a href="#">26</a>

## **H**

<a href="#">Hand brake.....</a>	<a href="#">38</a>
<a href="#">Handling.....</a>	<a href="#">81</a>
<a href="#">Hazard warning flashers.....</a>	<a href="#">37</a>
<a href="#">Head restraint - center rear.....</a>	<a href="#">3</a>
<a href="#">Head restraints, rear - folding.....</a>	<a href="#">29</a>
<a href="#">Headlight bulbs - replacing.....</a>	<a href="#">106</a>
<a href="#">Headlight wiper blades - replacing.....</a>	<a href="#">127</a>
<a href="#">Headlights.....</a>	<a href="#">32</a>
<a href="#">Heated front seats.....</a>	<a href="#">37</a>
<a href="#">Heated rear window.....</a>	<a href="#">37</a>
<a href="#">Heated sideview mirrors.....</a>	<a href="#">37</a>
<a href="#">Heating.....</a>	<a href="#">45 - 49</a>
<a href="#">Hoisting the car.....</a>	<a href="#">120</a>
<a href="#">Home Safe System.....</a>	<a href="#">60</a>
<a href="#">HomeLink® .....</a>	<a href="#">153-155</a>
<a href="#">Hood - opening.....</a>	<a href="#">121</a>

## **I**

<a href="#">Ignition switch.....</a>	<a href="#">36</a>
<a href="#">Immobilizer (start inhibitor).....</a>	<a href="#">60,73</a>

[Indicator lights.....26, 27](#)  
[Inflatable curtain \(IC\).....9](#)  
[Instrument illumination.....32](#)  
[Instrument panel.....25](#)  
[Instruments.....24](#)  
[Integrated booster cushion ..... 13](#)  
[Interior Air Quality system .....49](#)  
[Interior features - overview.....22](#)  
[Interior lighting.....54](#)

## **J**

[Jack.....57, 98, 99](#)  
[Jump starting.....88](#)

## **K**

[Key - removing from ignition switch.....73](#)  
[Keyless entry system.....61, 62](#)  
[Keyless entry system - replacing batteries.....62](#)  
[Keylock.....73](#)  
[Keys.....60](#)  
[Kickdown.....76](#)

## **L**

[Label information.....130](#)  
[License plate lights - replacing.....110](#)  
[Lifting the car.....120](#)  
[Lights - accessory.....297](#)  
[Load carriers.....82](#)  
[Locking and unlocking the car.....60](#)  
[Locking steering wheel.....36](#)  
[Long distance trip.....90](#)  
[Long loads.....53, 58](#)

## **M**

[Maintenance service.....116](#)  
[Malfunction indicator lamp.....27](#)  
[Manually unlocking the fuel filler door.....33](#)  
[Memory function - front seats.....52](#)  
[Mirrors.....40](#)  
[Mirrors, sideview - memory function.....40](#)  
[Moonroof.....41](#)

## **O**

[Occupant safety.....11](#)  
[Octane rating.....70](#)  
[Odometer.....25](#)  
[Oil - engine.....89, 122, 123, 133](#)  
[Oil pressure warning light ..... 26](#)  
[Opening the hood.....121](#)

[Opening the trunk from the inside.....63](#)

## **P**

[Paint touch-up.....113](#)

[Panic function \(alarm\).....65](#)

[Parking Assistance, rear.....79](#)

[Parking brake.....38](#)

[Parking brake reminder light.....26](#)

[Parking lights.....32](#)

[Passenger's seat backrest - folding.....53](#)

[PCV system.....119](#)

[Polishing.....115](#)

[Power moonroof.....41](#)

[Power seats.....52](#)

[Power steering - speed-sensitive.....81](#)

[Power steering fluid ..... 124, 133](#)

[Power windows.....39](#)

[PROPOSITION 65 WARNING.....125](#)

## **R**

[Rain sensor - windshield wipers.....35](#)

[Reading lights - front/rear ..... 54](#)

[Rear door step lights - replacing.....110](#)

[Rear fog light.....27, 32](#)

[Rear Parking Assistance.....79](#)

[Rear reading lights.....54](#)

[Rear seat backrests - folding.....58](#)

[Rear suspension.....134](#)

[Rear window - heated.....37](#)

[Rearview mirror.....40](#)

[Refrigerant.....48, 133](#)

[Refueling.....72](#)

[Remote control - keyless entry system.....61](#)

[Remote control - keyless entry system and sideview mirrors.....40](#)

[Remote keyless entry system.....61](#)

[Remote keyless entry system - replacing batteries.....62](#)

[Remote keyless entry system and driver's seat.....53](#)

[Replacing bulbs.....106-112](#)

[Replacing fuses.....102](#)

[Replacing wiper blades.....127](#)

[Reporting safety defects.....11](#)

[Road assistance.....136](#)

[Roadholding.....81](#)

[Roof load - maximum.....131](#)

[Roof racks.....82](#)

## **S**



<a href="#">Safety defects - reporting.....</a>	<a href="#">11</a>
<a href="#">Safety locks - child.....</a>	<a href="#">67</a>
<a href="#">Seat belt maintenance.....</a>	<a href="#">11</a>
<a href="#">Seat belts.....</a>	<a href="#">2, 3, 14</a>
<a href="#">Seat belts - cleaning.....</a>	<a href="#">115</a>
<a href="#">Seats - front.....</a>	<a href="#">52</a>
<a href="#">Servicing.....</a>	<a href="#">119, 120</a>
<a href="#">Shiftlock.....</a>	<a href="#">73, 74, 76</a>
<a href="#">Side direction indicator - replacing.....</a>	<a href="#">111</a>
<a href="#">Side impact airbag system (SIPS).....</a>	<a href="#">8</a>
<a href="#">Side marker lights - replacing.....</a>	<a href="#">111</a>
<a href="#">Sideview mirrors.....</a>	<a href="#">40</a>
<a href="#">Sideview mirrors - heated.....</a>	<a href="#">37</a>
<a href="#">Sideview mirrors - memory function.....</a>	<a href="#">40</a>
<a href="#">Snow chains.....</a>	<a href="#">95</a>
<a href="#">Snow tires.....</a>	<a href="#">95</a>
<a href="#">Spare tire.....</a>	<a href="#">57, 96</a>
<a href="#">Spark plugs.....</a>	<a href="#">119, 134</a>
<a href="#">Specifications.....</a>	<a href="#">132</a>
<a href="#">Speed-sensitive power steering.....</a>	<a href="#">811</a>
<a href="#">SRS.....</a>	<a href="#">6</a>
<a href="#">SRS diagnostic system.....</a>	<a href="#">26</a>
<a href="#">Stability Traction Control (STC).....</a>	<a href="#">17, 29</a>
<a href="#">Start inhibitor (immobilizer).....</a>	<a href="#">60, 73</a>
<a href="#">Starting the engine.....</a>	<a href="#">73</a>
<a href="#">Steering wheel adjustment .....</a>	<a href="#">36</a>
<a href="#">Steering wheel lock.....</a>	<a href="#">36</a>
<a href="#">Storage compartment in center console.....</a>	<a href="#">56</a>
<a href="#">Storage compartments.....</a>	<a href="#">55/a&gt;</a>
<a href="#">Studded tires.....</a>	<a href="#">95</a>
<a href="#">Sun blinds.....</a>	<a href="#">42</a>
<a href="#">Supplemental Restraint System.....</a>	<a href="#">4, 26</a>
<a href="#">Suspension.....</a>	<a href="#">134</a>
<a href="#">Switches in center console .....</a>	<a href="#">29</a>
<b>T</b>	
<a href="#">Tachometer.....</a>	<a href="#">25</a>
<a href="#">Tail light bulbs - replacing .....</a>	<a href="#">108</a>
<a href="#">Temperature gauge.....</a>	<a href="#">25</a>
<a href="#">Temporary spare tire.....</a>	<a href="#">96</a>
<a href="#">Text window.....</a>	<a href="#">28</a>
<a href="#">Three-way catalytic converters.....</a>	<a href="#">91</a>
<a href="#">Timing belt.....</a>	<a href="#">119</a>
<a href="#">Tire pressure.....</a>	<a href="#">96</a>
<a href="#">Tires.....</a>	<a href="#">81, 94 - 97</a>

<a href="#">Tires - changing.....</a>	<a href="#">98, 99</a>
<a href="#">Tool bag.....</a>	<a href="#">57</a>
<a href="#">Towing a trailer.....</a>	<a href="#">85</a>
<a href="#">Towing eyelet.....</a>	<a href="#">83</a>
<a href="#">Towing the car.....</a>	<a href="#">83, 84</a>
<a href="#">Trailer towing.....</a>	<a href="#">85</a>
<a href="#">Trailer weight - maximum.....</a>	<a href="#">131</a>
<a href="#">Transmission - automatic.....</a>	<a href="#">74 - 79</a>
<a href="#">Transmission - specifications.....</a>	<a href="#">132</a>
<a href="#">Transmission fluid (automatic).....</a>	<a href="#">133</a>
<a href="#">Trip computer.....</a>	<a href="#">30</a>
<a href="#">Trip odometer.....</a>	<a href="#">25</a>
<a href="#">Trunk - opening from the inside.....</a>	<a href="#">63</a>
<a href="#">Trunk - unlocking with master key.....</a>	<a href="#">63</a>
<a href="#">Trunk lights - replacing.....</a>	<a href="#">111</a>
<a href="#">Trunk lock switch.....</a>	<a href="#">29</a>
<a href="#">Turn signals.....</a>	<a href="#">35</a>
<b>U</b>	
<a href="#">Uniform tire quality grading.....</a>	<a href="#">97</a>
<a href="#">Unlocking the trunk with key.....</a>	<a href="#">63</a>
<a href="#">Upholstery - cleaning.....</a>	<a href="#">115</a>
<b>V</b>	
<a href="#">Vanity mirror lights - replacing.....</a>	<a href="#">109</a>
<a href="#">Vehicle Identification Number (VIN).....</a>	<a href="#">130</a>
<a href="#">Vehicle loading.....</a>	<a href="#">134</a>
<a href="#">Ventilation.....</a>	<a href="#">44</a>
<a href="#">Volumes (oils and fluids) .....</a>	<a href="#">133</a>
<a href="#">Volvo On Call.....</a>	<a href="#">136</a>
<b>W</b>	
<a href="#">Warning light - center.....</a>	<a href="#">26</a>
<a href="#">Warning lights.....</a>	<a href="#">26, 27</a>
<a href="#">Warranty.....</a>	<a href="#">116</a>
<a href="#">Washer fluid reservoir.....</a>	<a href="#">120</a>
<a href="#">Washer fluid solvent.....</a>	<a href="#">89</a>
<a href="#">Washing the car.....</a>	<a href="#">114, 115</a>
<a href="#">Waxing.....</a>	<a href="#">115</a>
<a href="#">Weight distribution.....</a>	<a href="#">81</a>
<a href="#">Weights.....</a>	<a href="#">131</a>
<a href="#">Wheels - changing.....</a>	<a href="#">98, 99</a>
<a href="#">Wheels and tires.....</a>	<a href="#">94 - 99</a>
<a href="#">Whiplash Protection System (WHIPS).....</a>	<a href="#">10</a>
<a href="#">Windows - electrically operated.....</a>	<a href="#">39</a>
<a href="#">Windshield washer solvent .....</a>	<a href="#">89</a>
<a href="#">Windshield wiper blades - replacing.....</a>	<a href="#">127</a>

[Windshield wipers/washers.....35](#)

[Winter driving.....89](#)

[Winter tires.....95](#)

[Winter/Wet driving mode.....75, 77, 89](#)

[Wiper blades - replacing.....127](#)

---



[Contents](#) | [Top of Page](#)

# 2004 VOLVO S80

## Back Cover

## Back Cover

### **Accessory Installation - Important Warning**

- We strongly recommend that Volvo owners install only genuine, Volvo-approved accessories, and that accessory installations be performed only by the factory-trained technicians at your authorized Volvo retailer.
- Genuine Volvo accessories are tested to ensure compatibility with the performance, safety, and emission systems in your car. Additionally, your authorized Volvo retailer knows where accessories may and may not be safely installed in your Volvo. In all cases, please consult your authorized Volvo retailer before installing any accessory in or on your car.
- Accessories that have not been approved by Volvo may or may not be specifically tested for compatibility with your car. Additionally, an inexperienced installer may not be familiar with some of your car's systems.
- Any of your car's performance and safety systems could be adversely affected if you install accessories that Volvo has not tested, or if you allow accessories to be installed by someone unfamiliar with your car.
- Damage caused by unapproved or improperly installed accessories may not be covered by your new car warranty. See your Warranty and Service Records Information booklet for more warranty information. Volvo assumes no responsibility for death, injury, or expenses that may result from the installation of non-genuine accessories.

### **Driver Distraction**

- Driver distraction results from driver activities that are not directly related to controlling the car in the driving environment. Your new Volvo is, or can be, equipped with many feature-rich entertainment and communication systems. These include hands-free cellular telephones, navigation systems, and multipurpose audio systems. You may also own other portable electronic devices for your own convenience. When used properly and safely, they enrich the driving experience. Improperly used, any of these could cause a distraction.
- For all of these systems, we want to provide the following warning that reflects the strong Volvo concern for your safety:
  - Never use these devices or any feature of your vehicle in a way that distracts you from the task of driving safely. Distraction can lead to a serious accident.
  - In addition to this general warning, we offer the following guidance regarding specific newer features that may be found in your vehicles:
    - Never use a hand-held cellular telephone while driving. Some jurisdictions prohibit cellular telephone use by a driver while the vehicle is moving.
    - If your car is equipped with a navigation system, set and make changes to your travel itinerary only with the vehicle parked.
    - Never program your audio system while the vehicle is moving. Program radio presets with the vehicle parked, and use your programmed presets to make radio use quicker and simpler.
    - Never use portable computers or personal digital assistants while the vehicle is moving.

A driver has a responsibility to do everything possible to ensure his or her own safety and the safety of passengers in

the vehicle and others sharing the roadway. Avoiding distractions is part of that responsibility.

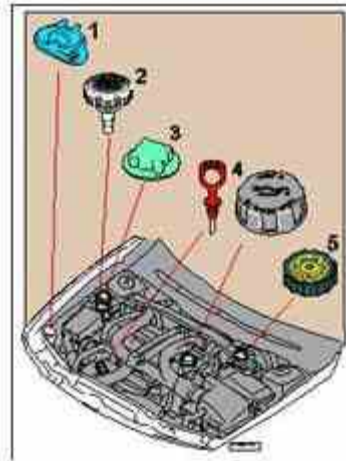

## The following should be checked regularly: \*

**1 Washer fluid** reservoir should be filled with water and solvent (wintertime: windshield washer anti-freeze). See [page 120](#).

**2 Power steering** - When cold, the level must not be above the COLD mark and when hot it must not be above the HOT mark. Top up if the level drops to the ADD mark with ATF fluid. See [page 124](#).

**3 Coolant** level should be between the expansion tank marks. Mixture: 50% anti-freeze and 50% water. See [page 118](#).

**4 Engine oil** level should be between the dipstick marks. The distance between the marks represents approx. 1.6 US qts (1.5 liters). See [page 123](#).

**5 Brake fluid** - check, without removing the cap, that the level is above the MIN mark. Use brake fluid DOT 4+. See [page 124](#).

\* Engine oil should be checked each time the car is refuelled.

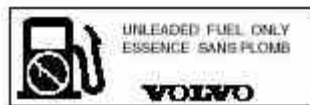

Octane rating, see [page 70](#).

Tire pressure, see label located on the rear edge of the right front door.

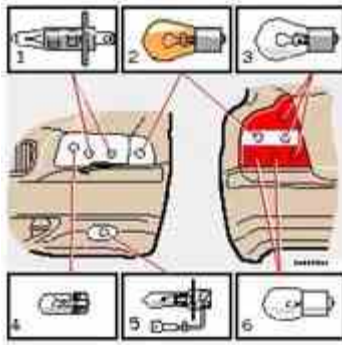

**Bulbs Power Socket US no.**

**Bulb Power Socket US no.**

1	55 W	H 7	-
2	21 W	BAU 15s	-
3	21 W	BA 15s	1156
5	5 W	W 2.1x9.5d	-
4	55 W	H 1	-
6	5 W	BA 15s	67



[Contents](#) | [Top of Page](#)