

# 2003 VOLVO S60



## Introduction



Welcome to the world-wide family of Volvo owners. We trust that you will enjoy many years of safe driving in your Volvo, an automobile designed with your safety and comfort in mind. To help ensure your satisfaction with this vehicle, we encourage you to familiarize yourself with the equipment descriptions, operating instructions and maintenance requirements/recommendations in this manual. We also urge you and your passengers to wear seat belts at all times in this (or any other) automobile. And, of course, please do not operate a vehicle if you may be affected by alcohol, medication or any impairment that could hinder your ability to drive.

Your Volvo is designed to meet all applicable safety and emission standards, as evidenced by the certification labels attached to the driver's door opening and on the left wheel housing in the engine compartment.

**For further information please contact your retailer, or:**

**In the USA:**

Volvo Cars of North America

Customer Relations  
P.O. Box 914  
Rockleigh, New Jersey 07647-0914  
800-458-1552

**In Canada:**

Volvo Canada Ltd.  
175 Gordon Baker Road  
North York, Ontario M2H 2N7  
800-663-8255

## General Information

### **Shiftlock (automatic transmission)**

When your car is parked, the gear selector is locked in the (P)ark position. To release the selector from this position, turn the ignition key to position II (or start the engine), depress the brake pedal, press the button on the front side of the gear selector and move the selector from (P)ark.

### **Keylock (automatic transmission)**

When you switch off the ignition, the gear selector must be in the (P)ark position before the key can be removed from the ignition switch.

### **Anti-lock Brake System (ABS)**

The ABS system in your car performs a self-diagnostic test when the vehicle first reaches the speed of approximately 12 mph (20 km/h). The brake pedal will pulsate several times and a sound may be audible from the ABS control module. This is normal.

### **Fuel filler door**

The fuel filler door, located on the right rear fender, is connected to your car's central locking system. Press the button on the light switch panel (see illustration on [page 30](#)) when the car is at a standstill to unlock the fuel filler door. Please note that the fuel filler door will remain unlocked until the car begins to move forward. An audible click will be heard when the fuel filler door relocks.

### **Fuel filler cap**

After refueling, close the fuel filler cap by turning it clockwise until it clicks into place. If this cap is not closed tightly or if the engine is running when the car is refueled, the Malfunction Indicator Lamp (" Check Engine" light) will illuminate.

### **Important information**

Before you operate your car for the first time, please familiarize yourself with the new- engine oil consumption information on [page 78](#). You should also be familiar with the information in chapters one, two and four of this manual. Information contained in the balance of the manual is extremely useful and should be read after operating the vehicle for the first time.

The manual is structured so that it can be used for reference. For this reason, it should be kept in the car for ready access.

Do not export your Volvo to another country before investigating that country's applicable safety and exhaust emission requirements. In some cases it may be difficult or impossible to comply with these requirements. Modifications to the emission control system( s) may render your Volvo not certifiable for legal operation in the U. S., Canada and other countries.

All information, illustrations and specifications contained in this manual are based on the latest product information available at the time of publication. Please note that some vehicles may be equipped differently, depending on special legal requirements. Optional equipment described in this manual may not be available in all markets.

Volvo reserves the right to make model changes at any time, or to change specifications or design without notice and without incurring obligation.

## **WARNING!**

### **CALIFORNIA Proposition 65 Warning!**

Engine exhaust, some of its constituents, and certain vehicle components contain or emit chemicals known to the state of California to cause cancer, and birth defects or other reproductive harm. In addition, certain fluids contained in vehicles and certain products of component wear contain or emit chemicals known to the State of California to cause cancer, and birth defects or other reproductive harm.

## **Volvo and the environment**

Volvo is committed to the well being of its customers. As a natural part of this commitment, we care about the environment in which we all live. Caring for the environment means an everyday involvement in reducing our environmental impact.

Volvo's environmental activities are based on a holistic view, which means we consider the overall environmental impact of a product throughout its complete life cycle. In this context, design, production, product use, and recycling are all important considerations.

In production, Volvo has partly or completely phased out several chemicals including freons, lead chromates, naphthanates, asbestos, mercury and cadmium; and reduced the amount of chemicals used in our plants 50% since 1991. Volvo was the first in the world to introduce into production a three-way catalytic converter with a Lambda sond, now called oxygen sensor, in 1976. The current version of this highly efficient system reduces emissions of harmful substances (CO, HC, NOx) from the exhaust pipe by approximately 95% and the search to eliminate the remaining emissions continues. Volvo is the only automobile manufacturer to offer CFC-free retrofit kits for the air conditioning system of all models as far back as the 1975 model 240. Advanced electronic engine controls, refined purification systems and cleaner fuels are bringing us closer to our goal.

After Volvo cars and parts have fulfilled their use, recycling is the next critical step in completing the life cycle. The metal content is about 75% of the total weight of a car, which makes the car among the most recycled industrial products. In order to have efficient and well controlled recycling, many Volvo variants have printed dismantling manuals, indicating the weight and material of individual components.

For Volvo, all homogeneous plastic parts weighing more than 1.7 oz. (50 grams) are marked with international symbols that indicate how the component is to be sorted for recycling.

In addition to continuous environmental refinement of conventional gasoline-powered internal combustion engines, Volvo is actively looking at advanced technology alternative-fuel vehicles.

When you drive a Volvo, you become our partner in the work to lessen the car's impact on the environment. To reduce your vehicle's environmental impact, you can:

- Maintain proper air pressure in your tires. Tests have shown decreased fuel economy with improperly inflated tires.
- Follow the recommended maintenance schedule.
- Drive at a constant speed.
- See an authorized Volvo retailer as soon as possible for inspection if the check engine (malfunction indicator) lamp illuminates, or stays on after the vehicle has started.
- Properly dispose of any vehicle-related waste such as used motor oil, used batteries, brake pads, etc.
- When cleaning your car, use Volvo's own car care products, all of which have systematically been adapted to the environment.

For additional information regarding the environmental activities in which Volvo Cars of North America, LLC. and Volvo Car Corporation are involved, visit our Internet Home Page at: <http://www.volvocars.com>

### **PremAir®**

On the surface of the radiator in the engine compartment, there is a special coating called PremAir®. PremAir® works as a catalytic converter, converting most of the ground level ozone passing through the radiator into oxygen, thereby

reducing harmful ground-level ozone.

## Instruments, switches and controls

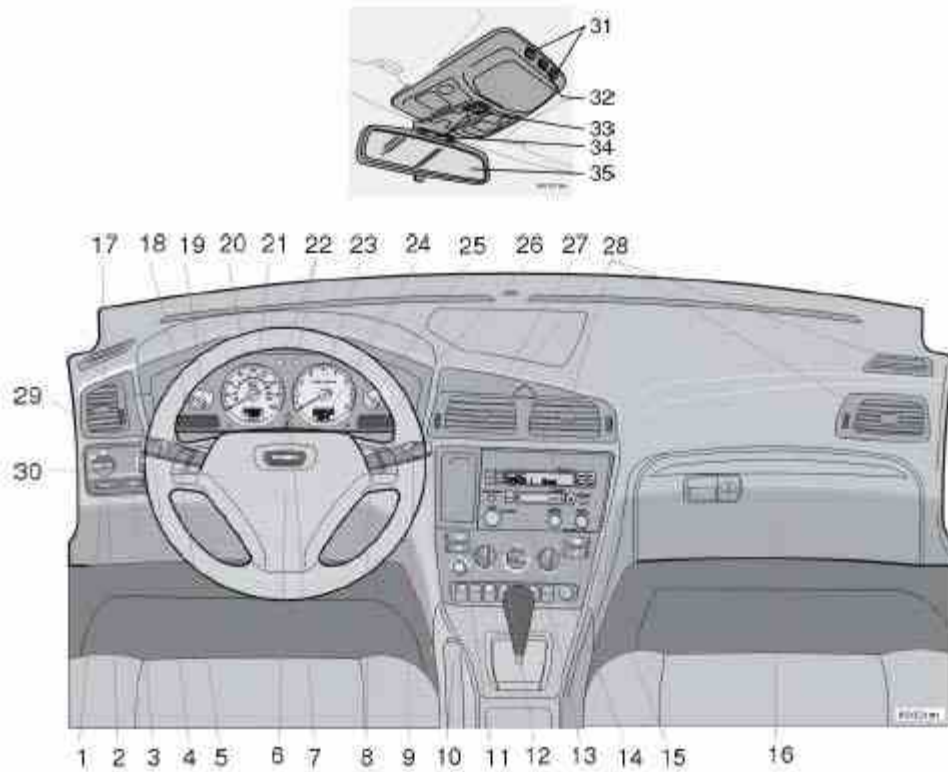

	Page
1. Front fog lights	<a href="#">30</a>
2. Headlights/Parking lights/switch for unlocking fuel filler door	<a href="#">30</a>
3. Rear fog light	<a href="#">30</a>
4. Turn signals/High/low beams	<a href="#">32</a>
5. Cruise control	<a href="#">36</a>
6. Horn	<a href="#">iv</a>
7. Instrument panel	<a href="#">22</a>
8. Audio controls in steering wheel	<a href="#">162</a>
9. Windshield wipers	<a href="#">33</a>
10. Parking brake (hand brake)	<a href="#">37</a>
11. Center console switches	<a href="#">27</a>
12. Climate control	<a href="#">43</a>
13. Audio system	<a href="#">157</a>
14. 12 V socket	<a href="#">37</a>
15. Hazard warning flashers	<a href="#">34</a>
16. Glove compartment	<a href="#">62</a>
17. Panel vents	<a href="#">45</a>
18. Text window	<a href="#">26</a>
19. Temperature gauge	<a href="#">22</a>

20. Odometer/ Trip odometer/Cruise control indicator	<a href="#">22/ 36</a>
21. Speedometer	<a href="#">22</a>
22. Turn signal indicators	<a href="#">22</a>
23. Tachometer	<a href="#">22</a>
24. Ambient temperature/Clock/Selected gear indicator	<a href="#">22</a>
25. Fuel gauge	<a href="#">22</a>
26. Indicator and warning symbols	<a href="#">23</a>
27. -	-
28. Panel vents	<a href="#">45</a>
29. Instrument lighting	<a href="#">30</a>
30. Lighting panel	<a href="#">30</a>
31. Reading lights	<a href="#">58</a>
32. Interior lighting	<a href="#">58</a>
33. Sun roof control	<a href="#">41</a>
34. Seat belt reminder	<a href="#">iv</a>
35. Rearview mirror	<a href="#">40</a>
36. Lock button, for all doors	<a href="#">71</a>
37. Blocking rear seat power windows	<a href="#">38</a>
38. Controls, power windows	<a href="#">38</a>
39. Controls, sideview mirrors	<a href="#">40</a>

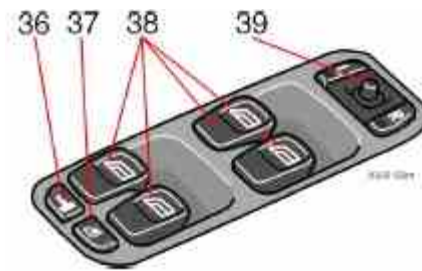

*Control panel in the driver's door (controls 36-39).*

## Contents

### Contents

[Safety](#)

[Instruments and controls](#)

[Climate control](#)

[Interior](#)

[Locks and alarm](#)

[Starting and driving](#)

[Wheels and tires](#)

[Car care](#)

[Maintenance and service](#)

[Specifications](#)

[Audio](#)

[Index](#)

[Back Cover](#)



[Contents](#) | [Top of Page](#)

# 2003 VOLVO S60

## Safety

### pg. 1 Safety

Seat belts	<a href="#">2</a>
Airbags (Supplemental Restraint System)	<a href="#">4</a>
Side airbags (SIPS airbags)	<a href="#">10</a>
Inflatable Curtain (IC)	<a href="#">12</a>
Inspection of airbags, inflatable curtains and seat belt tensioners	<a href="#">13</a>
WHIPS	<a href="#">14</a>
Child safety	<a href="#">16</a>
Occupant safety, Reporting safety defects	<a href="#">20</a>

### pg. 2 Safety

#### Seat belts

Not wearing a seat belt is like believing "It'll never happen to me!" Volvo, the inventor of the three-point seat belt, urges you and all occupants of your car to wear seat belts and ensure that children are properly restrained, using an infant, car or booster seat determined by age, weight and height. Volvo also believes no child should sit in the front seat of a car.

**NOTE:** Legislation in your state or province may mandate seat belt usage. Additionally, most states and provinces have already made it mandatory for occupants of a car to use seat belts.

So, urging you to "buckle up" is not just our recommendation - legislation in your state or province may mandate seat belt usage. The few seconds it takes to buckle up may one day allow you to say, "It's a good thing I was wearing my seat belt."

**NOTE:** A chime will sound several times if the driver has not fastened his/her seat belt.

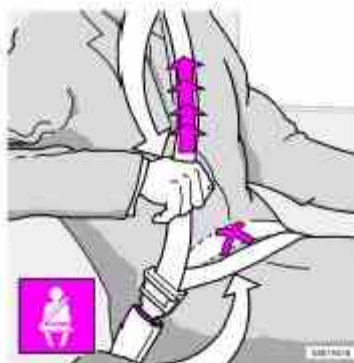

*Extending the lap belt*

## To buckle a seat belt:

Pull the belt out far enough to insert the latch plate into the receptacle until a distinct click is heard. The seat belt retractor is normally "unlocked" and you can move freely, provided that the shoulder belt is not pulled out too far. The retractor will lock up as follows:

- if the belt is pulled out rapidly
- during braking and acceleration
- if the vehicle is leaning excessively
- when driving in turns

For the seat belt to provide maximum protection in the event of an accident, it must be worn correctly. When wearing the seat belt remember:

- The belt should not be twisted or turned.
- The lap belt must be positioned low on the hips (not pressing against the abdomen).

Make sure that the shoulder belt is rolled up into its retractor and that the shoulder and lap belts are taut.

Before exiting the car, check that the seat belt retracts fully after being unbuckled.

If necessary, guide the belt back into the retractor slot.

## Child seats:

Please refer to [page 19](#) for information on securing child seats with the seat belts.

pg. 3 Safety



## During pregnancy

Pregnant women should always wear seat belts. Remember that the belt should always be positioned in such a way as to avoid any possible pressure on the abdomen. The lap portion of the belt should be located low, as shown in the above illustration.

## WARNING!

### Seat belts:

- Never use a seat belt for more than one occupant. Never wear the shoulder portion of the belt under the arm, behind the back or otherwise out of position. Such use could cause injury in the event of an accident. As seat belts lose much of their strength when exposed to violent stretching, they should be replaced after any collision, even if they appear to be undamaged.
- Never repair the belt on your own; have this work done by an authorized Volvo retailer only.
- Any device used to induce slack into the shoulder belt portion of the three-point belt system will have a detrimental effect on the amount of protection available to you in the event of a collision.
- The seat back should not be tilted too far back. The shoulder belt must be taut in order to function properly.



• Do not use child safety seats or child booster cushions/backrests in the front passenger's seat. We also recommend that children who have outgrown these devices sit in the rear seat with the seat belt properly fastened.



*Sample label found on all seat belts with tensioners*

pg. 4 Safety

## Airbags (Supplemental Restraint System)



### Driver's side airbag

As an enhancement to the three-point seat belt system, your Volvo is equipped with a Supplemental Restraint System (SRS) to complement the three-point seat belt system. The inflatable airbag is installed folded up in the center of the steering wheel. The wheel is embossed with SRS.

### **⚠ WARNING!**

Never drive an SRS equipped car with your hands on the steering wheel pad / airbag housing.

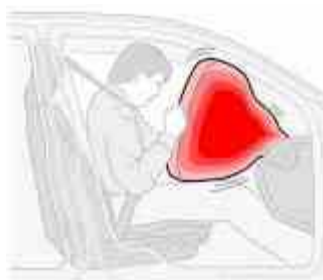

## Passenger side airbag

The airbag on the front passenger side is folded up in a compartment above the glove compartment. The panel is embossed SRS.

### **WARNING!**

No objects, accessory equipment or stickers may be placed on, attached to, or installed near the SRS cover in the center of the steering wheel, the SRS cover above the glove compartment or the area affected by airbag deployment.

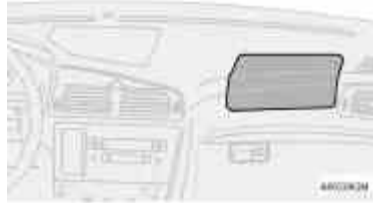

*Passenger side airbag - location*

### **WARNING!**

As its name implies, SRS is designed to be a SUPPLEMENT to - not a replacement for - the three-point belt system. For maximum protection, wear seat belts at all times. Be aware that no system can prevent all possible injuries that may occur in an accident.

When installing any optional equipment, make sure that the SRS system is not damaged. Do not attempt to service any component of the SRS yourself. Attempting to do so may result in serious personal injury. If a problem arises, take your car to the nearest authorized Volvo retailer for inspection as soon as possible.



*SRS text on outside of both sun visors.*



*SRS text on inside of both sun visors.*



*SRS text on passenger's dash.*



*SRS text at the end of the dash*

**NOTE:** Deployment of SRS components occurs only one time during an accident. In a collision where deployment occurs, the airbags and seat belt tensioners activate. Some noise occurs and a small amount of powder is released. The release of the powder may appear as smoke-like matter. This is a normal characteristic and does not indicate fire.

**NOTE:** Volvo's dual-threshold, dual-stage airbags use special sensors that are integrated with the front seat buckles. The point at which the airbag deploys is determined by whether or not the seat belt is being used, as well as the severity of the collision. Collisions can occur where only one of the airbags deploys.

If the impact is less severe, but severe enough to present a clear injury risk, the dual-stage airbags are triggered at just 70% of their total capacity. If the impact is more severe, the dual-stage airbags are triggered at full capacity.

### **⚠ WARNING!**

Do not use child safety seats or child booster cushions/backrests in the front passenger's seat. We also recommend that occupants under 4 feet 7 inches (140 cm) in height who have outgrown these devices sit in the rear seat with the seat belt fastened.

Never drive with the airbags deployed. The fact that they hang out can impair the steering of your car. Other safety systems can also be damaged. The smoke and dust formed when the airbags are deployed can cause skin and eye irritation in the event of prolonged exposure.

pg. 6 Safety

## **Airbags (Supplemental Restraint System) (Contd)**

### **⚠ WARNING!**

Children must never be allowed in the front passenger's seat. Volvo recommends that ALL occupants (adults and children) shorter than 4 feet 7 inches (140 cm) be seated in the back seat of any vehicle with a front passenger-side airbag. See [page 19](#) for guidelines.

Occupants in the front passenger's seat must never sit on the edge of the seat, sit leaning toward the instrument panel or otherwise sit out of position. The occupant's back must be as upright as comfort allows and be against the seat back with the seat belt properly fastened.

Feet must be on the floor, e.g. not on the dash, seat or out of the window.

No objects or accessory equipment, e.g. dash covers, may be placed on, attached to, or installed near the SRS hatch (the area above the glove compartment) or the area affected by airbag deployment (see illustration on [page 4](#)).

There should be no loose articles, e.g. coffee cups, on the floor, seat or dash area.

Never try to open the SRS cover on the steering wheel or the passenger side dash. This should only be done by an authorized Volvo service technician.

Failure to follow these instructions can result in injury to the vehicle occupants

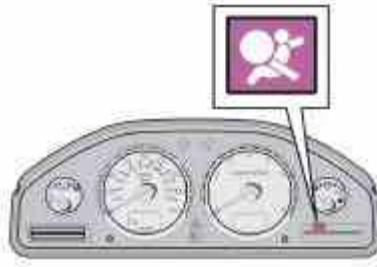

### Warning light in the instrument panel

A self-diagnostic system incorporated in the sensor monitors the SRS. This system does not, however, monitor the Side Impact Protection System (SIPS) airbags. If a fault is detected, the warning light will illuminate. The light is included in the warning/indicator light cluster in the instrument panel. Normally, the SRS warning lamp should light up when the ignition key is turned to positions I, II or III and should go out after 7 seconds or when the engine is started. Check that this light is functioning properly every time the car is started.

The following items are monitored by the self-diagnostic system:

- Sensor unit
- Cable harness
- Gas generator

### **WARNING!**

If the SRS warning light stays on after the engine has started or if it comes on while you are driving, drive the car to the nearest authorized Volvo retailer for inspection as soon as possible.

**NOTE:** The information on this page does not pertain to the Side Impact Protection System airbags.

### When are the airbags deployed?

The SRS system is designed to deploy during certain frontal or front-angular collisions, impacts, or decelerations, depending on the crash severity, angle, speed and object impacted. The SRS sensor is designed to react to both the impact of the collision and the inertial forces generated by it and to determine if the intensity of the collision is sufficient for the seat belt tensioners or airbags to be deployed.

If the airbags have been deployed, we recommend the following:

- Have the car towed to an authorized Volvo retailer. Never drive with the airbags deployed.
- Have an authorized Volvo retailer replace the SRS system components.
- Use only new, Genuine Volvo Parts when replacing SRS components (airbags, seat belts, tensioners, etc.).

### When are the airbags NOT deployed?

Not all frontal collisions activate the SRS system. If the collision involves a nonrigid object (e.g., a snow drift or bush), or a rigid, fixed object at a low speed, the SRS system will not necessarily deploy. Front airbags do not normally deploy in a side impact collision, in a collision from the rear or in a rollover situation. The amount of damage to the bodywork does not reliably indicate if the airbags should have deployed or not.

### Seat belts - the heart of the Volvo safety system

The heart of the Volvo safety system is the three-point seat belt (a Volvo invention)! In order for the SRS system to provide the protection intended, seat belts must be worn at all times by everyone in the car. **The SRS system is a**

supplement to the seat belts.

**⚠ WARNING!**

Never drive with the airbags deployed. The fact that they hang out can impair the steering of your car. Other safety systems can also be damaged. The smoke and dust formed when the airbags are deployed can cause skin and eye irritation in the event of prolonged exposure.

pg. 7 Safety

## Airbags (Supplemental Restraint System) (Contd)

**⚠ WARNING!**

If your car has been subjected to flood conditions (e.g. soaked carpeting/standing water on the floor of the vehicle) or if your car has become flood-damaged in any way, do not attempt to start the vehicle or put the key in the ignition before disconnecting the battery (see below). This may cause airbag deployment which could result in personal injury. **Have the car towed to an authorized Volvo retailer for repairs.**

**Automatic transmission:**

Before attempting to tow the car, use the following procedure to override the shiftlock system to move the gear selector to the neutral position.

- Switch off the ignition for at least 10 minutes and disconnect the battery
- Wait at least one minute
- Insert the key in the ignition and turn it to position II
- Press firmly on the brake pedal.
- Move the gear selector from (P)ark to the (N) eutral position.

There is no maintenance to perform on the SRS yourself. The month and year shown on the decal on the door pillar indicate when you should contact your Volvo retailer for specific servicing or replacement of airbags and seat belt tensioners. This service must be performed by an authorized Volvo retailer.

Should you have any questions about the SRS system, please contact your authorized Volvo retailer or Volvo Customer Support.:

**In the USA:**

Volvo Cars of North America, LLC.  
Customer Relations  
P.O. Box 914  
Rockleigh, New Jersey 07647-0914  
800-458-1552

**In Canada:**

Volvo Canada Ltd.  
175 Gordon Baker Road  
North York, Ontario M2H 2N7  
800-663-8255

pg. 9 Safety

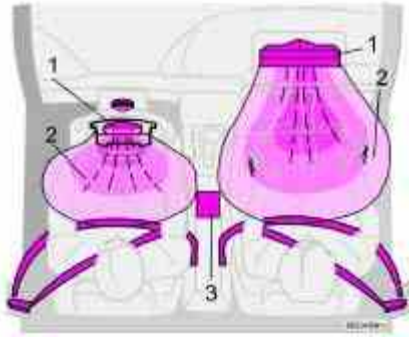

### Front airbag (SRS) system

As an enhancement to the three-point seat belt system, your Volvo is equipped with a Supplemental Restraint System (SRS). The Volvo SRS consists of an airbag (2) on both the driver's and passenger's sides and seat belt tensioners in both front door pillars. The system is designed to supplement the protection provided by the three-point seat belt system. All three rear seat belts are also equipped with tensioners.

The SRS system is indicated by the "SRS" embossed on the steering wheel pad and above the glove compartment, and by decals on both sun visors and on the front and far right side of the dash.

The airbags are folded and located in the steering wheel hub and above the glove compartment.

**Deployment:** The SRS airbags are designed to deploy during certain frontal or front-angular collisions, impacts, or decelerations, depending on the crash severity, angle, speed and object impacted. The airbags may also deploy in certain non-frontal collisions where rapid deceleration occurs.

The airbag system includes gas generators (1) surrounded by the airbags (2) and front seat belt tensioners for both of the front seats. To deploy the system, the sensor (3) activates the gas generators causing the airbags to be inflated with nitrogen gas.

As the movement of the seats' occupants compresses the airbags, some of the gas is expelled at a controlled rate to provide better cushioning. Both seat belt tensioners also deploy, minimizing any seat belt slack. The entire process, including inflation and deflation of the airbags, takes approximately two-tenths of a second.

### **⚠ WARNING!**

The SRS is designed to help prevent serious injury. Deployment occurs very quickly and with considerable force. During normal deployment and depending on variables such as seating position, one may experience abrasions, bruises, swellings, or other injuries as a result of airbag(s) deployment.

**Never** try to repair any part of the SRS or SIPS bag systems yourself. Any interference in the system could cause malfunction and serious injury. All work on these systems should be performed by an authorized Volvo retailer.

### Side airbags (SIPS airbags)



*SIPS airbag\**

### **SIPS airbag (front seats only)**

As an enhancement to the structural Side Impact Protection System built into your car, the car is also equipped with Side Impact Protection System (SIPS) airbags. The SIPS airbag system consists of airbag modules built into the sides of both front seat backrests, wires and gas generators/sensor units (see illustration on next page).



The SIPS airbag system is designed to help increase occupant protection in the event of certain side impact collisions. The SIPS airbags are designed to deploy only during certain side-impact collisions, depending on the crash severity, angle, speed and point of impact. The airbags are not designed to deploy in all side impact situations.

**NOTE:** SIPS airbag deployment (one airbag) occurs only on the side of the vehicle affected by the impact. The airbags are not designed to deploy in all side impact situations.

\*A SIPS airbag warning decal is also located at the end of the instrument panel on the driver's side of the car.

### **⚠ WARNING!**

The SIPS airbag system is a supplement to the Side Impact Protection System and the three-point seat belt system. It is not designed to deploy during collisions from the front or rear of the car or in rollover situations.

The use of seat covers on the front seats may impede SIPS airbag deployment.

No objects, accessory equipment or stickers may be placed on, attached to or installed near, the SIPS airbag system or in the area affected by SIPS airbag deployment (see illustration above). Never try to open or repair any components of the SIPS airbag system. This should be done only by an authorized Volvo service technician.

In order for the SIPS airbag to provide its best protection, both front seat occupants should sit in an upright position with the seat belt properly fastened.

Failure to follow these instructions can result in injury to the occupants of the vehicle in the event of an accident.

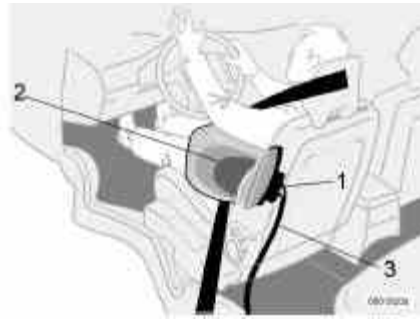

### **The SIPS airbag system**

This system consists of a gas generator (1), the side airbags (2), and electronic sensors/cables (3).

---



[Contents](#) | [Top of Page](#)



# 2003 VOLVO S60

## Instruments and controls

### pg. 21 Instruments and controls

Instrument panel	<a href="#">22</a>
Indicator and warning symbols	<a href="#">23</a>
Switches in the center console	<a href="#">27</a>
Steering wheel adjustment	<a href="#">29</a>
Lighting panel	<a href="#">30</a>
Manually unlocking the fuel filler door	<a href="#">31</a>
Turn signals	<a href="#">32</a>
Windshield wipers/washer	<a href="#">33</a>
Hazard warning flashers, rear window/sideview mirror defroster, heated front seats	<a href="#">34</a>
Trip computer (option)	<a href="#">35</a>
Cruise control	<a href="#">36</a>
Parking brake, electric socket/cigarette lighter	<a href="#">37</a>
Electrically operated windows	<a href="#">38</a>
Rearview mirror/sideview mirrors	<a href="#">40</a>
Electrically operated sun roof (option)	<a href="#">41</a>

### pg. 22 Instruments and controls

## Instrument panel

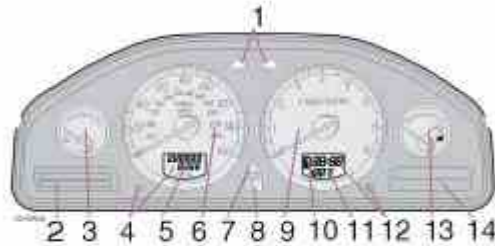

### 1. Turn signal indicators - right - left

### 2. Text window

The text window displays information and warning messages.

### 3. Temperature gauge

The pointer should be approximately midway on the gauge when driving. **Do not drive the car if the warning light is on.** The text window will provide you with additional information. If the engine temperature remains high, check

coolant level - see [page 121](#).

#### 4. Trip odometer

The trip odometers are used for measuring shorter distances. The right-hand digit gives tenth of a mile/kilometer. Press the button for more than 2 seconds to reset. Change between trip odometers 1 and 2 using one short press on the button.

#### 5. Odometer

#### 6. Speedometer

#### 7. Warning symbol

#### 8. High beam indicator

#### 9. Tachometer

Indicates engine speed in thousands of revolutions per minute (rpm). Do not drive for long with the needle in the red section. The engine has an built-in function preventing excessively high engine speeds. When this function operates, you may discern some pulsation, which in that case is quite normal.

#### 10. Gear and driving mode indicator

The currently selected driving mode is displayed here. If you use the optional Geartronic function on the automatic transmission, the currently selected gear will be displayed.

#### 11. Ambient temperature gauge

This display indicates the air temperature outside your car. A "snowflake" symbol in the text window is displayed when the temperature is in the range of 23 - 36° F (-5 - +2° C).

Please note that this symbol does not indicate a fault with your car.

At low speeds or when the car is not moving, the temperature readings may be slightly higher than the actual ambient temperature.

#### 12. Clock/set button

Turn the button to set the clock.

#### 13. Fuel gauge

The fuel tank holds approximately 18.5 US gals (70 liters) or 19 US gals (72 liters) on models equipped with All Wheel Drive.

When a warning light in the gauge comes on, there are approximately 1.8 US gal. (8 liters) of fuel remaining in the tank.

#### 14. Indicator and warning symbols

pg. 23 Instruments and controls

## Indicator and warning symbols

The indicator and warning symbols light up when you turn the ignition key to the driving position (position II) before starting. This shows that the symbols are functioning. When the engine starts, all symbols go out. If the engine is not started within 5 seconds, all symbols except **CHECK ENGINE** and  go out. Certain symbols may not have their functions illustrated, depending on the car's equipment. The symbol for the parking brake goes out when the parking brake is released.

Warning symbol  in center of dashboard

This symbol shines as a red or yellow light depending on the severity of the discovered fault.

**Red symbol** - Stop the car as soon as possible in a suitable location and read the message shown in the text window.

**Yellow symbol** - Follow the instructions shown in the text window.

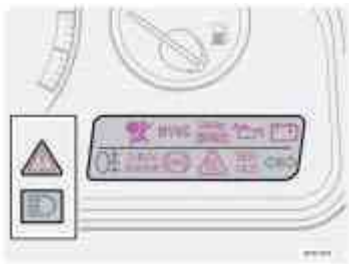

### **Anti-lock brake system ABS**

If the warning light comes on, there is a malfunction of the ABS system (the standard braking system will still function). The vehicle should be driven to a Volvo retailer for inspection. See [page 92](#) for additional information.

### **Stability Traction Control (STC)\* system or Dynamic Stability Traction Control (DSTC) system\*\***

This indicator light will flash when STC or DSTC is actively working to stabilize the car. See [page 93](#) for more detailed information.

### **BRAKE Brake failure warning light**

If the light comes on while driving or braking, stop immediately, open the hood and check the brake fluid level in the reservoir. See [page 122](#) for reservoir position and [page 125](#) for instructions.

 Canadian models are equipped with this warning light:

**If the BRAKE and ABS warning lights come on at the same time, this could indicate a fault in the brake system.**

- Stop the car in a suitable place and switch off the engine.
- Restart the engine.
- If both warning lights go off, no further action is required.
- If both lights are still on after the engine has been restarted, switch off the engine again and check the brake fluid level (see [page 122](#) for the location of the brake fluid reservoir).

\* Standard on all models except the T5 turbo.

\*\* Standard on the T5 turbo, option on all other models.

## **Indicator and warning symbols (Contd)**

### **WARNING!**

If the fluid level is below the MIN mark in the reservoir or if a "Brake failure - Service urgent" message is displayed in the text window: DO NOT DRIVE. Have the car towed to an authorized Volvo retailer and have the brake system inspected.

- If the brake fluid level is above the MIN mark, drive carefully to an authorized Volvo retailer and have the brake system inspected.

## pg. 25 Instruments and controls

### **Supplemental Restraint System SRS**

If the light comes on (or stays on after the vehicle has started), the SRS diagnostic system has detected a fault. Drive to an authorized Volvo retailer for an inspection of the system. See the SRS section for more information.

### **Generator warning light**

If the light comes on while the engine is running, have the charging system checked.

### **Seat belt reminder**

This symbol lights up to indicate that the driver has not fastened his/her seat belt.

### **PARK BRAKE Parking brake applied**

This light will be on when the parking brake (hand brake) is applied. The parking brake lever is situated between the front seats.

 Canadian models are equipped with this symbol.

### **Rear fog light**

This light indicates that the fog light is on.

### **Turn signal indicator - trailer (certain models)**

If you are towing a trailer, this light will flash simultaneously with the turn signals on the trailer. If the light does not flash when signaling, neither the trailer's turn signals nor the car's turn signals are functioning.

### **Oil pressure warning light**

**If the light comes on while driving, stop the car and then stop the engine immediately and check the engine oil level.** See [page 124](#). If the light stays on after restart, have the car towed to the nearest authorized Volvo retailer. After hard driving, the light may come on occasionally when the engine is idling. This is normal, provided it goes off when the engine speed is increased.

### **CHECK ENGINE Malfunction indicator light**

On-Board Diagnostic II (OBDII): As you drive, a computer called "OBDII" monitors your car's engine, transmission, electrical and emission systems. The CHECK ENGINE light will light up if the computer senses a condition that potentially may need correcting. When this happens, please have your car checked by a Volvo retailer as soon as possible.

A CHECK ENGINE light may have many causes. Sometimes, you may not notice a change in your car's behavior. Even so, an uncorrected condition could hurt fuel economy, emission cleanliness, and driveability. Extended driving without correcting the cause could even damage other components in your car.

 Canadian models are equipped with this warning light.

## pg. 26 Instruments and controls

## **Indicator and warning symbols (Contd)**

## Messages in the text window

When a warning light in the instrument panel comes on, a message is also displayed in the text window. After you have read the message, you can erase it by pressing button A (see illustration).

**NOTE:** Certain messages cannot be erased until the condition has been corrected.

If a warning message is displayed when e.g. you are using the trip computer this message must be erased before you can access the function of your choice. Press button A to erase the warning message.

You can scroll through the stored messages by pressing button A (see illustration). The text window can be cleared (the message will be returned to memory) by pressing button A again.



Message	Meaning:
STOP SAFELY:	Stop and switch off the engine - to help prevent serious risk of damage.
STOP ENGINE:	Stop and switch off the engine - to help prevent serious risk of damage.
SERVICE URGENT:	Take your car to an authorized Volvo retailer for inspection as soon as possible.
SEE MANUAL:	Refer to your owner's manual. For additional information, please contact your Volvo retailer.
SERVICE REQUIRED:	Take your car to an authorized Volvo retailer for inspection at your convenience (but preferably before the next scheduled maintenance service).
FIX NEXT SERVICE:	Have the system affected inspected at the next scheduled maintenance service.
TIME FOR REGULAR SERVICE:	This light will come on at 7,500 mile (12,000 km) intervals, after 750 hours of driving or after 12 months, whichever occurs first, to remind the driver that the service interval has been exceeded. The light will stay on for 2 minutes after start until reset by the servicing retailer.

pg. 27 Instruments and controls

## Switches in the center console

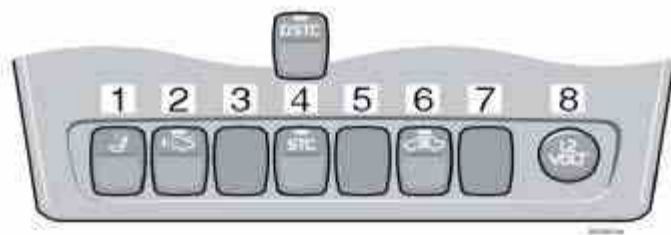

*The positions of these buttons may vary, depending on the specifications of your car*

### 1. Folding head restraints

This button is used to fold down the outboard rear head restraints. The ignition key must be in position I or II or the engine must be running.

**NOTE:** If the head restraints have been folded down, they must be returned to their original position manually. The head restraints should be in the upright position before the rear seat backrests are folded down.

**⚠ WARNING!**

For safety reasons, no one should be allowed to sit in the outboard rear seat positions if the head restraints are folded down. If these positions are occupied, the head restraints should be in the upright (fixed) position.

## 2. Valet lock (trunk lock)

Pressing this switch locks the trunk, even if the doors are unlocked. The trunk will remain locked even if the doors are locked/unlocked using the **master** key or the remote control.

To use this function:

- Turn the master key to position II.
- Press the "Valet lock" button. An LED in the button will light up and "VALET LOCK ON" will be displayed on the text window to indicate that this function is activated.
- The function can be turned off (deactivated) by turning the ignition key to position II and pressing the "Valet lock" button again (the LED in the button will go out and "VALET LOCK OFF" will be displayed in the text window).

## 3. Not in use

## 4. Stability Traction Control (STC)/Dynamic Stability Traction Control (DSTC) (option)

Press this switch for at least half a second to turn the Spin Control (SC) function of the STC/ DSTC system on or off. An LED in the switch will light up to indicate that the system is on. See [page 93](#) for more information on STC/ DSTC. The SC function should be switched off if you, for any reason, temporarily have to drive with tires of different dimensions (e.g., spare tire).

**NOTE:**To help reduce the risk that the SC function is turned off inadvertently, the switch must be held in for at least half a second to disable this function. "STC/DSTC SPIN CONTROL OFF" will be displayed in the text window.

pg. 28 Instruments and controls

## Switches in the center console (Contd)

This function will be automatically reactivated when the engine is restarted.

**⚠ WARNING!**

Please be aware that the car's handling characteristics may be affected if Spin Control function is switched off.

## 5. Not in Use

## 6. Temporarily disconnecting the alarm sensors (option)

See [page 76](#) for more details.

## 7. Not in use

## 8. 12 volt socket

This 12 volt socket can be used to plug in certain accessories such as cellular telephones, etc. The ignition key must be in position 1 (or higher) for the auxiliary socket to function.

**NOTE:** The auxiliary sockets can also be used for cigarette lighters, which are available at your Volvo retailer.

pg. 29 Instruments and controls

## Steering wheel adjustment

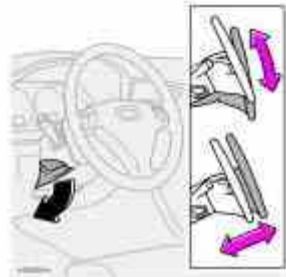

Both the height and the reach of the steering wheel can be adjusted to a comfortable position for the driver. Pull down the lever on the left of the steering column. Adjust the steering wheel to a suitable position and press the lever back into place to lock the steering wheel in the new position. Check that the steering wheel is locked in the new position.

### **⚠ WARNING!**

Never adjust the steering wheel while driving.

pg. 30 Instruments and controls

## Lighting panel

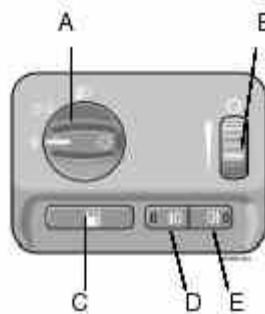

### **A - Headlights and parking lights**

0 All lighting off.

### **Models with daytime running lights:**

Low beam headlights will automatically come on if the ignition key is in position II. Front and rear parking lights and license plate lights will also be on. Volvo recommends the use of daytime running lights. If, however, you would prefer to have these lights turned off (USA only), please consult your Volvo retailer. Please note that the use of daytime running lights is mandatory in Canada.

**⏻ Parking lights on. The parking lights should be switched off when you leave the car to help avoid battery drain.**



Headlights, parking lights, license plate lights and instrument panel illumination are on if the ignition key is in position II.

If the headlight switch is in this position, all lights will go out when the ignition is switched off.

The headlight switch must be in this position before the high beams will function.

Switch from high to low beams and vice versa by pulling the turn signal switch lever on the left side of steering column toward you.

### **B - Instrument lighting**

Move the thumb wheel up to increase brightness or down to decrease brightness. There is also an instrument panel illumination sensor (see illustration on [page 46](#)) which automatically adjusts the level of illumination.

The symbols have maximum illumination in daylight (only the background lighting can be adjusted). At night, both the symbol light and background lighting can be adjusted.

### **C - Unlocking the fuel filler door**

Press this button when the car is at a standstill to unlock the fuel filler door. Please note that the fuel filler door will remain unlocked until the car begins to move forward. An audible click will be heard when the fuel filler door relocks.

See also [page 80](#).

**NOTE:** If the fuel filler door does not unlock after the button has been pressed, please see [page 31](#) for information on manually unlocking this door.

### **D - Front fog lights \***

The front fog lights will function only in combination with the low beam headlights.

An LED in the switch indicates when the front fog lights are on.

### **E - Rear fog light\***

The rear fog light is considerably brighter than the normal tail lights and should be used only when conditions such as fog, rain, snow, smoke or dust reduce visibility for other vehicles to less than 500 ft (150 meters).

An LED in the switch indicates when the rear fog light is on.

The rear fog light will only function in combination with the high/low beam headlights. By design, there is one rear fog light only, located in the driver's side tail light cluster.

\* Standard on T5/accessory on the other models.

These lights will be automatically switched off the next time the car is started.





## Manually unlocking the fuel filler door

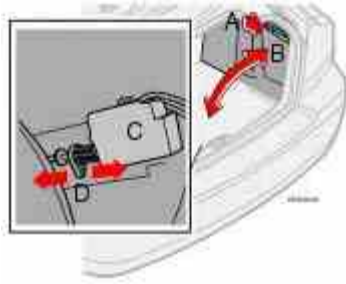

### Manually unlocking the fuel filler door

**NOTE:** Cotton gloves are available in the tool kit located in the spare wheel well.

The electric motor that controls the fuel filler door locking mechanism is located on the inside of the rear fender on the passenger side of the car, just behind the fuel filler door. To unlock this door manually:

1. Turn the knob (A) 1/4 turn counterclockwise to release the cover panel (B).
2. Fold down the cover panel to access the electric motor (C).
3. Press the catch (D) rearward to unlock the fuel filler door, or forward to lock the door.

## Turn Signals

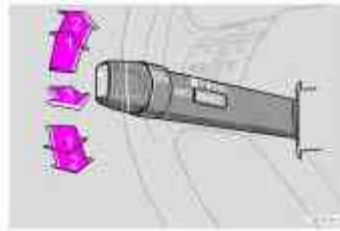

### 1. Lane change position

In maneuvers such as lane changing, the driver can flash the turn signals by moving the turn signal lever to the first stop and holding it there. The lever will return to the neutral position when released.

### 2. Signal lever engaged for normal turns

### 3. High/low beam switch (headlights on).

Move the lever towards the steering wheel and release it.

### Headlight flasher (headlights off).

Move the lever towards the steering wheel. The headlight high beam will be on until the lever is released.

### NOTE:

If the turn signal indicator flashes faster than normal, check for a burned-out turn signal bulb.

### 3. Exterior courtesy lights

#### Home Safe System

When you leave your car at night, you can make use of the courtesy lighting function:

- Remove the key from the ignition switch.
- Pull the direction indicator lever towards the steering wheel (as when using the headlight flasher function).
- Exit the car and lock the doors.

The headlights, parking lights, license plate lights and the lights in the sideview mirrors will now come on and remain on for 30, 60 or 90 seconds (the time interval is at your discretion and can be changed by an authorized Volvo retailer).

#### Approach lighting

When approaching the car at night, press the yellow button in the central locking remote control (see illustration on [page 69](#)). This lights up the interior courtesy lights, parking lights, license plate lights and the lights in the sideview mirrors.

pg. 33 Instruments and controls

## Windshield wipers/washer

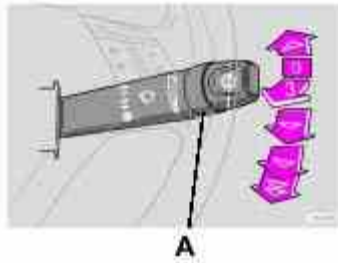

### Windshield wipers

#### 0 Windshield wipers off

If the lever is in the 0 position and you move it upwards, the wipers will sweep one stroke at a time for as long as you hold the lever up.

**Intermittent wiper function** With the lever in this position, you can set the wiper interval by twisting the control ring (A) upward to increase wiper speed or downward to decrease the speed.

#### Rain sensor (option)

The rain sensor replaces the intermittent wiper function and automatically regulates wiper speed according to the amount of water on the windshield. The **sensitivity** of the sensor can be adjusted by twisting control A upward or downward.

#### Activating the rain sensor function:

1. Switch on the ignition.
2. Move the windshield wiper lever to the intermittent position.

The rain sensor is deactivated when the ignition is switched completely off.

#### To reactivate the rain sensor function:

1. Switch on the ignition.
2. Move the windshield wiper lever to position 0 and then back to the intermittent position.

---

**CAUTION:**

When washing the car in an automatic car wash, etc move the windshield wiper lever to position 0 or switch off the ignition completely to deactivate the rain sensor. If the sensor function is left on, the wipers will start inadvertently in the car wash and could be damaged.

 Wipers operate at "normal" speed

 Wipers operate at "high" speed

### 3 - Windshield washer/headlight washer (certain models)

The wipers will make 2-3 sweeps across the windshield and headlights (certain models) after the lever is released.

pg. 34 Instruments and controls

## Hazard warning flashers, rear window/sideview mirror defroster, heated front seats



### Hazard warning flashers

The four-way flasher should be used to indicate that the vehicle has become a traffic hazard. To activate the flashers, press the triangular button in the center dash. Press the button again to turn off the flashers.

**NOTE:** Regulations regarding the use of the hazard warning flasher may vary, depending on where you live.



### Sideview mirror and rear window defroster

Press the switch to start heating the rear window and sideview mirrors to remove ice or condensation. An LED in the switch will light up.

A timer automatically switches off the heating to the sideview mirrors after approximately 6 minutes and to the rear window after approximately 12 minutes. The LED will go out correspondingly.



### Heated front seats (option)

- The front seat heating can be switched on and off as required.
- Press the switch once for maximum seat heating. Both LEDs in the switch will be lit.
- Press the switch a second time for comfort heating. One LED in the switch will be lit.
- Press the switch a third time to turn the heating off completely. The seat heating for the passenger seat should be switched off when the seat is not occupied.

pg. 35 Instruments and controls

## Trip computer (option)

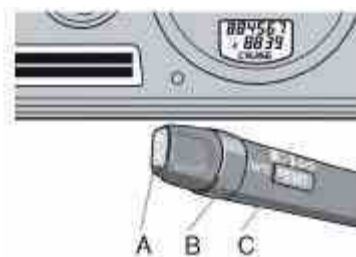

The trip computer stores information gathered from several systems in your car and has four menus that can be displayed in the text window.

- Driving distance on current fuel reserve
- Average fuel consumption
- Current fuel consumption
- Average speed
- Current speed in mph (Canadian models only)

**NOTE:** Warning messages from the car's monitoring systems will override the trip computer function. If a warning message is displayed in the text window while you are using the trip computer, you must acknowledge the message by pressing button A. Press button A again to return to the trip computer function.

### Trip computer controls

The four\* trip computer functions can be accessed by twisting control B one step at a time in either direction. Twisting a fifth\*\* time returns you to the original function.

The trip computer can be reset (current data will be erased from system memory) by pressing RESET (button C).

#### 1. Driving distance on current fuel reserve

This function shows the approximate distance that can be driven on the fuel remaining in the tank. This calculation is based on average fuel consumption during the last 12 miles (20 km) of driving and the amount of fuel remaining in the tank when the reading was taken.

When the driving distance on current fuel reserve is less than 12 miles (20 km), "----" will be displayed in the text window.

#### 2. Average fuel consumption

This value indicates fuel consumption since the last time the trip computer was reset (by pressing RESET, button C). When the engine is switched off, information on fuel consumption is stored and remains in system memory until the RESET (button C) is pressed again.

#### 3. Current fuel consumption

This value indicates the current fuel consumption, based on readings taken once per second. When the car is not moving, "----" will be displayed.

#### 4. Average speed

This value indicates average speed since the last time the trip computer was reset (by pressing RESET, button C). When the engine is switched off, information on average speed is stored and remains in system memory until the RESET (button C) is pressed again.

#### 5. Current speed in miles per hour (Canadian models only)

This function provides the driver with an instantaneous conversion of the car's current speed from km/h to mph.

\*Five functions on Canadian models

\*\*A sixth time on Canadian models

pg. 36 Instruments and controls

## Cruise control



### Cruise control

The cruise control panel is located on the left side of the steering wheel hub.

### Engaging cruise control/setting speed

- Press the CRUISE button
- Press + or - to set the current speed
- Increase or decrease speed as desired

**NOTE:** Cruise control will not function at speeds below 22 mph (35 km/h).

### Braking

Cruise control is automatically disengaged when the brake pedal is depressed. The currently set speed is stored in memory. Quickly pressing resume  will return the car to the previously set speed.

### Acceleration

- Momentary acceleration, such as when passing another car, does not affect cruise control operation. The car will automatically return to the previously set speed when you release the accelerator pedal.
- When the cruise control is already engaged, the car's speed can be increased or decreased by holding down + or - until the car reaches the desired speed. One short press on either symbol corresponds to a speed change of approximately 1 mph (1.6 km/h).



### Disengaging cruise control

Cruise control can also be disengaged by:

- Pressing the CRUISE button.
- Putting the gear selector in (N)eutral.

**NOTE:** Cruise control is automatically disengaged if the engine is switched off, if the gear selector is placed in (N)eutral, if the car's speed drops to under 70% of the currently set speed or if the wheels start to spin.

### Temporarily disengaging cruise control

- Press 0 to temporarily disengage cruise control. Press "resume"  to return to the previously set speed.
- Press the brake pedal. Press "resume"  to return to the previously set speed.

### **WARNING!**

Cruise control should not be used in heavy traffic or when driving on wet or slippery roads. Cruise control may not maintain set speed on steep downgrades.

pg. 37 Instruments and controls

## Parking brake, electric socket/cigarette lighter



### Parking brake (hand brake)

The lever is situated between the front seats. The brake is applied to the rear wheels. The indicator light in the instrument panel will light up to indicate when the parking brake is applied. Apply the parking brake by pulling up firmly on the lever. Release the parking brake by depressing the button at the end of the lever and lowering the lever completely.



*Auxiliary 12 volt socket*

### **WARNING!**

Always use the parking brake (hand brake) when parking. On hills, also turn the front wheels toward the curb. The indicator light in the instrument panel will light up even if the parking brake is applied only slightly. Be sure to pull the lever up sufficiently

### Auxiliary sockets

These 12 volt sockets can be used to plug in certain accessories such as cellular telephones, etc. The key must be in position I (or higher) for the auxiliary socket to function.

The auxiliary sockets can also be used for cigarette lighters, which are available at your Volvo retailer.

**NOTE:** The cover should be kept on when the auxiliary socket is not in use.

### Ashtrays

Volvo cars in North America do not have an ashtray in the front seat as standard equipment. If you want to have an ashtray in the front seat, please contact your Volvo retailer.

pg. 38 Instruments and controls

## Electrically operated windows

### Electrically operated windows

The electrically operated windows are controlled by buttons in the arm rests. The ignition switch must be ON \* (ignition key in position I, II or the engine running) for the electrically operated windows to function.

To lower: Press down the front edge of the button to the first detent ("stop").

To raise: Lightly pull up the front edge of the button to the first detent ("stop").

\* The electrically operated windows will also function after the ignition has been switched off as long as neither of the front doors has been opened.

### Auto up/down function (front doors only):

Either front door window can be opened or closed automatically.

**Auto down:** Press the front part of the button as far down as possible and release it immediately. To stop the window at any time, pull the button up.

**Auto up:** Pull the front part of the button up as far as possible and release it immediately. To stop the window at any time, press the button down.

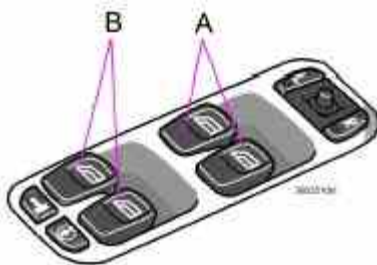

*A - front windows,, B - rear windows*

**NOTE:** The electrically operated windows in the front seat have an overload protecting circuit breaker which reverses movement of the electrically operated windows to their starting points if they are obstructed in any way. Thereafter the windows will operate normally again.

### WARNING!

Always remove the ignition key when the vehicle is unattended.

Make sure that children's hands are clear before raising the windows.  
Never leave children unattended in the car.

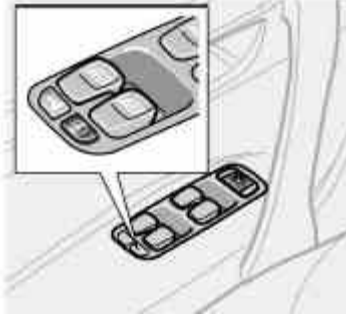

*Cutout switch for rear windows*

### **Cutout switch for rear windows**

The electrically operated rear door windows can be disabled by a switch located on the driver's door (see illustration).

**If the LED in the switch is OFF:** The rear door windows can be raised or lowered with the buttons on the rear door armrests or with the buttons on the driver's door armrest.

**If the LED in the switch is ON:** The rear door windows can only be raised or lowered with the buttons on the driver's door armrest.

pg. 39 Instruments and controls



### **Electrically operated window in the front passenger's seat**

The control for the electrically operated window in the front passenger's seat operates that window only.



### **Electrically operated windows in the rear doors.**

The rear door windows can be operated with the control on each door and the switch on the driver's door. If the LED in the switch for blocking electrically operated windows in the rear doors (located in the driver's door control panel) is on, the rear door windows can only be operated from the driver's door.

pg. 40 Instruments and controls



# Rearview mirror/sideview mirrors



## Rearview mirror

**A** Normal position

**B** Night position, reduces glare from following headlights

## Autodim function (option)

The autodim function reacts to headlights from following traffic and automatically reduces glare.

**NOTE:** This function is automatically switched off when the gear selector is placed in the Reverse position.

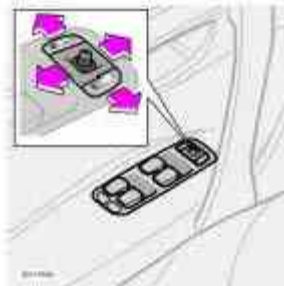

## Electrically operated sideview mirrors

The mirror control switches are located on the driver's door armrest.

**Driver's side:** Press the L switch (an LED in the switch will light up) to activate the adjustment control and then use this control to adjust the driver's door mirror.

**Passenger's door:** Press the R switch (an LED in the switch will light up) and then use the adjustment control to adjust the passenger's door mirror.

After you have adjusted the mirror(s), press the L or R switch again (the LED will go out) to deactivate the adjustment control.

## WARNING!

The mirrors should always be adjusted prior to driving. Objects seen in the passenger's side wide-angle sideview mirror are closer than they appear to be.

## Remote central locking and sideview mirror memory-option

If you lock the car and later unlock it with the **same** remote control and open the driver's door, the sideview mirrors (and the driver's seat) will automatically move to the position they were in when you left the car. This feature will work in the same way with all of the remote control transmitters (up to 3) that you use with your car. This feature will

not function if you lock your car with the key.

## Electrically operated sun roof (option)



### Electrically operated sun roof

To operate the sun roof, the ignition key must first be turned to the intermediate or drive position (position I, II or the engine running).

- To slide open the sun roof: Pull the switch back to the first detent ("stop") and hold it until the sun roof has opened to the position you prefer. The sun roof will initially open to the "comfort" <sup>1</sup> position. Pull and hold the switch again to open the sun roof completely.

1. A position where the sun roof is not quite fully open which helps alleviate "rumbling" wind noise.



- AUTO open: Pull the switch as far back as possible and release it to automatically slide open the sun roof to the "comfort" position. Pull the switch again to open the sun roof completely.
- To close the sun roof: Push the switch forward to the first detent ("stop") and hold it until the sun roof has closed completely.
- AUTO close: Push the switch forward as far as possible and release it to automatically close the sun roof.

**NOTE:** If the sun roof is impeded during AUTO close, it will reverse direction, reopen and stop.

- Ventilation position (opening the rear edge of the sun roof): With the sun roof closed, push up the rear section of the switch.

To close, pull the front section of the switch straight down until the sun roof has closed completely.

### **WARNING!**

- Never open/close the sun roof if it is obstructed in any way when in operation.
- Never allow a child to operate the sun roof.
- Never extend any object or body part through the open sun roof, even if the vehicle's ignition is completely switched off.
- Never leave a child alone in a vehicle.

---

**CAUTION:**

- Remove ice and snow before opening the sun roof.
- Do not operate the sun roof if it is frozen closed.
- Never place heavy objects on the sun roof.

pg. 42 Instruments and controls

## Electrically operated sun roof (option) (contd)

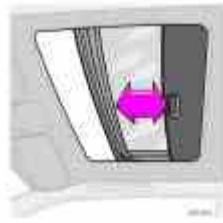
**Sun visor:**

The optional sun roof also features a sliding sun visor. The visor slides open automatically when the sun roof is opened. The visor must be closed manually.

**⚠ WARNING!**

The sun roof must never be obstructed in any way when in operation.



[Contents](#) | [Top of Page](#)

# 2003 VOLVO S60

## Climate control

pg. 43 Climate control

Climate control systems - general information	<a href="#">44</a>
Air distribution	<a href="#">45</a>
Electronic climate control, ECC (2.4T and T5)	<a href="#">46</a>
Manual climate control with air conditioning, (A/C)	<a href="#">50</a>

pg. 44 Climate control

## Climate control systems - general information

### Condensation on the inside of the windows

Keeping the insides of the windows clean will help reduce the amount of condensation that forms on the windows. Use a commercial window cleaning agent to clean the windows.

### Ice and snow

Always keep the air intake grille at the base of the windshield free of snow.

### Cabin air filter

Replace the cabin air filter with a new one at the recommended intervals. The filter should be replaced more often when driving under dirty and dusty conditions. The filter cannot be cleaned and therefore should always be replaced with a new one.

### Sensors

The sunlight sensor on the dashboard and passenger compartment temperature sensor in the ECC control panel should not be covered in any way as this could cause incorrect information to be sent to the ECC system.

### Parking the car in warm weather

If your car has been parked in the sun in warm weather, opening the windows and sun roof (option) for several minutes before driving will help release the warm air from the passenger compartment. When the engine is running, close the windows and sun roof and use the recirculation function for several minutes to enable the air conditioning to cool the compartment as quickly as possible.

### Windows and optional sun roof

The ECC system (2.4T and T5 models only) will function best if the windows and optional sun roof are closed. If you drive with the sun roof open, we recommend that you manually adjust the temperature and blower control (the LED in the AUTO switch should be off).

### Acceleration

The air conditioning is momentarily disengaged during full-throttle acceleration.

### Climate control maintenance

All maintenance on the climate control systems should be carried out by an authorized Volvo service technician only.

### Refrigerant

Volvo cares about the environment. The air conditioning system in your car contains a CFC-free refrigerant - R134a. This substance will not deplete the ozone layer. The system contains 2.2 lbs (1000 g) R134a and uses PAG oil.

### Passenger compartment blower

Approximately 50 minutes after the ignition is turned off, the blower may come on automatically, and run for seven minutes, to remove condensation in the A/C evaporator.

pg. 45 Climate control

## Air distribution

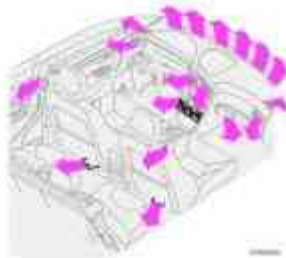

### Air distribution

The incoming air is distributed through 14 ventilation points in the passenger compartment.

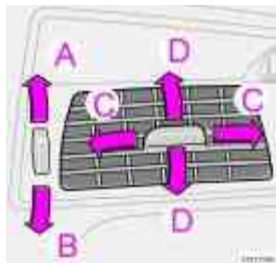

### Air vents in the dash

- A Open
- B Closed
- C Horizontal air flow
- D Vertical air flow

- Direct the outer air vents toward the side windows to defrost.
- In cold weather, close the air vents in the center of the dash to direct as much air as possible toward the windows.

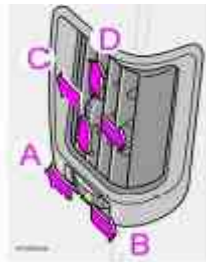

### Air vents in the door pillars (certain models)

- A Open

- B Closed
- C Horizontal air flow
- D Vertical air flow

- Direct the outer air vents toward the side windows to defrost.
- In cold weather, close the air vents in the center of the dash to direct as much air as possible toward the windows.

pg. 46 Climate control

## Electronic climate control, ECC (2.4T and T5)

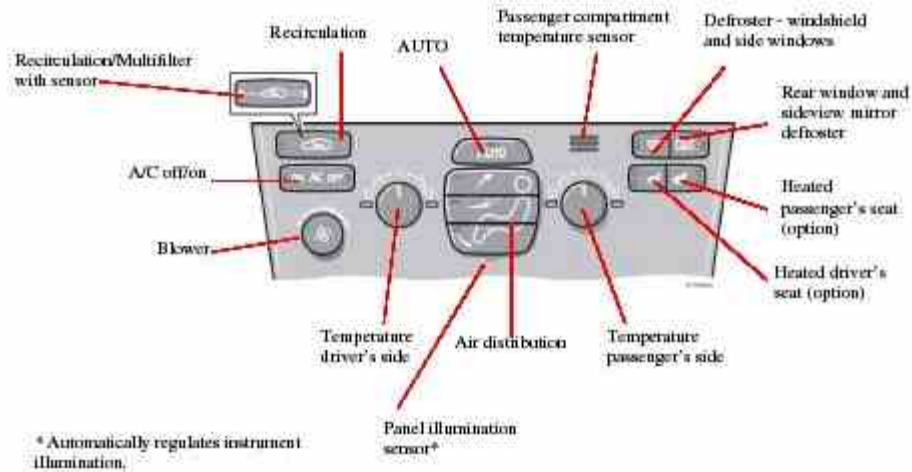

pg. 47 Climate control

## Electronic climate control, ECC (2.4T and T5) (contd)



### AUTO

This function automatically regulates the Electronic Climate Control system so that the selected temperatures are maintained. The blower, heating, air distribution (air flow) and air conditioning are controlled. If you prefer to manually set any of these functions, the remaining functions will still be controlled automatically. Pressing the AUTO button overrides any settings that were previously made manually.



### Rear window and sideview mirror defrosters

This function defrosts/ de-ices the rear window and sideview mirrors. The LED in the switch will light up to indicate that the heating function is engaged. See [page 34](#) for additional information on this function.

**Never use ice scrapers made of metal as they can easily scratch the mirror surface.**



### Temperature

These controls are used to individually set the temperature for both sides of the passenger compartment.

Please note that the compartment will not be heated or cooled faster by setting the temperature higher or lower than necessary.

Set the control to the temperature you prefer.



### Defroster

This function defrosts/ de-ices the windshield and front side windows. The LED in the switch will light up to indicate that the defrost function is engaged. Blower speed increases automatically and the air in the passenger compartment is dehumidified. Recirculation will not function while defrost is engaged.



### Blower control

Turn the control clockwise to increase or counterclockwise to decrease the blower speed. Pressing the AUTO switch will automatically regulate blower speed and override manual adjustment.

**NOTE:** Turning the blower control counter-clockwise until an orange LED comes on will turn both the blower and the air conditioning off.

pg. 48 Climate control

## Electronic climate control, ECC (2.4T and T5) (contd)



Air flow to windows  
Air through panel vents  
Air through floor vents

### Air distribution

Press AUTO to automatically regulate air flow or press any combination of the controls shown in the illustration to manually adjust air flow. An LED in the switch will light up if an air flow control has been pressed.



### Heated front seats (option)

- Press the switch once for maximum seat heating. Both LEDs in the switch will be lit.
- Press the switch a second time for comfort heating. One LED in the switch will be lit.
- Press the switch a third time to turn the heating off completely. The LED will go off. The seat heating for the passenger seat should be switched off when the seat is not occupied.



### A/C - ON/OFF

Press the switch to turn the air conditioning on or off. The "ON" or "OFF" LED will light up to indicate if the system is switched on or off. Other functions will still be regulated automatically (if the AUTO switch is on).

- The air conditioning functions only at temperatures above 32° F (0° C).
- While the Defroster function is selected, the air conditioning is temporarily activated to dehumidify the air, even if

you have manually switched the air conditioning off. This will only function if the blower is not switched off.



### Recirculation

Press this switch to engage the recirculation function (air in the passenger compartment recirculates - no fresh air enters the compartment). The LED in the switch will light up to indicate that the function is engaged.

- Use this function if the outside air is contaminated with exhaust gases, smoke, etc or to heat/cool the car quickly.
- Recirculation should not be used for more than 15 minutes. *If your windows begin to fog or mist, make sure that the recirculation function is switched off.*
- Selecting **Defroster** automatically switches recirculation off.
- Timer mode activation: (cars with the Interior Air Quality system have no timer mode) Press and hold the recirculation button for at least 3 seconds to activate a recirculation timer mode. The amber LED in the recirculation button will flash 5 times to show that the timer mode is being activated. In timer mode, each time the recirculation button is pressed, the climate control system will recirculate the air in the passenger compartment for 5-12 minutes, depending on the outside air temperature, and then revert back to fresh air.
- Timer mode deactivation: Press and hold the recirculation button for 3 seconds. The amber LED in the recirculation button will illuminate steadily for 5 seconds to show a return to "normal" mode.

pg. 49 Climate control

## Electronic climate control, ECC (2.4T and T5) (contd)

- In normal mode, when the recirculation button is pressed, the climate control system will recirculate the air in the passenger compartment until the recirculation button is pressed again.
- Timer mode memory: If the car is turned off while timer mode is active, timer mode will still be active when the car is restarted.



### Interior air quality sensor (option on 2.4T and T5)

Some cars are equipped with a multifilter and air quality sensor. The filter separates gases and particles, thereby reducing the amounts of odors and contaminants entering the car. The air quality sensor detects increased levels of contaminants in the outside air. When the air quality sensor detects contaminated outside air, the air intake closes and the air inside the passenger compartment is recirculated, i.e. no outside air enters the car. The filter also cleans recirculated passenger compartment air.

When the ECC system is in the AUTO mode, the green LED will be on .

### Operation

Press  to operate the air quality sensor (normal setting).

Or:

Select one of the following three functions by pressing  1, 2 or 3 times.

1. The AUT LED lights. The air quality sensor is now activated.



2. No LED lights. Recirculation is not activated unless needed to cool the passenger compartment in a warm climate.
3. The MAN LED lights. Recirculation is now activated.

**Keep in mind the following:**

- Make it a rule to have the air quality sensor activated at all times.
- Recirculation is limited in cold climates to avoid fogging.
- If window fogging occurs, you should deactivate the air quality sensor.
- If fogging occurs, use the defroster functions for the windshield, side windows and rear window. See [page 47](#).
- The filter should be changed at the intervals recommended in the service schedule. However, if the car is used in a severely contaminated environment, it may be necessary to change the filter more frequently.

pg. 50 Climate control

**Manual climate control with air conditioning, (A/C)**

- You must turn the blower knob (from the 0 position) to activate the air conditioning.

- Use the air conditioning at low temperatures to dehumidify incoming air.

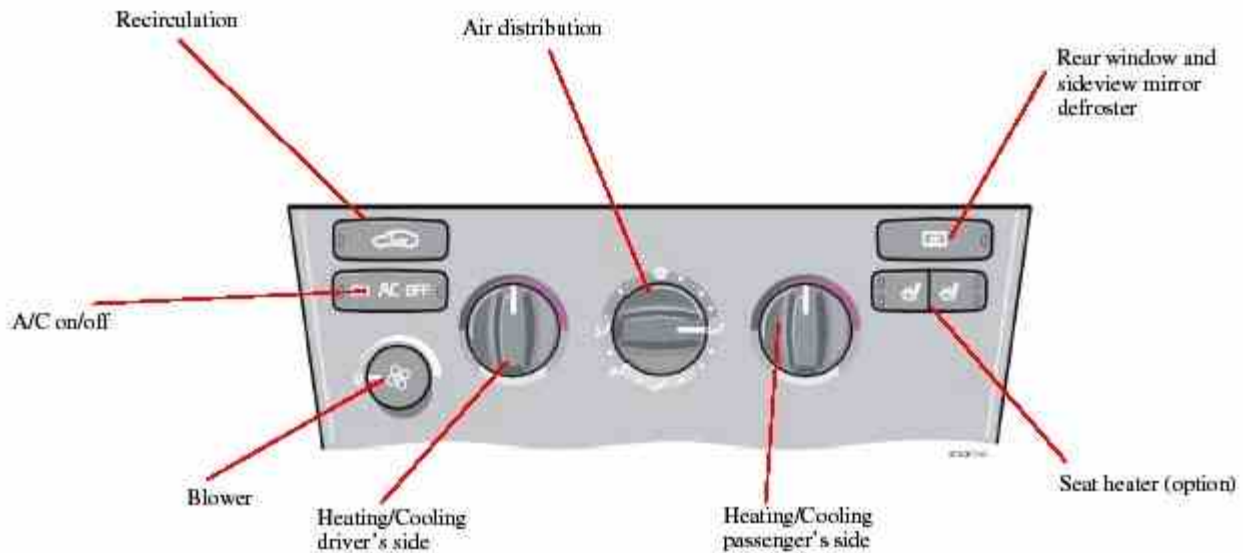

pg. 51 Climate control

**Manual climate control with air conditioning, (A/C) (contd)**



**A/C - ON/OFF**

The air conditioning function is engaged by pressing ON and disengaged by pressing OFF.

When you select Defroster , the air conditioning is automatically engaged if the fan is not set to position 0.



### Blower

Blower speed can be increased or decreased by turning the knob. If the knob is set to 0, the air conditioning function is automatically disengaged.



### Temperature

Turn the control to set the temperature for the driver's and passenger's sides of the car. For cooler air, the air conditioning function must be engaged.



### Rear window and sideview mirror defrosters

This function defrosts/de-ices the rear window and sideview mirrors. The LED in the switch will light up to indicate that the heating function is engaged. See [page 34](#) for additional information on this function.

**Never use ice scrapers made of metal as they can easily scratch the mirror surface.**



### Heated front seats (option)

- Press the switch once for maximum seat heating. Both LEDs in the switch will be lit.
- Press the switch a second time for comfort heating. One LED in the switch will be lit.
- Press the switch a third time to turn the heating off completely. The LED will go off.

The seat heating for the passenger seat should be switched off when the seat is not occupied.

## Manual climate control with air conditioning, (A/C) (contd)





### Recirculation

Recirculation can be used to shut out stale air, exhaust, etc. from the passenger compartment. The air in the passenger compartment is then recirculated, i.e. no air from outside the car is taken into the car when this function is activated. Recirculation (together with the air conditioning system) cools the passenger compartment more quickly in warm weather.

If you allow the air in the car to recirculate, there is a risk of icing and fogging, especially in winter. The timer function minimizes the risk of ice, misting and stale air.

Activate the timer function as follows:





- Press  for more than 3 seconds. The LED flashes for 5 seconds. The air recirculates in the car for 3-12 minutes depending on the outside temperature.
- The timer function is activated each time you press .
- To switch off the timer function: Press  again for more than 3 seconds. The LED lights for 5 seconds to confirm your selection.

Recirculation is always disconnected when you select  Defroster.



### Air distribution

Use the air distribution control positions (marked with dots) between the different symbols to fine-tune air distribution for maximum comfort.

Air distribution	Use
 Air through front and rear air vents.	When you want good cooling in warm weather.
 Air to windows. Air is not recirculated in this position. Air conditioning is always connected. There is a certain amount of airflow to the air vents.	When you want to remove ice and fog from the windshield. Set the blower to its highest setting.
 Air to both floor and windows. There is a certain amount of airflow to the air vents.	When you want comfortable conditions and good demisting in cold weather.
 Air to floor. There is a certain amount of airflow to the air vents and the defroster vents for the windshield and side windows.	When you want to warm your feet.
 Air to floor and air vents.	In sunny weather with cool outside temperature.



# 2003 VOLVO S60

## Interior

pg. 53 Interior

Front seats	<a href="#">54</a>
Interior lighting	<a href="#">58</a>
Floor mats	<a href="#">59</a>
Storage compartments	<a href="#">60</a>
Rear seat and trunk	<a href="#">63</a>
Spare wheel and tools	<a href="#">65</a>

pg. 54 Interior

## Front seats

### Manual height adjustment - front seat

The front edges of the driver and passenger seat cushions can be adjusted to seven different settings and the rear edges to nine different settings.

Lever (A) - adjusting the front edge of the seat.

Lever (B) - adjusting the rear edge of the seat.

### Manual front-rear adjustment

The seat can be moved forward or rearward by pulling up on the front-rear adjustment bar.

Check that the seat is securely locked into position after adjusting.

### WARNING!

Do not adjust the seat while driving. The seat should be adjusted so that the brake pedal can be depressed fully. In addition, position the seat as far rearward as comfort and control allow.



pg. 55 Interior

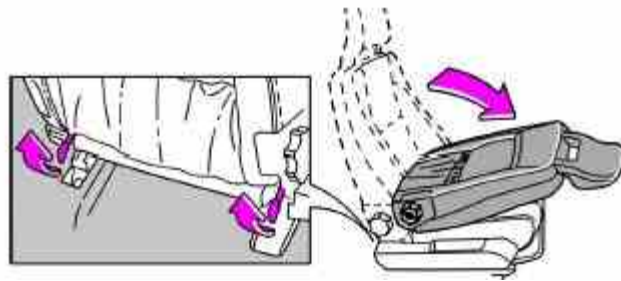

### Folding the backrests in the front seat

The front passenger seat backrest can be folded to a horizontal position to make room for a long load. Fold the backrest as follows:

- Move the seat as far back as possible.
- Adjust the backrest to the upright position.
- Lift the catches on the rear of the backrest.
- Without releasing the catches, push the backrest forward.
- Move the seat as far forward as possible.

### **⚠ WARNING!**

Cover sharp edges on the load to help prevent injury to occupants. Secure the load to help prevent shifting during sudden stops.

pg. 56 Interior

## Front seats (Contd)

### Power seat - T5 (option on 2.4/2.4T)

#### Operation

**Passenger seat:** The seat can only be adjusted if the ignition key is in position I, II or if the engine is running.

**Driver's seat:** The seat can be adjusted if the ignition key is in position I, II or if the engine is running. It can also be adjusted in the following circumstances:

1. Within 40 seconds of the ignition key being turned to position 0 or removed from the ignition switch.
2. After you have unlocked the driver's door with the key or remote control, the driver's seat can be adjusted during a 10 minute period **if the door remains open**. If the door is closed, the seat can be adjusted for 40 seconds. The ignition key can be in position 0 or not yet inserted in the ignition switch.

### Remote keyless entry system and driver's seat

The remote control transmitter also controls the electrically operated driver's seat in the following way:

- Adjust the seat to your preferences.
- When you leave your car, lock it using the remote control.

The next time you unlock the driver's door with the same remote control (the one you used to lock the doors with) and open the driver's door, the driver's seat will automatically move to the position in which you left it.

The seat will move to this position even if someone else has adjusted it since you last unlocked the car with the same remote control.

**NOTE!** This feature will work in the same way with all of the remote control transmitters (up to 3) that you use with your car.

This feature will not function if you lock your car with the key. This feature will not function if you lock your car with the key.

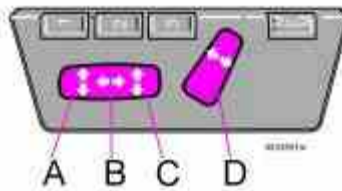

*Power seat control panel*

### Seat adjustment

If your Volvo is equipped with power seats, the following may be adjusted with the two switches at the side of the seat:

- A - Front edge of seat (raise/lower)
- B - Front-rear
- C - Rear edge of seat (raise/lower)
- D - Backrest tilt

**NOTE!** The power seats have an overload protector that activates if a seat is blocked by any object. If this occurs, switch off the ignition (key in position 0) and wait about 20 seconds before operating the seat again.

**Please refer to the following page for information on programming the memory function in the driver's seat.**

### Emergency stop

If the seat accidentally begins to move, press one of the buttons to stop the seat.

Because the driver's seat can be adjusted with the ignition off, children should never be left unattended in the car.

Movement of the seat can be STOPPED at any time by pressing any button on the power seat control panel.

Do not adjust the seat while driving. The seat should be adjusted so that the brake pedal can be depressed fully. In addition, position the seat as far rearward as comfort and control allow.

The seat rails on the floor must not be obstructed in any way when the seat is in motion.

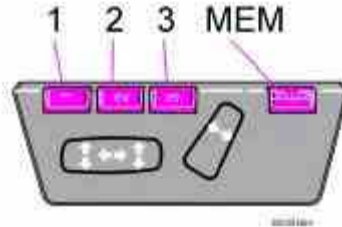

### Programming the memory

*Please note that only the driver's seat is equipped with the memory function.*

Three seat positions can be programmed. To program a seat position:

1. Adjust the seat to the desired position.
  2. Hold down the MEM button.
  3. While holding down the MEM button, press button 1 to program the current position of the seat.
- Buttons 2 and 3 can be programmed in the same way.

To move the seat to a programmed position, press and hold down button 1, 2 or 3 until the seat moves to the preset position and stops.

**As a safety precaution, the seat will stop automatically if the button is released before the seat has reached the programmed position.**

pg. 58 Interior

## Interior lighting



### Courtesy light

The courtesy light can be turned on or off by pressing the center button. The light also has a timer function which turns the light on for 30 seconds if:

- You unlock the car from the outside with the key or remote control.
- You switch off the ignition (turn the key to position 0).

The courtesy light stays on for 10 minutes if one of the doors is left open after the car is unlocked.

The courtesy light switches off if:

- The engine is started.
- The car is locked from the outside with the key or remote control.

The courtesy light can be switched off or on in all situations by briefly pressing the button.

When you switch the light on, it remains lit for 10 minutes.

You can disconnect the automatic function by pressing the courtesy light button for more than 3 seconds. Briefly pressing the courtesy light button again automatically reconnects the function.

The courtesy light timer periods can be changed. Contact your Volvo retailer.



*Rear reading lights*

### **Reading lights - front/rear**

The reading lights can be switched on or off by pressing the respective buttons. These lights switch off automatically after 10 minutes if the engine is not running. If the engine is running, the lights stay on indefinitely. The lights can be switched off at any time by pressing the button.

pg. 59 Interior



### **Vanity mirror**



The light comes on when you open the cover.

### **Floor mats**

Volvo offers floor mats specially manufactured for your car. They must be properly placed and secured in the mat clips.

 **WARNING!**

An extra mat on the driver's floor can cause the accelerator pedal to catch. Check that the movement of the accelerator pedal is not impeded. No more than one protective floor covering may be used at one time.



[Contents](#) | [Top of Page](#)

# 2003 VOLVO S60

## Locks and alarm

pg. 67 Locks and alarm

Keys and remote controls [68](#)

Locking and unlocking [71](#)

Child safety lock [74](#)

Alarm [75](#)

pg. 68 Locks and alarm

## Keys and remote controls

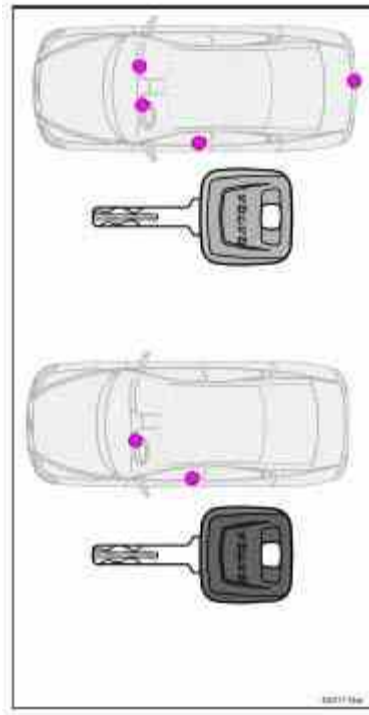

### Keys

Two keys are provided with your car; a master key and a service (valet) key. The master key, the remote control, and the central locking button may all be used to lock and unlock all of your car's locks.

The service key will operate only the driver's door and the ignition switch. It is intended to help deter unwanted entry into the glove compartment and trunk.

- Turn the key once to unlock the **driver's door only**.
- Turn the key again (within 10 seconds) to unlock all doors and the trunk.
- One turn with the key towards lock in the drivers door locks all doors, trunk.

- Use the switch on the driver's door armrest to lock/unlock the car from the inside.

### **⚠ WARNING!**

If the doors are locked while driving, this may hinder rapid access to the occupants of the car in the event of an accident. (Also see information on "Child safety locks")

**NOTE:** To help prevent accidentally locking the keys in the car, the central locking system is designed to unlock the doors immediately if the key is left in the ignition switch, the car is locked using the lock button on the door and the door is then closed. A sound from the lock will be audible at this time.

*Please note that this function will not unlock the doors if the engine is running.*

### **Immobilizer (start inhibitor)**

Each of the keys supplied with your car contains a coded transmitter. The code in the key is transmitted to an antenna in the ignition switch where it is compared to the code stored in the start inhibitor module. The car will start only with a properly coded key.

If you misplace a key, take the other keys to an authorized Volvo retailer for reprogramming as an antitheft measure.

**NOTE:** This device complies with part 15 of the FCC rules. Operation is subject to the following condition: (1) This device may not cause harmful interference, and (2) this device must accept any interference received, including interference that may cause undesired operation.

pg. 69 Locks and alarm



### **Remote controls**

Your car is equipped with a remote control transmitter. This transmitter uses a radio signal to allow "keyless" entry into the passenger compartment or the trunk. You will be supplied with two coded key ring transmitters, which will enable you to lock/unlock all doors and the trunk from a distance of 10-15 feet (3-5 meters).

On vehicles equipped with an alarm, the alarm will also be activated/deactivated by this system.

The car can also be locked/unlocked with the key.

As an extra security precaution in certain situations (valet parking, etc.), Volvo recommends that the transmitter not be included when the keys are given to anyone. The service key can be used instead. If one of the transmitters is misplaced, contact the nearest authorized Volvo retailer for assistance.



*Buttons in remote control:  
1 - Lock, 2 - Unlock, 3 - Open trunk,  
4 - "Panic" function\*, 5 - Approach lighting*

## Using the remote control

- Press the LOCK button once to lock all doors and trunk.
- Press the UNLOCK button once to unlock the driver's door and fuel filler door. Wait for at least 1 second and press this button again (within 10 seconds) to unlock all doors and the trunk.
- To pop open the trunk (without unlocking the doors), press the OPEN trunk button twice within 3 seconds.

## NOTE:

- Airbag deployment will automatically unlock the doors.
- The keys may also be used to lock and unlock the doors, and to activate and deactivate the alarm system.
- To avoid leaving your keys in the car, make a habit of always locking the car with the remote control.

## Automatic re-locking

If the doors are unlocked, the locks will automatically re-engage (re-lock) and the alarm will rearm after 2 minutes unless a door or the trunk has been opened. \* See [page 75](#) for more information on this function.

pg. 70 Locks and alarm

FCC ID:LQNP2T-APU

This device complies with part 15 of the FCC rules. Operation is subject to the following conditions: (1) This device may not cause harmful interference, and (2) this device must accept any interference received, including interference that may cause undesired operation.

Canadian 2306104388

Model 504 2927 by Donnelly Operation is subject to the following conditions: (1) this device may not cause interference, and (2) this device must accept any interference, including interference that may cause undesired operation of the device

Canadian 2306104388A

Model 509 977 by Connaught Electronics Operation is subject to the following conditions: (1) this device may not cause interference, and (2) this device must accept any interference, including interference that may cause undesired operation of the device

## WARNING!

Never use the transmitter to lock the doors from inside the car

Doing so would **ACTIVATE**:

- the break-in alarm, which would sound if one of the doors were opened
- the optional interior motion and inclination alarm sensors.

Doing so would **DEACTIVATE**:

- the sunroof and interior courtesy light controls.
- the central locking buttons on the front door armrests, although the interior door handles would still function to allow occupants to leave the car.

Disabled features would remain disabled until the remote were used again to unlock the car.

In addition, locking an occupied vehicle would hinder rapid access to the occupants in an accident or emergency.

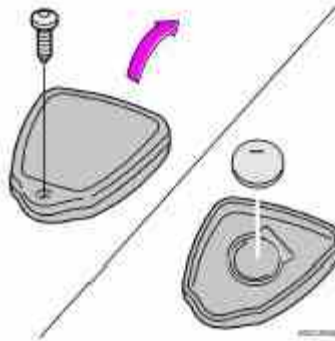

### **Replacing the battery in the remote control**

If the range of the transmitter is noticeably reduced, this indicates that the battery is weak and should be replaced.

#### **To replace the battery**

- Remove the screw on the transmitter cover with a small screwdriver.
  - Remove the cover carefully pressing it rearward/upward.
  - Replace the battery with a new 3-volt, CR 2032 battery. The battery should be inserted with the minus side upward.
- Avoid touching the contact surfaces of the battery with your fingers.
- Reinstall the cover and tighten the screw to help protect the transmitter.

pg. 71 Locks and alarm

## **Locking and unlocking**



## Locking and unlocking the car from the inside

The switch on the driver's door armrest can be used to lock or unlock all doors and the trunk, and to set the alarm.

pg. 72 Locks and alarm

## Locking and unlocking (contd)

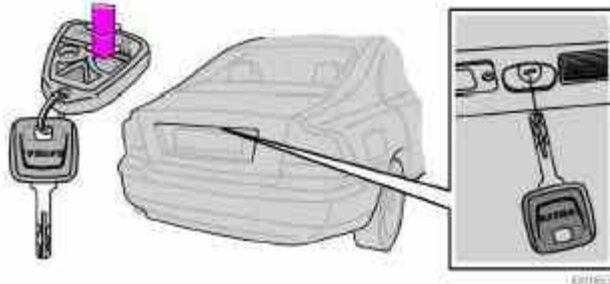

### Opening/locking the trunk lid with the remote control

Do as follows to unlock the trunk lid only:

- Press the "Open trunk" button on the remote control twice. If all doors are locked when you close the trunk lid, it locks automatically.

### Unlocking the trunk lid with the master key

The master key should only be used to unlock the trunk lid in emergencies (if the remote control is not working or the car is without power). Open the trunk lid as follows:

- Insert the master key into the upper or lower part of the plug covering the lock.
- Twist upward or downward to remove the plug.
- Unlock the trunk lid.

**NOTE:** If the trunk is opened with the master key, the alarm will sound. To turn off the alarm, unlock the driver's door with the master key.

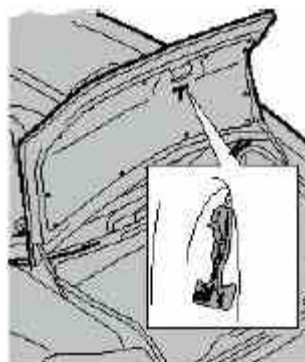

*Opening the trunk from the inside*

### Opening the trunk from the inside (U.S. models only)

The S60 is equipped with a florescent handle on the inside of the trunk lid, which can be used in an emergency situation to open the trunk from the inside. *Pull the handle down to release the trunk lid. After use, the handle must be pushed back into its original position before the trunk can be closed.*

This handle is not intended to be used to anchor the trunk lid when long loads are being transported.

**⚠ WARNING!**

Keep vehicle doors and trunk locked and keep keys out of a child's reach. Unsupervised children could lock themselves in an open trunk and risk injury. Children should be taught not to play in vehicles. On hot days, the temperature in the trunk or vehicle interior can rise very quickly. Exposure of people to these high temperatures for even a short period of time can cause heat-related injury or death. Small children are particularly at risk.

## Child safety lock

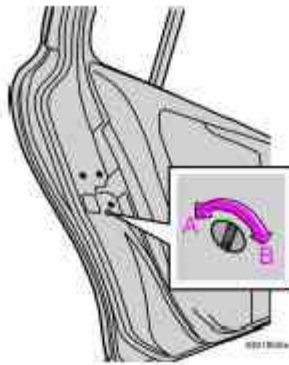

*Control for child safety lock - left rear door*

### Manual child safety locks - rear doors

The controls are located on the rear door jambs. Use a screwdriver to adjust these controls.

**A** The door cannot be opened from the inside. Normal operation from the outside.

**B** The door lock functions normally.

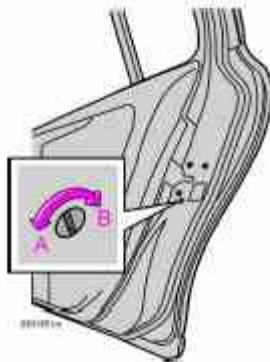

*Control for child safety lock - right rear door*

**⚠ WARNING!**

Remember, in the event of an accident, the rear seat passengers cannot open the doors from the inside with the

## Alarm

### Alarm

The alarm is automatically armed whenever you lock your car.

When armed, the alarm continuously monitors a number of points on the car. The following conditions will set off the alarm:

- The hood is forced open.
- The trunk is forced open.
- A door is forced open.
- The ignition switch is tampered with.
- If there is movement in the passenger compartment (if the car is equipped with the optional movement sensor).
- The car is lifted or towed (if the car is equipped with the optional inclination sensor).
- The battery is disconnected (while the alarm is armed).
- The siren is disconnected when the alarm is disarmed.

### Arming the alarm

Press the LOCK button on the remote control, lock the car using the key in the driver's door or press the central lock button on one of the front doors with the door open. One long flash of the turn signals will confirm that the alarm is armed.

### Disarming the alarm

Press the UNLOCK button on the remote control or unlock the doors with the key.

### Turning off (stopping) the alarm

If the alarm is sounding, it can be stopped by pressing the UNLOCK button on the remote control or by unlocking the driver's door with the key.

### Visual alarm signal

The visual alarm signal is given by flashing all turn signals and turning on the interior lighting for approximately 5 minutes.

### Audible alarm signal

An audible alarm signal is given by a battery powered siren. One alarm cycle lasts for 25 seconds.

### "Panic" button

In an emergency situation, this feature can be used to attract attention.

Activate the "panic" button by pressing the red button on the remote control (see illustration on [page 69](#)) for at least 3 seconds or by pressing this button twice within 3 seconds. The turn signals will flash, the interior lights will go on and the car's horn will sound.

The function can be turned off by pressing any of the buttons on the remote control or will stop automatically after 25 seconds. When a button is pressed, there is a 5 second delay before the panic alarm is deactivated.

**NOTE:** This button will NOT unlock the car.





### **Temporarily turning off the alarm sensor( s) - option**

This button will only be found in cars equipped with the optional inclination and/or movement sensors.

In certain situations it may be desirable to turn off the optional inclination and movement alarm sensors if, for example, you drive your car onto a ferry where the rocking of the boat could trigger the alarm or if a pet is left in the car with the doors locked.

### **To temporarily turn off the inclination and movement alarm sensors from the alarm system:**

From the time the ignition key is turned from the Drive position (position II) until you lock the car, you can press the button in the center console\*. The LED in the switch will light up and a message will be displayed in the text window to indicate that the sensors are disconnected.

The car can then be locked in the usual way to set the alarm.

**NOTE:** The optional sensors are automatically reconnected to the alarm system the next time the car is unlocked and then locked again.

**LED alarm status signals** The status of the alarm system is indicated by the red LED at the top of the dash:

- LED off - the alarm is not armed
- LED flashes once per second - the alarm is armed
- LED flashes rapidly before the ignition is switched on - the alarm has been triggered
- **Fault in the alarm system:** If a fault has been detected in the alarm system, a message will be displayed in the text window. Contact your Volvo retailer.

### **Automatic re-lock/re-arm system**

If the car is unlocked with the remote, the car will re-lock and the alarm will re-arm after 2 minutes unless a door or the trunk has been opened.

\* The position of this button may vary, depending on the specifications of your car.



# 2003 VOLVO S60

## Starting and driving

### pg. 77 Starting and driving

Refueling	<a href="#">78</a>
Starting the car	<a href="#">81</a>
General information	<a href="#">83</a>
Manual transmission	<a href="#">85</a>
Automatic transmission (option)	<a href="#">86</a>
Geartronic (option)	<a href="#">88</a>
All Wheel Drive (option)	<a href="#">90</a>
Brake system	<a href="#">91</a>
Stability system	<a href="#">93</a>
Towing	<a href="#">95</a>
Jump starting	<a href="#">97</a>
Towing a trailer	<a href="#">98</a>
Detachable trailer hitch - installing	<a href="#">100</a>
Detachable trailer hitch - removing	<a href="#">101</a>
Attaching load carriers	<a href="#">102</a>
Cold weather precautions	<a href="#">103</a>
Before a long distance trip	<a href="#">104</a>

### pg. 78 Starting and driving

## Refueling

### ENGINE OIL

Although some oil consumption occurs during normal engine operation, more oil is consumed when the engine is new as the internal parts generate higher friction while wearing-in to each other. From the time the engine is new until the first service is performed, the oil consumption could be higher than normal. For this reason, it is especially important to check the oil every time you refuel your car during this period. See [page 124](#).

### Fuel requirements

#### Octane rating

Volvo engines are designed for optimum performance on unleaded premium gasoline with an AKI octane rating of 91 or above. AKI (ANTI KNOCK INDEX) is an average of the Research Octane Number, RON, and the Motor Octane Number, MON. (RON + MON/2). The minimum octane requirement is AKI 87 (RON 91).

#### Deposit control gasoline (detergent additives)

Volvo recommends the use of detergent gasoline to control engine deposits. Detergent gasoline is effective in keeping injectors and intake valves clean. Consistent use of deposit control gasolines will help ensure good driveability and

fuel economy. If you are not sure whether the gasoline contains deposit control additives, check with the service station operator.

**NOTE:** Volvo does not recommend the use of external fuel injector cleaning systems. Unleaded fuel Each Volvo has a three-way catalytic converter and must use only unleaded gasoline. U.S. and Canadian regulations require that pumps delivering unleaded gasoline be labelled "UNLEADED". Only these pumps have nozzles which fit your car's filler inlet. It is unlawful to dispense leaded fuel into a vehicle labeled "unleaded gasoline only". Leaded gasoline damages the three-way catalytic converter and the heated oxygen sensor system. Repeated use of leaded gasoline will lessen the effectiveness of the emission control system and could result in loss of emission warranty coverage. State and local vehicle inspection programs will make detection of misfueling easier, possibly resulting in emission test failure for misfueled vehicles.

**NOTE:** Some U.S. and Canadian gasolines contain an octane enhancing additive called methyl-cyclopentadienyl manganese tricarbonyl (MMT). If such fuels are used, your Emission Control System performance may be affected, and the Check Engine Light (malfunction indicator lamp) located on your instrument panel may light. If this occurs, please return your vehicle to an authorized Volvo retailer for service.

### **Gasoline containing alcohol and ethers**

"Oxygenated fuels"

Some fuel suppliers sell gasoline containing "oxygenates" which are usually alcohols or ethers. In some areas, state or local laws require that the service pump be marked indicating use of alcohols or ethers. However, there are areas in which the pumps are unmarked. If you are not sure whether there is alcohol or ethers in the gasoline you buy, check with the service station operator. To meet seasonal air quality standards, some areas require the use of "oxygenated" fuel.

Volvo allows the use of the following "oxygenated" fuels; however, the octane ratings listed on this page must still be met.

Alcohol - Ethanol: Fuels containing up to 10% ethanol by volume may be used. Ethanol may also be referred to as Ethyl alcohol, or "Gasohol".

Ethers - MTBE: Fuels containing up to 15% MTBE may be used.

pg. 79 Starting and driving

### **Carbon Monoxide - Important Warning**

Carbon monoxide is a poisonous, colorless, and odorless gas. It is present in all exhaust gases. If you ever smell exhaust fumes inside the vehicle, make sure the passenger compartment is ventilated, and immediately return the vehicle to your retailer for correction.

### **Fuel Formulations**

Do not use gasoline that contains lead as a knock inhibitor, and do not use lead additives. Besides damaging the exhaust emission control systems on your car, lead has been strongly linked to certain forms of cancer.

Many fuels contain benzene as a solvent. Unburned benzene has been strongly linked to certain forms of cancer. If you live in an area where you must fill your own gas tank, take precautions. These may include:

- standing upwind away from the filler nozzle while refueling
- refueling only at gas stations with vapor recovery systems that fully seal the mouth of the filler neck during refueling
- wear neoprene gloves while handling a fuel filler nozzle.

### **Use of Additives**

With the exception of gas line antifreeze during winter months, do not add solvents, thickeners, or other store-bought additives to your car's fuel, cooling, or lubricating systems. Overuse may damage your engine, and some of these

additives contain organically volatile chemicals. Do not needlessly expose yourself to these chemicals.

## Refueling (contd)



### Fuel filler door

Press the button on the light switch panel (see illustration on [page 30](#)) when the car is at a standstill to unlock the fuel filler door. Please note that the fuel filler door will remain unlocked until the car begins to move forward. An audible click will be heard when the fuel filler door relocks.

If you intend to leave your car while it is being refueled, this feature enables you to lock the doors/trunk while leaving the fuel filler door unlocked.

You can also keep the car locked if you remain inside during refueling. The central locking button does not lock the fuel filler door.

Be sure the fuel filler door is not obstructed and is completely closed after refueling.

### Open the fuel filler cap slowly during hot weather.

**NOTE:** During a transitional period, a small number of service stations may still have fuel nozzles that are not compatible with the fuel filler neck on cars equipped with the evaporative control system.

### Refueling

The fuel tank is designed to hold approximately 18.5 US gals (70 liters) or 19 US gals (72 liters) on models equipped with All Wheel Drive, with sufficient volume left over to accommodate possible expansion of the fuel in hot weather. Be aware that the "usable" tank capacity will be somewhat less than the specified maximum. When the fuel level is low, such factors as ambient temperature, the fuel's "Reid vapor pressure" characteristics, and terrain can affect the fuel pump's ability to supply the engine with an adequate supply of fuel. Therefore, it is advisable to refuel as soon as possible when the needle nears the red zone, or when the fuel warning light comes on.

---

### CAUTION:

Do not refuel with the engine running \*. Turn the ignition off or to position I. If the ignition is on, an incorrect reading could occur in the fuel gauge After refueling, close the fuel filler cap by turning it clockwise until it clicks into place\*.

Allow for fuel expansion by not overfilling the tank. Overfilling could also cause damage to the emission control systems. Avoid spilling gasoline during refueling. In addition to causing damage to the environment, gasolines containing alcohol can cause damage to painted surfaces, which may not be covered under the New Vehicle Limited Warranty.

Do not use gasolines containing methanol (methyl alcohol, wood alcohol). This practice can result in vehicle performance deterioration and can damage critical parts in the fuel system. Such damage may not be covered under the New Vehicle Limited Warranty.

---

\* If the fuel filler cap is not closed tightly or if the engine is running when the car is refueled, the Check Engine Light (malfunction indicator lamp) may indicate a fault. However, your vehicle's performance will not be affected. Use only Volvo original or approved fuel filler caps.

pg. 81 Starting and driving

## Starting the car

### Starting the engine

1. Fasten the seat belt.

#### **WARNING!**

Before starting, check that the seat, steering wheel and mirrors are adjusted properly. Make sure the brake pedal can be depressed completely. Adjust the seat if necessary. See [pages 54, 56](#).

2. Apply the parking brake (hand brake) if not already set. The gear selector (automatic transmission) is locked in the (P)ark position (SHIFTLOCK).

Manual transmission: the clutch must be fully depressed.

3. Without touching the accelerator pedal, turn the ignition key\* to the starting position. Allow the starter to operate for up to 10 seconds. Release the key as soon as the engine starts. If the engine fails to start, repeat this step.

**NOTE:** On certain models, when the car is started, idle speed may be noticeably higher than normal for a short period, depending on the temperature of the engine. This has been done to help bring components in the emission control system to their normal operating temperature as quickly as possible, which enables them to function normally.

For cold starts at altitudes above 6000 ft (1800 meters), depress the accelerator pedal halfway and turn the key to the starting position. Release the pedal slowly when the engine starts.

4. To release the gear selector from the (P)ark position, the engine must be running (or the ignition key must be in position II) and the brake pedal must be depressed.

5. Select the desired gear. The gear engages after a very slight delay which is especially noticeable when selecting R.

**NOTE:** Your car is equipped with a **KEYLOCK** system (automatic transmission). When the engine is switched off, the gear selector must be in the (P)ark position before the key can be removed from the ignition switch.

When starting in cold weather, the transmission may shift up at slightly higher engine speeds than normal until the automatic transmission fluid reaches normal operating temperature.

---

### **CAUTION:**

#### **Automatic transmission**

The engine should be idling when you move the gear selector. Never accelerate until after you feel the transmission engage! Accelerating immediately after selecting a gear will cause harsh engagement and premature transmission wear. Selecting **P** or **N** when idling at a standstill for prolonged periods of time will help prevent overheating of the automatic transmission fluid.

---

**⚠ WARNING!**

Always place the gear selector in Park and apply the parking brake before leaving the vehicle. Never leave the car unattended with the engine running.  
Always open garage doors fully before starting the engine inside a garage to ensure adequate ventilation. The exhaust gases contain carbon monoxide, which is invisible and odorless but very poisonous

Do not race a cold engine immediately after starting. Oil flow may not reach some lubrication points fast enough to prevent engine damage.

\* If two of the keys to your car are close together, e.g., on the same key ring, when you try to start the car, this could cause interference in the immobilizer system and result in the car not starting. If this should occur, remove one of the keys from the key ring before trying to start the car again.

pg. 82 Starting and driving

## Starting the car (contd)

### Ignition switch and steering wheel lock

**0 Locked position:** Remove the key to lock the steering wheel \*.

**⚠ WARNING!**

Never turn the key to position O while driving or when the car is being towed.

**I Intermediate position - "radio position":** Certain accessories, radio, etc. on, daytime running lights off.

**II Drive position:** The key position when driving. The car's entire electrical system is connected.

**III Start position:** Release the key when the engine starts. The key returns automatically to the Drive position.

**A chime will sound if the key is left in the ignition and the driver's door is opened.**

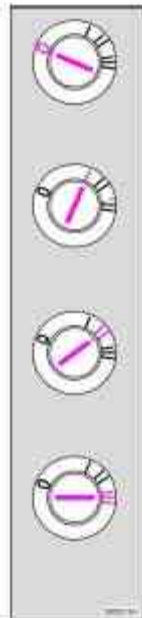

### **Steering wheel lock**

The steering wheel lock might be under tension when the car is parked.  
Turn the steering wheel slightly to free the ignition key.

**In order to help reduce car theft, make sure the steering wheel lock is engaged before leaving the car.**

\* The gear selector must be in the (P)ark position (automatic transmission).

\*\* Please be aware that leaving the key in this position will increase battery drain.

pg. 83 Starting and driving

## **General information**

### **Economical driving conserves natural resources**

Better driving economy may be obtained by thinking ahead, avoiding rapid starts and stops and adjusting the speed of your vehicle to immediate traffic conditions. Observe the following rules:

- Bring the engine to normal operating temperature as soon as possible by driving with a light foot on the accelerator pedal for the first few minutes of operation. A cold engine uses more fuel and is subject to increased wear.
- Whenever possible, avoid using the car for driving short distances. This does not allow the engine to reach normal operating temperature.
- Drive carefully and avoid rapid acceleration and hard braking.
- Do not exceed posted speed limits.
- Avoid carrying unnecessary items (extra load) in the car.
- Maintain correct tire pressure. Check tire pressure regularly (when tires are cold).
- Remove snow tires when threat of snow or ice has ended.
- Note that roof racks, ski racks, etc, increase air resistance and also fuel consumption.
- Avoid using automatic transmission kickdown feature unless necessary.
- However, at higher driving speeds, fuel consumption will be lower with the air conditioning on and the windows closed than with the air conditioning off and the windows open.
- Using the onboard trip computer's fuel consumption modes can help you learn how to drive more economically.

### **Other factors that decrease gas mileage are:**

- Dirty air cleaner
  - Dirty engine oil and clogged oil filter
  - Dragging brakes
  - Incorrect front end alignment
- Some of the above mentioned items and others are checked at the standard Maintenance Service intervals.

**NOTE:** Vehicles equipped with automatic transmissions should use **(D)**rive as often as possible and avoid using "kickdown" to help improve fuel economy.

### **⚠ WARNING!**

**Driving with the trunk open:** Driving with the trunk open could lead to poisonous exhaust gases entering the passenger compartment.

If the trunk must be kept open for any reason, proceed as follows

- Close the windows
- Set the ventilation system control to air flow to floor, windshield and side windows and blower control to its highest setting.

---

**CAUTION:** Drive slowly and carefully if going through standing water (i.e. flooded roadways, etc.). Damage to the engine could result if excess water is drawn in through the air intake system. Never drive the vehicle in water deeper than 1 foot (300 mm).

---

### **Weight distribution affects handling**

At the specified curb weight your car has a tendency to understeer, which means that the steering wheel has to be turned more than might seem appropriate for the curvature of a bend. This ensures good stability and reduces the risk of rear wheel skid. Remember that these properties can alter with the vehicle load.

pg. 84 Starting and driving

## **General information (contd)**

The heavier the load in the trunk (max. 220 lbs, 100 kg), the less the tendency to understeer.

### **Handling, roadholding**

Vehicle load, tire design and inflation pressure all affect vehicle handling. Therefore, check that the tires are inflated to the recommended pressure according to the vehicle load. See "Tire pressure" section.

Loads should be distributed so that capacity weight or maximum permissible axle loads are not exceeded.

pg. 85 Starting and driving

## **Manual transmission**



### **Shift positions**

Depress the clutch pedal completely when changing gears\*.

Remove your foot from the clutch pedal while driving. The shift pattern should be followed.

Overdrive (5th gear) should be used as often as possible to help improve fuel economy.

### **\* Clutch interlock**

The clutch must be fully depressed before you can start your car. If the clutch is not depressed, it will not be possible to start the engine.





### **Engaging reverse gear**

Reverse gear should only be engaged from a complete stop.

---

### **CAUTION:**

Be careful to avoid inadvertently engaging reverse while moving forward.

---



### **"Sport shifter" gear selector (option on T5 models)**

The shift positions for the "sport shifter" are the same as for the standard manual gear selector.

pg. 86 Starting and driving

## **Automatic transmission (option)**



### **Automatic transmission AW55- 50 (option)**

#### **P Park**

Use this position when starting the engine or parking the car.

Never use **P** while the car is in motion.

The parking brake should be set whenever the car is parked.

The gear selector is mechanically locked in the **P** position (SHIFTLOCK). To release the gear selector from this position, the engine must be running (or the ignition key must be in position II) and the brake pedal must be depressed.

**⚠ WARNING!**

Never leave the car unattended when the engine is running. If, by mistake, the gear selector is moved from **P**, the car may start moving.

**R (Reverse)**

Never engage **R** while the car is moving forward.

**N (Neutral)**

Neutral - no gear engaged. Use the parking brake.

**D (Drive)**

**D** is the normal driving position and should be used as often as possible to help improve fuel economy. The car should not be moving when shifting from **R** to the **D** position.

**4 (Intermediate gear)**

The transmission will shift automatically between gears 4, 3, 2 or 1 from this position. The transmission cannot shift up to **(D)**rive from fourth gear.

**3 (Intermediate gear)**

The transmission will shift automatically between gears 3, 2 and 1 from this position. The transmission cannot shift up to fourth gear or **(D)**rive from third gear.

**L (Low gears)**

The transmission is locked in gears 1 and 2 when the selector is in this position.

**NOTE:** Gears 4, 3, or L can be used if you are driving in a mountainous area, towing a trailer or to increase engine braking effect.

The transmission has a built-in limiter designed to help prevent excessive engine speeds (high rpm) when gears 4, 3 or L are selected.

pg. 87 Starting and driving

## Automatic transmission (option) (contd)



**W - Winter/Wet driving mode - enhanced vehicle traction**

- Mode W will only function if the gear selector is in the (D)rive position.
- Press the button at the base of the gear selector to engage/disengage this driving mode (see illustration).
- When the W driving mode is engaged, this is displayed in the instrument panel (see [page 22](#)).
- This mode may be selected for starting/moving off on slippery roads.

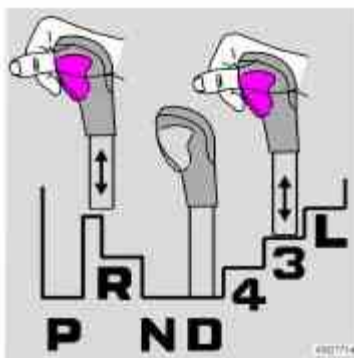

### Automatic transmission AW55- 50 - shift gate positions

The gear selector can be moved freely between N and D.

Depressing the button on the front of the gear selector knob enables you to move the gear selector to positions P, R, N, D, 4, 3 and L.

### "Kickdown"

Automatic shift to a lower gear (kickdown) is achieved by depressing the accelerator pedal fully and briskly. An upshift will occur when approaching the top speed for a particular gear or by releasing the accelerator pedal slightly.

Kickdown can be used for maximum acceleration or when passing at highway speeds.

### Automatic transmission - adaptive system

The automatic transmission is controlled by an adaptive control system that constantly monitors the way in which the transmission functions. It senses and adapts each gear shift for optimal performance. The system also monitors your particular driving style and adapts gear shifting accordingly.

### Cold starts

When driving before the engine has reached its normal operating temperature, the transmission will shift up at a slightly higher engine speeds to heat the three-way catalytic converter as quickly as possible.

pg. 88 Starting and driving

## Geartronic (option)



## **P Park**

Use this position when starting the engine or parking the car.

**Never use P while the car is in motion.**

The parking brake should also be set whenever the car is parked.

**The gear selector is mechanically locked in the P position (SHIFTLOCK).** To release the gear selector from this position, the engine must be running (or the ignition key must be in position II) and the brake pedal must be depressed.

### **⚠ WARNING!**

Never leave the car unattended when the engine is running. If, by mistake, the gear selector is moved from P, the car may start moving.

## **R (Reverse)**

Never engage **R** while the car is moving forward.

## **N (Neutral)**

Neutral - no gear engaged. Use the parking brake.

## **D (Drive)**

D is the normal driving position and should be used as often as possible to help improve fuel economy. The car should not be moving when shifting from **R** to the **D** position.

### **Automatic transmission - adaptive system**

The automatic transmission is controlled by an adaptive control system that constantly monitors the way in which the transmission functions. It senses and adapts each gear shift for optimal performance. The system also monitors your particular driving style and adapts gear shifting accordingly.

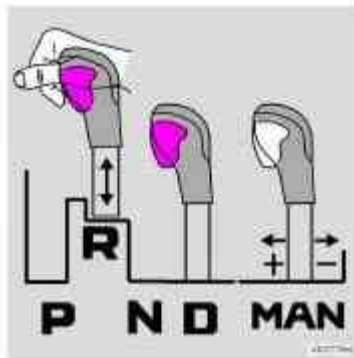

### **Automatic transmission - shift gate positions**

You can move the gear selector freely between the (MAN)ual and (D)rive positions while driving.

Depress the button on the front of the gear selector knob to move between the R, N, D, and P positions.

## **Geartronic (option) (contd)**

### **Manual shifting - Geartronic**

You can move the gear selector freely between the **(MAN)**ual and **(D)**rive positions while driving. Gears 3, and 4 have a "lock-up" function which reduces engine speed and helps save fuel.

The currently selected gear will be displayed in the instrument panel (see [page 22](#)).

- To access the **(MAN)**ual shifting position from **(D)**rive, move the gear selector to the left to **MAN**.
- To return to the **(D)**rive position from **MAN**, move the gear selector to the right.

### **While driving**

If you select the **(MAN)**ual position while driving, the gear that was being used in the **(D)**rive position will also initially be selected in **(MAN)**ual position.

- Move the gear selector forward (toward "+") to shift to a higher gear or rearward (toward "-") to shift to a lower gear.
- If you hold the gear selector toward "-", the transmission will downshift one gear and will utilize the braking power of the engine. If the current speed is too high for using a lower gear, the downshift will not occur until the speed has decreased enough to allow the lower gear to be used.
- If you slow down to a very low speed, the transmission will automatically shift down.
- When starting in the **(MAN)**ual position, 3rd gear is the highest gear that may be selected.

**NOTE:** Kickdown does not function when the transmission is in the manual shift (Geartronic) mode. The gear selector must be in the D(Drive) position.

### **Kickdown**

Automatic shift to a lower gear (kickdown) is achieved by depressing the accelerator pedal fully and briskly. An upshift will occur when approaching the top speed for a particular gear or by releasing the accelerator pedal slightly. Kickdown can be used for maximum acceleration or when passing at highway speeds.

**Kickdown does not function when the transmission is in the manual shift (Geartronic) mode.**



### **W - Winter/Wet driving mode - enhanced vehicle traction**

- Mode W will only function if the gear selector is in the **(D)**rive position.
- Press the button at the base of the gear selector to engage/disengage this driving mode (see illustration).
- When the W driving mode is engaged, this is displayed in the instrument panel (see [page 22](#)).
- This mode may be selected for starting/ moving off on slippery roads.

pg. 90 Starting and driving

## **All Wheel Drive (option)**

### **All Wheel Drive (AWD) - general information**

Your Volvo can be equipped with permanent All Wheel Drive, which means that power is distributed automatically between the front and rear wheels. Under normal driving conditions, most engine's power is directed to the front wheels. However, if there is any tendency for the front wheels to spin, an electronically controlled coupling distributes power to the wheels that have the best traction.

### **Tire dimensions**

Volvo recommends that you always drive on tires of the same brand, size, construction (radial), tread pattern, load-, speed-, traction-, temperature-, and treadwear rating. Never drive on mixed tires, except for brief periods when the temporary spare tire is in use.

Always use properly inflated tires of correct dimensions. Tire size and inflation pressures are shown on the tire pressure label located inside the fuel filler door.

### **Tire Rotation**

Volvo recommends rotating the tires every 7,500 miles (12,000 km). Tires should be rotated front-to-back/back-to-front only. Tires must maintain the same direction of rotation throughout their lifetime, and should never be rotated from one side of the vehicle to the other.

### **Temporary Spare**

The temporary spare tire is for temporary, low-speed, short-distance use only. Replace it with a full-size tire as soon as possible, in accordance with "Tire Rotation" above. Do not drive on the temporary spare at speeds above 50 mph (80 km/h) or for distances greater than 50 miles (80 km.)

Never install snow chains on a temporary spare.

pg. 91 Starting and driving

## **Brake system**

### **BRAKE Brake circuit malfunction**

The brake system is a hydraulic system consisting of two master cylinders and two separate brake circuits. If a problem should occur in one of these circuits, it is still possible to stop the car with the other brake circuit.

If the brake pedal must be depressed farther than normal and requires greater foot pressure, the stopping distance will be longer.

A warning light in the instrument panel will light up to warn the driver that a fault has occurred.

If this light comes on while driving or braking, stop immediately and check the brake fluid level in the reservoir.

**NOTE:** Press the brake pedal hard and maintain pressure on the pedal ⚠ do not pump the brakes.

### **WARNING!**

If the fluid level is below the MIN mark in the reservoir or if a "Brake failure - Service urgent" message is displayed in the text window: **DO NOT DRIVE**. Have the car towed to a Volvo retailer and have the brake system inspected.

**NOTE:** When the car is at a standstill and the engine is idling, e.g. at a traffic light and the brake pedal is depressed, the pedal may go down slightly. This is a normal function of the power-assisted brake system.

### **Power brakes function only when the engine is running**

The power brakes utilize vacuum pressure which is only created when the engine is running. Never let the vehicle roll to a stop with the engine switched off.

If the power brakes are not working, the brake pedal must be pressed approximately four times harder than usual to make up for the lack of power assistance. This can happen for example when towing your vehicle or if the engine is switched off when the vehicle is rolling. The brake pedal feels harder than usual.

### **Water on brake discs and brake pads affects braking**

Driving in rain and slush or passing through an automatic car wash can cause water to collect on the brake discs and pads. This will cause a delay in braking effect when the pedal is depressed. To avoid such a delay when the brakes are needed, depress the pedal occasionally when driving through rain, slush etc. This will remove the water from the brakes. Check that brake application feels normal. This should also be done after washing or starting in very damp or cold weather.

### **Severe strain on the brake system**

The brakes will be subject to severe strain when driving in mountains or hilly areas or towing. Vehicle speed is usually slower, which means that the cooling of the brakes is less efficient than when driving on level roads. To reduce the strain on the brakes, shift into a lower gear and let the engine help with the braking. Do not forget that, if you are towing a trailer, the brakes will be subjected to a greater than normal load.

pg. 92 Starting and driving

## **Brake system (contd)**



### **Anti-lock brakes (ABS)**

If the warning lamp lights up there is a malfunction of the ABS system (the standard braking system will however function) and the vehicle should be driven cautiously to a Volvo retailer for inspection. The Anti-lock Braking System (ABS) helps to improve vehicle control (stopping and steering) during severe braking conditions by limiting brake lockup. When the system "senses" impending lockup, braking pressure is automatically modulated in order to help prevent lockup, which could lead to a skid.

**The system performs a self-diagnostic test when the engine is started and when the vehicle first reaches a speed of approximately 12 mph (20 km/h).** The brake pedal will pulsate several times and a sound may be audible from the ABS control module. This is normal.

To obtain optimal effect from the ABS system, constant pressure should be kept on the brake pedal, keep constant pressure on the brake pedal. Do not pump the brake pedal.

The switching of the ABS modulator will be audible and the brake pedal will pulsate during braking. Please be aware that ABS does not increase the absolute braking potential of the vehicle. While control will be enhanced, ABS will not shorten stopping distances on slippery surfaces.

### **ABS with EBD (Electronic Brake Force Distribution)**

EBD is an integrated part of the ABS system. EBD regulates the hydraulic pressure to the rear brakes to help provide optimal braking capacity. The brake pedal will pulsate during braking, which is normal.

If the BRAKE and ABS warning lights come on at the same time, this could indicate a fault in the brake system.

- Stop the car in a suitable place and switch off the engine.
- Restart the engine.
- If both warning lights go off, no further action is required.
- If both lights are still on after the engine has been restarted, switch off the engine again and check the brake fluid level (see [page 122](#) for the location of the brake fluid reservoir).
- If the brake fluid level is above the MIN mark, drive carefully to an authorized Volvo retailer and have the brake

system inspected.

 **WARNING!**

If the fluid level is below the MIN mark in the reservoir or if a "Brake failure - Service urgent" message is displayed in the text window: DO NOT DRIVE. Have the car towed to a Volvo retailer and have the brake system inspected.



[Contents](#) | [Top of Page](#)



# 2003 VOLVO S60

## Wheels and tires

pg. 105 Wheels and tires

General information	<a href="#">106</a>
Tire pressure	<a href="#">108</a>
Tread wear indicators	<a href="#">109</a>
Changing wheels	<a href="#">110</a>
Uniform Tire Quality Grading	<a href="#">112</a>

pg. 106 Wheels and tires

## General information

### General information about wheels and tires

Your vehicle is equipped with tires according to the tire information label on the inside of the fuel filler door.

All tires have a dimension designation.

**Example** of designation: **215/55R16**.

215 section width (mm)  
55 relationship between section  
height and width  
R radial tire  
16 wheel rim diameter (")

The tires have good road holding characteristics and offer good handling on dry and wet surfaces. It should be noted however that the tires have been developed to give these features on snow/ice-free surfaces.

**Certain models are equipped with "all-season" tires, which provide a somewhat higher degree of road holding on slippery surfaces than tires without the "all-season" rating.**

However, for optimum road holding on icy or snow-covered roads - we recommend suitable winter tires on all four wheels. When replacing tires, be sure that the new tires are the same size designation, type (radial) and preferably from the same manufacturer, on all four wheels. Otherwise there is a risk of altering the car's roadholding and handling characteristics.

**NOTE:** When storing wheel/tire assemblies (e.g. winter tires and wheels), either stand the assemblies upright, or suspend them off the ground. Laying wheel/tire assemblies on their sides for prolonged periods can cause wheel and/or tire damage.



### New tires

Remember that tires are perishable goods. This tire was manufactured week 15 in 1998! (158). As of 2000, manufacturing year and week will be indicated with 4 digits (e.g. 0015 means that the tire is manufactured year 2000, week 15).

### Improving tire economy:

- Maintain correct tire pressure. See the tire pressure label on the inside of the fuel filler door.
- Drive smoothly: avoid fast starts, hard braking and tire screeching.
- Tire wear increases with speed.
- Correct front wheel alignment is very important.
- Unbalanced wheels impair tire economy and driving comfort.
- If tires are rotated, they must be kept on the same side of the car so that they revolve in the same direction as before rotation.
- Hitting curbs or potholes can damage the tires and/or wheels permanently.

### Flat spots

All tires become warm during use. After cooling, when the vehicle is parked, the tires have a tendency to distort slightly, forming flat spots. These flat spots can cause vibrations similar to the vibrations caused by unbalanced wheels. They do, however, disappear when the tire warms up. The degree to which flat spots form depends on the type of cord used in the tire. In cold weather, it takes longer for the tire to warm up and consequently longer for the flat spot to disappear.

---

**CAUTION:** The car must not be driven with wheels of different dimensions or with a spare tire other than the one that came with the car. The use of different size wheels can seriously damage your car's transmission.

pg. 107 Wheels and tires

### Snow chains

Snow chains can be used on your Volvo with the following restrictions:

- Snow chains should be installed on front wheels only. Use only Volvo approved snow chains.
- Special snow chains must be mounted on 195/65 R15. For tires of other dimensions, consult your Volvo retailer.
- If accessory, aftermarket or "custom" tires and wheels are installed and are of a size different than the original tires and wheels, chains in some cases CANNOT be used. Sufficient clearances between chains and brakes, suspension and body components must be maintained.
- Some strap-on type chains will interfere with brake components and therefore CANNOT be used.
- **All Wheel Drive models :** Snow chains should only be installed on the *front* wheels. Only chains adapted for AWD models should be used.

**NOTE:** Consult your Volvo retailer for additional snow chain information

---

### CAUTION:

Check local regulations regarding the use of snow chains before installing

Always follow the chain manufacturer's installation instructions carefully. Install chains as tightly as possible and retighten periodically.

Never exceed the chain manufacturer's specified maximum speed limit. (Under no circumstances should you exceed 31 mph (50 km/h))

Avoid bumps, holes or sharp turns when driving with snow chains.

The handling of the vehicle can be adversely affected when driving with chains. Avoid fast or sharp turns as well as locked wheel braking.

---

## **Snow tires, studded tires \***

Tires for winter use:

Owners who live in or regularly commute through areas with sustained periods of snow or icy driving conditions are strongly advised to fit suitable winter tires to help retain the highest degree of traction.

It is important to install winter tires on all four wheels to help retain traction during cornering, braking, and accelerating. Failure to do so could reduce traction to an unsafe level or adversely affect handling. Do not mix tires of different design as this could also negatively affect overall tire road grip.

Volvo recommends 195/65 R15 (205/55R16 on turbo models) winter tires on all four wheels.

Winter tires wear more quickly on dry roads in warm weather. They should be removed when the winter driving season has ended.

Studded tires should be run-in 300-600 miles (500-1000 km) during which the car should be driven as smoothly as possible to give the studs the opportunity to seat properly in the tires. The tires should have the same rotational direction throughout their entire lifetime. In other words, if you wish to rotate the wheels, make sure that the same wheels are always on the same side of the car.

**NOTE:** Please consult state or provincial regulations restricting the use of studded winter tires before installing such tires.

\* Where permitted

pg. 108 Wheels and tires

## **Tire pressure**

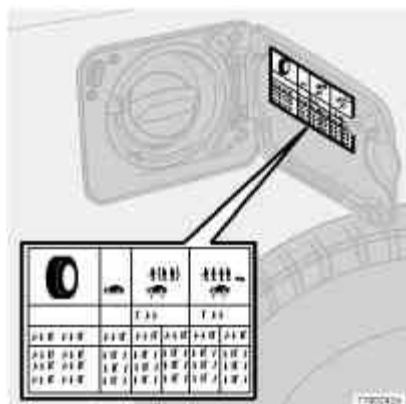

*Tire pressure label*

### **Checking and correcting tire pressure**

The tire pressure label is located on the inside of the fuel filler door.

- Check the tire pressure regularly.
- The tire pressure should be corrected only when the tires are cold.
- With warm tires, correct only when the pressure is too low. The tire temperature rises after driving just a few miles.

**Vehicle loading** The tires on your Volvo will perform to specifications at all normal loads when inflated as recommended on the tire information label located on the inside of the fuel filler door. This label lists both tire and vehicle design limits. Do not load your car beyond the load limits indicated.

**⚠ WARNING!**

Improperly inflated tires will reduce tire life, adversely affect vehicle handling and can possibly lead to failure resulting in loss of vehicle control without prior warning.

**Temporary Spare**

The spare tire in your car is called a "Temporary Spare". It has the following designation: T125/80 R17.

Recommended tire pressure (see decal on Fuel filler door) should be maintained irrespective of which position on the car the Temporary Spare tire is used on. In the event of damage to this tire, a new one can be purchased from your Volvo retailer.

**⚠ WARNING!**

Current legislation prohibits the use of the "Temporary Spare" tire other than as a temporary replacement for a punctured tire. It must be replaced as soon as possible by a standard tire. Road holding and handling may be affected with the "Temporary Spare" in use. Do not exceed 50 mph (80 km/h). Do not drive farther than 50 miles (80 km) on a temporary spare tire.

**CAUTION:**

The car must not be driven with wheels of different dimensions or with a spare tire other than the one that came with the car. The use of different size wheels can seriously damage your car's transmission.

**NOTE:** Certain models may be equipped with a full-size spare tire. When used, it should be inflated to the same pressure as the tire it is replacing.

pg. 109 Wheels and tires

## Tread wear indicators



**Tires have tread**

wear indicators The tires have wear indicator strips running across or parallel to the tread.

When approx. 1/16" (1.6 mm) is left on the tread, these strips become visible and indicate that the tire should be replaced.

Tires with less than 1/16" (1.6 mm) tread have a very poor grip in rain or snow.

When replacing worn tires, it is recommended that the tire be identical in type (radial) and size as the one being replaced. Using a tire of the same make (manufacturer) will prevent alteration of the driving characteristics of the

## Changing wheels

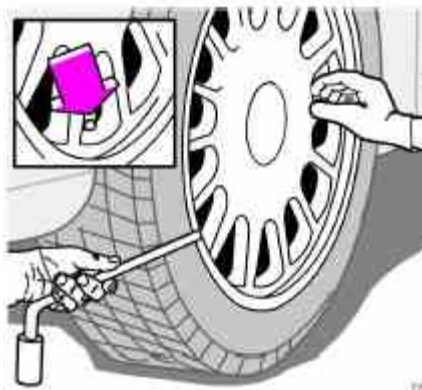

*Insert flat end of lug wrench and turn/pull straight out*

### Changing wheels

The spare wheel is located under the carpet on the trunk floor. The jack and crank are secured in the wheel recess.

There are two jack attachment points on each side of the car (see illustration on next page). To change a wheel:

- Engage the parking brake.
- Put the gear selector in (P)ark (automatic transmission) or reverse (manual transmission).

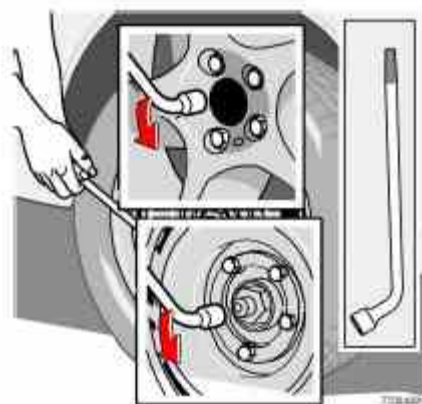

*Loosen the wheel bolts*

- Remove the wheel cap (where applicable) using the lug wrench in the tool kit.
- With the car still on the ground, use the lug wrench to loosen the wheel bolts 1/2 - 1 turn. Turn the bolts counterclockwise to loosen.

### CAUTION:

The car must not be driven with wheels of different dimensions or with a spare tire other than the one that came with the car. The use of different size wheels can seriously damage your car's transmission.

Correct tightening torque on wheel bolts must be observed. The wheel bolts should never be greased or lubricated. The extended, chromed wheel bolts must not be used with steel rims, as they make it impossible to fit the hub caps.

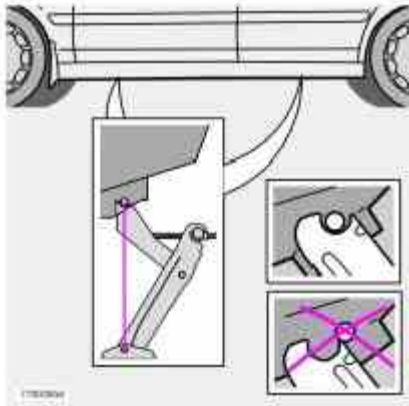

*Attaching the jack*

- Position the jack correctly on the bar in the attachment (see illustration above) and crank while simultaneously guiding the base of the jack to the ground. The base of the jack must be flat on a level, firm, non-slippery surface. Before raising the car, check that the jack is still correctly positioned in the attachment.
- Raise the vehicle until the wheel to be changed is lifted off the ground.
- Unscrew the wheel bolts completely and carefully remove the wheel so as not to damage the threads on the studs.

**NOTE:** To avoid excessive wear and the necessity of rebalancing, mark and reinstall wheels in the same location and position as before removal. To lessen the chance of imbalance, each wheel hub is equipped with a guide stud to ensure that a removed wheel can be reinstalled in its original position (as when changing over to winter tires/wheels).



### Installing the wheel

- Clean the contact surfaces on the wheel and hub.
- Lift the wheel and place it on the hub.
- Install the wheel bolts and tighten hand-tight. Using the lug wrench, tighten crosswise until all bolts are snug.
- Lower the vehicle to the ground and alternately tighten the bolts crosswise to 102 ft. lbs. (140 Nm).
- Install the wheel cap (where applicable).

### **⚠ WARNING!**

The jack must correctly engage the bar in the jack attachment. The car's weight must not rest on the jack attachment. See illustration "Attaching the jack" to the left.

Be sure the jack is on a firm, level, non-slippery surface.

Never allow any part of your body to be extended under a car supported by a jack. Use the jack intended for the car when replacing a wheel. For any other job, use stands to support the side of the car being worked on.

Apply the parking brake and put the gear selector in the (P)ark position (or reverse on manual transmissions).

Block the wheels standing on the ground, use rigid wooden blocks or large stones. The jack should be kept well-greased.

## Uniform Tire Quality Grading

**ALL PASSENGER CAR TIRES MUST CONFORM TO FEDERAL SAFETY REQUIREMENTS IN ADDITION TO THESE GRADES**

Quality grades can be found, where applicable, on the tire sidewall between the tread shoulder and maximum section width. For example:

**Treadwear 200 Traction AA Temperature A**

### TREADWEAR

The treadwear grade is a comparative rating based on the wear rate of the tire when tested under controlled conditions on a specified government test course. For example, a tire graded 150 would wear one and one half (1 1/2) times as well on the government course as a tire graded 100. The relative performance of tires depends upon the actual conditions of their use, however, and many depart significantly from the norm due to variation in driving habits, service practices and differences in road characteristics and climate.

### TRACTION

The traction grades, from highest to lowest, are AA, A, B, and C, as measured under controlled conditions on specified government test surfaces of asphalt and concrete. A tire marked C may have poor traction performance.

#### **WARNING!**

The traction grade assigned to this tire is based on braking (straight-ahead) traction tests and is not a measure of cornering (turning) traction.

### TEMPERATURE

The temperature grades are AA (the highest), A, B, and C, representing the tire's resistance to the generation of heat and its ability to dissipate heat when tested under controlled conditions on a specified indoor laboratory test wheel. Sustained high temperature can cause the material of the tire to degenerate and reduce tire life, and excessive temperature can lead to sudden tire failure. The grade C corresponds to a minimum level of performance that all passenger car tires must meet under the Federal Motor Safety Standard No. 109. Grades B and A represent higher levels of performance on the laboratory test wheel than the minimum required by law.

#### **WARNING!**

The temperature grade for this tire is established for a tire that is properly inflated and not overloaded. Excessive speed, under-inflation, or excessive loading, either separately or in combination, can cause heat buildup and possible tire failure.



# 2003 VOLVO S60

## Car care

pg. 113 Car care

- Washing and cleaning the car [114](#)
- Paint touch up [116](#)

pg. 114 Car care

## Washing and cleaning the car

- The car should be washed at regular intervals since dirt, dust, insects and tar spots adhere to the paint and may cause damage. It is particularly important to wash the car frequently in the wintertime to prevent corrosion, when salt has been used on the roads.
- When washing the car, do not expose it to direct sunlight. Use lukewarm water to soften the dirt before you wash with a sponge, and plenty of water, to avoid scratching.
- Bird droppings: Remove from paintwork as soon as possible. Otherwise the finish may be permanently damaged.
- A detergent can be used to facilitate the softening of dirt and oil.
- A water-soluble grease solvent may be used in cases of sticky dirt. However, use a wash place equipped with a drainage separator.
- Dry the car with a clean chamois and remember to clean the drain holes in the doors and rocker panels.
- Tar spots can be removed with kerosene or tar remover after the car has been washed.
- A stiff-bristle brush and lukewarm soapy water can be used to clean the wiper blades. Frequent cleaning improves visibility considerably.
- Wash off the dirt from the underside (wheel housings, fenders, etc.).
- In areas of high industrial fallout, more frequent washing is recommended.

### CAUTION:

During high pressure washing, the spray mouthpiece must never be closer to the vehicle than 13" (30 cm). Do not spray into the locks.

When washing or steam cleaning the engine, avoid spraying water or steam directly on the electrical components or toward the rear side of the engine.

### Special sun roof cautions:

- Always close the sun roof and sun shade before washing your vehicle.
- Never use abrasive cleaning agents on the sun roof.
- Never use wax on the rubber seals around the sun roof.

- After cleaning the engine, the spark plug wells should be inspected for water and blown dry if necessary.

**Suitable detergents:** Special car washing detergents should be used. A suitable mixture is about 2.5 fl. oz. (8.5 cl) of detergent to 2.6 US gal. (10 liters) of warm water. After washing with a detergent the car should be well rinsed with clean water.



**Bumpers:** Wash the bumpers with the same cleaning agent used on the rest of the car. Never clean the bumpers with gasoline or paint thinner. Difficult spots can be removed with denatured alcohol. To avoid scratches, do not dry the bumpers with paper.

**NOTE:** When washing the car, remember to remove dirt from the drain holes in the doors and sills.

### **Automatic car wash**

An automatic car wash is a simple and quick way of washing the car. Bear in mind, however, that an automatic car wash can never replace a proper handwashing. During the first months of the car's life - while the paint is still curing - we recommend that you handwash the car.

#### **WARNING!**

When the car is driven immediately after being washed, apply the brakes several times in order to remove any moisture from the brake linings.

Engine cleaning agents should not be used when the engine is warm. This constitutes a fire risk.

pg. 115 Car care

### **Automatic washing - simple and quick**

- We do NOT recommend washing your car in an automatic wash during the first six months (because the paint will not have hardened sufficiently).
- An automatic wash is a simple and quick way to clean your car, but it is worth remembering that it may not be as thorough as when you yourself go over the car with sponge and water. Keeping the underbody clean is most important, especially in the winter. Some automatic washers do not have facilities for washing the underbody.
- Before driving into an automatic car wash, make sure that side view mirrors, auxiliary lamps, etc, are secure, and that any antenna( s) are retracted or removed. Otherwise there is risk of the machine dislodging them.

### **Polishing and Waxing**

- Normally, polishing is not required during the first year after delivery, however, waxing may be beneficial.
- Before applying polish or wax the car must be washed and dried. Tar spots can be removed with kerosene or tar remover. Difficult spots may require a fine rubbing compound.
- After polishing use liquid or paste wax.
- Several commercially available products contain both polish and wax.
- Waxing alone does not substitute for polishing a dull surface.
- A wide range of polymer-based car waxes can be purchased today. These waxes are easy to use and produce a long-lasting, high-gloss finish that protects the bodywork against oxidation, road dirt and fading.
- Do not polish or wax your car in direct sunlight (the surface of the car should not be warmer than 113° F (45° C)).

### **Cleaning the upholstery**

- The fabric can be cleaned with soapy water or a detergent. For more difficult spots caused by oil, ice cream, shoe polish, grease, etc., use a clothing/fabric stain remover.
- The plastic in the upholstery can be cleaned with a soft cloth and mild soap solution.
- Leather upholstery/suede-like upholstery (alcantara<sup>TM</sup>) can be cleaned with a soft cloth and mild soap solution. For more difficult spots, Volvo offers a leather care kit.
- Under no circumstances should gasoline, naphtha or similar cleaning agents be used on the plastic or the leather since these can cause damage.

### **Cleaning the seat belts**

Clean only with lukewarm water and a mild soap solution.

## Cleaning floor mats

The floor mats should be vacuumed or brushed clean regularly, especially during winter when they should be taken out for drying. Spots on textile mats can be removed with a mild detergent.

## Bear in mind

- Take extra care when removing stains such as ink or lipstick since the coloring can spread.
- Use solvents sparingly. Too much solvent can damage the seat padding.
- Start from the outside of the stain and work toward the center.

pg. 116 Car care

## Paint touch up

Paint damage requires immediate attention to avoid rusting. Make it a habit to check the finish regularly - when washing the car for instance. Touch-up if necessary.

Paint repairs require special equipment and skill. Contact your Volvo retailer for any extensive damage.

Minor scratches can be repaired by using Volvo touch-up paint.

**NOTE:** When ordering touch-up paint from your Volvo retailer, use the paint code indicated on the model plate. The plate is located in the engine compartment.

### Color code

Make sure you have the right color. The color code number is on the data plate in the engine compartment.



### Minor stone chips and scratches

Material:

- Primer - can
- Paint - touch-up pen
- Brush
- Masking tape
- If the stone chip has not gone down to the bare metal and an undamaged color coat remains, you can add paint immediately after removing dirt.

**NOTE:** When touching up the car, it should be clean and dry. The surface temperature should be above 60° F (15° C).

### Minor scratches on the surface

If the stone chip has not penetrated down to the metal and an undamaged layer of paint remains, the touch-up paint can be applied as soon as the spot has been cleaned.

### Deep scratches

1. Place a strip of masking tape over the damaged surface. Pull the tape off so that any loose flakes of paint adhere to it.
2. Thoroughly mix the primer and apply it with a small brush.

When the primer surface is dry, the paint can be applied using a brush. Mix the paint thoroughly; apply several thin paint coats and let dry after each application.

3. If there is a longer scratch, you may want to protect surrounding paint by masking it off.



[Contents](#) | [Top of Page](#)

# 2003 VOLVO S60

## Maintenance and service

pg. 117

Volvo service	<a href="#">118</a>
Working on your car	<a href="#">120</a>
Hood and engine compartment	<a href="#">122</a>
Oils and fluids	<a href="#">123</a>
Wiper blades	<a href="#">127</a>
Battery	<a href="#">128</a>
Bulbs	<a href="#">131</a>
Fuses	<a href="#">138</a>

pg. 118 Maintenance and service

## Volvo service

### Maintenance service

Volvo advises you to follow the service program outlined in the Warranty and Service Records Information booklet. This maintenance program contains inspections and services necessary for the proper function of your car. The maintenance services contain several checks which require special instruments and tools and therefore must be performed by a qualified technician. To keep your Volvo in top condition, specify time-tested and proven Genuine Volvo Parts and Accessories.

### The Federal Clean Air Act - U. S.

The Federal Clean Air Act requires vehicle manufacturers to furnish written instructions to the ultimate purchaser to assure the proper servicing and function of the components that control emissions. These services, which are listed in the "Warranty and Service Records Information booklet," are not covered by the warranty. You will be required to pay for labor and material used.

### Maintenance services

Your Volvo passed several major inspections before it was delivered to you, in accordance with Volvo specifications. The maintenance services outlined in the Warranty and Service Records Information booklet, many of which will positively affect your vehicle's emissions, should be performed as indicated. It is recommended that receipts for vehicle emission services be retained in case questions arise concerning maintenance.

Inspection and service should also be performed anytime a malfunction is observed or suspected.

[Page 119](#) provides more information about maintenance of emission-related components.

Applicable warranties - U.S.

In accordance with applicable U.S. and Canadian regulations, the following list of warranties is provided

- New Car Limited Warranty
- Parts and Accessories Limited Warranty
- Corrosion Protection Limited Warranty
- Seat Belt and Supplemental Restraint Systems Limited Warranty
- Emission Design and Defect Warranty
- Emission Performance Warranty

These are the Federal warranties; other warranties are provided as required by state/provincial law. Refer to your separate Warranty and Service Records Information booklet for detailed information concerning each of the warranties.

pg. 119 Maintenance and service

### **Periodic maintenance helps minimize emissions**

Periodic maintenance will help keep your vehicle running well. Your Warranty and Service Records Information booklet provides a comprehensive periodic maintenance schedule up to 150,000 miles (240,000 km) of vehicle service. The schedule includes components that affect vehicle emissions. This page describes some of the emission-related components.

### **Engine air filter**

The engine air filter cleans particles from air entering the engine. Replace the engine air filter cartridge with a new one every 37,500 miles (60,000 km) under normal driving conditions. Replace the cartridge more often when the vehicle is driven under dirty and dusty conditions. The cartridge cannot be cleaned, and should always be replaced with a new one.

### **Fuel filter**

The fuel filter should be replaced at 105,000 miles (168,000 km). The filter is replaced as one complete unit. Replace more frequently if contaminated fuel is introduced into the tank, or if there is reason to suspect that this has occurred.

### **Fuel filler cap, tank and lines and connections**

The ability of the fuel system to contain hydrocarbons is dependent upon a leak-free system. Inspect fuel lines every 30,000 miles (48,000 km). Check for proper sealing of the fuel filler cap which contains "O" ring type seals.

**NOTE:** If the fuel filler cap is not closed tightly or if the engine is running when the car is refueled, the Check Engine light (Malfunction Indicator) may indicate a fault. However, your vehicle's performance will not be affected. Use only Volvo original or approved fuel filler caps.

### **Timing belt**

For proper functioning of the engine and emission control systems, the timing belt and belt tensioner must be replaced every 105,000 miles (168,000 km). Engine damage will occur if the belt fails.

### **PCV system**

(on turbocharged models)

The nipple in the intake manifold and the filter at the end of the PCV hose in the air cleaner should be inspected at 105,000 miles (168,000 km) and thereafter, at 150,000 mile (240,000 km) intervals.

### **Spark plugs**

The spark plugs should be replaced every 60,000 miles (96,000 km) under normal driving conditions. City driving or fast highway driving may necessitate replacement sooner.

Under normal driving conditions, spark plugs require no maintenance between replacement intervals. When installing new plugs, be sure to use the right type and to tighten them correctly. When changing the plugs, clean the terminals and rubber seals. Also check that the suppressor connectors are in good condition. Cracked or damaged connectors should be replaced.

pg. 120 Maintenance and service

## Working on your car

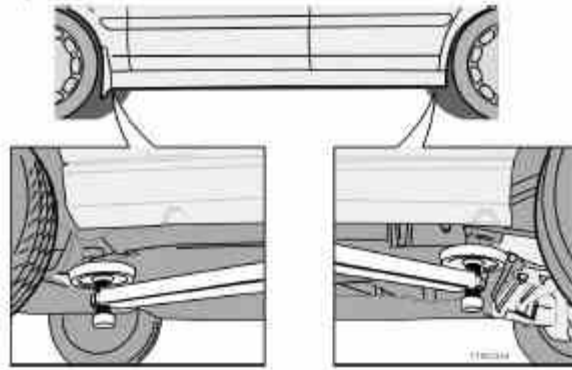

**Note the following before you begin working on your car:**

### **Battery**

- Ensure that the battery cables are correctly connected and tightened.
- Never disconnect the battery when the engine is running (e.g. when replacing the battery).
- Never use a fast charger to charge the battery. The battery cables should be disconnected when recharging.
- The battery contains acid that is both corrosive and poisonous. It is important that the battery is handled in an environmentally friendly way. Let your Volvo dealer assist you.

### **Hoisting the car**

If a garage jack is used to lift the car, the two jack attachments points should be used. They are specially reinforced to bear the weight of the car. A garage jack can also be placed under the front of the engine support frame. Take care not to damage the splash guard under the engine. Ensure that the jack is positioned so that the car cannot slide off it. Always use axle stands or similar structures.

If a two-post hoist is used to lift the car, the front and rear lift arm pads should be centered under the reinforced lift plates on the inboard edge of the sill rail (see illustration).

### **⚠ WARNING!**

The car ignition system has very high voltage!

The voltage in the ignition system is dangerous!

Do not touch spark plugs, ignition cables or the ignition coil when the engine is running or the ignition is switched on!

**The ignition should be switched off when:**

- Conducting engine tests.
- Replacing parts in the ignition system, such as spark plugs, ignition coil, distributor, ignition cables, etc.

### **⚠ WARNING!**

**Never** try to repair any part of the SRS or SIPS bag systems yourself. Any interference in the system could cause malfunction and serious injury. Any work should only be performed by an authorized Volvo workshop.

### Belt check

Check the belt regularly to make sure it is in good condition and is clean. A worn or dirty belt can cause poor cooling and low alternator output as well as impair the operation of the power steering and the air conditioning unit.

**NOTE:** The drive belt is equipped with a self-tensioning mechanism and requires no adjustment between changes!

#### **WARNING!**

The engine must not be running when this check is performed.

### Check coolant level

The cooling system must be filled with coolant and not leak to operate at maximum efficiency. Check the coolant level regularly. The level should be between the "MAX" and "MIN" marks on the expansion tank. The check should be made with particular thoroughness when the engine is new or when the cooling system has been drained.

Do not remove the filler cap other than for topping up with coolant. Frequent removal may prevent coolant circulation between the engine and the expansion tank during engine warm up and cooling.

### Changing coolant

Normally, the coolant does not need to be changed. If the system must be drained, consult your Volvo retailer.

**NOTE:** Do not top off with water only. This reduces the rust-protective and antifreeze qualities of the coolant and has a lower boiling point. It can also cause damage to the cooling system if it should freeze. Top off with Volvo Genuine Coolant/Antifreeze only (a 50/50 mix of water and antifreeze).

### CAUTION:

The cooling system must always be kept filled to the correct level. If it is not kept filled, there can be high local temperatures in the engine which could result in damage. Different types of antifreeze/coolant may not be mixed.

#### **WARNING!**

Never remove the radiator cap while the engine is warm. Wait until the car cools.

## Hood and engine compartment

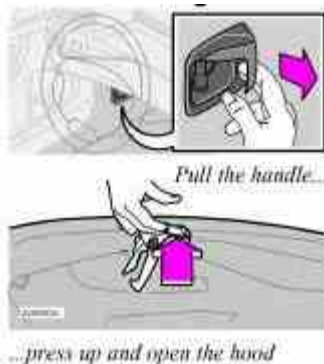

## Opening the hood

- Pull the lever located under the left side of the dash to release the hood lock.
- Lift the hood slightly.
- Press up the release control located under the front edge of the hood (at the center) and lift.

### **⚠ WARNING!**

Check that the hood locks properly when closed!

## Engine compartment

1. Expansion tank - coolant
2. Power steering fluid reservoir
3. Washer fluid reservoir
4. Dipstick - engine oil
5. Radiator
6. Cooling fan
7. Oil filler cap - engine
8. Clutch/brake fluid reservoir
9. Relay/fuse box
10. Air cleaner
11. Battery (in trunk)
12. Data plate

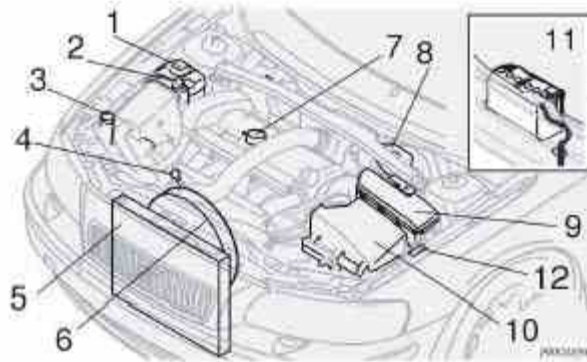

### **⚠ WARNING!**

The cooling fan (6) may start or continue to operate (for up to 6 minutes) after the engine has been switched off.

pg. 123 Maintenance and service

## Oils and fluids

### Oil quality

Engine oil must meet the minimum ILSAC specification GF-2, including ACEA A1, API SJ, SJ/CF and SJ/ Energy Conserving.

Your Volvo has been certified to standards using ILSAC oil specification GF-2 5W-30. Volvo recommends use of oil with a quality rating equal to or higher than ILSAC GF-2. Equivalent and better oils include ACEA A1, API SJ, SJ/CF, and SJ/Energy conserving. Lower quality oils may not offer the same fuel economy, engine performance, or



engine protection.

Volvo Cars recommends Castrol.

Depending on your driving habits, premium or synthetic oils may provide superior fuel economy and engine protection. Consult your Volvo retailer for recommendations on premium or synthetic oils.

### **Oil additives must not be used.**

**NOTE:** Synthetic oil is not used when the oil is changed at normal maintenance services. This oil is only used at customer request, at additional charge. Please consult your Volvo retailer.

### **Operation in hot climates**

When temperatures exceed 86° F (30° C) in your area, Volvo recommends, for the protection of your engine, that you use a heavier weight oil, such as SAE 10W/30. See the viscosity chart below.

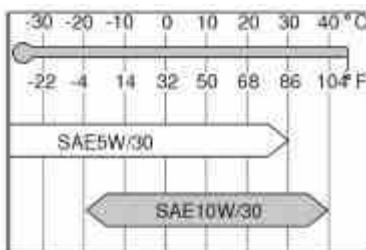

### **Oil viscosity (stable ambient temperatures)**

#### **Operation in temperate climates**

Incorrect viscosity oil can shorten engine life. Under normal use when temperatures do not exceed 86° F (30° C), SAE 5W/30 will provide good fuel economy and engine protection. See the viscosity chart above.

#### **Extreme engine operation**

Synthetic oils meeting SAE 10W/30 and complying with oil quality requirements are recommended for driving in areas of sustained temperature extremes (hot or cold), when towing a trailer over long distances, and for prolonged driving in mountainous areas.

#### **Changing oil and oil filter**

Oil and oil filter changes should be made at 7,500 mile (12,000 km) intervals.

#### **Volvo does not recommend the use of oil additives.**

**Synthetic oil is not used when the oil is changed at the normal maintenance service intervals.**



- The API Service Symbol "donut" is divided into three parts:
- The top half describes the oil's performance level.
- The center identifies the oil's viscosity.
- The bottom half tells whether the oil has demonstrated energy-conserving properties in a standard test in comparison to a reference oil.

# Oils and fluids (Contd)

## Checking the oil level

The oil level should be checked every time the car is refueled. This is especially important during the period up to the first service.

### CAUTION:

Not checking the oil level regularly can result in serious engine damage if the oil level becomes too low.

Park the car on a level surface and wait for at least 5 minutes after the engine has been switched off. Be sure the oil level is maintained between the upper and lower marks on the dipstick. Low oil level can cause internal damage to the engine and overfilling can result in high oil consumption. The distance between the dipstick marks represents approx. 1.6 US qt (1.5 liter). The oil should preferably be checked when cold, before the engine has been started.

**NOTE:** The engine must be stopped when checking the oil.

### WARNING!

Do not allow oil to spill onto or come into contact with hot exhaust pipe surfaces.

## Adding oil (topping up)

- Add oil of the same kind as already used.
- Capacity (including filter): Normally-aspirated 5-cylinder engine - 5.8 US qts (5.5 liters). Turbo 5-cylinder engine - 6.1 US qts (5.8 liters).
- The oil filter should be replaced at every oil change.

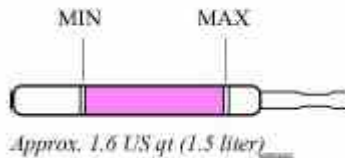

pg. 125 Maintenance and service

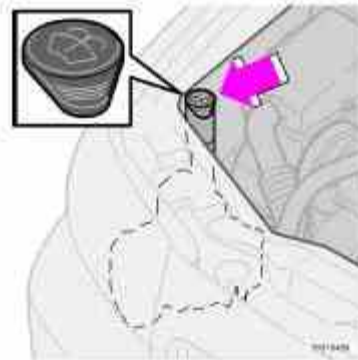

*Washer fluid reservoir*

## Washer fluid reservoir

The washer fluid reservoir is located in the engine compartment and holds approx. 4.7 US qts. (4.5 liters).

During cold weather, the reservoir should be filled with windshield washer solvent containing antifreeze.

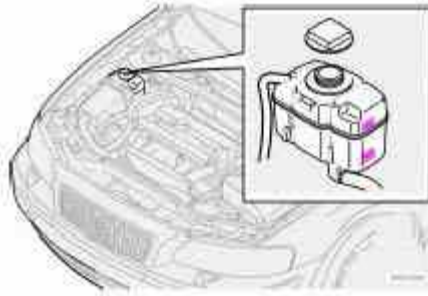

*Coolant reservoir*

### **Changing coolant**

Normally, the coolant does not need to be changed. If the system must be drained, consult your Volvo retailer.

**NOTE:** Do not top off with water only. This reduces the rust-protective and antifreeze qualities of the coolant and has a lower boiling point. It can also cause damage to the cooling system if it should freeze. Top off with Volvo Genuine Coolant/Antifreeze only (a 50/50 mix of water and antifreeze).

---

### **CAUTION:**

The cooling system must always be kept filled to the correct level. If it is not kept filled, there can be high local temperatures in the engine which could result in damage. Different types of antifreeze/coolant may not be mixed. Check coolant regularly!

### **⚠ WARNING!**

Never remove the radiator cap while the engine is warm. Wait until the car cools.

If it is necessary to top up the coolant when the engine is warm, unscrew the expansion tank cap slowly so that the overpressure dissipates.

pg. 126 Maintenance and service

## **Oils and fluids (Contd)**

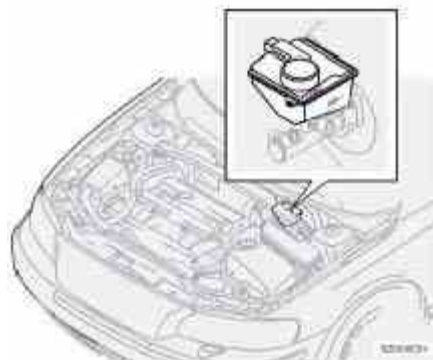

### **Clutch and brake fluid reservoir**

The clutch and brake fluid should always be above the MIN mark on the side of the reservoir. Check, without removing the cap, that there is sufficient fluid in the reservoir.

**Fluid type:** DOT 4+ boiling point > 536° F (280° C), P/N 9437433

**Replace:** Every second year or 30,000 miles (48,000 km). The fluid should be replaced once a year or every 15,000 miles (24,000 km) when driving under extremely hard conditions (mountain driving, etc.)

Always entrust brake fluid changing to an authorized Volvo retailer.

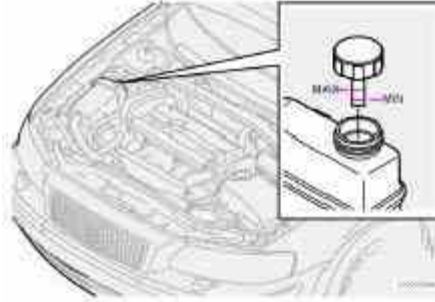

### **Power steering fluid reservoir**

The fluid level should always be between the MIN and MAX marks.

**Fluid type:** ATF

**Replace:** No fluid change required

**NOTE:** If a problem should occur in the power steering system or if the car has no electrical current and must be towed, it is still possible to steer the car. However, keep in mind that greater effort will be required to turn the steering wheel.



[Contents](#) | [Top of Page](#)

# 2003 VOLVO S60

## Specifications

### pg. 143 Specifications

Label information	<a href="#">144</a>
Dimensions, weights	<a href="#">145</a>
Capacities	<a href="#">147</a>
Lubricants	<a href="#">148</a>
Cooling system	<a href="#">148</a>
Three way catalytic converter	<a href="#">149</a>
Suspension	<a href="#">150</a>
Bulbs	<a href="#">151</a>
Electrical system	<a href="#">152</a>
Engine specifications	<a href="#">153</a>
Transmission	<a href="#">154</a>

### pg. 144 Specifications

## Label information

### 1 Vehicle Emission Control Information

Your Volvo is designed to meet all applicable emission standards, as evidenced by the certification label on the underside of the hood. For further information regarding these regulations, please consult your Volvo retailer.

### 2 Vacuum hose routing

(underside of hood)

### 3 Loads and Tire Pressures

(on inside of fuel filler door)

### 4 Model plate

Vehicle Identification Number (VIN). Codes for color and upholstery, etc. The plate is located in the engine compartment, on the inside of the left front fender.

### 5 Vehicle Identification Number (VIN) \*

The VIN plate is located on the top left surface of the dashboard. The VIN is also stamped on the right hand door pillar.

### 6 Federal Motor Vehicle Safety Standards (FMVSS) specifications (USA) and Ministry of Transport (CMVSS) standards (Canada)

Your Volvo is designed to meet all applicable safety standards, as evidenced by the certification label on the facing side of the driver's door. For further information regarding these regulations, please consult your Volvo retailer.

## 7 Child safety latch label

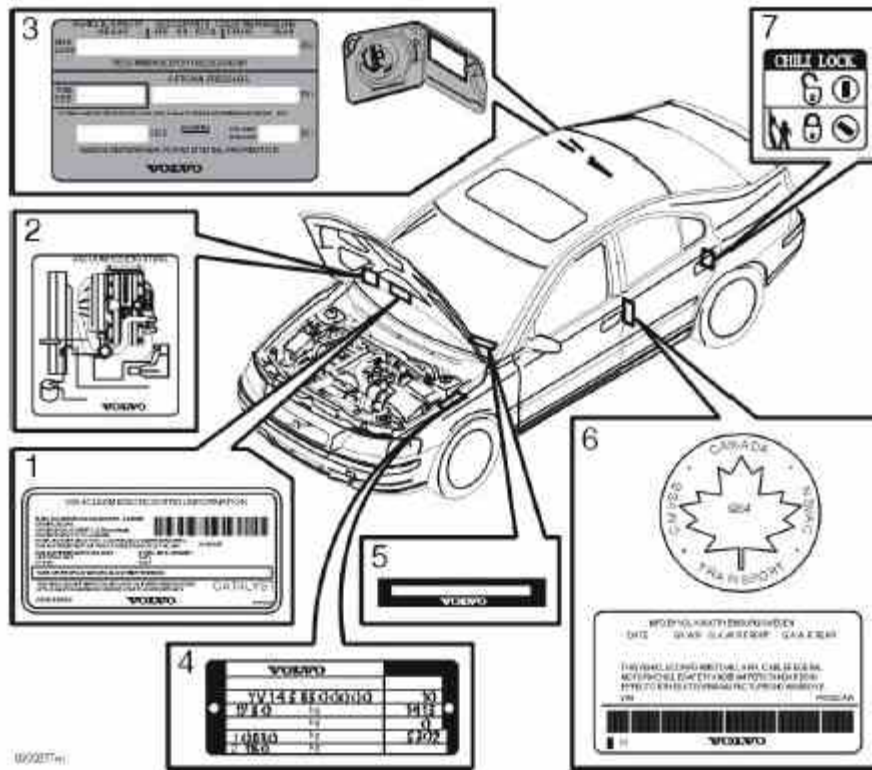

\*The Vehicle Identification Number (VIN) should always be quoted in all correspondence concerning your vehicle with the retailer and when ordering parts.

pg. 145 Specifications

## Dimensions, weights

### Dimensions

Length 180 in. (458 cm)

Width 71 in. (180 cm)

Height 56.2 in. (143 cm)

Wheelbase 107 in. (272 cm)

Front track 61.5 in. (156 cm)

Rear track 61.4 (156 cm)

Turning circle, between curbs 35.4- 38.7 ft. (10.8- 11.8 m)

Cargo capacity, trunk SAE V1 - 13.9 (394)

### Weights

#### *Gross vehicle weight \**

5 cyl. (manual transmission)

USA 4360 lbs

Canada 1980 kg

5 cyl. (automatic transmission)

USA 4400 lbs

Canada 1996 kg

5 cyl. turbo (manual transmission)

USA 4430 lbs

Canada 2010 kg

5 cyl. turbo (automatic transmission)

USA 4470 lbs

Canada 2030 kg

5 cyl. turbo (automatic transmission) AWD

USA 4540 lbs

Canada 2060 kg

***Capacity weight***

5 cyl./5 cyl. turbo

USA 890 lbs

Canada 400 kg

5 cyl. turbo AWD

USA 860 lbs

Canada 390 kg

***Permissible axle weights, front \****

5 cyl.

USA 2330 lbs

Canada 1060 kg

5 cyl. turbo

USA 2400 lbs

Canada 1010 kg

5 cyl. turbo AWD

USA 2420 lbs

Canada 1100 kg

***Permissible axle weights, rear \****

5 cyl./5 cyl. turbo

USA 2220 lbs

Canada 1010 kg

5 cyl. turbo AWD

USA 2310 lbs

Canada 1050 kg

***Curb weight***

5 cyl.

USA 3240- 3345 lbs

Canada 1475- 1517 kg

5 cyl. turbo

USA 3335- 3430 lbs

Canada 1515- 1560 kg

5 cyl. turbo AWD  
USA 3535- 3570 lbs  
Canada 1605- 1625 kg

\* Permissible axle weight or gross vehicle weight must never be exceeded.

pg. 146 Specifications

## Dimensions, weights

Max. loads,

Max. roof load 220 lbs 100 kg

Max. trailer weight

**without** brakes 1100 lbs (500 kg)

**with** brakes 2" ball 3300 lbs (1500 kg)

1 7/ 8" ball 3300 lbs (1500 kg)

Max. tongue weight \*\* 165 lbs (75 kg)

\*\* See also section "Trailer towing"

\* When driving for prolonged periods at temperatures above 86°F (30°C), the maximum recommended weight is 2000 lbs (900 kg).

### **WARNING!**

When adding accessories, equipment, luggage and other cargo to your vehicle, the total capacity weight must not be exceeded.

pg. 147 Specifications

## Capacities

**Fuel tank** 18.5/19 US gal. (70/72 liters)\*

### **Engine oil**

B5244S 5.8 US qts. (5.5 liters)

B5234T3 6.1 US qts. (5.8 liters)

B5244T3 6.1 US qts. (5.8 liters)

B5254T2 6.1 US qts. (5.8 liters)

### **Transmission oil**

manual (M 56) 2.2 US qts. (2.1 liters)

automatic (AW 55-50) 7.9 US qts. (7.5 liters)

### **Miscellaneous**

Power steering 0.9 US qts. (0.9 liters)

Windshield washer reservoir 4.8 US qts. (4.5 liters)

Brake and clutch fluid 0.69 US qts. (0.65 liters)

Air conditioning system 2.2 lbs. (1 kg) R 134a



\* 19 US gals (72 liters) on models equipped with All Wheel Drive.

Minimum octane requirement - AKI 87 (RON 91) unleaded fuel (See also [page 78](#))

pg. 148 Specifications

## Lubricants

### Engine oil

Meeting minimum ILSAC specification GF- 2, including ACEA A1, API SJ, SJ/ CF and SJ/Energy Conserving.

**Volvo does not recommend the use of oil additives.**

### Transmission

#### Oil grade:

Manual: Volvo synthetic transmission oil 97308

Automatic: Volvo transmission oil 1161540-8

Different types of oil should never be mixed.

Power steering

**Grade:** ATF

### Brake fluid

Fluid type: Brake fluid DOT 4+ boiling point > 536°F (280° C), P/N 94374433

## Cooling system

**Type** Positive pressure, closed system.

**Coolant** Volvo original coolant/antifreeze

**Volume** 5 cyl. non-turbo

8.5 US qts. (8.0 liters)

5 cyl. turbo

9.3 US qts (8.8 liters)

The thermostat begins to open at 194°F (90° C).

pg. 149 Specifications

## Three way catalytic converter

### Three-way catalytic converter cautions

- Keep your engine properly tuned. Certain engine malfunctions, particularly involving the electrical, fuel or distributor ignition systems, may cause unusually high three-way catalytic converter temperatures. Do not continue to operate your vehicle if you detect engine misfire, noticeable loss of power or other unusual operating conditions, such as engine overheating or backfiring. A properly tuned engine will help avoid malfunctions that could damage the three-way catalytic converter.
- Do not park your car over combustible materials, such as grass or leaves, which can come into contact with the hot exhaust system and cause such materials to ignite under certain wind and weather conditions.
- Excessive starter cranking (in excess of one minute), or an intermittently firing or flooded engine can cause three-

way catalytic converter or exhaust system overheating.

- Remember that tampering or unauthorized modifications to the engine, the Electronic Control Module, or the vehicle may be illegal and can cause three-way catalytic converter or exhaust system overheating. This includes:
  - Altering fuel injection setting or components.
  - Altering emission system components or location or removing components.
  - Repeated use of leaded fuel.

**NOTE:** Unleaded fuel is required for cars with three-way catalytic converters.)

pg. 150 Specifications

## Bulbs

<b>Bulbs</b>	<b>Output Socket</b>	
Low beam	55 W	H 7
High beam	55 W	HB3
Fog lights, front	55 W	H 1
Side indicator lamps	P10 W	-
Turn signals, parking lights, front	21 W	PY
Turn signals, rear	21 W	PY
Parking lights, rear	5 W	BA 15 s
Brake light	21 W	BA 15 s
Back up lights	21 W	BA 15 s
Fog light/ Parking lights, rear	5 W	BA 15 s
License plate lighting	5 W	W 2.1x9.5 d
Courtesy lighting, front	5 W	SV 8.5
Trunk lighting	5 W	SV 8.5
Glove compartment lighting	2 W	BA 9 s
Vanity mirror	1.2 W	12V

pg. 151 Specifications

## Suspension

<b>Wheel dimension</b>	<b>15"</b>	<b>16"</b>
Rim diameter (mm)	415	440
tire side diameter(mm)	515	540
Toe-in front (degrees)	0.1°± 0. 1°	0.1°± 0. 1°
Toe-in rear (degrees)	0.2°+± 0.2°	0.2±± 0. 2°
Toe-in front (mm) rim measurement	2.2± 0.7	2.3± 0.8
tire side measurement	2.7± 0.9	2.8± 0.9
Toe-in rear (mm) rim measurement	1.4± 1.4	1.5± 1.5
tire side measurement	1.8± 1.8	1.9± 1.9

### Rear suspension

Individual rear wheel suspension with longitudinal support arms, double link arms and track rods.

### Front suspension

Spring strut suspension with integrated shock absorbers and control arms linked to the support frame. Power-assisted rack and pinion steering. Safety type steering column.

pg. 152 Specifications

## Electrical system

12-volt system with voltage controlled generator. Single wire system in which the chassis and engine block are used as conductors, grounded on the chassis.

### Battery

Voltage 12 V

Cold start capacity (CCA) 600 A

Reserve capacity (RC) 115 min

If you must replace your battery, be sure to replace it with a battery of the same cold start capacity and reserve capacity as the original (See the decal on the battery).

**Generator max. current** 140 A

**Starter motor, power** 1.4 kW

**Spark plugs** P/N272313-8 or equivalent

Gap 0.028- 0.032 in. 0.7-0.8 mm

Tightening torque 22 ft. lbs. (30 Nm)

Firing order 1-2-4-5-3

### WARNING!

The distributor ignition system operates at very high voltages. Special safety precautions must be followed to prevent injury. Always turn the ignition off when:

-Replacing distributor ignition components e.g. plugs, coil, etc.

-Do not touch any part of the distributor ignition system while the engine is running. This may result in unintended movements and body injury.

pg. 153 Specifications

## Engine specifications

	<b>B5244S</b>	<b>B5234T3</b>	<b>B5244T3</b>	<b>B5254T2</b>
Output (kW/rps)	123/100	184/87	147/100	154/83
(hp/rpm)	165/6000	247/5200	197/6000	208/5000
Torque (Nm/rps)	225/75	330/42-87	285/30-83	320/25-75
(ft. lbs./rpm)	166/4500	243/2400-5200	210/1800-5000	236/1500-4500
No. of cylinders	5	5	5	5
Bore (mm)	83	81	83	81

Stroke (mm)	90	90	90	93.2
Cylinder displacement, l	2.44 (148.6 cu. in.)	2.3 (141.5 cu. in.)	2.44 (148.6 cu. in.)	2.52 (153.8 cu. in.)
Compression ratio	10.3:1	8.5:1	9.0:1	9.0:1

### Charge air cooler (Intercooler)

Turbocharged engines employ a turbo-compressor to force air into the engine inlet manifold and a charge air cooler to cool the compressed inlet air. The resulting increase in air flow raises pressure in the intake manifold and increases engine power over that developed by the normally-aspirated engine. The charge air cooler (which resembles a radiator) is located between the turbo-compressor and inlet manifold.

### Fuel system

The engine is equipped with a multiport fuel injection system.

pg. 154 Specifications

## Transmission

### Gear ratios

Gear	M56H	M56L	AW55-50
1st	3.07: 1	3.39: 1	4.77: 1
2nd	1.77: 1	1.90: 1	3.00: 1
3rd	1.19: 1	1.19: 1	1.96: 1
4th	0.87: 1	0.87: 1	1.32: 1
5th	0.70: 1	0.70: 1	1.02: 1
Reverse	2.99: 1	3.30: 1	3.23: 1
Final drive	4.25: 1	4.00: 1	2.44: 1

pg. 155 Specifications

### Volvo On Call Roadside Assistance

Your new Volvo comes with a four year ON CALL roadside assistance. Additional information, features, and benefits are described in a separate information package in your glove compartment.

If you have misplaced your package, dial:

In the U.S.A.

1-800-638-6586 (1-800-63-VOLVO)

In Canada:

1-800-263-0475

### Technician certification

In addition to Volvo factory training, Volvo supports certification by the National Institute for Automotive Excellence (A.S.E.). Certified technicians have demonstrated a high degree of competence in specific areas. Besides passing exams, each technician must also have worked in the field for two or more years before a certificate is issued. These professional technicians are best able to analyze vehicle problems and perform the necessary service procedures to keep your Volvo at peak operating condition.



# 2003 VOLVO S60

## Audio

pg. 157 Audio

Audio system HU-613 - overview	<a href="#">158</a>
Audio system HU-803 - overview	<a href="#">159</a>
Audio systems HU-613/HU-803	<a href="#">160</a>
Program types (HU-803 only)	<a href="#">165</a>
AUM (Advanced User Mode)	<a href="#">166</a>
Audio system HU-613 - cassette deck	<a href="#">167</a>
Audio system HU-613/HU-803 - CD player	<a href="#">169</a>
Audio system HU-613/HU-803 - CD changer (accessory)	<a href="#">171</a>
Dolby Surround Pro Logic HU-803 (option)	<a href="#">172</a>
Audio systems - specifications	<a href="#">174</a>
Audio systems - general information	<a href="#">175</a>
HomeLink® Universal Transceiver - T5 (option on 2.4/2.4T)	<a href="#">176</a>

pg. 158 Audio

## Audio system HU-613 - overview

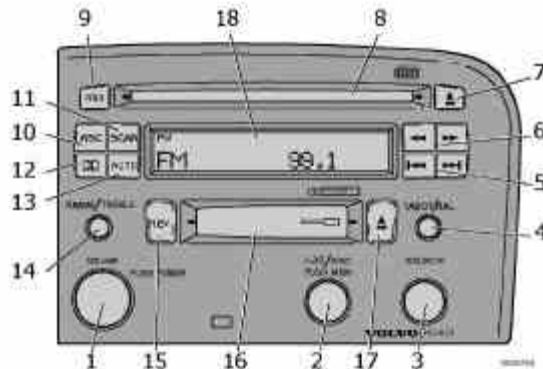

1. On/ off - press  
Volume - turn
2. Selector knob for:  
Stored radio frequencies  
CD changer - selecting disc
3. Selector knob:  
Radio  
Cassette  
CD

- CD changer (option)
- 4. Fader - press and turn
  - Balance - press, pull and turn
- 5. Radio - Station seek up/down
  - Cassette - selecting next/previous track
  - CD - Selecting next/previous track
- 6. Radio - Manual station selection
  - Cassette - Fast winding forward/backward
  - CD - Fast forwards/backward
- 7. CD eject
- 8. CD slot
- 9. CD random play
- 10. Active Sound Control (ON or OFF)
- 11. Scan function
- 12. Dolby B Noise Reduction
- 13. Automatic presetting of radio stations
- 14. Bass - press and turn
  - Treble - press, pull and turn
- 15. Tape direction selector
- 16. Cassette opening
- 17. Cassette eject
- 18. Display

pg. 159 Audio

## Audio system HU-803 - overview

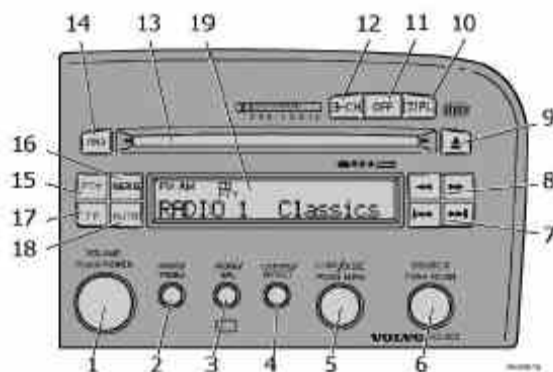

- 1. On/ off - press
  - Volume - turn
- 2. Bass - press and turn
  - Treble - press, pull and turn
- 3. Fader - press and turn
  - Balance - press, pull and turn
- 4. Center volume - press and turn
  - Effect channel volume - press, pull and turn
- 5. Selector knob for:
  - Stored radio frequencies
  - CD - selecting disc
- 6. Selector knob:
  - Radio
  - Internal CD changer

- Station scan - press
- External CD changer (option)
- 7. Radio - Station seek up/down
  - CD - Selecting next/previous track
- 8. Radio - Manual station selection
  - CD - Fast forward/backward
- 9. CD eject
- 10. Dolby Pro Logic - switching on
- 11. 2 channel stereo
- 12. 3 channel stereo
- 13. CD slot
- 14. CD random play
- 15. Program type
- 16. News
- 17. Traffic information
- 18. Automatic presetting of radio stations
- 19. Display

pg. 160 Audio

## Audio systems HU-613/HU-803



### Switch on/off

Press the knob to switch on or turn off the radio.

### Volume control

Turn the knob clockwise to increase volume. Volume control is electronic and does not have an end stop. If you have a key pad in the steering wheel, increase or decrease the volume with the + or - buttons.



### Band selector

Turn "SOURCE" knob to select FM or AM. The station and band are displayed. You can also select cassette deck, CD, or the optional CD changer if connected, with this knob.

### Active sound control (ASC)

The ASC (Active Sound Control) automatically adapts volume to vehicle speed.

Press the ASC button (HU-613) for several seconds to switch this function ON or OFF. This function is included in

the Advanced User Mode on the HU-803 equipped with this feature.

"ASC ON" or "ASC OFF" will be shown in the display for several seconds.



### **Bass**

Adjust the bass by pressing the button to extend the control and turning it to the left (less bass) or to the right (more bass). A "detent" indicates "equalized" bass. Press the button back in when you have made the adjustment.

### **Treble**

Adjust the treble by pressing the button to extend the control, pulling it out as far as possible, and then turning it to the left (less treble) or to the right (more treble). A "detent" indicates "equalized" treble. Press the button back in when you have made the adjustment.

pg. 161 Audio



### **Fader - Balance front/rear**

Adjust front/ rear speaker balance by pressing the button to extend the control and turning it to the left (more sound from the rear speakers) or to the right (more sound from the front speakers). A "detent" indicates "equalized" balance. Press the button back in when you have made the adjustment.

### **Balance right/left**

Adjust left/right speaker balance by pressing the button to extend the control, pulling it out as far as possible and then turning it to the left (more sound from the left speakers) or to the right (more sound from the right speakers). A "detent" indicates "equalized" balance. Press the button back in when you have made the adjustment.

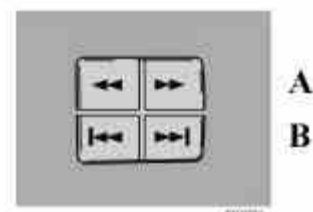

### **A - Setting station**

Press the left side of the button to select lower frequencies and the right side for higher frequencies. Set frequencies are displayed.

### **B - Station seek up/ down**

Press the left side (lower frequency) or right side (higher frequency) of the button to start the seek function. The radio





seeks the next audible station and tunes it in. Repeat the procedure to continue the seek function.

pg. 162 Audio



## Audio systems HU-613/HU-803 (contd)



### Station setting

Press the left button  to select a lower frequency and the right button  for a higher frequency. The set frequency is shown in the display.

### Station seek up/down

Press the left  or right-hand  side of the button to seek lower or higher frequencies. The radio seeks the next audible station and sets it. Press the button again to continue seek.

### Steering wheel keypad

If you have a keypad in the steering wheel, press the right or left arrow to select preset stations.

### Scan function

Press the SCAN button (HU-613) or the SOURCE knob (HU-803) to start the station scan function. When a station is found, scanning stops for several seconds, after which scanning will continue.

Press the SCAN button or SOURCE knob when a station has been found if you would like to listen to that station and to discontinue the scan function.

pg. 163 Audio



### Automatic station preset

This function seeks and stores up to 10 strong AM or FM stations in a separate memory. This function is especially useful in areas where you are not familiar with the radio stations.

1. Press in the "AUTO" button for at least 2 seconds. A number of strong signal stations (max. 10) from the currently selected waveband are now stored automatically in the memory. An "A" and "AUTO" is displayed. If there is no station with sufficient signal strength "NO STATION" is displayed.

2. Turn "1- 20/DISC" knob if you wish to change to another of the auto-stored stations.

Another auto-stored station is selected with each turn.



### **Programming stations**

1. Tune in the desired frequency.

2. Press the "1-20/DISC" knob. Select a number by turning forwards or backwards. Press again to store the selected frequency and station.

### **Preset**

To choose a pre-set station, turn "1-20/DISC" knob to the stored number. The currently selected station is displayed.

### **Radio Data System (RDS, also referred to as RBDS) - HU-803 only**

This feature, which may not work in your area, functions only with FM broadcasts. The HU-803 radio in your car is equipped with an advanced system allowing information from broadcasters to be transmitted visually, as text, together with the audio signal. This information is then decoded by the radio and made available for several new and unique features. **The RDS or Radio Data System operates in the FM band only, and the information transmitted is supplied exclusively by participating broadcasters.** Volvo has no control over the accuracy of the data or information. Please refer to the following pages regarding specific descriptions and operation of these functions.

Coverage by local broadcasters may be limited at this time, but as the technology and benefits grow, you will find the radio in your car is equipped to take advantage of this system.

pg. 164 Audio

## **Audio systems HU-613/HU-803 (contd)**



### **Traffic information (TP) - HU-803 only**

**This feature may not be apply in your area and only functions with FM broadcasts. (See previous page)**

Push the "TP" button for traffic information from RDS stations. "TP" is displayed when the function is connected.

When the unit is in Cassette or CD mode, the FM radio function will seek in the background for a station with a strong signal broadcasting traffic information. If a cassette or CD are playing when the radio receives a traffic bulletin, that function is interrupted and the bulletin is broadcast with the volume pre-selected for traffic information.

When the bulletin is finished the unit immediately returns to the previously set volume and continues playing the cassette or CD.

- Traffic information can only be heard when TP and <sup>TP</sup> are displayed at the same time.

- If only TP is displayed, it means that no traffic information is being broadcast from the current transmitter.
- If you do not wish to listen to an ongoing traffic bulletin, press the TP button. The TP function, however, is still connected and the radio waits for the next traffic bulletin.
- Press the TP button to switch off the TP function. TP will no longer be shown in the display.

### News on/ off - HU-803 only

This feature may not apply in your area and only functions with FM broadcasts. (See previous page)



Press the "NEWS" button to activate the news function. The text NEWS is displayed. Press the "NEWS" button again if you want to switch off the function.

As soon as a news broadcast begins, the news program will interrupt the Cassette, CD or CD changer.



If you do not wish to listen to the news program, press the "NEWS" button again. The news function will remain active and the radio will continue to monitor news programs.

### pg. 165 Audio

<b>Program type</b>	<b>Text displayed</b>
News	News
Information	Inform
Sports	Sports
Talk	Talk
Rock	Rock
Classic rock	Cls_ Rock
Adult hits	Adlt_ Hit
Soft rock	Soft_ Rck
Top 40	Top_ 40
Country	Country
Oldies	Oldies
Soft	Soft
Nostalgia	Nostalgia
Jazz	Jazz
Classical	Classicl
Rhythm and Blues	R_&_ B
Soft Rhythm and Blues	Soft_ R& B
Foreign language	Language
Religious music	Rel_ Musc
Religious talk	Rel_ Talk
Personality	Persnlty
Public	Public
College	College
Weather	Weather

### **Program type - HU-803 only**

The PTY function enables you to select specific types of programs. To search for a particular program type:

1. Press "PTY" button to initiate the function. The currently tuned station's program type is displayed.
2. Scroll through the list of program types by turning the "1- 20/DISC" knob.
3. When you have reached the program type you require press the "1- 20/DISC" knob to begin the search.
4. If there is more than one station with the selected program type, you can select using ,  or the scan button. The PTY function is active until the radio finds the selected program type and as long as the selected station transmits that program type.
5. To return to standby mode, press PTY again. The CD will resume playing until the selected program type is sent again.

To deactivate PTY standby, press the PTY button again. The PTY symbol will turn off.

### **Volume of traffic information/news/PTY - HU-803 only**

If you change the volume when the TP, PTY or NEWS function is active, the new volume setting will be stored automatically.



**2 0 0 3**  
**VOLVO**  
**S60**

**Index**

pg. 207 Index

**A**

A/C (air conditioning)	<a href="#">48</a> , <a href="#">51</a>
ABS	<a href="#">11</a> , <a href="#">23</a> , <a href="#">92</a>
Accessory bracket	<a href="#">62</a>
Adjustable steering wheel	<a href="#">29</a>
Advanced User Mode (AUM) - radio	<a href="#">166</a>
Air bags - dual threshold/stage	<a href="#">5</a>
Air distribution	<a href="#">45</a> , <a href="#">48</a> , <a href="#">52</a>
Air quality sensor	<a href="#">49</a>
Air vents	<a href="#">45</a>
Airbag - Side Impact (SIPS)	<a href="#">10</a>
Airbags	<a href="#">4</a>
Airbags (front)	<a href="#">4</a>
Alarm	<a href="#">67</a> , <a href="#">75</a>
All Wheel Drive	<a href="#">90</a>
All Wheel Drive - snow chains	<a href="#">107</a>
All Wheel Drive - towing	<a href="#">96</a>
Anti-lock Brake System (ABS)	<a href="#">ii</a> , <a href="#">23</a>
Approach lighting	<a href="#">32</a>
Ashtray	<a href="#">37</a> , <a href="#">61</a>
Audio	<a href="#">157</a>
Audio systems - general information	<a href="#">175</a>
Audio systems - specifications	<a href="#">174</a>
AUM	<a href="#">166</a>
AUTO	<a href="#">47</a>
AUTO (climate control)	<a href="#">47</a>
Automatic Climate Control, ECC	<a href="#">46</a>
Automatic gearbox	<a href="#">83</a>
Automatic transmission	<a href="#">86</a>
Automatic transmission - adaptive system	<a href="#">87</a>
Automatic transmission - kickdown	<a href="#">87</a>
Auxiliary lamps	<a href="#">27</a>
Average speed	<a href="#">35</a>
AWD	<a href="#">90</a>

## **B**

Back up light	<a href="#">135</a>
Backrest	<a href="#">63</a>
Bass	<a href="#">160</a>
Battery	<a href="#">120</a> , <a href="#">128</a> , <a href="#">152</a>
Battery - replacing	<a href="#">129</a>
Belt check	<a href="#">121</a>
Blower (fan)	<a href="#">47</a> , <a href="#">51</a>
Booster cushion	<a href="#">16</a>
Brake circuit	<a href="#">91</a>
Brake fluid	<a href="#">126</a>
Brake light	<a href="#">135</a>
Brake system	<a href="#">23</a> , <a href="#">91</a>
Bulbs	<a href="#">131</a> , <a href="#">150</a>

## **C**

Capacities	<a href="#">147</a>
Carbon Monoxide - Important Warning	<a href="#">79</a>
Cargo compartment	<a href="#">63</a>
Cassette player	<a href="#">167</a>
Catalytic converter	<a href="#">149</a>
CD player	<a href="#">169</a> , <a href="#">171</a>
Ceiling lighting	<a href="#">137</a>
Center console - storage compartments	<a href="#">61</a>
Central locking system - remote control	<a href="#">69</a>
Changing	<a href="#">121</a>
Changing coolant	<a href="#">121</a>
Changing oil and oil filter	<a href="#">123</a>
Changing wheels	<a href="#">110</a>
Check Engine warning light	<a href="#">25</a>
Child restraint anchorages	<a href="#">18</a>
Child safety	<a href="#">16</a>
Child safety locks	<a href="#">74</a>
Child seat (Isofix fasteners)	<a href="#">17</a>
Cigarette lighter	<a href="#">37</a>
Climate control systems -general information	<a href="#">44</a>
Clock	<a href="#">22</a>
Coat hanger	<a href="#">62</a>
Coin compartment	<a href="#">61</a>
Cold weather precautions	<a href="#">103</a>
Coolant	<a href="#">125</a>
Coolant - changing	<a href="#">121</a> , <a href="#">125</a>
Coolant - checking level of	<a href="#">121</a>
Cooling system	<a href="#">148</a>
Courtesy light	<a href="#">58</a>

Cruise control	<a href="#">36</a>
Cup holder	<a href="#">61</a>
Cup holder in rear seat	<a href="#">61</a>
Current fuel consumption	<a href="#">35</a>
<b>D</b>	
Defroster	<a href="#">47</a>
Dimension designation (tires)	<a href="#">106</a>
Direction indicator	<a href="#">135</a>
Direction indicators	<a href="#">32</a>
Dolby Surround Pro Logic	<a href="#">172</a>
Door mirror defroster	<a href="#">34</a>
Door mirrors	<a href="#">27</a>
Driving economically	<a href="#">83</a>
DSTC	<a href="#">28</a>
Dual- threshold airbags	<a href="#">5</a>
<b>E</b>	
ECC	<a href="#">46</a>
Economical driving	<a href="#">83</a>
Electric socket	<a href="#">28</a> , <a href="#">37</a>
Electrical system	<a href="#">152</a>
Electrically operated windows	<a href="#">38</a>
Engine - starting	<a href="#">81</a>
Engine compartment	<a href="#">122</a>
Engine oil	<a href="#">123</a>
Engine oil - checking	<a href="#">124</a>
Engine oil, capacity	<a href="#">147</a>
Engine specifications	<a href="#">153</a>
Environment	<a href="#">iii</a>
<b>F</b>	
Federal Clean Air Act	<a href="#">118</a>
FIX NEXT SERVICE	<a href="#">26</a>
Floor mats	<a href="#">59</a>
Fog lamp	<a href="#">25</a> , <a href="#">135</a>
Front seat - backrest	<a href="#">55</a>
Front seats	<a href="#">54</a>
Front seats - heated	<a href="#">34</a>
Front seats - manual adjustment	<a href="#">54</a>
Front seats - power	<a href="#">56</a>
Front suspension	<a href="#">151</a>
Fuel	<a href="#">ii</a> , <a href="#">78</a>
Fuel filler cap	<a href="#">ii</a> , <a href="#">80</a>
Fuel filler door	<a href="#">ii</a> , <a href="#">80</a>
Fuel filler door - unlocking	<a href="#">30</a>
Fuel Formulations	<a href="#">79</a>

Fuel gauge	<a href="#">22</a>
Fuel tank, capacity	<a href="#">147</a>
Fuses	<a href="#">138</a>
<b>G</b>	
Gasoline	<a href="#">78</a>
Gear position	<a href="#">85</a>
Geartronic	<a href="#">88</a>
Geartronic - kickdown	<a href="#">89</a>
Geartronic - manual shifting	<a href="#">89</a>
General information	<a href="#">ii</a>
Generator	<a href="#">152</a>
Generator warning light	<a href="#">25</a>
Glove compartment	<a href="#">62</a>
Grocery bag holder	<a href="#">64</a>
<b>H</b>	
Handling	<a href="#">84</a>
Hazard warning flashers	<a href="#">34</a>
Head restraint - center, rear	<a href="#">65</a>
Headlight flasher	<a href="#">32</a>
Headlight washer	<a href="#">33</a>
Headlight wiper blades	<a href="#">127</a>
Headlights	<a href="#">30</a>
Heated front seats	<a href="#">34</a> , <a href="#">48</a> , <a href="#">51</a>
High beam "flash"	<a href="#">32</a>
High beam bulb	<a href="#">133</a>
High beam indicator	<a href="#">22</a>
High/low beams - replacing	<a href="#">131</a>
Hoisting the car	<a href="#">120</a>
HomeLink® Universal Transceiver	<a href="#">176</a>
Hood	<a href="#">122</a>
Hood - opening	<a href="#">122</a>
<b>I</b>	
IC	<a href="#">12</a>
Ignition switch	<a href="#">82</a>
Immobilizer (start inhibitor)	<a href="#">68</a>
Indicator and warning symbols	<a href="#">22</a> , <a href="#">23</a>
Inflatable Curtain	<a href="#">12</a>
Instrument lighting	<a href="#">30</a>
Instrument panel	<a href="#">22</a>
Interior	<a href="#">53</a>
Interior lighting	<a href="#">58</a>
Intermittent wiping	<a href="#">33</a>
Introduction	<a href="#">i</a>
ISOFIX fasteners (child seats)	<a href="#">17</a>



## **J**

Jack [65](#) , [111](#)  
Jump starting [97](#)

## **K**

Keylock [ii](#) , [81](#)  
Keys [68](#)  
Kickdown [87](#)

## **L**

LED illumination [32](#)  
Lighting panel [30](#)  
Load carriers [102](#)  
Locking [71](#)  
Locking steering wheel [82](#)  
Locks [67](#)  
Long distance trips [104](#)  
Long loads - carrying [64](#)  
Low beam bulb [132](#)  
Lubricants [148](#)

## **M**

Maintenance Schedule [118](#)  
Malfunction indicator light [25](#)  
Manual climate control with air conditioning [50](#)  
Manual transmission [85](#)  
Messages in the display [26](#)  
Multifilter with air quality sensor [49](#)

## **O**

Occupant safety [20](#)  
Octane rating [78](#)  
Odometer [22](#)  
Oil pressure [25](#)  
Oil quality [123](#)  
Oil viscosity [123](#)  
Opening the trunk from the inside [72](#)  
Opening/ locking the trunk [72](#)

## **P**

P Park [86](#) , [88](#)  
Paint [116](#)  
Paint - color code [116](#)  
Paintwork damage [116](#)  
Parking brake [25](#) , [37](#)  
Parking lamps [30](#)  
Parking lights [30](#)  
Pen holder [62](#)  
Polishing [115](#)

Power seat	<a href="#">56</a>
Power steering fluid	<a href="#">126</a>
Power sun roof	<a href="#">41</a>
PremAir	<a href="#">iii</a>
Programme type PT	<a href="#">165</a>
PROPOSITION 65 WARNING	<a href="#">97</a>
<b>R</b>	
Radiator	<a href="#">122</a>
Radio	<a href="#">160</a>
Rain sensor	<a href="#">33</a>
Rain sensor - windshield wipers	<a href="#">33</a>
Reading lamps	<a href="#">58</a>
Rear fog lights	<a href="#">30</a>
Rear seat	<a href="#">63</a>
Rear suspension	<a href="#">151</a>
Rear window defroster	<a href="#">34</a> , <a href="#">51</a>
Rearview mirror/door mirrors	<a href="#">40</a>
Recirculation	<a href="#">48</a> , <a href="#">51</a>
REDUCE SPEED	<a href="#">26</a>
Refrigerant (A/C system)	<a href="#">44</a>
Refueling	<a href="#">48</a> , <a href="#">52</a>
Remote control - central locking system	<a href="#">69</a>
Replacing the battery	<a href="#">129</a>
Reporting safety defects	<a href="#">20</a>
Reverse gear inhibitor	<a href="#">85</a>
Roadholding	<a href="#">84</a>
Roof racks (load carriers)	<a href="#">102</a>
<b>S</b>	
Safety	<a href="#">1</a>
Safety defects - reporting	<a href="#">20</a>
Seat belt	<a href="#">2</a>
Seat belt maintenance	<a href="#">20</a>
Seat belt reminder	<a href="#">40</a>
Seat belts (keeping child seats in place)	<a href="#">19</a>
Service	<a href="#">118</a>
Service key	<a href="#">68</a>
Service reminder	<a href="#">25</a>
SERVICE REQUIRED	<a href="#">26</a>
SERVICE URGENT	<a href="#">26</a>
Shiftlock	<a href="#">ii</a> , <a href="#">81</a>
Side airbags	<a href="#">10</a>
Side marker lamp	<a href="#">135</a>
SIPS airbags	<a href="#">10</a>
Ski hatch	<a href="#">64</a>

Snow chains	<a href="#">107</a>
Snow tires	<a href="#">107</a>
Spare tires	<a href="#">108</a>
Spare wheel	<a href="#">65</a>
Spark plugs	<a href="#">152</a>
Specifications	<a href="#">143</a>
Speedometer	<a href="#">22</a>
Spoiler lamps	<a href="#">30</a>
Sport shifter	<a href="#">85</a>
SRS	<a href="#">4</a>
Stability system	<a href="#">93</a>
Stability systems	<a href="#">93</a>
Stability Traction Control (STC)	<a href="#">93</a>
Start inhibitor (immobilizer)	<a href="#">68</a>
Starting the car	<a href="#">81</a>
STC	<a href="#">27</a>
Steering	<a href="#">82</a>
Steering wheel adjustment	<a href="#">29</a>
Steering wheel lock	<a href="#">82</a>
Stone chips	<a href="#">116</a>
STOP	<a href="#">26</a>
STOP ENGINE	<a href="#">26</a>
Storage compartments	<a href="#">61</a>
Studded tires	<a href="#">107</a>
Sun roof (electrically operated)	<a href="#">41</a>
Sun visor	<a href="#">42</a>
Supplemental Restraint System (SRS)	<a href="#">4</a>
Supplemental Restraint System (SRS) - warning light	<a href="#">25</a>
Suspension	<a href="#">151</a>
Switches in the center console	<a href="#">27</a>
<b>T</b>	
Tachometer	<a href="#">22</a>
Temperature	<a href="#">47</a>
Temperature gauge	<a href="#">22</a>
Temporary spare tire	<a href="#">108</a>
Text window - messages	<a href="#">26</a>
TIME FOR REGULAR SERVICE	<a href="#">26</a>
Tires economy	<a href="#">106</a>
Tires economy - improving	<a href="#">109</a>
Tires	<a href="#">106</a>
Tires - tread wear indicators	<a href="#">109</a>
Towing	<a href="#">95</a>
Towing - cars with All Wheel Drive	<a href="#">96</a>
Towing a trailer	<a href="#">98</a>

Trailer indicator lamp	<a href="#">25</a>
Trailer towing	<a href="#">98</a>
Transmission - automatic	<a href="#">86</a>
Transmission - Geartronic	<a href="#">88</a>
Transmission - manual	<a href="#">85</a>
Transmission - sport shifter	<a href="#">85</a>
Trip computer	<a href="#">35</a>
Trip odometer	<a href="#">22</a>
Trunk - opening from the inside	<a href="#">72</a>
Trunk - unlocking	<a href="#">72</a>
Turn signals - normal turns	<a href="#">32</a>
Turn signals - lane change position	<a href="#">32</a>
Type designations	<a href="#">144</a>
<b>U</b>	
Uniform Tire Quality Grading	<a href="#">111</a> , <a href="#">112</a>
Unlocking	<a href="#">71</a>
Unlocking the trunk	<a href="#">72</a>
Use of Additives	<a href="#">79</a>
<b>V</b>	
Valet key	<a href="#">68</a>
Vanity mirror	<a href="#">59</a>
Vehicle Identification Number (VIN)	<a href="#">144</a>
Vehicle loading	<a href="#">108</a>
VIN (Vehicle Identification Number)	<a href="#">144</a>
Volvo and the environment	<a href="#">iii</a>
Volvo On Call	<a href="#">155</a>
<b>W</b>	
W - Winter	<a href="#">87</a> , <a href="#">89</a>
Warning	<a href="#">23</a>
Warning symbol in center of dashboard	<a href="#">23</a>
Warranties	<a href="#">118</a>
Washer fluid reservoir	<a href="#">122</a> , <a href="#">125</a>
Washing the car	<a href="#">114</a>
Waxing	<a href="#">115</a>
Weight distribution	<a href="#">83</a>
Weights	<a href="#">145</a>
Wheels	<a href="#">106</a>
WHIPS	<a href="#">14</a>
Windshield washer	<a href="#">33</a>
Windshield washer fluid reservoir	<a href="#">125</a>
Windshield wipers	<a href="#">33</a>
Winter tires	<a href="#">106</a>
Winter/ Wet driving mode	<a href="#">103</a>
Wiper blades	<a href="#">127</a>



[Contents](#) | [Top of Page](#)

# 2003 VOLVO S60

## Back Cover

## Back Cover

### **Accessory Installation - Important Warning**

- We strongly recommend that Volvo owners install only genuine, Volvo-approved accessories, and that accessory installations be performed only by the factory-trained technicians at your authorized Volvo retailer.
- Genuine Volvo accessories are tested to ensure compatibility with the performance, safety, and emission systems in your car. Additionally, your authorized Volvo retailer knows where accessories may and may not be safely installed in your Volvo. In all cases, please consult your authorized Volvo retailer before installing any accessory in or on your car.
- Accessories that have not been approved by Volvo may or may not be specifically tested for compatibility with your car. Additionally, an inexperienced installer may not be familiar with some of your car's systems.
- Any of your car's performance and safety systems could be adversely affected if you install accessories that Volvo has not tested, or if you allow accessories to be installed by someone unfamiliar with your car.
- Damage caused by unapproved or improperly installed accessories may not be covered by your new car warranty. See your Warranty and Service Records Information booklet for more warranty information. Volvo assumes no responsibility for death, injury, or expenses that may result from the installation of non-genuine accessories.

### **Driver Distraction**

- Driver distraction results from driver activities that are not directly related to controlling the car in the driving environment. Your new Volvo is, or can be, equipped with many feature-rich entertainment and communication systems. These include hands-free cellular telephones, navigation systems, and multipurpose audio systems. You may also own other portable electronic devices for your own convenience. When used properly and safely, they enrich the driving experience. Improperly used, any of these could cause a distraction.
- For all of these systems, we want to provide the following warning that reflects the strong Volvo concern for your safety:
  - Never use these devices or any feature of your vehicle in a way that distracts you from the task of driving safely. Distraction can lead to a serious accident. In addition to this general warning, we offer the following guidance regarding specific newer features that may be found in your vehicles:
    - Never use a hand-held cellular telephone while driving. Some jurisdictions prohibit cellular telephone use by a driver while the vehicle is moving.
    - If your car is equipped with a navigation system, set and make changes to your travel itinerary only with the vehicle parked.
    - Never program your audio system while the vehicle is moving. Program radio presets with the vehicle parked, and use your programmed presets to make radio use quicker and simpler.
    - Never use portable computers or personal digital assistants while the vehicle is moving.

A driver has a responsibility to do everything possible to ensure his or her own safety and the safety of passengers in the vehicle and others sharing the roadway. Avoiding distractions is part of that responsibility.

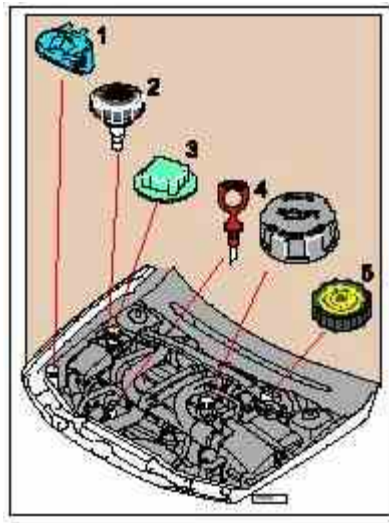

**The following should be checked regularly: \***

- 1 Washer fluid reservoir should be filled with water and solvent (wintertime: windshield washer anti-freeze). See [page 125](#).
- 2 Power steering- When cold, the level must not be above the COLD mark and when hot it must not be above the HOT mark. Top up if the level drops to the ADD mark with ATF fluid. See [page 126](#).
- 3 Coolant level should be between the expansion tank marks. Mixture: 50% anti-freeze and 50% water. See [page 121](#).
- 4 Engine oil level should be between the dipstick marks. The distance between the marks represents approx. 1.6 US qts (1.5 liters). See [page 124](#).
- 5 Brake fluid - check, without removing the cap, that the level is above the MIN mark. Use brake fluid DOT 4+. See [page 126](#).

**Fuel octane rating, see [page 78](#).**

**Tire pressure, see label located on the inside of the fuel tank cover.**

\* Engine oil should be check each time the car is refueled.

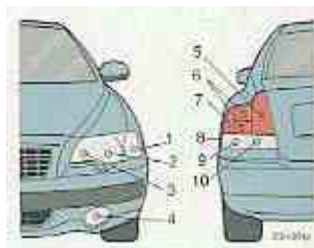

**Bulbs Power Socket US no.**

<b>Bulb no.</b>	<b>Name</b>	<b>Designation/power</b>
1	Direction indicator/parking light	PY 21 W
2	Low beam	H7 55 W
3	High beam	HB3 55 W
4	Fog light (option)	H1 55W
5	Fog light	BA 5s 21 W
6	Tail/parking light	BA 15s 5 W
7	Brake light	BA 15s 21 W
8	Side marker light	P 10 W
9	Direction indicator	PY 21 W
10	Backup light	BA 15s 21 W

---



[Contents](#) | [Top of Page](#)