

2000 VOLVO S & V 40

This manual deals with the operation and care of your Volvo.

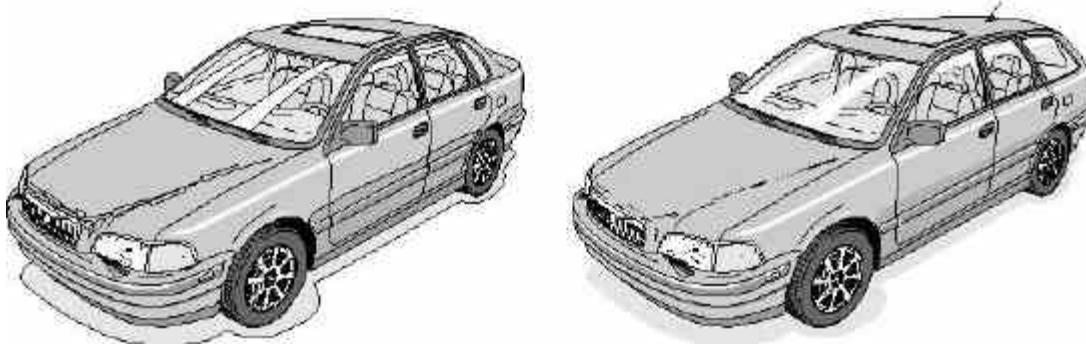

Welcome to the worldwide family of Volvo owners. We trust that you will enjoy many years of safe driving in your Volvo, an automobile designed with your safety and comfort in mind. To help ensure your satisfaction with this vehicle, we encourage you to familiarize yourself with the equipment descriptions, operating instructions and maintenance requirements/recommendations in this manual. We also urge you and your passengers to wear seat belts at all times in this (or any other) automobile. And, of course, please do not operate a vehicle if you may be affected by alcohol, medication or any impairment that could hinder your ability to drive.

Your Volvo is designed to meet all applicable safety and emission standards, as evidenced by the certification labels attached to the driver's door opening and on the left wheel housing in the engine compartment.

For further information please contact your retailer, or:

In the USA:

Volvo Cars of North America

Customer Relations

P.O. Box 914

Rockleigh, New Jersey 07647-0914

800-458-1552

We also invite you to visit our Home Page on the Internet at:

<http://www.volvocars.com>

Contents

Contents

[Chapter 1 - Occupant safety](#)

[Chapter 2 - Instruments, switches and controls](#)

[Chapter 3 - Body and interior](#)

[Chapter 4 - Starting and driving](#)

[Chapter 5 - Wheels and tires](#)

[Chapter 6 - In case of an emergency](#)

[Chapter 7 - Car care](#)

[Chapter 8 - Volvo Service](#)

[Chapter 9 - Specifications](#)

[Chapter 10 - Audio systems](#)

[Index](#)

General information

Important

Before you operate your car for the first time please familiarize yourself with the engine oil consumption information and refueling recommendations on pages 58 and 59. You should also be familiar with the information in the first three chapters of this manual.

Information contained in the balance of the manual is extremely useful and should be read after operating the vehicle for the first time.

The manual is structured so that it can be used for reference. For this reason, it should be kept in the car for ready access.

Do not export your Volvo to another country before investigating that country's applicable safety and exhaust emission requirements. In some cases it may be difficult or impossible to comply with these requirements. Modifications to the emission control system(s) may render your Volvo not certifiable for legal operation in the U.S., Canada and other countries.

All information, illustrations and specifications contained in this manual are based on the latest product information available at the time of publication. Please note that some vehicles may be equipped differently, depending on special legal requirements and that optional equipment described in this manual may not be available in all markets.

Volvo reserves the right to make model changes at any time, or to change specifications or design, without notice and without incurring obligation.

Shiftlock

When your car is parked, the gear selector is locked in the (P)ark position. To release the selector from this position, turn the ignition key to position II (or start the engine), depress the brake pedal, press the button on the front of the gear selector knob and move the selector from (P)ark.

If it is necessary to manually override the shiftlock system:

- Turn the starting (ignition) key to position I
- Press firmly on the "SHIFTLOCK OVERRIDE" button located at the base of the gear selector
- While holding the override button down, press the button on the front of the gear selector
- Move the selector from the (P)ark position.

Keylock

When you switch off the ignition, the gear selector must be in the (P)ark position before the key can be removed.

Anti-lock Brake System (ABS)

The ABS system in your car performs a self-diagnostic test when the vehicle first reaches the speed of approximately 12 mph (20 km/h). The brake pedal will pulsate several times and a sound may be audible from the ABS control module. This is normal.

Fuel filler door

When you lock the doors, the fuel filler door also locks, with a delay of 10 minutes. When all doors are unlocked, the fuel filler door is also unlocked. Your key, keyless remote, and the door lock button on the dashboard will all unlock the fuel filler door. To open the unlocked fuel filler door, press at the forward edge of the door. See pages 39 for information about locking and unlocking features.

© 1999 Volvo Cars of North America Inc.

Volvo and the environment

Volvo is committed to the well being of our customers. As a natural part of this commitment, we care about the environment in which we all live. Caring for the environment means an everyday involvement in reducing our environmental impact.

Volvo's environmental activities are based on a holistic view, which means we consider the overall environmental impact of a product throughout its complete life cycle. In this context, design, production, product use, and recycling are all important considerations.

In production, Volvo has partly or completely phased out several chemicals including freons, lead chromates, naphthanates, asbestos, mercury and cadmium; and reduced the amount of chemicals used in our plants 50% since 1991.

In use, Volvo was the first in the world to introduce into production a three-way catalytic converter with a Lambda sond, now called oxygen sensor, in 1976. The current version of this highly efficient system reduces emissions of harmful substances (CO, HC, NOx) from the exhaust pipe by approximately 95% and the search to eliminate the remaining emissions continues. Volvo is the only automobile manufacturer to offer CFC-free retrofit kits for the air

conditioning system for all models as far back as the M/Y 1975 240. Advanced electronic engine controls, refined purification systems and cleaner fuels are bringing us closer to our goal.

After Volvo cars and parts have fulfilled their use, recycling is the next critical step in completing the life cycle. The metal content is about 75% of the total weight of a car, which makes the car among the most recycled industrial products. In order to have efficient and well controlled recycling, many Volvo variants have printed dismantling manuals, indicating the weight and material of individual components. For Volvo, all homogeneous plastic parts weighing more than 1.7 oz. (50 grams) are marked with international symbols that indicate how the component is to be sorted for recycling.

In addition to continuous environmental refinement of conventional gasoline-powered internal combustion engines, Volvo is actively looking at advanced technology alternative-fuel vehicles.

When you drive a Volvo, you become our partner in the work to lessen the car's impact on the environment.

To reduce your vehicle's environmental impact, you can:

- Maintain proper air pressure in your tires. Tests have shown decreased fuel economy with improperly inflated tires
- Follow the recommended maintenance schedule
- Drive at a constant speed
- See an authorized Volvo retailer as soon as possible for inspection if the check engine (malfunction indicator) lamp illuminates, or stays on after the vehicle has started
- Properly dispose of any vehicle related waste such as used motor oil, used batteries, brake pads, etc.
- When cleaning your car, use Volvo's own car care products, all of which have systematically been adapted to the environment

For additional information regarding the environmental activities in

which Volvo Cars of North America, Inc. and Volvo Car Corporation are involved, visit our Internet Home Page at:

<http://www.volvocars.com>



[Top of Page](#)

2000
VOLVO
S & V 40

Chapter 1 - Occupant safety

pg. 1 Occupant safety

Occupant safety

Not wearing a seat belt is like believing "It'll never happen to me!" Volvo, the inventor of the three-point seat belt, urges you and all adult occupants of your car to wear seat belts and ensure that children are properly restrained, using an infant, car or booster seat determined by age, weight and height. Volvo also believes **no child should sit in the front seat of a car and that no one under 4 feet 7 inches should ride as a passenger in the front seat of any vehicle equipped with a passenger side airbag.**

Fact: In every state and province, some type of child-restraint legislation has been passed. Additionally, most states and provinces have already made it mandatory for occupants of a car to use seat belts.

So, urging you to "buckle up" is not just our recommendation - legislation in your state or province may mandate seat belt usage. The few seconds it takes to buckle up may one day allow you to say, "It's a good thing I was wearing my seat belt".



[Seat belts](#) 2

[Volvo SRS](#) 4

[Side Impact Protection System - \(SIPS\) air bag](#) 8

[Child safety](#) 9

[Occupant safety](#) 14

[Reporting Safety Defects](#) 14

pg. 2 Seat belts

Seat belts

Always fasten the seat belts before you drive or ride.

Two lights above the rear view mirror will be illuminated for 4-8 seconds after the starting (ignition) key is turned to the driving position. A chime will sound at the same time if the driver has not fastened his seat belt. The rear seats are provided with self-retracting inertial reel belts. The front seats are provided with single roller belts with tensioners.

To buckle:

Pull the belt out far enough to insert the latch plate into the receptacle (buckle for rear seats) until a distinct snapping sound is heard. The seat belt retractor is normally "unlocked" and you can move freely, provided that the shoulder belt is not pulled out too far. The retractor will lock up as follows:

- if the belt is pulled out rapidly
- during braking and acceleration
- if the vehicle is leaning excessively
- when driving in turns

For the seat belt to provide maximum protection in the event of an accident, it must be worn correctly. When wearing the seat belt remember:

- The belt should not be twisted or turned.
- The lap belt must be positioned low on the hips (not pressing against the abdomen).
- The shoulder section of the front seat >belts adjusts automatically to the driver's height.

Adjusting the shoulder belt

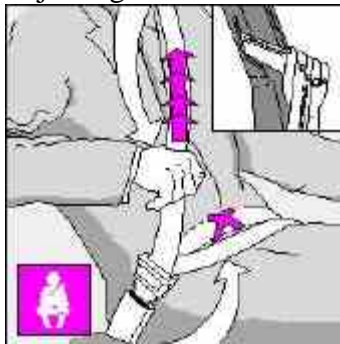

Lap portion of the seat belt should sit low

Make sure that the shoulder belt is rolled up into its retractor and that the shoulder and lap belts are taut.

Before exiting the car, check that the seat belt retracts fully after being unbuckled. If necessary, guide the belt back into the retractor slot.

NOTE: Legislation in your state or province may mandate seat belt usage.

WARNING!

Any device used to induce slack into the shoulder belt portion of the three-point belt system will have a detrimental effect on the amount of protection available to you in the event of a collision. The seat back should not be tilted too far back. The shoulder belt must be taut in order to function properly.

WARNING!

Do not use child safety seats or child booster cushions/backrests in the front passenger's seat. We also recommend that children who have outgrown these devices sit in the rear seat with the seat belt properly fastened.

pg. 3 Seat belts, Head restraints



During pregnancy

Pregnant women should always wear seat belts. Remember that the belt should always be positioned in such a way as to avoid any possible pressure on the abdomen. The lap portion of the belt should be located low, as shown in the above illustration.

WARNING!

Never use a seat belt for more than one occupant. Never wear the shoulder

portion of the belt under the arm, behind the back or otherwise out of position. Such use could cause injury in the event of an accident. As the seat belts lose much of their strength when exposed to violent stretching, they should be replaced after any collision, even if they appear to be undamaged. Never repair the belt on your own; have this work done by an authorized Volvo retailer only.

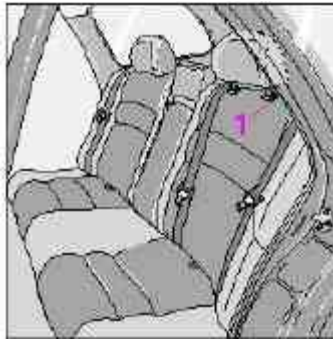

Rear head restraints

The rear head restraints can be adjusted according to the passenger's height. The restraint should be carefully adjusted to support the occupant's head.

The head restraint can be **raised** by pulling straight up or **lowered** by pressing the catch (1) at the base of the left head restraint support and pushing down.

pg. 4 Volvo SRS

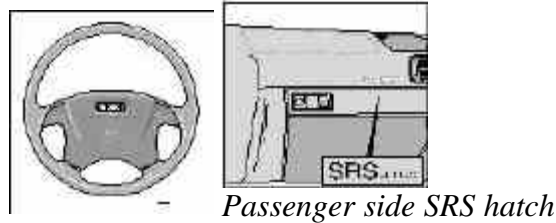

As an enhancement to the three-point seat belt system, your Volvo is equipped with a Supplemental Restraint System (SRS). The Volvo SRS consists of an airbag (2) on both the driver's and passenger's sides and seat belt tensioners in both front door pillars (4). The system is designed to supplement the protection provided by the three-point seat belt system.

The SRS system is indicated by the "SRS" embossed on the steering wheel pad and above the glove compartment, and by decals on both sun visors and on the far right side of the dash.

The airbags are folded and located in the steering wheel hub and above the glove compartment. They are designed to deploy during certain frontal or front-angular collisions, impacts, or decelerations, depending on the crash severity, angle, speed and object impacted. The airbags may also deploy in certain non-frontal collisions where rapid deceleration occurs.

The airbag system includes gas generators (1) surrounded by the airbags (2) and front seat belt tensioners for both of the front seats (4). To deploy the system, the sensor (3) activates the gas generators causing the airbags to be inflated with nitrogen gas. As the movement of the seats' occupants compresses the airbags, some of the gas is expelled at a controlled rate to provide better cushioning. Both seat belt tensioners also deploy, minimizing any seat belt slack.

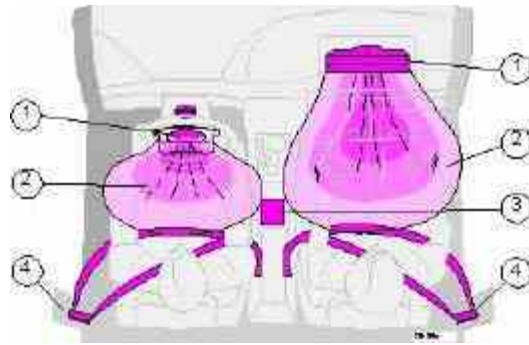

The entire process, including inflation and deflation of the airbags, takes approximately two-tenths of a second.

WARNING!

- As its name implies, SRS is designed to be a **SUPPLEMENT** to - not a replacement for - the three-point belt system. For maximum protection, wear seat belts at all times. Be aware that no system can prevent all possible injuries that may occur in an accident.
- When installing any optional equipment, make sure that the SRS system is not damaged. Do not attempt to service any component of the SRS yourself. Attempting to do so may result in serious personal injury. If a problem arises, take your car to the nearest authorized Volvo retailer for inspection as soon as possible.

pg. 5 Volvo SRS

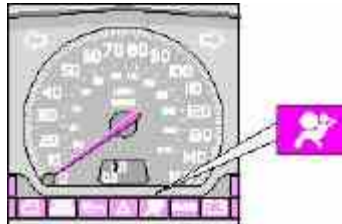

A self-diagnostic system incorporated into the sensor monitors the SRS. If a fault is detected, the "SRS" warning light will illuminate. The light is included in the warning/indicator light cluster in the instrument panel. Normally, the SRS warning lamp should light up when the ignition is switched on and should go out after 5 seconds or when the engine is started. Check that this light is functioning properly every time the car is started.

The following items are monitored by the self-diagnostic system:

- Sensor unit
- Cable harness
- Gas generator igniters

WARNING!

Never drive an SRS equipped car with your hands on the steering wheel pad / airbag housing.

No objects, accessory equipment or stickers may be placed on, attached to or installed near the SRS cover in the center of the steering wheel, the SRS cover above the glove compartment or the area affected by airbag deployment.

If the SRS warning light stays on after the engine has started or if it comes on while you are driving, drive the car to the nearest authorized Volvo retailer for inspection as soon as possible.

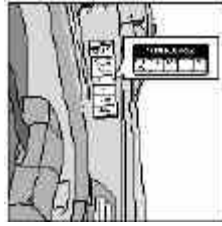

SRS decal on door pillar driver's side

There is no maintenance to perform on the SRS yourself. The month and year shown on the decal on the door pillar indicate when you should contact your Volvo retailer for specific servicing or replacement of airbags and seatbelt tensioners. This service must be performed by an authorized Volvo retailer.

Should you have any questions about the SRS system, please contact your authorized Volvo retailer or Volvo Customer Support:

In the USA:

Volvo Cars of North America

Customer Relations

P.O. Box 914

Rockleigh, New Jersey 07647-0914

800-458-1552



SRS texts on inside of both sun visors



SRS texts on outside of both sun visors



SRS texts on the passenger's dash



SRS text at far right of instrument panel

WARNING!

Do not use child safety seats or child booster cushions/backrests in the front passenger's seat. We also recommend that children who have outgrown these devices sit in the rear seat with the seat belt properly fastened.

NOTE: Deployment of SRS components occurs only one time during an accident. In a collision where deployment occurs, the air bags and seat belt tensioners activate. Some noise occurs and a small amount of powder is released. The release of the powder may appear as smoke-like matter. This is a normal characteristic and does not indicate fire.

NOTE: NOTE: Volvo's dual-threshold air bags use special sensors that are integrated with the front seat buckles. The point at which the air bag deploys is determined by whether or not the seat belt is being used, as well as, the severity of the collision. Collisions can occur where only one of the airbags deploys.

WARNING!

- Children must never be allowed in the front passenger seat. Volvo recommends that ALL occupants (adults and children) shorter than 4 feet 7 inches (140 cm) be seated in the back seat of any vehicle with a front passenger side airbag. See page 11 for guidelines.
- Occupants in the front passenger's seat must never sit on the edge of the seat, sit leaning toward the instrument panel or otherwise sit out of position. The occupant's back must be as upright as comfort allows and be against the seat back with the seat belt properly fastened.
- Feet must be on the floor, e.g. not on the dash, seat or out of the window.
- No objects or accessory equipment, e.g. dash covers, may be placed on, attached to or installed near the SRS hatch (the area above the glove compartment) or the area affected by airbag deployment (see illustration).
- There should be no loose articles, e.g. coffee cups, on the floor, seat or dash area.
- Never try to open the SRS cover on the steering wheel or the passenger side SRS seam. This should only be done by an authorized Volvo service technician.
- Failure to follow these instructions can result in injury to the vehicle occupants in an accident.

NOTE: The information on this page does not pertain to the Side Impact Protection System airbags.

When are the airbags deployed?

The SRS system is designed to deploy during certain frontal or frontangular collisions, impacts, or decelerations, depending on the crash severity, angle, speed and object impacted. The SRS sensor is designed to react to both the impact of the collision and the inertial forces generated by it and to determine if the intensity of the collision is sufficient for the airbags to be deployed.

WARNING!

The SRS is designed to help prevent serious injury. Deployment occurs very quickly and with considerable force. During normal deployment and depending on variables such as seating position, one may experience abrasions, bruises, swellings, or other injuries as a result of airbag(s) deployment.

If the airbags have been deployed, we recommend the following:

- Have the car towed to an authorized Volvo retailer. Never drive with the airbags deployed.
- Have an authorized Volvo retailer replace the SRS system components.
- Use only new, Genuine Volvo Parts when replacing SRS components (airbags, seat belts, tensioners, etc.).

When are the airbags NOT deployed?

Not all frontal collisions activate the SRS system. If the collision involves a nonrigid object (e.g., a snow drift or bush), or a rigid, fixed object at a low speed, the SRS system will not necessarily deploy. Front airbags do not normally deploy in a side impact collision, in a collision from the rear or in a rollover situation. The amount of damage to the bodywork does not reliably indicate if the airbags should have deployed or not.

Seat belts the heart of the Volvo safety system

The heart of the Volvo safety system is the **threepoint seat belt** (a Volvo invention)! In order for the SRS system to provide the protection intended, seat belts must be worn at all times by everyone in the car. **The SRS system is a supplement to the seat belts.**

WARNING!

If your car has been subjected to flood conditions (e.g. soaked carpeting/standing water on the floor of the vehicle) or if your car has become flooddamaged in any way, do not attempt to start the vehicle or put the key in the ignition before disconnecting the battery (see below). This may cause airbag deployment which could result in personal injury. Have the car towed to an authorized Volvo retailer for repairs.

Before attempting to tow the car, use the following procedure to override the shiftlock system to move the gear selector to the neutral position.

- Disconnect the battery
- Wait at least one minute
- Insert the key in the ignition and turn it to position 1
- Press firmly on the shiftlock override button (located near the base of the gear selector).
- While holding the override button down, move the gear selector from the park position.

WARNING!

Never drive with the airbags deployed. The fact that they hang out can impair the steering of your car. Other safety systems can also be damaged. The smoke and dust formed when the airbags are deployed can cause skin and eye irritation in the event of prolonged exposure.



**2000
VOLVO
S & V 40**

Chapter 2 - Instruments, switches and controls

pg. 15 Instruments, switches and controls

Instruments, switches and controls

Instruments, switches, controls etc. are described on the following pages.

[Instruments](#) 17

[Warning lights](#) 20

[Lights](#) 22

[Wipers](#) 23

[Hazard warning, Heated window, mirrors](#) 24

[Trip Computer](#) 25

[Dynamic Stability Assistance](#) 28

[Cruise control](#) 29

[Heated seats, Parking brake](#) 30

[Ashtrays](#) 31

[Steering wheel adjustment](#) 32

[Heating, Ventilation](#) 33

[Electrically operated windows](#) 36

pg. 16 Instruments, switches and controls

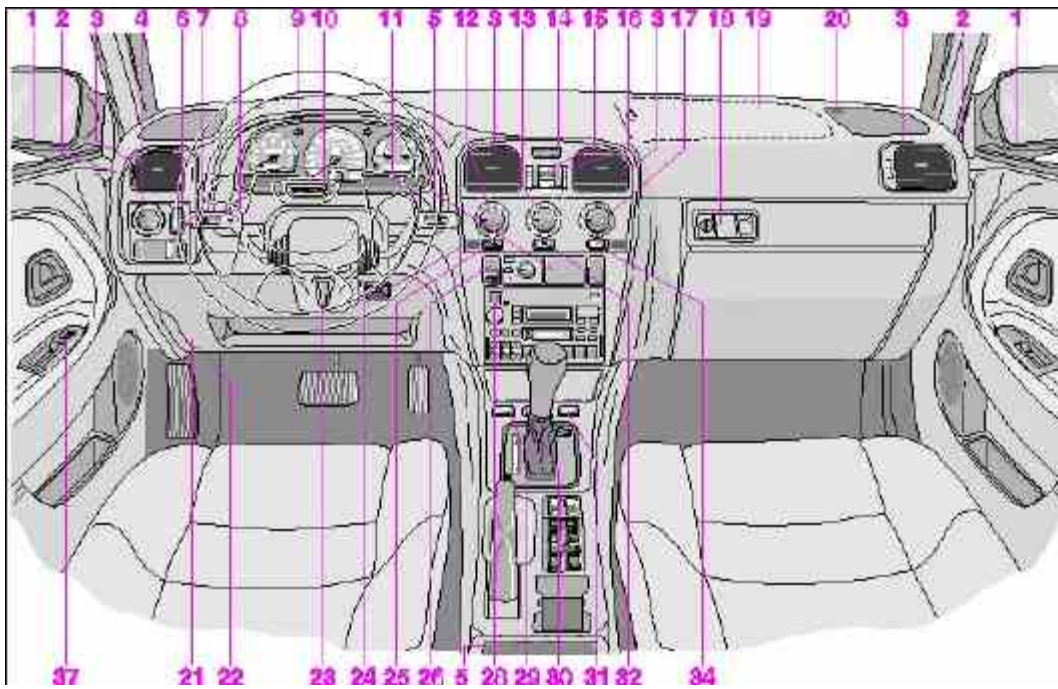

pg. 17 Instruments, switches and controls

Chapter 2 - Instruments, switches and controls

The pages in this section provide detailed descriptions of the vehicle's instruments and controls. Note that vehicles may be equipped differently, depending on special legal requirements.

	Page
1 Adjustable door mirrors	47
2 Defroster side windows	34
3 Air vents	33
4 Light switch	22
5 Cup holder	31
6 Foglight switch	22
7 Dimmer instrument lighting	22
8 Turn signals, high/low beams, Home Safe Lighting, cruise control	29
9 Instruments	18
10 Horn	
11 Windshield wash/wipe, headlight wash/wipe	23
12 Fan	34
13 Air distribution control (ECC: temperature control)	34
14 Hazard warning flashers	24
15 Mixing outside air, air vents	33
16 Air flow, air vents	33
17 Temperature control (ECC: temperature control)	34
18 Glove compartment	43
19 Passenger airbag	4
20 Light-sensitive diode for Electronic Climate Control and LED for immobilizer and alarm	35
21 Fuse box	91

22 Hood latch	50
23 Steering wheel height adjustment	32
24 ECC temperature sensor	34
25 Recirculation	35
26 Door lock switch	39
27 -	
28 Trip Computer operation	25
29 Seat heater	30
30 DSA switch (Dynamic Stability Assistance)	28
31 Seat heater	30
32 Rear window/door mirror heater switch	34
34 ECC: air-conditioning switch	34
35 Automatic transmission switch	63
36 Door mirror switch	47
37 Electric window switch front	36
38 Cut-out switch windows rear	36
39 Electric window switch rear	36

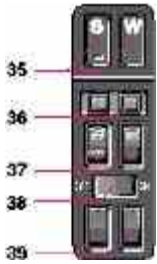

Controls in center console

Some of the items listed on this page are available on certain models only.

pg. 18 Instruments

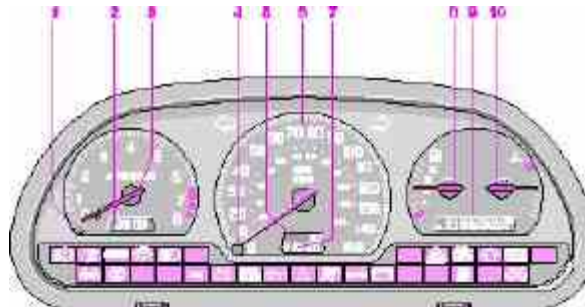

1 Clock reset knob

Turn the knob:

Clockwise: advance

Counterclockwise: set clock back The longer the knob is turned, the faster the setting will change.

2 Clock

3 Tachometer

Reads thousands of engine rpm. The needle should never be in the solid red range.

4 Trip odometer reset button

Press the button to reset the trip odometer. The ignition must be switched on.

5 Odometer

6 Speedometer

7 Trip odometer

Used for measuring shorter distances. The last digit indicates 1/10 mile/kilometer.

8 Fuel gauge

Fuel tank capacity: 16 US gallons (60 liters).

When the warning light comes on there is approximately 1.5 US gal. (7 liters) of fuel remaining. See "Refueling" for additional information. When refuelling the fuel gauge needle will not register until the volume of gasoline in the tank exceeds 3.5 US gal. (12 liters).

9 Trip Computer/Ambient temperature

NOTE: See [page 26/27](#) for information on the trip computer.

10 Temperature gauge (engine coolant)

Do not drive the car with the pointer in the red range. The pointer should be approximately midway on the gauge face when driving. If the pointer approaches the red range repeatedly, check coolant level. See [page 116](#).

pg. 19 Indicator and warning lights

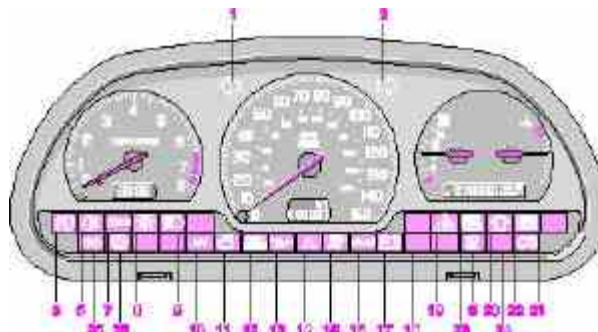

1 Turn signal, left

2 Turn signal, right

3 Fuel level low

4 Not in use

5 Front fog lamp on

6 Rear fog lamp on

7 Cruise control

8 Brake light* failure warning.

9 Main beam on

10 ABS (anti-lock brakes) malfunction

11 Door open

12 Parking brake applied

13 Low oil pressure

14 Hazard warning light on

15 Fault in SRS system

16 Brake circuit not working (brake fluid level too low) and EBD

17 Battery charge failure

- 18 Not in use
- 19 DSA (option)
- 19 Not in use
- 20 Automatic transmission: position W, 3 or L or MIL**
- 21 Check engine light
- 22 Immobilizer on or MIL**
- 23 Service Reminder Indicator
- 24 Not connected
- 25 Low washer fluid level
- 26 Turn indicator trailer (certain models)

Starting check

After a few seconds, all lights except 10 and 22 will go out. Once the engine starts, 10 and 22 will also go out.

* Indicates failure of a brake light, not failure of the braking system (see item 16).

**MIL = Check Engine Lamp

pg. 20 Warning lights

The warning lights described on [pages 20 and 21](#) should never stay on when driving

When the ignition key is turned on and before the engine starts, all of the warning lights should go on to test the function of the bulbs. Should a light not go off after the engine has started, the system indicated should be inspected. However, the parking brake reminder light will not go off until the parking brake has been fully released.

Supplemental Restraint System (SRS)

If the light comes on (or stays on after the vehicle has started), the SRS diagnostic system has detected a fault. Drive to an authorized Volvo retailer for an inspection of the system. See the SRS section for more information.

Check Engine Lamp

If the lamp comes on (or stays on after the vehicle has started), the engine diagnostic system has detected a possible fault in the emission control system. Although driveability may not be affected, see an authorized Volvo retailer as soon as possible for inspection.

NOTE: If the fuel filler cap is not closed tightly or if the engine is running when the car is refueled, the Check Engine Lamp may indicate a fault. However, your vehicle's performance will not be affected. Use only Volvo original or approved fuel filler caps.

Oil pressure warning light

If the light comes on while driving, stop the car and then stop the engine immediately and check the engine oil level. See [page 112](#). If the light stays on after restart, have the car towed to the nearest authorized Volvo retailer. After hard driving, the light may come on occasionally when the engine is idling. This is normal, provided it goes off when the engine speed is increased.

Parking brake reminder light

This light will be on when the parking brake (hand brake) is applied. The parking brake lever is situated between the front seats.

WARNING!

If the fluid level is below the MIN mark in either section of the reservoir: DO NOT DRIVE. Tow the car to a Volvo retailer and have the brake system checked and any leakage repaired.

Brake failure warning light

If the light comes on while driving or braking, stop immediately, open the hood and check the brake fluid level in the reservoir. See [page 114](#) for reservoir position.

If the control lamp still stays on, the EBD (Electronic Brakeforce Distribution) is not working.

Drive to your Volvo dealer. See ABS control lamp and also [page 69](#).

Bulb failure warning light

The light will come on if one of the brake light bulbs are defective when the brake pedal is pressed.

Check the fuse and bulb. See sections "Replacing bulbs" and "fuses."

pg. 21 Warning lights, Daytime Running Lights

DSA (option)

Dynamic Stability Assistance

This is a system which helps keep the drivewheels from spinning. The light flashes if the road surface is slippery, the wheels are spinning and the system is working.

The control light comes on if a fault occurs in the DSA system. It also comes on if the system is switched off via the switch.

For more information see [page 28](#).

Service reminder indicator

This light will come on according to preset service intervals or after 750 hours of driving or after 12 months, whichever occurs first. It is a reminder to the driver that the service interval has been exceeded. The light will stay on for 2 minutes after start until reset by the servicing retailer.

Anti-lock Brake system (ABS)

If the warning lamp lights up there is a malfunction of the ABS system (the standard braking system will however function). The vehicle should be driven to a Volvo retailer for inspection.

See [page 69](#) for additional information.

Daytime Running Lights:

The S40 and V40 come from the factory with daytime running lights activated. Carry out the following steps if you will deactivate them. These steps may be carried out again to reactivate and deactivate the daytime running lights as desired.

Programming for On or OFF

Turn the headlight switch to position .

Turn the ignition key in position II.

Pull the turn signal lever towards you and hold it while turning the headlight switch to position 0.

If the green light underneath the headlight switch is on the daytime running lights are on.

WARNING!

Do not activate or deactivate the Daytime Running Lights while driving.

pg. 22 Headlights, Parking lights, Instrument illumination, Fog lights

1 Headlights and parking lights

A green lamp (3) below the switch indicates when the lighting is on.

0 Switch position

Ignition key in positions 0+I: All lights switched off

Ignition key in position II:

Low beam headlights on (+ front and rear parking lights, license plate light and instrument lighting).

Switch position

Parking lights front and rear.

Ignition key in positions 0, I and II

Parking lights should only be used when the car is parked, **never** when the car is being driven.

It also switches on the position lights in bumpers, and license plate light (and the instrument lights in position II).

Switch position

Ignition key in positions 0 and I: All lights off.

Ignition key in position II: Headlights on (+ parking lights front and rear, license plate light, position lights in the bumpers and instrument lights).

Note: You have to turn the light switch to this position in order to switch on high beams.

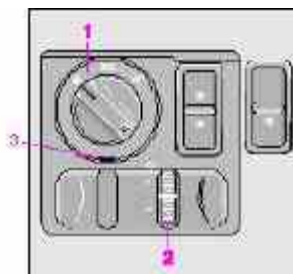

Rear fog light *

The rear fog light (located in the driver's side tail light cluster) is considerably brighter than the normal tail lights and should be used only when the atmospheric conditions, such as fog, rain, snow, smoke or dust reduce the daytime or nighttime visibility of other vehicles to less than 500 ft (150 meters).

Fog lights

Ignition key must always be in position II.

Headlight or parking lights must be activated

- Front fog lights (option): press 

- Rear fog light: press  - headlights or front fog lights must be activated

Switching fog lights off

To switch the fog lights off, press the appropriate fog light switch again.

If headlights or parking lights are switched off, the fog lights will also go out. The fog lights are also switched off when the ignition is switched off and must be switched back on manually if required when the ignition is switched on again.

The fog lights switch off automatically when the high beams are switched on.

2 Dimmer instrument lighting

Instrument lighting can be dimmed to 6% of maximum lighting.

+ brighter

- darker

* By design, there is one rear fog light only, located in the driver's side tail light cluster.

pg. 23 Turn signals, Home Safe lighting, Wipers/washers

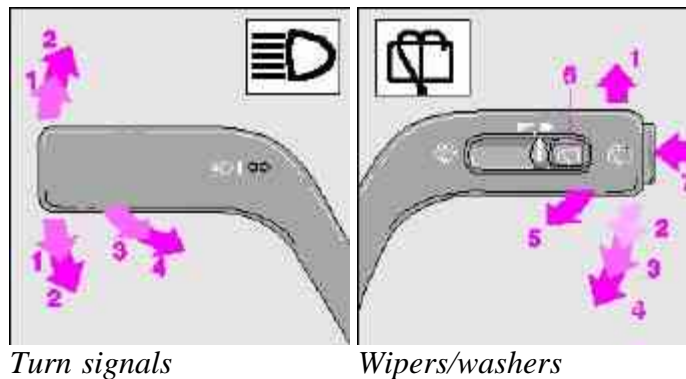

Turn signals

Wipers/washers

Turn signals

1 Lane change position. In maneuvers such as lane changing, the driver can flash the turn signals by moving the turn signal lever to the first stop and holding it there. The lever will return to the neutral position when released.

2 Signal lever engaged for normal turns.

3 High beam/low beam switch (headlights on).
Move the lever towards the steering wheel and release it.

4 Headlight flasher (headlights off).

Move the lever towards the steering wheel. The headlight high beam will be on until the lever is released.

NOTE: A defective turn signal bulb will cause the turn signal indicator and remaining signal lights to flash more rapidly than normal.

Home Safe lighting

When you leave your car at night, you can make use of the exterior courtesy lighting function:

- Remove the key from the ignition switch.
- Pull the turn signal lever towards the steering wheel (as when using the headlight flasher function).

The low beam headlights will now remain on for 30 seconds to light your way.

Repeat the above measures if you want to switch off the Home Safe Lighting.

Wipers/washers

1 "Single sweep" position:

The switch returns automatically when released.

2 Intermittent wiper

The wipers will sweep approximately every 5 seconds (car speed depending).

3 Wipers, normal speed

4 Wipers, high speed

5 Windshield wiper/washer, headlight wiper/washer.

The wipers will make 23 sweeps across the windshield and headlights and 1 sweep after 3 seconds.

6 Tailgate window wiper (V40)

The tailgate wiper switch has two positions:

OFF

ON : intermittent and synchronized with windshield wiper

Tip function

When pressing switch 7 briefly the wiper will make one sweep, independent of the interval

Backing up

When the gearlever is moved towards rear and the windshield wipers are on, the rear window wiper will come on for two sweeps.

7 Tailgate window washer (V40)

The washer keeps working for as long as you keep the button depressed.

The wiper will make 2-3 sweeps after the lever is released and 1 sweep after 3 seconds.



[Contents](#) | [Top of Page](#)

2000
VOLVO
S & V 40

Chapter 3 - Body and interior

pg. 37 Body and interior

Body and interior

The seats, sun roof, mirrors, etc. are described on the following pages.

<u>Keys</u>	<u>38</u>
<u>Doors and locks</u>	<u>39</u>
<u>Alarm</u>	<u>41</u>
<u>Trunk/tailgate</u>	<u>43</u>
<u>Child safety locks</u>	<u>44</u>
<u>Front seats</u>	<u>45</u>
<u>Rear/side view mirrors</u>	<u>47</u>
<u>Interior lights, Vanity mirror</u>	<u>48</u>
<u>Sun roof</u>	<u>49</u>
<u>Hood</u>	<u>50</u>
<u>Storage compartments</u>	<u>51</u>
<u>Trunk light, Spare tire, Jack</u>	<u>52</u>
<u>Folding rear seat</u>	<u>53</u>
<u>Folding front seat, Luggage strap</u>	<u>54</u>
<u>Side cargo net, Luggage net</u>	<u>55</u>
<u>Weight distribution, Handling, Roadholding, Roofrack</u>	<u>56</u>

pg. 38 Keys



Key

The key activates all locks (ignition switch/steering wheel lock, all doors, trunk/tailgate, fuel filler door and glove compartment).

Immobilizer (start inhibitor)

Each of the keys supplied with your car is electronically coded. When the key is inserted into the ignition switch, the code is transmitted to and compared with a code stored in the start inhibitor module. The car can only be started if a properly coded key is used.

If you misplace a key, take the other keys to an authorized Volvo retailer. The existing code in the start inhibitor module and all the keys will be erased as an antitheft measure and a new code will be programmed in.

NOTE:

You should never keep more than one of your ignition keys on the ring at the same time. This could cause conflicting signals to be transmitted to the ignition switch, making it impossible to start the car.

This device complies with part 15 of the FCC rules. Operation is subject to the following condition: (1) This device may not cause harmful interference, and (2) this device must accept any interference received, including interference that may cause undesired operation.

pg. 39 Doors and locks

Doors and locks

Your car is equipped with a central locking system.

The key, used on the driver's door, the remote control, or central locking button, will lock/unlock all doors, trunk/tailgate.

Turn the key once to unlock the driver's door and the fuel filler door.

Turn the key again within 10 seconds to unlock other doors, trunk/tailgate.

One turn with the key towards "lock" in the driver's door locks all doors, trunk/tailgate and fuel filler door with a 10 minutes delay in the fuel filler door.

WARNING!

If the doors are locked while driving, this may hinder rapid access to the occupants of the car in the event of an accident. (Also see information on "Child safety locks").

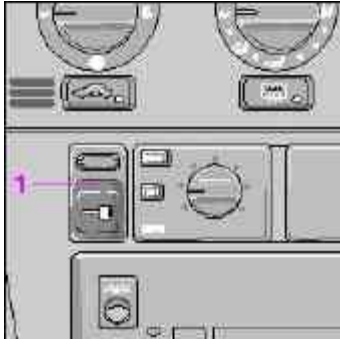

Central locking button

Central locking button

The central locking button (1) can be used to lock or unlock all doors and trunk/tailgate.

Lock: Press the lower side of the button.

Unlock: Press the upper side of the button.

Note: As long as ignition is on, you can always lock or unlock with the central locking button.

With ignition off and 25 seconds after having locked all doors and trunk/tailgate with the key or with the remote control, the central locking button will not lock or unlock the car any more.

Note: If the key is in the ignition switch and you close the driver's door, the driver's door will be immediately unlocked again in order to prevent accidentally locking the car with the keys left inside the car.

pg. 40 Remote keyless entry system

Remote keyless entry system

Your car is equipped with a remote control transmitter. This transmitter uses a radio frequency which will allow "keyless" entry into the passenger compartment or the trunk. You will be supplied with two coded key ring transmitters, which will enable you to lock/unlock all doors and the trunk/tailgate and fuel filler door from a distance of 10-15 feet (3-5 meters).

The Remote also activates/deactivates the alarm system that comes standard with this car.

The car can also be locked/unlocked with the key.

Using the remote control

- Press the **LOCK** button once to lock all doors and trunk/tailgate.
- Press the **UNLOCK** button **once** to unlock the driver's door and the fuel filler door only. Press this button again (within 10 seconds) to unlock other doors, trunk/tailgate.
- Press the **OPEN trunk/tailgate** button to unlock the tailgate/trunk.



This device complies with FCC rules Part 15. Operation is subject to the following two conditions: (1) This device may not cause harmful interference and (2) this device must accept any interference that may be received, including interference that may cause undesired operation.

NOTE: If only the driver's door is unlocked, the lock will automatically reengage (re-lock) and the alarm will be set after 2 minutes unless the door has been opened (see [page 42](#)).

The lock/unlock and alarm features can also be utilized by using the keys. See section: Doors and Locks on [page 39](#).

WARNING!

Volvo does not recommend using the transmitter to lock the doors from inside the car. The alarm would be activated and would sound when one of the doors is opened. The doors must not be locked using the remote transmitter while the vehicle is occupied. In case of an accident, this may hinder rapid access to the occupants of the vehicle.

Remote control not functioning.

If the remote control is not functioning the car can be started as follows:

Open the driver's door with the key. The alarm and alarm siren will activate.

Turn the ignition on. The alarm will deactivate.

Note: The remote control will not function if a key is left in the ignition switch.

pg. 41 Alarm

Alarm

The radio signal emitted from the transmitter, which is used to set/unset the alarm, is a "rolling code" signal. This means that the signal is changed randomly for each transmission and is intended to help prevent unauthorized recording of the code.

When armed (set), the alarm continuously monitors a number of points on the car. The following conditions will set off the alarm:

- The hood is opened
- The trunk/tailgate is opened
- A door is opened
- The ignition switch is tampered with

The alarm will sound for 30 second intervals, with a 10 second pause between intervals. This function cannot be interrupted.

· If the battery or the siren are disconnected, the alarm will sound for five minutes

Arming (setting) the alarm

Press the LOCK button on the remote control, lock the car using the key in the driver's door . One long flash of the turn signals will confirm that the alarm is set.

Disarming the alarm

Press the UNLOCK button on the remote control or unlock the driver's door with the key.

Turning off (stopping) the alarm

If the alarm is sounding, it can be stopped by pressing the UNLOCK button on the remote control or by unlocking the driver's door with the key.

Visual alarm signal

The visual alarm signal is given by flashing all turn signals and turning on the interior lighting for approximately 5 minutes.

Audible alarm signal

An audible alarm signal is given by the backup siren. One alarm cycle lasts for 30 seconds.



"Panic" function

In an emergency situation, this feature can be used to attract attention, if you are within 10-15 feet (3-5) meters of the car. .

Activate the "panic" function by pressing the red panic button on the remote control for at least 3 seconds or by pressing this button twice within 3 seconds. The turn signals will flash, the interior lights will go on and the alarm will sound.

The "panic" alarm can be turned off after 5 seconds by pressing any of the buttons on the remote control or it will stop automatically after 25 seconds.

NOTE: This button will **NOT** unlock the car.

LED alarm status signals

The status of the alarm system is indicated by the red LED at the right side of the dash:

- LED off - the alarm is not armed (set)
- LED flashes once per second - the alarm is armed (set)
- LED flashes rapidly before the ignition is switched on - the alarm has been triggered
- LED flashes rapidly for 15 seconds after the ignition has been switched on - a fault has been detected in the alarm system. Contact a Volvo retailer.

Automatic relock

If only the driver's door is unlocked with the remote control, the lock will automatically reengage (re-lock) and the alarm will be set after 2 minutes unless the door has been opened.

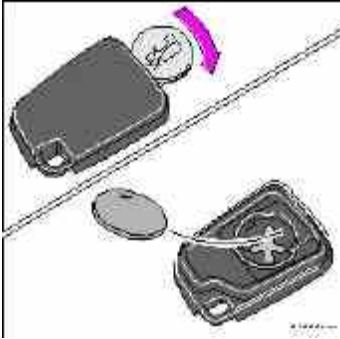

Batteries

Each remote transmitter is powered by two three-volt batteries, type CR 2016. If the range of the transmitter is noticeably reduced, this indicates that the battery is weak and should be replaced.

Replacement: Open the remote control by twisting a coin in the ring between front and back (leave the ring in place). Replace the batteries. Reinstall the cover, making sure it is secured tightly to help protect the transmitter.

CAUTION: Do not attempt to service or repair any components of the alarm system yourself. This should only be done by an authorized Volvo retailer.

pg. 43 Trunk/Tailgate, Glove compartment

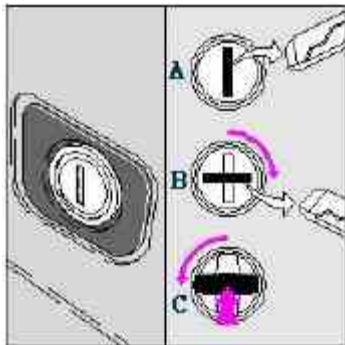

Opening/unlocking the trunk/tailgate

The trunk/tailgate locks are incorporated in the central locking system and are locked or unlocked when the driver's door is locked/unlocked.

- A - Remove key vertically:** Trunk/tailgate remains locked (disconnected from the central locking system).
- B - Turn key clockwise and remove:** Trunk/tailgate are locked/unlocked with the central locking system).
- C - Turn key counterclockwise:** Insert key and open lock without using central locking system. The key cannot be removed.

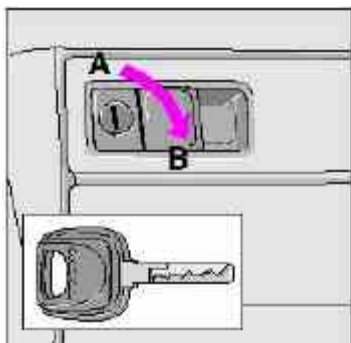

Glove compartment

The glove compartment can be locked with the key.

A unlocked

B locked



[Contents](#) | [Top of Page](#)

2000
VOLVO
S & V 40

Chapter 4 - Starting and driving

pg. 57 Starting and driving

Starting and driving

This section on starting and driving contains items such as starting the engine, operating the gear selector, towing, trailers, etc.

Fuel requirements, Refueling	58
Driving economy	60
Starting the engine	61
Automatic transmission	62
Points to remember	64
Emergency towing	66
Vehicle towing information	67
Jump starting	68
Brake system, ABS	69
Electronic Brake Force Distribution	70
Winter driving	71
Long distance trips	72
Trailer towing	73

pg. 58 Fuel requirements

NOTE ENGINE OIL:

Although some oil consumption occurs during normal engine operation, more oil is consumed when the engine is new as the internal parts generate higher friction while wearing in to each other. **From the time the engine is new until the first service is performed, the oil consumption could be higher than normal. For this reason, it is especially important to check the oil every time you refuel your car during this period. See [page 112](#).**

Deposit control gasoline (detergent additives)

Volvo recommends the use of gasoline containing deposit control additives. These additives have shown to be efficient in keeping injectors and intake valves clean. Consistent use of deposit control gasolines will help ensure good driveability and fuel economy. If you are not sure whether the gasoline contains deposit control additives, check with the service station operator.

Unleaded fuel

Each Volvo has a three-way catalytic converter and must use only unleaded gasoline. U.S. and Canadian regulations require that pumps delivering unleaded gasoline be labelled "UNLEADED". Only these pumps have nozzles which fit your car's filler inlet. It is unlawful to dispense leaded fuel into a vehicle labelled "unleaded gasoline only". Leaded gasoline damages the three-way catalytic converter and the heated oxygen sensor system. Repeated use of leaded gasoline will lessen the effectiveness of the emission control system and could result in loss of emission warranty coverage. State and local vehicle inspection programs will make detection of misfueling easier, possibly resulting in emission test failure for misfueled vehicles.

NOTE: Some U.S. and Canadian gasolines contain an octane enhancing additive called methyl-cyclopentadienyl manganese tricarbonyl (MMT). If such fuels are used, your Emission Control System performance may be affected, and the Check Engine Lamp located on your instrument panel may light. If this occurs, please return your vehicle to an authorized Volvo retailer for service.

pg. 59 Fuel requirements, Refueling

Octane rating

Volvo engines are designed for optimum performance on unleaded premium gasoline with an octane rating. AKI of 91, or above. AKI (ANTI KNOCK INDEX) is an average of the Research Octane Number, RON, and the Motor Octane Number, MON. $(RON + MON/2)$.

The minimum octane requirement is AKI 87 (RON 91).

Gasoline containing alcohol and ethers

"Oxygenated fuels"

Some fuel suppliers sell gasoline containing "oxygenates" which are usually alcohols or ethers. In some areas, state or local laws require that the service pump be marked indicating use of alcohols or ethers. However, there are areas in which the pumps are unmarked. If you are not sure whether there is alcohol or ethers in the gasoline you buy, check with the service station operator. To meet seasonal air quality standards, some areas require the use of "oxygenated" fuel.

Volvo allows the use of the following "oxygenated fuels; however, the octane ratings listed on this page must still be met.

Alcohol — Ethanol

Fuels containing up to 10% ethanol by volume may be used.

Ethanol may also be referred to as Ethyl alcohol, or "Gasohol".

Ethers — MTBE

Fuels containing up to 15% MTBE may be used.

Refueling

The fuel tank is designed to hold approximately: 16 US gallons (60 liters) with sufficient volume left over to accommodate possible expansion of the fuel in hot weather.

Fuel filler door

The fuel filler door (on the left rear fender) is unlocked along with the car's central locking system.

Open fuel filler cap slowly during hot weather conditions.

See [page 95](#) in case the fuel filler door does not unlock along with the central locking system

CAUTION:

- Do not refuel with the engine running *. Turn the ignition off or to position I. If the ignition is on, an incorrect reading could occur in the fuel gauge.
 - After refueling, close the fuel filler cap by turning it clockwise until it *clicks* into place *.
 - Avoid spilling gasoline during refueling. Gasolines containing alcohol can cause damage to painted surfaces, which may not be covered under the New Vehicle Limited Warranty.
 - Do not use gasolines containing methanol (methyl alcohol, wood alcohol). This practice can result in vehicle performance deterioration and can damage critical parts in the fuel system. Such damage may not be covered under the New Vehicle Limited Warranty.
 - Do not overfill the fuel tank. Overfilling could damage the emission control system.
-

**** If the fuel filler cap is not closed tightly or if the engine is running when the car is refueled, the Check Engine Lamp may indicate a fault. However, your vehicle's performance will not be affected. Use only Volvo original or approved fuel filler caps.***

pg. 60 Driving economy

Economical driving conserves natural resources

Better driving economy may be obtained by thinking ahead, avoiding rapid starts and stops and adjusting the speed of your vehicle to immediate traffic conditions. Observe the following rules:

- Bring the engine to normal operating temperature as soon as possible by driving with a light foot on the accelerator pedal for the first few minutes of operation. A cold engine uses more fuel and is subject to increased wear.
- Whenever possible, avoid using the car for driving short distances. This does not allow the engine to reach normal operating temperature.
- Drive carefully and avoid rapid acceleration and hard braking.
- Do not exceed posted speed limits.
- Avoid carrying unnecessary items (extra load) in the car.
- Maintain correct tire pressure. Check tire pressure regularly (check when tires are cold).
- Remove snow tires when threat of snow or ice has ended.
- Note that roof racks, ski racks, etc., increase air resistance and thereby fuel consumption.
- Avoid using automatic transmission kickdown feature unless necessary.

- Avoid using the air conditioning when it is not required. When engaged, the air conditioner's compressor places an additional load on the engine. However, please note that fuel consumption is lower with the air conditioning on than it is when driving with the air conditioning switched off and the windows down.
- Utilizing the fuel consumption modes in the Trip Computer can help you "learn" how to drive more economically.

Other factors which decrease gas mileage are:

- Worn or dirty spark plugs
- Incorrect spark plug gap
- Dirty air cleaner
- Dirty engine oil and clogged oil filter
- Dragging brakes
- Incorrect front end alignment

Some of the above mentioned items and others are checked at the standard Maintenance Service intervals.

NOTE: The automatic transmission's **(D)**rive position should be used as often as possible to help improve fuel economy.

WARNING!

It is recommended that tires of the same make and dimensions be used on all four wheels (including the use of snow tires). Do not use bias ply tires as this will adversely alter vehicle handling characteristics. Maintain correct tire pressure.

pg. 61 Starting the engine

Starting and stopping

1. Fasten the seat belt.

WARNING!

Before starting, check that the seat, steering wheel and mirrors are adjusted properly. Make sure the brake pedal can be depressed completely. Move the seat closer if necessary. Refer to section "front seats".

2. Apply the parking brake, if not already set. The gear selector is locked in the **(P)**ark position (**SHIFT LOCK**).
3. **Without touching the accelerator pedal**, turn the ignition key to the starting position. Allow the starter to operate for up to 5 seconds. Release the key as soon as the engine starts. If the engine fails to start, repeat step 3.

For cold starts at altitudes above 6000 ft (1800 meters), depress the accelerator pedal halfway and turn the key to the starting position. Release the pedal slowly when the engine starts.

4. To release the gear selector from the **(P)**ark position, the ignition key must be in position II and the brake pedal must be depressed.

See [page 95](#) for instructions on manually releasing the **SHIFTLOCK** system.

NOTE: Your car is equipped with a **KEYLOCK** system. When the engine is switched off, the gear selector must be in the **(P)**ark position before the starting key can be removed from the ignition switch.

5. Select the desired gear. The gear engages after a slight delay which is especially noticeable when selecting R.
-

CAUTION:

The engine should be idling; never accelerate until after you feel the gear engage! Too rapid acceleration immediately after selecting a gear will cause harsh engagement and premature transmission wear.

NOTE: Selecting P or N when idling at a standstill for prolonged periods of time will help prevent overheating of transmission oil.

WARNING!

Always place the gear selector in Park and apply the parking brake before leaving the vehicle. Never leave the car unattended with the engine running.

Always open the garage doors fully before starting the engine inside a garage to ensure adequate ventilation. The exhaust gases contain carbon monoxide, which is invisible and odorless but very poisonous.

CAUTION:

Never race the engine **immediately after starting**. Oil flow may not reach some lubricating points fast enough to prevent engine damage.

Do not race the engine just prior to switching off!

pg. 62 Automatic transmission

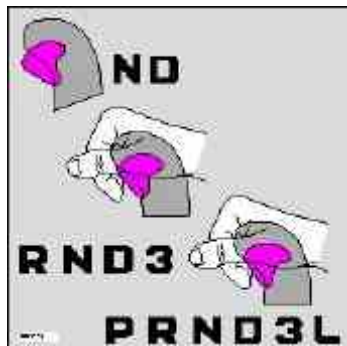

Automatic transmission - shift gate positions

The gear selector can be moved freely between N and D. Selections of other positions are obtained by depressing the selector knob prior to moving the selector.

Slightly depressing the selector knob allows selection of positions R, N, D, 3 and L. Fully depressing the selector knob allows selection of position P. This is also necessary when initially bringing the selector out of position P. Fully depressing the selector knob permits shifting freely between all positions.

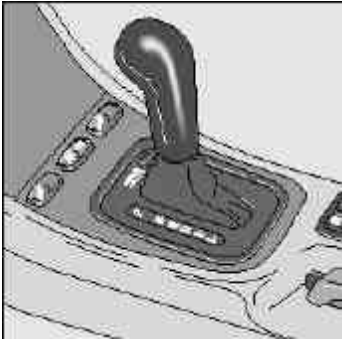

P (Park)

Use this position when starting the engine or parking the car.

Never select P while the car is in motion.

The parking brake should also be used when parking on grades.

The gear selector is mechanically locked in the P position (SHIFT LOCK). To release the selector, start the engine and depress the brake pedal.

If it is necessary to manually release the gear selector, see page 95 for instructions.

WARNING!

Never leave the car unattended when the engine is running. If, by mistake, the gear selector is moved from P, the car may start moving.

R (Reverse)

Never engage R while the car is moving forward.

N (Neutral)

Neutral = no gear engaged. Use the parking brake. The engine can be started with the gear selector in this position.

D (Drive)

D is the normal driving position and should be used as often as possible to help improve fuel economy. When the driving modes S or E are selected, upshift and downshift of the forward gears occur automatically and are governed by accelerator pedal position and engine speed.

3 (Intermediate position)

The indicator lamp in the instrument panel lights up when this gear is selected. The transmission automatically shifts up and down between 1st, 2nd, and 3rd gears when the driving modes S or E are selected. There is no upshift from 3rd gear. Position 3 can be used for driving in hilly terrain, for towing trailers or for increased engine braking power.

L (Low position)

The indicator lamp in the instrument panel lights up when this gear is selected. No upshift can occur when L is engaged. Select position L for driving in first and second gears. Use this position to select low gear with no upshift, e.g. when ascending and descending steep grades. The transmission will make a very noticeable downshift from 2nd to 1st gear if road speed drops to below 30 mph (45 km/h) in E mode or 6 mph (10 km/h) in S mode.

Kick-down

Automatic shift to a lower gear (kick-down) is achieved by depressing the accelerator pedal fully and briskly. An upshift will be achieved when approaching the top speed for a particular gear or by releasing the accelerator pedal slightly. Kick-down can be used for maximum acceleration or when passing at highway speeds. Avoid using the kick-down function during the break-in period (first 1,200 miles of vehicle operation).

"Lock-up"

The automatic transmission has a "lock-up" function which reduces engine speed and saves fuel. The "lock-up" function can sometimes be felt as an additional gear change.

Driving mode selectors

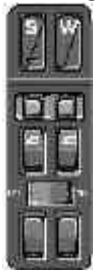

Driving mode selectors

The button at the base of the gear lever allows you to select the **Winter/Wet** driving mode.

W Winter/Wet mode Enhanced Vehicle Traction

This mode may be selected for starting/moving off on slippery roads.

- In position D*, the gearbox starts in 3rd gear and changes up to 4th gear.
- In position 3*, 2nd gear is locked and there is no change up to 3rd gear.
- In position L, 1st gear is locked.

The indicator lamp in the instrument panel  lights up when this mode is selected (even if the gear selector is in position 3 or L). Press **W** to disengage this mode. When this mode is disengaged or if the ignition is switched off, the gearbox automatically reverts to Economy (the default driving mode).

Economy mode

This is the default driving mode. The transmission changes gears at a lower engine speeds to help improve fuel consumption.

S Sport Mode

Press S to select Sport mode. The transmission shifts up and down at higher engine speeds for improved performance. The red LED in the button comes on to indicate that Sport mode is selected.

Press the switch again to return to Economy mode (the LED in the button will go out).

Check Engine Lamp

If the indicator lamp  begins to flash, this is an indication of a fault in the automatic gearbox. The Check Engine Lamp will also light up if a fault is detected. If the transmission does not shift properly, place the gear selector in position L. Please contact your Volvo retailer if this occurs.

* These positions always offer the kick-down function.



[Contents](#) | [Top of Page](#)

2000
VOLVO
S & V 40

Chapter 5 - Wheels and tires

pg. 75 Wheels and tires

Wheels and tires

The handling and riding comfort of the vehicle is dependent on the inflation pressure and the type of tires fitted. Read the following pages carefully.

[General information, Wear indicator, Tire economy, Flat spots](#) 76

[Snow chains, Winter tires](#) 77

[Inflation pressure](#) 78

[Uniform tire quality grading](#) 79

["Special spare" tire](#) 80

pg. 76 Wheels and tires

General information

Your vehicle is equipped with tires according to the tire information label located on the inside of the fuel filler door

The following is an **example** of a tire designation code 195/60R15:

195 = tire width in mm.

60 = tire profile. This is the relationship (in percent) between the section height and width of the tire.

R = radial tires.

15 = diameter in inches.

The tires have good road holding characteristics and offer good handling on dry and wet surfaces. It should be noted however that the tires have been developed to give these features on snow/icefree surfaces. However, for optimum road holding on icy or snow covered roads **we recommend suitable winter tires on all four wheels**. When replacing tires, be sure that the new tires are the same size designation, type (radial) and from the same manufacturer, on all four wheels. Otherwise there is a risk of altering the car's roadholding and handling characteristics.

NOTE: When storing wheel/tire assemblies (e.g. winter tires and wheels), either stand the assemblies upright, or suspend them off the ground. Laying wheel/tire assemblies on their sides for prolonged periods can cause wheel and/or

tire damage.

Wear indicator

The tires have a so-called "wear indicator" in the form of a number of narrow strips running across or parallel to the tread. When approx. 1/16" (1.6 mm) is left on the tread, these strips become visible and indicate that the tire should be replaced.

Tires with less than 1/16" (1.6 mm) tread have a very poor grip in rain or snow.

When replacing worn tires, it is recommended that the tire be identical in type (radial) and size as the one being replaced. Using a tire of the same make (manufacturer) will prevent alteration of the driving characteristics of the vehicle.

To improve tire economy:

- Maintain correct tire pressure. See the tire pressure label on the inside of the fuel filler door.
- Drive smoothly: avoid fast starts, hard braking and tire screeching.
- Tire wear increases with speed.
- Correct front wheel alignment is very important.
- Unbalanced wheels impair tire economy and driving comfort.
- If the wheels are rotated, they should be kept on the same side of the car so that they revolve in the same direction as prior to rotation.
- Hitting curbs or potholes can damage the tires and/or wheels permanently.

Flat spots

All tires become warm during use. After cooling, when the vehicle is parked, the tires have a tendency to distort slightly, forming flat spots. These flat spots can cause vibrations similar to the vibrations caused by unbalanced wheels. They do, however, disappear when the tire warms up. The degree to which flat spots form depends on the type of cord used in the tire. Remember that, in cold weather, it takes longer for the tire to warm up and consequently longer for the flat spot to disappear.

CAUTION: The car must not be driven with wheels of different dimensions or with a spare tire other than the one that came with the car. The use of different size wheels can seriously damage your car's transmission.

pg. 77 Wheels and tires

Snow chains

Snow chains can be used on your Volvo with the following restrictions:

- Snow chains should be installed on front wheels only. Use only Volvo approved snow chains.
- Snow chains may only be mounted on approved snow tires 195/55 R15. Consult your Volvo retailer.

If accessory, aftermarket or "custom" tires and wheels are installed and are of a size different than the original tires and wheels, chains in some cases CANNOT be used. Sufficient clearances between chains and brakes, suspension and body components must be maintained.

- Some strapon type chains will interfere with brake components and therefore CANNOT be used.

Consult your Volvo retailer for additional snow chain information.

Snow tires, studded tires *

Tires for winter use:

Owners who live in or regularly commute through areas with sustained periods of snow or icy driving conditions are strongly advised to fit suitable winter tires to help retain the highest degree of traction.

It is important to install winter tires **on all four wheels** to help retain traction during cornering, braking, and accelerating. Failure to do so could reduce traction to an unsafe level or adversely affect handling. Do not mix tires of different design as this could also negatively affect overall tire road grip. **Volvo recommends 195/55 R15 winter tires on 15" steel rims on all S/V 40 models.**

Winter tires wear more quickly on dry roads in warm weather. They should be removed when the winter driving season has ended.

Studded tires should be run 300600 miles (5001000 km) during which the car should be driven as smoothly as possible to give the studs the opportunity to seat properly in the tires. The car tires should have the same rotational direction throughout their entire lifetime. In other words, if you wish to rotate the wheels, make sure that the same wheels are always on the same side of the car.

NOTE: Please consult state or provincial regulations restricting the use of studded winter tires before installing such tires.

CAUTION:

- Check local regulations regarding the use of snow chains before installing.
- Always follow the chain manufacturer's installation instructions carefully. Install chains as tightly as possible and retighten periodically.
- Never exceed the chain manufacturer's specified maximum speed limit. (Under no circumstances should that limit be higher than 30 mph (45 km/h).
- Avoid bumps, holes or sharp turns when driving with snow chains.
- The handling of the vehicle can be adversely affected when driving with chains. Avoid fast or sharp turns as well as locked wheel braking.

* Where permitted.

- Check the tire pressure when refuelling.
- The tire pressure should be corrected only when the tires are cold.
- With warm tires, correct only when the pressure is too low. The tire temperature rises after driving just a few miles.

Vehicle loading

The tires on your Volvo will perform to specifications at all normal loads when inflated as recommended on the tire information label* located on the inside of the fuel filler flap. This label lists both tire and vehicle design limits.

Do not load your car beyond the load limits indicated.

*Please note that the tire information label indicates pressure for both comfort and fuel economy.



Tire pressure label on fuel filler door

pg. 79 Wheels and tires

Uniform tire quality grading

All passenger car tires must conform to Federal Safety Requirements in addition to these grades

TREADWEAR

The treadwear grade is a comparative rating based on the wear rate of the tire when tested under controlled conditions on a specified government test course. For example, a tire graded 150 would wear one and one half (1 1/2) times as well on the government course as a tire graded 100. The relative performance of tires depends upon the actual conditions of their use, however, and many depart significantly from the norm due to variation in driving habits, service practices and differences in road characteristics and climate.

TRACTION

The traction grades, from highest to lowest, are AA, A, B, and C, as measured under controlled conditions on specified government test surfaces of asphalt and concrete. A tire marked C may have poor traction performance.

WARNING!

The traction grade assigned to this tire is based on braking (straight-ahead) traction tests and does not include cornering (turning) traction.

TEMPERATURE

The temperature grades are AA (the highest), A, B, and C, representing the tire's resistance to the generation of heat and its ability to dissipate heat when tested under controlled conditions on a specified indoor laboratory test wheel. Sustained high temperature can cause the material of the tire to degenerate and reduce tire life, and excessive temperature can lead to sudden tire failure. The grade C corresponds to a level of performance which all passenger car tires must meet under the Federal Motor Safety Standard No. 109. Grades B and A represent higher levels of performance on the laboratory test wheel than the minimum required by law.

WARNING!

The temperature grade for this tire is established for a tire that is properly inflated and not overloaded. Excessive speed, underinflation, or excessive loading, either separately or in combination, can cause heat buildup and possible tire failure.

pg. 80 Spare tire

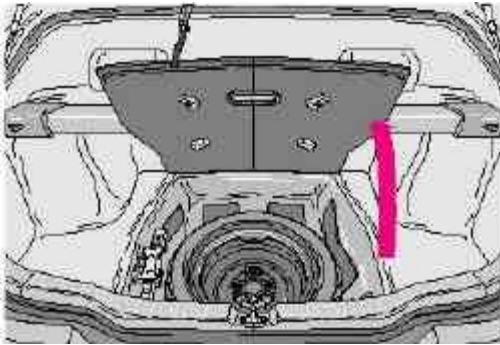

Special Spare

The spare tire in your car is called a "Special Spare". It has the following designation: 124/90 R15 96M.

Recommended tire pressure (see decal on the inside of the fuel filler door) should be maintained irrespective of which position on the car the Special Spare tire is used on.

In the event of damage to this tire, a new one can be purchased from your Volvo retailer.

WARNING!

Current legislation prohibits the use of the "Special Spare" tire other than as a temporary replacement for a punctured tire. In other words, it must be replaced as soon as possible by a standard tire. Roadholding, etc., may be affected with the "Special Spare" in use. Do not, therefore, exceed 50 mph (80 km/h).

CAUTION: The car must not be driven with wheels of different dimensions or with a spare tire other than the one that came with the car. The use of different size wheels can seriously damage your car's transmission.

CAUTION: We recommend that you switch the DSA system off whenever you use the "Special Spare" tire that does not match the diameter of your other tires. See [page 28](#).



**2000
VOLVO
S & V 40**

Chapter 6 - In case of an emergency

pg. 81 In case of an emergency

In case of an emergency

Even if you maintain your car in good running condition, there is always the possibility that something might go wrong and prevent you from driving, such as a punctured tire, blown fuse or bulb, etc. For additional information, see section "ON CALL Road Assistance".

[Tool kit, Jack](#) **82**

[Changing a wheel](#) **83**

[Replacing bulbs](#) **85**

[Replacing fuses](#) **91**

[Replacing wiper blades](#) **94**

[In case of emergency](#) **96**

[Manually closing the sun roof](#) **96**

pg. 82 Tool kit, Jack

Tool kit and jack

The tool kit and jack are under the carpet in the cargo space floor, next to the spare wheel.

Contents of tool kit

1. Combined screwdriver/socket wrench
2. Lug wrench
3. Crank (for the jack)
4. Gloves

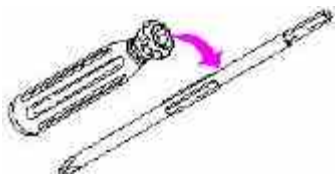

The screwdriver is combined with the socket wrench. The tools can be alternated by pulling the shaft out of the handle and reinserting the opposite end of the shaft into the handle.

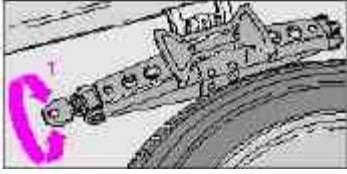

Removing the jack

Take the spare wheel out.

Tighten the jack slightly by turning the axle (1) and remove it from the retaining clip.

Replacing the jack

Put the jack in the clip and turn axle (1) until the jack is securely in place.

Replace the tools in the same place.

CAUTION:

- The car must not be driven with wheels of different dimensions or with a spare tire other than the one that came with the car. The use of different size wheels can seriously damage your car's transmission.
- Correct tightening torque on wheel bolts must be observed. The wheel bolts should never be greased or lubricated. Extended, chromed wheel bolts must not be used with steel rims, as they make it impossible to fit the hub caps.

WARNING!

- The jack (see the following pages) must be correctly placed in the jack attachment.
- Be sure the jack is on a firm, level, non-slippery surface.
- Never allow any part of your body to be extended under a car supported by a jack.
- Use the jack intended for the car when replacing a wheel. For any other job, use stands to support the side of the car being worked on.
- Apply the parking brake and put the gear selector in position P.
- Block the wheels standing on the ground, use rigid wooden blocks or large stones.
- The jack should be kept well-greased.
- Use gloves

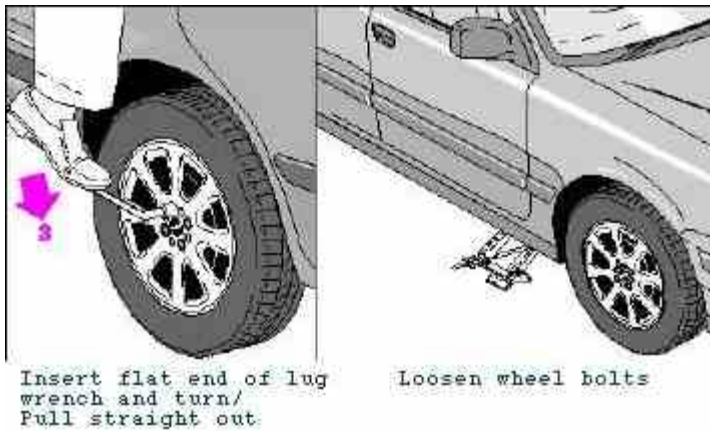

Changing a wheel

- Engage the parking brake.
- Put the gear selector in (P)ark.
- **Get all the passengers to move to a safe place outside the car.**
- **Close all doors.**
- Block the wheels remaining on the ground with wooden blocks, stones or something similar.
- Pull the wheel cover off the wheel (steel rims) or use the flat end of the lug wrench in the tool kit (1) (alloy rims) and twist it to loosen the wheel cap (2).
- With the car still on the ground, use the lug wrench to loosen the wheel bolts 1/2 1 turn. Turn the bolts counterclockwise to loosen. Press the lug wrench with your foot to loosen the bolts if necessary (3).

pg. 84 Wheel changing

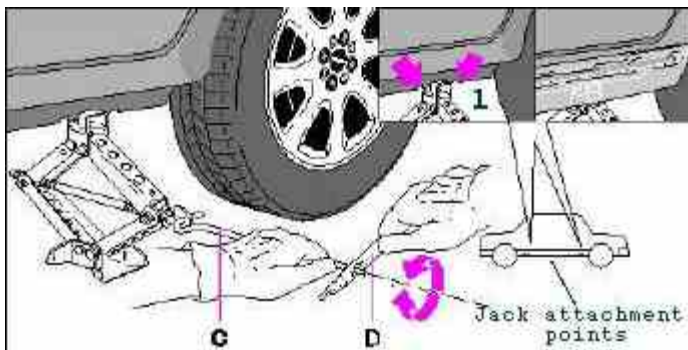

Attaching the jack

There are two jack attachment points located on each side of the car. These attachment points are marked by arrows on the outside of the cover over the bottom sill (see illustration).

Check that the **doors are closed** and stay closed all the time the car is jacked up.

- Position the jack under the two notches closest to the wheel to be changed (1).

- Attach the crank to the jack (C).
- Attach the lug wrench (D) to the crank.
- Raise the jack by cranking it clockwise. **Be sure the jack engages the attachment point correctly. The base of the jack must be flat on a level, firm, non-slippery surface. Before raising the car, check that the jack is still correctly positioned in the attachment point.**
- Raise the car until the wheel to be changed is lifted off the ground.
- Unscrew the wheel bolts completely and carefully remove the wheel so as not to damage the thread on the studs.

WARNING!

The jack must be correctly placed in the jack attachment.

Installing the wheel

Clean the contact surfaces on the wheel and

hub. Lift the wheel and place it on the hub. Install the wheel bolts crosswise and tighten by turning lightly clockwise. Lower the vehicle to the ground and alternately tighten the bolts to 81 ft. lbs. (110 Nm). Install the wheel cap (where applicable).

pg. 85 Replacing bulbs

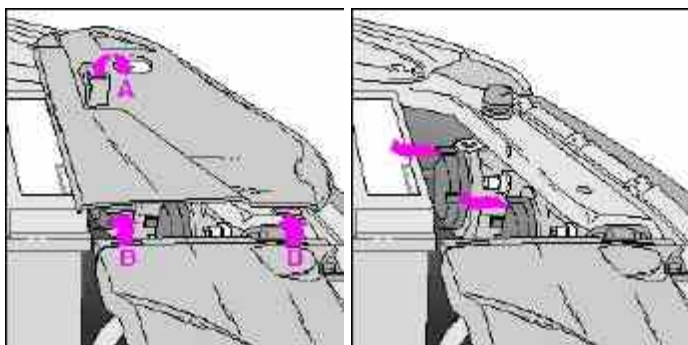

Remove cover

Removing high/low beam headlight bulbs

- Switch off the ignition
- Turn the light switch off and open the hood.
- Lift the tab (A) to release (B) the hard plastic cover above the headlight unit and remove it.
- Pull off the rubber cover from the rear of the bulb unit to be replaced.
- Release the retaining spring and withdraw the connector/bulb from the headlight unit. Pull the bulb out of the

connector.

NOTE: Never touch the glass of a bulb with your fingers: this could leave traces of grease or oil on the glass which then evaporate and may damage the reflector.

pg. 86 Replacing bulbs

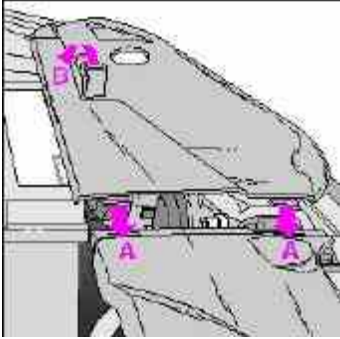

Replacing cover

Installing high/low beam headlight bulbs

- Insert the new bulb in the headlight unit
- Reconnect the connector and wiring.
- Press the retaining spring over the connector/bulb until it clicks into position.
- Reinstall the rubber cover at the rear of the headlight unit.
- Put the hard plastic cover in place above the headlight housing and press the tab down to secure the cover.

NOTE: Never touch the glass of a bulb with your fingers: this could leave traces of grease or oil on the glass which then evaporate and may damage the reflector.

pg. 87 Replacing bulbs

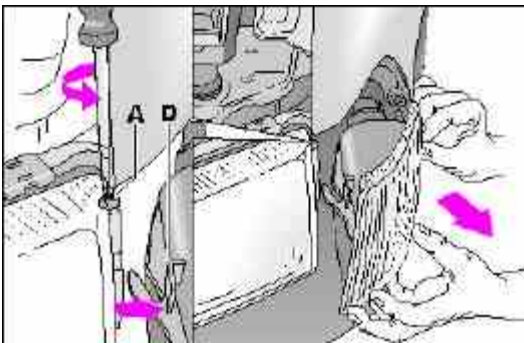

Front direction indicators and parking lights

Removing the bulb:

- Loosen the screw (A) between the headlight and direction indicator housings (max. 2 complete turns

counterclockwise), using the screwdriver supplied in the tool kit.

- Press clip D and move the direction indicator housing forward.
- With the wiring still attached, turn bulb holder slightly counterclockwise and withdraw it from the lamp housing.
- Pull the bulb to remove.

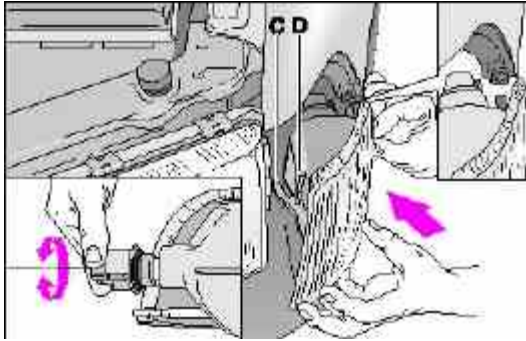

Replacement

- Insert a new bulb in the holder.
- Reinsert the bulb holder in the lamp housing and turn it clockwise until it clicks into place.
- Press the lamp housing into place.
Make sure that locating pin B fits into the hole in the fender and slotted hole (C) around the screw.
- Tighten the screw.

pg. 88 Replacing bulbs

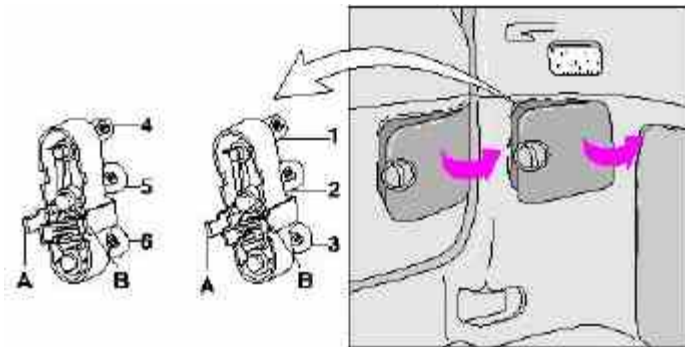

- 1 Tail light (rear parking light) 5W
- 2 Direction indicator 21W
- 3 Brake light 21W
- 4 Tail light 5W
- 5 Backup light 21W
- 6 Rear fog light (left side only) 21W

Tail light bulbs

All the bulbs in the tail light unit are replaced from inside the trunk/cargo compartment.

The bulb holders are behind one cover on each side.

V40: Bulbs 4,5 and 6 are located in the tailgate.

Procedure:

- Switch off the lights and turn the ignition key to position 0.
- Open the rear light cover. The cover is held in place by a clip.
- Press in catches A and B and remove the bulb holder.
- Leave the connector and cables connected to the bulb holder.
- Remove the bulb by pressing it inward and turning it slightly counterclockwise.
- Insert a new bulb into the bulb holder and replace the holder. Check that the bulb works and refit the cover.

pg. 89 Replacing bulbs

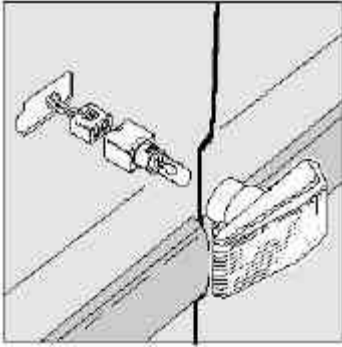

Side direction indicator

1. Slide the lens forward and pull out the rear edge.
2. Pull out the entire lens/bulb unit.
3. With the lens toward you, turn the bulb holder 1/4 turn (the wires should not be disconnected from the holder) and pull out the bulb holder from the lens unit.
4. Pull the old bulb straight out and press a new one into place.
5. Replace the entire unit in the reverse order.

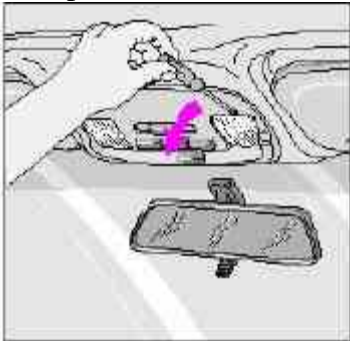

Insert screwdriver, turn and pull downward

Front courtesy lights

- Switch off the ignition.
- Insert a flat screwdriver and turn carefully to loosen the glass lens.
- Replace the bulb and press the glass lens back into place.

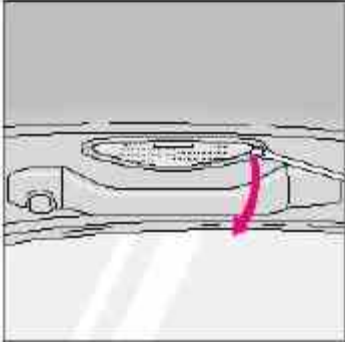

Insert a screwdriver and turn

Rear reading lights

- Switch off the ignition.
- Insert a screwdriver and turn to loosen the lamp unit.
- Replace the bulb and press the lamp unit back into place.



[Contents](#) | [Top of Page](#)

**2000
VOLVO
S & V 40**

Chapter 7 - Car care

pg. 97 Car care

Car care

Car care includes not only maintaining the appearance of the car, but also protecting the car exterior from the effects of air pollution, rain, mud or road salt. The paintwork should also be touched up immediately, if damaged, to prevent rust formation.

[Paint touchup](#) **98**

[Washing](#) **99**

[Automatic car washing, Polishing and waxing](#) **100**

[Cleaning the upholstery](#) **101**

pg. 98 Paint touch up

Paint touchup

Paint damage requires immediate attention to avoid rusting. Make it a habit to check the finish regularly when washing the car for instance. Touchup if necessary.

Paint repairs require special equipment and skill. Contact your Volvo retailer for any extensive damage.

Minor scratches can be repaired by using Volvo touchup paint.

NOTE: When ordering touchup paint from your Volvo retailer, use the paint code indicated on the model plate. The plate is located in the rear wall of the engine compartment (fire wall).

Minor stone chips and scratches

Material:

Primer can

Paint touchup bottle

Brush

Masking tape

NOTE: When touching up the car, it should be clean and dry. The surface temperature should be above 60° F (15° C).

Scratches on the surface

If the stone chip has not penetrated down to the metal and an undamaged layer of paint remains, the touchup paint can be applied as soon as the spot has been cleaned.

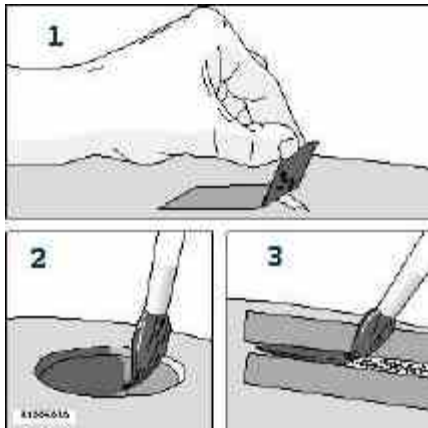

Deep scratches

1. Place a strip of masking tape over the damaged surface. Pull the tape off so that any loose flakes of paint adhere to it.
2. Thoroughly mix the primer and apply it with a small brush. When the primer surface is dry, the paint can be applied using a brush. Mix the paint thoroughly; apply several thin paint coats and let dry after each application.
3. If there is a longer scratch, you may want to protect surrounding paint by masking it off.

pg. 99 Washing

Washing the car

· The car should be washed at regular intervals since dirt, dust, insects and tar spots adhere to the paint and may cause damage.

NOTE: It is particularly important to wash the car frequently in the wintertime to prevent corrosion, when salt has been used on the roads.

- When washing the car, do not expose it to direct sunlight. Use lukewarm water to soften the dirt before you wash with a sponge, and plenty of water, to avoid scratching.
- **Bird droppings:** Remove from paintwork as soon as possible. Otherwise the finish may be permanently damaged.
- A detergent can be used to facilitate the softening of dirt and oil.
- A water-soluble grease solvent may be used in cases of sticky dirt. However, use a wash place equipped with a drainage separator.
- Dry the car with a clean chamois and remember to clean the drain holes in the doors and rocker panels.
- The power radio antenna (sedans) must be dried after washing.

- Tar spots can be removed with kerosene or tar remover after the car has been washed.
- A stiff-bristle brush and lukewarm soapy water can be used to clean the wiper blades. Frequent cleaning improves visibility considerably.
- Wash off the dirt from the underside (wheel housings fenders, etc.).
- In areas of high industrial fallout, more frequent washing is recommended.

CAUTION: During high pressure washing, the spray mouthpiece must never be closer to the vehicle than 13" (30 cm). Do not spray into the locks.

- When washing or steam cleaning the engine, avoid spraying water or steam directly on the electrical components or toward the rear side of the engine.
- After cleaning the engine, the spark plug wells should be inspected for water and blown dry if necessary.

Suitable detergents

Special car washing detergents should be used. A suitable mixture is about 2.5 fl. oz. (8.5 cl) of detergent to 2.6 US gal. (10 liters) of warm water. After washing with a detergent the car should be well rinsed with clean water.

WARNING!

- When the car is driven immediately after being washed, apply the brakes several times in order to remove any moisture from the brake linings.
- Engine cleaning agents should not be used when the engine is warm. This may constitute a fire risk.

NOTE: When washing the car, remember to remove dirt from the drain holes in the doors and sills. Bumpers: Wash the bumpers with the same cleaning agent used on the rest of the car. Never clean the bumpers with gasoline or paint thinner. Difficult spots can be removed with denatured alcohol. To avoid scratches, do not dry the bumpers with paper.

pg. 100 Automatic car washing, Polishing and waxing

Automatic washing simple and quick

Brushless car washes are recommended. An automatic wash is a simple and quick way to clean your car, but it is worth remembering that it may not be as thorough as when you yourself go over the car with sponge and water. Keeping the underbody clean is most important, especially in the winter. Some automatic washers do not have facilities for washing the underbody.

Before driving into an automatic wash, make sure that side view mirrors, auxiliary lamps, etc., are secure, otherwise there is risk of the machine dislodging them. You should also lower the antenna (sedans).

We do NOT recommend washing your car in an automatic wash during the first six months (because the paint will not have hardened sufficiently).

Polishing and waxing

Normally, polishing is not required during the first year after delivery, however, waxing is recommended.

Before applying polish or wax the car must be washed and dried. Tar spots can be removed with kerosene or tar remover. Difficult spots may require a fine rubbing compound.

After polishing use liquid or paste wax.

Several commercially available products contain both polish and wax.

Waxing alone does not substitute for polishing of a dull surface.

A wide range of polymerbased car waxes can be purchased today. These waxes are easy to use and produce a longlasting, highgloss finish that protects the bodywork against oxidation, road dirt and fading.

Note: Polishing removes oxidized paint from the surface. This is normal. Therefore, when polishing, it may be noticed that traces of paint color remain on the polishing cloth. This is also normal.

Note: Machine buffing is not recommended.

pg. 101 Cleaning the upholstery

Cleaning the upholstery

The **fabric** can be cleaned with soapy water or a detergent. For more difficult spots caused by oil, ice cream, shoe polish, grease, etc., use a clothing/fabric stain remover.

The **plastic** in the upholstery can be cleaned with a soft cloth and mild soap solution.

Leather upholstery/suede-like upholstery (alcantera™) can be cleaned with a soft cloth and mild soap solution. For more difficult spots, Volvo offers a leather care kit.

On no account must gasoline, naphtha or similar cleaning agents be used on the plastic or the leather since these can cause damage.

Cleaning the seat belts

Clean only with lukewarm water and mild soap solution.

Cleaning floor mats

The floor mats should be vacuumed or brushed clean regularly, especially during winter when they should be taken out for drying. Spots on textile mats can be removed with a mild detergent. Make sure the carpets are properly secured in the fixation points on the floor.

Bear in mind

- Take extra care when removing stains such as ink or lipstick since the coloring can spread.
- Use solvents sparingly. Too much solvent can damage the seat padding.
- Start from the outside of the stain and work toward the center.

pg. 102 Paint touch up



[Contents](#) | [Top of Page](#)

**2 0 0 0
VOLVO
S & V 40**

Chapter 8 - Volvo Service

pg. 103 Volvo Service

Service - an investment

An investment which will pay dividends in the form of improved reliability, durability and resale value.

Label information 104

Maintenance service, Warranty 105

Maintenance schedule 106

Servicing 108

Engine compartment 109

Fuel/emissions systems 110

Lubrication 111

Engine oil 112

Power steering fluid, Brake/clutch system fluid reservoir 114

Coolant 115

Windshield washer nozzle, Washer fluid reservoir 116

Battery maintenance 117

Automatic transmission fluid 118

pg. 104 Label information

1 Vehicle Emission Control Information

Your Volvo is designed to meet all applicable emission standards, as evidenced by the certification label on the underside of the hood. For further information regarding these regulations, please consult your Volvo retailer.

2 Vacuum hose routing

(underside of hood)

3 Loads and Tire Pressures

(on inside of fuel filler door)

4 Model plate

Vehicle Identification Number (VIN). Codes for color and upholstery, etc. The plate is located in the engine compartment.

5 Vehicle Identification Number (VIN) *

The VIN plate is located on the top left surface of the dashboard.

6 Federal Motor Vehicle Safety Standards (FMVSS) specifications (USA) and Ministry of Transport (CMVSS) standards (Canada)

Your Volvo is designed to meet all applicable safety standards, as evidenced by the certification label on the facing side of the driver's door. For further information regarding these regulations, please consult your Volvo retailer.

7 Child safety latch label

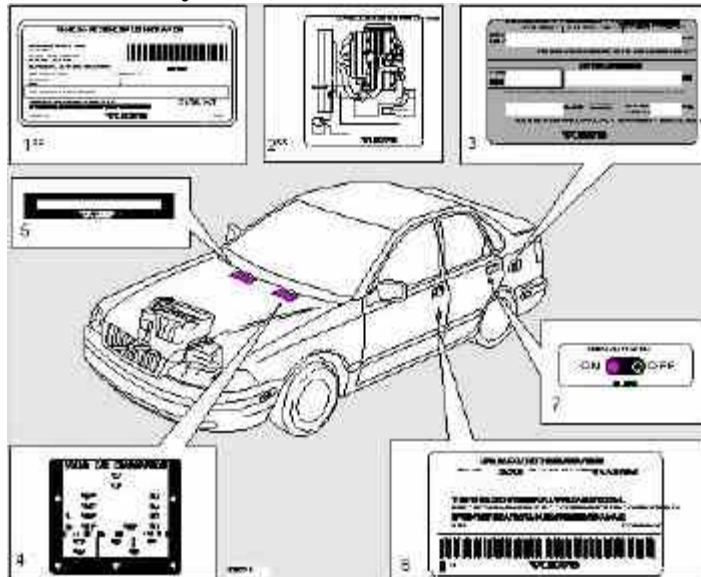

* The Vehicle Identification Number (VIN) should always be quoted in all correspondence concerning your vehicle with the retailer and when ordering parts.

** These decals are located on the underside of the hood.

All specifications are subject to change without notice.

pg. 105 Maintenance service, Warranty

Maintenance service

Volvo advises you to follow the service program which is outlined in the "Warranty and Service Records Information booklet". This maintenance program contains inspections and services necessary for the proper function of your car.

The maintenance services contain several checks which require special instruments and tools and therefore must be performed by a qualified technician. To keep your Volvo in top condition, specify time tested and proven Genuine Volvo Parts and Accessories.

The Federal Clean Air Act U.S.

The Clean Air Act requires vehicle manufacturers to furnish written instructions to the ultimate purchaser to assure the proper functioning of those components that control emissions. The maintenance instructions listed in the "Servicing" section of this Manual represent the minimum maintenance required. These services are not covered by the warranty. You will be required to pay for labor and material used. Refer to your Warranty booklet for further details.

Maintenance services

Your Volvo has passed several major inspections before being delivered to you, according to Volvo specifications. The maintenance services outlined in this book should be performed as indicated. The extended maintenance service intervals make it even more advisable to follow this program. Inspection and service should also be performed any time a malfunction is observed or suspected. It is recommended that receipts for vehicle emission services be retained in the event that questions arise concerning maintenance. See your "Warranty and Service Records Information booklet".

Applicable warranties

In accordance with U.S. Federal Regulations, the following list of applicable U.S. warranties is provided.

- New Car Limited Warranty
- Parts and Accessories Limited Warranty
- Corrosion Protection Limited Warranty
- Seat belt and Supplemental Restraint Systems Limited Warranty
- Emission Design and Defect Warranty
- Emission Performance Warranty

These are the Federal warranties; other warranties are provided as required by state law. Refer to your separate "Warranty and Service Records Information booklet" for detailed information concerning each of the warranties.

pg. 106 Maintenance schedule

2000 MAINTENANCE SCHEDULE SV40

**For complete maintenance information, please refer to your
Warranty and Service Records Information Booklet.**

- A** = Adjust (Correct if necessary)
- R** = Replace
- I** = Inspect (Correct or Replace if necessary)
- L** = Lubricate

Tires ³ , check pressure, wear and condition	I	I	I	I	I	I	I	I	I	I	I	I
Check power steering fluid level				I		I		I		I		I
Body												
Power antenna (clean)		L		L		L		L		L		L
Trunk/hood, hinges and latches				L				L				L
Cabin air filter (see page 108)		R		R		R		R		R		R

1) Replace at 105,000 miles (168,000 km)

2) Brake fluid should be changed at owner request every second year or 30,000 miles (48,000 km). The fluid should be replaced once a year or every 15,000 miles (24,000 km) when driving under extremely hard conditions (mountain driving, etc.).

3) Rotate tires at owner request.

The following items should be checked weekly by the driver (it takes only a few minutes):

Engine oil level, brake fluid level, radiator coolant level, operation of all lights, horns, windshield wipers, tire pressure (all five tires), windshield washer fluid level

The following should also be carried out at regular intervals:

Washing (check all drain holes), polishing, cleaning

pg. 108 Servicing

Air cleaner

Replace the air cleaner cartridge with a new one every 30,000 miles (48,000 km). The cartridge should be replaced more often when driving under dirty and dusty conditions. The filter cannot be cleaned and therefore should always be replaced with a new one.

Timing belt

For proper functioning of the vehicle and its emission control systems, the timing belt and tensioner must be replaced every 105,000 miles (168,000 km). Engine damage will occur if the belt fails.

Fuel system cap, tank and lines and connections

The effectiveness of the fuel system to contain hydrocarbons is dependent largely on a leakfree system. Check for proper sealing of the fuel filler cap which contains "O" ring type seals.

NOTE: If the fuel filler cap is not closed tightly or if the engine is running when the car is refueled, the Check Engine Lamp ("Check Engine") may indicate a fault. However, your vehicle's performance will not be affected. Use only Volvo original or approved fuel filler caps.

Fuel (line) filter

For proper functioning of the vehicle and its emission control systems, the fuel line filter should be replaced at 105,000 miles (168,000 km). The filter is replaced as one complete unit. Replace more frequently if contaminated fuel is introduced into the tank (or if there is reason to suspect that this has occurred).

PCV system

The orifice nipple in the intake manifold and the filter at the end of the PCV hose in the air cleaner should be inspected at 60,000 miles (96,000 km) and thereafter, at 30,000 mile (48,000 km) intervals.

Cabin air filter

Replace the cabin air filter with a new one according every 15,000 miles (24,000 km). Volvo recommends replacing the filter more often if the car is driven under dirty and dusty conditions. The filter cannot be cleaned and therefore should always be replaced with a new one.

pg. 109 Engine compartment

Engine compartment S40/V40

- 1 Power brakes
- 2 -
- 3 Brake fluid reservoir
- 4 Fusebox
- 5 Air cleaner
- 6 Battery
- 7 Oil dipstick, automatic transmission
- 8 Radiator
- 9 Oil filter
- 10 Charcoal canister (under fender)
- 11 Oil dipstick, engine
- 12 Generator
- 13 Windshield/headlight washer fluid reservoir
- 14 Power steering pump
- 15 Power steering fluid reservoir
- 16 Oil filler cap, engine
- 17 Expansion tank, coolant
- 18 Windshield wiper motor
- 19 Chassis number

- A ABS
B Air conditioning compressor
C Condenser, air conditioning
D Accumulator, air conditioning

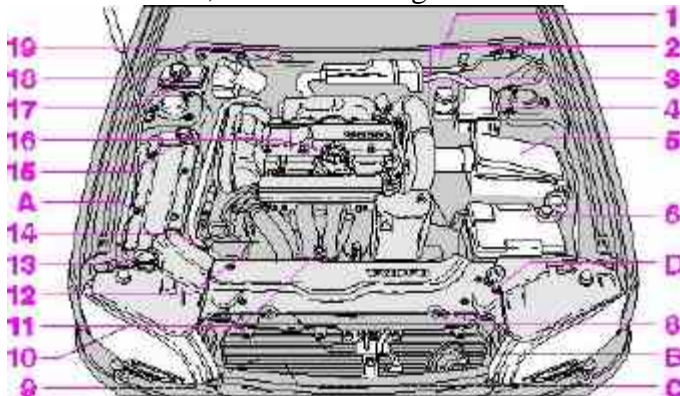

WARNING!

The coolant fan may start or continue to operate (for up to 6 minutes) after the engine has been switched off.

pg. 110 Fuel/emissions systems

Fuel system

The fuel system is allelectronic and is microprocessorcontrolled. It can continually compensate for variation in engine load, speed and temperature to give the best economy and power. A mass air flow sensor measures the inducted air. In this way the system can make instantaneous adjustments for changes in air temperature or density, thus always assuring the best economy with the lowest possible exhaust emissions.

Heated oxygen sensor

This is an emission control system designed to reduce emissions and improve fuel economy. The heated oxygen sensor monitors the composition of the exhaust gases leaving the engine. The exhaust gas analysis is fed into an electronic module. This adjusts the airfuel ratio to provide optimum conditions for combustion and efficient reduction of the three major pollutants (hydrocarbons, carbon monoxide and oxides of nitrogen (NOx) by a threeway catalytic converter.

Secondary Air Injection (certain models)

This system adds air to the hot exhaust gases as they are expelled from the engine. This causes a secondary combustion of residual hydrocarbons and carbon monoxide, resulting in lower emissions levels in the exhaust gases.

Crankcase ventilation

The engine is provided with positive crankcase ventilation which prevents crankcase gases from being released into the atmosphere. Instead, the crankcase gases are admitted to the intake manifold and cylinders.

Evaporative control system

The car is equipped with an evaporative control system which prevents gasoline vapor from being released into the atmosphere.

The system consists of a fuel tank with filler pipe and cap, a rollover valve, a Fill Limit Vent Valve (FLVV), vapor vent lines, a charcoal canister, a purge line, a purge control valve and engine connections.

In addition, there is a pressure sensor connected to the fuel tank and a filter-protected Canister Close Valve (CCV) on the atmospheric side of the canister, for system diagnosis.

The gasoline vapor is channeled through the rollover valve and the FLVV via the vapor vent lines into the charcoal canister, where it is stored. When the engine is started, the gasoline vapor is drawn from the charcoal canister to the engine's air intake system and into the combustion process.

NOTE:

· If the fuel filler cap is not closed tightly or if the engine is running when the car is refueled, the Malfunction Indicator Lamp may indicate a fault.

· During a transitional period, a small number of service stations may still have fuel nozzles that are not compatible with the fuel filler neck on cars equipped with the evaporative control system (ORVR) mandated by the U.S. Environmental Protection Agency and the California Air Resources Board. If you experience difficulties in refueling your vehicle, please ask the gas station attendant for assistance.

CAUTION:

Fuel must not be siphoned from the fuel tank. This will damage the Evaporative control system.



[Contents](#) | [Top of Page](#)

2000
VOLVO
S & V 40

Chapter 9 - Specifications

pg. 119 Specifications

Specifications

This chapter contains facts and figures pertaining to the technical specifications of your car.

[Oil/fluids specifications](#) 120

[Engine specifications](#) 121

[Cooling/fuel/distributor ignition systems](#) 122

[Front/rear suspensions](#) 122

[Transmission, Capacities, Vehicle loading](#) 123

[Electrical system/bulbs](#) 124

[Weights](#) 125

[Road assistance](#) 126

pg. 120 Oil/fluid specifications

Oil quality

Meeting API specification SJ, SJ/CF, or SJ/Energy Conserving.

For best fuel economy and engine protection, consult with your authorized Volvo retailer for recommended oils. Oil with a different quality rating may not provide adequate engine protection.

Synthetic oils complying with oil quality requirements are recommended for: driving in areas of sustained temperature extremes (hot or cold), when towing a trailer over long distances or for prolonged driving in mountainous areas.

Extra oil additives must not be used unless advised by an authorized Volvo retailer.

Viscosity (stable ambient temperatures):

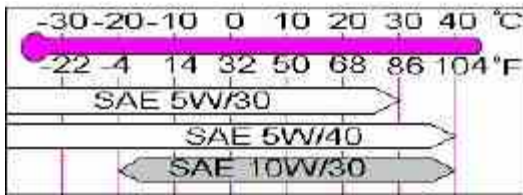

Engine oil	Quality: Meeting API specification SG or SH	Capacity (incl. filter): 5.7 US qts (5.4 liters)
Automatic transmission fluid	Quality: ATF Dexron III and Mercon	Capacity: 8 US qts. (7.6 liters)
Power steering fluid	Quality: ATF oil	Capacity: 1.05 US qts. (1 liters)
Brake fluid	Quality: DOT 4+	Capacity: 0.42 US qts. (0.4 liters)

All specifications are subject to change without notice.

pg. 121 Engine

Engine

Liquidcooled gasoline, 4-cylinder, inline engine. Aluminum alloy cylinder block with castiron cylinder liners cast directly into the block. Aluminum alloy cylinder head with double overhead camshafts and separate intake and outlet channels.

Engine lubrication is provided by an eccentric pump driven from the crankshaft. Fullflow type oil filter. Exhaust emission control is accomplished by multiport fuel injection, a heated oxygen sensor and a three-way catalytic converter.

Designation:	Volvo B 4204 T2
Output	160 hp at 5100 rpm (118 kw at 5100 rpm)
Max torque	170 ft. lbs. at 1800-4800 rpm (230 Nm at 1800-4800 rpm)
Number of cylinders	4
Bore	3.27" (83 mm)
Stroke	3.54" (90 mm)
Displacement	1.95 liters
Compression ratio	9.0:1
Number of valves	16

All specifications are subject to change without notice.

pg. 122 Specifications

Cooling system

Type: Positive pressure, closed system

Thermostat begins to open at 186° F (90° C)

Coolant: Volvo original coolant/antifreeze

Capacity: 6 US qts. (5.7 liters)

Fuel system

The engine is equipped with a multipoint fuel injection system.

Distributor ignition system

Firing order: 13-4-2

Distributor ignition setting: Not adjustable

Spark plugs: Champion RC8PYP or equivalent

Spark plug gap: 0.03" (0.75 mm)

Tightening torque: 18.4 ft. lbs. (25 Nm)

WARNING!

The distributor ignition system operates at very high voltages. Special safety precautions must be followed to prevent injury. Always turn the ignition off when:

- Replacing distributor ignition components e.g. plugs, coil, etc.
- Do not touch any part of the distributor ignition system while the engine is running. This may result in unintended movements and body injury.

All specifications are subject to change without notice.

Replacing spark plugs

The spark plugs should be changed according to your service program in your Warranty booklet. However, city driving or fast highway driving may necessitate changing after 15,000 miles (24,000 km) of driving. When installing new plugs, be sure to fit the right type and use correct torque, see "Specifications". When changing the plugs, check that the suppressor connectors are in good condition. Cracked or damaged connectors should be replaced. When changing the spark plugs, clean the terminals and the rubber seals.

Front suspension

Spring strut suspension with integrated shock absorbers and control arms linked to the support frame. Powerassisted rack and pinion steering. Safety type steering column.

The alignment specifications apply to a car at curb weight (without passengers or cargo).

Toe-in measured on the wheel rims: 2,1 mm +- 0,7 mm

Toe-in measured on tire sides: 2,6 mm +- 0,8 mm

Rear suspension

Multilink individual rear wheel suspension with longitudinal support arms, double link arms and track rods.

Toe-in measured on the tire sides: 2,6 mm +/- 0,8 mm

Power transmission

Automatic transmission: AW 50-42

4speed automatic electronically controlled gearbox comprising a hydraulic torque converter with a lockup function; planetary gear, integrated final drive.

Operation via a floor mounted gear selector lever. Drive shafts with symmetrical joint location. Overdrive.

Final drive ratio 2.76:1

Reduction ratios

1st gear 3.61:1

2nd gear 2.06:1

3rd gear 1.37:1

4th gear 0.98:1

Reverse 3.96:1

Capacities

Fuel tank : 16 US gal. (60 liters)

Cooling system : 6 US qts. (5,7 liters)

Engine oil (incl. filter) : 5.7 US qts. (5.4 liters)

Automatic transmission : 8 US qts (7.6 liters)

Power steering fluid : 1.05 US qts (1 liters)

Washer fluid reservoir : 3.9 US qts. (3.75 liters)

Brake system : 0.42 US qts (0.4 liters)

Vehicle loading

The tires on your Volvo should perform to specifications at all normal loads when inflated as recommended on the tire information label. The label is located on the inside of the fuel filler flap. The label lists both tire and vehicle design limits. Do not load your car beyond the load limits indicated.

WARNING!

Improperly inflated tires will reduce tire life, adversely affect vehicle handling and can possibly lead to failure resulting in loss of vehicle control without prior warning.

All specifications are subject to change without notice.

pg. 124 Specifications

Electrical system

12 Volt, negative ground.

Voltagecontrolled generator. Singlewire system with chassis and engine used as conductors.

Battery

Voltage: 12 Volt, capacity: 600 A/100 min

The battery contains corrosive and poisonous acids. It is of the utmost importance that old batteries are disposed of correctly. Your Volvo retailer can assist you in this matter.

Generator

Rated output: 120 A

Bulbs

Bulb	US no.	Power	Socket	No/bulbs
Headlights				
		High beam 55W	H7	2
		Low beam 55W	H7	2
Parking lights and				
Turn signals, front	3457NA	26/7W/30/2.2cp	W2.5 16q	2
Turn signals, rear	1156	21W/32cp	BA 15 s	2
Side direction indicators	-	5W	W 2.1x9.5 d	2
Tail lights	67	5W/4cp	BA 15 s	4
Brake lights	1156	21W/32cp	BA 15 s	2
Backup lights	1156	21W/32cp	BA 15 s	2
Rear fog light	1156	21W/32cp	BA 15 s	1
Front fog lights	H3	55 W	PK22.5	2
License plate light (S40) -		5 W	W 2.1x9.5 d	2
License plate light (V40) -		5 W	SV8.5	2
Door step courtesy lights -		10W	SV8.5	2
Trunk light	-	5 W	SV 8.5	1
Vanity mirror lights	-	1.2 W	SV5.5	2
Front courtesy lights	-	5 W	SV5.5	2
Rear reading lights	-	5 W	W 2.1x9.5 d	2

All specifications are subject to change without notice.

pg. 125 Specifications

Dimensions

Length	S40/V40	176.4 in. (448 cm)
Width	S40/V40	67.7 in. (172 cm)
Height	S40/V40	55.5 in. (141 cm)
Wheel base	S40/V40	100.4 in. (255 cm)
Track, front	S40/V40	57.1 in. (145 cm)
Track, rear	S40/V40	57.9 in. (147 cm)
Turning circle:	S40/V40	34.1 ft. (11.2 m)
Cargo capacity:		
	S40 (rear seat up)	39.8 in. (101 cm)
	S40 (rear seat down)	68.5 in. (174 cm)
	V40 (rear seat up)	40.2 in. (102 cm)
	V40 (rear seat down)	68.9 in. (175 cm)
	Max width of load opening	27.6 in. (67 cm)
	Max height of load opening	20.1 in. (51 cm)

Weights

Gross Vehicle Weight (GVW):

S40	4180 lbs (1896 kg)
V40	4340 lbs (1969 kg)

Capacity Weight:

S40	841 lbs (382 kg)
V40	837 lbs (380 kg)

Permissible axle weight, front:

S40	2093 lbs (950 kg)
V40	2093 lbs (950 kg)

Permissible axle weight, rear:

S40	1885 lbs (856 kg)
V40	1916 lbs (870 kg)

Permissible axle weight total:

S40	3921 lbs (1780 kg)
V40	3964 lbs (1800 kg)

Curb weight:

S40	2996 lbs (1360 kg)
V40	3040 lbs (1380 kg)

The max permissible axle loads or the gross vehicle weight must not be exceeded.

Max roof load *	220 lbs (100 kg)
------------------------	------------------

Max trailer weight

(w/o brakes)	1100 lbs (500 kg)
(with brakes)	2000 lbs (908 kg)

Max tongue weight **	110 lbs (50 kg)
-----------------------------	-----------------

* For permanent roof racks, check the manufacturer's weight specifications.

** Please refer to section "Trailer towing"

WARNING!

When adding accessories, equipment, luggage and other cargo to your vehicle, the total loaded weight capacity of the vehicle must not be exceeded.

All specifications are subject to change without notice.

pg. 126 Road Assistance



Your new Volvo comes with a four year road assistance program named ONCALL. Additional information, features, and benefits are described in a separate information package in your glove compartment.

If you have misplaced your package, dial:

In the U.S.A.

1-800-63-VOLVO (1-800-638-6586)

In Canada:

1-800-263-0475



Volvo supports Voluntary Mechanic Certification by the A.S.E. (pertains to the USA only). Certified mechanics have demonstrated a high degree of competence in specific areas. Besides passing exams each mechanic must also have worked in the field for two or more years before a certificate is issued. These professional mechanics are fully able to analyze vehicle problems and perform the necessary service procedures to keep your Volvo at peak operating condition.

All specifications are subject to change without notice.



[Contents](#) | [Top of Page](#)

2000 VOLVO S & V 40

Chapter 10 - Audio systems

pg. 127 Audio systems

Audio systems

Even if you maintain your car in good running

This chapter describes the audio system in your car.

[SC-813](#) [128](#)

[SC-816](#) [141](#)

[General information](#) [157](#)

pg. 128 Audio system SC813

The following pages describe the use of your SC813 Cassette radio and CD remote control

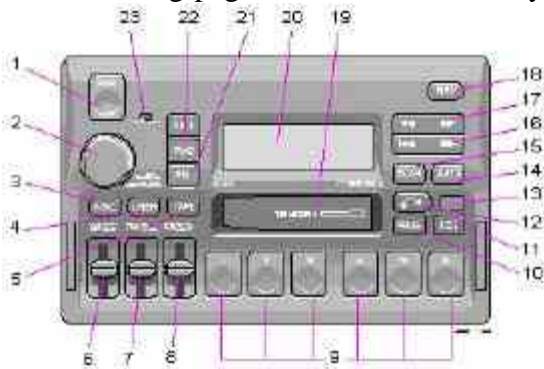

1. On/off (push)
2. · Volume (turn)
- Pause/Mute (push)
- Balance (pull)
3. Active Sound Control
4. CD changer selector
5. · Tape mode selector
- Tape direction selector PROG
6. Bass control
7. Treble control

8. Fader control
9. · Preset buttons - radio
 - CD-Disc No. selector
10. PROG - Reversing the tape
11. Dolby B NR button
12. Cassette eject
13. Not in use
14. Scan
15. Auto seek memory
16. · Radio - Seek tuning up/down
 - **TP**-Next/Previous song
 - **CD**-Next UP/Previous DOWN track
17. · Radio - Manual tuning
 - **TP**-fast forward/Rewind
 - **CD**-Music searchUP/DOWN
18. RND (random order play) button

19. Cassette slot
20. Display
21. Waveband selector (AM)
22. Waveband selectors (FM)
23. Anti-theft LED

TP = Applicable only in Tape Mode

CD = Applicable only when in CD mode and connected to a CD changer.

pg. 129 Anti-theft code



Anti-theft code

The radio features anti-theft circuitry. If the set is removed from the vehicle or if the battery power is disconnected, a special code must be entered to enable operation of the set.

Refer to the radio code card supplied with your vehicle or ask your Volvo retailer for the correct code.

When the car is parked with the ignition key removed, the anti-theft LED will flash.

Anti-theft LED



To enter the code

After installation or when the set has been disconnected from power, the set displays "COdE" when it is switched on.

Enter the 4-digit code using the preset buttons.

If the correct code is entered, "on" is displayed and the set is ready to use.

If you enter an incorrect code you must enter the correct code again from the beginning.



Incorrect code

If an incorrect code has been entered "rPt" is displayed. Enter the correct code.

After three unsuccessful coding attempts the set will lock and remain locked for two hours. "**OFF**" is displayed.

During this waiting period:

- the battery must be connected
- the ignition key must be turned to position I
- the unit must be turned on

Make sure the headlights are turned off to help prevent battery drain (please refer to page 26 for information on turning the headlights off).

Enter the code again once this time has elapsed.



A - On/off switch

Push the button to switch on the radio. Press the button slightly longer to turn the radio off.

B - Volume control

Turn the button clockwise to increase the volume. The volume control is electronic and has no end stop.

C - Waveband selector

The desired waveband is set by pressing one of the waveband selector buttons. The frequency and waveband is shown on the display.

NOTE: There are two FM wavebands and one AM waveband. This makes it possible to store 2 x 6 FM stations and 6 AM stations in memory.

D - Setting frequency selection

The radio can be used in most parts of the world by changing the frequency selection intervals as follows:

Depress and hold preset button 5 and turn the radio ON. "USA" will flash on the display.

Each time button 5 is pressed, the frequency selection will change from "USA" to "AUS", etc. When the correct country name is displayed, wait 5 seconds and the radio will be ready for use.

E - Manual tuning

Press the left side tune button to tune to lower frequencies and the right side to tune to higher frequencies. The tuned frequency is displayed.

ST will be displayed to indicate stereo FM reception.



A - Seek tuning up/down

Press the left side tune button to tune to lower frequencies and the right side to tune to higher frequencies. The radio seeks the next audible station and stops there. If you wish to continue the seek tuning, press the tune button again.

B - Preset programming

1. Tune to the desired frequency.
2. Depress and hold a preset button. The audio will cut out. Keep the button depressed until the audio comes on again (approx. 2 seconds).
3. The frequency is now stored on this preset button.

C - Preset buttons

To select a pre-programmed radio frequency, depress the preset button. The set frequency will be displayed.

pg. 132 Radio SC-813



A - Automatic programming (Auto)

Please note that this function will not interfere with pre-stored stations on buttons 1-6.

This function automatically seeks and stores up to 8 strong AM or FM stations.

This is especially useful when travelling in areas where radio stations are unfamiliar.

1. Depress and hold the "AUTO" button for **at least 1 second**. A number of strong stations (max. 8) on the chosen waveband are now automatically stored in the memory.

If there are no audible stations, "- - -" is displayed.

B - Bass control

Adjust the bass by sliding the control up or down (up to increase, down to decrease).

A "detent" indicates "equalized" bass.

C - Treble control

Adjust the treble by sliding the control up or down (up to increase, down to decrease).

A "detent" indicates "equalized" treble.

2. Briefly press the "AUTO" button again to retrieve one of the newly stored stations. A new station will be retrieved each time the button is pressed again.

pg. 133 Radio SC-813



A - Fader control

Adjust front/rear speaker balance by sliding the control up or down.

(**Up** to direct more sound to the front speakers, **Down** to direct more sound to the rear speakers).

The "detent" indicates "equalized" front /rear balance position.

B - Pause function

Press the "volume" knob to temporarily mute the sound. "PAUSE" is displayed.

C - Balance control

Pull out the "volume" knob and adjust the left/right balance by turning the knob counter- clockwise or clockwise.

D - Scan

Press this button to listen to each station for five seconds. Press it again to stop scanning. "Scan" will be displayed during scanning.

E - Active sound control (ASC)

The ASC function automatically adjusts the volume level of the audio system according to driving speed.

To deactivate ASC depress the "ASC" button.

To activate ASC, depress the "ASC" button until "ASC" is displayed.



[Contents](#) | [Top of Page](#)

**2000
VOLVO
S & V 40**

INDEX

pg. 158 - 160 Index

A	
ABS	21,69
Adjustable steering wheel	32
Air conditioning	35
Air mix	33
Air vents	33
Airbag (SIPS)	8
Airbag (SRS)	4
Alarm	41
Anti-lock Brake System (ABS)	21,69
Antifreeze	71,115
Ashtrays	31
Audio systems	
SC-813	128
SC-816	141
Automatic car washing	100
Automatic transmission	63,64,65,123
Driving mode selector	63
Automatic transmission fluid	118,120
Auxiliary socket	31
B	
Battery	71,124
Battery maintenance	117
Booster cushion	10
Brake failure warning light	20
Brake fluid	114,120
Brake fluid warning light	20
Brake system	69,70
Bulb failure warning	20
Bulbs	124
C	

Cabin air filter	33
Capacities	123
Center head restraint	3
Central locking button	39
Chains - winter driving	77
Changing a wheel	83
Child booster cushion	10
Child safety	13
Child safety locks - rear doors	44
Clock	18
Concealed storage bin (wagon)	56
Coolant - checking/changing	115
Cooling system	64,122
Cruise control	29
Cup holders	51
Cupholders	31,51
D	
Dimensions	125
Doors and locks	39
Drive belt	115
Driving economy	60
Dynamic Stability Assistance (DSA)	28
E	
ECC - Electronic Climate Control	34,35
Electrical system	65,124
Electrically operated driver's seat	47
Electrically operated front seats	46
Electrically operated sun roof	49
Electrically operated windows	36
Emergency towing	66
Emergency warning flashers	24
Emissions systems	110
Engine	121
Engine compartment	109
Engine oil	113,120
Engine oil - checking/changing	112
F	
Fog light - rear	22
Folding rear seat (sedan)	53
Front courtesy lights	48
Front seats	45,46
Front seats - heated	30
Front suspension	122
Fuel gauge	18

Fuel system	110,122
Fuel tank cover - opening	59
Fuses	91,92,93
G	
Gas tank cover - opening	59
Generator	124
H	
Hand brake	30
Handling	56
Hazard warning flashers	24
Heated front seats	30
Heating	35
Heating and air conditioning	33
Hood	50
I	
Ignition switch	24
Immobilizer (start inhibitor)	38
Instruments	16,17
Integrated booster cushion	10
J	
Jack	82
Jack (sedan)	52
Jump starting	68
K	
Keyless entry system	40
Keylock	61
Keys	38
L	
Label information	104
Locking button - central	39
Locks	39
Long distance trips	72
Lubrication	111
Lumbar support	45,46
M	
Maintenance schedule	106
Maintenance service	105
Malfunction indicator lamp	20
Manual transmission fluid	120
Mirrors - rear/side view	47
O	
Occupant safety	14
Octane rating	59
Odometer	18

Oil - engine	113
Oil pressure warning light	20
On-call	126
P	
Paint touchup	98
Parking brake	30
Parking brake reminder light	20
Polishing	100
Power seats	46
Power steering fluid	114,120
R	
Radio	
SC-813	128
SC-816	141
Reading lights	48
Rear fog light	22
Rear suspension	122
Refueling	59
Remote control (central locking system)	40
Remote keyless entry system	40
Replacing bulbs	86,88,89,90
Replacing fuses	91
Reporting safety defects	14
Roadholding	56
Roof rails/racks	56
S	
Safety defects - reporting	14
Safety locks - child	44
Seat belt maintenance	14
Seat belts	2,3
Seat belts - cleaning	101
Seats	45
Service reminder indicator	21
Servicing	108,109
Shift lock	61,62
Shiftlock release (override)	95
Side Impact Protection System (SIPS)	8
Side-view mirrors - heated	24
SIPS	8
Snow chains	77
Snow tires	77
Spare tire	80
Spare tire (sedan)	52
Spark plugs	122

Specifications	119
Speed warning	25
SRS	5,6,7
SRS diagnostic system	20
SRS warning light	5,20
Start inhibitor (immobilizer)	38
Starting the engine	61
Steering wheel adjustment	32
Steering wheel lock	24
Storage compartments	51
Studded tires	77
Sun roof	49
T	
Tachometer	18
Tailgate (opening/locking)	43
Temperature gauge	18
Temporary spare tire	80
Tire pressure	78
Tires	76
Tires - changing	83
Tool kit	82
Towing	66,67
Towing a trailer	73
Traction Control System (TRACS)	21,70
Trailer towing	73
Trip Computer	25
Trip odometer	18
Turn signals	23
U	
Uniform tire quality grading	79
Upholstery - cleaning	101
V	
Vanity mirrors	48
Vehicle Identification Number (VIN)	104
Vehicle loading	123
Volvo On Call	126
W	
Warning flashers	24
Warning lights	20,21
Warranty	105
Washer fluid reservoir	116
Washing	99
Waxing	100
Weights	125

Wheel changing	82,83,84
Wheels and tires	76
Whiplash Protection System (WHIPS)	9
Windows - electrically-operated	36
Windshield washer nozzles	116
Windshield wiper blades - replacing	94
Winter driving	71



[Contents](#) | [Top of Page](#)