

2000 VOLVO S80

This manual deals with the operation and care of your Volvo.

This manual deals with the operation and care of your Volvo

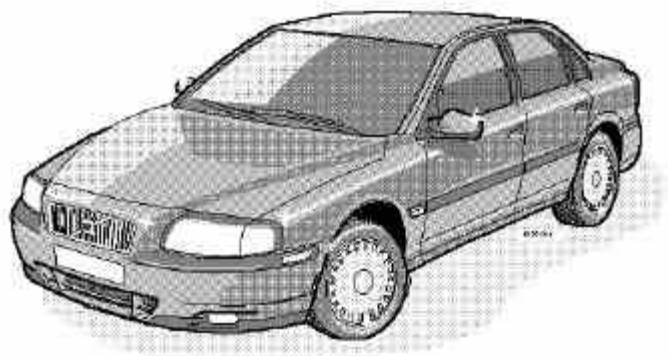

Welcome to the world-wide family of Volvo owners. We trust that you will enjoy many years of safe driving in your Volvo, an automobile designed with your safety and comfort in mind. To help ensure your satisfaction with this vehicle, we encourage you to familiarize yourself with the equipment descriptions, operating instructions and maintenance requirements/recommendations in this manual. We also urge you and your passengers to wear seat belts at all times in this (or any other) automobile. And, of course, please do not operate a vehicle if you may be affected by alcohol, medication or any impairment that could hinder your ability to drive.

Your Volvo is designed to meet all applicable safety and emission standards, as evidenced by the certification labels attached to the driver's door opening and on the left wheel housing in the engine compartment.

For further information please contact your retailer, or:

In the USA:

Volvo Cars of North America

Customer Relations

P.O. Box 914

Rockleigh, New Jersey 07647-0914 800-663-8255

800-458-1552

In Canada:

Volvo Canada Ltd.

175 Gordon Baker Road

Willowdale, Ontario M2H 2N7

We also invite you to visit our Home Page on the Internet at:

<http://www.volvocars.com>

Contents

Contents

[Chapter 1 - Safety](#)

[Chapter 2 - Instruments, switches and controls](#)

[Chapter 3 - Climate control system](#)

[Chapter 4 - Interior](#)

[Chapter 5 - Keys, Locks, Alarm](#)

[Chapter 6 - Starting and driving](#)

[Chapter 7 - Wheels and tires](#)

[Chapter 8 - Maintenance/Serviceing](#)

[Chapter 9 - Specifications](#)

[Chapter 10 - Audio systems](#)

[HomeLink® Universal Transceiver \(option\)](#)

[Index](#)

© 1998 Volvo Cars of North America Inc.

General information

Shiftlock

When your car is parked, the gear selector is locked in the (P)ark position. To release the selector from this position, turn the ignition key to position II (or start the engine), depress the brake pedal, press the button on the front side of the gear selector and move the selector from (P)ark.

Keylock

This means that when you switch off the ignition, the gear selector must be in the (P)ark position before the key can be removed from the ignition switch.

Anti-lock Brake System (ABS)

The ABS system in your car performs a self-diagnostic test when the vehicle first reaches the speed of approximately 12 mph (20 km/h). The brake pedal will pulsate several times and a sound may be audible from the ABS control module. This is normal.

Fuel tank cover The fuel tank cover, located on the right rear fender, is connected to your car's central locking system. The driver's door must be unlocked before the fuel tank cover can be opened.

Fuel filler cap

After refueling, close the fuel filler cap by turning it clockwise until it *clicks* into place. If this cap is not closed tightly or if the engine is running when the car is refueled, the Malfunction Indicator Lamp ("Check Engine" light) may indicate a fault.

Important

Before you operate your car for the first time, please familiarize yourself with the BREAK-IN information on [page 62](#). You should also be familiar with the information in the first three chapters of this manual.

Information contained in the balance of the manual is extremely useful and should be read after operating the vehicle for the first time.

The manual is structured so that it can be used for reference. For this reason, it should be kept in the car for ready access.

Do not export your Volvo to another country before investigating that country's applicable safety and exhaust emission requirements. In some cases it may be difficult or impossible to comply with these requirements. Modifications to the emission control system(s) may render your Volvo not certifiable for legal operation in the U.S., Canada and other countries.

All information, illustrations and specifications contained in this manual are based on the latest product information available at the time of publication. Please note that some vehicles may be equipped differently, depending on special legal requirements and that optional equipment described in this manual may not be available in all markets.

Volvo reserves the right to make model changes at any time, or to change specifications or design, without notice and without incurring obligation.

Volvo and the environment

Volvo is committed to the well being of our customers. As a natural part of this commitment, we care about the environment in which we all live. Caring for the environment means an everyday involvement in reducing our environmental impact.

Volvo's environmental activities are based on a holistic view, which means we consider the overall environmental impact of a product throughout its complete life cycle. In this context, design, production, product use, and recycling are all important considerations.

In production, Volvo has partly or completely phased out several chemicals including freons, lead chromates, naphthanates, asbestos, mercury and cadmium; and reduced the amount of chemicals used in our plants 50% since 1991.

In use, Volvo was the first in the world to introduce into production a three-way catalytic converter with a Lambda sond, now called oxygen sensor, in 1976. The current version of this highly efficient system reduces emissions of harmful substances (CO, HC, NOx) from the exhaust pipe by approximately 95% and the search to eliminate the remaining emissions continues. Volvo is the only automobile manufacturer to offer CFC-free retrofit kits for the air conditioning system for all models as far back as the M/Y 1975 240. Advanced electronic engine controls, refined purification systems and cleaner fuels are bringing us closer to our goal.

After Volvo cars and parts have fulfilled their use, recycling is the next critical step in completing the life cycle. The metal content is about 75% of the total weight of a car, which makes the car among the most recycled industrial products. In order to have efficient and well controlled recycling, many Volvo variants have printed dismantling manuals, indicating the weight and material of individual components. For Volvo, all homogeneous plastic parts weighing more than 1.7 oz. (50 grams) are marked with international symbols that indicate how the component is to be sorted for recycling.

In addition to continuous environmental refinement of conventional gasoline-powered internal combustion engines, Volvo is actively looking at advanced technology alternative-fuel vehicles.

When you drive a Volvo, you become our partner in the work to lessen the car's impact on the environment.

To reduce your vehicle's environmental impact, you can:

- Maintain proper air pressure in your tires. Tests have shown decreased fuel economy with improperly inflated tires
- Follow the recommended maintenance schedule
- Drive at a constant speed
- See an authorized Volvo retailer as soon as possible for inspection if the check engine (malfunction indicator) lamp illuminates, or stays on after the vehicle has started
- Properly dispose of any vehicle related waste such as used motor oil, used batteries, brake pads, etc.
- When cleaning your car, use Volvo's own car care products, all of which have systematically been adapted to the environment.

For additional information regarding the environmental activities in which Volvo Cars of North America, Inc. and Volvo Car Corporation are involved, visit our Internet Home Page at:

<http://www.volvocars.com>



[Top of Page](#)

2000 VOLVO S80

Chapter 1 - Safety

pg. 1 Safety

Despite our strongest recommendations, and your best intentions, not wearing a seat belt is like believing "It'll never happen to me!". Volvo, the inventor of the three-point seat belt, urges you and all adult occupants of your car to wear seat belts and ensure that children are properly restrained, using an infant, car or booster seat determined by age, weight and height. Volvo also believes no child should sit in the front seat of a car.

Fact: In every state and province, some type of childrestraint legislation has been passed. Additionally, most states and provinces have already made it mandatory for occupants of a car to use seat belts.

So, urging you to "buckle up" is not just our recommendation legislation in your state or province may mandate seat belt usage. The few seconds it takes to buckle up may one day allow you to say, "It's a good thing I was wearing my seat belt".

[Seat belts](#) [2](#)

[Center head restraint](#) [3](#)

[Front airbags \(SRS\)](#) [4](#)

[Side impact airbags \(SIPS\)](#) [8](#)

[Volvo Inflatable Curtain \(VIC\)](#) [9](#)

[Whiplash Protection System \(WHIPS\)](#) [10](#)

[Occupant safety](#) [11](#)

[Child safety](#) [12](#)

[Brake system](#) [16](#)

[Anti-lock Brake System \(ABS\)](#) [17](#)

[Stability Traction Control \(STC\)](#) [18](#)

[Dynamic Stability and Traction Control \(DSTC\)](#) [18](#)

pg. 2 Seat belts

Seat belts

Always fasten the seat belts before you drive or ride. A chime will sound several times if the driver has not fastened his seat belt.

To buckle:

Pull the belt out far enough to insert the latch plate into the receptacle until a distinct click is heard. The seat belt retractor is normally "unlocked" and you can move freely, provided that the shoulder belt is not pulled out too far. The retractor will lock up as follows:

- if the belt is pulled out rapidly
- during braking and acceleration
- if the vehicle is leaning excessively
- when driving in turns

For the seat belt to provide maximum protection in the event of an accident, it must be worn correctly. When wearing the seat belt remember:

- The belt should not be twisted or turned.
- The lap belt must be positioned low on the hips (not pressing against the abdomen).

Make sure that the shoulder belt is rolled up into its retractor and that the shoulder and lap belts are taut.

Before exiting the car, check that the seat belt retracts fully after being unbuckled. If necessary, guide the belt back into the retractor slot.

NOTE: Legislation in your state or province may mandate seat belt usage.

Adjusting shoulder belt

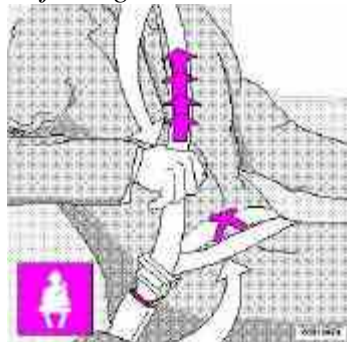

Lap portion of the belt should sit low

Child seats: Please refer to [page 14](#) for information on securing child seats with the seat belts.

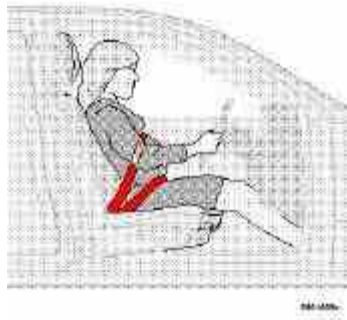

During pregnancy Pregnant women should always wear seat belts. Remember that the belt should always be positioned in such a way as to avoid any possible pressure on the abdomen. The lap portion of the belt should be located low, as shown in the above illustration.

WARNING!

- Never use a seat belt for more than one occupant.
- Never wear the shoulder portion of the belt under the arm, behind the back or otherwise out of position. Such use could cause injury in the event of an accident.
- As the seat belts lose much of their strength when exposed to violent stretching, they should be replaced after any collision, even if they appear to be undamaged.
- Never repair the belt on your own; have this work done by an authorized Volvo retailer only.
- Any device used to induce slack into the shoulder belt portion of the three-point belt system will have a detrimental effect on the amount of protection available to you in the event of a collision.
- The seat back should not be tilted too far back. The shoulder belt must be taut in order to function properly.
- Do not use child safety seats or child booster cushions/backrests in the front passenger's seat. We also recommend that children who have outgrown these devices sit in the rear seat with the seat belt properly fastened.

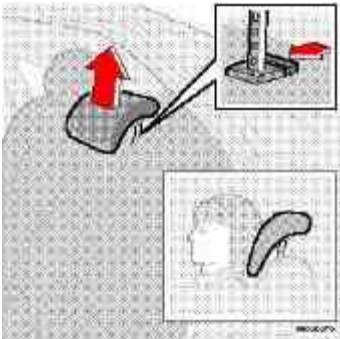

Adjust head restraint height

Center head restraint

The center head restraint can be adjusted according to the passenger's height. The restraint should be carefully adjusted to support the occupant's head.

The head restraint can be **raised** by pulling straight up or **lowered** by pressing the catch at the base of the left head restraint support and pushing down.



Driver's side airbag - in steering wheel hub

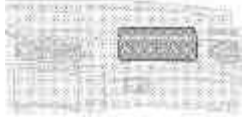

Passenger's side airbag - above glove compartment

As an enhancement to the three-point seat belt system, your Volvo is equipped with a Supplemental Restraint System (SRS). The Volvo SRS consists of an airbag (2) on both the driver's and passenger's sides and seat belt tensioners in both front door pillars (4). The system is designed to supplement the protection provided by the three-point seat belt system. All three rear seat belts are also equipped with tensioners.

The SRS system is indicated by the "SRS" embossed on the steering wheel pad and above the glove compartment, and by decals on both sun visors and on the far right side of the dash.

The airbags are folded and located in the steering wheel hub and above the glove compartment. They are designed to deploy during certain frontal or front-angular collisions, impacts, or decelerations, depending on the crash severity, angle, speed and object impacted. The airbags may also deploy in certain non-frontal collisions where rapid deceleration occurs.

The airbag system includes gas generators (1) surrounded by the airbags (2) and front seat belt tensioners for both of the front seats (4). To deploy the system, the sensor (3) activates the gas generators causing the airbags to be inflated with nitrogen gas. As the movement of the seats' occupants compresses the airbags, some of the gas is expelled at a controlled rate to provide better cushioning. Both seat belt tensioners also deploy, minimizing any seat belt slack.

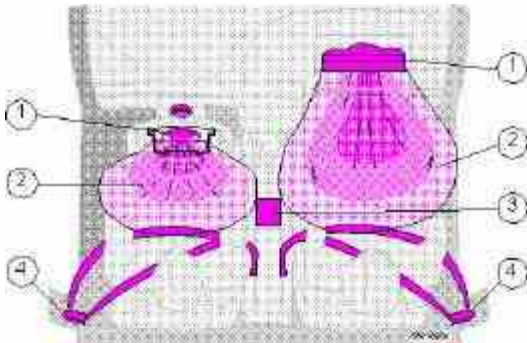

The entire process, including inflation and deflation of the airbags, takes approximately two-tenths of a second.

WARNING!

- As its name implies, SRS is designed to be a SUPPLEMENT to - not a replacement for - the three-point belt system. For maximum protection, wear seat belts at all times. Be aware that no system can prevent all possible injuries that may occur in an accident.
- When installing any optional equipment, make sure that the SRS system is not damaged. Do not attempt to service any component of the SRS yourself. Attempting to do so may result in serious personal injury. If a problem arises, take your car to the nearest authorized Volvo retailer for inspection as soon as possible.

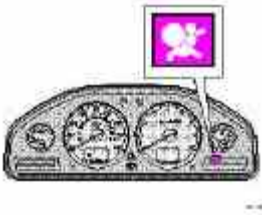

A self-diagnostic system incorporated in the sensor monitors the SRS. This system does not, however, monitor the Side Impact Protection System (SIPS) airbags. If a fault is detected, the warning light will illuminate. The light is included in the warning/indicator light cluster in the instrument panel. Normally, the SRS warning lamp should light up when the ignition key is turned to positions I, II or III and should go out after 7 seconds or when the engine is started. Check that this light is functioning properly every time the car is started.

The following items are monitored by the self-diagnostic system:

- Sensor unit
- Cable harness
- Gas generator igniters

WARNING!

- Never drive an SRS equipped car with your hands on the steering wheel pad / airbag housing.
- No objects, accessory equipment or stickers may be placed on, attached to or installed near the SRS cover in the center of the steering wheel, the SRS cover above the glove compartment or the area affected by airbag deployment.
- If the SRS warning light stays on after the engine has started or if it comes on while you are driving, drive the car to the nearest authorized Volvo retailer for inspection as soon as possible.



The above is a sample of the label found on all seat belts equipped with tensioners, located on the front seat belts near the lower anchorage point.



The above is a sample of the decal which can be found on the edge of the left rear door.

There is no maintenance to perform on the SRS yourself. The month and year shown on the decal on the door pillar indicate when you should contact your Volvo retailer for specific servicing or replacement of airbags and seatbelt tensioners. This service must be performed by an authorized Volvo retailer.

Should you have any questions about the SRS system, please contact

your authorized Volvo retailer or Volvo Customer Support:

In the USA:

Volvo Cars of North America

Customer Relations

P.O. Box 914

Rockleigh, New Jersey 07647-0914 800-663-8255

800-458-1552

In Canada:

Volvo Canada Ltd.

175 Gordon Baker Road

Willowdale, Ontario M2H 2N7

pg. 6 Front airbags - SRS



SRS texts on inside of both sun visors



SRS texts on outside of both sun visors



SRS texts on the passenger's dash



SRS decals at far right of instrument panel

WARNING!

Do not use child safety seats or child booster cushions/backrests in the front passenger's seat. We also recommend that children under 4 feet 7 inches (140 cm) in height who have outgrown these devices sit in the rear seat with the seat belt fastened.

NOTE: Deployment of SRS components occurs only one time during an accident. In a collision where deployment

occurs, the air bags and seat belt tensioners activate. Some noise occurs and a small amount of powder is released. The release of the powder may appear as smoke-like matter. This is a normal characteristic and does not indicate fire.

NOTE: NOTE: Volvo's dual-threshold air bags use special sensors that are integrated with the front seat buckles. The point at which the air bag deploys is determined by whether or not the seat belt is being used, as well as, the severity of the collision. Collisions can occur where only one of the airbags deploys.

WARNING!

- Children must never be allowed in the front passenger seat. Volvo recommends that ALL occupants (adults and children) shorter than 4 feet 7 inches (140 cm) be seated in the back seat of any vehicle with a front passenger side airbag. See [page 14](#) for guidelines.
- Occupants in the front passenger's seat must never sit on the edge of the seat, sit leaning toward the instrument panel or otherwise sit out of position. The occupant's back must be as upright as comfort allows and be against the seat back with the seat belt properly fastened.
- Feet must be on the floor, e.g. not on the dash, seat or out of the window.
- No objects or accessory equipment, e.g. dash covers, may be placed on, attached to or installed near the SRS hatch (the area above the glove compartment) or the area affected by airbag deployment (see illustration).
- There should be no loose articles, e.g. coffee cups, on the floor, seat or dash area.
- Never try to open the SRS cover on the steering wheel or the passenger side SRS seam. This should only be done by an authorized Volvo service technician.
- Failure to follow these instructions can result in injury to the vehicle occupants in an accident.

pg. 7 Front airbags - SRS

NOTE: The information on this page does not pertain to the Side Impact Protection System airbags.

When are the airbags deployed?

The SRS system is designed to deploy during certain frontal or frontangular collisions, impacts, or decelerations, depending on the crash severity, angle, speed and object impacted. The SRS sensor is designed to react to both the impact of the collision and the inertial forces generated by it and to determine if the intensity of the collision is sufficient for the airbags to be deployed.

WARNING!

The SRS is designed to help prevent serious injury. Deployment occurs very quickly and with considerable force. During normal deployment and depending on variables such as seating position, one may experience abrasions, bruises, swellings, or other injuries as a result of airbag(s) deployment.

If the airbags have been deployed, we recommend the following:

- Have the car towed to an authorized Volvo retailer. Never drive with the airbags deployed.
- Have an authorized Volvo retailer replace the SRS system components.
- Use only new, Genuine Volvo Parts when replacing SRS components (airbags, seat belts, tensioners, etc.).

When are the airbags NOT deployed? Not all frontal collisions activate the SRS system. If the collision involves a nonrigid object (e.g., a snow drift or bush), or a rigid, fixed object at a low speed, the SRS system will not necessarily deploy. Front airbags do not normally deploy in a side impact collision, in a collision from the rear or in a rollover situation. The amount of damage to the bodywork does not reliably indicate if the airbags should have deployed or not.

Seat belts the heart of the Volvo safety system The heart of the Volvo safety system is the **threepoint seat belt** (a Volvo invention)! In order for the SRS system to provide the protection intended, seat belts must be worn at all times by everyone in the car. **The SRS system is a supplement to the seat belts.**

WARNING!

If your car has been subjected to flood conditions (e.g. soaked carpeting/standing water on the floor of the vehicle) or if your car has become flooddamaged in any way, do not attempt to start the vehicle or put the key in the ignition before disconnecting the battery (see below). This may cause airbag deployment which could result in personal injury. Have the car towed to an authorized Volvo retailer for repairs.

Automatic transmission:

Before attempting to tow the car, use the following procedure to override the shiftlock system to move the gear selector to the neutral position.

- Switch off the ignition for at least 10 minutes and disconnect the battery
- Wait at least one minute
- Insert the key in the ignition and turn it to position II
- Press firmly on the brake pedal.
- Move the gear selector from (P)ark to the (N)eutral position.

WARNING!

Never drive with the airbags deployed. The fact that they hang out can impair the steering of your car. Other safety systems can also be damaged. The smoke and dust formed when the airbags are deployed can cause skin and eye irritation in the event of prolonged exposure.

pg. 8 Side impact airbags (SIPS)



*SIPS airbag **

SIPS airbag (front seats only)

As an enhancement to the structural Side Impact Protection System built into your car, the car is also equipped with Side Impact Protection System (SIPS) airbags. The SIPS airbag system consists of airbag modules built into the sides of both front seat backrests (1), wires (2) and gas generators/sensor units (3).

The SIPS airbag system is designed to help increase occupant protection in the event of certain side impact collisions. The SIPS airbags are designed to deploy only during certain sideimpact collisions, depending on the crash severity, angle, speed and point of impact. The airbags are not designed to deploy in all side impact situations.

NOTE: SIPS airbag deployment (one airbag) occurs only on the side of the vehicle affected by the impact.

WARNING!

- The SIPS airbag system is a supplement to the Side Impact Protection System and the three-point seat belt system. It is not designed to deploy during collisions from the front or rear of the car or in rollover situations.
- The use of seat covers on the front seats may impede SIPS airbag deployment.
- No objects, accessory equipment or stickers may be placed on, attached to or installed near, the SIPS airbag system or in the area affected by SIPS airbag deployment (see illustration to the right above).
- Never try to open or repair any components of the SIPS airbag system. This should only be done by an authorized Volvo service technician.
- For best protection from the SIPS airbag system, both front seat occupants should sit in an upright position with the seat belt properly fastened.

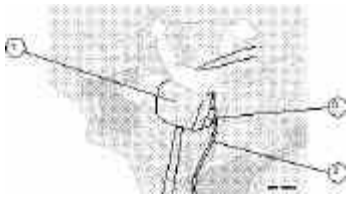

1 - Airbag, 2 - wire, 3 - gas generator/sensor unit

WARNING!

- Never drive with the airbags deployed. The fact that they hang out can impair the steering of your car. Other safety systems can also be damaged. The smoke and dust formed when the airbags are deployed can cause skin and eye irritation in the event of prolonged exposure.
- If your car has been subjected to flood conditions (e.g. soaked carpeting/standing water on the floor of the vehicle) or if your car has become flooddamaged in any way, do not attempt to start the vehicle or put the key in the ignition before disconnecting the battery. This may cause airbag deployment which could result in personal injury. Have the car towed to an authorized Volvo retailer for repairs.

*A SIPS airbag warning decal is also located at the end of the instrument panel on the driver's side of the car.

pg. 9 Volvo Inflatable curtain (VIC)

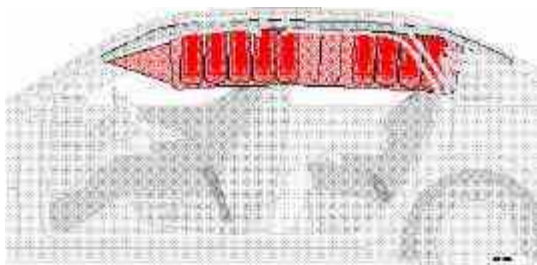

Volvo Inflatable curtain (VIC) This system consists of inflatable curtains located along the sides of the roof liners, stretching from the center of both front side windows to the rear edge of the rear side windows. It is designed to help protect the heads of the occupant of the front seat and the occupant of the outboard rear seat position in certain side impact collisions.

NOTE: IC system deployment occurs only on the side of the vehicle affected by the impact.

In certain side impacts, **BOTH** the Inflatable Curtain (IC) and the Side Impact Airbag System (SIPS-bag) will deploy, whereas, in some cases, **ONLY** the Inflatable Curtain (IC) will deploy. In cases where **BOTH** the IC and the SIPS-bag deploy, deployment will occur simultaneously.

If the inflatable curtain deploys, it remains inflated for approximately 3 seconds.

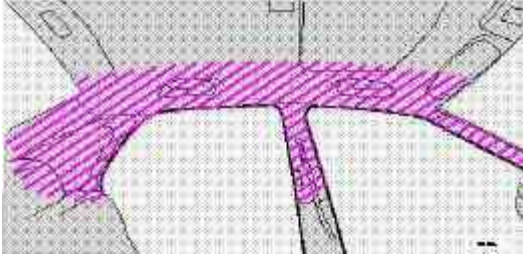

WARNING!

- The IC system is a supplement to the Side Impact Protection System. It is not designed to deploy during collisions from the front or rear of the car or in most rollover situations.
- Never try to open or repair any components of the IC system. This should only be done by an authorized Volvo service technician.
- The inflatable curtains are designed to deploy only during certain sideimpact collisions, depending on the crash severity, angle, speed and impact. The inflatable curtains are not designed to deploy in all side impact situations.
- For best protection from the IC, both front seat occupants and both outboard rear seat occupants should sit in an upright position with the seat belt properly fastened; adults using the seat belt and children using the proper child restraint system. Only adults should sit in the front seats. Children must never be allowed in the front passenger seat. See [page 14](#) for guidelines. Failure to follow these instructions can result in injury to the vehicle occupants in an accident.



[Contents](#) | [Top of Page](#)

2000
VOLVO
S80

Chapter 2 - Instruments, switches and controls

pg. 19 Instruments, switches and controls

<u>Interior</u>	<u>20</u>
<u>Exterior</u>	<u>21</u>
<u>Instruments</u>	<u>22</u>
<u>Instrument panel</u>	<u>23</u>
<u>Indicator and warning lights</u>	<u>24</u>
<u>Indicator and warning lights</u>	<u>24</u>
<u>Text information window</u>	<u>26</u>
<u>Switches in center console</u>	<u>27</u>
<u>Trip computer</u>	<u>28</u>
<u>Cruise control</u>	<u>29</u>
<u>Headlights, parking lights, fog lights, instrument illumination</u>	<u>30</u>
<u>Turn signals, windshield wipers/washers</u>	<u>31</u>
<u>Steering wheel adjustment/lock, ignition switch</u>	<u>32</u>
<u>Warning flashers, heated mirrors/rear window/front seats</u>	<u>33</u>
<u>Parking brake, auxiliary socket</u>	<u>34</u>
<u>Electrically operated windows</u>	<u>35</u>
<u>Rearview/sideview/vanity mirrors</u>	<u>36</u>
<u>Sun roof</u>	<u>37</u>

pg. 20 Interior

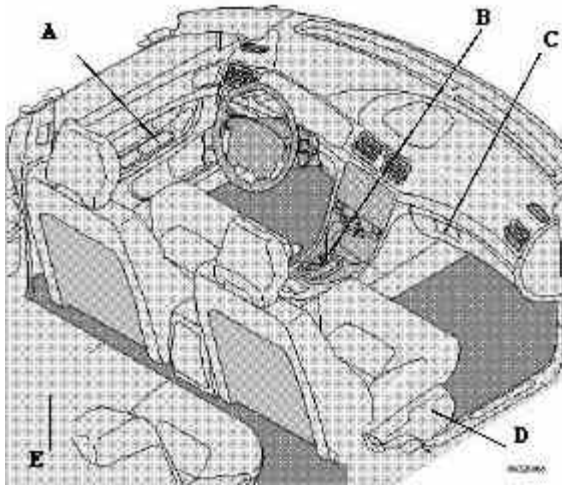

A

Locking and unlocking the car [54](#)

Alarm [58](#)

Power windows [35](#)

Sideview mirror controls [36](#)

B

Glove compartment [54](#)

C

Automatic transmission [65](#)

Geartronic [67](#)

Parking brake [34](#)

Center console switches [27](#)

D

Power seat adjustment [46](#)

Heated seats (option) [33](#)

Cleaning upholstery [101](#)

D

Folding rear seat [52](#)

Panel for long loads [52](#)

Folding down head restraint [27](#)

Adjusting head restraint [3](#)

Child safety locks [57](#)

Integrated booster cushion [13](#)

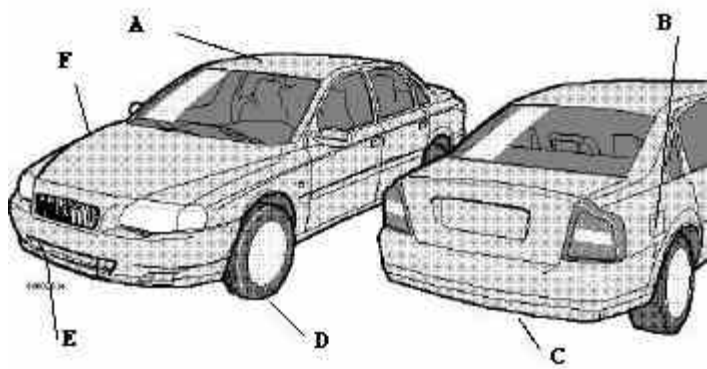

A	
Sun roof (option)	37
B	
Fuel tank cover	63
Refuelling	63
Economical driving	69
C	
Replacing a back-up light	94
Replacing a brake light	94
Replacing a tail light	94
Replacing a direction indicator	94
Replacing a fog light	94
Replacing license plate lights	96
D	
Tires	80
Wheels	80
Brake system	16
Spare wheel	82
Changing wheels	84
E	
Replacing a high beam	92
Replacing a low beam	92
Replacing a parking light	93
Replacing a direction indicator	93
Replacing a fog light	95
Replacing a headlight wiper	115
F	
Washing the car	100
Paint touch-up	99

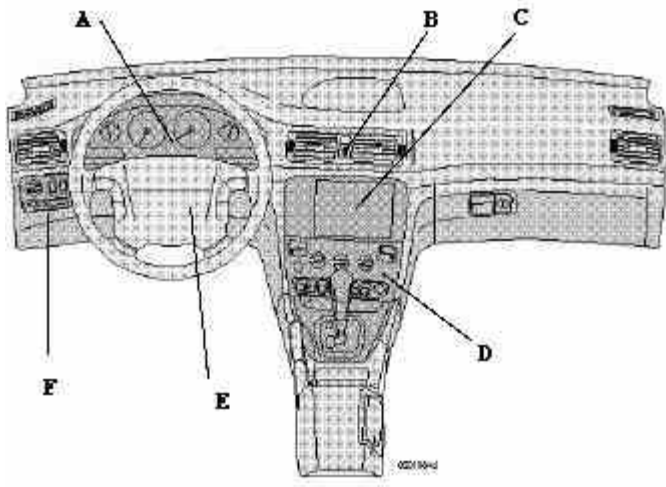

A

Temperature gauge	23
Speedometer	23
Odometer	23
Trip odometer	23
Warning lights	24
Text window	26
Tachometer	23
Clock	23
Ambient temperature sensor	23
Fuel gauge	23

B

Hazard warning flashers	33
-------------------------	--------------------

C

Audio system	125
--------------	---------------------

D

Electronic climate control	41
Heated seats (option)	33
Heated rear window/rearview mirrors	33

E

Steering wheel adjustment	32
Airbag	4
Cruise control	29
Windshield wipers/washer	31
Turn signal lever	31
Trip computer	28
Audio system controls	125

F

High/low beam headlights	30
Parking lights	30
Fog lights	30
Instrument panel lighting	30

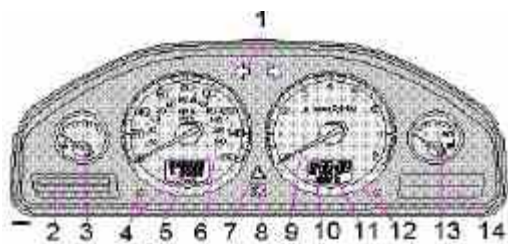

1 Turn signals

2 Text window

3 Temperature gauge

The pointer should be approximately midway on the gauge when driving.

Do not drive the car if the warning light is on. The text window will provide you with additional information.

If the engine temperature remains high, check coolant level - see [page 106](#).

4 Trip odometer/reset button

The trip odometer is used for measuring shorter distances. The last digit indicates 1/10 mile/kilometer. Press the button quickly to toggle between trip odometers 1 and 2. Hold in the button for more than 2 seconds to reset.

5 Odometer

6 Speedometer

7 General warning light (see [page 24](#)).

8 High beam indicator light

9 Tachometer

Reads thousands of engine rpm. Do not drive for long with the needle in the red section. The engine has an inbuilt function preventing too high a rotation speed. When this function operates, you may discern some pulsation, which in that case is quite normal.

10 Gear and driving mode indicator

The currently selected driving mode is displayed here. If you use the geartronic function on the automatic transmission, the currently selected gear will be displayed.

11 Ambient temperature indicator

This sensor indicates the air temperature outside your car. A "snowflake" symbol in the text window is displayed when the temperature is in the range of 23 - 36° F (-5 - +2° C).

Please note that this symbol does not indicate a fault with your car.

At low speeds or when the car is not moving, the temperature readings may be slightly higher than the actual ambient

temperature.

12 Clock/reset button

Turn the button to adjust the clock.

13 Fuel gauge

The fuel tank holds approximately 21.1 US gal. (80 liters).

When the warning light comes on there is approximately 1.8 US gal. (8 liters) of fuel remaining.

14 Indicator and warning lights

pg. 24 Indicator and warning lights

The indicator and warning lights described on [pages 24 and 25](#) should never stay on when driving

When the ignition key is turned, all of the warning lights in the lower right-hand side of the instrument panel should go on to test the function of the bulbs. If a light does not go off after the engine has started, the system indicated should be inspected.

NOTE: The parking brake reminder light will not go off until the parking brake has been fully released.

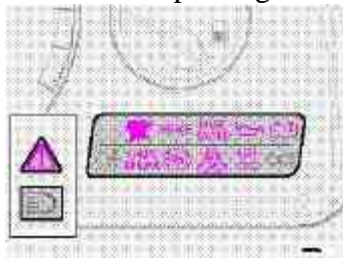

Warning lamp  **in the center of the instrument panel** This lamp lights up **red** or **orange** depending on the severity of the fault that has been detected.

Orange light: Follow the instructions shown in the text window.

Red light: Stop the car as soon as possible in a suitable location and read the message shown in the text window.



Supplemental Restraint System (SRS)

If the light comes on (or stays on after the vehicle has started), the SRS diagnostic system has detected a fault. Drive to an authorized Volvo retailer for an inspection of the system. See the SRS section for more information.

BRAKE

Brake failure warning light

If the light comes on while driving or braking, stop immediately, open the hood and check the brake fluid level in the reservoir. See [page 109](#) for reservoir position.

Canadian models are equipped with this warning light: 

Park Brake

Parking brake reminder light

This light will be on when the parking brake (hand brake) is applied. The parking brake lever is situated between the front seats.

Canadian models are equipped with this warning light: 



Oil pressure warning light

If the light comes on while driving, stop the car and then stop the engine immediately and check the engine oil level. See [page 111](#). If the light stays on after restart, have the car towed to the nearest authorized Volvo retailer. After hard driving, the light may come on occasionally when the engine is idling. This is normal, provided it goes off when the engine speed is increased.



Generator warning light

If the light comes on while the engine is running, have the charging system checked.

pg. 25 Indicator and warning lights



Rear fog light

This light indicates that the rear fog light is on.

CHECK ENGINE

Malfunction indicator lamp

If the light comes on (or stays on after the vehicle has started), the engine diagnostic system has detected a possible fault in the emission control system. Although driveability may not be affected, see an authorized Volvo retailer as soon as possible for inspection. Canadian models are equipped with this warning light: 

NOTE: If the fuel filler cap is not closed tightly or if the engine is running when the car is refueled, the Malfunction Indicator Lamp may indicate a fault. However, your vehicle's performance will not be affected. Use only Volvo original or approved fuel filler caps.



Anti-lock Brake System ABS

If the warning light comes on, there is a malfunction of the ABS system (the standard braking system will however function). The vehicle should be driven to a Volvo retailer for inspection. See page 17 for additional information.

Stability Traction Control (STC) system (option)

Dynamic Stability and Traction Control (DSTC) system (option)

An LED in the STC or DSTC switch in the center console will light up to indicate that the system is activated. See page 18 for further information.



Service reminder indicator

This light will come on at 7,500 mile (12,000 km) intervals, after 750 hours of driving or after 12 months, whichever occurs first, to remind the driver that the service interval has been exceeded. The light will stay on for 2 minutes after start until reset by the servicing retailer.



Turn signal indicator - trailer (certain models)

If you are towing a trailer, this light will flash simultaneously with the turn signals on the trailer. If the light does not flash when signaling, neither the trailer's turn signals nor the car's turn signals are functioning.



[Contents](#) | [Top of Page](#)

2000
VOLVO
S80

Chapter 3 - Climate control system

pg. 39 Climate control system

Ventilation 40

Electronic Climate Control (ECC) 41

Climate control system - general information 44

pg. 40 Ventilation

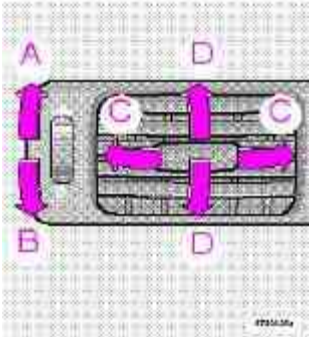

Air vents in dash

Air vents (dash)

A Open

B Closed

C Horizontal air flow

D Vertical air flow

Direct the outer air vents toward the side windows to demist.

In cold weather, close the air vents in the center of the dash to direct as much air as possible toward the windows.



Air flow

The air that is drawn into the passenger compartment is distributed from 14 ventilation points.

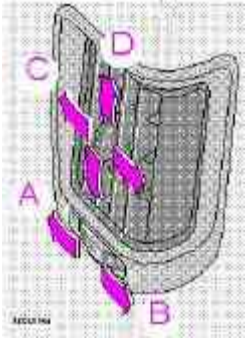

Air vents in door pillars

Air vents in door pillars

A Closed

B Open

C Horizontal air flow

D Vertical air flow

Direct the air vents toward the rear side windows to demist.

Direct the air vents toward the rear seat for the best heating/cooling effect.

pg. 41 Electronic Climate Control (ECC)

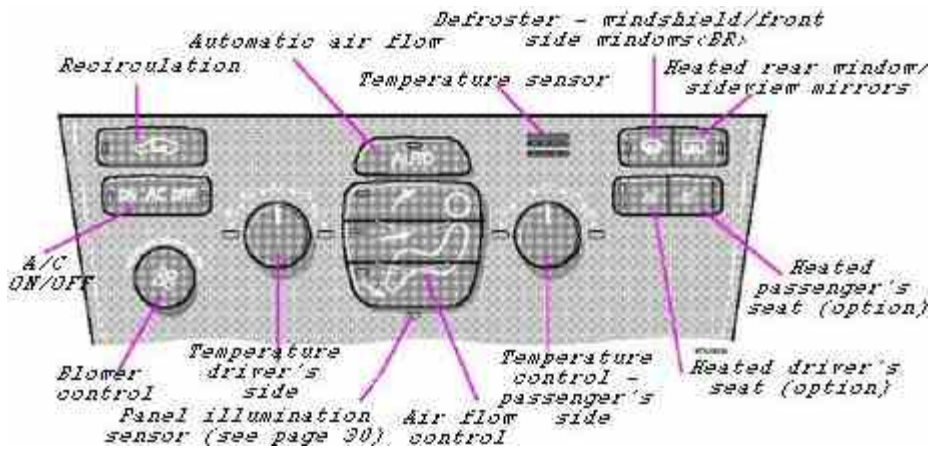

pg. 42 Electronic Climate Control (ECC)



AUTO

This function automatically regulates the Electronic Climate Control system so that the selected temperatures are maintained. The blower, heating, air distribution (air flow) and air conditioning are controlled. If you prefer to manually set any of these functions, the remaining functions will still be controlled automatically. Pressing the AUTO button overrides any settings that were previously made manually.

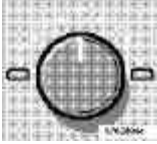

Temperature

These controls are used to individually set the temperature for both sides of the passenger compartment. Please note that the compartment will not be heated or cooled faster by setting the temperature higher or lower than necessary. Set the control to the temperature you prefer.

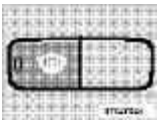

Defroster

This function demists/de-ices the windshield and front side windows. The LED in the switch will light up to indicate that the defrost function is engaged. Blower speed increases automatically and the air in the passenger compartment is dehumidified. Recirculation will not function while defrost is engaged.

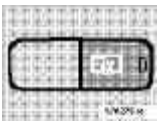

Heated rear window/sideview mirrors

This function demists/de-ices the rear window and sideview mirrors. The LED in the switch will light up to indicate that the heating function is engaged. See [page 33](#) for additional information on this function.

CAUTION:

Never use ice scrapers made of metal as they can easily scratch the mirror surface.

pg. 43 Electronic Climate Control (ECC) - manual settings



Recirculation

Press this switch to engage the recirculation function (air in the passenger compartment recirculates - no fresh air enters the compartment). The LED in the switch will light up to indicate that the function is engaged.

- Use this function if the outside air is contaminated with exhaust gases, smoke, etc or to heat/cool the car quickly.

- Recirculation should not be used for more than 15 minutes. *If your windows begin to fog or mist, make sure that the recirculation function is switched off.*
- Selecting **Defroster** automatically switches recirculation off.
- **Timer function:** Pressing and holding the switch for at least 3 seconds activates a timer function. The LED in the switch will flash for approximately 5 seconds. Recirculation will then always operate for periods of 5 to 12 minutes, depending on the ambient temperature, after which it will switch off automatically. Pressing the switch at any time during the recirculation period will disengage the function and allow fresh air into the passenger compartment. Press and hold the switch again for at least 3 seconds to return the button to its original function (i.e., recirculation will remain on until you switch it off).

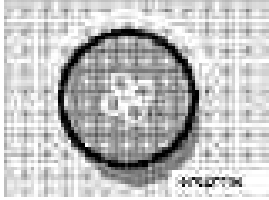

Blower control Turn the control clockwise to increase or counterclockwise to decrease the blower speed. Pressing the AUTO switch will automatically regulate blower speed and override manual adjustment.

NOTE: Turning the blower control counterclockwise as far as possible (an LED next to the control will light up) will turn both the blower and the air conditioning off.

Air flow

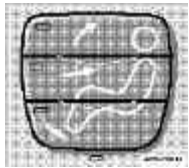

Air flow to windows
Air from panel vents
Air through floor vents

Press **AUTO** to automatically regulate air flow or press any combination of the controls shown in the illustration to manually adjust air flow. An LED in the switch will light up if an air flow control has been pressed.

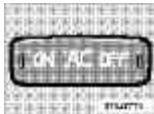

Air conditioning ON/OFF Press the switch to turn the air conditioning on or off. The "ON" or "OFF" LED will light up to indicate if the system is switched on or off. Other functions will still be regulated automatically (if the **AUTO** switch is on).

- The air conditioning functions only at temperatures above 32° F (0° C).

· While the **Defroster** function is selected, the air conditioning is temporarily activated to dehumidify the air, even if you have manually switched the air conditioning off. This will only function if the blower is *not* switched off.

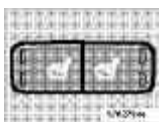

Heated front seats (option)

Please see [page 33](#) for more information on this function.

Condensation on the inside of the windows

Keeping the insides of the windows clean will help reduce the amount of condensation that forms on the windows. Use a commercial window cleaning agent to clean the windows.

Ice and snow

Always keep the air intake grille at the base of the windshield free of snow.

Air cabin filter

Replace the air cabin filter with a new one at the recommended intervals. The filter should be replaced more often when driving under dirty and dusty conditions. The filter cannot be cleaned and therefore should always be replaced with a new one.

Sensors

The sunlight sensor on the dashboard and passenger compartment temperature sensor in the ECC control panel should not be covered in any way as this could cause incorrect information to be sent to the ECC system.

Parking the car in warm weather

If your car has been parked in the sun in warm weather, opening the windows and sun roof (option) for several minutes before driving will help release the warm air from the passenger compartment. When the engine is running, close the windows and sun roof and use the recirculation function for several minutes to enable the air conditioning to cool the compartment as quickly as possible.

Windows and optional sun roof

The ECC system will function best if the windows and optional sun roof are closed. If you drive with the sun roof open, we recommend that you manually adjust the temperature and blower control (the LED in the AUTO switch should be off).

Acceleration

The air conditioning is momentarily disengaged during full-throttle acceleration.

ECC maintenance

All maintenance on the climate control systems should be carried out by an authorized Volvo service technician only.

Refrigerant

Volvo cares about the environment. The air conditioning system in your car contains a CFC-free refrigerant - R134a. This substance will not deplete the ozone layer. The system contains 2.2 lbs (1000 g) R134a and uses PAG oil.

Passenger compartment blower

The blower may come on automatically (certain models) after approximately 50 minutes, and stay on for 5 minutes, to remove excess condensation in the A/C evaporator.



2000 VOLVO S80

Chapter 4 - Interior

pg. 45 Interior

[Front seats](#) [46](#)

[Interior lighting](#) [48](#)

[Storage compartments](#) [49](#)

[Storage compartments in center console](#) [50](#)

[Spare tire, Cargo net in trunk](#) [51](#)

[Folding rear seat backrests, Carrying long loads](#) [52](#)

pg. 46 Front seats

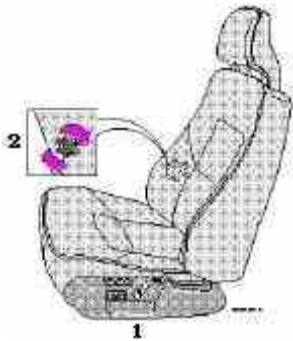

Electrically operated front seats

From the time the driver's door is unlocked, the driver's seat can be adjusted *with the ignition off* during a **10 minute period, if the door remains opened**. If the door is closed, the seat can be adjusted for 40 seconds.

1 - Power seat control panel

2 - Lumbar support

Turn the control for softer or firmer lumbar support.

Move the seat as far rearward as possible for easiest access to the lumbar support control.

Electrically operated seats with memory function * *Power seat control panel*

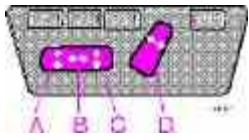

- A Front edge of seat (raise/lower)
- B Forward - rearward
- C Rear edge of seat (raise/lower)
- D Backrest tilt

WARNING!

- From the time the driver's door is unlocked, the driver's seat can be adjusted *with the ignition off* during a **10 minute period, if the door remains opened** (40 seconds if the door is closed). Therefore, children should never be left unattended in the car.
- Movement of the seat can be STOPPED at any time by pressing any button on the power seat control panel.
- Do not adjust the seat while driving. The seat should be adjusted so that the brake pedal can be depressed fully. In addition, position the seat as far rearward as comfort and control allow.
- The seat rails on the floor must not be obstructed in any way when the seat is in motion.

Programming the memory

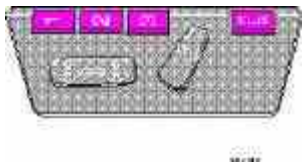

Three seat positions can be programmed. To program a seat position:

- 1 Adjust the seat to the desired position.
- 2 Hold down the MEM button.
- 3 While holding down the MEM button, press button 1 to program the current position of the seat.

Buttons 2 and 3 can be programmed in the same way.

To move the seat to a programmed position, press and hold down button 1, 2 or 3 until the seat moves to the preset position and stops.

As a safety precaution, the seat will stop automatically if the button is released before the seat has reached the programmed position.

NOTE: The seat has an overload protector which engages if an object blocks the movement of the seat. If this happens, remove the object and wait 20 seconds before operating the seat again.

* Only the driver's seat is equipped with the memory function.

Adjusting the front seats:

Passengers's seat: The passenger's seat can only be adjusted if the ignition key is in position I or II (see page 46).

Driver's seat: The driver's seat can be adjusted if the ignition key is in position I or II (see page 46). However, it can also be adjusted:

- Within 40 seconds after the ignition has been switched off (even if the key has been removed from the ignition switch).
- Within 40 seconds after the driver's door has been unlocked with the key or remote control and opened. The key does not have to be in the ignition switch during this period.

Remote control (central locking system)

If you lock the car and later unlock it with the **same** remote control and open the driver's door, the driver's seat will automatically move to the position it was in when you left the car. See page 56 for more information on this function.

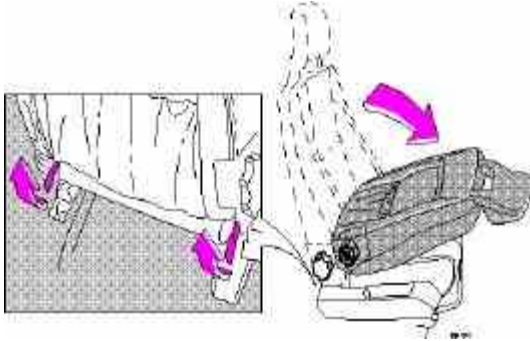

Folding passenger's seat backrest

The passenger seat backrest can be folded down to the horizontal position for carrying long loads. To fold down the backrest:

- Move the seat as far rearward as possible
- Adjust the backrest tilt to the most upright position
- Lift the catches on the lower rear side of the backrest
- Without releasing the catches, push the backrest forward
- Move the seat as far forward as possible

WARNING!

Cover sharp edges on the load to help prevent injury to occupants. Secure the load to help prevent shifting during sudden stops.

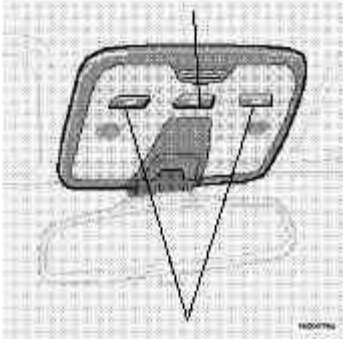

Front reading lights

Courtesy light

The courtesy light can be turned on or off by pressing the button. The light also has a timer function which turns the light on for *30 seconds* if:

- You unlock the car from the outside with the key or remote control.
- You switch off the ignition (turn the key to position 0).

The courtesy light stays on for *10 minutes* if one of the doors is left open after the car is unlocked.

The courtesy light switches off if:

- The engine is started.
- The car is locked from the outside with the key or remote control.

The interior courtesy light can be switched on or off at any time by pressing the center button in the panel above the rearview mirror. When switched on with the engine off, the light will stay on for 10 minutes. When switched on with the engine running, the light will stay on indefinitely. The light may be switched off at any time by pressing the center button a second time.

The courtesy light timer periods can be changed. Consult your Volvo retailer.

Overriding the Interior and Trunk Courtesy Lights

Normally if a car door is left open with the engine turned off, the interior courtesy light will stay on for 10 minutes. Normally, if the trunk is left open with the engine turned off, the trunk courtesy lights will stay on for 10 minutes.

If a car door is left open or the interior courtesy lights are turned on while the engine is left running, the interior courtesy lights will stay on indefinitely. Likewise, if the trunk is left open while the engine is running, the trunk courtesy light will stay on indefinitely.

At times, you may wish to be assured that the courtesy lights will stay off regardless of door or trunk lid position.

To switch off the interior and trunk courtesy lights indefinitely, press and hold the center button in the panel above the rearview mirror for 3 seconds. The courtesy lights will go off and remain off until the center button is pressed again.

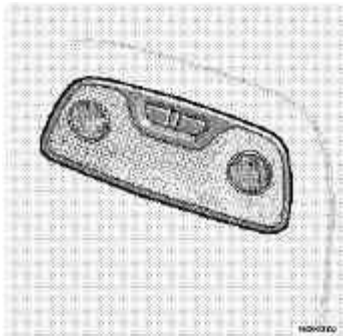

Rear reading lights

Reading lights - front/rear

The reading lights can be switched on or off by pressing the respective buttons. These lights are designed to switch off automatically after 10 minutes or can be switched off at any time by pressing the button.

pg. 49 Storage compartments

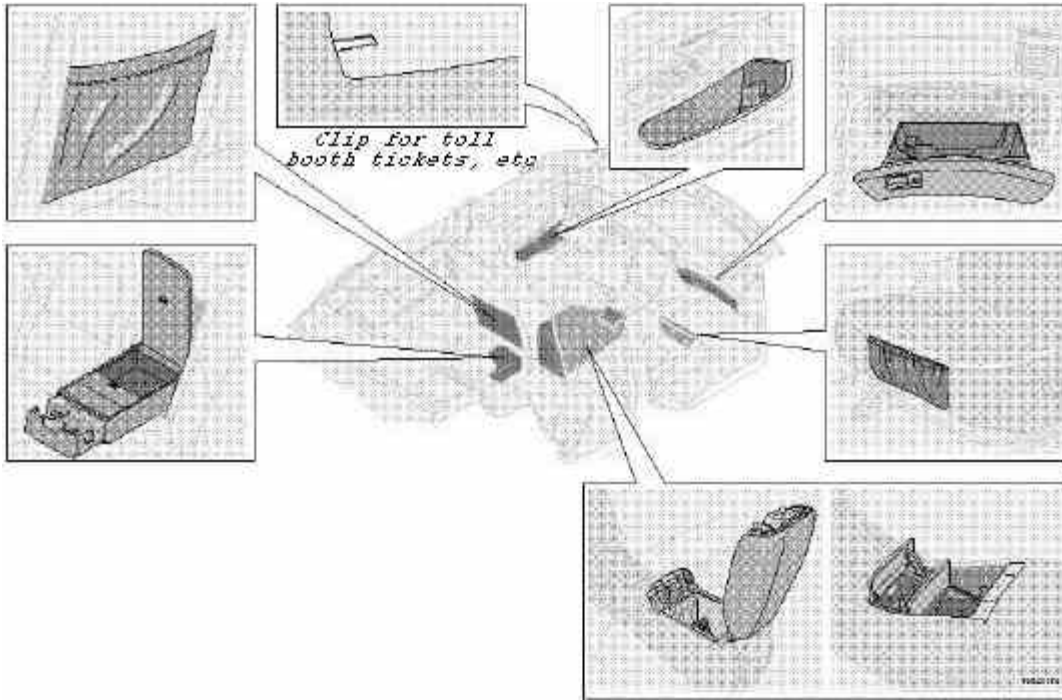

WARNING!

Packages on the rear window shelf can obscure vision and may become dangerous projectiles in the event of a sudden stop or an accident.

Anchor any heavy objects to help prevent them from moving during sudden stops.

pg. 50 Storage compartment in center console

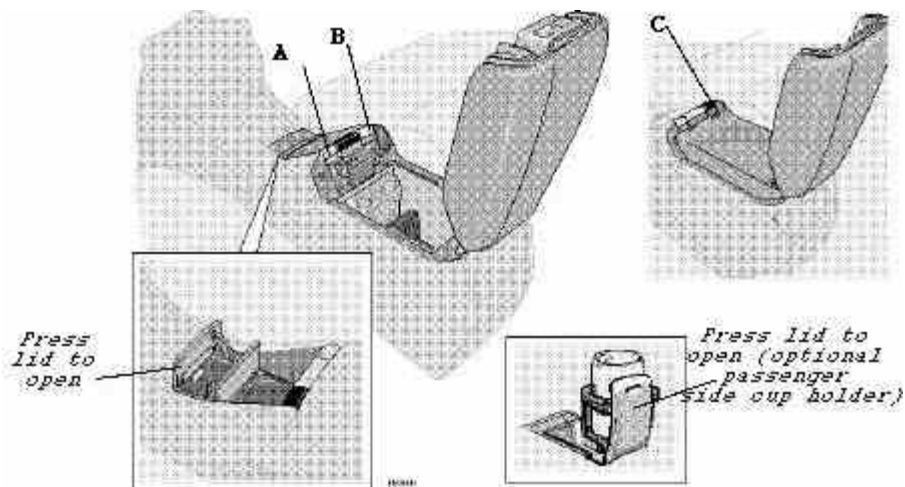

Storage compartment in center console/cup holders

- Press button A to pop open the cup holder.
- Press button B to open the storage space in the center console for cassettes, change holder, etc.
- Press button C to open the outer cover only over the storage compartment.

pg. 51 Spare tire, Cargo net in trunk

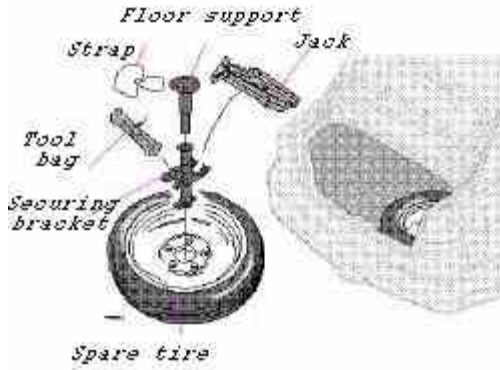

Spare tire

The spare tire, jack and tool bag are located under the floor of the trunk. To access the spare tire: · Lift the rear edge of the floor of the trunk and fold it back toward the rear seat backrest.

- Lift out the trunk floor support (certain models) from the spare tire securing bracket.
- Release the strap to lift out the jack and tool bag.
- Unscrew the securing bracket and lift out the spare tire.
- To return the spare tire to the trunk, follow the reverse procedure.

WARNING!

Make sure that the spare tire, jack and tool bag are properly secured with the securing bracket and strap to help keep these components in place in the event of a sudden stop.

NOTE: See [page 84](#) for information on how the jack should be used.

Cargo net in the trunk

The cargo net in the trunk can be used to secure light objects. Pull the net out and slide the runner in the handle down into one of the two slots provided at the rear edge of the trunk. Use the release tab to release tension on the net while it is being placed around an object. Be sure the net is then pulled taut around the object.

The net can be retracted when not in use.

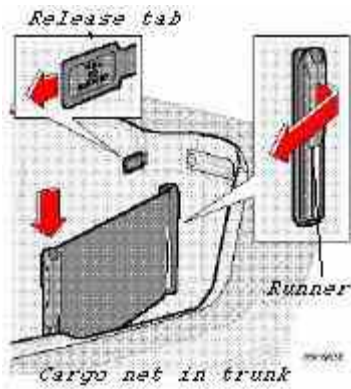

NOTE: If you have purchased the accessory plastic floor cover for the trunk, it may be necessary to cut notches in the rear edge of this cover so that the runner on the cargo net can be securely pressed into the slots provided.

WARNING!

Never use this net to secure sharp or heavy objects. In such cases, tie down the object using the cargo eyelets provided. Both rear seat backrests should be secured in the upright position when the cargo net is in use.

pg. 52 Folding rear seat backrests, Carrying long loads

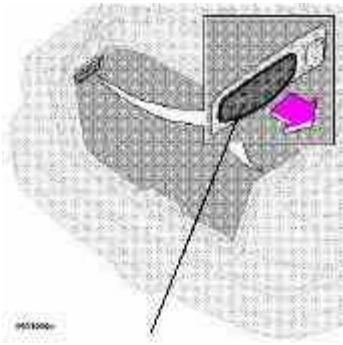

Backrest controls (on opposite sides of trunk)

Folding rear seat backrest The rear seat backrest is split into two sections. Each section can be folded independently to allow you to transport long objects.

To fold down the backrest(s):

- Pull the release control handle(s) in the trunk to release the backrest(s) (see illustration above). If the outboard rear head restraints are folded down, they should be returned to the upright position before folding the backrest down. It may be necessary to manually adjust the center head restraint.
- Fold the backrest down.

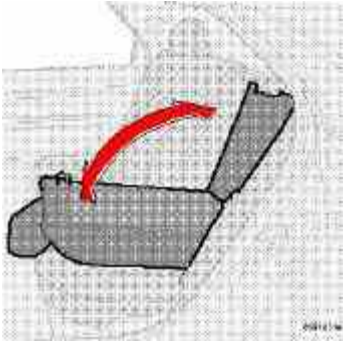

WARNING!

- When the backrest is returned to the upright position, check that it is properly locked in place. Return the head restraints to the upright position.
- Long loads should always be securely anchored to help avoid injury in the event of a sudden stop.
- Always turn the engine off and apply the parking brake when loading/unloading the vehicle.
- Place the transmission in the P (PARK) position to help prevent inadvertent movement of the gear selector.

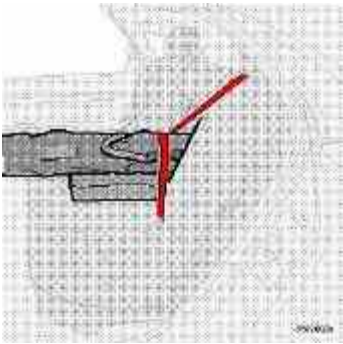

Secure long loads with the seat belt

Carrying long loads

There is a flap in the right section of the rear seat backrest for transporting long, light objects such as skis, etc. To open the flap:

- Pull the right release control handle in the trunk to release the backrest.
- From the rear seat, fold down the right section of the backrest slightly*.
- Release the flap by pushing the catch (located on the *rear* side of the backrest) upward and pulling the flap forward.
- Return the backrest to the upright position.

* If your car is equipped with the optional integrated child booster cushion, this cushion must be folded *down* before you fold down the backrest (see [page 13](#)).



2000
VOLVO
S80

Chapter 5 - Keys, Locks, Alarm

pg. 52 Keys, Locks, Alarm

[Keys, Exterior courtesy lights, Locking and unlocking the car](#) 54

[Unlocking the trunk with the master key, Central locking buttons, "Trunk lock" function](#) 55

[Remote keyless entry system](#) 56

[Alarm](#) 58

[Child safety locks - rear doors](#) 60

pg. 54 Keys, Locking and unlocking the car

Master key

This key operates all locks.

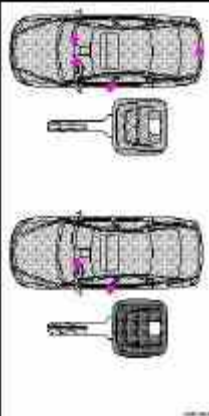

Service key

Driver's door and ignition switch/steering wheel lock.

Keys

Your car is equipped with a central locking system. The key, used on the driver's door, the remote control, or central locking button, will lock/unlock all doors and the trunk. The glove compartment can also be locked with the master key.

Turn the key once to unlock the driver's door only.

Turn the key again (within 10 seconds) to unlock all doors and the trunk.
One turn with the key towards lock in the drivers door locks all doors, trunk.
Use the switch on the front door armrests to lock/unlock the car from the inside.

WARNING!

If the doors are locked while driving, this may hinder rapid access to the occupants of the car in the event of an accident. (Also see information on "Child safety locks").

Note: To help prevent accidentally locking the keys in the car, the central locking system is designed to unlock the doors immediately if the key is left in the ignition switch, the car is locked using the lock button on the door and the door is then closed. **A sound from the lock will be audible at this time.**

Please note that this function will not unlock the doors if the engine is running.

Immobilizer (start inhibitor)

Each of the keys supplied with your car contains a coded transmitter and receiver (transponder). The code in the key is transmitted to an antenna in the ignition switch where it is compared to the code stored in the start inhibitor module. The car can only be started if a properly coded key is used.

If you misplace a key, take the other keys to an authorized Volvo retailer for reprogramming as an antitheft measure.

This device complies with part 15 of the FCC rules. Operation is subject to the following condition: (1) This device may not cause harmful interference, and (2) this device must accept any interference received, including interference that may cause undesired operation.

Courtesy lights

Home Safe System

When you leave your car at night, you can make use of the courtesy lighting function:

- Remove the key from the ignition switch.
- Pull the direction indicator lever towards the steering wheel (as when using the headlight flasher function).
- Exit the car and lock the doors.

The headlights, parking lights, license plate lights and the lights in the sideview mirrors will now come on and remain on for 30, 60 or 90 seconds (the time interval is at your discretion and can be changed by an authorized Volvo retailer).

Approach lighting

When approaching the car at night, press the yellow button in the central locking remote control (see illustration on [page 56](#)). This lights up the interior courtesy light, parking lights, license plate lights and the lights in the sideview mirrors.

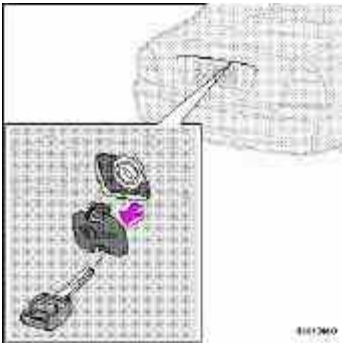

Unlocking the trunk with the master key

Normally, the trunk should be locked and unlocked via the central locking system using the remote control or by using the key in the driver's door lock. This function should only be used if it is not possible to unlock the trunk via the central locking system.

NOTE: Unlocking the trunk in this manner will cause the alarm to sound. See [page 58](#) for information on turning off the alarm. This function will not unlock the other doors.

If, for any reason, it should be necessary to unlock the trunk with the master key:

- Press the key into the upper or lower edge of the cover over the lock in the trunk lid.
- Move the key upward or downward to remove the cover.
- Insert the master key in the lock and unlock the trunk.

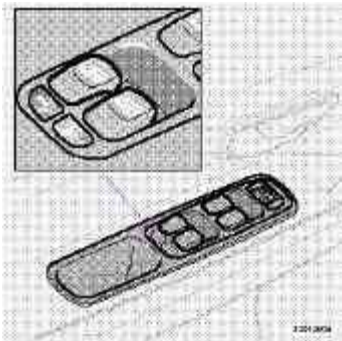

Central locking buttons

Central locking buttons

These buttons (located on the both front door armrests) can be used to lock/unlock all doors and the trunk and set the alarm if your car is so equipped.

The lock buttons on all doors can be used in the same way.

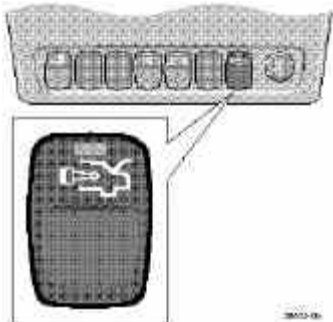

*"Trunk lock" button**

"Trunk lock" function

Pressing this switch locks the trunk, even if the doors are unlocked. The trunk will remain locked even if the doors are locked/unlocked using the **master** key or the remote control.

To use this function:

- Turn the **master** key to position II.
- Press the "trunk lock" button. An LED in the button will light up and a message will be displayed in the text window to indicate that this function is activated.
- The function can be turned off (deactivated) by turning the ignition key to position II and pressing the "trunk lock" button again (the LED in the button will go out).

* The position of this button may vary, depending on the specifications of your car.

pg. 56 Remote keyless entry system

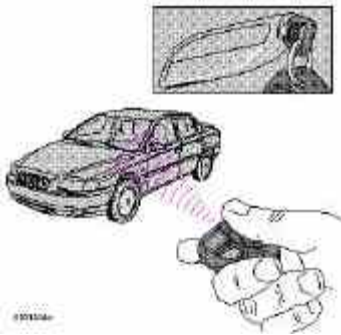

Remote keyless entry system

Your car is equipped with a remote control transmitter. This transmitter uses a radio frequency which will allow "keyless" entry into the passenger compartment or the trunk. You will be supplied with two coded key ring transmitters, which will enable you to lock/unlock all doors and the trunk from a distance of 10-15 feet (3-5 meters).

On vehicles equipped with an alarm, the alarm will also be activated/deactivated by this system.

The car can also be locked/unlocked with the key.

As an extra security precaution in certain situations (valet parking, etc.), Volvo recommends that the transmitter not be included when the keys are given to anyone. The service key can be used instead. If one of the transmitters is misplaced, contact the nearest authorized Volvo retailer for assistance.



Buttons in remote control

1 - Lock, 2 - Unlock, 3 - Open trunk
4 - "Panic" function *, 5 - Approach lighting

Using the remote control

- Press the **LOCK** button once to lock all doors and trunk.
- Press the **UNLOCK** button **once** to unlock the driver's door only. Press this button again (within 10 seconds) to unlock all doors, trunk.
- To pop open the trunk (without unlocking the other doors), press the **OPEN trunk** button *twice* within 3 seconds.

* See [page 58](#) for more information on this function.

Remote keyless entry system and driver's seat

The remote control transmitter also controls the electrically operated driver's seat in the following way:

- Adjust the seat to your preferences.
- When you leave your car, lock it using the remote control.
- The next time you unlock the driver's door with the **same** remote control (the one you used to lock the doors with) *and open the driver's door*, the driver's seat will automatically move to the position in which you left it. The seat will move to this position even if someone else has adjusted the seat since you last drove the car.

NOTE:

- This feature will work in the same way with all of the remote control transmitters (up to 3) that you use with your car.
- This feature will not function if you lock your car with the key.

This device complies with FCC rules Part 15. Operation is subject to the following two conditions: (1) This device may not cause harmful interference and (2) this device must accept any interference that may be received, including interference that may cause undesired operation.

pg. 57 Remote keyless entry system

WARNING!

Volvo does not recommend using the transmitter to lock the doors from inside the car. On cars equipped with an alarm, the alarm would be activated and would sound when one of the doors is opened. The doors must not be locked using the remote transmitter while the vehicle is occupied. In case of an accident, this may hinder rapid access to the occupants of the vehicle. The alarm will also sound on models equipped with this feature.

NOTE:

- If the doors are unlocked, the locks will automatically reengage (re-lock) and the alarm will reset after 2 minutes unless a door has been opened.
- Airbag deployment will automatically unlock the doors.
- The lock/unlock and alarm features can also be utilized by using the keys. See [page 54](#).
- To avoid leaving your keys in the car, make a habit of always locking the car with the remote control.

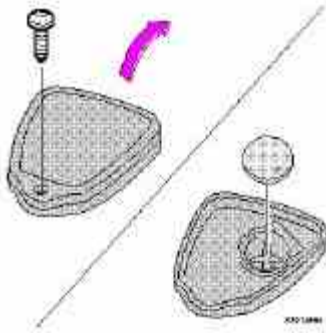

Remote keyless entry system - replacing batteries

Each remote transmitter is powered by a three-volt, CR 2032 battery.

If the range of the transmitter is noticeably reduced, this indicates that the battery is weak and should be replaced.

Replacement: Remove the screw on the back of the transmitter cover. Replace the battery. Reinstall the cover and tighten the screw to help protect the transmitter.

NOTE: The old battery should be disposed of properly at a recycling center or at your Volvo retailer.

pg. 58 Alarm

Alarm

The alarm is automatically set (armed) whenever you lock your car.

When armed (set), the alarm continuously monitors a number of points on the car. The following conditions will set off the alarm:

- The hood is opened.
- The trunk is opened.
- A door is opened.
- The ignition switch is tampered with.
- If there is movement in the passenger compartment (if the car is equipped with the optional movement sensor).
- The car is lifted or towed (if the car is equipped with the optional inclination sensor).
- The battery is disconnected (while the alarm is set).

Arming (setting) the alarm

Press the LOCK button on the remote control, lock the car using the key in the driver's door or press the central lock button on one of the front doors with the door open. One long flash of the turn signals will confirm that the alarm is set.

Disarming the alarm

Press the UNLOCK button on the remote control or unlock the doors with the key.

Turning off (stopping) the alarm

If the alarm is sounding, it can be stopped by pressing the UNLOCK button on the remote control or by unlocking the driver's door with the key.

Visual alarm signal

The visual alarm signal is given by flashing all turn signals and turning on the interior lighting for approximately 5 minutes.

Audible alarm signal

An audible alarm signal is given by a battery powered siren. One alarm cycle lasts for 25 seconds.

"Panic" function

In an emergency situation, this feature can be used to attract attention.

Activate the "panic" function by pressing the red button on the remote control (see illustration on [page 56](#)) for at least 3 seconds or by pressing this button twice within 3 seconds. The turn signals will flash, the interior lights will go on and the car's horn will sound.

The function can be turned off by pressing any of the buttons on the remote control or will stop automatically after 25 seconds.

NOTE: This button will **NOT** unlock the car.

pg. 59 Alarm

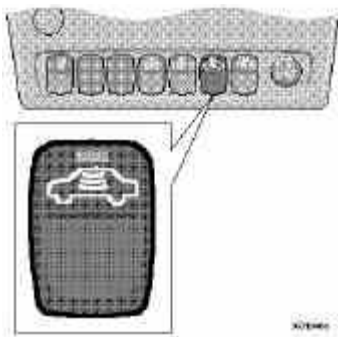

Temporarily disconnecting the alarm sensor(s) - option

This button will only be found in cars equipped with the optional inclination and/or movement sensors.

In certain situations it may be desirable to disconnect the alarm sensors if, for example, you drive your car onto a ferry where the rocking of the boat could trigger the alarm or if a person or pet remains in the car with the doors locked.

To temporarily disconnect the sensor(s) from the alarm system:

From the time the ignition key is turned from the Drive position (position I) until you lock the car, you can press the button in the center console *. The LED in the switch will light up and a message will be displayed in the text window to indicate that the sensors are disconnected.

The car can then be locked in the usual way to set the alarm.

NOTE: The optional sensors are automatically reconnected to the alarm system the next time the car is unlocked and then locked again.

LED alarm status signals

The status of the alarm system is indicated by the red LED at the top of the dash:

- LED off - the alarm is not armed (set)
- LED flashes once per second - the alarm is armed (set)
- LED flashes rapidly before the ignition is switched on - the alarm has been triggered
- **Fault in the alarm system:** If a fault has been detected in the alarm system, a message will be displayed in the text window. Contact a Volvo retailer.

Automatic reset function

If the car has been unlocked with the remote control, the locks will automatically reengage (re-lock) and the alarm will reset after 2 minutes unless a door or the trunk has been opened.

* The position of this button may vary, depending on the specifications of your car.

pg. 60 Child safety locks - rear doors

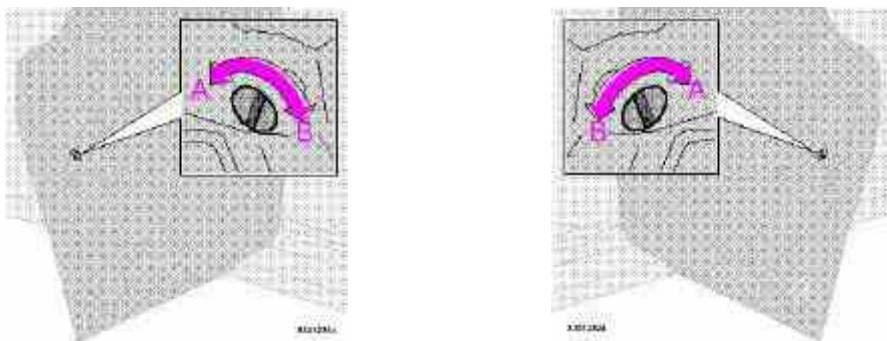

Child safety lock control in left rear door Child safety lock control in right rear door

Child safety locks - rear doors

The controls are located on the rear door jambs. Use a screwdriver to adjust these controls.

A The door cannot be opened from the inside. Normal operation from the outside.

B The door lock functions normally.

WARNING!

Remember, in the event of an accident, the rear seat passengers cannot open the doors from the inside with the buttons in position A.



2000
VOLVO
S80

Chapter 6 - Starting and driving

pg. 61 Starting and driving

[Fuel requirements](#) 62

[Refueling](#) 63

[Starting the engine](#) 64

[Automatic transmission](#) 65

[Driving economy](#) 69

[Points to remember](#) 70

[Emergency towing](#) 72

[Vehicle towing information](#) 73

[Towing a trailer](#) 74

[Jump starting](#) 75

[Winter driving](#) 76

[Long distance trips](#) 77

[Three-way catalytic converter](#) 78

pg. 62 Fuel requirements

NOTE ENGINE OIL:

Although some oil consumption occurs during normal engine operation, more oil is consumed when the engine is new as the internal parts generate higher friction while wearing in to each other. **From the time the engine is new until the first service is performed, the oil consumption could be higher than normal.** For this reason, it is especially important to check the oil every time you refuel your car during this period. See [page 111](#).

Fuel requirements

Octane rating

Volvo engines are designed for optimum performance on unleaded premium gasoline with an octane rating. AKI of 91, or above. AKI (ANTI KNOCK INDEX) is an average of the Research Octane Number, RON, and the Motor Octane Number, MON. (RON + MON/2).

The minimum octane requirement is AKI 87 (RON 91).

Deposit control gasoline (detergent additives)

Volvo recommends the use of gasoline containing deposit control additives. These additives have shown to be efficient in keeping injectors and intake valves clean. Consistent use of deposit control gasolines will help ensure good driveability and fuel economy. If you are not sure whether the gasoline contains deposit control additives, check with the service station operator.

Unleaded fuel

Each Volvo has a three-way catalytic converter and must use only unleaded gasoline. U.S. and Canadian regulations require that pumps delivering unleaded gasoline be labelled "UNLEADED". Only these pumps have nozzles which fit your car's filler inlet. It is unlawful to dispense leaded fuel into a vehicle labelled "unleaded gasoline only". Leaded gasoline damages the three-way catalytic converter and the heated oxygen sensor system. Repeated use of leaded gasoline will lessen the effectiveness of the emission control system and could result in loss of emission warranty coverage. State and local vehicle inspection programs will make detection of misfueling easier, possibly resulting in emission test failure for misfueled vehicles.

NOTE: Some U.S. and Canadian gasolines contain an octane enhancing additive called methyl-cyclopentadienyl manganese tricarbonyl (MMT). If such fuels are used, your Emission Control System performance may be affected, and the Malfunction Indicator Lamp located on your instrument panel may light. If this occurs, please return your vehicle to an authorized Volvo retailer for service.

Gasoline containing alcohol and ethers

"Oxygenated fuels"

Some fuel suppliers sell gasoline containing "oxygenates" which are usually alcohols or ethers. In some areas, state or local laws require that the service pump be marked indicating use of alcohols or ethers. However, there are areas in which the pumps are unmarked. If you are not sure whether there is alcohol or ethers in the gasoline you buy, check with the service station operator. To meet seasonal air quality standards, some areas require the use of "oxygenated" fuel.

Volvo allows the use of the following "oxygenated fuels; however, the octane ratings listed on this page must still be met.

Alcohol — Ethanol: Fuels containing up to 10% ethanol by volume may be used. Ethanol may also be referred to as Ethyl alcohol, or "Gasohol".

Ethers — MTBE: Fuels containing up to 15% MTBE may be used.

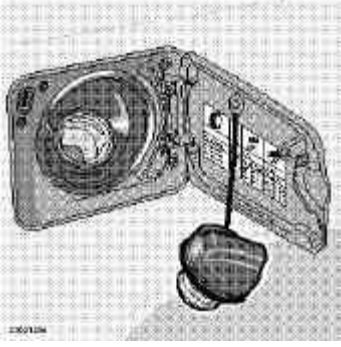

Refueling

The fuel tank is designed to hold approximately 21.1 US gal. (80 liters) with sufficient volume left over to accommodate possible expansion of the fuel in hot weather. Be aware that the "usable" tank capacity will be somewhat less than the specified maximum. When the fuel level is low, such factors as ambient temperature, the fuel's "Reid vapor pressure" characteristics, and terrain can affect the fuel pumps' ability to supply the engine with an adequate supply of fuel. Therefore, it is advisable to refuel as soon as possible when the needle nears the red zone, or when the fuel warning light comes on.

Fuel tank cover

The fuel tank cover, located on the right rear fender, is connected to your car's central locking system. The driver's door must be unlocked before the fuel tank cover can be opened.

Be sure the fuel tank cover is not obstructed and is completely closed after refueling.

Open the fuel filler cap slowly during hot weather conditions.

NOTE: During a transitional period, a small number of service stations may still have fuel nozzles that are not compatible with the fuel filler neck on cars equipped with the evaporative control system (ORVR). Please refer to [page 105](#) for additional information.

CAUTION:

- Do not refuel with the engine running *. Turn the ignition off or to position I. If the ignition is on, an incorrect reading could occur in the fuel gauge.
- After refueling, close the fuel filler cap by turning it clockwise until it *clicks* into place *.
- Allow for fuel expansion by not overfilling the tank. Overfilling could also cause damage to the emission control systems.
- Avoid spilling gasoline during refueling. Gasolines containing alcohol can cause damage to painted surfaces, which may not be covered under the New Vehicle Limited Warranty.
- Do not use gasolines containing methanol (methyl alcohol, wood alcohol). This practice can result in vehicle performance deterioration and can damage critical parts in the fuel system. Such damage may not be covered under the New Vehicle Limited Warranty.

** If the fuel filler cap is not closed tightly or if the engine is running when the car is refueled, the Malfunction Indicator Lamp may indicate a fault. However, your vehicle's performance will not be affected. Use only Volvo original or approved fuel filler caps.*

1. Fasten the seat belt.

WARNING!

Before starting, check that the seat, steering wheel and mirrors are adjusted properly. Make sure the brake pedal can be depressed completely. Adjust the seat if necessary. See [page 46](#).

2. Apply the parking brake, if not already set. The gear selector is locked in the **(P)**ark position (**SHIFTLOCK**).
3. **Without touching the accelerator pedal**, turn the ignition key* to the starting position. Allow the starter to operate for up to 5 seconds (turbo: 10 seconds). Release the key as soon as the engine starts. If the engine fails to start, repeat this step.

For cold starts at altitudes above 6000 ft (1800 meters), depress the accelerator pedal halfway and turn the key to the starting position. Release the pedal slowly when the engine starts.

4. To release the gear selector from the **(P)**ark position, the engine must be running (or the ignition key must be in position II) and the brake pedal must be depressed.
5. Select the desired gear. The gear engages after a very slight delay which is especially noticeable when selecting R.

NOTE:

- Your car is equipped with a **KEYLOCK** system. When the engine is switched off, the gear selector must be in the **(P)**ark position before the key can be removed from the ignition switch.
- When starting in cold weather, the transmission may shift up at slightly higher engine speeds than normal until the automatic transmission fluid reaches normal operating temperature.

CAUTION:

- The engine should be idling when you move the gear selector. Never accelerate until after you feel the gear engage! Accelerating immediately after selecting a gear will cause harsh gear engagement and premature transmission wear.
- Selecting P or N when idling at a standstill for prolonged periods of time will help prevent overheating of the automatic transmission fluid.
- Do not race a cold engine immediately after starting. Oil flow may not reach some lubrication points fast enough to prevent engine damage.

WARNING!

- Always place the gear selector in Park and apply the parking brake before leaving the vehicle. Never leave the car unattended with the engine running.
- Always open the garage doors fully before starting the engine inside a garage to ensure adequate ventilation. The exhaust gases contain carbon monoxide, which is invisible and odorless but very poisonous.

* Your car is equipped with an electronic start inhibitor (immobilizer). The keys you received with your car are specially coded. The code in the key is transmitted to an antenna in the ignition switch where it is compared to the code stored in the start inhibitor module. The car can only be started if a properly coded key is used.

If two of the keys to your car are close together, e.g., on the same key ring, when you try to start the car, this could cause interference in the immobilizer system and result in the car not starting. If this should occur, remove one of the keys from the key ring before trying to start the car again.

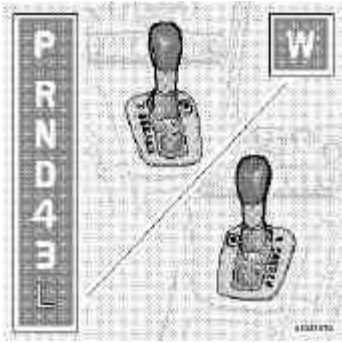

P (Park)

Use this position when starting the engine or parking the car.

Never use P while the car is in motion.

The parking brake should also be used when parking on grades.

The gear selector is mechanically locked in the P position (SHIFTLOCK). To release the gear selector from this position, the engine must be running (or the ignition key must be in position II) and the brake pedal must be depressed.

WARNING!

Never leave the car unattended when the engine is running. If, by mistake, the gear selector is moved from P, the car may start moving.

R (Reverse)

Never engage R while the car is moving forward.

N (Neutral)

Neutral - no gear engaged. Use the parking brake.

D (Drive)

D is the normal driving position and should be used as often as possible to help improve fuel economy. The car should not be moving when shifting from R to the D position.

4 (Intermediate gear)

The transmission will shift automatically between gears 4, 3, 2 or 1 from this position. **The transmission cannot shift up to 4 (D) from position 3.**

3 (Intermediate gear)

The transmission will shift automatically between gears 3, 2 and 1 from this position. **The transmission cannot shift up to 3 from position 2.**

L (Low gear)

The transmission is locked in gears 1 and 2 when the selector is in this position.

NOTE:

- Gears 4, 3, or L can be used if you are driving in a mountainous area, towing a trailer or to increase engine braking capacity.
- The transmission has a built-in function which is designed to help prevent excessive engine speeds (high rpm) when gears 4, 3 or L are selected.

Automatic transmission - adaptive system

The automatic transmission is controlled by an adaptive guidance system that constantly monitors the way in which the transmission functions. It senses and adapts each gear shift for optimal performance. The system also monitors your particular driving style and adapts gear shifting accordingly.

pg. 66 Automatic transmission AW5

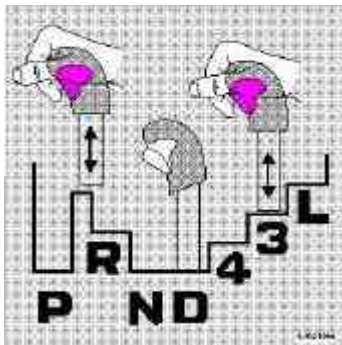

Automatic transmission - shift gate positions

The gear selector can be moved freely between N and D.

Depressing the selector knob enables you to move the gear selector to positions P, R, N, D, 4, 3 and L.

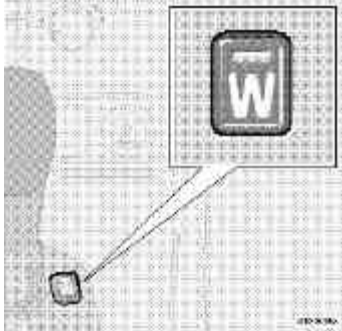

W Winter/Wet driving mode - enhanced vehicle traction

- Mode W will only function if the gear selector is in the (D)rive position.
- Press the button at the base of the gear selector to engage/disengage this driving mode (see illustration).
- An LED in the button will light up to indicate that **W** is engaged and this will also be displayed in the instrument panel (see [page 23](#)).
- This mode may be selected for starting/moving off on slippery roads.

Kickdown

Automatic shift to a lower gear (kickdown) is achieved by depressing the accelerator pedal fully and briskly. An

upshift will occur when approaching the top speed for a particular gear or by releasing the accelerator pedal slightly. Kickdown can be used for maximum acceleration or when passing at highway speeds.

pg. 67 Automatic transmission (Geartronic)



P (Park)

Use this position when starting the engine or parking the car.

Never use P while the car is in motion.

The parking brake should also be used when parking on grades.

The gear selector is mechanically locked in the P position (SHIFTLOCK). To release the gear selector from this position, the engine must be running (or the ignition key must be in position II) and the brake pedal must be depressed.

WARNING!

Never leave the car unattended when the engine is running. If, by mistake, the gear selector is moved from P, the car may start moving.

R (Reverse)

Never engage R while the car is moving forward.

N (Neutral)

Neutral - no gear engaged. Use the parking brake.

D (Drive)

D is the normal driving position and should be used as often as possible to help improve fuel economy. The car should not be moving when shifting from R to the D position.

Kickdown

Automatic shift to a lower gear (kickdown) is achieved by depressing the accelerator pedal fully and briskly. An upshift will occur when approaching the top speed for a particular gear or by releasing the accelerator pedal slightly. Kickdown can be used for maximum acceleration or when passing at highway speeds. **Kickdown does not function when the transmission is in the manual shift (geartronic) mode (see next page).**

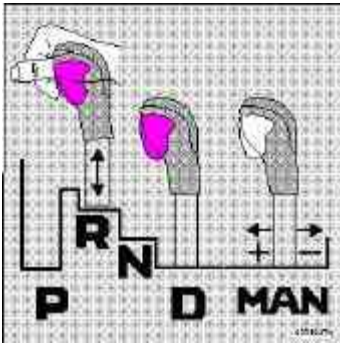

Shift gate positions

Automatic transmission - adaptive system

The automatic transmission is controlled by an adaptive control system that constantly monitors the way in which the transmission functions. It senses and adapts each gear shift for optimal performance. The system also monitors your particular driving style and adapts gear shifting accordingly.

Automatic transmission - shift gate positions

You can move the gear selector freely between the (MAN)ual and (D)rive positions while driving.

Depress the selector knob on the front side of the gear selector to move between the R, N, D and P positions.

Please see the following page for information on using the manual (Geartronic) shifting function.

pg. 68 Automatic transmission (Geartronic)

Manual shifting - Geartronic

You can move the gear selector freely between the (MAN)ual and (D)rive positions while driving. Gears 2, 3, and 4 have a "lock-up" function which reduces engine speed and helps save fuel.

The currently selected gear will be displayed in the instrument panel (see [page 23](#)).

- To access the (MAN)ual shifting position from (D)rive, pull the gear selector back slightly from D and move it to the left to MAN.
- To return to the (D)rive position from MAN, move the gear selector to the right and push it forward to the (D)rive position.

While driving

If you select the (MAN)ual position while driving, the gear that was being used in the (D)rive position will also initially be selected in (MAN)ual position.

- Move the gear selector forward (toward "+") to shift to a higher gear or rearward (toward "-") to shift to a lower gear.
- If you hold the gear selector toward "-", the transmission will downshift, one gear at a time, and will utilize the braking power of the engine.
- If you slow down to a very low speed, the transmission will automatically shift down.
- When starting in the (MAN)ual position, 3rd gear is the highest gear that may be selected.

NOTE: Kickdown (see previous page) **does not function** when the transmission is in the manual shift (geartronic) mode.

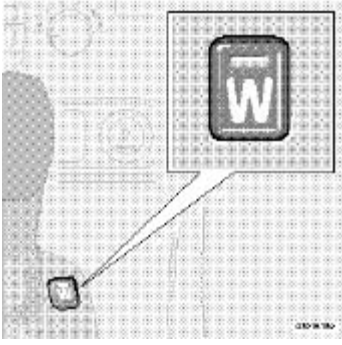

W Winter/Wet driving mode - enhanced vehicle traction

- Mode W will only function if the gear selector is in the (D)rive position.
- Press the button at the base of the gear selector to engage/disengage this driving mode (see illustration).
- An LED in the button will light up to indicate that **W** is engaged and this will also be displayed in the instrument panel (see [page 23](#)).
- This mode may be selected for starting/moving off on slippery roads.

pg. 69 Driving economy

Economical driving conserves natural resources

Better driving economy may be obtained by thinking ahead, avoiding rapid starts and stops and adjusting the speed of your vehicle to immediate traffic conditions. Observe the following rules:

- Bring the engine to normal operating temperature as soon as possible by driving with a light foot on the accelerator pedal for the first few minutes of operation. A cold engine uses more fuel and is subject to increased wear.
- Whenever possible, avoid using the car for driving short distances. This does not allow the engine to reach normal operating temperature.
- Drive carefully and avoid rapid acceleration and hard braking.
- Do not exceed posted speed limits.
- Avoid carrying unnecessary items (extra load) in the car.
- Maintain correct tire pressure. Check tire pressure regularly (when tires are cold).
- Remove snow tires when threat of snow or ice has ended.
- Note that roof racks, ski racks, etc., increase air resistance and also fuel consumption.
- Avoid using automatic transmission kickdown feature unless necessary.
- Avoid using the air conditioning when it is not required. When engaged, the air conditioner's compressor places an additional load on the engine. However, please note that fuel consumption is lower with the air conditioning on than it is when driving with the air conditioning switched off and the windows down.
- If your car is equipped with the optional Trip Computer, utilizing the fuel consumption modes can help you "learn" how to drive more economically.

Other factors which decrease gas mileage are:

- Worn or dirty spark plugs
- Incorrect spark plug gap
- Dirty air cleaner
- Dirty engine oil and clogged oil filter
- Dragging brakes
- Incorrect front end alignment

Some of the above mentioned items and others are checked at the standard Maintenance Service intervals.

NOTE: (D)rive should be used as often as possible to help improve fuel economy.



[Contents](#) | [Top of Page](#)

2000
VOLVO
S80

Chapter 7 - Wheels and tires

pg. 79 Wheels and tires

[General information, Wear indicator, Tire economy, Flat spots](#) 80

[Snow chains, Winter tires](#) 81

[Inflation pressure, Spare tire](#) 82

[Uniform tire quality grading](#) 83

[Changing wheels](#) 84

pg. 80 Wheels and tires

General information

Your vehicle is equipped with tires according to the tire information label on the inside of the fuel tank cover.

The following is an **example** of a tire designation code: 225/55 R16

225 = tire width in mm.

55 = tire profile. This is the relationship (in percent) between the section height and width of the tire.

R = radial tires.

16 = diameter in inches.

The tires have good road holding characteristics and offer good handling on dry and wet surfaces. It should be noted however that the tires have been developed to give these features on snow/icefree surfaces. **Certain models are equipped with "all-season" tires, which provide a somewhat higher degree of road holding on slippery surfaces than tires without the "all-season" rating.** However, for optimum road holding on icy or snow covered roads **we recommend suitable winter tires on all four wheels.** When replacing tires, be sure that the new tires are the same size designation, type (radial) and preferably from the same manufacturer, on all four wheels. Otherwise there is a risk of altering the car's roadholding and handling characteristics.

NOTE: When storing wheel/tire assemblies (e.g. winter tires and wheels), either stand the assemblies upright, or suspend them off the ground. Laying wheel/tire assemblies on their sides for prolonged periods can cause wheel and/or

tire damage.

Wear indicator

The tires have a so-called "wear indicator" in the form of a number of narrow strips running across or parallel to the tread. When approx. 1/16" (1.6 mm) is left on the tread, these strips become visible and indicate that the tire should be replaced.

Tires with less than 1/16" (1.6 mm) tread have a very poor grip in rain or snow.

When replacing worn tires, it is recommended that the tire be identical in type (radial) and size as the one being replaced. Using a tire of the same make (manufacturer) will prevent alteration of the driving characteristics of the vehicle.

To improve tire economy:

- Maintain correct tire pressure. See the tire pressure label on the inside of the fuel tank cover.
- Drive smoothly: avoid fast starts, hard braking and tire screeching.
- Tire wear increases with speed.
- Correct front wheel alignment is very important.
- Unbalanced wheels impair tire economy and driving comfort.
- If the wheels are rotated, they should be kept on the same side of the car so that they revolve in the same direction as prior to rotation.
- Hitting curbs or potholes can damage the tires and/or wheels permanently.

Flat spots

All tires become warm during use. After cooling, when the vehicle is parked, the tires have a tendency to distort slightly, forming flat spots. These flat spots can cause vibrations similar to the vibrations caused by unbalanced wheels. They do, however, disappear when the tire warms up. The degree to which flat spots form depends on the type of cord used in the tire. Remember that, in cold weather, it takes longer for the tire to warm up and consequently longer for the flat spot to disappear.

CAUTION:

The car must not be driven with wheels of different dimensions or with a spare tire other than the one that came with the car. The use of different size wheels can seriously damage your car's transmission.

pg. 81 Wheels and tires

Snow chains

Snow chains can be used on your Volvo with the following restrictions:

- Snow chains should be installed on front wheels only. Use only Volvo approved snow chains.
- Special snow chains must be mounted on 215/55 R16, 225/55 R16 and 225/50 R17 tires. Consult your Volvo retailer.
- If accessory, aftermarket or "custom" tires and wheels are installed and are of a size different than the original tires and wheels, chains in some cases CANNOT be used. Sufficient clearances between chains and brakes, suspension and body components must be maintained.
- Some strapon type chains will interfere with brake components and therefore CANNOT be used.

Consult your Volvo retailer for additional snow chain information.

CAUTION:

- Check local regulations regarding the use of snow chains before installing.
 - Always follow the chain manufacturer's installation instructions carefully. Install chains as tightly as possible and retighten periodically.
 - Never exceed the chain manufacturer's specified maximum speed limit. (Under no circumstances should that limit be higher than 31 mph (50 km/h).
 - Avoid bumps, holes or sharp turns when driving with snow chains.
 - The handling of the vehicle can be adversely affected when driving with chains. Avoid fast or sharp turns as well as locked wheel braking.
-

Snow tires, studded tires *

Tires for winter use:

Owners who live in or regularly commute through areas with sustained periods of snow or icy driving conditions are strongly advised to fit suitable winter tires to help retain the highest degree of traction.

It is important to install winter tires **on all four wheels** to help retain traction during cornering, braking, and accelerating. Failure to do so could reduce traction to an unsafe level or adversely affect handling. Do not mix tires of different design as this could also negatively affect overall tire road grip.

Volvo recommends 215/55 R16 winter tires on all four wheels.

Winter tires wear more quickly on dry roads in warm weather. They should be removed when the winter driving season has ended.

Studded tires should be run in 300600 miles (5001000 km) during which the car should be driven as smoothly as possible to give the studs the opportunity to seat properly in the tires. The tires should have the same rotational direction throughout their entire lifetime. In other words, if you wish to rotate the wheels, make sure that the same wheels are always on the same side of the car.

NOTE: Please consult state or provincial regulations restricting the use of studded winter tires before installing such tires.

* Where permitted.

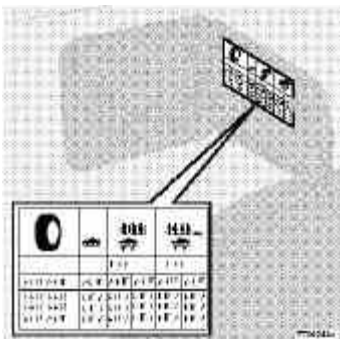

Tire pressure label

Checking and correcting tire pressure

- Check the tire pressure when refuelling.
- The tire pressure should be corrected only when the tires are cold.
- With warm tires, correct only when the pressure is too low. The tire temperature rises after driving just a few miles.

Vehicle loading

The tires on your Volvo will perform to specifications at all normal loads when inflated as recommended on the tire information label located on the inside of the fuel tankcover. This label lists both tire and vehicle design limits.

Do not load your car beyond the load limits indicated.

Temporary Spare (certain models)

The spare tire in your car is called a "Temporary Spare". It has the following designation: T125/80 R17.

Recommended tire pressure (see decal on fuel tank cover) should be maintained irrespective of which position on the car the Temporary Spare tire is used on.

In the event of damage to this tire, a new one can be purchased from your Volvo retailer.

WARNING!

Current legislation prohibits the use of the "Temporary Spare" tire other than as a temporary replacement for a punctured tire. In other words, it must be replaced as soon as possible by a standard tire. Roadholding, etc., may be affected with the "Temporary Spare" in use. Do not, therefore, exceed 50 mph (80 km/h).

CAUTION:

The car must not be driven with wheels of different dimensions or with a spare tire other than the one that came with the car. The use of different size wheels can seriously damage your car's transmission.

NOTE: Certain models may be equipped with a full-size spare wheel.

pg. 83 Wheels and tires

Uniform tire quality grading

All passenger car tires must conform to Federal Safety Requirements in addition to these grades

TREADWEAR

The treadwear grade is a comparative rating based on the wear rate of the tire when tested under controlled conditions on a specified government test course. For example, a tire graded 150 would wear one and one half (1 1/2) times as well on the government course as a tire graded 100. The relative performance of tires depends upon the actual conditions of their use, however, and many depart significantly from the norm due to variation in driving habits, service practices and differences in road characteristics and climate.

TRACTION

The traction grades, from highest to lowest, are AA, A, B, and C, as measured under controlled conditions on specified government test surfaces of asphalt and concrete. A tire marked C may have poor traction performance.

WARNING!

The traction grade assigned to this tire is based on braking (straight-ahead) traction tests and does not include cornering (turning) traction.

TEMPERATURE

The temperature grades are AA (the highest), A, B, and C, representing the tire's resistance to the generation of heat and its ability to dissipate heat when tested under controlled conditions on a specified indoor laboratory test wheel. Sustained high temperature can cause the material of the tire to degenerate and reduce tire life, and excessive temperature can lead to sudden tire failure. The grade C corresponds to a level of performance which all passenger car tires must meet under the Federal Motor Safety Standard No. 109. Grades B and A represent higher levels of performance on the laboratory test wheel than the minimum required by law.

WARNING!

The temperature grade for this tire is established for a tire that is properly inflated and not overloaded. Excessive speed, under-inflation, or excessive loading, either separately or in combination, can cause heat buildup and possible tire failure.

pg. 84 Changing wheels

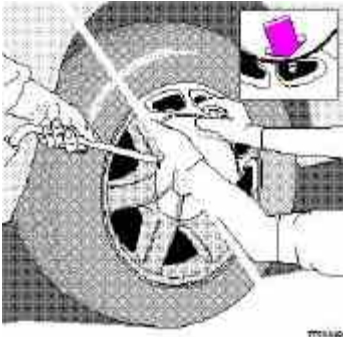

Insert flat end of lug wrench and turn/pull straight out

Changing wheels

The spare wheel is located under the carpet on the trunk floor. The jack and crank are secured in the wheel recess.

There are two jack attachment points on each side of the car.

To change a wheel:

- Engage the parking brake.
- Put the gear selector in (P)ark.
- Remove the wheel cap (where applicable) using the lug wrench in the tool kit.
- With the car still on the ground, use the lug wrench to loosen the wheel bolts 1/2 1 turn. Turn the bolts counterclockwise to loosen.

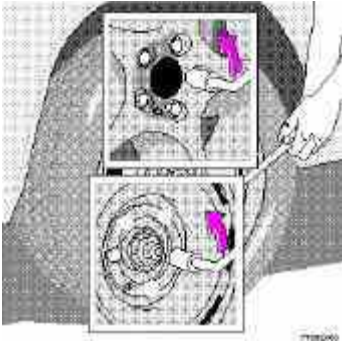

Loosen wheel bolts

- Position the jack on the bar in the attachment (**A** in the illustration in right column) and crank while simultaneously guiding the base of the jack to the ground. **The base of the jack must be flat on a level, firm, non-slippery surface. Before raising the car, check that the jack is still correctly positioned in the attachment.**
- Raise the vehicle until the wheel to be changed is lifted off the ground.
- Unscrew the wheel bolts completely and carefully remove the wheel so as not to damage the thread on the studs.

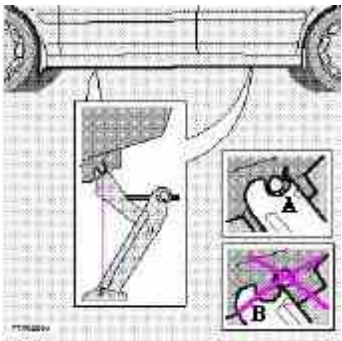

Attaching the jack

NOTE: To avoid excessive wear and the necessity of rebalancing, mark and reinstall wheels in the same location and position as before removal. To lessen the chance of imbalance, each wheel hub is equipped with a guide stud to ensure that a removed wheel can be reinstalled in its original position (as when changing over to winter tires/wheels).

pg. 85 Changing wheels



Correct tightening order for wheel bolts

Installing the wheel

- Clean the contact surfaces on the wheel and hub.
- Lift the wheel and place it on the hub. Make sure that you align the wheel with the guide stud on the wheel hub prior to installation.
- Install the wheel bolts crosswise (see illustration above) and tighten by turning lightly clockwise.
- Lower the vehicle to the ground and alternately tighten the bolts crosswise to 100 ft. lbs. (136 Nm).
- Install the wheel cap (where applicable).

WARNING!

- The jack must correctly engage the bar in the jack attachment (A). The car's weight must not rest on the jack attachment (B). See illustration on page 84.
- Be sure the jack is on a firm, level, non-slippery surface.
- Never allow any part of your body to be extended under a car supported by a jack.
- Use the jack intended for the car when replacing a wheel. For any other job, use stands to support the side of the car being worked on.
- Apply the parking brake and put the gear selector in the (P)ark position.
- Block the wheels standing on the ground, use rigid wooden blocks or large stones.
- The jack should be kept well-greased.

CAUTION:

- The car must not be driven with wheels of different dimensions or with a spare tire other than the one that came with the car. The use of different size wheels can seriously damage your car's transmission.
- Correct tightening torque on wheel bolts must be observed. The wheel bolts should never be greased or lubricated. The extended, chromed wheel bolts must not be used with steel rims, as they make it impossible to fit the hub caps.



2000
VOLVO
S80

Chapter 8 - Maintenance/Serviceing

pg.87 Maintenance/Serviceing

Fuses 88

Replacing bulbs 92

Paint touch up 99

Washing the car 100

Cleaning the upholstery 101

Maintenance service, Warranty 102

Maintenance schedule 103

Fuel/emissions systems 105

Drive belt, Air pump system, Coolant 106

Serviceing 107

Opening the hood, Engine compartment 109

Engine oil 110

Power steering/Brake fluid reservoirs 112

Automatic transmission fluid 113

Battery maintenance 114

Replacing wiper blades 115

pg.88 Fuses

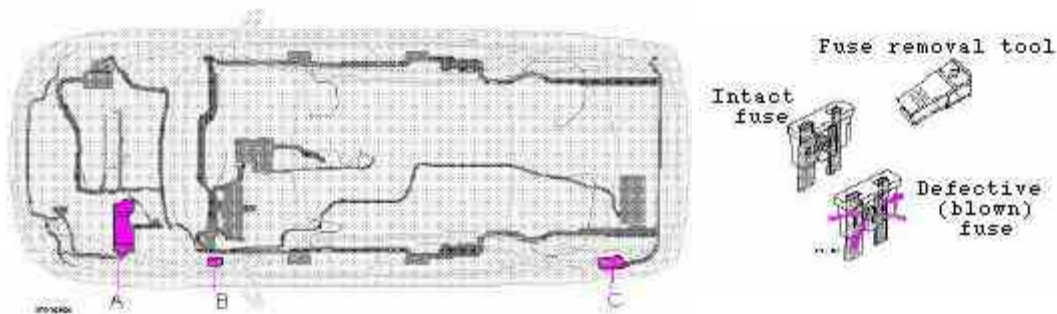

Replacing fuses

If an electrical component fails to function, it is likely that a fuse has blown due to a temporary circuit overload.

The fuse boxes are located in three different places:

A - Relays/fuse box in the engine compartment *

B - Fuse box in the passenger compartment

C - Relays/fuse box in the trunk *

A label on the inside of each cover indicates the amperage and the electrical components that are connected to each fuse.

The easiest way to see if a fuse is blown is to remove it. Pull the fuse straight out. If a fuse is difficult to remove, you will find a special fuse removal tool in the passenger compartment fuse box. From the side, examine the curved metal wire to see if it is broken. If so, put in a new

fuse of the **same color and amperage** (written on the fuse). Spare fuses are stored in the fuse box in the passenger compartment. If fuses burn out repeatedly, have the electrical system inspected by an authorized Volvo retailer.

*** The relays and main fuses in the engine compartment and trunk should only be replaced by an authorized Volvo retailer. You can, however, replace the ordinary fuses if necessary.**

pg.89 Fuses in the engine compartment

Relays/fuses in the engine compartment

The relay/fuse box in the engine compartment contains 8 main fuses and space for 21 ordinary fuses. **The main fuses should only be replaced by an authorized Volvo retailer.** You can, however, replace the ordinary fuses if necessary. Be sure to replace a blown fuse with a new one of the **same color and amperage** (written on the fuse).

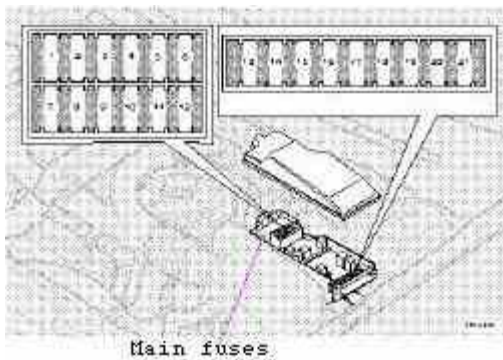

Main fuses

Location	Amperage
1 Air pump (certain models)	60A
2 Engine compartment/passenger compartment	60A
3 Engine compartment/passenger compartment	60A
4 Engine compartment/passenger compartment	60A
5 -	
6 -	
7 Electric cooling fan	60A
8 -	60A

Ordinary fuses

Location	Amperage
1 High beams	20A
2 Low beams	15A
3 Brake light connector	5A
4 Windshield wipers	25A
5 Windshield washers, headlight washers (certain models)	15A
6 -	
7 -	
8 Horn	15A
9 -	
10 -	
11 ABS	30A
12 ABS	30A
13 Starter motor	25A
14 Engine control systems	5A
15 -	
16 A/C compressor, throttle sensor, automatic transmission	20A
17 Air pump, electric cooling fan, A/C compressor, ignition coil	20A
18 Mass air flow sensor, engine control module, fuel injectors	15A
19 Emission controls	20A
20 Crankcase ventilation heater, turbo control valve	15A

pg.90 Fuses in the passenger compartment

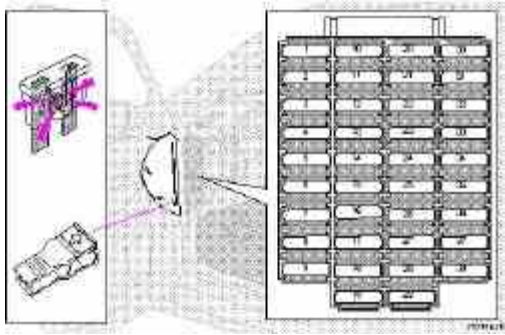

Fuse box in the passenger compartment

This fuse box is located at the far left side of the instrument panel. Extra fuses and the fuse removal tool are also stored here. When replacing a blown fuse, be sure to replace it with a new one of the **same color and amperage** (written on the fuse).

Location	Amperage
1 Left low beam	10A
2 Right low beam	10A
3 Front fog lights	15A
4 Power driver's seat	30A
5 Power passenger's seat	30A
6 -	
7 SRS, central electrical module, X-relay, seat belt locks	5A
8 Heated front seats (option)	25A
9 ABS	5A
10 Left high beam	15A
11 Right high beam	15A
12 Headlight wipers	15A
13 Auxiliary sockets (front/rear)	20A
14 Power passenger's seat	5A
15 Audio system	5A
16 Audio system 20A	
17 Radio amplifier	30A
18 Telephone (option) VNS (option)	10A
19 -	
20 -	
21 Direction indicators	20A
22 Steering wheel lever modules	5A
23 Headlight switch module, module for electrical connections, climate control system, onboard diagnostic connector	5A
24 Relay for extended X-feed: climate control system,	10A

	power driver's seat, text window, shiftlock geartronic	
25	Ignition switch	10A
26	Control module - climate control blower	30A
27	Central locking system, power windows, sideview mirrors, warning lights	15A
28	Power sun roof, courtesy lights, vanity mirror lights	10A
29	-	
30	Left front/rear parking lights	10A
31	Right front/rear parking lights, license plate lights	10A
32	Central electrical module, interior courtesy lights, progressive power steering	10A
33	Fuel pump	15A
34	Power sun roof	15A
35	Central locking system, power windows	25A
36	Central locking system, power windows	25A
37	Power windows - rear doors, child safety locks	30A
38	-	

pg.91 Fuses in the trunk

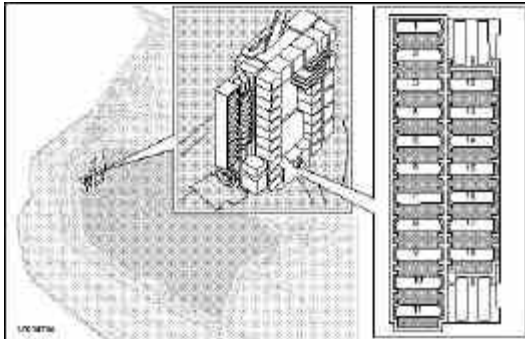

Fuses in the trunk

The fuses in the trunk are located on the left side under the covering material. **The main fuses, under a cover held in place by screws, should only be replaced by an authorized Volvo retailer.** When replacing a blown ordinary fuse, be sure to replace it with a new one of the **same color and amperage** (written on the fuse).

Main fuses

Location	Amperage
1 -	
2 -	
3 -	
4 -	
5 Heated rear window	40A
6 Rear main fuse	40A
7 Rear main fuse	40A

Ordinary fuses

Location	Amperage
1 Rear electrical module, trunk lights	10A
2 Rear fog light	10A
3 Brake lights	15A
4 Backup lights	10A
5 Rear window heater	5A
6 Trunk release	10A
7 Folding rear outboard head restraints	10A
8 Central locking system - rear doors/fuel tank cover	15A
9 Connector for trailer	20A
10 CD changer	10A

pg.92 Replacing bulbs

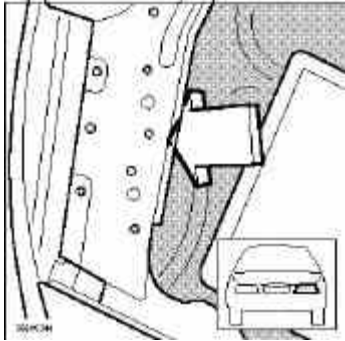

Replacing high/low beam headlight bulbs

The headlight bulbs must be replaced from the engine compartment.

CAUTION:

- Do not touch the glass on halogen bulbs with your fingers. Grease, oil or any other impurities can be carbonized onto the bulb and cause damage to the reflector.
- Be sure to use bulbs of the correct type and voltage.

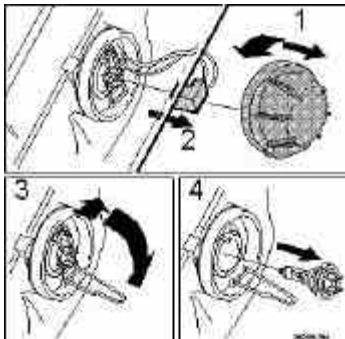

Removing a defective bulb

To remove a defective bulb:

- Switch off the ignition.
- Open the hood.
- Remove the plastic cover over the bulb (1) by turning it counterclockwise.
- Remove the connector (2).
- Loosen the retaining spring (3) by first moving it to the right and then moving it down, out of the way.
- Pull out the defective bulb. Note the position of the guide lug on the base of the bulb (4).

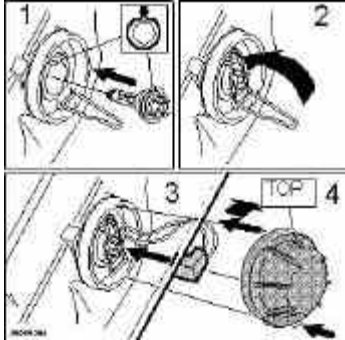

Installing a new bulb

To install a new bulb:

- Insert the new bulb, without touching the glass, with the guide lug upward (1). The bulb will only seat properly in this position.
- Move the retaining spring up and push it slightly to the left until it seats properly (2).
- Press the connector into place on the bulb (3).
- Reinstall the plastic cover and turn it clockwise until it is correctly in place (4). "TOP" must be upward.

NOTE: If the vertical aim of your headlights needs to be adjusted for any reason (e.g., towing a trailer for extended periods), this should be done by an authorized Volvo retailer.

pg.93 Replacing bulbs

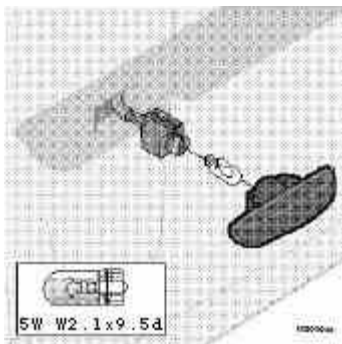

Side direction indicator

- Open the front door halfway.
- From the inside of the fender, push the lamp housing out.
- Turn the bulb holder 1/4 turn counterclockwise and pull it out from the lens.
- Remove the defective bulb by pulling it straight out.
- Insert a new bulb.
- Reinsert the bulb holder in the lens and press the entire unit back into place on the fender.



Front parking light/direction indicator

Front parking lights/direction indicators

- Switch off the ignition.
- Open the hood.
- Press down the retaining catch with a screwdriver and pull out the lamp housing.
- Press the retaining spring downward and pull the connector out of the lamp housing.
- Turn the bulb holder counterclockwise and remove it.
- Remove the defective bulb from the holder by first pressing it in slightly and then turning it counterclockwise.
- Install a new bulb in the holder and reinsert the bulb and holder in the lamp housing.

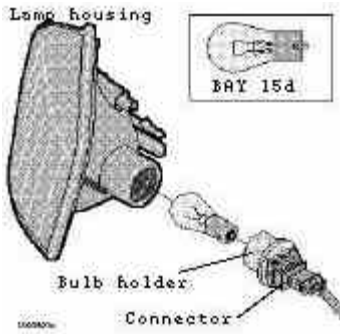

- Press the connector onto the bulb holder.
- Switch on the ignition to test the bulb.
- Press the lamp housing back into place on the fender. Be sure it seats properly.

pg.94 Replacing bulbs

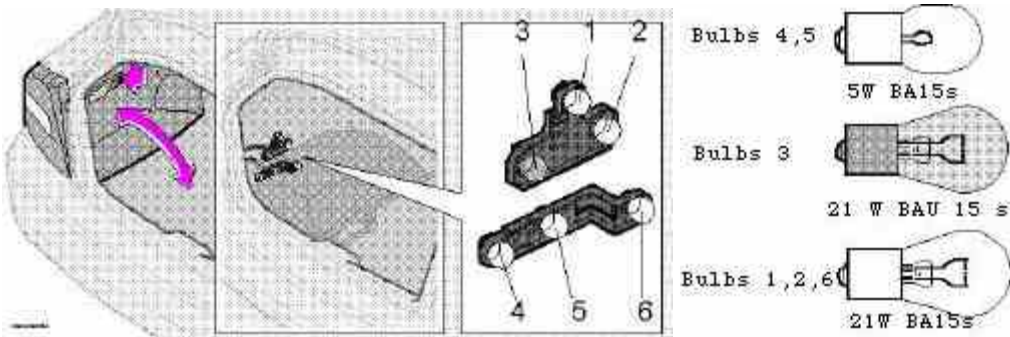

Tail lights

1. Brake light
2. Back-up light
3. Direction indicator
- 4/5. Tail lights
6. Fog light (left side only)

All tail light bulbs are accessed from inside the trunk.

- Switch off the ignition and open the trunk.
- Fold the covering panel inward to access the bulbs. When replacing right tail light bulbs, access is made easier if you pull out the cargo net in the trunk completely before folding down the panel.

The bulbs are located in two separate holders, an upper and a lower one. Each holder has a retaining catch.

To replace a bulb in the *upper* holder:

- Disconnect the wiring from the bulb holder.
- Press the retaining catch upward to release the lower part of the holder.
- Press the retaining catch downward to release the upper part of the holder.
- Replace the defective bulb.
- Press the bulb holder back into place.
- Reconnect the wiring.
- Fold up and close the covering panel.

To replace a bulb in the *lower* holder:

- Disconnect the wiring from the bulb holder.
- Press the retaining catch toward the outside of the car to release the holder.
- Replace the defective bulb.
- Press the bulb holder back into place.
- Reconnect the wiring.
- Fold up and close the covering panel.

pg.95 Replacing bulbs

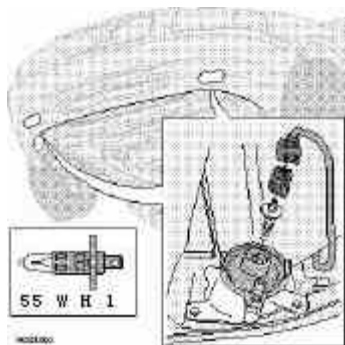

Front fog lights (option)

CAUTION:

Avoid touching the glass on the bulb with your fingers.

- Switch off the ignition.
- Turn the bulb holder slightly counterclockwise to release it.
- Replace the bulb. The shape of the foot of the bulb corresponds to the shape of the bulb holder.
- Reinstall the bulb holder by turning it slightly clockwise. "TOP" on the holder should be upward.



Vanity mirror lights

- Carefully insert a screwdriver and pry out the lens.
- Pry out the bulb and replace it.
- Carefully press the lower edge of lens onto the four tabs and press the upper edge of the lens into place.

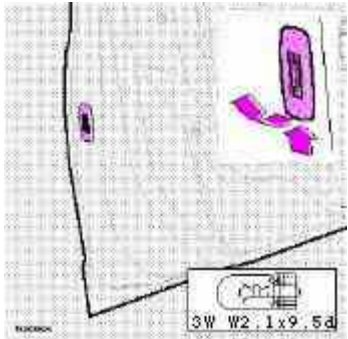

Door warning lights

All four doors are equipped with warning lights.

- Using your fingers (or a small piece of plastic or wood if necessary to avoid scratching the paint) press the lens upward and pull it out.
- Replace the bulb.
- Press the lens back into place.

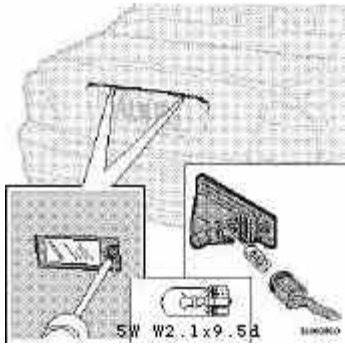

License plate lights

- Switch off the ignition.
- Loosen the screws with a torx screwdriver.
- Carefully pull out the lamp housing.
- Turn the bulb holder counterclockwise and pull it out.
- Pull out the defective bulb and insert a new one.
- Reinsert the bulb holder into the housing and turn it clockwise.
- Reinstall the housing and screw it in place.

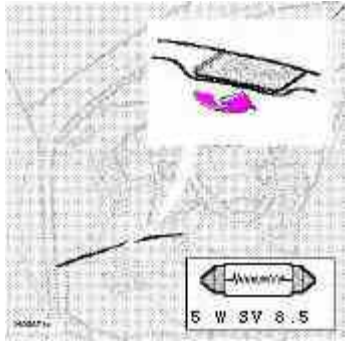

Door step courtesy lights

The door step courtesy lights are located under the dash on the driver's and passenger's sides. To replace a bulb:

- Carefully insert a screwdriver and pry out the lens.
- Replace the defective bulb.
- Reinstall the lens.

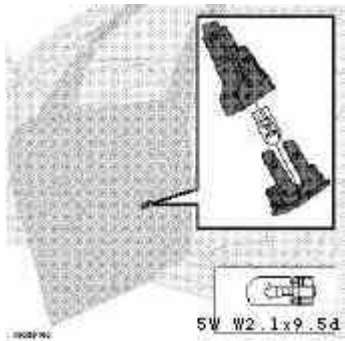

Rear door step lights

- Carefully insert a screwdriver and pry out the lens.
- Disconnect the wiring from the lamp housing.

- Remove the lens from the lamp housing by pressing the two side catches out.
 - Pull out the defective bulb and replace it.
 - Reinstall the lamp housing in the reverse order.
-



[Contents](#) | [Top of Page](#)

2000 VOLVO S80

Chapter 9 - Specifications

pg.117 Specifications

[Label information](#) [118](#)

[Dimensions and weights](#) [119](#)

[Engine/transmission specifications](#) [120](#)

[Oil/fluid specifications and volumes](#) [121](#)

[Fuel system, Distributor ignition system, Suspension](#) [122](#)

[Electrical system](#) [123](#)

[Volvo On Call, Service manuals](#) [124](#)

pg.118 Label information

1 Vehicle Emission Control Information

Your Volvo is designed to meet all applicable emission standards, as evidenced by the certification label on the underside of the hood. For further information regarding these regulations, please consult your Volvo retailer.

2 Vacuum hose routing

(underside of hood)

3 Loads and Tire Pressures

(on inside of fuel tank cover)

4 Model plate

Vehicle Identification Number (VIN). Codes for color and upholstery, etc. The plate is located in the engine compartment, on the inside of the left front fender.

5 Vehicle Identification Number (VIN) *

The VIN plate is located on the top left surface of the dashboard. The VIN is also stamped on the right hand door pillar.

6 Federal Motor Vehicle Safety Standards (FMVSS) specifications (USA) and Ministry of Transport (CMVSS)

standards (Canada)

Your Volvo is designed to meet all applicable safety standards, as evidenced by the certification label on the facing side of the driver's door. For further information regarding these regulations, please consult your Volvo retailer.

7 Child safety latch label

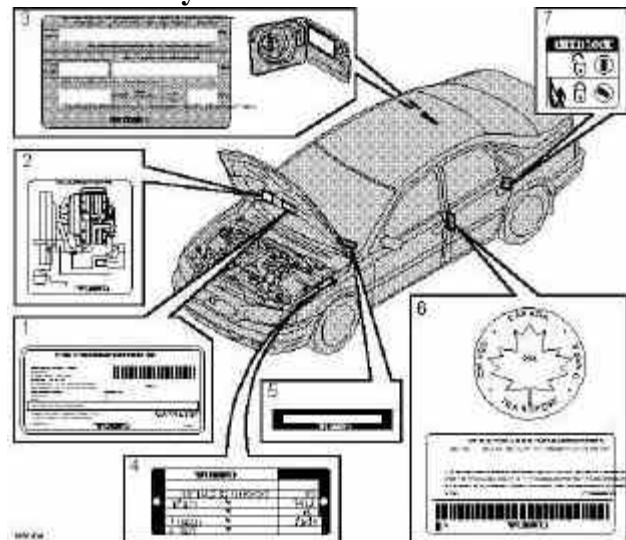

* The Vehicle Identification Number (VIN) should always be quoted in all correspondence concerning your vehicle with the retailer and when ordering parts.

All specifications are subject to change without prior notice.

pg.119 Dimensions and weights

Dimensions

Length	189.8 in. (482 cm)
Width	72 in. (183 cm)
Height	57.1 in. (145 cm)
Wheelbase	109.8 in. (279 cm)
Track, front	62.2 in. (158 cm)
Track, rear	61.4 in. (156 cm)
Turning circle (between curbs)	38.1 ft. (11.6 m)
Cargo capacity - trunk	14.2 cu. ft. (0.4 m ³)

Weights

	USA	Canada
Gross vehicle weight (GVW)		
5 cyl	4490 lbs (2037 kg)	2040 kg
6 cyl.	4600 lbs (2087 kg)	2090 kg
6 cyl. turbo	4630 lbs (2100 kg)	2100 kg
Capacity weight *		
5 cyl	890 lbs	

6 cyl.	890 lbs (400 kg)	400 kg
6 cyl. turbo	890 lbs (400 kg)	400 kg
Curb weight		
5 cyl	3425-3455 lbs (1550-1570 kg)	1555-1570 kg
6 cyl.	3585-3620 lbs (1625-1645 kg)	1630-1645 kg
6 cyl. turbo	3675-3710 lbs (1665-1685 kg)	1665-1685 kg
Permissible axle weight, front		
5cyl.	2230 lbs (1039 kg)	1040 kg
6 cyl.	2290 lbs (1039 kg)	1140 kg
Permissible axle weight, rear		
5 cyl.	2290 lbs (1041 kg)	1041 kg
6 cyl.	2311 lbs (1049 kg)	1049 kg
Max roof load	220 lbs (100 kg)	100 kg
Max trailer weight		
(w/o brakes)	1100 lbs (500 kg)	500 kg
Max trailer weight		
(with brakes)		
2" ball	3300 lbs (1500 kg)	1500 kg
1 7/8" ball	2000 lbs (908 kg)	900 kg
Max tongue weight **	165 lbs (75 kg)	75 kg

WARNING!

When adding accessories, equipment, luggage and other cargo to your vehicle, the total loaded weight capacity of the vehicle must not be exceeded.

* The max permissible axle loads or the gross vehicle weight must not be exceeded.

** See also section "Trailer towing"

All specifications are subject to change without prior notice.

pg.120 Engine/transmission specifications

Engine specifications

Designation: Volvo B 6284 T

Output	268 hp at 5400 rpm (200 KW/90 rps)
Max torque	280 ft. lbs. at 2100-5000 rpm (380 Nm at 35-83 rps)
Number of cylinders	6
Bore	3.19" (81 mm)
Stroke	3.54" (90 mm)
Displacement	2.78 liters
Compression ratio	8.5:1
Number of valves	24

Valve clearance when checking (mm)

Charge air cooler (Intercooler)

Turbocharged engines employ a turbocompressor to force air into the engine inlet manifold and a charge air cooler to cool the compressed inlet air. The resulting increase in air flow raises pressure in the intake manifold and increases engine power over that developed by the normally aspirated engine. The charge air cooler (which resembles a radiator) is located between the turbocompressor and inlet manifold.

Designation: Volvo B 6294 S

Output 197 hp at 6000 rpm (147 KW/100 rps)
Max. torque 207 ft. lbs. at 4200 rpm (280 Nm at 70 rps)
Number of cylinders 6
Bore 3.27" (83 mm)
Stroke 3.54" (90 mm)
Displacement 2.92 liters
Compression ratio 10.7:1
Number of valves 24
Valve clearance when checking (mm)

Transmission specifications

Automatic transmission

Gear ratios:

Engine: B 6284 T B 6294 S B5244 S

1st gear	2.92:1	3.27:1	4.77:1
2nd gear	1.57:1	1.57:1	2.10:1
3rd gear	1.00:1	1.12:1	1.96:1
4 th gear	0.70:1	0.79:1	1.32:1
5 th gear			1.02:1
Reverse	2.38:1	2.67:1	3.23:1
Final drive	3.29:1	3.29:1	2.44:1

Designation: Volvo B 5244 S

Output 168 hp at 5700 rpm (125 KW/95 rps)
Max. torque 170 ft. lbs. at 4500 rpm (230 Nm at 75 rps)
Number of cylinders 5
Bore 3.27" (83 mm)
Stroke 3.54" (90 mm)
Displacement 2.43 liters
Compression ratio 10.3:1
Number of valves 20
Valve clearance when checking (mm)

All specifications are subject to change without prior notice.

Engine oil

Meeting API specification SJ, SJ/CF, or SJ/Energy Conserving.

Extra oil additives must not be used unless advised by an authorized Volvo retailer.

Volume: (including filter):

Normally-aspirated 6-cylinder engine - 7.3 US qts (6.9 liters).

Turbo 6-cylinder engine - 7.3 US qts (6.9 liters).

5 cyl. engine - 6.1 US qts (5.8 liters)

Automatic transmission fluid

Geartronic: ATF Dexron® III.

AW5: Only Volvo gearbox oil (1161540-8). Do not mix with other oils.

Volume: 7.9 US qts (7.5 liters).

Cooling system

Type: Positive pressure, closed system. The thermostat begins to open at 194 °F (90 °C).

Coolant: Volvo original coolant/antifreeze.

Volume: Normally-aspirated 6-cylinder engine - 9.3 US qts (8.8 liters).

Turbo 6-cylinder engine - 10.1 US qts (9.6 liters).

Power steering fluid

ATF fluid.

Volume: 0.95 US qt (0.9 liter).

Brake fluid

DOT 4+

Volume: 0.64 US qt (0.6 liter)

Climate control system - refrigerant (R 134a)

Oil: PAG

Volume: 2.2 lbs (1000 g) R134a.

Fuel

Minimum octane requirement - AKI 87 (RON 91)

Volume (fuel tank): 21.1 US gals (80 liters)

Washer fluid reservoir

Volume: 6 cyl: 4.7 US qts. (4.5 liters)

5 cyl: 3.2 US qts. (3.0 liters)

All specifications are subject to change without prior notice.

pg.122 Fuel system, Distributor ignition system, Suspension

Fuel system

The engine is equipped with a multiport fuel injection system.

Distributor ignition system

Firing order:	15-3-6-2-4
Distributor ignition setting:	Not adjustable
Spark plugs:	B 6284 T: P/N 271367-4 (or equivalent) B 6294 S: P/N 272371-8 (or equivalent) B 5244 S: P/N 272313-8
Spark plug gap:	0.028-0.032" (0.7-0.8 mm)
Tightening torque:	18.4 ft. lbs. (25 Nm)

Replacing spark plugs

The spark plugs should be changed every 30,000 miles (48,000 km). However, city driving or fast highway driving may necessitate changing after 15,000 miles (24,000 km) of driving. When installing new plugs, be sure to fit the right type and use correct torque. When changing the plugs, check that the suppressor connectors are in good condition. Cracked or damaged connectors should be replaced. When changing the spark plugs, clean the terminals and the rubber seals.

WARNING!

The distributor ignition system operates at very high voltages. Special safety precautions must be followed to prevent injury. Always turn the ignition off when:

- Replacing distributor ignition components e.g. plugs, coil, etc.
- Do not touch any part of the distributor ignition system while the engine is running. This may result in unintended movements and body injury.

Front suspension

Spring strut suspension with integrated shock absorbers and control arms linked to the support frame. Powerassisted rack and pinion steering. Safety type steering column.

The alignment specifications apply to an unladen car but include fuel, coolant and spare wheel.

Toe-in measured on the wheel rims: 2.3 mm +/- 0.8 mm

Toe-in measured on tire sides: 2.8 +/- 0.9 mm

Rear suspension

Individual rear wheel suspension with longitudinal support arms, double link arms and track rods.

Toe-in measured on the tire sides: 1.9 mm +/- 1.9 mm

Vehicle loading

The tires on your Volvo should perform to specifications at all normal loads when inflated as recommended on the tire information label. The label is located on the inside of the fuel tank cover. The label lists both tire and vehicle design limits. Do not load your car beyond the load limits indicated.

WARNING!

Improperly inflated tires will reduce tire life, adversely affect vehicle handling and can possibly lead to failure resulting in loss of vehicle control without prior warning.

All specifications are subject to change without prior notice.

pg.123 Electrical system

Electrical system

12 Volt, negative ground.

Voltagecontrolled generator. Singlewire system with chassis and engine used as conductors. Grounded on chassis.

Battery

Voltage: 12 Volt, capacity: 600 A/115 min.

The battery contains corrosive and poisonous acids. It is of the utmost importance that old batteries are disposed of correctly. Your Volvo retailer can assist you in this matter.

Generator

Rated output: max. current: 120 A

Starter motor:

Output: 1.7 kW

Bulbs

Bulb	US no.	Power	Socket
Headlights			
High beam	H7	55W	-
Low beam	H7	55W	-
Front parking lights/ direction indicators	1157NA	21/5 W	BAY 15d
Front fog lights	H1	55 W	-
Side marker lights	-	3 W	W2.1x9.5d
Rear direction indicators	-	21W	BAU 15 s
Tail lights	67	5W/4cp	BA 15 s

Brake lights	1156	21W/32cp	BA 15 s
Backup lights	1156	21W/32cp	BA 15 s
Rear fog light	1156	21W/32cp	BA 15 s
License plate light	-	5 W	W 2.1x9.5d
Door open warning light	-	3 W	W 2.1x9.5d
Door step courtesy lights			
Front	-	5W	SV 8.5
Rear	-	5W	W 2.1x9.5d
Trunk lights	-	10 W	SV 8.5
Glove compartment light	-	2 W	BA 9s
Vanity mirror lights	-	1.2 W	SV 5.5
Instrument lighting	-	3 W	W 2.1x9.5d
Rear ashtray	-	1.2 W	W 2x4.6d
Front courtesy lights	-	10 W	SV 8.5
Rear reading lights	-	5 W	W2.1x9.5d
Sideview mirror	-	5W	W2.1x9.5d

All specifications are subject to change without prior notice.

pg.124 Volvo On Call, Service manuals



Your new Volvo comes with a four year road assistance program named ONCALL. Additional information, features, and benefits are described in a separate information package in your glove compartment.

If you have misplaced your package, dial:

In the U.S.A.

1-800-63-VOLVO (1-800-638-6586)

In Canada:

1-800-263-0475



Volvo supports Voluntary Mechanic Certification by the A.S.E. (pertains to the USA only). Certified mechanics have demonstrated a high degree of competence in specific areas. Besides passing exams each mechanic must also have

worked in the field for two or more years before a certificate is issued. These professional mechanics are fully able to analyze vehicle problems and perform the necessary service procedures to keep your Volvo at peak operating condition.

All specifications are subject to change without prior notice.



[Contents](#) | [Top of Page](#)

2000 VOLVO S80

Chapter 10 - Audio systems

pg.125 Audio systems

[HU-611 overview](#) 126

[HU-801 overview](#) 127

[Functions](#) 128

[Specifications](#) 139

[General information](#) 140

NOTE: The text on the face of the radio, describing the button functions, may vary slightly depending on which audio system you have in your car.

pg.126 Audio system HU-611 - overview

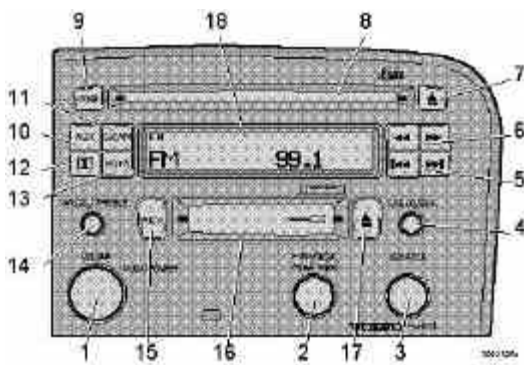

1. On/off - press
Volume - turn
2. Selector knob for:
Stored radio frequencies
CD changer - selecting disc
3. Selector knob:
Radio
Cassette
CD
CD changer
4. Fader - press and turn

- Balance - press, pull and turn
- 5. Radio - Station seek up/down
- Cassette - selecting next/previous track
- CD - Selecting next/previous track
- 6. Radio - Manual station selection
- Cassette - Fast winding forward/backward
- CD - Fast forwards/backward
- 7. CD eject
- 8. CD slot
- 9. CD random play
- 10. Active Sound Control (ON or OFF)
- 11. Scan function
- 12. Dolby B Noise Reduction
- 13. Automatic presetting of radio stations
- 14. Bass - press and turn
- Treble - press, pull and turn
- 15. Tape direction selector
- 16. Cassette opening
- 17. Cassette eject
- 18. Display

pg.127 Audio system HU-801 - overview

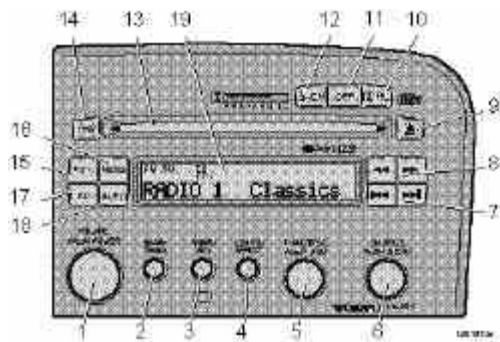

- 1. On/off - press
- Volume - turn
- 2. Bass - press and turn
- Treble - press, pull and turn
- 3. Fader - press and turn
- Balance - press, pull and turn
- 4. Center volume - press and turn
- Output volume - press, pull and turn
- 5. Selector knob for:
 - Stored radio frequencies
 - CD - selecting disc
- 6. Selector knob:
 - Radio
 - CD
- Station scan - press
- 7. Radio - Station seek up/down
- CD - Selecting next/previous track
- 8. Radio - Manual station selection
- CD - Fast forward/backward

9. CD eject
10. Dolby Pro Logic - switching on
11. Dolby Pro Logic - switching off
- 12 3 channel stereo
13. CD slot
14. CD random play
15. Program type
- Active Sound Control (ON or OFF)
16. News
17. Traffic information
18. Automatic presetting of radio stations
19. Display

pg.128 Audio systems HU-611/HU-801

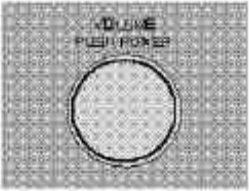

Switch on/off

Press the knob to switch on or turn off the radio.

Volume control

Turn the knob clockwise to increase volume. Volume control is electronic and does not have an end stop. If you have a key pad in the steering wheel, increase or decrease the volume with the + or- buttons.

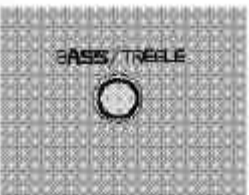

Bass

Adjust the bass by pressing the button to extend the control and turning it to the left (less bass) or to the right (more bass). A "detent" indicates "equalized" bass. Press the button back in when you have made the adjustment.

Treble

Adjust the treble by pressing the button to extend the control, pulling it out as far as possible, and then turning it to the left

(less treble) or to the right (more treble). A "detent" indicates "equalized" treble. Press the button back in when you have made the adjustment.

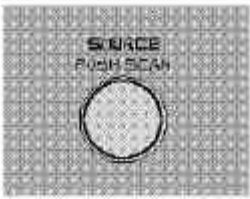

Wavelength selector

Turn "SOURCE" knob to select FM or AM. The station and wavelength are displayed. You can also select cassette deck, CD or CD changer, if connected, with this knob.

Active sound control (ASC)

The ASC (Active Sound Control) automatically adapts volume to vehicle speed.

Press the ASC button (HU-611) or the PTY button (HU-801) for several seconds to switch this function ON or OFF.

"ASC ON" or "ASC OFF" will be shown in the display for several seconds.

pg.129 Audio systems HU-611/HU-801



Fader - Balance front/rear

Adjust front/rear speaker balance by pressing the button to extend the control and turning it to the left (more sound from the rear speakers) or to the right (more sound from the front speakers). A "detent" indicates "equalized" balance. Press the button back in when you have made the adjustment.

Balance right/left

Adjust left/right speaker balance by pressing the button to extend the control, pulling it out as far as possible and then turning it to the left (more sound from the left speakers) or to the right (more sound from the right speakers). A "detent" indicates "equalized" balance. Press the button back in when you have made the adjustment.

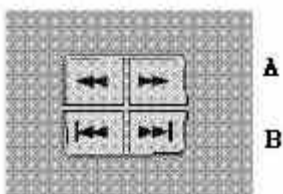

A - Setting station

Press the left side of the button to select lower frequencies and the right side for higher frequencies. Set frequencies are displayed.

B - Station seek up/down

Press the left side (lower frequency) or right side (higher frequency) of the button to start the seek function. The radio seeks the next audible station and tunes it in. Repeat the procedure to continue the seek function.

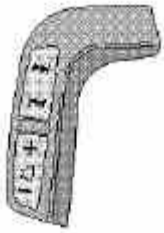

Audio system controls on the steering wheel

Station seek up/down

If you have a key pad in the steering wheel press the right or left arrow to switch between preset stations.

Scan function

Press the SCAN button (HU-611) or the SOURCE button (HU-801) to start the station scan function. When a station is found, scanning stops for several seconds, after which scanning will continue.

Press the SCAN or SOURCE button when a station has been found if you would like to listen to that station and to discontinue the scan function.

pg.130 Audio systems HU-611/HU-801 - radio

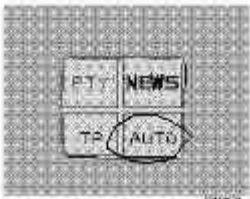

A - Automatic station preset

This function seeks and stores up to 10 strong AM or FM stations in a separate memory. This function is especially useful in areas where you are not familiar with the radio stations.

1. Press in the "AUTO" button. A number of strong signal stations (max. 10) from the currently selected waveband are now stored automatically in the memory. An "A" and "AUTO" is displayed. If there is no station with sufficient signal strength "NO STATION" is displayed.
2. Turn "1-20/DISC" button if you wish to change to another of the auto-stored stations.

Another auto-stored station is selected with each turn.

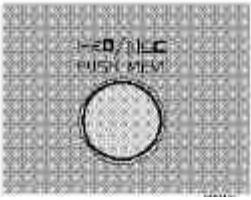

Programming stations

1. Tune in the desired frequency.
2. Press the "1-20/DISC" button. Select a number by turning forwards or backwards. Press again to store the selected frequency and station.

Preset

To choose a pre-set station, turn "1-20/DISC" button to the stored number. The currently selected station is displayed.
Radio Data System (RDS, also referred to as RBDS) - HU-801 only

The HU-801 radio in your car is equipped with an advanced system allowing information from broadcasters to be transmitted visually, as text, together with the audio signal. This information is then decoded by the radio and made available for several new and unique features. **The RDS or Radio Data System operates in the FM band only, and the information transmitted is supplied exclusively by participating broadcasters.** Volvo has no control over the accuracy of the data or information. Please refer to the following pages regarding specific descriptions and operation of these functions.

Volvo was among the first to pioneer this technology throughout Europe and it is slowly making its way to North America. Coverage by local broadcasters may be limited at this time, but as the technology and benefits grow, you will find the radio in your car is equipped to take advantage of this system.

pg.131 Audio systems HU-801 - radio

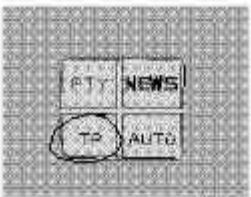

Traffic information (TP) - HU-801 only

This feature may not be apply in your area and only functions with FM broadcasts.

A short push on the "TP" button (less than 1 second) gives the traffic information from RDS stations. "TP" is displayed when the function is connected.

When the unit is in Cassette or CD mode, the FM radio function will seek in the background for a station with a strong signal broadcasting traffic information. If a cassette or CD are playing when the radio receives a traffic bulletin, that function is interrupted and the bulletin is broadcast with the volume pre-selected for traffic information.

When the bulletin is finished the unit immediately returns to the previously set volume and continues playing the cassette or CD.

- Traffic information can only be heard when TP is displayed.
- If only TP is displayed, this indicates that no traffic information is being received at the time.
- If you do not wish to listen to an ongoing traffic bulletin, press the "TP" button. The TP function will remain active and the radio will continue to monitor traffic information.

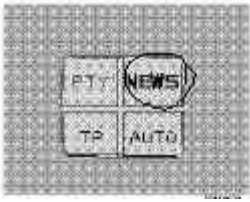

News on/off - HU-801 only

This feature may not be apply in your area and only functions with FM broadcasts.

Press the "NEWS" button to activate the news function. The text NEWS is displayed. Press the "NEWS" button again if you want to switch off the function.

As soon as a news broadcast begins, the news program will interrupt the Cassette, CD or CD changer.

If you do not wish to listen to the news program, press the "NEWS" button again. The news function will remain active and the radio will continue to monitor news programs.

pg.132 Audio systems HU-801 - radio

Program types (HU-801 only)

Program type Text displayed

1	News	News
2	Information	Inform
3	Sports	Sports
4	Talk	Talk
5	Rock	Rock
6	Classic rock	Cls_Rock
7	Adult hits	Adlt_Hit
8	Soft rock	Soft_Rck
9	Top 40	Top_40
10	Country	Country
11	Oldies	Oldies
12	Soft	Soft
13	Nostalgia	Nostalga
14	Jazz	Jazz
15	Classical	Classicl
16	Rhythm and Blues	R_&_B
17	Soft Rhythm and Blues	Soft_R&B

18	Foreign language	Language
19	Religious music	Rel_Musc
20	Religious talk	Rel_Talk
21	Personality	Persnlty
22	Public	Public
23	College	College
24	-	
25	-	
26	-	
27	-	
28	-	
29	Weather	Weather



[Contents](#) | [Top of Page](#)

2000 VOLVO S80

HomeLink® Universal Transceiver (option)

pg.141 HomeLink® Universal Transceiver (option)

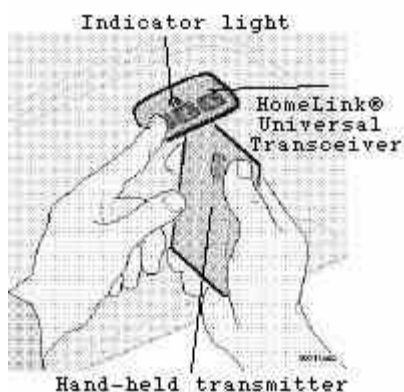

HomeLink® Universal Transceiver

This transceiver allows you to replace 3 hand-held transmitters with a single built-in device which can be installed in your car on a sun visor or overhead console. This feature "learns" the radio frequency codes of most current transmitters to operate garage doors, driveway gates, security lighting and home security systems. This transceiver is powered by your car's electrical system.

NOTE: As a security precaution, the HomeLink® Universal Transceiver is designed to **not** function if the car has been locked from the *outside*.

Programming the transceiver

1. Begin by erasing all 3 factory default channels by holding down the two *outside* buttons (buttons 1 and 3 in the illustration above) on the HomeLink® Universal Transceiver until the indicator light on the transceiver begins to flash, after approximately 20 seconds. Release the buttons.
2. Hold the end of your hand-held transmitter 2 to 5 in. (5 to 12 cm) away from the HomeLink® surface, keeping the indicator light in view. For placement questions, please contact HomeLink® at 1-800-355-3515 (Internet: www.HomeLink.jci.com).
3. Using both hands, simultaneously push the hand-held transmitter button *and* the HomeLink® button to be programmed. **Do not release the buttons until this step has been completed.** The HomeLink® indicator light will begin to flash, first slowly, then rapidly. When the indicator light flashes rapidly (indicating that the HomeLink® button has been successfully programmed), both buttons may be released.

The remaining two HomeLink® buttons can be programmed in the same way.

If, after several attempts, you do not successfully program the HomeLink® Universal Transceiver to learn the signal of the hand-held transmitter, refer to the section "Programming rolling codes" or call the toll-free customer assistance number: 1-800-355-3515 (Internet: www.HomeLink.jci.com).

WARNING!

- If you use the HomeLink® Universal Transceiver to open a garage door or gate, be sure that no one is near the gate or door while it is in motion.
- Do not use the HomeLink® Universal Transceiver with any garage door opener that lacks safety "stop" and "reverse" features as required by federal safety standards. (This includes any garage door opener model manufactured before April 1, 1982). A garage door opener which cannot "detect" an object, signalling the door to "stop" and "reverse" does not meet current federal safety standards. Using a garage door opener without these features increases the risk of serious injury or death. For more information on this matter, call toll-free 1-800-355-3515 (Internet: www.HomeLink.jci.com).

pg.142 HomeLink® Universal Transceiver (option)

NOTE - Canadian residents:

During programming, your hand-held transmitter may automatically stop transmitting. To train your hand-held transmitter, continue to hold the HomeLink® button (see steps 2, 3 under "Programming the transceiver") while you press and repress ("cycle") your hand-held transmitter button *every two seconds* until the frequency signal has been learned. The HomeLink® indicator light will flash slowly and then rapidly to indicate that the HomeLink® button has been successfully programmed.

Programming rolling codes

Determine, in one of the following ways, if your garage door uses a rolling code system and is manufactured after 1996:

- Refer to the garage door opener's owner's manual for verification.
- The hand-held transmitter appears to program the HomeLink® Universal Transceiver but the transceiver does not activate the garage door.
- Press the programmed HomeLink® button. The garage door opener has the rolling code feature if the HomeLink® indicator light flashes rapidly and then glows steadily after approximately 2 seconds.

To train a garage door opener with the rolling code feature, follow these instructions after the transceiver has been programmed (the aid of a second person may make the training quicker and easier):

1. Locate the training button on the *garage door opener motor head unit*. The exact location and color of the button may vary. If you encounter difficulty, refer to the garage door opener owner's manual or call: 1-800-355-3515 (Internet: www.HomeLink.jci.com).
2. Press the "training" button on the garage door opener motor head unit until the "training" light comes on.
3. Firmly press and release the programmed HomeLink® button. Press and release the HomeLink® button a *second* time to complete the training process.

Some garage door openers may require you to do this procedure a *third time* to complete the training.

The programmed button on your HomeLink® Universal Transceiver should now operate your garage door opener. The original hand-held transmitter can also be used, if necessary, to operate the garage door.

The remaining two buttons can be programmed in the same way. In the event of any problems in programming the HomeLink® Universal Transceiver, call 1-800-355-3515 (Internet: www.HomeLink.jci.com).

Operating the HomeLink® Universal Transceiver

Once programmed, the HomeLink® Universal Transceiver can be used in place of hand-held transmitters.

To operate, press the programmed HomeLink® button to activate the garage door, driveway gate, security lighting, home security system, etc.

The original hand-held transmitter can, of course, be used at any time.

Erasing programmed buttons

Individual buttons cannot be erased. To erase all three programmed buttons:

1. Hold down the two outside buttons on the HomeLink® Universal Transceiver until the indicator light begins to flash, after approximately 20 seconds.
2. Release both buttons.

The HomeLink® buttons can be reprogrammed using the procedures described on the previous page.

(HomeLink® information is continued on the next page)

pg.143 HomeLink® Universal Transceiver (option)

Reprogramming a single HomeLink® button

1. Press and hold the desired HomeLink® button. **Do not release** the button until step 3 has been completed.
2. When the indicator light begins to flash slowly (after approximately 20 seconds), position the hand-held transmitter 2 to 5 in. (5 to 12 cm) away from the HomeLink® surface.
3. Press and hold the hand-held transmitter button.
The HomeLink® indicator light will begin to flash, first slowly then rapidly. When the indicator light flashes rapidly, release both buttons.

The previously programmed device has now been erased and the new device can be activated by pressing the HomeLink® button that has just been programmed. This procedure will not affect any other programmed HomeLink® buttons.

NOTE:

- Retain the original transmitter(s) for future programming procedures (i.e., if you purchase a new car).
- It is also suggested that if you sell your car, the programmed channels on the HomeLink® Universal Transceiver be

erased for security purposes.



[Contents](#) | [Top of Page](#)

2000 VOLVO S80

INDEX

pg.144 Index

A	
ABS	17
ABS - warning light	25
Accessory lights	27
Adjusting the steering wheel	32
Air conditioning	41-43
Air pump system	106
Air vents	40
Airbag (SIPS)	8
Airbag (SRS)	4
Alarm	58-59
Alarm - "panic" function	58
ALR/ELR	14
Anti-lock Brake System (ABS)	17
Anti-lock Brake System - warning light	25
Antifreeze	76,106
Approach lighting	54
Ashtrays	34
Audio systems	125
cassette deck	136
CD player	134
HU-611 - overview	126
HU-801 - overview	127
radio	130
specifications	139
Automatic car washing	101
Automatic Locking Retractor (ALR)	14
Automatic transmission	65-66
Geartronic	67-68
Kickdown	66-67
Specifications	120
Automatic transmission fluid	113
Auxiliary socket	27,34

B

Backrests, rear seat - folding	52
Battery	75-76,123
Battery maintenance	113-114
Replacing the battery	114
Ventilation hose	114
Booster cushion	13,15
Booster cushion - integrated	13
Brake failure warning light	24
Brake fluid	112,121
Brake system	16
Bulbs (list)	123
Bulbs - replacing	92-98

C

Capacities (oils and fluids)	117,121
Cargo net in trunk	51
Catalytic converters - three-way	78
Center console - switches	27
Center head restraint - rear seat	3
Central locking buttons	55
Chains - winter driving	81
Changing wheels	84-85
Child booster cushion	13,15
Child restraint anchorages	12
Child safety	12-15
Child safety locks - rear doors	60
Climate controls	41-43
Climate system - general information	44
Clock	23
Cold weather driving	76
Coolant	76,106,121
Cooling system	121
Cooling system - general information	71
Courtesy light	48
Courtesy lights (front) - replacing	98
Courtesy lights - exterior	54
Cruise control	29
Cup holder - opening	50

D

Dimensions	119
Direction indicator bulbs (front)	93
Direction indicators	31
Distributor ignition system	122
Door step courtesy lights - replacing	96

Door warning lights - replacing	95
Doors and locks	54
Drive belt	106
Driving economy	69
Driving mode indicator	23
Driving mode W	66,68,76
Driving with trunk open	70
Dynamic Stability Traction System(DSTC)	18,27
E	
Economical driving	69
Electrical system	123
Electrical system - general information	70
Electrically operated front seats	46
Electrically operated sideview mirrors	36
Electrically operated sun roof	37
Electrically operated windows	35
Electronic Brake Force Distribution	17
Electronic Climate Control (ECC)	41-43
Emergency Locking Retractor (ELR)	14
Emergency towing	71-73
Emergency warning flashers	33
Emissions systems	105
Engine - specifications	120
Engine - starting	64
Engine compartment	109
Engine oil	62,76,110-111,121
Exterior features - overview	21
F	
Fog light - rear	25,30
Fog lights - front	30
Folding head restraints	27
Folding passenger's seat backrest	47
Folding rear seat backrests	52
Folding sideview mirrors	27
Front airbags - SRS	4-7
Front airbags - SRS - warning light	24
Front courtesy lights - replacing	98
Front fog lights	30
Front fog lights - replacing	95
Front reading lights	48
Front seats - adjusting	46
Front seats - heated	33
Front suspension	122
Fuel	62,121

Fuel filler cap	63
Fuel gauge	23
Fuel requirements	62
Fuel system	105,122
Fuel tank cover	4,63
Fuel/emissions systems	105
Fuses	88-91
G	
Gas cap	63
Gasoline	62
Gear indicator	23
Gear ratios	120
Geartronic (automatic transmission)	67-68
Generator	123
Generator warning light	24
Glove compartment	54
H	
Hand brake	34
Handling	70
Hazard warning flashers	33
Head restraint - center rear	3
Head restraints, rear - folding	27
Headlight bulbs - replacing	92
Headlight wiper blades - replacing	115
Headlights	30
Heated front seats	33
Heated rear window	33
Heated sideview mirrors	33
Heating	41-43
Hoisting the car	108
Home Safe System	54
Hood - opening	109
I	
Ignition switch	32
Immobilizer (start inhibitor)	54,64
Indicator lights	24-25
Inflatable curtain (IC)	9
Instrument illumination	30
Instrument panel	23
Instruments	22
Integrated booster cushion	13
Interior features - overview	20
Interior lighting	48
J	

Jack	51,84-85
Jump starting	75
K	
Key - removing from ignition switch	64
Keyless entry system	56-57
Keyless entry system - replacing batteries	57
Keylock	64
Keys	54
Kickdown	66-67
L	
Label information	118
License plate lights - replacing	96
Lifting the car	108
Lights - accessory	27
Locking and unlocking the car	54
Locking steering wheel	32
Long distance trip	77
Long loads	47,52
M	
Maintenance schedule	103-104
Maintenance service	102
Malfunction indicator lamp	25
Memory function - front seats	46
Mirrors	36
Mirrors, sideview - folding	27
O	
Occupant safety	11
Octane rating	62
Odometer	23
Oil - engine	62,76,110-111,121
Oil pressure warning light	24
On-call	124
Opening the hood	109
P	
Paint touch-up	99
Panic function (alarm)	58
Parking brake	34
Parking brake reminder light	24
Parking lights	30
Passenger's seat backrest - folding	47
Polishing	101
Power seats	46
Power steering - speed-sensitive	70
Power steering fluid	112,121

Power windows [35](#)

R

Reading lights - front/rear [48](#)

Rear door step lights - replacing [96](#)

Rear fog light [25,30](#)

Rear reading lights [48](#)

Rear seat backrests - folding [52](#)

Rear suspension [122](#)

Rear window - heated [33](#)

Rearview mirror [36](#)

Refrigerant [44,121](#)

Refueling [63](#)

Remote control - keyless entry system [56](#)

Remote keyless entry system [56](#)

Remote keyless entry system - replacing batteries [57](#)

Replacing bulbs [92-98](#)

Replacing fuses [88](#)

Replacing wiper blades [115](#)

Reporting safety defects [11](#)

Road assistance [124](#)

Roadholding [70](#)

Roof load - maximum [119](#)

Roof racks [71](#)

S

Safety defects - reporting [11](#)

Safety locks - child [60](#)

Seat belt maintenance [11](#)

Seat belts [2-3,14](#)

Seat belts - cleaning [101](#)

Seats - front [46](#)

Servicing [107-108](#)

Shiftlock [64-65,67](#)

Side direction indicator - replacing [93](#)

Side impact airbag system (SIPS) [8](#)

Side marker lights - replacing [97](#)

Sideview mirrors [36](#)

Sideview mirrors - folding [27](#)

Sideview mirrors - heated [33](#)

Snow chains [81](#)

Snow tires [81](#)

Spare tire [51,82](#)

Spare tire (sedan) [51](#)

Spark plugs [122](#)

Specifications [120](#)

Speed-sensitive power steering	70
SRS diagnostic system	24
Stability Traction Control (STC)	18,27
Start inhibitor (immobilizer)	54,64
Starting the engine	64
Steering wheel adjustment	32
Steering wheel lock	32
Storage compartment in center console	50
Storage compartments	49
Studded tires	81
Sun roof	37
Supplemental Restraint System	4,24
Suspension	122
Switches in center console	27
T	
Tachometer	23
Tail light bulbs - replacing	94
Temperature gauge	23
Temporary spare tire	82
Text window	26
Three-way catalytic converters	78
Tire pressure	82
Tires	70,80-83
Tires - changing	84-85
Tool bag	51
Towing a trailer	74
Towing eyelet	72
Towing the car	72,73
Trailer towing	74
Trailer weight - maximum	119
Transmission - automatic	65-68
Transmission - specifications	120
Transmission fluid (automatic)	121
Trip computer	28
Trip odometer	23
Trunk - unlocking with master key	55
Trunk lights - replacing	97
Trunk lock switch	27,55
Turn signals	31
U	
Uniform tire quality grading	83
Unlocking the trunk with key	55
Upholstery - cleaning	101

V

Vanity mirror lights - replacing	95
Vanity mirrors	36
Vehicle Identification Number (VIN)	118
Vehicle loading	122
Ventilation	40
Volumes (oils and fluids)	121
Volvo On Call	124
W	
Warning flashers	33
Warning light - center	24
Warning lights	24-25
Warranty	102
Washer fluid reservoir	108,121
Washer fluid solvent	76
Washing the car	100-101
Waxing	101
Weight distribution	70
Weights	119
Wheels - changing	84,85
Wheels and tires	80-85
Whiplash Protection System (WHIPS)	10
Windows - electrically operated	35
Windshield washer solvent	76
Windshield wiper blades - replacing	115
Windshield wipers/washers	31
Winter driving	76
Winter tires	81
Winter/Wet driving mode	66,68,76
Wiper blades - replacing	115

