

VOLVO
S70 & V70
1999
VOLVO

This manual deals with the operation and care of your Volvo.



Welcome to the world-wide family of Volvo owners. We trust that you will enjoy many years of safe driving in your Volvo, an automobile designed with your safety and comfort in mind. To help ensure your satisfaction with this vehicle, we encourage you to familiarize yourself with the equipment descriptions, operating instructions and maintenance requirements/recommendations in this manual. We also urge you and your passengers to wear seat belts at all times in this (or any other) automobile. And, of course, please do not operate a vehicle if you may be affected by alcohol, medication or any impairment that could hinder your ability to drive.

Your Volvo is designed to meet all applicable safety and emission standards, as evidenced by the certification labels attached to the driver's door opening and on the left wheel housing in the engine compartment.

Volvo and the environment

Volvo is committed to the well being of our customers. As a natural part of this commitment, we care about the environment in which we all live. Caring for the environment means an everyday involvement in reducing our environmental impact.

Volvo's environmental activities are based on a holistic view, which means we consider the overall environmental impact of a product throughout its complete life cycle. In this context, design, production, product use, and recycling are all important considerations.

In production, Volvo has partly or completely phased out several chemicals including freons, lead chromates, naphthanates, asbestos, mercury and cadmium; and reduced the amount of chemicals used in our plants 50% since 1991.

In use, Volvo was the first in the world to introduce into production a three-way catalytic converter with a Lambda sond, now called oxygen sensor, in 1976. The current version of this highly efficient system reduces emissions of harmful substances (CO, HC, NOx) from the exhaust pipe by approximately 95% and the search to eliminate the remaining emissions continues. Volvo is the only automobile manufacturer to offer CFC-free retrofit kits for the air conditioning system for all models back to the M/Y 1975 240. Advanced electronic engine controls, refined purification systems and cleaner fuels are bringing us closer to our goal.

After Volvo cars and parts have fulfilled their use, recycling is the next critical step in completing the life cycle. The metal content is about 75% of the total weight of the car, which makes the car among the most recycled industrial products. In order to have efficient and well controlled recycling, many Volvo variants have printed dismantling manuals indication the weight and material of individual components. For Volvo, all homogeneous plastic parts weighing more than 1.7 oz. (50 grams) are marked with international symbols that indicate how the component is to be sorted for recycling.

In addition to continuous environmental refinement of conventional gasoline-powered internal combustion engines, Volvo is actively looking at advanced technology alternative-fuel vehicles.

When you drive a Volvo, you become our partner in the work to lessen the car's impact on the environment. To reduce your vehicle's environmental impact, you can:

- Maintain proper air pressure in your tires. Tests have shown decreased fuel economy with improperly inflated tires Follow the recommended maintenance schedule
- Drive at a constant speed
- See an authorized Volvo retailer as soon as possible for inspection if the check engine (malfunction indicator) lamp illuminates, or stays on after the vehicle has started
- Properly dispose of any vehicle related waste such as used motor oil, used batteries, brake pads, etc.
- When cleaning your car, use Volvo's own car care products, all of which have systematically been adapted to the environment.

Contents

Table of Contents

<u>Page No.</u>	<u>Chapter and Subject</u>
pg. 1	Chapter 1 - Occupant safety
pg. 16	Chapter 2 - Instruments and controls
pg. 41	Chapter 3 - Body and interior
pg. 65	Chapter 4 - Starting and driving
pg. 85	Chapter 5 - Wheels and tires
pg. 91	Chapter 6 - In case of emergency
pg. 109	Chapter 7 - Car care
pg. 115	Chapter 8 - Volvo Service

[pg. 133](#) Chapter 9 - Specifications
[pg. 141](#) Chapter 10 - Audio systems
[pg. 198](#) Index

Important

Before you operate your car for the first time, please familiarize yourself with the BREAK-IN information on page 66. You should also be familiar with the information in the first three chapters of this manual. Information contained in the balance of the manual is extremely useful and should be studied after operating the vehicle for the first time.

This manual is structured so that it can be used for reference. It should thus be kept in the car for ready access. Do not export your Volvo to another country before investigating the country's applicable safety and exhaust emission requirements. In some cases it may be difficult or impossible to comply with these requirements. Modifications to the emission control system(s) may render your Volvo not certifiable for legal operation in the U.S., Canada or other countries.

All information, illustrations and specifications contained in this manual are based on the latest product information available at the time of publication. Please note that some vehicles may be equipped differently, depending of special legal requirements and that optional equipment described in this manual may not be available in all markets.

Volvo reserves the right to make model changes at any time, or to change specifications or design, without notice and without incurring obligation.

CAUTION: Certain models have reduced ground clearance due to the design of the front spoiler. Please observe caution when e.g., driving onto garage hoists, through drifted snow or when other road debris is encountered, or when parking near curbs.

©1998 Volvo Cars of North America Inc.



[Contents](#) | [Top of Page](#)

Occupant safety

Despite our strongest recommendations, and your best intentions, not wearing a seat belt is like believing "It'll never happen to me!". Volvo urges you and all adult occupants of your car to wear seat belts and ensure that children are properly restrained, using an infant, car or booster seat determined by age, weight and height.

Fact: In every state and province, some type of child-restraint legislation has been passed. Additionally, most states and provinces have already made it mandatory for occupants of a car to use seat belts.

So, urging you to "buckle up" is not just our recommendation - legislation in your state or province may mandate seat belt usage. The few seconds it takes to buckle up may one day allow you to say, "It's a good thing I was wearing my seat belt".



Chapter Contents

Page No. Subject

pg. 2	Seat belts
pg. 4	Volvo SRS
pg. 8	Side Impact Protection System - (SIPS) air bag
pg. 9	Child safety
pg. 14	Occupant safety
pg. 14	Reporting Safety Defects

Seat belts

Always fasten the seat belts before you drive or ride.

Two lights above the rear view mirror will be illuminated for 4-8 seconds after the starting (ignition) key is turned to the driving position. A chime will sound at the same time if the driver has not fastened his seat belt. The rear seats are provided with self-retracting inertia reel belts. The front seats are provided with single roller belts with tensioners.



To buckle:

Pull the belt out far enough to insert the latch plate into the receptacle (buckle for rear seats) until a distinct snapping sound is heard. The seat belt retractor is normally "unlocked" and you can move freely, provided that the shoulder belt is not pulled out too far. The retractor will lock up as follows:

- if the belt is pulled out rapidly
- during braking and acceleration
- if the vehicle is leaning excessively
- when driving in turns

For the seat belt to provide maximum protection in the event of an accident, it must be worn correctly. When wearing the seat belt remember:

- The belt should not be twisted or turned.
- The lap belt must be positioned low on the hips (not pressing against the abdomen).
- The shoulder section of the front seat belts adjusts automatically to the driver's height.

Make sure that the shoulder belt is rolled up into its retractor and that the shoulder and lap belts are taut.

Before exiting the car, check that the seat belt retracts fully after being unbuckled.

If necessary, guide the belt back into the retractor slot.

NOTE: Legislation in your state or province may mandate seat belt usage.

WARNING! Any device used to induce slack into the shoulder belt portion of the three-point belt system will have a detrimental effect on the amount of protection available to you in the event of a collision. The seat back should not be tilted too far back. The shoulder belt must be taut in order to function properly.

Spool-out

To make child seat installation easier, each seat belt buckle (except for the driver's belt) is equipped with a locking mechanism to help keep the lap section of the seat belt taut. Please refer to page 12 for more information on this function.

WARNING! Do not use child safety seats or child booster cushions/backrests in the front passenger's seat. We also recommend that children who have outgrown these devices sit in the rear with the seat belt properly fastened.



During pregnancy

Pregnant women should always wear seat belts. Remember that the belt should always be positioned in such a way as to avoid any possible pressure on the abdomen. The lap portion of the belt should be located low, as shown in the above illustration.

WARNING! Never use a seat belt for more than one occupant. Never wear the shoulder portion of the belt under the arm, behind the back or otherwise out of position. Such use could cause injury in event of accident. As the seat belts lose much of their strength when exposed to violent stretching, they should be replaced after any collision, even if they may appear to be undamaged. Never repair the belt on your own; have this done by an authorized Volvo retailer only.

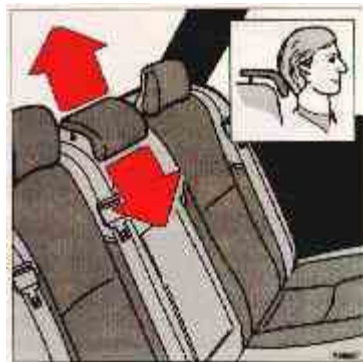

Center head restraint

The center head restraint can be adjusted according to the passenger's height. The restraint should be carefully adjusted

to support the occupant's head.

To raise: Pull straight up

To lower: Pull forward and push down



[Contents](#) | [Top of Page](#)

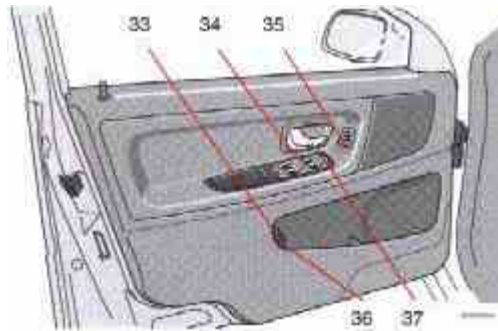
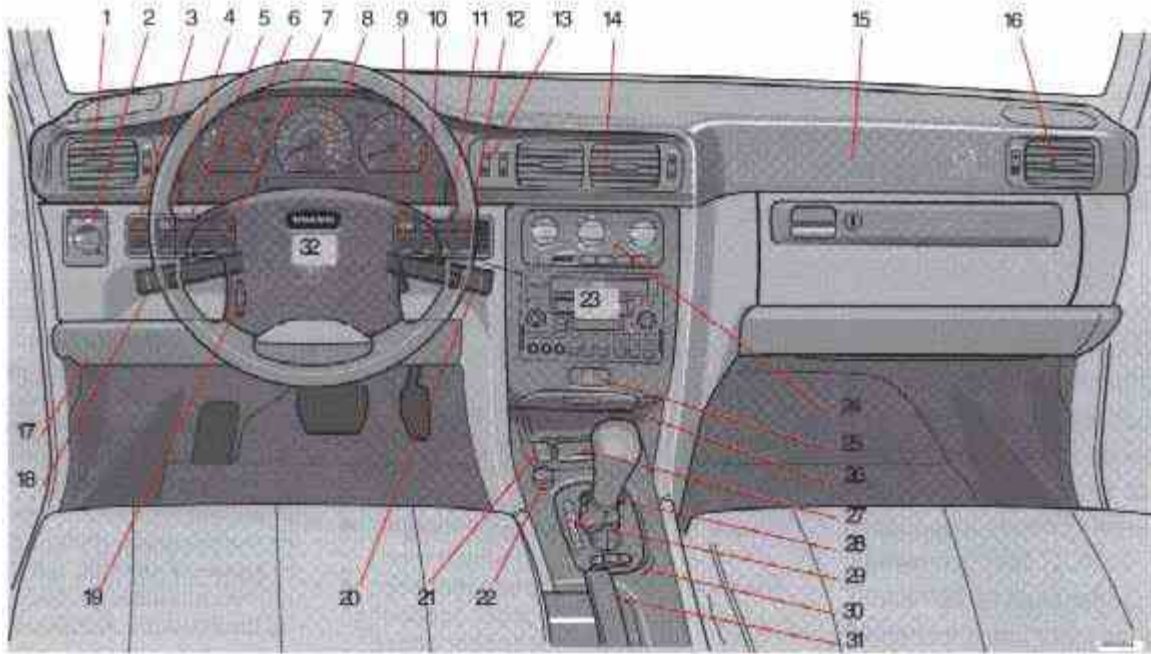

The pages in this section provide detailed descriptions of the vehicle's instruments and controls. Note that vehicles may be equipped differently, depending on special legal requirements.

Chart for Picture of Instruments and Controls

Number	Page No.	Subject
1	pg. 35	Air vents
2	pg. 22	Headlights, parking lights
3	pg. 24	Instrument illumination
4	pg. 24	Rear fog light
5	pg. 24	Front fog lights
6		Space for additional equipment
7		Space for additional equipment

8	pg. 16-17	Instruments
9	pg. 25	TRACS/STC (optional)
10	pg. 28-30	Trip computer (optional)
11	pg. 52	Electrically operated sun roof (optional)
12	pg. 25	Rear window demister/heated door mirrors
13	pg. 35	Air mix
14	pg. 35	Air vents
15	pg. 4-6	Passenger side SRS (air bag) hatch
16	pg. 35	Air vents
17	pg. 53	Hood release
18	pg. 22	Turn signals, high/low beams/exterior courtesy lights
	pg. 31	Cruise control
19	pg. 34	Adjustable steering wheel
20	pg. 23	Windshield wiper/washer
:	pg. 26	Tailgate wiper/washer (wagons)
21	pg. 32	Heated front seats (optional)
22	pg. 33	Auxiliary socket
23	pg. 141	Audio system
24	pg. 35-39	Heating and ventilation controls
25	pg. 25	Hazard warning flashers
26	pg. 33	Ash tray
27		Coin holder
28	pg. 108	Shiftlock release button (automatic transmission only)
29	pg. 70-71	Gear selector shift positions
30	pg. 72	Winter mode selectors
31	pg. 32	Parking brake
32	pg. 4-6	Horn/SRS
33	pg. 47	Trunk/tailgate open control
34	pg. 40	Power window controls
35	pg. 50	Power mirror controls
36	pg. 67	Fuel tank open control
37	pg. 43	Central locking button

Some of the items above are available on certain models only.



1 Fuel gauge

Fuel tank capacity:

18 US gals. (68 liters) Front Wheel Drive

17.4 US gals. (66 liters) All Wheel Drive

. When the warning light comes on there is approximately 1.8 US gals. (8 liters) of fuel remaining. See "Refueling" for further information.

2 Temperature gauge

Do not drive the car with the pointer in the red range. The pointer should be approximately midway on the gauge face when driving. If the pointer approaches the red range repeatedly, check coolant level. [See page 130.](#)

3 Speedometer

4 Clock, ambient temperature sensor, trip computer (certain models)

5 Trip odometer

Used for measuring shorter distances. The last digit indicates 1/10 mile/kilometer.

6 Odometer

7 Trip odometer reset button

8 Tachometer

Reads thousands of engine rpm.



[Contents](#) | [Top of Page](#)

Body and interior

The seats, sun roof, mirrors, etc. are described on the following pages.

Page No. Subject

- [pg. 42](#) Keys
- [pg. 43](#) Doors and locks
- [pg. 44](#) Remote keyless entry system
- [pg. 45](#) Alarm
- [pg. 47](#) Trunk/tailgate
- [pg. 48](#) Child safety locks
- [pg. 49-50](#) Front seats
- [pg. 50](#) Rear/side view mirrors
- [pg. 51](#) Interior lights, Vanity mirror
- [pg. 52](#) Sun roof
- [pg. 53](#) Hood
- [pg. 54](#) Storage compartments
- [pg. 55](#) Trunk light, Spare tire, Jack
- [pg. 56](#) Cargo space lighting, Spare tire, Jack (wagon)
- [pg. 57](#) Folding rear seat (sedan)
- [pg. 58-59](#) Folding rear seat (wagon)
- [pg. 59](#) Removing seat cushions
- [pg. 60](#) Concealed storage bin/Bumper cover (wagon), Avoiding battery drain
- [pg. 61](#) Luggage net/Side cargo net (wagon)
- [pg. 62](#) Securing cargo
- [pg. 63](#) Folding front seat, Long load storage

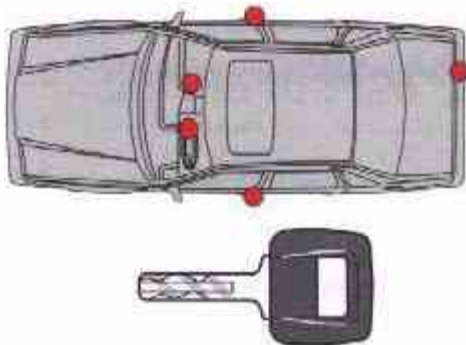

Master key

This key operates all locks (ignition switch/steering wheel lock, driver's door, trunk/tailgate and glove compartment).

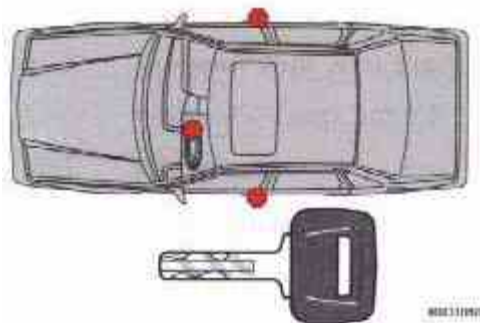

Service key

This key operates the driver's door and the ignition switch/steering wheel lock.

NOTE:

- An added anti-theft measure, new keys have been developed which may take slightly longer to copy or replace if the original keys are misplaced. Duplicate keys may be ordered from your Volvo retailer.
- The key number codes are stamped on a separate tag supplied with the keys. This tag should be separated from the key ring and kept in a safe place.

Immobilizer (start inhibitor)

Each of the keys supplied with your car contains a coded transmitter and receiver (transponder). The code in the key is transmitted to an antenna in the ignition switch where it is compared to the code stored in the start inhibitor module. The car can only be started if a properly coded key is used.

If you misplace a key, take the other keys to an authorized Volvo retailer. The existing code in the start inhibitor module and all the keys will be erased as an anti-theft measure and a new code will be programmed in.

NOTE:

Not more than one of the keys for your car should be kept on the same key ring. This could cause conflicting signals to be transmitted to the ignition switch, making it impossible to start the car.

This device complies with FCC rules Part 15. Operation is subject to the following two conditions: (1) This device may not cause harmful interference and (2) this device must accept any interference that may be received, including interference that may cause undesired operation.

pg. 43 Doors and Locks

Doors and locks

Your car is equipped with a two door operated central locking system.

The key, used on the driver's doors, the remote control, or central locking button, will lock/unlock all doors, trunk/tailgate.

Turn the key once to unlock the driver's door only.

Turn the key again (within 10 seconds) to unlock all doors, trunk/tailgate.

One turn with the key towards lock in the drivers door locks all doors, trunk/tailgate.

Use the switch on the front door armrests to lock/unlock the car from the inside.

Check the action of the buttons on the other doors to verify their correct function (lock/unlock).

WARNING! The doors should not be locked while driving. In case of an accident, this may hinder rapid access to the occupants of the vehicle. (Also see information on "Child safety locks".)



Central locking button (on both front doors)

Central locking button

The central locking buttons on both front door armrests can be used to lock or unlock all doors and trunk/tailgate and set the alarm if your car is so equipped. This switch functions even if a door/trunk/tailgate is open.

Lock: Press the left side of the button

Unlock: Press the right side of the button

NOTE: To help prevent accidentally locking the keys in the car, the central locking system is designed to unlock the driver's door immediately if the key is left in the ignition switch and the car is locked using the lock button on the door. A sound from the lock will be audible at this time.

Please note that this function will not unlock the doors if the engine is running.

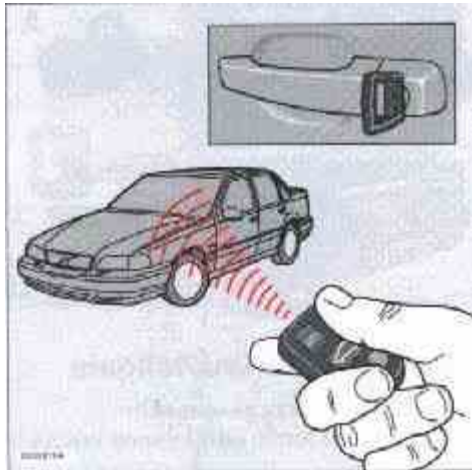

Remote keyless entry system

Your car is equipped with a remote control transmitter. This transmitter uses a radio frequency which will allow “keyless” entry into the passenger compartment or the trunk. You will be supplied with two coded key ring transmitters, which will enable you to lock/unlock all doors and the trunk/tailgate from a distance of 10-15 feet (3-5 meters).

The car can also be locked/unlocked with the key.

As an extra security precaution in certain situations (valet parking, etc.), Volvo recommends that the transmitter not be included when the keys are given to anyone. The service key can be used instead. If one of the transmitters is misplaced, contact the nearest authorized Volvo retailer for assistance.



Using the remote control

* Press the LOCK button once to lock all doors and trunk/tailgate.

* Press the UNLOCK button once to unlock the driver's door only. Press this button again (within 10 seconds) to unlock all doors, trunk/tailgate.

* Press the OPEN TRUNK/TAILGATE button *twice* within 3 seconds to pop open the trunk or unlock the tailgate

This device complies with FCC rules Part 15. Operation is subject to the following two conditions: (1) This device may not cause harmful interference and (2) this device must accept any interference that may be received, including interference that may cause undesired operation.

NOTE: If only the driver's door is unlocked, the lock will automatically reengage (re-lock) and the alarm will reset after 2 minutes unless the door has been opened.

The lock/unlock and alarm features can also be utilized by using the keys. See section: Doors and Locks on [page 43](#). If the alarm LED glows continuously for 5 seconds, this indicates a fault in the system or that a door is not properly closed.

WARNING! Volvo does not recommend using the transmitter to lock the doors from inside the car. On cars equipped with an alarm, the alarm would be activated and would sound when one of the doors is opened. The doors must not be locked using the remote transmitter while the vehicle is occupied. In case of an accident, this may hinder rapid access to the occupants of the vehicle. The alarm will also sound on models equipped with this feature.

NOTE : To avoid leaving your keys in the car, make a habit of always locking the car with the remote control.



[Contents](#) | [Top of Page](#)

Starting and driving

This section on starting and driving contains items such as starting the engine, operating the gear selector, towing, trailers, etc.

Page No. Subject

pg. 66	Break-in period
pg. 66-67	Fuel requirements, Refueling
pg. 68	Driving economy
pg. 69	Starting the engine
pg. 70	Manual transmission
pg. 70-73	Automatic transmission, All Wheel Drive (AWD)
pg. 74-75	Points to remember
pg. 76	Emergency towing
pg. 77	Vehicle towing information
pg. 78	Jump starting
pg. 79	Three-way catalytic converter
pg. 80	Brake system, ABS
pg. 81	TRACS/STC
pg. 82	Winter driving
pg. 83	Long distance trips
pg. 84	Trailer towing

A new car should be broken-in

Refrain from utilizing your car's full driving potential during the first 1,200 miles (2,000 km) including the "kick-down" function (automatic transmission).

NOTE - ENGINE OIL:

Although some oil consumption occurs during normal engine operation, more oil is consumed when the engine is new as the internal parts generate higher friction while wearing-in to each other. From the time the engine is new until the first service is performed, the oil consumption could be higher than normal. For this reason, it is especially important to check the oil every time you refuel your car during this period. [See page 124.](#)

In general, the rate of oil consumption depends on such factors as: engine temperature, length of trip, driving conditions, oil viscosity and quality, engine speed and acceleration/deceleration.

Checking your engine oil level each time the car is refueled is one of the most important items you can perform to

help keep your car in good running order.

Manual transmission

The following speeds should not be exceeded during the break-in period:

	Up to 600 miles (1000 km)	600 - 1,200 miles (1000 - 2000 km)
1st gear	20 mph (30 km/h)	25 mph (40 km/h)
2nd gear	30 mph (50 km/h)	40 mph (70 km/h)
3rd gear	45 mph (80 km/h)	65 mph (100 km/h)
4th gear	70 mph (110 km/h)	80 mph (130 km/h)
5th gear/overdrive	80 mph (130 km/h)	95 mph (150 km/h)

Posted speed limits should not be exceeded.

Deposit control gasoline (detergent additives)

Volvo recommends the use of gasoline containing deposit control additives. These additives have shown to be efficient in keeping injectors and intake valves clean. Consistent use of deposit control gasolines will help ensure good driveability and fuel economy. If you are not sure whether the gasoline contains deposit control additives, check with the service station operator.

Unleaded Fuel

Each Volvo has a three-way catalytic converter and must use only unleaded gasoline. U.S. and Canadian regulations require that pumps delivering unleaded gasoline be labeled "UNLEADED". Only these pumps have nozzles which fit your car's filler inlet. It is unlawful to dispense leaded fuel into a vehicle labeled "unleaded gasoline only". Leaded gasoline damages the three-way catalytic converter and the heated oxygen sensor system. Repeated use of leaded gasoline will lessen the effectiveness of the emission control system and could result in loss of emission warranty coverage. State and local vehicle inspection programs will make detection of misfueling easier, possibly resulting in emission test failure for misfueled vehicles.

NOTE: Some U.S. and Canadian gasolines contain an octane enhancing additive called methyl-cyclopentadienyl manganese tricarbonyl (MMT). If such fuels are used, your Emission Control System performance may be affected, and the Malfunction Indicator Lamp located on your instrument panel may light. If this occurs, please return your vehicle to an authorized Volvo retailer for service.

Octane Rating

Volvo engines are designed for optimum performance on unleaded premium gasoline with an octane rating. AKI of 91, or above. AKI (ANTI KNOCK INDEX) is an average of the Research Octane Number, RON, and the Motor Octane Number, MON, $(RON + MON/ 2)$.

The minimum octane requirement is AKI 87 (RON 91).

Gasoline containing alcohol and ethers

"Oxygenated fuels"

Some fuel suppliers sell gasoline containing "oxygenates" which are usually alcohols or ethers. In some areas, state or local laws require that the service pump be marked indicating use of alcohol or ethers. However, there are areas in which the pumps are unmarked. If you are not sure whether there is alcohol or ethers in the gasoline you buy, check with the service station operator.

To meet seasonal air quality restrictions, some states require the use of "oxygenated" fuel in certain areas.

Volvo allows the use of the following "oxygenated fuels; however, the octane ratings listed on this page must still be met.

Alcohol — Ethanol

Fuels containing up to 10% ethanol by volume may be used.

Ethanol may also be referred to as Ethyl alcohol, or "Gasohol".

Ethers — MTBE

Fuels containing up to 15% MTBE may be used.

Refueling

The fuel tank is designed to hold approximately:

18.4 US gal. (68 liters) - Front Wheel Drive

17.4 US gal. (66 liters) - All Wheel Drive

with sufficient volume left over to accommodate possible expansion of the fuel in hot weather. Be aware that the "usable" tank will be somewhat less than the specified maximum. When the fuel level is low, such factors as ambient temperature, the fuel's "Reid vapor pressure" characteristics, and terrain can affect the fuel pumps' ability to supply the engine with an adequate supply of fuel. Therefore, it is advisable to refuel as soon as possible when the needle nears the red zone, or when the fuel warning light comes on.

Fuel tank cover

The fuel tank cover (on the right rear fender) is locked and must be popped open using the control on the driver's door.

Open fuel filler cap slowly during hot eather conditions.

CAUTION:

- Do not refuel with the engine running. Turn the ignition off or to position I. If the ignition is on, an incorrect reading could occur in the fuel gauge.
- Allow for fuel expansion by not overfilling the tank. Overfilling could also cause damage to the emission control systems.
- Avoid spilling gasoline during refueling. Gasolines containing alcohol can cause damage to painted surfaces, which may not be covered under the New Vehicle Limited Warranty.
- Do not use gasoline containing methanol (methyl alcohol, wood alcohol). This practice can result in vehicle performance deterioration and can damage critical parts in the fuel system. Such damage may not be covered under the New Vehicle LimitedWarranty.

* If the fuel filler cap is not closed tightly or if the engine is running when the car is refueled, the Malfunction Indicator Lamp may indicate a fault. However, your vehicle's performance will not be affected. Use only Volvo original or approved fuel filler caps.

pg. 68 Driving economy

Economical driving conserves natural resources

Better driving economy may be obtained by thinking ahead, avoiding rapid starts and stops and adjusting the speed of your vehicle to immediate traffic conditions. Observe the following rules:

- Bring the engine to normal operating temperature as soon as possible by driving with a light foot on the accelerator pedal for the first few minutes of operation. A cold engine uses more fuel and is subject to increased wear.
- Whenever possible, avoid using the car for driving short distances. This does not allow the engine to reach normal operating temperature.
- Drive carefully and avoid rapid acceleration and hard braking.
- Do not exceed posted speed limit.
- Avoid carrying unnecessary items (extra load) in the car.
- Maintain correct tire pressure. Check tire pressure regularly (check when tires are cold).
- Remove snow tires when threat of snow or ice has ended.
- Note that roof racks, ski racks, etc., increase air resistance and thereby fuel consumption.
- Avoid using automatic transmission kick-down feature unless necessary.
- Avoid using the air conditioning when it is not required. When engaged, the air conditioner's compressor places an additional load on the engine. However, please note that fuel consumption is lower with the air conditioning on than it is when driving with the air conditioning switched off and the windows down.
- If your car is equipped with the optional Trip Computer, utilizing the fuel consumption modes can help you "learn" how to drive more economically.

Other factors which decrease gas mileage are:

- Worn or dirty spark plugs

- Incorrect spark plug gap
- Dirty air cleaner
- Dirty engine oil and clogged oil filter
- Dragging brakes
- Incorrect front end alignment

Some of the above mentioned items and others are checked at the standard Maintenance Service intervals.

NOTE: (D)rive or 5th gear (manual transmissions) should be used as often as possible to help improve fuel economy.



[Contents](#) | [Top of Page](#)

Wheels and tires

The handling and riding comfort of the vehicle is dependent on the inflation pressure and the type of tires fitted. Read the following pages carefully.

Page No. Subject

[pg. 86](#) General information, Wear indicator, Tire economy, Flat spots

[pg. 87](#) Snow chains, Winter tires

[pg. 88](#) Inflation pressure

[pg. 89](#) Uniform tire quality grading

General information

Your vehicle is equipped with tires according to the tire information label located on the rear facing side of the right front door.

The following is an example of a tire designation code 195/60R15:

195 = tire width in mm.

60 = tire profile. This is the relationship (in percent) between the section height and the width of the tire.

R = radial tires.

15 = diameter in inches.

The tires have good road holding characteristics and offer good handling on dry and wet surfaces. It should be noted however that the tires have been developed to give these features on snow/ice-free surfaces. Certain models are equipped with "all-season" tires, which provide a somewhat higher degree of winter roadholding on slippery surfaces than tires without the "all-season" rating. However, for optimum road holding on icy or snow covered roads - we recommend suitable winter tires on all four wheels. When replacing tires, be sure that the new tires are the same size designation, type (radial) and preferably from the same manufacturer, on all four wheels. Otherwise there is a risk of altering the car's road-holding and handling characteristics .

NOTE: When storing wheel/tire assemblies (e.g. winter tires and wheels), either stand the assemblies upright or suspend them off the ground. Laying wheel/tire assemblies on their sides for prolonged periods can cause wheel and/or tire damage.

Wear indicator

The tires have a so-called "wear indicator" in the form of a number of narrow strips running across or parallel to the tread. When approx. 1/16" (1.6 mm) is left on the tread, these strips show up and indicate that the tire should be replaced.

Tires with less than 1/16" (1.6 mm) tread have a very poor grip in rain or snow.

When replacing worn tires, it is recommended that the tire be identical in type (radial) and size as the one being replaced. Using a tire of the same make (manufacturer) will prevent alteration of the driving characteristics of the vehicle.

To improve tire economy:

- Maintain correct tire pressure. See the tire pressure label on the inside of the fuel tank cover.
- Drive smoothly: avoid fast starts, hard braking and tire screeching.
- Tire wear increases with speed.
- Correct front wheel alignment is very important.
- Unbalanced wheels impair tire economy and driving comfort.
- If the wheels are rotated, they should be kept on the same side of the car so that they revolve in the same direction as prior to rotation.
- Hitting curbs or potholes can damage the tires and/or wheels permanently.

Flat spots

All tires become warm during use. After cooling, when the vehicle is parked, the tires have a tendency to distort slightly, forming flat spots. These flat spots can cause vibrations similar to the vibrations caused by unbalanced wheels. They do, however, disappear when the tire warms up. The degree to which the flat spots form depends on the type of cord used in the tire. Remember that, in cold weather, it takes longer for the tire to warm up and consequently longer for the flat spot to disappear.

CAUTION: The car must not be driven with wheels of different dimensions or with a spare tire other than the one that came with the car. The use of different size wheels can seriously damage your car's transmission. *

*** This also applies to models equipped with All Wheel Drive (AWD).**

pg. 87 Wheels and tires (cont.)

Snow chains

Snow tire chains can be used on your Volvo with the following restrictions:

- Snow chains should be installed on front wheels only (**this applies to cars with front wheel drive and to cars equipped with All Wheel Drive**) . Use only Volvo approved snow chains.

- Snow chains may be mounted on tire dimension

Front wheel drive:185/65R15 and 195/60R15. Tire dimension 205/55R15 and 205/50R16 require a special type of snow chain.

- Chains cannot be used on front wheel drive models equipped with 205/55R16 tires.

All Wheel Drive: Special snow chains are available for AWD models equipped with 195/65R15 and 205/55R16 tires.

Chains cannot be used on V70 XC AWD models equipped with 205/65R15 tires. Consult your Volvo retailer.

If accessory, aftermarket or "custom" tires and wheels are installed and are of a size different than the original tires and wheels, chains in some cases CANNOT be used. Snow chains cannot be used on those turbo-charged models fitted with all-season tires 205/55 R16. Models equipped with 205/55 R15 or 205/50 R16 need specially designed snow chains. Sufficient clearances between chains and brakes, suspension and body components must be maintained.

- Some strap-on type chains will interfere with brake components and therefore CANNOT be used.

Consult your Volvo retailer for additional snow chain information.

CAUTION:

- Check local regulations regarding the use of snow chains before installing.
- Always follow the chains manufacturer's installation instructions carefully. Install chains as tightly as possible and re-tighten periodically.
- Never exceed the chain manufacture's specified maximum speed limit. (Under no circumstances should that limit be higher than 30 mph (45 km/h).
- Avoid bumps, holes or sharp turns when driving with snow chains.
- The handling of the vehicle can be adversely affected when driving with chains. Avoid fast or sharp turns as well as locked wheel braking.

Snow tires, studded tires *

Tires for winter use:

Owners who live in or regularly commute through areas with sustained periods of snow or icy driving conditions are strongly advised to fit suitable winter tires to help retain the highest degree of traction.

It is important to install winter tires on all four wheels to help retain traction during cornering, braking and accelerating. Failure to do so could reduce traction to an unsafe level or adversely affect handling. Do not mix tires of different design as this could also negatively affect overall tire road grip. **Volvo recommends 185/65 R15 winter tires on 15" wheels on all front wheel drive S/V 70 models** including models equipped with 16" or 17" wheels.**

Winter tires wear more quickly on dry roads in warm weather. They should be removed when the winter driving season has ended.

Studded tires should be run-in 300-600 miles (500-1000 km) during which the car should be driven as smoothly as possible to give the studs the opportunity to seat properly in the tires. The car tires should have the same rotational

direction throughout their tire lifetime. In other words, if you wish to rotate the wheels, make sure that the same wheels are always on the same side of the car.

NOTE: Please consult state or provincial regulations restricting the use of studded winter tires before installing such tires.

* Where permitted

** All Wheel Drive models, including the AWD XC should be equipped with 195/65 R15 winter tires

pg. 88 Wheels and tires (cont.)

Checking and correcting tire pressure

- Check the tire pressure when refueling.
- The tire pressure should be corrected only when the tires are cold.
- With warm tires, correct only when the pressure is too low. The tire temperature rises after driving just a few miles.

Vehicle Loading

The tires on your Volvo will perform to specifications at all normal loads when inflated as recommended on the tire information label* located on the inside of the fuel filler flap. This label lists both the tire and vehicle design limits. Do not load your car beyond the load limits indicated.

* Please note that the tire information label indicates pressures for both comfort and fuel economy.



Tire pressure label

pg. 89 Wheels and tires (cont.)

Uniform tire quality grading

ALL PASSENGER CAR TIRES MUST CONFORM TO FEDERAL SAFETY REQUIREMENTS IN ADDITION TO THESE GRADES

TREADWEAR

The treadwear grade is a comparative rating based on the wear rate of the tire when tested under controlled conditions on a specified government test course. For example, a tire graded at 150 would wear one and one half (1 1/2) times as well on the government course as a tire graded 100. The relative performance of tires depends upon the actual conditions of their use, however, and many depart significantly from the norm due to variation in driving habits, service practices and differences in road characteristics and climate.

TRACTION

The traction grades, from highest to lowest, are AA, A, B, and C, as measured under controlled conditions on specified government test surfaces of asphalt and concrete. A tire marked C may have poor traction performance.

WARNING! The traction grade assigned to this tire is based on braking (straight-ahead) traction tests and does not include cornering (turning) traction.

TEMPERATURE

The temperature grades are AA (the highest), A, B, and C, representing the tire's resistance to the generation of heat and its ability to dissipate heat when tested under controlled conditions on a specified indoor laboratory test wheel. Sustained high temperature can cause the material of the tire to degenerate and reduce tire life, and excessive temperature can lead to sudden tire failure. The grade C corresponds to a level of performance which all passenger car tires must meet under the Federal Motor Safety Standard No. 109. Grades B and A represent higher levels of performance on the laboratory test wheel than the minimum required by law.

WARNING! The temperature grade for this tire is established for a tire that is properly inflated and not overloaded. Excessive speed, underinflation, or excessive loading, either separately or in combination, can cause heat buildup and possible tire failure.



Chapter 6 - In case of emergency

pg. 91 In case of an emergency

In case of an emergency

Even if you maintain your car in good running condition, there is always the possibility that something might go wrong and prevent you from driving, such as a punctured tire, blown fuse or bulb, etc. For additional information, see section "ON CALL Road Assistance".

[pg. 92-93](#) Wheel changing

[pg. 94](#) Spare tire

[pg. 95-101](#) Replacing bulbs

[pg. 102-104](#) Replacing fuses

[pg. 105](#) Installation of accessories

[pg. 106-107](#) Replacing wiper blades

[pg. 108](#) In case of emergency

pg. 92 Wheel changing

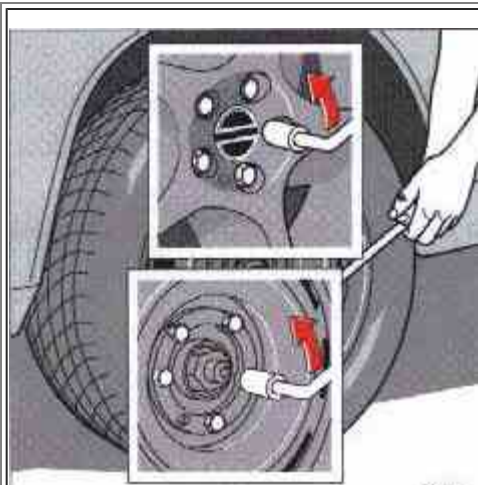

Loosen wheel bolts



Insert flat end of lug wrench and turn
Pull straight out

Changing a wheel

The spare wheel is located under the carpet on the trunk floor. The jack and crank are secured in the wheel recess.

- Engage the parking brake.
- Put the gear selector in (P)ark (automatic) or in Reverse (manual).
- Remove the wheel cap (where applicable) using the lug wrench in the tool kit.

- With the car still on the ground, use the lug wrench to loosen the wheel bolts 1/2 - 1 turn. Turn the bolts counterclockwise to loosen.
- Fold out the crank handle on the jack by pressing the nob on the handle downward. To attach the jack, refer to the illustration on the following page.

NOTE: To avoid excessive wear and the necessity of rebalancing, mark and reinstall wheels in same location and position as before removal. To lessen the chance of imbalance, each wheel hub is equipped with a guide stud to ensure that a removed wheel can be reinstalled in its original position (as when changing over to winter tires/wheels).

CAUTION:

- The car must not be driven with wheels of different dimensions or with a spare tire other than the one that came with the car. The use of different size wheels can seriously damage your car's transmission.
- Correct tightening torque on wheel bolts must be observed. The wheel bolts must be observed. The wheel bolts should never be greased or lubricated. The extended, chromed wheel bolts must not be used with steel rims, as they make it impossible to fit the hub caps.

WARNING!

- The jack (see the following page) must engage the bar in the jack attachment (A). The car's weight must not rest on the jack's attachment (B).
- Be sure the jack is on a firm, level, non-slippery surface.
- Never allow any part of your body to be extended under a car supported by a jack.
- Use the jack intended for the car when replacing a wheel. For any other job, use stands to support the end of the car being worked on.
- Apply the parking brake, select position P (automatic transmission) or Reverse gear (manual transmission).
- Block the wheels standing on the ground, use rigid wooden blocks or large stones.
- The jack should be kept well-greased.



Jack attachment - front wheel drive models

Attaching the jack

There is a jack attachment located in the center on each side of the car. Position the jack on the bar in the attachment (A in illustration above) and crank while simultaneously guiding the base of the jack to the ground. The base of the jack must be flat on a level, firm, non-slippery surface. Before raising the car check that the jack is still correctly positioned in the attachment. Raise the vehicle until both wheels on the side of the car where the jack is attached are lifted off the ground. Unscrew the wheel bolts completely and carefully remove the wheel so as not to damage the thread on the studs.

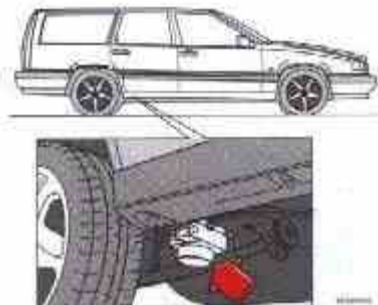

Additional rear jack attachment on All Wheel Drive cars

Attaching the jack on cars with All Wheel Drive (AWD)

Due to the greater weight of AWD-equipped cars, these models have an additional jack attachment point located directly in front of the rear axle. When using a workshop floor jack, make sure that the correct attachment is used and that the jack does not damage the fuel tank.

The attachment is, of course, also intended for use with the standard jack supplied with the car.

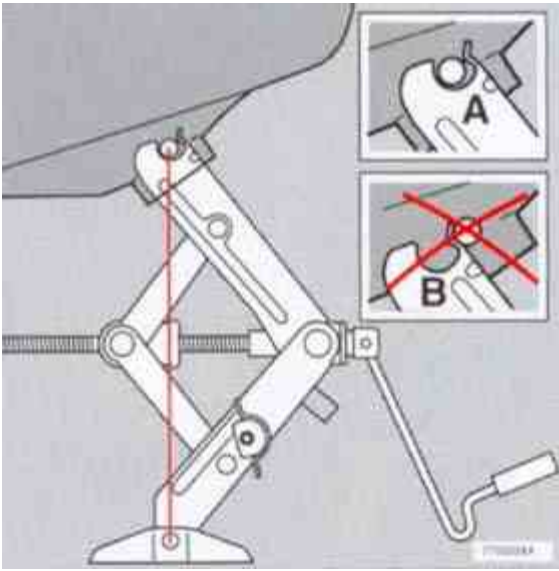

Proper Jack attachment on AWD cars.

Installing the wheel

Clean the contact surfaces on the wheel and hub. Lift the wheel and place it on the hub. Make sure that you align the wheel with the guide stud on the wheel hub prior to installation. Install the wheel bolts crosswise (see illustration) and tighten by turning lightly clockwise. Lower the vehicle to the ground and alternately tighten the nuts to 81 ft. lbs. (110 Nm). Install the wheel cap (where applicable).



Correct tightening order for wheel bolts

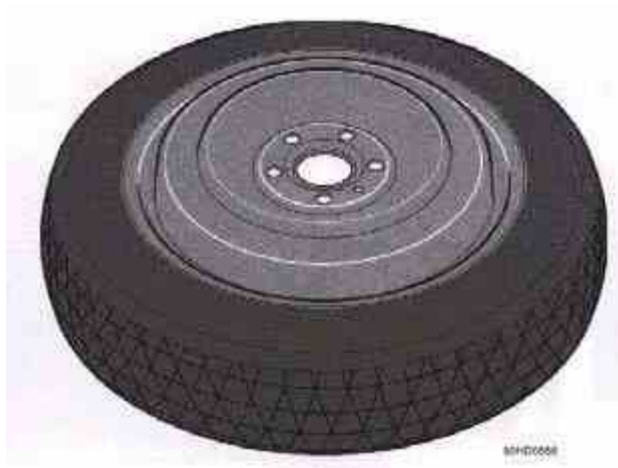

Temporary Spare (certain models)

The spare tire of your car is what is called a "Temporary Spare". It has the following designation: T115/70 R15 or T125/80 R17.

Recommended tire pressure (see decal on fuel filler flap) should be maintained irrespective of which position on the car the Temporary Spare tire is used on.

In the event of damage to this tire a new one can be purchased from your Volvo retailer.

CAUTION: The car must not be driven with wheels of different dimensions or with a spare tire other than the one that came with the car. The use of different size wheels can seriously damage your car's transmission.

WARNING!

Current legislation prohibits the use of the "Temporary Spare" tire other than as a temporary replacement for a punctured tire. In other words, it must be replaced as soon as possible by a standard tire. Roadholding, etc., may be affected with the "Temporary Spare" in use. Do not, therefore, exceed 50 mph (80 km/h).

NOTE : Certain models are equipped with a full-size spare wheel.



[Contents](#) | [Top of Page](#)

Car care

Car care includes not only maintaining the appearance of the car, but also protecting the car exterior from the effects of air pollution, rain, mud or road salt. The paintwork should also be touched up immediately, if damaged, to prevent rust formation.

Page No. Subject

[pg. 110-111](#) Paint touch-up

[pg. 112](#) Washing

[pg. 113](#) Automatic car washing, Polishing and waxing

[pg. 114](#) Cleaning the upholstery

Paint touch-up

Paint damage requires immediate attention to avoid rusting. Make it a habit to check the finish regularly - when washing the car for instance. Touch up if necessary.

Paint repairs require special equipment and skill. Contact your Volvo retailer for any extensive damage.

Minor scratches can be repaired by using Volvo touch-up paint.

NOTE: When ordering touch-up paint from your Volvo retailer, use the paint code indicated on the model plate. The plate is located in the engine compartment, on the inside of the left front fender.

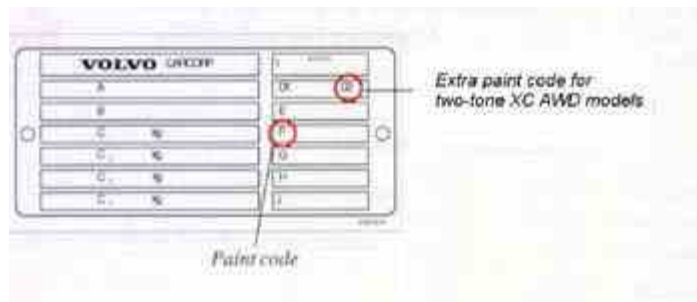

Minor stone chips and scratches

Material:

Primer - can

Paint - touch-up bottle

Brush

Masking tape

NOTE: When touching up the car, it should be clean and dry. The surface temperature should be above 60° F (15° C).

Scratches on the surface

If the stone chip has not penetrated down to the metal and undamaged layer of paint remains, the touch-up paint can be applied as soon as the spot has been cleaned.

pg. 111 Paint touch-up (cont.)

Deep scratches

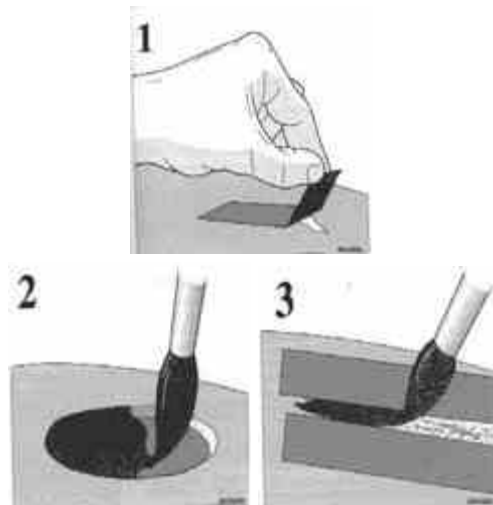

1. Place a strip of masking tape over the damaged surface. Pull the tape off so that any loose flakes of paint adhere to it.

2. Thoroughly mix the primer and apply it with a small brush.

When the primer surface is dry, the paint can be applied using a brush. Mix the paint thoroughly; apply several thin paint coats and let dry after each application.

3 If there is a longer scratch, you may want to protect surrounding paint by masking it off.

pg. 112 Washing

Washing the car

- The car should be washed at regular intervals since dirt, dust, insects and tar spots adhere to the paint and may cause damage.

NOTE: It is particularly important to wash the car frequently in the wintertime to prevent corrosion, when salt has been used on the roads.

- When washing the car, do not expose it to direct sunlight. Use lukewarm water to soften the dirt before you wash with a sponge, and plenty of water, to avoid scratching.
- Bird droppings: Remove from paintwork as soon as possible. Otherwise the finish may be permanently damaged.
- A detergent can be used to facilitate the softening of dirt and oil.
- A water-soluble grease solvent may be used in cases of sticky dirt. However, use a washplace equipped with a drainage separator.
- Dry the car with a clean chamois and remember to clean the drain holes in the doors and rocker panels.
- The power radio antenna (sedans) must be dried after washing.
- Tar spots can be removed with kerosene or tar remover after the car has been washed.
- A stiff-bristle brush and lukewarm soapy water can be used to clean the wiper blades. Frequent cleaning improves visibility considerably.
- Wash off the dirt from the underside (wheel housings fenders, etc.).
- In areas of high industrial fallout, more frequent washing is recommended.

CAUTION: During high pressure washing the spray mouthpiece must never be closer to the vehicle than 13" (30 cm). Do not spray into the locks.

- When washing or steam cleaning the engine, avoid spraying water or steam directly on the electrical components or toward the rear side of the engine.
- After cleaning the engine, the spark plug wells should be inspected for water and blown dry if necessary.

Suitable detergents

Special car washing detergents should be used. A suitable mixture is about 2.5 fl. oz. (8.5 cl) of detergent to 2.6 US gal. (10 liters) of warm water. After washing with a detergent the car should be well rinsed with clean water.

WARNING!

- When the car is driven immediately after being washed, apply the brake several times in order to remove any moisture from the brake linings.
- Engine cleaning agents should not be used when the engine is warm. This constitutes a fire risk.

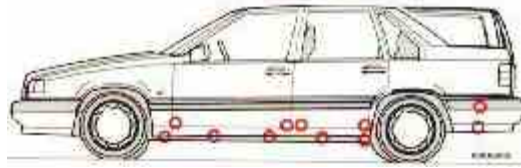

NOTE: When washing the car, remember to remove dirt from the drain holes in the doors and sills. Bumpers: Wash the bumpers with the same cleaning agent used on the rest of the car. Never clean the bumpers with gasoline or paint thinner. Difficult spots can be removed with denatured alcohol. To avoid scratches, do not dry the bumpers with paper.

* Pay special attention to the drain holes near the base of the windshield, under the rear edge of the hood.

pg. 113 Automatic car washing, Polishing and waxing

Automatic washing - simple and quick

An automatic wash is a simple and quick way to clean your car, but it is worth remembering that it may not be as thorough as when you yourself go over the car with sponge and water. Keeping the underbody clean is most important, especially in the winter. Some automatic washers do not have facilities for washing the underbody.

Before driving into an automatic wash, make sure that the side view mirrors, auxiliary lamps, etc., are secure, otherwise there is risk of the machine dislodging them. You should also lower the antenna (sedans).

We do NOT recommend washing your car in an automatic wash during the first six months (because the paint will not have hardened sufficiently).

Polishing and waxing

Normally, polishing is not required during the first year after delivery, however, waxing may be beneficial.

Before applying polish or wax the car must be washed and dried. Tar spots can be removed with kerosene or tar remover. Difficult spots may require a fine rubbing compound.

After polishing use liquid or paste wax.

Several commercially available products contain both polish and wax.

Waxing alone does not substitute for polishing of a dull surface.

A wide range of polymer-based car waxes can be purchased today. The waxes are easy to use and produce a long-lasting, high-gloss finish that protects the bodywork against oxidation, road dirt and fading.

pg. 114 Cleaning the upholstery

Cleaning the upholstery

The fabric can be cleaned with soapy water or a detergent. For more difficult spots caused by oil, ice cream, shoe polish, grease, etc., use a clothing/clothing fabric stain remover.

The plastic in the upholstery can be cleaned with a soft cloth and mild soap solution.

Leather upholstery/suede-like upholstery (alcantera) can be cleaned with a soft cloth and mild soap solution. For more different spots, Volvo offers a leather care kit.

On no account must gasoline, naphtha or similar cleaning agents be used on the plastic or the leather since these can cause damage.

Cleaning the seat belts

Clean only with lukewarm water and mild soap solution.

Cleaning floor mats

The floor mats should be vacuumed or brushed clean regularly, especially during winter when they should be taken out for drying. Spots on textile mats can be removed with a mild detergent.

Bear in mind

- Take extra care when removing stains such as ink or lipstick since the coloring can spread.
 - Use solvents sparingly. Too much solvent can damage the seat padding.
 - Start from the outside of the stain and work toward the center.
-



[Contents](#) | [Top of Page](#)

Service - an investment

An investment which will pay dividends in the form of improved reliability, durability, and resale value.

Page No.	Subject
pg. 116	Label information
pg. 117	Maintenance service, Warranty
pg. 118-119	Maintenance schedule
pg. 120-121	Servicing
pg. 122	Fuel/emissions systems
pg. 123	Lubrication
pg. 124-125	Engine oil
pg. 126	Power steering fluid, Brake/clutch system fluid reservoir
pg. 127	Automatic transmission fluid
pg. 128	Drive belt, Air pump system
pg. 129	Windshield washer nozzle, Washer fluid reservoir
pg. 130	Coolant
pg. 131	Engine compartment
pg. 132	Battery maintenance

1 Vehicle Emission Control Information

Your Volvo is designed to meet all applicable emission standards, as evidenced by the certification label on the underside of the hood. For further information regarding these regulations, please consult your Volvo retailer.

2 Vacuum hose routing

(underside of hood)

3 Loads and Tire Pressures

(on inside of fuel tank cover)

4 Model plate

Vehicle Identification Number (VIN). Codes for color and upholstery etc. The plate is located in the engine compartment, on the inside of left front fender. headlight.

5 Vehicle Identification Number (VIN) *

The VIN plate is located on the top left surface of the dashboard. The VIN is also stamped on the right hand door pillar.

6 Federal Motor Vehicle Safety Standards (FMVSS) specifications (USA) and Ministry of Transport (CMVSS) Standards (Canada)

Your Volvo is designed to meet all applicable safety standards, as evidenced by the certification label on the facing side of the driver's door. For further information regarding these regulations, please consult your Volvo retailer.

7 Child safety latch label

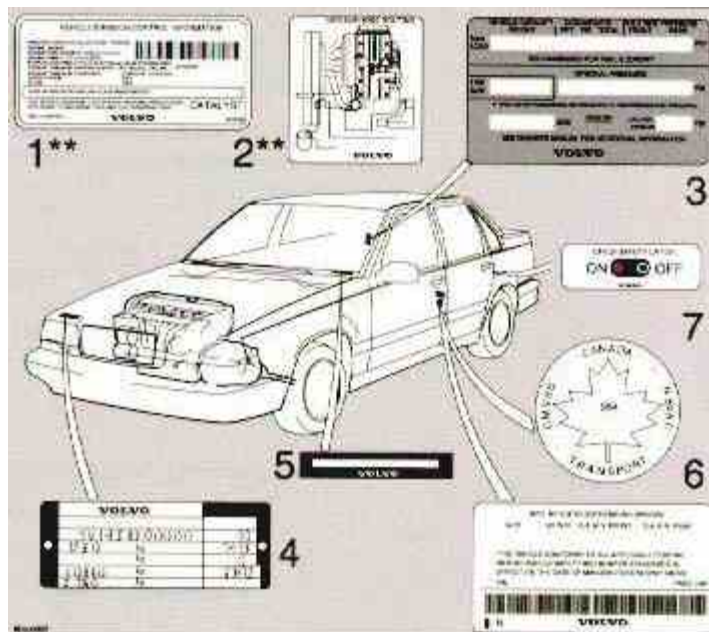

* The Vehicle Identification Number (VIN) should always be quoted in all correspondence concerning your vehicle with the retailer and when ordering parts.

** These decals are located on the underside of the hood.

All specifications are subject to change without notice.

pg. 117 Maintenance service, Warranty

Maintenance service

Volvo advises you to follow the service program which is outlined in the "Maintenance Records Manual". This maintenance program contains inspections and services necessary for the proper function of your car. The maintenance services contain several checks which require special instruments and tools and therefore must be performed by a qualified technician. To keep your Volvo in top condition, specify time tested and proven Genuine Volvo Parts and Accessories.

The Federal Clean Air Act - U.S.

The Clean Air Act requires vehicle manufacturers to furnish written instructions to the ultimate purchaser to assure the proper functioning of those components that control emissions. The maintenance instructions listed in the "Servicing" section of this Manual represent the minimum maintenance required. These services are not covered by the warranty. You will be required to pay for labor and material used. Refer to your Warranty booklet for further details.

Timing belt - all engines³

1) See section "Engine oil" for detailed information

NOTE: The oil should be changed at these intervals or after 750 hours of driving or after 12 months which ever occurs first.

2) For services beyond 90,000 miles (144,000 km), please refer to the Warranty and Service Records.

3) For proper functioning of the vehicle and its emission control system, the timing belt and tensioner must be replaced every 105,000 miles (168,000 km).

pg. 119 Maintenance schedule (cont.)

Maintenance schedule

A = Adjust (Correct if necessary)

I = Inspect (Correct or Replace if necessary)

R = Replace

L = Lubricate

Maintenance Operation (thousand km)	thousand miles	7.5 (12)	15 (24)	22.5 (36)	30 (48)	37.5 (60)	45 (72)	52.5 (84)	60 (96)	67.5 (108)	75 (120)	82.5 (132)	90 (144)
ENGINE SYSTEM MAINTENANCE													
ENGINE													
Fuel line Filter ¹													
PCV Nipple (orifice)/hoses,clean									I				I
Battery (check charge and electrolyte level)		I	I	I	I	I	I	I	I	I	I	I	I
BRAKES													
Inspect brakes, replace components as necessary		I	I	I	I	I	I	I	I	I	I	I	I
Brake Fluid ² -check		I		I		I		I		I		I	
STEERING/SUSPENSION													
Tires ³ , check pressure, wear and condition		I	I	I	I	I	I	I	I	I	I	I	I
Check power steering fluid level					I		I		I		I		I
BODY													
Power antenna (clean)		L		L		L		L		L		L	
Trunk/hood, hinges and latches				L				L					L
Air cabin filter(see page 121)		R		R		R		R		R		R	

1) Replace at 105,000 miles (168,000 km)

2) Brake fluid should be changed at owner request every second year or 30,000 miles (48,000 km). The fluid should be replaced once a year or every 15,000 miles (24,000 km) when driving under extremely hard conditions (mountain driving, etc.)

3) Rotate tires at owner request.

The following items should be checked weekly by the driver (it takes only a few minutes).

Engine oil level

Horns

Brake fluid level

Windshield wipers

Radiator coolant level

Tire pressure (all five tires)

Operation of all lights

Level of windshield washer fluid

The following should also be carried out at regular intervals:

Washing (check all drain holes)

Polishing

Cleaning



[Contents](#) | [Top of Page](#)

Specifications

This chapter contains facts and figures pertaining to the technical specifications of your car.

Page No. Subject

- [pg. 134](#) Oil/Fluids specifications
- [pg. 135](#) Engine specifications
- [pg. 136](#) Cooling/fuel/distributor ignition systems
- [pg. 136](#) Front/rear suspensions
- [pg. 137](#) Transmission, Capacities, Vehicle loading
- [pg. 138](#) Electrical system/bulbs
- [pg. 139](#) Weights
- [pg. 140](#) Dimensions, Service manuals, Road assistance

Oil quality

Meeting API specification SG, SG/CD, SH or Energy Conserving (EC) II

For best fuel economy and engine protection, consult with your authorized Volvo retailer for recommended oils. Oil with a different quality rating may not provide adequate engine protection. Synthetic oils complying with oil quality requirements are recommended for : driving in areas of sustained temperature extremes (hot or cold), when towing a trailer over long distances or for prolonged driving in mountainous areas.

Extra oil additives must not be used unless advised by an authorized Volvo retailer.

NOTE: SAE 15 W-40 oil should only be used in extreme operating conditions such as trailer towing in sustained ambient temperatures over 104° F (40° C). However, SAE 10W-30 synthetic oil would be a better alternative in such conditions.

SAE 15W-30 should not be used under normal operating conditions.

Viscosity (stable ambient temperatures):

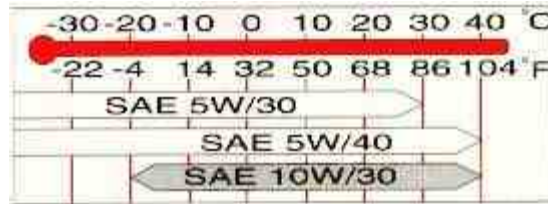

Engine oil	Quality: Meeting API specification SG or SH	Capacity (incl. filter) : 6.1 US qts. (5.8 liters)*
Automatic transmission fluid	Quality: ATF Dexron IIE/ III and Mercon	Capacity: 8 US qts. (7.6 liters)
Manual transmission fluid	Quality: Volvo synthetic gearbox oil 1161423	Capacity: 2.2 US qts (2.1 liters)
Power steering fluid	Quality: ATF	Capacity: 0.95 US qts. (0.9 liters) Capacity: 0.64 US qts. (0.6 liters)

Brake fluid Quality: DOT 4+

* Turbo-charged models: Add 0.95 qts. (0.9 liters) if the oil cooler has been drained

All specifications are subject to change without notice.

pg. 135 Engine

Engine

Liquid-cooled gasoline, 5-cylinder, in-line engine. Aluminum alloy cylinder block with cast-iron cylinder liners cast directly into block. Aluminum alloy cylinder head with double overhead camshafts and separate intake and outlet channels.

Engine lubrication is provided by an eccentric pump driven from the crankshaft. Full-flow type oil filter. Exhaust emission control accomplished by multiport fuel injection, heated oxygen sensor(s) and three-way catalytic converter

Designation: Volvo B 5254 S

Output 168 hp at 6200 rpm (125 kw 103 rps)
 Max torque 162.3 ft. lbs. at 4700 rpm (220 Nm/55 rps)
 Number of cylinders 5
 Bore 3.27" (83 mm)
 Stroke 3.54" (90 mm)
 Displacement 2.4 liters
 Compression ratio 10.5:1
 Number of valves 20
 Valve clearance Self-adjusting

Designation: Volvo B 5254 T

Output 190 hp at 5100 rpm (142 kw/85 rps)
Max torque 199 ft. lbs. at 1800-4998 rpm (270 Nm/30-83.3 rps)
Number of cylinders 5
Bore 3.27" (83 mm)
Stroke 3.54" (90 mm)
Displacement 2.4 liters
Compression ratio 9.0:1
Number of valves 20
Valve clearance Self-adjusting

Designation: Volvo B 5234 T3

Output 236 hp at 5100 rpm (176 kw/85 rps)
Max torque 243 ft. lbs. at 2700-5100 rpm (330 Nm/45-85 rps)
Number of cylinders 5
Bore 3.19" (81 mm)
Stroke 3.54" (90 mm)
Displacement 2.3 liters
Compression ratio 8.5:1
Number of valves 20
Valve clearance Self-adjusting

Designation: Volvo B 5234 T8

Output 247 hp at 5700 rpm (184 kw/95 rps)
Max torque 229 ft. lbs. at 2400-5400 rpm (310 Nm/40-90 rps)
Number of cylinders 5
Bore 3.19" (81 mm)
Stroke 3.54" (90 mm)
Displacement 2.3 liters
Compression ratio 8.5:1
Number of valves 20
Valve clearance Self-adjusting

All specifications are subject to change without notice.

Type: Positive pressure, closed system
Thermostat begins to open at 186°F (90°C)
Turbo-charged models 180° F (87° C)
Coolant: Volvo original coolant/anti-freeze
Capacity: 7.6 US qts. (7.2 liters)
Turbo-charged models - 7.4 US qts. (7.0 liters)

Fuel system

The engine is equipped with a multiport fuel injection system

Distributor ignition system

Firing order 1-2-4-5-3
Distributor ignition setting Not adjustable
Spark plugs Bosch FR 7 DC or Champion RC9YC
Spark plug gap 0.028" (0.7 mm)
Turbo-charged models: Champion RC8PYP (or equivalent)
Spark plug gap 0.03" (0.75 mm)
Tightening torque 18.4 ft. lbs. +/- 3.7 ft. lbs. (25 Nm +/- 5 Nm)

WARNING!

The distributor ignition system operates at very high voltages. Special safety precautions must be followed to prevent injury. Always turn the ignition off when:

- Replacing distributor ignition components e.g. plugs, coil, etc.
- Do not touch any part of the distributor ignition system while the engine is running. This may result in unintended movements and body injury.

Replacing spark plugs

The spark plugs should be changed every 30,000 miles (48,000 km). However, city driving or fast highway driving may necessitate changing after 15,000 miles (24,000 km) of driving. When installing new plugs, be sure to fit the right type and use correct torque, see "Specifications". When changing the plugs, check that the suppressor connectors are in good condition. Cracked or damaged connectors should be replaced. When changing the spark plugs, clean the terminals and the rubber seals.

Front suspension

Spring strut suspension with integrated shock absorbers and control arm linked to the support frame. Power-assisted rack and pinion steering. Safety type steering column.

The alignment specifications apply to an unladen car but include fuel, coolant, and spare wheel.

Toe-in measured on the wheel rims: 2.4 mm +/- 0.7 mm

Toe-in measured on tire sides: 2.9 +/- 0.9 mm

Rear Suspension

Delta-link individual rear-wheel suspension with longitudinal support arms, double link arms and track rods.

Toe-in measured on the tire sides: 4° +/- 10°

All specifications are subject to change without notice.



[Contents](#) | [Top of Page](#)

Audio systems

This chapter describes the audio system in your car.

[pg. 142](#) SC-813

[pg. 155](#) SC-816

[pg. 171](#) SC-900/901

[pg. 194](#) General information

pg. 142 Audio system SC-813 (certain models)

The following pages describe the use of your SC-813 Cassette radio and CD remote control



1. On/off (push)

2.

- Volume (turn)
 - Pause/Mute (push)
 - Balance (pull)
3. Active Sound Control
4. CD changer selector
- 5.
- Tape mode selector
 - Tape direction selector PROG
6. Bass control
7. Treble control
8. Fader control
- 9.
- Preset buttons

- CD-Disc No. selector
- 10. PROG - Reversing the tape
- 11. Dolby B NR button
- 12. Cassette eject
- 13. Not in use
- 14. Scan
- 15. Auto seek memory
- 16.
 - Seek tuning up/down
 - TP -Next/Previous song
 - CD -Next UP/Previous DOWN track
- 17.
 - Manual tuning
 - TP -fast forward/Rewind
 - CD -Music search UP/DOWN
- 18. RND button
- 19. Cassette slot
- 20. Display
- 21. Waveband selector (AM)
- 22. Waveband selectors (FM)
- 23. Anti-theft LED

TP = Applicable only in Tape Mode

CD = Applicable only when in CD mode and connected to a CD changer.

pg. 143 Anti-theft code



Anti-theft code

The radio features anti-theft circuitry. If the set is removed from the vehicle or if the battery power is disconnected, a special code must be entered to enable operation of the set. Refer to the radio code card supplied with your vehicle or ask your retailer for the correct code . When the car is parked with the ignition key removed, the anti-theft LED will flash

To enter the code

After installation or when the set has been disconnected from power, the set displays "COdE" when it is switched on. Enter the 4-digit code using the preset buttons. If the correct code is entered, "on" is displayed and the set is ready to use.

If you enter an incorrect code you must enter the correct code again from the beginning.

Incorrect code

If an incorrect code has been entered "rPt" is displayed. Enter the correct code.

After three unsuccessful coding attempts the set will lock and remain locked for two hours.

"OFF" is displayed.

During this waiting period:

- the battery must be connected
- the ignition key must be turned to position I
- the unit must be turned on

Make sure the headlights are turned off to help prevent battery drain (please [refer to page 26](#) for information on turning the headlights off). Enter the code again once this time has elapsed.

pg. 144 Radio SC-813

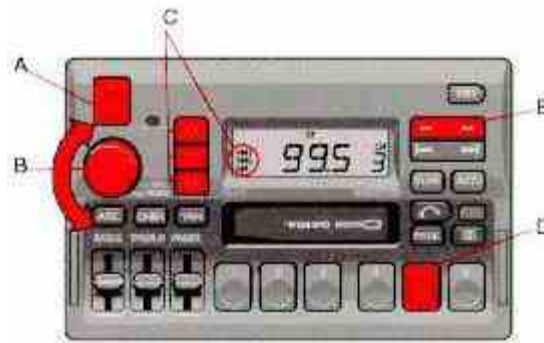

A - On/off switch

Push the button to switch on the radio. Press the button slightly longer to turn the radio off.

B - Volume control

Turn the button clockwise to increase the volume. The volume control is electronic and has no end stop.

C - Waveband selector

The desired waveband is set by pressing one of the waveband selector buttons. The frequency and waveband is shown on the display.

NOTE: There are two FM wavebands and one AM waveband. This makes it possible to store 2 x 6 FM stations and 6 AM stations in memory.

D - Setting frequency selection

The radio can be used in most parts of the world by changing the frequency selection intervals as follows: Depress and hold preset button 5 and turn the radio ON. "USA" will flash on the display. Each time button 5 is pressed, the frequency selection will change from "USA" to "AUS", etc. When the correct country name is displayed, wait 5 seconds and the radio will be ready for use.

E - Manual tuning

Press the left side button to tune to lower frequencies and the right side to tune to higher frequencies. The tuned frequency is displayed.

ST will be displayed to indicate stereo FM reception.

pg. 145 Radio SC-813 (cont.)



A - Seek tuning up/down

Press the left side tune button to tune to lower frequencies and the right side to tune to higher frequencies. The radio seeks the next audible station and stops there. If you wish to continue the seek tuning, press the tuning button again.

B - Preset programming

1. Tune to the desired frequency.
2. Depress and hold a preset button. The audio will cut out. Keep the button depressed until the audio comes on again (approx. 2 seconds).
3. The frequency is now stored on this preset button.

C - Preset buttons

To select a pre-programmed radio frequency, depress the preset button. The set frequency will be displayed.

pg. 146 Radio SC-813 (cont.)



A - Automatic programming (Auto)

Please note that this function will not interfere with pre-stored stations on buttons 1-6. This function automatically seeks and stores up to 8 strong AM or FM stations. This is especially useful when travelling in areas where radio stations are unfamiliar.

1. Depress and hold the "AUTO" button for at least 1 second. A number of strong stations (max. 8) on the chosen waveband are now automatically stored in the memory. If there are no audible stations, "- - -" is displayed.
 2. Press the "AUTO" button (for less than 1 second) to obtain another autostored station.
- A new station will be selected each time the button is pressed momentarily.

B - Bass control

Adjust the bass by sliding the control up or down (up to increase, down to decrease). A "detent" indicates "equalized" bass.

C - Treble control

Adjust the treble by sliding the control up or down (up to increase, down to decrease). A "detent" indicates "equalized" treble.

pg. 147 Radio SC-813 (cont.)



A - Fader control

Adjust front/rear speaker balance by sliding the control up or down.
(**Up** to direct more sound to the front speakers, **down** to direct more sound to the rear speakers.
The "detent" indicates "equalized" front/rear balance position.

B - Pause function

Press the "volume" knob to temporarily mute the sound. "PAUSE" is displayed.

C - Balance control

Pull out the "volume" knob and adjust the left/right balance by turning the knob counter-clockwise or clockwise.

D - Scan

Press this button to listen to each station for five seconds. Press it again to stop scanning. "Scan" will be displayed during scanning.

E - Active sound control (ASC)

The ASC function automatically adjusts the volume level of the audio system according to driving speed.

To deactivate ASC depress the "ASC" button.

To activate ASC, depress the "ASC" button until "ASC" is displayed.



[Contents](#) | [Top of Page](#)

A

ABS	19, 21, 80
Accessories - installing	105
Adjustable steering wheel	34
Adjusting headlights	96
Air conditioning	36, 37, 39
Air mix	35
Air pump system	128
Air vents	35
Airbag (SIPS)	8
Airbag (SRS)	4
Alarm	45
All Wheel Drive (AWD)	73, 120
..changing wheels	93
..snow chains	87
..towing	77
..wheel dimension caution	86
Ambient temperature sensor	27
Anti-lock Brake System (ABS)	19, 21, 70
antifreeze	82, 130
Ashtrays	33
Audio systems	
General information	194
SC-813	142
SC-816	155
SC-900/901	171
Automatic car washing	113
Automatic daytime running lights	26
Automatic transmission	70, 71, 72, 73, 137
Driving mode selector	72
Automatic transmission fluid	127, 134
Auxiliary seat	11
Automatic daytime running lights	33

B

Battery	82, 138
Battery drain - avoiding	60
Battery maintenance	132
Booster cushion	10, 13
Brake failure warning light	19, 20
Brake fluid	126, 134
Brake fluid warning light	20
Brake system	80, 81
Break-in period	66
Bulb failure warning	21
Bulb failure warning light	19
Bulbs	138
Bumper cover	60

C

Capacities	137
Cargo eyelets	62
Cargo new - side	61
Cargo space lighting (wagon)	56
Catalytic converter	79
Center head restraints	3
Central locking button	43
Chains - winter driving	87
Changing a wheel	92
Child auxiliary seat (wagon)	11
Child booster cushion	10, 13
Child Restraint Anchorages	9
Child safety	13
Child safety locks - rear doors	48
Clock	18
Clock - resetting	27
Clutch fluid	126
Clutch interlock	70

Concealed storage bin (wagon)	60
Coolant - checking/changing	130
Coolant level sensor	21
Coolant level warning light	19
Cooling system	74, 136
Courtesy lights - exterior	22
Cross bars (AWD XC)	75
Cruise control	31

D

Daytime running lights	26
Demister - rear window	25
Dimensions	140
Diversity antenna	197
Doors and locks	43
Drive belt	128
Driving economy	68

E

EBD (Electroinc Brake-force Distribution)	81
ECC - Electronic Climate Control	38, 39
Electrical system	74, 138
Electrically operated driver's seat	50
Electrically operated front seats	49, 108
Electrically operated sun roof	52
Electrically-operated windows	40, 108
Electroinc Brake Distribution (EBD)	81
Electroinc Brake-force Distribution (EBD)	81
Emergency towing	76
Emergency warning flashers	25
Emissions systems	122
Engine	135
Engine compartment	131
Engine oil	125, 134
Engine oil - checking/changing	124
Engine oil pressure	19
Exterior courtesy lights	22

F

Fog light - rear	19, 24
Fog lights - front	24
Folding front seat (sedans/wagons)	63
Folding rear seat (sedan)	57
Folding rear seat (wagon)	58, 59
Four wheel drive	73, 120
..changing wheels	93
..snow chains	87
..towing	77
Front courtesy lights	51
Front seats	49
Front seats - heated	32
Front suspension	136
Fuel gauge	18
Fuel level	19
Fuel requirements	66
Fuel system	122, 136
Fuel tank cover - opening	67
Fuses	102, 103, 104

G

Gas tank cover - opening	67
Generator	19, 138
Generator warning light	21

H

Hand brake	32
Handling	75
Hazard warning flashers	25

Headlight adjustment	96
Headlight wiper blades - replacing	107
Headlights	22
Heated front seats	32
Heated side-view mirrors	25
Heating	36, 37, 39
Heating and air conditioning	35
High beams	19
Hood	53

I

Ignition switch	23
Immobilizer(start inhibitor)	42
Instrument illumination	24
Instruments	16, 17
Integrated booster cushion	10

J

Jack (sedan)	55
Jack (wagon)	56
Jump starting	78

K

Keyless entry system	44
Keylock	69
Keys	42
Kick-down	71

L

Label information	116
Lock button - tailgate	47
Lock button - central	43
Locks	43
Long distance trips	83
Long load storage (sedan)	63
Lubrication	123
Luggage net - wagon	61
Lumbar support	49

M

Maintenance schedule	118
Maintenance service	117
Malfunction indicator lamp	19, 20
Manual transmission	70, 137
Manual transmission fluid	134
Memory function - front seats	49
Mirrors - rear/side view	50

O

Occupant safety	14
Octane rating	67
Odometer	18
Oil pressure warning light	20
On-call	140

P

Paint touch-up	110
Parking brake	19, 32
Parking brake reminder light	20
Parking lights	22
Polishing	113
Power seats	49, 108
Power steering fluid	126, 134
Power windows	40, 108

R

Radio	
SC-813	142
SC-816	155
SC-900/901	171
Radio Data System - RDS	176
Rails (roof)	75
Reading lights	51
Rear fog light	19, 24
Rear suspension	136
Rear window demister	25
Rear/side-view mirrors	50
Refueling	67
Remote control (central locking system)	44
Remote keyless entry system	44
Replacing bulbs	96-101
Replacing fuses	102
Reporting Safety Defects	14
Road Assistance	140
Roadholding	75
Roof rails/racks	75

S

Safety defects (reporting)	14
Safety locks	48
Seat belt maintenance	14
Seat belts	2, 3, 12
Seat belts - cleaning	114
Seats	49
Securing cargo	62
Service reminder indicator	19, 21
Servicing	120, 121
Shift lock	69, 71
Shiftlock release (override)	108
Side cargo net	61
Side Impact Protection System (SIPS)	8
Side-view mirrors - heated	25
SIPS	8
Snow chains	87
Snow tires	87
Spare tire	94
Spare tire (sedan)	55
Spare tire (wagon)	56
Spark plugs	136
Specifications	133
Spool-out (seat belt)	12
SRS	5, 6, 7
SRS diagnostic system	20
SRS warning light	5, 19, 20
Stability and Traction Control (STC)	19, 21, 25, 81
Start Inhibitor (Immobilizer)	42
Starting the engine	69
Steering wheel adjustment	34
Steering wheel lock	23
Storage compartments	54
Studded tires	87
Sun roof	25, 52, 108

T

Tachometer	18
Tailgate (opening/locking)	47
..lock button	47
Tailgate wiper/washer	26
Temperature gauge	18
Temporary spare tire	94
Three-way catalytic converter	79
Tire pressure	88
Tires	86
Tires - changing	92
Towing	76, 77
Towing a trailer	84
Traction Control System(TRACS)	19, 21, 25, 81
Trailer towing	84
Trip computer	25, 28, 29, 30
Trip odometer	18
Trunk - opening/locking	47
Trunk light	55
Turn signals	19, 22

U

Uniform tire quality grading	89
Upholstery - cleaning	114

V

Vanity mirrors	51
Vehicle Identification Number (VIN)	116
Vehicle loading	137
Volvo On Call	140

W

Warning flashers	25
Warning lights	20, 21
Warranty	117
Washer fluid level	19
Washer fluid reservoir	129
Washing	112
Waxing	113
Weights	139
Wheel changing	92, 93
Wheels and tires	86
Windows - electrically-operated	40
Windshield washer nozzles	129
Windshield wiper blades - replacing	106
Winter driving	82

Inside Back Cover

WARNING!

Detergents and solvents

Do not use gasoline containing lead or benzene as a detergent or solvent. Both lead and benzene are toxic and may be hazardous to your health.

Installation of optional equipment/use of mobile telephones

Incorrectly installed optional equipment, alarm systems or the use of mobile telephones which

are not connected to a suitable antenna can cause faults in the car's electronic control systems. Your car is equipped with an accessory connector located under the dashboard on the driver's side. Please consult your Volvo retailer if you have any questions before connecting accessory or optional equipment to the vehicle's electrical systems.

Carbon monoxide

Carbon monoxide is a poisonous, colorless and odorless gas which is present in all exhaust gases. If you ever smell exhaust fumes from inside the vehicle, make sure the passenger compartment is ventilated and immediately return the vehicle to your retailer for correction. Never sit in a parked or stopped car for any extended amount of time, nor have it unattended while the engine is running. Never operate the engine in confined, unventilated areas.

Back Cover

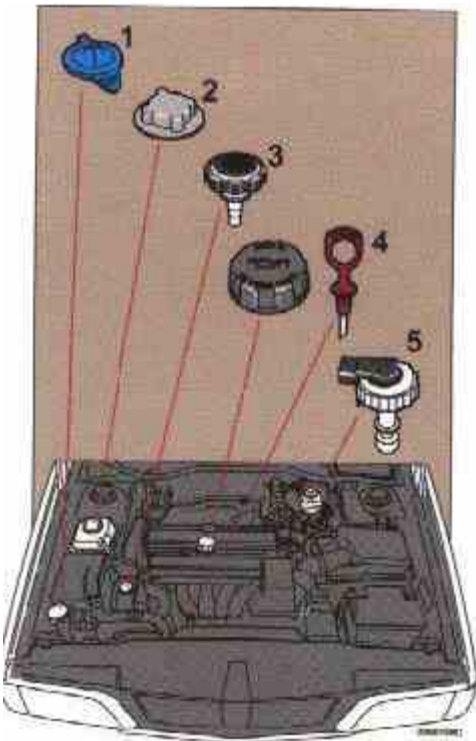

The following should be checked regularly: *

1 Washer fluid reservoir should be filled with water and solvent (wintertime: windshield washer anti-freeze). [See page 129](#).

2 Coolant level should be between the expansion tank marks. Mixture: 50% anti-freeze and 50% water. [See page 130](#).

3 Power steering - When cold, the level must not be above the COLD mark and when hot it must not be above the HOT mark. Top up if the level drops to the ADD mark with ATF fluid. [See page 126](#).

4 Engine oil level should be between the dipstick marks. The distance between the marks represents approx. 1.6 US qts (1.5 liter). [See page 124](#).

5 Brake fluid - check, without removing the cap, that the level is above the MIN mark. Use brake fluid DOT 4+. [See page 126](#).

* Engine oil should be checked each time the car is refuelled.

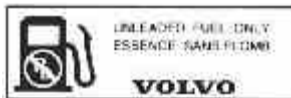

Octane rating, see [page 67](#)

Tire pressure, see label located on inside of the fuel filler flap.



Bulbs	Power	Socket	US Bulb No.
1	55 W	-	H7
2	5 W	BA 15s	67
3	21 W	BA 15s	1156
4	21/4 W	BAZ 15d	-
5	21 W	BAU 15s	-
6	26/7 W	W2.5x15q	3357NA
7	55 W	-	H1

See [pages 95-101](#) for more detailed information

VOLVO

Volvo Car Corporation

Göteborg, Sweden

TP 4174/1 (Canada & USA) 25.000.04.97 Printed in Sweden, Graphic Systems AB, Göteborg 199



[Contents](#) | [Top of Page](#)