

# TABLE OF CONTENTS

1	<b>Before driving</b>	Adjusting and operating features such as door locks, mirrors, and steering column.
2	<b>When driving</b>	Driving, stopping and safe-driving information.
3	<b>Interior and exterior features</b>	Air conditioning and multimedia systems, as well as other interior features for a comfortable driving experience.
4	<b>Maintenance and care</b>	Cleaning and protecting your vehicle, performing do-it-yourself maintenance, and maintenance information.
5	<b>When trouble arises</b>	What to do if the vehicle needs to be towed, gets a flat tire, or is involved in an accident.
6	<b>Vehicle specifications</b>	Detailed vehicle information.
7	<b>For owners</b>	Reporting safety defects for U.S. owners, seat belt and SRS airbag instructions for Canadian owners and camper information.
	<b>Index</b>	Alphabetical listing of information contained in this manual.

**1 Before driving**

**1-1. Key information**  
 Keys ..... 30

**1-2. Opening, closing and locking the doors**  
 Wireless remote control ..... 32  
 Side doors ..... 35  
 Access doors (Access Cab models only)..... 39  
 Tailgate ..... 40

**1-3. Adjustable components (seats, mirrors, steering wheel)**  
 Front seats ..... 45  
 Rear seats ..... 49  
 Head restraints ..... 53  
 Seat belts ..... 57  
 Steering wheel ..... 63  
 Anti-glare inside rear view mirror..... 64  
 Outside rear view mirrors ..... 68

**1-4. Opening and closing the windows**  
 Power windows ..... 71  
 Back window (vehicles with sliding type) ..... 73

**1-5. Refueling**  
 Opening the fuel tank cap..... 74

**1-6. Theft deterrent system**  
 Engine immobilizer system... 77

**1-7. Safety information**  
 Correct driving posture ..... 80  
 SRS airbags ..... 82  
 Front passenger occupant classification system..... 95  
 Child restraint systems ..... 100  
 Installing child restraints ..... 104

**2 When driving**

**2-1. Driving procedures**  
 Driving the vehicle ..... 120  
 Engine (ignition) switch..... 131  
 Automatic transmission ..... 134  
 Manual transmission..... 138  
 Turn signal lever ..... 141  
 Parking brake ..... 142  
 Horn..... 144

**2-2. Gauges and meters**  
 Gauges and meters ..... 145  
 Indicators and warning lights ..... 148

**2-3. Operating the lights and wipers**

Headlight switch..... 152  
 Fog light switch ..... 155  
 Windshield wipers and washer ..... 156

**2-4. Using other driving systems**

Cruise control..... 162  
 Rear view monitor system... 166  
 Four-wheel drive system..... 177  
 Active traction control system ..... 181  
 AUTO LSD system..... 183  
 Rear differential lock system ..... 185  
 Downhill Assist Control system ..... 188  
 Clutch start cancel switch ... 190  
 Driving assist systems ..... 191

**2-5. Driving information**

Off-road precautions (4WD models and PreRunner).... 197  
 Cargo and luggage ..... 202  
 Vehicle load limits ..... 207  
 Winter driving tips ..... 209  
 Trailer towing ..... 213  
 Dinghy towing ..... 233

**3 Interior and exterior features**

**3-1. Using the air conditioning system and defogger**

Air conditioning system ..... 236

**3-2. Using the multimedia system**

Multimedia system types .... 243  
 Entune Audio..... 245  
 USB port/AUX port ..... 249  
 Setup menu ..... 250  
 Basic audio operations ..... 256  
 Using the radio ..... 261  
 Playing an audio CD and MP3/WMA/AAC discs ..... 263  
 Listening to an iPod..... 270  
 Listening to a USB memory device ..... 276  
 Using the AUX port..... 281  
 Connecting Bluetooth® ..... 282  
 Listening to Bluetooth® audio ..... 304  
 Using a Bluetooth® phone ..... 305  
 Operating the sub woofer (on some Access Cab models) ..... 334  
 Detachable pole antenna ... 335

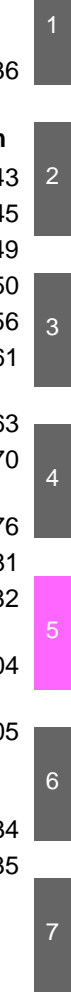

**3-3. Using the interior lights**  
 Interior lights list ..... 338  
 • Interior light ..... 339  
 • Personal lights ..... 339

**3-4. Using the storage features**  
 List of storage features..... 340  
 • Glove box ..... 341  
 • Front console box ..... 341  
 • Cup holders..... 342  
 • Bottle holders ..... 344  
 • Auxiliary boxes ..... 345  
 • Overhead console ..... 348

**3-5. Other interior features**  
 Sun visors ..... 349  
 Vanity mirrors ..... 350  
 Clock ..... 351  
 Power outlets (12 VDC) ..... 352  
 Power outlet (120 VAC) ..... 353  
 Seat heaters ..... 359  
 Seatback table ..... 361  
 Floor mat ..... 362  
 Luggage compartment  
 features ..... 364  
 Garage door opener ..... 373  
 Compass (vehicles with  
 auto anti-glare inside  
 rear view mirror) ..... 381

**4 Maintenance and care**

**4-1. Maintenance and care**  
 Cleaning and protecting  
 the vehicle exterior ..... 388  
 Cleaning and protecting  
 the vehicle interior ..... 391

**4-2. Maintenance**  
 Maintenance  
 requirements ..... 394  
 General maintenance ..... 396  
 Emission inspection and  
 maintenance (I/M)  
 programs..... 399

**4-3. Do-it-yourself maintenance**  
 Do-it-yourself service  
 precautions ..... 400  
 Hood ..... 404  
 Engine compartment ..... 406  
 Tires..... 422  
 Tire inflation pressure ..... 431  
 Wheels..... 436  
 Air conditioning filter ..... 439  
 Wireless remote control  
 battery ..... 442  
 Checking and replacing  
 fuses ..... 444  
 Light bulbs ..... 454

**5 When trouble arises**

**5-1. Essential information**

Emergency flashers ..... 466  
 If your vehicle needs to  
 be towed ..... 467  
 If you think something is  
 wrong ..... 474  
 Fuel pump shut off  
 system ..... 475

**5-2. Steps to take in an emergency**

If a warning light turns on  
 or a warning buzzer  
 sounds... ..... 476  
 If you have a flat tire..... 486  
 If the engine will not start .... 501  
 If the shift lever cannot  
 be shifted from P (vehicles  
 with an automatic  
 transmission) ..... 502  
 If you lose your keys ..... 503  
 If the vehicle battery is  
 discharged ..... 504  
 If your vehicle overheats ..... 508  
 If the vehicle becomes  
 stuck ..... 511  
 If your vehicle has to  
 be stopped in  
 an emergency ..... 513

**6 Vehicle specifications**

**6-1. Specifications**

Maintenance data  
 (fuel, oil level, etc.) ..... 516  
 Fuel information..... 537  
 Tire information ..... 540

**6-2. Customization**

Customizable features..... 551  
 Items to initialize..... 552

**7 For owners**

Reporting safety defects  
 for U.S. owners ..... 554  
 Seat belt instructions  
 for Canadian owners  
 (in French)..... 555  
 SRS airbag instructions  
 for Canadian owners  
 (in French)..... 557  
 Camper information..... 567

**Index**

**Abbreviation list..... 574**  
**Alphabetical index ..... 576**  
**What to do if... ..... 585**

► Access Cab models

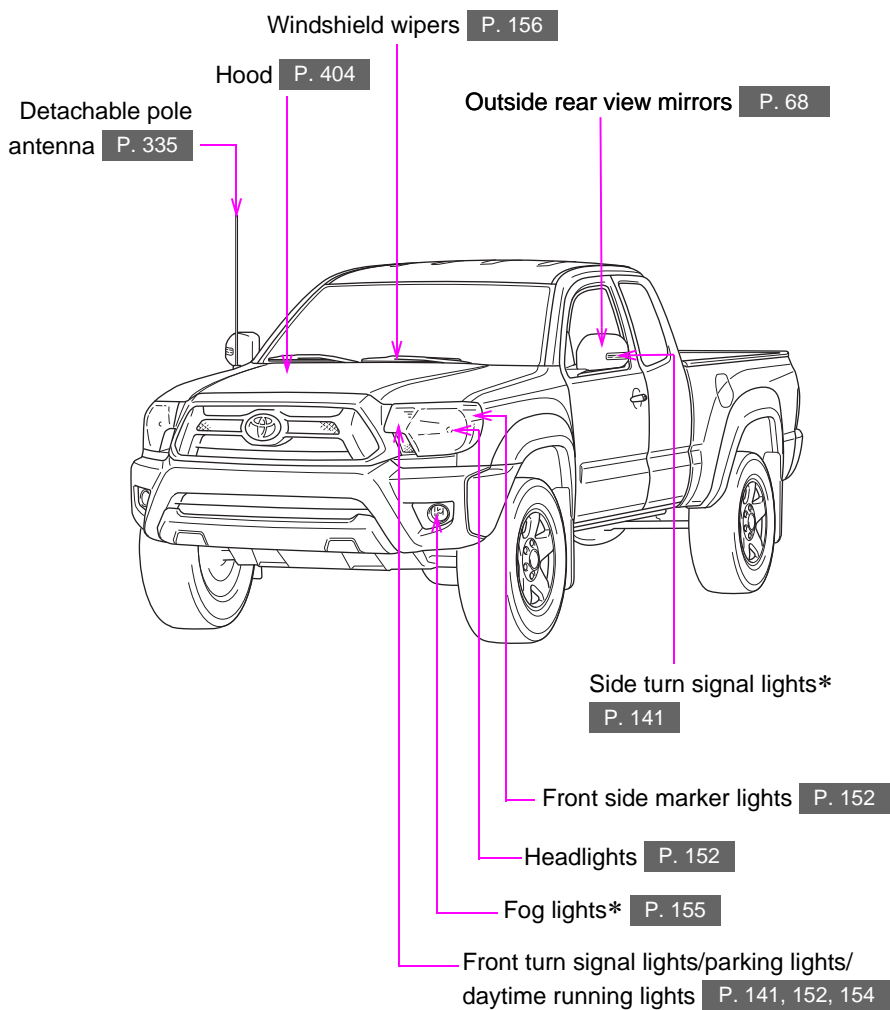

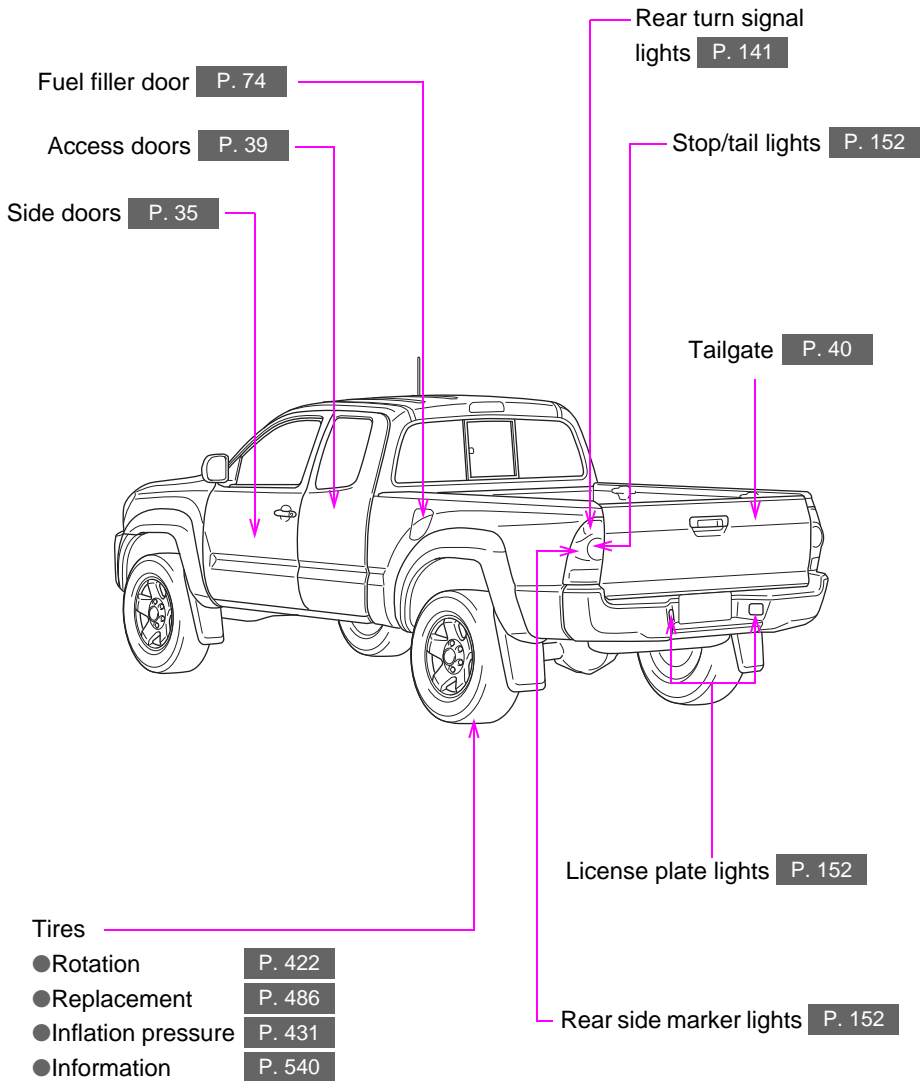

\*: If equipped

► Double Cab models

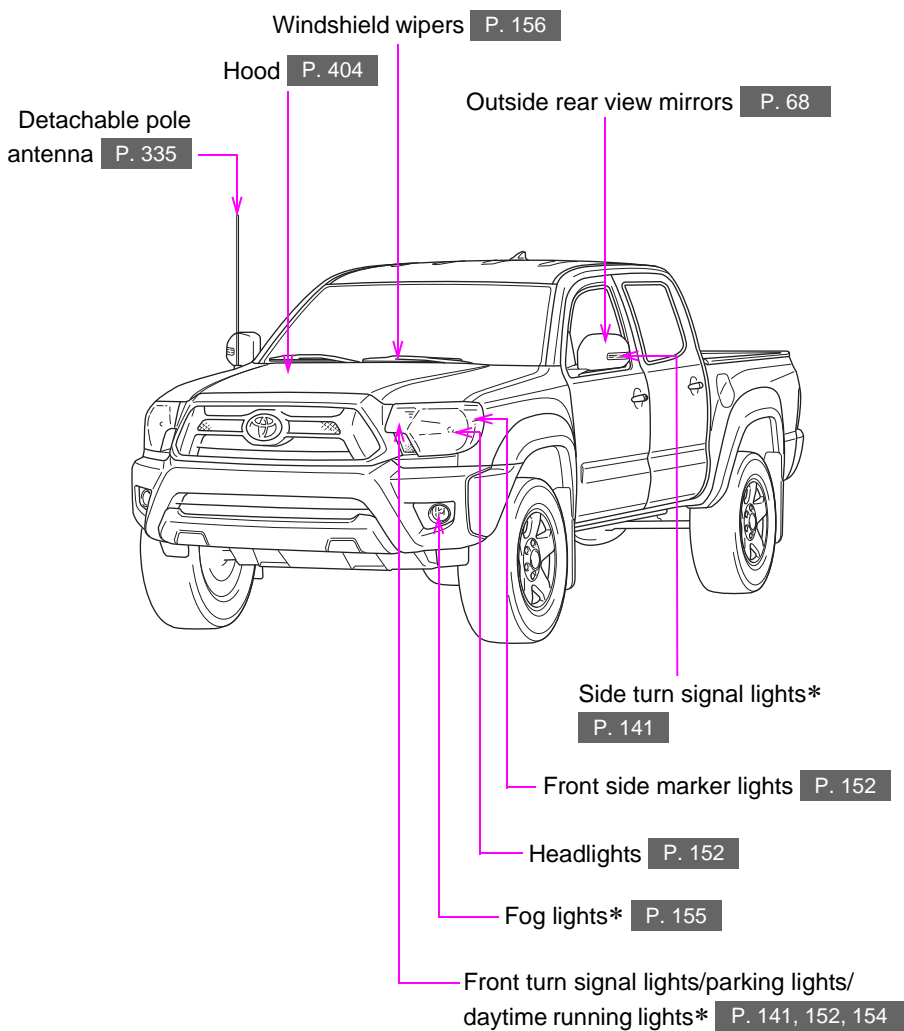



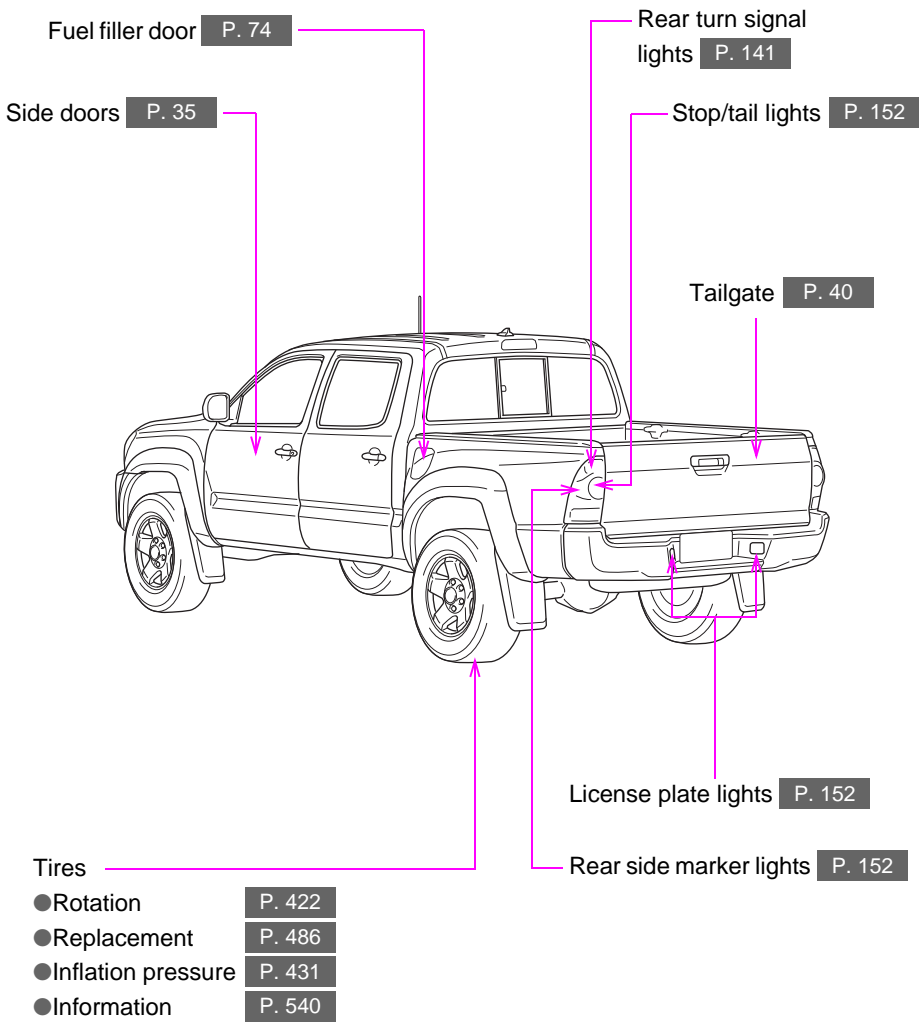

\*: If equipped

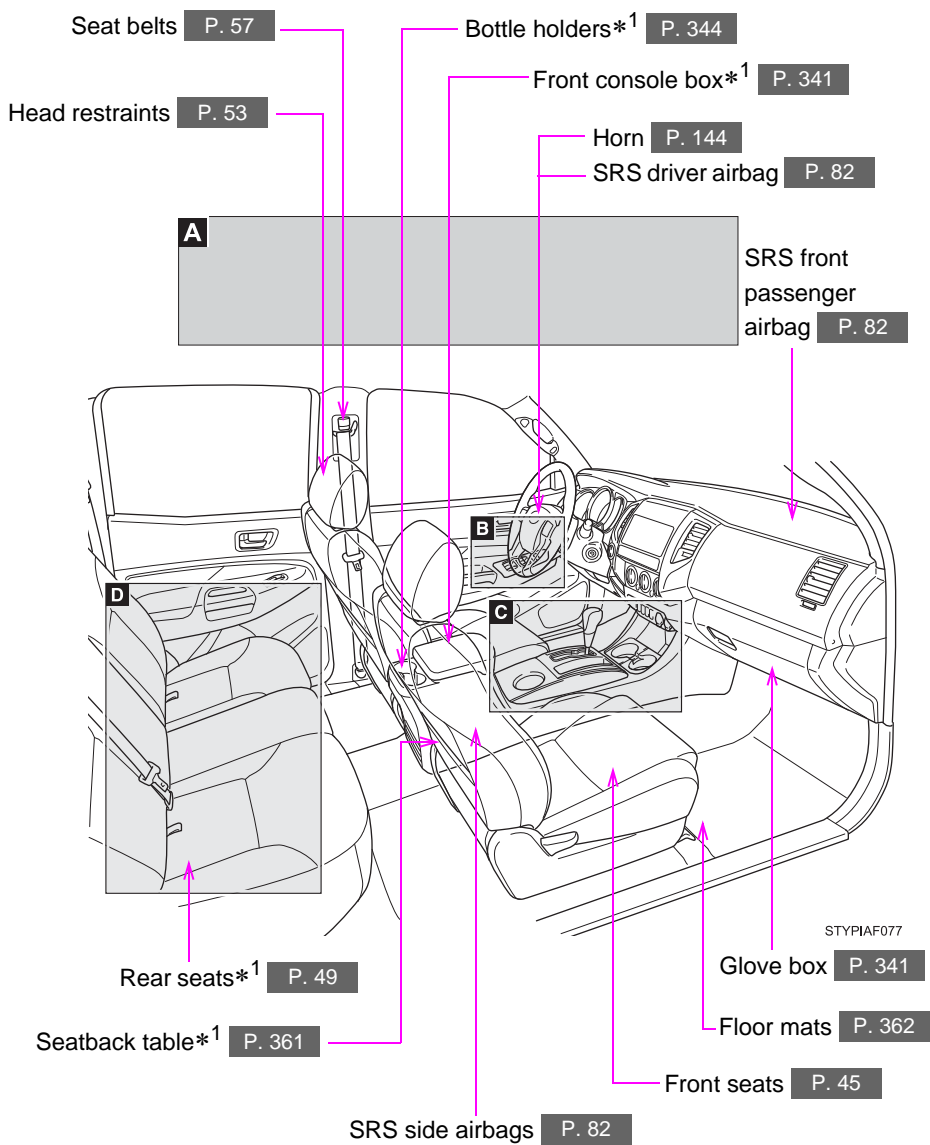

**A**

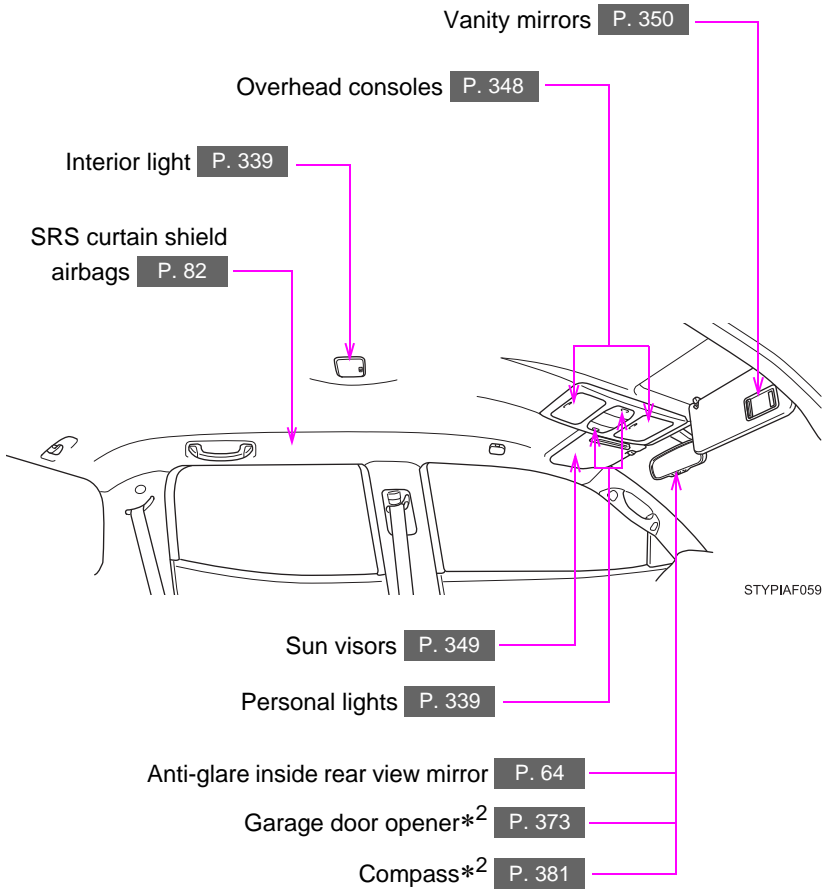

\*<sup>1</sup>: If equipped

\*<sup>2</sup>: Vehicles with auto anti-glare inside rear view mirror

**B**

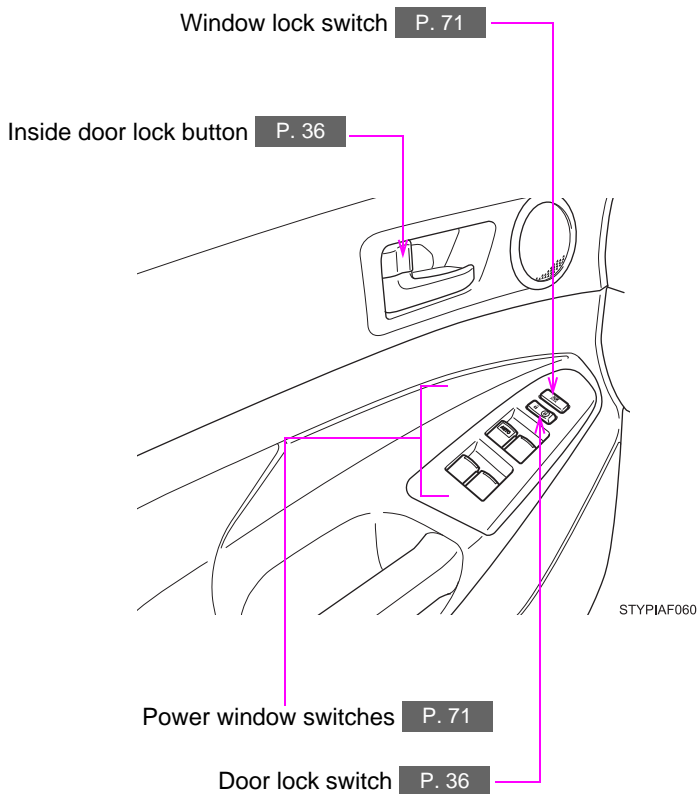

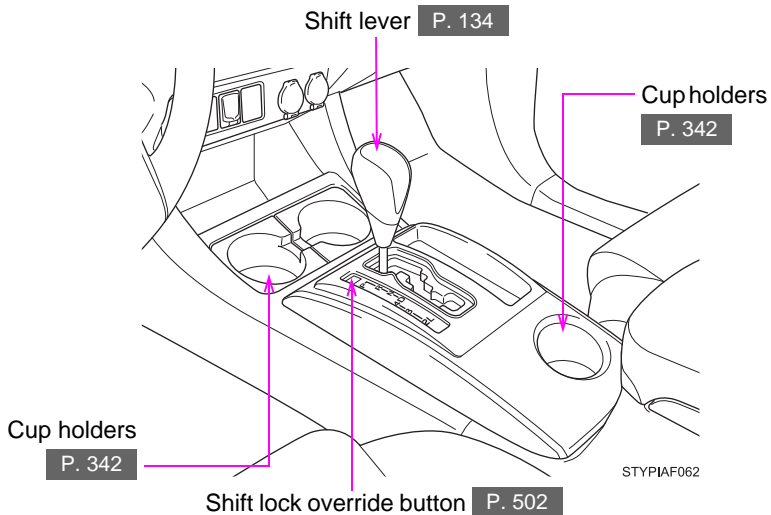
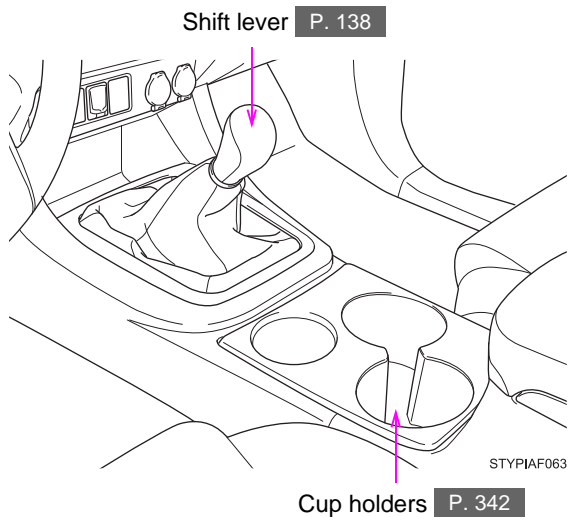
**C****► Vehicles with an automatic transmission****► Vehicles with a manual transmission**

**D**

► Access Cab models

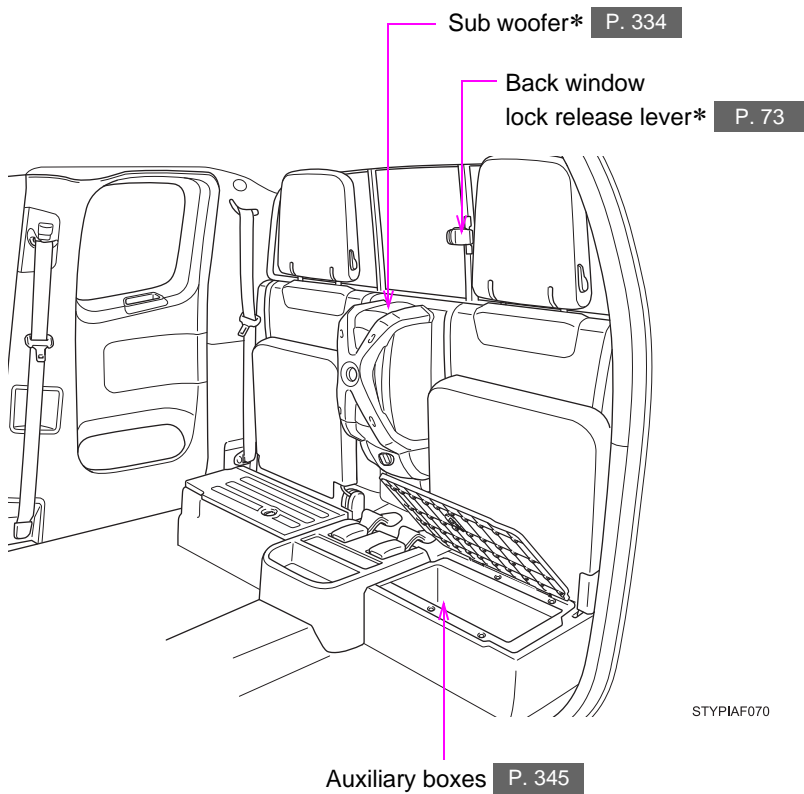

STYPIAF070

\*: If equipped

# D

## ► Double Cab models

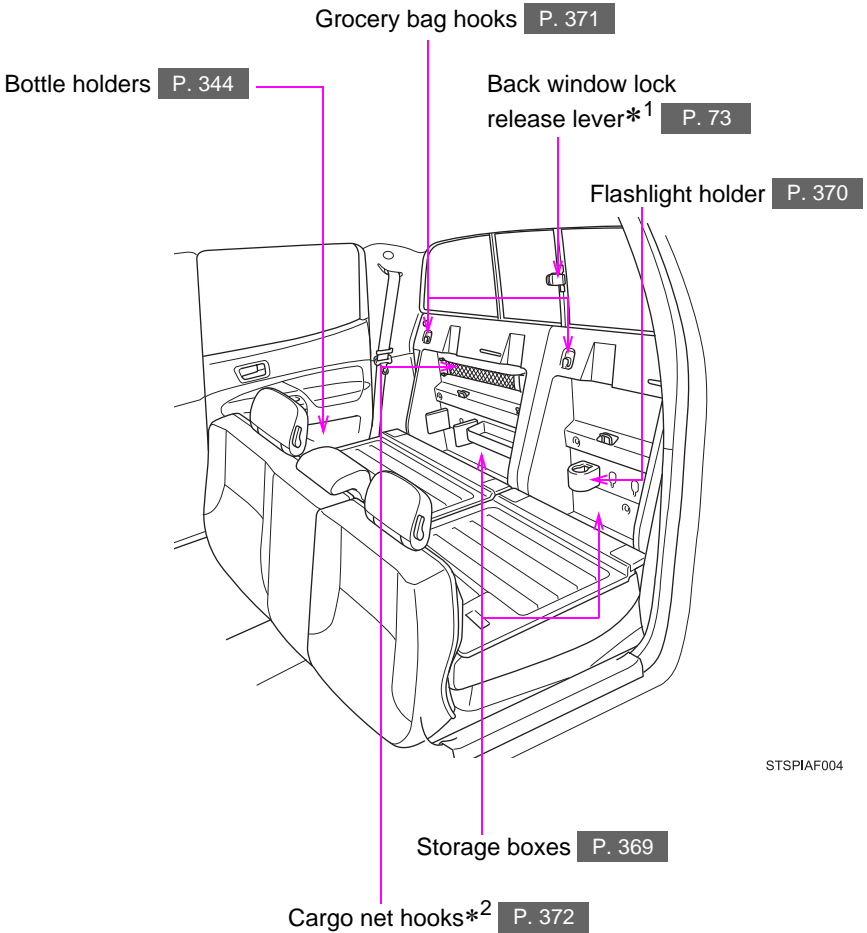

STSPIAF004

\*<sup>1</sup>: If equipped

\*<sup>2</sup>: Vehicles with sub woofer

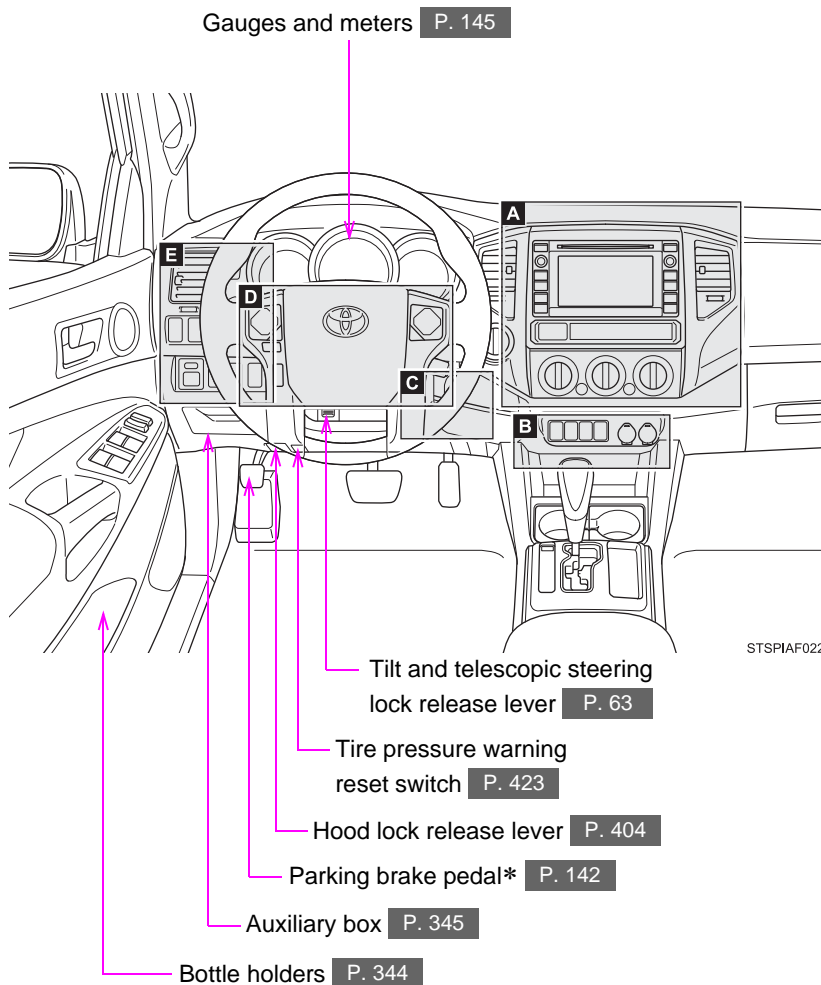

\*: Vehicles with an automatic transmission



**A**

Multimedia system\*<sup>2</sup> P. 243

Rear view monitor system\*<sup>2</sup> P. 166

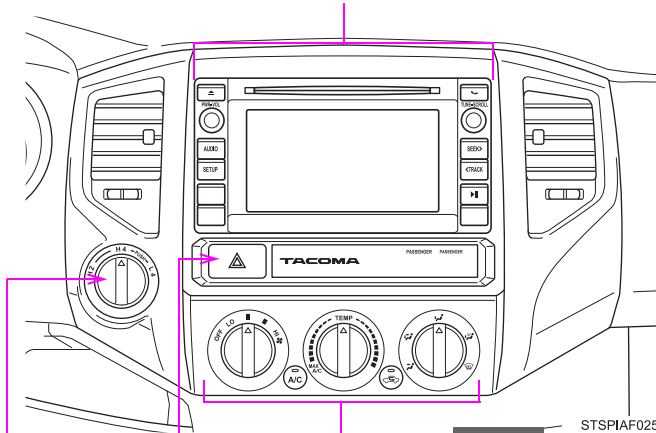

STSPIAF025

Front-wheel drive control switch\*<sup>1</sup> P. 177

Air conditioning system P. 236

Emergency flasher switch P. 466

**B**

A-TRAC switch\*<sup>2</sup> P. 181

AUX port/USB port P. 249

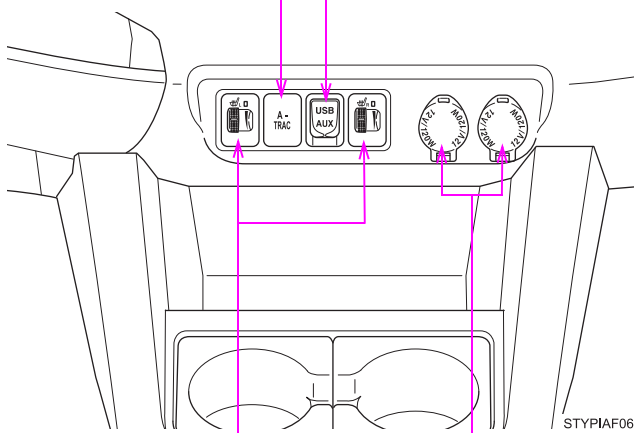

STYPIAF066

Seat heater switches\*<sup>2</sup> P. 359

Power outlets P. 352

\*<sup>1</sup>: 4WD models only

\*<sup>2</sup>: If equipped

**C**

Windshield wipers and washer switch **P. 156**

Engine (ignition) switch **P. 131**

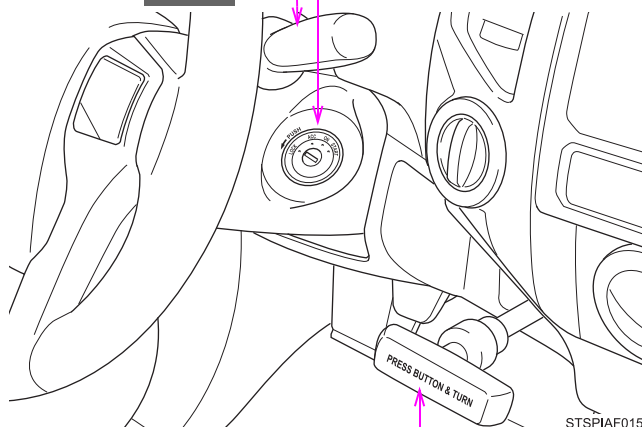

STSPIAF015

Parking brake lever\*<sup>3</sup> **P. 142**

**D**

Audio remote control switches\*

Telephone switches\*

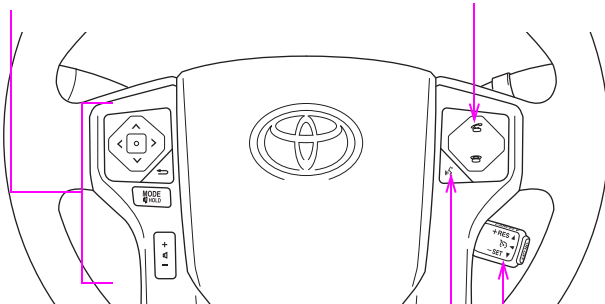

STSPIAF016

Talk switch\*

Cruise control switch\*<sup>1</sup> **P. 162**

**E**

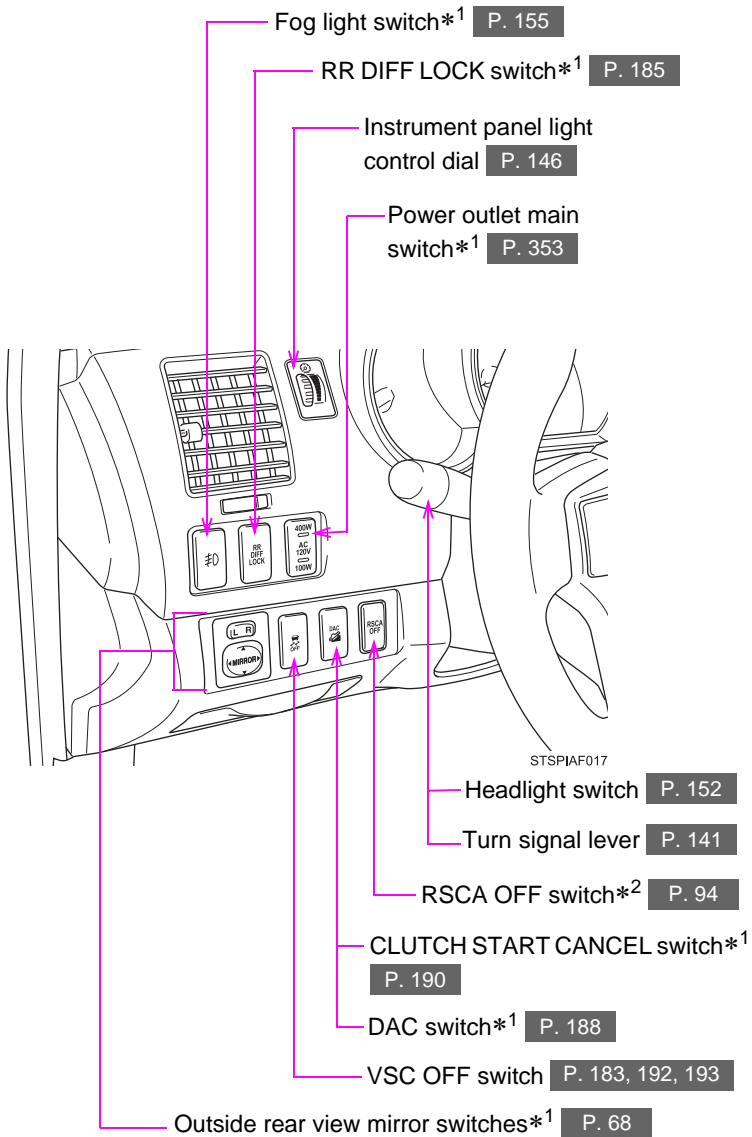

\*<sup>1</sup>: If equipped

\*<sup>2</sup>: 4WD models only

\*<sup>3</sup>: Vehicles with a manual transmission

\*: Refer to "NAVIGATION SYSTEM OWNER'S MANUAL".

Back window\* P. 73

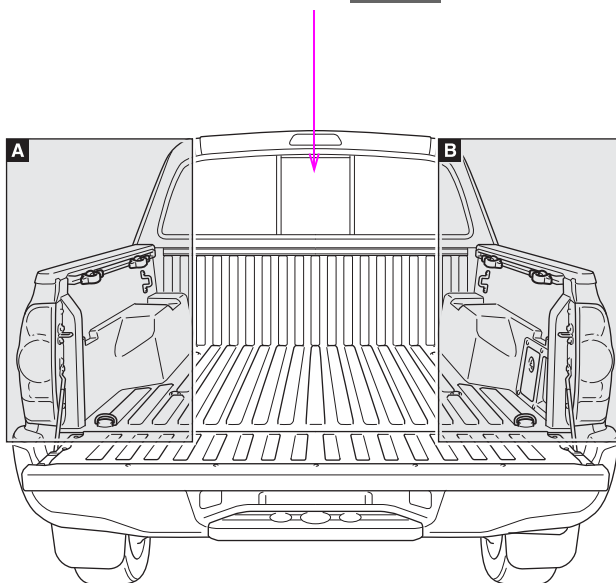

STSPIAF014

\*: If equipped

**A**

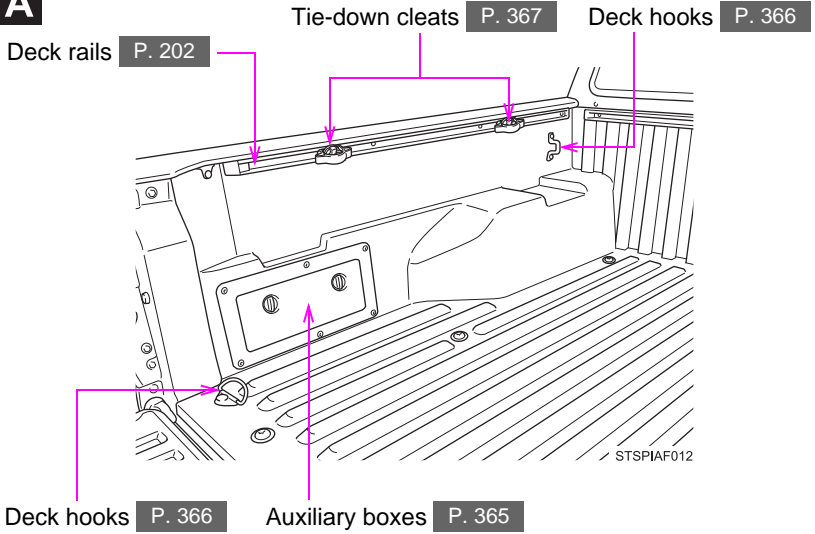

**B**

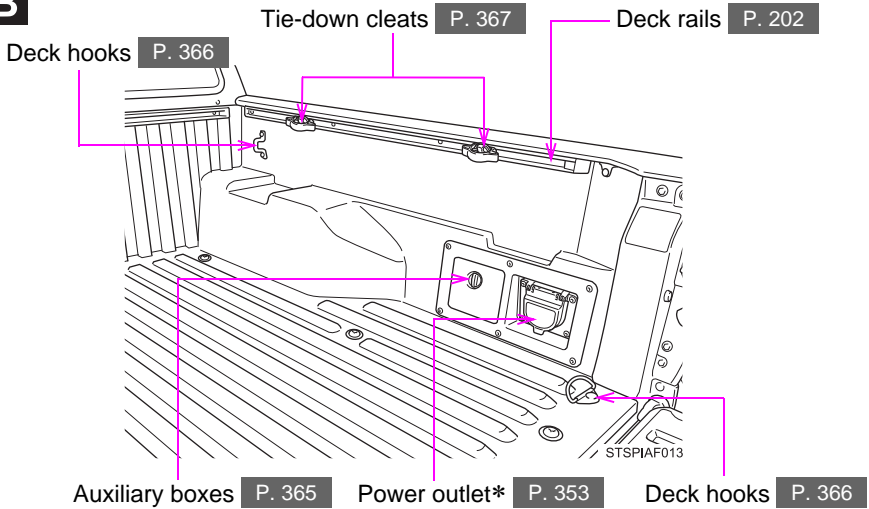

\*: If equipped

## For your information

### **Main Owners Manual**

Please note that this manual applies to all models explains and all equipment, including options. Therefore, you may find some explanations for equipment not installed on your vehicle.

All specifications provided in this manual are current at the time of printing. However, because of the Toyota policy of continual product improvement, we reserve the right to make changes at any time without notice.

Depending on specifications, the vehicle shown in the illustrations may differ from your vehicle in terms of equipment.

### **Noise from under vehicle after turning off the engine**

Approximately five hours after the engine is turned off, you may hear sound coming from under the vehicle for several minutes. This is the sound of a fuel evaporation leakage check and, it does not indicate a malfunction.

### **Accessories, spare parts and modification of your Toyota**

A wide variety of non-genuine spare parts and accessories for Toyota vehicles are currently available in the market. You should know that Toyota does not warrant these products and is not responsible for their performance, repair, or replacement, or for any damage they may cause to, or adverse effect they may have on, your Toyota vehicle.

This vehicle should not be modified with non-genuine Toyota products. Modification with non-genuine Toyota products could affect its performance, safety or durability, and may even violate governmental regulations. In addition, damage or performance problems resulting from the modification may not be covered under warranty.

## **Installation of a mobile two-way radio system**

The installation of a mobile two-way radio system in your vehicle could affect electronic systems such as:

- Multiport fuel injection system/sequential multiport fuel injection system
- Cruise control system
- Anti-lock brake system
- SRS airbag system
- Seat belt pretensioner system

Be sure to check with your Toyota dealer for precautionary measures or special instructions regarding installation of a mobile two-way radio system.

## **Vehicle data recordings**

Your Toyota is equipped with several sophisticated computers that will record certain data, such as:

- Engine speed
- Accelerator status
- Brake status
- Vehicle speed
- Shift position (except manual transmission)

The recorded data varies according to the vehicle grade level and options with which it is equipped. Furthermore, these computers do not record conversations, sounds or pictures.

### ● Data usage

Toyota may use the data recorded in these computers to diagnose malfunctions, conduct research and development, and improve quality.

Toyota will not disclose the recorded data to a third party except:

- With the consent of the vehicle owner or with the consent of the lessee if the vehicle is leased
- In response to an official request by the police, a court of law or a government agency
- For use by Toyota in a lawsuit
- For research purposes where the data is not tied to a specific vehicle or vehicle owner

## Event data recorder

This vehicle is equipped with an event data recorder (EDR). The main purpose of an EDR is to record, in certain crash or near crash-like situations, such as an airbag deployment or hitting a road obstacle, data that will assist in understanding how a vehicle's systems performed. The EDR is designed to record data related to vehicle dynamics and safety systems for a short period of time, typically 30 seconds or less.

The EDR in this vehicle is designed to record such data as:

- How various systems in your vehicle were operating;
- Whether or not the driver and passenger safety belts were buckled/fastened;
- How far (if at all) the driver was depressing the accelerator and/or brake pedal; and,
- How fast the vehicle was traveling.

These data can help provide a better understanding of the circumstances in which crashes and injuries occur.

NOTE: EDR data are recorded by your vehicle only if a non-trivial crash situation occurs; no data are recorded by the EDR under normal driving conditions and no personal data (e.g., name, gender, age, and crash location) are recorded. However, other parties, such as law enforcement, could combine the EDR data with the type of personally identifying data routinely acquired during a crash investigation.

To read data recorded by an EDR, special equipment is required, and access to the vehicle or the EDR is needed. In addition to the vehicle manufacturer, other parties, such as law enforcement, that have the special equipment, can read the information if they have access to the vehicle or the EDR.



● Disclosure of the EDR data

Toyota will not disclose the data recorded in an EDR to a third party except when:

- An agreement from the vehicle's owner (or the lessee for a leased vehicle) is obtained
- In response to an official request by the police, a court of law or a government agency
- For use by Toyota in a lawsuit

However, if necessary, Toyota may:

- Use the data for research on vehicle safety performance
- Disclose the data to a third party for research purposes without disclosing information about the specific vehicle or vehicle owner

### **Scrapping of your Toyota**

The SRS airbag and seat belt pretensioner devices in your Toyota contain explosive chemicals. If the vehicle is scrapped with the airbags and seat belt pretensioners left as they are, this may cause an accident such as fire. Be sure to have the systems of the SRS airbag and seat belt pretensioner removed and disposed of by a qualified service shop or by your Toyota dealer before you scrap your vehicle.

### **Perchlorate Material**

Special handling may apply,  
See [www.dtsc.ca.gov/hazardouswaste/perchlorate](http://www.dtsc.ca.gov/hazardouswaste/perchlorate).

Your vehicle has components that may contain perchlorate. These components may include airbag, seat belt pretensioners, and wireless remote control batteries.



## CAUTION

### ■ General precautions while driving

**Driving under the influence:** Never drive your vehicle when under the influence of alcohol or drugs that have impaired your ability to operate your vehicle. Alcohol and certain drugs delay reaction time, impair judgment and reduce coordination, which could lead to an accident that could result in death or serious injury.

**Defensive driving:** Always drive defensively. Anticipate mistakes that other drivers or pedestrians might make and be ready to avoid accidents.

**Driver distraction:** Always give your full attention to driving. Anything that distracts the driver, such as adjusting controls, talking on a cellular phone or reading can result in a collision with resulting death or serious injury to you, your occupants or others.

### ■ General precaution regarding children's safety

Never leave children unattended in the vehicle, and never allow children to have or use the key.

Children may be able to start the vehicle or shift the vehicle into neutral. There is also a danger that children may injure themselves by playing with the windows, or other features of the vehicle. In addition, heat build-up or extremely cold temperatures inside the vehicle can be fatal to children.

## Symbols used throughout this manual

### Cautions & Notices

#### CAUTION

This is a warning against anything which may cause injury to people if the warning is ignored. You are informed about what you must or must not do in order to reduce the risk of injury to yourself and others.

#### NOTICE

This is a warning against anything which may cause damage to the vehicle or its equipment if the warning is ignored. You are informed about what you must or must not do in order to avoid or reduce the risk of damage to your Toyota and its equipment.



### Symbols used in illustrations

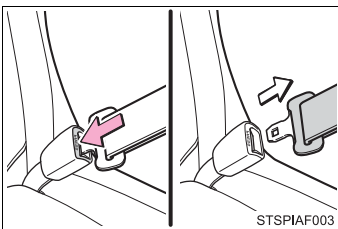

The symbol of a circle with a slash through it means “Do not”, “Do not do this”, or “Do not let this happen”.



#### Arrows indicating operations

-  Indicates the action (pushing, turning, etc.) used to operate switches and other devices.
-  Indicates the outcome of an operation (e.g. a lid opens).



## Before driving

# 1

- 1-1. Key information**
  - Keys ..... 30
- 1-2. Opening, closing and locking the doors**
  - Wireless remote control ..... 32
  - Side doors..... 35
  - Access doors (Access Cab models only) ..... 39
  - Tailgate ..... 40
- 1-3. Adjustable components (seats, mirrors, steering wheel)**
  - Front seats ..... 45
  - Rear seats..... 49
  - Head restraints..... 53
  - Seat belts ..... 57
  - Steering wheel ..... 63
  - Anti-glare inside rear view mirror ..... 64
  - Outside rear view mirrors... 68
- 1-4. Opening and closing the windows**
  - Power windows ..... 71
  - Back window (vehicles with sliding type) ..... 73
- 1-5. Refueling**
  - Opening the fuel tank cap ..... 74
- 1-6. Theft deterrent system**
  - Engine immobilizer system ..... 77
- 1-7. Safety information**
  - Correct driving posture..... 80
  - SRS airbags..... 82
  - Front passenger occupant classification system ..... 95
  - Child restraint systems..... 100
  - Installing child restraints... 104

# Keys

**The following keys are provided with the vehicle.**

▶ Vehicles without engine immobilizer system

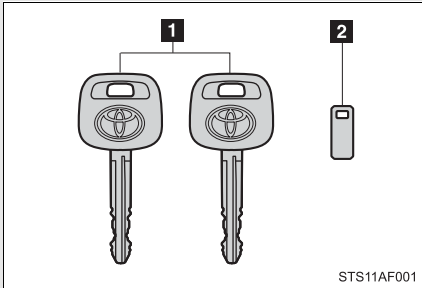

- 1** Master keys
- 2** Key number plate

▶ Vehicles with engine immobilizer system

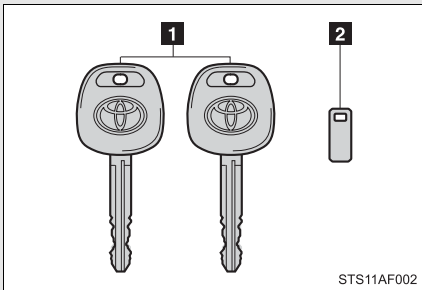

- 1** Master keys
- 2** Key number plate

■ **Key number plate**

Keep the plate in a safe place such as your wallet, not in the vehicle. In the event that a key is lost, a new key can be made by your Toyota dealer using the key number plate. (→P. 503)

**NOTICE****■ To prevent key damage (vehicles with engine immobilizer system)**

- Do not subject the keys to strong shocks, expose them to high temperatures by placing them in direct sunlight, or get them wet.
- Do not expose the keys to electromagnetic materials or attach any material that blocks electromagnetic waves to the key surface.

## 1-2. Opening, closing and locking the doors

# Wireless remote control\*

The wireless remote control can be used to lock and unlock the vehicle from outside the vehicle.

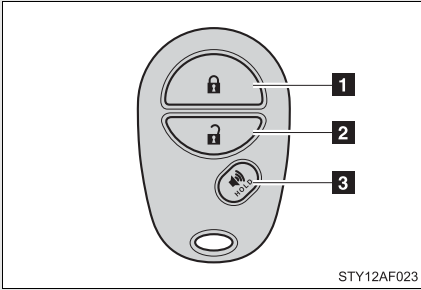

### 1 Locks all doors

Check that the door is securely locked.

### 2 Unlocks all doors

Pressing the button unlocks the driver's door. Pressing the button again within 3 seconds unlocks the other doors.

### 3 Sounds alarm

(push and hold)

## ■ Operation signals

A buzzer sounds and the emergency flashers flash to indicate that the doors have been locked/unlocked. (Locked: Once; Unlocked: Twice)

## ■ Panic mode



When  is pushed for longer than about 1 second, an alarm will sound for about 60 seconds and the vehicle lights will flash to deter any person from trying to break into or damage your vehicle.

To stop the alarm, push any button on the wireless remote control.

## ■ Door lock buzzer

If a door is not fully closed, a buzzer sounds for 10 seconds if an attempt to lock the door is made. Fully close the door to stop the buzzer, and lock the vehicle once more.

\*: If equipped



### ■ Wireless remote control depletion

The standard battery life is 1 to 2 years. (The battery becomes depleted even if the key is not used.) If the wireless remote control function does not operate, the battery may be depleted. Replace the battery when necessary. (→P. 442)

### ■ If the wireless remote control does not operate

Locking and unlocking the doors: Use the key. (→P. 35)

### ■ Security feature

If a door is not opened within approximately 30 seconds after the vehicle is unlocked, the security feature automatically locks the vehicle again.

### ■ Conditions affecting operation

The wireless remote control function may not operate normally in the following situations.

- Near a TV tower, radio station, electric power plant, airport or other facility that generates strong radio waves
- When carrying a portable radio, cellular phone or other wireless communication device
- When multiple wireless keys are in the vicinity
- When the wireless key has come into contact with, or is covered by a metallic object
- When a wireless key (that emits radio waves) is being used nearby
- When the wireless key has been left near an electrical appliance such as a personal computer

### ■ When riding in an aircraft

When bringing a wireless remote control onto an aircraft, make sure you do not press any buttons on the wireless remote control while inside the aircraft cabin. If you are carrying a wireless remote control in your bag etc, ensure that the buttons are not likely to be pressed accidentally. Pressing a button may cause the wireless remote control to emit radio waves that could interfere with the operation of the aircraft.

### ■ Customization that can be configured at Toyota dealer

Settings (e.g. wireless remote control system) can be changed. (Customizable features →P. 551)

■ **Certification for wireless remote control**

**MODEL/FCC IDs:**

**Transmitter: GQ43VT20T**

**Receiver: GQ4-34R**

**IC (Canada) IDs:**

**Transmitter: 1470A-1T**

**Receiver: 1470A-6R**

**MADE IN USA**

This device complies with Part 15 of the FCC Rules and with RSS-210 of Industry Canada. Operation is subject to the following two conditions:

(1) This device may not cause harmful interference, and (2) This device must accept any interference received, including interference that may cause undesired operation.

**WARNING:**

Changes or modifications not expressly approved by the party responsible for compliance could void the user's authority to operate the equipment.

## 1-2. Opening, closing and locking the doors

### Side doors

The vehicle can be locked/unlocked using the wireless remote control, key or door lock switch.

#### ■ Wireless remote control (if equipped)

→P. 32

#### ■ Key

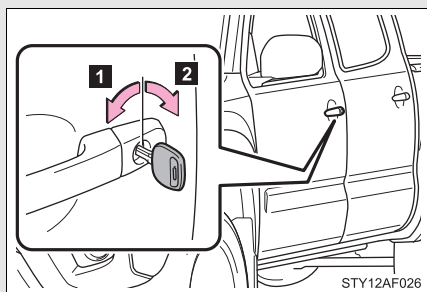

**1** Locks all doors

**2** Unlocks all doors

Turning the key a single time in the driver's door unlocks the driver's door, and turning the key again unlocks the other doors.

■ Door lock switch (if equipped)

▶ Driver's door lock switch

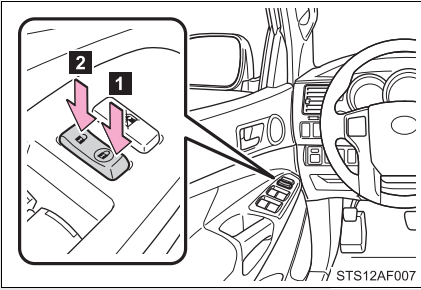

- 1 Locks all doors
- 2 Unlocks all doors

▶ Passenger's door lock switch

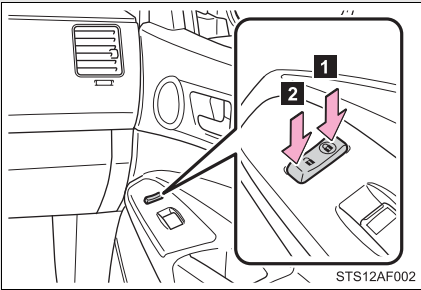

- 1 Locks all doors
- 2 Unlocks all doors

■ Inside door lock button

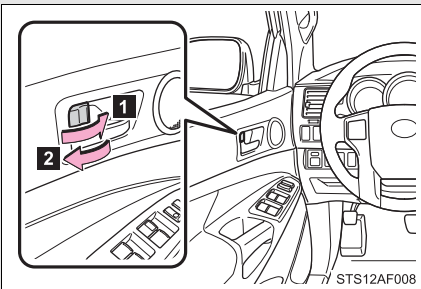

- 1 Locks the door
- 2 Unlocks the door

Pulling the inside handle can open the front door even if the inside door lock button is in the lock position.

### Locking the front doors from the outside without a key

**STEP 1** Move the inside door lock button to the lock position.

**STEP 2** Close the door.

► Vehicles with power door lock system

The door cannot be locked if a front door is open and the key is in the engine switch.

### Rear door child-protector lock (Double Cab models only)

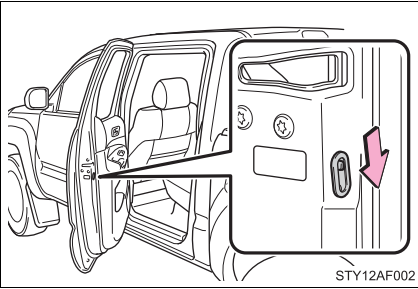

The door cannot be opened from inside the vehicle when the locks are set.

These locks can be set to prevent children from opening the rear doors. Push down on each rear door switch to lock both rear doors.

### ■ Key reminder buzzer

A buzzer sounds if the driver's door is opened, while the engine switch is in the ACC or LOCK position to remind you to remove the key.

 CAUTION

■ **To prevent an accident**

Observe the following precautions while driving the vehicle.

Failing to do so may result in a door opening and an occupant falling out, resulting in death or serious injury.

- Always use a seat belt.
- Always lock all doors.
- Ensure that all doors are properly closed.
- Do not pull the inside handle of the doors while driving.  
The doors may be opened and the passengers are thrown out of the vehicle and it may result in serious injury or death.  
Be especially careful for the front doors, as the doors may be opened even if the inside lock buttons are in locked position.
- Set the rear door child protector locks when children are seated in the rear seat.

## Access doors (Access Cab models only)

The access door (rear door) can be opened using the inside handle.

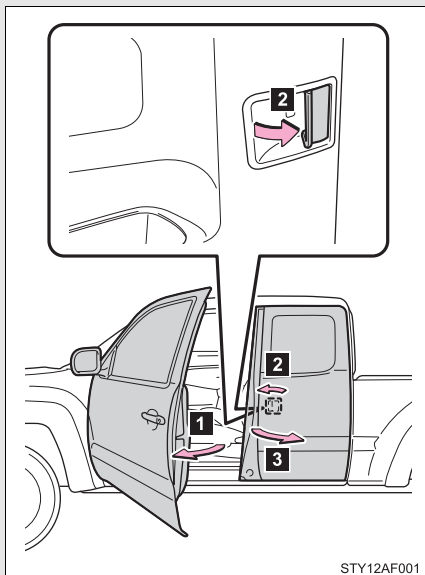

- 1 Open the front door widely
- 2 Pull (from the outside) or push (from the inside) the inside handle of the access door.
- 3 Open the access door

You can open and close the access door only when the front door is widely opened.

1

Before driving

### NOTICE

#### ■ When opening or closing the front door and access door

The front door and access door could be damaged if they hit each other when being opened or closed.

## Tailgate

The tailgate can be opened.

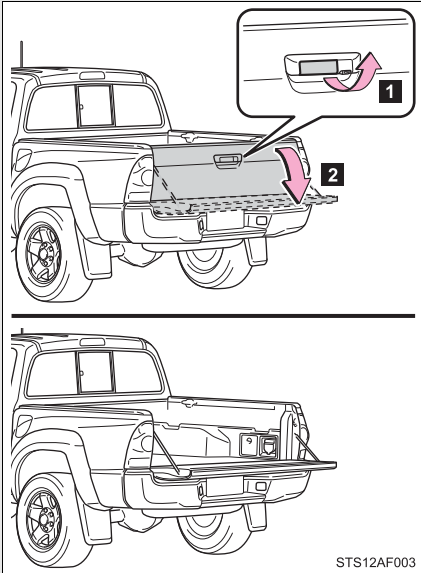

- 1** Pull the handle
- 2** Open the tailgate slowly

The support cables will hold the tailgate horizontal.

After closing the tailgate, try pulling it toward you to make sure it is securely locked.

### Removing the tailgate

- **Before removing the tailgate (vehicles with rear view monitor system)**

These connector covers are used when removing the tailgate, to prevent the back-up camera wire harness connectors from being contaminated.

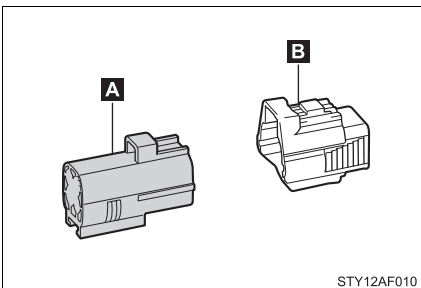

- A** Connector cover (Gray)
- B** Connector cover (White)

Store the connector covers in the glove box in a plastic bag when not using.



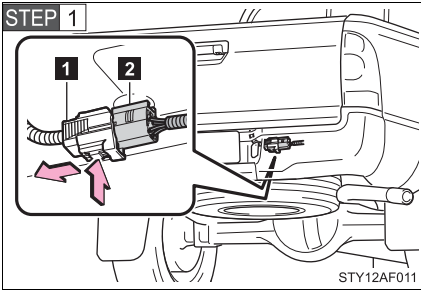

To disconnect the wire harness connectors (1 and 2), press and hold the lock of the tailgate wire harness connector (White) and pull apart.

- 1 Tailgate wire harness connector (White)
- 2 Frame wire harness connector (Gray)

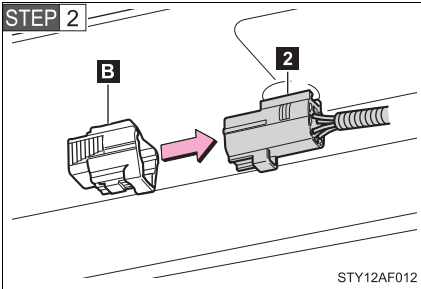

Attach the connector cover (white) to the frame wire harness connector (Gray).

- B Connector cover (White)
- 2 Frame wire harness connector (Gray)

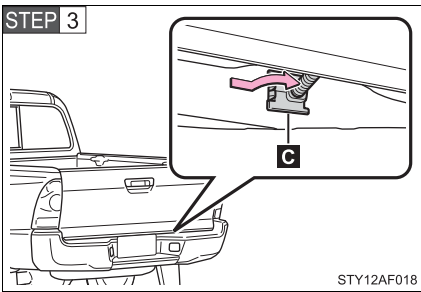

Pull out the plastic wire protector located in the vehicle bed by pressing the tabs and pulling the protector.

Be careful not to pull out all of the tailgate wire harness. Doing so may result in damage to vehicle components.

- C Plastic wire protector

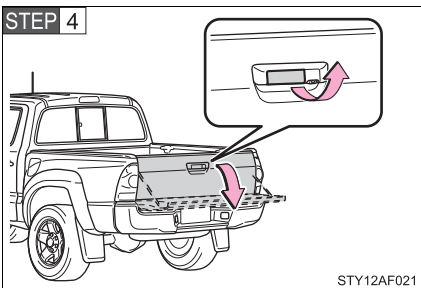

Open the tailgate.

## 1-2. Opening, closing and locking the doors

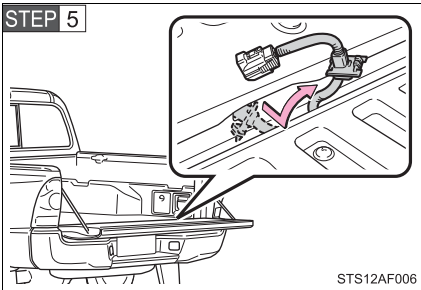

Pull out the wire harness from the vehicle bed.

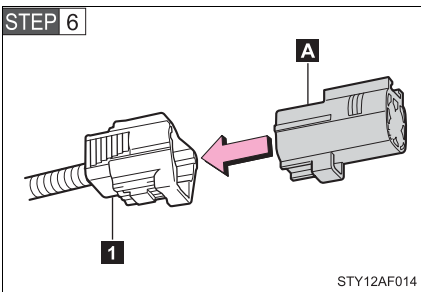

Attach the connector cover (Gray) to the tailgate wire harness connector (White).

**1** Tailgate wire harness connector (White)

**A** Connector cover (Gray)

### ■ Removing the tailgate

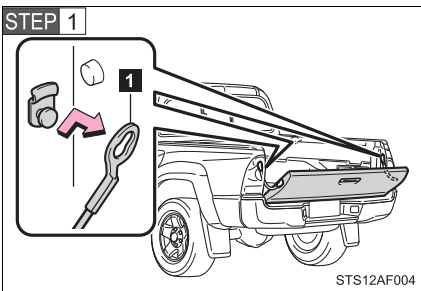

Open the tailgate to the angle where you can release the brackets on the support cables from the lugs on both sides. Lift the support cable bracket up and slide it off.

**1** Support cable bracket

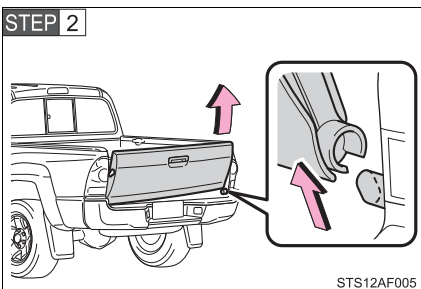

Tilt the tailgate to about 30° from vertical and pull up the right side of the tailgate to unhook the right side.

**STEP 3**

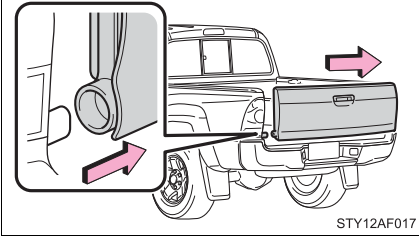

Slide the tailgate a little to the right to unhook the left side.

To attach the tailgate, follow the removal procedure in reverse order.

1

Before driving

### Rear step bumper

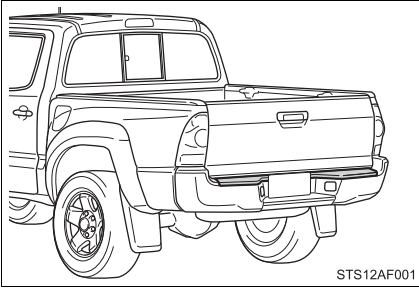

For rear end protection and easier step-up loading.

To get on the rear step bumper, use the shaded area in the illustration.

### **⚠ CAUTION**

#### ■ **Before removing the tailgate (vehicles with rear view monitor system)**

Disconnect the wire harness between the back-up camera and the vehicle. Failure to do so may result in serious injury or damage to the vehicle components.

#### ■ **Caution while driving**

Observe the following precautions. Failure to do so may result in death or serious injury.

- Do not drive with the tailgate open.
- Do not let anyone ride on the rear step bumper.



## NOTICE

■ **To prevent damage to the tailgate wire harness (vehicles with rear view monitor system)**

Do not pull out all of the tailgate wire harness before open the tailgate.

■ **To prevent damage to the camera lens (vehicles with rear view monitor system)**

Store the removed tailgate with the back-up camera lens facing upward.

■ **After closing the tailgate**

Try pulling it toward you to make sure it is securely locked.

■ **To prevent damage to the rear step bumper**

Do not allow more than one person to get on the rear step bumper at a time.

## Front seats

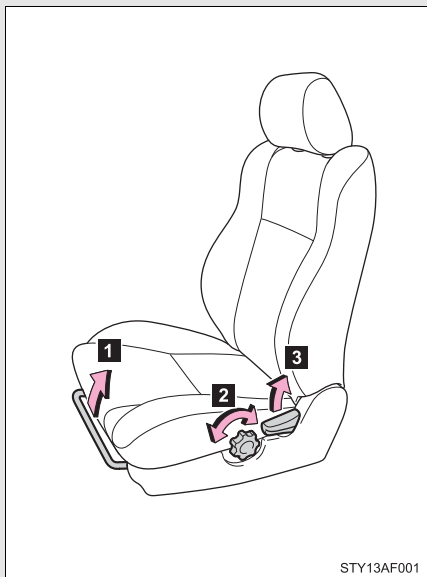

- 1** Seat position adjustment lever
- 2** Driver's seat lumbar support adjustment knob (if equipped)
- 3** Seatback angle adjustment lever

### Moving passenger's seat for rear seat entry (if equipped)

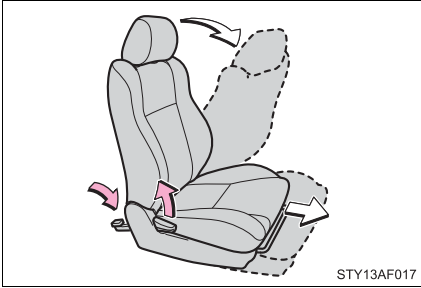

Lift the seatback angle adjusting lever or press the pedal behind the seatback. The seat will slide forward.

Move the seat to the front-most position.

#### ■ After passengers are in the vehicle

Lift the seatback and return the seat until it locks.

### Folding passenger's seat

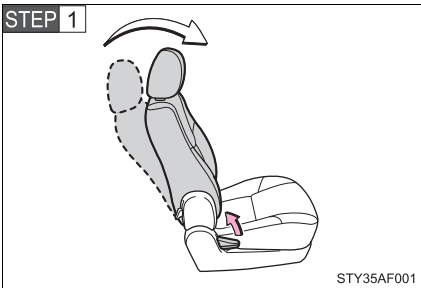

Pull the seatback angle adjusting lever and raise the seatback to its upright position.

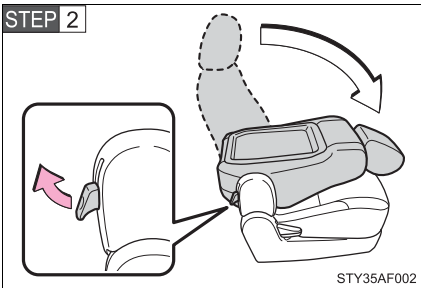

Pull the seatback folding lever and fold the seatback down.

### Active head restraints

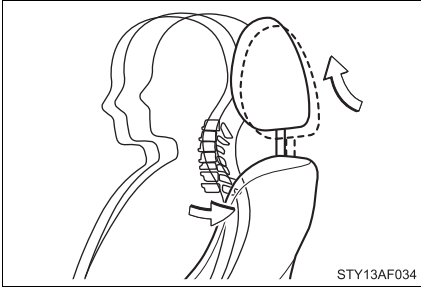

When the occupant's back presses against the seatback during a rear-end collision, the head restraint moves slightly forward to help reduce the risk of whiplash on the seat occupant.

1

Before driving

### Active head restraints

Even small forces applied to the seatback may cause the head restraint to move. Pushing up a locked head restraint forcibly may show the head restraint inner structure. These do not indicate problems.

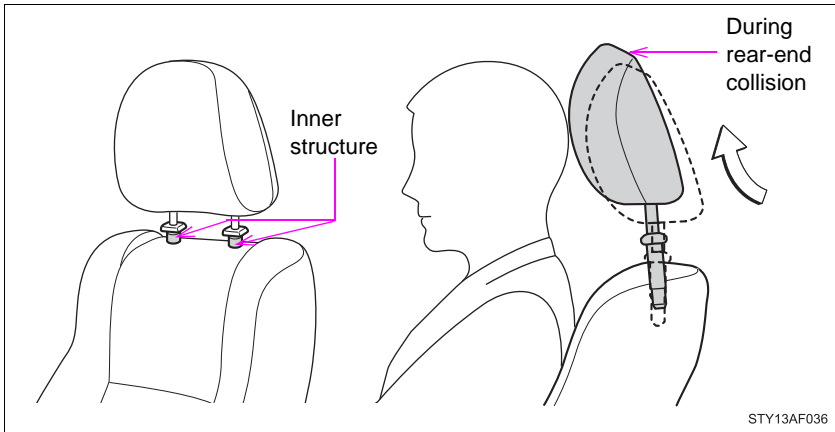

### Waterproof and water-repellent seats (if equipped)

Waterproof and water-repellent seats are installed in your vehicle; however, the water-repellent effect does not last forever.

 **CAUTION**

■ **Seat adjustment**

- Be careful that the seat does not hit passengers or luggage.
- Do not recline the seat more than necessary when the vehicle is in motion to reduce the risk of sliding under the lap belt.  
If the seat is too reclined, the lap belt may slide past the hips and apply restraint forces directly to the abdomen or your neck may contact the shoulder belt, increasing the risk of death or serious injury in the event of an accident.
- After adjusting the seat, make sure that the seat is locked in position.

■ **After returning the seatback to the upright position**

Observe the following precautions. Failure to do so may result in death or serious injury.

- Make sure the seatback is securely locked.
- Check that the seat belts are not twisted or caught in the seatback.
- Arrange the seat belts in the proper positions for ready use.

■ **Caution while driving**

- Vehicles with seatback table: Do not sit on or place anything on the folded seatback.
- Access Cab models only: Do not rest your foot on the press pedal behind the passenger seat.



# 1-3. Adjustable components (seats, mirrors, steering wheel)

## Rear seats\*

### ► Access Cab models

The bottom cushion of the rear seats can be raised and lowered.

#### ■ Before raising the bottom cushion

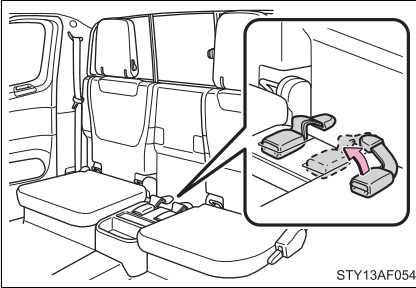

Stow the seat belt buckles.

This prevents the seat belt buckles from falling out when you fold the seatback.

#### ■ Raising the bottom cushion

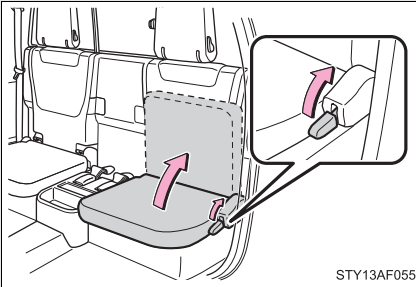

Raise the bottom cushion up while pulling the lever until it locks.

#### ■ Lowering the bottom cushion

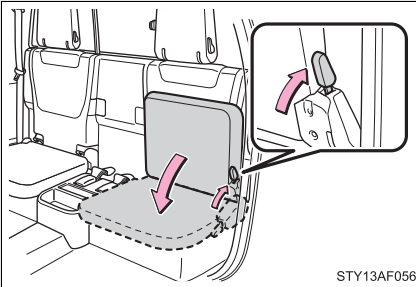

Push the bottom cushion down while pulling the lever until the bottom cushion locks into the seat position.

\*: If equipped

► Double Cab models

The seatback of the rear seat can be folded.

■ Before folding rear seats

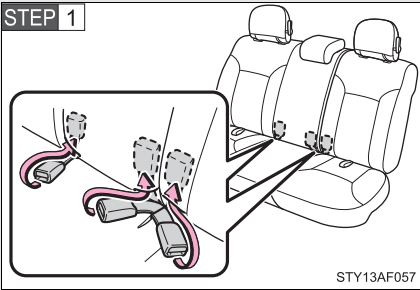

Stow the rear seat belt buckles.

This prevents the seat belt buckles from falling out when you fold the seatback.

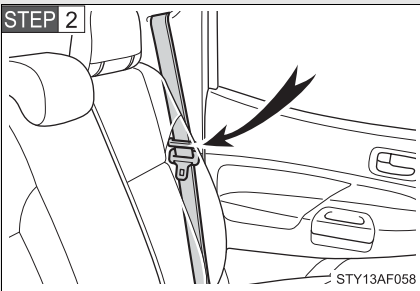

Pass the seat belts through the seat belt hangers.

This prevents the shoulder belt from being damaged.

Make sure that the seat belts are removed from the hangers before using them.

■ Folding rear seats

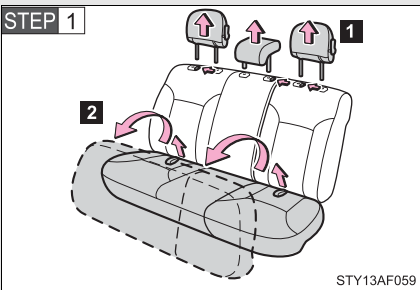

**1** Remove the head restraint

**2** Swing the bottom cushion up by pulling the lock release strap

**STEP 2**

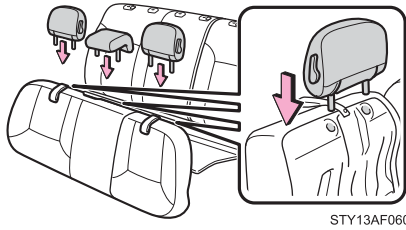

Attach the head restraints to the holders located on the back sides of the bottom cushions.

**STEP 3**

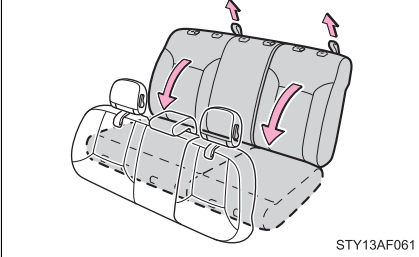

Fold down the seatback by pulling the lock release strap.

■ **Waterproof and water-repellent seats (if equipped)**

Waterproof and water-repellent seats are installed in your vehicle; however, the water-repellent effect does not last forever.

 CAUTION

■ **When the seatback is folded/the bottom cushion is raised**

Do not sit on or place anything on the seatback or auxiliary box while driving.

■ **When returning the seats to their original position**

Observe the following precautions. Failure to do so may result in death or serious injury.

- Be careful not to get your hands or feet pinched in the seat.
- Make sure the seatbacks and bottom cushions are securely locked. Failure to do so will prevent the seat belt from operating properly.
- Check that the seat belts are not twisted or caught under the seat.
- Arrange the seat belts in the proper positions for ready use.

 NOTICE

■ **Before folding the seats**

The seat belts buckles must be stowed.

# 1-3. Adjustable components (seats, mirrors, steering wheel)

## Head restraints

Head restraints are provided for all seats.

### ■ Adjusting the head restraints

#### ► Front seat

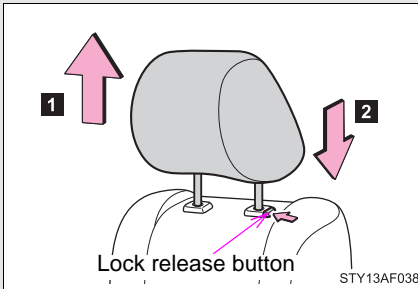

#### 1 Up

Pull the head restraints up.

#### 2 Down

Push the head restraint down while pushing the lock release button.

#### ► Rear seat (Double Cab models only)

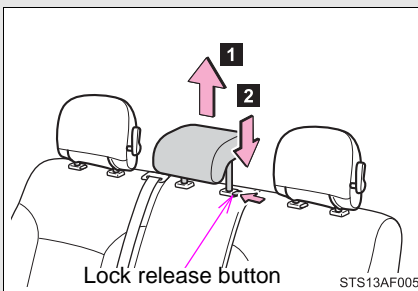

#### 1 Up

Pull the head restraints up.

#### 2 Down

Push the head restraint down while pushing the lock release button.

■ **When using the rear head restraints**

► **Access Cab models (vehicles with rear seats)**

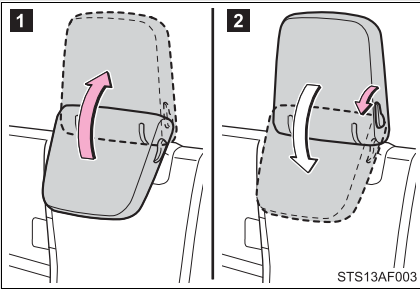

**1** To use

Lift up the head restraint until it locks.

**2** To fold

Pull the head restraint lock release lever to fold the head restraint.

► **Double Cab models**

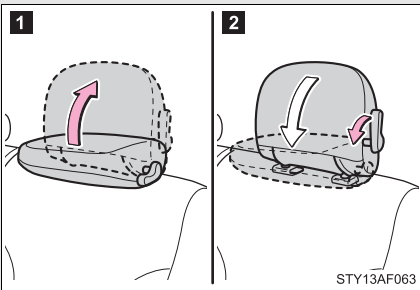

**1** To use

Lift up the head restraint until it locks.

**2** To fold

Pull the head restraint lock release lever to fold the head restraint.

### ■ Removing the front head restraints

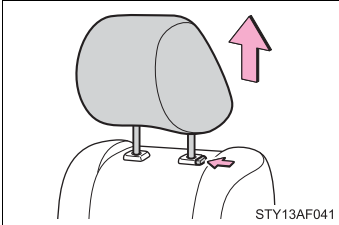

Pull the head restraint up while pushing the lock release button.

### ■ Removing the rear head restraints (Double Cab models only)

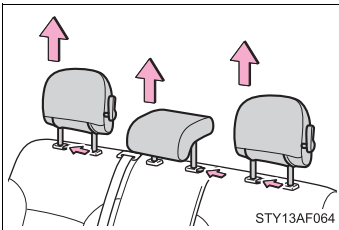

Pull the head restraint up while pushing the lock release button.

### ■ Installing the front head restraints

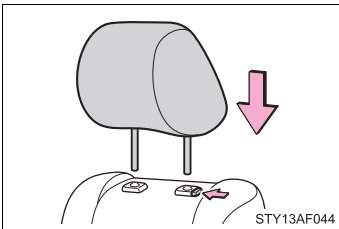

Align the head restraint with the installation holes and push it down to the lock position.

Press and hold the lock release button when lowering the head restraint.

### ■ Installing the rear head restraints (Double Cab models only)

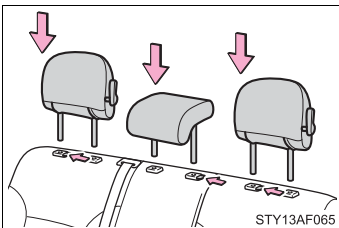

Align the head restraint with the installation holes and push it down to the lock position.

Press and hold the lock release button when lowering the head restraint.

■ **When installed the rear outboard head restraints to opposite direction (Double Cab models only)**

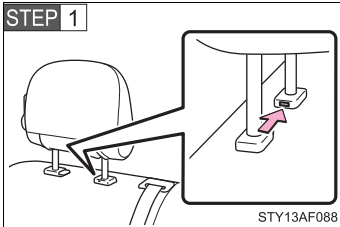

Push a flathead screwdriver into the slot. The slot is located on the left side of the right head restraint anchor.

**STEP 2** While pressing in the screwdriver, pull up the head restraint.

■ **Adjusting the height of the head restraints**

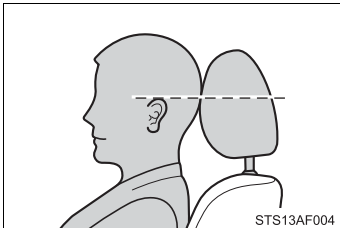

Make sure that the head restraints are adjusted so that the center of the head restraint is closest to the top of your ears.

■ **Adjusting the rear center seat head restraints (Double Cab models)**

Always raise the head restraint one level from the stowed position when using.

**⚠ CAUTION**

■ **Head restraint precautions**

Observe the following precautions regarding the head restraints. Failure to do so may result in death or serious injury.

- Use the head restraints designed for each respective seat.
- Adjust the head restraints to the correct position at all times.
- After adjusting the head restraints, push down on them and make sure they are locked in position.
- Do not drive with the head restraints removed.



**Make sure that all occupants are wearing their seat belts before driving the vehicle.**

■ **Correct use of the seat belts**

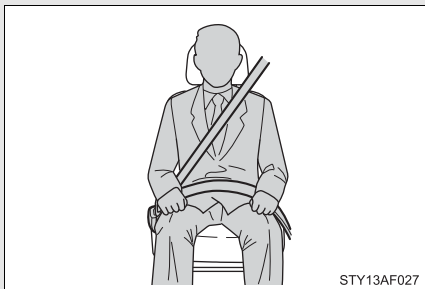

- Extend the shoulder belt so that it comes fully over the shoulder, but does not come into contact with the neck or slide off the shoulder.
- Position the lap belt as low as possible over the hips.
- Adjust the position of the seatback. Sit up straight and well back in the seat.
- Do not twist the seat belt.

■ **Fastening and releasing the seat belt**

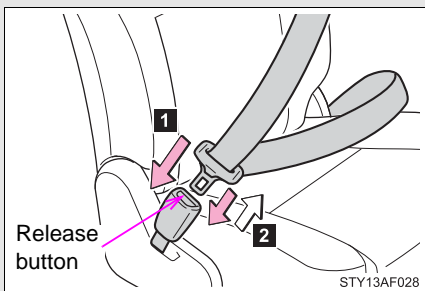

**1** Fastening the belt

Push the tab into the buckle until a clicking sound is heard.

**2** Releasing the belt

Press the release button.

### ■ Adjusting the height of the belt (front seats)

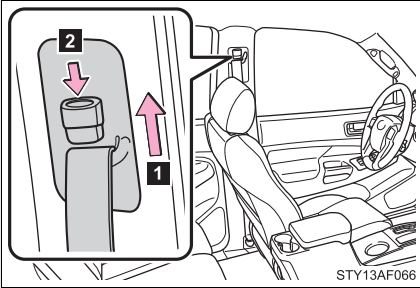

#### 1 Up

Move the height adjuster up as needed until you hear a click.

#### 2 Down

Push the lock release button and slide the height adjuster down.

### Seat belt pretensioners (front seats)

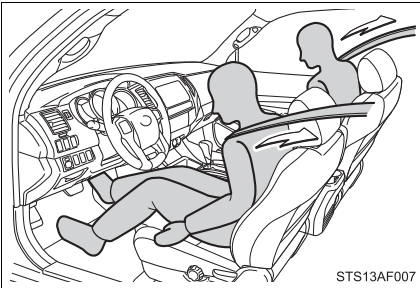

The pretensioner helps the seat belt to quickly restrain the occupant by retracting the seat belt when the vehicle is subjected to certain types of severe frontal collision or a vehicle rollover.

The pretensioner may not activate in the event of a minor frontal impact, a side impact or a rear impact.

### ■ Emergency locking retractor (ELR)

The retractor will lock the belt during a sudden stop or on impact. It may also lock if you lean forward too quickly. A slow, easy motion will allow the belt to extend so that you can move around fully.

### ■ Automatic locking retractor (ALR)

When a passenger's shoulder belt is completely extended and then retracted even slightly, the belt is locked in that position and cannot be extended. This feature is used to hold the child restraint system (CRS) firmly. To free the belt again, fully retract the belt and then pull the belt out once more. (→P. 104)

### ■ Pregnant women

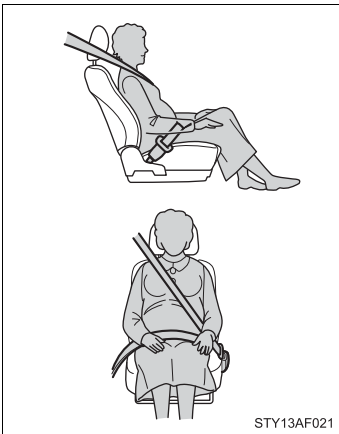

Obtain medical advice and wear the seat belt in the proper way. (→P. 57)

Women who are pregnant should position the lap belt as low as possible over the hips in the same manner as other occupants. Extend the shoulder belt completely over the shoulder and position the belt across the chest. Avoid belt contact over the rounding of the abdominal area.

If the seat belt is not worn properly, not only a pregnant woman, but also the fetus could suffer death or serious injury as a result of sudden braking or a collision.

### ■ People suffering illness

Obtain medical advice and wear the seat belt in the proper way.

### ■ Child seat belt usage

The seat belts of your vehicle were principally designed for persons of adult size.

- Use a child restraint system appropriate for the child, until the child become large enough to properly wear the vehicle's seat belt. (→P. 100)
- When the child becomes large enough to properly wear the vehicle's seat belt, follow the instructions on P. 57 regarding seat belt usage.

### ■ Replacing the belt after the pretensioner has been activated

If the vehicle is involved in multiple collisions, the pretensioner will activate for the first collision, but will not activate for the second or subsequent collisions.

### ■ Seat belt extender

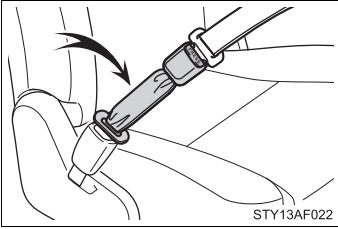

If your seat belts cannot be fastened securely because they are not long enough, a personalized seat belt extender is available from your Toyota dealer free of charge.

## ⚠ CAUTION

Observe the following precautions to reduce the risk of injury in the event of sudden braking, sudden swerving or an accident. Failing to do so may cause death or severe injury.

### ■ Wearing a seat belt

- Ensure that all passengers wear a seat belt.
- Always wear a seat belt properly.
- Each seat belt should be used by one person only. Do not use a seat belt for more than one person at once, including children.
- Toyota recommends that children be seated in the rear seat and always use a seat belt and/or an appropriate child restraint system.
- Do not recline the seat any more than necessary to achieve a proper seating position. The seat belt is most effective when the occupants are sitting up straight and well back in the seats.
- Do not wear the shoulder belt under your arm.
- Always wear your seat belt low and snug across your hips.

 **CAUTION****■ When children are in the vehicle**

Do not allow children to play with the seat belt. If the seat belt becomes twisted around a child's neck, it may lead to choking or other serious injuries that could result in death. If this occurs and the buckle cannot be unfastened, scissors should be used to cut the belt.

**■ Seat belt pretensioners**

- Do not place anything, such as a cushion, on the front passenger's seat. Doing so will disperse the passenger's weight, which prevents the sensor from detecting the passenger's weight properly. As a result, the seat belt pretensioner for the front passenger's seat may not activate in the event of a collision.
- If the pretensioner has activated, the SRS warning light will come on. In that case, the seat belt cannot be used again and must be replaced at your Toyota dealer.

**■ Adjustable shoulder anchor**

Always make sure the shoulder belt is positioned across the center of your shoulder. The belt should be kept away from your neck, but not falling off your shoulder. Failure to do so could reduce the amount of protection in an accident and cause death or serious injuries in the event of a sudden stop, sudden swerve or accident. (→P. 58)

**■ Seat belt damage and wear**

- Do not damage the seat belts by allowing the belt, plate, or buckle to be jammed in the door.
- Inspect the seat belt system periodically. Check for cuts, fraying, and loose parts. Do not use a damaged seat belt until it is replaced. Damaged seat belts cannot protect an occupant from death or serious injury.
- Ensure that the belt and tab are locked and the belt is not twisted. If the seat belt does not function correctly, immediately contact your Toyota dealer.
- Replace the seat assembly, including the belts, if your vehicle has been involved in a serious accident, even if there is no obvious damage.

 CAUTION

■ **Seat belt damage and wear**

- Do not attempt to install, remove, modify, disassemble or dispose of the seat belts. Have any necessary repairs carried out by your Toyota dealer. Inappropriate handling of the pretensioner may prevent it from operating properly resulting in death or serious injury.

■ **Using a seat belt extender**

- Do not wear the seat belt extender, if you can fasten the seat belt without the extender.
- Do not use the seat belt extender when installing a child restraint system, because the belt will not securely hold the child restraint system, increasing the risk of death or serious injury in the event of an accident.
- The personalized extender may not be safe on another vehicle, when used by another person, or at a different seating position other than the one originally intended.

 NOTICE

■ **When using a seat belt extender**

When releasing the seat belt, press on the buckle release button on the extender, not on the seat belt.  
This helps prevent damage to the vehicle interior and the extender itself.

## 1-3. Adjustable components (seats, mirrors, steering wheel)

### Steering wheel

The steering wheel can be adjusted to a comfortable position.

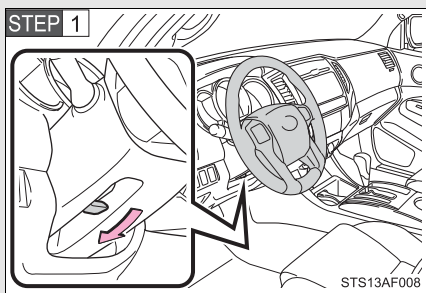

Hold the steering wheel and press the lever down.

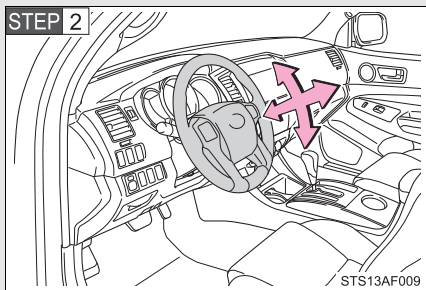

Adjust to the ideal position by moving the steering wheel horizontally and vertically.

After adjustment, pull the lever up to secure the steering wheel.

#### CAUTION

##### ■ Caution while driving

Do not adjust the steering wheel while driving. Doing so may cause the driver to mishandle the vehicle and an accident may occur resulting in death or serious injury.

##### ■ After adjusting the steering wheel

Make sure that the steering wheel is securely locked. Otherwise, the steering wheel may move suddenly, possibly causing an accident and resulting in death or serious injury.

# 1-3. Adjustable components (seats, mirrors, steering wheel) Anti-glare inside rear view mirror

Glare from the headlights of vehicles behind can be reduced by using the following functions.

► Manual anti-glare inside rear view mirror

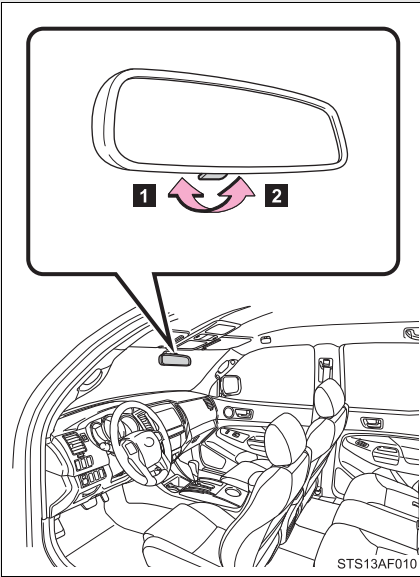

- 1** Normal position
- 2** Anti-glare position



► Auto anti-glare inside rear view mirror (type A)

In automatic mode, sensors are used to detect the headlights of vehicles behind and automatically reduces the reflected light.

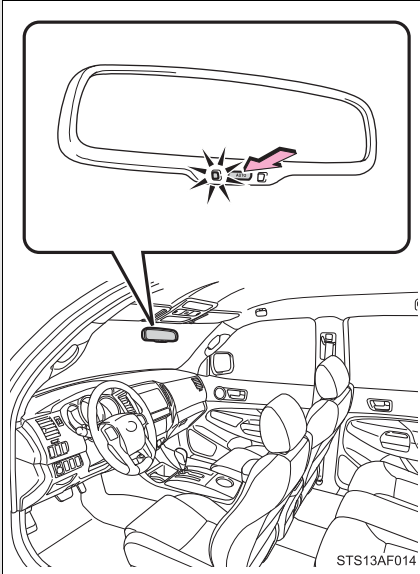

Turns automatic mode on/off

The indicator comes on when automatic mode is turned on.

The mirror will revert to the automatic mode each time the engine switch is turned on.

► Auto anti-glare inside rear view mirror (type B)

In automatic mode, sensors are used to detect the headlights of vehicles behind and automatically reduces the reflected light.

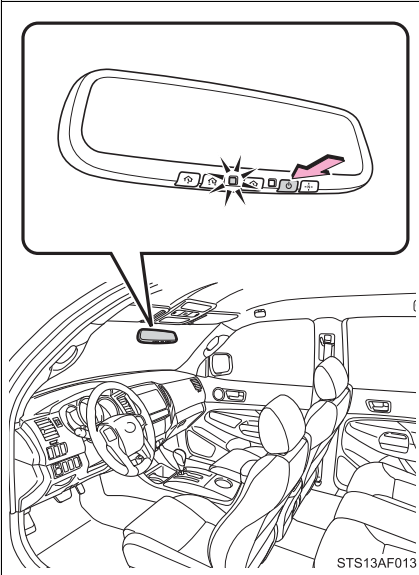

Turns automatic mode on/off

The indicator comes on when automatic mode is turned on.

The mirror will revert to the automatic mode each time the engine switch is turned on.

### Adjusting the height of rear view mirror

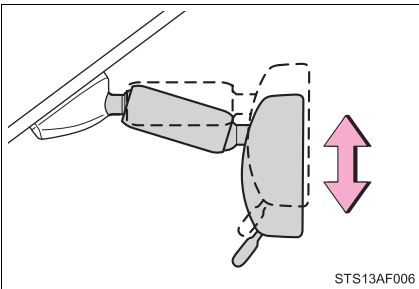

Adjust the height of the rear view mirror by moving it up and down.

**Inside rear view mirror display (vehicles with auto anti-glare inside rear view mirror)**

The inside rear view mirror displays the following information.

■ **Compass**

→P. 381

■ **Garage door opener**

→P. 373

■ **To prevent sensor error (vehicles with auto anti-glare inside rear view mirror)**

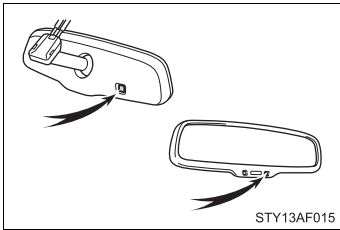

To ensure that the sensors operate properly, do not touch or cover them.

**⚠ CAUTION**

■ **Caution while driving**

Do not adjust the position of the mirror while driving.

Doing so may lead to mishandling of the vehicle and cause an accident, resulting in death or serious injury.

# 1-3. Adjustable components (seats, mirrors, steering wheel)

## Outside rear view mirrors

**Mirror angle can be adjusted.**

► Power-adjustable type

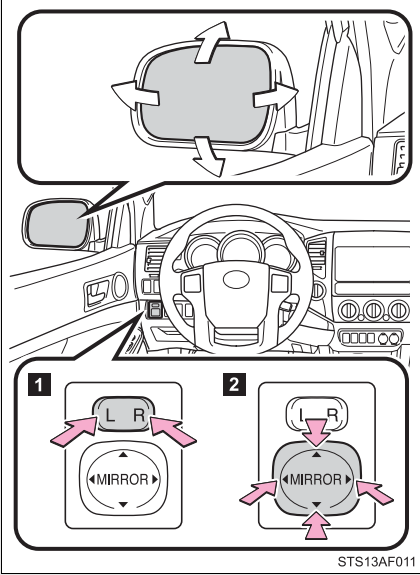

**1** Select a mirror to adjust.  
(L: left or R: right)

**2** Adjust the mirror up, down, in or out using the switch.

► Manually adjustable type

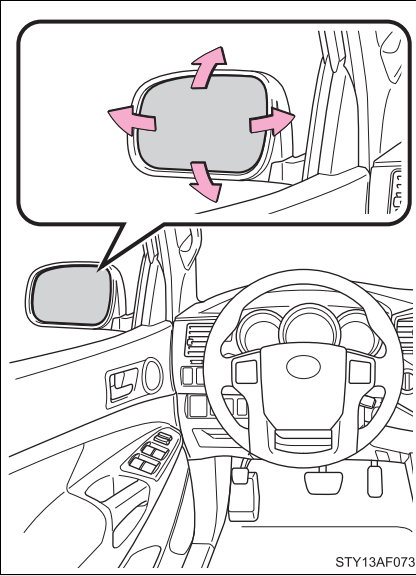

Adjust the mirror up, down, in or out by pushing the mirror surface.

**Folding back the mirrors**

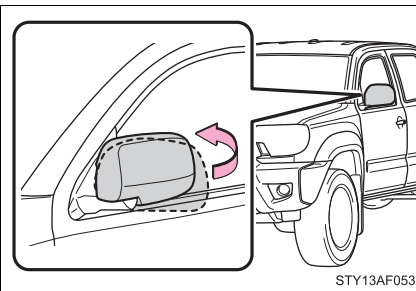

Push backward to fold the mirrors.

■ **Mirror operating conditions (vehicles with power-adjustable type only)**

The engine switch is in the ACC or ON position.

 CAUTION

■ **When driving the vehicle**

Observe the following precautions while driving.

Failing to do so may result in loss of control of the vehicle and cause an accident, resulting in death or serious injury.

- Do not adjust the mirrors while driving.
- Do not drive with the mirrors folded back.
- Both the driver and passenger side mirrors must be extended and properly adjusted before driving.

 NOTICE

■ **If ice should jam the mirror**

Do not operate the control or scrape the mirror face. Use a spray de-icer to free the mirror.

## 1-4. Opening and closing the windows

### Power windows

The power windows can be opened/closed using the following switches.

#### ► Driver's power window switches

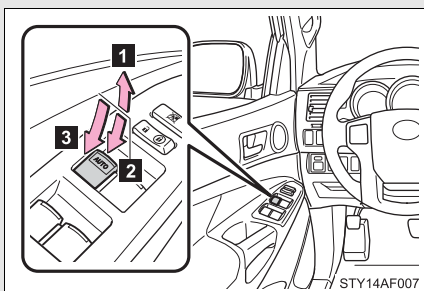

- 1 Closing
- 2 Opening
- 3 One-touch opening (driver's window only)\*

\*: To stop the window partway, operate the switch in the opposite direction.

#### ► Front and rear passenger's power window switch

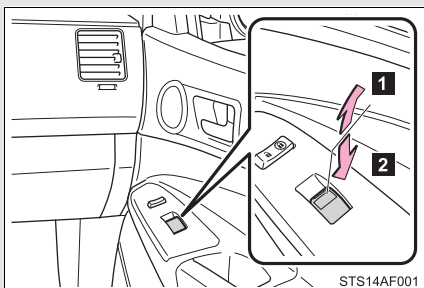

- 1 Closing
- 2 Opening

### Lock switch

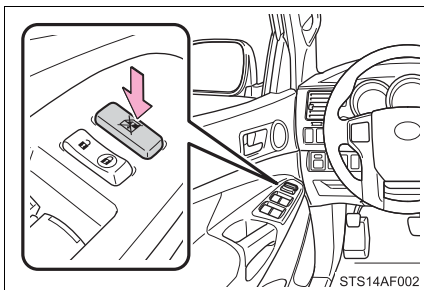

Press the switch down to lock passenger window switches.

Use this switch to prevent children from accidentally opening or closing a passenger window.

■ **The power windows can be operated when**

The engine switch is in the ON position.

■ **Operating the power windows after turning the engine off**

The power windows can be operated for approximately 43 seconds even after the engine switch is turned to the ACC or LOCK position. They cannot, however, be operated once either front door is opened.

 **CAUTION**

■ **Closing the windows**

Observe the following precautions.

Failing to do so may result in death or serious injury.

- The driver is responsible for all the power window operations, including the operation for the passengers. In order to prevent accidental operation, especially by a child, do not let a child operate the power windows. It is possible for children and other passengers to have body parts caught in the power window. Also, when riding with a child, it is recommended to use the window lock switch. (→P. 71)
- Check to make sure that all passengers do not have any part of their body in a position where it could be caught when a window is being operated.
- When exiting the vehicle, turn the engine switch off, carry the key and exit the vehicle along with the child. There may be accidental operation, due to mischief, etc., that may possibly lead to an accident.



## 1-4. Opening and closing the windows

### Back window (vehicles with sliding type)

The back window can be opened and closed using the lock release lever.

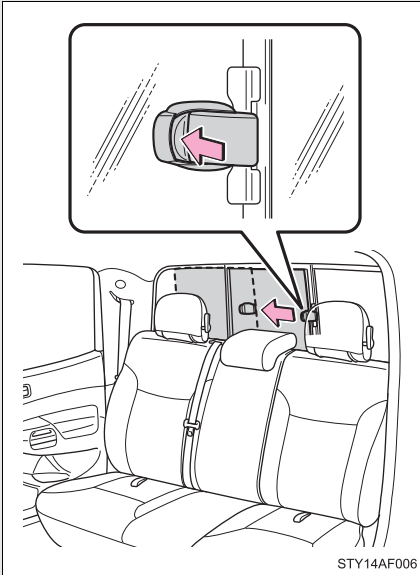

Open/close

Push the lock release lever and slide the back window.

1

Before driving

#### ■ Closing the back window

Make sure that the back window is securely closed after closing it.

#### ⚠ CAUTION

#### ■ While driving

Keep the back window closed.

This not only keeps personal belongings from being thrown out, but also prevents exhaust gases from entering the vehicle.

# Opening the fuel tank cap

Perform the following steps to open the fuel tank cap.

■ **Before refueling the vehicle**

Turn the engine switch off and ensure that all the doors and windows are closed.

■ **Opening the fuel tank cap**

STEP 1

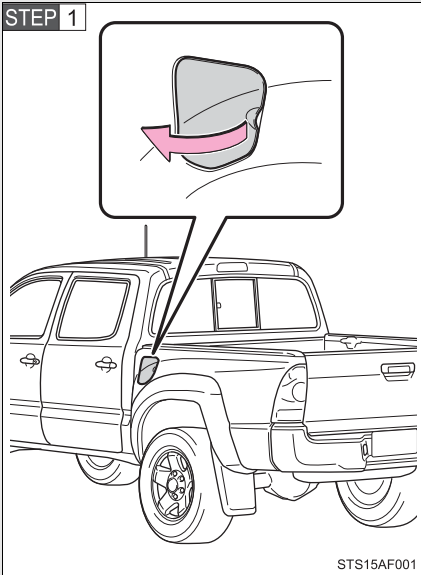

STS15AF001

Open the fuel filler door.

STEP 2

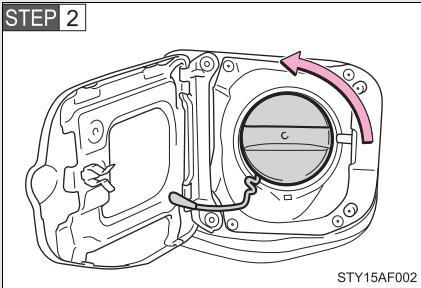

STY15AF002

Turn the fuel tank cap slowly to open.

## Closing the fuel tank cap

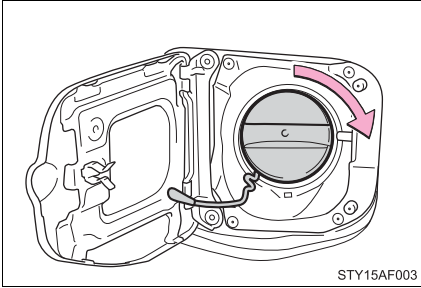

When replacing the fuel tank cap, turn it until a clicking sound is heard.

After releasing your hand, the cap will turn slightly to the opposite direction.

1

Before driving

### ■ Fuel types

Use unleaded gasoline. (Octane Rating 87 [Research Octane Number 91] or higher)

### ■ Fuel tank capacity

Approximately 21.1 gal. (80.0 L, 17.6 Imp.gal.)

## ⚠ CAUTION

### ■ Refueling the vehicle

Observe the following precautions while refueling the vehicle. Failure to do so, may result in death or serious injury.

- Touch the vehicle or some other metal surface to discharge any static electricity.  
Sparks resulting from discharging static electricity may cause the fuel vapors to ignite.
- Always hold the grips on the fuel tank cap and turn it slowly to remove it. A whooshing sound may be heard when the fuel tank cap is loosened. Wait until the sound cannot be heard before fully removing the cap. In hot weather, pressurized fuel may spray out of the filler neck and cause injury.
- Do not allow anyone that has not discharged static electricity from their bodies to come close to an open fuel tank.

 CAUTION

■ **Refueling the vehicle**

- Do not inhale vaporized fuel.  
Fuel contains substances that are harmful if inhaled.
- Do not smoke while refueling the vehicle.  
Doing so may cause the fuel to ignite and cause a fire.
- Do not return to the vehicle or touch any person or object that is statically charged.  
This may cause static electricity to build up, resulting in a possible engine hazard.

■ **When replacing the fuel tank cap**

Do not use anything but a genuine Toyota fuel tank cap designed for your vehicle. Doing so may cause a fire or other incident which may result in death or serious injury.

 NOTICE

■ **Refueling**

Do not spill fuel during refueling.  
Doing so may damage the vehicle, such as causing the exhaust systems to operate abnormally or damaging fuel system components or the vehicle's painted surface.

■ **To prevent damage to the fuel filler door**

Do not apply excessive force.

## 1-6. Theft deterrent system Engine immobilizer system\*

1

Before driving

The vehicle's keys have built-in transponder chips that prevent the engine from starting if the key has not been previously registered in the vehicle's on-board computer.

Never leave the keys inside the vehicle when you leave the vehicle.

This system is designed to help prevent vehicle theft but does not guarantee absolute security against all vehicle thefts.

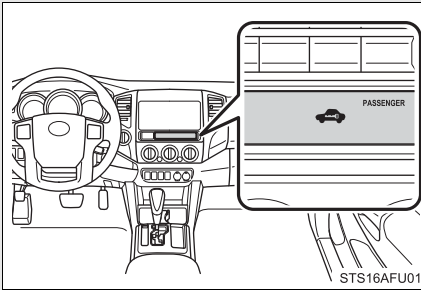

The indicator light flashes after the key has been removed from the engine switch to indicate that the system is operating.

The indicator light stops flashing after the registered key has been inserted into the engine switch to indicate that the system has been canceled.

### ■ System maintenance

The vehicle has a maintenance-free type engine immobilizer system.

### ■ Conditions that may cause the system to malfunction

- If the key is in contact with a metallic object
- If the key is in close proximity to or touching a key to the security system (key with a built-in transponder chip) of another vehicle

\*: If equipped

■ **Certifications for the engine immobilizer system**

- ▶ For vehicles sold in U.S.A.

FCC ID: MOZRI-21BTY

This device complies with part 15 of the FCC Rules. Operation is subject to the following two conditions: (1) This device may not cause harmful interference, and (2) this device must accept any interference received, including interference that may cause undesired operation.

FCC WARNING:

Changes or modifications not expressly approved by the party responsible for compliance could void the user's authority to operate the equipment.

- ▶ For vehicles sold in Canada

This device complies with Industry Canada licence-exempt RSS standard(s). Operation is subject to the following two conditions: (1) this device may not cause interference, and (2) this device must accept any interference, including interference that may cause undesired operation of the device.

► For vehicles sold in New Caledonia

“Hereby, Tokai Rika Co., Ltd., declares that this RI-21BTY is in compliance with the essential requirements and other relevant provisions of Directive 1999/5/EC.”

**TOKAI RIKA**

**R&TTE Declaration of Conformity**

We,

Manufacturer's Name: Tokai Rika Co., Ltd.  
 Manufacturer's Address: 260, Toyota 3-chome, Oguchi-cho, Niwa-gun, Aichi-ken,  
 480-0195, Japan

hereby declare under our sole responsibility that the product:

Product Name: Immobilizer  
 Product Model: RI-21BTY

to which this declaration relates is in conformity with the essential requirements and other relevant requirements of the R&TTE Directive (1999/5/EC). The product is compliant with the following standards and/or other normative documents:

Safety: EN50600-1  
 EMC: EN301 489-1 & -3  
 Spectrum: EN300 330-2

Supplementary information:

* CE mark	
* Member states intended for use	EU and EFTA
* Member states with restrictive use	None

Date:

24 January 2007

Signature:

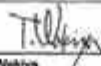
  
 Tadashi Wakiya  
 General Manager,  
 Electronics Engineering Div.

Position of the signatory:



**NOTICE**

■ **To ensure the system operates correctly**

Do not modify or remove the system. If modified or removed, the proper operation of the system cannot be guaranteed.

## Correct driving posture

Drive in a good posture as follows:

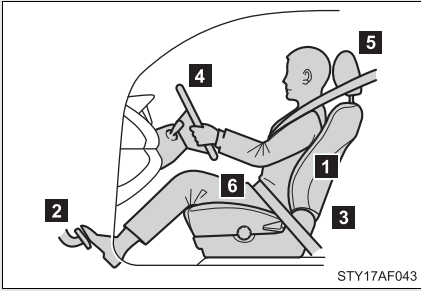

- 1** Sit upright and well back in the seat. (→P. 45)
- 2** Adjust the position of the seat forward or backward to ensure the pedals can be reached and easily depressed to the extent required. (→P. 45)
- 3** Adjust the seatback so that the controls are easily operable.
- 4** Adjust the tilt and telescopic positions of the steering wheel downward so the air-bag is facing your chest. (→P. 63)
- 5** Lock the head restraint in place with the center of the head restraint closest to the top of your ears. (→P. 53)
- 6** Wear the seat belt correctly. (→P. 57)



 **CAUTION****■ While driving**

- Do not adjust the position of the driver's seat while driving. Doing so could cause the driver to lose control of the vehicle.
- Do not place a cushion between the driver or passenger and the seatback. A cushion may prevent correct posture from being achieved, and reduce the effectiveness of the seat belt and head restraint, increasing the risk of death or serious injury to the driver or passenger.
- Do not place anything under the front seats. Objects placed under the front seats may become jammed in the seat tracks and stop the seat from locking in place. This may lead to an accident. The adjustment mechanism may also be damaged.

**■ Adjusting the seat position**

- Take care when adjusting the seat position to ensure that other passengers are not injured by the moving seat.
- Do not put your hands under the seat or near the moving parts to avoid injury. Fingers or hands may become jammed in the seat mechanism.

## SRS airbags

The SRS airbags inflate when the vehicle is subjected to certain types of severe impacts that may cause significant injury to the occupants. They work together with the seat belts to help reduce the risk of death or serious injury.

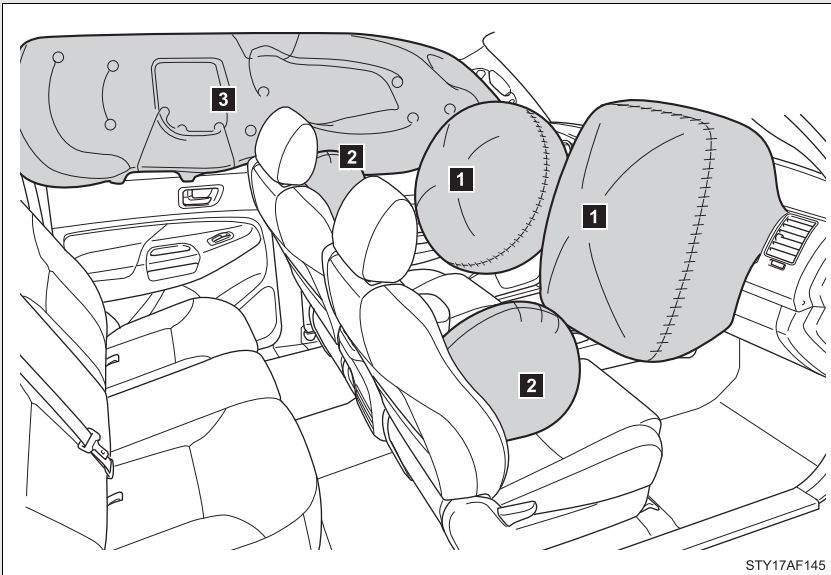

### ► Front airbags

#### **1** Driver airbag/front passenger airbag

Can help protect the head and chest of the driver and right front passenger from impact with interior components.

### ► Side and curtain shield airbags

#### **2** Side airbags

Can help protect the torso of the front seat occupants.

#### **3** Curtain shield airbags

Can help protect primarily the head of outside occupants.

## Airbag system components

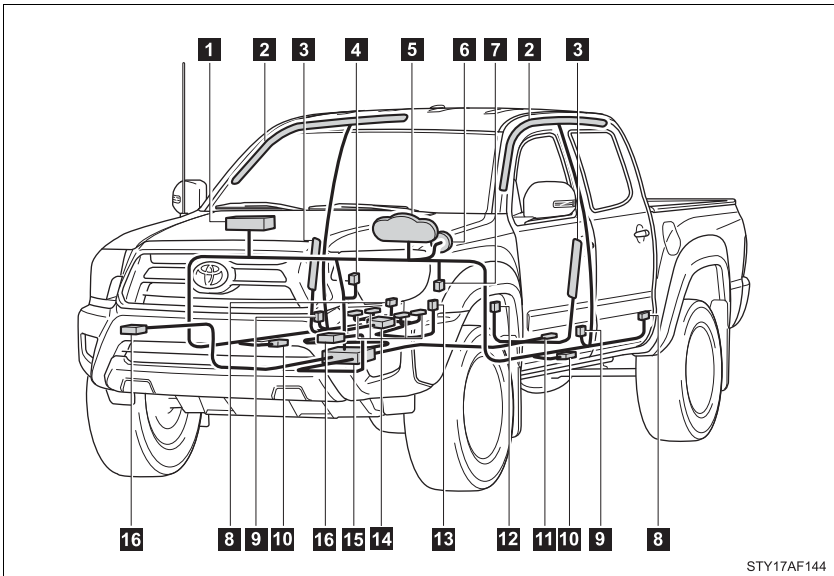

- 1 Front passenger airbag
- 2 Curtain shield airbags
- 3 Side airbags
- 4 AIR BAG ON and AIR BAG OFF indicator lights
- 5 SRS warning light and RSCA OFF indicator light (4WD models only)
- 6 Driver airbag
- 7 RSCA OFF switch (4WD models only)
- 8 Curtain shield airbag sensors
- 9 Seat belt pretensioners and force limiters
- 10 Side and curtain shield airbag sensors
- 11 Driver's seat position sensor
- 12 Driver's seat belt buckle switch
- 13 Front passenger's seat belt buckle switch
- 14 Front passenger occupant classification system (ECU and sensors)
- 15 Airbag sensor assembly
- 16 Front airbag sensors

STY17AF144

1

Before driving

Your vehicle is equipped with ADVANCED AIRBAGS designed based on the US motor vehicle safety standards (FMVSS208). The airbag sensor assembly (ECU) controls airbag deployment based on information obtained from the sensors etc. shown in the system components diagram above. This information includes crash severity and occupant information. As the airbags deploy, a chemical reaction in the inflators quickly fills the airbags with non-toxic gas to help restrain the motion of the occupants.

---

### ■ SRS warning light

This warning light system monitors the airbag sensor assembly, front airbag sensors, side and curtain shield airbag sensor assemblies, curtain shield airbag sensor assemblies, driver's seat position sensor, driver's seat belt buckle switch, front passenger occupant classification system (ECU and sensors), AIR BAG ON and AIR BAG OFF indicator lights, front passenger's seat belt buckle switch, front seat belt pretensioner assemblies, RSCA OFF indicator light (4WD models only), airbags, interconnecting wiring and power sources. (→P. 477)

### ■ If the SRS airbags deploy (inflate)

- Bruising and slight abrasions may result from contact with a deploying (inflating) SRS airbag.
- A loud noise and white powder will be emitted.
- Parts of the airbag module (steering wheel hub, airbag cover and inflator) as well as the front seats, and parts of the front and rear pillars and roof side rail, may be hot for several minutes. The airbag itself may also be hot.
- The front windshield may crack.

### ■ Operating conditions (front airbags)

- The SRS front airbag will deploy in the event of an impact that exceeds the set threshold level (the level of force corresponding to an approximately 12-18 mph [20-30 km/h] frontal collision with a fixed wall that does not move or deform).

However, this threshold velocity will be considerably higher if the vehicle strikes an object, such as a parked vehicle or sign pole, which can move or deform on impact, or if the vehicle is involved in an underride collision (e.g. a collision in which the front of the vehicle “underrides”, or goes under, the bed of a truck, etc.).

- Depending on the type of collision, it is possible that only the seat belt pretensioners will activate.
- The SRS front passenger airbag will not activate if there is no passenger sitting in the front passenger seat. However, the front passenger airbag may deploy if luggage is put in the seat, even if the seat is unoccupied. (→P. 95)

### ■ Operating conditions (side airbags and curtain shield airbags)

The SRS side airbags and SRS curtain shield airbags will deploy in the event of an impact that exceeds the set threshold level (the level of force corresponding to the impact force produced by an approximately 3300 lb. [1500 kg] vehicle colliding with the vehicle cabin from a direction perpendicular to the vehicle orientation at an approximate speed of 12-18 mph [20-30 km/h]).

### ■ Operating conditions (curtain shield airbags)

The SRS curtain shield airbags are designed to inflate when the passenger compartment is subjected to a severe impact from the side or vehicle roll-over.

■ **Conditions under which the SRS airbags may deploy (inflate), other than a collision**

The SRS front airbags may also deploy if a serious impact occurs to the underside of your vehicle. Some examples are shown in the illustration.

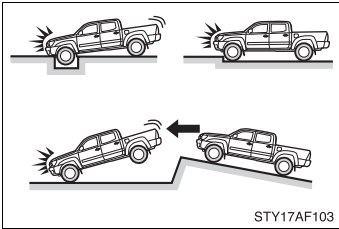

- Hitting a curb, edge of pavement or hard surface
- Falling into or jumping over a deep hole
- Landing hard or vehicle falling

The SRS curtain shield airbags may also deploy under the situation shown in the illustration.

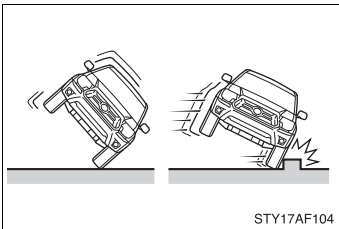

- The angle of vehicle tip-up is marginal.
- The vehicle skids and hits a curb stone.

■ **Types of collisions that may not deploy the SRS airbag (front airbags)**

The SRS front airbags are generally not designed to inflate if the vehicle is involved in a side or rear collision, if it rolls over, or if it is involved in a low-speed frontal collision. But, whenever a collision of any type causes sufficient forward deceleration of the vehicle, deployment of the SRS front airbags may occur.

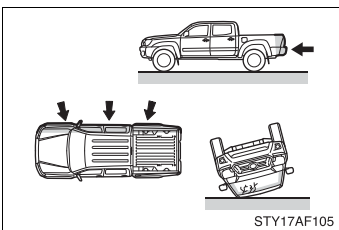

- Collision from the side
- Collision from the rear
- Vehicle rollover

### ■ Types of collisions that may not deploy the SRS airbag (side airbags and curtain shield airbags)

The SRS side airbag and curtain shield airbag system may not activate if the vehicle is subjected to a collision from the side at certain angles, or a collision to the side of the vehicle body other than the passenger compartment.

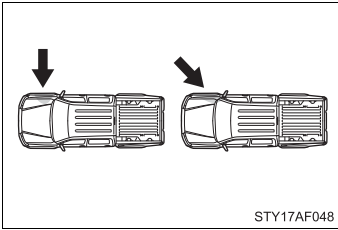

- Collision from the side to the vehicle body other than the passenger compartment
- Collision from the side at an angle

The SRS side airbags are not generally designed to inflate if the vehicle is involved in a frontal or rear collision, if it rolls over, or if it is involved in a low-speed side collision.

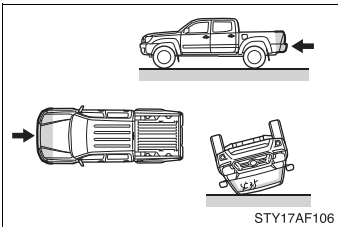

- Collision from the front
- Collision from the rear
- Vehicle rollover

The SRS curtain shield airbags are not generally designed to inflate if the vehicle is involved in a frontal or rear collision, if it pitches end over end, or if it is involved in a low-speed side collision.

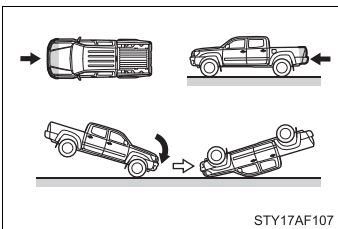

- Collision from the front
- Collision from the rear
- Pitching end over end

### ■ When to contact your Toyota dealer

In the following cases, contact your Toyota dealer as soon as possible.

- Any of the SRS airbags have been inflated.

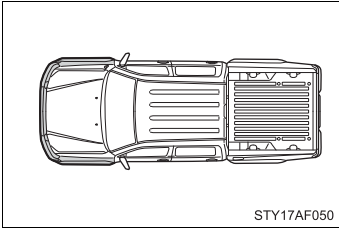

- The front of the vehicle is damaged or deformed, or was involved in an accident that was not severe enough to cause the SRS airbags to inflate.

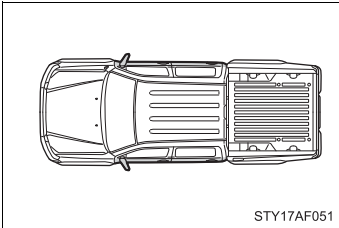

- A portion of a door is damaged or deformed, or the vehicle was involved in an accident that was not severe enough to cause the SRS side airbags and curtain shield airbags to inflate.

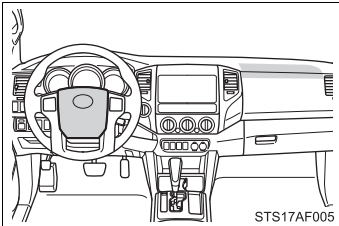

- The pad section of the steering wheel or dashboard near the front passenger airbag is scratched, cracked, or otherwise damaged.

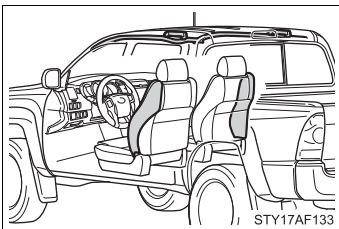

- The surface of the seats with the side airbag is scratched, cracked or otherwise damaged.
- The portion of the front pillars, rear pillars or roof side rail garnishes (padding) containing the curtain shield airbags inside is scratched, cracked or otherwise damaged.



 **CAUTION**
**■ SRS airbag precautions**

Observe the following precautions regarding the airbags.  
Failure to do so may cause death or serious injury.

- The driver and all passengers in the vehicle must wear their seat belts properly.

The SRS airbags are supplemental devices to be used with the seat belts.

- The SRS driver airbag deploys with considerable force, and can cause death or serious injury especially if the driver is very close to the airbag. The National Highway Traffic Safety Administration (“NHTSA”) advises:

Since the risk zone for the driver’s airbag is the first 2 - 3 in. (50 - 75 mm) of inflation, placing yourself 10 in. (250 mm) from your driver airbag provides you with a clear margin of safety. This distance is measured from the center of the steering wheel to your breastbone. If you now sit less than 10 in. (250 mm) away, you can change your driving position in several ways:

- Move your seat to the rear as far as you can while still reaching the pedals comfortably.
- Slightly recline the back of the seat.  
Although vehicle designs vary, many drivers can achieve the 10 in. (250 mm) distance, even with the driver seat all the way forward, simply by reclining the back of the seat somewhat. If reclining the back of your seat makes it hard to see the road, raise yourself by using a firm, non-slippery cushion, or raise the seat if your vehicle has that feature.
- If your steering wheel is adjustable, tilt it downward. This points the airbag toward your chest instead of your head and neck.

**⚠ CAUTION**

**■ SRS airbag precautions**

The seat should be adjusted as recommended by NHTSA above, while still maintaining control of the foot pedals and steering wheel, and your view of the instrument panel controls.

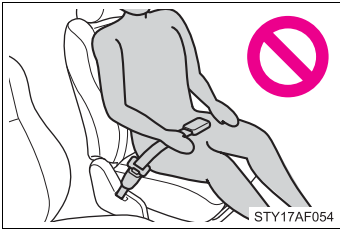

- If the seat belt extender has been connected to the front seat belt buckles but the seat belt extender has not also been fastened to the latch plate of the seat belt, the SRS front airbags will judge that the driver and front passenger are wearing the seat belt even though the seat belt has not been connected. In this case, the SRS front airbags may not activate correctly in a collision, resulting in death or serious injury in the event of a collision. Be sure to wear the seat belt with the seat belt extender.
- The SRS front passenger airbag also deploys with considerable force, and can cause death or serious injury especially if the front passenger is very close to the airbag. The front passenger seat should be as far from the airbag as possible with the seatback adjusted, so the front passenger sits upright.
- Improperly seated and/or restrained infants and children can be killed or seriously injured by a deploying airbag. An infant or child who is too small to use a seat belt should be properly secured using a child restraint system. Toyota strongly recommends that all infants and children be placed in the rear seats of the vehicle and properly restrained. The rear seats are the safest for infants and children. (→P. 100)

 CAUTION

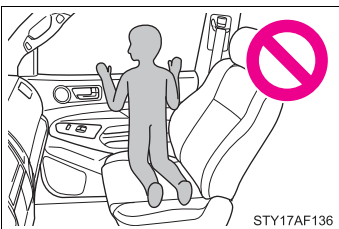
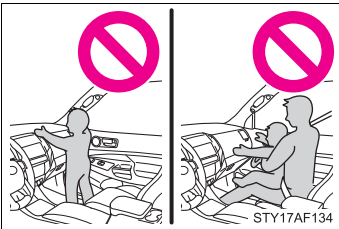
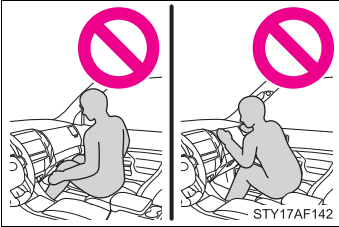
**■ SRS airbag precautions**

- Do not sit on the edge of the seat or lean against the dashboard.
- Do not allow a child to stand in front of the SRS front passenger airbag unit or sit on the knees of a front passenger.
- Do not drive the vehicle while the driver or passenger has items resting on their knees.
- Do not lean against the door, the roof side rail or the front, side and rear pillars.
- Do not allow anyone to kneel on the passenger seat toward the door or put their head or hands outside the vehicle.

**CAUTION**

**SRS airbag precautions**

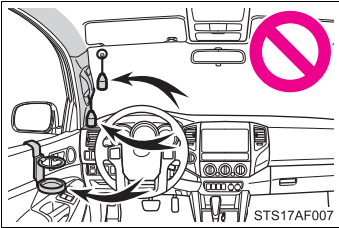
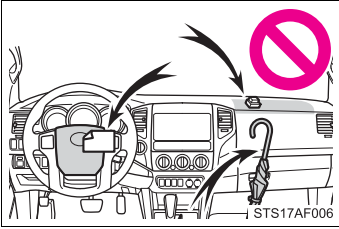

- Do not attach anything to or lean anything against areas such as the dashboard or steering wheel pad. These items can become projectiles when SRS driver and front passenger airbags deploy.
- Do not attach anything to areas such as the door, windshield glass, side door glass, front and rear pillars, roof side rail or assist grip.
- Do not hang coat hangers or other hard objects on the coat hooks. All of these items could become projectiles and seriously injure or kill you, should the SRS curtain shield airbag deploy.

- Do not use seat accessories which cover the parts where the SRS side airbags inflate as they may interfere with inflation of the airbags.
- Do not strike or apply significant levels of force to the area of the SRS airbag components (→P. 83). Doing so can cause the SRS airbags to malfunction.
- Do not touch any of the component parts immediately after the SRS airbags have deployed (inflated) as they may be hot.
- If breathing becomes difficult after the SRS airbag has deployed, open a door or window to allow fresh air in, or leave the vehicle if it is safe to do so. Wash off any residue as soon as possible to prevent skin irritation.
- If the areas where the SRS airbags are stored, such as the steering wheel pad and front and rear pillar garnishes, are damaged or cracked, have them replaced by your Toyota dealer.

 CAUTION**■ Modification and disposal of SRS airbag system components**

Do not dispose of your vehicle or perform any of the following modifications without consulting your Toyota dealer.

The SRS airbags may malfunction or deploy (inflate) accidentally, causing death or serious injury.

- Installation, removal, disassembly and repair of the SRS airbags.
- Repairs, modifications, removal or replacement of the steering wheel, instrument panel, dashboard, seats or seat upholstery, front, side and rear pillars or roof side rails.
- Repairs or modifications of the front fender, front bumper, or side of the occupant compartment.
- Installation of a grille guard (bull bars, kangaroo bar, etc.), snow plows, winches or roof luggage carrier.
- Modifications to the vehicle's suspension system.
- Do not use tires or wheels other than the manufacturer's recommended size. (→P. 532)
- Installation of electronic devices such as mobile two-way radios or CD players.
- Modifications to your vehicle for a person with a physical disability.

**Deactivating the curtain shield airbags in a vehicle rollover (4WD models only)**

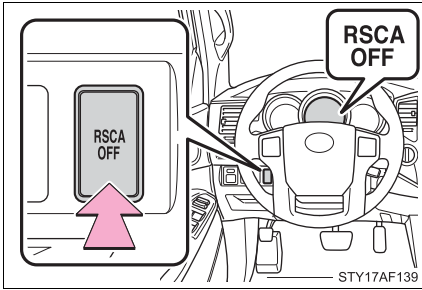

On/off (hold for a few seconds)

The RSCA OFF indicator turns on (only when the engine switch is in the ON position.)

The roll sensing function for the curtain shield airbags and seat belt pretensioners will turn back on automatically each time the engine switch is turned on.

■ **The switch only should be used**

In a situation where inflation is not desired (such as during extreme off-road driving).

■ **Operating conditions when the RSCA OFF indicator is on**

- The curtain shield airbag and seat belt pretensioner will not activate in a vehicle rollover.
- The curtain shield airbag will activate in a severe side impact.
- The pretensioner will active in a severe frontal collision.

**⚠ CAUTION**

■ **For normal driving**

Make sure the RSCA OFF indicator is not turned on. If it is left on, the curtain shield airbag will not activate in the event of an accident, which may result in death or serious injury.

# Front passenger occupant classification system

Your vehicle is equipped with a front passenger occupant classification system. This system detects the conditions of the right front passenger seat and activates or deactivates the devices for the front passenger.

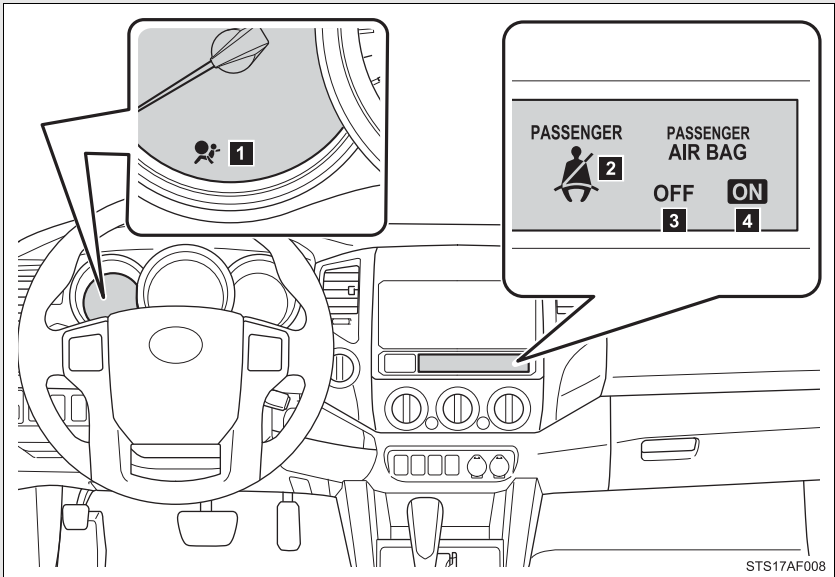

- 1** SRS warning light
- 2** Front passenger's seat belt reminder light
- 3** AIR BAG OFF indicator light
- 4** AIR BAG ON indicator light

**Conditions and operation of the front passenger occupant classification system**

■ **Adult\*1**

Indicator/ warning light	AIR BAG ON and AIR BAG OFF indicator lights	AIR BAG ON
	SRS warning light	Off
	Front passenger's seat belt reminder light	Flashing*2
Devices	Front passenger airbag	Activated
	Side airbag on the front passenger seat	
	Curtain shield airbag in the front passenger side	
	Front passenger's seat belt pretensioner	

■ **Child\*3 or child restraint system\*4**

Indicator/ warning light	AIR BAG ON and AIR BAG OFF indicator lights	AIR BAG OFF*5
	SRS warning light	Off
	Front passenger's seat belt reminder light	Flashing*2
Devices	Front passenger airbag	Deactivated
	Side airbag on the front passenger seat	Activated
	Curtain shield airbag in the front passenger side	
	Front passenger's seat belt pretensioner	



## ■ Unoccupied

Indicator/ warning light	AIR BAG ON and AIR BAG OFF indicator lights	Not illuminated
	SRS warning light	Off
	Front passenger's seat belt reminder light	
Devices	Front passenger airbag	Deactivated
	Side airbag on the front passenger seat	Activated
	Curtain shield airbag in the front passenger side	
	Front passenger's seat belt pretensioner	Deactivated

## ■ There is a malfunction in the system

Indicator/ warning light	AIR BAG ON and AIR BAG OFF indicator lights	AIR BAG OFF
	SRS warning light	On
	Front passenger's seat belt reminder light	Off
Devices	Front passenger airbag	Deactivated
	Side airbag on the front passenger seat	Activated
	Curtain shield airbag in the front passenger side	
	Front passenger's seat belt pretensioner	

- \*1: The system judges a person of adult size as an adult. When a smaller adult sits in the front passenger seat, the system may recognize him/her as a child depending on his/her physique and posture.
- \*2: In the event the front passenger does not wear a seat belt.
- \*3: When a larger child who has outgrown a child restraint system sits in the front passenger seat, the system may recognize him/her as an adult depending on his/her physique or posture.

- \*4: Never install a rear-facing child restraint system on the front passenger seat. A forward-facing child restraint system should only be installed on the front passenger seat when it is unavoidable. (→P. 100)
- \*5: In case the indicator is not illuminated, consult this manual for installing the child restraint system properly. (→P. 104)

 CAUTION

**■ Front passenger occupant classification system precautions**

Observe the following precautions regarding front passenger occupant classification system.

Failure to do so may cause death or serious injury.

- Wear the seat belt properly.
- Make sure the front passenger's seat belt tab has not been left inserted into the buckle before someone sits in the front passenger seat.
- Make sure the AIR BAG OFF indicator light is not illuminated when using the seat belt extender for the front passenger seat. If the AIR BAG OFF indicator light is illuminated, disconnect the extender tongue from the seat belt buckle, then reconnect the seat belt. Reconnect the seat belt extender after making sure the AIR BAG ON indicator light is illuminated. If you use the seat belt extender while the AIR BAG OFF indicator light is illuminated, the SRS airbags for the passenger may not activate correctly, which could cause death or serious injury in the event of collision.
- Do not place a heavy load on the front passenger seat or equipment (e.g. seatback table).
- Do not apply pressure to the front passenger seat by resting hands or legs on the seatback.
- Do not let a rear passenger lift the front passenger seat with their feet or press on the seatback with their legs.
- Do not put objects under the front passenger seat.

 CAUTION**Front passenger occupant classification system precautions**

- Do not recline the front passenger seatback so far that it touches a rear seat or a back wall. This may cause the AIR BAG OFF indicator light to be illuminated, which indicates that the passenger's airbags will not deploy in the event of a severe accident. If the seatback touches the rear seat or back wall, return the seatback to a position where it does not touch the rear seat or back wall. Keep the front passenger seatback as upright as possible when the vehicle is moving. Reclining the seatback excessively may lessen the effectiveness of the seat belt system.
- If an adult sits in the front passenger seat, the AIR BAG ON indicator light is illuminated. If the AIR BAG OFF indicator is illuminated, ask the passenger to sit up straight, well back in the seat, feet on the floor, and with the seat belt worn correctly. If the AIR BAG OFF indicator still remains illuminated, either ask the passenger to move to the rear seat, or if that is not possible, move the front passenger seat fully rearward.
- When it is unavoidable to install the forward-facing child restraint system on the front passenger seat, install the child restraint system on the front passenger seat in the proper order. (→P. 104)
- Do not modify or remove the front seats.
- Do not kick the front passenger seat or subject it to severe impact. Otherwise, the SRS warning light may come on to indicate a malfunction of the detection system. In this case, contact your Toyota dealer immediately.
- Child restraint systems installed on the rear seat should not contact the front seatbacks.
- Do not use a seat accessory, such as a cushion or seat cover, that covers the seat cushion surface.
- Do not attach a commercial seatback table or other heavy item to the back of the front passenger seat.
- Do not modify or replace the upholstery of the front seat.

## Child restraint systems

**A child restraint system for a small child or baby must itself be properly restrained on the seat with the lap portion of the lap/shoulder belt.**

**The laws of all 50 states of the U.S.A. and Canada now require the use of child restraint systems.**

### Points to remember

Studies have shown that installing a child restraint on a rear seat is much safer than installing one to the front passenger seat.

- Choose a child restraint system that suits your vehicle and is appropriate to the age and size of the child.
- For installation details, follow the instructions provided with the child restraint system.

General installation instructions are provided in this manual.

(→P. 104)

### Types of child restraints

Child restraint systems are classified into the following 3 types according to the age and size of the child.

- ▶ Rear facing — Infant seat/convertible seat

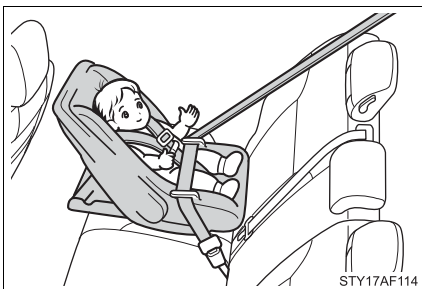

► Forward facing — Convertible seat

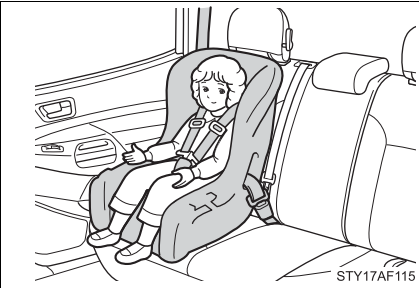

► Booster seat

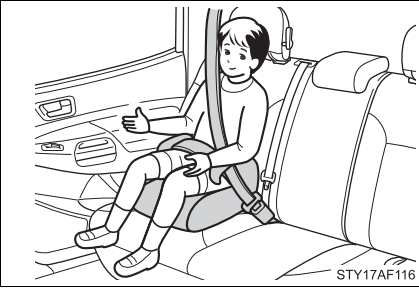

■ Selecting an appropriate child restraint system

- Use a child restraint system appropriate for the child until the child becomes large enough to properly wear the vehicle's seat belt.
- If a child is too large for a child restraint system, sit the child on a rear seat and use the vehicle's seat belt. (→P. 57)

 CAUTION

■ **Child restraint precautions**

- For effective protection in automobile accidents and sudden stops, a child must be properly restrained, using a seat belt or child restraint system depending on the age and size of the child. Holding a child in your arms is not a substitute for a child restraint system. In an accident, the child can be crushed against the windshield, or between you and the vehicle's interior.
- Vehicles without rear seats: Toyota strongly urges use of a proper child restraint system which conforms to the size of the child.
- Vehicles with rear seats: Toyota strongly urges the use of a proper child restraint system that conforms to the size of the child, installed on the rear seat. According to accident statistics, the child is safer when properly restrained in the rear seat than in the front seat.
- Never install a rear-facing child restraint system on the front passenger seat even if the AIR BAG OFF indicator light is illuminated. In the event of an accident, the force of the rapid inflation of the front passenger airbag can cause death or serious injury to the child if the rear-facing child restraint system is installed on the front passenger seat.
- Vehicles with rear seats: A forward-facing child restraint system may be installed on the front passenger seat only when it is unavoidable. A child restraint system that requires a top tether strap should not be used in the front passenger seat since there is no top tether strap anchor for the front passenger seat. Adjust the seatback as upright as possible and always move the seat as far back as possible even if AIR BAG OFF indicator light is illuminated, because the front passenger airbag could inflate with considerable speed and force. Otherwise, the child may be killed or seriously injured.

 CAUTION**■ Child restraint precautions**

- Do not use the seat belt extender when installing a child restraint system on the front or rear passenger seat. If installing a child restraint system with the seat belt extender connected to the seat belt, the seat belt will not securely hold the child restraint system, which could cause death or serious injury to the child or other passengers in the event of a sudden stop, sudden swerve or an accident.
- Do not allow the child to lean his/her head or any part of his/her body against the door or the area of the seat, front and rear pillars or roof side rail from which the side airbags or curtain shield airbags deploy even if the child is seated in the child restraint system. It is dangerous if the side airbags and curtain shield airbags inflate, and the force of the rapid inflation could cause death or serious injury to the child.
- Make sure you have complied with all installation instructions provided by the child restraint manufacturer and that the system is properly secured. If it is not secured properly, it may cause death or serious injury to the child in the event of a sudden stop, sudden swerve or an accident.

**■ When children are in the vehicle**

Do not allow children to play with the seat belt. If the seat belt becomes twisted around a child's neck, it may lead to choking or other serious injuries that could result in death. If this occurs and the buckle cannot be unfastened, scissors should be used to cut the belt.

**■ When the child restraint system is not in use**

- Keep the child restraint system properly secured on the seat even if it is not in use. Do not store the restraint unsecured in the passenger compartment.
- If it is necessary to detach the child restraint system, remove it from the vehicle. This will prevent it from injuring passengers in the event of a sudden stop, sudden swerve or an accident.

## Installing child restraints

**Follow the child restraint system manufacturer's instructions. Firmly secure child restraints to the seats using the LATCH anchors or a seat belt. Attach the top tether strap when installing a child restraint.**

**The lap/shoulder belt can be used if your child restraint system is not compatible with the LATCH (Lower Anchors and Tethers for Children) system.**

### ■ Using the LATCH anchors

#### ▶ Access Cab models (vehicles with rear seats)

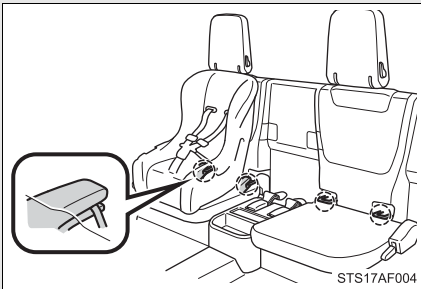

Child restraint LATCH anchors

LATCH anchors are provided for the each rear seat.

#### ▶ Double Cab models

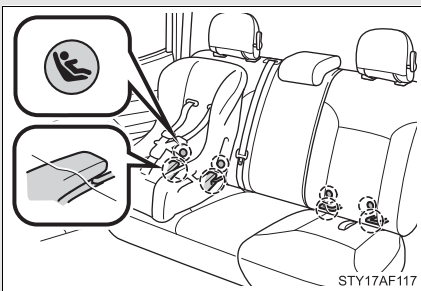

Child restraint LATCH anchors

LATCH anchors are provided for the outside rear seats.

Buttons displaying the location of the anchors are attached to the seats.



### ■ Using the seat belts

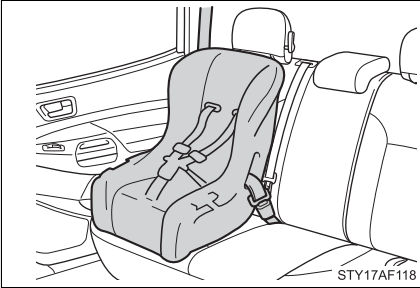

Seat belts equipped with a child restraint locking mechanism (ALR/ELR belts except driver's seat belt) (→P. 57)

### ■ Using the top tether strap

▶ Access Cab models (vehicles without rear seats)

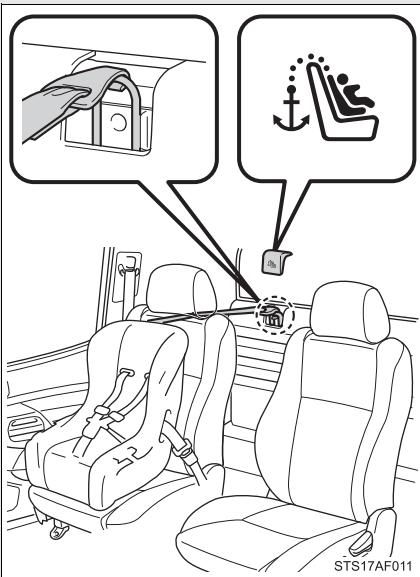

Anchor bracket (for top tether strap)

Anchor bracket is provided for passenger seat.

► Access Cab models (vehicles with rear seats)

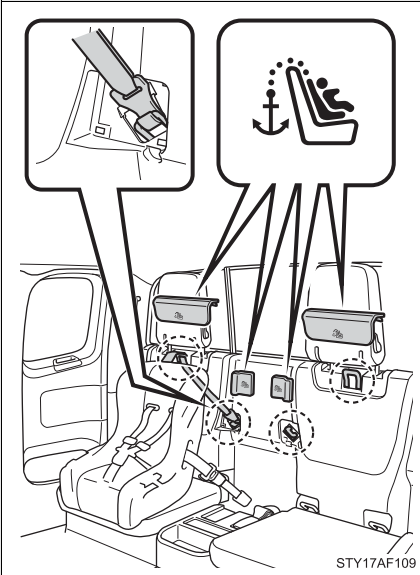

Anchor bracket (for top tether strap)

Anchor bracket is provided for each rear seat.

► Double Cab models

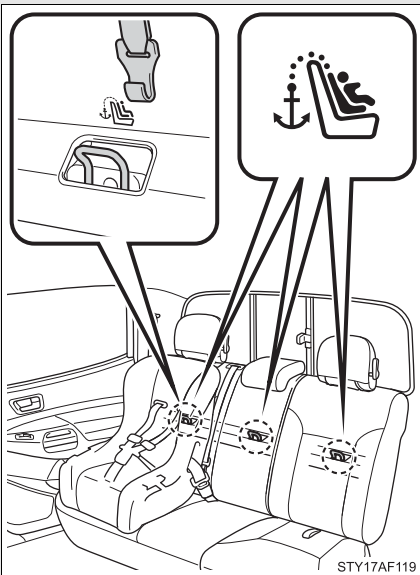

Anchor bracket (for top tether strap)

Anchor bracket is provided for each rear seat.

## Installation with LATCH system (Access Cab models [vehicles with rear seats])

### ► Type A

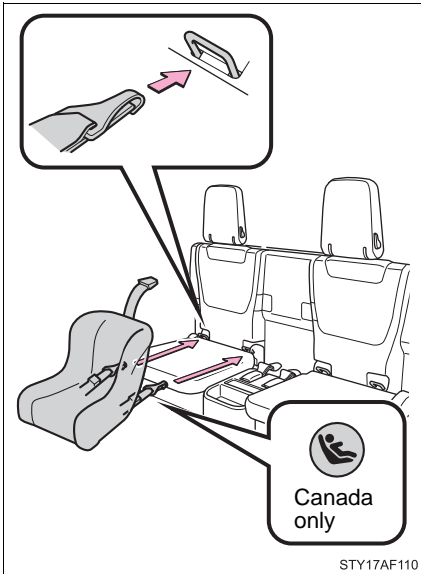

**STEP 1** Latch the hooks of the lower straps onto the LATCH anchors and tighten the lower straps.

**STEP 2** If the child restraint has a top tether strap, the top tether strap should be latched onto the top tether strap anchor.

For owners in Canada:

A symbol on a child restraint system indicates the presence of a lower connector system.

1

Before driving

► Type B

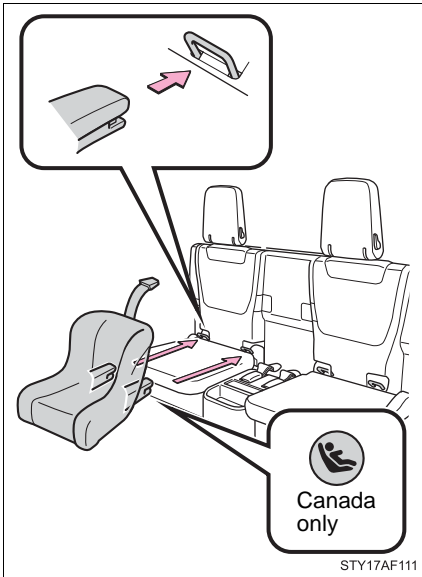

**STEP 1** Latch the buckles onto the LATCH anchors.

**STEP 2** If the child restraint has a top tether strap, the top tether strap should be latched onto the top tether strap anchor.

For owners in Canada:

A symbol on a child restraint system indicates the presence of a lower connector system.

## Installation with LATCH system (Double Cab models)

### ► Type A

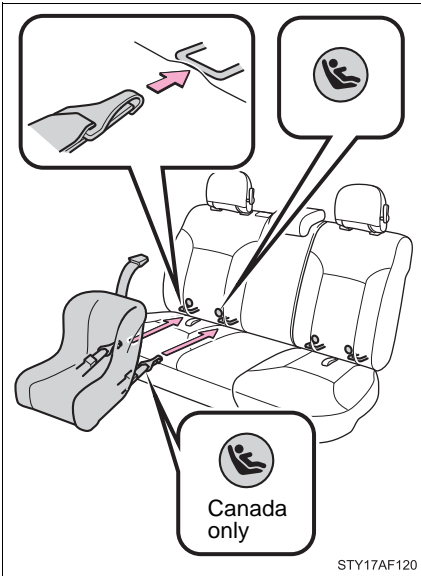

**STEP 1** Widen the gap between the seat cushion and seatback slightly.

**STEP 2** Latch the hooks of the lower straps onto the LATCH anchors and tighten the lower straps.

**STEP 3** If the child restraint has a top tether strap, the top tether strap should be latched onto the top tether strap anchor.

For owners in Canada:

A symbol on a child restraint system indicates the presence of a lower connector system.

► Type B

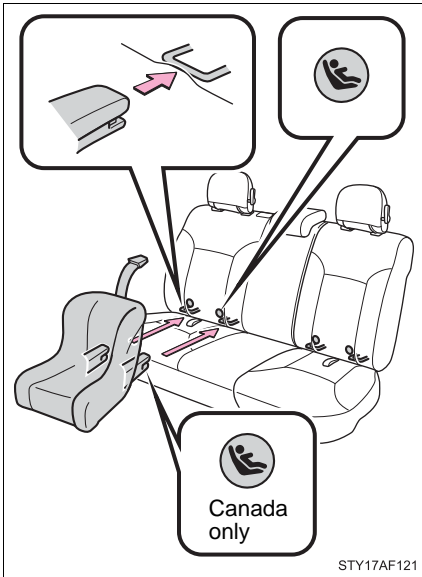

**STEP 1** Widen the gap between the seat cushion and seatback slightly.

**STEP 2** Latch the buckles onto the LATCH anchors.

**STEP 3** If the child restraint has a top tether strap, the top tether strap should be latched onto the top tether strap anchor.

For owners in Canada:

A symbol on a child restraint system indicates the presence of a lower connector system.

**Installing child restraints using a seat belt (child restraint lock function belt)**

■ **Rear-facing (vehicles without rear seats) — Infant seat/convertible seat**

Never install a rear-facing child restraint. Your vehicle is not designed to carry an infant.

■ **Rear-facing (vehicles with rear seats) — Infant seat/convertible seat**

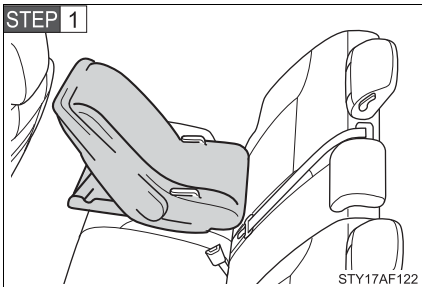

**STEP 1**

Place the child seat on the rear seat facing the rear of the vehicle.

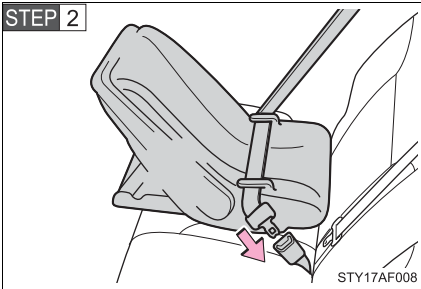

Run the seat belt through the child seat and insert the plate into the buckle. Make sure that the belt is not twisted.

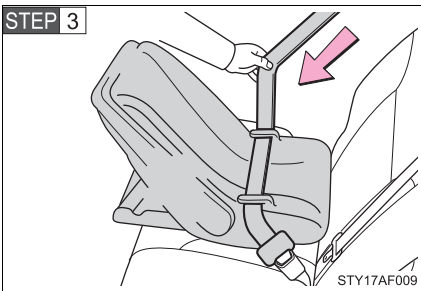

Fully extend the shoulder belt and then allow it to retract slightly in order to activate the ALR lock mode.

Lock mode allows the seat belt to retract only.

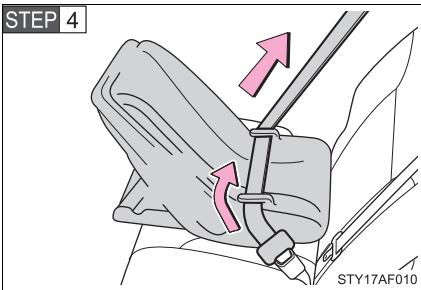

While pushing the child seat down into the rear seat, allow the shoulder belt to retract until the child seat is securely in place.

After the shoulder belt has retracted to a point where there is no slack in the belt, pull the belt to check that it cannot be extended.

### ■ Forward-facing — Convertible seat

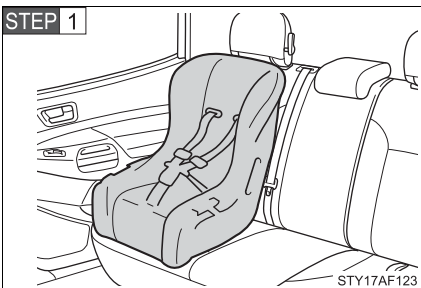

Place the child seat on the seat facing the front of the vehicle.

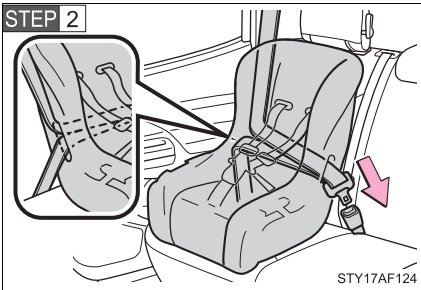

Run the seat belt through the child seat and insert the plate into the buckle. Make sure that the belt is not twisted.

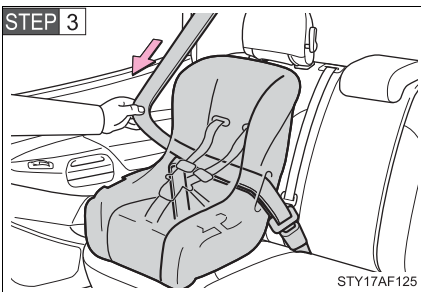

Fully extend the shoulder belt and then allow it to retract slightly in order to activate the ALR lock mode.

Lock mode allows the seat belt to retract only.

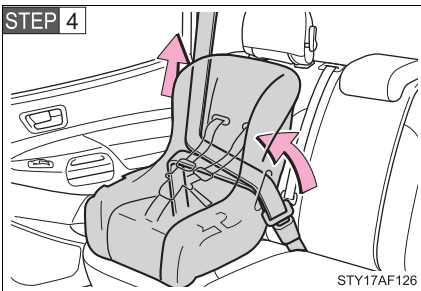

While pushing the child seat into the seat, allow the shoulder belt to retract until the child seat is securely in place.

After the shoulder belt has retracted to a point where there is no slack in the belt, pull the belt to check that it cannot be extended.

**STEP 5** If the child restraint has a top tether strap, the top tether strap should be latched onto the top tether strap anchor.  
(→P. 114, 115)



## ■ Booster seat

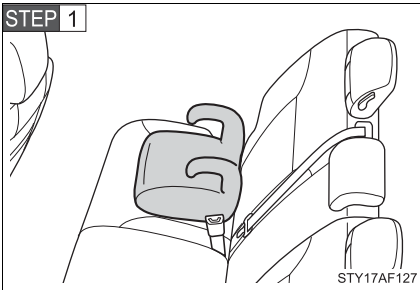

Place the booster seat on the seat facing the front of the vehicle.

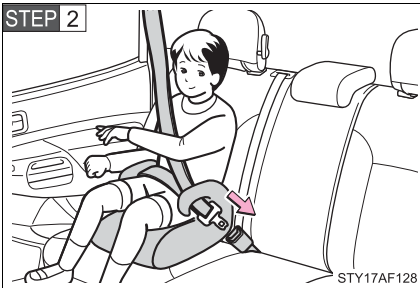

Sit the child in the booster seat. Fit the seat belt to the booster seat according to the manufacturer's instructions and insert the plate into the buckle. Make sure that the belt is not twisted.

Check that the shoulder belt is correctly positioned over the child's shoulder, and that the lap belt is as low as possible.  
(→P. 57)

## Removing a child restraint installed with a seat belt

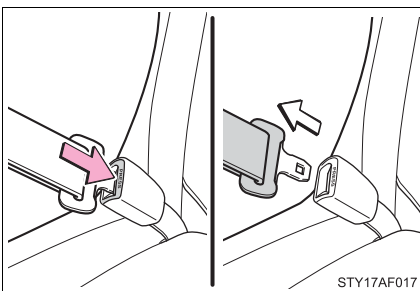

Push the buckle release button and fully retract the seat belt.

## Child restraint systems with a top tether strap (Access Cab models)

### ► Vehicles without rear seats

**STEP 1** Remove the head restraints (→P. 53)

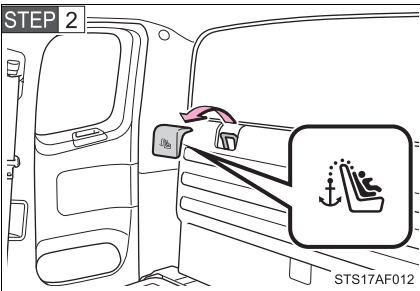

Remove the anchor bracket covers.

Store the removed covers in a safe place such as the glove box.

**STEP 3** Secure the child restraint using a seat belt.

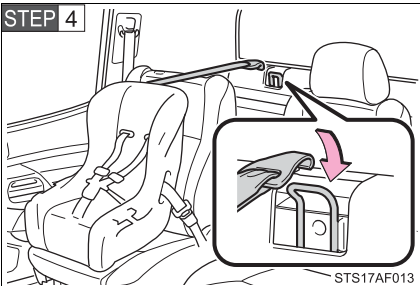

Latch the hook onto the anchor bracket and tighten the top tether strap.

Make sure the top tether strap is securely latched.

**STEP 5** Install the head restraint to the original position (→P. 53)

### ► Vehicles with rear seats

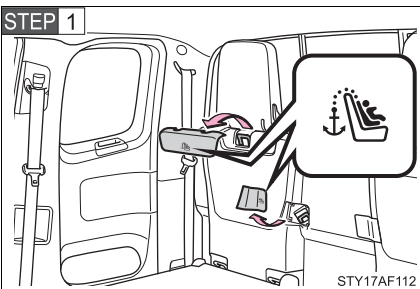

Remove the anchor bracket covers.

Store the removed covers in a safe place such as the glove box.

**STEP 2** Secure the child restraint using a seat belt or lower anchors.

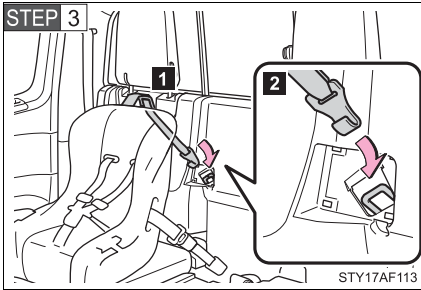

- 1 Route the top tether strap through the routing device as shown in the illustration.

Make sure the top tether strap is not twisted.

- 2 Latch the hook onto the anchor bracket and tighten the top tether strap.

Make sure the top tether strap is securely latched.

### Child restraint systems with a top tether strap (Double Cab models)

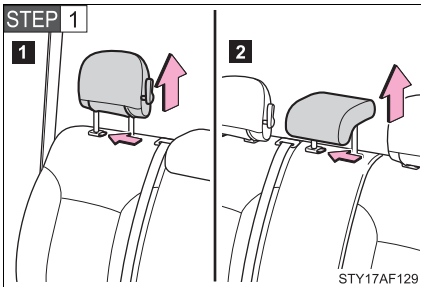

Remove the head restraint.

Installing position:

- 1 Outside passenger seat
- 2 Center passenger seat

#### ► Outside passenger seat

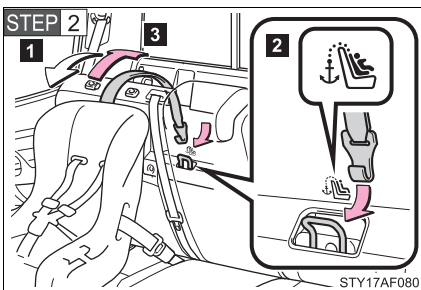

- 1 Swing the seatback forward slightly. (→P. 50)
- 2 Latch the hook onto the anchor bracket.
- 3 Return the seatback to its original position.

Make sure the seatback is securely locked by pushing forward and rearward on the top of the seatback.

► Center passenger seat

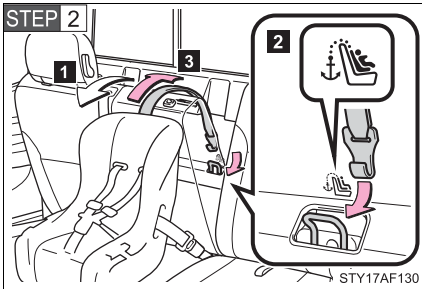

- 1 Swing the seatback forward slightly. (→P. 50)
- 2 Latch the hook onto the anchor bracket.
- 3 Return the seatback to its original position.

Make sure the seatback is securely locked by pushing forward and rearward on the top of the seatback.

- STEP 3** Secure the child restraint using a seat belt or lower anchors, and tighten the top tether strap.

Make sure the top tether strap is securely latched.

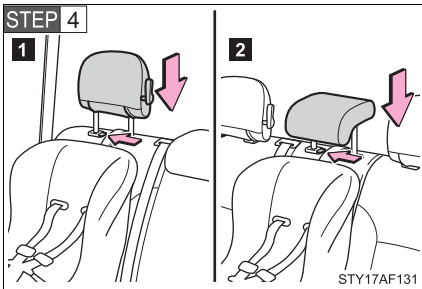

Replace the head restraint.

Installing position:

- 1 Outside passenger seat
- 2 Center passenger seat

■ Laws and regulations pertaining to anchorages

The LATCH system conforms to FMVSS225 or CMVSS210.2.

Child restraint systems conforming to FMVSS213 or CMVSS213 specifications can be used.

This vehicle is designed to conform to the SAE J1819.

## ⚠ CAUTION

### ■ When installing a booster seat

Do not fully extend the shoulder belt to prevent the belt from going to ALR lock mode. (→P. 59)

ALR mode causes the belt to tighten only which could cause injury or discomfort to the child.

### ■ When installing a child restraint system

Follow the directions given in the child restraint system installation manual and fix the child restraint system securely in place.

If the child restraint system is not correctly fixed in place, the child or other passengers may be seriously injured or even killed in the event of sudden braking, sudden swerving or an accident.

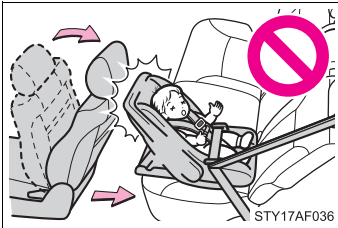

- Vehicles with rear seats: If the driver's seat interferes with the child restraint system and prevents it from being attached correctly, attach the child restraint system to the right-hand rear seat.

- Vehicles with rear seats: Adjust the front passenger seat so that it does not interfere with the child restraint system.

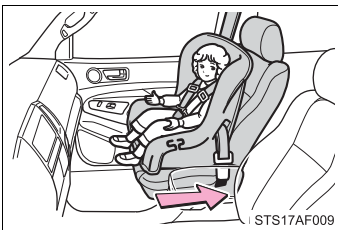

- Only put a forward-facing or booster child seat on the front seat when it is unavoidable. When installing a forward-facing or booster child seat on the front passenger seat, move the seat as far back as possible even if AIR BAG OFF indicator light is illuminated. Failing to do so may result in death or serious injury if the airbags deploy (inflate).

 **CAUTION**

■ **When installing a child restraint system**

- When a booster seat is installed, always ensure that the shoulder belt is positioned across the center of the child's shoulder. The belt should be kept away from the child's neck, but not so that it could fall off the child's shoulder. Failing to do so may result in death or serious injury in the event of sudden braking, sudden swerving or an accident.
- Ensure that the belt and tab are securely locked and the seat belt is not twisted.
- Push and pull the child restraint system from side to side and forward to be sure it is secure.
- After securing the child restraint system, never adjust the seat.
- Follow all installation instructions provided by the child restraint system manufacturer.

■ **Do not use a seat belt extender**

If a seat belt extender is used when installing a child restraint system, the seat belt will not securely hold the child restraint system, which could cause death or serious injury to the child or other passengers in the event of sudden braking, sudden swerving or an accident.

■ **To correctly attach a child restraint system to the anchors**

When using the LATCH anchors, be sure that there are no foreign objects around the anchors and that the seat belt is not caught behind the child restraint. Make sure the child restraint system is securely attached, or it may cause death or serious injury to the child or other passengers in the event of a sudden stop, sudden swerve or accident.

### 2-1. Driving procedures

Driving the vehicle.....	120
Engine (ignition) switch....	131
Automatic transmission....	134
Manual transmission .....	138
Turn signal lever .....	141
Parking brake.....	142
Horn .....	144

### 2-2. Gauges and meters

Gauges and meters .....	145
Indicators and warning lights .....	148

### 2-3. Operating the lights and wipers

Headlight switch.....	152
Fog light switch .....	155
Windshield wipers and washer .....	156

### 2-4. Using other driving systems

Cruise control.....	162
Rear view monitor system .....	166
Four-wheel drive system .....	177
Active traction control system .....	181
AUTO LSD system.....	183
Rear differential lock system .....	185
Downhill Assist Control system .....	188
Clutch start cancel switch .....	190
Driving assist systems .....	191

### 2-5. Driving information

Off-road precautions (4WD models and PreRunner) .....	197
Cargo and luggage .....	202
Vehicle load limits .....	207
Winter driving tips .....	209
Trailer towing .....	213
Dinghy towing .....	233

## 2-1. Driving procedures

# Driving the vehicle

The following procedures should be observed to ensure safe driving.

### ■ Starting the engine

→P. 131

### ■ Driving

#### ▶ Automatic transmission

**STEP 1** With the brake pedal depressed, shift the shift lever to D. (→P. 134)

**STEP 2** Release the parking brake. (→P. 142)

**STEP 3** Gradually release the brake pedal and gently depress the accelerator pedal to accelerate the vehicle.

#### ▶ Manual transmission

**STEP 1** With the clutch pedal fully depressed, shift the shift lever to 1. (→P. 138)

**STEP 2** Release the parking brake. (→P. 142)

**STEP 3** Gradually release the clutch pedal. At the same time, gently depress the accelerator pedal to accelerate the vehicle.

### ■ Stopping

#### ▶ Automatic transmission

**STEP 1** With the shift lever in D, depress the brake pedal.

**STEP 2** If necessary, set the parking brake.

When the vehicle is stopped for an extended period of time, shift the shift lever to P or N. (→P. 134)

#### ▶ Manual transmission

**STEP 1** With the clutch pedal fully depressed, depress the brake pedal.

**STEP 2** If necessary, set the parking brake.

When the vehicle is stopped for an extended period of time, shift the shift lever to N. (→P. 138)



## ■ Parking the vehicle

### ▶ Automatic transmission

**STEP 1** With the shift lever in D, depress the brake pedal.

**STEP 2** Set the parking brake. (→P. 142)

**STEP 3** Shift the shift lever to P. (→P. 134)

When parking on a hill, if necessary, block the wheels.

**STEP 4** Turn the engine switch to the LOCK position to stop the engine.

**STEP 5** Lock the door, making sure that you have the key on your person.

### ▶ Manual transmission

**STEP 1** With the clutch pedal fully depressed, depress the brake pedal.

**STEP 2** Set the parking brake. (→P. 142)

**STEP 3** Shift the shift lever to N. (→P. 138)

When parking on a hill, shift the shift lever to 1 or R. If necessary, block the wheels.

**STEP 4** Turn the engine switch to the LOCK position to stop the engine.

**STEP 5** Lock the door, making sure that you have the key on your person.

## Starting on a steep uphill

### ▶ Automatic transmission

**STEP 1** With the brake pedal depressed, firmly set the parking brake and shift the shift lever to D.

**STEP 2** Gently depress the accelerator pedal.

**STEP 3** Release the parking brake.

► Manual transmission

**STEP 1** With the parking brake firmly set and the clutch pedal fully depressed, shift the shift lever to 1.

**STEP 2** Lightly depress the accelerator pedal at the same time as gradually releasing the clutch pedal.

**STEP 3** Release the parking brake.

---

■ **Driving in the rain**

- Drive carefully when it is raining, because visibility will be reduced, the windows may become fogged-up, and the road will be slippery.
- Drive carefully when it starts to rain, because the road surface will be especially slippery.
- Refrain from high speeds when driving on an expressway in the rain, because there may be a layer of water between the tires and the road surface, preventing the steering and brakes from operating properly.

■ **Engine speed while driving (vehicles with an automatic transmission)**

In the following conditions, the engine speed may become high while driving. This is due to automatic up-shifting control or down-shifting implementation to meet driving conditions. It does not indicate sudden acceleration.

- The vehicle is judged to be driving uphill or downhill
- When the accelerator pedal is released

■ **Breaking in your new Toyota**

To extend the life of the vehicle, the following precautions are recommended to observe:

- For the first 200 miles (300 km):  
Avoid sudden stops.
- For the first 500 miles (800 km):  
Do not tow a trailer.
- For the first 1000 miles (1600 km):
  - Do not drive at extremely high speeds.
  - Avoid sudden acceleration.
  - Do not drive continuously in the low gears.
  - Do not drive slowly with the manual transmission in a high gear.
  - Do not drive at a constant speed for extended periods.

### ■ Drum-in-disc type parking brake system

Your vehicle has a drum-in-disc type parking brake system. This type of brake system needs bedding-down of the brake shoes periodically or whenever the parking brake shoes and/or drum are replaced. Have your Toyota dealer perform the bedding down operation.

### ■ Operating your vehicle in a foreign country

Comply with the relevant vehicle registration laws and confirm the availability of the correct fuel. (→P. 523)

### ■ When turning off the engine

The emission system operating sounds may continue for a short time after the engine is turned off. This is not a malfunction, and helps to ensure optimal performance of the emission system.

## CAUTION

### ■ When starting the vehicle (vehicles with an automatic transmission)

Always keep your foot on the brake pedal while stopped with the engine running. This prevents the vehicle from creeping.

### ■ When driving the vehicle

- Do not drive if you are unfamiliar with the location of the brake and accelerator pedals to avoid depressing the wrong pedal.
  - Accidentally depressing the accelerator pedal instead of the brake pedal will result in sudden acceleration that may lead to an accident that could result in death or serious injury.
  - When backing up, you may twist your body around, leading to a difficulty in operating the pedals. Make sure to operate the pedals properly.
  - Make sure to keep a correct driving posture even when moving the vehicle only slightly, allowing you to depress the brake and accelerator pedals properly.
  - Depress the brake pedal using your right foot. Depressing the brake pedal using your left foot may delay response in an emergency, resulting in an accident.
- Do not drive the vehicle over or stop the vehicle near flammable materials. The exhaust system and exhaust gases can be extremely hot. This may cause a fire if there is any flammable material nearby.

 CAUTION

■ **When driving the vehicle**

- On vehicles with an automatic transmission, do not let the vehicle roll backwards while the shift lever is in a driving position, or roll forward while the shift lever is in R.

Doing so may cause the engine to stall or lead to poor brake and steering performance, resulting in an accident or damage to the vehicle.

- If the smell of exhaust is noticed inside the vehicle, open the windows and check that the back window is closed. Large amounts of exhaust in the vehicle can cause driver drowsiness and an accident, resulting in death or a serious health hazard. Have the vehicle inspected by your Toyota dealer immediately.

- On vehicles with an automatic transmission, do not shift the shift lever to P while the vehicle is moving.

Doing so can damage the transmission and may result in a loss of vehicle control.

- Do not shift the shift lever to R while the vehicle is moving forward.

Doing so can damage the transmission and may result in a loss of vehicle control.

- Do not shift the shift lever to D (vehicles with an automatic transmission) or 1 (vehicles with a manual transmission) while the vehicle is moving backward.

Doing so can damage the transmission and may result in a loss of vehicle control.

- Moving the shift lever to N while the vehicle is moving will disengage the engine from the transmission. Engine braking is not available when N is selected.

- During normal driving, do not turn off the engine. Turning the engine off while driving will not cause loss of steering or braking control, but the power assist to these systems will be lost. This will make it more difficult to steer and brake, so you should pull over and stop the vehicle as soon as it is safe to do so.

However, in the event of an emergency, such as if it becomes impossible to stop the vehicle in the normal way: →P. 513

 CAUTION**■ When driving the vehicle**

- Use engine braking (downshift) to maintain a safe speed when driving down a steep hill.  
Using the brakes continuously may cause the brakes to overheat and lose effectiveness. (→P. 134, 138)
- When stopped on an inclined surface, use the brake pedal and parking brake to prevent the vehicle from rolling backward or forward and causing an accident.
- Do not adjust the position of the steering wheel, the seat, or the inside or outside rear view mirrors while driving.  
Doing so may result in a loss of vehicle control that can cause accidents that may result in death or serious injury.
- Always check that all passengers' arms, heads or other parts of their bodies are not outside the vehicle, as this may result in death or serious injury.
- Do not drive in excess of the speed limit. Even if the legal speed limit permits it, do not drive over 85 mph (140 km/h) unless your vehicle has high-speed capability tires. Driving over 85 mph (140 km/h) may result in tire failure, loss of control and possible injury. Be sure to consult a tire dealer to determine whether the tires on your vehicle are high-speed capability tires or not before driving at such speeds.

**■ When driving on slippery road surfaces**

- Sudden braking, acceleration and steering may cause tire slippage and reduce your ability to control the vehicle, resulting in an accident.
- Sudden changes in engine speed, such as engine braking caused by up-shifting or down-shifting, may cause the vehicle to skid, resulting in an accident.
- After driving through a puddle, lightly depress the brake pedal to make sure that the brakes are functioning properly. Wet brake pads may prevent the brakes from functioning properly. If the brakes on only one side are wet and not functioning properly, steering control may be affected, resulting in an accident.

 **CAUTION**

■ **When shifting the shift lever**

On vehicles with an automatic transmission, be careful not to shift the shift lever with the accelerator pedal depressed.

This may lead to unexpected rapid acceleration of the vehicle that may cause an accident and result in death or serious injury.

■ **When the vehicle is stopped**

- Do not race the engine.

If the vehicle is in any gear other than P (automatic transmission only) or N, the vehicle may accelerate suddenly and unexpectedly, and may cause an accident.

- Do not leave the vehicle with the engine running for a long time.

If such a situation cannot be avoided, park the vehicle in an open space and check that exhaust fumes do not enter the vehicle interior.

- On vehicles with an automatic transmission, in order to prevent accidents due to the vehicle rolling away, always keep depressing the brake pedal while the engine is running, and apply the parking brake as necessary.

- If the vehicle is stopped on an incline, in order to prevent accidents caused by the vehicle rolling forward or backward, always depress the brake pedal and securely apply the parking brake as needed.

- Avoid revving or racing the engine.

Running the engine at high speed while the vehicle is stopped may cause the exhaust system to overheat, which could result in a fire if combustible material is nearby.

■ **When the vehicle is parked**

- Do not leave glasses, cigarette lighter, spray cans, or soft drink cans in the vehicle when it is in the sun.

Doing so may result in the following.

- Gas may leak from a cigarette lighter, spray can, and may lead to a fire.
- The temperature inside the vehicle may cause the plastic lenses and plastic material of eye glasses to deform or crack.
- Soft drink cans may rupture, causing the contents to spray over the interior of the vehicle, and may also cause a short circuit in the vehicle's electrical components.

 CAUTION**■ When the vehicle is parked**

- Always apply the parking brake, shift the shift lever to P (automatic transmission only), stop the engine and lock the vehicle.  
Do not leave the vehicle unattended while the engine is running.
- Do not touch the exhaust pipe while the engine is running or immediately after turning the engine off.  
Doing so may cause burns.
- Do not leave the engine running in an area with snow build-up, or where it is snowing. If snowbanks build up around the vehicle while the engine is running, exhaust gases may collect and enter the vehicle. This may lead to death or a serious health hazard.

**■ Exhaust gases**

Exhaust gases include harmful carbon monoxide (CO) that is colorless and odorless. Inhaling exhaust gases may lead to death or a serious health hazard.

- If the vehicle is in a poorly ventilated area, stop the engine. In a closed area, such as a garage, exhaust gases may collect and enter the vehicle. This may lead to death or a serious health hazard.
- The exhaust should be checked occasionally. If there is a hole or crack caused by corrosion, damage to a joint or abnormal exhaust noise, be sure to have the vehicle inspected and repaired by your Toyota dealer. Failure to do so may allow exhaust gases to enter the vehicle, resulting in death or a serious health hazard.
- Toyota does not recommend occupying the rear cargo area when it is fitted with a slide-in camper, camper shell or other type cover while the engine is running. This caution applies to both driving and stopped or parked situations with the engine running. Particular care should be taken to prevent exhaust gases from entering camper bodies, trailers or other enclosures on or around your vehicle. If exhaust fumes are detected, open all windows and thoroughly ventilate the area.

 **CAUTION**

■ **When taking a nap in the vehicle**

Always turn the engine off. Otherwise, you may accidentally move the shift lever or depress the accelerator pedal, which could cause an accident or fire due to engine overheating. Additionally, if the vehicle is parked in a poorly ventilated area, exhaust gases may collect and enter the vehicle, leading to death or a serious health hazard.

■ **When braking the vehicle**

- When the brakes are wet, drive more cautiously.  
Braking distance increases when the brakes are wet, and may cause one side of the vehicle to brake differently than the other side. Also the parking brake may not securely hold the vehicle.
- If the power brake assist function does not operate, do not follow other vehicles closely and avoid hills or sharp turns that require braking.  
In this case, braking is still possible, but the brake pedal should be depressed more firmly than usual. Also, the braking distance will increase. Have your brakes fixed immediately.
- Do not pump the brake pedal if the engine stalls.  
Each push on the brake pedal uses up the reserve for the power-assisted brakes.
- The brake system consists of 2 individual hydraulic systems: If one of the systems fails, the other will still operate. In this case, the brake pedal should be depressed more firmly than usual and braking distance becomes longer.  
Have your brakes fixed immediately.



 NOTICE

**■ When driving the vehicle**

- Do not depress the accelerator and brake pedals at the same time during driving, as this may restrain driving torque.
  - ▶ Vehicles with a manual transmission
- Do not rest your foot on the clutch pedal while driving. Doing so may cause clutch trouble.
- Do not use any gear other than the first gear when starting off and moving forward. Doing so may damage the clutch.
- Do not use the clutch to hold the vehicle when stopping on an uphill grade. Doing so may damage the clutch.
  - ▶ Vehicles with an automatic transmission
- Do not use the accelerator pedal or depress the accelerator and brake pedals at the same time to hold the vehicle on a hill.

**■ When parking the vehicle**

On vehicles with an automatic transmission, always put the shift lever in P. Failure to do so may cause the vehicle to move or the vehicle may accelerate suddenly if the accelerator pedal is accidentally depressed.

**■ Avoiding damage to vehicle parts**

- Do not turn the steering wheel fully in either direction and hold it there for a long time. Doing so may damage the power steering pump.
- When driving over bumps in the road, drive as slowly as possible to avoid damaging the wheels, underside of the vehicle, etc.

**■ If you hear a squealing or scraping noise while driving (brake pad wear limit indicators)**

Have the brake pads checked and replaced by your Toyota dealer as soon as possible.

The rotor damage can result if the pads are not replaced when needed.

It is dangerous to drive the vehicle when the wear limits of the brake pads and/or that of the brake discs are exceeded.

 NOTICE

■ **If you get a flat tire while driving**

A flat or damaged tire may cause the following situations. Hold the steering wheel firmly and gradually press the brake pedal to slow down the vehicle.

- It may be difficult to control your vehicle.
- The vehicle will make abnormal sounds.
- The vehicle will behave abnormally.

Replace a flat tire with a new one. (→P. 486)

■ **When encountering flooded roads**

Do not drive on a road that has flooded after heavy rain etc. Doing so may cause the following serious damage to the vehicle.

- Engine stalling
- Short in electrical components
- Engine damage caused by water immersion

In the event that you drive on a flooded road and the vehicle is flooded, be sure to have your Toyota dealer check the following.

- Brake function
- Changes in quantity and quality of oil and fluid used for the engine, transmission, transfer (4WD models), differentials, etc.
- Lubricant condition for the propeller shaft, bearings and suspension joints (where possible) and the function of all joints, bearings, etc.

## 2-1. Driving procedures

### Engine (ignition) switch

#### ■ Engine switch

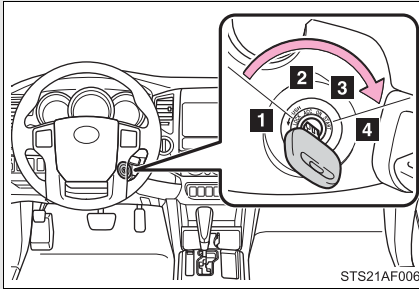

#### 1 LOCK

The steering wheel is locked and the key can be removed. (Vehicles with an automatic transmission: The key can be removed only when the shift lever is in P.)

#### 2 ACC

Some electrical components such as the audio system can be used.

#### 3 ON

All electrical components can be used.

#### 4 START

For starting the engine.

#### ■ Starting the engine

##### ▶ Automatic transmission

**STEP 1** Check that the parking brake is set.

**STEP 2** Check that the shift lever is set in P.

**STEP 3** Sit in the driver's seat and firmly depress the brake pedal.

**STEP 4** Turn the engine switch to the START position and start the engine.

##### ▶ Manual transmission

**STEP 1** Check that the parking brake is set.

**STEP 2** Check that the shift lever is set in N.

**STEP 3** Firmly depress the brake pedal and clutch pedal.

**STEP 4** Turn the engine switch to the START position and start the engine.

### ■ Turning the key from ACC to LOCK

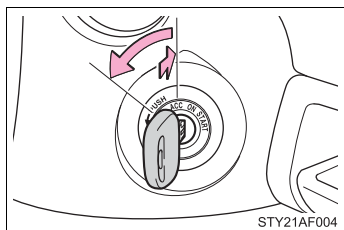

**STEP 1** Shift the shift lever to P (automatic transmission) or N (manual transmission). (→P. 134, 138)

**STEP 2** Push in the key and turn to the LOCK position.

### ■ Steering lock release

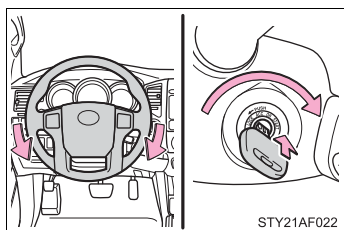

When starting the engine, the engine switch may seem stuck in the LOCK position. To free it, turn the key while turning the steering wheel slightly in either direction.

### ■ If the engine does not start (vehicles with engine immobilizer system)

The engine immobilizer system may not have been deactivated. (→P. 77)

### ■ Key reminder function

A buzzer sounds if the driver's door is opened, while the engine switch is in the ACC or LOCK position to remind you to remove the key.

### ⚠ CAUTION

#### ■ When starting the engine

Always start the engine while sitting in the driver's seat. Do not depress the accelerator while starting the engine under any circumstances.

Doing so may cause an accident resulting in death or serious injury.

 **CAUTION****■ Caution while driving**

Do not turn the engine switch to the LOCK position.

If in an emergency, you must turn the engine off while the vehicle is moving, turn the engine switch only to the ACC position.

 **NOTICE****■ To prevent battery discharge**

Do not leave the engine switch in the ACC or ON position for long periods if the engine is not running.

**■ When starting the engine**

- Do not crank for more than 30 seconds at a time. This may overheat the starter and wiring systems.
- Do not race a cold engine.
- If the engine becomes difficult to start or stalls frequently, have the engine checked immediately.

# Automatic transmission\*

Select a shift position appropriate for the driving conditions.

## ■ Shifting the shift lever

### ▶ 5-speed models

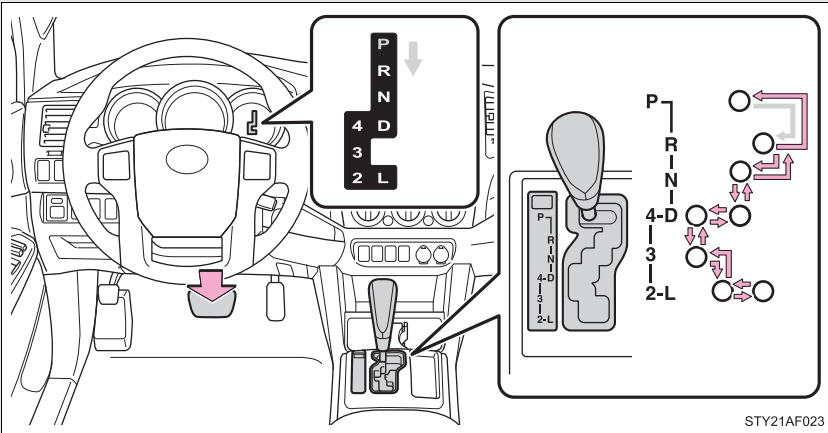

While the engine switch is on, depress the brake pedal and move the shift lever.

\*: If equipped

### ► 4-speed models

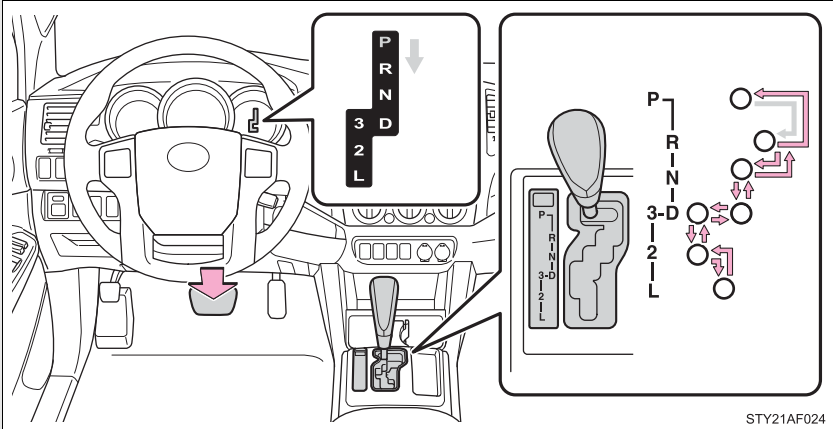

While the engine switch is on, depress the brake pedal and move the shift lever.

### ■ Shift position uses

Shift position	Function	
	5-speed models	4-speed models
P	Parking the vehicle or starting the engine	
R	Reversing	
N	Neutral	
D	Normal driving*	
4	Position for engine braking	—
3	Position for more powerful engine braking	Position for engine braking
2	Position for more powerful engine braking	
L	Position for maximum engine braking	

\*: To improve fuel consumption and reduce noises, set the shift lever in D for normal driving.

### ■ Downshifting restrictions

The shift lever cannot be downshifted if the following speeds are exceeded.

#### ▶ 2WD models

mph (km/h)

Downshifting	Maximum speed	
	5-speed models	4-speed models
4 → 3	81 (130)	—
3 → 2	56 (90)	71 (115)
2 → L	22 (35)	34 (55)

#### ▶ 4WD models

mph (km/h)

Downshifting	Transfer position	Maximum speed	
		5-speed models	4-speed models
4 → 3	H2 and H4	81 (130)	—
	L4	31 (50)	—
3 → 2	H2 and H4	56 (90)	71 (115)
	L4	22 (35)	22 (35)
2 → L	H2 and H4	22 (35)	34 (55)
	L4	9 (15)	6 (10)



**■ When driving with the cruise control system (if equipped)**

The engine brake will not operate when downshifting from D to 4 (5-speed models) or 3 (4-speed models). (→P. 162)

**■ If the shift lever cannot be shifted from P**

→P. 502

**■ AI-SHIFT**

AI-SHIFT automatically selects the suitable gear according to driver performance and driving conditions.

AI-SHIFT automatically operates when the shift lever is in the D position.

The engine speed may remain high after releasing the accelerator pedal. This does not indicate a malfunction.

## 2-1. Driving procedures

# Manual transmission\*

### ■ Shifting the shift lever

#### ▶ 6-speed models

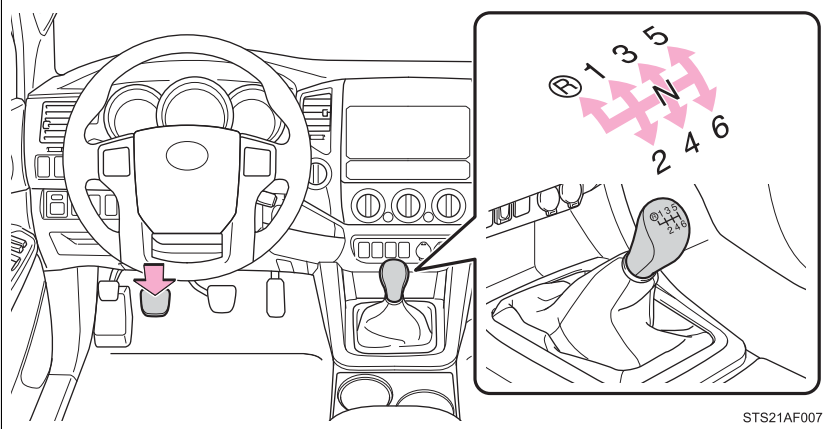

Fully depress the clutch pedal before operating the shift lever, and then release it slowly.

#### ▶ 5-speed models

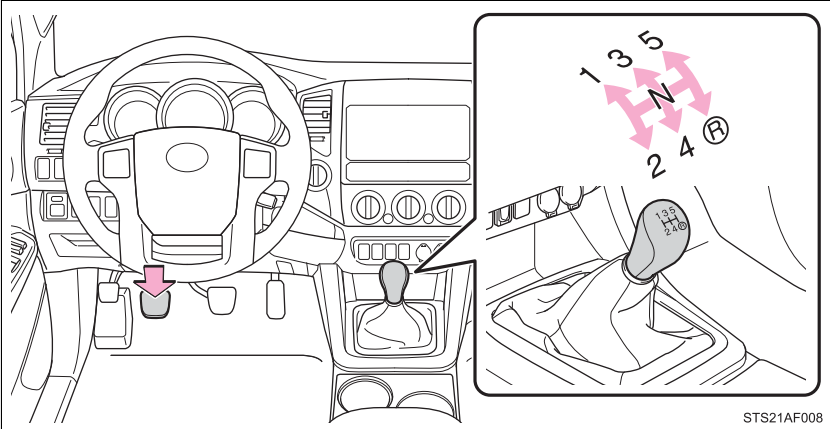

Fully depress the clutch pedal before operating the shift lever, and then release it slowly.

\*: If equipped

### ■ Maximum allowable speed

Observe the following maximum allowable speeds in each gear when maximum acceleration is necessary.

#### ▶ 2WD models except PreRunner

mph (km/h)

Shift position	Maximum speed	
	6-speed models	5-speed models
1	32 (52)	33 (53)
2	61 (99)	63 (101)
3	91 (146)	90 (146)
4	113 (182)	130 (209)

#### ▶ PreRunner

mph (km/h)

Shift position	Maximum speed	
	6-speed models	5-speed models
1	30 (49)	30 (48)
2	58 (93)	57 (92)
3	85 (137)	82 (133)
4	106 (171)	118 (190)
5	127 (204)	—

## ► 4WD models

mph (km/h)

Shift position	Transfer position	Maximum speed	
		6-speed models	5-speed models
1	H2 and H4	30 (49)	30 (48)
	L4	11 (19)	11 (18)
2	H2 and H4	58 (93)	57 (92)
	L4	22 (36)	22 (36)
3	H2 and H4	85 (137)	82 (133)
	L4	33 (53)	32 (51)
4	H2 and H4	106 (171)	118 (190)
	L4	41 (66)	46 (74)
5	H2 and H4	127 (204)	—
	L4	49 (79)	—

## ■ Reverse warning buzzer (6-speed models only)

When shifting into R, a buzzer will sound to inform the driver that the shift lever is in R.

## 2-1. Driving procedures

### Turn signal lever

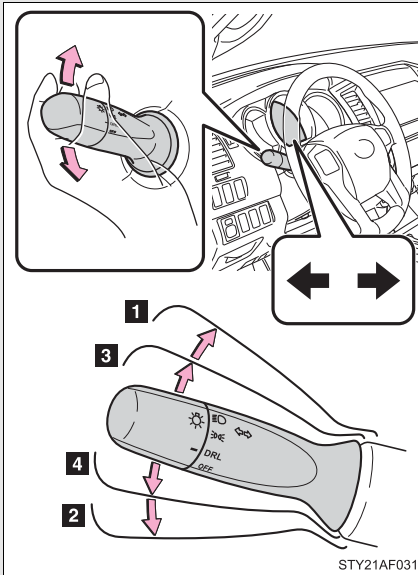

- 1 Right turn
- 2 Left turn
- 3 Move and hold the lever partway to signal a lane change.

The right hand signal will flash until you release the lever.

- 4 Move and hold the lever partway to signal a lane change.

The left hand signal will flash until you release the lever.

2

When driving

#### ■ Turn signals can be operated when

The engine switch is in the ON position.

#### ■ If the indicators flash faster than usual

Check that a light bulb in the front or rear turn signal lights has not burned out.

## 2-1. Driving procedures

### Parking brake

#### ▶ Lever type

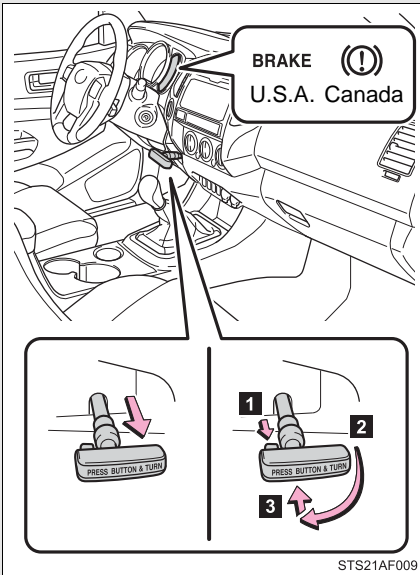

#### ● Sets the parking brake

Fully set the parking brake while depressing the brake pedal.

At this time, the indicator will come on.

#### ● Release the parking brake

1 Press the button

2 Turn the lever clockwise

3 Press it in completely

#### ▶ Pedal type

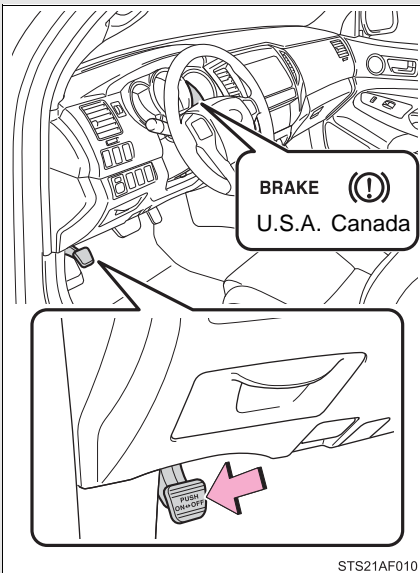

Sets the parking brake\*.  
(Depressing the pedal again releases the parking brake.)

At this time, the indicator will come on.

\*: Fully depress the parking brake pedal with your left foot while depressing the brake pedal with your right foot.

---

**■ Parking brake engaged warning buzzer**

The buzzer sounds to indicate that parking brake is still engaged (with the vehicle having reach a speed of 3 mph [5 km/h]).

**■ Usage in winter time**

See “Winter driving tips” for parking brake usage in winter time. (→P. 209)

**NOTICE****■ Before driving**

Fully release the parking brake.

Driving the vehicle with the parking brake set will lead to brake components overheating, which may affect braking performance and increase brake wear.

## Horn

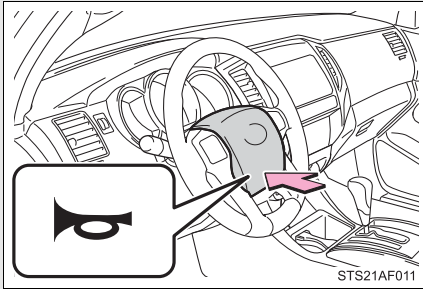

To sound the horn, press on or close to the  mark.

### ■ After adjusting the steering wheel

Make sure that the steering wheel is securely locked.

The horn may not sound if the steering wheel is not securely locked.

(→P. 63)



## 2-2. Gauges and meters

### Gauges and meters

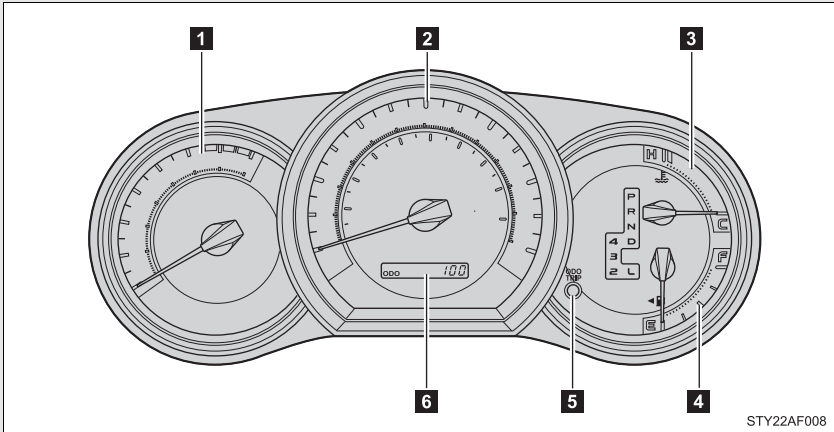

The following gauges, meters and displays illuminate when the engine switch is in the ON position.

**1** Tachometer

Displays the engine speed in revolutions per minute.

**2** Speedometer

Displays the vehicle speed.

**3** Engine coolant temperature gauge

Displays the engine coolant temperature.

**4** Fuel gauge

Displays the quantity of fuel remaining in the tank.

**5** ODO/TRIP button

Switches between odometer and trip meter displays. Pushing and holding the button will reset the trip meter when the trip meter is being displayed.

### 6 Odometer/trip meter

Odometer:

Displays the total distance the vehicle has been driven.

Trip meter:

Displays the distance the vehicle has been driven since the meter was last reset. Trip meters A and B can be used to record and display different distances independently.

### Odometer and trip meter display button

Pressing this button switches between odometer and trip meter displays.

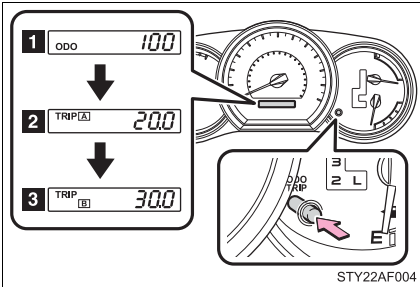

1 Odometer

2 Trip meter A\*

3 Trip meter B\*

\*: Pushing and holding the button will reset the trip meter.

### Instrument panel light control

The brightness of the instrument panel lights can be adjusted.

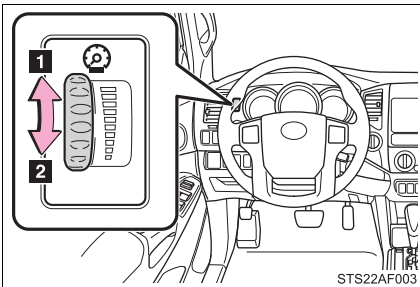

1 Brighter

2 Darker

**NOTICE****■ To prevent damage to the engine and its components**

- Do not let the indicator needle of the tachometer enter the red zone, which indicates the maximum engine speed.
- The engine may be overheating if the engine coolant temperature gauge is in the red zone (H). In this case, immediately stop the vehicle in a safe place, and check the engine after it has cooled completely. (→P. 508)

# Indicators and warning lights

The indicator and warning lights on the instrument cluster and center panel inform the driver of the status of the vehicle's various systems.

## ► Instrument cluster

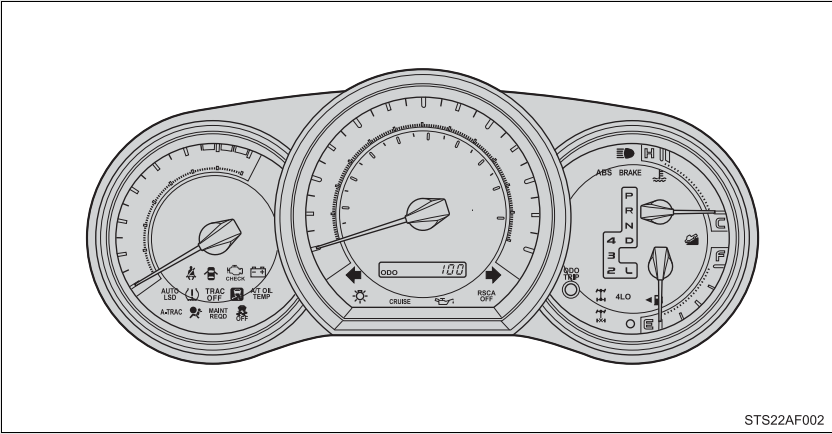

STS22AF002

## ► Center panel

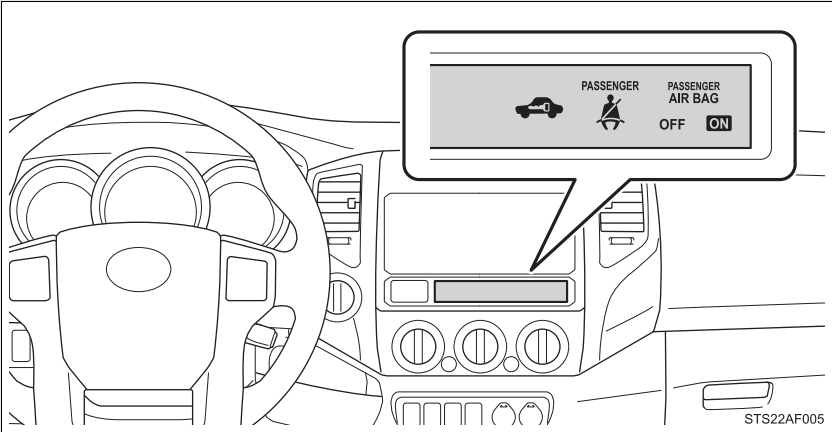

STS22AF005

## ■ Indicators

The indicators inform the driver of the operating state of the vehicle's various systems.



Turn signal indicator  
(→P. 141)



Headlight high beam indicator (→P. 153)



(U.S.A.)

Headlight indicator  
(→P. 152)



(Canada)

Tail light indicator  
(→P. 152)



(if equipped)

Security indicator  
(→P. 77)

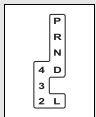

(5-speed automatic transmission vehicles)

Shift position and shift range indicators  
(→P. 134)

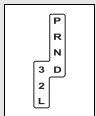

(4-speed automatic transmission vehicles)

Shift position and shift range indicators  
(→P. 134)



(if equipped)

Cruise control indicator  
(→P. 162)



\*1,2

Slip indicator  
(→P. 181, 183, 192)



\*1

VSC OFF indicator  
(→P. 183, 192, 193)



\*1

TRAC OFF indicator  
(→P. 192, 193)



\*1

(if equipped)

Downhill assist control system indicator  
(→P. 188)



\*1,5

RSCA OFF indicator  
(→P. 94)



(if equipped)

Active traction control system indicator  
(→P. 181)



\*1

AUTO LSD indicator  
(→P. 183)



(4WD models)

Four-wheel drive indicator (→P. 177)



(4WD models)

4LO indicator (→P. 177)



\*1

(if equipped)

Rear differential lock indicator (→P. 185)



<sup>\*1</sup> AIR BAG ON indicator  
(→P. 95)



<sup>\*1</sup> AIR BAG OFF indicator  
(→P. 95)

## ■ Warning lights

Warning lights inform the driver of malfunctions in any of the vehicle's systems. (→P. 476)

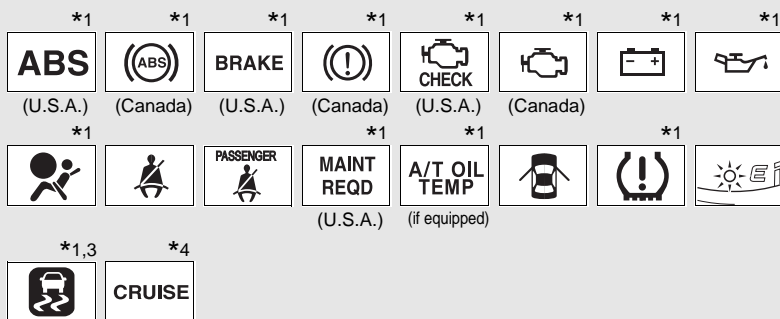

<sup>\*1</sup>: These lights turn on when the engine switch is turned to the ON position to indicate that a system check is being performed. They will turn off after the engine is started, or after a few seconds. There may be a malfunction in a system if a light does not come on, or if the lights do not turn off. Have the vehicle inspected by your Toyota dealer.

<sup>\*2</sup>: The indicator flashes to indicate that the system is operating.

<sup>\*3</sup>: The indicator light comes on to indicate a malfunction.

<sup>\*4</sup>: The indicator flashes to indicate a malfunction.

<sup>\*5</sup>: For 2WD models, even though there is no function of deactivating the curtain shield airbags in a vehicle rollover, the RSCA OFF indicator turns on briefly when the engine switch is turned to the ON position. But this is not a malfunction.

 CAUTION**■ If a safety system warning light does not come on**

Should a safety system light such as ABS and the SRS airbag warning light not come on when you start the engine, this could mean that these systems are not available to help protect you in an accident, which could result in death or serious injury. Have the vehicle inspected by your Toyota dealer immediately if this occurs.



## Headlight switch

**The headlights can be operated manually.**

Turning the end of the lever turns on the lights as follows:

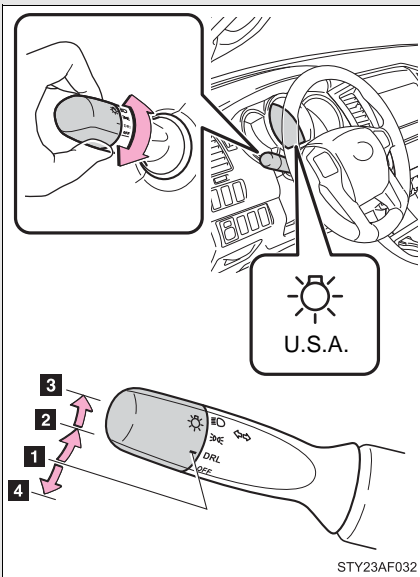
► Type A





- 1 DRL** The daytime running lights turn on.
- 2**  The side marker, parking, tail, license plate, daytime running lights and instrument panel lights turn on.
- 3**  The headlights and all lights listed above (except daytime running lights) turn on.
- 4 OFF** The daytime running lights turn off.

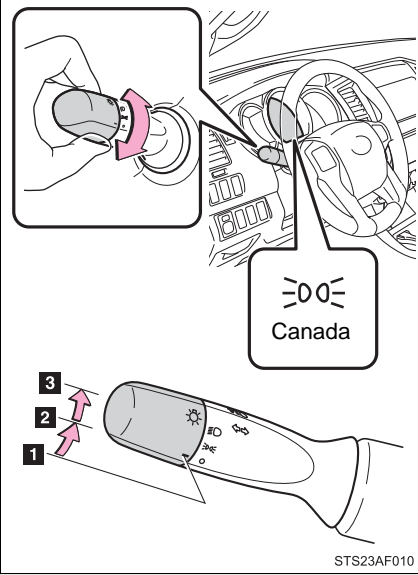

► Type B



- 1**  The daytime running lights turn on.
- 2**  The side marker, parking, tail, license plate, daytime running lights and instrument panel lights turn on.
- 3**  The headlights and all lights listed above (except daytime running lights) turn on.

**Turning on the high beam headlights**

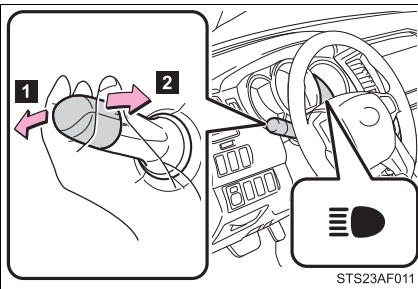

- 1** With the headlights on, push the lever forward to turn on the high beams.  
Pull the lever back to the center position to turn the high beams off.
- 2** Pull the lever toward you to turn on the high beams.  
Release the lever to turn them off. You can flash the high beams with the headlights on or off.

---

### ■ Daytime running light system



- To make your vehicle more visible to other drivers, the front turn signal lights turn on automatically whenever the engine is started and the parking brake is released. Daytime running lights are not designed for use at night.

Type A: Daytime running lights can be turned off by operating the switch.

- Compared to turning on the headlights, the daytime running light system offers greater durability and consumes less electricity, so it can help improve fuel economy.

### ■ Automatic light off system

Opening the driver's door with the engine switch in the ACC or LOCK position will turn the headlights and tail lights off.

To turn the lights on again, turn the engine switch to the ON position, or turn the headlight switch off once and then back to the  or  position.



#### NOTICE

#### ■ To prevent battery discharge

Do not leave the lights on longer than necessary when the engine is not running.

## 2-3. Operating the lights and wipers Fog light switch\*

The fog lights improve visibility in difficult driving conditions, such as in rain or fog.

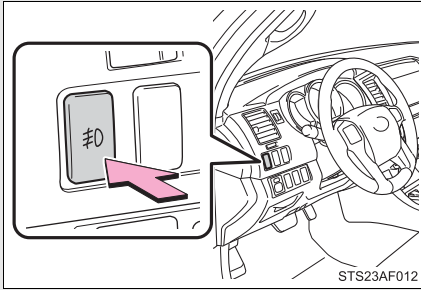

On/off

### ■ The fog lights can be turned on only when

The headlights are on low beam.

## 2-3. Operating the lights and wipers Windshield wipers and washer

### ■ Without intermittent type

#### ▶ Type A

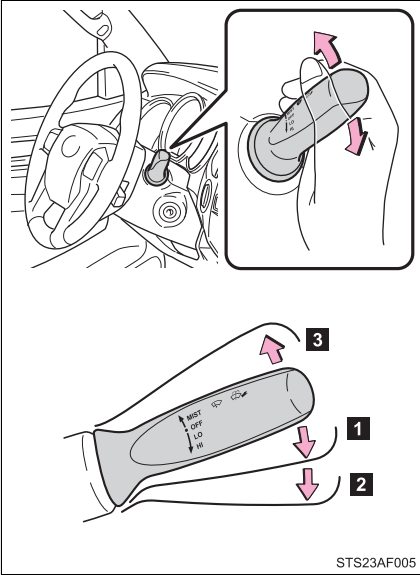

- 1 LO** Low speed windshield wiper operation
- 2 HI** High speed windshield wiper operation
- 3 MIST** Temporary operation

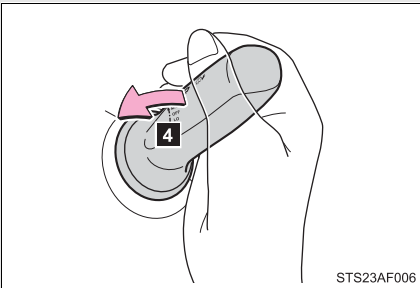

- 4** Washer operation

► Type B

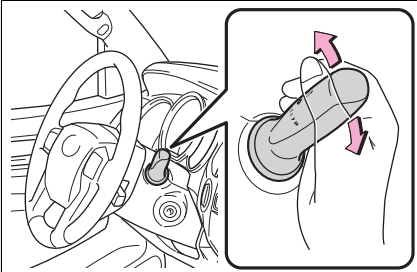

- 1 ▼ Low speed wind-shield wiper operation
- 2 ▾ High speed wind-shield wiper operation
- 3 ▲ Temporary operation

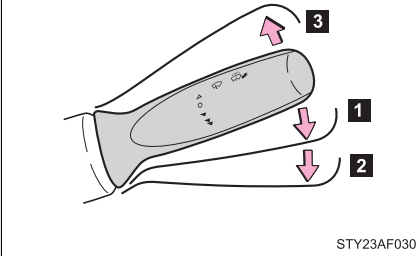

STY23AF030

4 Washer operation

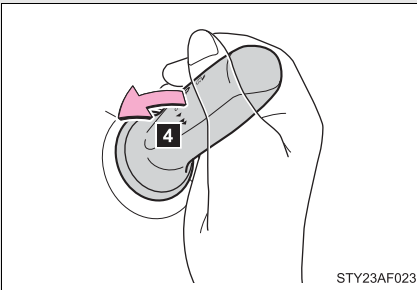

STY23AF023

### ■ Intermittent wiper with interval adjuster

Wiper intervals can be adjusted for intermittent operation (when **INT** or  is selected).

#### ► Type A

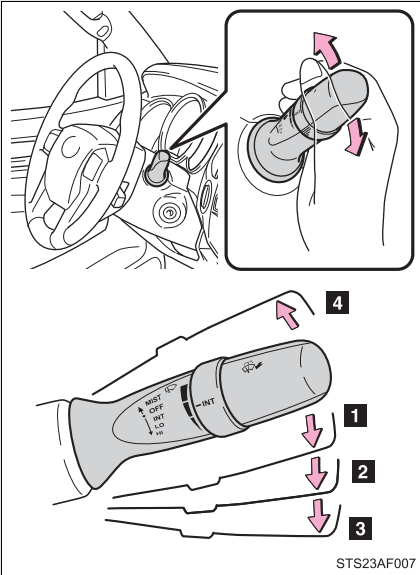

- 1 INT** Intermittent windshield wiper operation
- 2 LO** Low speed windshield wiper operation
- 3 HI** High speed windshield wiper operation
- 4 MIST** Temporary operation

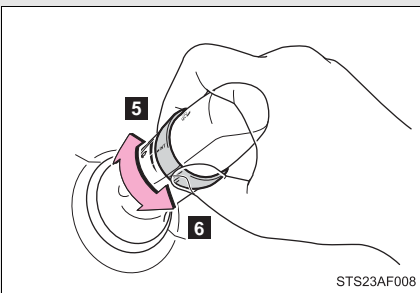

- 5** Increases the intermittent windshield wiper frequency
- 6** Decreases the intermittent windshield wiper frequency

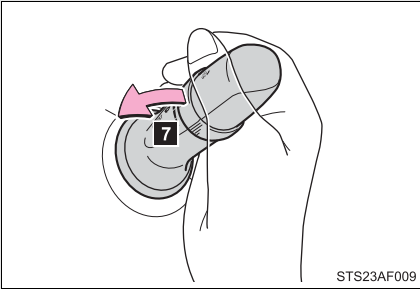



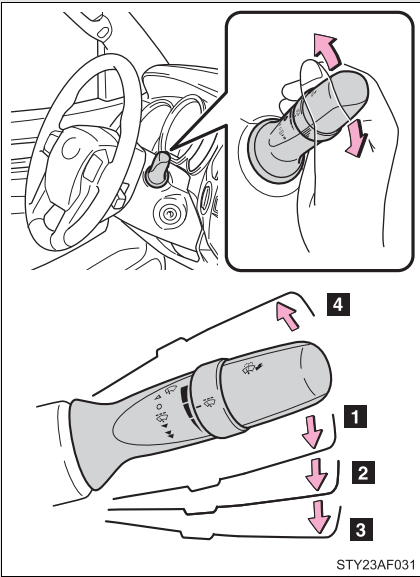

**7** Washer/wiper dual operation

Wipers will automatically operate a couple of times after the washer squirts.

► Type B



- 1**  Intermittent wind-shield wiper operation
- 2**  Low speed wind-shield wiper operation
- 3**  High speed wind-shield wiper operation
- 4**  Temporary operation

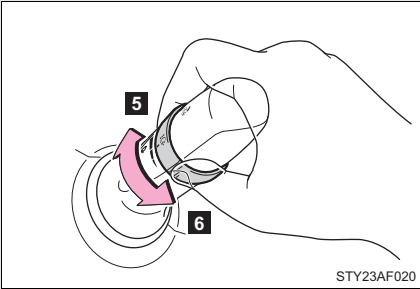

**5** Increases the intermittent windshield wiper frequency

**6** Decreases the intermittent windshield wiper frequency

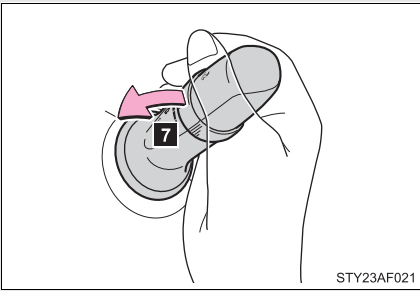

**7** Washer/wiper dual operation

Wipers will automatically operate a couple of times after the washer squirts.

■ **The windshield wiper and washer can be operated when**

The engine switch must be in the ON position.

■ **If no windshield washer fluid sprays**

Check that the washer nozzles are not blocked and if there is washer fluid in the windshield washer fluid reservoir.





**NOTICE**

■ **When the windshield is dry**

Do not use the wipers, as they may damage the windshield.

■ **When there is no washer fluid spray from the nozzle**

Damage to the washer fluid pump may be caused if the lever is pulled toward you and held continually.

■ **When a nozzle becomes blocked**

Do not try to clear it with a pin or other object. The nozzle will be damaged.

## Cruise control\*

Use the cruise control to maintain a set speed without depressing the accelerator pedal.

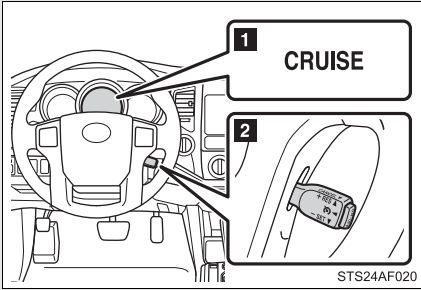

1 Indicator

2 Cruise control switch

### ■ Setting the vehicle speed

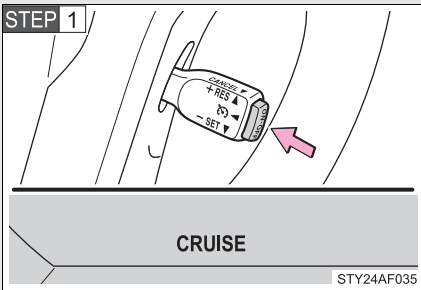

Press the ON-OFF button to activate the cruise control.

Cruise control indicator will come on.

Press the button again to deactivate the cruise control.

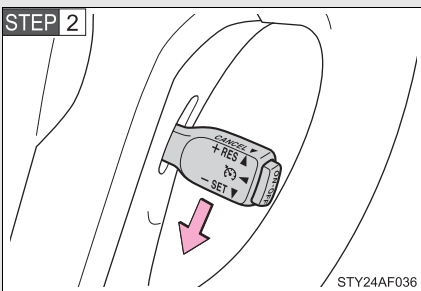

Accelerate or decelerate the vehicle to the desired speed, and push the lever down to set the speed.

The vehicle speed at the moment the lever is released becomes the set speed.

\*: If equipped

### ■ Adjusting the set speed

To change the set speed, operate the lever until the desired set speed is obtained.

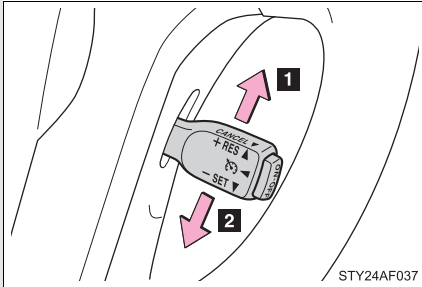

- 1 Increases the speed
- 2 Decreases the speed

Fine adjustment: Momentarily move the lever in the desired direction.

Large adjustment: Hold the lever in the desired direction.

The set speed will be increased or decreased as follows:

Fine adjustment: By approximately 1 mph (1.6 km/h) each time the lever is operated.

Large adjustment: The set speed can be increased or decreased continually until the lever is released.

### ■ Canceling and resuming the constant speed control

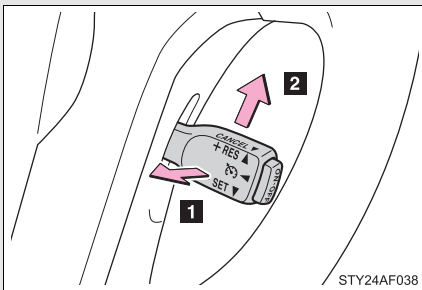

- 1 Pulling the lever toward you cancels the constant speed control.

The speed setting is also canceled when the brakes are applied or the clutch pedal (manual transmission only) is depressed.

- 2 Pushing the lever up resumes the constant speed control.

Resuming is available when the vehicle speed is more than approximately 25 mph (40 km/h).

### ■ **Cruise control can be set when**

- The shift lever is in the D or range 4. (vehicles with 5-speed automatic transmission)
- The shift lever is in the D or range 3. (vehicles with 4-speed automatic transmission)
- Vehicle speed is above approximately 25 mph (40 km/h).

### ■ **Accelerating after setting the vehicle speed**

- The vehicle can be accelerated normally. After acceleration, the set speed resumes.
- Even without canceling the cruise control, the set speed can be increased by first accelerating the vehicle to the desired speed and then pushing the lever down to set the new speed.

### ■ **Automatic cruise control cancelation**

Cruise control will stop maintaining the vehicle speed in any of the following situations.

- Actual vehicle speed falls more than approximately 10 mph (16 km/h) below the preset vehicle speed.  
At this time, the memorized set speed is not retained.
- Actual vehicle speed is below approximately 25 mph (40 km/h).
- VSC is activated.

### ■ **If the cruise control indicator light flashes**

Press the ON-OFF button once to deactivate the system, and then press the button again to reactivate the system.

If the cruise control speed cannot be set or if the cruise control cancels immediately after being activated, there may be a malfunction in the cruise control system. Have the vehicle inspected by your Toyota dealer.

 **CAUTION****■ To avoid operating the cruise control by mistake**

Switch the cruise control off using the ON-OFF button when not in use.

**■ Situations unsuitable for cruise control**

Do not use cruise control in any of the following situations.

Doing so may result in loss of control and could cause an accident resulting in death or serious injury.

- In heavy traffic
- On roads with sharp bends
- On winding roads
- On slippery roads, such as those covered with rain, ice or snow
- On steep hills  
Vehicle speed may exceed the set speed when driving down a steep hill.
- When your vehicle is towing a trailer or during emergency towing

## Rear view monitor system\*

The rear view monitor system assists the driver by displaying guide lines and an image of the view behind the vehicle while backing up, for example while parking.

The screen illustrations used in this text are intended as examples, and may differ from the image that is actually displayed on the screen.

- ▶ Vehicles with Entune Audio Plus or Entune Premium Audio (Multimedia system types: →P. 243)

Refer to the “NAVIGATION SYSTEM OWNER’S MANUAL”.

- ▶ Vehicles with Entune Audio (Multimedia system types: →P. 243)

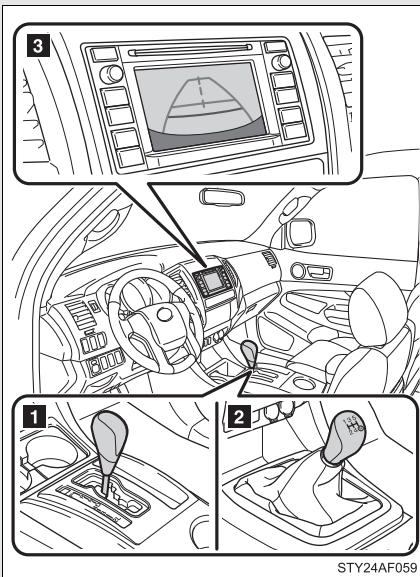

The rear view image is displayed when the shift position is in R and the engine switch is in the “ON” position.

The rear view monitor system will be deactivated when the shift lever is in any position other than R.

- 1 Automatic transmission
- 2 Manual transmission
- 3 Screen

\*: If equipped

## Using the rear view monitor system

### ■ Screen description

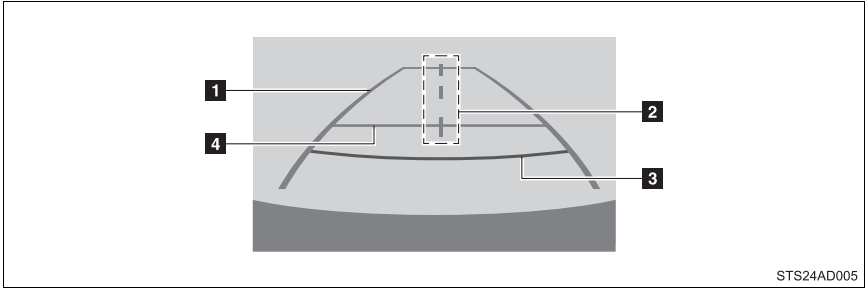

#### 1 Vehicle width guide lines

The line indicates a guide path when the vehicle is being backed straight up.

The displayed width is wider than the actual vehicle width.

#### 2 Vehicle center guide lines

These lines indicate the estimated vehicle center on the ground.

#### 3 Distance guide line

The line shows points approximately 1.5 ft. (0.5 m) (red) from the center of the edge of the bumper.

#### 4 Distance guide line

The line shows distance behind the vehicle, a point approximately 3 ft. (1 m) (blue) from the edge of the bumper.

## Rear view monitor system precautions

### ■ Area displayed on screen

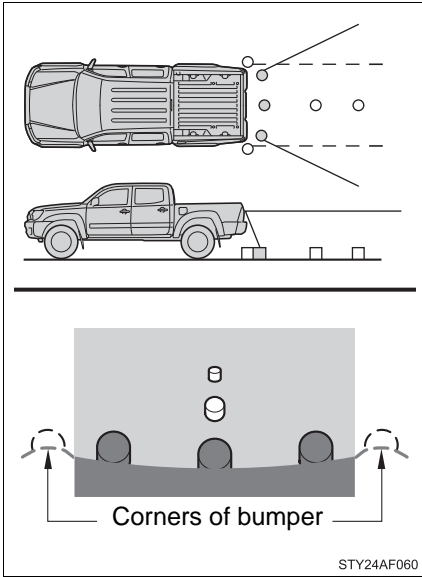

The rear view monitor system displays an image of the view from the bumper of the rear area of the vehicle.

To adjust the image on the rear view monitor system screen. (→P. 254)

- The area displayed on the screen may vary according to vehicle orientation conditions.
- Objects which are close to either corner of the bumper or under the bumper cannot be seen on the screen.
- The camera uses a special lens. The distance of the image that appears on the screen differs from the actual distance.
- Items which are located higher than the camera may not be displayed by the monitor.



### ■ Rear view monitor system camera

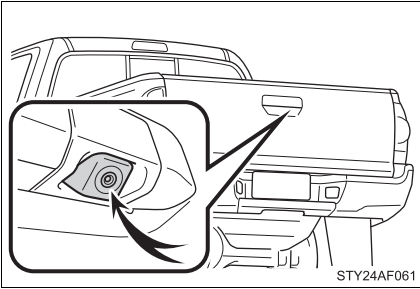

The camera for the rear view monitor system is located as shown in the illustration.

### ● Using the camera

If the camera lens becomes dirty, it cannot transmit a clear image. If water droplets, snow or mud adhere to the lens, rinse it with water and wipe with a soft cloth. If the lens is extremely dirty, wash it with a mild cleanser and rinse.

### ■ Differences between the screen and the actual road

The distance guide lines and the vehicle width guide lines may not actually be parallel with the dividing lines of the parking space, even when they appear to be so. Be sure to check visually.

The distances between the vehicle width guide lines and the left and right dividing lines of the parking space may not be equal, even when they appear to be so. Be sure to check visually.

The distance guide lines give a distance guide for flat road surfaces. In any of the following situations, there is a margin of error between the fixed guide lines on the screen and the actual distance/course on the road.

### ● When the ground behind the vehicle slopes up sharply

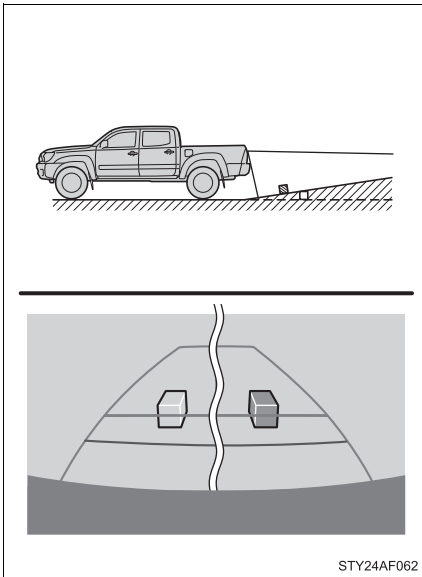

The distance guide lines will appear to be closer to the vehicle than the actual distance. Because of this, objects will appear to be farther away than they actually are. In the same way, there will be a margin of error between the guidelines and the actual distance/course on the road.

● When the ground behind the vehicle slopes down sharply

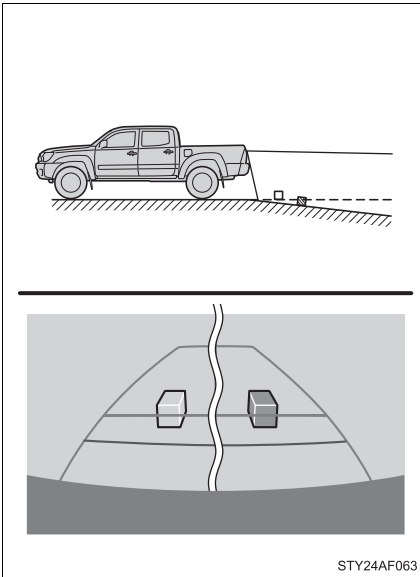

The distance guide lines will appear to be further from the vehicle than the actual distance. Because of this, objects will appear to be closer than they actually are. In the same way, there will be a margin of error between the guidelines and the actual distance/course on the road.

● When any part of the vehicle sags

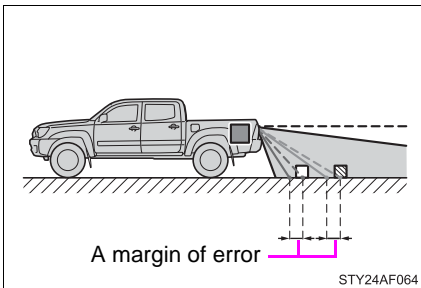

When any part of the vehicle sags due to the number of passengers or the distribution of the load, there is a margin of error between the fixed guide lines on the screen and the actual distance/course on the road.

■ When approaching three-dimensional objects

The distance guide lines are displayed according to flat surfaced objects (such as the road). It is not possible to determine the position of three-dimensional objects (such as vehicles) using the distance guide lines. When approaching a three-dimensional object that extends outward (such as the flatbed of a truck), be careful of the following.

● Distance guidelines

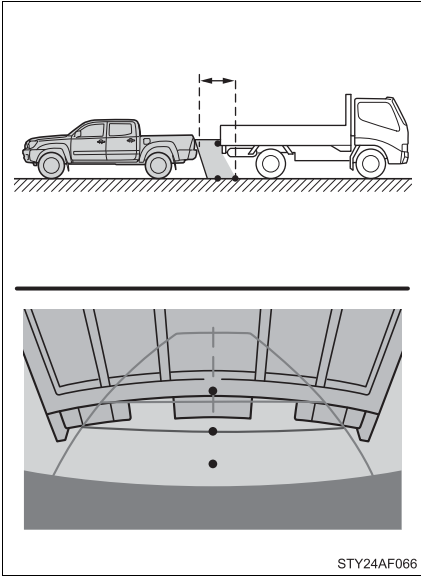

STY24AF066

Visually check the surroundings and the area behind the vehicle. On the screen, it appears that a truck is parked at point **2**. However, in reality if you back up to point **1**, you will hit the truck. On the screen, it appears that **1** is closest and **3** is furthest away. However, in reality, the distance to **1** and **3** is the same, and **2** is farther than **1** and **3**.

■ Vehicle width guide lines

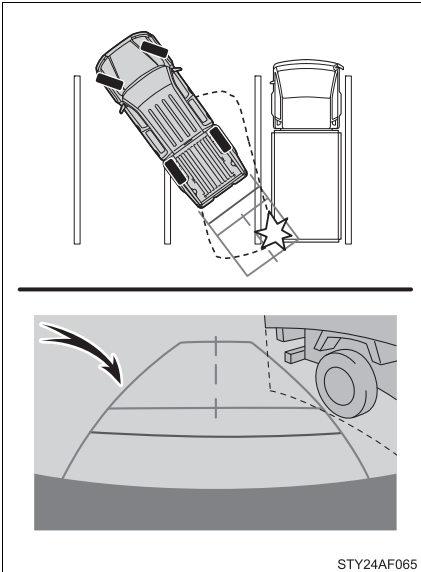

STY24AF065

Visually check the surroundings and the area behind the vehicle. In the case shown below, the truck appears to be outside of the vehicle width guide lines and the vehicle does not look as if it hits the truck. However, the rear body of the truck may actually cross over the vehicle width guide lines. In reality if you back up as guided by the vehicle width guide lines, the vehicle may hit the truck.

## Things you should know

### ■ If you notice any symptoms

If you notice any of the following symptoms, refer to the likely cause and the solution, and re-check.

If the symptom is not resolved by the solution, have the vehicle inspected by your Toyota dealer.

Symptom	Likely cause	Solution
The image is difficult to see	<ul style="list-style-type: none"> <li>• The vehicle is in a dark area</li> <li>• The temperature around the lens is either high or low</li> <li>• The outside temperature is low</li> <li>• There are water droplets on the camera</li> <li>• It is raining or humid</li> <li>• Foreign matter (mud, etc.) is adhering to the camera</li> <li>• There are scratches on the camera</li> <li>• Sunlight or headlights are shining directly into the camera</li> <li>• The vehicle is under fluorescent lights, sodium lights, mercury lights, etc.</li> </ul>	<p>If this happens due to these causes, it does not indicate a malfunction.</p> <p>Back up while visually checking the vehicle's surroundings. (Use the monitor again once conditions have been improved.)</p> <p>To adjust the image on the rear view monitor system screen. (→P. 254)</p>
The image is blurry	Dirt or foreign matter (such as water droplets, snow, mud etc.) is adhering to the camera.	<p>Rinse the camera lens with water and wipe it clean with a soft cloth.</p> <p>Wash with a mild soap if the dirt is stubborn.</p>
The image is out of alignment	The camera or surrounding area has received a strong impact.	Have the vehicle inspected by your Toyota dealer.

Symptom	Likely cause	Solution
<p>The fixation guide lines are very far out of alignment</p>	<ul style="list-style-type: none"> <li>• The vehicle is tilted (there is a heavy load on the vehicle, tire pressure is low due to a tire puncture, etc.)</li> <li>• The vehicle is used on an incline.</li> </ul>	<p>If this happens due to these causes, it does not indicate a malfunction. Back up while visually checking the vehicle's surroundings.</p>
	<p>The camera position is out of alignment.</p>	<p>Have the vehicle inspected by your Toyota dealer.</p>

 CAUTION

**■ When using the rear view monitor system**

The rear view monitor system is a supplemental device intended to assist the driver when backing up. When backing up, be sure to check visually behind and all around the vehicle before proceeding.

Observe the following precautions to avoid an accident that could result in death or serious injuries.

- Never depend on the rear view monitor system entirely when backing up. The image and the position of the guide lines displayed on the screen may differ from the actual state.  
Use caution, just as you would when backing up any vehicle.
- Be sure to back up slowly, depressing the brake pedal to control vehicle speed.
- The instructions given are only guidelines.  
When and how much to turn the steering wheel will vary according to traffic conditions, road surface conditions, vehicle condition, etc., when parking. It is necessary to be fully aware of this before using the rear view monitor system.
- When parking, be sure to check that the parking space will accommodate your vehicle before maneuvering into it.
- Do not use the rear view monitor system in the following cases:
  - On icy or slick road surfaces, or in snow
  - When using tire chains or the compact spare tire
  - When the tailgate is not closed completely
  - On roads that are not flat or straight, such as curves or slopes.
- In low temperatures, the screen may darken or the image may become faint. The image could distort when the vehicle is moving, or you may become unable to see the image on the screen. Be sure to directly check visually and with the mirrors all around the vehicle before proceeding.
- If the tire sizes are changed, the position of the fixed guide lines displayed on the screen may change.
- The camera uses a special lens. The distances between objects and pedestrians that appear in the image displayed on the screen will differ from the actual distances. (→P. 170)

 NOTICE

■ **How to use the camera**

- The rear view monitor system may not operate properly in the following cases.
  - If the back of the vehicle is hit, the position and mounting angle of the camera may change.
  - As the camera has a water proof construction, do not detach, disassemble or modify it. This may cause incorrect operation.
  - Do not strongly rub the camera lens. If the camera lens is scratched, it cannot transmit a clear image.
  - Do not allow organic solvent, car wax, window cleaner or glass coat to adhere to the camera. If this happens, wipe it off as soon as possible.
  - If the temperature changes rapidly, such as when hot water is poured on the vehicle in cold weather, the system may not operate normally.
  - When washing the vehicle, do not apply intensive bursts of water to the camera or camera area. Doing so may result in the camera malfunctioning.
  - When the camera is used under fluorescent lights, sodium light or mercury light, etc., the lights and the illuminated areas may appear to flicker.
- Do not expose the camera to strong impact as this could cause a malfunction. If this happens, have the vehicle inspected by your Toyota dealer as soon as possible.



## 2-4. Using other driving systems

### Four-wheel drive system\*

Use the front-wheel drive control switch to select the following transfer modes.

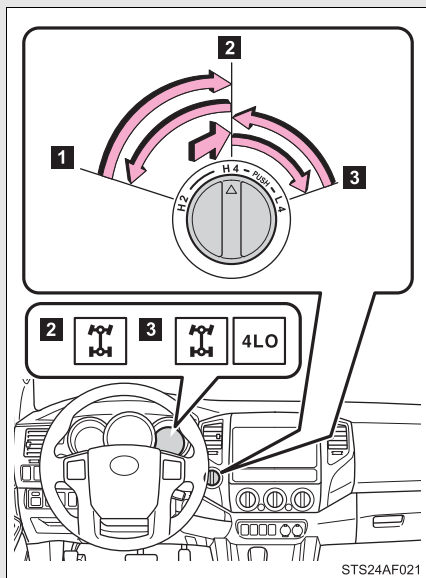

- 1** H2 (high speed position, two-wheel drive)

Use this for normal driving on dry hard-surfaced roads. This position gives greater economy, quietest ride and least wear.

- 2** H4 (high speed position, four-wheel drive)

Use this for driving only on tracks that permit the tires slide, like off-road, icy or snow-covered roads. This position provides greater traction than two-wheel drive.

The four-wheel drive indicator comes on.

- 3** L4 (low speed position, four-wheel drive)

Use this for maximum power and traction. Use L4 for climbing or descending steep hills, off-road driving, and hard pulling in sand, mud or deep snow.

The four-wheel drive and 4LO indicators come on.

\*: If equipped

## Shifting between H4 and L4

### ■ Shifting from H4 to L4

#### ▶ Automatic transmission

**STEP 1** Stop the vehicle completely with brake pedal help down.

**STEP 2** Shift the shift lever to N.

**STEP 3** Push and turn the front-wheel drive control switch fully clockwise.

If the four-wheel drive indicator flashes and the buzzer sounds, try the above steps again.

#### ▶ Manual transmission

**STEP 1** Stop the vehicle or reduce your speed to less than 2 mph (3 km/h).

**STEP 2** Depress and hold the clutch pedal.

**STEP 3** Push and turn the front-wheel drive control switch fully clockwise.

If the four-wheel drive indicator flashes and the buzzer sounds, try the above steps again.

### ■ Shifting from L4 to H4

#### ▶ Automatic transmission

**STEP 1** Stop the vehicle completely with brake pedal help down.

**STEP 2** Shift the shift lever to N.

**STEP 3** Turn the front-wheel drive control switch counterclockwise.

If the four-wheel drive indicator flashes and the buzzer sounds, try the above steps again.

#### ▶ Manual transmission

**STEP 1** Stop the vehicle or reduce your speed to less than 2 mph (3 km/h).

**STEP 2** Depress and hold the clutch pedal.

**STEP 3** Turn the front-wheel drive control switch counterclockwise.

If the four-wheel drive indicator flashes and the buzzer sounds, try the above steps again.

### ■ Shifting between H2 and H4

- Shifting from H2 to H4

Reduce the vehicle speed to less than 62 mph (100 km/h) and turn the front-wheel drive control switch fully clockwise.

- Shifting from H4 to H2

Turn the front-wheel drive control switch fully counterclockwise.

This can be done at any speed. You need not depress the clutch pedal. (manual transmission)

### ■ If the four-wheel drive indicator light or the 4LO indicator light blinks

- Shifting from H2 to H4

- If the four-wheel drive indicator continues to blink, drive straight ahead while accelerating or decelerating.

- If the four-wheel drive indicator continues to blink and the buzzer sounds, stop the vehicle or reduce the vehicle speed to less than 62 mph (100 km/h). Operate the switch again.

- Shifting from H4 to H2

If the four-wheel drive indicator continues to blink, drive straight ahead while accelerating or decelerating, or drive forward or backward in a short distance.

- Shifting to H4 or L4

- ▶ Automatic transmission

If the 4LO indicator continues to blink when you operate the front-wheel drive control switch to the H4 or L4 position, drive forward or backward in a short distance, then stop the vehicle completely, shift the shift lever securely to N and operate the switch again.

- ▶ Manual transmission

If the 4LO indicator continues to blink when you operate the front-wheel drive control switch to the H4 or L4 position, drive forward or backward in a short distance, then stop the vehicle completely, depress the clutch pedal and operate the switch again.

If the indicator light continues to blink even if doing so, contact your Toyota dealer as soon as possible. There may be a trouble in the four-wheel drive system.

■ **Shifting to L4**

VSC is automatically turned off.

■ **Four-wheel drive usage frequency**

You should drive in four-wheel drive for at least 10 miles (16 km) each month.

This will assure that the front-drive components are lubricated.

 **CAUTION**

■ **Caution while driving**

- Never shift the front-wheel drive control switch from H2 to H4 if the wheels are slipping.  
Stop the slipping or spinning before shifting.
- For normal driving on dry and hard surface roads, use H2 position. Driving on dry and hard surface roads in H4 or L4 position may cause drive component oil leakage, seizure, or other problems resulting in an accident. Further, it may cause tire wear and increased fuel consumption.
- Avoid turning suddenly in H4 or L4 position. If you do turn suddenly, the difference in turning speeds between the front and rear wheels may have a similar effect to braking, thus making driving difficult.

## Active traction control system\*

The active traction control system automatically helps prevent the spinning of 4 wheels when the vehicle is started or accelerated on slippery road surfaces.

### ■ System operation

**STEP 1** Vehicles with an automatic transmission:

Stop the vehicle, shift the shift lever to N and put the front-wheel drive control switch in the L4 position.

Vehicles with a manual transmission:

Stop the vehicle or reduce your speed to less than 2 mph (3 km/h). Depress the clutch pedal and put the front-wheel drive control switch in the L4 position.

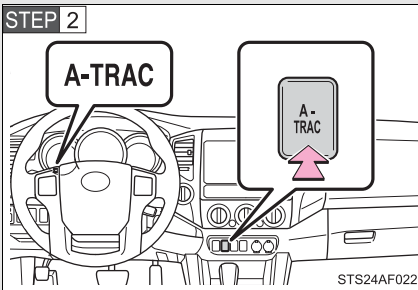

Press the A-TRAC switch to activate the system.

At this time, the active traction control system indicator will come on.

To cancel the system, push the switch again.

### When the active traction control system is operating

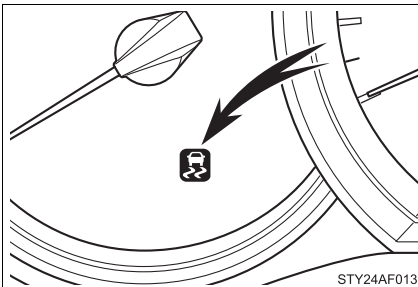

If four wheels spin, the slip indicator flashes to indicate that the active traction control system has been engaged.

\*: If equipped

---

■ **When the rear differential is locked (vehicles with the rear differential lock system)**

The active traction control system is activated only when the vehicle speed is less than 3 mph (6 km/h).

■ **Sounds and vibrations caused by the active traction control system**

- A sound may be heard from the engine compartment when the engine is started or just after the vehicle begins to move. This sound does not indicate that a malfunction has occurred in the system.
- Vibrations may be felt through the vehicle body and steering. It may occur when the system is operating.

■ **If the brake system overheats**

The system will cease operation, a buzzer will sound and A-TRAC indicator blink to alert the driver. Stop the vehicle in a safe place. (There is no problem with continuing normal driving.)

The system will be automatically restored after a short time.

 **CAUTION**

■ **The active traction control system may not operate effectively when**

Directional control and power may not be achievable while driving on slippery road surfaces, even if the active traction control system is operating. Do not drive the vehicle in conditions where stability and power may be lost.

## AUTO LSD system

The AUTO LSD system aids traction by using the traction control system to control engine performance and braking when one of the rear wheels begins to spin.

The system should be used only when one of the rear wheels spinning occurs in a ditch or rough surface.

### ■ System operation

The system can be used on 2WD models and in 2WD mode on 4WD models.

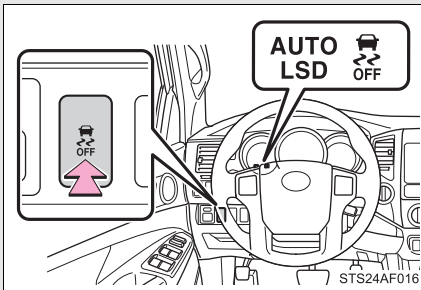

Press the VSC OFF switch to turn on the system.

At this time, the AUTO LSD and VSC OFF indicators will come on simultaneously.

To turn off the system, push the switch again.

If the engine is turned off while the AUTO LSD indicator is on and then restarted, the indicator will turn off automatically.

### When the AUTO LSD system is operating

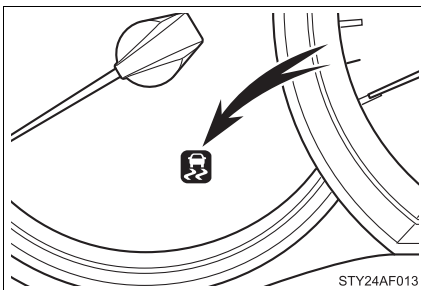

If the rear wheels spin, the slip indicator flashes to indicate that the AUTO LSD system has been controlled the spinning of the rear wheels.

■ **If the engine is turned off and restarted**

The AUTO LSD system and the indicators are automatically turned off.

■ **Reactivation of the VSC system linked to vehicle speed**

When the AUTO LSD system is turned on, the VSC system will turn on automatically if vehicle speed increases.

■ **If the brake system overheats**

The system will cease operation and a buzzer will sound to alert the driver. Stop the vehicle in a safe place. (There is no problem with continuing normal driving.)

The system will be automatically restored after a short time.

 **CAUTION**

■ **To avoid an accident**

- Do not use the AUTO LSD system in conditions other than the above. A much greater steering effort and more careful cornering control will be required.
- Do not drive with the AUTO LSD system continuously turned on.



## Rear differential lock system\*

**The rear differential lock system is provided for use only when wheel spinning occurs in a ditch or on a slippery or rugged surface.**

The rear differential lock system is effective in case one of the rear wheels is spinning.

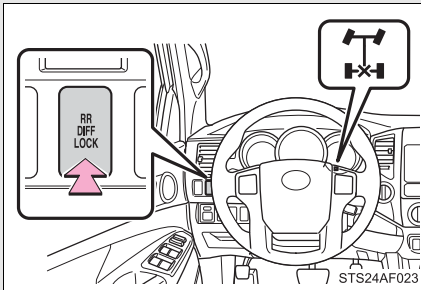

Press the RR DIFF LOCK switch to lock the rear differential.

At this time, the indicator will blink. Wait a few seconds for the system to complete operation. After the rear differential is locked, the rear differential lock indicator will stop blinking and remain on.

To unlock the rear differential, push the switch again.

### Using the rear differential lock system

#### ► Automatic transmission

**STEP 1** 4WD models: Before using the rear differential lock system.

Stop the vehicle, shift the shift lever to N and put the front-wheel drive control switch in the L4 position to see if this is sufficient. If this has no effect, additionally use the rear differential lock system.

**STEP 2** Be sure to stop the wheels.

**STEP 3** Press the RR DIFF LOCK switch.

After the rear differential is locked, the indicator will come on.

**STEP 4** Gently depress the accelerator pedal.

Unlock the rear differential as soon as the vehicle moves.

To unlock the rear differential, push the switch again.

\*: If equipped

► Manual transmission

**STEP 1** 4WD models: Before using the rear differential lock system.

Stop the vehicle or reduce your speed to less than 2 mph (3 km/h). Depress the clutch pedal and put the front-wheel drive control switch in the L4 position to see if this is sufficient. If this has no effect, additionally use the rear differential lock system.

**STEP 2** Be sure to stop the wheels.

**STEP 3** Depress the clutch pedal.

**STEP 4** Press the RR DIFF LOCK switch.

After the rear differential is locked, the indicator will come on.

**STEP 5** Slowly release the clutch pedal.

Unlock the rear differential as soon as the vehicle moves.

To unlock the rear differential, push the switch again.

---

■ **Locking the rear differential**

- When the rear differential is locked, VSC is automatically turned off. (The rear differential lock and VSC OFF indicators come on.)
- The following systems do not operate when the rear differential is locked. It is normal operation for the ABS warning light and VSC OFF indicator to be on at this time. If the DAC switch turns on, the downhill assist control system indicator light flashes.
  - ABS
  - Brake assist system
  - VSC
  - TRAC
  - Downhill assist control system
  - Hill-start assist control system

■ **The rear differential lock is disengaged when**

Shift the front-wheel drive control switch to H2 or H4 position. (4WD models)

Never forget to turn off the switch after using this feature.

**■ After unlocking the rear differential**

To check that the indicator goes off, turn the engine switch to the ON position, but do not start the engine.

**⚠ CAUTION****■ To avoid an accident**

- Do not use the rear differential lock system except when wheel spinning occurs in a ditch or on a slippery or ragged surface. Large steering effort and careful cornering control will be required.
- Do not lock the rear differential until the wheels have stopped spinning. Otherwise, the vehicle may move in an unexpected direction when the differential lock is engaged, resulting in an accident. This may also lead to possible damage to differential lock component parts.
- Do not drive over 5 mph (8 km/h) when the differential is locked.
- Do not keep driving with the RR DIFF LOCK switch on.

## Downhill Assist Control system\*

**The downhill assist control system helps to prevent excessive speed on steep downhill descents.**

### ■ System operation

The system will operate when the vehicle is traveling under 15 mph (25 km/h) and the front-wheel drive control switch is in the L4 position.

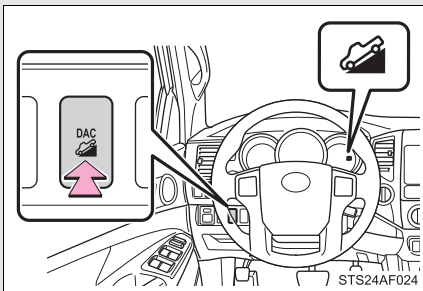

Press the DAC switch. The indicator will come on, and the system will operate.

With the vehicle traveling at a speed of 15 mph (25 km/h) or less, release your foot from the accelerator or brake pedal to activate the system.

When the system is in operation, the slip indicator will flash, and the stop lights/high mounted stop light will come on. A sound may also occur during the operation. This does not indicate a malfunction.

### ■ Turning off the system

Press the DAC switch while the system is in operation. The indicator will flash as the system gradually ceases operation, and will turn off when the system is fully off.

Pressing the DAC switch while the indicator is flashing will start the system again.

\*: If equipped

### ■ Operating tips

The system will operate when the shift lever is in a position other than P. However, to make effective use of the system it is recommended that the shift lever be shifted to 2 or L.

### ■ The system will not operate when

- The front-wheel drive control switch is in the H2 or H4 position.
- The rear differential is locked.

### ■ The downhill assist control system indicator light flashes when

- The shift lever is in the N position.
- The front-wheel drive control switch is in the H2 or H4 position.
- The rear differential is locked.

### ■ If the brake system overheats

The system will cease operation and a buzzer will sound to alert the driver. Stop the vehicle in a safe place. (There is no problem with continuing normal driving.)

### ■ System malfunction

- The downhill assist control system indicator does not come on when the engine switch is turned to the ON position.
- The downhill assist control system indicator does not come on when the DAC switch is pressed.

In the above cases have your vehicle checked by your Toyota dealer.

### CAUTION

### ■ Do not rely excessively on the downhill assist control system

It may not be able to maintain a low speed over road surfaces on which sliding can easily occur, such as extremely steep slopes or icy or muddy roads.

## Clutch start cancel switch\*

**The switch allows the vehicle to be driven out of difficult situations by cranking the engine with the clutch engaged.**

Never use the switch for normal engine starting. Be sure to follow the starting procedure. (→P. 131)

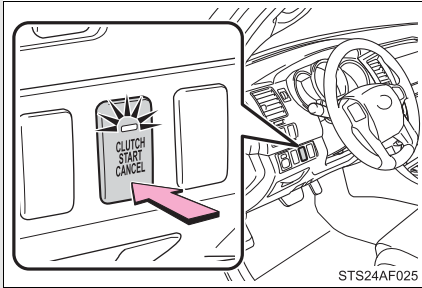

Press the CLUTCH START CANCEL switch to cancel the clutch start system when the engine switch is turned to the ON position.

The indicator comes on when the clutch start system is canceled.

The clutch start cancel switch is automatically turned off when the engine switch is turned off.

### ■ Clutch start system

The system is designed to keep the starter motor from operating if the clutch pedal is not depressed all the way down.

\*: If equipped

**To help enhance driving safety and performance, the following systems operate automatically in response to various driving situations. Be aware, however, that these systems are supplementary and should not be relied upon too heavily when operating the vehicle.**

### ■ **ABS (Anti-lock Brake System)**

Helps to prevent wheel lock when the brakes are applied suddenly, or if the brakes are applied while driving on a slippery road surface.

### ■ **Brake assist**

Generates an increased level of braking force after the brake pedal is depressed, while the system detects a panic stop situation.

### ■ **VSC (Vehicle Stability Control)**

Helps the driver to control skidding when swerving suddenly or turning on slippery road surfaces.

### ■ **Trailer Sway Control (vehicles with towing hitch and 7 pin connector)**

Helps the driver to control trailer sway by selectively applying brake pressure for individual wheels and reducing engine torque when trailer sway is detected.

Trailer Sway Control is part of the VSC system and will not operate if VSC is turned off or experiences a malfunction.

### ■ **TRAC (Traction Control)**

Helps to maintain drive power and prevent the drive wheels from spinning when starting the vehicle or accelerating on slippery roads.

### ■ **Hill-start assist control (if equipped)**

Helps prevent the vehicle from rolling backwards when starting on an incline or slippery slope. It operates for approximately 5 seconds at maximum.

**When the VSC/Trailer Sway Control/TRAC/hill-start assist control systems are operating**

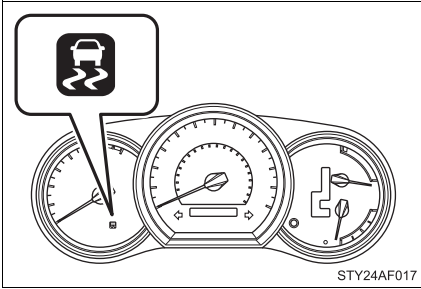

The slip indicator will flash while the VSC/Trailer Sway Control/TRAC/hill-start assist control systems are operating.

The stop lights and high mounted stoplight turn on when the hill-start assist control system or Trailer Sway Control is operating.

**To disable VSC, Trailer Sway Control and TRAC (2WD models and 2WD mode on 4WD models)**

If the vehicle gets stuck in fresh snow or mud, VSC, Trailer Sway Control and TRAC may reduce power from the engine to the wheels. You may need to turn the system off to enable you to rock the vehicle in order to free it.

**■ Turning off TRAC, VSC and Trailer Sway Control**

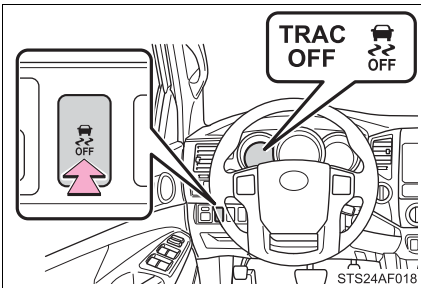

Press and hold the VSC OFF switch for more than 3 seconds while the vehicle is stopped to turn off TRAC, VSC and Trailer Sway Control.

The VSC OFF and TRAC OFF indicators will come on.

Push the switch again to turn both systems back on.



## To disable VSC, Trailer Sway Control and/or TRAC (4WD mode on 4WD models)

If the vehicle gets stuck in fresh snow or mud, VSC, Trailer Sway Control and TRAC may reduce power from the engine to the wheels. You may need to turn the system off to enable you to rock the vehicle in order to free it.

### ■ Turning off TRAC

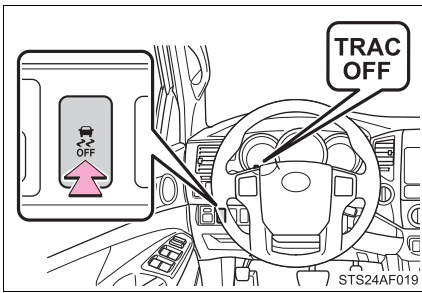

Quickly push and release the VSC OFF switch to turn off TRAC.

The TRAC OFF indicator will come on.

Push the switch again to turn the system back on.

### ■ Turning off TRAC, VSC and Trailer Sway Control

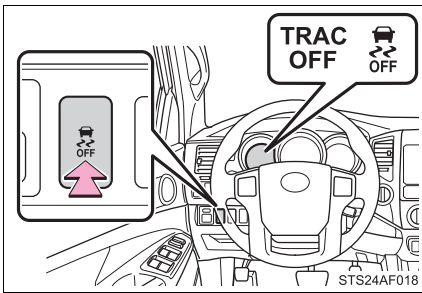

Press and hold the VSC OFF switch for more than 3 seconds while the vehicle is stopped to turn off TRAC, VSC and Trailer Sway Control.

The VSC OFF and TRAC OFF indicators will come on.

Push the switch again to turn both systems back on.

■ **When the TRAC OFF indicator light comes on even if the VSC OFF switch has not been pressed**

TRAC, hill-start assist control, downhill assist control system cannot be operated. Contact your Toyota dealer.

■ **Reactivation of the TRAC, VSC and Trailer Sway Control systems after turning off the engine**

Turning off the engine after turning off the TRAC, VSC and Trailer Sway Control systems will automatically reactivate them.

■ **Automatic TRAC reactivation (AUTO LSD mode)**

With AUTO LSD mode, VSC OFF and AUTO LSD indicator lights turn on. The TRAC system will turn on when the vehicle speed increases.

■ **Automatic TRAC, VSC and Trailer Sway Control reactivation**

If the TRAC, VSC and Trailer Sway Control systems are turned off, the systems will not turn on even when vehicle speed increases.

■ **Sounds and vibrations caused by the ABS, TRAC, VSC, Trailer Sway Control, brake assist and hill-start assist control system**

● A sound may be heard from the engine compartment when the engine is started or just after the vehicle begins to move. This sound does not indicate that a malfunction has occurred in any of these systems.

● Any of the following conditions may occur when the above systems are operating. None of these indicates that a malfunction has occurred.

- Vibrations may be felt through the vehicle body and steering.
- A motor sound may be heard after the vehicle comes to a stop.
- The brake pedal may pulsate slightly when the ABS is activated.
- The brake pedal may move down slightly after the ABS is activated.

■ **Hill-start assist control is operational when (if equipped)**

● The shift lever is in the D, 4, 3, 2 (5-speed automatic transmission), D, 3, 2 (4-speed automatic transmission) or L positions.

● The brake pedal is not depressed.

■ **Hill-start assist control will not operate when (if equipped)**

- The shift lever is in the P, R or N positions.
- The rear differential is locked.

■ **If the brake system overheats**

TRAC and hill-start control will cease operation and a buzzer will sound to alert the driver. Stop the vehicle in a safe place. (There is no problem with continuing normal driving.)

 **CAUTION**

■ **The ABS does not operate effectively when**

- The limits of tire gripping performance have been exceeded.
- The vehicle hydroplanes while driving at high speed on the wet or slick road.

■ **Stopping distance when the ABS is operating may exceed that of normal conditions**

The ABS is not designed to shorten the vehicle's stopping distance. Always maintain a safe distance from the vehicle in front of you, especially in the following situations.

- When driving on dirt, gravel or snow-covered roads
- When driving with tire chains
- When driving over bumps in the road
- When driving over roads with potholes or roads with uneven roads

■ **When VSC and Trailer Sway Control are activated**

The slip indicator flashes. Always drive carefully. Reckless driving may cause an accident. Exercise particular care when the indicator flashes.

■ **TRAC may not operate effectively when**

Directional control and power may not be achievable while driving on slippery road surfaces, even if TRAC is operating.  
Do not drive the vehicle in conditions where stability and power may be lost.

■ **If the hill-start assist control does not operate effectively**

Do not overly rely on the hill-start assist control. The hill start assist control may not operate effectively on steep inclines and roads covered in ice.

 **CAUTION**

■ **Replacing tires**

Make sure that all tires are of the same size, brand, tread pattern and total load capacity. In addition, make sure that the tires are inflated to the appropriate tire pressure level.

The ABS, VSC, TRAC and Trailer Sway Control will not function correctly if different tires are fitted on the vehicle.

Contact your Toyota dealer for further information when replacing tires or wheels.

■ **Handling of tires and suspension**

Using tires with any kind of problem or modifying the suspension will affect the driving assist systems, and may cause the system to malfunction.

■ **Trailer Sway Control precaution**

The Trailer Sway Control system is not able to reduce trailer sway in all situations. Depending on many factors such as the conditions of the vehicle, trailer, road surface, and driving environment, the Trailer Sway Control system may not be effective. Refer to your trailer owner's manual for information on how to tow your trailer properly.

■ **If trailer sway occurs**

Observe the following precautions.

Failing to do so may cause death or serious injury.

● Firmly grip the steering wheel. Steer straight ahead.

Do not try to control trailer swaying by turning the steering wheel.

● Begin releasing the accelerator pedal immediately but very gradually to reduce speed.

Do not increase speed. Do not apply vehicle brakes.

If you make no extreme correction with the steering or brakes, your vehicle and trailer should stabilize. (→P. 229)

**This vehicle has higher ground clearance and narrower tread in relation to the height of its center of gravity to make it capable of performing in a wide variety of off-road applications.**

#### Off-road vehicle feature

- Specific design characteristics give it a higher center of gravity than ordinary passenger cars. This vehicle design feature causes this type of vehicle to be more likely to rollover. And, it has a significantly higher rollover rate than other types of vehicles.
- An advantage of the higher ground clearance is a better view of the road allowing you to anticipate problems.
- It is not designed for cornering at the same speeds as ordinary passenger cars any more than low-slung sports cars are designed to perform satisfactorily under off-road conditions. Therefore, sharp turns at excessive speeds may cause rollover.

 CAUTION

■ **Off-road vehicle precautions**

Always observe the following precautions to minimize the risk of serious personal injury or damage to your vehicle:

- In a rollover crash, an unbelted person is significantly more likely to die than a person wearing a seat belt. Therefore, the driver and all passengers should fasten their seat belts whenever the vehicle is moving.
- Avoid sharp turns or abrupt maneuvers, if at all possible.  
Failure to operate this vehicle correctly may result in loss of control or vehicle rollover causing death or serious injury.
- Avoid loading any items on the roof that will raise the vehicle's center of gravity.
- Always slow down in gusty crosswinds. Because of its profile and higher center of gravity, your vehicle is more sensitive to side winds than an ordinary passenger car. Slowing down will allow you to have much better control.
- When driving off-road or in rugged terrain, do not drive at excessive speeds, jump, make sharp turns, strike objects, etc. This may cause loss of control or vehicle rollover causing death or serious injury. You are also risking expensive damage to your vehicle's suspension and chassis.
- Do not drive horizontally across steep slopes. Driving straight up or straight down is preferred. Your vehicle (or any similar off-road vehicle) can tip over sideways much more easily than forward or backward.

## Off-road driving

When driving your vehicle off-road, please observe the following precautions to ensure your driving enjoyment and to help prevent the closure of areas to off-road vehicles.

- Drive your vehicle only in areas where off-road vehicles are permitted to travel.
- Respect private property. Get owner's permission before entering private property.
- Do not enter areas that are closed. Honor gates, barriers and signs that restrict travel.
- Stay on established roads. When conditions are wet, driving techniques should be changed or travel delayed to prevent damage to roads.

---

### ■ Additional information for off-road driving

► For owners in U.S. mainland, Hawaii and Puerto Rico:

To obtain additional information pertaining to driving your vehicle off-road, consult the following organizations.

- State and Local Parks and Recreation Departments
- State Motor Vehicle Bureau
- Recreational Vehicle Clubs
- U.S. Forest Service and Bureau of Land Management

 CAUTION

■ **Off-road driving precautions**

Always observe the following precautions to minimize the risk of serious injury or damage to your vehicle:

- Drive carefully when off the road. Do not take unnecessary risks by driving in dangerous places.
- Do not grip the steering wheel spokes when driving off-road. A bad bump could jerk the wheel and injure your hands. Keep both hands and especially your thumbs on the outside of the rim.
- Always check your brakes for effectiveness immediately after driving in sand, mud, water or snow.
- After driving through tall grass, mud, rock, sand, rivers, etc., check that there is no grass, bush, paper, rags, stone, sand, etc. adhering or trapped on the underbody. Clear off any such matter from the underbody. If the vehicle is used with these materials trapped or adhering to the underbody, a breakdown or fire could occur.
- In a rollover crash, an unbelted person is significantly more likely to die than a person wearing a seat belt. Therefore, the driver and all passengers should fasten their seat belts whenever the vehicle is moving.
- When driving off-road or in rugged terrain, do not drive at excessive speeds, jump, make sharp turns, strike objects, etc. This may cause loss of control or vehicle rollover causing death or serious injury. You are also risking expensive damage to your vehicle's suspension and chassis.



 NOTICE**■ To prevent the water damage**

- Take all necessary safety measures to ensure that water damage to the engine or other components does not occur.
- Water entering the engine air intake will cause severe engine damage.
- Water entering the automatic transmission will cause deterioration in shift quality, locking up of your transmission accompanied by vibration, and ultimately damage.
- Water can wash the grease from wheel bearings, causing rusting and premature failure, and may also enter the differentials, transmission and transfer case, reducing the gear oil's lubricating qualities.

**■ When you drive through water**

If driving through water, such as when crossing shallow streams, first check the depth of the water and the bottom of the river bed for firmness. Drive slowly and avoid deep water.

**■ Inspection after off-road driving**

- Sand and mud that has accumulated in brake drums and around brake discs may affect braking efficiency and may damage brake system components.
- Always perform a maintenance inspection after each day of off-road driving that has taken you through rough terrain, sand, mud, or water. For scheduled maintenance information, refer to the "Scheduled Maintenance Guide" or "Owner's Manual Supplement".

## 2-5. Driving information

# Cargo and luggage

**Take notice of the following information about storage precautions, cargo capacity and load.**

- Stow cargo and luggage in the rear deck whenever possible.
- Be sure all items are secured in place.
- Be careful to keep the vehicle level. Placing the weight as far forward as possible helps maintain vehicle balance.
- For better fuel economy, do not carry unnecessary weight.

### ■ Deck rails

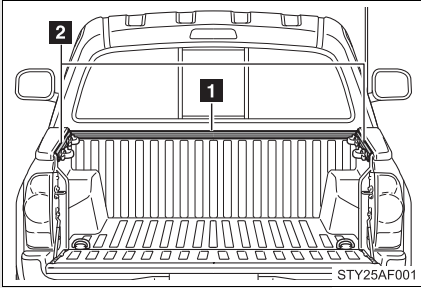

#### 1 Headboard rail

#### 2 Side rails

To use the deck rails, you must install genuine Toyota accessories or their equivalent for the deck rails.

Follow the manufacturer's instructions and precautions when installing a genuine Toyota accessory or equivalent.

### ⚠ CAUTION

#### ■ When you secure cargo with the deck rails

Be sure to follow the instructions below in order to avoid the cargo coming loose.

- Do not install accessories (tie-down cleats, storage boxes, etc.) at more than the following number of locations per deck rail.
  - Side rail:
    - Short deck—Max. 3 locations
    - Long deck—Max. 4 locations
  - Headboard rail:
    - Max 3 locations

**⚠ CAUTION****■ When you secure cargo with the deck rails**

- Spread out tie-down/support locations evenly along the length of the rails.
- Do not exceed a total tensile load of 440 lb. (200 kg) per deck rail.
- To prevent luggage or cargo from sliding forward during braking, make sure the deck rail accessories such as storage box are securely attached on the deck rails.

**Capacity and distribution**

Cargo capacity depends on the total weight of the occupants.

(Cargo capacity) = (Total load capacity) – (Total weight of occupants)

**Steps for Determining Correct Load Limit—**

- (1) Locate the statement “The combined weight of occupants and cargo should never exceed XXX kg or XXX lbs.” on your vehicle’s placard.
- (2) Determine the combined weight of the driver and passengers that will be riding in your vehicle.
- (3) Subtract the combined weight of the driver and passengers from XXX kg or XXX lbs.
- (4) The resulting figure equals the available amount of cargo and luggage load capacity.  
For example, if the “XXX” amount equals 1400 lbs. and there will be five 150 lb passengers in your vehicle, the amount of available cargo and luggage load capacity is 650 lbs. (1400 – 750 (5 × 150) = 650 lbs.)
- (5) Determine the combined weight of luggage and cargo being loaded on the vehicle. That weight may not safely exceed the available cargo and luggage load capacity calculated in Step 4.

- (6) If your vehicle will be towing a trailer, load from your trailer will be transferred to your vehicle. Consult this manual to determine how this reduces the available cargo and luggage load capacity of your vehicle.

### Calculation formula for your vehicle

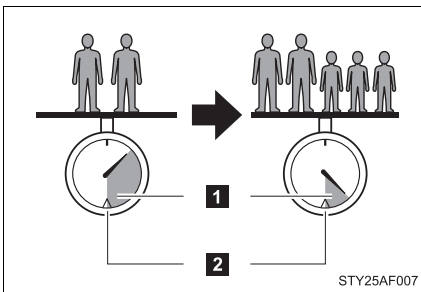

**1** Cargo capacity

**2** Total load capacity (vehicle capacity weight) (→P. 518)

When 2 people with the combined weight of A lb. (kg) are riding in your vehicle, which has a total load capacity (vehicle capacity weight) of B lb. (kg), the available amount of cargo and luggage load capacity will be C lb. (kg) as follows:

$$B^{*2} \text{ lb. (kg)} - A^{*1} \text{ lb. (kg)} = C^{*3} \text{ lb. (kg)}$$

\*1: A = Weight of people

\*2: B = Total load capacity

\*3: C = Available cargo and luggage load

In this condition, if 3 more passengers with the combined weight of D lb. (kg) get on, the available cargo and luggage load will be reduced E lb. (kg) as follows:

$$C \text{ lb. (kg)} - D^{*4} \text{ lb. (kg)} = E^{*5} \text{ lb. (kg)}$$

\*4: D = Additional weight of people

\*5: E = Available cargo and luggage load

As shown in the above example, if the number of occupants increases, the cargo and luggage load will be reduced by an amount that equals the increased weight due to the additional occupants. In other words, if an increase in the number of occupants causes an excess of the total load capacity (combined weight of occupants plus cargo and luggage load), you must reduce the cargo and luggage on your vehicle.

### CAUTION

#### ■ Things that must not be carried in the luggage compartment

The following things may cause a fire if loaded in the luggage compartment.

- Receptacles containing gasoline
- Aerosol cans

#### ■ Storage precautions

Observe the following precautions.

Failing to do so may result in death or serious injury.

- Do not stack anything behind the front seats higher than the seat-backs.  
Such items may be thrown about and possibly injure people in the vehicle during sudden braking or in an accident.
- Do not place cargo or luggage in or on the following locations as the item may get under the clutch, brake or accelerator pedal and prevent the pedals from being depressed properly, block the driver's vision, or hit the driver or passengers, causing an accident.
  - Driver's feet
  - Front passenger or rear seats (when stacking items)
  - Instrument panel
  - Dashboard
  - Auxiliary box or tray that has no lid
- Secure all items in the occupant compartment, as they may shift and injure someone during sudden braking, sudden swerving or an accident.

 CAUTION

■ **Storage precautions**

- Never allow anyone to ride in the rear deck. It is not designed for passengers. They should ride in their seats with their seat belts properly fastened. Otherwise, they are much more likely to suffer death or serious bodily injury, in the event of sudden braking, sudden swerving or an accident.

■ **Capacity and distribution**

- Do not exceed the maximum axle weight rating or the total vehicle weight rating.
- Even if the total load of occupant's weight and the cargo load is less than the total load capacity, do not apply the load unevenly. Improper loading may cause deterioration of steering or braking control which may cause death or serious injury.

**Vehicle load limits include total load capacity, seating capacity, TWR (Trailer Weight Rating) and cargo capacity.**

■ **Total load capacity (vehicle capacity weight): (→P. 518)**

Total load capacity means the combined weight of occupants, cargo and luggage.

■ **Seating capacity:**

▶ **Access Cab models**

**2 or 4 occupants (Front 2, Rear 0 or 2)**

▶ **Double Cab models**

**5 occupants (Front 2, Rear 3)**

Seating capacity means the maximum number of occupants whose estimated average weight is 150 lb. (68 kg) per person.

Even if the number of occupants are within the seating capacity, do not exceed the total load capacity.

■ **TWR (Trailer Weight Rating): (→P. 218, 519)**

TWR means the maximum gross trailer weight (trailer weight plus its cargo weight) that your vehicle is able to tow.

■ **Cargo capacity**

Cargo capacity may increase or decrease depending on the weight and the number of occupants.

---

■ **Total load capacity and seating capacity**

These details are also described on the tire and loading information label. (→P. 431)

 CAUTION

■ **Overloading the vehicle**

Do not overload the vehicle.

It may not only cause damage to the tires, but also degrade steering and braking ability, resulting in an accident.



**Carry out the necessary preparations and inspections before driving the vehicle in winter. Always drive the vehicle in a manner appropriate to the prevailing weather conditions.**

■ **Pre-winter preparations**

- Use fluids that are appropriate to the prevailing outside temperatures.
  - Engine oil
  - Engine coolant
  - Washer fluid
- Have a service technician inspect the level and specific gravity of battery electrolyte.
- Have the vehicle fitted with four snow tires or purchase a set of tire chains for the rear tires.

Ensure that all tires are the same size and brand, and that chains match the size of the tires.

■ **Before driving the vehicle**

Perform the following according to the driving conditions.

- Do not try to forcibly open a window, scrape an outside rear view mirror surface or move a wiper or outside rear view mirror that is frozen. Pour warm water over the frozen area to melt the ice. Wipe away the water immediately to prevent it from freezing.
- To ensure proper operation of the climate control system fan, remove any snow that has accumulated on the air inlet vents in front of the windshield.
- Remove any ice that has accumulated on the vehicle chassis.
- Periodically check for and remove any excess ice or snow that may have accumulated in the wheel well or on the brakes.

### ■ When driving the vehicle

Accelerate the vehicle slowly and drive at a reduced speed suitable to road conditions.

### ■ When parking the vehicle

Park the vehicle and move the shift lever to P (automatic transmission) or 1 or R (manual transmission) without setting the parking brake. The parking brake may freeze up, preventing it from being released. If necessary, block the wheels to prevent inadvertent sliding or creeping.

## Selecting tire chains

Use the correct tire chain size when mounting the snow chains. Chain size is regulated for each tire size.

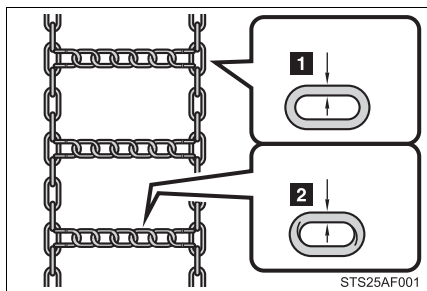

#### 1 Side chain

0.2 in. (5 mm) in diameter

#### 2 Cross chain

0.25 in. (6.3 mm) in diameter

## Regulations on the use of snow chains

- Regulations regarding the use of tire chains vary according to location and type of road. Always check local regulations before installing chains.
- Install the chains on the rear tires.
- Retighten the chains after driving 1/4 - 1/2 mile (0.5 - 1.0 km).

### ■ Snow chain installation

Observe the following precautions when installing and removing chains.

- Install and remove tire chains in a safe location.
- Install tire chains on the rear tires only. Do not install tire chains on the front tires.
- Install tire chains following the instructions provided in the accompanying instructions.

### CAUTION

#### ■ Driving with snow tires

Observe the following precautions to reduce the risk of accidents.

Failing to do so may result in a loss of vehicle control and cause death or serious injury.

- Use tires of the size specified for your vehicle.
- Maintain the recommended level of air pressure.
- Do not drive in excess of 75 mph (120 km/h) regardless of the type of snow tires being used.
- Snow tires should be installed on all wheels.
- 4WD models:  
Do not mix tires of different makes, models, tread patterns or treadwear.

#### ■ Driving with snow chains

Observe the following precautions to reduce the risk of accidents.

Failing to do so may result in the vehicle being unable to be driven safely, and may cause death or serious injury.

- Do not drive in excess of the speed limit specified for the tire chains being used or 30 mph (50 km/h), whichever is lower.
- Avoid driving on bumpy road surfaces or over potholes.
- Avoid sudden turns and braking.
- Slow down sufficiently before entering a curve to ensure that vehicle control is maintained.

 **CAUTION**

■ **When parking the vehicle**

Always use wheel blocks when parking without the parking brake. Failure to do so may allow the vehicle to move, resulting in an accident.

 **NOTICE**

■ **Repairing or replacing snow tires**

Request repairs of and obtain replacement snow tires from Toyota dealers or legitimate tire retailers.

This is because the removal and attachment of snow tires affects the operation of the tire pressure warning valves and transmitters.

■ **Fitting tire chains**

The tire pressure warning valves and transmitters may not function correctly when tire chains are fitted.

## Trailer towing

**Your vehicle is designed primarily as a passenger-and-load-carrying vehicle. Towing a trailer can have an adverse impact on handling, performance, braking, durability, and fuel consumption. For your safety and the safety of others, you must not overload your vehicle or trailer. You must also ensure that you are using appropriate towing equipment, that the towing equipment has been installed correctly and used properly, and that you employ the requisite driving habits.**

**Vehicle-trailer stability and braking performance are affected by trailer stability, brake performance and setting, trailer brakes, the hitch and hitch systems (if equipped).**

**To tow a trailer safely, use extreme care and drive the vehicle in accordance with your trailer's characteristics and operating conditions.**

**Toyota warranties do not apply to damage or malfunction caused by towing a trailer for commercial purposes.**

Contact your Toyota dealer for further information about additional requirements such as towing kits, etc.

## Towing related terms

### ■ GCWR (Gross Combination Weight Rating)

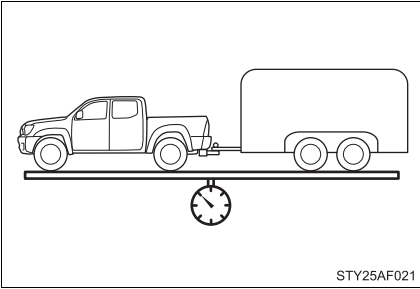

The maximum allowable gross combination weight. The gross combination weight is the sum of the total vehicle weight (including the occupants, cargo and any optional equipment installed on the vehicle) and the weight of the trailer being towed (including the cargo in the trailer).

### ■ GVWR (Gross Vehicle Weight Rating)

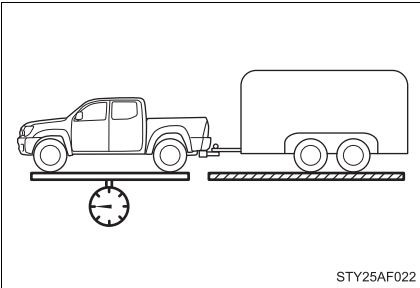

The maximum allowable gross vehicle weight. The gross vehicle weight is the total weight of the vehicle. When towing a trailer, it is the sum of the vehicle weight (including the occupants, cargo and any optional equipment installed on the vehicle) and the tongue weight.

## ■ GAWR (Gross Axle Weight Rating)

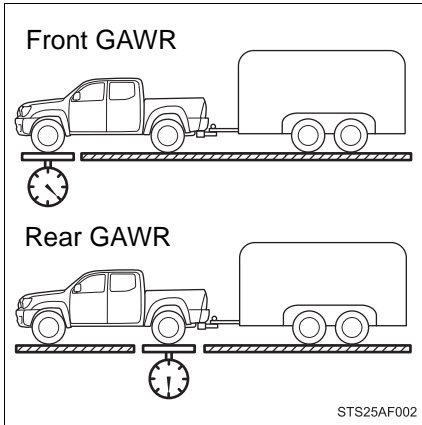

The maximum allowable gross axle weight. The gross axle weight is the load placed on each axle (front and rear).

## ■ TWR (Trailer Weight Rating)

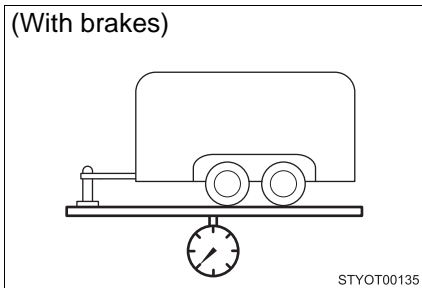

The maximum allowable gross trailer weight. The gross trailer weight is the sum of the trailer weight and the weight of the cargo in the trailer.

TWR is calculated assuming base vehicle with one driver, one front passenger, towing package (if available), hitch and hitch systems (if required).

Additional optional equipment, passengers and cargo in the vehicle will reduce the trailer weight rating so as not to exceed GCWR, GVWR and GAWR.

If the gross trailer weight exceeds 3000 lb. (1360 kg), it is recommended to use a trailer with 2 or more axles.

### ■ Unbraked TWR (Unbraked Trailer Weight Rating)

(Without brakes)

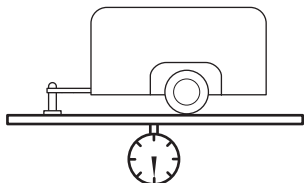

STSOT00046

The trailer weight rating for towing a trailer without a trailer service brake system.

### ■ Tongue Weight

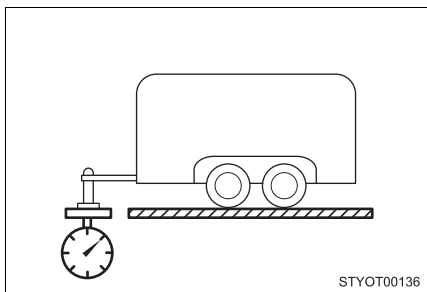

STYOT00136

The load placed on the trailer hitch ball. (→P. 221)



## Weight limits

- The gross trailer weight must never exceed the TWR described in the table. (→P. 218, 519)
- The gross combination weight must never exceed the GCWR described in the table. (→P. 218)

### ► Access Cab models

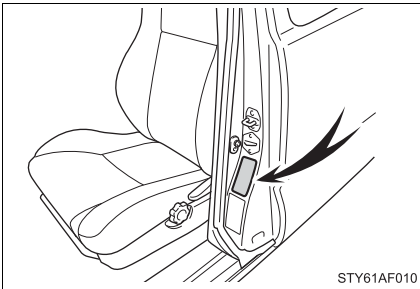

- The gross vehicle weight must never exceed the GVWR indicated on the Certification Label.
- The gross axle weight on each axle must never exceed the GAWR indicated on the Certification Label.

### ► Double Cab models

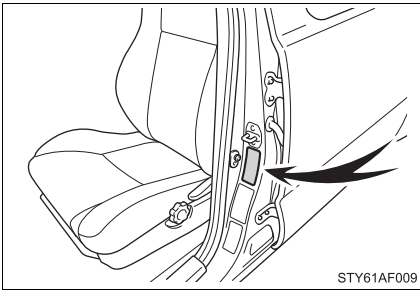

- If the gross trailer weight is over the unbraked TWR, trailer service brakes are required.
- If the gross trailer weight is over 2000 lb. (905 kg), a sway control device with sufficient capacity is required.
- If the gross trailer weight is over 5000 lb. (2265 kg), a weight distributing hitch with sufficient capacity is required.

**GCWR, TWR, Unbraked TWR, Fifth wheel and Gooseneck towing TWR**

Confirm that the gross trailer weight, gross combination weight, gross vehicle weight, gross axle weight and tongue weight are all within the limits.

■ **GCWR\* and TWR\***

► Access Cab models

Model code *1	Engine	Driving system	GCWR	TWR
TRN225L-CRMDKA	2.7 L 4-cylinder (2TR-FE) engine	2WD	7440 lb. (3370 kg)	3500 lb. (1585 kg)
TRN225L-CRPDKA			7470 lb. (3385 kg)	
TRN245L-CRMDKA		4WD	7860 lb. (3565 kg)	
TRN245L-CRPDKA			7880 lb. (3570 kg)	
TRN265L-CRPDKA		2WD	7640 lb. (3465 kg)	
GRN225L-CRFDKA	4.0 L V6 (1GR-FE) engine	2WD	7460 lb. (3380 kg)	3300 lb. (1495 kg)
GRN245L-CRADKA		4WD	7970 lb. (3615 kg) <sup>*2</sup>	3500 lb. (1585 kg) <sup>*2</sup>
			11100 lb. (5030 kg) <sup>*3</sup>	6500 lb. (2945 kg) <sup>*3</sup>
GRN245L-CRFDKA			7930 lb. (3595 kg) <sup>*2</sup>	3500 lb. (1585 kg) <sup>*2</sup>
			11070 lb. (5020 kg) <sup>*3</sup>	6500 lb. (2945 kg) <sup>*3</sup>
GRN265L-CRADKA		2WD	7730 lb. (3505 kg) <sup>*2</sup>	3500 lb. (1585 kg) <sup>*2</sup>
			10860 lb. (4925 kg) <sup>*3</sup>	6500 lb. (2945 kg) <sup>*3</sup>

\*: These models meet the tow-vehicle trailering requirement of SAE International per SAE J2807.

## ► Double Cab models

Model code*1	Engine	Driving system	GCWR	TWR
TRN225L-PRPDKA	2.7 L 4-cylinder (2TR-FE) engine	2WD	7450 lb. (3375 kg)	3400 lb. (1540 kg)
TRN265L-PRPDKA			7720 lb. (3500 kg)	3500 lb. (1585 kg)
GRN245L-PRADKA	4.0 L V6 (1GR-FE) engine	4WD	8050 lb. (3650 kg)*2	3500 lb. (1585 kg)*2
GRN245L-PRFDKA			11180 lb. (5070 kg)*3	6500 lb. (2945 kg)*3
			8020 lb. (3635 kg)*2	3500 lb. (1585 kg)*2
GRN250L-PRADKA			11160 lb. (5060 kg)*3	6500 lb. (2945 kg)*3
			8010 lb. (3630 kg)*2	3400 lb. (1540 kg)*2
			10960 lb. (4970 kg)*3	6200 lb. (2810 kg)*3

Model code*1	Engine	Driving system	GCWR	TWR
GRN265L-PRADKA	4.0 L V6 (1GR-FE) engine	2WD	7810 lb. (3540 kg)*2	3500 lb. (1585 kg)*2
			10950 lb. (4965 kg)*3	6500 lb. (2945 kg)*3
GRN270L-PRADKA			7900 lb. (3580 kg)*2	3500 lb. (1585 kg)*2
			11030 lb. (5000 kg)*3	6500 lb. (2945 kg)*3

\*1: The model code is indicated on the Certification Label. (→P. 217, 521)

\*2: Without towing package

\*3: With towing package

#### ■ Unbraked TWR\*

1000 lb. (450 kg)

#### ■ Fifth wheel and gooseneck towing TWR\*

Toyota does not recommend fifth wheel and gooseneck towing.

\*: These models meet the tow-vehicle trailering requirement of SAE International per SAE J2807.

## Trailer Tongue Weight

- A recommended tongue weight varies in accordance with the types of trailers or towing as described below.
- To ensure the recommended values shown below, the trailer must be loaded by referring to the following instructions.
  - Tongue Weight

The gross trailer weight should be distributed so that the tongue weight is 9% to 11%. (Tongue weight /Gross trailer weight x 100 = 9% to 11%)

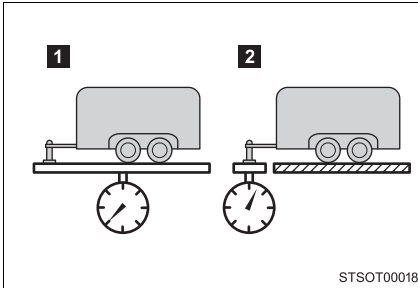

- 1 Gross trailer weight
- 2 Tongue weight

If using a weight distributing hitch when towing, return the front axle to the same weight as before the trailer connection.

If front axle weight cannot be measured directly, measure the front fender height above the front axle before connection. Adjust weight distributing hitch torque until front fender is returned to the same height as before connection.

The gross trailer weight, gross axle weight and tongue weight can be measured with platform scales found at a highway weighing station, building supply company, trucking company, junk yard, etc.

## Hitch

Trailer hitch assemblies have different weight capacities. Toyota recommends the use of Toyota hitch/bracket for your vehicle. For details, contact your Toyota dealer.

- If you wish to install a trailer hitch, contact your Toyota dealer.
- Use only a hitch that conforms to the gross trailer weight requirement of your vehicle.
- Follow the directions supplied by the hitch manufacturer.
- Lubricate the hitch ball with a light coating of grease.
- Remove the trailer hitch whenever you are not towing a trailer. After removing the hitch, seal any mounting hole in the vehicle body to prevent entry of any substances into the vehicle.

## Bumper towing (vehicles with steel bumper only)

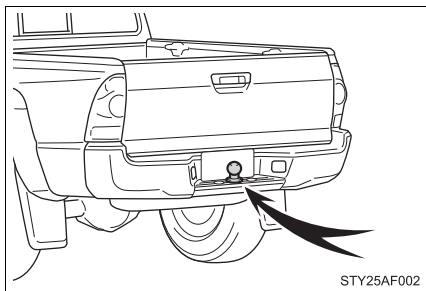

The rear bumper of your vehicle is equipped with a hole to install a trailer ball. If you have any questions, contact your Toyota dealer.

The gross trailer weight (trailer weight plus cargo weight) when towing with the bumper must never exceed the TWR (→P. 218, 519) or 3500 lb. (1585 kg) whichever is lower.

## Selecting trailer ball

Use the correct trailer ball for your application.

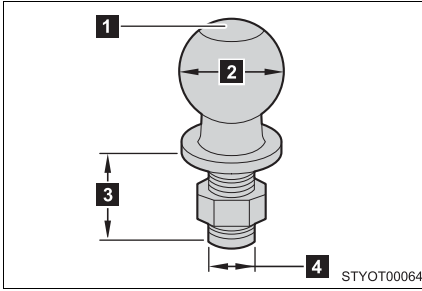

### 1 Trailer ball load rating

Matches or exceeds the gross trailer weight rating of the trailer.

### 2 Ball diameter

Matches the size of the trailer coupler. Most couplers are stamped with the required trailer ball size.

Trailer class	Typical trailer ball size
IV	2 5/16 in.
II and III	2 in.
I	1 7/8 in.

### 3 Shank length

Protrudes beyond the bottom of the lock washer and nut by at least 2 threads.

### 4 Shank diameter

Matches the ball mount hole diameter size.

### Positions for towing hitch receiver and hitch ball

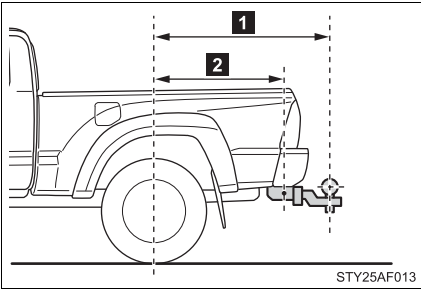

- 1** Weight carrying ball position:  
56.1 in. (1425 mm)
- 2** Hitch receiver pin hole position:  
44.2 in. (1123 mm)

### Connecting trailer lights

- ▶ Vehicles with 7 pin connector

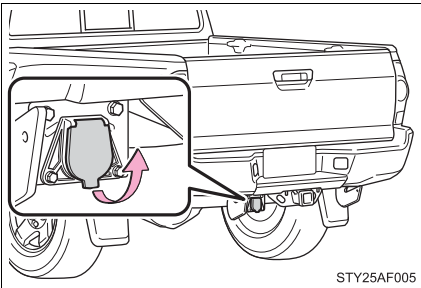

Use the wire harness stored in the rear end under the vehicle body.

- ▶ Vehicles without 7 pin connector

Please consult your dealer when installing trailer lights, as incorrect installation may cause damage to the vehicle's lights. Please take care to comply with your state's laws when installing trailer lights.



## ■ Service connector for towing brake controller (vehicles with 7 pin connector)

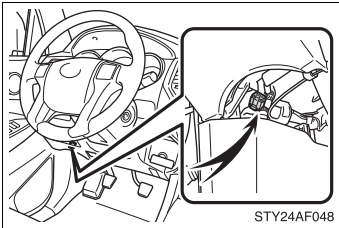

Your vehicle is equipped with a service connector for the trailer brake controller as shown.

### Trailer towing tips

Your vehicle will handle differently when towing a trailer. Help to avoid an accident, death or serious injury, keep the following in mind when towing:

- Speed limits for towing a trailer vary by state or province. Do not exceed the posted towing speed limit.
- Toyota recommends that the vehicle-trailer speed limit is 65 mph (104 km/h) on a flat, straight, dry road. Do not exceed this limit, the posted towing speed limit or the speed limit for your trailer as set forth in your trailer owner's manual, whichever is lowest. Instability of the towing vehicle-trailer combination (trailer sway) increases as speed increases. Exceeding speed limits may cause loss of control.
- Before starting out, check the trailer lights, tires and the vehicle-trailer connections. Recheck after driving a short distance.
- Practice turning, stopping and reversing with the trailer attached in an area away from traffic until you become accustomed to the feel of the vehicle-trailer combination.

- Reversing with a trailer attached is difficult and requires practice. Grip the bottom of the steering wheel and move your hand to the left to move the trailer to the left. Move your hand to the right to move the trailer to the right. (This is generally opposite to reversing without a trailer attached.) Avoid sharp or prolonged turning. Have someone guide you when reversing to reduce the risk of an accident.
- As stopping distance is increased when towing a trailer, vehicle-to-vehicle distance should be increased. For each 10 mph (16 km/h) of speed, allow at least one vehicle and trailer length.
- Avoid sudden braking as you may skid, resulting in the trailer jackknifing and a loss of vehicle control. This is especially true on wet or slippery surfaces.
- Avoid jerky starts or sudden acceleration.
- Avoid jerky steering and sharp turns, and slow down before making a turn.
- Note that when making a turn, the trailer wheels will be closer than the vehicle wheels to the inside of the turn. Compensate by making a wider than normal turning radius.
- Slow down before making a turn, in cross winds, on wet or slippery surfaces, etc.  
Increasing vehicle speed can destabilize the trailer.
- Take care when passing other vehicles. Passing requires considerable distance. After passing a vehicle, do not forget the length of your trailer, and be sure you have plenty of room before changing lanes.
- To maintain engine braking efficiency and charging system performance when using engine braking, do not use fifth gear (5-speed manual transmission), sixth gear (6-speed manual transmission), or do not put the transmission in D (automatic transmission).

- Instability happens more frequently when descending steep or long downhill grades. Before descending, slow down and downshift. Do not make sudden downshifts while descending steep or long downhill grades.
- Avoid holding the brake pedal down too long or applying the brakes too frequently. This could cause the brakes to overheat and result in reduced braking efficiency.
- Due to the added load of the trailer, your vehicle's engine may overheat on hot days (at temperatures over 85°F [30°C]) when driving up a long or steep grade. If the engine coolant temperature gauge indicates overheating, immediately turn off the air conditioning (if in use), pull your vehicle off the road and stop in a safe spot. (→P. 508)
- Always place wheel blocks under both the vehicle's and the trailer's wheels when parking. Apply the parking brake firmly, and put the transmission in P (automatic transmission) or in 1 or R (manual transmission). Avoid parking on a slope, but if unavoidable, do so only after performing the following:
  - STEP 1** Apply the brakes and keep them applied.
  - STEP 2** Have someone place wheel blocks under both the vehicle's and trailer's wheels.
  - STEP 3** When the wheel blocks are in place, release the brakes slowly until the blocks absorb the load.
  - STEP 4** Apply the parking brake firmly.
  - STEP 5** Shift into P (automatic transmission) or 1 or R (manual transmission) and turn off the engine.
- When restarting after parking on a slope:
  - STEP 1** With the transmission in P (automatic transmission) or the clutch pedal (manual transmission) depressed, start the engine. On vehicles with an automatic transmission, be sure to keep the brake pedal depressed.
  - STEP 2** Shift into a forward gear. If reversing, shift into R.

**STEP 3** Release the parking brake (and also the brake pedal on vehicles with an automatic transmission), and slowly pull or back away from the wheel blocks. Stop and apply the brakes.

**STEP 4** Have someone retrieve the blocks.

### ■ Matching trailer ball height to trailer coupler height

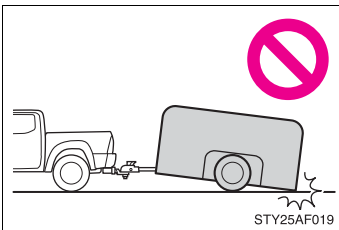

No matter which class of tow hitch applies, for a more safe trailer hookup, the trailer ball setup must be the proper height for the coupler on the trailer.

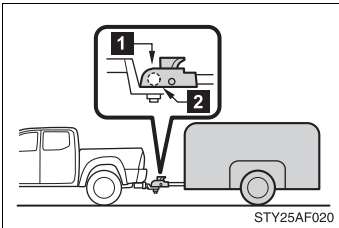

**1** Coupler

**2** Trailer ball

### ■ Before towing

Check that the following conditions are met:

- Ensure that your vehicle's tires are properly inflated. (→P. 532)
- Trailer tires are inflated according to the trailer manufacturer's recommendation.
- All trailer lights work as required by law.
- All lights work each time you connect them.
- The trailer ball is set at the proper height for the coupler on the trailer.
- The trailer is level when it is hitched.  
Do not drive if the trailer is not level, and check for improper tongue weight, overloading, worn suspension, or other possible causes.
- The trailer cargo is securely loaded.

- The rear view mirrors conform to all applicable federal, state/provincial or local regulations. If they do not, install rear view mirrors appropriate for towing purposes.

### ■ Break-in schedule

If your vehicle is new or equipped with any new power train components (such as an engine, transmission, differential or wheel bearing), Toyota recommends that you do not tow a trailer until the vehicle has been driven for over 500 miles (800 km).

After the vehicle has been driven for over 500 miles (800 km), you can start towing. However, for the next 500 miles (800 km), drive the vehicle at a speed of less than 50 mph (80 km/h) when towing a trailer, and avoid full throttle acceleration.

### ■ Maintenance

- If you tow a trailer, your vehicle will require more frequent maintenance due to the additional load. (See “Owner’s Warranty Information Booklet” or “Scheduled Maintenance Guide/Owner’s Manual Supplement”.)
- Retighten the fixing bolts of the towing ball and bracket after approximately 600 miles (1000 km) of trailer towing.

### ■ If trailer sway occurs

One or more factors (crosswinds, passing vehicles, rough roads, etc.) can adversely affect handling of your vehicle and trailer, causing instability.

- If trailer swaying occurs:

- Firmly grip the steering wheel. Steer straight ahead.  
Do not try to control trailer swaying by turning the steering wheel.
- Begin releasing the accelerator pedal immediately but very gradually to reduce speed.  
Do not increase speed. Do not apply vehicle brakes.

If you make no extreme correction with the steering or brakes, your vehicle and trailer should stabilize. (if enabled, Trailer Sway Control can also help to stabilize the vehicle and trailer.)

● After the trailer swaying has stopped:

- Stop in a safe place. Get all occupants out of the vehicle.
- Check the tires of the vehicle and the trailer.
- Check the load in the trailer.  
Make sure the load has not shifted.  
Make sure the tongue weight is appropriate, if possible.
- Check the load in the vehicle.

Make sure the vehicle is not overloaded after occupants get in.

If you cannot find any problems, the speed at which trailer swaying occurred is beyond the limit of your particular vehicle-trailer combination.

Drive at a lower speed to prevent instability. Remember that swaying of the towing vehicle-trailer increases as speed increases.

 CAUTION

■ **Trailer towing precautions**

To tow a trailer safely, use extreme care and drive the vehicle in accordance with the trailer's characteristics and operating conditions. Failure to do so could cause an accident resulting in death or serious injury. Vehicle stability and braking performance are affected by trailer stability, brake setting and performance, and the hitch. Your vehicle will handle differently when towing a trailer.

■ **To avoid accident or injury**

- Do not exceed the TWR, unbraked TWR, GCWR, GVWR or GAWR.
- If the gross trailer weight is over 2000 lb. (905 kg), a sway control device with sufficient capacity is required.
- If the gross trailer weight is over 5000 lb. (2265 kg), a weight distributing hitch with sufficient capacity is required.
- Adjust the tongue weight within the appropriate range. Place heavier loads as close to the trailer axle as possible.

 **CAUTION****■ To avoid accident or injury**

- Do not exceed 65 mph (104 km/h), the posted towing speed limit or the speed limit for your trailer as set forth in your trailer owner's manual, whichever is lowest. Slow down sufficiently before making a turn, in cross winds, on wet or slippery surface, etc. to help avoid an accident. If you experience a vehicle-trailer instability from reducing a certain speed, slow down and make sure you keep your vehicle speed under the speed of which you experience the instability.
- Do not make jerky, abrupt or sharp turns.
- Do not apply the brakes suddenly as you may skid, resulting in jackknifing and loss of vehicle control. This is especially true on wet or slippery surfaces.
- Do not exceed the trailer hitch assembly weight, gross vehicle weight, gross axle weight and trailer tongue weight capacities.
- Do not use cruise control when towing.
- Slow down and downshift before descending steep or long downhill grades. Do not make sudden downshifts while descending steep or long downhill grades.
- Vehicle-trailer instability is more likely on steep long downhills. Before descending steep or long downhill grades, slow down and downshift. Do not make sudden downshifts when descending steep or long downhill grades. Avoid holding the brake pedal down too long or applying the brakes too frequently. This could cause the brakes to overheat and result in reduced braking efficiency.
- Do not tow a trailer when the temporary spare tire is installed on your vehicle.

**■ Hitch**

Trailer hitch assemblies have different weight capacities established by the hitch manufacturer. Even though the vehicle may be physically capable of towing a higher weight, the operator must determine the maximum weight rating of the particular hitch assembly and never exceed the maximum weight rating specified for the trailer-hitch. Exceeding the maximum weight rating set by the trailer-hitch manufacturer can cause an accident resulting in death or serious personal injuries.

 CAUTION

■ **When towing a trailer**

Toyota recommends trailers with brakes that conform to any applicable federal and state/provincial regulations.

- If the gross trailer weight exceeds unbraked TWR, trailer brakes are required. Toyota recommends trailers with brakes that conform to all applicable federal and state/provincial regulations.
- Never tap into your vehicle's hydraulic system, as this will lower the vehicle's braking effectiveness.
- Never tow a trailer without using a safety chain securely attached to both the trailer and the vehicle. If damage occurs to the coupling unit or hitch ball, there is danger of the trailer wandering into another lane.

 NOTICE

■ **When installing a trailer hitch**

Use only the position recommended by your Toyota dealer. Do not install the trailer hitch on the bumper; this may cause body damage.

■ **Do not directly splice trailer lights**

Do not directly splice trailer lights. Directly splicing trailer lights may damage your vehicle's electrical system and cause a malfunction.



## 2-5. Driving information

### Dinghy towing

Your vehicle is not designed to be dinghy towed (with 4 wheels on the ground) behind a motor home.

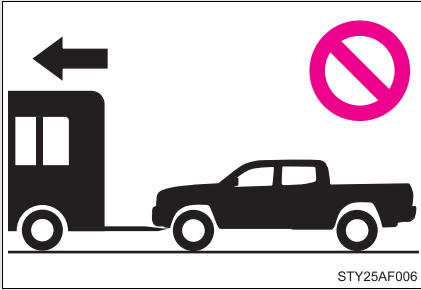

 NOTICE

**■ To avoid serious damage to your vehicle**

Do not tow your vehicle with four wheels on the ground.



## Interior and exterior features

# 3

### 3-1. Using the air conditioning system and defogger

Air conditioning system .... 236

### 3-2. Using the multimedia system

Multimedia system  
types ..... 243

Entune Audio ..... 245

USB port/AUX port..... 249

Setup menu..... 250

Basic audio operations..... 256

Using the radio..... 261

Playing an audio CD and  
MP3/WMA/AAC discs .... 263

Listening to an iPod ..... 270

Listening to a USB  
memory device ..... 276

Using the AUX port ..... 281

Connecting Bluetooth® .... 282

Listening to Bluetooth®  
audio ..... 304

Using a Bluetooth®  
phone ..... 305

Operating the sub woofer  
(on some Access Cab  
models) ..... 334

Detachable pole  
antenna..... 335

### 3-3. Using the interior lights

Interior lights list ..... 338

• Interior light ..... 339

• Personal lights ..... 339

### 3-4. Using the storage features

List of storage features .... 340

• Glove box..... 341

• Front console box ..... 341

• Cup holders ..... 342

• Bottle holders..... 344

• Auxiliary boxes..... 345

• Overhead console..... 348

### 3-5. Other interior features

Sun visors ..... 349

Vanity mirrors ..... 350

Clock ..... 351

Power outlets (12 VDC) ... 352

Power outlet (120 VAC) ... 353

Seat heaters..... 359

Seatback table ..... 361

Floor mat..... 362

Luggage compartment  
features ..... 364

Garage door opener..... 373

Compass (vehicles with  
auto anti-glare inside  
rear view mirror)..... 381

## 3-1. Using the air conditioning system and defogger

### Air conditioning system

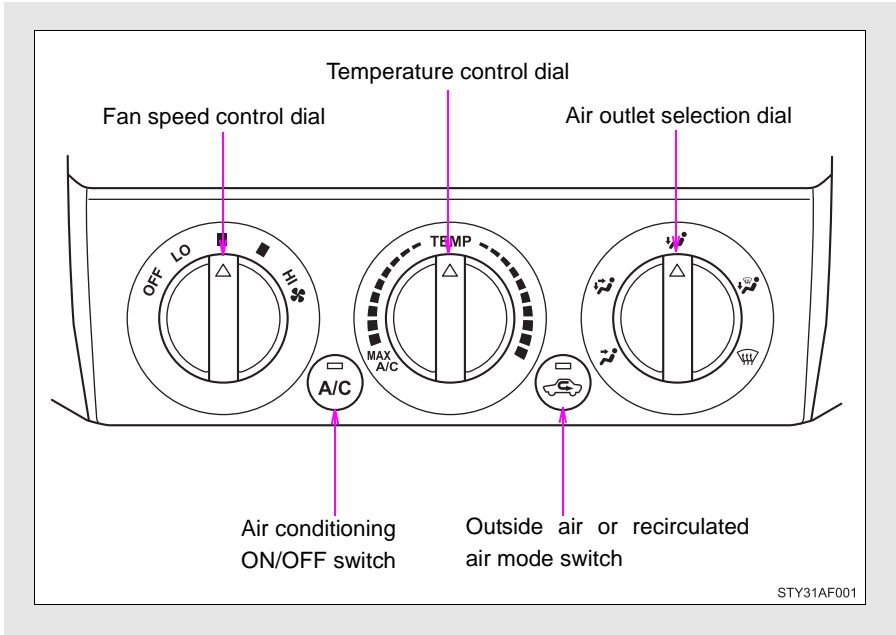

### Adjusting the settings

#### ■ Adjusting the temperature setting

Turn the temperature control dial clockwise (warm) or counter-clockwise (cool).

If  is not pressed, the system will blow ambient temperature air or heated air.

For quick cooling, turn the temperature control dial to the MAX A/C position. The air conditioning will automatically turn on and the air intake selector will be set to recirculated air mode.

#### ■ Adjusting the fan speed

Turn the fan speed control dial clockwise (increase) or counter-clockwise (decrease).

Set the dial to OFF to turn the fan off.

### ■ Selecting the air outlets

Set the air outlet selection dial to an appropriate position.

The positions between the air outlet selections shown below can also be selected for more detailed adjustment.

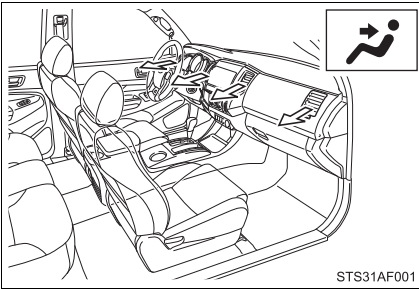

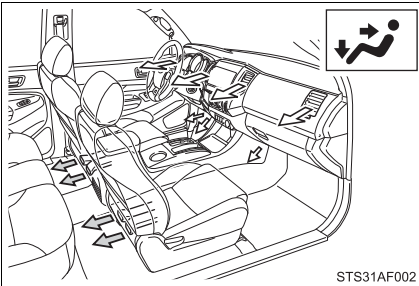

When the dial is set to , air flows to the upper body.

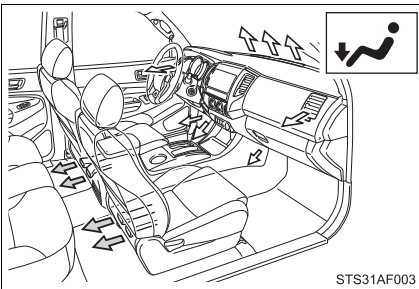

When the dial is set to , air flows to the upper body and feet.

← Double Cab models only



When the dial is set to , air flows to the feet.

← Double Cab models only

### 3-1. Using the air conditioning system and defogger

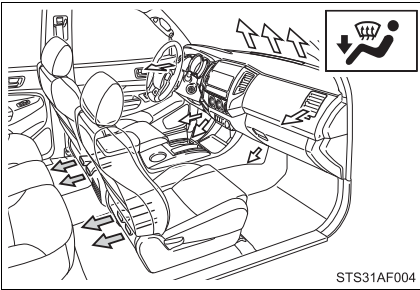



When the dial is set to , air flows to the feet and the windshield defogger operates.

The air intake selector is automatically set to outside air mode.

In this position, the air intake selector cannot be changed to the recirculated air mode.

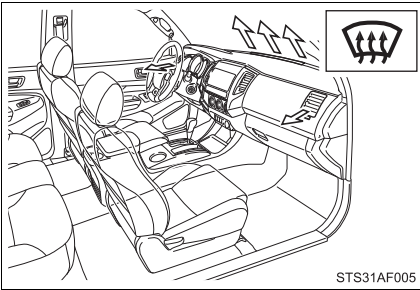
← Double Cab models only





When the dial is set to , air flows to the windshield and side windows.

The air intake selector is automatically set to outside air mode.

In this position, the air intake selector cannot be changed to the recirculated air mode.

#### ■ Switching between outside air and recirculated air modes

Press .

The mode switches between  (outside air mode) and  (recirculated air mode) each time the switch is pressed.

## Adjusting the position of the air outlets

### ► Center outlets

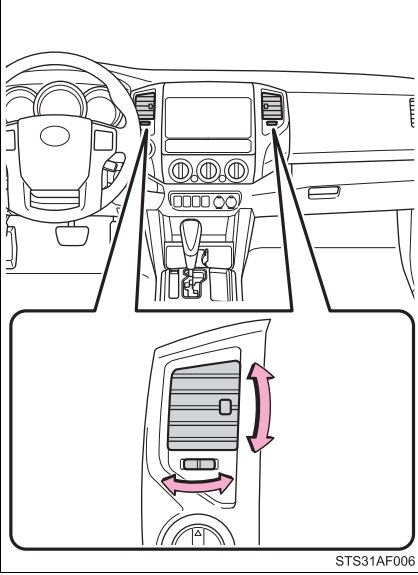

Direct air flow to the left or right, up or down.

► Right and left side outlets

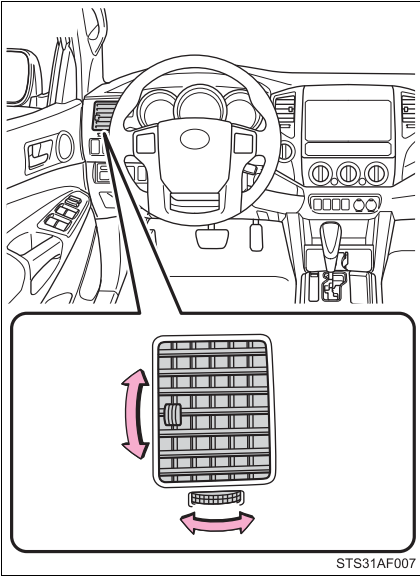

Direct air flow to the left or right, up or down.

**Opening and closing the air outlets**

► Center outlets

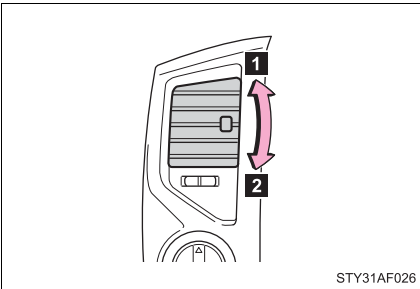

**1** Open the vent.

**2** Close the vent.



► Right and left side outlets

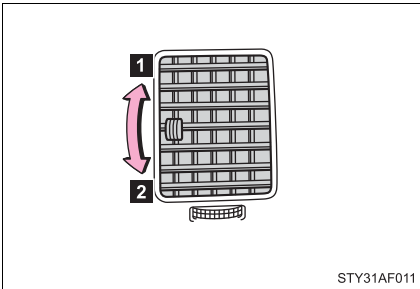

- 1 Open the vent.
- 2 Close the vent.

■ For quick clearing of the windshield and side windows

Press  to turn the air conditioning on.

■ Using the system in recirculated air mode

The windows will fog up more easily if the recirculated air mode is used for an extended period.

■ When outside air temperature approaches 32°F (0°C)

The air conditioning system may not operate even when  is pressed.

■ Air conditioning filter

→P. 439

■ When  is selected for the air outlets used

For your driving comfort, air flowing to the feet may be warmer than air flowing to the upper body depending on the position of the temperature adjustment dial.

■ Ventilation and air conditioning odors

- To let fresh air in, set the air conditioning system to the outside air mode.
- During use, various odors from inside and outside the vehicle may enter into and accumulate in the air conditioning system. This may then cause odor to be emitted from the vents.
- To reduce potential odors from occurring:  
It is recommended that the air conditioning system be set to outside air mode prior to turning the vehicle off.

 CAUTION

■ **To prevent the windshield from fogging up**

Do not set the air outlet selection dial to  during cool air operation in extremely humid weather. The difference between the temperature of the outside air and that of the windshield can cause the outer surface of the windshield to fog up, blocking your vision.

 NOTICE

■ **To prevent battery discharge**

Do not leave the air conditioning system on longer than necessary when the engine is stopped.

## 3-2. Using the multimedia system Multimedia system types\*

### ▶ Entune Audio

→P. 245

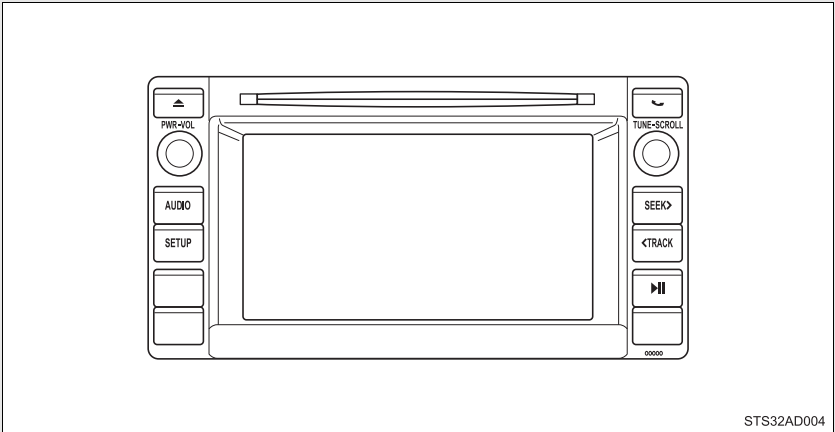

### ▶ Entune Audio Plus

Refer to the “NAVIGATION SYSTEM OWNER’S MANUAL”.

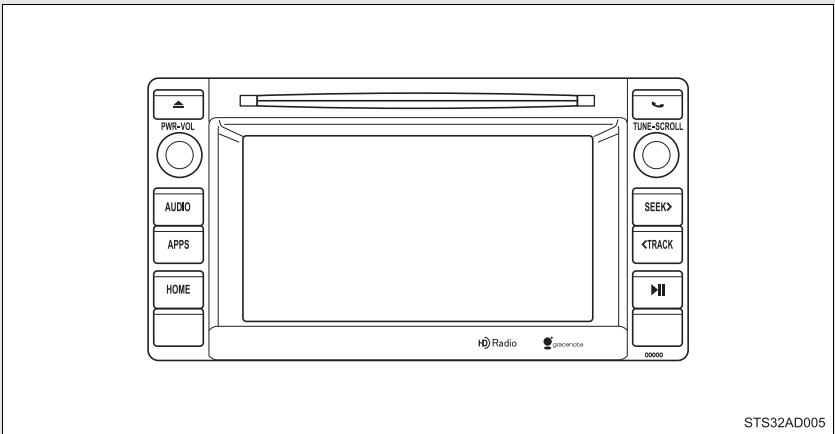

\*: If equipped

► Entune Premium Audio

Refer to the “NAVIGATION SYSTEM OWNER’S MANUAL”.

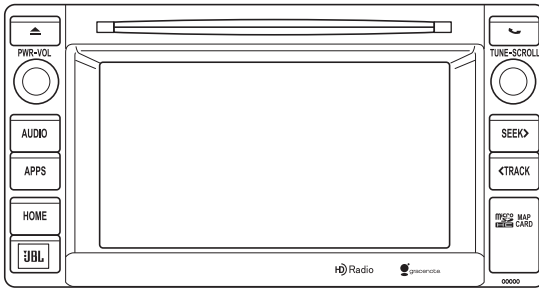

STS32AD006

## 3-2. Using the multimedia system Entune Audio\*

Operations such as listening to audio, using the hands-free phone, confirming vehicle information and changing multimedia system settings are started by using the following buttons.

### Multimedia system operation buttons

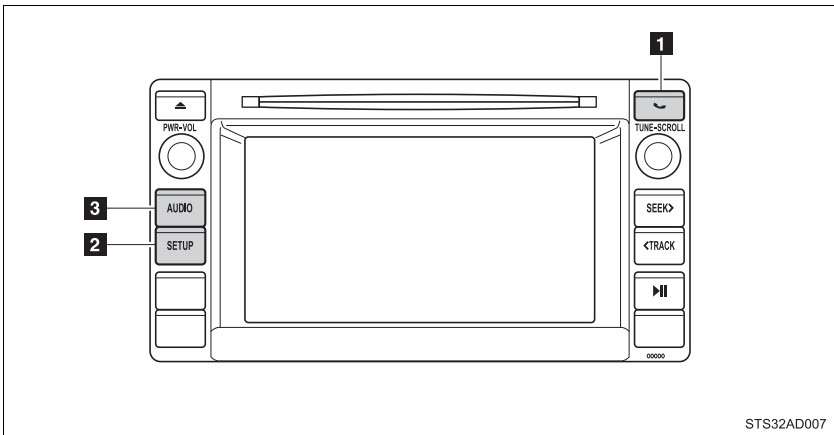

#### 1 button

Press this button to access the Bluetooth® hands-free system.  
(→P. 305)

#### 2 "SETUP" button

Press this button to customize the function settings. (→P. 250)

#### 3 "AUDIO" button

Display the "Select Audio Source" screen or audio control screen.  
(→P. 257)

\*: If equipped

## Operating the touch screen

By touching the screen with your finger, you can control the Audio, hands-free system, etc.

### ■ Drag\*

Touch the screen with your finger and move the screen to the desired position.

- Scrolling the lists
- Using scroll bar in lists

### ■ Flick\*

Touch the screen with your finger and then quickly move the screen.

- Scrolling the main screen page
- Returning to the menu screen from the sub-menu screen (screen one level below)

\*: The above operations may not be performed on all screens.

---

### ■ When using the touch screen

- If the screen is cold, the display may be dark, or the system may seem to be operating slightly slower than normal.
- The screen may seem dark and hard to see when viewed through sunglasses. Change your angle of viewing, adjust the display on the “Display Settings” screen (→P. 254) or remove your sunglasses.

### ■ Using cellular phones

Interference may be heard through the multimedia system’s speakers if a cellular phone is being used inside or close to the vehicle while the multimedia system is operating.

 **CAUTION****■ For vehicles sold in U.S.A. and Canada****● Part 15 of the FCC Rules**

## FCC Warning:

Any unauthorized changes or modifications to this equipment will void the user's authority to operate this device.

**● Laser products**

This product is a class 1 laser product.

Do not open the cover of the player or attempt to repair the unit yourself. Refer servicing to qualified personnel.

- Do not take this unit apart or attempt to make any changes yourself. This is an intricate unit that uses a laser pickup to retrieve information from the surface of compact discs. The laser is carefully shielded so that its rays remain inside the cabinet. Therefore, never try to disassemble the player or alter any of its parts since you may be exposed to laser rays and dangerous voltages.
- This product utilizes a laser. Use of controls or adjustments or performance of procedures other than those specified herein may result in hazardous radiation exposure.

**THE USE OF OPTICAL INSTRUMENTS WITH THIS PRODUCT WILL INCREASE EYE HAZARD.**

 NOTICE

■ **To avoid damaging the touch screen**

- To prevent damaging the screen, lightly touch the screen buttons with your finger.
- Do not use objects other than your finger to touch the screen.
- Wipe off fingerprints using a glass cleaning cloth. Do not use chemical cleaners to clean the screen, as they may damage the touch screen.

■ **To prevent battery discharge**

Do not leave the multimedia system on longer than necessary when the engine is off.

■ **To avoid damaging the multimedia system**

Take care not to spill drinks or other fluids on the multimedia system.



## 3-2. Using the multimedia system USB port/AUX port

Connect an iPod, USB memory device or portable audio player to the USB port/AUX port as indicated below. Select “iPod”, “USB” or “AUX” on the “Select Audio Source” screen and the device can be operated via multimedia system.

### Connecting using the USB port/AUX port

#### ■ iPod

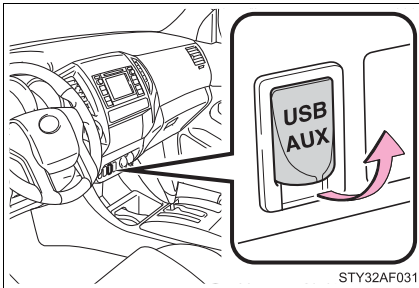

Open the cover and connect an iPod using an iPod cable.

Turn on the power of the iPod if it is not turned on.

#### ■ USB memory

Open the cover and connect the USB memory device.

Turn on the power of the USB memory device if it is not turned on.

#### ■ Portable audio player

Open the cover and connect the portable audio player.

Turn on the power of the portable audio player if it is not turned on.

### ⚠ CAUTION

#### ■ While driving

Do not connect a device or operate the device controls.

## 3-2. Using the multimedia system Setup menu

You can adjust the multimedia system to your desired settings.

### Display “Setup” screen

Press the “SETUP” button to display the “Setup” screen.

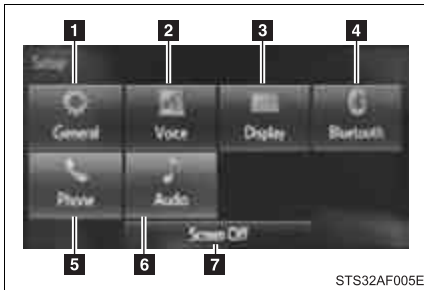

- 1 Select to adjust the settings for operation sounds, screen animation, etc. (→P. 251)
- 2 Select to set the voice settings. (→P. 255)
- 3 Select to adjust the settings for contrast and brightness of the screen. (→P. 254)
- 4 Select to adjust the settings for registering, removing, connecting and disconnecting Bluetooth® devices. (→P. 291)
- 5 Select to adjust the settings for phone sound, contact, etc. (→P. 320)
- 6 Select to set audio settings. (→P. 253)
- 7 Select to turn the screen off.

## General settings

Settings are available for adjusting the operation sounds, screen animation, etc.

### ■ Screen for general settings

**STEP 1** Press the “SETUP” button.

**STEP 2** Select “General” on the “Setup” screen.



**1** Select to adjust the clock. (→P. 252)

**2** “English”, “Français” or “Español” can be selected.

**3** On/off can be selected to sound beeps.

**4** Select to change the screen color.

**5** Select to change the keyboard layout.

**6** The animation effect for the screen can be set to on/off.

**7** Select to delete personal data (→P. 252)

**8** Select to update program versions. For details, contact your Toyota dealer.

**9** Select to display the software information. Notices related to third party software used in this product are enlisted. (This includes instructions for obtaining such software, where applicable.)

### ■ Setting the clock

**STEP 1** Select “Clock” on the “General Settings” screen.



Adjust the time, then select “OK”.

### ■ Delete personal data

**STEP 1** Select “Delete Personal Data” on the “General Settings” screen.

**STEP 2** Select “Delete”.

Check carefully beforehand, as data cannot be retrieved once deleted.

**STEP 3** A confirmation screen will be displayed. Select “Yes”.

The following personal data will be deleted or changed to its default settings.

- General settings
- Audio settings
- Phone settings

---

### ■ To return to the default settings

Select “Default”, and then “Yes”.

## Audio settings

Settings are available for adjusting the radio operation, cover art, etc.

### ■ Screen for audio settings

**STEP 1** Press the “SETUP” button.

**STEP 2** Select “Audio” on the “Setup” screen.

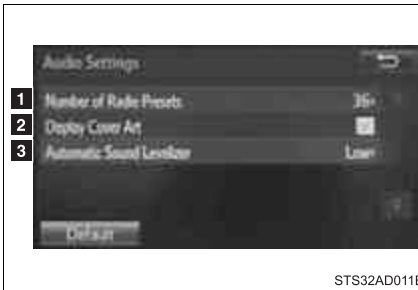

STS32AD011E

**1** Select the number of radio preset stations.

**2** Select to display the cover art

**3** Select “High”, “Middle”, “Low” or “Off”.

### ■ About Automatic Sound Leveliser (ASL)

ASL automatically adjusts the volume and tone quality according to the vehicle speed.

## Display settings

Settings are available for adjusting the contrast and brightness of the screen.

### ■ Screen for display settings

**STEP 1** Press the “SETUP” button.

**STEP 2** Select “Display” on the “Setup” screen.



**1** Adjust general screen contrast/brightness

**2** Adjust camera screen contrast/brightness

**3** Changes to day mode.

### ■ Adjusting the screen contrast/brightness

**STEP 1** Select “General” or “Camera” on the “Display Settings” screen.

**STEP 2** Adjust the display as desired by selecting “+” or “-”.

### ■ Day mode

When the headlights are turned on, the screen dims.

However, the screen can be switched to day mode by selecting “Day Mode”.

The screen will stay in day mode when the headlights are turned on until “Day Mode” is selected again.

## Voice settings

This screen is used for guidance for voice command systems setting.

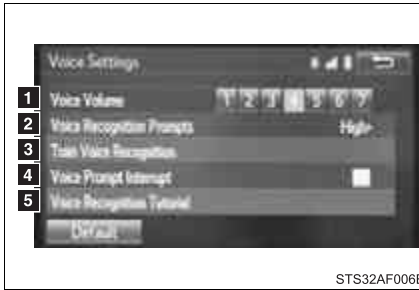

- 1** Adjust the voice guidance volume setting.
- 2** Set the voice recognition prompts "High", "Low" or "Off".
- 3** Set the train voice recognition.
- 4** Set the voice prompt interrupt on/off.
- 5** Voice recognition tutorial

## 3-2. Using the multimedia system

### Basic audio operations

Basic audio operations and functions common to each mode are explained in this section.

#### Operating the multimedia system

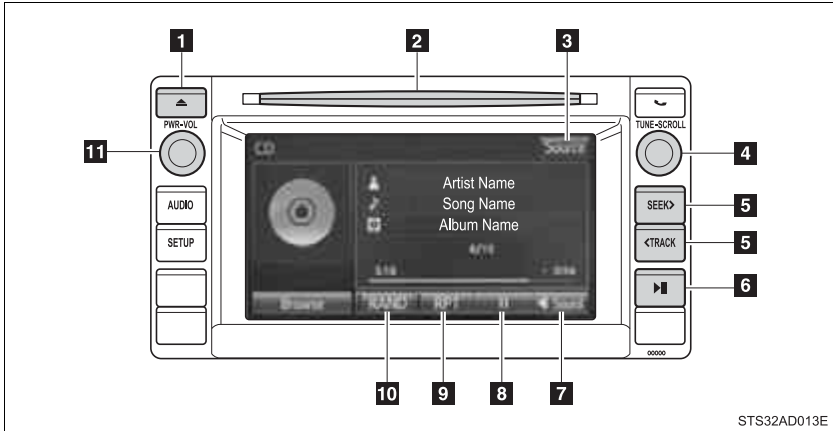

- 1** Press this button to eject a disc
- 2** Insert a disc into the disc slot
- 3** “Select Audio Source” screen appears (→P. 257)
- 4** Turn this knob to select radio station bands, tracks and files. Also the knob can be used to select items in the list display.
- 5** Press the “<TRACK” or “SEEK>” button to seek up or down for a radio station, or to access a desired track or file.
- 6** Press to pause or resume playing music.
- 7** Setting the Sound (→P. 260)
- 8** Pause or resume playing music
- 9** Select to enable repeat play
- 10** Select to enable random playback
- 11** Press this knob to turn the multimedia system on and off, and turn it to adjust the volume.



## Selecting the audio source

**STEP 1** Press the “AUDIO” button.

**STEP 2** Select “Source” on the audio control screen or press the “AUDIO” button again.

**STEP 3**



STS32AD014E

Select the desired audio source.

## Reordering the audio source

**STEP 1** Select “Reorder”.

**STEP 2** Select the desired audio source then ◀ or ▶ to reorder.



**STEP 3** Select “OK”.



## List screen operation

When a list style screen is displayed, use the appropriate buttons to scroll through the list.

### ■ How to scroll



 : Select to scroll to the next or previous page.

: If  appears to the right of titles, the complete titles are too long for the display. Select this button to scroll the title.

Turn the “TUNE·SCROLL” knob to move the cursor box to select a desired item from the list, and press the “TUNE·SCROLL” knob to play it. The track that is being played is highlighted.

To return to the top screen, select “Now Playing” on the list screen.

### ■ Selecting, fast-forwarding and reversing tracks/files/songs

#### ● Selecting a track/file/song

Press the “<TRACK” or “SEEK>” button or turn the “TUNE·SCROLL” knob to select the desired track/file/song number.

To fast-forward or reverse, press and hold the “<TRACK” or “SEEK>” button.

● Selecting a track/file/song from the track/file/song list

**STEP 1** Select “Browse” or cover art.

**STEP 2**



Select the desired track/file/song.

When an MP3/WMA/AAC disc or USB memory device is being used, the folder can be selected. When a Bluetooth® device or iPod is being used, the album can be selected.

According to the audio device, the following is displayed.

Audio source	List name
Audio CD	Track
MP3/WMA/AAC disc, USB	Folder, File
Bluetooth®	Album, Track
iPod	Album, Song

## Sound settings

On the “Sound Settings” screen, sound quality (Treble/Mid/Bass), volume balance can be adjusted.

### ■ Tone and balance

Select “Sound” on the audio control screen to adjust the sound settings.



- 1 2 3** Select “-” or “+” to adjust the treble, mid or bass to a level between -5 and 5.
- 4 5** Select “Front” or “Rear” to adjust the front/rear audio balance.
- 6 7** Select “L” or “R” to adjust the left/right audio balance.

---

### ■ The sound quality level is adjusted individually

The treble, mid and bass levels can be adjusted for each audio mode separately.

## Using the radio

Select “AM” or “FM” on the “Select Audio Source” screen to begin listening to the radio.

### Audio control screen

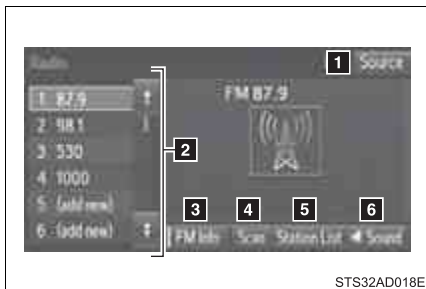

- 1 “Select Audio Source” screen appears
- 2 Preset stations
- 3 Select to display RBDS text message
- 4 Scanning for receivable station
- 5 Select to display a list of receivable stations
- 6 Setting the sound (→P. 260)

### Selecting a station

Tune in to the desired station using one of the following methods.

#### ■ Seek tuning

Press the “<TRACK” or “SEEK>” button.

The radio will begin seeking up or down for a station of the nearest frequency and will stop when a station is found.

#### ■ Manual tuning

Turn the “TUNE-SCROLL” knob.

#### ■ Preset stations

Select the desired preset station.

## Setting station presets

**STEP 1** Search for desired stations by turning the “TUNE·SCROLL” knob or pressing the “<TRACK” or “SEEK>” button.

**STEP 2** Select “(add new)”

To change the preset station to a different one, select and hold the preset station.

**STEP 3** Select “Yes”.

**STEP 4** Select “OK” after setting the new preset station.

### ■ Refreshing the station list

**STEP 1** Select “Refresh” on the “Station List” screen.

To cancel the refresh, select “Cancel Refresh”.

---

### ■ Reception sensitivity

- Maintaining perfect radio reception at all times is difficult due to the continually changing position of the antenna, differences in signal strength and surrounding objects, such as trains, transmitters, etc.
- The radio antenna is mounted inside the rear quarter window. To maintain clear radio reception, do not attach metallic window tinting or other metallic objects to the antenna wire mounted inside the rear quarter window.

Insert disc or select “CD” on the “Select Audio Source” screen to begin listening to a CD.

## Audio control screen



- 1 “Select Audio Source” screen appears
- 2 ▶ Audio CD  
Displaying the track list  
(→P. 258)  
▶ MP3/WMA/AAC  
Displaying the folder list  
(→P. 258)
- 3 Random playback
- 4 Repeat play
- 5 Pause  
Select  to resume play
- 6 Setting the sound (→P. 260)

**■ Displaying the title and artist name**

If a CD-TEXT disc is inserted, the title of the disc and track will be displayed.

**■ Error messages**

If an error message is displayed, refer to the following table and take the appropriate measures. If the problem is not rectified, take the vehicle to your Toyota dealer.

Message	Cause	Correction procedures
“Check DISC”	<ul style="list-style-type: none"> <li>• The disc is dirty or damaged.</li> <li>• The disc is inserted upside down.</li> <li>• The disc is not playable with the player.</li> </ul>	<ul style="list-style-type: none"> <li>• Clean the disc.</li> <li>• Insert the disc correctly.</li> <li>• Confirm the disc is playable with the player.</li> </ul>
“Disc Error”	There is a malfunction within the system.	Eject the disc.
“No music files found.”	No playable data is included on the disc.	Eject the disc.

**■ Discs that can be used**

Discs with the marks shown below can be used.

Playback may not be possible depending on recording format or disc features, or due to scratches, dirt or deterioration.



CDs with copy-protection features may not play correctly.

**■ CD player protection feature**

To protect the internal components, playback is automatically stopped when a problem is detected.

**■ If a disc is left inside the CD player or in the ejected position for extended periods**

Disc may be damaged and may not play properly.



### ■ Lens cleaners

Do not use lens cleaners. Doing so may damage the CD player.

### ■ MP3, WMA and AAC files

MP3 (MPEG Audio LAYER3) is a standard audio compression format.

Files can be compressed to approximately 1/10 of their original size by using MP3 compression.

WMA (Windows Media Audio) is a Microsoft audio compression format.

This format compresses audio data to a size smaller than that of the MP3 format.

AAC is short for Advanced Audio Coding and refers to an audio compression technology standard used with MPEG2 and MPEG4.

MP3, WMA and AAC file and media/formats compatibility are limited.

#### ● MP3 file compatibility

- Compatible standards  
MP3 (MPEG1 LAYER3, MPEG2 LSF LAYER3)
- Compatible sampling frequencies  
MPEG1 LAYER3: 32, 44.1, 48 (kHz)  
MPEG2 LSF LAYER3: 16, 22.05, 24 (kHz)
- Compatible bit rates (compatible with VBR)  
MPEG1 LAYER3: 32-320 (kbps)  
MPEG2 LSF LAYER3: 8-160 (kbps)
- Compatible channel modes: stereo, joint stereo, dual channel and monaural

#### ● WMA file compatibility

- Compatible standards  
WMA Ver. 7, 8, 9
- Compatible sampling frequencies  
32, 44.1, 48 (kHz)
- Compatible bit rates (only compatible with 2-channel playback)  
Ver. 7, 8: CBR 48-192 (kbps)  
Ver. 9: CBR 48-320 (kbps)

### ● AAC file compatibility

- Compatible standards  
MPEG4/AAC-LC
- Compatible sampling frequencies  
11.025/12/16/22.05/24/32/44.1/48 (kHz)
- Compatible bit rates  
16-320 (kbps)

### ● Compatible media

Media that can be used for MP3, WMA and AAC playback are CD-Rs and CD-RWs.

Playback in some instances may not be possible if the CD-R or CD-RW is not finalized. Playback may not be possible or the audio may jump if the disc is scratched or marked with fingerprints.

### ● Compatible disc formats

The following disc formats can be used.

- Disc formats: CD-ROM Mode 1 and Mode 2  
CD-ROM XA Mode 2, Form 1 and Form 2
- File formats: ISO9660 Level 1, Level 2, (Romeo, Joliet)  
UDF (2.01 or lower)

MP3, WMA and AAC files written in any format other than those listed above may not play correctly, and their file names and folder names may not be displayed correctly.

Items related to standards and limitations are as follows.

- Maximum directory hierarchy: 8 levels (including the root)
- Maximum length of folder names/file names: 32 characters
- Maximum number of folders: 192 (including the root)
- Maximum number of files per disc: 255

### ● File names

The only files that can be recognized as MP3/WMA/AAC and played are those with the extension .mp3, .wma or .m4a.

### ● Discs containing multi-session recordings

As the multimedia system is compatible with multi session discs, it is possible to play discs that contain MP3, WMA and AAC files. However, only the first session can be played.

- ID3, WMA and AAC tags

ID3 tags can be added to MP3 files, making it possible to record the track title, artist name, etc.

The system is compatible with ID3 Ver. 1.0, 1.1, and Ver. 2.2, 2.3 ID3 tags. (The number of characters is based on ID3 Ver. 1.0 and 1.1.)

WMA tags can be added to WMA files, making it possible to record the track title and artist name in the same way as with ID3 tags.

AAC tags can be added to AAC files, making it possible to record the track title and artist name in the same way as with ID3 tags.

- MP3, WMA and AAC playback

When a disc containing MP3, WMA or AAC files is inserted, all files on the disc are first checked. Once the file check is finished, the first MP3, WMA or AAC file is played. To make the file check finish more quickly, we recommend you do not write any files to the disc other than MP3, WMA or AAC files or create any unnecessary folders.

Discs that contain a mixture of music data and MP3, WMA or AAC format data cannot be played.

- Extensions

If the file extensions .mp3, .wma and .m4a are used for files other than MP3, WMA and AAC files, they may be mistakenly recognized and played as MP3, WMA and AAC files. This may result in large amounts of interference and damage to the speakers.

### ● Playback

- To play MP3 files with steady sound quality, we recommend a fixed bit rate of at least 128 kbps and a sampling frequency of 44.1 kHz.
- CD-R or CD-RW playback may not be possible in some instances, depending on the characteristics of the disc.
- There is a wide variety of freeware and other encoding software for MP3, WMA and AAC files on the market, and depending on the status of the encoding and the file format, poor sound quality or noise at the start of playback may result. In some cases, playback may not be possible at all.
- When files other than MP3, WMA or AAC files are recorded on a disc, it may take more time to recognize the disc and in some cases, playback may not be possible at all.
- Microsoft, Windows, and Windows Media are the registered trademarks of Microsoft Corporation in the U.S.A. and other countries.
- This system can playback AAC files encoded by iTunes.

 NOTICE

■ **Discs and adapters that cannot be used**

Do not use the following types of CDs.

Also, do not use 3 in. (8 cm) CD adapters, Dual Discs or printable discs.

Doing so may damage the CD player and/or the CD insert/eject function.

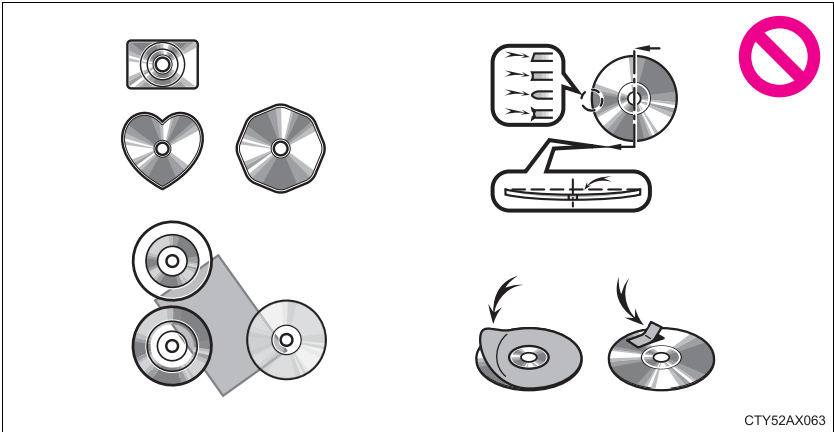

- Discs that have a diameter that is not 4.7 in. (12 cm).
- Low-quality or deformed discs.
- Discs with a transparent or translucent recording area.
- Discs that have tape, stickers or CD-R labels attached to them, or that have had the label peeled off.

■ **Player precautions**

Failure to follow the precautions below may result in damage to the discs or the player itself.

- Do not insert anything other than discs into the disc slot.
- Do not apply oil to the player.
- Store discs away from direct sunlight.
- Never try to disassemble any part of the player.

## Listening to an iPod

Connecting an iPod enables you to enjoy music from the vehicle speakers.

Select “iPod” on the “Select Audio Source” screen.

When the iPod connected to the system includes iPod video, the system can only output the sound by selecting the browse screen.

### Connecting an iPod

→P. 249

### Audio control screen

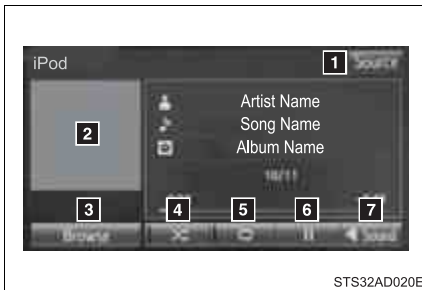

**1** “Select Audio Source” screen appears

**2** Displays cover art

**3** Selecting the play mode

**4** Shuffle play

**5** Repeat play

**6** Pause

Select  to resume play-back

**7** Setting the sound (→P. 260)

### Selecting a play mode

**STEP 1** Select “Browse” on the “iPod” screen.

**STEP 2** Select the desired play mode by selecting the “Playlists”, “Artists”, “Albums”, “Songs”, “Podcasts”, “Audio books”, “Genres”, “Composers” or “Video”. Then select a song to begin using the selected play mode.

## ■ About iPod



- “Made for iPod”, “Made for iPhone” and “Made for iPad” mean that an electronic accessory has been designed to connect specifically to iPod or iPhone, or iPad, respectively, and has been certified by the developer to meet Apple performance standards.
- Apple is not responsible for the operation of this device or its compliance with safety and regulatory standards. Please note that the use of this accessory with iPod, iPhone or iPad may affect wireless performance.
- iPad, iPhone, iPod, iPod classic, iPod nano, and iPod touch are trademarks of Apple Inc., registered in the U.S. and other countries. Lightning is a trademark of Apple Inc.

## ■ iPod cover art

- Depending on the iPod and songs in the iPod, iPod cover art may be displayed.
- This function can be changed to on/off. (→P. 253)
- It may take time to display iPod cover art, and the iPod may not be operated while the cover art display is in process.
- Only iPod cover art that is saved in JPEG format can be displayed.

### ■ iPod functions

- When an iPod is connected and the audio source is changed to iPod mode, the iPod will resume play from the same point in which it was last used.
- Depending on the iPod that is connected to the system, certain functions may not be available. If a function is unavailable due to a malfunction (as opposed to a system specification), disconnecting the device and reconnecting it may resolve the problem.
- While connected to the system, the iPod cannot be operated with its own controls. It is necessary to use the controls of the vehicle's multimedia system instead.
- When the battery level of an iPod is very low, the iPod may not operate. If so, charge the iPod before use.
- Compatible models (→P. 274)

### ■ iPod problems

To resolve most problems encountered when using your iPod, disconnect your iPod from the vehicle iPod connection and reset it. For instructions on how to reset your iPod, refer to your iPod Owner's Manual.



### ■ Error messages

Message	Cause/Correction procedures
<p>“Connection error. Please consult your Owner’s Manual for instructions on how to connect the iPod.”</p>	<p>This indicates a problem in the iPod or its connection.</p>
<p>“No music files found.”</p>	<p>This indicates that there is no music data in the iPod.</p>
<p>“There are no songs available for playback. Please add compatible files to your iPod.”</p>	<p>This indicates that songs are not found in a selected playlist.</p>
<p>“Please check the iPod firmware version.”</p>	<p>This indicates that the software version is not compatible. Please check the compatible models. (→P. 274)</p>
<p>“iPod authorization unsuccessful.”</p>	<p>This indicates that the display multimedia system failed to authorize the iPod. Please check your iPod.</p>

### ■ Compatible models

The following iPod®, iPod nano®, iPod classic®, iPod touch® and iPhone® devices can be used with this system.

● Made for

- iPod touch (5th generation)
- iPod touch (4th generation)
- iPod touch (3rd generation)
- iPod touch (2nd generation)
- iPod touch (1st generation)
- iPod classic
- iPod with video
- iPod nano (7th generation)
- iPod nano (6th generation)
- iPod nano (5th generation)
- iPod nano (4th generation)
- iPod nano (3rd generation)
- iPod nano (2nd generation)
- iPod nano (1st generation)
- iPhone 5
- iPhone 4S
- iPhone 4
- iPhone 3GS
- iPhone 3G
- iPhone

Depending on differences between models or software versions etc., some models might be incompatible with this system.

#### CAUTION

#### ■ While driving

Do not connect an iPod or operate the controls.

**NOTICE****■ To prevent damage to the iPod or its terminals**

- Do not leave the iPod in the vehicle. The temperature inside the vehicle may become high, resulting in damage to the iPod.
- Do not push down on or apply unnecessary pressure to the iPod while it is connected.
- Do not insert foreign objects into the port.

## Listening to a USB memory device

Connecting a USB memory device enables you to enjoy music from the vehicle speakers.

Select “USB” on the “Select Audio Source” screen.

### Connecting a USB memory device

→P. 249

### Audio control screen



- 1 “Select Audio Source” screen appears
- 2 Displaying the folder list (→P. 258)
- 3 Random playback
- 4 Repeat play
- 5 Pause  
Select  to resume playback
- 6 Setting the sound (→P. 260)

### ■ USB memory functions

- Depending on the USB memory device that is connected to the system, the device itself may not be operable and certain functions may not be available. If the device is inoperable or a function is unavailable due to a malfunction (as opposed to a system specification), disconnecting the device and reconnecting it may resolve the problem.
- If the USB memory device still does not begin operation after being disconnected and reconnected, format the memory.

### ■ Error messages for USB memory

Message	Cause/Correction procedures
“Connection error. Please consult your Owner’s Manual for instructions on how to connect the USB device.”	This indicates a problem with the USB memory device or its connection.
“There are no file available for playback. Please add compatible file to your USB device.”	This indicates that no MP3/WMA/AAC files are included on the USB memory device.

### ■ USB memory

#### ● Compatible devices

USB memory device that can be used for MP3, WMA and AAC playback.

#### ● Compatible device formats

The following device format can be used:

- USB communication format: USB2.0 FS (12 Mbps), USB2.0 HS (480 Mbps)
  - File system format: FAT16/32 (Windows)
  - Correspondence class: Mass storage class
- MP3, WMA and AAC files written to a device with any format other than those listed above may not play correctly, and their file names and folder names may not be displayed correctly.

Items related to standards and limitations are as follows:

- Maximum directory hierarchy: 8 levels
  - Maximum number of folders in a device: 3000 (including the root)
  - Maximum number of files in a device: 9999
  - Maximum number of files per folder: 255
- MP3, WMA and AAC files

MP3 (MPEG Audio LAYER 3) is a standard audio compression format.

Files can be compressed to approximately 1/10 of their original size using MP3 compression.

WMA (Windows Media Audio) is a Microsoft audio compression format. This format compresses audio data to a size smaller than that of the MP3 format.

AAC is short for Advanced Audio Coding and refers to an audio compression technology standard used with MPEG2 and MPEG4.

MP3, WMA and AAC file and media/formats compatibility are limited.

● MP3 file compatibility

- Compatible standards  
MP3 (MPEG1 AUDIO LAYER3, MPEG2 AUDIO LAYER3)
- Compatible sampling frequencies  
MPEG1 AUDIO LAYER3: 32, 44.1, 48 (kHz)  
MPEG2 AUDIO LAYER3: 16, 22.05, 24 (kHz)
- Compatible bit rates (compatible with VBR)  
MPEG1 AUDIO LAYER3: 32-320 (kbps)  
MPEG2 AUDIO LAYER3: 8-160 (kbps)
- Compatible channel modes: stereo, joint stereo, dual channel and monaural

● WMA file compatibility

- Compatible standards  
WMA Ver. 7, 8, 9
- Compatible sampling frequencies  
HIGH PROFILE 32, 44.1, 48 (kHz)
- Compatible bit rates  
HIGH PROFILE 48-320 (kbps, VBR)

- AAC file compatibility

- Compatible standards  
MPEG4/AAC-LC
- Compatible sampling frequencies  
11.025/12/16/22.05/24/32/44.1/48 (kHz)
- Compatible bit rates  
16-320 (kbps)
- Compatible channel modes: 1 ch and 2 ch

- File names

The only files that can be recognized as MP3/WMA/AAC and played are those with the extension .mp3 or .wma.

- ID3, WMA and AAC tags

ID3 tags can be added to MP3 files, making it possible to record the track title, artist name, etc.

The system is compatible with ID3 Ver. 1.0, 1.1, and Ver. 2.2, 2.3 ID3 tags. (The number of characters is based on ID3 Ver. 1.0 and 1.1.)

WMA tags can be added to WMA files, making it possible to record the track title and artist name in the same way as with ID3 tags.

AAC tags can be added to AAC files, making it possible to record the track title and artist name in the same way as with ID3 tags.

- MP3, WMA and AAC playback

- When a device containing MP3, WMA and AAC files is connected, all files in the USB memory device are checked. Once the file check is finished, the first MP3, WMA and AAC file is played. To make the file check finish more quickly, we recommend that you do not include any files other than MP3, WMA and AAC files or create any unnecessary folders.
- When a USB memory device is connected and the audio source is changed to USB memory mode, the USB memory device will start playing the first file in the first folder. If the same device is removed and reconnected (and the contents have not been changed), the USB memory device will resume play from the same point in which it was last used.

- Extensions

If the file extensions .mp3, .wma and .m4a are used for files other than MP3, WMA and AAC files, they will be skipped (not played).

### ● Playback

- To play MP3 files with steady sound quality, we recommend a fixed bit rate of at least 128 kbps and a sampling frequency of 44.1 kHz.
- There is a wide variety of freeware and other encoding software for MP3, WMA and AAC files on the market, and depending on the status of the encoding and the file format, poor sound quality or noise at the start of playback may result. In some cases, playback may not be possible at all.
- Microsoft, Windows, and Windows Media are the registered trademarks of Microsoft Corporation in the U.S.A. and other countries.

### CAUTION

#### ■ While driving

Do not connect a USB memory device or operate the device controls.

### NOTICE

#### ■ To prevent damage to the USB memory device or its terminals

- Do not leave the USB memory device in the vehicle. The temperature inside the vehicle may become high, resulting in damage to the USB memory device.
- Do not push down on or apply unnecessary pressure to the USB memory device while it is connected.
- Do not insert foreign objects into the port.



## Using the AUX port

To use the AUX port, connect a portable player, then select “AUX” on the “Select Audio Source” screen.

### Connecting a portable audio player

→P. 249

#### ■ Operating portable audio players connected to the multimedia system

The volume can be adjusted using the vehicle’s audio controls. All other adjustments must be made on the portable audio player itself.

#### ■ When using a portable audio player connected to the power outlet

Noise may occur during playback. Use the power source of the portable audio player.

#### CAUTION

#### ■ While driving

Do not connect a portable audio player or operate the device controls.

## Connecting Bluetooth®

The following can be performed using Bluetooth® wireless communication:

- A portable audio player can be operated and listened to via multimedia system

- Hands-free phone calls can be made via a cellular phone

In order to use wireless communication, register and connect a Bluetooth® device by performing the following procedures.

## Device registration/connection flow

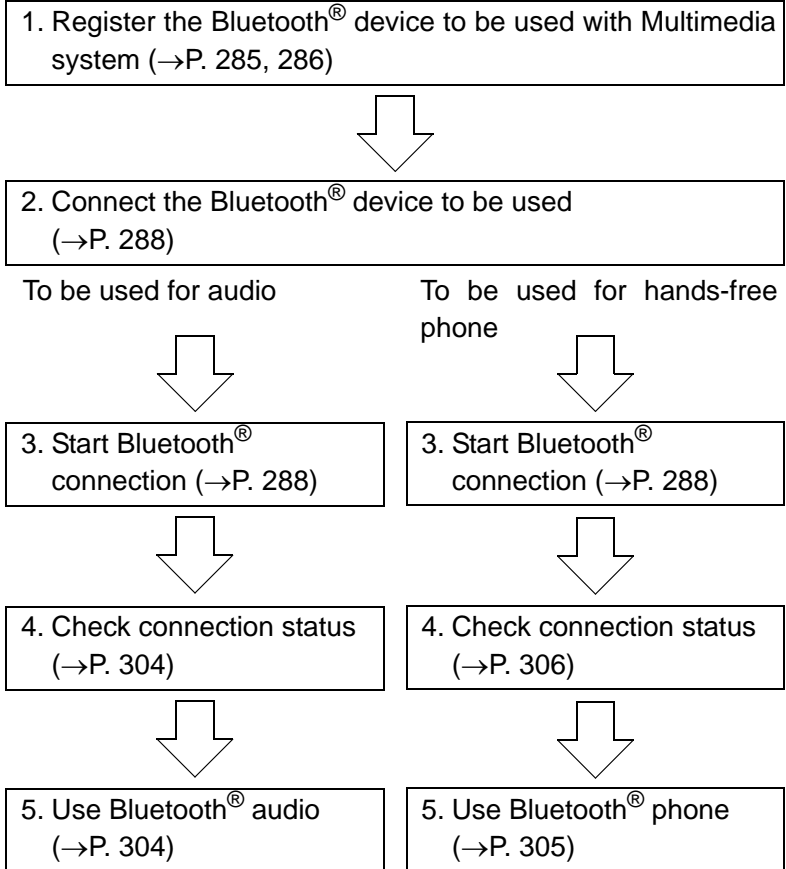

### Registering and connecting from the “Bluetooth Setup” screen

To display the screen shown below, press the “SETUP” button and select “Bluetooth” on the “Setup” screen.

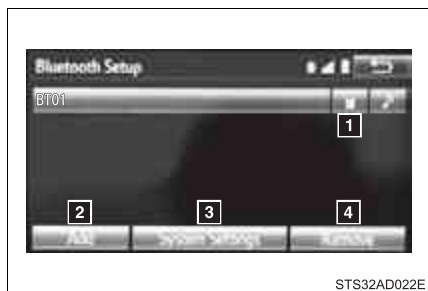

- 1 Select to connect the device to be used with multimedia system. (→P. 288)
- 2 Select to register a Bluetooth<sup>®</sup> device to be used with multimedia system. (→P. 286)
- 3 Select to set detailed Bluetooth<sup>®</sup> system settings. (→P. 291)
- 4 Select to delete registered devices. (→P. 287)

### Registering a Bluetooth® audio player for the first time

To use the Bluetooth® Audio, it is necessary to register an audio player with the system.

Once the player has been registered, it is possible to use the Bluetooth® Audio.

This operation cannot be performed while driving.

For details about registering a Bluetooth® device (→P. 286)

**STEP 1** Turn the Bluetooth® connection setting of your audio player on.

This function is not available when the Bluetooth® connection setting of your audio player is set to off.

**STEP 2** Press the “AUDIO” button.

**STEP 3** Select  “Audio” on the “Select Audio Source” screen.

**STEP 4** Select “Select Device”.

**STEP 5** Follow the steps in “How to register a Bluetooth® device” from “STEP 2”. (→P. 286)

### Registering a Bluetooth® phone for the first time

To use the hands-free system, it is necessary to register a Bluetooth® phone with the system.

Once the phone has been registered, it is possible to use the hands-free system.

For details about registering a Bluetooth® device (→P. 286)

**STEP 1** Turn the Bluetooth® connection setting of your cellular phone on.

**STEP 2** Press the  button.

**STEP 3** Select “OK” to register a phone.

**STEP 4** Follow the steps in “How to register a Bluetooth® device” from “STEP 2”. (→P. 286)

## Registering a Bluetooth® device

Bluetooth® compatible phones (HFP) and portable audio players (AVP) can be registered simultaneously. You can register up to 5 Bluetooth® devices.

### ■ How to register a Bluetooth® device

**STEP 1** Display the “Bluetooth Setup” screen. (→P. 284)

**STEP 2** Select “Add”.

**STEP 3**

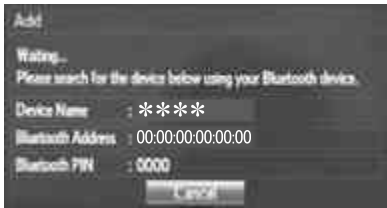

STS32AD023E

When this screen is displayed, search for the device name displayed on this screen on the screen of your Bluetooth® device.

For details about operating the Bluetooth® device, see the manual that comes with it.

To cancel the registration, select “Cancel”.

**STEP 4** Register the Bluetooth® device using your Bluetooth® device.

A PIN-code is not required for SSP (Secure Simple Pairing) compatible Bluetooth® devices. Depending on the type of Bluetooth® device being connected, a message confirming registration may be displayed on the Bluetooth® device's screen. Respond and operate the Bluetooth® device according to the confirmation message.

**STEP 5**

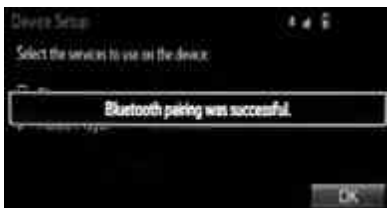

CTHDAAK050US

Check that this screen is displayed when registration is complete.

**STEP 6** Select “OK” when the connection status changes from “Connecting...” to “Connected”.

If an error message is displayed, follow the guidance on the screen to try again.

Registration can be performed from screens other than the “Bluetooth Setup” screen.

### ■ When registering from the “Bluetooth Audio” screen

**STEP 1** Display the “Bluetooth Audio” screen. (→P. 257)

**STEP 2** Select “Select Device”.

**STEP 3** Follow the steps in “How to register a Bluetooth® device” from “STEP 2”. (→P. 286)

### ■ Deleting a Bluetooth® device

**STEP 1** Display the “Bluetooth Setup” screen. (→P. 284)

**STEP 2** Select “Remove”.

**STEP 3** Select the desired device.

**STEP 4** A confirmation message will be displayed, select “Yes” to delete the device.

**STEP 5** Check that a confirmation screen is displayed when the operation is complete.

## Connecting a Bluetooth® device

Up to 5 Bluetooth® devices (Phones (HFP) and audio players (AVP)) can be registered.

If more than 1 Bluetooth® device has been registered, select which device to connect to.

**STEP 1** Press the “SETUP” button.

**STEP 2** Select “Bluetooth” on the “Setup” screen.

**STEP 3**



Select the device to be connected.

Supported profile icons will be displayed.

**1** Phone

**2** Audio player

Supported profile icons for currently connected devices will illuminate.

Dimmed icons can be selected to connect to the function directly.

### ■ Auto connection

To turn auto connection mode on, set “Bluetooth Power” to on.  
(→P. 291)

When you register a phone, auto connection will be activated. Always set it to this mode and leave the Bluetooth® phone in a place where a connection can be established.

When the engine switch is turned to the “ACC” or “ON” position, the system will search for a nearby cellular phone you have registered.

Next, the system automatically connects with the most recent of the phones connected to in the past. Then, the connection result is displayed.



### ■ Manual connection

When auto connection has failed or “Bluetooth Power” is turned off, you must connect the Bluetooth® device manually.

Follow the steps in “Connecting a Bluetooth® device” from “STEP 1”. (→P. 288)

### ■ Connecting a Bluetooth® audio player

#### ▶ Registering an additional device

**STEP 1** Select “Select Device” on the “Bluetooth Audio” screen.

**STEP 2** For more information: →P. 286

#### ▶ Selecting a registered device

**STEP 1** Select “Select Device” on the “Bluetooth Audio” screen.

**STEP 2** For more information: →P. 288

---

### ■ Reconnecting a Bluetooth® phone

If the system cannot connect due to poor signal strength with the engine switch in the “ACC” or “ON” position, the system will automatically attempt to reconnect.

If the phone is turned off, the system will not attempt to reconnect. In this case, the connection must be made manually, or the phone must be reselected.

## Displaying a Bluetooth® device details

You can confirm and change the registered device details.

### ■ Bluetooth® device registration status

**STEP 1** Display the “Bluetooth Setup” screen. (→P. 284)

**STEP 2** Select the device.

**STEP 3** Select “Device Info”.

**STEP 4** Following screen is displayed:



**1** Device name

**2** Change connection method (→P. 290)

**3** Bluetooth® address

**4** Display your telephone number

The number may not be displayed depending on the model of phone.

**5** Compatibility profile of the device

**6** Restore default settings

### ■ Changing connection method

**STEP 1** Select “Connect Audio Player from”.

**STEP 2** Select “Vehicle” or “Device”.

“Vehicle”: Connect the multimedia system to the portable audio player.

“Device”: Connect the portable audio player to the multimedia system.

## Detailed Bluetooth® system settings

You can confirm and change the detailed Bluetooth® settings.

### ■ How to check and change detailed Bluetooth® settings

**STEP 1** Display the “Bluetooth Setup” screen. (→P. 284)

**STEP 2** Select “System Settings”.

**STEP 3** The following screen is displayed:



#### 1 Bluetooth® power on/off

You can change Bluetooth® function on/off

#### 2 Bluetooth® name

#### 3 Change PIN-code (→P. 291)

#### 4 Bluetooth® address

#### 5 Display phone status

You can set the system to show the status confirmation display when connecting a telephone

#### 6 Display audio player status

You can set the system to show the status confirmation display when connecting an audio player

#### 7 Compatibility profile of the system

#### 8 Restore default settings

### ■ Editing the Bluetooth® PIN

You can change the PIN-code that is used to register your Bluetooth® devices in the system.

**STEP 1** Select “Bluetooth® PIN”.

**STEP 2** Input a PIN-code, and select “OK”.

**What to do if... (Troubleshooting)**

If there is a problem with the hands-free system or a Bluetooth® device, first check the table below.

► When using the hands-free system with a Bluetooth® device

Symptom	Likely cause	Solution
The hands-free system or Bluetooth® device does not work.	The connected device may not be a compatible Bluetooth® cellular phone.	For a list of specific devices which operation has been confirmed on this system, check with your Toyota dealer or the following website: <a href="http://www.toyota.com/bluetooth">http://www.toyota.com/bluetooth</a>
	The Bluetooth® version of the connected cellular phone may be older than the specified version.	Use a cellular phone with Bluetooth® version 2.0 or higher (recommended: Ver. 3.0 with EDR or higher). (→P. 297)

## ► When registering/connecting a cellular phone

Symptom	Likely cause	Solution
A cellular phone cannot be registered.	An incorrect passcode was entered on the cellular phone.	Enter the correct passcode on the cellular phone.
	The registration operation has not been completed on the cellular phone side.	Complete the registration operation on the cellular phone (approve registration on the phone).
	Old registration information remains on either this system or the cellular phone.	Delete the existing registration information from both this system and the cellular phone, then register the cellular phone you wish to connect to this system. (→P. 287)
A Bluetooth® connection cannot be made.	Another Bluetooth® device is already connected.	Manually connect the cellular phone you wish to use to this system. (→P. 289)
	Bluetooth® function is not enabled on the cellular phone.	Enable the Bluetooth® function on the cellular phone.
“Please check your device settings.” message is displayed.	Bluetooth® function is not enabled on the cellular phone.	Enable the Bluetooth® function on the cellular phone.
	Old registration information remains on either this system or the cellular phone.	Delete the existing registration information from both this system and the cellular phone, then register the cellular phone you wish to connect to this system. (→P. 287)

## ► When making/receiving a call

Symptom	Likely cause	Solution
A call cannot be made/received.	Your vehicle is in a out of cellular service area.	Move to where “Out of cellular service area. Please try again later.” no longer appears on the display.

## ► When using the contacts

Symptom	Likely cause	Solution
Contact data cannot be transferred manually/ automatically.	The profile version of the connected cellular phone may not be compatible with transferring contact data.	For a list of specific devices which operation has been confirmed on this system, check with your Toyota dealer or the following website: <a href="http://www.toyota.com/bluetooth">http://www.toyota.com/bluetooth</a>
	Automatic contact transfer function on this system is set to off.	Set automatic contact transfer function on this system to on. (→P. 322)
	Passcode has not been entered on the cellular phone.	Enter the passcode on the cellular phone if requested (default passcode: 1234).
	Transfer operation on the cellular phone has not completed.	Complete transfer operation on the cellular phone (approve transfer operation on the phone).
Contact data cannot be edited.	Automatic contact transfer function on this system is set to on.	Set automatic contact transfer function on this system to off. (→P. 322)

► When using the Bluetooth® message function

Symptom	Likely cause	Solution
Messages cannot be viewed.	Message transfer is not enabled on the cellular phone.	Enable message transfer on the cellular phone (approve message transfer on the phone).
	Automatic transfer function on this system is set to off.	Set automatic transfer function on this system to on. (→P. 329)
New message notifications are not displayed.	Notification of SMS/MMS/E-mail reception on this system is set to off.	Set notification of SMS/MMS/E-mail reception on this system to on. (→P. 329)
	Automatic message transfer function is not enabled on the cellular phone.	Enable automatic transfer function on the cellular phone.

► In other situations

Symptom	Likely cause	Solution
<p>Even though all conceivable measures have been taken, the symptom status does not change.</p>	<p>The cellular phone is not close enough to this system.</p>	<p>Bring the cellular phone closer to this system.</p>
	<p>The cellular phone is the most likely cause of the symptom.</p>	<ul style="list-style-type: none"> <li>• Turn the cellular phone off, remove and reinstall the battery pack, and then restart the cellular phone.</li> <li>• Enable the cellular phone's Bluetooth<sup>®</sup> connection.</li> <li>• Stop the cellular phone's security software and close all applications.</li> <li>• Before using an application installed on the cellular phone, carefully check its source and how its operation might affect this system.</li> </ul>



## Bluetooth®

### ■ About Bluetooth®



The Bluetooth® word mark and logos are registered trademarks owned Bluetooth SIG, Inc. and any use of such marks by Panasonic Corporation is under license. Other trademarks and trade names are those of their respective owners.

### ■ When using the Bluetooth® audio system

- In the following conditions, the system may not function.
  - If the portable audio player is turned off
  - If the portable audio player is not connected
  - If the portable audio player's battery is low
- There may be a delay if a cellular phone connection is made during Bluetooth® audio play.
- Depending on the type of portable audio player that is connected to the system, operation may differ slightly and certain functions may not be available.

### ■ When using the hands-free system

- The multimedia system is muted when making a call.
- If both parties speak at the same time, it may be difficult to hear.
- If the received call volume is overly loud, an echo may be heard. If the Bluetooth® phone is too close to the system, quality of the sound may deteriorate and connection status may deteriorate.
- In the following circumstances, it may be difficult to hear the other party:
  - When driving on unpaved roads
  - When driving at high speeds
  - If a window is open
  - If the air conditioning is blowing directly on the microphone
  - If there is interference from the network of the cellular phone

■ **Conditions under which the system will not operate**

- If using a cellular phone that does not support Bluetooth®
- If the cellular phone is turned off
- If you are outside of cellular phone service coverage
- If the cellular phone is not connected
- If the cellular phone's battery is low
- When outgoing calls are controlled, due to heavy traffic on telephone lines, etc.
- When the cellular phone itself cannot be used
- When transferring contact data from the cellular phone

■ **Bluetooth® antenna**

The antenna is built into the display.

If the portable audio player is behind the seat or in the glove box or console box, or is touching or covered by metal objects, the connection status may deteriorate.

If the cellular phone is behind the seat or in the console box, or touching or covered by metal objects, the connection status may deteriorate.

■ **Battery charge/signal status**

- This display may not correspond exactly with the portable audio player or cellular phone itself.
- This system does not have a charging function.
- The portable audio player or cellular phone battery will be depleted quickly when the device is connected to Bluetooth®.

■ **When using the Bluetooth® audio and hands-free system at the same time**

The following problems may occur.

- The Bluetooth® audio connection may be interrupted.
- Noise may be heard during Bluetooth® audio playback.

### ■ About the contact in this system

The following data is stored for every registered cellular phone. When another phone is connecting, you cannot read the registered data.

- Contact data
- Call history
- Favorite
- Message

When removing a Bluetooth® phone from the system, the above-mentioned data is also deleted.

### ■ Compatible models

The Bluetooth® audio system supports portable audio players with the following specifications

- Bluetooth® specifications:  
Ver. 2.0, or higher (Recommended: Ver. 3.0+EDR or higher)
- Profiles:
  - A2DP (Advanced Audio Distribution Profile) Ver. 1.0, or higher (Recommended: Ver. 1.2 or higher)  
This is a profile to transmit stereo audio or high quality sound to the multimedia system.
  - AVRCP (Audio/Video Remote Control Profile) Ver. 1.0 or higher (Recommended: Ver. 1.4 or higher)  
This is a profile to allow remote control the A/V equipment.

However, please note that some functions may be limited depending on the type of portable audio player connected.

The hands-free system supports cellular phones with the following specifications.

- Bluetooth® specification:  
Ver. 2.0 or higher (Recommended: Ver. 3.0+EDR or higher)

### ● Profiles:

- HFP (Hands Free Profile) Ver. 1.0 or higher (Recommended: Ver. 1.6 or higher)  
This is a profile to allow hands-free phone calls using a cellular phone or head set. It has outgoing and incoming call functions.
- OPP (Object Push Profile) Ver. 1.1 or higher (Recommended: Ver. 1.2)  
This is a profile to transfer contact data. When a Bluetooth® compatible cellular phone has both PBAP and OPP, OPP cannot be used.
- PBAP (Phone Book Access Profile) Ver. 1.0 or higher (Recommended: Ver. 1.1)  
This is a profile to transfer contact data.

If the cellular phone does not support HFP, you cannot register it with the hands-free system. OPP, PBAP services must be selected individually.

### ■ Certifications for the Bluetooth®

► For vehicles sold in U.S.A.

FCC ID: ACJ932YEAP01A446

This device complies with Part 15 of the FCC Rules. Operation is subject to the following two conditions: (1) this device may not cause harmful interference, and (2) this device must accept any interference received, including interference that may cause undesired operation.

► For vehicles sold in Canada

IC: 216J-YEAP01A446

This device complies with Industry Canada licence-exempt RSS standard(s). Operation is subject to the following two conditions: (1) this device may not cause interference, and (2) this device must accept any interference, including interference that may cause undesired operation of the device.

This radio transmitter (identify the device by certification number, or model number if Category II) has been approved by Industry Canada to operate with the antenna types listed below with the maximum permissible gain and required antenna impedance for each antenna type indicated. Antenna types not included in this list, having a gain greater than the maximum gain indicated for that type, are strictly prohibited for use with this device.



### ■ Reconnecting the portable audio player

If the portable audio player is disconnected due to poor reception when the engine switch is in the “ACC” or “ON” position, the system automatically reconnects the portable audio player.

If you have switched off the portable audio player yourself, follow the instructions below to reconnect:

- Select the portable audio player again
- Enter the portable audio player

### ■ When you sell your car

Be sure to delete your personal data. (→P. 252)

## CAUTION

### ■ FCC WARNING

Changes or modifications not expressly approved by the party responsible for compliance could void the user’s authority to operate the equipment.

Radio frequency radiation exposure information:

This equipment complies with FCC radiation exposure limits set forth for an uncontrolled environment.

This equipment should be installed and operated with minimum distance of 7.9 in. (20 cm) between the radiator and your body.

This transmitter must not be co-located operating in conjunction with any other antenna or transmitter.

### ■ While driving

Do not use the portable audio player, cellular phone or connect a device to the Bluetooth® system.

 CAUTION**■ Caution regarding interference with electronic devices**

- Your audio unit is fitted with Bluetooth® antennas. People with implantable cardiac pacemakers, cardiac resynchronization therapy-pacemakers or implantable cardioverter defibrillators should maintain a reasonable distance between themselves and the Bluetooth® antennas. The radio waves may affect the operation of such devices.
- Before using Bluetooth® devices, users of any electrical medical device other than implantable cardiac pacemakers, cardiac resynchronization therapy-pacemakers or implantable cardioverter defibrillators should consult the manufacturer of the device for information about its operation under the influence of radio waves. Radio waves could have unexpected effects on the operation of such medical devices.

 NOTICE**■ When leaving the vehicle**

Do not leave your portable audio player or cellular phone in the vehicle. The inside of the vehicle may become hot, causing damage to the portable audio player or cellular phone.

## 3-2. Using the multimedia system Listening to Bluetooth® audio

The Bluetooth® audio system enables the user to enjoy music played on a portable player from the vehicle speakers via wireless communication.

Select “ Audio” on the “Select Audio Source” screen.

When a Bluetooth® device cannot be connected, check the connection status on the “Bluetooth Audio” screen. If the device is not connected, either register or reconnect the device. (→P. 288)

### Audio control screen

Some titles and controls may not be displayed depending on the type of portable audio player used.



**1** Connection status

**2** Battery charge

**3** “Select Audio Source” screen appears

**4** Selecting a Bluetooth® device

**5** Select to display the play mode selection screen





**6** Random playback

**7** Repeat play

**8** Pause

Select  to resume play

**9** Setting the sound (→P. 260)

Indicators	Conditions
Connection status	Good  <span style="display: inline-block; width: 100px; border-bottom: 1px solid black;"></span> Not connected 
Battery charge	Full  <span style="display: inline-block; width: 100px; border-bottom: 1px solid black;"></span> Empty 



## 3-2. Using the multimedia system

### Using a Bluetooth<sup>®</sup> phone



The hands-free system is a function that allows you to use your cellular phone without touching it.

This system supports Bluetooth<sup>®</sup>. Bluetooth<sup>®</sup> is a wireless data system that allows the cellular phone to wirelessly connect to the hands-free system and make/receive calls.

Before making a phone call, check the connection status, battery charge, call area and signal strength. (→P. 306)

If a Bluetooth<sup>®</sup> device cannot be connected, check the connection status on the phone screen. If the device is not connected, either register or reconnect it. (→P. 288)

#### Phone screen

To display the screen shown below, press the  switch on the steering wheel or press the  button.

Several functions are available to operate on each screen that is displayed by selecting the 4 tabs.



- 1 Device name
- 2 Bluetooth<sup>®</sup> connection status

### ■ Microphone

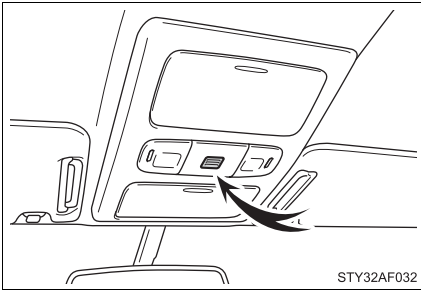

The vehicle's built in microphone is used when talking on the phone.

The person you are speaking to can be heard from the front speakers.







To use the hands-free system, you must register your Bluetooth® phone in the system. (→P. 286)

### Status display

You can check indicators such as signal strength and battery charge on any screen.



- 1 Connection status
- 2 Signal strength
- 3 Battery charge

Indicators	Conditions
Connection status	Good (Blue)  ↔  Not connected
Battery charge	Full  ↔  Empty
Call area	“Rm”: Roaming area
Signal strength	Excellent  ↔  Poor

## Making a call

Once a Bluetooth® phone is registered, you can make a call using the following procedure:



### ■ Dialing

**STEP 1** Display the phone screen. (→P. 305)

**STEP 2** Select the “Dial Pad” tab and enter a phone number.

To delete the input phone number, select .

For the first digit, you can enter “+” by selecting “\*” for a while.

**STEP 3** Press the  switch on the steering wheel or select .



### ■ Dialing from the contacts list

You can dial a number from the contact data imported from your cellular phone. The system has one contact for each registered phone. Up to 2500 contacts may be stored in each contact.  
(→P. 308)

**STEP 1** Display the phone screen. (→P. 305)

**STEP 2** Select “Contacts” tab.

**STEP 3** Choose the desired contact to call from the list.

**STEP 4** Choose the number and then press the  switch on the steering wheel or select .

### ■ When the contact is empty

You can transfer the phone numbers in a Bluetooth® phone to the system.

Operation methods differ between PBAP (Phone Book Access Profile) compatible and PBAP incompatible Bluetooth® phones. If the cellular phone does not support either PBAP or OPP (Object Push Profile) service, you cannot transfer contacts.

#### ● For PBAP compatible Bluetooth® phones

▶ When “Automatic Contact/History Transfer” is set to on (→P. 322)

**STEP 1** Select the “Contacts” tab.

**STEP 2** Check that a confirmation screen is displayed when the operation is complete.

Transfer the contact data to the system using a Bluetooth® phone.

▶ When “Automatic Contact/History Transfer” is set to off

**STEP 1** Select the “Contacts” tab.

**STEP 2** Select the desired item.

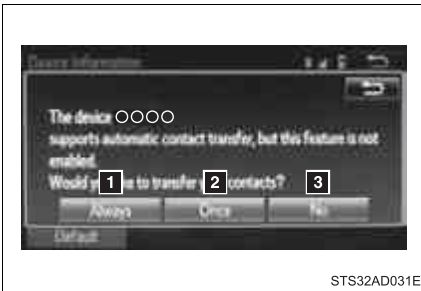

**1** Select to transfer new contacts from a cellular phone, select “Always” and then enable “Automatic Transfer”.

**2** Select to transfer all the contacts from a connected cellular phone only once.

**3** Select to cancel transferring.

**STEP 3** Check that a confirmation screen is displayed when the operation is complete.

- For PBAP incompatible but OPP compatible Bluetooth® phones

**STEP 1** Select the “Contacts” tab.

**STEP 2** Follow the steps in “Update contacts from phone” from “STEP 2”. (→P. 323)

### ■ **Calling using favorites list**

You can make a call using numbers registered in the contact.

**STEP 1** Display the phone screen. (→P. 305)

**STEP 2** Select “Favorites” tab.

**STEP 3** Select the desired number to make a call.

### ■ Dialing from call history

You can make a call using the call history, which has the 3 functions below.

: calls which you missed

: calls which you received

: calls which you made

**STEP 1** Display the phone screen. (→P. 305)

**STEP 2** Select “Call History” tab.

**STEP 3** Select  or the desired entry from the list.

▶ When  is selected

**STEP 4** Check that the “Call” screen is displayed.

▶ When the desired contact is selected

**STEP 4** Select the desired number.

**STEP 5** Check that the “Call” screen is displayed.

---

### ■ Call history list

- If you make a call to or receive a call from a number registered in the contact, the name is displayed in the call history.
- If you make multiple calls to the same number, only the last call made is displayed in the call history.

### ■ International calls



You may not be able to make international calls, depending on the mobile phone in use.

## Receiving a call



When a call is received, the following screen is displayed together with a sound.

### ■ To answer the phone



Press the  switch on the steering wheel or select .

### ■ To refuse a call

Press the  switch on the steering wheel or select .

### ■ To adjust the incoming call volume

Turn the “PWR·VOL” knob.

### ■ International calls

Received international calls may not be displayed correctly depending on the cellular phone in use.

## Speaking on the phone

The following screen is displayed when speaking on the phone.



### ■ To adjust the call volume

Select “-” or “+”. You can also adjust the volume using the volume knob.

### ■ To prevent the other party from hearing your voice

Select “Mute”.

### ■ Inputting tones

When using phone services such as an answering service or a bank, you can store phone numbers and code numbers in the contact.

**STEP 1** Select “0-9”.

**STEP 2** Input the number.

### ● Release Tones

“Release Tones” appear when a continuous tone signal(s) containing a “w” is registered in the contact list.

**STEP 1** Select “Release Tones”.



### ■ Release Tones

- A continuous tone signal is a character string that consists of numbers and the characters “p” or “w”. (e.g.056133w0123p#1\*)
- When the “p” pause tone is used, the tone data up until the next pause tone will be automatically sent after 2 seconds have elapsed. When the “w” pause tone is used, the tone data up until the next pause tone will be automatically sent after a user operation is performed.
- Release tones can be used when automated operation of a phone based service such as an answering machine or bank phone service is desired. A phone number with continuous tone signals can be registered in the contact list.
- Tone data after a “w” pause tone can be operated on voice command during a call.

### ■ To transfer a call

Select “Handset Mode” to change from a hands-free call to a cellular phone call.

Select “Handset Mode” to off from a cellular phone call to a hands-free call.



### ■ Transmit volume setting

**STEP 1** Select “Transmit Volume”.

**STEP 2** Select the desired level for the transmit volume.

**STEP 3** Select “OK”.



### ■ To hang up



Press the  switch on the steering wheel or select .



### ■ Call waiting

When a call is interrupted by a third party while talking, an incoming call message will be displayed.



To talk with the other party:  
Press the  switch on the steering wheel or select .

To refuse the call:  
Press the  switch on the steering wheel or select .

Every time you press the  switch on the steering wheel or select  during call waiting, you will be switched to the other party.

---

### ■ Transferring calls

- If you transfer from the cellular phone to hands-free, the hands-free screen will be displayed, and you can operate the system using the screen.
- Transfer method and operation may vary according to the cellular phone used.
- For operation of the cellular phone in use, see the phone's manual.

### ■ Call waiting operation

Call waiting operation may differ depending on your phone company and cellular phone.



## Bluetooth® phone message function

Received messages can be forwarded from the connected Bluetooth® phone, enabling checking and replying using the multimedia system.

Depending on the type of Bluetooth® phone connected, received messages may not be transferred to the message inbox.

If the phone does not support the message function, this function cannot be used.

### ■ Displaying “Message Inbox” screen

**STEP 1** Press the  switch on the steering wheel or press the  button.

**STEP 2** Select  on the phone screen.

**STEP 3**

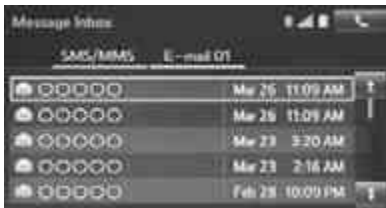

STS59AZ001

Check that the “Message Inbox” screen is displayed.

### ■ Receiving a message

When an e-mail/SMS/MMS is received, the incoming message screen pops up with sound and is ready to be operated on the screen.

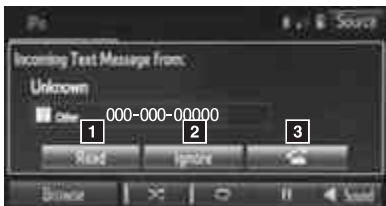

STS32AD036E

- 1** E-mail: Select to check the message.
- 2** Select to refuse the message.
- 3** Select to call the message sender.

### ■ Receiving a message

- Depending on the cellular phone used for receiving messages, or its registration status with the navigation system, some information may not be displayed.
- The pop up screen is separately available for incoming e-mail and SMS/MMS messages under the following conditions:

E-mail:

- “Incoming E-mail Display” is set to “Full Screen”. (→P. 329)
- “E-mail Notification Popup” is set to on. (→P. 329)

SMS/MMS:

- “Incoming SMS/MMS Display” is set to “Full screen”. (→P. 329)
- “SMS/MMS Notification Popup” is set to on. (→P. 329)

### ■ Checking the messages

**STEP 1** Display the “Message Inbox” screen. (→P. 315)

**STEP 2** Select the desired message from the list.

**STEP 3** Check that the message is displayed.

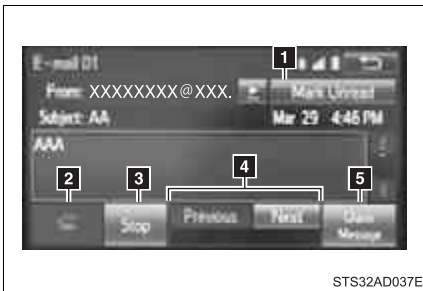

**1** E-mails: Select “Mark Unread” or “Mark Read” to mark mail unread or read on the “Message Inbox” screen.

This function is available when “Update Message Read Status on Phone” is set to on (→P. 329)

**2** Select to make a call to the sender.

**3** Select to have messages read out. To cancel this function, select “Stop”.

**4** Select to display the previous or next message.

**5** Select to reply the message.

### ■ Check the messages

- Depending on the type of Bluetooth® phone being connected, it may be necessary to perform additional steps on the phone.
- Messages are displayed in the appropriate connected Bluetooth® phone's registered mail address folder.  
Select the tab of the desired folder to be displayed.
- Only received messages on the connected Bluetooth® phone can be displayed.
- The text of the message is not displayed while driving.
- When "Automatic Message Readout" is set to on, messages will be automatically read out. (→P. 329)
- Turn the "PWR·VOL" knob to adjust the message read out volume.
- The message read out function is available even while driving.

### ■ Replying to a message

**STEP 1** Display the "Message Inbox" screen. (→P. 315)

**STEP 2** Select the desired message from the list.

**STEP 3** Select "Quick Message".

**STEP 4** Select the desired message.

**STEP 5** Select "Send".

#### ● Editing quick reply message

This operation cannot be performed while driving.

**STEP 1** Select "Quick Message".

**STEP 2** Select  corresponding to the desired message to edit.

**STEP 3** Select "OK" when editing is completed.

### ■ Calling the message sender

Calls can be made to an e-mail/SMS/MMS message sender's phone number.

**STEP 1** Display the "Message Inbox" screen. (→P. 315)

**STEP 2** Select the desired message.

**STEP 3** Select .

**STEP 4** Check that the "Call" screen is displayed.

#### ● Calling from a number within a message

Calls can be made to a number identified in a message's text area.

**STEP 1** Display the "Message Inbox" screen. (→P. 315)

**STEP 2** Select the desired message.

**STEP 3** Select the text area.

**STEP 4** Select  corresponding to the desired number.

**STEP 5** Check that the "Call" screen is displayed.

#### ● Calling from the incoming message screen

→P. 314

## Using the steering wheel switches (if equipped)

The steering wheel switches can be used to operate a connected cellular phone.

### ■ Operating a telephone using the steering wheel switches

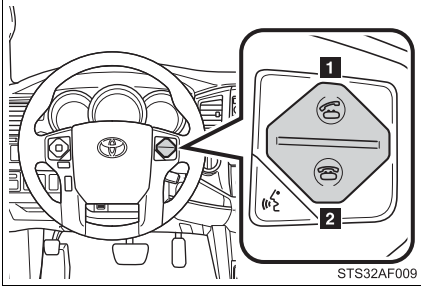

#### 1 Off hook switch

- Make a call
- Receive a call
- Display "Phone" screen

#### 2 On hook switch

- End a call
- Refuse a call

## Bluetooth® phone settings

You can adjust the hands-free system to your desired settings.

### ■ “Phone/Message Settings” screen

To display the screen shown below, press the “SETUP” button, and select “Phone” on the “Setup” screen.

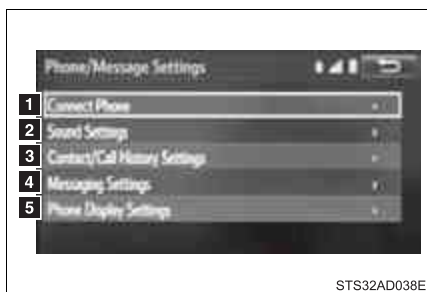

- 1 Set the phone connection (→P. 286)
- 2 Sound Settings (→P. 320)
- 3 Contact/Call History Settings (→P. 322)
- 4 Messaging Settings (→P. 329)
- 5 Phone Display Settings (→P. 331)

### ■ Sound setting

**STEP 1** Display the “Phone/Message Settings” screen. (→P. 320)

**STEP 2** Select “Sound Settings” on the “Phone/Message Settings” screen.



- 1 Set the desired ringtone.
- 2 Adjust the ringtone volume.
- 3 Adjust the message readout volume.
- 4 Set the desired incoming SMS/MMS tone.
- 5 Adjust the incoming SMS/MMS tone volume.
- 6 Set the incoming e-mail tone.
- 7 Adjust the incoming e-mail tone volume.
- 8 Adjust the default volume of the other party’s voice.



---

■ **To return to the default settings**

Select “Default”, and then “Yes”.

## Contact/Call history settings

The contact can be transferred from a Bluetooth® phone to the system. The contact also can be added, edited and deleted.

The call history can be deleted and contact and favorites can be changed.

- STEP 1** Display the “Phone/Message Settings” screen. (→P. 320)
- STEP 2** Select “Contact/Call History Settings”.
- STEP 3** Select the desired item to be set.

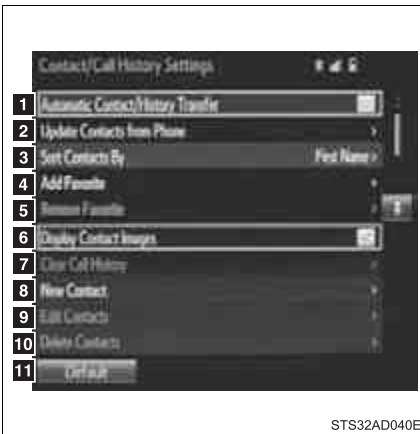

- 1** For PBAP compatible Bluetooth® phones, select to set automatic contact/history transfer on/off. When set to on, the phone’s contact data and history are automatically transferred.
- 2** Select to update contacts from the connected phone. (→P. 323)
- 3** Select to sort contacts by the first name or last name field.
- 4** Select to add contacts to the favorites list. (→P. 327)
- 5** Select to delete contacts from the favorites list. (→P. 328)
- 6** Select to display contact images.
- 7** Select to clear contacts from the call history.
- 8** Select to add new contacts to the contact list.\* (→P. 325)
- 9** Select to edit contacts in the contact list.\* (→P. 325)

**10** Select to delete contacts from the contact list.\* (→P. 326)

**11** Select to reset all setup items.\*

\*: For PBAP compatible Bluetooth® phones only, this function is available when “Automatic Contact/History Transfer” is set to off. (→P. 322)

### ■ Update contacts from phone

Operation methods differ between PBAP compatible and PBAP incompatible but OPP compatible Bluetooth® phones.

If your cellular phone is neither PBAP nor OPP compatible, the contacts cannot be transferred.

#### ● For PBAP Compatible Bluetooth® Phones

**STEP 1** Select “Update Contacts from Phone”.

**STEP 2** Check that a confirmation screen is displayed when the operation is complete.

This operation may be unnecessary depending on the type of cellular phone.

Depending on the type of cellular phone, OBEX authentication may be required when transferring contact data. Enter “1234” into the Bluetooth® phone.

If another Bluetooth® device is connected when transferring contact data, depending on the phone, the connected Bluetooth® device may need to be disconnected.

Depending on the type of Bluetooth® phone being connected, it may be necessary to perform additional steps on the phone.

● For PBAP Incompatible Bluetooth® Phones

**STEP 1** Select “Update Contacts from Phone”.

**STEP 2** Transfer the contact data to the system using a Bluetooth® phone.

This operation may be unnecessary depending on the type of cellular phone.

Depending on the type of cellular phone, OBEX authentication may be required when transferring contact data. Enter “1234” into the Bluetooth® phone.

To cancel this function, select “Cancel”.

**STEP 3** Select “Done” when it appears on the screen.

**STEP 4** Check that a confirmation screen is displayed when the operation is complete.

● Updating the contacts in a different way (From the “Call History” screen)

For PBAP compatible Bluetooth® phones, this function is available when “Automatic Contact/History Transfer” is set to off. (→P. 322)

**STEP 1** Display the phone screen. (→P. 305)

**STEP 2** Select the “Call History” tab and select a contact not yet registered in the contact list.

**STEP 3** Select “Update Contact”.

**STEP 4** Select the desired contact.

**STEP 5** Select a phone type for the phone number.

### ■ Registering a new contact to the contact list

New contact data can be registered. Up to 4 numbers per person can be registered. For PBAP compatible Bluetooth® phones, this function is available when “Automatic Contact/History Transfer” is set to off. (→P. 322)

**STEP 1** Select “New Contact”.

**STEP 2** Enter the name and select “OK”.

**STEP 3** Enter the phone number and select “OK”.

**STEP 4** Select the phone type for the phone number.

**STEP 5** To add another number to this contact, select “Yes”.

● Registering a new contact in a different way (From the “Call History” screen)

**STEP 1** Display the phone screen. (→P. 305)

**STEP 2** Select the “Call History” tab and select a contact not yet registered in the contact list.

**STEP 3** Select “Add to Contacts”.

**STEP 4** Follow the steps in “Registering a new contact to the contact list” from “STEP 3”. (→P. 325)

### ■ Editing the contact data

For PBAP compatible Bluetooth® phones, this function is available when “Automatic Contact/History Transfer” is set to off. (→P. 322)

**STEP 1** Select “Edit Contact”.

**STEP 2** Select the desired contact.

**STEP 3** Select  corresponding to the desired name or number.

▶ For editing the name

**STEP 4** Follow the steps in “Registering a new contact to the contact list” from “STEP 3”. (→P. 325)

▶ For editing the number

**STEP 4** Follow the steps in “Registering a new contact to the contact list” from “STEP 4”. (→P. 325)

- Editing the contacts in a different way (From the “Contact Details” screen)

**STEP 1** Display the phone screen. (→P. 305)

**STEP 2** Select the “Contacts”, “Call History” tab or the “Favorites” tab and select the desired contact.

**STEP 3** Select “Edit Contact”.

“E-mail Addresses”: Select to display all registered e-mail addresses for the contact.

**STEP 4** Follow the steps in “Editing the contact data” from “STEP 4”. (→P. 325)

#### ■ Deleting the contact data

For PBAP compatible Bluetooth<sup>®</sup> phones, this function is available when “Automatic Contact/History Transfer” is set to off. (→P. 322)

**STEP 1** Select “Delete Contacts”.

**STEP 2** Select the desired contact and select “Delete”.

**STEP 3** Select “Yes” when the confirmation screen appears.

- Deleting the contact in a different way (From the “Contact Details” screen)

**STEP 1** Display the phone screen. (→P. 305)

**STEP 2** Select the “Contacts”, “Call History” tab or the “Favorites” tab and select the desired contact.

**STEP 3** Select “Edit Contact”.

**STEP 4** Select “Yes” when the confirmation screen appears.

## ■ Favorites list setting

Up to 15 contacts (maximum of 4 numbers per contact) can be registered in the favorites list.

### ● Registering the contacts in the favorites list

**STEP 1** Select “Add Favorite”.

**STEP 2** Select the desired contact to add to the favorites list.

Dimmed contacts are already stored as a favorite.

**STEP 3** Check that a confirmation screen is displayed when the operation is complete.

▶ When 15 contacts have already been registered to the favorites list

**STEP 1** When 15 contacts have already been registered to the favorites list, a registered contact needs to be replaced.

Select “Yes” when the confirmation screen appears to replace a contact.

**STEP 2** Select the contact to be replaced.

**STEP 3** Check that a confirmation screen is displayed when the operation is complete.

▶ Registering contacts in the favorites list in a different way (from the “Contacts” screen)

**STEP 1** Display the phone screen. (→P. 305)

**STEP 2** Select the “Contacts” tab.

**STEP 3** Select ☆ at the beginning of the desired contact list name to be registered in the favorites list.

When selected, ☆ is changed to ★, and the contact is registered in the favorites list.

- ▶ Registering contacts in the favorites list in a different way (from the “Contact Details” screen)

**STEP 1** Display the phone screen. (→P. 305)

**STEP 2** Select the “Contacts” tab or the “Call History” tab and select the desired contact.

**STEP 3** Select “Add Favorite”.

**STEP 4** Check that a confirmation screen is displayed when the operation is complete.

- Deleting the contacts in the favorites list

**STEP 1** Select “Remove Favorite”.

**STEP 2** Select the desired contacts and select “Remove”.

**STEP 3** Select “Yes” when the confirmation screen appears.

**STEP 4** Check that a confirmation screen is displayed when the operation is complete.

- ▶ Deleting contacts in the favorites list in a different way (from the “Contacts” screen)

**STEP 1** Display the phone screen. (→P. 305)

**STEP 2** Select the “Contacts” tab.

**STEP 3** Select ★ at the beginning of the contact list name to be deleted from the favorites. list.

When selected, ★ is changed to ☆, and the data is deleted from the list.

- ▶ Deleting contacts in the favorites list in a different way (from the “Contact Details” screen)

**STEP 1** Display the phone screen. (→P. 305)

**STEP 2** Select the “Contacts”, “Call History” tab or the “Favorites” tab and select the desired contact to delete.

**STEP 3** Select “Remove Favorite”.

**STEP 4** Select “Yes” when the confirmation screen appears.

**STEP 5** Check that a confirmation screen is displayed when the operation is complete.



## ■ Message Settings

**STEP 1** Display the “Phone/Message Settings” screen. (→P. 320)

**STEP 2** Select “Messaging Settings”.

**STEP 3** Select the desired item to be set.



**1** Set automatic message transfer on/off.

**2** Set automatic message read-out on/off.

**3** Set the SMS/MMS notification popup on/off.

**4** Set the e-mail notification popup on/off.

**5** Set adding the vehicle signature to outgoing messages on/off.

**6** Set updating message read status on phone on/off.

**7** Change the incoming SMS/MMS display.

“Full Screen”: When an SMS/MMS message is received, the incoming SMS/MMS display screen is displayed and can be operated on the screen.

“Drop-Down”: When an SMS/MMS message is received, a message is displayed on the upper side of the screen.

**8** Change the incoming e-mail display.

“Full Screen”: When an e-mail is received, the incoming e-mail display screen is displayed and can be operated on the screen.

“Drop-Down”: When an e-mail is received, a message is displayed on the upper side of the screen.

**9** Set display of messaging account names on the inbox tab on/off.

When set to on, messaging account names used on the cellular phone will be displayed.

● Displaying the “Messaging Settings” screen in a different way

**STEP 1** Display the phone screen. (→P. 305)

**STEP 2** Select .

**STEP 3** Select “Settings”.

---

■ **To return to the default settings**

Select “Default”, and then “Yes”.

## ■ Phone Display Settings

**STEP 1** Display the “Phone/Message Settings” screen. (→P. 320)

**STEP 2** Select “Phone Display Settings”.

**STEP 3** Select the desired item to be set.



**1** Change the incoming call display.

“Full Screen”: When a call is received, the hands-free screen is displayed and can be operated on the screen.

“Drop-Down”: A message is displayed on the upper side of the screen.

**2** Set display of the contact/history transfer completion message on/off.

## Voice command system

The voice command system enables the hands-free system to be operated using voice commands.

Operations of the voice command system can be performed by selecting the menu corresponding to each function on the screen. Even if any menu is selected, commands displayed on all menus can be operated.

### ■ Using the voice command system

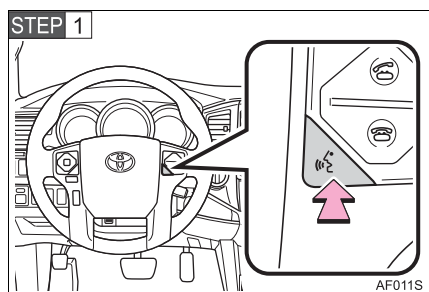

Press the talk switch.

To cancel the voice command system, press and hold the talk switch.

**STEP 2** After a beep sounds, say the desired command.

On the list screen, you can select the desired command.

### ■ Microphone

→P. 306

### ■ When using the microphone

- It is unnecessary to speak directly into the microphone when giving a command.
- It is not necessary to wait for the confirmation beep before speaking a command.

- Voice commands may not be recognized if:
  - Spoken too quickly.
  - Spoken at a low or high volume.
  - The roof or windows are open.
  - Passengers are talking while voice commands are spoken.
  - The air conditioning speed is set high.
  - The air conditioning vents are turned towards the microphone.
- In the following conditions, the system may not recognize the command properly and using voice commands may not be possible:
  - The command is incorrect or unclear. Note that certain words, accents or speech patterns may be difficult for the system to recognize.
  - There is excessive background noise, such as wind noise.

### ■ Casual speech recognition

Due to natural language speech recognition technology, this system enables recognition of a command when spoken naturally. However, the system cannot recognize every variation of each command.

In some situations, it is possible to omit the command for the procedure and directly state the desired operation.

Not all voice commands are displayed in the short cut menu.

This function is available in English, Spanish and French.

- Expression examples for each function

Command	Expression examples
“Call <name> <type>”	Get me <Robert Brown>. I need to call <Robert Brown> at <Work> right away.
“Dial <number>”	Please dial the number <3334445555>. Ring <3334445555>.

### 3-2. Using the multimedia system

## Operating the sub woofer (on some Access Cab models)

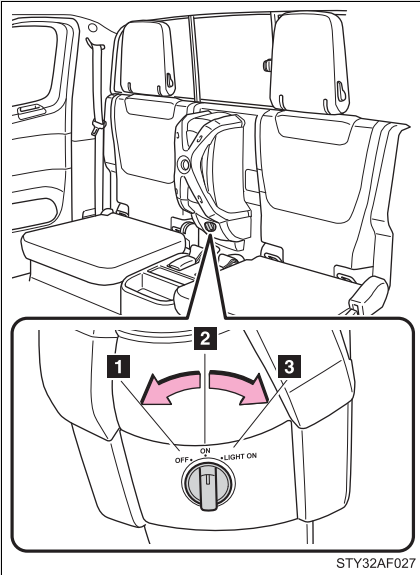

- 1** OFF
- 2** ON
- 3** LIGHT ON

The sub woofer illumination turns on. In this position, the sub woofer operates.

## 3-2. Using the multimedia system Detachable pole antenna

The antenna can be removed.

### ■ Removing the antenna

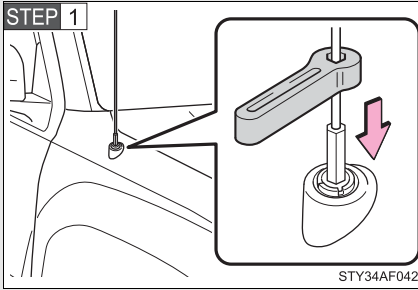

Place the included wrench around the antenna.

When not in use, the wrench is stored in glove box.

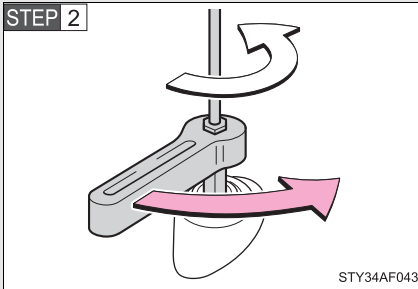

Loosen the antenna with the wrench and remove it.

### ■ Installing the antenna

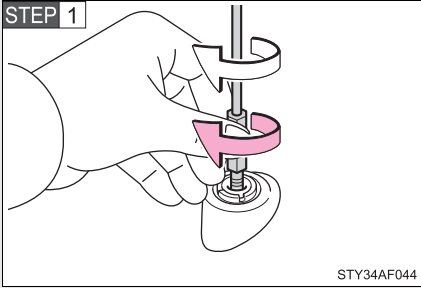

Tighten the antenna by one hand until it will not turn any more.

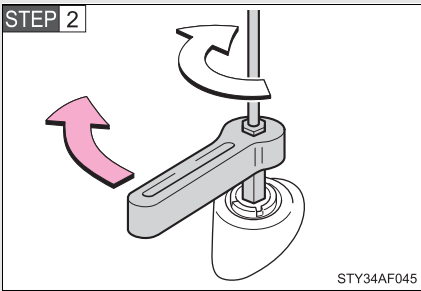

Using the wrench, tighten the antenna an additional 1/8th turn (20 to 45 degrees) to secure it in place.

After tightening the antenna, remove the wrench.

### ■ About the wrench

- A standard 5/16 in. (8 mm) wrench can also be used to install or remove the antenna.
- After using the included wrench, store it in the glove box for safekeeping.



 NOTICE**■ To avoid damaging the antenna**

Remove the antenna in the following situations.

- When using an automatic carwash.
- When the antenna will touch the ceiling of a garage, etc.
- When covering the vehicle with a car cover.

**■ Removing the antenna**

- For normal driving, make sure the antenna is installed.
- When removing the antenna to use an automatic carwash, etc., be careful not to lose the antenna. Also, make sure to reinstall the antenna before driving the vehicle.

**■ Using the wrench**

- When installing or removing the antenna, use the included wrench or a standard 5/16 in. (8 mm) wrench.
- Be careful not to scratch or damage the vehicle body with the wrench.
- Do not over-tighten the antenna.  
Over-tightening may damage the antenna.
- Do not use pliers to install or remove the antenna.  
Pliers may damage the antenna's finish.

### 3-3. Using the interior lights

## Interior lights list

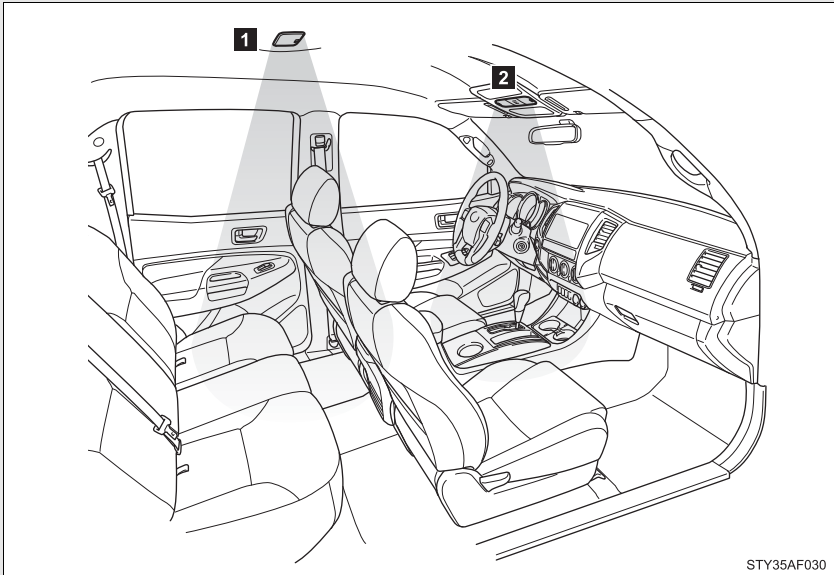

STY35AF030

**1** Interior light (→P. 339)

**2** Personal lights (→P. 339)

#### ■ Illuminated entry system

When the interior light switch is in the DOOR position, the interior light automatically turns on/off according to whether the doors are locked/unlocked and whether the doors are open/closed.

#### ■ To prevent the battery from being discharged

If the interior light remains on when the door is not fully closed and the interior light switch is in the DOOR position, the light will go off automatically after 20 minutes.

## Interior light

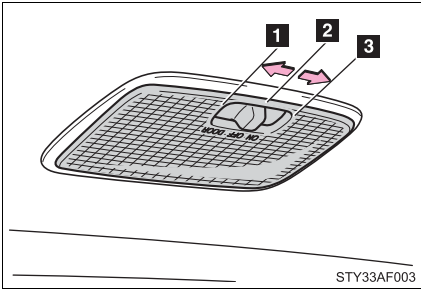

- 1** DOOR position
- 2** OFF
- 3** ON

## Personal lights

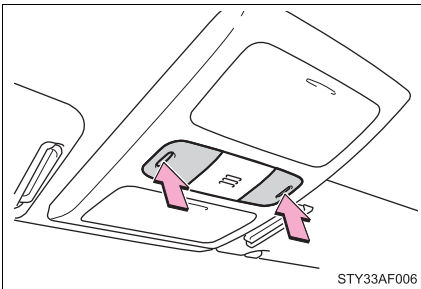

On/off

### 3-4. Using the storage features

## List of storage features

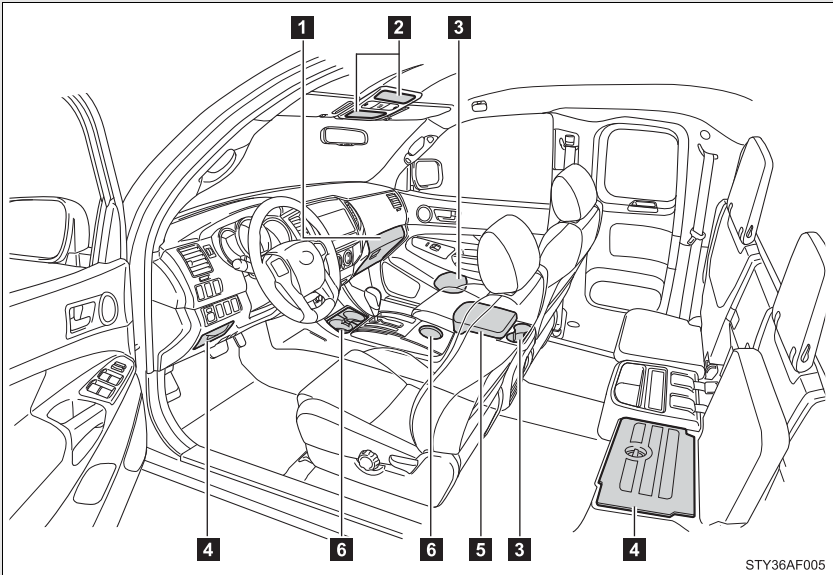

- 1** Glove box
- 2** Overhead console
- 3** Bottle holders
- 4** Auxiliary boxes
- 5** Front console box
- 6** Cup holders

#### **⚠ CAUTION**

##### **■ Items that should not be left in the storage spaces**

Do not leave glasses, lighters or spray cans in the storage spaces, as this may result in the following when cabin temperature becomes high:

- Glasses may be deformed by heat or cracked if they come into contact with other stored items.
- Lighters or spray cans may explode. If they come into contact with other stored items, the lighter may catch fire or the spray can may release gas, causing a fire hazard.

## Glove box

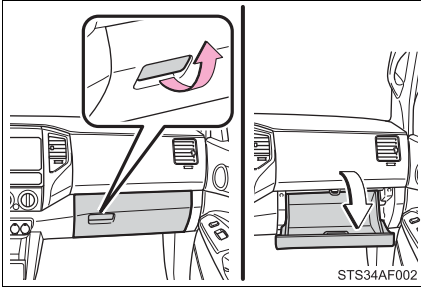

Pull up the lever.

### ⚠ CAUTION

#### ■ Caution while driving

Keep the glove box closed. In the event of sudden braking or sudden swerving, an accident may occur due to an occupant being struck by the open glove box or the items stored inside.

## Front console box

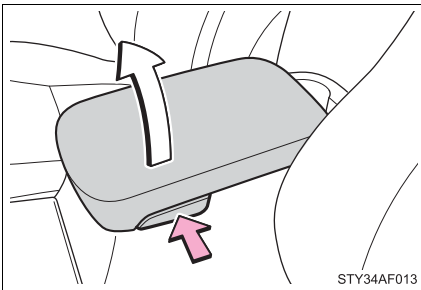

Push the button.

### ⚠ CAUTION

#### ■ Caution while driving

Keep the console box closed. Injuries may result in the event of an accident or sudden braking.

## Cup holders

► Vehicles with an automatic transmission

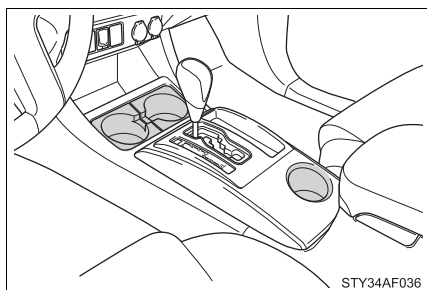

► Vehicles with a manual transmission

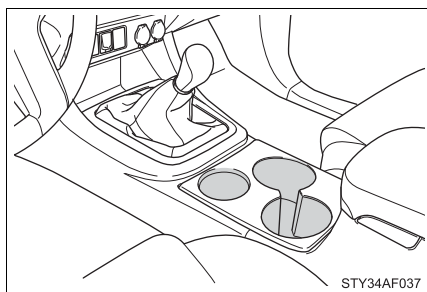

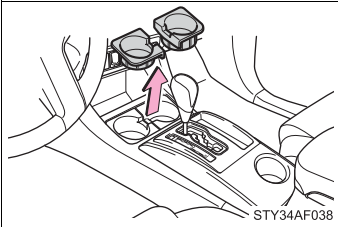
**■ Removing the cup holder (vehicles with an automatic transmission)**

Pull the cup holder up.

**⚠ CAUTION****■ Items unsuitable for the cup holder**

Do not place anything other than cups or aluminum cans in the cup holders. Other items may be thrown out of the holders in the event of an accident or sudden braking and cause injury. If possible, cover hot drinks to prevent burns.

## Bottle holders

### ► Front

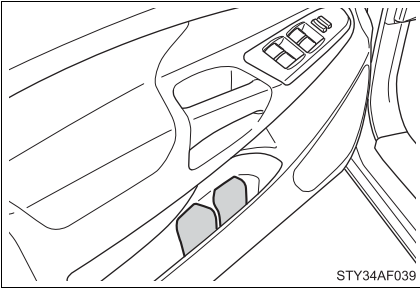

### ► Front console box

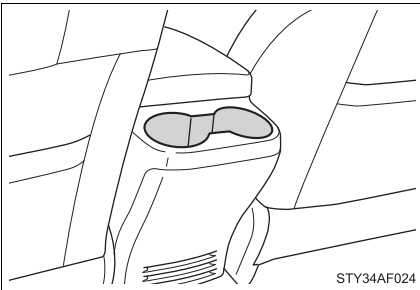

### ► Rear (Double Cab models)

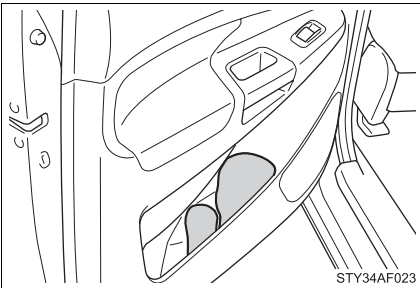

## ■ Bottle holders

Depending on their size or shape, some bottles may not fit in the holders.



 NOTICE

■ **Items that should not be stowed in the bottle holders**

Put the cap on before stowing a bottle. Do not place open bottles in the bottle holders, or glasses and paper cups containing liquid. The contents may spill and glasses may break.

**Auxiliary boxes**

► Front

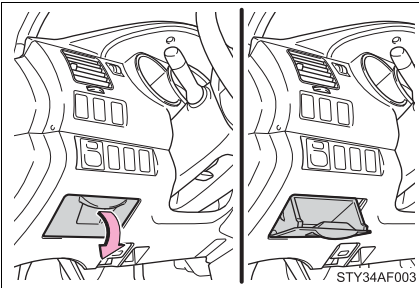

Pull the lid down.

► Rear (Access Cab models [vehicles without rear seats])

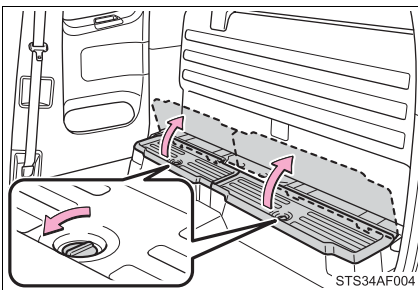

► Under the rear seats (Access Cab models [vehicles with rear seats])

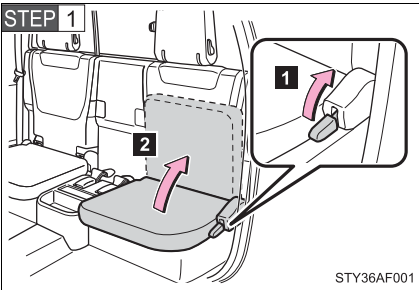

**1** Pull up the lever.

**2** Raise the bottom cushion up.

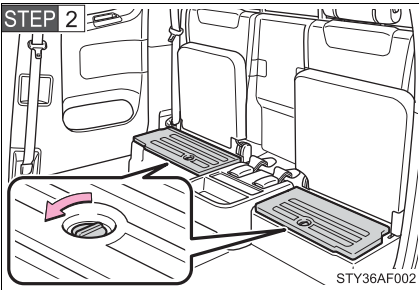

Turn the knob counterclockwise.

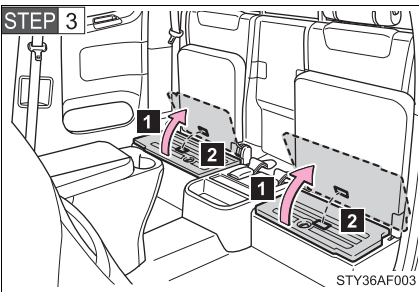

**1** Open the lid.

**2** Press the lid against the bottom of the lower cushion until it is supported by the hook-and-loop fastener.

Make sure that the lid is supported to prevent it from closing unexpectedly.

► Under the rear seats (Double Cab models)

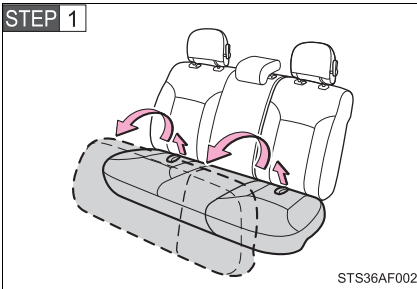

Swing the bottom cushion up by pulling the lock release strap.

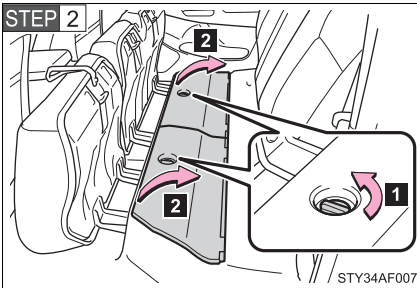

1 Turn the knob counterclockwise.

2 Open the lid.

**⚠ CAUTION**

■ **Caution while driving**

Keep the auxiliary boxes closed and locked. Injuries may result in the event of an accident or sudden braking.

■ **Auxiliary box (Access cab models [vehicles without rear seat])**

Never let anyone sit on the auxiliary box. Doing so may damage the auxiliary box and cause injury. In addition, it may cause death or severe injury in the event of sudden braking, sudden swerving or an accident.

**Overhead console**

The overhead console is useful for temporarily storing sunglasses and similar small items.

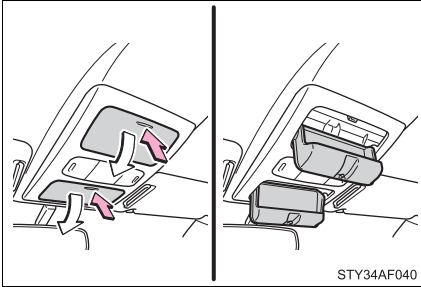

Pull the lid down while pushing the knob.

**⚠ CAUTION****■ Caution while driving**

Keep the overhead console closed.  
Injuries may result in the event of an accident or sudden braking.

**■ Items unsuitable for storing**

Do not store items heavier than 0.4 lb. (0.2 kg).  
Doing so may cause the overhead console to open and the items inside may fall out, resulting in an accident.

## Sun visors

### ► Type A

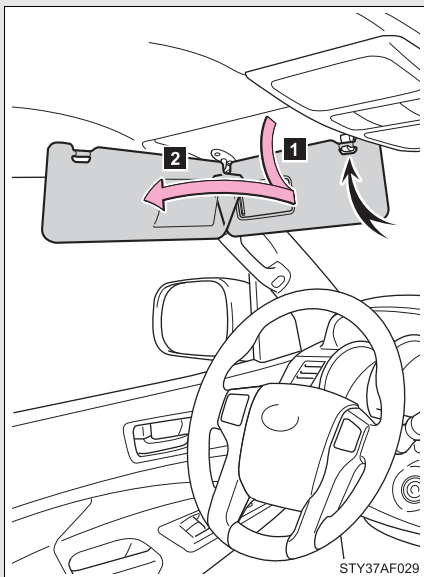

**1** Forward position:

Flip down.

**2** Side position:

Flip down, unhook, and swing to the side.

### ► Type B

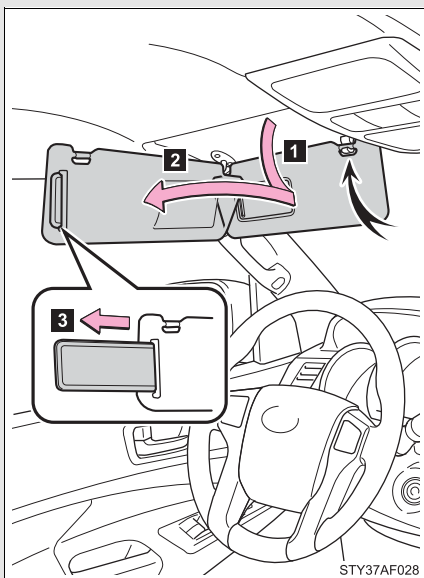

**1** Forward position:

Flip down.

**2** Side position:

Flip down, unhook, and swing to the side.

**3** Side extender:

Place in side position, then slide backwards.

### 3-5. Other interior features

## Vanity mirrors

#### ► Vehicles without vanity light

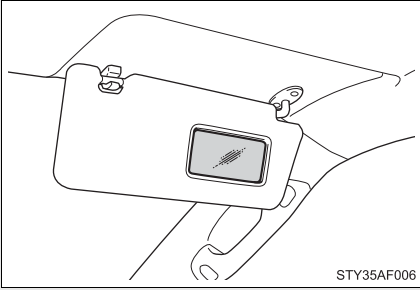

#### ► Vehicles with vanity light

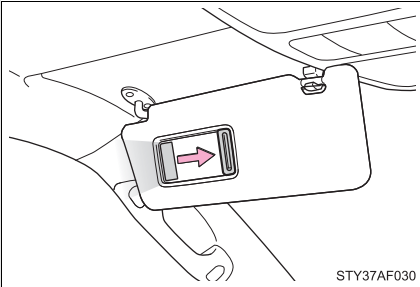

Slide the cover.

The light turns on when the cover is opened.

## Clock

The clock is displayed on the screen.



### ■ Setting the clock

- ▶ Vehicles with Entune Audio (Multimedia system types: →P. 243)  
→P. 251
- ▶ Vehicles with Entune Audio Plus or Entune Premium Audio  
(Multimedia system types: →P. 243)  
Refer to the “NAVIGATION SYSTEM OWNER’S MANUAL”.

---

### ■ The clock is displayed when

The engine switch is in the ACC or ON position.

### ■ When disconnecting and reconnecting battery terminals

The clock data will be reset.

## Power outlets (12 VDC)

**Please use as a power supply for electronic goods that use less than 12 VDC/10 A (power consumption of 120 W).**

**When using electronic goods, make sure that the power consumption of all the connected power outlets is less than 120 W.**

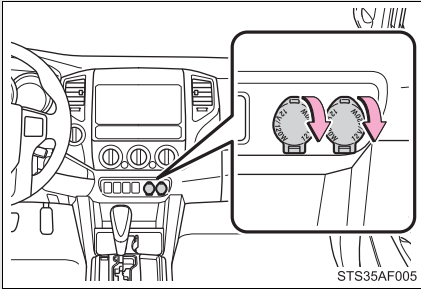

### ■ The power outlets can be used when

The engine switch is in the ACC or ON position.

### NOTICE

#### ■ To avoid damaging the power outlets

Close the power outlets lid when not in use.

Foreign objects or liquids that enter the power outlets may cause a short circuit.

#### ■ To prevent the battery from being discharged

Do not use the power outlets longer than necessary when the engine is not running.



## Power outlet (120 VAC)\*

The power outlet can be used for electrical appliances.

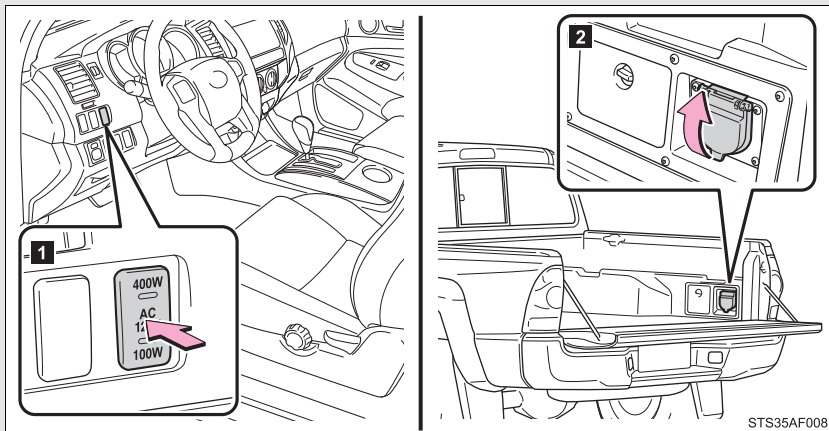

### 1 Main switch

To use the power outlet, turn on the main switch.

The power supply starts a few seconds after the main switch is pressed.

### 2 Power outlet socket

## Maximum available capacity of the power outlet

### ■ While the vehicle is being driven

The maximum capacity of the power outlet is always 120 VAC/100 W.

### ■ When the vehicle is stationary

The maximum capacity of the power outlet varies depending on the following conditions.

- The maximum capacity is 120 VAC/400 W when the following condition applies:

- The shift lever is in P or N. (automatic transmission)

\*: If equipped

- The shift lever is in N and the clutch pedal is not depressed. (manual transmission)

A maximum capacity of 400W can only be restored by turning the power outlet main switch off and then on again under condition described above.

- The maximum capacity is 120 VAC/100 W when the following condition applies:
  - The shift lever is moved to any positions other than P and N. (automatic transmission)
  - The clutch pedal is depressed. (manual transmission)

---

■ **The power outlet can be used when**

The engine is started.

■ **The indicator light changes according the maximum available capacity, as follows:**

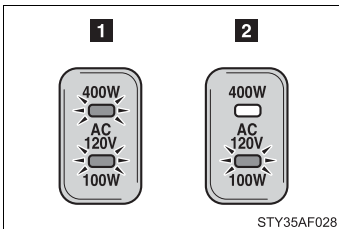

1 Indicates 120 VAC/400 W

2 Indicates 120 VAC/100 W

■ **When the power outlet is in operation**

The sound of the cooling fan may be heard from the front console box. This is normal and does not indicate a malfunction.

■ **If the engine is started with the power outlet main switch on**

The maximum capacity of the power supply may decrease to below the standard, or may be cut off completely, even when the vehicle is stationary.

■ **The protection circuit may be activated to cut the power supply if any of the following conditions apply:**

- The engine is started with the power outlet main switch on.
- Use of electrical appliances exceeding the maximum capacity is attempted.

A sound may be heard when the protection circuit is activated. This is normal and does not indicate a malfunction.

- Electrical appliances, which consume power exceeding 100 W, have been used continuously for a long time period.
- The total power usage by all electrical features (headlights, air conditioning, etc.) has exceeded the total vehicle maximum for an extended period of time.

■ **If the protection circuit is activated and the power supply is cut, conduct the following procedure:**

**STEP 1** Park the vehicle in a safe place, and then securely apply the parking brake.

**STEP 2** Check and ensure the following conditions:

- The shift lever is in P or N. (automatic transmission)
- The shift lever is in N and the clutch pedal is not depressed. (manual transmission)

**STEP 3** Make sure that the power consumption of the electric appliance is within the maximum capacity of the power outlet and the appliance is not broken.

**STEP 4** Press the power outlet main switch again.

When the cabin temperature is high, open the windows to cool the temperature down. Once it reaches the normal temperature, turn the power outlet main switch on again.

If the power supply is not resumed even after performing the above procedure, have the vehicle inspected by a Toyota dealer.

 CAUTION

■ **Using a power outlet**

Observe the following precautions to reduce the risk of injury.

- Use of the power outlet when it is wet with rain, drinks water or snow may result in electrical shocks and is extremely dangerous. The power outlet must be thoroughly dried before use.
- Do not allow children to use or play with the power outlet.
- Be careful not to get any part of your body caught in the power outlet lid.
- When using electrical appliances, strictly follow any cautions and notices written on their labels and in the manufacturers' instruction manuals.
- Do not modify, disassemble or repair the power outlet or its inverter, in any way. Doing so may result in unexpected malfunctions or accidents, which could cause serious damage or injuries. Contact a Toyota dealer for any necessary repairs.

■ **To prevent injuries and accidents, securely fix all electric appliances before use and do not use any appliances that may do any of the following:**

- Distract the driver while driving, or hamper safe driving.
- Result in a fire or burn injuries due to the appliance rolling, falling or overheating while driving.
- Emit steam, while the windows of the cabin are closed.

■ **To prevent unexpected accidents, such as electric shocks, do not perform any of the following**

- Using the power outlet for electric heaters while sleeping.
- Contaminating the power outlet with liquid substances or mud.
- Handling electrical appliance plugs at the power outlet with wet hands or feet.
- Inserting foreign objects into the power outlet.
- Using malfunctioning electric appliances.
- Inserting inappropriate or badly fitting plugs into the power outlet.

 NOTICE**■ To avoid damaging the power outlet and the plug**

- Close the power outlet lid when not in use.
- Foreign objects or liquids that enter the power outlet may cause a short circuit.
- Do not use plug adaptors to connect too many plugs to the power outlet.
- After inserting a plug, gently close the power outlet lid.

**■ To prevent the fuse from being blown**

Do not use a 120 VAC appliance that requires more than maximum capacity. If a 120 VAC appliance that consumes more than maximum capacity is used, the protection circuit will cut the power supply.

**■ Appliances that may not operate properly (120 VAC)**

The following 120 VAC appliances may not operate even if their power consumption is under maximum capacity.

- Appliances with high initial peak wattage
- Measuring devices that process precise data
- Other appliances that require an extremely stable power supply

**■ To prevent the battery from being discharged**

Turn off all the vehicle's electronic equipment and accessories, such as the headlights and air conditioning, when electrical appliances that consume in excess of 100W are used continuously for long periods of time.

**■ To prevent any damage caused by heat**

- Do not use any electrical appliances that give off intense heat such as toasters, in any locations including the internal or external trim, seats and deck.
- Do not use any electrical appliances, which are easily affected by vibration or heat, inside the vehicle.  
Vibration while driving, or the heat of the sun while parking, may result in damage to those electrical appliances.



## NOTICE

■ **If any electrical appliances are to be used while driving**

Securely fasten both the appliances and their cables to prevent them from falling or getting caught any of the power train components.

■ **If the power outlet is loose when an electrical appliance plug is connected**

Replace the outlet.

Contact a Toyota dealer for any necessary replacements.

■ **If the power outlet gets dirty**

Turn the main switch off and use a soft, clean cloth to wipe it gently.

Do not use any cleansing materials, such as organic solvents, wax, or compound cleaners, as these may damage the power outlet or cause it to malfunction.

## Seat heaters\*

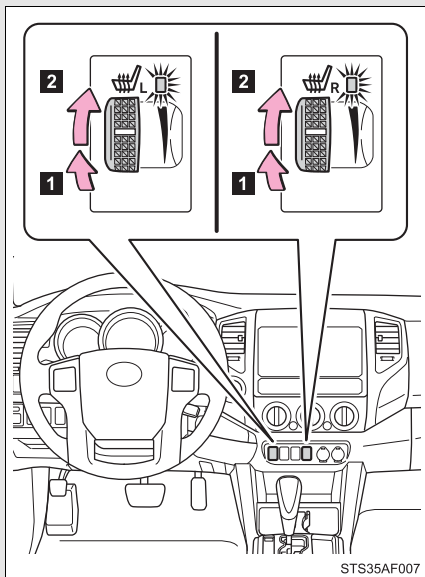

**1** On

The indicator comes on.

**2** Adjusts the seat temperature.

The further you turn the dial upward, the warmer the seat becomes.

■ **The seat heaters can be used when**

The engine switch is in the ON position.

■ **When not in use**

Turn the dial fully downward. The indicator turns off.

\*: If equipped

 CAUTION

■ **Burns**

- Use caution when seating the following persons in a seat with the seat heater on to avoid the possibility of burns:
  - Babies, small children, the elderly, the sick and the physically challenged
  - Persons with sensitive skin
  - Persons who are fatigued
  - Persons who have taken alcohol or drugs that induce sleep (sleeping drugs, cold remedies, etc.)
- Do not cover the seat with anything when using the seat heater. Using the seat heater with a blanket or cushion increases the temperature of the seat and may lead to overheating.
- Do not use the seat heater more than necessary. Doing so may cause minor burns or overheating.

 NOTICE

■ **To prevent seat heater damage**

Do not put heavy objects that have an uneven surface on the seat and do not stick sharp objects (needles, nails, etc.) into the seat.

■ **To prevent battery discharge**

Turn the seat heaters off when the engine is not running.



## Seatback table\*

**Front passenger's seatback can be used as a temporary table only when the vehicle is stopped.**

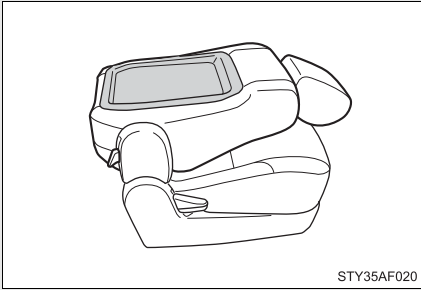

Fold down the front passenger's seat to use the seatback table. (→P. 46)

### CAUTION

#### ■ Caution while driving

Observe the following precautions to avoid death or serious injury.

- Do not set up the seatback table.
- Do not sit on or place anything on the seatback table.

### NOTICE

#### ■ To prevent damage to the seatback table

Do not put heavy loads on the table.

\*: If equipped

## Floor mat

Use only floor mats designed specifically for vehicles of the same model and model year as your vehicle. Fix them securely in place onto the carpet.

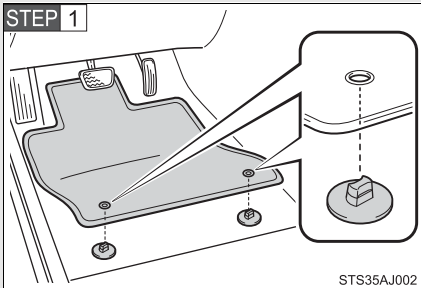

Insert the retaining hooks (clips) into the floor mat eyelets.

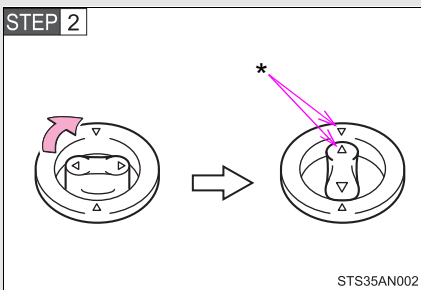

Turn the upper knob of each retaining hook (clip) to secure the floor mats in place.

\*: Always align the  $\triangle$  marks.

The shape of the retaining hooks (clips) may differ from that shown in the illustration.

## ⚠ CAUTION

Observe the following precautions.

Failure to do so may cause the driver's floor mat to slip, possibly interfering with the pedals while driving. An unexpectedly high speed may result or it may become difficult to stop the vehicle, leading to a serious accident.

### ■ When installing the driver's floor mat

- Do not use floor mats designed for other models or different model year vehicles, even if they are Toyota Genuine floor mats.
- Only use floor mats designed for the driver's seat.
- Always install the floor mat securely using the retaining hooks (clips) provided.
- Do not use two or more floor mats on top of each other.
- Do not place the floor mat bottom-side up or upside-down.

### ■ Before driving

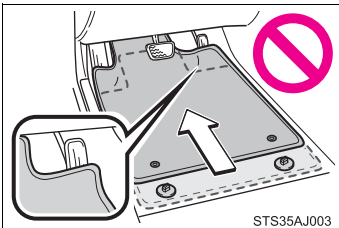

- Check that the floor mat is securely fixed in the correct place with all the provided retaining hooks (clips). Be especially careful to perform this check after cleaning the floor.
- With the engine stopped and the shift lever in P (automatic transmission) or N (manual transmission), fully depress each pedal to the floor to make sure it does not interfere with the floor mat.

### 3-5. Other interior features

## Luggage compartment features

#### ► Behind the rear seat (Double Cab models only)

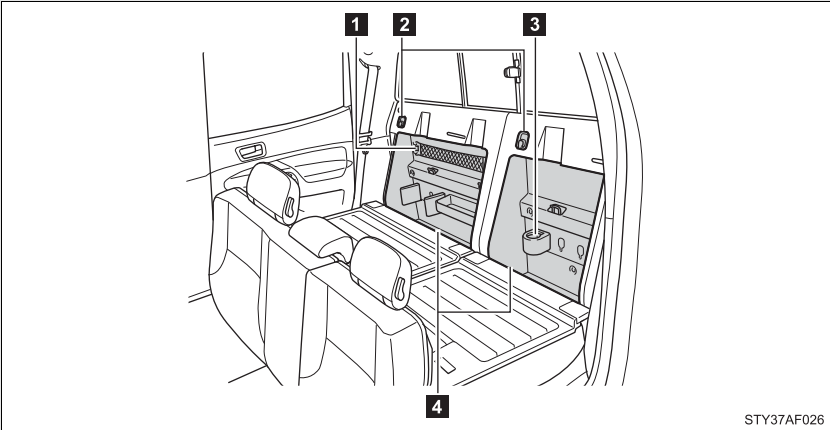

**1** Cargo net hooks (vehicles with sub woofer)

**2** Grocery bag hooks

**3** Flashlight holder

**4** Storage boxes

#### ► Deck

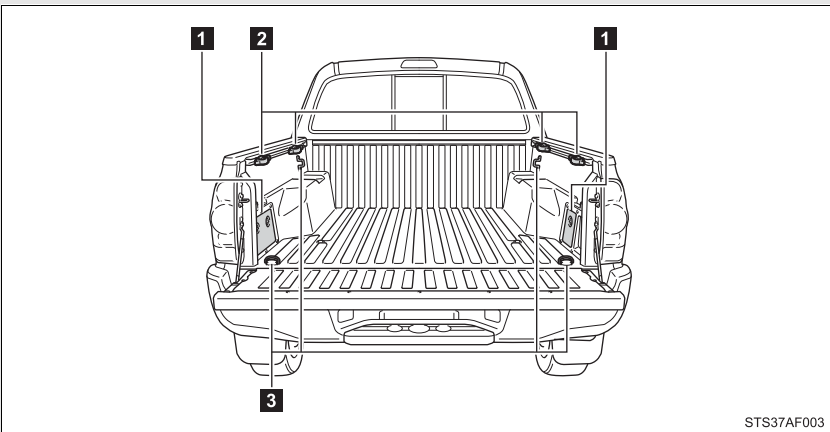

**1** Auxiliary boxes

**2** Tie-down cleats

**3** Deck hooks

## Auxiliary boxes

### ► Left side

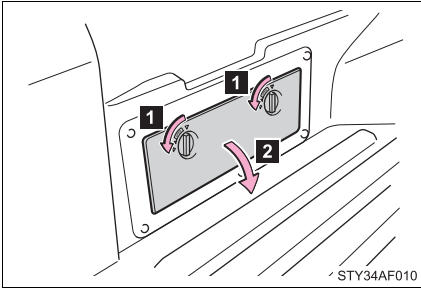

- 1** Turn the knob counterclockwise.
- 2** Open the lid.

### ► Right side (vehicles without 120V power outlet)

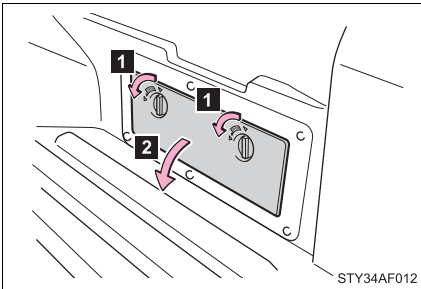

- 1** Turn the knob counterclockwise.
- 2** Open the lid.

### ► Right side (vehicles with 120V power outlet)

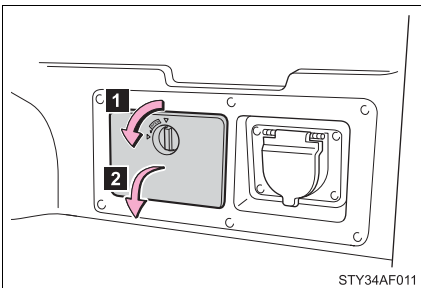

- 1** Turn the knob counterclockwise.
- 2** Open the lid.

**⚠ CAUTION**

**■ Caution while driving**

Keep the auxiliary boxes closed and locked.  
Injuries may result in the event of an accident or sudden braking.

**Deck hooks**

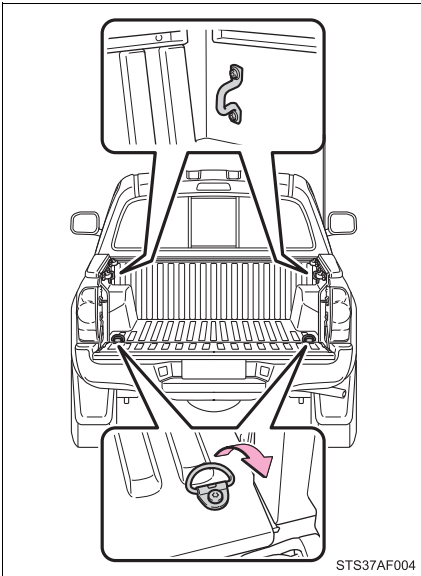

Deck hooks are provided for securing loose items.

**⚠ CAUTION**

**■ When not in use**

Keep the deck hooks folded.

## Tie-down cleats

The deck rail system enables you to insert and move tie-down cleats to their best location along deck rails to secure a load.

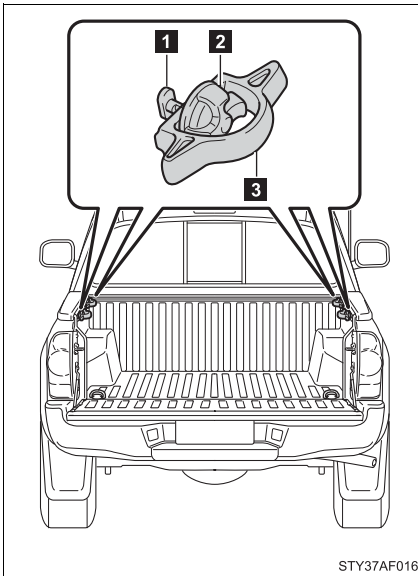

- 1** Locking plate
- 2** Thumb wheel
- 3** Tie-down cleat

### ■ Installing the tie-down cleat

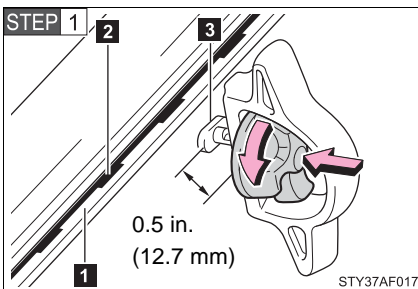

Loosen the thumb wheel in a counterclockwise motion, and depress the wheel so that the locking plate maintains 0.5 in. (12.7 mm) gap.

- 1** Deck rail
- 2** Detent
- 3** Locking plate

### 3-5. Other interior features

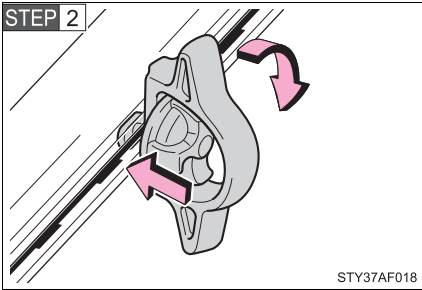

Insert the locking plate into the deck rail, rotate the tie-down cleat 90°, and release the thumb wheel.

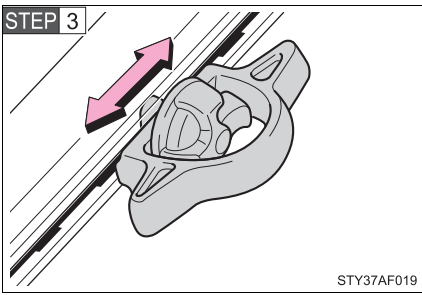

Slide the cleat to the closest detent in the rail system. You will feel that the locking plate snaps into a detent.

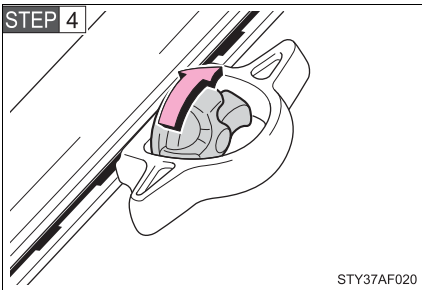

Tighten the thumb wheel in a clockwise motion until the clutch mechanism ratchets.

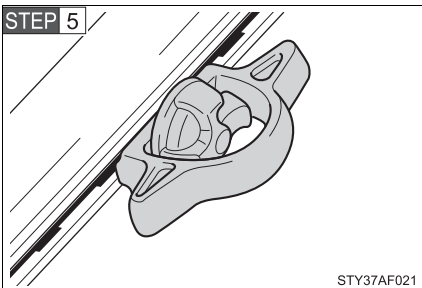

Check the tie-down cleat to confirm that it is locked into a detent and securely mounted to the deck rail system.



**⚠ CAUTION****■ Tie-down cleat precautions**

- Properly install and tighten the tie-down cleats into the deck rail system. Failure to properly install and tighten the tie-down cleats can cause cargo to become unsecured. Unsecured cargo can cause injury when the vehicle is in motion.
- Properly secure all cargo to prevent shifting or sliding during driving. Failure to properly secure cargo can cause injury when the vehicle is in motion.
- Applying loads at an angle to the tie-down cleat greater than 45° or loads greater than 220 lb. (100 kg) may cause damage to the deck, deck rail system, tie-down cleat and/or the cargo.
- Do not exceed a total tensile load of 440 lb. (200 kg) per deck rail.
- Do not install more than the following number of tie-down cleats per deck rail:
  - Side rail:
    - Short deck—Max. 3 locations
    - Long deck—Max. 4 locations
  - Headboard rail: Max. 3 locations

**Storage boxes (Double Cab models only)**

Storage box is designed to place things like bottles.

- ▶ Right side (vehicles without sub woofer)

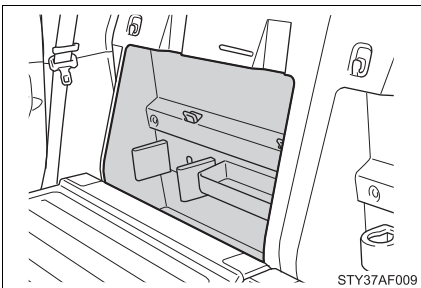

► Left side

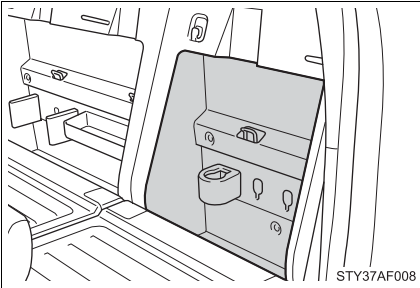

■ Removing the separator

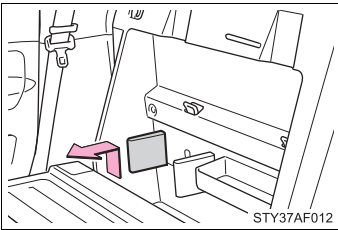

Remove the separator.  
It can be installed in various positions as required.

**Flashlight holder (Double Cab models only)**

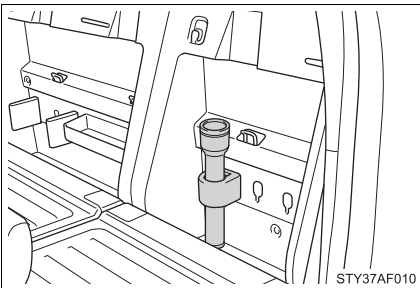

Flashlight holder is designed to hold the flashlight securely.

### ■ Removing the flashlight holder

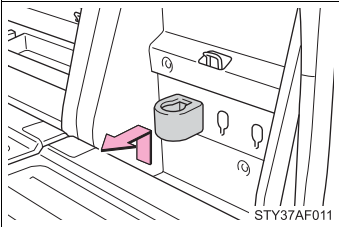

Remove the flashlight holder. It can be installed in various positions as required.

### Grocery bag hooks (Double Cab models only)

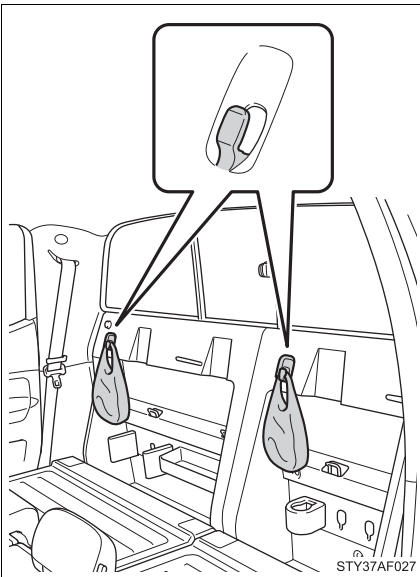

Grocery bag hook is designed to hang things like grocery bag.

#### NOTICE

#### ■ Grocery bag hook weight capacity

Do not hang any object heavier than 7 lb. (3 kg) on the grocery bag hooks.

**Cargo net hooks (Double Cab models with sub woofer)**

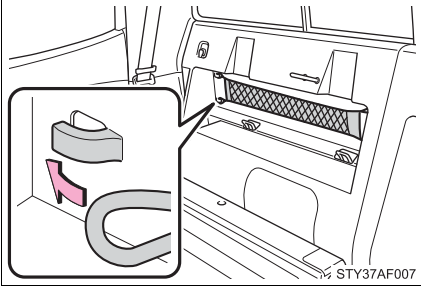

Cargo net hooks are designed to hang the factory-supplied cargo net.

**⚠ NOTICE**

- **To prevent damage to the cargo net hook.**  
Do not hang items other than the cargo net.

### 3-5. Other interior features

## Garage door opener\*

The garage door opener can be trained to operate garage doors, gates, entry doors, door locks, home lighting systems, security systems, and other devices.

The garage door opener (HomeLink® Universal Transceiver) is manufactured under license from HomeLink®.

### Training the HomeLink® (for U.S. owners)

The HomeLink® compatible transceiver in your vehicle has 3 buttons which can be trained to operate 3 different devices. Refer to the training method below appropriate for the device.

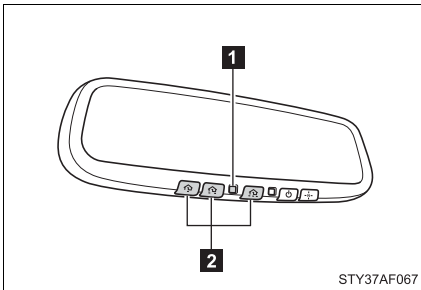

**1** Indicator light

**2** Buttons

\*: If equipped

## ■ Training the HomeLink®

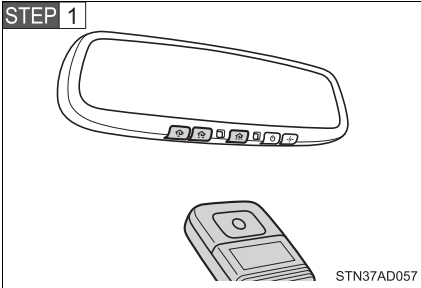

Point the remote control transmitter for the device 1 to 3 in. (25 to 75 mm) from the HomeLink® control buttons.

Keep the indicator on the HomeLink® in view while training.

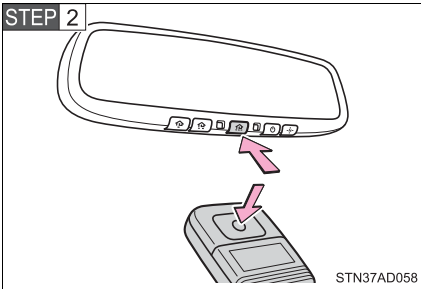

Press and hold down one of the buttons on the HomeLink® and the button on the transmitter. When the indicator on the HomeLink® changes from a slow to a rapid flash, you can release both buttons.

If the HomeLink® indicator comes on but does not flash, or flashes rapidly for 2 seconds and remains lit, the HomeLink® button is already trained. Use the other buttons or follow the “Retraining a HomeLink® button” instructions. (→P. 378)

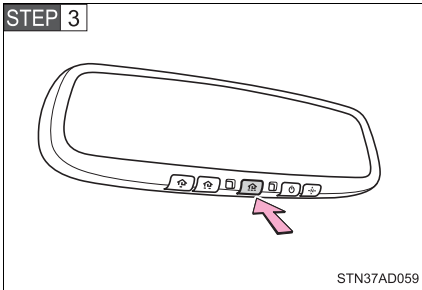

Test the operation of the HomeLink® by pressing the newly trained button.

If training a garage door opener, check to see if the garage door opens and closes. If the garage door does not operate, see if your garage transmitter is of the Rolling Code type. Press and hold the trained HomeLink® button. The garage door has the rolling code feature if the indicator (on the HomeLink®) flashes rapidly for 2 seconds and then remains lit. If your transmitter is the Rolling Code type, proceed to the heading “Training a rolling code system”.

**STEP 4** Repeat the steps above to train another device for each of the remaining HomeLink® buttons.

### ■ Training a Rolling Code system (for U.S. owners)

If your device is Rolling Code equipped, follow the steps under the heading “Training the HomeLink®” before proceeding with the steps listed below.

**STEP 1** Locate the learn button on the ceiling mounted garage door opener motor. The exact location and color of the button may vary by brand of garage door opener.

Refer to the operation manual supplied with the garage door opener for the location of the learning button.

**STEP 2** Press the learning button.

Following this step, you have 30 seconds in which to initiate step 3 below.

**STEP 3** Press and hold the vehicle’s trained HomeLink® button for 2 seconds and release it. Repeat this step once again. The garage door may open.

If the garage door opens, the training process is complete. If the door does not open, press and release the button a third time. This third press and release will complete the training process by opening the garage door.

The ceiling mounted garage door opener motor should now recognize the HomeLink® transceiver and operate the garage door.

**STEP 4** Repeat the steps above to train another rolling code system for any of the remaining HomeLink® buttons.



### ■ Training an entry gate (for U.S. owners)/Training a device in the Canadian market

**STEP 1** Place the remote control transmitter 1 to 3 in. (25 to 75 mm) away from the HomeLink<sup>®</sup> buttons

Keep the HomeLink<sup>®</sup> indicator light in view while training.

**STEP 2** Press and hold the selected HomeLink<sup>®</sup> button.

**STEP 3** Repeatedly press and release (cycle) one of the buttons on the remote control transmitter for 2 seconds at a time until

**STEP 4** is completed.

**STEP 4** When the HomeLink<sup>®</sup> indicator light starts to flash rapidly, release the buttons on the HomeLink<sup>®</sup>.

**STEP 5** Test the HomeLink<sup>®</sup> operation by pressing the newly trained button. Check to see if the gate/device operates correctly.

**STEP 6** Repeat the steps above to train another device for any of the remaining HomeLink<sup>®</sup> buttons.

### ■ Training other devices

To train other devices such as home security systems, home door locks and lighting, contact your Toyota dealer for assistance.

### ■ Retraining a button

The individual HomeLink<sup>®</sup> buttons cannot be erased but can be retrained. To retrain a button, follow the “Retraining a HomeLink<sup>®</sup> button” instructions.

### Operating HomeLink®

Press the appropriate HomeLink® button. The HomeLink® indicator light should come on.

The HomeLink® compatible transceiver in your vehicle continues to send a signal for up to 20 seconds as long as the button is pressed.

### Retraining a HomeLink® button

Press and hold the desired HomeLink® button. After 20 seconds, the HomeLink® indicator light will start flashing slowly. Keep pressing the HomeLink® button and then follow the “Training the HomeLink® (for U.S. owners)” instructions. (→P. 373)

### Erasing the entire HomeLink® memory (all three programs)

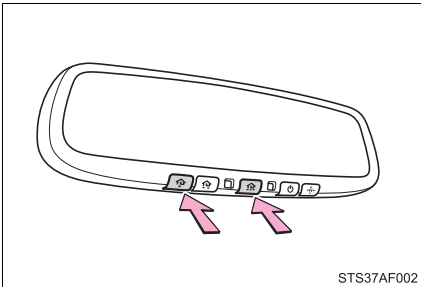

Press and hold down the 2 outside buttons for 10 seconds until the indicator flashes.

If you sell your vehicle, be sure to erase the programs stored in the HomeLink® memory.

---

### ■ Before training

- Install a new battery in the remote control transmitter.
- The battery side of the remote control transmitter must be pointed away from the HomeLink® button.

### ■ Certification for the garage door opener

- ▶ For vehicles sold in the U.S.A.

FCC ID: NZLWZLHL4

#### NOTE:

This device complies with part 15 of the FCC Rules.

Operation is subject to the following two conditions: (1) This device may not cause harmful interference, and (2) this device must accept any interference received, including interference that may cause undesired operation.

#### FCC WARNING:

Changes or modifications not expressly approved by the party responsible for compliance could void the user's authority to operate the equipment.

- ▶ For vehicles sold in Canada

#### NOTE:

This device complies with Industry Canada licence-exempt RSS standard(s). Operation is subject to the following two conditions: (1) this device may not cause interference, and (2) this device must accept any interference, including interference that may cause undesired operation of the device.

### ■ When support is necessary

Visit on the web at [www.homelink.com](http://www.homelink.com) or call 1-800-355-3515.

 **CAUTION**

■ **When training a garage door or other remote control devices**

The garage door or other devices may operate, so ensure people and objects are out of danger to prevent potential harm.

■ **Conforming to federal safety standards**

Do not use the HomeLink<sup>®</sup> compatible transceiver with any garage door opener or device that lacks safety stop and reverse features as required by federal safety standards.

This includes any garage door that cannot detect an interfering object. A door or device without these features increases the risk of death or serious injury.

### 3-5. Other interior features

## Compass (vehicles with auto anti-glare inside rear view mirror)

The compass on the inside rear view mirror indicates the direction in which the vehicle is heading.

### ■ Operation

#### ▶ Type A

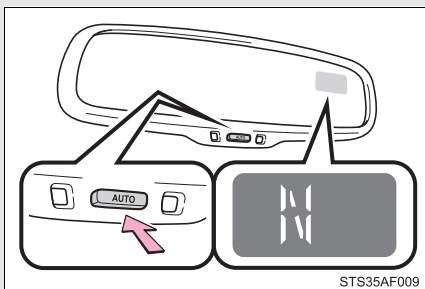

To turn the compass on or off, press the button.

#### ▶ Type B

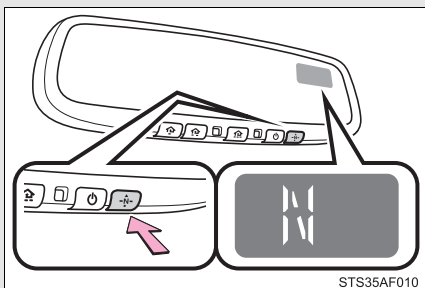

■ **Displays and directions**

Display	Direction
N	North
NE	Northeast
E	East
SE	Southeast
S	South
SW	Southwest
W	West
NW	Northwest

## Calibrating the compass

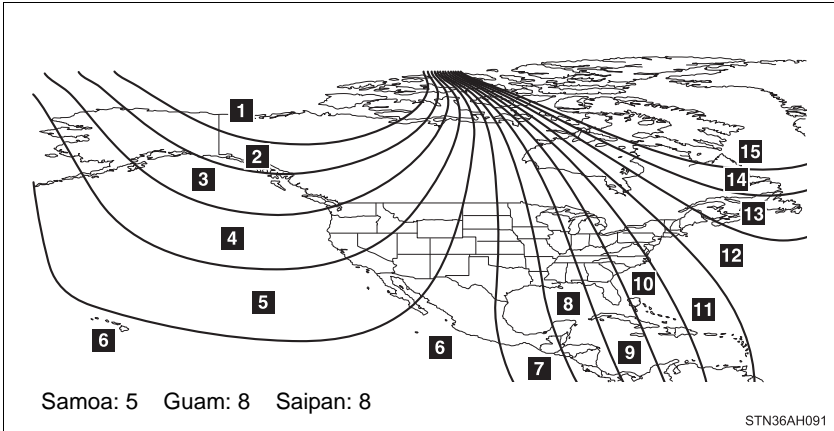

The direction display deviates from the true direction determined by the earth's magnetic field. The amount of deviation varies depending on the geographic position of the vehicle.

If you cross over one of the map boundaries shown in the illustration, the compass will deviate.

To obtain higher precision or perfect calibration, refer to "Deviation calibration".

### ■ Deviation calibration

**STEP 1** Stop the vehicle where it is safe to drive in a circle.

**STEP 2** Press the button until a number (1 to 15) appears on the compass display.

► Type A

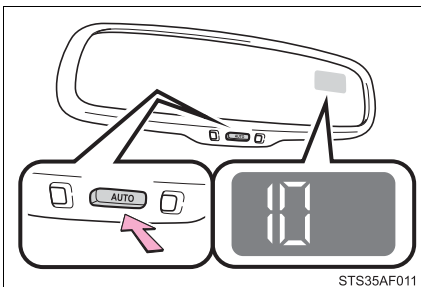

► Type B

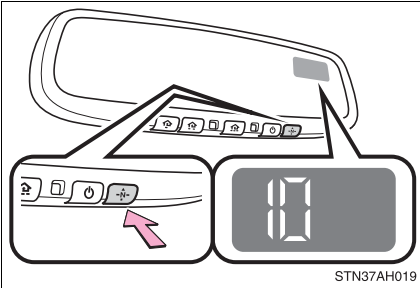

**STEP 3** Press the button, and referring to the map above, select the number of the zone where you are.

If the direction is displayed several seconds after adjustment, the calibration is complete.

■ **Circling calibration**

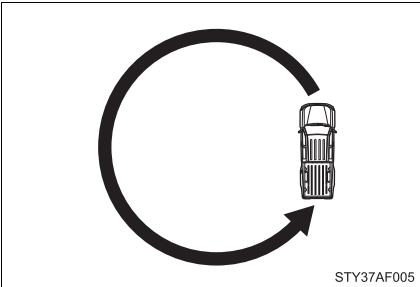

When “C” appears on the display, drive the vehicle at 5 mph (8 km/h) or less in a circle until a direction is displayed.

If there is not enough space to drive in a circle, drive around the block until the direction is displayed.



### ■ Conditions unfavorable to correct operation

The compass may not show the correct direction in the following conditions:

- The vehicle is stopped immediately after turning.
- The vehicle is on an inclined surface.
- The vehicle is in a place where the earth's magnetic field is subject to interference by artificial magnetic fields (underground car park/parking lot, under a steel tower, between buildings, roof car park/parking lot, near an intersection, near a large vehicle, etc.).
- The vehicle has become magnetized.  
(There is a magnet or metal object near the inside rear view mirror.)
- The battery has been disconnected.
- A door is open.

### CAUTION

#### ■ While driving the vehicle

Do not adjust the display. Adjust the display only when the vehicle is stopped.

#### ■ When doing the circling calibration

Secure a wide space, and watch out for people and vehicles in the vicinity. Do not violate any local traffic rules while performing circling calibration.

### NOTICE

#### ■ To avoid the compass malfunctions

Do not place magnets or any metal objects near the inside rear view mirror. Doing this may cause the compass sensor to malfunction.

#### ■ When doing the circling calibration

- Do not perform a circling calibration of the compass in a place where the earth's magnetic field is subject to interference by artificial magnetic fields.
- During calibration, do not operate electric systems (power windows, etc.) as they may interfere with the calibration.



**4-1. Maintenance and care**

Cleaning and protecting  
the vehicle exterior..... 388

Cleaning and protecting  
the vehicle interior..... 391

**4-2. Maintenance**

Maintenance  
requirements..... 394

General maintenance..... 396

Emission inspection and  
maintenance (I/M)  
programs ..... 399

**4-3. Do-it-yourself maintenance**

Do-it-yourself service  
precautions ..... 400

Hood ..... 404

Engine compartment..... 406

Tires ..... 422

Tire inflation pressure ..... 431

Wheels ..... 436

Air conditioning filter..... 439

Wireless remote control  
battery ..... 442

Checking and replacing  
fuses ..... 444

Light bulbs..... 454

## Cleaning and protecting the vehicle exterior

**Perform the following to protect the vehicle and maintain it in prime condition.**

- Working from top to bottom, liberally apply water to the vehicle body, wheel wells and underside of the vehicle to remove any dirt and dust.

Wash the vehicle body using a sponge or soft cloth, such as a chamois.

- For hard-to-remove marks, use car wash soap and rinse thoroughly with water.
- Wipe away any water.
- Wax the vehicle when the waterproof coating deteriorates.

If water does not bead on a clean surface, apply wax when the vehicle body is cool.

---

### ■ Automatic car washes

- Fold the mirrors and remove the detachable pole antenna before washing the vehicle. Start washing from the front of the vehicle. Make sure to re-install the detachable pole antenna and extend the mirrors before driving.
- Brushes used in automatic car washes may scratch the vehicle surface and harm your vehicle's paint.
- In certain automatic car washes, the roof antenna (if equipped) may interfere with machine operation. This may prevent the vehicle from being cleaned properly or result in damage to the roof antenna.

### ■ High pressure car washes

Do not allow the nozzles of the car wash to come within close proximity of the windows. Before entering an automatic car wash, check that the fuel filler door on your vehicle is closed properly.

### ■ Aluminum or chrome cladded wheels (if equipped)

- Remove any dirt immediately by using a neutral detergent. Do not use hard brushes or abrasive cleaners. Do not use strong or harsh chemical cleaners. Use the same mild detergent and wax as used on the paint.
- Do not use detergent on the wheels when they are hot, for example after driving for long distance in the hot weather.
- Wash detergent from the wheels immediately after use.

### ■ Bumpers and side moldings

Do not scrub with abrasive cleaners.

#### CAUTION

##### ■ Caution about the exhaust pipe

Exhaust gasses cause the exhaust pipe to become quite hot.

When washing the vehicle, be careful not to touch the pipe until it has cooled sufficiently, as touching a hot exhaust pipe can cause burns.

#### NOTICE

##### ■ To prevent paint deterioration and corrosion on the body and components (aluminum or chrome cladded wheels etc.)

- Wash the vehicle immediately in the following cases:
  - After driving near the sea coast
  - After driving on salted roads
  - If you see coal tar or tree sap on the paint surface
  - If you see dead insects, insect droppings or bird droppings on the paint
  - After driving in an area contaminated with soot, oily smoke, mine dust, iron powder or chemical substances
  - If the vehicle becomes heavily soiled in dust or mud
  - If liquids such as benzene and gasoline are spilled on the paint surface
- If the paint is chipped or scratched, have it repaired immediately.
- To prevent the wheels from corroding, remove any dirt and store in a place with low humidity when storing the wheels.

 NOTICE

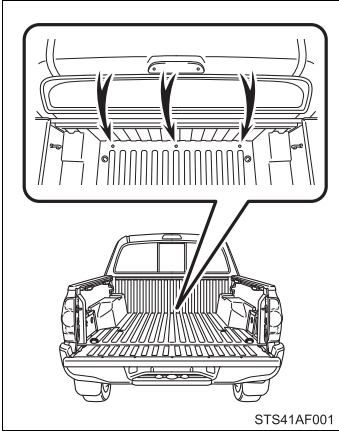

- Clean the drainage hole of the deck regularly.  
If the drainage hole is stopped up, the water will not be able to flow, and it will cause rust.

■ **Cleaning the exterior lights**

- Wash carefully. Do not use organic substances or scrub with a hard brush. This may damage the surfaces of the lights.
- Do not apply wax on the surfaces of the lights. Wax may cause damage to the lenses.

■ **Detachable pole antenna installation and removal precautions**

- Before driving, ensure that the antenna is installed.
- When the antenna is removed, such as before entering an automatic car wash, make sure to store it in a suitable place so as not to lose it. Also, before driving, make sure to reinstall the antenna in its original position.

**The following procedures will help protect your vehicle's interior and keep it in top condition:**

### ■ Protecting the vehicle interior

Remove dirt and dust using a vacuum cleaner. Wipe dirty surfaces with a cloth dampened with lukewarm water.

### ■ Cleaning the leather areas

- Remove dirt and dust using a vacuum cleaner.
- Wipe any excess dirt and dust with a soft cloth dampened with diluted detergent.

Use a diluted water solution of approximately 5% neutral wool detergent.

- Wring out any excess water from the cloth and thoroughly wipe off all remaining traces of detergent.
- Wipe the surface with a dry, soft cloth to remove any remaining moisture. Allow the leather to dry in a shaded and ventilated area.

### ■ Synthetic leather areas

- Remove loose dirt using a vacuum cleaner.
- Apply a mild soap solution to the synthetic leather using a sponge or soft cloth.
- Allow the solution to soak in for a few minutes. Remove the dirt and wipe off the solution with a clean, damp cloth.

### ■ Caring for leather areas

Toyota recommends cleaning the interior of the vehicle at least twice a year to maintain the quality of the vehicle's interior.

### ■ Shampooing the carpets

There are several commercial foaming-type cleaners available. Use a sponge or brush to apply the foam. Rub in overlapping circles. Do not apply water. The excellent results are obtained when keeping the carpet as dry as possible.

### ■ Seat belts

Clean with mild soap and lukewarm water using a cloth or sponge. Also check the belts periodically for excessive wear, fraying or cuts.

## CAUTION

### ■ Water in the vehicle

- Do not splash or spill liquid in the vehicle.

Doing so may cause the electrical components etc. to malfunction or catch fire.

- Do not get any of the SRS components or wiring in the vehicle interior wet. (→P. 83)

Electrical malfunction may cause the airbags to deploy or not function properly, resulting in death or severe injury.

### ■ Cleaning the interior (especially instrument panel)

Do not use polish wax or polish cleaner. The instrument panel may reflect off the windshield, obstructing the driver's view and leading to an accident, resulting in death or serious injury.



**NOTICE****■ Cleaning detergents**

- Do not use organic substances such as benzene or gasoline, acidic or alkaline solutions, dye, bleach or other detergent. Doing so may discolor the vehicle interior or cause streaks or damage to painted surfaces.
- Do not use polish wax or polish cleaner. The instrument panel's or other interior part's painted surface may be damaged.

**■ Preventing damage to leather surfaces**

Observe the following precautions to avoid damage to and deterioration of leather surfaces.

- Remove any dust or dirt on leather surfaces immediately.
- Do not expose the vehicle to direct sunlight for extended periods of time. Park the vehicle in the shade, especially during summer.
- Do not place items made of vinyl, plastic, or that contain wax on the upholstery, as they may stick to the leather surface if the vehicle interior heats up significantly.

**■ Water on the floor**

Do not wash the vehicle floor with water.

Vehicle systems such as the audio system may be damaged if water comes into contact with electrical components under the floor of the vehicle, and may also cause the body to rust.

## Maintenance requirements

**To ensure safe and economical driving, day-to-day care and regular maintenance is essential. It is the owner's responsibility to perform regular checks. Toyota recommends the following maintenance.**

### ■ General maintenance

Should be performed on a daily basis. This can be done by yourself or by a Toyota dealer.

### ■ Scheduled maintenance

Should be performed at specified intervals according to the maintenance schedule.

For details about maintenance items and schedules, refer to the "Scheduled Maintenance Guide" or "Owner's Manual Supplement".

### ■ Do-it-yourself maintenance

You can perform some maintenance procedures yourself. Please be aware that do-it-yourself maintenance may affect warranty coverage.

The use of Toyota Repair Manuals is recommended.

For details about warranty coverage, see the separate "Owner's Warranty Information Booklet", "Owner's Manual Supplement".

---

### ■ Repair and replacement

It is recommended that genuine Toyota parts be used for repair to ensure performance of each system. If non-Toyota parts are used in replacement or if a repair shop other than Toyota dealer performs repairs, confirm the warranty coverage.

### ■ Resetting the maintenance required reminder light (U.S.A. only)

After the required maintenance is performed according to the maintenance schedule, please reset the reminder light.

To reset the data, follow the procedures described below:

- STEP 1** Switch the display to the trip meter A when the engine is running. (→P. 145)
- STEP 2** Turn the engine switch to the LOCK position.
- STEP 3** While pressing the ODO/TRIP button (→P. 145), turn the engine switch to the ON position. Continue to press and hold the button until the odometer displays 000000.

If the system fails to reset, the light will continue flashing.

### ■ Allow inspection and repairs to be performed by a Toyota dealer

- Toyota technicians are well-trained specialists and are kept up to date with the latest service information. They are well informed about the operations of all systems on your vehicle.
- Keep a copy of the repair order. It proves that the maintenance that has been performed is under warranty coverage. If any problem should arise while your vehicle is under warranty, your Toyota dealer will promptly take care of it.

### CAUTION

#### ■ Warning in handling of battery

- Engine exhaust, some of its constituents, and a wide variety of automobile components contain or emit chemicals known to the State of California to cause cancer and birth defects and other reproductive harm. Work in a well ventilated area.
- Oils, fuels and fluids contained in vehicles as well as waste produced by component wear contain or emit chemicals known to the State of California to cause cancer and birth defects or other reproductive harm. Avoid exposure and wash any affected area immediately.
- Battery posts, terminals and related accessories contain lead and lead compounds which are known to cause brain damage. Wash your hands after handling. (→P. 418)

## General maintenance

Listed below are the general maintenance items that should be performed at the intervals specified in the “Scheduled Maintenance Guide” or “Owner’s Manual Supplement”. It is recommended that any problem you notice should be brought to the attention of your Toyota dealer or qualified service shop for advice.

### Engine compartment

Items	Check points
Battery	Maintenance-free. (→P. 418)
Brake fluid	At the correct level? (→P. 414)
Engine coolant	At the correct level? (→P. 412)
Engine oil	At the correct level? (→P. 408)
Exhaust system	No fumes or strange sounds?
Power steering fluid	At the correct level? (→P. 416)
Radiator/condenser/hoses	Not blocked with foreign matter? (→P. 414)
Washer fluid	At the correct level? (→P. 420)

<b>Vehicle interior</b>
-------------------------

Items	Check points
Accelerator pedal	<ul style="list-style-type: none"> <li>• Moves smoothly (without uneven pedal effort or catching)?</li> </ul>
Automatic transmission “Park” mechanism	<ul style="list-style-type: none"> <li>• Can the vehicle be held securely on an incline with the shift lever in P?</li> </ul>
Brake pedal	<ul style="list-style-type: none"> <li>• Moves smoothly?</li> <li>• Does it have appropriate clearance and correct amount of free play?</li> </ul>
Brakes	<ul style="list-style-type: none"> <li>• Not pull to one side when applied?</li> <li>• Loss of brake effectiveness?</li> <li>• Spongy feeling brake pedal?</li> <li>• Pedal almost touches floor?</li> </ul>
Clutch pedal	<ul style="list-style-type: none"> <li>• Moves smoothly?</li> <li>• Does it have correct amount of free play?</li> </ul>
Head restraints	<ul style="list-style-type: none"> <li>• Move smoothly and lock securely?</li> </ul>
Indicators/buzzers	<ul style="list-style-type: none"> <li>• Function properly?</li> </ul>
Lights	<ul style="list-style-type: none"> <li>• Do all the lights come on?</li> <li>• Headlights aimed correctly?</li> </ul>
Parking brake	<ul style="list-style-type: none"> <li>• Moves smoothly?</li> <li>• Can hold the vehicle securely on an incline?</li> </ul>
Seat belts	<ul style="list-style-type: none"> <li>• Does the seat belt system operate smoothly?</li> <li>• Are the belts undamaged?</li> </ul>
Seats	<ul style="list-style-type: none"> <li>• Do the seat controls operate properly?</li> </ul>

Items	Check points
Steering wheel	<ul style="list-style-type: none"> <li>• Moves smoothly?</li> <li>• Has correct free play?</li> <li>• No strange noises?</li> </ul>

### Vehicle exterior

Items	Check points
Doors	<ul style="list-style-type: none"> <li>• Operate smoothly?</li> </ul>
Engine hood	<ul style="list-style-type: none"> <li>• The lock system works properly?</li> </ul>
Fluid leaks	<ul style="list-style-type: none"> <li>• Is there any leakage after parking?</li> </ul>
Tire	<ul style="list-style-type: none"> <li>• Inflation pressure is correct?</li> <li>• Tire surfaces not worn or damaged?</li> <li>• Tires rotated according to the maintenance schedule?</li> <li>• Wheel nuts are not loose?</li> </ul>
Windshield wipers	<ul style="list-style-type: none"> <li>• The wiper blades should not show any signs of cracking, splitting, wear, contamination or deformation.</li> <li>• The wiper blades should clear the windshield without streaking or skipping.</li> </ul>

### CAUTION

#### If the engine is running

Turn the engine off and ensure that there is adequate ventilation before performing maintenance checks.

**Some states have vehicle emission inspection programs which include OBD (On Board Diagnostics) checks. The OBD system monitors the operation of the emission control system.**

■ **If the malfunction indicator lamp comes on**

The OBD system determines that a problem exists somewhere in the emission control system. Your vehicle may not pass the I/M test and may need to be repaired. Contact your Toyota dealer to service the vehicle.

■ **Your vehicle may not pass the I/M test:**

- When the battery is disconnected or discharged

Readiness codes that are set during ordinary driving are erased.

Also, depending on your driving habits, the readiness codes may not be completely set.

- When the fuel tank cap is loose

The malfunction indicator lamp comes on as a temporary malfunction and your vehicle may not pass the I/M test.

■ **When the malfunction indicator lamp goes off after several driving trips**

The error code in the OBD system will not be cleared unless the vehicle is driven 40 or more times.

■ **If your vehicle does not pass the I/M test**

Contact your Toyota dealer to prepare the vehicle for re-testing.

## Do-it-yourself service precautions

**If you perform maintenance yourself, be sure to follow the correct procedures as given in these sections.**

Items	Parts and tools
Battery condition (→P. 418)	<ul style="list-style-type: none"> <li>• Warm water</li> <li>• Baking soda</li> <li>• Grease</li> <li>• Conventional wrench (for terminal clamp bolts)</li> </ul>
Brake fluid level (→P. 414)	<ul style="list-style-type: none"> <li>• FMVSS No.116 DOT 3 or SAE J1703 brake fluid</li> <li>• Rag or paper towel</li> </ul>
Engine coolant level (→P. 412)	<ul style="list-style-type: none"> <li>• “Toyota Super Long Life Coolant” or similar high quality ethylene glycol based non-silicate, non-amine, non-nitrite and non-borate coolant with long-life hybrid organic acid technology.</li> </ul> <p>U.S.A.:</p> <p>“Toyota Super Long Life Coolant” is pre-mixed with 50% coolant and 50% deionized water.</p> <p>Canada:</p> <p>“Toyota Super Long Life Coolant” is pre-mixed with 55% coolant and 45% deionized water.</p>
Engine oil level (→P. 408)	<ul style="list-style-type: none"> <li>• Toyota Genuine Motor Oil or equivalent</li> <li>• Rag or paper towel</li> <li>• Funnel (used only for adding oil)</li> </ul>
Fuses (→P. 444)	<ul style="list-style-type: none"> <li>• Fuse with same amperage rating as original</li> </ul>



Items	Parts and tools
Light bulbs (→P. 454)	<ul style="list-style-type: none"> <li>• Bulb with same number and wattage rating as original</li> <li>• Phillips-head screwdriver</li> <li>• Conventional wrench</li> </ul>
Power steering fluid level (→P. 416)	<ul style="list-style-type: none"> <li>• Automatic transmission fluid DEXRON® II or III</li> <li>• Rag or paper towel</li> </ul>
Radiator and condenser (→P. 414)	—
Tire inflation pressure (→P. 431)	<ul style="list-style-type: none"> <li>• Tire pressure gauge</li> <li>• Compressed air source</li> </ul>
Washer fluid (→P. 420)	<ul style="list-style-type: none"> <li>• Washer fluid containing antifreeze (for winter use)</li> <li>• Water</li> </ul>

 **CAUTION**

The engine compartment contains many mechanisms and fluids that may move suddenly, become hot, or become electrically energized. To avoid death or serious injury observe the following precautions.

■ **When working on the engine compartment**

- Keep hands, clothing, and tools away from the moving fan and engine drive belt.
- Be careful not to touch the engine, radiator, exhaust manifold, etc. right after driving as they may be hot. Oil and other fluids may also be hot.
- Do not leave anything that may burn easily, such as paper or rags, in the engine compartment.
- Do not smoke, cause sparks or expose an open flame to fuel or the battery. Fuel and battery fumes are flammable.
- Be extremely cautious when working on the battery. It contains poisonous and corrosive sulfuric acid.
- Take care because brake fluid can harm your hands or eyes and damage painted surfaces.  
If fluid gets on your hands or in your eyes, flush the affected area with clean water immediately.

If you still experience discomfort, see a doctor.

■ **When working near the cooling fan or radiator grille**

Be sure the engine switch is off.

With the engine switch on, the cooling fan may automatically start to run if the air conditioning is on and/or the coolant temperature is high.

■ **Safety glasses**

Wear safety glasses to prevent flying or falling material, fluid spray, etc. from getting in the eyes.

**NOTICE****■ If you remove the air cleaner**

Driving with the air cleaner removed may cause excessive engine wear due to dirt in the air.

**■ If the fluid level is low or high**

It is normal for the brake fluid level to go down slightly as the brake pads wear or when the fluid level in the accumulator is high.

If the reservoir needs frequent refilling, it may indicate a serious problem.

## 4-3. Do-it-yourself maintenance

### Hood

**Release the lock from the inside of the vehicle to open the hood.**

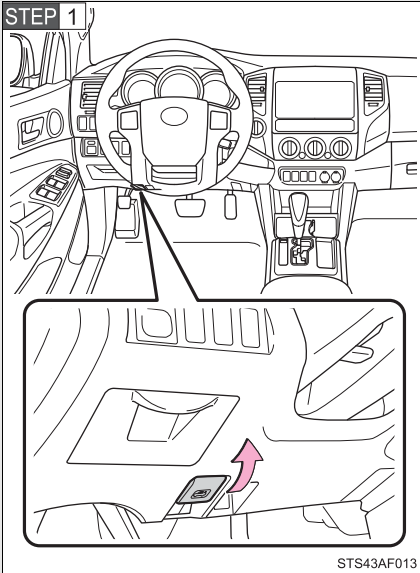

Pull the hood release lever.

The hood will pop up slightly.

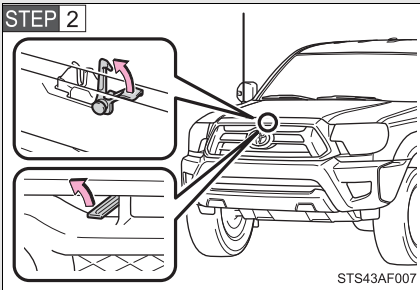

Pull up the hood catch lever and lift the hood.

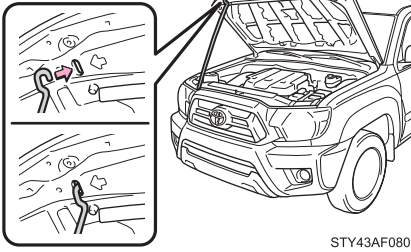
**STEP 3**

Hold the hood open by inserting the supporting rod into the slot.

**⚠ CAUTION**

■ **Pre-driving check**

Check that the hood is fully closed and locked.

If the hood is not locked properly, it may open while the vehicle is in motion and cause an accident, which may result in death or serious injury.

■ **After installing the support rod into the slot**

Make sure the rod supports the hood securely from falling down on to your head or body.

**⚠ NOTICE**

■ **When closing the hood**

Be sure to return the support rod to its clip before closing the hood. Closing the hood with the support rod up could cause the hood to bend.

## 4-3. Do-it-yourself maintenance

### Engine compartment

#### ► 2.7 L 4-cylinder (2TR-FE) engine

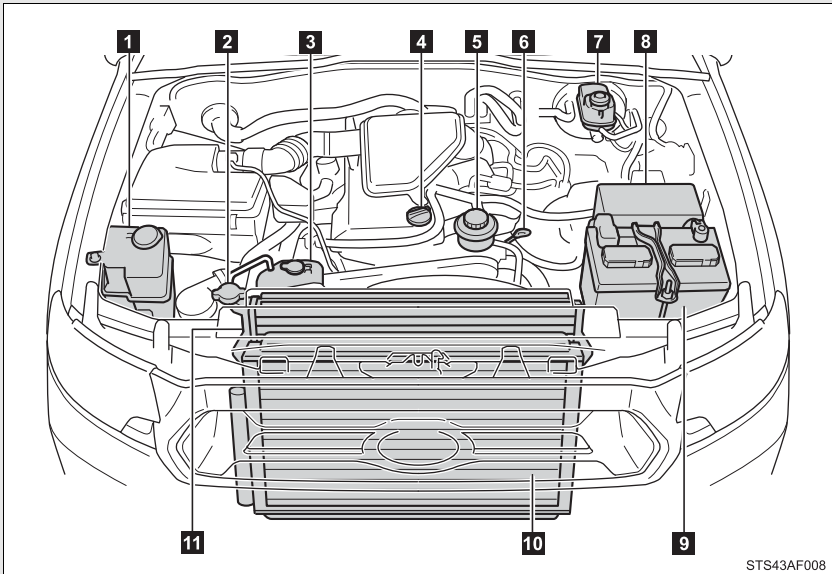

STS43AF008

- |   |  |
|---|--|
| <b>1</b> Washer fluid tank (→P. 420)              | <b>6</b> Engine oil level dipstick (→P. 408) |
| <b>2</b> Radiator cap                             | <b>7</b> Brake fluid reservoir (→P. 414)     |
| <b>3</b> Engine coolant reservoir (→P. 412)       | <b>8</b> Fuse box (→P. 444)                  |
| <b>4</b> Engine oil filler cap (→P. 409)          | <b>9</b> Battery (→P. 418)                   |
| <b>5</b> Power steering fluid reservoir (→P. 416) | <b>10</b> Condenser (→P. 414)                |
|   | <b>11</b> Radiator (→P. 414)                 |

## ▶ 4.0 L V6 (1GR-FE) engine

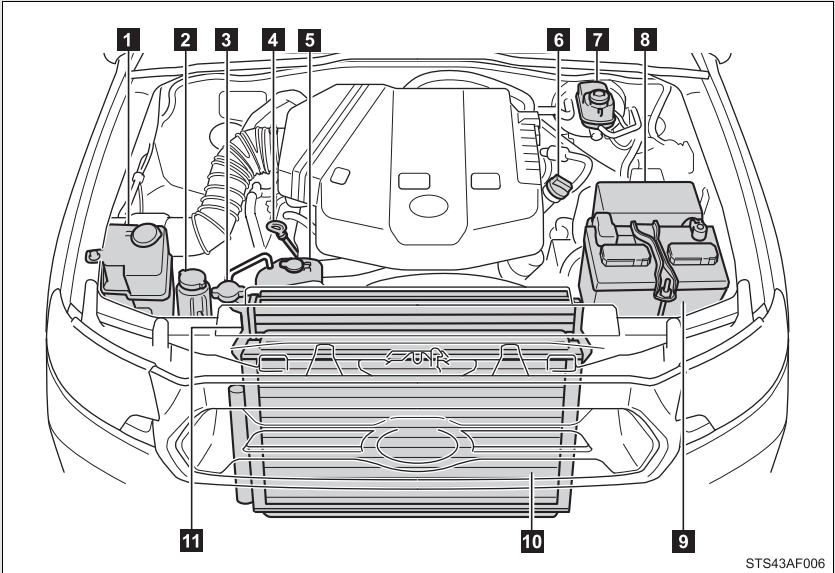

**1** Washer fluid tank (→P. 420)

**2** Power steering fluid reservoir  
(→P. 416)

**3** Radiator cap

**4** Engine oil level dipstick  
(→P. 408)

**5** Engine coolant reservoir  
(→P. 412)

**6** Engine oil filler cap  
(→P. 409)

**7** Brake fluid reservoir  
(→P. 414)

**8** Fuse box (→P. 444)

**9** Battery (→P. 418)

**10** Condenser (→P. 414)

**11** Radiator (→P. 414)

## Engine oil

With the engine at operating temperature and turned off, check the oil level on the dipstick.

### ■ Checking the engine oil

**STEP 1** Park the vehicle on level ground. After warming up the engine and turning it off, wait more than 5 minutes for the oil to drain back into the bottom of the engine.

**STEP 2** Hold a rag under the end and pull the dipstick out.

▶ 2.7 L 4-cylinder (2TR-FE) engine

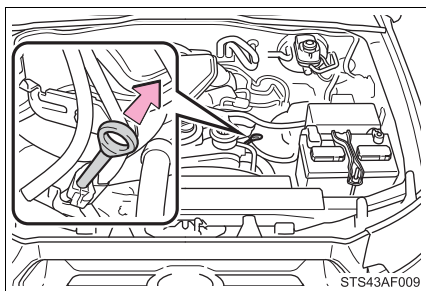

▶ 4.0 L V6 (1GR-FE) engine

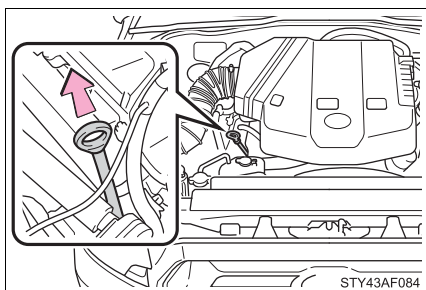

**STEP 3** Wipe the dipstick clean.

**STEP 4** Reinsert the dipstick fully.



**STEP 5** Holding a rag under the end, pull the dipstick out and check the oil level.

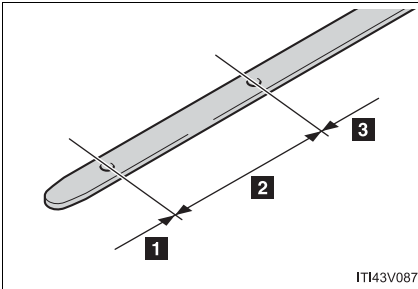

- 1** Low
- 2** Normal
- 3** Excessive

The shape of the dipstick may differ depending on the type of vehicle or engine.

**STEP 6** Wipe the dipstick and reinsert it fully.

### ■ Adding engine oil

► 2.7 L 4-cylinder (2TR-FE) engine

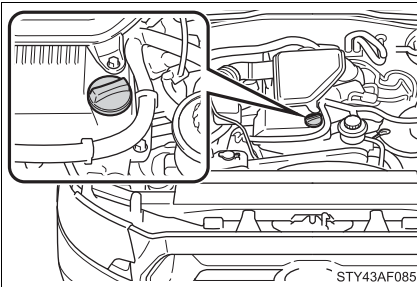

If the oil level is below or near the low level mark, add engine oil of the same type as already in the engine.

▶ 4.0 L V6 (1GR-FE) engine

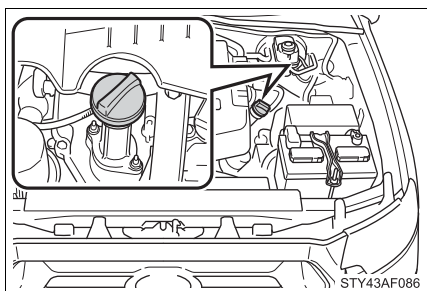

Make sure to check the oil type and prepare the items needed before adding oil.

Engine oil selection	→P. 525
Items	Clean funnel

**STEP 1** Remove the oil filler cap, turning it counterclockwise.

**STEP 2** Add engine oil slowly.

**STEP 3** Checking the dipstick.

**STEP 4** Reinstall the filler cap, turning it clockwise.

The approximate quantity of oil needed to raise the level between low and full on the dipstick is indicated as follows:

▶ 2.7 L 4-cylinder (2TR-FE) engine

1.4 qt. (1.3 L, 1.1 Imp.qt.)

▶ 4.0 L V6 (1GR-FE) engine

1.6 qt. (1.5 L, 1.3 Imp.qt.)

### ■ Engine oil consumption

A certain amount of engine oil will be consumed while driving. In the following situations, oil consumption may increase, and engine oil may need to be refilled in between oil maintenance intervals.

- When the engine is new, for example directly after purchasing the vehicle or after replacing the engine
- If low quality oil or oil of an inappropriate viscosity is used
- When driving at high engine speeds or with a heavy load, when towing, or when driving while accelerating or decelerating frequently
- When leaving the engine idling for a long time, or when driving frequently through heavy traffic

### CAUTION

#### ■ Used engine oil

- Used engine oil contains potentially harmful contaminants which may cause skin disorders such as inflammation or skin cancer, so care should be taken to avoid prolonged and repeated contact. To remove used engine oil from your skin, wash thoroughly with soap and water.
- Dispose of used oil and filters only in a safe and acceptable manner. Do not dispose of used oil and filters in household trash, in sewers or onto the ground. Call your Toyota dealer, service station or auto parts store for information concerning recycling or disposal.
- Do not leave used engine oil within the reach of children.

 NOTICE

■ **To prevent serious engine damage**

Check the oil level on regular basis.

■ **When replacing the engine oil**

- Be careful not to spill engine oil on the vehicle components.
- Avoid overfilling, as the engine could be damaged.
- Check the oil level on the dipstick every time you refill the vehicle.
- Be sure the engine oil filler cap is properly tightened.

**Engine coolant**

The coolant level is satisfactory if it is between the FULL and LOW lines on the reservoir when the engine is cold.

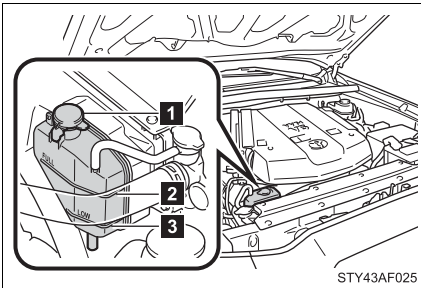

**1** Reservoir cap

**2** FULL line

**3** LOW line

If the level is on or below the LOW line, add coolant up to the FULL line.

### ■ If the coolant level drops within a short time after replenishing

Visually check the radiator, hoses, reservoir cap, radiator cap, drain cock and water pump.

If you cannot find a leak, have your Toyota dealer pressure test the cap and check for leaks in the cooling system.

### ■ Coolant selection

Only use “Toyota Super Long Life Coolant” or similar high quality ethylene glycol based non-silicate, non-amine, non-nitrite and non-borate coolant with long-life hybrid organic acid technology.

U.S.A.: “Toyota Super Long Life Coolant” is a mixture of 50% coolant and 50% deionized water. (Enabled: -31°F [-35°C])

Canada: “Toyota Super Long Life Coolant” is a mixture of 55% coolant and 45% deionized water. (Enabled: -44°F [-42°C])

For more details about engine coolant, contact your Toyota dealer.

### CAUTION

#### ■ When the engine is hot

Do not remove the radiator cap.

The cooling system may be under pressure and may spray hot coolant if the cap is removed, causing serious injuries, such as burns.

### NOTICE

#### ■ When adding engine coolant

Coolant is neither plain water nor straight antifreeze. The correct mixture of water and antifreeze must be used to provide proper lubrication, corrosion protection and cooling. Be sure to read the antifreeze or coolant label.

#### ■ If you spill coolant

Be sure to wash it off with water to prevent damage to parts or paint.

## Radiator and condenser

Check the radiator and condenser and clear any foreign objects. If either of the above parts are extremely dirty or you are not sure of their condition, have your vehicle checked by your Toyota dealer.

### ⚠ CAUTION

#### ■ When the engine is hot

Do not touch the radiator or condenser as they may be hot and cause serious injuries, such as burns.

## Brake fluid

### ■ Checking fluid level

#### ▶ Type A

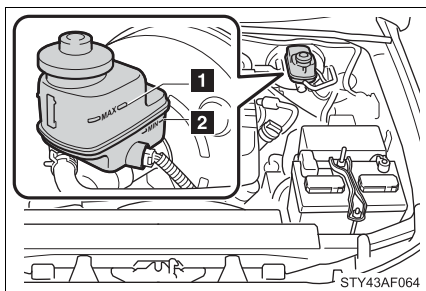

The brake fluid level should be between the MAX and MIN lines on the reservoir.

1 MAX line

2 MIN line

#### ▶ Type B

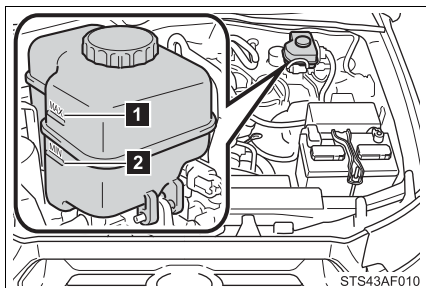

1 MAX line

2 MIN line

## ■ Adding fluid

Make sure to check the fluid type and prepare the necessary items.

Fluid type	FMVSS No.116 DOT 3 or SAE J1703 brake fluid
Items	Rag or paper towel

### ▶ Type B only

**STEP 1** Turn the engine off.

**STEP 2** Depress the brake pedal 20 times or more.

**STEP 3** Remove the reservoir cap.

**STEP 4** Add newly opened brake fluid up to the MAX line.

## ■ Brake fluid can absorb moisture from the air

Excess moisture in the fluid can cause a dangerous loss of braking efficiency. Use only newly opened brake fluid.

### CAUTION

#### ■ When filling the reservoir

Take care because brake fluid can harm your hands or eyes and damage painted surfaces.

If fluid gets on your hands or in your eyes, flush the affected area with clean water immediately.

If you still experience discomfort, see a doctor.

### NOTICE

#### ■ If the fluid level is low or high

It is normal for the brake fluid level to go down slightly as the brake pads wear or when the fluid level in the accumulator is high.

If the reservoir needs frequent refilling, it may indicate a serious problem.

#### ■ If you spill fluid

Be sure to wash it off with water to prevent damage to parts or paint.

## Power steering fluid

### ■ Fluid level

The fluid level should be within the appropriate range.

#### ▶ 2.7 L 4-cylinder (2TR-FE) engine

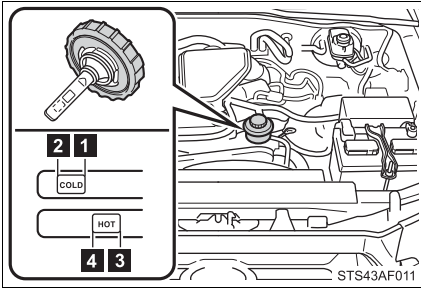

- 1 Full (when cold)
- 2 Add fluid (when cold)
- 3 Full (when hot)
- 4 Add fluid (when hot)

**Hot:** Vehicle has been driven around 50 mph (80 km/h) for 20 minutes, or slightly longer in frigid temperatures. (Fluid temperature, 104°F - 175°F [40°C - 80°C])

**Cold:** Engine has not been run for about 5 hours. (Room temperature, 32°F - 104°F [0°C - 40°C])

#### ▶ 4.0 L V6 (1GR-FE) engine

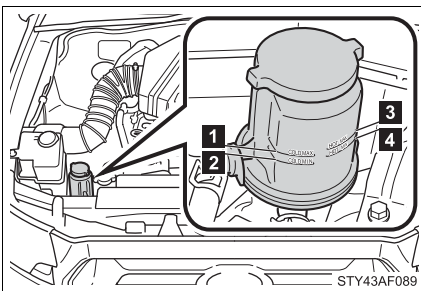

- 1 Full (when cold)
- 2 Add fluid (when cold)
- 3 Full (when hot)
- 4 Add fluid (when hot)

**Hot:** Vehicle has been driven around 50 mph (80 km/h) for 20 minutes, or slightly longer in frigid temperatures. (Fluid temperature, 140°F - 175°F [60°C - 80°C])

**Cold:** Engine has not been run for about 5 hours. (Room temperature, 50°F - 85°F [10°C - 30°C])



### ■ Checking the fluid level

Make sure to check the fluid type and prepare the necessary items.

Fluid type	Automatic transmission fluid DEXRON® II or III
Items	Rag or paper towel

**STEP 1** Clean all dirt off the reservoir.

**STEP 2** Remove the cap by turning it counterclockwise.

**STEP 3** Wipe the dipstick clean.

**STEP 4** Reinstall and remove the reservoir cap again.

**STEP 5** Check the fluid level.

#### CAUTION

##### ■ Checking the fluid level

Take care, as the reservoir may be hot.

#### NOTICE

##### ■ When adding fluid

Avoid overfilling, or the power steering may be damaged.

##### ■ After replacing the reservoir cap

Check the steering box case, vane pump and hose connections for leaks or damage.

## Battery

### ■ Battery exterior

Make sure that the battery terminals are not corroded and that there are no loose connections, cracks, or loose clamps.

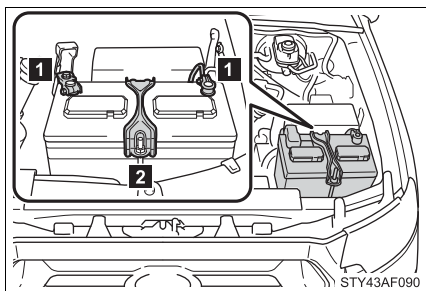

1 Terminals

2 Hold-down clamp

### ■ Before recharging

When recharging, the battery produces hydrogen gas which is flammable and explosive. Therefore, before recharging:

- If recharging with the battery installed on the vehicle, be sure to disconnect the ground cable.
- Make sure the power switch on the charger is off when connecting and disconnecting the charger cables to the battery.

 **CAUTION**
**■ Chemicals in the battery**

A battery contains poisonous and corrosive sulfuric acid and may produce hydrogen gas which is flammable and explosive. To reduce the risk of death or serious injury, take the following precautions while working on or near battery:

- Do not cause sparks by touching the battery terminals with tools.
- Do not smoke or light a match near the battery.
- Avoid contact with eyes, skin and clothes.
- Never inhale or swallow electrolyte.
- Wear protective safety glasses when working near the battery.
- Keep children away from the battery.

**■ Where to safety charge the battery**

Always charge the battery in an open area. Do not charge the battery in a garage or closed room where there is not sufficient ventilation.

**■ How to recharge the battery**

Only perform a slow charge (5A or less).

The battery may explode if charged at a quicker rate.

**■ Emergency measures regarding electrolyte**

- If electrolyte gets in your eyes  
Flush your eyes with clean water for at least 15 minutes and get immediate medical attention. If possible, continue to apply water with a sponge or cloth while traveling to the nearest medical facility.
- If electrolyte gets on your skin  
Wash the affected area thoroughly. If you feel pain or burning, get medical attention immediately.
- If electrolyte gets on your clothes  
It can soak through clothing on to your skin. Immediately take off the clothing and follow the procedure above if necessary.
- If you accidentally swallow electrolyte  
Drink a large quantity of water or milk. Get emergency medical attention immediately.

 NOTICE

■ **When recharging the battery**

Never recharge the battery while the engine is running. Also, be sure all accessories are turned off.

**Washer fluid**

If the washer does not work, the washer tank may be empty.

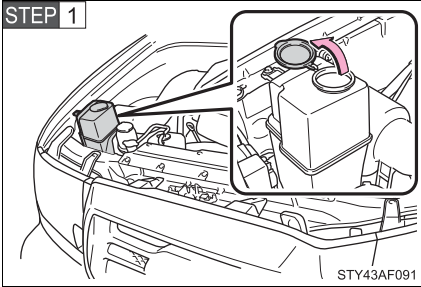

Open the lid.

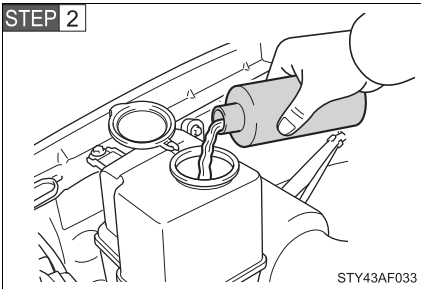

Add washer fluid.

 CAUTION

■ **When refilling the washer fluid**

Do not refill the washer fluid when the engine is hot or running, as the washer fluid contains alcohol and may catch fire if spilled on the engine etc.

**NOTICE****■ Do not use any fluid other than washer fluid**

Do not use soapy water or engine antifreeze instead of washer fluid. Doing so may cause streaking on the vehicle's painted surfaces.

**■ Diluting washer fluid**

Dilute washer fluid with water as necessary.

Refer to the freezing temperatures listed on the label of the washer fluid bottle.

## 4-3. Do-it-yourself maintenance

### Tires

Replace or rotate tires in accordance with maintenance schedules and treadwear.

#### ■ Checking tires

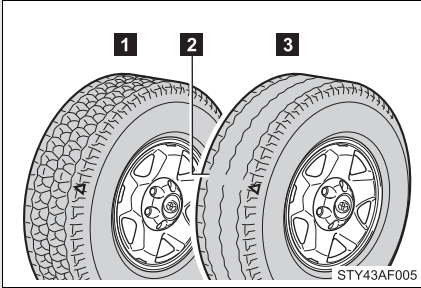

- 1 New tread
- 2 Treadwear indicator
- 3 Worn tread

The location of treadwear indicators is shown by the “TWI” or “△” marks, etc., molded on the sidewall of each tire.

Check spare tire condition and inflation pressure if not rotated.

#### ■ Tire rotation

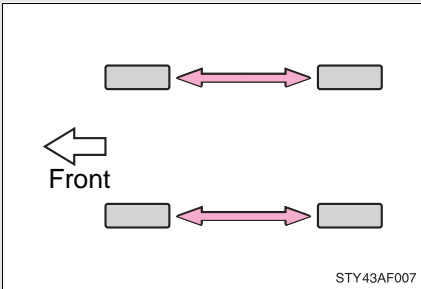

Rotate the tires in the order shown.

To equalize tire wear and extend tire life, Toyota recommends that tire rotation is carried out at the same interval as tire inspection.

Vehicles with P215/70R15 and P265/70R16 tires: Do not fail to initialize the tire pressure warning system after tire rotation.

#### ■ The tire pressure warning system

Your Toyota is equipped with a tire pressure warning system that uses tire pressure warning valves and transmitters to detect low tire inflation pressure before serious problems arise. (→P. 480)

## Installing tire pressure warning valves and transmitters

When replacing tires or wheels, tire pressure warning valves and transmitters must also be installed.

When new tire pressure warning valves and transmitters are installed, new tire pressure warning valve and transmitter ID codes must be registered in the tire pressure warning computer and tire pressure warning system must be initialized. Have tire pressure warning valve and transmitter ID codes registered by your Toyota dealer. (→P. 424)

## Initializing the tire pressure warning system

■ **The tire pressure warning system must be initialized in the following circumstances:**

- Vehicles with P215/70R15 and P265/70R16 tires: When rotating the tires on vehicles differing with front and rear tire inflation pressures.
- When changing the tire inflation pressure by changing traveling speed or load weight, etc.
- When changing the tire size.

When the tire pressure warning system is initialized, the current tire inflation pressure is set as the pressure benchmark.

■ **How to initialize the tire pressure warning system**

**STEP 1** Park the vehicle in safe place and turn the engine switch to the LOCK position.

While the vehicle is moving, initialization is not performed.

**STEP 2** Adjust the tire inflation pressure to the specified cold tire inflation pressure level. (→P. 532)

Make sure to adjust the tire pressure to the specified cold tire inflation pressure level. The tire pressure warning system will operate based on this pressure level.

**STEP 3** Turn the engine switch to the ON position.

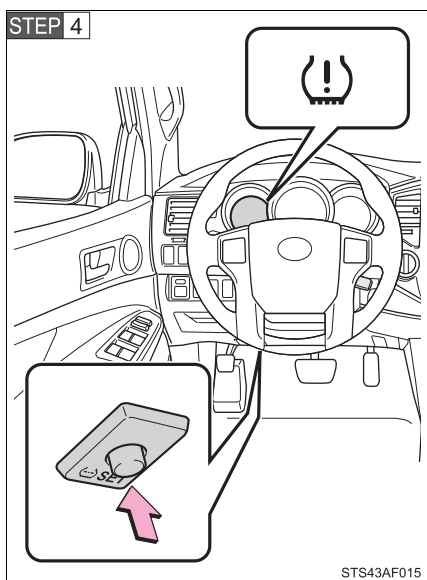

Press and hold the tire pressure warning reset switch until the tire pressure warning light blinks slowly 3 times.

**STEP 5** Wait for a few minutes with the engine switch in the ON position, and then turn the engine switch to the ACC or LOCK position.

### Registering ID codes

The tire pressure warning valve and transmitter is equipped with a unique ID code. When replacing a tire pressure warning valve and transmitter, it is necessary to register the ID code of tire pressure warning valve and transmitter. Have the ID code registered by your Toyota dealer.



### ■ When to replace your vehicle's tires

Tires should be replaced if:

- You have tire damage such as cuts, splits, cracks deep enough to expose the fabric or bulges indicating internal damage
- A tire goes flat repeatedly or cannot be properly repaired due to the size or location of a cut or other damage

If you are not sure, consult with your Toyota dealer.

### ■ Replacing tires and wheels

If the ID code of the tire pressure warning valve and transmitter is not registered, the tire pressure warning system will not work properly. After driving for about 20 minutes, the tire pressure warning light blinks for 1 minute and stays on to indicate a system malfunction.

### ■ Tire life

Any tire over 6 years old must be checked by a qualified technician even if they have seldom or never been used or damage is not obvious.

### ■ If the tread wears down below 0.16 in. (4 mm) on snow tires

The effectiveness of snow tires is lost.

### ■ Maximum load of tire

Check that the number given by dividing the maximum load by 1.10 of the replacement tire is greater than 1/2 of the Gross Axle Weight Ratings (GAWR) of either the front axle or the rear axle, whichever is greater.

For the GAWR, see the Certification Label. For the maximum load of the tire, see the load limit at maximum cold tire inflation pressure mentioned on the sidewall of the tire (→P. 540).

#### ▶ Access Cab models

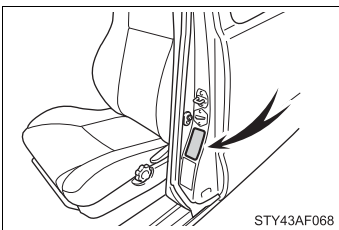

► Double Cab models

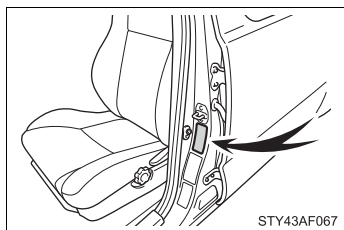

■ Tire types

1 Summer tires

Summer tires are high-speed performance tires best suited to highway driving under dry conditions. Since summer tires do not have the same traction performance as snow tires, summer tires are inadequate for driving on snow-covered or icy roads. For driving on snow-covered roads or icy roads, the use of snow tires is recommended. When installing snow tires, be sure to replace all four tires.

2 All season tires

All season tires are designed to provide better traction in snow and to be adequate for driving in most winter conditions, as well as for use year round. All season tires, however, do not have adequate traction performance compared with snow tires in heavy or loose snow. Also, all season tires fall short in acceleration and handling performance compared with summer tires in highway driving.

3 Snow tires

For driving on snow-covered roads or icy roads, we recommend using snow tires. If you need snow tires, select tires of the same size, construction and load capacity as the originally installed tires. Since your vehicle has radial tires as original equipment, make sure your snow tires also have radial construction. Do not install studded tires without first checking local regulations for possible restriction. Snow tires should be installed on all wheels. (→P. 209)

■ Initializing the tire pressure warning system

Initialize the tire pressure warning system with the tire inflation pressure adjusted to the specified level.

**■ If you push the tire pressure warning reset switch accidentally**

If initialization is performed, adjust the tire inflation pressure to the specified level and initialize the tire pressure warning system again.

**■ When the initialization of the tire pressure warning system has failed**

Initialization can be completed in a few minutes. However, in the following cases, the settings have not been recorded and the system will not operate properly. If repeated attempts to record tire inflation pressure settings are unsuccessful, have the vehicle inspected by your Toyota dealer.

- When operating the tire pressure warning reset switch, the tire pressure warning light does not blink 3 times.
- After carrying out the initialization procedure, the tire pressure warning light blinks for 1 minute then stays on after driving for about 20 minutes.

**■ Routine tire inflation pressure checks**

The tire pressure warning system does not replace routine tire inflation pressure checks. Make sure to check tire inflation pressure as part of your routine of daily vehicle checks.

■ **Tire pressure warning system certification**

FCC ID: PAXPMV107J

FCC ID: PAXPMV108J

FCC ID: HYQ13BCX

► For vehicles sold in U.S.A.

NOTE:

This device complies with part 15 of the FCC Rules. Operation is subject to the following two conditions: (1) This device may not cause harmful interference, and (2) this device must accept any interference received, including interference that may cause undesired operation.

FCC WARNING:

Changes or modifications not expressly approved by the party responsible for compliance could void the user's authority to operate the equipment.

► For vehicles sold in Canada

NOTE:

Operation is subject to the following two conditions: (1) this device may not cause interference, and (2) this device must accept any interference, including interference that may cause undesired operation of the device.

 **CAUTION****■ When inspecting or replacing tires**

Observe the following precautions to prevent accidents. Failure to do so may cause damage to parts of the drive train, as well as dangerous handling characteristics, which may lead to an accident resulting in death or serious injury.

- Do not mix tires of different makes, models or tread patterns.  
Also, do not mix tires of remarkably different treadwear.
- Do not use tire sizes other than those recommended by Toyota.
- Do not mix differently constructed tires (radial, bias-belted or bias-ply tires).
- Do not mix summer, all season and winter tires.
- Do not use tires that have been used on another vehicle.
- Do not use tires if you do not know how they were used previously.

**■ When initializing the tire pressure warning system**

Do not push the tire pressure warning reset switch without first adjusting the tire inflation pressure to the specified level. Otherwise, the tire pressure warning light may not come on even if the tire inflation pressure is low, or it may come on when the tire inflation pressure is actually normal.

 NOTICE

■ **Repairing or replacing tires, wheels, tire pressure warning valves, transmitters and tire valve caps**

- When removing or fitting the wheels, tires or the tire pressure warning valve and transmitter, contact your Toyota dealer as the tire pressure warning valve and transmitter may be damaged if not handled correctly.
- When replacing tire valve caps, do not use tire valve caps other than those specified. The cap may become stuck.

■ **To avoid damage to the tire pressure warning valves and transmitters**

When a tire is repaired with liquid sealants, the tire pressure warning valve and transmitter may not operate properly. If a liquid sealant is used, contact your Toyota dealer or other qualified service shop as soon as possible. Make sure to replace the tire pressure warning valve and transmitter when replacing the tire. (→P. 423)

■ **Driving on rough roads**

Take particular care when driving on roads with loose surfaces or potholes.

These conditions may cause losses in tire inflation pressure, reducing the cushioning ability of the tires. In addition driving on rough roads may cause damage to the tires themselves, as well as the vehicle's wheels and body.

■ **If tire inflation pressures become low while driving**

Do not continue driving, or your tires and/or wheels may be ruined.

## 4-3. Do-it-yourself maintenance

### Tire inflation pressure

#### ■ Tire inflation pressure

The recommended cold tire inflation pressure and tire size is displayed on the tire and loading information label. (→P. 532)

#### ▶ Access Cab models

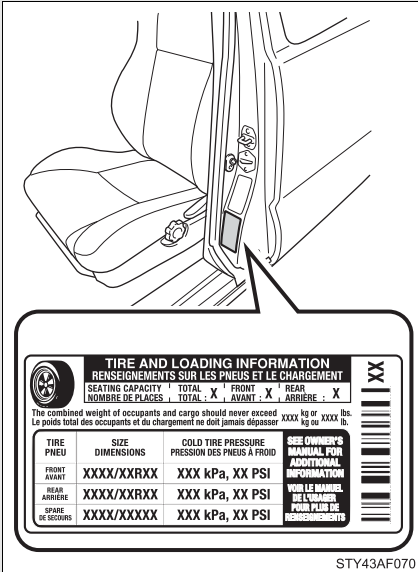

► Double Cab models

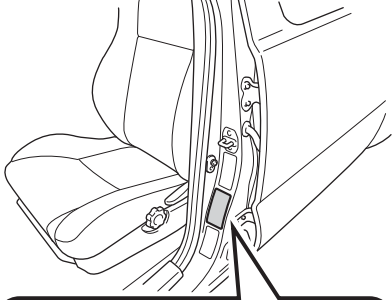

**TIRE AND LOADING INFORMATION**  
**RENSEIGNEMENTS SUR LES PNEUS ET LE CHARGEMENT**

SEATING CAPACITY<sup>1</sup> TOTAL: X | FRONT: X | REAR: X  
 NOMBRE DE PLACES<sup>1</sup> TOTAL: X | AVANT: X | ARRIERE: X

The combined weight of occupants and cargo should never exceed XXXX kg or XXXX lbs.  
 Le poids total des occupants et du chargement ne doit jamais dépasser XXXX kg ou XXXX lb.

TIRE PNEU	SIZE DIMENSIONS	COLD TIRE PRESSURE PRESSION DES PNEUS A FROID	SEE OWNER'S MANUAL FOR ADDITIONAL INFORMATION. VOIR LE MANUEL DE L'USAGER POUR PLUS DE RENSEIGNEMENTS.
FRONT AVANT	XXXX/XXRXX	XXX kPa, XX PSI	
REAR ARRIERE	XXXX/XXRXX	XXX kPa, XX PSI	
SPARE DE SECOURS	XXXX/XXXXX	XXX kPa, XX PSI	

XX

STY43AF069



### ■ Inspection and adjustment procedure

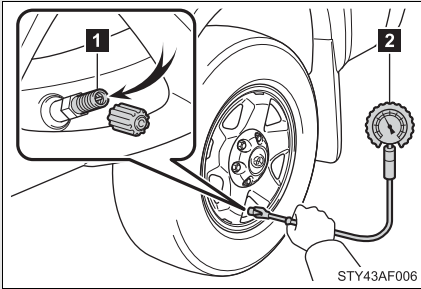

- 1 Tire valve
- 2 Tire pressure gauge

**STEP 1** Remove the tire valve cap.

**STEP 2** Press the tip of the tire pressure gauge onto the tire valve.

**STEP 3** Read the pressure using the graduations of the gauge.

**STEP 4** If the tire inflation pressure is not within the recommended levels, adjust inflate the tire.  
If you add too much air, press the center of the valve to lower.

**STEP 5** After completing the tire inflation pressure measurement and adjustment, apply soapy water to the valve and check for leakage.

**STEP 6** Reinstall the tire valve cap.

### ■ **Tire inflation pressure check interval**

You should check tire pressure every two weeks, or at least once a month.

Do not forget to check the spare.

### ■ **Effects of incorrect tire inflation pressure**

Driving with incorrect tire inflation pressure may result in the following:

- Reduced fuel efficiency
- Reduced driving comfort and tire life
- Reduced safety
- Damage to the drive train

If a tire needs frequent refilling, have it checked by your Toyota dealer.

### ■ **Instructions for checking tire inflation pressure**

When checking tire inflation pressure, observe the following:

- Check only when the tires are cold.

If your vehicle has been parked for at least 3 hours and has not been driven for more than 1 mile or 1.5 km, you will get an accurate cold tire inflation pressure reading.

- Always use a tire pressure gauge.

The appearance of the tire can be misleading. In addition, tire inflation pressures that are even just a few pounds off can degrade ride and handling.

- Do not bleed or reduce tire inflation pressure after driving. It is normal for the tire inflation pressure to be higher after driving.

- Never exceed the vehicle capacity weight.

Passengers and luggage weight should be placed so that the vehicle is balanced.

 CAUTION**■ Proper inflation is critical to save tire performance**

Keep your tires properly inflated.

Otherwise, the following conditions may occur and result in an accident causing death or serious injury.

- Excessive wear
- Uneven wear
- Poor handling
- Possibility of blowouts resulting from overheated tires
- Poor sealing of the tire bead
- Wheel deformation and/or tire separation
- A greater possibility of tire damage from road hazards

 NOTICE**■ When inspecting and adjusting tire inflation pressure**

Be sure to reinstall the tire valve caps.

Without the valve caps, dirt or moisture could get into the valve and cause air leakage, which could result in an accident. If the caps have been lost, replace them as soon as possible.

## Wheels

**If a wheel is bent, cracked or heavily corroded, it should be replaced.**

**Otherwise, the tire may separate from the wheel or cause loss of handling control.**

### ■ Wheel selection

When replacing wheels, care should be taken to ensure that they are equivalent to those removed in load capacity, diameter, rim width, and inset\*.

Replacement wheels are available at your Toyota dealer.

\*: Conventionally referred to as “offset”.

Toyota does not recommend using:

- Wheels of different sizes or types
- Used wheels
- Bent wheels that have been straightened

### ■ Wheel precautions

- Use only Toyota wheel nuts and wrench designed for use with your aluminum wheels.
- When rotating, repairing or changing your tires, check that the wheel nuts are still tight after driving 100 miles (160 km).
- Be careful not to damage the aluminum wheels when using tire chains.
- Use only Toyota genuine balance weights or equivalent and a plastic or rubber hammer when balancing your wheels.

### ■ When replacing wheels

The wheels of your Toyota are equipped with tire pressure warning valves and transmitters (except for spare tire) that allow the tire pressure warning system to provide advanced warning in the event of a loss in tire inflation pressure. Whenever wheels are replaced, the tire pressure warning valves and transmitters must be installed. (→P. 423)

## ⚠ CAUTION

### ■ When replacing wheels

- Do not use wheels that are a different size from those recommended in the Owner's Manual, as this may result in loss of handling control.
- Never use an inner tube in a leaking wheel which is designed for a tubeless tire. Doing so may result in an accident, causing death or serious injury.

### ■ When installing the wheel nuts

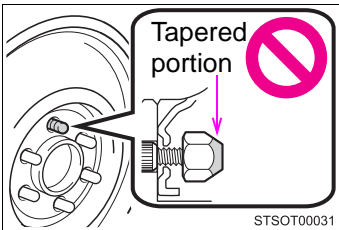

- Be sure to install the wheel nuts with the tapered end facing inward. Installing the nuts with the tapered end facing outward can cause wheel to break and eventually cause a wheel to come off while driving, which could lead to an accident resulting in death or serious injury.

- Never use oil or grease on the wheel bolts or wheel nuts. Oil and grease may cause the wheel nuts to be excessively tightened, leading to bolt or disc wheel damage. In addition, the oil or grease can cause the wheel nuts to loosen and the wheel may fall off, causing an accident and resulting in death or serious injury. Remove any oil or grease from the wheel bolts or wheel nuts.

 NOTICE

■ **Replacing tire pressure warning valves and transmitters**

- Because tire repair or replacement may affect the tire pressure warning valves and transmitters, make sure to have tires serviced by your Toyota dealer or other qualified service shop. In addition, make sure to purchase your tire pressure warning valves and transmitters at your Toyota dealer.
- Ensure that only genuine Toyota wheels are used on your vehicle. Tire pressure warning valves and transmitters may not work properly with non-genuine wheels.

## 4-3. Do-it-yourself maintenance

### Air conditioning filter

The air conditioning filter must be changed regularly to maintain air conditioning efficiency.

#### ■ Removal method

**STEP 1** Turn the engine switch to the LOCK position.

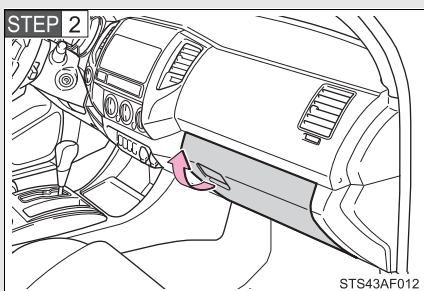

Open the glove box.

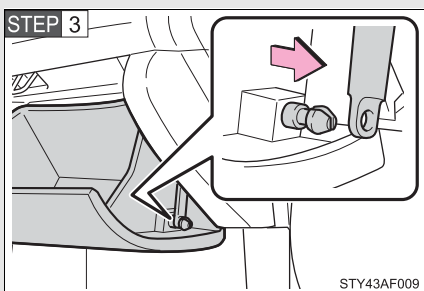

Slide off the damper.

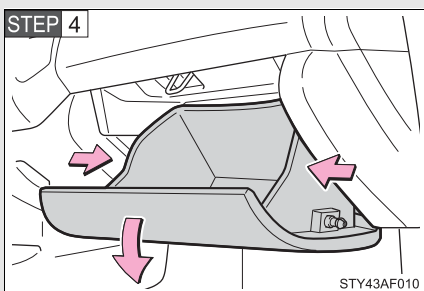

Push in each side of the glove box to disconnect the claws.

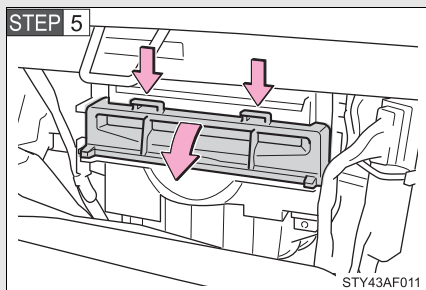

Open the filter door.

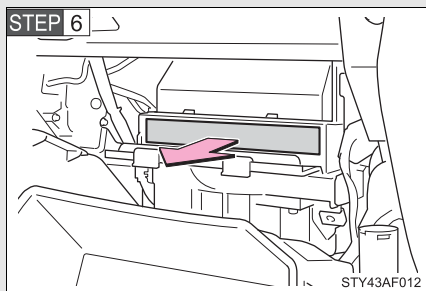

Remove the filter.

### ■ Replacement method

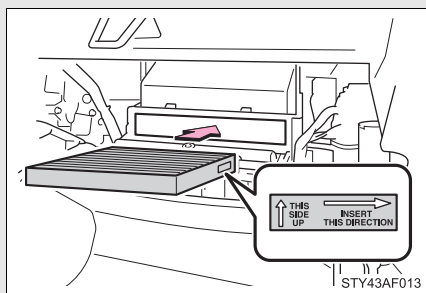

Remove the air conditioning filter and replace it with a new one.

When installing the filter, follow the instructions indicated on the label.



---

**■ Checking interval**

Inspect and replace the air conditioning filter according to the maintenance schedule. In dusty areas or areas with heavy traffic flow, early replacement may be required. (For scheduled maintenance information, please refer to the “Scheduled Maintenance Guide” or “Owner’s Manual Supplement”.)

**■ If air flow from the vents decreases dramatically**

The filter may be clogged. Check the filter and replace if necessary.

**NOTICE****■ When using the air conditioning system**

Make sure that a filter is always installed.

Using the air conditioning system without a filter may cause damage to the system.

## Wireless remote control battery\*

**Replace the battery with a new one if it is discharged.**

■ **You will need the following items:**

Lithium battery CR2032

■ **Replacing the battery**

**STEP 1**

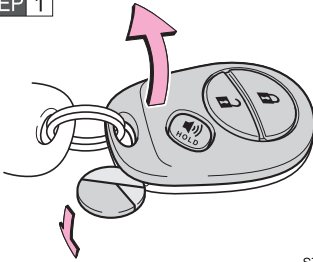

STY43AF014

Remove the cover using a coin protected with tape etc.

**STEP 2**

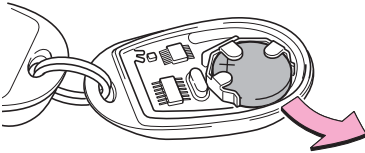

STY43AF015

Remove the discharged transmitter battery.

Insert a new battery with the "+" terminal facing up.

\*: If equipped

### ■ If the wireless remote control battery is discharged

The following symptoms may occur.

- The wireless remote control will not function properly.
- The operational range is reduced.

### ■ Use a CR2032 lithium battery

- Batteries can be purchased at your Toyota dealer, jewelers, or camera stores.
- Replace only with the same or equivalent type recommended by your Toyota dealer.
- Dispose of used batteries according to the local laws.

## CAUTION

### ■ Removed battery and other parts

These parts are small and if swallowed by a child, they can cause choking. Keep away from children. Failure to do so could result in death or serious injury.

### ■ Certification for the lithium battery

RISK OF EXPLOSION IF BATTERY IS REPLACED BY AN INCORRECT TYPE. DISPOSE OF USED BATTERIES ACCORDING TO THE INSTRUCTIONS

## NOTICE

### ■ For normal operation after replacing the battery

Observe the following precautions to prevent accidents.

- Always work with dry hands.  
Moisture may cause the battery to rust.
- Do not touch or move any other components inside the remote control.
- Do not bend either of the battery terminals.

## 4-3. Do-it-yourself maintenance

### Checking and replacing fuses

If any of the electrical components do not operate, a fuse may have blown. If this happens, check and replace the fuses as necessary.

**STEP 1** Turn the engine switch to the LOCK position.

**STEP 2** The fuses are located in the following places. To check the fuses, follow the instructions below.

#### ► Engine compartment

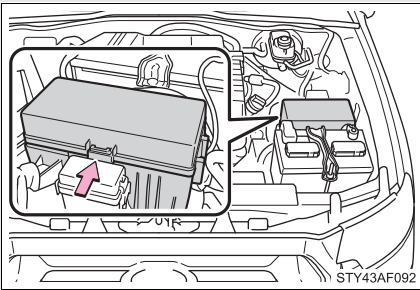

Push the tab in and lift the lid off.

#### ► Under the instrument panel

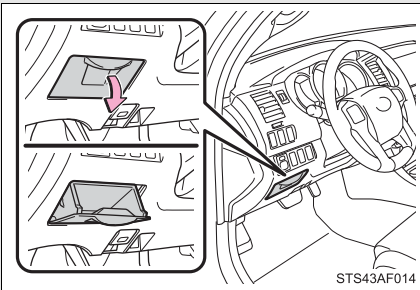

1. Open the auxiliary box.

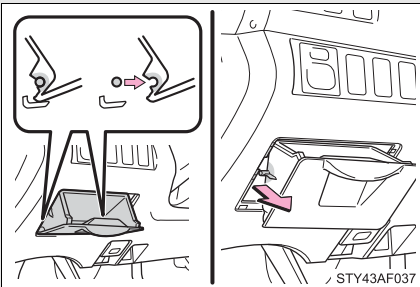

2. Pull up the box and disengage the claws. Remove the stoppers from the cutouts and remove the box.

**STEP 3** After a system failure, see “Fuse layout and amperage ratings” (→P. 447) for details about which fuse to check.

**STEP 4**

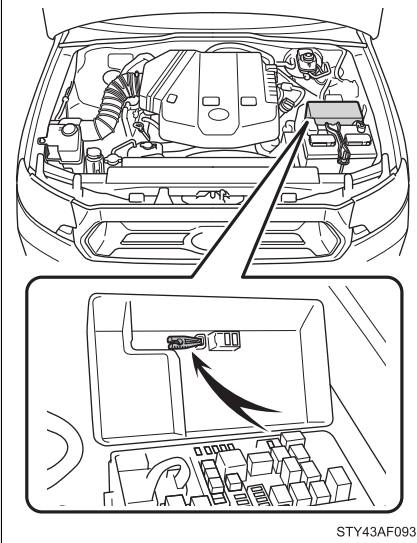

Remove the fuse with the pull-out tool.

**STEP 5** Check if the fuse has blown.

► Type A

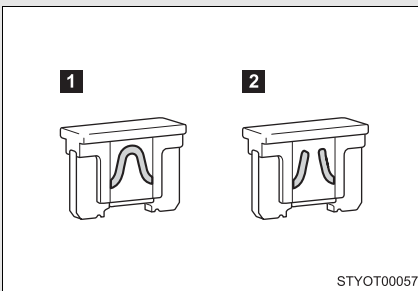

**1** Normal fuse

**2** Blown fuse

Replace it with one of an appropriate amperage rating. The amperage rating can be found on the fuse box lid.

► Type B

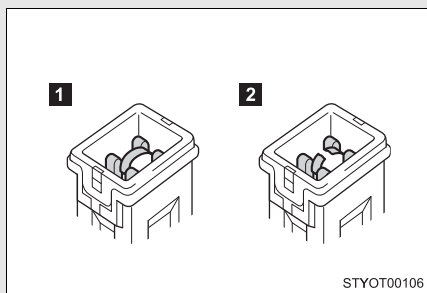

**1** Normal fuse

**2** Blown fuse

Replace it with one of an appropriate amperage rating. The amperage rating can be found on the fuse box lid.

► Type C

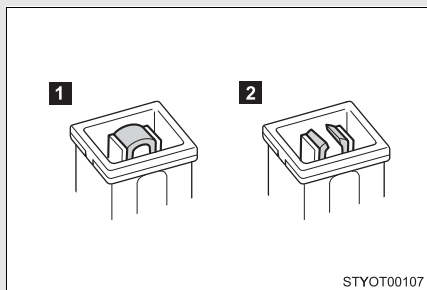

**1** Normal fuse

**2** Blown fuse

Replace it with one of an appropriate amperage rating. The amperage rating can be found on the fuse box lid.

► Type D

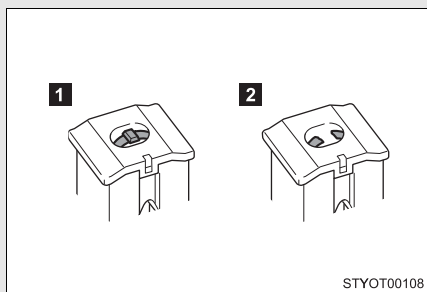

**1** Normal fuse

**2** Blown fuse

Replace it with one of an appropriate amperage rating. The amperage rating can be found on the fuse box lid.

**Fuse layout and amperage ratings**

■ **Engine compartment**

► **Type A**

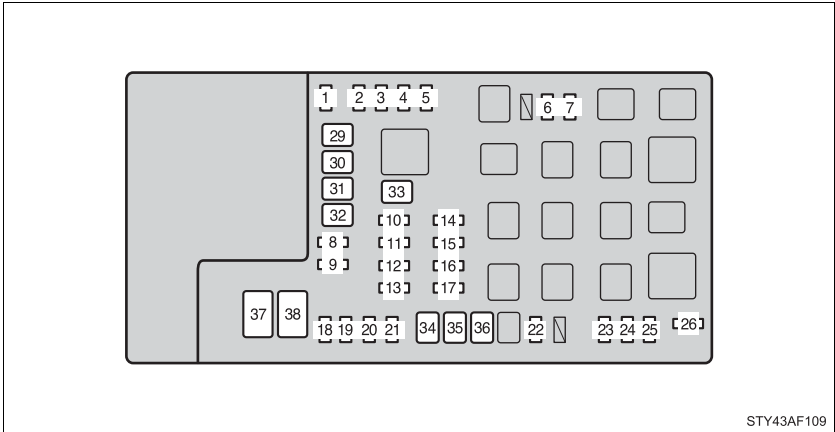

► **Type B**

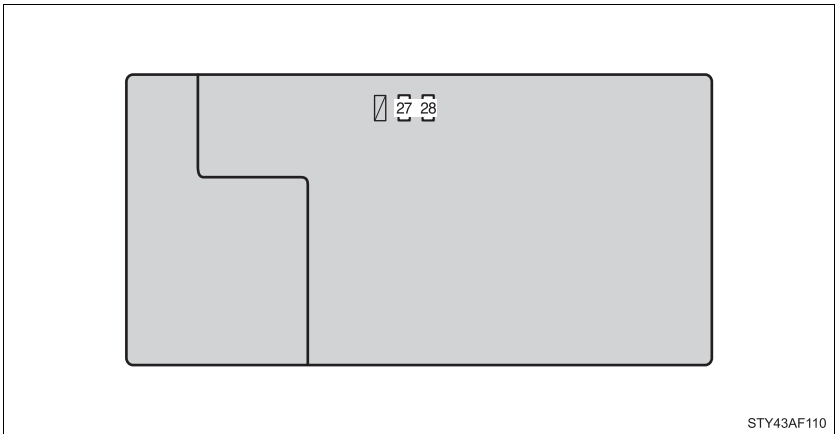

Fuse		Ampere	Circuit
1	A/C	10 A	Air conditioning system
2	TOWING TAIL	30 A	Trailer lights (tail lights)
3	FOG FR	15 A	Front fog lights
4	STOP	10 A	Stop lights, high mounted stop-light, vehicle stability control system, anti-lock brake system, shift lock system, multiport fuel injection system/sequential multiport fuel injection system, towing lights
5	TOWING BRK	30 A	Trailer brake controller
6	EFI	10 A	Multiport fuel injection system/ sequential multiport fuel injection system
7	S/HTR NO.2	30 A	Seat heaters
8	OBD	7.5 A	On-board diagnosis system
9	BATT CHG	30 A	Trailer sub battery
10	AIR PMP HTR	10 A	AI system
11	TOWING	30 A	Towing lights
12	TURN & HAZ	15 A	Turn signal lights, emergency flashers, meter and gauge
13	RADIO NO.2	30 A	Audio system
14	H-LP RH-LO	10 A	Right-hand headlight (low beam), front fog lights
15	H-LP LH-LO	10 A	Left-hand headlight (low beam)
16	H-LP RH-HI	10 A	Right-hand headlight (high beam)
17	H-LP LH-HI	10 A	Left-hand headlight (high beam), meter and gauge
18	ETCS	10 A	Multiport fuel injection system/ sequential multiport fuel injection system, electronic throttle control system



Fuse		Ampere	Circuit
19	ALT-S	7.5 A	Charging system
20	EFI-MAIN	20 A	Multiport fuel injection system/ sequential multiport fuel injection system
21	HORN	10 A	Horn
22	A/F HTR	15 A	Multiport fuel injection system/ sequential multiport fuel injection system
23	ECU-B	7.5 A	Wireless remote control system, air conditioning system, multiplex communication system, meter and gauge, front passenger occupant classification system, garage door opener
24	DOME	7.5 A	Interior light, personal lights, vanity lights
25	RADIO NO.1	20 A	Audio system
26	STA	7.5 A	Starting system, multiport fuel injection system/sequential multi- port fuel injection system, meter and gauge, clutch start cancel switch
27	Spare	10 A	Spare fuse
28	Spare	15 A	Spare fuse
29	S/HTR NO.1	50 A	Seat heaters
30	J/B	50 A	TAIL, AC SKT, DR LCK, D FR P/W, D RR P/W, P FR P/W and P RR P/W fuses
31	AM1	50 A	ACC, IG1, IG1 NO.2, WIP, WSH, 4WD, BKUP LP and STA fuses
32	HTR	50 A	A/C fuse, air conditioning system
33	ABS NO.1	50 A	Anti-lock brake system, vehicle sta- bility control system

Fuse		Ampere	Circuit
34	AM2	30 A	IGN and GAUGE fuses, multiport fuel injection system/sequential multiport fuel injection system
35	AIR PMP	50 A	Multiport fuel injection system/sequential multiport fuel injection system
36	ABS NO.2	30 A	Anti-lock brake system, vehicle stability control system
37	INV	100 A	Power outlets
38	ALT	120 A*	AM1, AC SKT, HEATER, FR FOG, STOP, OBD, J/B, TOWING TAIL, TOWING BRK and BATT CHG fuses
		140 A*	

\*: Replace the fuse with one of the same ampere rating as the original

## ■ Under the instrument panel

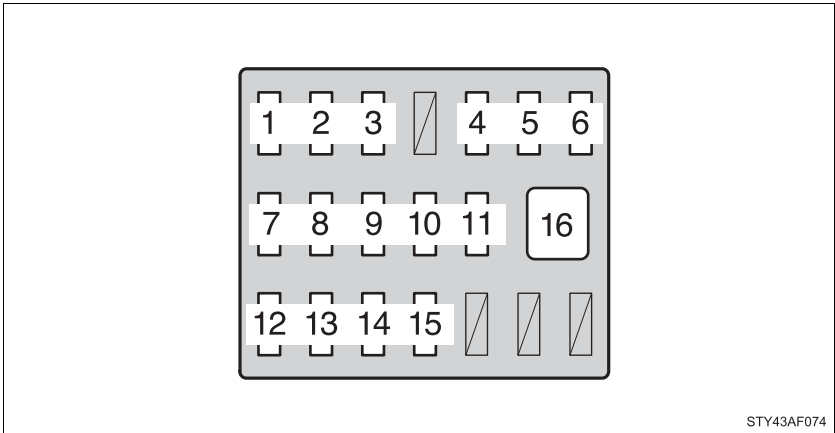

Fuse		Ampere	Circuit
1	IGN	15 A	Multiport fuel injection system/sequential multiport fuel injection system, anti-lock brake system, traction control system, vehicle stability control system, SRS airbag system, front passenger occupant classification system
2	GAUGE	7.5 A	Meter and gauge, emergency flashers
3	TAIL	10 A	Tail lights, license plate lights, parking lights, multiport fuel injection system/sequential multiport fuel injection system, instrument panel light control, illuminations
4	ACC	7.5 A	Shift lock system, outside rear view mirrors, audio system, power outlets
5	PWR OUTLET	15 A	Power outlets
6	DR LCK	20 A	Door lock system

Fuse		Ampere	Circuit
7	IG1 NO.2	10 A	Anti-lock brake system, vehicle stability control system, stop lights, charging system, multiport fuel injection system/sequential multiport fuel injection system, air conditioning system, instrument panel light control, anti-glare inside rear view mirror, back monitor, clutch start cancel switch, rear differential lock system, power outlets, tire pressure warning system
8	BKUP LP	10 A	Trailer lights (back-up lights)
9	IG1	10 A	Anti-lock brake system, traction control system, vehicle stability control system, back-up lights, air conditioning system, shift lock system, audio system
10	P RR P/W	20 A	Rear passenger's power window (right side)
11	P FR P/W	20 A	Front passenger's power window
12	WSH	10 A	Wipers and washer
13	D RR P/W	20 A	Rear passenger's power window (left side)
14	4WD	20 A	Four-wheel drive system, rear differential lock system
15	WIP	30 A	Wipers and washer
16	D FR P/W	30 A	Power windows

**■ After a fuse is replaced**

- If the lights do not turn on even after the fuse has been replaced, a bulb may need replacement. (→P. 454)
- If the replaced fuse blows again, have the vehicle inspected by your Toyota dealer.

**■ If there is an overload in the circuits**

The fuses are designed to blow, protecting the wiring harness from damage.

**⚠ CAUTION****■ To prevent system breakdowns and vehicle fire**

Observe the following precautions.

Failing to do so may cause damage to the vehicle, and possibly a fire or injury.

- Never use a fuse of a higher amperage rating than indicated, or use any other object in place of a fuse.
- Always use a genuine Toyota fuse or equivalent.  
Never replace a fuse with a wire, even as a temporary fix.
- Do not modify the fuse or the fuse box.

**⚠ NOTICE****■ Before replacing fuses**

Have the cause of electrical overload determined and repaired by your Toyota dealer as soon as possible.

## Light bulbs

You may replace the following bulbs yourself. The difficulty level of replacement varies depending on the bulb. If necessary bulb replacement seems difficult to perform, contact your Toyota dealer.

For more information about replacing other light bulbs, contact your Toyota dealer.

### ■ Prepare a replacement light bulb

Check the wattage of the light bulb being replaced. (→P. 536)

### ■ Front bulb locations

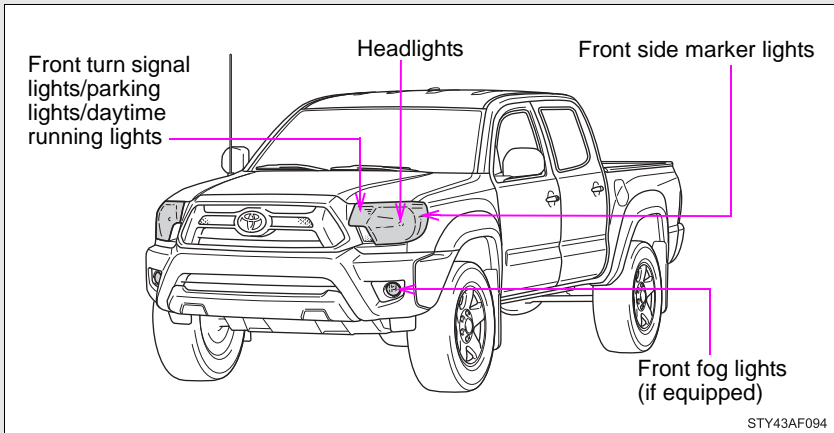

### ■ Rear bulb locations

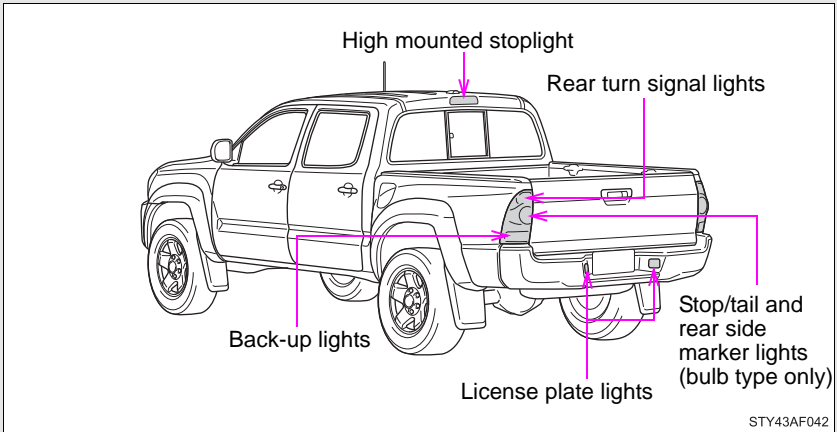

### Replacing light bulbs

#### ■ Headlights

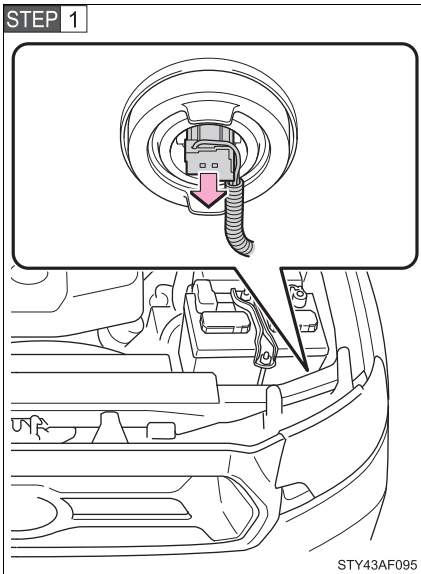

Unplug the connector.

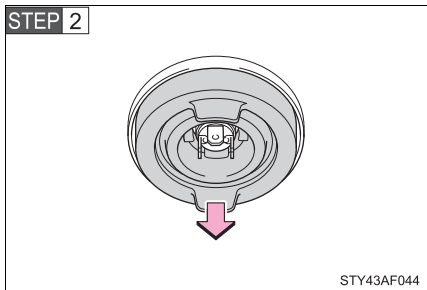

Remove the rubber cover.

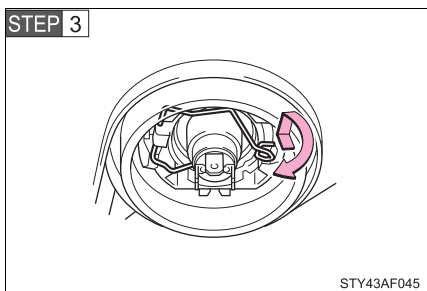

Release the bulb retaining spring.

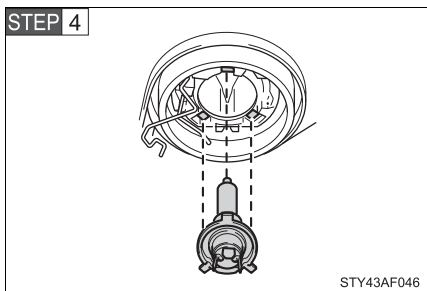

Remove the bulb.

To install a new bulb, align the tabs of the bulb with the cutouts of the mounting hole.



■ Front fog lights (if equipped)

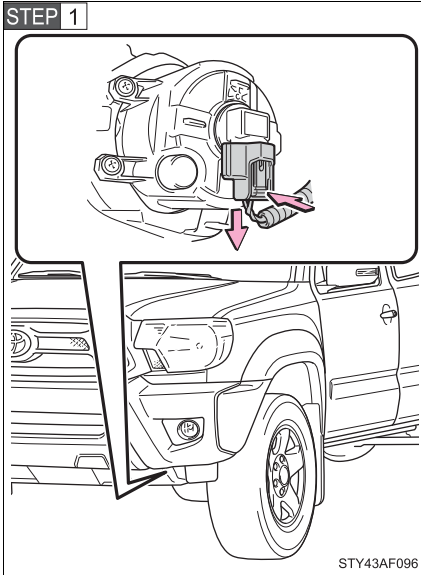

Unplug the connector while pulling the lock release.

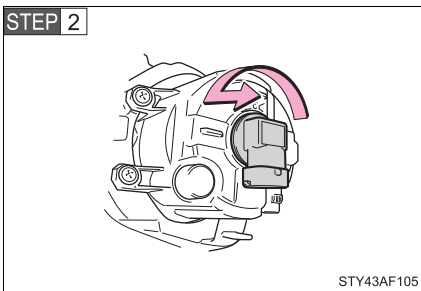

Turn the bulb counterclockwise.

### ■ Front side marker lights

STEP 1

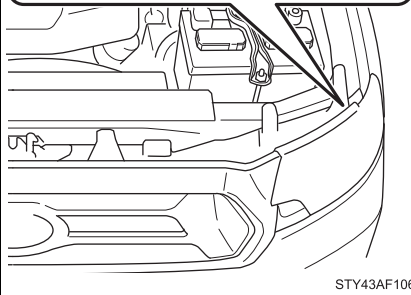
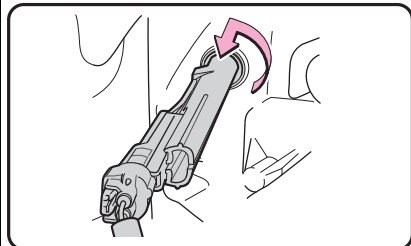

STY43AF106

Turn the bulb base counterclockwise.

STEP 2

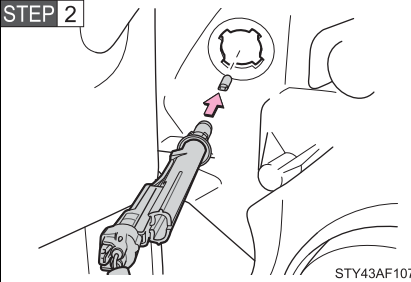

STY43AF107

Remove the light bulb.

■ Front turn signal lights/parking lights/daytime running lights

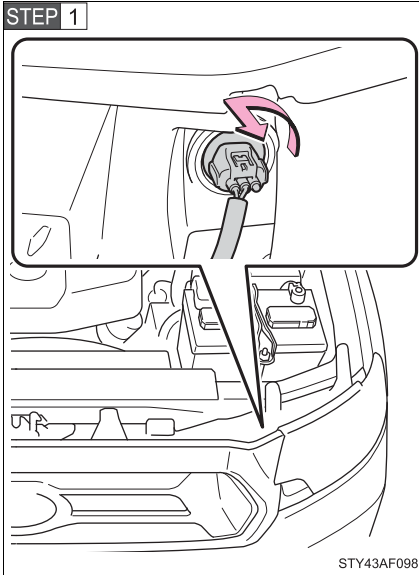

Turn the bulb base counterclockwise.

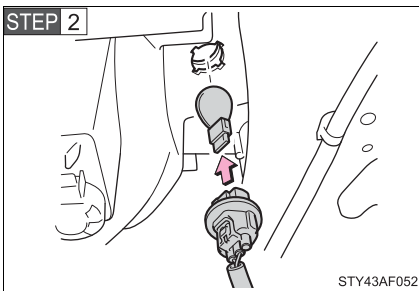

Remove the light bulb.

■ **Stop/tail lights, rear side marker lights (bulb type only), back-up lights and rear turn signal lights**

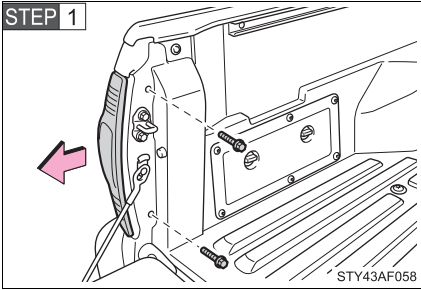

Remove the bolts and rear combination assembly.

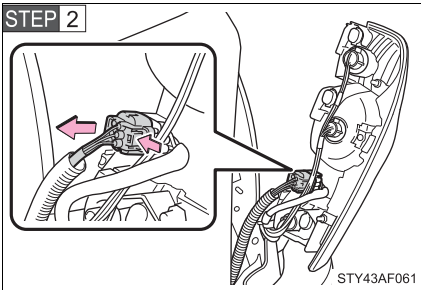

Unplug the connector while depressing the lock release.

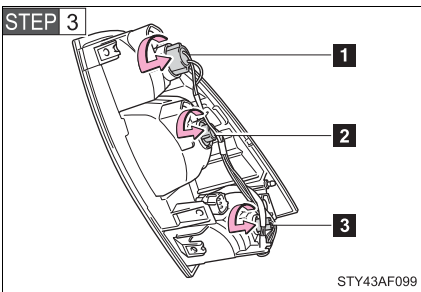

Turn the bulb bases counter-clockwise.

- 1 Rear turn signal light
- 2 Stop/tail and rear side marker lights (bulb type only)
- 3 Back-up light

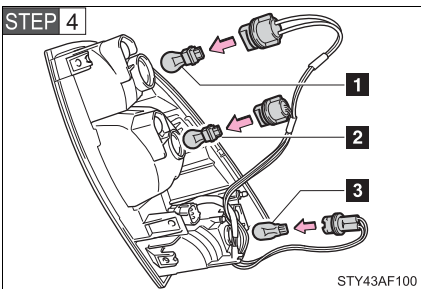

Remove the light bulb.

- 1 Rear turn signal light
- 2 Stop/tail and rear side marker lights (bulb type only)
- 3 Back-up light

### ■ High mounted stoplight

STEP 1

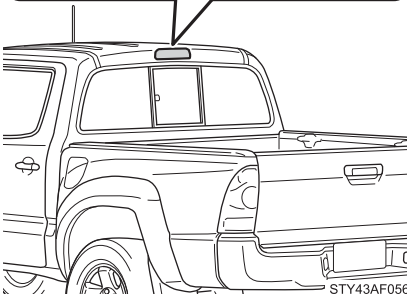
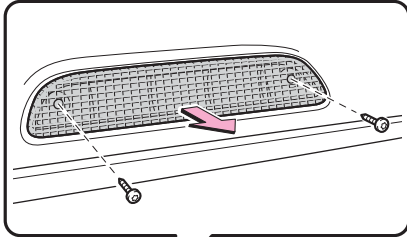

Remove the screws and cover.

STEP 2

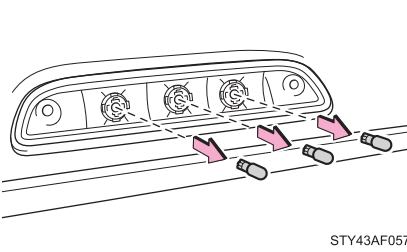

Remove the light bulbs.

### ■ License plate lights

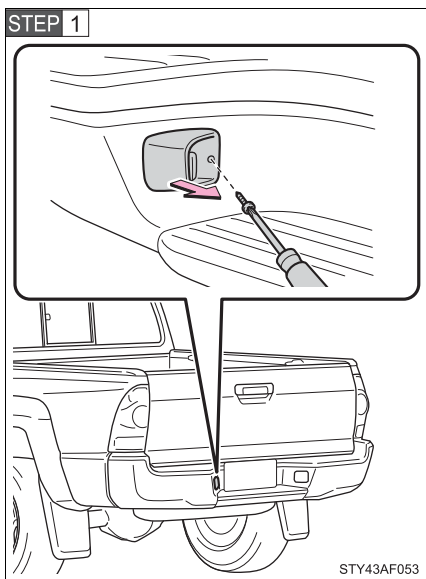

Remove the screw and light unit.

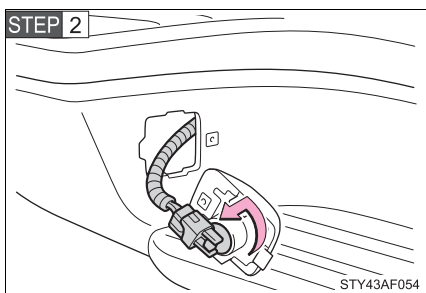

Turn the bulb base counterclockwise.

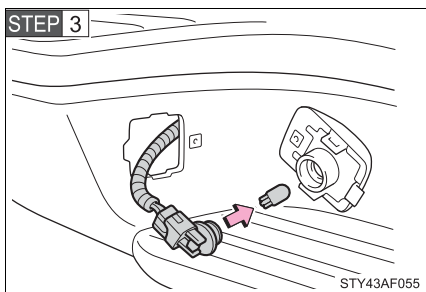

Remove the light bulb.

### ■ Lights other than the above

If any of the lights listed below has burnt out, have it replaced by your Toyota dealer.

- Side turn signal lights (if equipped)
  - Stop/tail lights (LED type)
  - Rear side marker lights (LED type)
- 

### ■ Condensation build-up on the inside of the lens

Temporary condensation build-up on the inside of the headlight lens does not indicate a malfunction. Contact your Toyota dealer for more information in the following situations:

- Large drops of water are built up on the inside of the lens.
- Water has built up inside the headlight.

### ■ LED light bulbs

The side turn signal lights (if equipped), stop/tail and rear side marker lights (LED type) consist of a number of LEDs. If any of the LEDs burn out, take your vehicle to your Toyota dealer to have the light replaced.

If two or more LEDs in a stop light burn out, your vehicle may not conform to local laws (SAE).

 **CAUTION**

■ **Replacing light bulbs**

- Turn off the headlights. Do not attempt to replace the bulb immediately after turning off the headlights.  
The bulbs become very hot and may cause burns.
- Do not touch the glass portion of the light bulb with bare hands. When it is unavoidable to hold the glass portion, use and hold with a clean dry cloth to avoid getting moisture and oils on the bulb.  
Also, if the bulb is scratched or dropped, it may blow out or crack.
- Fully install light bulbs and any parts used to secure them. Failing to do so may result in heat damage, fire, or water entering the headlight unit. This may damage the headlights or cause condensation to build up on the lens.

■ **To prevent damage or fire**

Make sure bulbs are fully seated and locked.



## When trouble arises

# 5

### 5-1. Essential information

Emergency flashers .....	466
If your vehicle needs to be towed .....	467
If you think something is wrong .....	474
Fuel pump shut off system .....	475

### 5-2. Steps to take in an emergency

If a warning light turns on or a warning buzzer sounds... ..	476
If you have a flat tire.....	486
If the engine will not start.....	501
If the shift lever cannot be shifted from P (vehicles with an automatic transmission) .....	502
If you lose your keys .....	503
If the vehicle battery is discharged .....	504
If your vehicle overheats .....	508
If the vehicle becomes stuck .....	511
If your vehicle has to be stopped in an emergency .....	513

## 5-1. Essential information

### Emergency flashers

Use the emergency flashers if the vehicle malfunctions or is involved in an accident.

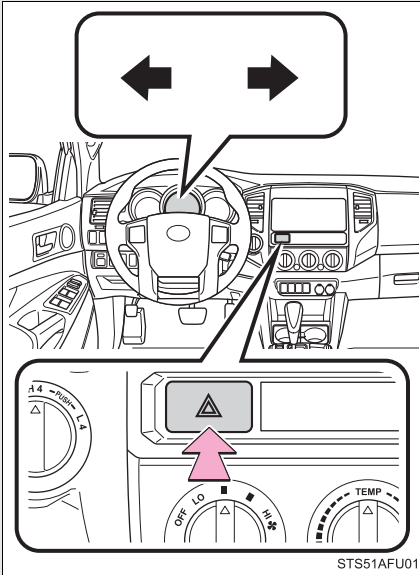

Press the switch to flash all the turn signal lights. To turn them off, press the switch once again.

#### NOTICE

##### To prevent battery discharge

Do not leave the emergency flashers on longer than necessary when the engine is not running.

## If your vehicle needs to be towed

**If towing is necessary, we recommend having your vehicle towed by your Toyota dealer or a commercial towing service, using a lift-type truck or a flat bed truck.**

**Use a safety chain system for all towing, and abide by all state/provincial and local laws.**

**The wheels and axle on the ground must be in good condition.**

**If they are damaged, use a towing dolly or flat bed truck.**

### Before towing

The following may indicate a problem with your transmission. Contact your Toyota dealer before towing.

- The engine is running, but the vehicle will not move.
- The vehicle makes an abnormal sound.

### Emergency towing (4WD models and PreRunner only)

If a tow truck is not available, in an emergency your vehicle may be temporarily towed using a cable or chain secured to the emergency towing hook. This should only be attempted on hard, surfaced roads for short distances at low speeds.

A driver must be in the vehicle to steer and operate the brakes. The vehicle's wheels, drive train, axles, steering and brakes must be in good condition.

#### ► Type A

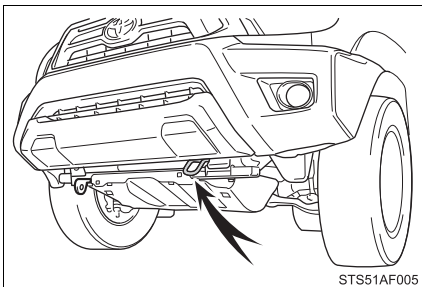

Towing hook

► Type B

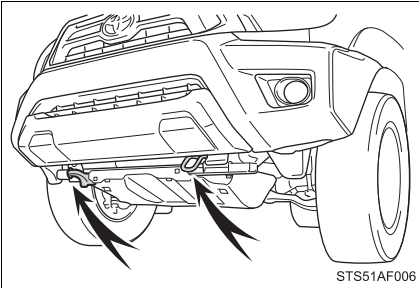

Towing hook

■ **Emergency towing procedure**

- STEP 1** The engine switch must be in the ACC (engine off) or the ON (engine running) position.
- STEP 2** 4WD models: Put the front-wheel drive control switch in H2.
- STEP 3** Put the shift lever in N.
- STEP 4** Release the parking brake.

**⚠ CAUTION**

■ **Caution while towing**

- Use extreme caution when towing the vehicle. Avoid sudden starts or erratic driving maneuvers which place excessive stress on the emergency towing hook and the cables or chains. Always be cautious of the surroundings and other vehicles while towing.
- If the engine is not running, the power assist for the brakes and steering will not function, making steering and braking more difficult.

 NOTICE

■ **Emergency towing hook precautions**

- Before emergency towing, check that the hook is not broken or damaged.
- Fasten the towing cable or chain securely to the hook.
- Do not jerk the hook. Apply steady and even force.
- To avoid damaging the hook, do not pull from the side or at a vertical angle. Always pull straight ahead.

**Towing with a sling-type truck**

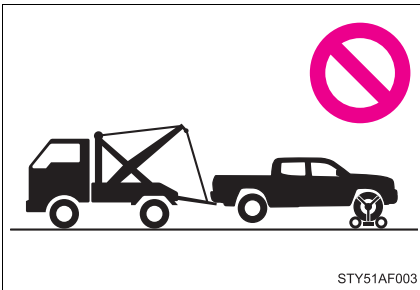

 NOTICE

■ **To prevent body damage**

Do not tow with a sling-type truck, either from the front or rear.

## Towing with a wheel lift-type truck from the front

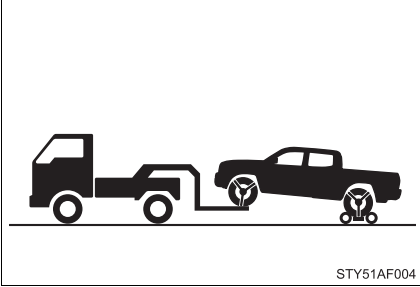

Vehicles with an automatic transmission: Use a towing dolly under the rear wheels.

2WD models with a manual transmission: We recommend to use a towing dolly under the rear wheels.

When not using a towing dolly, release the parking brake and shift the shift lever to N.

4WD models with a manual transmission: We recommend to use a towing dolly under the rear wheels.

When not using a towing dolly, release the parking brake, shift the shift lever to N and put the front-wheel drive control switch in H2.

### NOTICE

■ **To prevent causing serious damage to the transmission (vehicles with an automatic transmission)**

Never tow this vehicle wheels on the ground.

## Towing with a wheel lift-type truck from the rear

### ▶ 2WD models

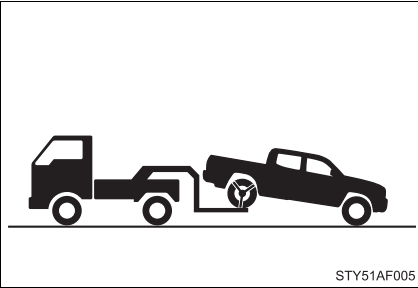

Turn the engine switch to the ACC position.

### ▶ 4WD models

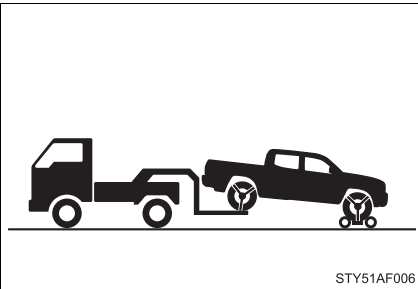

We recommend to use a towing dolly under the front wheels.

When not using a towing dolly, turn the engine switch to the ACC position, shift the shift lever to N and put the front-wheel drive control switch in H2.

## ⚠ NOTICE

### ■ To prevent damaging the vehicle

- Do not tow the vehicle with the key removed or in the LOCK position. The steering lock mechanism is not strong enough to hold the front wheel straight.
- When raising the vehicle, ensure adequate ground clearance for towing at the opposite end of the raised vehicle. Without adequate clearance, the vehicle could be damaged while being towed.

## Using a flat bed truck

### ► Type A

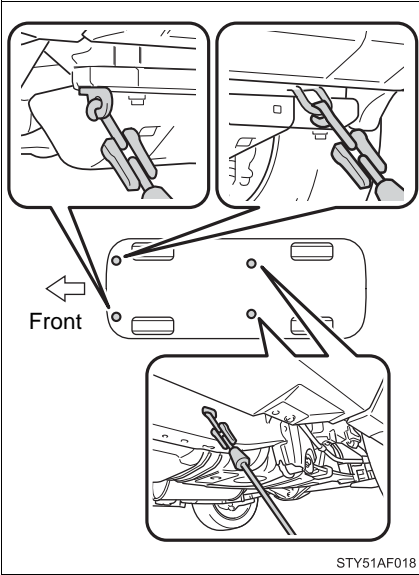

If your Toyota is transported by a flat bed truck, it should be tied down at the locations shown in the illustration.



## ► Type B

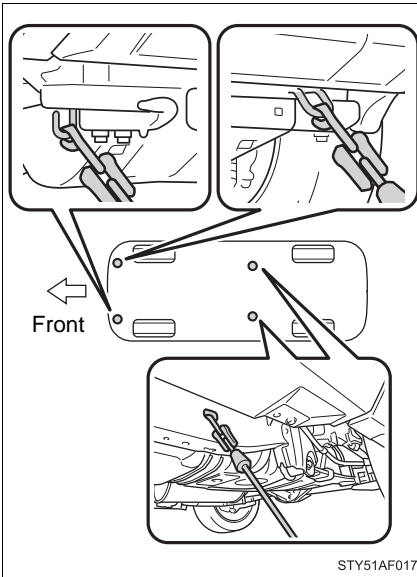

If your Toyota is transported by a flat bed truck, it should be tied down at the locations shown in the illustration.

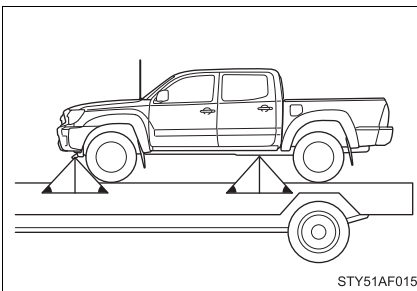

If you use chains or cables to tie down your vehicle, the angles shaded in black must be 45°.

Do not overly tighten the tie downs or the vehicle may be damaged.

Apply the parking brake firmly.

## If you think something is wrong

**If you notice any of the following symptoms, your vehicle probably needs adjustment or repair. Contact your Toyota dealer as soon as possible.**

### ■ Visible symptoms

- Fluid leaks under the vehicle  
(Water dripping from the air conditioning after use is normal.)
- Flat-looking tires or uneven tire wear
- Engine coolant temperature gauge needle continually points higher than normal

### ■ Audible symptoms

- Changes in exhaust sound
- Excessive tire squeal when cornering
- Strange noises related to the suspension system
- Pinging or other noises related to the engine

### ■ Operational symptoms

- Engine misfire, stumbling or running rough
- Appreciable loss of power
- Vehicle pulls heavily to one side when braking
- Vehicle pulls heavily to one side when driving on a level road
- Loss of brake effectiveness, spongy feeling, pedal almost touches the floor

## Fuel pump shut off system

**To minimize the risk of fuel leakage when the engine stalls or an air-bag inflates upon collision, the fuel pump shut off system stops supplying fuel to the engine.**

Follow the procedure below to restart the engine after the system is activated.

**STEP 1** Turn the engine switch to the ACC or LOCK position.

**STEP 2** Restart the engine.



### NOTICE

■ **Before starting the engine**

Inspect the ground under the vehicle.

If you find that fuel has leaked onto the ground, the fuel system has been damaged and is in need of repair. Do not restart the engine.



## 5-2. Steps to take in an emergency

### If a warning light turns on or a warning buzzer sounds...

**Calmly perform the following actions if any of the warning lights turn on or flash. If a light turns on or flashes, but then turns off, this does not necessarily indicate a malfunction in the system.**

**Stop the vehicle immediately. Continuing to drive the vehicle may be dangerous.**

The following warning indicates a possible problem in the brake system. Immediately stop the vehicle in a safe place and contact your Toyota dealer.



Warning light	Warning light/Details
 (U.S.A.)	<b>Brake system warning light (warning buzzer)*</b> <ul style="list-style-type: none"><li>• Low brake fluid</li><li>• Malfunction in the brake system</li></ul> This light also comes on when the parking brake is not released. If the light turns off after the parking brake is fully released, the system is operating normally.
 (Canada)	

\*: Parking brake engaged warning buzzer:

The buzzer sounds to indicate that parking brake is still engaged (with the vehicle having reached a speed of 3 mph [5 km/h])

### Stop the vehicle immediately.



The following warnings indicate the possibility of damage to the vehicle that may lead to an accident. Immediately stop the vehicle in a safe place and contact your Toyota dealer.

Warning light	Warning light/Details
	<p><b>Charging system warning light</b> Indicates a malfunction in the vehicle's charging system.</p>
	<p><b>Low engine oil pressure warning light</b> Indicates that the engine oil pressure is too low*.</p>

\*: The light may come on when the oil level is extremely low. It is not designed to indicate low oil level, and the oil level must be checked using the engine oil level dipstick.

### Have the vehicle inspected immediately.





Failing to investigate the cause of the following warnings may lead to the system operating abnormally and possibly cause an accident. Have the vehicle inspected by your Toyota dealer immediately.



Warning light	Warning light/Details
 (U.S.A.)	<p><b>Malfunction indicator lamp</b> Indicates a malfunction in:</p> <ul style="list-style-type: none"> <li>• The electronic engine control system;</li> <li>• The electronic throttle control system;</li> <li>• The electronic automatic transmission control system; or</li> <li>• Emission control system.</li> </ul>
 (Canada)	
	<p><b>SRS warning light</b> Indicates a malfunction in:</p> <ul style="list-style-type: none"> <li>• The SRS airbag system;</li> <li>• The front passenger occupant classification system; or</li> <li>• The seat belt pretensioner system.</li> </ul>

Warning light	Warning light/Details
<div data-bbox="150 264 240 321" data-label="Image"> </div> <p data-bbox="146 329 240 358">(U.S.A.)</p> <div data-bbox="150 394 240 451" data-label="Image"> </div> <p data-bbox="139 459 247 488">(Canada)</p>	<p data-bbox="338 310 559 339"><b>ABS warning light</b></p> <p data-bbox="352 342 650 371">Indicates a malfunction in:</p> <ul data-bbox="352 375 650 436" style="list-style-type: none"> <li data-bbox="352 375 508 404">• The ABS; or</li> <li data-bbox="352 407 650 436">• The brake assist system.</li> </ul>
<div data-bbox="150 589 240 651" data-label="Image"> </div>	<p data-bbox="338 505 501 534"><b>Slip indicator</b></p> <p data-bbox="352 537 937 566">The indicator comes on to indicate a malfunction in:</p> <ul data-bbox="352 570 937 794" style="list-style-type: none"> <li data-bbox="352 570 479 599">• The VSC;</li> <li data-bbox="352 602 495 631">• The TRAC;</li> <li data-bbox="352 634 905 664">• The active traction control system (if equipped);</li> <li data-bbox="352 667 639 696">• The AUTO LSD system;</li> <li data-bbox="352 699 910 729">• The downhill assist control system (if equipped);</li> <li data-bbox="352 732 932 761">• The hill-start assist control system (if equipped); or</li> <li data-bbox="352 764 804 794">• The Trailer Sway Control (if equipped).</li> </ul>
<div data-bbox="150 813 240 870" data-label="Image"> </div> <p data-bbox="139 878 247 907">(Flashes)</p>	<p data-bbox="338 826 846 855"><b>Cruise control indicator light (if equipped)</b></p> <p data-bbox="352 859 937 888">Indicates a malfunction in the cruise control system.</p>

**Follow the correction procedures.**

After taking the specified steps to correct the suspected problem, check that the warning light turns off.

Warning light	Warning light/Details	Correction procedure
	<p><b>Open door warning light</b> Indicates that a door is not fully closed.</p>	<p>Check that all doors are closed.</p>
 (On the instrument cluster)	<p><b>Driver's seat belt reminder light (warning buzzer)*1</b> Warns the driver to fasten his/her seat belt.</p>	<p>Fasten the seat belt.</p>
 (On the center panel)	<p><b>Front passenger's seat belt reminder light (warning buzzer)*1</b> Warns the front passenger to fasten his/her seat belt.</p>	<p>Fasten the seat belt.</p>
	<p><b>Automatic transmission fluid temperature warning light (if equipped)</b></p> <p>When the light comes on: Indicates that the automatic transmission fluid temperature is too high.</p> <p>When the light flashes: Indicates a malfunction in the automatic transmission system.</p>	<p>Stop the vehicle in a safe place, shift the shift lever to P and wait until the light goes off. If the light goes off, you may start the vehicle again. If the light does not go off, contact your Toyota dealer.</p> <p>Have the system checked by your Toyota dealer.</p>

Warning light	Warning light/Details	Correction procedure
	<p><b>Tire pressure warning light</b></p> <p>When the light comes on:                      Low tire inflation pressure such as</p> <ul style="list-style-type: none"> <li>• Natural causes (→P. 482)</li> <li>• Flat tire (→P. 486)</li> </ul> <p>• When the light stays on after blinking for 1 minute: Malfunction in the tire pressure warning system. (→P. 483)</p>	<p>Adjust the tire inflation pressure to the specified level.                      The light will turn off after a few minutes.                      In case the light does not turn off even if the tire inflation pressure is adjusted, have the system checked by your Toyota dealer.</p> <p>Have the system checked by your Toyota dealer.</p>
	<p><b>Low fuel level warning light</b></p> <p>Low level of fuel.</p>	<p>Refuel the vehicle.</p>



Warning light	Warning light/Details	Correction procedure
<div style="border: 1px solid black; padding: 5px; display: inline-block; text-align: center;">                     MAINT REQD                 </div> (U.S.A.)	<p><b>Maintenance required reminder light</b>                      Indicates that maintenance is required according to the driven distance on the maintenance schedule.*2</p>	
	<p>Illuminates for about 3 seconds and then flashes for about 15 seconds approximately 4500 miles (7200 km) after the reminder light has been reset.</p>	<p>If necessary, perform maintenance.</p>
	<p>Comes on and remains on if the distance driven exceeds 5000 miles (8000 km) after the reminder light has been reset.                      (The indicator will not work properly unless the reminder light has been reset.)</p>	<p>Perform the necessary maintenance.                      Please reset the reminder light after the maintenance is performed. (→P. 395)</p>

\*1: Driver's and front passenger's seat belt buzzer:

The driver's and front passenger's seat belt buzzer sounds to alert the driver and front passenger that their seat belt is not fastened. Once the engine switch is turned to the ON or START position, the buzzer sounds for 6 seconds. The buzzer sounds once if the driver's or front passenger's seat belt is unfastened when the vehicle reaches a speed of 12 mph (20 km/h). Then, if the seat belt is still unfastened after 30 seconds elapse, the buzzer will sound intermittently for approximately 10 seconds, followed by a different tone for approximately 20 more seconds.

\*2: Refer to the separate "Scheduled Maintenance Guide" or "Owner's Manual Supplement" for the maintenance interval applicable to your vehicle.

### ■ Key reminder buzzer

The buzzer indicates that the key has not been removed (with the engine switch in the ACC or LOCK position and the driver's door opened).

### ■ If the malfunction indicator lamp comes on while driving

First check the following:

- Is your vehicle low on gas?  
If it is, refuel the vehicle immediately.
- Is the fuel tank cap loose?  
If it is, tighten it securely.

The light will go off after taking several driving trips.

If the light does not go off even after several trips, contact your Toyota dealer as soon as possible.

### ■ Front passenger detection sensor and passenger seat belt reminder

If luggage or other load is placed on the front passenger seat, depending on its weight, the reminder light to flash and buzzer to sound.

### ■ When the tire pressure warning light comes on

Check the tire inflation pressure and adjust to the appropriate level.

Pushing the tire pressure warning reset switch does not turn off the tire pressure warning light.

### ■ The tire pressure warning light may turn on due to natural causes

The tire pressure warning light may turn on due to natural causes such as natural air leaks or tire inflation pressure changes caused by temperature. In this case, adjusting the tire inflation pressure will turn off the warning light (after a few minutes).

### ■ When a tire is replaced with a spare tire

The temporary spare tire is not equipped with the tire pressure warning valve and transmitter. If a tire goes flat, the tire pressure warning light will not turn off even though the flat tire is replaced with the temporary spare tire. Replace the temporary spare tire with the repaired tire and adjust the proper tire inflation pressure. The tire pressure warning light will turn off after a few minutes.

**■ If the tire pressure warning system is inoperative**

The tire pressure warning system will be disabled in the following conditions:

(When the condition becomes normal, the system will work properly.)

- If tires not equipped with tire pressure warning valves and transmitters are used.
- If the ID code on the tire pressure warning valves and transmitters is not registered in the tire pressure warning computer.
- If the tire inflation pressure is 73 psi (500 kPa, 5.1 kgf/cm<sup>2</sup> or bar) or higher.

The tire pressure warning system may be disabled in the following conditions:

(When the condition becomes normal, the system will work properly.)

- If electronic devices or facilities using similar radio wave frequencies are nearby.
- If a radio set at similar frequencies is in use in the vehicle.
- If a window tint that affects the radio wave signals is installed.
- If there is a lot of snow or ice on the vehicle, in particular around the wheels or wheel housings.
- If non-genuine Toyota wheels are used. (Even if you use Toyota wheels, the tire pressure warning system may not work properly with some types of tires.)
- If tire chains are used.

**■ If the tire pressure warning light frequently comes on after blinking for 1 minute**

If the tire pressure warning light frequently comes on after blinking for 1 minute when the engine switch is turned to the ON position, have it checked by your Toyota dealer.

**■ Customization that can be configured at Toyota dealer**

The vehicle speed linked seat belt reminder buzzer can be disabled. (Customizable features →P. 551)

 **CAUTION**

■ **If the tire pressure warning light comes on**

Be sure to observe the following precautions. Failure to do so could cause loss of vehicle control and result in death or serious injury.

- Stop your vehicle in a safe place as soon as possible. Adjust the tire inflation pressure immediately.
- If the tire pressure warning light comes on even after tire inflation pressure adjustment, it is probable that you have a flat tire. Check the tires. If the tire is flat, change to the spare tire and have the flat tire repaired by the nearest Toyota dealer.
- Avoid abrupt maneuvering and braking. If the vehicle tires deteriorate, you could lose control of the steering wheel or the brakes.

■ **If a blowout or sudden air leakage should occur**

The tire pressure warning system may not activate immediately.

■ **Maintenance of the tire**

Each tire, including the spare (if provided), should be checked monthly when cold and inflated to the inflation pressure recommended by the vehicle manufacturer on the vehicle placard or tire inflation pressure label (tire and load information label). (If your vehicle has tires of a different size than the size indicated on the vehicle placard or tire inflation pressure label [tire and load information label], you should determine the proper tire inflation pressure for those tires.)

As an added safety feature, your vehicle has been equipped with a tire pressure monitoring system (TPMS-tire pressure warning system) that illuminates a low tire pressure telltale (tire pressure warning light) when one or more of your tires is significantly under-inflated. Accordingly, when the low tire pressure telltale (tire pressure warning light) illuminates, you should stop and check your tires as soon as possible, and inflate them to the proper pressure. Driving on a significantly under-inflated tire causes the tire to overheat and can lead to tire failure. Under-inflation also reduces fuel efficiency and tire tread life, and may affect the vehicle's handling and stopping ability.

 CAUTION**■ Maintenance of the tire**

Please note that the TPMS (tire pressure warning system) is not a substitute for proper tire maintenance, and it is the driver's responsibility to maintain correct tire pressure, even if under-inflation has not reached the level to trigger illumination of the TPMS low tire pressure telltale (tire pressure warning light).

Your vehicle has also been equipped with a TPMS (tire pressure warning system) malfunction indicator to indicate when the system is not operating properly. The TPMS (tire pressure warning system) malfunction indicator is combined with the low tire pressure telltale (tire pressure warning light). When the system detects a malfunction, the telltale will flash for approximately one minute and then remain continuously illuminated. This sequence will continue upon subsequent vehicle start-ups as long as the malfunction exists. When the malfunction indicator is illuminated, the system may not be able to detect or signal low tire pressure as intended.

TPMS (tire pressure warning system) malfunctions may occur for a variety of reasons, including the installation of replacement or alternate tires or wheels on the vehicle that prevent the TPMS (tire pressure warning system) from functioning properly. Always check the TPMS (tire pressure warning system) malfunction telltale after replacing one or more tires or wheels on your vehicle to ensure that the replacement or alternate tires and wheels allow the TPMS (tire pressure warning system) to continue to function properly.

 NOTICE**■ To ensure the tire pressure warning system operates properly**

Do not install tires with different specifications or makers, as the tire pressure warning system may not operate properly.

## 5-2. Steps to take in an emergency If you have a flat tire

Your vehicle is equipped with a spare tire. The flat tire can be replaced with the spare tire.

### ■ Before jacking up the vehicle

- Stop the vehicle on a hard, flat surface.
- Set the parking brake.
- Shift the shift lever to P (automatic transmission) or R (manual transmission).
- Stop the engine.
- Turn on the emergency flashers.

### ■ Location of the spare tire

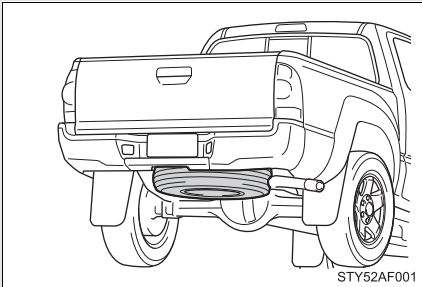

### ■ Location of the jack and tools

#### ► Access Cab models

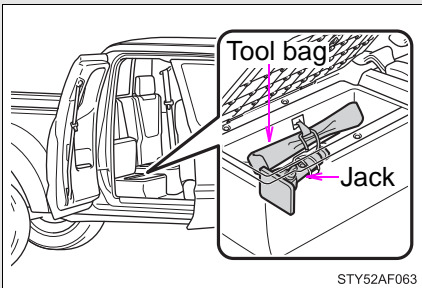

► Double Cab models

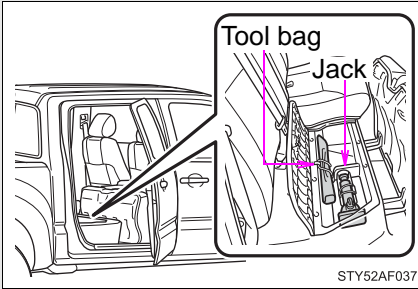

**Taking out the jack and tool bag**

► Access Cab models

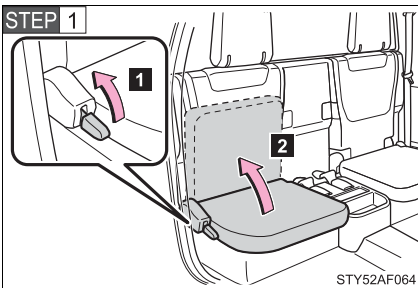

Vehicles with rear seats:

- 1** Pull up the lever.
- 2** Raise the bottom cushion up.

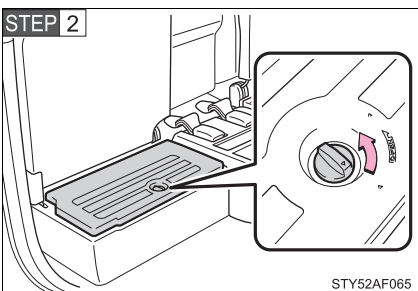

Turn the knob counterclockwise.

## 5-2. Steps to take in an emergency

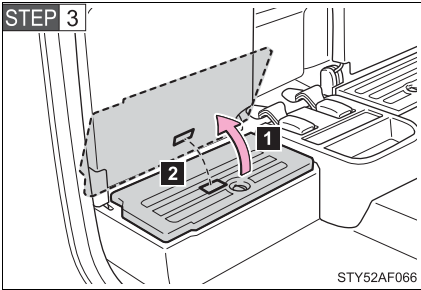

**1** Open the lid.

**2** Vehicles with rear seats: Press the lid against the bottom of the lower cushion until it is supported by the hook-and-loop fastener.

Make sure that the lid is supported to prevent it from closing unexpectedly.

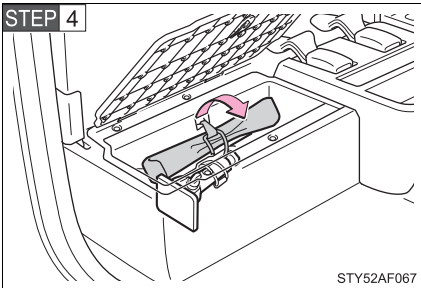

Unhook the strap and remove the tool bag.

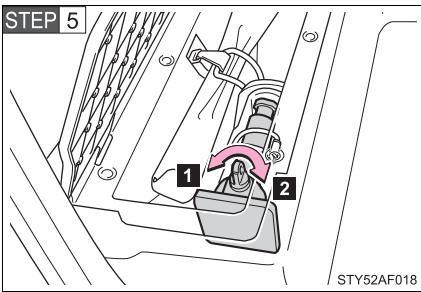

Loosen and remove the jack.

**1** Loosen

**2** Tighten



► Double Cab models

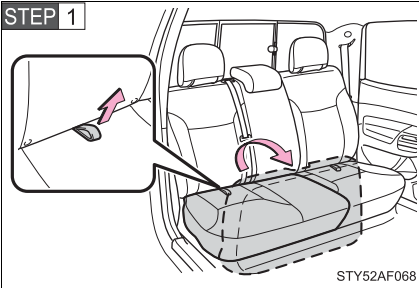

Swing the bottom cushion up by pulling the lock release strap.

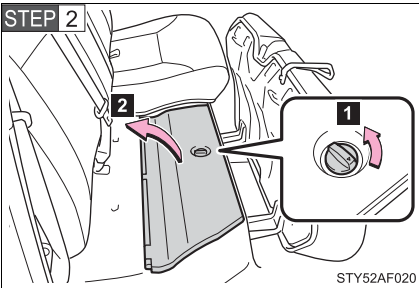

- 1 Turn the knob counterclockwise.
- 2 Open the lid.

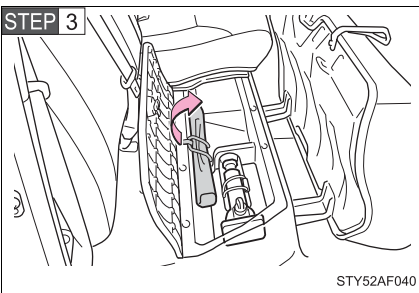

Unhook the strap and remove the tool bag.

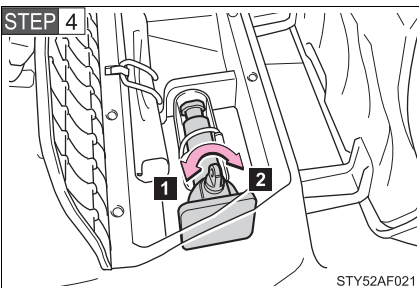

Loosen and remove the jack.

- 1 Loosen
- 2 Tighten

### Assemble the jack handle (in the tool bag)

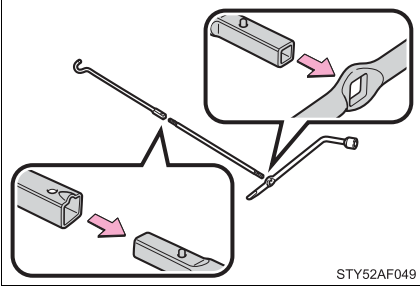

Assemble the jack handle extension as shown.

### Taking out the spare tire

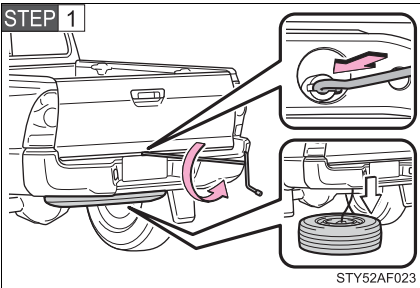

Insert the end of the jack handle extension into the lowering screw and turn it counterclockwise.

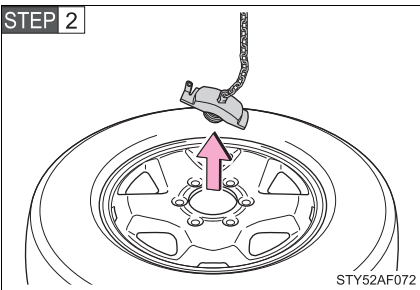

After the tire is lowered completely to the ground, remove the holding bracket.

## Replacing a flat tire

STEP 1

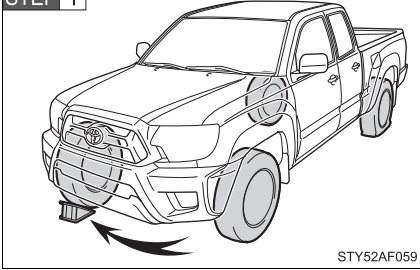

Chock the tires.

Flat tire		Wheel chock positions
Front	Left-hand side	Behind the rear right-hand side tire
	Right-hand side	Behind the rear left-hand side tire
Rear	Left-hand side	In front of the front right-hand side tire
	Right-hand side	In front of the front left-hand side tire

STEP 2

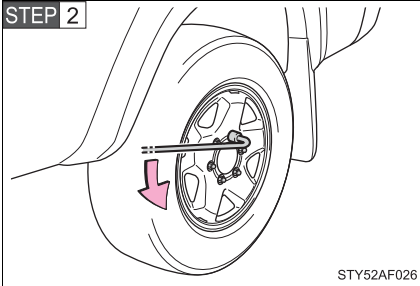

Slightly loosen the wheel nuts (one turn).

STEP 3

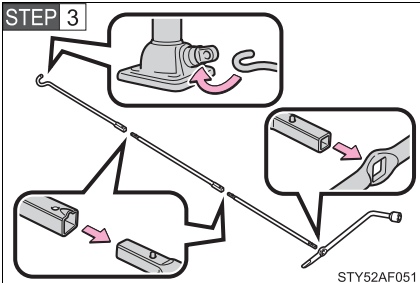

Assemble the jack handle extension as shown.

## 5-2. Steps to take in an emergency

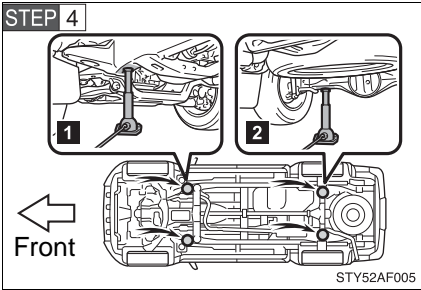

Position the jack at the correct jack point as shown.

- 1 Front
- 2 Rear

Make sure the jack is positioned on a level and solid place.

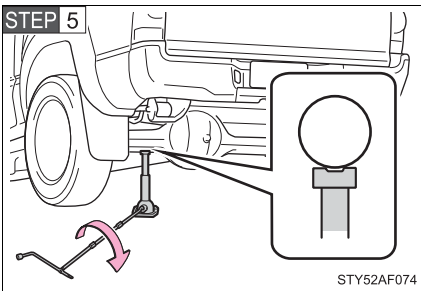

Raise the vehicle until the tire is slightly raised off the ground.

When positioning the jack under the rear axle housing, make sure the groove on the top of the jack fits with the rear axle housing.

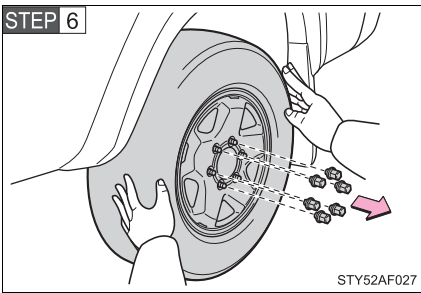

Remove all the wheel nuts and the tire.

When resting the tire on the ground, place the tire so that the wheel design faces up to avoid scratching the wheel surface.

### Installing the tire

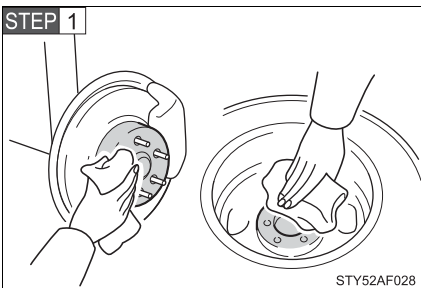

Remove any dirt or foreign matter from the wheel contact surface.

If foreign matter is on the wheel contact surface, the wheel nuts may loosen while the vehicle is in motion, and the tire may come off the vehicle.

**STEP 2** Install the tire and loosely tighten each wheel nut by hand by approximately the same amount.

► Replacing a steel wheel with a steel wheel

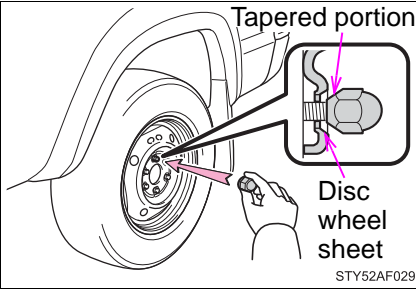

Tighten the nuts until the tapered portion comes into loose contact with the disc wheel sheet.

► Replacing an aluminum wheel with a steel wheel

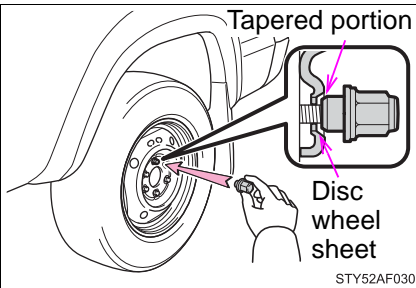

Tighten the nuts until the tapered portion comes into loose contact with the disc wheel sheet.

► Replacing an aluminum wheel with an aluminum wheel

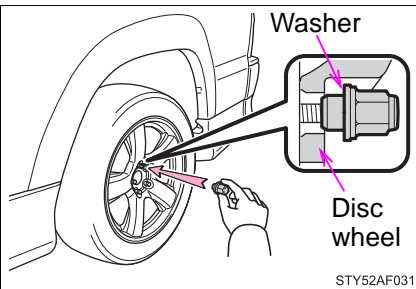

Tighten the nuts until the washer of the nut comes into loose contact with the disc wheel.

## 5-2. Steps to take in an emergency

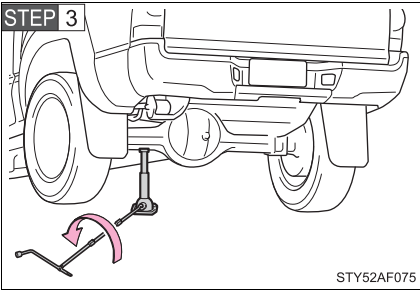

Lower the vehicle.

**STEP 4** Firmly tighten each nut two or three times in the order shown in the illustration.

**Tightening torque:**  
83 ft·lbf (113 N·m, 11.5 kgf·m)

► 2WD models except PreRunner

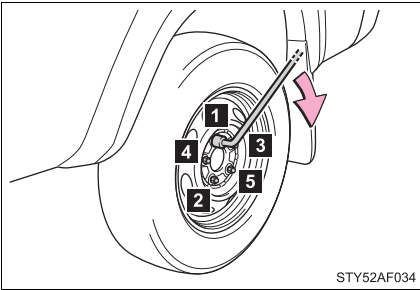

► 4WD models and PreRunner

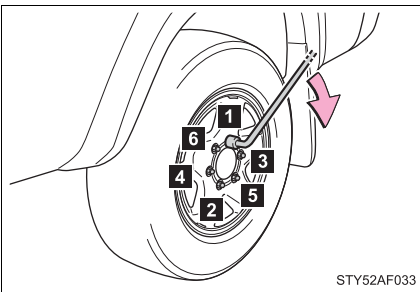

**⚠ CAUTION****■ Stowing the flat tire**

Failure to follow steps listed under stowing the tire may result in damage to the spare tire carrier and loss of the tire, which could result in serious injury or death.

**Stowing the flat tire, jack and all tools**

**STEP 1** Remove the center wheel ornament by pushing from the reverse side.

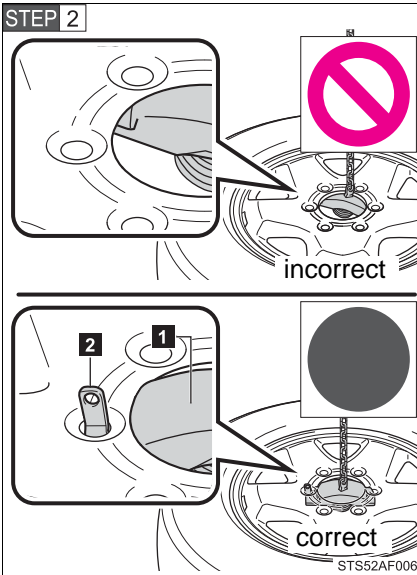

Lay down the tire with the valve stem facing up and install the holding bracket, inserting the claw into the wheel lug nut hole. Turn the jack handle extension clockwise to take up slack in the chain.

Then, check to ensure the claw is in the wheel lug nut hole and the holding bracket is centered in the wheel hub.

**1** Holding bracket

**2** Claw (Claw on 4WD and Pre-Runner only)

While raising, secure the tire, taking care that the tire goes straight up without catching on any surrounding parts, to prevent it from flying forward during a collision or sudden braking.

**Tightening torque:**

27.6 ft·lbf (37.4 N·m, 3.8 kgf·m)

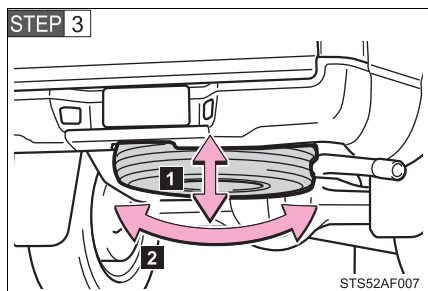

Confirm that the tire is not loose after tightening:

- 1 Push and pull the tire
- 2 Try rotating

Visually check to ensure the tire is not hung on surrounding parts.

If looseness or misassembly exists, repeat step 2 and step 3.

**STEP 4** Repeat step 3 any time the tire is lowered or disturbed.

**STEP 5** Stow the tools and jack securely.

#### ■ After completing the tire change

The tire pressure warning system must be reset. (→P. 423)

#### ■ When using the temporary spare tire

As the temporary spare tire is not equipped with the tire pressure warning valve and transmitter, low inflation pressure of the spare tire will not be warned. Also, if you replace the temporary spare tire after the tire pressure warning light comes on, the light remains on.



 **CAUTION****■ Using the jack**

Improper use of the jack may lead to death or serious injuries due to the vehicle suddenly falling off the jack.

- Do not use the jack for any purpose other than replacing tires or installing and removing tire chains.
- Only use the jack that comes with this vehicle for replacing a flat tire. Do not use it on other vehicles, and do not use other jacks for replacing tires on this vehicle.
- Always check that the jack is securely set to the jack point.
- Do not put any part of your body under the vehicle supported by a jack.
- Do not start or run the engine while your vehicle is supported by the jack.
- Do not raise the vehicle while someone is in it.
- When raising the vehicle, do not put an object on or under the jack.
- Do not raise the vehicle to a height greater than that required to replace the tire.
- Use a jack stand if it is necessary to get under the vehicle.

Take particular care when lowering the vehicle to ensure that no one working on or near the vehicle will be injured.

**■ Using the jack handle**

Tighten all the screws securely to prevent the extension parts from coming apart unexpectedly.

**■ Replacing a flat tire**

- Observe the following precautions.

Failure to do so may result in serious injury:

- Lower the spare tire completely to the ground before removing it from under the vehicle.
- Do not try to remove the wheel ornament by hand. Take due care in handling the ornament to avoid unexpected personal injury.

 CAUTION

■ **Replacing a flat tire**

- Do not touch the disc wheels or the area around the brakes immediately after the vehicle has been driven.

After the vehicle has been driven the disc wheels and the area around the brakes will be extremely hot. Touching these areas with hands, feet or other body parts while changing a tire, etc. may result in burns.

- Failure to follow these precautions could cause the wheel nuts to loosen and the tire to fall off, resulting in death or serious injury.
- Have the wheel nuts tightened with a torque wrench to 83 ft·lbf (113 N·m, 11.5 kgf·m) as soon as possible after changing wheels.
- When installing a tire, only use wheel nuts that have been specifically designed for that wheel.
- If there are any cracks or deformations in the bolt screws, nut threads or bolt holes of the wheel, have the vehicle inspected by your Toyota dealer.
- Do not attach a heavily damaged wheel ornament, as it may fly off the wheel while the vehicle is moving.
- When installing the wheel nuts, be sure to install them with the tapered ends facing inward. (→P. 437)

■ **When using the temporary spare tire**

- Remember that your temporary spare tire is specifically designed for use with your vehicle. Do not use your temporary spare tire on another vehicle.
- Do not use two temporary spare tires simultaneously.
- Replace the temporary spare tire with a standard tire as soon as possible.
- Avoid sudden acceleration, deceleration and braking, as well as sharp cornering.

 CAUTION**■ Speed limit when using the temporary spare tire**

Do not drive at speeds in excess of 50 mph (80 km/h) when a temporary spare tire is installed on the vehicle.

The temporary spare tire is not designed for driving at high speeds. Failing to observe this precaution may lead to an accident causing death or serious injury.

**■ Driving with tire chains and the temporary spare tire**

Do not fit tire chains to the temporary spare tire.

Tire chains may damage the vehicle body and adversely affect driving performance.

**■ When the spare tire is attached**

The vehicle speed may not be correctly detected, and the following systems may not operate correctly:

- ABS & Brake assist
- VSC
- TRAC
- Active traction control system (if equipped)
- Hill-start assist control system (if equipped)
- Downhill assist control system (if equipped)
- AUTO LSD system
- Cruise control (if equipped)

Also, not only can the following system not be utilized fully, it may actually negatively effect the drive-train components:

- 4WD system

 NOTICE

■ **Do not drive the vehicle with a flat tire**

Do not continue driving with a flat tire.

Driving even a short distance with a flat tire can damage the tire and the wheel beyond repair.

■ **When stowing the flat tire**

Ensure that there is no object caught between the tire and the vehicle underbody.

■ **When replacing the tires**

● When removing or fitting the wheels, tires or the tire pressure warning valve and transmitter, contact your Toyota dealer as the tire pressure warning valve and transmitter may be damaged if not handled correctly.

● Replace the grommets for the tire pressure warning valves and transmitters as well.

■ **To avoid damage to the tire pressure warning valves and transmitters**

When a tire is repaired with liquid sealants, the tire pressure warning valve and transmitter may not operate properly. If a liquid sealant is used, contact your Toyota dealer or other qualified service shop as soon as possible. Make sure to replace the tire pressure warning valve and transmitter when replacing the tire. (→P. 423)

## 5-2. Steps to take in an emergency If the engine will not start

**If the engine still does not start after following the correct starting procedure (→P. 131) or releasing the steering lock (→P. 132), confirm the following points.**

■ **The engine will not start even when the starter motor operates normally.**

One of the following may be the cause of the problem.

- There may not be sufficient fuel in the vehicle's tank.  
Refuel the vehicle.
- The engine may be flooded.  
Try to restart the engine once more following correct starting procedures.
- There may be a malfunction in the engine immobilizer system.  
(→P. 77)

■ **The starter motor turns over slowly, the interior lights and headlights are dim, or the horn does not sound or sounds at a low volume.**

One of the following may be the cause of the problem.

- The battery may be discharged. (→P. 504)
- The battery terminal connections may be loose or corroded.

■ **The starter motor does not turn over, the interior lights and headlights do not turn on, or the horn does not sound.**

One of the following may be the cause of the problem.

- One or both of the battery terminals may be disconnected.
- The battery may be discharged. (→P. 504)

Contact your Toyota dealer if the problem cannot be repaired, or if repair procedures are unknown.

## 5-2. Steps to take in an emergency

If the shift lever cannot be shifted from P (vehicles with an automatic transmission)

**If the shift lever cannot be shifted with your foot on the brake, there may be a problem with the shift lock system (a system to prevent accidental operation of the shift lever). Have the vehicle inspected by your Toyota dealer immediately.**

**The following steps may be used as an emergency measure to ensure that the shift lever can be shifted.**

**STEP 1** Set the parking brake.

**STEP 2** Turn the engine switch to the ACC or ON position.

**STEP 3** Depress the brake pedal.

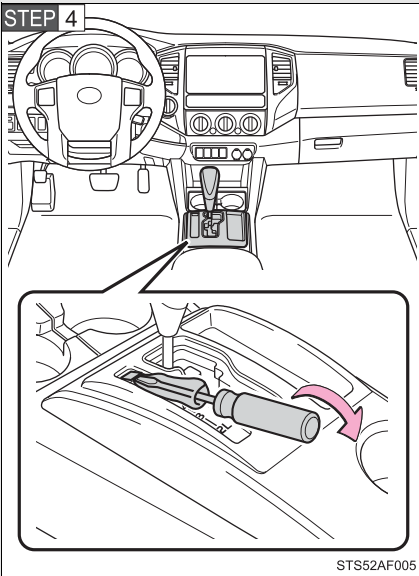

Pry the cover up with a flat-head screwdriver or equivalent.

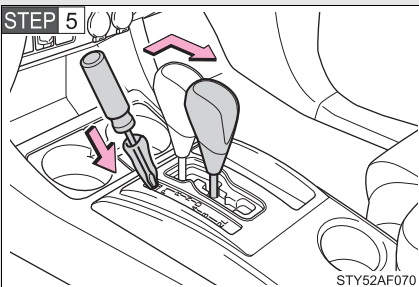

Press the shift lock override button.

The shift lever can be shifted while the button is pressed.

## If you lose your keys

**New genuine Toyota keys can be made by your Toyota dealer using the other key and the key number stamped on your key number plate.**

## 5-2. Steps to take in an emergency

### If the vehicle battery is discharged

The following procedures may be used to start the engine if the vehicle's battery is discharged.

You can call your Toyota dealer or qualified repair shop.

If you have a set of jumper (or booster) cables and a second vehicle with a 12-volt battery, you can jump start your Toyota following the steps below.

**STEP 1** Connect the jumper cables.

► 2.7 L 4-cylinder (2TR-FE) engine

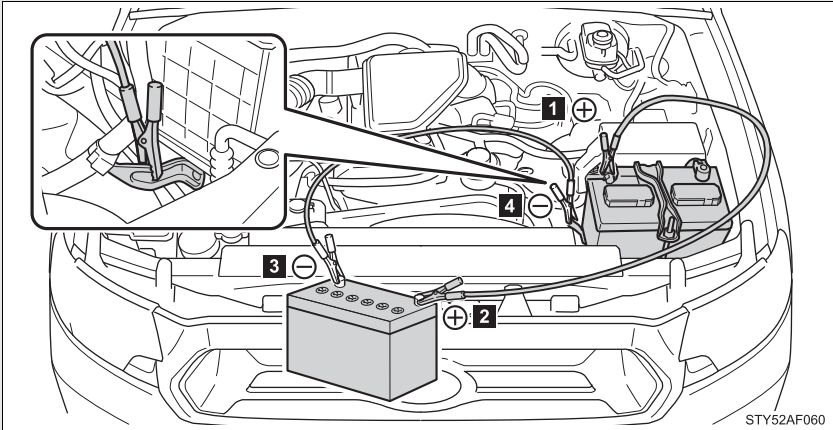



## ► 4.0 L V6 (1GR-FE) engine

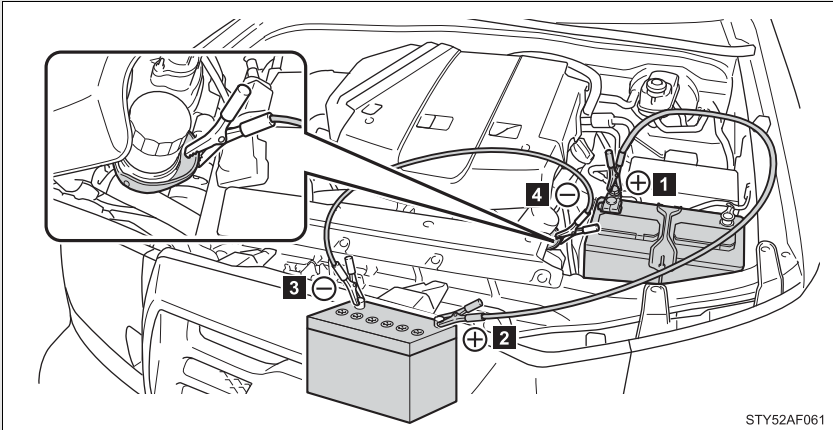

STY52AF061

- 1** Positive (+) battery terminal on your vehicle
- 2** Positive (+) battery terminal on the second vehicle
- 3** Negative (-) battery terminal on the second vehicle
- 4** Connect the jumper cable to ground on your vehicle as shown in the illustration.

**STEP 2** Start the engine of the second vehicle. Increase the engine speed slightly and maintain at that level for approximately 5 minutes to recharge the battery of your vehicle.

**STEP 3** Maintain the engine speed of the second vehicle and start the vehicle's engine.

**STEP 4** Once the vehicle's engine has started, remove the jumper cables in the exact reverse order in which they were connected.

Once the engine starts, have the vehicle checked at your Toyota dealer as soon as possible.

---

■ **Starting the engine when the battery is discharged (vehicles with an automatic transmission)**

The engine cannot be started by push-starting.

■ **Avoiding a discharged battery**

- Turn off the headlights and the audio system while the engine is turned off.
- Turn off any unnecessary electrical components when the vehicle is running at a low speed for an extended period, such as in heavy traffic, etc.

■ **Charging the battery**

The electricity stored in the battery will discharge gradually even when the vehicle is not in use, due to natural discharge and the draining effects of certain electrical appliances. If the vehicle is left for a long time, the battery may discharge, and the engine may be unable to start. (The battery recharges automatically during driving.)

 **CAUTION**

■ **Avoiding battery fires or explosions**

Observe the following precautions to prevent accidentally igniting the flammable gas that may be emitted from the battery.

- Make sure the jumper cable is connected to the correct terminal and that it is not unintentionally in contact with any part other than the intended terminal.
- Do not allow the jumper cables to come into contact with the “+” and “-” terminals.
- Do not smoke, use matches, cigarette lighters or allow open flame near the battery.

 CAUTION**■ Battery precautions**

The battery contains poisonous and corrosive acidic electrolyte, while related parts contain lead and lead compounds. Observe the following precautions when handling the battery.

- When working with the battery, always wear safety glasses and take care not to allow any battery fluids (acid) to come into contact with skin, clothing or the vehicle body.
- Do not lean over the battery.
- In the event that battery fluid comes into contact with the skin or eyes, immediately wash the affected area with water and seek medical attention. Place a wet sponge or cloth over the affected area until medical attention can be received.
- Always wash your hands after handling the battery support, terminals, and other battery-related parts.
- Do not allow children near the battery.

 NOTICE**■ To prevent damaging the vehicle (vehicles with a manual transmission)**

Do not pull- or push-start the vehicle, because the three-way catalytic converter may overheat and become a fire hazard.

**■ When handling jumper cables**

Be careful that the jumper cables do not become tangled in the cooling fan or any of the belts when connecting or disconnecting them.

## 5-2. Steps to take in an emergency If your vehicle overheats

### The following may indicate that your vehicle is overheating.

- The needle of the engine coolant temperature gauge (→P. 145) enters the red zone or a loss of engine power is experienced. (For example, the vehicle speed does not increase.)
- Steam comes out from under the hood.

### Correction procedures

**STEP 1** Stop the vehicle in a safe place and turn off the air conditioning system, and then stop the engine.

**STEP 2** If you see steam:

Carefully lift the hood after the steam subsides completely.

If you do not see steam:

Carefully lift the hood.

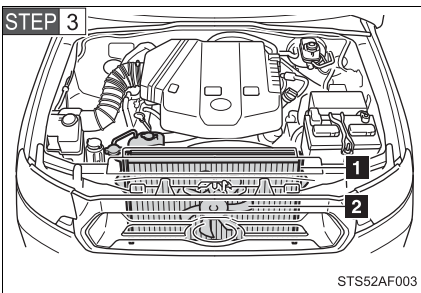

After the engine has cooled down sufficiently, inspect the hoses and radiator core (radiator) for any leaks.

- 1 Radiator
- 2 Cooling fan

If a large amount of coolant leaks, immediately contact your Toyota dealer.

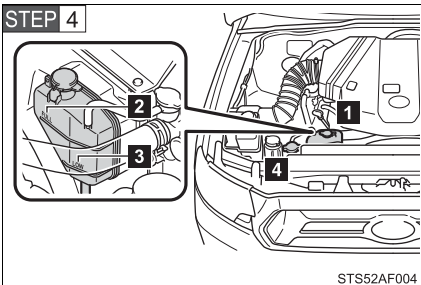

The coolant level is satisfactory if the reservoir level is between the "FULL" and "LOW" lines on the reservoir.

- 1 Reservoir
- 2 "FULL"
- 3 "LOW"
- 4 Radiator cap

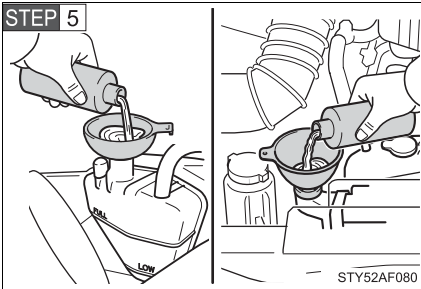

Add coolant if necessary.

Water can be used in an emergency if coolant is unavailable.

**STEP 6** Start the engine to check that the radiator cooling fan operates and check for coolant leaks from the radiator or hoses.

**STEP 7** If the fan is not operating:

Stop the engine immediately and contact your Toyota dealer.

If the fan is operating:

Have the vehicle inspected at the nearest Toyota dealer.

### ⚠ CAUTION

#### ■ To prevent an accident or injury when inspecting under the hood of your vehicle

- If steam is seen coming from under the hood, do not open the hood until the steam has subsided. The engine compartment may be very hot, causing serious injuries such as burns.
- Keep hands and clothing (especially a tie, a scarf or a muffler) away from the fan and belts. Failure to do so may cause the hands or clothing to be caught, resulting in serious injury.
- Do not loosen the radiator cap and the coolant reservoir cap while the engine and radiator are hot. Serious injury, such as burns, may result from hot coolant and steam released under pressure.

 NOTICE

■ **When adding engine coolant**

Wait until the engine has cooled down before adding engine coolant. When adding coolant, do so slowly. Adding cool coolant to a hot engine too quickly can cause damage to the engine.

■ **To prevent damage to the cooling system**

Observe the following precautions:

- Avoid contaminating the coolant with foreign matter (such as sand or dust etc.).
- Do not use any coolant additives.

## 5-2. Steps to take in an emergency If the vehicle becomes stuck

**Carry out the following procedures if the tires spin or the vehicle becomes stuck in mud, dirt, or snow.**

- STEP 1** Stop the engine. Set the parking brake and put the shift lever in P (vehicles with an automatic transmission) or N (vehicles with a manual transmission).
- STEP 2** Remove the mud, snow, or sand from around the stuck tire.
- STEP 3** Place wood, stones or some other material to help provide traction under the tires.
- STEP 4** Restart the engine.
- STEP 5** Turn off the VSC. (→P. 192, 193)
- STEP 6** Shift the shift lever to D or R (automatic transmission) or 1 or R (manual transmission) and carefully apply the accelerator to free the vehicle.

### CAUTION

#### ■ When attempting to free a stuck vehicle

If you choose to rock the vehicle back and forth to free it, make sure the surrounding area is clear, to avoid striking other vehicles, objects or persons. The vehicle may also lunge forward or back suddenly as it becomes free. Use extreme caution.

#### ■ When shifting the shift lever

Vehicles with an automatic transmission: Be careful not to shift the shift lever with the accelerator pedal depressed.

This may lead to unexpected rapid acceleration of the vehicle that may cause an accident and result in death or serious injury.



## NOTICE

### ■ **To avoid damaging the transmission and other components**

- Avoid spinning the wheels and do not rev up the engine.
- If the vehicle remains stuck after trying these procedures, the vehicle may require towing to be freed.



## 5-2. Steps to take in an emergency

### If your vehicle has to be stopped in an emergency

**Only in an emergency, such as if it becomes impossible to stop the vehicle in the normal way, stop the vehicle using the following procedure:**

**STEP 1** Steadily step on the brake pedal with both feet and firmly depress it.

Do not pump the brake pedal repeatedly as this will increase the effort required to slow the vehicle.

**STEP 2** Shift the shift lever to N.

► If the shift lever is shifted to N

**STEP 3** After slowing down, stop the vehicle in a safe place by the road.

**STEP 4** Stop the engine.

► If the shift lever cannot be shifted to N

**STEP 3** Keep depressing the brake pedal with both feet to reduce vehicle speed as much as possible.

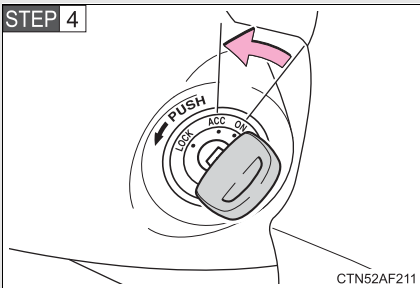

Stop the engine by turning the engine switch to the ACC position.

**STEP 5** Stop the vehicle in a safe place by the road.

 CAUTION

■ **If the engine has to be turned off while driving**

- Power assist for the brakes and steering wheel will be lost, making the brake pedal harder to depress and the steering wheel heavier to turn. Decelerate as much as possible before turning off the engine.
- Never attempt to remove the key, as doing so will lock the steering wheel.





### 6-1. Specifications

Maintenance data (fuel, oil level, etc.).....	516
Fuel information .....	537
Tire information .....	540

### 6-2. Customization

Customizable features .....	551
Items to initialize .....	552

## 6-1. Specifications

### Maintenance data (fuel, oil level, etc.)

#### Dimensions

##### ► 2WD models except PreRunner

Cab type	Access Cab		Double Cab
	Except X-Runner	X-Runner	
Overall length	208.1 in. (5285 mm)	208.5 in. (5295 mm)	208.1 in. (5285 mm)
Overall width	72.2 in. (1835 mm)	74.0 in. (1880 mm)	74.6 in. (1895 mm)
Overall height*	66.1 in. (1680 mm)	65.6 in. (1665 mm)	66.1 in. (1680 mm)
Wheelbase	127.4 in. (3235 mm)		
Front tread	61.0 in. (1550 mm)	62.2 in. (1580 mm)	61.0 in. (1550 mm)
Rear tread	61.0 in. (1550 mm)	62.2 in. (1580 mm)	61.0 in. (1550 mm)

\*: Unladen vehicle

## ► 4WD models and PreRunner

Cab type	Access Cab
Overall length	208.1 in. (5285 mm)
Overall width	74.6 in. (1895 mm)
Overall height* <sup>1</sup>	70.3 in. (1785 mm)
Wheelbase	127.4 in. (3235 mm)
Front tread	63.0 in. (1600 mm) 63.4 in. (1610 mm)* <sup>2</sup>
Rear tread	63.2 in. (1605 mm) 63.6 in. (1615 mm)* <sup>2</sup>

Cab type		Double Cab	
		With short deck	With long deck
Overall length		208.1 in. (5285 mm)	221.3 in. (5620 mm)
Overall width		74.6 in. (1895 mm)	
Overall height* <sup>1</sup>	2.7 L 4-cylinder (2TR-FE) engine	70.3 in. (1785 mm)	
	4.0 L V6 (1GR-FE) engine	70.1 in. (1780 mm)	
Wheelbase		127.4 in. (3235 mm)	140.6 in. (3570 mm)
Front tread		63.0 in. (1600 mm) 63.4 in. (1610 mm)* <sup>2</sup>	
Rear tread		63.4 in. (1610 mm) 63.8 in. (1620 mm)* <sup>2</sup>	

\*<sup>1</sup>:Unladen vehicle\*<sup>2</sup>:P265/60R18 tires

<b>Vehicle capacity weight</b>
--------------------------------

## ► 2WD models except PreRunner

Cab type	Engine	Deck type	Vehicle capacity weight (Occupant + luggage)*
Access Cab	2.7 L 4-cylinder (2TR-FE) engine	Long deck	1050 lb. (475 kg)
	4.0 L V6 (1GR-FE) engine		850 lb. (385 kg)
Double Cab	2.7 L 4-cylinder (2TR-FE) engine		950 lb. (430 kg)

\*: Installing accessories in addition to those installed at the factory increases vehicle weight, thereby reducing vehicle capacity weight. Contact your Toyota dealer about the weight of accessory parts.

## ► PreRunner

Cab type	Engine	Deck type	Vehicle capacity weight (Occupant + luggage)*
Access Cab	2.7 L 4-cylinder (2TR-FE) engine	Long deck	1300 lb. (585 kg)
	4.0 L V6 (1GR-FE) engine		1250 lb. (565 kg)
Double Cab	2.7 L 4-cylinder (2TR-FE) engine	Short deck	1300 lb. (585 kg)
	4.0 L V6 (1GR-FE) engine	Long deck	1150 lb. (520 kg)

\*: Installing accessories in addition to those installed at the factory increases vehicle weight, thereby reducing vehicle capacity weight. Contact your Toyota dealer about the weight of accessory parts.



## ► 4WD models

Cab type	Engine	Deck type	Vehicle capacity weight (Occupant + luggage)*
Access Cab	2.7 L 4-cylinder (2TR-FE) engine	Long deck	1200 lb. (540 kg)
	4.0 L V6 (1GR-FE) engine		1140 lb. (515 kg)
Double Cab	4.0 L V6 (1GR-FE) engine	Short deck	1040 lb. (470 kg)
		Long deck	

\*: Installing accessories in addition to those installed at the factory increases vehicle weight, thereby reducing vehicle capacity weight. Contact your Toyota dealer about the weight of accessory parts.

<b>TWR (Trailer Weight Rating)</b>
------------------------------------

## ► Access Cab models

Model code*1	Engine	Driving system	TWR
TRN225L-CRMDKA	2.7 L 4-cylinder (2TR-FE) engine	2WD	3500 lb. (1585 kg)
TRN225L-CRPDKA			
TRN245L-CRMDKA		4WD	
TRN245L-CRPDKA			
TRN265L-CRPDKA		2WD	
GRN225L-CRFDKA	4.0 L V6 (1GR-FE) engine	4WD	3500 lb. (1585 kg) <sup>*2</sup>
GRN245L-CRADKA			6500 lb. (2945 kg) <sup>*3</sup>
			3500 lb. (1585 kg) <sup>*2</sup>
GRN245L-CRFDKA			6500 lb. (2945 kg) <sup>*3</sup>
		GRN265L-CRADKA	2WD
6500 lb. (2945 kg) <sup>*3</sup>			

► Double Cab models

Model code*1	Engine	Driving system	TWR
TRN225L-PRPDKA	2.7 L 4-cylinder (2TR-FE) engine	2WD	3400 lb. (1540 kg)
TRN265L-PRPDKA			3500 lb. (1585 kg)
GRN245L-PRADKA	4.0 L V6 (1GR-FE) engine	4WD	3500 lb. (1585 kg) <sup>*2</sup>
			6500 lb. (2945 kg) <sup>*3</sup>
GRN245L-PRFDKA			3500 lb. (1585 kg) <sup>*2</sup>
			6500 lb. (2945 kg) <sup>*3</sup>
GRN250L-PRADKA		3400 lb. (1540 kg) <sup>*2</sup>	
		6200 lb. (2810 kg) <sup>*3</sup>	
GRN265L-PRADKA		2WD	3500 lb. (1585 kg) <sup>*2</sup>
			6500 lb. (2945 kg) <sup>*3</sup>
GRN270L-PRADKA			3500 lb. (1585 kg) <sup>*2</sup>
			6500 lb. (2945 kg) <sup>*3</sup>

\*1: The model code is indicated on the Certification Label. (→P. 521)

\*2: Without towing package

\*3: With towing package

## Vehicle identification

### ■ Vehicle identification number

The vehicle identification number (VIN) is the legal identifier for your vehicle. This is the primary identification number for your Toyota. It is used in registering the ownership of your vehicle.

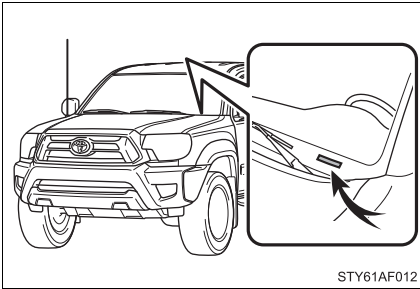

This number is stamped on the top left of the instrument panel.

#### ► Access Cab models

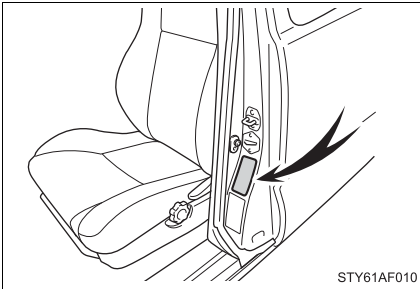

This number is also on the Certification Label.

#### ► Double Cab models

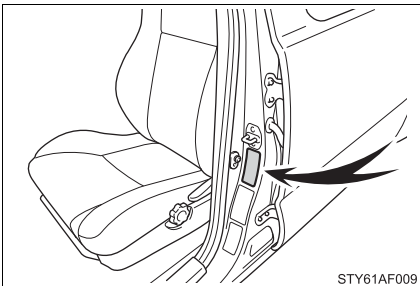

This number is also on the Certification Label.

■ **Engine number**

The engine number is stamped on the engine block as shown.

▶ **2.7 L 4-cylinder (2TR-FE) engine**

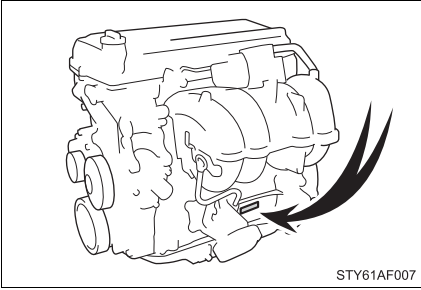

▶ **4.0 L V6 (1GR-FE) engine**

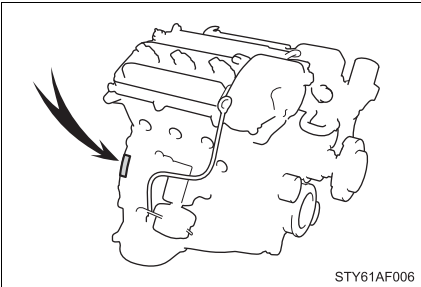

**Engine**

## ► 2.7 L 4-cylinder (2TR-FE) engine

Model	2TR-FE
Type	4-cylinder in line, 4-cycle, gasoline
Bore and stroke	3.74 × 3.74 in. (95.0 × 95.0 mm)
Displacement	164.3 cu.in. (2694 cm <sup>3</sup> )
Drive belt tension	Automatic adjustment
Valve clearance (engine cold) Intake Exhaust	Automatic adjustment

## ► 4.0 L V6 (1GR-FE) engine

Model	1GR-FE
Type	6-cylinder V type, 4-cycle, gasoline
Bore and stroke	3.70 × 3.74 in. (94.0 × 95.0 mm)
Displacement	241.4 cu.in. (3956 cm <sup>3</sup> )
Drive belt tension	Automatic adjustment
Valve clearance (engine cold) Intake Exhaust	0.006 — 0.010 in. (0.15 — 0.25 mm) 0.011 — 0.015 in. (0.29 — 0.39 mm)

**Fuel**

Fuel type	Unleaded gasoline only
Octane Rating	87 (Research Octane Number 91) or higher
Fuel tank capacity (Reference)	21.1 gal. (80.0 L, 17.6 Imp.gal.)

## Lubrication system

Oil capacity  
(Drain and refill - reference\*)

▶ Without filter

▶ 2.7 L 4-cylinder (2TR-FE) engine  
5.4 qt. (5.1 L, 4.5 Imp.qt.)

▶ 4.0 L V6 (1GR-FE) engine  
2WD models except PreRunner:  
4.4 qt. (4.2 L, 3.7 Imp.qt.)  
4WD models and PreRunner:  
5.2 qt. (4.9 L, 4.3 Imp.qt.)

▶ With filter

▶ 2.7 L 4-cylinder (2TR-FE) engine  
6.1 qt. (5.8 L, 5.1 Imp.qt.)

▶ 4.0 L V6 (1GR-FE) engine  
2WD models except PreRunner:  
4.8 qt. (4.5 L, 4.0 Imp.qt.)  
4WD models and PreRunner:  
5.5 qt. (5.2 L, 4.6 Imp.qt.)

\*: The engine oil capacity is a reference quantity to be used when changing the engine oil. Warm up and turn off the engine, wait more than 5 minutes, and check the oil level on the dipstick.

## ■ Engine oil selection

“Toyota Genuine Motor Oil” is used in your Toyota vehicle. Use Toyota approved “Toyota Genuine Motor Oil” or equivalent to satisfy the following grade and viscosity.

Oil grade: ILSAC GF-5 multigrade engine oil

Recommended viscosity:

- ▶ 2.7 L 4-cylinder (2TR-FE) engine  
SAE 0W-20

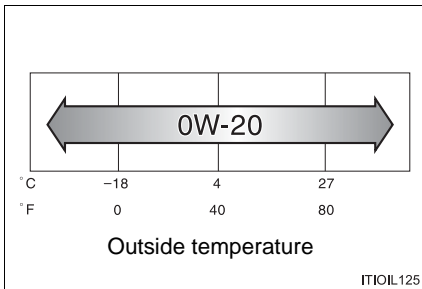

SAE 0W-20 is the best choice for good fuel economy and good starting in cold weather.

If SAE 0W-20 is not available, SAE 5W-20 oil may be used. However, it must be replaced with SAE 0W-20 at the next oil change.

Oil viscosity (0W-20 is explained here as an example):

- The 0W in 0W-20 indicates the characteristic of the oil which allows cold startability. Oils with a lower value before the W allow for easier starting of the engine in cold weather.
- The 20 in 0W-20 indicates the viscosity characteristic of the oil when the oil is at high temperature. An oil with a higher viscosity (one with a higher value) may be better suited if the vehicle is operated at high speeds, or under extreme load conditions.

► 4.0 L V6 (1GR-FE) engine  
SAE 5W-30

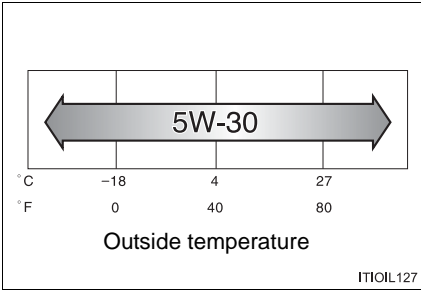

SAE 5W-30 is the best choice for good fuel economy and good starting in cold weather.

If SAE 5W-30 is not available, SAE 10W-30 oil may be used. However, it should be replaced with SAE 5W-30 at the next oil change.

Oil viscosity (5W-30 is explained here as an example):

- The 5W in 5W-30 indicates the characteristic of the oil which allows cold startability. Oils with a lower value before the W allow for easier starting of the engine in cold weather.
- The 30 in 5W-30 indicates the viscosity characteristic of the oil when the oil is at high temperature. An oil with a higher viscosity (one with a higher value) may be better suited if the vehicle is operated at high speeds, or under extreme load conditions.

How to read oil container label:

The International Lubricant Specification Advisory Committee (ILSAC) Certification Mark is added to some oil containers to help you select the oil you should use.

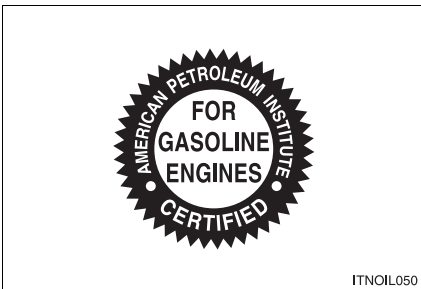



## Cooling system

Capacity	
▶ 2.7 L 4-cylinder (2TR-FE) engine	▶ Vehicles with an automatic transmission 9.1 qt. (8.6 L, 7.6 Imp.qt.) ▶ Vehicles with a manual transmission 9.2 qt. (8.7 L, 7.7 Imp.qt.)
▶ 4.0 L V6 (1GR-FE) engine	▶ Vehicles with an automatic transmission 10.1 qt. (9.6 L, 8.4 Imp.qt.) ▶ Vehicles with a manual transmission 10.3 qt. (9.7 L, 8.5 Imp.qt.)
Coolant type	Use either of the following. <ul style="list-style-type: none"> <li>• “Toyota Super Long Life Coolant”</li> <li>• Similar high-quality ethylene glycol-based non-silicate, non-amine, non-nitrite, and non-borate coolant with long-life hybrid organic acid technology</li> </ul> Do not use plain water alone.

## Ignition system

Spark plug	
▶ 2.7 L 4-cylinder (2TR-FE) engine	
Make	DENSO
Gap	SK20HR-A11 0.043 in. (1.1 mm)
▶ 4.0 L V6 (1GR-FE) engine	
Make	DENSO
	NGK
Gap	K20HR-U11 LFR6C11 0.043 in. (1.1 mm)



### NOTICE

#### ■ Iridium-tipped spark plugs (2.7 L 4-cylinder [2TR-FE] engine only)

Use only iridium-tipped spark plugs. Do not adjust gap when tuning engine.

## Electrical system

Battery	
Open voltage at 68°F (20°C):	12.6 — 12.8 V Fully charged 12.2 — 12.4 V Half charged 11.8 — 12.0 V Discharged (Voltage checked 20 minutes after the key is removed with all the lights turned off)
Charging rates	5 A max.

## Differential

Oil capacity	Front (4WD models)	1.59 qt. (1.50 L, 1.32 Imp.qt.)
	Rear	▶ 2WD models except PreRunner 3.66 qt. (3.46 L, 3.04 Imp.qt.) ▶ 4WD models and PreRunner 3.12 qt. (2.95 L, 2.60 Imp.qt.)
Oil type and viscosity*		Toyota Genuine Differential Gear Oil LT 75W-85 GL-5 or equivalent

\*: Your Toyota vehicle is filled with “Toyota Genuine Differential Gear Oil” at the factory. Use Toyota approved “Toyota Genuine Differential Gear Oil” or an equivalent oil of matching quality to satisfy the above specification. Please contact your Toyota dealer for further details.

## Automatic transmission

### ▶ 4-speed models

Fluid capacity*	10.8 qt. (10.2 L, 9.0 Imp.qt.)
Fluid type	Toyota Genuine ATF Type T-IV

### ▶ 5-speed models

Fluid capacity*	<ul style="list-style-type: none"> <li>▶ Vehicles without towing package 11.3 qt. (10.7 L, 9.4 Imp.qt.)</li> <li>▶ Vehicles with towing package 11.5 qt. (10.9 L, 9.6 Imp.qt.)</li> </ul>
Fluid type	Toyota Genuine ATF WS

\*: The fluid capacity is the quantity of reference. If replacement is necessary, contact your Toyota dealer.



## NOTICE

### ■ Automatic transmission fluid type (4-speed models)

Using automatic transmission fluid other than “Toyota Genuine ATF Type T-IV” may cause deterioration in shift quality, locking up of your transmission accompanied by vibration, and ultimately damage the automatic transmission of your vehicle.

### ■ Automatic transmission fluid type (5-speed models)

Using automatic transmission fluid other than “Toyota Genuine ATF WS” may cause deterioration in shift quality, locking up of your transmission accompanied by vibration, and ultimately damage the automatic transmission of your vehicle.

### Manual transmission

Gear oil capacity (Reference) ▶ 2.7 L 4-cylinder (2TR-FE) engine  ▶ 4.0 L V6 (1GR-FE) engine	▶ 2WD models 2.7 qt. (2.6 L, 2.3 Imp.qt.) ▶ 4WD models 2.3 qt. (2.2 L, 1.9 Imp.qt.) 1.9 qt. (1.8 L, 1.6 Imp.qt.)
Gear oil type	Gear oil API GL-3 (GL-4)
Recommended gear oil viscosity	SAE 75W-90

### Clutch

Clutch free play	0.2 — 0.6 in. (5 — 15 mm)
Fluid type	FMVSS No. 116 DOT 3 or SAE J1703

### Transfer (4WD models)

Oil capacity	1.1 qt. (1.0 L, 0.9 Imp.qt.)
Oil type	Gear oil API GL-5
Recommended oil viscosity	SAE 75W-90

## Brakes

Pedal clearance* <sup>1</sup>	
▶ 2WD models except PreRunner	4.5 in. (115 mm)
▶ PreRunner	4.4 in. (111 mm)
▶ 4WD models	▶ Without off-road package 4.4 in. (111 mm) ▶ With off-road package 3.6 in. (91 mm)
Pedal free play	0.04 — 0.24 in. (1 — 6 mm)
Brake pad wear limit	0.04 in. (1.0 mm)
Brake lining wear limit	0.04 in. (1.0 mm)
Parking brake pedal travel* <sup>2</sup> (pedal type)	7 — 10 clicks
Parking brake lever travel* <sup>3</sup> (lever type)	7 — 10 clicks
Fluid type	FMVSS No. 116 DOT 3 or SAE J1703

\*1: Minimum pedal clearance when depressed with a force of 110 lbf (490 N, 50 kgf) with the engine running.

\*2: Parking brake pedal travel when depressed with a force of 67.4 lbf (300 N, 30.6 kgf).

\*3: Parking brake lever travel when pulled with a force of 44.9 lbf (200 N, 20.4 kgf).

## Chassis lubrication (4WD models and PreRunner with 2.7L 4-cylinder [2TR-FE] engine only)

Propeller shafts Spider	Lithium base chassis grease, NLGI No.2
-------------------------	--

## Steering

Free play	Less than 1.2 in. (30 mm)
Power steering fluid type	Automatic transmission fluid DEXRON® II or III

## Tires and wheels

### ► Type A

Tire size	P215/70R15 97S
Tire inflation pressure (Recommended cold tire inflation pressure)	<p>Front tires: 30 psi (210 kPa, 2.1 kgf/cm<sup>2</sup> or bar)</p> <p>Rear tires: 33 psi (230 kPa, 2.3 kgf/cm<sup>2</sup> or bar)</p> <p>Spare tire*: 33 psi (230 kPa, 2.3 kgf/cm<sup>2</sup> or bar)</p> <p>Driving at high speeds above 100 mph (160 km/h) (in countries where such speeds are permitted by law) Add 3 psi (20 kPa, 0.2 kgf/cm<sup>2</sup> or bar) to the front tires and rear tires. Never exceed the maximum cold tire inflation pressure indicated on the tire sidewall.</p>
Wheel size	15 × 6 J, 15 × 6 JJ
Wheel nut torque	83 ft·lbf (113 N·m, 11.5 kgf·m)

\*: If you affix the spare tire to a front position, please make sure to adjust the tire to the correct inflation pressure as soon as possible.

## ► Type B

Tire size	P245/75R16 109S
Tire inflation pressure (Recommended cold tire inflation pressure)	<p>Front tires: 30 psi (210 kPa, 2.1 kgf/cm<sup>2</sup> or bar)</p> <p>Rear tires: 30 psi (210 kPa, 2.1 kgf/cm<sup>2</sup> or bar)</p> <p>Spare tire: 30 psi (210 kPa, 2.1 kgf/cm<sup>2</sup> or bar)</p> <p>Driving at high speeds above 100 mph (160 km/h) (in countries where such speeds are permitted by law) Add 3 psi (20 kPa, 0.2 kgf/cm<sup>2</sup> or bar) to the front tires and rear tires. Never exceed the maximum cold tire inflation pressure indicated on the tire sidewall.</p>
Wheel size	16 × 7 J, 16 × 7 JJ
Wheel nut torque	83 ft·lbf (113 N·m, 11.5 kgf·m)

## ► Type C

Tire size	P265/70R16 111T
Tire inflation pressure (Recommended cold tire inflation pressure)	<p>Front tires: 29 psi (200 kPa, 2.0 kgf/cm<sup>2</sup> or bar)</p> <p>Rear tires: 32 psi (220 kPa, 2.2 kgf/cm<sup>2</sup> or bar)</p> <p>Spare tire*: 32 psi (220 kPa, 2.2 kgf/cm<sup>2</sup> or bar)</p> <p>Driving at high speeds above 100 mph (160 km/h) (in countries where such speeds are permitted by law) Add 3 psi (20 kPa, 0.2 kgf/cm<sup>2</sup> or bar) to the front tires and rear tires. Never exceed the maximum cold tire inflation pressure indicated on the tire sidewall.</p>
Wheel size	16 × 7 JJ
Wheel nut torque	83 ft·lbf (113 N·m, 11.5 kgf·m)

\*: If you affix the spare tire to a front position, please make sure to adjust the tire to the correct inflation pressure as soon as possible.

## ► Type D

Tire size	P265/65R17 110S
Tire inflation pressure (Recommended cold tire inflation pressure)	<p>Front tires: 29 psi (200 kPa, 2.0 kgf/cm<sup>2</sup> or bar)</p> <p>Rear tires: 29 psi (200 kPa, 2.0 kgf/cm<sup>2</sup> or bar)</p> <p>Spare tire: 29 psi (200 kPa, 2.0 kgf/cm<sup>2</sup> or bar)</p> <p>Driving at high speeds above 100 mph (160 km/h) (in countries where such speeds are permitted by law) Add 3 psi (20 kPa, 0.2 kgf/cm<sup>2</sup> or bar) to the front tires and rear tires. Never exceed the maximum cold tire inflation pressure indicated on the tire sidewall.</p>
Wheel size	17 × 7 1/2 JJ
Wheel nut torque	83 ft·lbf (113 N·m, 11.5 kgf·m)

## ► Type E

Tire size	P255/45R18 99V
Tire inflation pressure (Recommended cold tire inflation pressure)	<p>Front tires: 35 psi (240 kPa, 2.4 kgf/cm<sup>2</sup> or bar)</p> <p>Rear tires: 35 psi (240 kPa, 2.4 kgf/cm<sup>2</sup> or bar)</p> <p>Spare tire: 35 psi (240 kPa, 2.4 kgf/cm<sup>2</sup> or bar)</p> <p>Driving at high speeds above 100 mph (160 km/h) (in countries where such speeds are permitted by law) Add 4 psi (30 kPa, 0.3 kgf/cm<sup>2</sup> or bar) to the front tires and rear tires. Never exceed the maximum cold tire inflation pressure indicated on the tire sidewall.</p>
Wheel size	18 × 8 JJ
Wheel nut torque	83 ft·lbf (113 N·m, 11.5 kgf·m)



## ► Type F

Tire size	P265/60R18 109H
Tire inflation pressure (Recommended cold tire inflation pressure)	<p>Front tires: 29 psi (200 kPa, 2.0 kgf/cm<sup>2</sup> or bar)</p> <p>Rear tires: 29 psi (200 kPa, 2.0 kgf/cm<sup>2</sup> or bar)</p> <p>Spare tire: 29 psi (200 kPa, 2.0 kgf/cm<sup>2</sup> or bar)</p> <p>Driving at high speeds above 100 mph (160 km/h) (in countries where such speeds are permitted by law) Add 3 psi (20 kPa, 0.2 kgf/cm<sup>2</sup> or bar) to the front tires and rear tires. Never exceed the maximum cold tire inflation pressure indicated on the tire sidewall.</p>
Wheel size	18 × 7 1/2 J
Wheel nut torque	83 ft·lbf (113 N·m, 11.5 kgf·m)

<b>Light bulbs</b>
--------------------

	Light Bulbs	Bulb No.	W	Type
Exterior	Headlights	—	60/55	A
	Front fog lights*1	—	55	B
	Front side marker lights	—	5	D
	Front turn signal lights/parking lights/daytime running lights	4157 NAK	27/8	D
	Rear turn signal lights	3157A	27/8	D
	Stop/tail and rear side marker lights*2	3157KX	27/8	C
	Back-up lights	921	18	C
	License plate lights	168	5	C
	High mounted stoplight	168	5	C
Interior	Interior light	—	5	E
	Personal lights	168	5	C

\*1: If equipped

\*2: Bulb type only

A: HB2 halogen bulbs

B: H11 halogen bulbs

C: Wedge base bulbs (clear)

D: Wedge base bulbs (amber)

E: Double end bulbs

**Your vehicle must use only unleaded gasoline.**

**Select octane rating 87 (Research Octane Number 91) or higher. Use of unleaded gasoline with an octane rating lower than 87 may result in engine knocking. Persistent knocking can lead to engine damage.**

At minimum, the gasoline you use should meet the specifications of ASTM D4814 in the U.S.A..

---

### ■ Fuel tank opening for unleaded gasoline

To help prevent incorrect fueling, your Toyota has a fuel tank opening that only accommodates the special nozzle on unleaded fuel pumps.

### ■ If your engine knocks

- Consult your Toyota dealer.
- You may occasionally notice light knocking for a short time while accelerating or driving uphill. This is normal and there is no need for concern.

### ■ Gasoline quality

In very few cases, driveability problems may be caused by the brand of gasoline you are using. If driveability problems persist, try changing the brand of gasoline. If this does not correct the problem, consult your Toyota dealer.

### ■ Gasoline quality standards

- Automotive manufacturers in the US, Europe and Japan have developed a specification for fuel quality called World-Wide Fuel Charter (WWFC) that is expected to be applied worldwide.
- The WWFC consists of four categories that are based on required emission levels. In the US, category 4 has been adopted.
- The WWFC improves air quality by lowering emissions in vehicle fleets, and customer satisfaction through better performance.

■ **Toyota recommends the use of gasoline containing detergent additives**

- Toyota recommends the use of gasoline that contains detergent additives to avoid build-up of engine deposits.
- All gasoline sold in the U.S. contains minimum detergent additives to clean and/or keep clean intake systems, per EPA's lowest additives concentration program.
- Toyota strongly recommends the use of Top Tier Detergent Gasoline. For more information on Top Tier Detergent Gasoline and a list of marketers, please go to the official website [www.toptiergas.com](http://www.toptiergas.com).

■ **Toyota recommends the use of cleaner burning gasoline**

Cleaner burning gasoline, including reformulated gasoline that contains oxygenates such as ethanol or MTBE (Methyl Tertiary Butyl Ether) is available in many areas.

Toyota recommends the use of cleaner burning gasoline and appropriately blended reformulated gasoline. These types of gasoline provide excellent vehicle performance, reduce vehicle emissions and improve air quality.

■ **Toyota does not recommend blended gasoline**

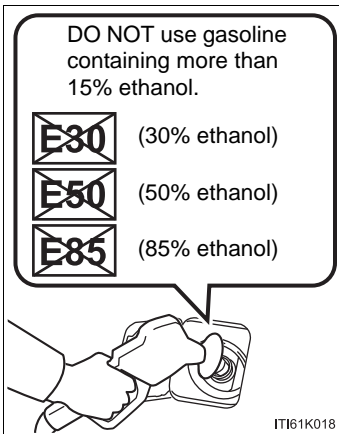

- Use only gasoline containing up to 15% ethanol.  
DO NOT use any flex-fuel or gasoline that could contain more than 15% ethanol, including from any pump labeled E30, E50, E85 (which are only some examples of fuel containing more than 15% ethanol).

- If you use gasohol in your Toyota, be sure that it has an octane rating no lower than 87.
- Toyota does not recommend the use of gasoline containing methanol.

### ■ Toyota does not recommend gasoline containing MMT

Some gasoline contains octane enhancing additive called MMT (Methylcyclopentadienyl Manganese Tricarbonyl).

Toyota does not recommend the use of gasoline that contains MMT. If fuel containing MMT is used, your emission control system may be adversely affected.

The malfunction indicator lamp on the instrument cluster may come on. If this happens, contact your Toyota dealer for service.

#### NOTICE

##### ■ Notice on fuel quality

- Do not use improper fuels.  
If improper fuels are used the engine will be damaged.
- Do not use leaded gasoline.  
Leaded gasoline can cause damage to your vehicle's three-way catalytic converters causing the emission control system to malfunction.
- Do not use gasohol other than that stated here.  
Other gasohol may cause fuel system damage or vehicle performance problems.
- Using unleaded gasoline with an octane number or rating lower than the level previously stated will cause persistent heavy knocking.  
At worst, this will lead to engine damage.

##### ■ Fuel-related poor driveability

If after using a different type of fuel, poor driveability is encountered (poor hot starting, vaporization, engine knocking, etc.), discontinue the use of that type of fuel.

##### ■ When refueling with gasohol

Take care not to spill gasohol.  
It can damage your vehicle's paint.

## 6-1. Specifications

### Tire information

#### Typical tire symbols

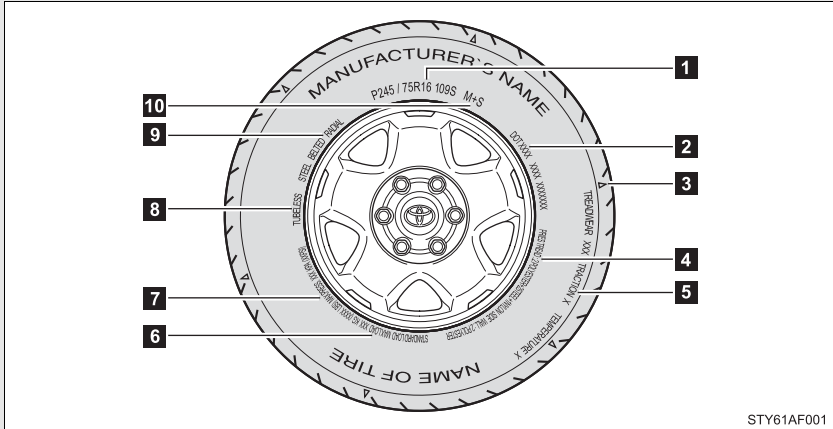

STY61AF001

- 1** Tire size (→P. 542)
- 2** DOT and Tire Identification Number (TIN) (→P. 541)
- 3** Location of treadwear indicators (→P. 422)
- 4** Tire ply composition and materials

Ply is layers of rubber-coated parallel cords. Cords are the strands which form the plies in a tire.

#### **5** Uniform tire quality grading

For details, see “Uniform tire quality grading” that follows.

- 6** Load limit at maximum cold tire inflation pressure (→P. 545)
- 7** Maximum cold tire inflation pressure (→P. 545)

This means the pressure to which a tire may be inflated.

#### **8** TUBELESS or TUBE TYPE

A tubeless tire does not have a tube and air is directly filled in the tire. A tube type tire has a tube inside the tire and the tube maintains the air pressure.

**9** Radial tires or bias-ply tires

A radial tire has RADIAL on the sidewall. A tire not marked RADIAL is a bias-ply tire.

**10** Summer tire or all season tire (→P. 426)

An all season tire has M+S on the sidewall. A tire not marked M+S is a summer tire.

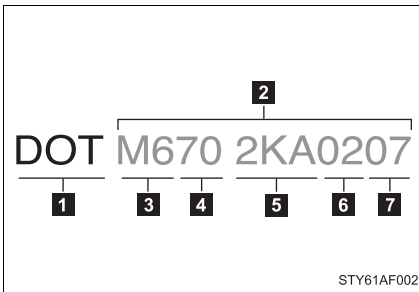
**Typical DOT and tire identification number (TIN)****1** DOT symbol\***2** Tire Identification Number (TIN)**3** Tire manufacturer's identification mark**4** Tire size code**5** Manufacturer's optional tire type code (3 or 4 letters)**6** Manufacturing week**7** Manufacturing year

\*: The DOT symbol certifies that the tire conforms to applicable Federal Motor Vehicle Safety Standards.

## Tire size

### ■ Typical tire size information

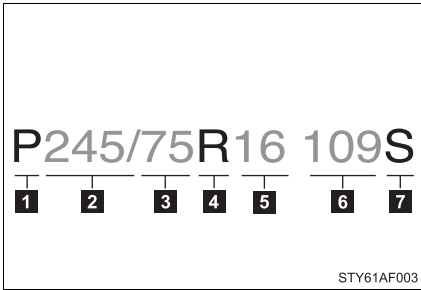

The illustration indicates typical tire size.

- 1** Tire use  
(P = Passenger car,  
T = Temporary use)
- 2** Section width (millimeters)
- 3** Aspect ratio  
(tire height to section width)
- 4** Tire construction code  
(R = Radial, D = Diagonal)
- 5** Wheel diameter (inches)
- 6** Load index (2 digits or 3 digits)
- 7** Speed symbol  
(alphabet with one letter)

### ■ Tire dimensions

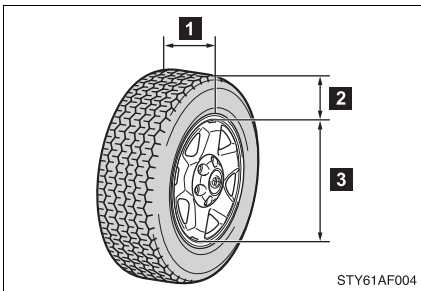

- 1** Section width
- 2** Tire height
- 3** Wheel diameter



## Tire section names

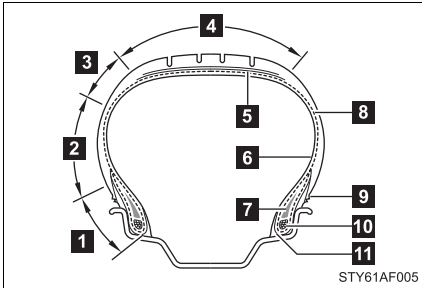

- 1** Bead
- 2** Sidewall
- 3** Shoulder
- 4** Tread
- 5** Belt
- 6** Inner liner
- 7** Reinforcing rubber
- 8** Carcass
- 9** Rim lines
- 10** Bead wires
- 11** Chafer

## Uniform Tire Quality Grading

This information has been prepared in accordance with regulations issued by the National Highway Traffic Safety Administration of the U.S.A. Department of Transportation.

It provides the purchasers and/or prospective purchasers of Toyota vehicles with information on uniform tire quality grading.

Your Toyota dealer will help answer any questions you may have as you read this information.

### ■ DOT quality grades

All passenger vehicle tires must conform to Federal Safety Requirements in addition to these grades. Quality grades can be found where applicable on the tire sidewall between tread shoulder and maximum section width.

For example: Treadwear 200 Traction AA Temperature A

### ■ Treadwear

The treadwear grade is a comparative rating based on the wear rate of the tire when tested under controlled conditions on a specified government test course.

For example, a tire graded 150 would wear one and a half (1 - 1/2) times as well on the government course as a tire graded 100.

The relative performance of tires depends upon the actual conditions of their use, however, and may depart significantly from the norm due to variations in driving habits, service practices and differences in road characteristics and climate.

### ■ Traction AA, A, B, C

The traction grades, from highest to lowest, are AA, A, B and C, and they represent the tire's ability to stop on wet pavement as measured under controlled conditions on specified government test surfaces of asphalt and concrete.

A tire marked C may have poor traction performance.

Warning: The traction grade assigned to this tire is based on braking (straight ahead) traction tests and does not include cornering (turning) traction.

### ■ Temperature A, B, C

The temperature grades are A (the highest), B, and C, representing the tire's resistance to the generation of heat and its ability to dissipate heat when tested under controlled conditions on a specified indoor laboratory test wheel.

Sustained high temperature can cause the material of the tire to degenerate and reduce tire life, and excessive temperature can lead to sudden tire failure.

The grade C corresponds to a level of performance which all passenger car tires must meet under the Federal Motor Vehicle Safety Standard No. 109.

Grades B and A represent higher levels of performance on the laboratory test wheel than the minimum required by law.

Warning: The temperature grades for this tire are established for a tire that is properly inflated and not overloaded.

Excessive speed, underinflation, or excessive loading, either separately or in combination, can cause heat buildup and possible tire failure.

### Glossary of tire terminology

Tire related term	Meaning
Cold tire inflation pressure	Tire pressure when the vehicle has been parked for three hours or more, or has not been driven more than 1 mile or 1.5 km under that condition
Maximum inflation pressure	The maximum cold inflated pressure to which a tire may be inflated, shown on the sidewall of the tire
Recommended inflation pressure	Cold tire inflation pressure recommended by a manufacturer
Accessory weight	The combined weight (in excess of those standard items which may be replaced) of transmission, power steering, power brakes, power windows, power seats, radio and heater, to the extent that these items are available as factory-installed equipment (whether installed or not)
Curb weight	The weight of a motor vehicle with standard equipment, including the maximum capacity of fuel, oil and coolant, and if so equipped, air conditioning and additional weight optional engine
Maximum loaded vehicle weight	The sum of: (a) Curb weight (b) Accessory weight (c) Vehicle capacity weight (d) Production options weight

Tire related term	Meaning
Normal occupant weight	150 lb. (68 kg) times the number of occupants specified in the second column of Table 1* that follows
Occupant distribution	Distribution of occupants in a vehicle as specified in the third column of Table 1* below
Production options weight	The combined weight of installed regular production options weighing over 5 lb. (2.3 kg) in excess of the standard items which they replace, not previously considered in curb weight or accessory weight, including heavy duty brakes, ride levelers, roof rack, heavy duty battery, and special trim
Rim	A metal support for a tire or a tire and tube assembly upon which the tire beads are seated
Rim diameter (Wheel diameter)	Nominal diameter of the bead seat
Rim size designation	Rim diameter and width
Rim type designation	The industry manufacturer's designation for a rim by style or code
Rim width	Nominal distance between rim flanges
Vehicle capacity weight (Total load capacity)	The rated cargo and luggage load plus 150 lb. (68 kg) times the vehicle's designated seating capacity
Vehicle maximum load on the tire	The load on an individual tire that is determined by distributing to each axle its share of the maximum loaded vehicle weight, and dividing by two
Vehicle normal load on the tire	The load on an individual tire that is determined by distributing to each axle its share of curb weight, accessory weight, and normal occupant weight (distributed in accordance with Table 1* below), and dividing by two

Tire related term	Meaning
Weather side	The surface area of the rim not covered by the inflated tire
Bead	The part of the tire that is made of steel wires, wrapped or reinforced by ply cords and that is shaped to fit the rim
Bead separation	A breakdown of the bond between components in the bead
Bias ply tire	A pneumatic tire in which the ply cords that extend to the beads are laid at alternate angles substantially less than 90 degrees to the centerline of the tread
Carcass	The tire structure, except tread and sidewall rubber which, when inflated, bears the load
Chunking	The breaking away of pieces of the tread or sidewall
Cord	The strands forming the plies in the tire
Cord separation	The parting of cords from adjacent rubber compounds
Cracking	Any parting within the tread, sidewall, or innerliner of the tire extending to cord material
CT	A pneumatic tire with an inverted flange tire and rim system in which the rim is designed with rim flanges pointed radially inward and the tire is designed to fit on the underside of the rim in a manner that encloses the rim flanges inside the air cavity of the tire
Extra load tire	A tire designed to operate at higher loads and at higher inflation pressures than the corresponding standard tire
Groove	The space between two adjacent tread ribs
Innerliner	The layer(s) forming the inside surface of a tubeless tire that contains the inflating medium within the tire

Tire related term	Meaning
Innerliner separation	The parting of the innerliner from cord material in the carcass
Intended outboard sidewall	(a)The sidewall that contains a whitewall, bears white lettering, or bears manufacturer, brand, and/or model name molding that is higher or deeper than the same molding on the other sidewall of the tire, or (b)The outward facing sidewall of asymmetrical tire that has a particular side that must always face outward when mounted on a vehicle
Light truck (LT) tire	A tire designated by its manufacturer as primarily intended for use on lightweight trucks or multipurpose passenger vehicles
Load rating	The maximum load that a tire is rated to carry for a given inflation pressure
Maximum load rating	The load rating for a tire at the maximum permissible inflation pressure for that tire
Maximum permissible inflation pressure	The maximum cold inflation pressure to which a tire may be inflated
Measuring rim	The rim on which a tire is fitted for physical dimension requirements
Open splice	Any parting at any junction of tread, sidewall, or innerliner that extends to cord material
Outer diameter	The overall diameter of an inflated new tire
Overall width	The linear distance between the exteriors of the sidewalls of an inflated tire, including elevations due to labeling, decorations, or protective bands or ribs
Passenger car tire	A tire intended for use on passenger cars, multipurpose passenger vehicles, and trucks, that have a gross vehicle weight rating (GVWR) of 10,000 lb. or less

Tire related term	Meaning
Ply	A layer of rubber-coated parallel cords
Ply separation	A parting of rubber compound between adjacent plies
Pneumatic tire	A mechanical device made of rubber, chemicals, fabric and steel or other materials, that, when mounted on an automotive wheel, provides the traction and contains the gas or fluid that sustains the load
Radial ply tire	A pneumatic tire in which the ply cords that extend to the beads are laid at substantially 90 degrees to the centerline of the tread
Reinforced tire	A tire designed to operate at higher loads and at higher inflation pressures than the corresponding standard tire
Section width	The linear distance between the exteriors of the sidewalls of an inflated tire, excluding elevations due to labeling, decoration, or protective bands
Sidewall	That portion of a tire between the tread and bead
Sidewall separation	The parting of the rubber compound from the cord material in the sidewall
Snow tire	A tire that attains a traction index equal to or greater than 110, compared to the ASTM E-1136 Standard Reference Test Tire, when using the snow traction test as described in ASTM F-1805-00, Standard Test Method for Single Wheel Driving Traction in a Straight Line on Snow-and Ice-Covered Surfaces, and which is marked with an Alpine Symbol (  ) on at least one sidewall
Test rim	The rim on which a tire is fitted for testing, and may be any rim listed as appropriate for use with that tire

Tire related term	Meaning
Tread	That portion of a tire that comes into contact with the road
Tread rib	A tread section running circumferentially around a tire
Tread separation	Pulling away of the tread from the tire carcass
Treadwear indicators(TWI)	The projections within the principal grooves designed to give a visual indication of the degrees of wear of the tread
Wheel-holding fixture	The fixture used to hold the wheel and tire assembly securely during testing

\*: Table 1 — Occupant loading and distribution for vehicle normal load for various designated seating capacities

Designated seating capacity, Number of occupants	Vehicle normal load, Number of occupants	Occupant distribution in a normally loaded vehicle
2 through 4	2	2 in front
5 through 10	3	2 in front, 1 in second seat
11 through 15	5	2 in front, 1 in second seat, 1 in third seat, 1 in fourth seat
16 through 20	7	2 in front, 2 in second seat, 2 in third seat, 1 in fourth seat



## Customizable features

**Your vehicle includes a variety of electronic features that can be personalized to your preferences. Programming these preferences requires specialized equipment and may be performed by an authorized Toyota dealership.**

Some function settings are changed simultaneously with other functions being customized. Contact your Toyota dealer for further details.

### Customizable features

Item	Function	Default setting	Customized setting
Wireless remote control (→P. 32)	Operation signal (Buzzer)	ON	OFF
Seat Belt Reminder Buzzer (→P. 479)	Vehicle speed linked seat belt reminder buzzer	ON	OFF

## Items to initialize

**The following items must be initialized for normal system operation in cases such as after the battery is reconnected, or maintenance is performed on the vehicle.**

Item	When to initialize	Reference
Maintenance required reminder light	After the maintenance is performed	P. 395
Tire pressure warning system	<ul style="list-style-type: none"> <li>• When rotating the tires on vehicles differing with front and rear tire inflation pressures.</li> <li>• When changing the tire inflation pressure by changing traveling speed or load weight, etc.</li> <li>• When changing the tire size.</li> </ul>	P. 423

**For owners**

**7**

Reporting safety defects  
for U.S. owners ..... 554

Seat belt instructions  
for Canadian owners  
(in French) ..... 555

SRS airbag instructions  
for Canadian owners  
(in French) ..... 557

Camper information ..... 567

## Reporting safety defects for U.S. owners

If you believe that your vehicle has a defect which could cause a crash or could cause injury or death, you should immediately inform the National Highway Traffic Safety Administration (NHTSA) in addition to notifying Toyota Motor Sales, U.S.A., Inc. (Toll-free: 1-800-331-4331).

If NHTSA receives similar complaints, it may open an investigation, and if it finds that a safety defect exists in a group of vehicles, it may order a recall and remedy campaign. However, NHTSA cannot become involved in individual problems between you, your dealer, or Toyota Motor Sales, U.S.A., Inc.

To contact NHTSA, you may call the Vehicle Safety Hotline toll-free at 1-888-327-4236 (TTY: 1-800-424-9153); go to <http://www.safercar.gov>; or write to: Administrator, NHTSA, 1200 New Jersey Ave, S.E., Washington, DC 20590. You can also obtain other information about motor vehicle safety from <http://www.safercar.gov>.

## Seat belt instructions for Canadian owners (in French)

The following is a French explanation of seat belt instructions extracted from the seat belt section in this manual.

See the seat belt section for more detailed seat belt instructions in English.

### Utilisation correcte des ceintures de sécurité

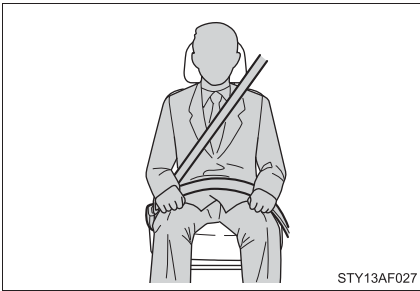

- Déroulez la sangle diagonale de telle sorte qu'elle passe bien sur l'épaule, sans pour autant être en contact avec le cou ou glisser de l'épaule.
- Placez la sangle abdominale le plus bas possible sur les hanches.
- Réglez la position du dossier de siège. Asseyez-vous le dos le plus droit possible et caliez-vous bien dans le siège.
- Ne pas vriller la ceinture de sécurité.

## Entretien et soin

### ■ Ceintures de sécurité

Nettoyez avec un chiffon ou une éponge humectée d'eau savonneuse tiède. Par ailleurs, vérifiez régulièrement que les ceintures ne sont pas effilochées, entaillées, ou ne paraissent pas exagérément usées.

### ATTENTION

#### ■ État et usure des ceintures de sécurité

Inspectez les ceintures de sécurité périodiquement. Contrôlez qu'elles ne sont pas entaillées, effilochées, et que leurs ancrages ne sont pas desserrés. Ne pas utiliser une ceinture de sécurité défectueuse avant qu'elle ne soit remplacée. Une ceinture de sécurité défectueuse n'apporte aucune garantie de protection de l'occupant contre des blessures graves, voire mortelles.

The following is a French explanation of SRS airbag instructions extracted from the SRS airbag section in this manual.

See the SRS airbag section for more detailed SRS airbag instructions in English.

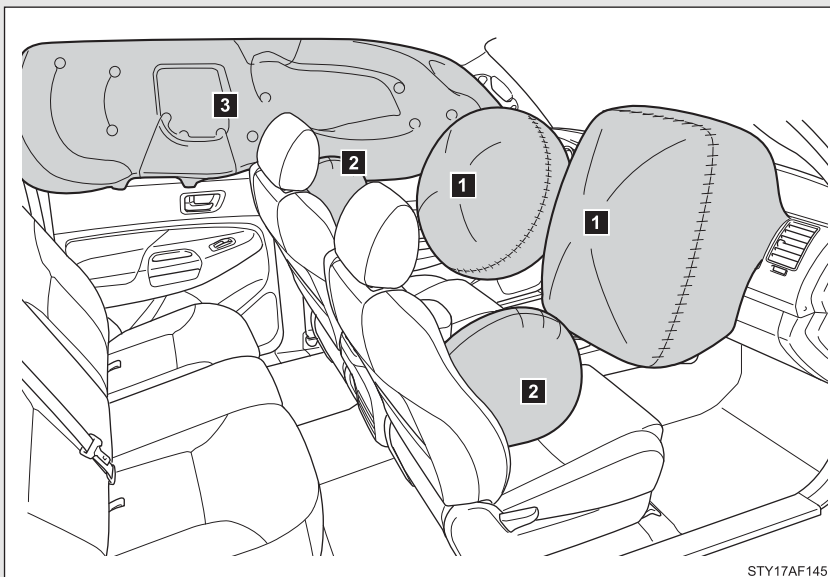

► Sacs de sécurité gonflables frontaux

**1** Sacs de sécurité gonflables conducteur/passager avant

Participent à la protection de la tête et du thorax du conducteur et du passager avant droit contre les chocs avec les éléments de l'habitacle.

► Sacs de sécurité gonflables latéraux et rideau

**2** Sacs de sécurité gonflables latéraux

Participent à la protection du thorax des occupants des sièges avant.

**3** Sacs de sécurité gonflables rideau

Participent principalement à la protection de la tête des occupants assis aux places extérieures.

## Composition du système de sacs de sécurité gonflables

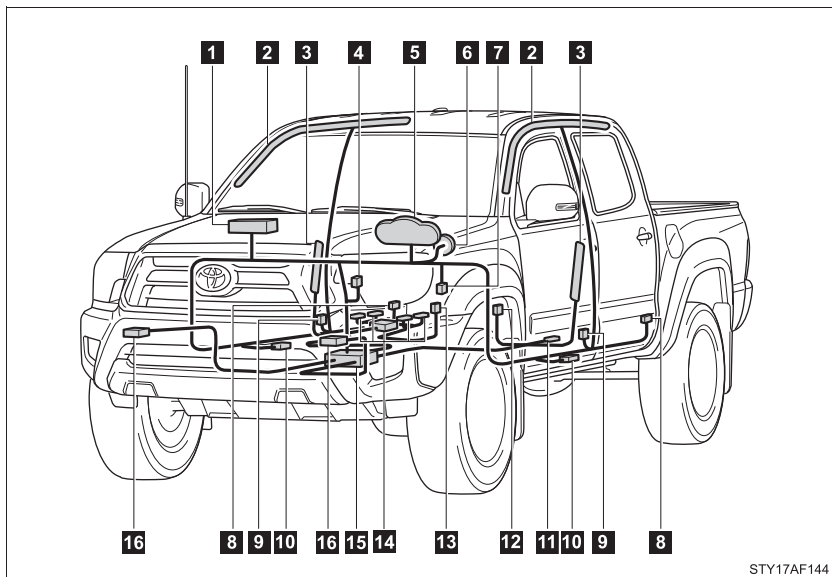

STY17AF144

**1** Coussin gonflable passager avant

**2** Coussins gonflables rideau

**3** Coussins gonflables latéraux

**4** Témoins indicateurs AIR BAG ON et AIR BAG OFF

**5** Témoin d'alerte SRS et témoin indicateur RSCA OFF (modèles 4 roues motrices uniquement)

**6** Coussin gonflable conducteur

**7** Bouton RSCA OFF (modèles 4 roues motrices uniquement)

**8** Capteurs de coussins gonflables rideau

**9** Prétensionneurs et limiteurs d'effort de ceintures de sécurité



- 10** Capteurs de coussins gonflables latéraux et rideaux
- 11** Capteur de position du siège conducteur
- 12** Contacteur de boucle de ceinture de sécurité conducteur
- 13** Contacteur de boucle de ceinture de sécurité passager avant
- 14** Système de classification d'occupant du siège passager avant (ECU et capteurs)
- 15** Boîtier électronique de coussins gonflables
- 16** Capteurs de coussin gonflables frontaux

Votre véhicule est équipé de COUSSINS GONFLABLES ÉVOLUÉS dont la conception est basée sur les normes de sécurité véhicules automobiles américains (FMVSS208). Le boîtier électronique de coussins gonflables (ECU) utilise les informations reçues des capteurs, etc. détaillés dans le schéma ci-dessus pour la composition du système pour commander le déploiement des coussins gonflables. Ces informations comprennent des informations sur la gravité de la collision et les occupants. Le déploiement des coussins gonflables est obtenu au moyen d'une réaction chimique dans les dispositifs pyrotechniques, qui produit un gaz inoffensif permettant d'amortir le mouvement des occupants.

## ATTENTION

### ■ Précautions avec les sacs de sécurité gonflables SRS

Prenez les précautions suivantes avec les sacs de sécurité gonflables. À défaut, des blessures graves, voire mortelles, pourraient s'ensuivre.

- Le conducteur et tous les passagers à bord du véhicule doivent porter leur ceinture de sécurité correctement.

Les sacs de sécurité gonflables SRS sont des dispositifs de protection complémentaires aux ceintures de sécurité.

- Le sac de sécurité gonflable SRS conducteur se déploie avec une violence considérable, qui peut être très dangereuse voire mortelle si le conducteur se trouve très près du sac de sécurité gonflable. La "NHTSA" (National Highway Traffic Safety Administration) conseille:

Sachant que la zone à risque du sac de sécurité gonflable conducteur se trouve dans les premiers 2 - 3 in. (50 - 75 mm) de déploiement, vous disposez d'une marge de sécurité confortable en vous plaçant à 10 in. (250 mm) du sac de sécurité gonflable conducteur. Cette distance est à mesurer entre le moyeu du volant de direction et le sternum. Si vous êtes assis à moins de 10 in. (250 mm), vous pouvez changer votre position de conduite de plusieurs façons:

- Reculez votre siège le plus possible, tout en continuant à pouvoir atteindre confortablement les pédales.
- Inclinez légèrement le dossier du siège.  
Bien que les véhicules puissent être différents les uns des autres, la plupart des conducteurs peuvent s'asseoir à une distance de 10 in. (250 mm), même avec le siège conducteur complètement avancé, simplement en inclinant un peu le dossier de siège. Si vous avez des difficultés à voir la route après avoir incliné votre siège, utilisez un coussin ferme et antidérapant pour vous rehausser ou, si votre véhicule est équipé du réglage en hauteur du siège, remontez-le.
- Si votre volant de direction est réglable, inclinez-le vers le bas. Cela a pour effet d'orienter le sac de sécurité gonflable en direction de votre poitrine plutôt que de votre tête et de votre cou.

## ATTENTION

### ■ Précautions avec les sacs de sécurité gonflables SRS

Réglez votre siège selon les recommandations de la NHTSA, tout en conservant le contrôle des pédales et du volant de direction, et la vue des commandes du tableau de bord.

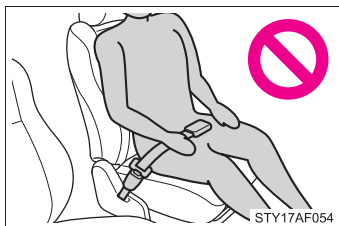

- Si vous attachez une rallonge de ceinture de sécurité aux boucles des ceintures de sièges avant, mais pas au pêne de la ceinture de sécurité proprement dite, les sacs de sécurité gonflables SRS frontaux déterminent que le conducteur et le passager avant portent leur ceinture de sécurité, alors même qu'elle n'est pas attachée. Dans ce cas, les sacs de sécurité gonflables SRS frontaux risquent de ne pas se déployer correctement en cas de collision, causant des blessures graves, voire mortelles. Veillez donc à porter la ceinture de sécurité avec la rallonge de ceinture de sécurité.
- Le sac de sécurité gonflable SRS passager avant se déploie également avec une violence considérable, qui peut être très dangereuse voire mortelle si le passager avant se trouve très près du sac de sécurité gonflable. Éloignez le siège passager avant au maximum du sac de sécurité gonflable, et réglez le dossier de siège de sorte à être assis bien droit dans le siège.
- Les nourrissons et les enfants qui ne sont pas correctement assis et/ou protégés peuvent être grièvement blessés ou tués par le déploiement d'un sac de sécurité gonflable. Installez dans un siège de sécurité enfant les enfants trop jeunes pour pouvoir utiliser la ceinture de sécurité. Toyota recommande vivement que tous les nourrissons et enfants soient installés dans les sièges arrière du véhicule et convenablement attachés. C'est à l'arrière que les nourrissons et les enfants sont les mieux protégés.

**⚠ ATTENTION**

**■ Précautions avec les sacs de sécurité gonflables SRS**

● N'installez jamais un siège de sécurité enfant type dos à la route sur le siège passager avant, même si le témoin indicateur AIR BAG OFF est allumé. En cas d'accident, la force exercée par le déploiement rapide du sac de sécurité gonflable passager avant peut blesser grièvement un enfant, voire le tuer, si le siège de sécurité enfant type dos à la route est installé sur le siège passager avant.

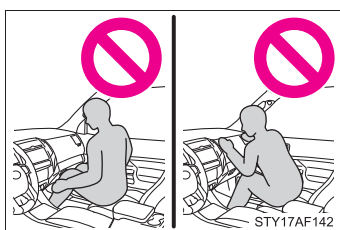

● Ne pas s'asseoir sur le bord du siège et ne pas s'appuyer contre la planche de bord.

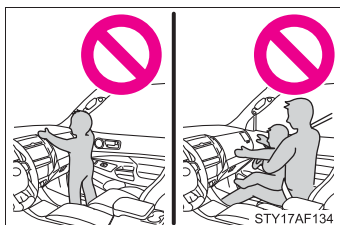

● Ne pas laisser un enfant rester debout devant le sac de sécurité gonflable SRS passager avant ou bien s'asseoir sur les genoux du passager avant.

● Ne pas conduire le véhicule avec quelque chose sur les genoux, et ne pas autoriser un passager à voyager avec quelque chose sur les genoux.



● Ne pas s'appuyer contre la porte, contre le rail latéral de toit ou contre les montants avant, latéraux et arrière.

**ATTENTION**

**■ Précautions avec les sacs de sécurité gonflables SRS**



- Interdisez à quiconque de s'agenouiller sur le siège passager en appui contre la porte ou de sortir la tête ou les mains à l'extérieur du véhicule.

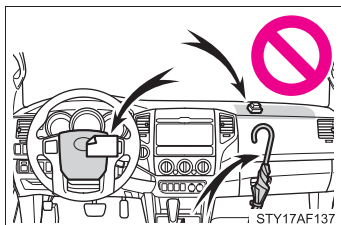

- Ne fixez ni ne posez aucun objet sur la planche de bord ou la garniture centrale du volant de direction. Au déploiement des sacs de sécurité gonflables SRS conducteur et passager avant, tout objet risque de se transformer en projectile.

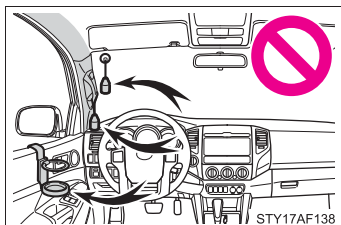

- Ne rien fixer aux portes, à la vitre de pare-brise, aux vitres latérales, aux montants avant et arrière, au rail latéral de toit et à la poignée de maintien.
- Ne suspendez aux crochets à vêtements aucun cintre nu ni aucun objet dur. En cas de déploiement du sac de sécurité gonflable rideau SRS, ces objets peuvent se transformer en projectiles capables de vous blesser grièvement, voire de vous tuer.

- Siège avant de type banquette: Ne pas recouvrir l'assise de siège avec un accessoire, comme un coussin ou une housse par exemple.
- N'utilisez aucun accessoire de siège venant recouvrir les zones de déploiement des sacs de sécurité gonflables SRS latéraux, car il risquerait d'en gêner le déploiement.

## ATTENTION

### ■ Précautions avec les sacs de sécurité gonflables SRS

- Évitez de faire subir des chocs ou des pressions excessives aux parties renfermant les composants des sacs de sécurité gonflables SRS (→P. 590).

En effet, cela pourrait entraîner un mauvais fonctionnement des sacs de sécurité gonflables SRS.

- Ne touchez aucun composant du système immédiatement après le déclenchement (déploiement) des sacs de sécurité gonflables SRS, car ils sont alors encore très chauds.
- Si vous avez des difficultés à respirer après le déploiement d'un sac de sécurité gonflable SRS, ouvrez une porte ou une vitre pour faire entrer de l'air frais, ou bien descendez du véhicule si cela ne présente pas de danger. Nettoyez tout résidu dès que possible afin d'éviter d'éventuelles irritations de la peau.
- Si les parties renfermant les sacs de sécurité gonflables SRS, telles que la garniture centrale du volant de direction et les garnitures de montants avant et arrière, apparaissent abîmées ou craquelées, faites-les remplacer par votre concessionnaire Toyota.

### ■ Modification et élimination en fin de vie des éléments du système de sacs de sécurité gonflables SRS

Consultez impérativement votre concessionnaire Toyota si vous avez besoin d'intervenir sur votre véhicule ou de procéder à l'une des modifications suivantes.

Les sacs de sécurité gonflables SRS peuvent ne pas fonctionner correctement ou se déployer (gonfler) accidentellement, provoquant ainsi des blessures graves, voire mortelles.

- Installation, dépose, démontage et réparations des sacs de sécurité gonflables SRS.
- Réparations, modifications, démontage ou remplacement du volant, du tableau de bord, de la planche de bord, des sièges ou de leur garnissage, des montants avant, latéraux et arrière ou des rails latéraux de toit.
- Réparations ou modifications de l'aile avant, du bouclier avant, ou du côté de l'habitacle.

## ATTENTION

### ■ Modification et élimination en fin de vie des éléments du système de sacs de sécurité gonflables SRS

- Installation de chasse-neige, de treuils, etc. sur la calandre (pare-buflle ou pare-kangourou, etc.).
- Modification des suspensions du véhicule.
- Ne pas utiliser des pneus ou des jantes dont les dimensions sont différentes de celles préconisées par le fabricant.
- Installation d'appareils électroniques, tels que radio émetteur/récepteur ou lecteurs de CD.
- Aménagements apportés au véhicule pour une personne atteinte d'un handicap physique.

### Désactivation des sacs de sécurité gonflables rideau en cas de retournement du véhicule (modèles à 4 roues motrices uniquement)

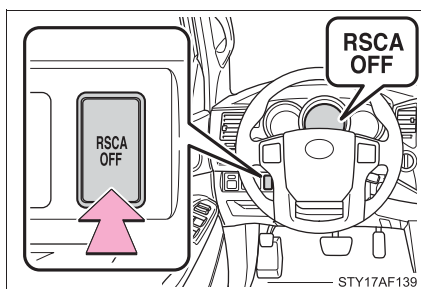

Marche/arrêt (maintenez pendant quelques secondes)

Le témoin indicateur RSCA OFF s'allume (uniquement lorsque le contacteur de démarrage antivol est sur ON).

La fonction de détection de retournement des sacs de sécurité gonflables rideau et des prétensionneurs de ceinture de sécurité est automatiquement réactivée dès lors que vous mettez le contacteur de démarrage antivol sur la position de marche.

 ATTENTION

■ **Pour la conduite normale**

Assurez-vous que le témoin indicateur RSCA OFF n'est pas allumé. S'il est laissé allumé, le sac de sécurité gonflable rideau ne se déploie pas en cas d'accident, avec pour conséquences possibles des blessures graves, voire mortelles.



# Camper information

This information has been prepared in accordance with regulation issued by the National Highway Traffic Safety Administration of the U.S. Department of Transportation. It provides the purchasers and/or prospective purchasers of Toyota vehicles with information on truck-camper loading. Your Toyota dealer will help answer any questions you may have as you read this information.

## Center of gravity location

The figures given in the illustration indicate the recommended center of gravity zone.

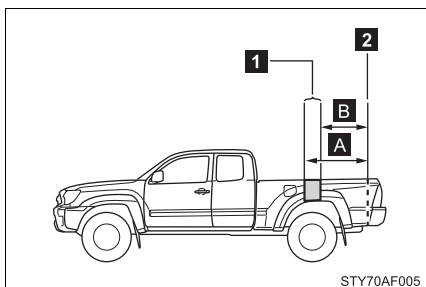

**1** Recommended location for cargo center of gravity for cargo weight rating

**2** Rear end of truck bed

	<b>A</b>	<b>B</b>
Access Cab models ▶ Except X-Runner ▶ X-Runner*	49.9 in. (1267 mm) —	36.1 in. (917 mm) —
Double Cab models ▶ With short deck ▶ With long deck	45.6 in. (1157 mm) 35.9 in. (911 mm)	31.8 in. (807 mm) 27.8 in. (706 mm)

\*:Truck-campers cannot be used with the X-Runner since it is not designed for them.

## **⚠ CAUTION**

### **■ Loading precaution**

If a load is too far back, it can cause dangerous handling. If it is too far forward, the front axle may be overloaded.

## **Cargo weight rating and proper matching**

When the truck is used to carry a slide-in camper, the total cargo load of the truck consists of the manufacturer's camper weight figure, the weight of installed additional camper equipment not included in the manufacturer's camper weight figure, the weight of camper cargo, and the weight of passengers in the camper.

The total cargo load should not exceed the truck's cargo weight rating and the camper's center of gravity should fall within the truck's recommended center of gravity zone when installed.

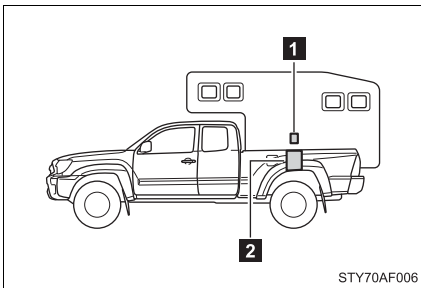

- 1** Camper center of gravity
- 2** Recommended center of gravity location zone

## ■ Cargo weight rating

### ▶ Access Cab models

2 people, 2TR-FE engine, 2WD except PreRunner:	750 lb. (340 kg)
4 people, 2TR-FE engine, 2WD except PreRunner:	450 lb. (204 kg)
2 people, 2TR-FE engine, PreRunner:	1000 lb. (453 kg)
4 people, 2TR-FE engine, PreRunner:	700 lb. (317 kg)
2 people, 1GR-FE engine, PreRunner:	950 lb. (430 kg)
4 people, 1GR-FE engine, PreRunner:	650 lb. (294 kg)
2 people, 2TR-FE engine, 4WD:	900 lb. (408 kg)
4 people, 2TR-FE engine, 4WD:	600 lb. (272 kg)
2 people, 1GR-FE engine, 4WD:	840 lb. (381 kg)
4 people, 1GR-FE engine, 4WD:	540 lb. (244 kg)

### ▶ Double Cab models with short deck

2 people, 2TR-FE engine, 2WD except PreRunner:	650 lb. (294 kg)
5 people, 2TR-FE engine, 2WD except PreRunner:	200 lb. (90 kg)
2 people, 1GR-FE engine, PreRunner:	850 lb. (385 kg)
5 people, 1GR-FE engine, PreRunner:	400 lb. (181 kg)
2 people, 1GR-FE engine, 4WD:	740 lb. (335 kg)
5 people, 1GR-FE engine, 4WD:	290 lb. (131 kg)

### ▶ Double Cab models with long deck

2 people, 1GR-FE engine, PreRunner:	850 lb. (385 kg)
5 people, 1GR-FE engine, PreRunner:	400 lb. (181 kg)
2 people, 1GR-FE engine, 4WD:	740 lb. (335 kg)
5 people, 1GR-FE engine, 4WD:	290 lb. (131 kg)

 **CAUTION**

**Overloading**

Be careful — overloading can cause dangerous braking and handling problems, and can damage your vehicle and its tires.

**Gross axle and vehicle weight ratings**

Secure loose items to prevent weight shifts that could affect the balance of your vehicle. When the truck camper is loaded, drive to a scale and weigh on the front and on the rear wheels separately to determine axle loads. Individual axle loads should not exceed either of the Gross Axle Weight Ratings (GAWR). The total of the axle loads should not exceed the Gross Vehicle Weight Rating (GVWR). These ratings are given on the vehicle certification label which is located on the door latch post on the left side of the vehicle. (→P. 521) If weight ratings are exceeded, move or remove items to bring all weights below the ratings.

► Gross axle weight rating

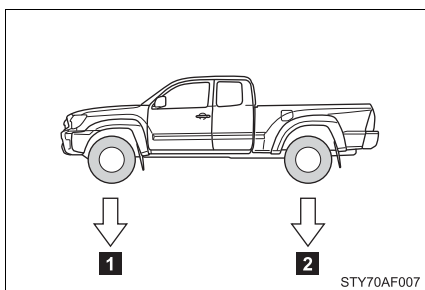

**1** Front GAWR

**2** Rear GAWR

► Gross vehicle weight rating

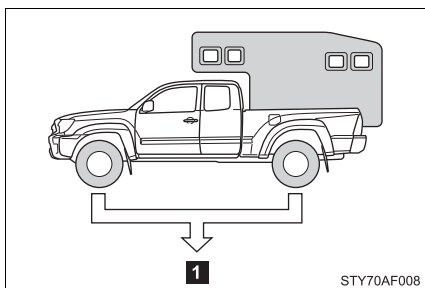

**1** Not exceed GVWR

■ **GAWR**

	GAWR	
	Front	Rear
2WD models except PreRunner	<ul style="list-style-type: none"> <li>► Vehicles with 2.7L 4-cylinder (2TR-FE) engine 2380 lb. (1075 kg)</li> <li>► Vehicles with 4.0 L V6 (1GR-FE) engine 2400 lb. (1085 kg)</li> </ul>	2650 lb. (1200 kg)
4WD models and PreRunner	<ul style="list-style-type: none"> <li>► PreRunner 2755 lb. (1245 kg)</li> <li>► 4WD models 2775 lb. (1255 kg)</li> </ul>	3110 lb. (1410 kg)

## ■ GVWR

### ▶ 2WD models except PreRunner

Cab type	GVWR
Access Cab	<ul style="list-style-type: none"><li>▶ Vehicles with 2.7 L 4-cylinder (2TR-FE) engine 4900 lb. (2220 kg)</li><li>▶ Vehicles with 4.0 L V6 (1GR-FE) engine 4700 lb. (2130 kg)</li></ul>
Double Cab	4900 lb. (2220 kg)

### ▶ PreRunner

Cab type	GVWR
Access Cab and Double Cab	<ul style="list-style-type: none"><li>▶ Vehicles with 2.7 L 4-cylinder (2TR-FE) engine 5250 lb. (2380 kg)</li><li>▶ Vehicles with 4.0 L V6 (1GR-FE) engine 5400 lb. (2445 kg)</li></ul>

### ▶ 4WD models

Cab type	GVWR
Access Cab	<ul style="list-style-type: none"><li>▶ Vehicles with 2.7 L 4-cylinder (2TR-FE) engine 5350 lb. (2425 kg)</li><li>▶ Vehicles with 4.0 L V6 (1GR-FE) engine 5500 lb. (2490 kg)</li></ul>
Double Cab	5500 lb. (2490 kg)

## Index

Abbreviation list .....	574
Alphabetical index.....	576
What to do if... ..	585

For vehicles with Entune Audio Plus or Entune Premium Audio, refer to the “NAVIGATION SYSTEM OWNER’S MANUAL” for information regarding the multimedia system.

Multimedia system types: →P. 243

## Abbreviation/Acronym list

ABBREVIATIONS	MEANING
2WD	Two Wheel Drive
4WD	Four Wheel Drive
ABS	Anti-Lock Brake System
ACC	Accessory
ALR	Automatic Locking Retractor
A-TRAC	Active Traction Control
AUTO LSD	Automatic Limited Slip Differential
CRS	Child Restraint System
DAC	Downhill assist control
ECU	Electronic Control Unit
EDR	Event Data Recorder
ELR	Emergency Locking Retractor
GAWR	Gross Axle Weight Rating
GCWR	Gross Combination Weight Rating
GVWR	Gross Vehicle Weight Rating
I/M	Emission inspection and maintenance
LATCH	Lower Anchors and Tethers for Children
LED	Light Emitting Diode
LT	Light truck
M + S	Mud + Snow
MMT	Methylcy clopentadienyl Manganese Tricarbonyl
MTBE	Methyl Tertiary Butyl Ether
OBD	On Board Diagnostics
RR DIFF LOCK	Rear differential lock
RSCA	Roll sensing of curtain shield airbag
SRS	Supplemental Restraint System
TIN	Tire Identification Number



ABBREVIATIONS	MEANING
TPMS	Tire Pressure Warning System
TRAC	Traction Control
TWI	Treadwear indicators
TWR	Trailer Weight Rating
VIN	Vehicle Identification Number
VSC	Vehicle Stability Control

<b>A</b>	<b>A/C</b> .....	<b>236</b>
	<b>AAC disc</b> .....	<b>263</b>
	<b>ABS</b> .....	<b>191</b>
	<b>Access doors</b> .....	<b>39</b>
	<b>Active traction control system</b> .....	<b>181</b>
	<b>Air conditioning filter</b> .....	<b>439</b>
	<b>Air conditioning system</b>	
	Air conditioning filter.....	439
	Manual air conditioning system.....	236
	<b>Airbags</b>	
	Airbag operating conditions.....	85
	Airbag precautions for your child.....	89
	Airbag warning light.....	477
	Curtain shield airbag operating conditions.....	85
	Curtain shield airbag precautions.....	89
	Front passenger occupant classification system.....	95
	General airbag precautions.....	89
	Locations of airbags.....	82
	Modification and disposal of airbags.....	93
	Proper driving posture.....	80, 89
	Roll sensing of curtain shield airbag off switch.....	94
	Side airbag operating conditions.....	85
	Side airbag precautions.....	89
	SRS airbags.....	82
	<b>Antenna</b> .....	<b>335, 388, 390</b>
	<b>Anti-lock brake system</b>	
	ABS warning light.....	477
	Anti-lock brake system.....	191
	<b>Audio input</b> .....	<b>249</b>

<b>Audio system</b>	
Antenna.....	335, 388, 390
Audio input.....	249
AUX port.....	249
CD player.....	263
iPod.....	270
MP3/WMA/AAC disc.....	263
Portable music player.....	249
Steering wheel audio switch <sup>*</sup> .....	
Sub woofer.....	334
Type.....	243
USB memory.....	276
<b>AUTO LSD system</b> .....	<b>183</b>
<b>Automatic light off system</b> .....	<b>154</b>
<b>Automatic limited slip differential</b> .....	<b>183</b>
<b>Automatic transmission</b>	
Automatic transmission.....	134
If the shift lever cannot be shifted from P.....	502
<b>AUX port</b> .....	<b>249</b>
<b>Auxiliary box</b> .....	<b>340, 345, 364, 365</b>

<b>B</b>	<b>Back-up lights</b>	
	Replacing light bulbs.....	460
	Wattage.....	536
	<b>Back window</b> .....	<b>73</b>
	<b>Battery</b>	
	Charging system warning light.....	477
	Checking.....	418
	If the vehicle battery is discharged.....	504
	Preparing and checking before winter.....	209
	<b>Bluetooth<sup>®</sup> audio</b> .....	<b>304</b>
	<b>Bluetooth<sup>®</sup> phone</b> .....	<b>305</b>
	<b>Bottle holders</b> .....	<b>340, 344</b>
	<b>Brake assist</b> .....	<b>191</b>

**Brakes**

- Brake system warning buzzer  
..... 182, 184, 189, 195, 476
- Brake system warning  
light ..... 476
- Fluid..... 414
- Parking brake ..... 142

**Break-in tips ..... 122**

**C Camper information ..... 567**

**Care**

- Exterior ..... 388
- Interior ..... 391
- Seat belts ..... 392

**Cargo capacity ..... 202, 518**

**Cargo net hook..... 364, 372**

**CD player ..... 263**

**Certification label ..... 217, 521**

**Chains ..... 210**

**Child restraint system**

- Booster seats, definition ..... 100
- Booster seats, installation .... 113
- Convertible seats,  
definition..... 100
- Convertible seats,  
installation ..... 110
- Front passenger occupant  
classification system ..... 95
- Infant seat, definition ..... 100
- Infant seats, installation..... 110
- Installing CRS with LATCH  
system..... 107, 109
- Installing CRS with seat  
belts ..... 110
- Installing CRS with top  
tether straps..... 114, 115

**Child safety**

- Airbag precautions .....89
- Battery precautions .....419, 507
- Child restraint system.....100
- Child-protectors.....37
- How your child should wear  
the seat belt .....59
- Installing child restraints..... 104
- Power window lock switch.....71
- Power window precautions .....72
- Removed wireless remote  
control battery  
precautions .....443
- Seat belt extender  
precautions .....62
- Seat belt precautions .....60
- Seat heater precautions.....360

**Child-protectors .....37**

**Cleaning**

- Exterior.....388
- Interior .....391
- Seat belts .....392

**Clock ..... 351**

**Clutch start cancel switch.....190**

**Compass.....381**

**Condenser .....414**

**Console box .....340, 341**

**Cooling system**

- Engine overheating .....508

**CRS .....100**

**Cruise control.....162**

**Cup holders .....340, 342**

**Curtain shield airbags .....82**

**Customizable features.....551**

\*: Refer to the “NAVIGATION SYSTEM OWNER’S MANUAL”.

<b>D</b>	<p><b>Daytime running light system</b> ..... 154</p> <p><b>Deck</b></p> <ul style="list-style-type: none"> <li>Auxiliary boxes ..... 365</li> <li>Deck ..... 364</li> <li>Deck hooks ..... 366</li> <li>Deck rails ..... 202</li> <li>Tie-down cleats ..... 367</li> </ul> <p><b>Detachable pole antenna</b>..... 335</p> <p><b>Dimension</b>..... 516</p> <p><b>Dinghy towing</b> ..... 233</p> <p><b>Do-it-yourself maintenance</b>.... 400</p> <p><b>Doors</b></p> <ul style="list-style-type: none"> <li>Access doors ..... 39</li> <li>Door glasses ..... 71</li> <li>Door lock ..... 32, 35</li> <li>Open door warning light ..... 479</li> <li>Side doors ..... 35</li> <li>Side mirrors ..... 68</li> </ul> <p><b>Downhill Assist Control System</b>..... 188</p> <p><b>Driver's seat belt reminder light</b>..... 479</p> <p><b>Driver's seat belt reminder warning buzzer</b> ..... 479</p> <p><b>Driving</b></p> <ul style="list-style-type: none"> <li>Break-in tips ..... 122</li> <li>Correct posture ..... 80</li> <li>Driving assist systems ..... 191</li> <li>Procedures ..... 120</li> <li>Winter driving tips ..... 209</li> </ul>
<b>E</b>	<p><b>Emergency, in case of</b></p> <ul style="list-style-type: none"> <li>Blown fuse ..... 444</li> <li>If the engine will not start ..... 501</li> <li>If the shift lever cannot be shifted from P ..... 502</li> <li>If the vehicle battery is discharged ..... 504</li> <li>If the warning buzzer sounds ..... 476</li> <li>If the warning light turns on ... 476</li> <li>If you have a flat tire ..... 486</li> <li>If you lose your keys ..... 503</li> <li>If you think something is wrong ..... 474</li> <li>If the vehicle becomes stuck ..... 511</li> <li>If your vehicle has to be stopped in an emergency ... 513</li> <li>If your vehicle needs to be towed ..... 467</li> <li>If your vehicle overheats ..... 508</li> </ul> <p><b>Emergency flashers</b></p> <ul style="list-style-type: none"> <li>Switch ..... 466</li> </ul> <p><b>Engine</b></p> <ul style="list-style-type: none"> <li>Compartment ..... 406</li> <li>Engine switch ..... 131</li> <li>Exhaust gas ..... 127</li> <li>Hood ..... 404</li> <li>How to start the engine ..... 131</li> <li>Identification number ..... 521</li> <li>If the engine will not start ..... 501</li> <li>Ignition switch ..... 131</li> <li>Immobilizer system ..... 77</li> <li>Overheating ..... 508</li> <li>Warning light ..... 477</li> </ul> <p><b>Engine coolant</b></p> <ul style="list-style-type: none"> <li>Capacity ..... 527</li> <li>Checking ..... 412</li> <li>Preparing and checking before winter ..... 209</li> <li>Temperature gauge ..... 145</li> </ul> <p><b>Engine coolant temperature gauge</b>..... 145</p> <p><b>Engine immobilizer system</b> ..... 77</p> <p><b>Engine oil</b></p> <ul style="list-style-type: none"> <li>Capacity ..... 524</li> <li>Checking ..... 408</li> <li>Preparing and checking before winter ..... 209</li> <li>Warning light ..... 477</li> </ul> <p><b>Engine switch</b>..... 131</p> <p><b>Event data recorder</b> ..... 24</p>

<b>F</b>	<b>Floor mat</b> .....	<b>362</b>
	<b>Fluid</b>	
	Brake .....	414
	Washer .....	420
	<b>Fog lights</b>	
	Replacing light bulbs .....	457
	Switch .....	155
	Wattage .....	536
	<b>Four-wheel drive system</b>	
	Front-wheel drive control switch .....	177
	<b>Front fog lights</b>	
	Replacing light bulbs .....	457
	Switch .....	155
	Wattage .....	536
	<b>Front passenger occupant classification system</b> .....	<b>95</b>
	<b>Front passenger's seat belt reminder light</b> .....	<b>479</b>
	<b>Front passenger's seat belt warning buzzer</b> .....	<b>479</b>
	<b>Front seats</b>	
	Adjustment .....	45
	<b>Front side marker lights</b>	
	Replacing light bulbs .....	458
	Switch .....	152
	Wattage .....	536
	<b>Front turn signal lights</b>	
	Lever .....	141
	Replacing light bulbs .....	459
	Switch .....	141
	Wattage .....	536
	<b>Fuel</b>	
	Capacity .....	523
	Fuel gauge .....	145
	Fuel pump shut off system ...	475
	Gas station information .....	588
	Information .....	537
	Refueling .....	74
	Type .....	523
	Warning light .....	479
	<b>Fuel door</b> .....	<b>74</b>
	<b>Fuel filler door</b> .....	<b>74</b>

<b>Fuel pump shut off system</b> .....	<b>475</b>
<b>Fuses</b>	
Fuses .....	444
Locations .....	447, 451

<b>G</b>	<b>Garage door opener</b> .....	<b>373</b>
	<b>Gas station information</b> .....	<b>588</b>
	<b>Gauges</b> .....	<b>145</b>
	<b>Glove box</b> .....	<b>341</b>
	<b>Grocery bag hooks</b> .....	<b>371</b>

<b>H</b>	<b>Hands-free system (for cellular phone)</b> .....	<b>305</b>
	<b>Hazard lights</b>	
	Switch .....	466

<b>Head restraints</b>	
Adjusting .....	53

<b>Headlights</b>	
Replacing light bulbs .....	455
Switch .....	152
Wattage .....	536

<b>Heaters</b>	
Seat heaters .....	359

<b>High mounted stoplight</b>	
Replacing .....	461
Wattage .....	536

<b>Hill-start assist control</b> .....	<b>191</b>
<b>Hood</b> .....	<b>404</b>

<b>Hooks</b>	
Cargo net .....	372
Deck hooks .....	366
Grocery bag .....	371
Tie-down cleats .....	367

<b>Horn</b> .....	<b>144</b>
-------------------	------------

<b>I</b>	<b>I/M test</b> .....	<b>399</b>
----------	-----------------------	------------

<b>Identification</b>	
Engine .....	522
Tire .....	541
Vehicle .....	521

<b>Ignition switch</b> .....	<b>131</b>
<b>Illuminated entry system</b> .....	<b>338</b>

**Immobilizer system**.....77

**Indicator lights** ..... 148

**Initialization**

Items to initialize.....552

**Inside rear view mirror** .....64

**Interior lights**

Interior lights.....339

Personal lights.....339

Switch.....339

Wattage.....536

**Instrument panel light**

control ..... 146

**J**

**Jack**

Positioning the jack .....491

Vehicle-equipped jack .....486

**Jack handle** .....490

**K**

**Keyless entry**.....32

**Keys**

Engine switch ..... 131

If you lose your keys .....503

Ignition switch.....131

Keyless entry.....32

Key number.....30

Keys .....30

Reminder buzzer.....482

Wireless remote control .....32

Wireless remote control  
battery.....442

**L**

**License plate lights**

Replacing light bulbs .....462

Switch.....152

Wattage.....536

**Light bulbs**

Replacing .....454

Wattage.....536

**Lights**

Automatic light off system ..... 154

Emergency flashers switch ...466

Fog light switch ..... 155

Hazard light switch.....466

Headlights switch ..... 152

**Instrument panel light**

control dial ..... 146

Interior light switch ..... 339

Replacing light bulbs.....454

Turn signal lights switch.....141

Wattage.....536

**Limited slip differential** ..... 183

**Load capacity**.....202, 207, 518

**Lock steering column**.....63

**Luggage storage box** ..... 369

**Luggage compartment**

features ..... 364

**M**

**Maintenance**

**Do-it-yourself**

maintenance ..... 400

General maintenance.....396

Maintenance data .....516

Maintenance requirements ...394

**Reset the maintenance**

data.....395

Vehicle exterior .....388

Vehicle interior .....391

**Malfunction indicator lamp** ....477

**Manual air conditioning**

system .....236

**Manual transmission** ..... 138

**Meter**

**Instrument panel light**

control.....146

Meters .....145

**Mirrors**

Inside rear view mirror ..... 64

Side mirrors.....68

Vanity mirrors.....350

**MP3 disc** .....263

**N**

**Noise from under vehicle**.....22

**O**

**Odometer**.....146

**Off-road precautions**

- Driving ..... 199
- Vehicle..... 197

**Oil**

- Engine oil..... 408
- Warning light ..... 477, 479

**Opener**

- Fuel door ..... 74
- Hood..... 404

**Outside rear view mirrors**

- Adjusting and folding ..... 68

**Overhead console..... 348**

**Overheating, Engine ..... 508**

**P**

**Parking brake ..... 142**

**Personal lights ..... 339**

**Parking lights**

- Replacing light bulbs ..... 459
- Switch..... 152
- Wattage..... 536

**Pole antenna..... 335**

**Power outlet..... 352, 353**

**Power steering**

- Fluid..... 416

**Power windows ..... 71**

**R**

**Radiator..... 406, 414**

**Radio ..... 261**

**Rear seat**

- Adjustment ..... 49
- Folding down..... 50
- Raising the bottom cushion..... 49

**Rear side marker lights**

- Replacing light bulbs .... 460, 464
- Switch..... 152
- Wattage..... 536

**Rear turn signal lights**

- Lever ..... 141
- Replacing light bulbs ..... 460
- Switch..... 141
- Wattage..... 536

**Rear view monitor system**

- Before removing the tailgate .....40
- Rear view monitor system .....166

**Rear window.....73**

**Replacing**

- Fuses .....444
- Light bulbs.....454
- Tires .....422, 486
- Wheels .....436
- Wireless remote control battery.....442

**Rear differential lock**

- system .....185

**Rear step bumper .....43**

**Reporting safety defects for**

- U.S. owners .....554

**Resetting the maintenance**

- required reminder light .....395

**Roll sensing of curtain shield**

- airbags off switch .....94

**S**

**Seat belts**

- Adjustment .....57
- ALR .....59
- Automatic Locking Retractor .....59
- Child restraint system installation..... 104
- Cleaning and maintaining.....392
- ELR .....59
- Emergency Locking Retractor .....59
- How to wear your seat belt.....57
- How your child should wear the seat belt .....59
- Pregnant women, proper seat belt use .....59
- Reminder buzzer.....479
- Reminder light .....479
- Seat belt extenders .....60
- Seat belt pretensioners .....58

<b>Seat heaters</b> .....	<b>359</b>
<b>Seating capacity</b> .....	<b>207</b>
<b>Seats</b>	
Adjustment .....	45
Adjustment precautions.....	48
Child seats/child restraint system installation .....	104
Cleaning .....	391
Folding down the rear seat.....	50
Folding down the rear seat precautions .....	52
Folding passenger's seat .....	46
Front seat adjustment .....	45
Front seat adjustment precautions .....	48
Head restraint.....	53
Moving passenger's seat for rear seat entry.....	46
Properly sitting in the seat.....	80
Raising the bottom cushion.....	49
Seat heaters.....	359
<b>Seatback table</b> .....	<b>361</b>
<b>Service reminder     indicators</b> .....	<b>148</b>
<b>Shift lever</b>	
Automatic transmission.....	134
If the shift lever cannot be shifted from P.....	502
Manual transmission .....	138
<b>Shift lock system</b> .....	<b>502</b>
<b>Side airbags</b> .....	<b>82</b>
<b>Side doors</b> .....	<b>35</b>
<b>Side marker lights</b>	
Replacing light bulbs .....	458, 464
Switch.....	152
Wattage.....	536
<b>Side mirror</b>	
Adjusting and folding.....	68

<b>Spare tire</b>	
Inflation pressure .....	532
Replacing .....	486
Storage location .....	486
<b>Spark plug</b> .....	<b>527</b>
<b>Specifications</b> .....	<b>516</b>
<b>Speedometer</b> .....	<b>145</b>
<b>SRS airbags</b>	
Curtain shield airbags .....	82
Front airbags.....	82
Precautions .....	89
Roll sensing of curtain shield airbag off switch.....	94
Side airbags .....	82
<b>Steering wheel</b>	
Adjustment .....	63
Audio switches*	
Telephone switches*	
<b>Stop lights</b>	
Replacing light bulbs.....	460, 463
Wattage.....	536
<b>Storage feature</b> .....	<b>340</b>
<b>Storage precautions</b> .....	<b>205</b>
<b>Stuck</b>	
If the vehicle becomes stuck .....	511
<b>Sun visors</b> .....	<b>349</b>
<b>Switch</b>	
A-TRAC switch.....	181
Clutch start cancel switch .....	190
Cruise control switch.....	162
DAC switch .....	188
Emergency flashers switch .....	466
Engine switch.....	131
Fog light switch .....	155
Front-wheel drive control switch.....	177
Hazard light switch.....	466
Headlights switch .....	152



Ignition switch.....	131
Light switch.....	152
Power door lock switch.....	36
Power window switch .....	71
Rear differential lock switch .....	185
Roll sensing of curtain shield airbag off switch .....	94
Tire pressure warning reset switch .....	423
Turn signal lights .....	141
VSC OFF switch.....	183, 192
Window lock switch .....	71
Wiper and washer .....	156

**T**

<b>Tachometer .....</b>	<b>145</b>
<b>Tailgate</b>	
Removing the tailgate.....	40
Tailgate.....	40
<b>Tail lights</b>	
Replacing light bulbs ....	460, 464
Switch.....	152
Wattage .....	536
<b>Talk switch*</b>	
<b>Telephone switch*</b>	
<b>Theft deterrent system</b>	
Engine immobilizer system....	77
<b>Tire inflation pressure .....</b>	<b>532</b>
<b>Tire information</b>	
Glossary .....	545
Size .....	542
Tire identification number ....	541
Uniform tire quality grading.....	543

**Tires**

Chains .....	210
Checking .....	422
If you have a flat tire.....	486
Identification number.....	541
Inflation pressure.....	532
Inflation pressure sensor.....	423
Information .....	540
Replacing .....	486
Rotating tires .....	422
Size .....	532
Snow tires .....	426
Spare tire.....	486
Tire pressure warning reset switch.....	423
Tire pressure warning system .....	422, 483
Warning light .....	479
<b>Tools .....</b>	<b>486</b>
<b>Total load capacity.....</b>	<b>207</b>
<b>Towing</b>	
Bumper towing .....	222
Dinghy towing.....	233
Emergency towing.....	467
Fifth wheel trailer.....	220
Trailer towing.....	213
<b>Traction control system .....</b>	<b>191</b>
<b>TRAC .....</b>	<b>191</b>
<b>Trip meter .....</b>	<b>146</b>
<b>Turn signal lights</b>	
Lever .....	141
Replacing light bulbs .....	459, 460
Switch.....	141
Wattage.....	536

\*: Refer to the “NAVIGATION SYSTEM OWNER’S MANUAL”.

**V**

**Vanity mirrors**.....350

**Vehicle control and operation data recording** .....23

**Vehicle data recordings** .....23

**Vehicle identification number** .....521

**Vehicle stability control**.....191

**VSC**.....191

**W**

**Warning buzzers**

Key reminder.....482

Brake system .....476

Seat belt reminder.....479

**Warning lights**

ABS .....477

Airbag system .....477

Anti-lock brake system.....477

Automatic transmission

fluid temperature.....479

Brake system .....476

Charging system .....477

Driver's seat belt .....479

Electronic engine control system .....477

Engine oil replacement.....479

Front passenger occupant classification system .....477

Front passenger's seat belt.....479

Low brake fluid .....476

Low engine oil pressure .....477

Low fuel level .....479

Low tire inflation pressure ....479

Malfunction indicator lamp ....477

Open door .....479

Seat belt.....479

Seat belt pretensioner system .....477

SRS.....477

SRS airbag system .....477

Tire pressure.....479

Tire pressure warning system .....479

VSC/TRAC.....477

**Washer**

Checking .....420

Preparing and checking before winter.....209

Switch .....156

**Washing and waxing** .....388

**Weight**

Cargo capacity.....202

Cargo weight rating.....568

Gross axle weight rating .....570

Gross combination weight rating.....218

Gross vehicle weight rating.....570

Load limits.....207

Trailer weight rating .....218, 519

Vehicle capacity weight.....518

Weight.....518

**Wheels** .....436

**Window glasses** .....71, 73

**Window lock switch**.....71

**Windows**

Power windows .....71

Washer.....156

**Windshield wipers** .....156

**Wireless remote control**

Replacing the battery .....442

Wireless remote control .....32

**Winter driving tips** .....209

**WMA disc**.....263

What to do if...

What to do if...

A tire punctures	P. 486	If you have a flat tire
The engine does not start	P. 501	If the engine will not start
	P. 77	Engine immobilizer system
	P. 504	If the vehicle battery is discharged
The shift lever cannot be moved out	P. 502	If the shift lever cannot be shifted from P
The engine coolant temperature gauge enters the red zone	P. 508	If your vehicle overheats
Steam can be seen coming from under the hood		
The key is lost	P. 503	If you lose your keys
The battery runs out	P. 504	If the vehicle battery is discharged
The doors cannot be locked	P. 35	Side doors
	P. 39	Access doors
The vehicle is stuck in mud or sand	P. 511	If the vehicle becomes stuck
The warning light or indicator light comes on	P. 476	If a warning light turns on





■ Warning lights

**BRAKE** Brake system warning light

or

 P. 476

 Charging system warning light P. 477

 Low engine oil pressure warning light P. 477

 Malfunction indicator lamp

or

 P. 477

 SRS warning light P. 477

**ABS** ABS warning light

or

 P. 478

 Slip indicator\*<sup>1</sup> P. 478

**CRUISE** Cruise control indicator light\*<sup>2</sup> P. 478

 Open door warning light P. 479

 Driver's seat belt reminder light P. 479

**PASSENGER** Front passenger's seat belt reminder light P. 479

**A/T OIL TEMP** Automatic transmission fluid temperature warning light P. 479

 Tire pressure warning light P. 480

 Low fuel level warning light P. 480

**MAINT REQD** Maintenance required reminder light P. 481

\*1: Slip indicator comes on.

\*2: The indicator flashes to indicate a malfunction.

## GAS STATION INFORMATION

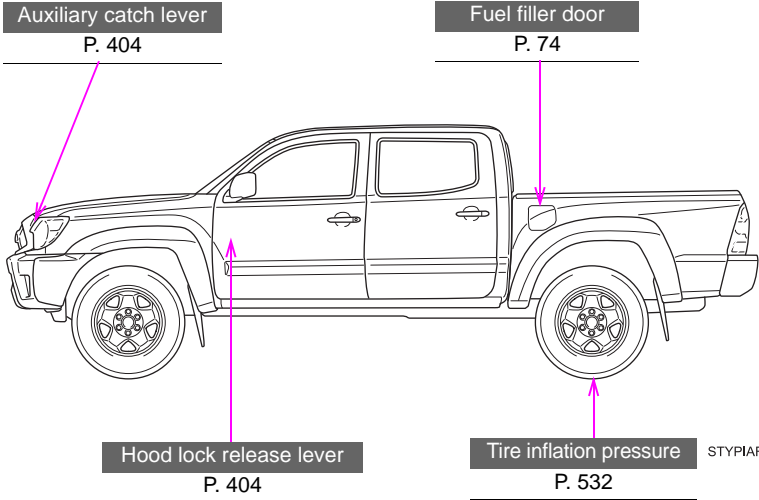

Fuel tank capacity (Reference)	21.1 gal. (80.0 L, 17.6 Imp.gal.)
Fuel type	Unleaded gasoline, Octane Rating 87 (Research Octane Number 91) or higher
Cold tire inflation pressure	P. 532
Engine oil capacity (Drain and refill -reference)	P. 524
Engine oil type	P. 525