

TABLE OF CONTENTS

1	Before driving	Adjusting and operating features such as door locks, mirrors, and steering column.
2	When driving	Driving, stopping and safe-driving information.
3	Interior features	Air conditioning and audio systems, as well as other interior features for a comfortable driving experience.
4	Maintenance and care	Cleaning and protecting your vehicle, performing do-it-yourself maintenance, and maintenance information.
5	When trouble arises	What to do if the vehicle needs to be towed, gets a flat tire, or is involved in an accident.
6	Vehicle specifications	Detailed vehicle information.
7	For owners	Reporting safety defects for U.S. owners, and seat belt and SRS airbag instructions for Canadian owners
	Index	Alphabetical listing of information contained in this manual.

For your information

Main Owner's Manual

Please note that this manual covers all models and all equipment, including options. Therefore, you may find some explanations for equipment not installed on your vehicle.

All specifications provided in this manual are current at the time of printing. However, because of the Toyota policy of continual product improvement, we reserve the right to make changes at any time without notice.

Depending on specifications, the vehicle shown in the illustrations may differ from your vehicle in terms of equipment.

Noise from under vehicle after turning off the engine

Approximately five hours after the engine is turned off, you may hear sound coming from under the vehicle for several minutes. This is the sound of a fuel evaporation leakage check and, it does not indicate a malfunction.

Accessories, spare parts and modification of your Toyota

A wide variety of non-genuine spare parts and accessories for Toyota vehicles are currently available on the market. You should know that these parts are not covered by Toyota warranty and that Toyota is not responsible for their performance, repair, or replacement, or for any damage they may cause to, or adverse effect they may have on, your Toyota vehicle.

This vehicle should not be modified with non-genuine Toyota products. Modification with non-genuine Toyota products could affect its performance, safety or durability, and may even violate governmental regulations. In addition, damage or performance problems resulting from the modification may not be covered under warranty.

Installation of a mobile two-way radio system

As the installation of a mobile two-way radio system in your vehicle may affect electronic systems such as the multi-port fuel injection system/sequential multi-port fuel injection system, cruise control system, anti-lock brake system, SRS airbag system or seat belt pretensioner system, be sure to check with your Toyota dealer for precautionary measures or special instructions regarding installation.

Vehicle data recordings

Your Toyota is equipped with several sophisticated computers that will record certain data, such as:

- Engine speed
- Accelerator status
- Brake status
- Vehicle speed
- Shift position (vehicles with an automatic transmission)

The recorded data varies according to the vehicle grade level and options with which it is equipped. Furthermore, these computers do not record conversations, sounds or pictures.

● Data usage

Toyota may use the data recorded in these computers to diagnose malfunctions, conduct research and development, and improve quality.

Toyota will not disclose the recorded data to a third party except:

- With the consent of the vehicle owner or with the consent of the lessee if the vehicle is leased
- In response to an official request by the police, a court of law or a government agency
- For use by Toyota in a lawsuit
- For research purposes where the data is not tied to a specific vehicle or vehicle owner

Event data recorder

This vehicle is equipped with an event data recorder (EDR). The main purpose of an EDR is to record, in certain crash or near crash-like situations, such as an air bag deployment or hitting a road obstacle, data that will assist in understanding how a vehicle's systems performed. The EDR is designed to record data related to vehicle dynamics and safety systems for a short period of time, typically 30 seconds or less.

The EDR in this vehicle is designed to record such data as:

- How various systems in your vehicle were operating;
- Whether or not the driver and passenger safety belts were buckled/fastened;
- How far (if at all) the driver was depressing the accelerator and/or brake pedal; and,
- How fast the vehicle was traveling.

These data can help provide a better understanding of the circumstances in which crashes and injuries occur.

NOTE: EDR data are recorded by your vehicle only if a non-trivial crash situation occurs; no data are recorded by the EDR under normal driving conditions and no personal data (e.g., name, gender, age, and crash location) are recorded. However, other parties, such as law enforcement, could combine the EDR data with the type of personally identifying data routinely acquired during a crash investigation.

To read data recorded by an EDR, special equipment is required, and access to the vehicle or the EDR is needed. In addition to the vehicle manufacturer, other parties, such as law enforcement, that have the special equipment, can read the information if they have access to the vehicle or the EDR.

● Disclosure of the EDR data

Toyota will not disclose the data recorded in an EDR to a third party except when:

- An agreement from the vehicle's owner (or the lessee for a leased vehicle) is obtained
- In response to an official request by the police, a court of law or a government agency
- For use by Toyota in a lawsuit

However, if necessary, Toyota may:

- Use the data for research on vehicle safety performance
- Disclose the data to a third party for research purposes without disclosing information about the specific vehicle or vehicle owner

Scrapping of your Toyota

The SRS airbag and seat belt pretensioner devices in your Toyota contain explosive chemicals. If the vehicle is scrapped with the airbags and seat belt pretensioners left as they are, this may cause an accident such as fire. Be sure to have the systems of the SRS airbag and seat belt pretensioner removed and disposed of by a qualified service shop or by your Toyota dealer before you scrap your vehicle.

Perchlorate Material

Special handling may apply, See www.dtsc.ca.gov/hazardouswaste/perchlorate.

Your vehicle has components that may contain perchlorate. These components may include airbags, seat belt pretensioners, and wireless remote control batteries.



CAUTION

■ **General precautions while driving**

Driving under the influence: Never drive your vehicle when under the influence of alcohol or drugs that have impaired your ability to operate your vehicle. Alcohol and certain drugs delay reaction time, impair judgment and reduce coordination, which could lead to an accident that could result in death or serious injury.

Defensive driving: Always drive defensively. Anticipate mistakes that other drivers or pedestrians might make and be ready to avoid accidents.

Driver distraction: Always give your full attention to driving. Anything that distracts the driver, such as adjusting controls, talking on a cellular phone or reading can result in a collision with resulting death or serious injury to you, your occupants or others.

■ **General precaution regarding children's safety**

Never leave children unattended in the vehicle, and never allow children to have or use the key.

Children may be able to start the vehicle or shift the vehicle into neutral. There is also a danger that children may injure themselves by playing with the cigarette lighter, the windows, or other features of the vehicle. In addition, heat build-up or extremely cold temperatures inside the vehicle can be fatal to children.

Symbols used throughout this manual

Cautions & Notices

CAUTION

This is a warning against anything which may cause death or injury to people if the warning is ignored. You are informed about what you must or must not do in order to reduce the risk of injury to yourself and others.

NOTICE

This is a warning against anything which may cause damage to the vehicle or its equipment if the warning is ignored. You are informed about what you must or must not do in order to avoid or reduce the risk of damage to your Toyota and its equipment.

Symbols used in illustrations



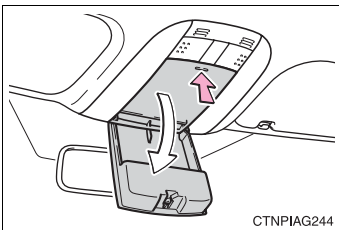

Safety symbol

The symbol of a circle with a slash through means “Do not”, “Do not do this”, or “Do not let this happen”.



Arrows indicating operations

-  Indicates the action (pushing, turning, etc.) used to operate switches and other devices.
-  Indicates the outcome of an operation (e.g. a lid opens).

Keys

The following keys are provided with the vehicle.

► Vehicles without wireless remote control

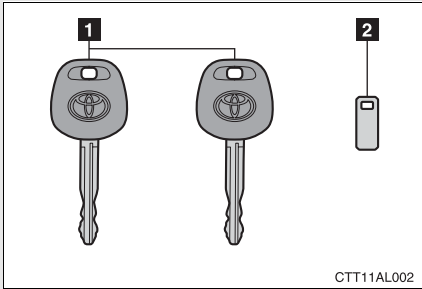

- 1 Keys
- 2 Key number plate

► Vehicles with wireless remote control

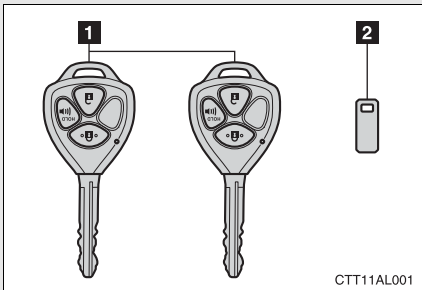

- 1 Keys
Operating the wireless remote control function (→P. 28)
- 2 Key number plate

■ Key number plate

Keep the plate in a safe place such as your wallet, not in the vehicle. In the event that a key is lost, a new key can be made by your Toyota dealer using the key number plate. (→P. 424)

■ When riding in an aircraft

When bringing a wireless remote control key onto an aircraft, make sure you do not press any buttons on the wireless remote control key while inside the aircraft cabin. If you are carrying the wireless remote control key in your bag etc, ensure that the buttons are not likely to be pressed accidentally. Pressing a button may cause the wireless remote control key to emit radio waves that could interfere with the operation of the aircraft.

 NOTICE**■ To prevent key damage**

- Do not subject the keys to strong shocks, expose them to high temperatures by placing them in direct sunlight, or get them wet.
- Do not expose the keys to electromagnetic materials or attach any material that blocks electromagnetic waves to the key surface.
- Do not disassemble the key.

1-2. Opening, closing and locking the doors Wireless remote control*

The wireless remote control can be used to lock and unlock the vehicle from outside the vehicle.

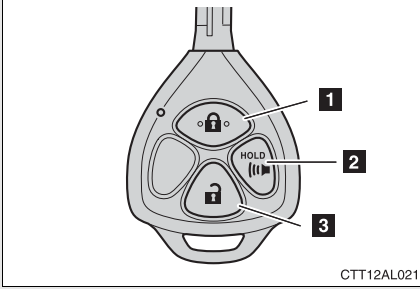

- 1 Locks all doors
- 2 Sounds an alarm (press and hold)
- 3 Unlocks doors

Pressing the button unlocks the driver's door. Pressing the button again within 3 seconds unlocks the other doors.

■ Operation signals

A buzzer sounds and the emergency flashers flash to indicate that the doors have been locked/unlocked. (Locked: Once; Unlocked: Twice)

■ Door lock buzzer

If a door is not fully closed, a buzzer sounds continuously for 10 seconds if an attempt to lock the door is made. Fully close the door to stop the buzzer, and lock the vehicle once more.

■ Panic mode



When  is pressed for longer than about one second, an alarm will sound intermittently and the vehicle lights will flash to deter any person from trying to break into or damage your vehicle.

To stop the alarm, press any button on the wireless remote control.

*: If equipped

■ Key battery depletion

If the wireless remote control function does not operate, the battery may be depleted. Replace the battery when necessary. (→P. 367)

■ Security feature

If a door is not opened within approximately 60 seconds after the vehicle is unlocked, the security feature automatically locks the vehicle again.

■ Conditions affecting operation

The wireless remote control function may not operate normally in the following situations.

- Near a TV tower, radio station, electric power plant, airport or other facility that generates strong radio waves
- When carrying a portable radio, cellular phone or other wireless communication devices
- When multiple wireless keys are in the vicinity
- When the wireless key has come into contact with, or is covered by, a metallic object
- When a wireless key (that emits radio waves) is being used nearby
- When the wireless key has been left near an electrical appliance such as a personal computer
- When the wireless key battery is depleted
- If window tint with a metallic content or metallic objects are attached to the rear window

■ Customization that can be configured at Toyota dealer

Settings (e.g. operation signal) can be changed.
(Customizable features →P. 469)

■ **Certification for wireless remote control**

- ▶ For vehicles sold in the U.S.A.

NOTE:

This device complies with Part 15 of the FCC Rules. Operation is subject to the following two conditions: (1) This device may not cause harmful interference, and (2) this device must accept any interference received, including interference that may cause undesired operation.

- ▶ For vehicles sold in Canada

NOTE:

Operation is subject to the following two conditions: (1) this device may not cause interference, and (2) this device must accept any interference, including interference that may cause undesired operation of the device.

1-2. Opening, closing and locking the doors

Doors

The vehicle can be locked and unlocked using the wireless remote control, key or door lock switch.

■ Wireless remote control (if equipped)

→P. 28

■ Key

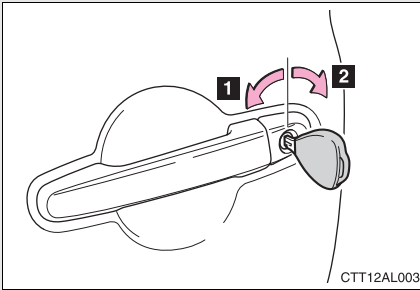

- 1 Locks the door
- 2 Unlocks the door

Vehicles with power door lock system: Turning the key locks and unlocks all doors. In the driver's door lock, turning the key once unlocks the driver's door. Turning the key again within 3 seconds unlocks the other doors.

■ Door lock switch (if equipped)

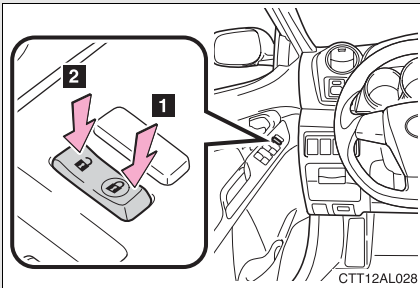

- 1 Locks all doors
- 2 Unlocks all doors

■ Inside lock button

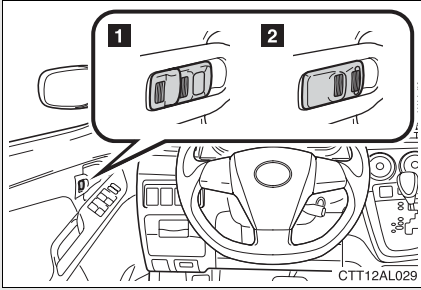

1 Unlocks the door

2 Locks the door

The front doors can be opened by pulling the inside handle even if the lock buttons are in the lock position.

Rear door child-protector lock

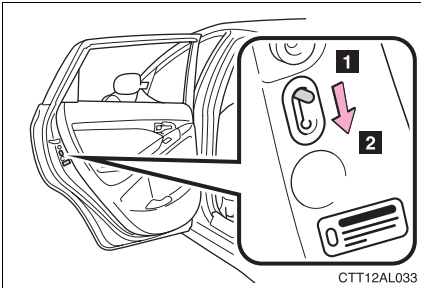

The door cannot be opened from inside the vehicle when the locks are set.

1 Unlock

2 Lock

These locks can be set to prevent children from opening the rear doors. Push down on each rear door switch to lock both rear doors.

Automatic door locking and unlocking systems (vehicles with power door lock system)

The following functions can be set or cancelled:

Function	Operation
Shift position linked door locking function *	Shifting the shift lever out of P locks all doors.
Shift position linked door unlocking function *	Shifting the shift lever to P unlocks all doors.
Driver's door linked door unlocking function	All doors are unlocked when the driver's door is opened within 10 seconds after turning the engine switch to "ACC" or "LOCK".

*: Vehicles with an automatic transmission only



The shift position linked door locking function works when all doors are closed.

■ Setting and canceling the functions

To switch between set and canceled, follow the procedure below:

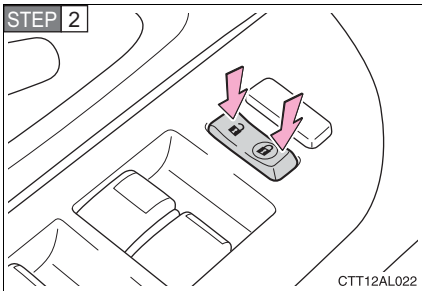

STEP 1 Close all the doors and switch the engine switch to the “ON” position. (Perform step 2 within 10 seconds.)



Shift the shift lever to P or N, and press and hold the driver's door lock switch ( or ) for approximately 5 seconds and then release.

The shift lever and switch positions corresponding to the desired function to be set are shown as follows.

Use the same procedure to cancel the function.

Function	Shift lever position	Switch position
Shift position linked door locking function*	P	
Shift position linked door unlocking function*		
Driver's door linked door unlocking function	N	

*: Vehicles with an automatic transmission only

When the setting or canceling operation is complete, all doors are locked and then unlocked.

■ When all the doors are locked with the wireless remote control or key

The doors cannot be unlocked with the door lock switch.

The door lock switch can be reset by unlocking all the doors with the wireless remote control or key.

■ The doors cannot be locked when

The key is in the engine switch and either of the front door is open.

■ Customization that can be configured at Toyota dealer

Settings (e.g. unlocking function using a key) can be changed.
(Customizable features →P. 469)

⚠ CAUTION**■ To prevent an accident**

Observe the following precautions while driving the vehicle.

Failing to do so may result in a door opening and an occupant falling out, resulting in death or serious injury.

● Always use a seat belt.

● Always lock the doors.

● Ensure that all doors are properly closed.

● Do not pull the inside handle of the doors while driving.

The doors may be opened and the passengers are thrown out of the vehicle and it may result in serious injury or death.

Be especially careful for the front doors, as the doors may be opened even if the inside lock buttons are in locked position.

● Set the rear door child protector locks when children are seated in the rear seat.

1-2. Opening, closing and locking the doors

Back door

The back door can be locked and unlocked using the wireless remote control or key.

▶ Wireless remote control (if equipped)

→P. 28

▶ Key

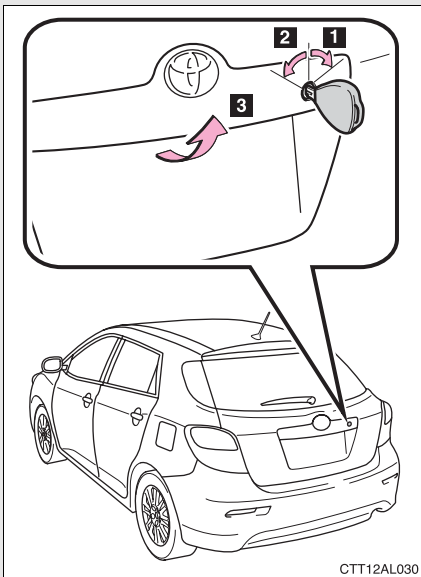

- 1 Locks the back door
- 2 Unlocks the back door
- 3 Opens the back door

■ Back door handle

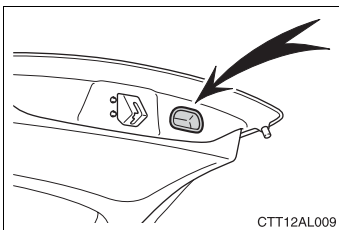

Use the back door handle when closing.

 **CAUTION****■ Caution while driving**

- Keep the back door closed while driving.

If the back door is left open, it may hit nearby objects while driving or luggage may be unexpectedly thrown out, causing an accident.

In addition, exhaust gases may enter the vehicle, causing death or a serious health hazard. Make sure to close the back door before driving.

- Before driving the vehicle, make sure that the back door is fully closed. If the back door is not fully closed, it may open unexpectedly while driving, causing an accident.
- Never let anyone sit in the luggage compartment. In the event of sudden braking or a collision, they are susceptible to death or serious injury.

■ When children are in the vehicle

Observe the following precautions.

Failure to do so may result in death or serious injury.

- Do not leave children alone in the luggage compartment.

If a child is accidentally locked in the luggage compartment, they could have heat exhaustion.

- Do not allow a child to open or close the back door.

Doing so may cause the back door to operate unexpectedly, or cause the child's hands, head, or neck to be caught by the closing back door, which may result in death or serious injury of the child.

■ Operating the back door

Observe the following precautions.

Failure to do so may cause parts of the body to be caught, resulting in serious injury.

- Remove any heavy loads, such as snow and ice, from the back door before opening it. Failure to do so may cause the back door to suddenly shut again after it is opened.

! CAUTION

- When opening or closing the back door, thoroughly check to make sure the surrounding area is safe.
- If anyone is in the vicinity, make sure they are safe and let them know that the back door is about to open or close.
- Use caution when opening or closing the back door in windy weather as it may move abruptly in strong wind.

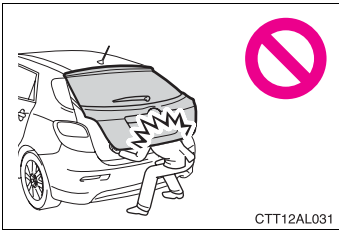

- The back door may suddenly shut if it is not opened fully. It is more difficult to open or close the back door on an incline than on a level surface, so beware of the back door unexpectedly opening or closing by itself. Make sure that the back door is fully open and secure before using the luggage compartment.

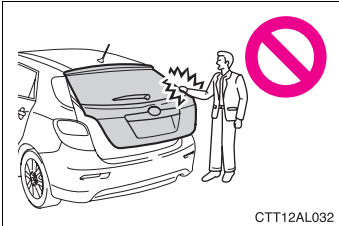

- When closing the back door, take extra care to prevent your fingers etc. from being caught.
- When closing the back door, make sure to press it lightly on its outer surface. If the back door handle is used to fully close the back door, it may result in hands or arms being caught.

- Do not pull on the back door damper stay to close the back door, and do not hang on the back door damper stay. Doing so may cause hands to be caught or the back door damper stay to break, causing an accident.
- Do not attach any accessories other than genuine Toyota parts to the back door. Such additional weight on the back door may cause the back door to suddenly shut again after it is opened.

 NOTICE**■ Back door damper stays**

The back door is equipped with damper stays that hold the back door in place.

Observe the following precautions.

Failure to do so may cause damage to the back door damper stay, resulting in malfunction.

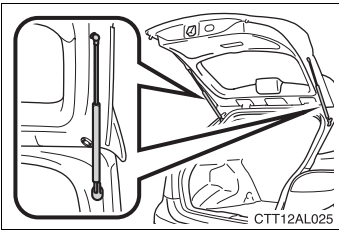

- Do not attach any foreign objects, such as stickers, plastic sheets, or adhesives to the damper stay rod.
- Do not touch the damper stay rod with gloves or other fabric items.
- Do not attach any accessories other than genuine Toyota parts to the back door.
- Do not place your hand on the damper stay or apply lateral forces to it.

1-3. Adjustable components (seats, mirrors, steering wheel)

Front seats

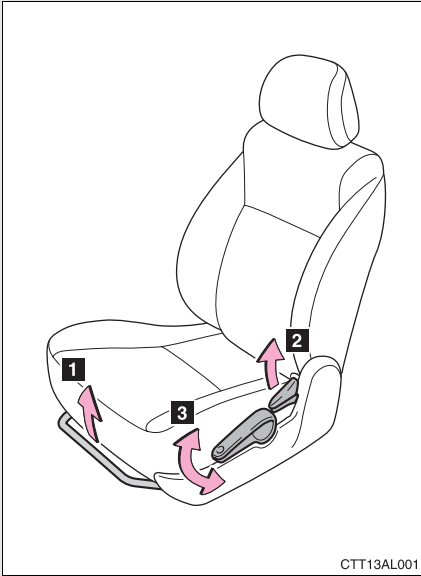

- 1** Seat position adjustment lever
- 2** Seatback angle adjustment lever
- 3** Vertical height adjustment lever (driver's side only)

Folding down the front passenger's seat (vehicles with seatback table)

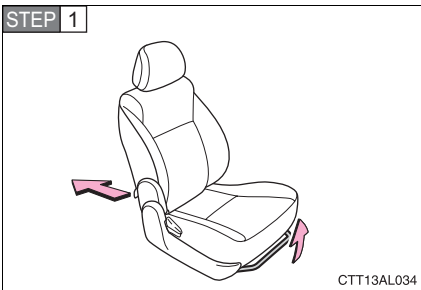

Move the seat rearward.

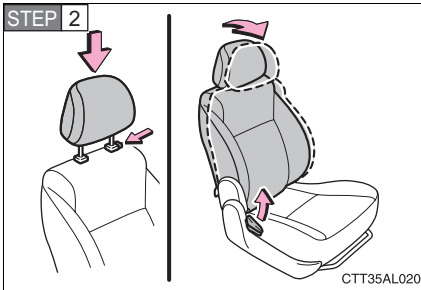

Lower the head restraint and fix the seatback at the most upright lock position.

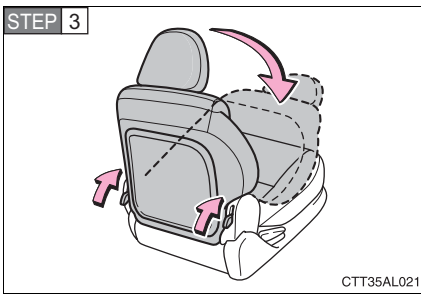

Pull up either seatback lock release knob beside the seatback and fold the seatback down.

Active head restraints

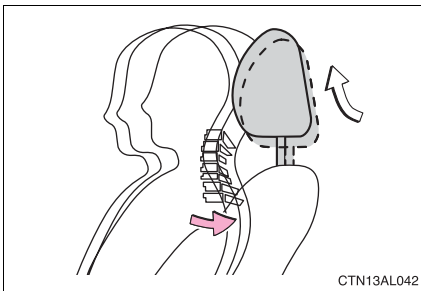

When the occupant's back presses against the seatback during a rear-end collision, the head restraint moves slightly forward to help reduce the risk of whiplash on the seat occupant.

■ Active head restraints

Even small forces applied to the seatback may cause the head restraint to move. Pushing up a locked head restraint forcibly may appear the head restraint inner structure. These do not indicate problems.

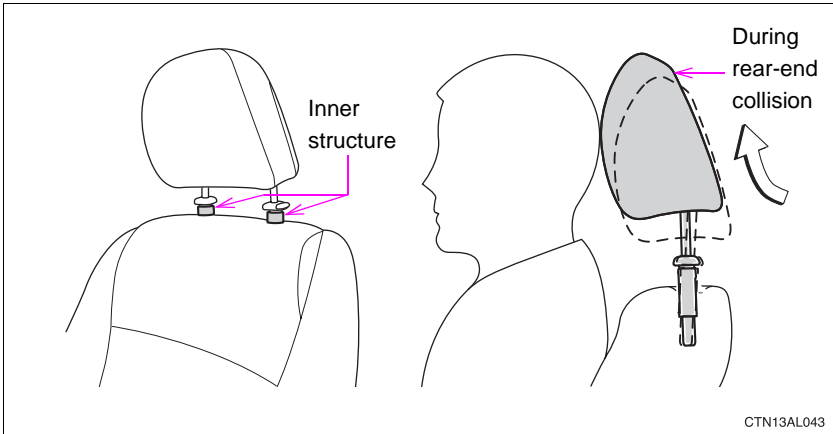

⚠ CAUTION

■ Seat adjustment

- Be careful that the seat does not hit passengers or luggage.
- Do not recline the seat more than necessary when the vehicle is in motion to reduce the risk of sliding under the lap belt.
If the seat is too reclined, the lap belt may slide past the hips and apply restraint forces directly to the abdomen or your neck may contact the shoulder belt, increasing the risk of death or serious injury in the event of an accident.
- After adjusting the seat, make sure that the seat is locked in position.

 CAUTION

■ **After returning the seatback to the upright position (vehicles with seatback table)**

Make sure the seatback is securely locked by pressing forward and rearward on the top of the seatback. Failure to do so will prevent seat belt from operating properly.

■ **Caution while driving (vehicles with seatback table)**

Do not sit on or place anything on the folded seatback.

1-3. Adjustable components (seats, mirrors, steering wheel)

Rear seats

The seatbacks of the rear seats can be folded down.

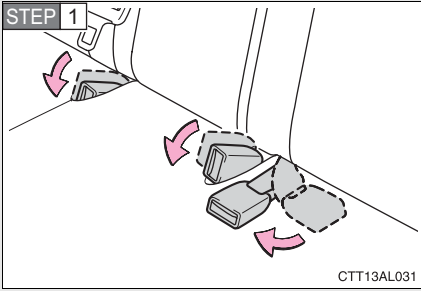

Stow the rear outside seat belt buckles and move the rear center seat belt buckle as shown.

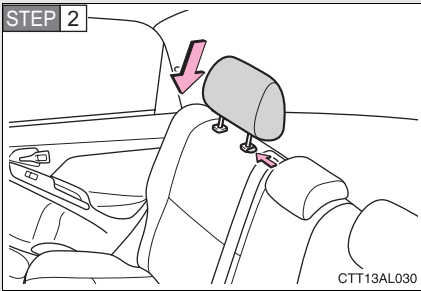

Lower the head restraints to the lowest position.

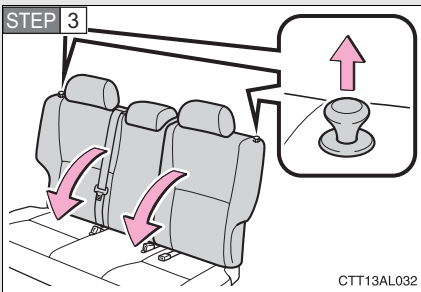

Fold the seatback down while pulling the seatback lock release knob.

! CAUTION

■ After returning the seatback to the upright position

Observe the following precautions. Failure to do so may result in death or serious injury.

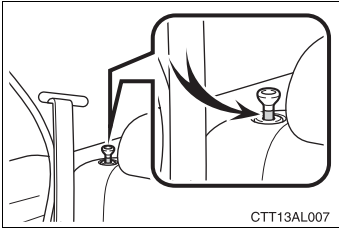

- Make sure that the seatback is securely locked in position by lightly rocking it back and forth. If the seatback is not securely locked, the red marking will be visible on the seatback lock release knob. Make sure that the red marking is not visible.

- Check that the seat belts are not twisted or caught in the seatback.

■ Caution while driving

Do not sit on the folded seatback.

1-3. Adjustable components (seats, mirrors, steering wheel)

Head restraints

Head restraints are provided for all seats.

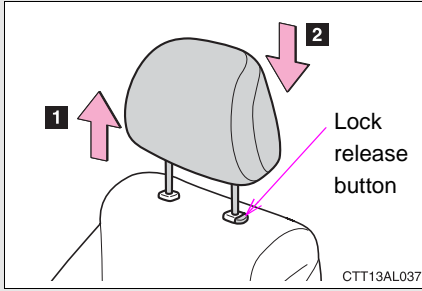

1 Up

Pull the head restraints up.

2 Down

Push the head restraint down while pushing the lock release button.

■ Removing the head restraints

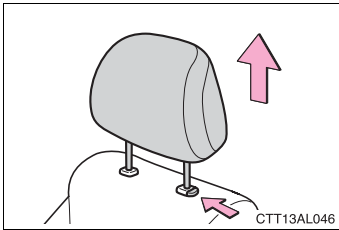

Pull the head restraint up while pushing the lock release button.

■ Installing the head restraints

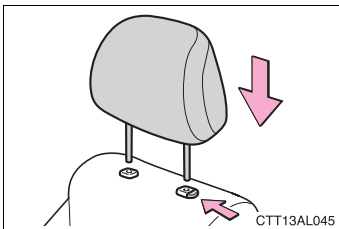

Align the head restraint with the installation holes and push it down while pressing the lock release button.

■ Adjusting the height of the head restraints

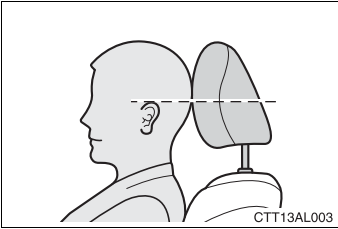

Make sure that the head restraints are adjusted so that the center of the head restraint is closest to the top of your ears.

■ Adjusting the rear center seat head restraint

Always raise the head restraint one level from the stowed position when using.

⚠ CAUTION

■ Head restraint precautions

Observe the following precautions regarding the head restraints. Failure to do so may result in death or serious injury.

- Use the head restraints designed for each respective seat.
- Adjust the head restraints to the correct position at all times.
- After adjusting the head restraints, push down on them and make sure they are locked in position.
- Do not drive with the head restraints removed.

1-3. Adjustable components (seats, mirrors, steering wheel)

Seat belts

Make sure that all occupants are wearing their seat belts before driving the vehicle.

■ Correct use of the seat belts

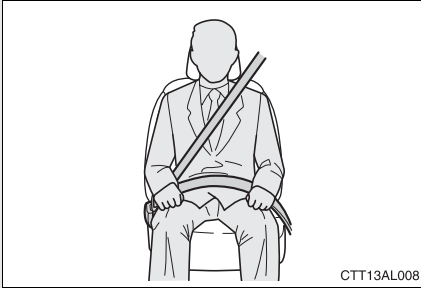

- Extend the shoulder belt so that it comes fully over the shoulder, but does not come into contact with the neck or slide off the shoulder.
- Position the lap belt as low as possible over the hips.
- Adjust the position of the seatback. Sit up straight and well back in the seat.
- Do not twist the seat belt.

■ Fastening and releasing the seat belt

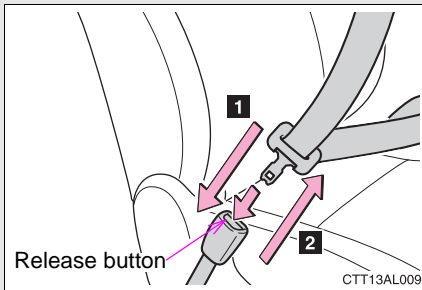

1 Fastening the belt

Push the tab into the buckle until a clicking sound is heard.

2 Releasing the belt

Press the release button.

■ Adjusting the height of the belt (front seats)

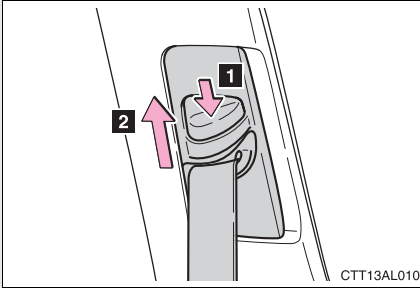

1 Push the seat belt shoulder anchor down while pressing the release button.

2 Push the seat belt shoulder anchor up.

Move the height adjuster up and down as needed.

■ Seat belt pretensioners (front seats)

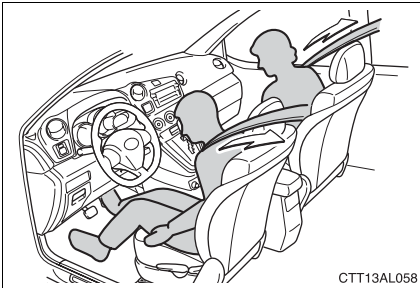

The pretensioner helps the seat belt to quickly restrain the occupant by retracting the seat belt when the vehicle is subjected to certain types of severe frontal collision.

The pretensioner may not activate in the event of a minor frontal impact, a side impact or a rear impact.

■ Emergency locking retractor (ELR)

The retractor will lock the belt during a sudden stop or on impact. It may also lock if you lean forward too quickly. A slow, easy motion will allow the belt to extend so that you can move around fully.

■ Automatic locking retractor (ALR)

When a passenger's shoulder belt is completely extended and then retracted even slightly, the belt is locked in that position and cannot be extended. This feature is used to hold the child restraint system (CRS) firmly. To free the belt again, fully retract the belt and then pull the belt out once more. (→P. 94)

■ Pregnant women

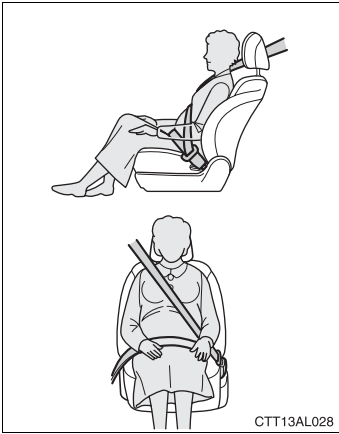

Obtain medical advice and wear the seat belt in the proper way. (→P. 48)

Women who are pregnant should position the lap belt as low as possible over the hips in the same manner as other occupants. Extend the shoulder belt completely over the shoulder and position the belt across the chest. Avoid belt contact over the rounding of the abdominal area.

If the seat belt is not worn properly, not only a pregnant woman, but also the fetus could suffer death or serious injury as a result of sudden braking or a collision.

■ People suffering illness

Obtain medical advice and wear the seat belt in the proper way.

■ Child seat belt usage

The seat belts of your vehicle were principally designed for persons of adult size.

- Use a child restraint system appropriate for the child, until the child becomes large enough to properly wear the vehicle's seat belt. (→P. 90)
- When the child becomes large enough to properly wear the vehicle's seat belt, follow the instructions on P. 48 regarding seat belt usage.

■ Replacing the belt after the pretensioner has been activated

If the vehicle is involved in multiple collisions, the pretensioner will activate for the first collision, but will not activate for the second or subsequent collisions.

■ Seat belt extender

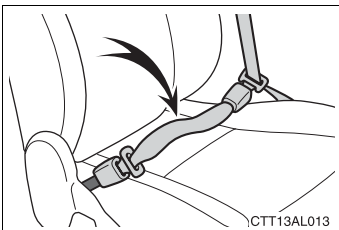

If your seat belts cannot be fastened securely because they are not long enough, a personalized seat belt extender is available from your Toyota dealer free of charge.

 **CAUTION**

Observe the following precautions to reduce the risk of injury in the event of sudden braking, sudden swerving or an accident. Failing to do so may cause death or severe injury.

■ Wearing a seat belt

- Ensure that all passengers wear a seat belt.
- Always wear a seat belt properly.
- Each seat belt should be used by one person only. Do not use a seat belt for more than one person at once, including children.
- Toyota recommends that children be seated in the rear seat and always use a seat belt and/or an appropriate child restraint system.
- Do not recline the seat any more than necessary to achieve a proper seating position. The seat belt is most effective when the occupants are sitting up straight and well back in the seats.
- Do not wear the shoulder belt under your arm.
- Always wear your seat belt low and snug across your hips.

■ Adjustable shoulder anchor

Always make sure the shoulder belt is positioned across the center of your shoulder. The belt should be kept away from your neck, but not falling off your shoulder. Failure to do so could reduce the amount of protection in an accident and cause death or serious injuries in the event of a sudden stop, sudden swerve or accident. (→P. 49)

■ Child restraint lock function belt

Do not allow children to play with the child restraint lock function belt. If the belt becomes twisted around a child's neck, it will not be possible to pull the belt out leading to choking or other serious injuries that could result in death. If this occurs and the buckle cannot be unfastened, scissors should be used to cut the belt.

 CAUTION

■ **Seat belt pretensioners**

- Do not place anything, such as a cushion, on the front passenger's seat. Doing so will disperse the passenger's weight, which prevents the sensor from detecting the passenger's weight properly. As a result, the seat belt pretensioner for the front passenger's seat may not activate in the event of a collision.
- If the pretensioner has activated, the SRS warning light will come on. In that case, the seat belt cannot be used again and must be replaced at your Toyota dealer.

■ **Seat belt damage and wear**

- Do not damage the seat belts by allowing the belt, plate, or buckle to be jammed in the door.
- Inspect the seat belt system periodically. Check for cuts, fraying, and loose parts. Do not use a damaged seat belt until it is replaced. Damaged seat belts cannot protect an occupant from death or serious injury.
- Ensure that the belt and tab are locked and the belt is not twisted. If the seat belt does not function correctly, immediately contact your Toyota dealer.
- Replace the seat assembly, including the belts, if your vehicle has been involved in a serious accident, even if there is no obvious damage.
- Do not attempt to install, remove, modify, disassemble or dispose of the seat belts. Have any necessary repairs carried out by your Toyota dealer. Inappropriate handling of the pretensioner may prevent it from operating properly resulting in death or serious injury.

■ **Using a seat belt extender**

- Do not wear the seat belt extender if you can fasten the seat belt without the extender.
- Do not use the seat belt extender when installing a child restraint system because the belt will not securely hold the child restraint system, increasing the risk of death or serious injury in the event of an accident.
- The personalized extender may not be safe on another vehicle, when used by another person, or at a different seating position other than the one originally intended.



NOTICE

■ **When using a seat belt extender**

When releasing the seat belt, press on the buckle release button on the extender, not on the seat belt.

This helps prevent damage to the vehicle interior and the extender itself.

1-3. Adjustable components (seats, mirrors, steering wheel)

Steering wheel

The steering wheel can be adjusted to a comfortable position.

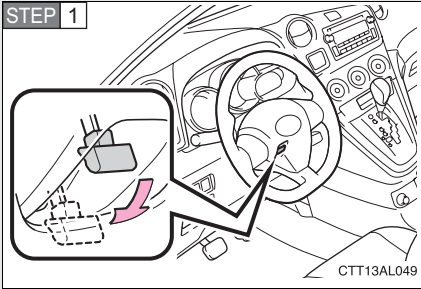

Hold the steering wheel and press the lever down.

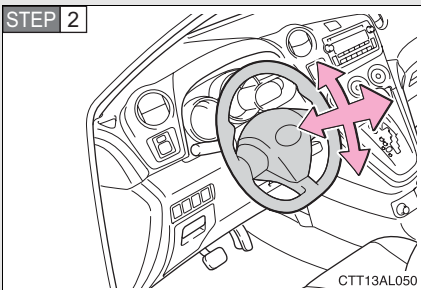

Adjust to the ideal position by moving the steering wheel horizontally and vertically.

After adjustment, pull the lever up to secure the steering wheel.

CAUTION

■ Caution while driving

Do not adjust the steering wheel while driving.

Doing so may cause the driver to mishandle the vehicle and cause an accident, resulting in death or serious injury.

■ After adjusting the steering wheel

Make sure that the steering wheel is securely locked.

Otherwise, the steering wheel may move suddenly, possibly causing an accident and resulting in death or serious injury.

1-3. Adjustable components (seats, mirrors, steering wheel)

Anti-glare inside rear view mirror

Glare from the headlights of vehicles behind can be reduced by using the following functions.

► Manual anti-glare inside rear view mirror

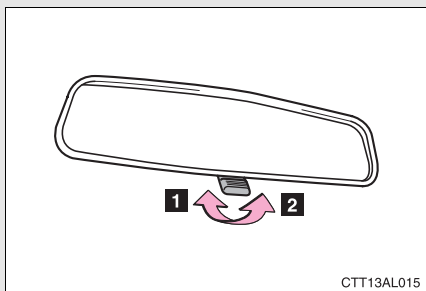

- 1** Normal position
- 2** Anti-glare position

► Auto anti-glare inside rear view mirror

In automatic mode, sensors are used to detect the headlights of vehicles behind and the reflected light is automatically reduced.

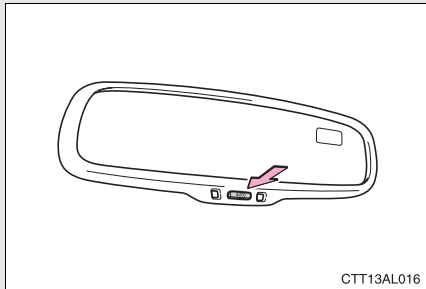

Turns automatic mode on/off

The indicator comes on when automatic mode is turned on.

The mirror will revert to the automatic mode each time the engine switch is turned to the "ON" position.

Adjusting the height of the rear view mirror

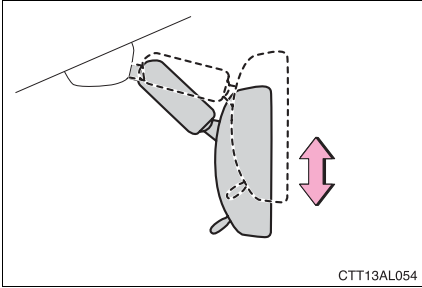

Adjust the height of the rear view mirror by moving it up and down.

■ To prevent sensor error

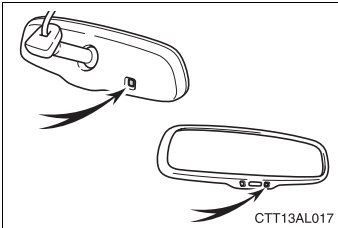

To ensure that the sensors operate properly, do not touch or cover them.

⚠ CAUTION

■ Caution while driving

Do not adjust the position of the mirror while driving. Doing so may lead to mishandling of the vehicle and an accident, resulting in death or serious injury.

1-3. Adjustable components (seats, mirrors, steering wheel)

Outside rear view mirrors

Mirror angle can be adjusted using the switch.

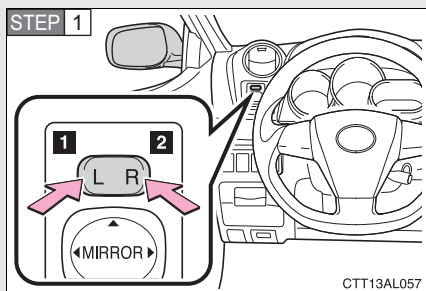

Select a mirror to adjust.

- 1 Left
- 2 Right

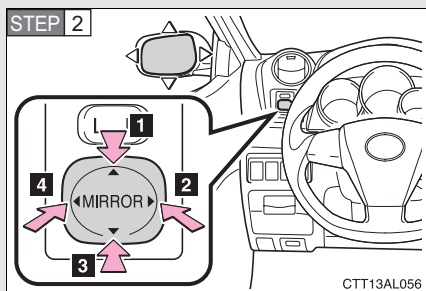

Adjust the mirror.

- 1 Up
- 2 Right
- 3 Down
- 4 Left

Folding back the mirrors

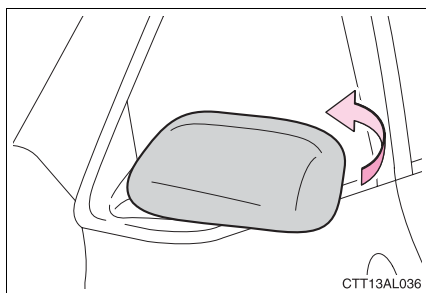

Push backward to fold the mirrors.

■ **Mirror angle can be adjusted when**

The engine switch is in the “ACC” or “ON” position.

■ **When the mirrors are fogged up (vehicles with outside rear view mirror defoggers)**

Turn on the mirror defoggers to defog the mirrors. (→P. 193)

 **CAUTION**

■ **When driving the vehicle**

Observe the following precautions while driving.

Failing to do so may result in loss of control of the vehicle and cause an accident, resulting in death or serious injury.

- Do not adjust the mirrors while driving.
- Do not drive with the mirrors folded back.
- Both the driver and passenger side mirrors must be extended and properly adjusted before driving.

■ **When the mirror defoggers are operating (vehicles with outside rear view mirror defoggers)**

Do not touch the rear view mirror surfaces, as they can become very hot and burn you.

1-4. Opening and closing the windows and moon roof Power windows*

The power windows can be opened and closed using the following switches.

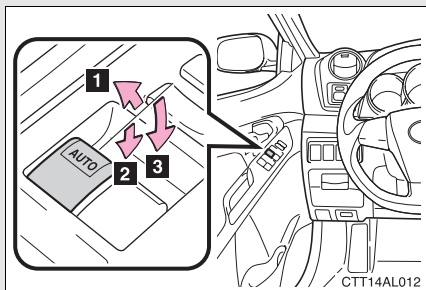

- 1 Closing
- 2 Opening
- 3 One-touch opening (driver's window only)*

*: Pressing the switch in the opposite direction will stop window travel partway.

Lock switch

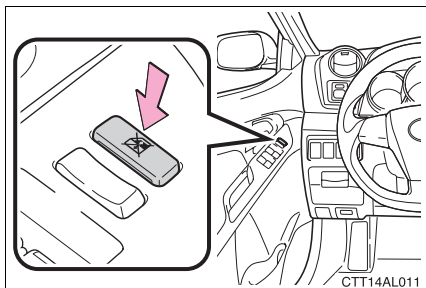

Press the switch down to lock the passenger window switches.

Use this switch to prevent children from accidentally opening or closing a passenger window.

■ The power windows can be operated when

The engine switch is in the "ON" position.

■ Operating the power windows after turning the engine OFF

The power windows can be operated for approximately 45 seconds after the engine switch is turned to the "ACC" or "LOCK" position. They cannot, however, be operated once either front door is opened.

*: If equipped

 CAUTION

■ **Closing the windows**

Observe the following precautions.

Failing to do so may result in death or serious injury.

- Check to make sure that all passengers do not have any part of their body in a position where it could be caught when a window is being operated.
- Do not allow children to operate the power windows.
Closing a power window on someone can cause serious injury, and in some instances, even death.

1-4. Opening and closing the windows and moon roof Moon roof*

Use the overhead switches to open, close, and tilt the moon roof up and down.

■ Opening and closing

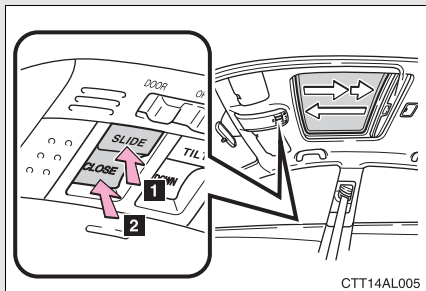

1 Opens the moon roof*

The moon roof stops slightly before the fully open position to reduce wind noise.

Press the switch again to fully open the moon roof.

2 Closes the moon roof*

*: Lightly press either of the moon roof switches to stop the moon roof partway.

■ Tilt up and down

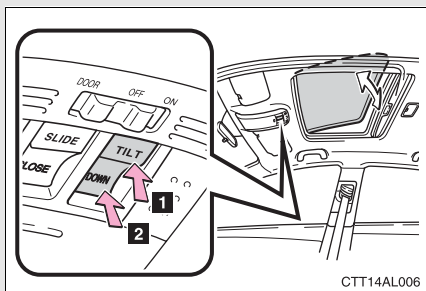

1 Tilts the moon roof up*

2 Tilts the moon roof down*

*: Lightly press either of the moon roof switches to stop the moon roof partway.

*: If equipped

■ **The moon roof can be operated when**

The engine switch is in the “ON” position.

■ **Operating the moon roof after turning the engine OFF**

The moon roof can be operated for approximately 45 seconds after the engine switch is turned to the “ACC” or “LOCK” position. It cannot, however, be operated once either front door is opened.

■ **Jam protection function**

If an object is detected between the moon roof and the frame while closing or tilting down, travel is stopped and the moon roof opens slightly.

■ **To reduce moon roof wind noise**

When the moon roof is opened automatically, it will stop slightly before the fully open position. Driving with the moon roof in this position can help reduce wind noise.

■ **Sunshade**

The sunshade can be opened and closed manually. However, the sunshade will open automatically when the moon roof is opened.

 **CAUTION****■ Opening the moon roof**

Observe the following precautions.

Failing to do so may cause death or serious injury.

- Do not allow any passengers to put their hands or heads outside the vehicle while it is moving.
- Do not sit on top of the moon roof.

■ Closing the moon roof

Observe the following precautions.

Failing to do so may result in death or serious injury.

- Check to make sure that all passengers do not have any part of their bodies in a position where it could be caught when the moon roof is being operated.
- Do not allow children to operate the moon roof.
Closing the moon roof on someone can cause death or serious injury.

■ Jam protection function

- Never try jamming any part of your body to activate the jam protection function intentionally.
- The jam protection function may not work if something gets caught just before the moon roof fully closes.

Opening the fuel tank cap

Perform the following steps to open the fuel tank cap.

■ Before refueling the vehicle

Turn the engine switch OFF and ensure that all the doors and windows are closed.

■ Opening the fuel tank cap

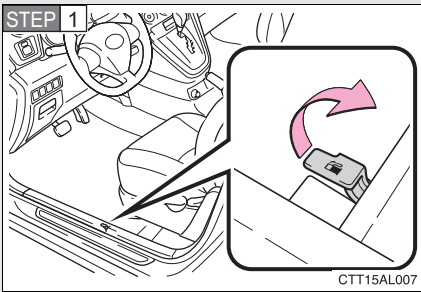

Pull up the fuel filler door opener.

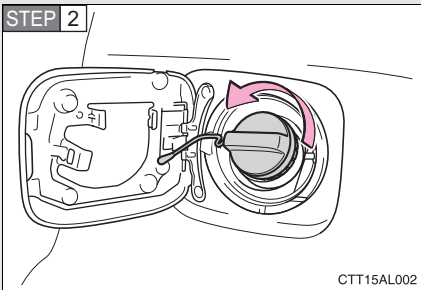

Turn the fuel tank cap slowly to open.

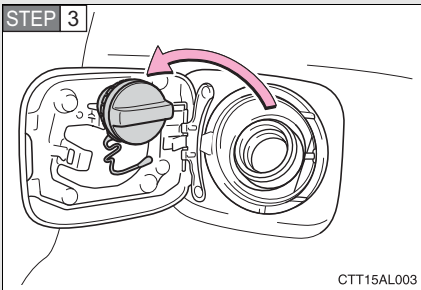

Hang the fuel tank cap on the back of the fuel filler door.

Closing the fuel tank cap

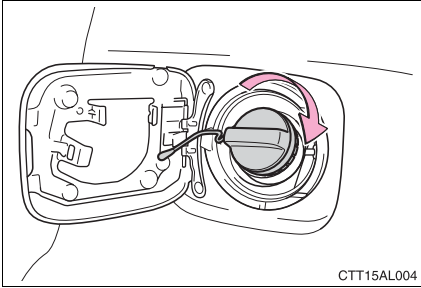

When replacing the fuel tank cap, turn it until a clicking sound is heard.

After releasing your hand, the cap will turn slightly to the opposite direction.

1

Before driving

■ Fuel type

Unleaded gasoline (Octane rating 87 [Research Octane Number 91] or higher)

■ Fuel tank capacity

13.2 gal. (50 L, 10.9 Imp. gal.)

 **CAUTION**

■ Refueling the vehicle

Observe the following precautions while refueling the vehicle.
Failure to do so may result in death or serious injury.

- Touch the vehicle or some other metal surface to discharge any static electricity.
Sparks resulting from discharging static electricity may cause the fuel vapors to ignite.
- Always hold the grips on the fuel tank cap and turn it slowly to remove it.
A whooshing sound may be heard when the fuel tank cap is loosened.
Wait until the sound cannot be heard before fully removing the cap.
In hot weather, pressurized fuel may spray out of the filler neck and cause injury.
- Do not allow anyone that has not discharged static electricity from their bodies to come close to an open fuel tank.
- Do not inhale vaporized fuel.
Fuel contains substances that are harmful if inhaled.
- Do not smoke while refueling the vehicle.
Doing so may cause the fuel to ignite and cause a fire.
- Do not return to the vehicle or touch any person or object that is statically charged.
This may cause static electricity to build up, resulting in a possible ignition hazard.

■ When replacing the fuel cap

Do not use anything but a genuine Toyota fuel tank cap designed for your vehicle. Doing so may cause a fire or other incident which may result in death or serious injury.

 NOTICE**■ Refueling**

Do not spill fuel during refueling.

Doing so may damage the vehicle, such as causing the exhaust systems to operate abnormally or damaging fuel system components or the vehicle's painted surface.

1-6. Theft deterrent system

Engine immobilizer system

The vehicle's keys have built-in transponder chips that prevent the engine from starting if the key has not been previously registered in the vehicle's on-board computer.

Never leave the keys inside the vehicle when you leave the vehicle.

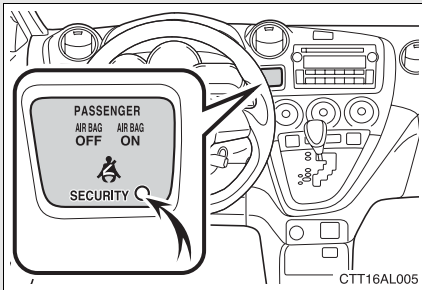

The indicator light flashes after the key has been removed from the engine switch to indicate that the system is operating.

The indicator light stops flashing after the registered key has been inserted into the engine switch to indicate that the system has been canceled.

■ System maintenance

The vehicle has a maintenance-free type engine immobilizer system.

■ Conditions that may cause the system to malfunction

- If the key is in contact with a metallic object
- If the key is in close proximity to or touching a key to the security system (key with a built-in transponder chip) of another vehicle

■ Certifications for the engine immobilizer system (for vehicles sold in U.S.A.)

FCC ID: WRKRI-34BTY

This device complies with Part 15 of the FCC Rules. Operation is subject to the following two conditions: (1) this device may not cause harmful interference, and (2) this device must accept any interference received, including interference that may cause undesired operation.

■ Certifications for the engine immobilizer system (for vehicles sold in Canada)

Operation is subject to the following two conditions: (1) this device may not cause interference, and (2) this device must accept any interference, including interference that may cause undesired operation of the device.

CAUTION

Changes or modifications not expressly approved by the party responsible for compliance could void the user's authority to operate the equipment.

NOTICE

■ To ensure the system operates correctly

Do not modify or remove the system. If modified or removed, the proper operation of the system cannot be guaranteed.

1-6. Theft deterrent system

Theft prevention labels (except for Canada)

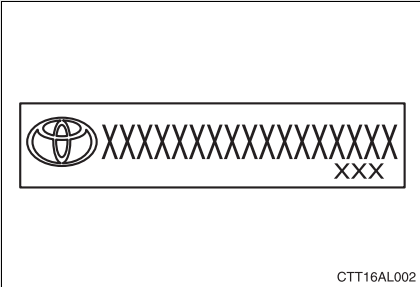

These labels are attached to the vehicle to reduce vehicle theft by facilitating the tracing and recovery of parts from stolen vehicles. Do not remove under penalty of law.

1-7. Safety information

Correct driving posture

Drive in a good posture as follows:

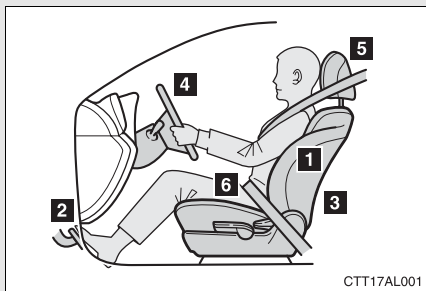

- 1** Sit upright and well back in the seat. (→P. 40)
- 2** Adjust the position of the seat forward or backward to ensure the pedals can be reached and easily depressed to the extent required. (→P. 40)
- 3** Adjust the seatback so that the controls are easily operable.
- 4** Adjust the tilt and telescopic positions of the steering wheel downward so the air-bag is facing your chest. (→P. 54)
- 5** Lock the head restraint in place with the center of the head restraint closest to the top of your ears. (→P. 46)
- 6** Wear the seat belt correctly. (→P. 48)

 **CAUTION**

■ **While driving**

- Do not adjust the position of the driver's seat while driving. Doing so could cause the driver to lose control of the vehicle.
- Do not place a cushion between the driver or passenger and the seatback. A cushion may prevent correct posture from being achieved, and reduce the effectiveness of the seat belt and head restraint, increasing the risk of death or serious injury to the driver or passenger.
- Do not place anything under the front seats. Objects placed under the front seats may become jammed in the seat tracks and stop the seat from locking in place. This may lead to an accident. The adjustment mechanism may also be damaged.

■ **Adjusting the seat position**

- Take care when adjusting the seat position to ensure that other passengers are not injured by the moving seat.
- Do not put your hands under the seat or near the moving parts to avoid injury. Fingers or hands may become jammed in the seat mechanism.

SRS airbags

The SRS airbags inflate when the vehicle is subjected to certain types of severe impacts that may cause significant injury to the occupants. They work together with the seat belts to help reduce the risk of death or serious injury.

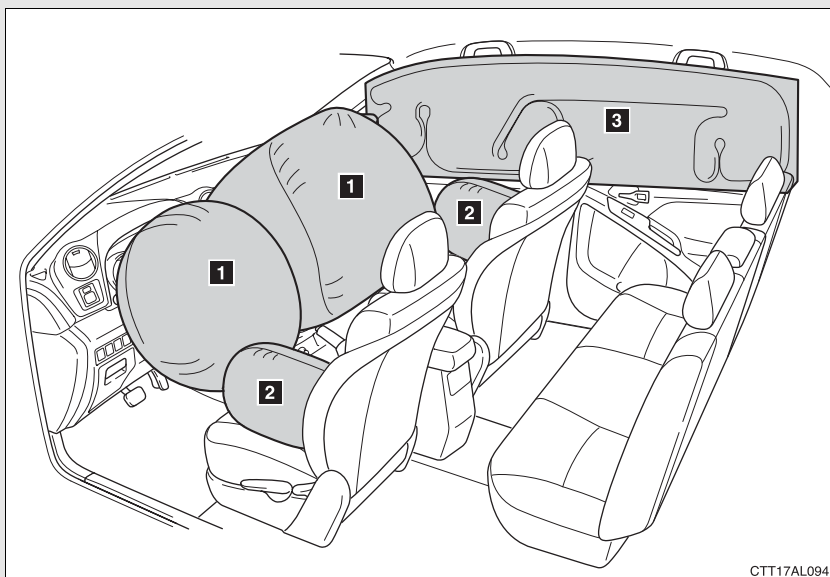

CTT17AL094

► Front airbags

1 Driver airbag and front passenger airbag

Can help protect the head and chest of the driver and front passenger from impact with interior components.

► Side and curtain shield airbags

2 Side airbags

Can help protect the torso of the front seat occupants.

3 Curtain shield airbags

Can help protect primarily the head of occupants in the outer seats.

Airbag system components

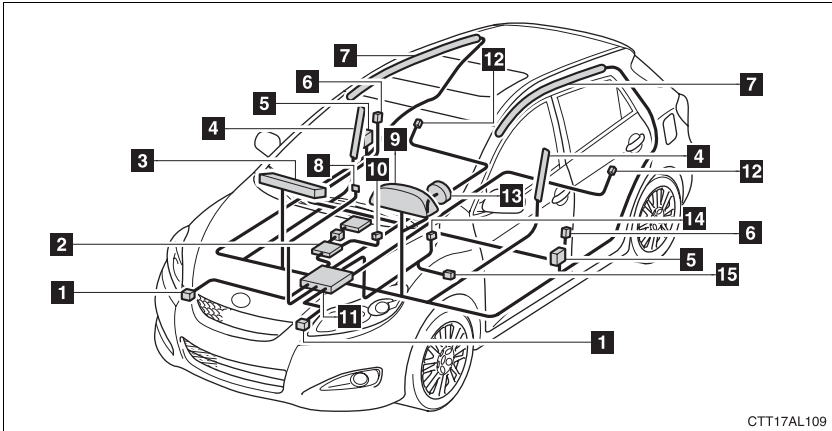

CTT17AL109

- 1** Front airbag sensors
- 2** Front passenger occupant classification system (ECU and sensors)
- 3** Front passenger airbag
- 4** Side airbags
- 5** Seat belt pretensioners and force limiters
- 6** Side and curtain shield airbag sensors
- 7** Curtain shield airbags
- 8** "AIR BAG ON" and "AIR BAG OFF" indicator lights
- 9** SRS warning light
- 10** Front passenger's seat belt buckle switch
- 11** Airbag sensor assembly
- 12** Curtain shield airbag sensors
- 13** Driver airbag
- 14** Driver's seat belt buckle switch
- 15** Driver's seat position sensor

Your vehicle is equipped with ADVANCED AIRBAGS designed based on the US motor vehicle safety standards (FMVSS208). The airbag sensor assembly (ECU) controls airbag deployment based on information obtained from the sensors etc. shown in the system components diagram above. This information includes crash severity and occupant information. As the airbags deploy, a chemical reaction in the inflators quickly fills the airbags with non-toxic gas to help restrain the motion of the occupants.

■ **If the SRS airbags deploy (inflate)**

- Bruising and slight abrasions may result from contact with a deploying (inflating) SRS airbag.
- A loud noise and white powder will be emitted.
- Parts of the airbag module (steering wheel hub, airbag cover and inflator) as well as the front seats, and parts of the front and rear pillars and roof side rail, may be hot for several minutes. The airbag itself may also be hot.
- The windshield may crack.

■ **SRS airbag deployment conditions (SRS front airbags)**

- The SRS front airbags will deploy in the event of an impact that exceeds the set threshold level (the level of force corresponding to an approximately 12 - 18 mph [20 - 30 km/h] frontal collision with a fixed wall that does not move or deform).

However, this threshold velocity will be considerably higher if the vehicle strikes an object, such as a parked vehicle or sign pole, which can move or deform on impact, or if the vehicle is involved in an underride collision (e.g. a collision in which the front of the vehicle “underrides”, or goes under, the bed of a truck, etc.).

- Depending on the type of collision, it is possible that only the seat belt pretensioners will activate.
- The SRS front passenger airbag will not activate if there is no passenger sitting in the front passenger seat. However, the front passenger airbag may deploy if luggage is put in the seat, even if the seat is unoccupied. (→P. 85)

■ **SRS airbag deployment conditions (SRS side airbags and curtain shield airbags)**

- The SRS side airbags and curtain shield airbags will deploy in the event of an impact that exceeds the set threshold level (the level of force corresponding to the impact force produced by an approximately 3300 lb. [1500 kg] vehicle colliding with the vehicle cabin from a direction perpendicular to the vehicle orientation at an approximate speed of 12 - 18 mph [20 - 30 km/h]).
- The SRS curtain shield airbags may also deploy in the event of a severe frontal collision.

■ Conditions under which the SRS airbags may deploy (inflate), other than a collision

The SRS front airbags may also deploy if a serious impact occurs to the underside of your vehicle. Some examples are shown in the illustration.

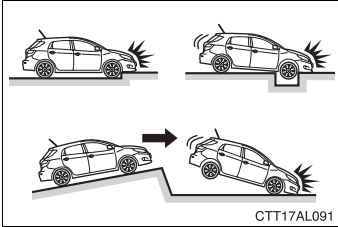

- Hitting a curb, edge of pavement or hard surface
- Falling into or jumping over a deep hole
- Landing hard or vehicle falling

■ Types of collisions that may not deploy the SRS front airbags

The SRS front airbags are generally not designed to inflate if the vehicle is involved in a side or rear collision, if it rolls over, or if it is involved in a low-speed frontal collision. But, whenever a collision of any type causes sufficient forward deceleration of the vehicle, deployment of the SRS front airbags may occur.

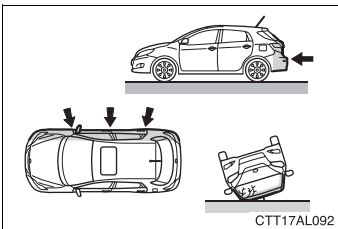

- Collision from the side
- Collision from the rear
- Vehicle rollover

■ Types of collisions that may not deploy the SRS side airbags and curtain shield airbags

The SRS side airbags and curtain shield airbag system may not activate if the vehicle is subjected to a collision from the side at certain angles, or a collision to the side of the vehicle body other than the passenger compartment.

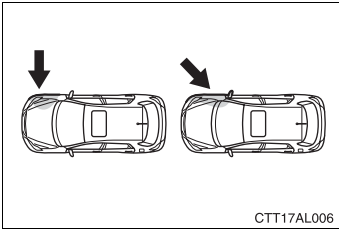

- Collision from the side to the vehicle body other than the passenger compartment
- Collision from the side at an angle

The SRS side airbags and curtain shield airbags are not generally designed to inflate if the vehicle is involved in a frontal or rear collision, if it rolls over, or if it is involved in a low-speed side collision.

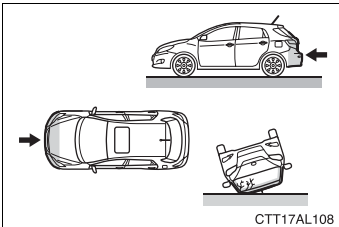

- Collision from the front*
- Collision from the rear
- Vehicle rollover

*: Depending on the conditions and type of accident, there are times when the curtain shield airbags may deploy (inflate) in front impact.

■ When to contact your Toyota dealer

In the following cases, contact your Toyota dealer as soon as possible.

- Any of the SRS airbags have been inflated.

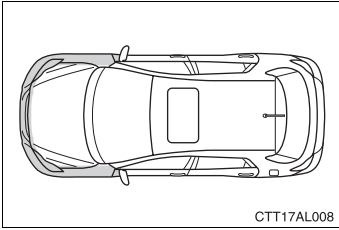

- The front of the vehicle is damaged or deformed, or was involved in an accident that was not severe enough to cause the SRS airbags to inflate.

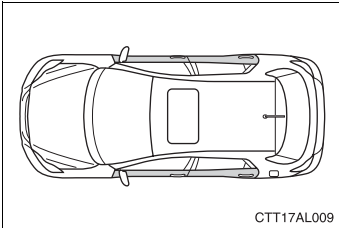

- A portion of a door is damaged or deformed, or the vehicle was involved in an accident that was not severe enough to cause the SRS side airbags and curtain shield airbags to inflate.

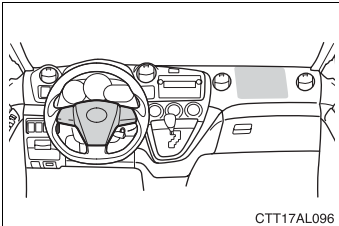

- The pad section of the steering wheel or dashboard (shaded in the illustration) is scratched, cracked, or otherwise damaged.

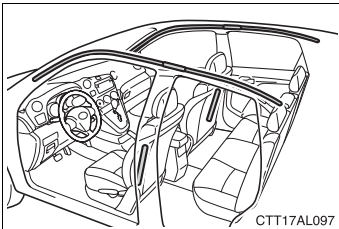

- The surface of the seats with the side airbag is scratched, cracked, or otherwise damaged.
- Curtain shield airbags: The portion of the front pillars, rear pillars or roof side rail garnishes (padding) containing the curtain shield airbags inside is scratched, cracked or otherwise damaged.

 CAUTION

■ **SRS airbag precautions**

Observe the following precautions regarding the airbags.
Failure to do so may cause death or serious injury.

- The driver and all passengers in the vehicle must wear their seat belts properly.

The SRS airbags are supplemental devices to be used with the seat belts.

- The SRS driver airbag deploys with considerable force, and can cause death or serious injury especially if the driver is very close to the airbag. The National Highway Traffic Safety Administration (“NHTSA”) advises:

Since the risk zone for the driver’s airbag is the first 2 - 3 in. (50 - 75 mm) of inflation, placing yourself 10 in. (250 mm) from your driver airbag provides you with a clear margin of safety. This distance is measured from the center of the steering wheel to your breastbone. If you sit less than 10 in. (250 mm) away now, you can change your driving position in several ways:

- Move your seat to the rear as far as you can while still reaching the pedals comfortably.
- Slightly recline the back of the seat.
Although vehicle designs vary, many drivers can achieve the 10 in. (250 mm) distance, even with the driver seat all the way forward, simply by reclining the back of the seat somewhat. If reclining the back of your seat makes it hard to see the road, raise yourself by using a firm, non-slippery cushion, or raise the seat if your vehicle has that feature.
- If your steering wheel is adjustable, tilt it downward. This points the airbag toward your chest instead of your head and neck.

The seat should be adjusted as recommended by NHTSA above, while still maintaining control of the foot pedals, steering wheel, and your view of the instrument panel controls.

 CAUTION

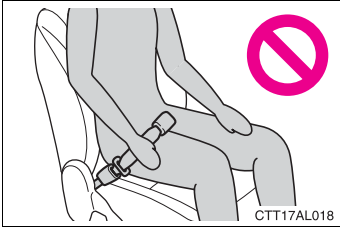
■ SRS airbag precautions

- If the seat belt extender has been connected to the front seat belt buckles but the seat belt extender has not also been fastened to the latch plate of the seat belt, the SRS front airbags will judge that the driver and front passenger are wearing the seat belt even though the seat belt has not been connected. In this case, the SRS front airbags may not activate correctly in a collision, resulting in death or serious injury in the event of a collision. Be sure to wear the seat belt with the seat belt extender.

- The SRS front passenger airbag also deploys with considerable force, and can cause death or serious injury especially if the front passenger is very close to the airbag. The front passenger seat should be as far from the airbag as possible with the seatback adjusted, so the front passenger sits upright.
- Improperly seated and/or restrained infants and children can be killed or seriously injured by a deploying airbag. An infant or child who is too small to use a seat belt should be properly secured using a child restraint system. Toyota strongly recommends that all infants and children be placed in the rear seats of the vehicle and properly restrained. The rear seats are the safest for infants and children. (→P. 90)

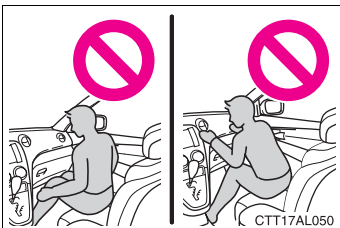

- Do not sit on the edge of the seat or lean against the dashboard.

! CAUTION

■ SRS airbag precautions

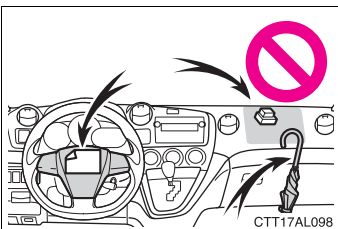
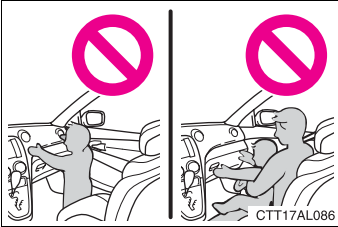

- Do not allow a child to stand in front of the SRS front passenger airbag unit or sit on the knees of a front passenger.
- Do not drive the vehicle while the driver or passenger has items resting on their knees.
- Do not lean against the door, the roof side rail or the front, side and rear pillars.
- Do not allow anyone to kneel on the passenger seat toward the door or put their head or hands outside the vehicle.
- Do not attach anything to or lean anything against areas such as the dashboard or steering wheel pad. These items can become projectiles when SRS driver and front passenger deploy.

 CAUTION

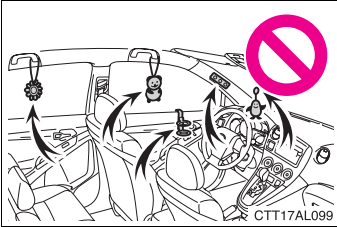
■ SRS airbag precautions

- Do not attach anything to areas such as the door, windshield glass, side door glass, front and rear pillars, roof side rail or assist grip.
- Do not hang coat hangers or other hard objects on the coat hooks. All of these items could become projectiles and seriously injure or kill you, should the SRS curtain shield airbag deploy.
- Do not use seat accessories which cover the parts where the SRS side airbags inflate as they may interfere with inflation of the airbags.
- Do not strike or apply significant levels of force to the area of the SRS airbag components (→P. 74).
Doing so can cause the SRS airbags to malfunction.
- Do not touch any of the component parts immediately after the SRS airbags have deployed (inflated) as they may be hot.

 CAUTION

■ **SRS airbag precautions**

- If breathing becomes difficult after the SRS airbag has deployed, open a door or window to allow fresh air in, or leave the vehicle if it is safe to do so. Wash off any residue as soon as possible to prevent skin irritation.
- If the areas where the SRS airbags are stored, such as the steering wheel pad and front and rear pillar garnishes, are damaged or cracked, have them replaced by your Toyota dealer.

■ **Modification and disposal of SRS airbag system components**

Do not dispose of your vehicle or perform any of the following modifications without consulting your Toyota dealer.

The SRS airbags may malfunction or deploy (inflate) accidentally, causing death or serious injury.

- Installation, removal, disassembly and repair of the SRS airbags.
- Repairs, modifications, removal or replacement of the steering wheel, instrument panel, dashboard, seats or seat upholstery, front, side and rear pillars or roof side rail.
- Repairs or modifications of the front fender, front bumper, or side of the occupant compartment.
- Installation of snow plows, winches, etc. to the front grille (bull bars, kangaroo bar etc.).
- Modifications to the vehicle's suspension system.
- Installation of electronic devices such as mobile two-way radios or CD players.
- Modifications to your vehicle for a person with a physical disability.

Front passenger occupant classification system

Your vehicle is equipped with a front passenger occupant classification system. This system detects the conditions of the front passenger seat and activates or deactivates the devices for the front passenger.

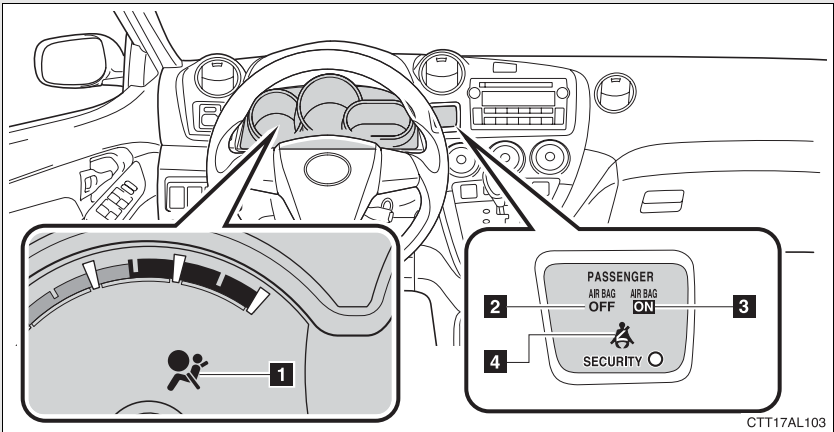

- 1** SRS warning light
- 2** "AIR BAG OFF" indicator light
- 3** "AIR BAG ON" indicator light
- 4** Front passenger's seat belt reminder light

Conditions and operation of the front passenger occupant classification system

■ **Adult*¹**

Indicator/ warning light	“AIR BAG ON” and “AIR BAG OFF” indicator lights	“AIR BAG ON”
	SRS warning light	Off
	Front passenger’s seat belt reminder light	Flashing* ²
Devices	Front passenger airbag	Activated
	Side airbag on the front passenger seats	
	Curtain shield airbag in the front passenger side	
	Front passenger’s seat belt pretensioner	

■ **Child*³ or child restraint system*⁴**

Indicator/ warning light	“AIR BAG ON” and “AIR BAG OFF” indicator lights	“AIR BAG OFF”* ⁵
	SRS warning light	Off
	Front passenger’s seat belt reminder light	Flashing* ²
Devices	Front passenger airbag	Deactivated
	Side airbag on the front passenger seats	Activated
	Curtain shield airbag in the front passenger side	
	Front passenger’s seat belt pretensioner	

■ Unoccupied

Indicator/ warning light	“AIR BAG ON” and “AIR BAG OFF” indicator lights	Not illuminated
	SRS warning light	Off
	Front passenger’s seat belt reminder light	
Devices	Front passenger airbag	Deactivated
	Side airbag on the front passenger seats	Activated
	Curtain shield airbag in the front passenger side	
	Front passenger’s seat belt pretensioner	Deactivated

1

Before driving

■ There is a malfunction in the system

Indicator/ warning light	“AIR BAG ON” and “AIR BAG OFF” indicator lights	“AIR BAG OFF”
	SRS warning light	On
	Front passenger’s seat belt reminder light	Off
Devices	Front passenger airbag	Deactivated
	Side airbag on the front passenger seats	Activated
	Curtain shield airbag in the front passenger side	
	Front passenger’s seat belt pretensioner	

*1: The system judges a person of adult size as an adult. When a smaller adult sits in the front passenger seat, the system may recognize him/her as a child depending on his/her physique and posture.

*2: In the event the front passenger does not wear a seat belt.

*3: When a larger child who has outgrown a child restraint system sits in the front passenger seat, the system may recognize him/her as an adult depending on his/her physique or posture.

- *4: Never install a rear-facing child restraint system on the front passenger seat. A forward-facing child restraint system should only be installed on the front passenger seat when it is unavoidable. (→P. 90)
- *5: In case the indicator is not illuminated, consult this manual as for installing the child restraint system properly. (→P. 94)

 CAUTION

■ Front passenger occupant classification system precautions

Observe the following precautions regarding the front passenger occupant classification system.

Failure to do so may cause death or serious injury.

- Wear the seat belt properly.
- Make sure the front passenger's seat belt tab has not been left inserted into the buckle before someone sits in the front passenger seat.
- Make sure the "AIR BAG OFF" indicator light is not illuminated when using the seat belt extender for the front passenger seat. If the "AIR BAG OFF" indicator light is illuminated, disconnect the extender tongue from the seat belt buckle, then reconnect the seat belt. Reconnect the seat belt extender after making sure the "AIR BAG ON" indicator light is illuminated. If you use the seat belt extender while the "AIR BAG OFF" indicator light is illuminated, the SRS airbags for the passenger may not activate correctly, which could cause death or serious injury in the event of a collision.
- Do not apply a heavy load to the front passenger seat.
- Do not put weight on the front passenger seat by putting your hands or feet on the front passenger seat seatback from the rear passenger seat.
- Do not let a rear passenger lift the front passenger seat with their feet or press on the seatback with their legs.
- Do not put objects under the front passenger seat.

 CAUTION**Front passenger occupant classification system precautions**

- Do not recline the front passenger seatback so far that it touches a rear seat. This may cause the “AIR BAG OFF” indicator light to be illuminated, which indicates that the passenger’s airbags will not deploy in the event of a severe accident. If the seatback touches the rear seat, return the seatback to a position where it does not touch the rear seat. Keep the front passenger seatback as upright as possible when the vehicle is moving. Reclining the seatback excessively may lessen the effectiveness of the seat belt system.
- If an adult sits in the front passenger seat, the “AIR BAG ON” indicator light is illuminated. If the “AIR BAG OFF” indicator is illuminated, ask the passenger to sit up straight, well back in the seat, feet on the floor, and with the seat belt worn correctly. If the “AIR BAG OFF” indicator still remains illuminated, either ask the passenger to move to the rear seat, or if that is not possible, move the front passenger seat fully rearward.
- When it is unavoidable to install the forward-facing child restraint system on the front passenger seat, install the child restraint system on the front passenger seat in the proper order. (→P. 94)
- Do not modify or remove the front seats.
- Do not kick the front passenger seat or subject it to severe impact. Otherwise, the SRS warning light may come on to indicate a malfunction of the detection system. In this case, contact your Toyota dealer immediately.
- Child restraint systems installed on the rear seat should not contact the front seatbacks.
- Do not use a seat accessory, such as a cushion or seat cover, that covers the seat cushion surface.
- Do not modify or replace the upholstery of the front seat.

Child restraint systems

A child restraint system for a small child or baby must be properly restrained on the seat with the lap portion of the lap/shoulder belt.

The laws of all 50 states of U.S.A. and Canada now require the use of child restraint systems.

Points to remember

Studies have shown that installing a child restraint system on a rear seat is much safer than installing one to the front passenger seat.

- Choose a child restraint system that suits your vehicle and is appropriate to the age and size of the child.
- For installation details, follow the instructions provided with the child restraint system.

General installation instructions are provided in this manual.

(→P. 94)

Types of child restraints

Child restraint systems are classified into the following 3 types according to the age and size of the child.

▶ Rear facing — Infant seat/convertible seat

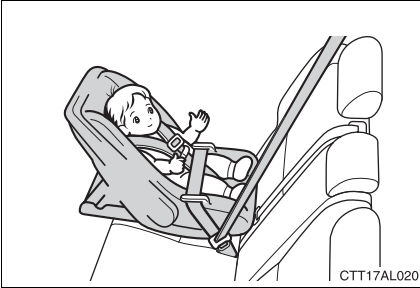

▶ Forward facing — Convertible seat



▶ Booster seat

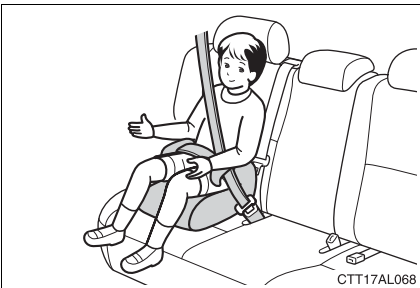

■ Selecting an appropriate child restraint system

- Use a child restraint system appropriate for the child until the child becomes large enough to properly wear the vehicle's seat belt.
- If a child is too large for a child restraint system, sit the child on a rear seat and use the vehicle's seat belt. (→P. 48)

CAUTION

■ Child restraint precautions

- For effective protection in automobile accidents and sudden stops, a child must be properly restrained, using a seat belt or child restraint system depending on the age and size of the child. Holding a child in your arms is not a substitute for a child restraint system. In an accident, the child can be crushed against the windshield, or between you and the vehicle's interior.
- Toyota strongly urges the use of a proper child restraint system that conforms to the size of the child, installed on the rear seat. According to accident statistics, the child is safer when properly restrained in the rear seat than in the front seat.
- Never install a rear-facing child restraint system on the front passenger seat even if the "AIR BAG OFF" indicator light is illuminated. In the event of an accident, the force of the rapid inflation of the front passenger airbag can cause death or serious injury to the child if the rear-facing child restraint system is installed on the front passenger seat.
- A forward-facing child restraint system may be allowed to be installed on the front passenger seat only when it is unavoidable. A child restraint system that requires a top tether strap should not be used in the front passenger seat since there is no top tether strap anchor for the front passenger seat. Adjust the seatback as uprights as possible and always move the seat as far back as possible even if the "AIR BAG OFF" indicator light is illuminated, because the front passenger airbag could inflate with considerable speed and force. Otherwise, the child may be killed or seriously injured.

 **CAUTION****■ Child restraint precautions**

- Do not use the seat belt extender when installing a child restraint system on the front or rear passenger seat. If installing a child restraint system with the seat belt extender connected to the seat belt, the seat belt will not securely hold the child restraint system, which could cause death or serious injury to the child or other passengers in the event of a sudden stop, sudden swerve or accident.
- Do not allow the child to lean his/her head or any part of his/her body against the door or the area of the seat, front and rear pillars or roof side rail from which the side airbags or curtain shield airbags deploy even if the child is seated in the child restraint system. It is dangerous if the side airbags and curtain shield airbags inflate, and the impact could cause death or serious injury to the child.
- Make sure you have complied with all installation instructions provided by the child restraint manufacturer and that the system is properly secured. If it is not secured properly, it may cause death or serious injury to the child in the event of a sudden stop, sudden swerve or accident.

■ Child restraint lock function belt precaution

Do not allow children to play with the child restraint lock function belt. If the belt becomes twisted around a child's neck, it will not be possible to pull the belt out leading to choking or other serious injuries that could result in death. If this occurs and the buckle cannot be unfastened, scissors should be used to cut the belt.

■ When the child restraint system is not in use

- Keep the child restraint system properly secured on the seat even if it is not in use.
Do not store the restraint unsecured in the passenger compartment.
- If it is necessary to detach the child restraint system, remove it from the vehicle or store it securely in the luggage compartment. This will prevent it from injuring passengers in the event of a sudden stop, sudden swerve or accident.

Installing child restraints

Follow the child restraint system manufacturer's instructions. Firmly secure child restraints to the rear seats using the LATCH anchors or a seat belt. Attach the top tether strap when installing a child restraint.

The lap/shoulder belt can be used if your child restraint system is not compatible with the LATCH (Lower Anchors and Tethers for Children) system.

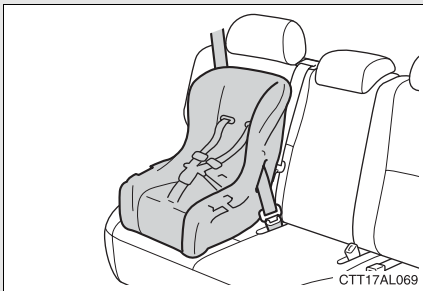

Seat belts equipped with a child restraint locking mechanism (ALR/ELR belts except driver's seat belt) (→P. 48)

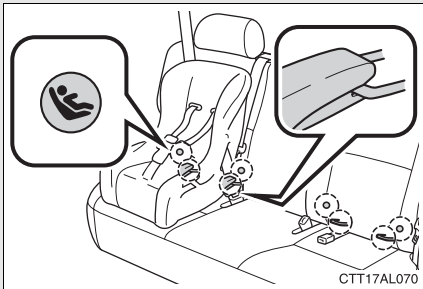

Child restraint LATCH anchors

LATCH anchors are provided for the outside rear seats. (Buttons displaying the location of the anchors are attached to the seats.)

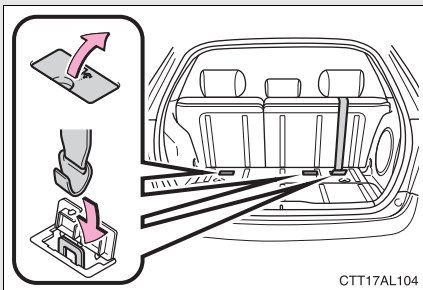

Anchor bracket (for top tether strap)

Anchor brackets are provided for all rear seats.

Installation with LATCH system

► Type A

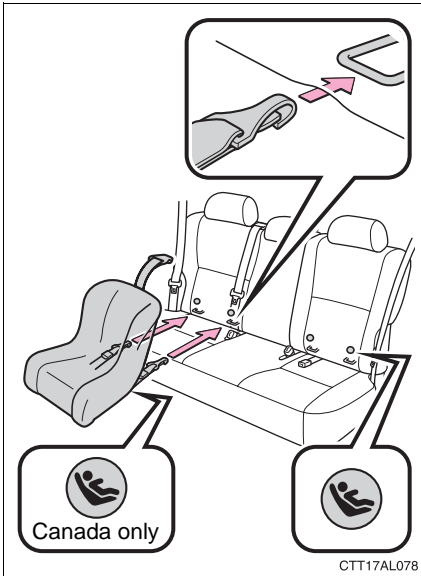

STEP 1 Widen the gap between the seat cushion and seatback slightly.

STEP 2 Latch the hooks of the lower straps onto the LATCH anchors.

STEP 3 If the child restraint has a top tether strap, the top tether strap should be latched onto the top tether strap anchors.

For owners in Canada:
A symbol on a child restraint system indicates the presence of a lower connector system.

1

Before driving

► Type B

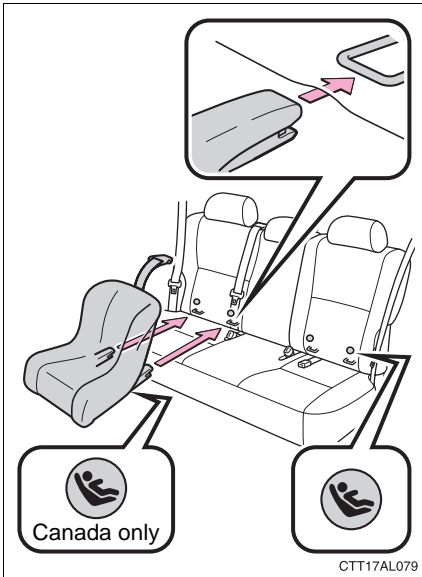

STEP 1 Widen the gap between the seat cushion and seatback slightly.

STEP 2 Latch the buckles onto the LATCH anchors.

STEP 3 If the child restraint has a top tether strap, the top tether strap should be latched onto the top tether strap anchors.

For owners in Canada:

A symbol on a child restraint system indicates the presence of a lower connector system.

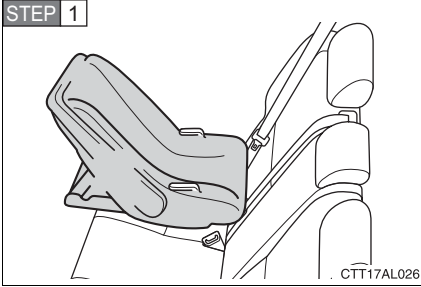
Installing child restraints using a seat belt (child restraint lock function belt)**■ Rear facing — Infant seat/convertible seat**

Place the child seat on the rear seat facing the rear of the vehicle.

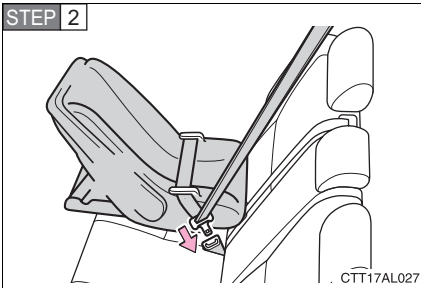

Run the seat belt through the child seat and insert the plate into the buckle. Make sure that the belt is not twisted.

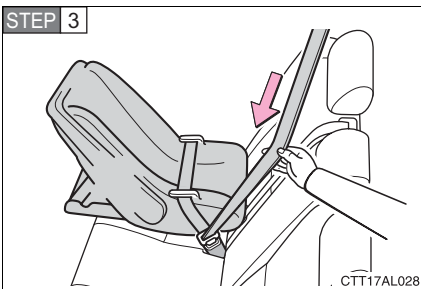

Fully extend the shoulder belt and then allow it to retract slightly in order to activate the ALR lock mode.

Lock mode allows the seat belt to retract only.

1

Before driving

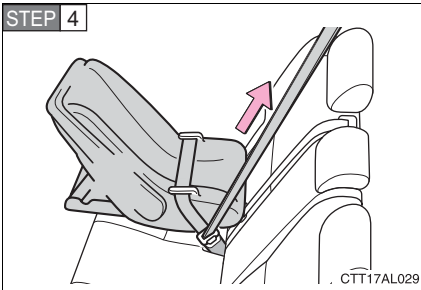

While pushing the child seat down into the rear seat, allow the shoulder belt to retract until the child seat is securely in place.

After the shoulder belt has retracted to a point where there is no slack in the belt, pull the belt to check that it cannot be extended.

■ Forward facing — Convertible seat

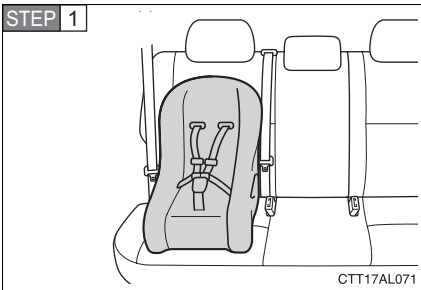

Place the child seat on the seat facing the front of the vehicle.

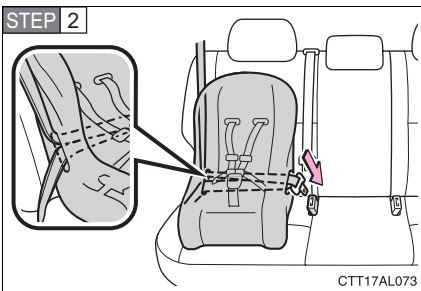

Run the seat belt through the child seat and insert the plate into the buckle. Make sure that the belt is not twisted.

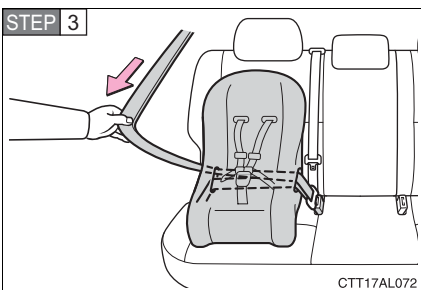

Fully extend the shoulder strap and then allow it to retract slightly into the ALR lock mode.

Lock mode allows the seat belt to retract only.

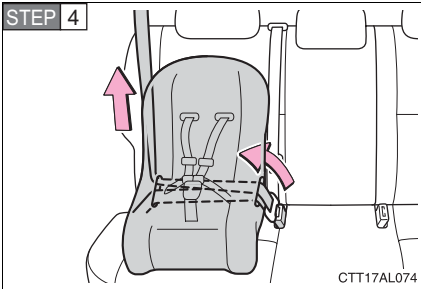

While pushing the child seat into the rear seat, allow the shoulder belt to retract until the child seat is securely in place.

After the shoulder belt has retracted to a point where there is no slack in the belt, pull the belt to check that it cannot be extended.

STEP 5 If the child restraint has a top tether strap, the top tether strap should be latched onto the top tether strap anchors.

■ Booster seat

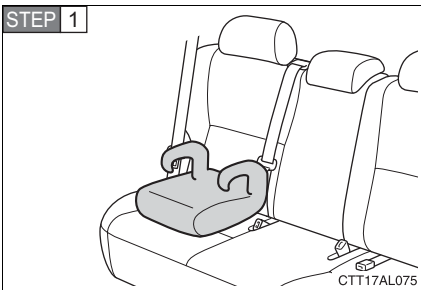

Place the booster seat on the seat facing the front of the vehicle.

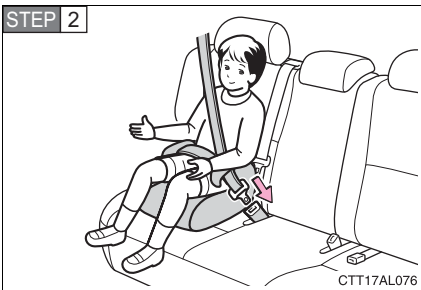

Sit the child in the booster seat. Fit the seat belt to the booster seat according to the manufacturer's instructions and insert the plate into the buckle. Make sure that the belt is not twisted.

Check that the shoulder belt is correctly positioned over the child's shoulder, and that the lap belt is as low as possible.

(→P. 48)

Removing a child restraint installed with a seat belt

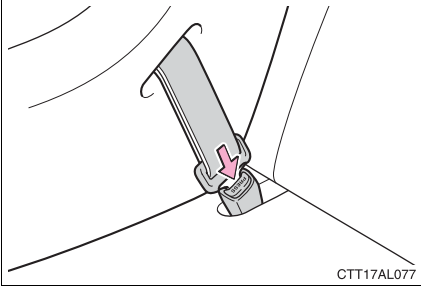

Push the release button and fully retract the seat belt.

Child restraint systems with a top tether strap

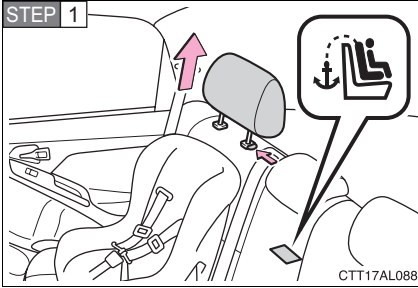

Secure the child restraint using the seat belt or the lower anchors, and remove the head restraint.

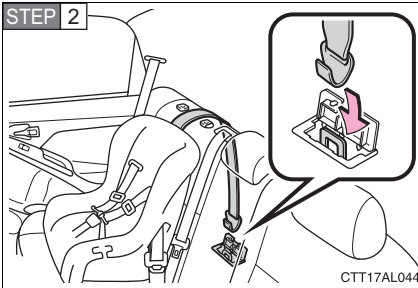

Open the anchor bracket cover, latch the hook onto the anchor bracket and tighten the top tether strap.

Make sure the top tether strap is securely latched.

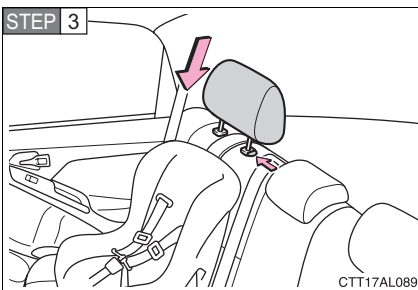

Replace the head restraint.

1

Before driving

■ Laws and regulations pertaining to anchorages

The LATCH system conforms to FMVSS225 or CMVSS210.2.

Child restraint systems conforming to FMVSS213 or CMVSS213 specifications can be used.

This vehicle is designed to conform to the SAE J1819.

! CAUTION

■ When installing a booster seat

Do not fully extend the shoulder belt to prevent the belt from going to ALR lock mode: (→P. 49)

ALR mode causes the belt to tighten only which could cause injury or discomfort to the child.

■ When installing a child restraint system

Follow the directions given in the child restraint system installation manual and fix the child restraint system securely in place.

If the child restraint system is not correctly fixed in place, the child or other passengers may be seriously injured or even killed in the event of sudden braking, sudden swerving or an accident.

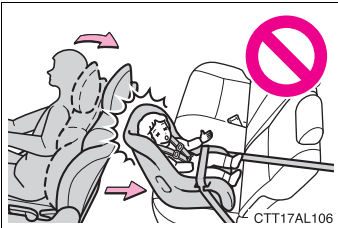

● If the driver's seat interferes with the child restraint system and prevents it from being attached correctly, attach the child restraint system to the right-hand rear seat.

● Adjust the front passenger seat so that it does not interfere with the child restraint system.

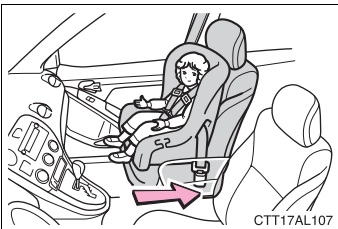

● Only put a forward-facing or booster child seat on the front seat when unavoidable. When installing a forward-facing or booster child seat on the front passenger seat, move the seat as far back as possible even if the "AIR BAG OFF" indicator light is illuminated. Failing to do so may result in death or serious injury if the airbags deploy (inflate).

 **CAUTION****■ When installing a child restraint system**

- When a booster seat is installed, always ensure that the shoulder belt is positioned across the center of the child's shoulder. The belt should be kept away from the child's neck, but not so that it could fall off the child's shoulder. Failing to do so may result in death or serious injury in the event of sudden braking, sudden swerving or an accident.
- Ensure that the belt and tab are securely locked and the seat belt is not twisted.
- Push and pull the child seat from side to side and forward to be sure it is secure.
- After securing a child restraint system, never adjust the seat.
- Follow all installation instructions provided by the child restraint system manufacturer.

■ Do not use a seat belt extender

If a seat belt extender is used when installing a child restraint system, the seat belt will not securely hold the child restraint system, which could cause death or serious injury to the child or other passengers in the event of sudden braking, sudden swerving or an accident.

■ To correctly attach a child restraint system to the anchors

When using the LATCH anchors, be sure that there are no foreign objects around the anchors and that the seat belt is not caught behind the child restraint. Make sure the child restraint system is securely attached, or it may cause death or serious injury to the child or other passengers in the event of a sudden stop, sudden swerve or an accident.

2-1. Driving procedures

Driving the vehicle

The following procedures should be observed to ensure safe driving.

■ Starting the engine

→P. 118

■ Driving

▶ Automatic transmission

STEP 1 With the brake pedal depressed, shift the shift lever to D. (→P. 122)

STEP 2 Release the parking brake. (→P. 130)

STEP 3 Gradually release the brake pedal and gently depress the accelerator pedal to accelerate the vehicle.

▶ Manual transmission

STEP 1 With the clutch pedal fully depressed, shift the shift lever to 1. (→P. 127)

STEP 2 Release the parking brake. (→P. 130)

STEP 3 Gradually release the clutch pedal. At the same time, gently depress the accelerator pedal to accelerate the vehicle.

■ Stopping

▶ Automatic transmission

STEP 1 With the shift lever in D, depress the brake pedal.

STEP 2 If necessary, set the parking brake.

When the vehicle is stopped for an extended period of time, shift the shift lever to P or N. (→P. 122)

▶ Manual transmission

STEP 1 With the clutch pedal fully depressed, depress the brake pedal.

STEP 2 If necessary, set the parking brake.

When the vehicle is stopped for an extended period of time, shift the shift lever to N. (→P. 127)

■ Parking the vehicle

▶ Automatic transmission

STEP 1 With the shift lever in D, depress the brake pedal.

STEP 2 Set the parking brake. (→P. 130)

STEP 3 Shift the shift lever to P. (→P. 122)

When parking on a hill, if necessary, block the wheels.

STEP 4 Turn the engine switch to the “LOCK” position and stop the engine.

STEP 5 Lock the door, making sure that you have the key on your person.

▶ Manual transmission

STEP 1 With the clutch pedal fully depressed, depress the brake pedal.

STEP 2 Set the parking brake. (→P. 130)

STEP 3 Shift the shift lever to N. (→P. 127)

When parking on a hill, shift the shift lever to 1 or R. If necessary, block the wheels.

STEP 4 Turn the engine switch to the “LOCK” position and stop the engine.

STEP 5 Lock the door, making sure that you have the key on your person.

Starting on a steep uphill

► Automatic transmission

STEP 1 Firmly set the parking brake and shift the shift lever to D.

STEP 2 Gently depress the accelerator pedal.

STEP 3 Release the parking brake.

► Manual transmission

STEP 1 With the parking brake firmly set and the clutch pedal fully depressed, shift the shift lever to 1.

STEP 2 Lightly depress the accelerator pedal at the same time as gradually releasing the clutch pedal.

STEP 3 Release the parking brake.

■ Driving in the rain

- Drive carefully when it is raining, because visibility will be reduced, the windows may become fogged-up, and the road will be slippery.
- Drive carefully when it starts to rain, because the road surface will be especially slippery.
- Refrain from high speeds when driving on an expressway in the rain, because there may be a layer of water between the tires and the road surface, preventing the steering and brakes from operating properly.

■ Engine speed while driving

In the following conditions, the engine speed may become high while driving. This is due to automatic up-shifting control or down-shifting implementation to meet driving conditions. It does not indicate sudden acceleration.

- The vehicle is judged to be driving uphill or downhill
- When the accelerator pedal is released

■ Breaking in your new Toyota

To extend the life of the vehicle, the following precautions are recommended to observe:

- For the first 200 miles (300 km):
Avoid sudden stops.
- For the first 500 miles (800 km):
Do not tow a trailer.
- For the first 1000 miles (1600 km):
 - Do not drive at extremely high speeds.
 - Avoid sudden acceleration.
 - Do not drive slowly with the manual transmission in a high gear.
 - Do not drive at a constant speed for extended periods.

■ Drum-in-disc type parking brake system (if equipped)

Your vehicle has a drum-in-disc type parking brake system. This type of brake system needs bedding-down of the brake shoes periodically or whenever the parking brake shoes and/or drum are replaced. Have your Toyota dealer perform the bedding down.

■ Operating your vehicle in a foreign country

Comply with the relevant vehicle registration laws and confirm the availability of the correct fuel. (→P. 442)

 CAUTION

■ **When starting the vehicle (vehicles with an automatic transmission)**

Always keep your foot on the brake pedal while stopped with the engine running. This prevents the vehicle from creeping.

■ **When driving the vehicle**

- Do not drive if you are unfamiliar with the location of the brake and accelerator pedals to avoid depressing the wrong pedal.
 - Accidentally depressing the accelerator pedal instead of the brake pedal will result in sudden acceleration that may lead to an accident that could result in death or serious injury.
 - When backing up, you may twist your body around, leading to a difficulty in operating the pedals. Make sure to operate the pedals properly.
 - Make sure to keep a correct driving posture even when moving the vehicle only slightly, allowing you to depress the brake and accelerator pedals properly.
 - Depress the brake pedal using your right foot. Depressing the brake pedal using your left foot may delay response in an emergency, resulting in an accident.
- Do not drive the vehicle over or stop the vehicle near flammable materials. The exhaust system and exhaust gases can be extremely hot. This may cause a fire if there is any flammable material nearby.
- Vehicles with an automatic transmission: Do not let the vehicle roll backwards while the shift lever is in a driving position, or roll forward while the shift lever is in R. Doing so may cause the engine to stall or lead to poor brake and steering performance, resulting in an accident or damage to the vehicle.

 CAUTION

- If the smell of exhaust is noticed inside the vehicle, open the windows and check that the back door is closed. Large amounts of exhaust in the vehicle can cause driver drowsiness and an accident, resulting in death or a serious health hazard. Have the vehicle inspected by your Toyota dealer immediately.
- Vehicles with an automatic transmission: Do not shift the shift lever to P while the vehicle is moving.
Doing so can damage the transmission and may result in a loss of vehicle control.
- Do not shift the shift lever to R while the vehicle is moving forward.
Doing so can damage the transmission and may result in a loss of vehicle control.
- Do not shift the shift lever to D (vehicles with an automatic transmission) or 1 (vehicles with a manual transmission) while the vehicle is moving backward.
Doing so can damage the transmission and may result in a loss of vehicle control.
- Moving the shift lever to N while the vehicle is moving will disengage the engine from the transmission. Engine braking is not available when N is selected.
- During normal driving, do not turn off the engine. Turning the engine off while driving will not cause loss of steering or braking control, but the power assist to these systems will be lost. This will make it more difficult to steer and brake, so you should pull over and stop the vehicle as soon as it is safe to do so.
However, in the event of an emergency, such as if it becomes impossible to stop the vehicle in the normal way: →P. 435
- Use engine braking (downshift) to maintain a safe speed when driving down a steep hill. Using the brakes continuously may cause the brakes to overheat and lose effectiveness. (→P. 123)

 **CAUTION**

- When stopped on an inclined surface, use the brake pedal and parking brake to prevent the vehicle from rolling backward or forward and causing an accident.
- Do not adjust the position of the steering wheel, the seat, or the inside or outside rear view mirrors while driving. Doing so may result in a loss of vehicle control that can cause accidents that may result in death or serious injury.
- Always check that all passengers' arms, heads or other parts of their bodies are not outside the vehicle, as this may result in death or serious injury.
- Do not drive the vehicle off-road.
This is not a AWD vehicle designed for real off-road driving. Proceed with all due caution if it becomes unavoidable to drive off-road.
- Do not drive across river crossings or through other bodies of water.
This may cause electric/electronic components to short circuit, damage the engine or cause other serious damage to the vehicle.
- Do not drive in excess of the speed limit. Even if the legal speed limit permits it, do not drive over 85 mph (140 km/h) unless your vehicle has high-speed capability tires. Driving over 85 mph (140 km/h) may result in tire failure, loss of control and possible injury. Be sure to consult a tire dealer to determine whether the tires on your vehicle are high-speed capability tires or not before driving at such speeds.

■ **When driving on slippery road surfaces**

- Sudden braking, acceleration and steering may cause tire slippage and reduce your ability to control the vehicle, resulting in an accident.
- Sudden changes in engine speed, such as engine braking caused by up-shifting or down-shifting, may cause the vehicle to skid, resulting in an accident.
- After driving through a puddle, lightly depress the brake pedal to make sure that the brakes are functioning properly. Wet brake pads may prevent the brakes from functioning properly. If the brakes on only one side are wet and not functioning properly, steering control may be affected, resulting in an accident.

 CAUTION

■ When shifting the shift lever (vehicles with an automatic transmission)

Be careful not to shift the shift lever with the accelerator pedal depressed. This may lead to unexpected rapid acceleration of the vehicle that may cause an accident and result in death or serious injury.

■ When the vehicle is stopped

- Do not race the engine. If the vehicle is in any gear other than P (vehicles with an automatic transmission) or N, the vehicle may accelerate suddenly and unexpectedly, and may cause an accident.
- Do not leave the vehicle with the engine running for a long time. If such a situation cannot be avoided, park the vehicle in an open space and check that exhaust fumes do not enter the vehicle interior.
- Vehicles with an automatic transmission: In order to prevent accidents due to the vehicle rolling away, always keep depressing the brake pedal while the engine is running, and apply the parking brake as necessary.
- If the vehicle is stopped on an incline, in order to prevent accidents caused by the vehicle rolling forward or backward, always depress the brake pedal and securely apply the parking brake as needed.
- Avoid revving or racing the engine. Running the engine at high speed while the vehicle is stopped may cause the exhaust system to overheat, which could result in a fire if combustible material is nearby.

■ When the vehicle is parked

- Do not leave glasses, cigarette lighters, spray cans, or soft drink cans in the vehicle when it is in the sun. Doing so may result in the following.
 - Gas may leak from a cigarette lighter or spray can, and may lead to a fire.
 - The temperature inside the vehicle may cause the plastic lenses and plastic material of eye glasses to deform or crack.
 - Soft drink cans may fracture, causing the contents to spray over the interior of the vehicle, and may also cause a short circuit in the vehicle's electrical components.

 **CAUTION**

- Always apply the parking brake, shift the shift lever to P (vehicles with an automatic transmission), stop the engine and lock the vehicle. Do not leave the vehicle unattended while the engine is running.
- Do not touch the exhaust pipe while the engine is running or immediately after turning the engine off. Doing so may cause burns.
- Do not leave the engine running in an area with snow build-up, or where it is snowing. If snowbanks build up around the vehicle while the engine is running, exhaust gases may collect and enter the vehicle. This may lead to death or a serious health hazard.

Exhaust gases

Exhaust gases include harmful carbon monoxide (CO) that is colorless and odorless. Inhaling exhaust gases may lead to death or a serious health hazard.

- If the vehicle is in a poorly ventilated area, stop the engine. In a closed area, such as a garage, exhaust gases may collect and enter the vehicle. This may lead to death or a serious health hazard.
- The exhaust should be checked occasionally. If there is a hole or crack caused by corrosion, damage to a joint or abnormal exhaust noise, be sure to have the vehicle inspected and repaired by your Toyota dealer. Failure to do so may allow exhaust gases to enter the vehicle, resulting in death or a serious health hazard.

When taking a nap in the vehicle

Always turn the engine off. Otherwise, you may accidentally move the shift lever or depress the accelerator pedal, which could cause an accident or fire due to engine overheating. Additionally, if the vehicle is parked in a poorly ventilated area, exhaust gases may collect and enter the vehicle, leading to death or a serious health hazard.

 **CAUTION****■ When braking the vehicle**

- When the brakes are wet, drive more cautiously. Braking distance increases when the brakes are wet, and may cause one side of the vehicle to brake differently than the other side. Also the parking brake may not securely hold the vehicle.
- If the power brake assist function does not operate, do not follow other vehicles closely and avoid downhills or sharp turns that require braking. In this case, braking is still possible, but it will require more force on the pedal than usual. Braking distance may also increase.
- Do not pump the brake pedal if the engine stalls. Each push on the brake pedal uses up the reserve for the power-assisted brakes.
- The brake system consists of 2 individual hydraulic systems: If one of the systems fails, the other will still operate. In this case, the brake pedal should be depressed more firmly than usual and braking distance becomes longer.
Do not drive your vehicle with only a single brake system. Have your brakes fixed immediately.

■ If the vehicle becomes stuck or bogged (AWD models)

Do not spin the wheels recklessly when any of the tires is up in the air, or stuck in sand or mud, etc. This may damage the drive system components or propel the vehicle forward (or in another direction) and cause an accident.

 NOTICE

■ **When driving the vehicle**

- Do not depress the accelerator and brake pedals at the same time during driving, as this may restrain driving torque.

▶ Manual transmission

- Do not shift gears unless the clutch pedal is fully depressed. After shifting, do not release the clutch pedal abruptly. Doing so may damage the clutch, transmission and gears.
- Observe the following to prevent the clutch from being damaged.
 - Do not rest your foot on the clutch pedal while driving.
Doing so may cause clutch trouble.
 - Do not use any gears other than the 1st gear when starting off and moving forward.
Doing so may damage the clutch.
 - Do not use the clutch to hold the vehicle when stopping on an uphill grade.
Doing so may damage the clutch.
- Do not shift the shift lever to R when the vehicle is still moving. Doing so may damage the clutch, transmission and gears.

▶ Automatic transmission

- Do not use the accelerator pedal or depress the accelerator and brake pedals at the same time to hold the vehicle on a hill.

■ **When parking the vehicle (vehicles with an automatic transmission)**

Always put the shift lever in P. Failure to do so may cause the vehicle to move or the vehicle may accelerate suddenly if the accelerator pedal is accidentally depressed.

■ **Avoiding damage to vehicle parts**

- Do not turn the steering wheel fully in either direction and hold it there for an extended period of time.
Doing so may damage the power steering motor.
- When driving over bumps in the road, drive as slowly as possible to avoid damaging the wheels, underside of the vehicle, etc.

 NOTICE

■ **If you hear a squealing or scraping noise (brake pad wear limit indicators)**

Have the brake pads checked and replaced by your Toyota dealer as soon as possible.

Rotor damage can result if the pads are not replaced when needed.

It is dangerous to drive the vehicle when the wear limits of the brake pads and/or those of the brake discs are exceeded.

■ **If you get a flat tire while driving**

A flat or damaged tire may cause the following situations. Hold the steering wheel firmly and gradually press the brake pedal to slow down the vehicle.

- It may be difficult to control your vehicle.
- The vehicle will make abnormal sounds.
- The vehicle will behave abnormally.

Replace a flat tire with a new one. (→P. 411)

■ **When encountering flooded roads**

Do not drive on a road that has flooded after heavy rain etc. Doing so may cause the following serious damage to the vehicle.

- Engine stalling
- Short in electrical components
- Engine damage caused by water immersion

In the event that you drive on a flooded road and the vehicle is flooded, be sure to have your Toyota dealer check the following.

- Brake function
- Changes in quantity and quality of oil and fluid used for the engine, transaxle, transfer (AWD vehicles), differential, etc.
- Lubricant condition for the propeller shaft (AWD vehicles), bearings and suspension joints (where possible) and the function of all joints, bearings, etc.

Engine (ignition) switch

■ Starting the engine

► Automatic transmission

STEP 1 Check that the parking brake is set.

STEP 2 Check that the shift lever is set in P.

STEP 3 Sit in the driver's seat and firmly depress the brake pedal.

STEP 4 Turn the engine switch to the "START" position and start the engine.

1.8 L 4-cylinder (2ZR-FE) engine: The engine will crank until it starts or for up to 25 seconds, whichever is less. If you turn the engine switch, the engine will keep cranking for about 30 seconds maximum.

Continue depressing the brake pedal until the engine is completely started.

► Manual transmission

STEP 1 Check that the parking brake is set.

STEP 2 Check that the shift lever is set in N.

STEP 3 Firmly depress the clutch pedal.

STEP 4 Turn the engine switch to the "START" position and start the engine.

1.8 L 4-cylinder (2ZR-FE) engine: The engine will crank until it starts or for up to 25 seconds, whichever is less. If you turn the engine switch, the engine will keep cranking for about 30 seconds maximum.

Continue depressing the brake pedal until the engine is completely started.

■ Changing engine switch position

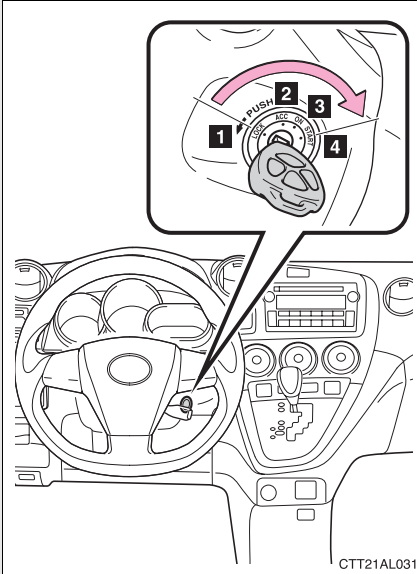

1 "LOCK"

The steering wheel is locked and the key can be removed. (Vehicles with an automatic transmission: The key can be removed only when the shift lever is in P.)

2 "ACC"

Some electrical components such as the audio system can be used.

3 "ON"

All electrical components can be used.

4 "START"

For starting the engine.

■ Turning the engine switch from “ACC” to “LOCK”

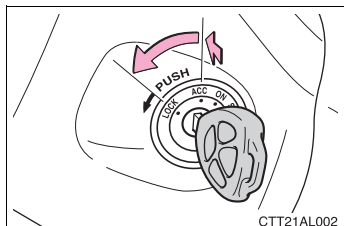

STEP 1 Shift the shift lever to P (automatic transmission) or N (manual transmission).
(→P. 122, 127)

STEP 2 Push in the key and turn to the “LOCK” position.

■ Steering lock release

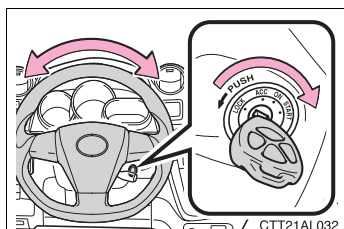

When starting the engine, the engine switch may seem stuck in the “LOCK” position. To free it, turn the key while turning the steering wheel slightly in either direction.

■ If the engine does not start

The engine immobilizer system may not have been deactivated. (→P. 68)

■ Key reminder buzzer

A buzzer sounds if the driver's door is opened while the engine switch is in the “LOCK” position to remind you to remove the key.

⚠ CAUTION

■ When starting the engine

Always start the engine while sitting in the driver's seat. Do not depress the accelerator while starting the engine under any circumstances.

Doing so may cause an accident resulting in death or serious injury.

■ Caution when driving

Do not turn the engine switch to the “LOCK” position while driving. If, in an emergency, you must turn the engine off while the vehicle is moving, turn the engine switch only to the “ACC” position.

 NOTICE**■ To prevent battery discharge**

Do not leave the key in the “ACC” or “ON” position for long periods if the engine is not running.

■ When starting the engine

- 2.4 L 4-cylinder (2AZ-FE) engine — Do not crank for more than 30 seconds at a time. This may overheat the starter and wiring systems.
- Do not race a cold engine.
- If the engine becomes difficult to start or stalls frequently, have the engine checked immediately.

2-1. Driving procedures

Automatic transmission*

Select a shift position appropriate for the driving conditions.

■ Shifting the shift lever

▶ Standard type

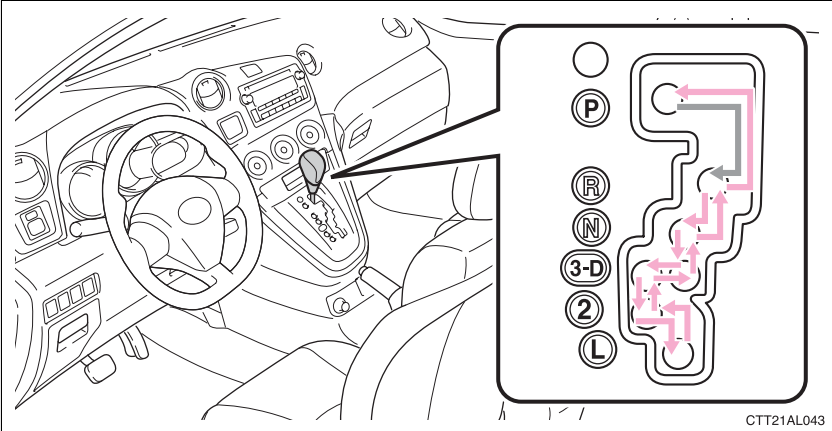

▶ Multi-mode type

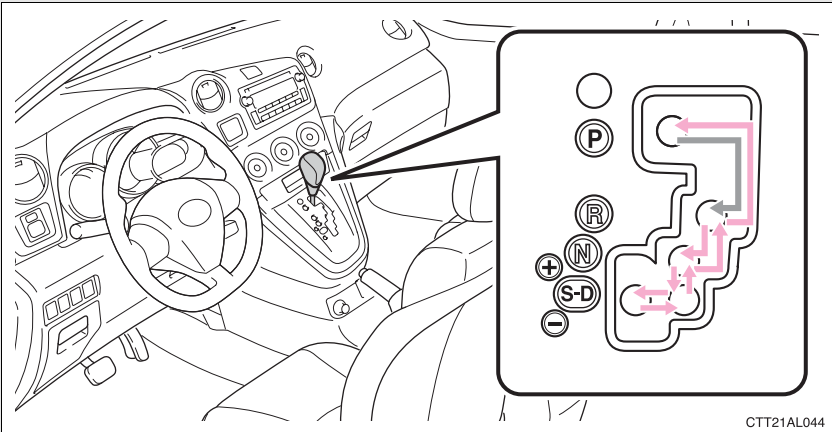

While the engine switch is in the "ON" position, depress the brake pedal and move the shift lever.

*: If equipped

■ Shift position uses

Shift position	Function	
	Standard type	Multi-mode type
P	Parking the vehicle or starting the engine	
R	Reversing	
N	Neutral	
D	Normal driving ^{*1}	
S		S mode driving ^{*2} (→P. 124)
3	Position for engine braking	
2	Position for more powerful engine braking	
L	Position for maximum engine braking	

^{*1}: Shifting to the D position allows the system to select a gear suitable for driving conditions. Setting the shift lever to the D position is recommended for normal driving.

^{*2}: Selecting shift ranges using S mode restricts the upper limit of the possible gear ranges, controls engine braking forces, and prevents unnecessary upshifting.

Changing shift ranges in S mode (multi-mode type)

Shift the shift lever to the S position and operate the shift lever.

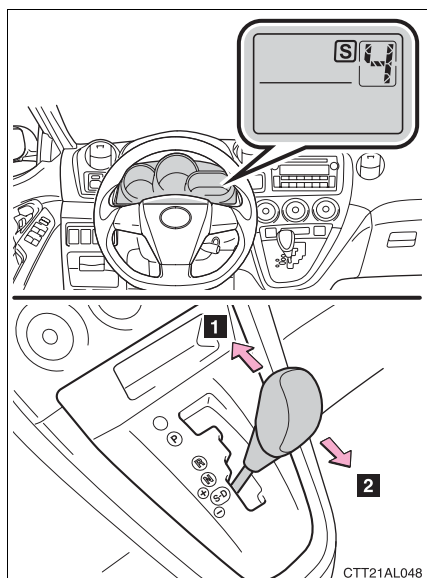

- 1 Upshifting
- 2 Downshifting

The initial shift range in S mode is automatically set to 4 or 5. However, the initial shift range may be set to 3 if AI-SHIFT has operated while the shift lever was in the D position. (→P. 126)

When the shift range is 4 or lower, holding the shift lever toward “+” sets the shift range to 5.

To protect the automatic transmission, a function is adopted that automatically selects a higher shift range when the fluid temperature is high.

■ Shift ranges and their functions

Shift range	Function
5	A gear between 1 and 5 is automatically selected according to vehicle speed and driving conditions.
4	A gear between 1 and 4 is automatically selected according to vehicle speed and driving conditions.
3	A gear between 1 and 3 is automatically selected according to vehicle speed and driving conditions.
2	A gear between 1 and 2 is automatically selected according to vehicle speed and driving conditions.
1	Setting the gear at 1.

A lower shift range will provide greater engine braking forces than a higher shift range.

■ Downshifting restrictions (standard type)

The shift lever cannot be downshifted if the following speeds are exceeded.

▶ 2.4 L 4-cylinder (2AZ-FE) engine

mph (km/h)

Downshifting	Maximum speed
3→2	64 (104)
2→L	32 (52)

▶ 1.8 L 4-cylinder (2ZR-FE) engine

mph (km/h)

Downshifting	Maximum speed
3→2	57 (92)
2→L	27 (44)

■ **Downshifting restrictions warning buzzer (multi-mode type — S mode)**

To help ensure safety and driving performance, downshifting operation may sometimes be restricted. In some circumstances, downshifting may not be possible even when the shift lever is operated. (The warning buzzer will sound twice.)

■ **When driving with the cruise control system (if equipped)**

▶ Standard type

Engine braking will not operate, even when downshifting to 3. (→P. 148)

▶ Multi-mode type

Engine braking will not operate in the S mode, even when downshifting to 4. (→P. 148)

■ **If the shift lever cannot be shifted from P**

→P. 423

■ **If the “S” indicator does not come on even after shifting the shift lever to S (multi-mode type)**

This may indicate a malfunction in the automatic transmission system. Have the vehicle inspected by your Toyota dealer immediately.

(In this situation, the vehicle will operate as if the shift lever is in D.)

■ **AI-SHIFT**

AI-SHIFT automatically selects the suitable gear according to driver performance and driving conditions.

▶ Standard type

AI-SHIFT automatically operates when the shift lever is in the D position.

▶ Multi-mode type

AI-SHIFT automatically operates when the shift lever is in the D position. (Shifting the shift lever to the S position cancels the function.)

2-1. Driving procedures

Manual transmission*

■ Shifting the shift lever

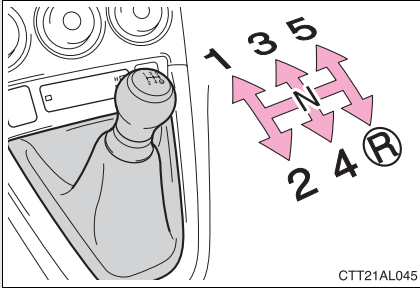

Fully depress the clutch pedal before operating the shift lever, and then release the clutch pedal slowly.

2

When driving

■ Maximum allowable speeds

Observe the following maximum allowable speeds in each gear when maximum acceleration is necessary.

- ▶ 2.4 L 4-cylinder (2AZ-FE) engine (without double wishbone rear suspension)

mph (km/h)

Shift position	Maximum speed
1	31 (50)
2	53 (86)
3	82 (132)
4	112 (181)

*: If equipped

► 2.4 L 4-cylinder (2AZ-FE) engine (with double wishbone rear suspension)

mph (km/h)

Shift position	Maximum speed
1	31 (50)
2	54 (87)
3	83 (134)
4	113 (183)

► 1.8 L 4-cylinder (2ZR-FE) engine

mph (km/h)

Shift position	Maximum speed
1	34 (55)
2	56 (91)
3	82 (132)
4	121 (195)

2-1. Driving procedures

Turn signal lever

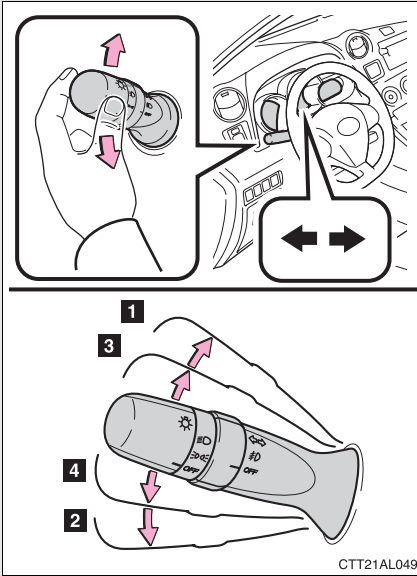

- 1 Right turn
- 2 Left turn
- 3 Move and hold the lever partway to signal a lane change.

The right hand signal will flash until you release the lever.

- 4 Move and hold the lever partway to signal a lane change.

The left hand signal will flash until you release the lever.

2

When driving

■ Turn signals can be operated when

The engine switch is in the "ON" position.

■ If the indicators flash faster than usual

Check that a light bulb in the front or rear turn signal lights has not burned out.

2-1. Driving procedures

Parking brake

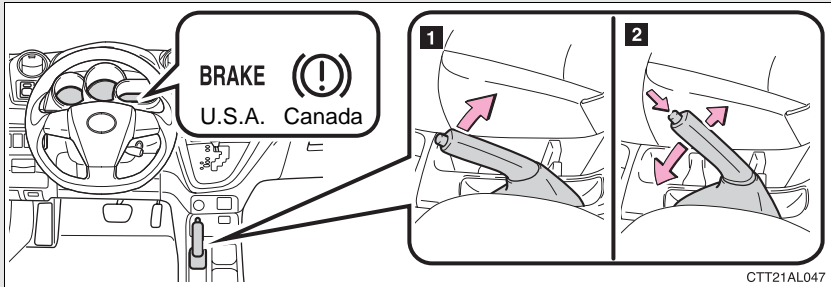

1 Sets the parking brake

Fully set the parking brake while depressing the brake pedal.

2 Releases the parking brake

Slightly raise the lever and lower it completely while pressing the button.

■ Usage in winter time

See "Winter driving tips" for parking brake usage in winter time. (→P. 162)

NOTICE

■ Before driving

Fully release the parking brake.

Driving the vehicle with the parking brake set will lead to brake components overheating, which may affect braking performance and increase brake wear.

Horn

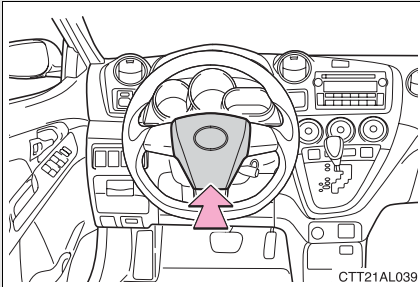

To sound the horn, press on or close to the  mark.

2

When driving

■ After adjusting the steering wheel

Make sure that the steering wheel is securely locked.

The horn may not sound if the steering wheel is not securely locked.

(→P. 54)

2-2. Instrument cluster

Gauges and meters

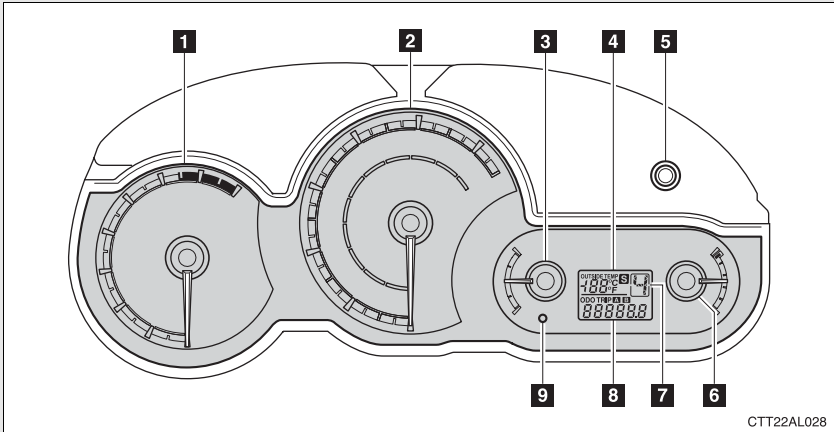

The following gauges, meters and displays illuminate when the engine switch is in the “ON” position.

1 Tachometer

Displays the engine speed in revolutions per minute.

2 Speedometer

Displays the vehicle speed.

3 Fuel gauge

Displays the quantity of fuel remaining in the tank.

4 Outside temperature display

Displays the outside air temperature.

The temperature range that can be displayed is from -40°F (-40°C) to 122°F (50°C).

5 Odometer/trip meter/instrument panel light control and trip meter reset button

Switches between odometer and trip meter displays. Pressing and holding the button will reset the trip meter when the trip meter is being displayed.

To adjust the brightness of the instrument panel light, turn the button. (→P. 134)

6 Engine coolant temperature gauge

Displays the engine coolant temperature.

7 Automatic transmission shift position indicator lights (if equipped)

→P. 122

8 Odometer and trip meter

Odometer: Displays the total distance the vehicle has been driven.

Trip meter: Displays the distance the vehicle has been driven since the meter was last reset. Trip meters A and B can be used to record and display different distances independently.

9 Low fuel level warning light

→P. 400

Instrument panel light control

The brightness of the instrument panel lights can be adjusted.

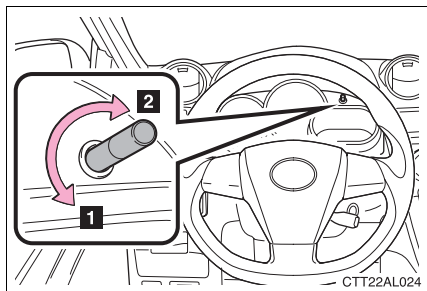

1 Darker

2 Brighter

When the headlight switch is turned on, the brightness will be reduced slightly unless the control button is turned fully clockwise.

■ Display

In the following situations, the correct outside temperature may not be displayed, or the display may take longer than normal to change.

- When stopped, or driving at low speeds (less than 12 mph [20 km/h])
- When the outside temperature has changed suddenly (at the entrance/exit of a garage, tunnel, etc.)

⚠ NOTICE

■ To prevent damage to the engine and its components

- Do not let the indicator needle of the tachometer enter the red zone, which indicates the maximum engine speed.
- The engine may be overheating if the engine coolant temperature gauge is in the red zone (H). In this case, immediately stop the vehicle in a safe place, and check the engine after it has cooled completely. (→P. 430)

Indicators and warning lights

The indicator and warning lights on the instrument cluster and center panel inform the driver of the status of the vehicle's various systems.

► Instrument cluster

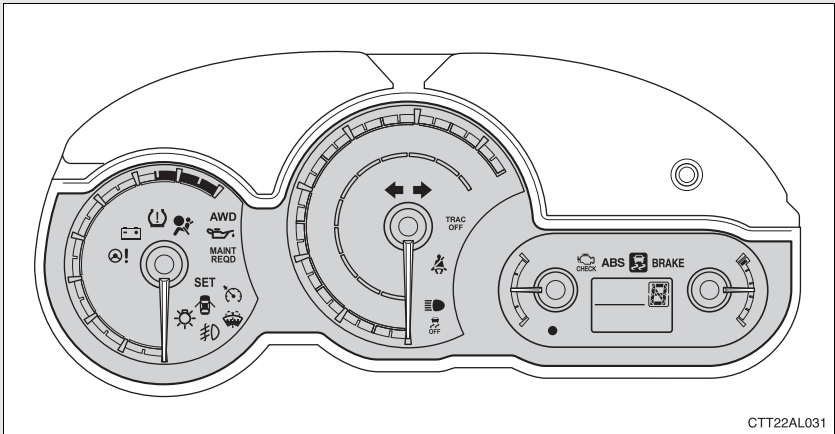

► Center panel

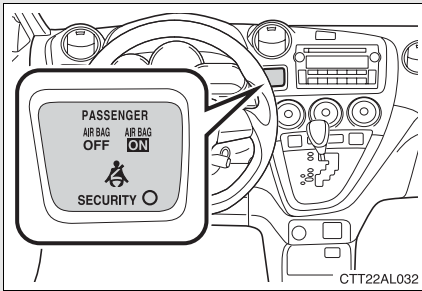

■ Indicators

The indicators inform the driver of the operating state of the vehicle's various systems.



Turn signal indicator
(→P. 129)



(U.S.A.)

Headlight indicator
(→P. 138)



Headlight high beam indicator (→P. 139)



(Canada)

Tail light indicator
(→P. 138)



Slip indicator
(→P. 153)



(if equipped)

Front fog light indicator
(→P. 141)



Engine immobilizer system indicator (→P. 68)



*1

“AIR BAG ON” and “AIR BAG OFF” indicator
(→P. 85)



VSC off indicator
(→P. 154)



(if equipped)

Cruise control indicator
(→P. 148)



“TRAC OFF” indicator
(→P. 153)



(if equipped)

Cruise control set indicator (→P. 148)

*1: These lights turn on when the engine switch is turned to the “ON” position to indicate that a system check is being performed. They will turn off after the engine is started, or after a few seconds. There may be a malfunction in a system if a light does not come on, or if the lights do not turn off. Have the vehicle inspected by your Toyota dealer for details.

*2: The light flashes to indicate that the system is operating.

■ Warning lights

Warning lights inform the driver of malfunctions in any of the vehicle's systems. (→P. 397)

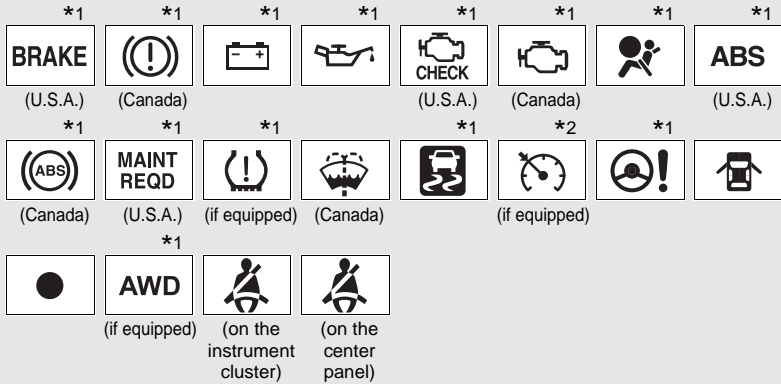

*1: These lights turn on when the engine switch is turned to the "ON" position to indicate that a system check is being performed. They will turn off after the engine is started, or after a few seconds. There may be a malfunction in a system if a light does not come on, or if the lights do not turn off. Have the vehicle inspected by your Toyota dealer for details.

*2: The light flashes to indicate a malfunction.

⚠ CAUTION

■ If a safety system warning light does not come on



Should a safety system light such as the ABS or the SRS airbag warning light not come on when you start the engine, this could mean that these systems are not available to help protect you in an accident, which could result in death or serious injury. Have the vehicle inspected by your Toyota dealer immediately if this occurs.

Headlight switch

The headlights can be operated manually.

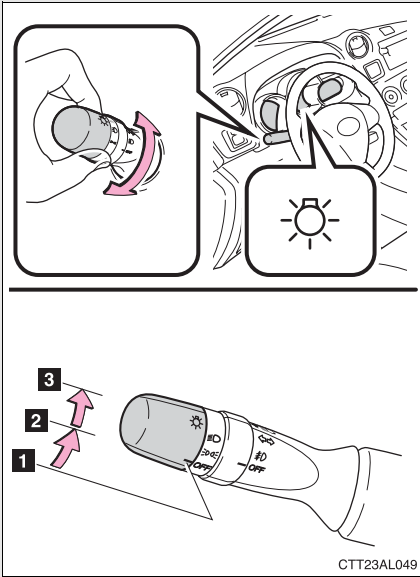

► Type A

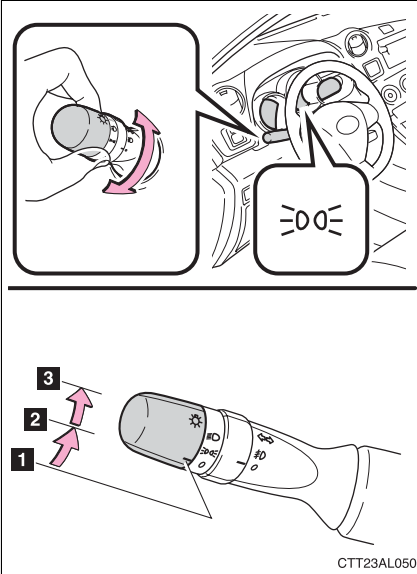

- 1 OFF** The daytime running lights turn on.
- 2 ** The side marker, parking, tail, license plate, daytime running lights and instrument panel lights turn on.
- 3 ** The headlights and all lights listed above (except daytime running lights) turn on.

► Type B



- 1**  The daytime running lights turn on.
- 2**  The side marker, parking, tail, license plate, daytime running lights and instrument panel lights turn on.
- 3**  The headlights and all lights listed above (except daytime running lights) turn on.

Turning on the high beam headlights

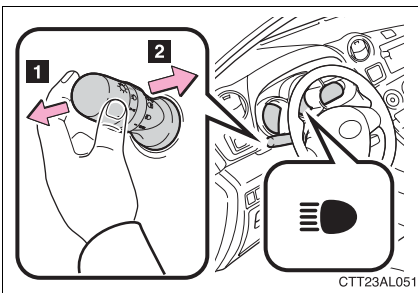

- 1** With the headlights on, push the lever forward to turn on the high beams.
Pull the lever back to the center position to turn the high beams off.
- 2** Pull the lever toward you to turn on the high beams.
Release the lever to turn them off. You can flash the high beams with the headlights on or off.

■ **Daytime running light system**

- To make your vehicle more visible to other drivers, the headlights turn on automatically whenever the engine is started and the parking brake is released.
- Compared to turning on the headlights, the daytime running light system offers greater durability and consumes less electricity, so it can help improve fuel economy.

■ **Light reminder buzzer**

A buzzer sounds when the engine switch is turned OFF and the driver's door is opened with the key removed from the engine switch while the lights are turned on.

 **NOTICE**

■ **To prevent battery discharge**

Do not leave the lights on longer than necessary when the engine is not running.

Fog light switch*

The fog lights improve visibility in difficult driving conditions, such as in rain or fog. They can be turned on only when the headlights are on low beam.

► Type A

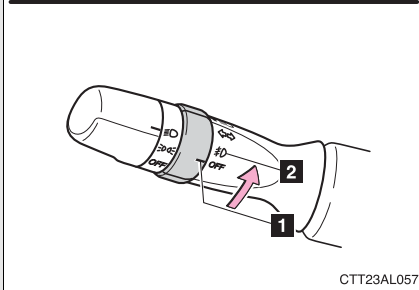
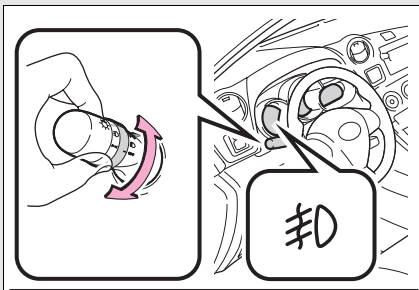

CTT23AL057

1 OFF Off

2  Front fog lights on

*: If equipped

► Type B

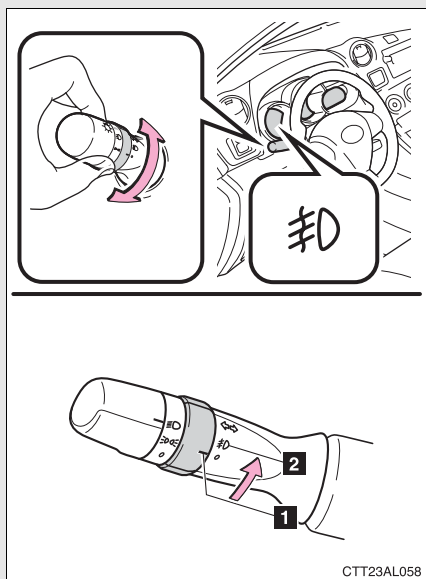

1 ○ Off

2 ☹ Off Front fog lights on

CTT23AL058

2-3. Operating the lights and wipers Windshield wipers and washer

Wiper can be operated manually.

► Type A

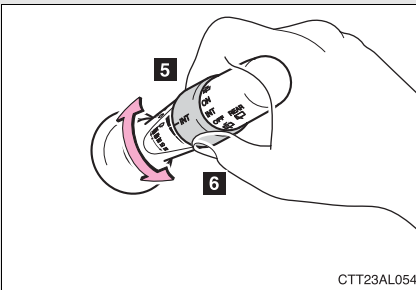
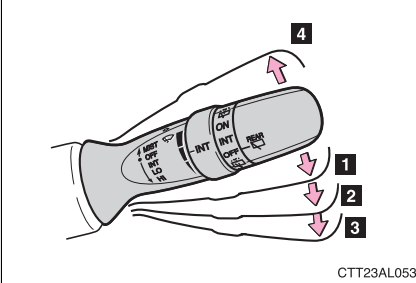
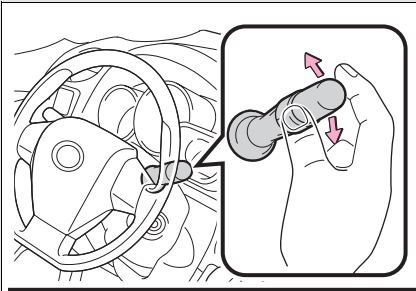

- 1 INT** Intermittent windshield wiper operation
- 2 LO** Low speed windshield wiper operation
- 3 HI** High speed windshield wiper operation
- 4 MIST** Temporary operation

- 5** Increases the intermittent windshield wiper frequency*
- 6** Decreases the intermittent windshield wiper frequency*

*: If equipped

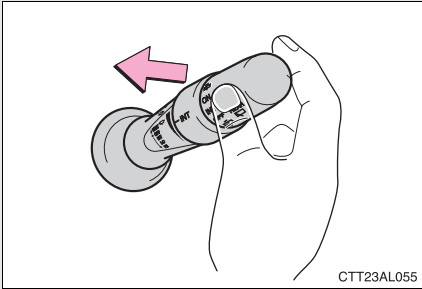



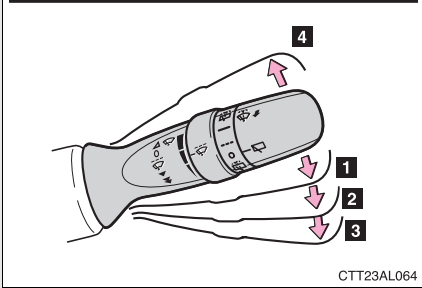
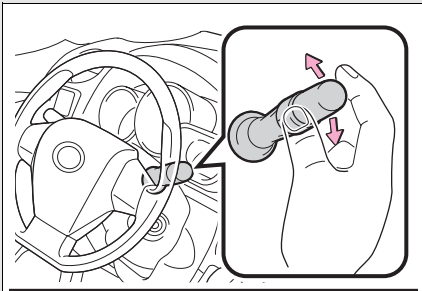

Wash/wipe operation

Wipers operate automatically.

► Type B



- 1**  Intermittent windshield wiper operation
- 2**  Low speed windshield wiper operation
- 3**  High speed windshield wiper operation
- 4**  Temporary operation

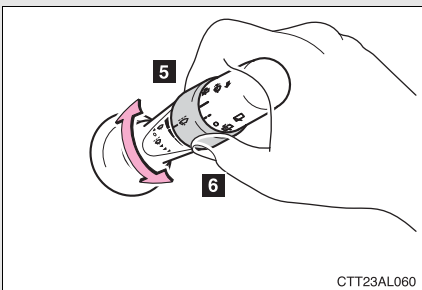

- 5** Increases the intermittent windshield wiper frequency*
- 6** Decreases the intermittent windshield wiper frequency*

*: If equipped

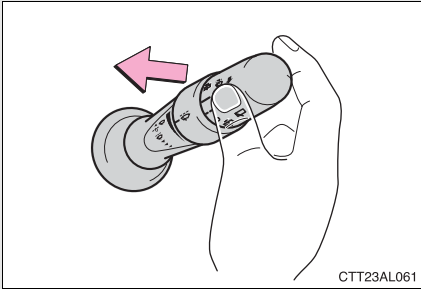

Wash/wipe operation

Wipers operate automatically.

■ The windshield wipers and washers can be operated when

The engine switch is in the "ON" position.

■ If no windshield washer fluid sprays

Check that the washer nozzles are not blocked and if there is washer fluid in the windshield washer fluid reservoir.

NOTICE

■ When the windshield is dry

Do not use the wipers, as they may damage the windshield.

■ When there is no washer fluid spray from the nozzle

Damage to the washer fluid pump may be caused if the lever is pulled toward you and held continually.

■ When a nozzle becomes blocked

Do not try to clear it with a pin or other object. The nozzle will be damaged.

2-3. Operating the lights and wipers

Rear window wiper and washer*

► Type A

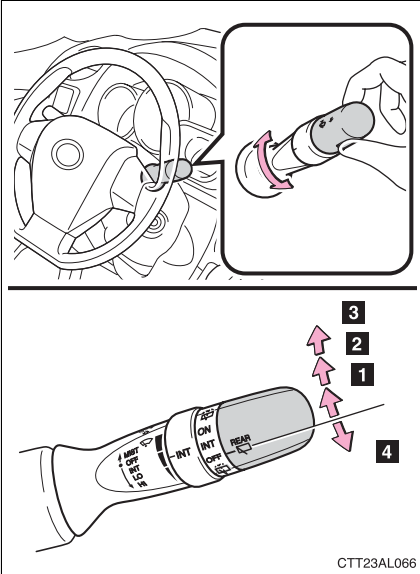

1 INT Intermittent window wiper operation

2 ON Normal window wiper operation

3  Washer/wiper dual operation

Wiper operates automatically.



4  Washer/wiper dual operation

Wiper operates automatically.

*: If equipped

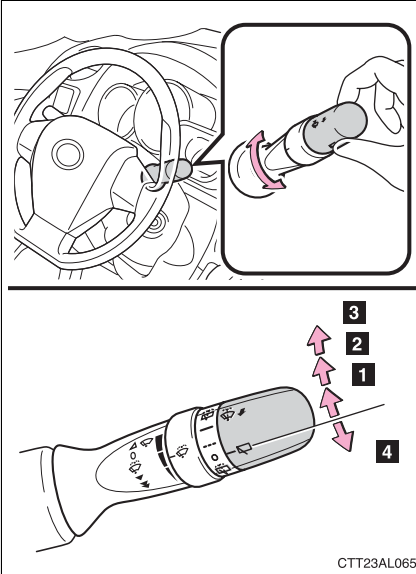
▶ Type B



- 1  Intermittent window wiper operation
- 2  Normal window wiper operation
- 3  Washer/wiper dual operation

Wiper operates automatically.

- 4  Washer/wiper dual operation

Wiper operates automatically.

- **The rear window wiper and washer can be operated when**
The engine switch is in “ON”.

 NOTICE

■ **When the rear window is dry**

Do not use the wipers, as they may damage the rear window.

■ **When there is no washer fluid spray from the nozzle**

Damage to the washer fluid pump may be caused if the lever is pulled toward you and held continually.

■ **When a nozzle becomes blocked**

Do not try to clear it with a pin or other object. The nozzle will be damaged.

2-4. Using other driving systems Cruise control*

Use the cruise control to maintain a set speed without depressing the accelerator pedal.

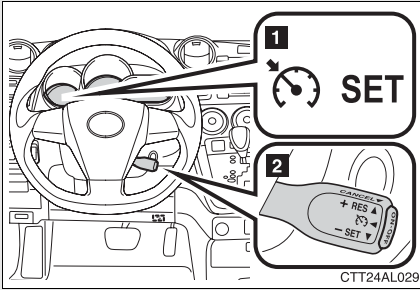

- 1 Indicators
- 2 Cruise control switch

■ Setting the vehicle speed

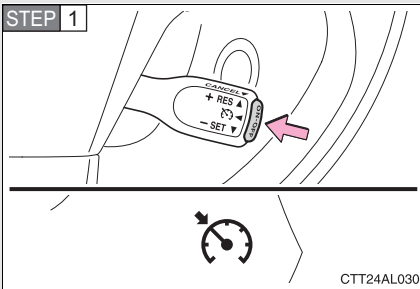

Press the “ON-OFF” button to activate the cruise control.

Cruise control indicator will come on.

Press the button again to deactivate the cruise control.

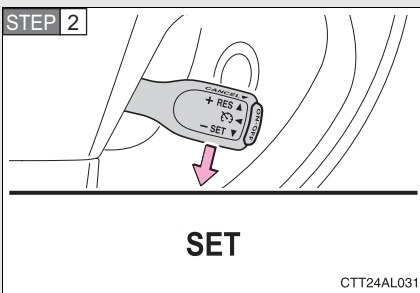

Accelerate or decelerate the vehicle to the desired speed, and push the lever down to set the speed.

“SET” indicator will come on.

The vehicle speed at the moment the lever is released becomes the set speed.

*: If equipped

■ Adjusting the speed setting

To change the set speed, operate the lever until the desired set speed is obtained.

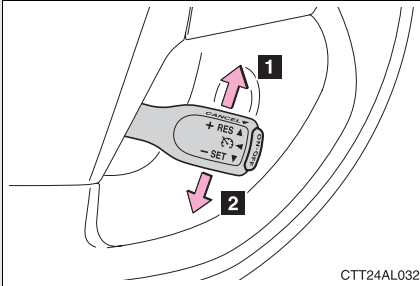

CTT24AL032

1 Increases the speed

2 Decreases the speed

Fine adjustment: Momentarily move the lever in the desired direction.

Large adjustment: Hold the lever in the desired direction.

The set speed will be increased or decreased as follows:

Fine adjustment: By approximately 1 mph (1.6 km/h) each time the lever is operated.

Large adjustment: The set speed can be increased or decreased continually until the lever is released.

■ Canceling and resuming the constant speed control

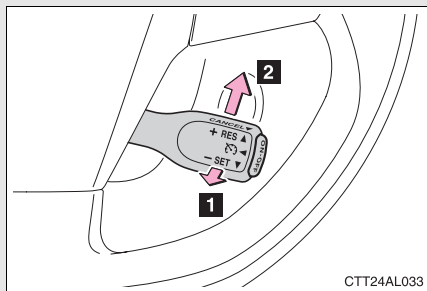

1 Pulling the lever toward you cancels the constant speed control.

The speed setting is also canceled when the brakes are applied or the clutch pedal (manual transmission only) is depressed.

2 Pushing the lever up resumes the constant speed control.

Resuming is available when the vehicle speed is more than approximately 25 mph (40 km/h).

■ Cruise control can be set when

- Automatic transmission:
The shift lever is in the D or range 3 (standard type), or in the D or range 4 or higher of S has been selected (multi-mode type).
- Vehicle speed is above approximately 25 mph (40 km/h).

■ Accelerating

The vehicle can be accelerated normally. After acceleration, the set speed resumes.

■ Automatic cruise control cancelation

Cruise control will stop maintaining the vehicle speed in any of the following situations.

- Actual vehicle speed falls more than approximately 10 mph (16 km/h) below the preset vehicle speed.
At this time, the memorized set speed is not retained.
- Actual vehicle speed is below approximately 25 mph (40 km/h).
- VSC is activated.

■ If the cruise control indicator light flashes

Press the “ON-OFF” button once to deactivate the system, and then press the button again to reactivate the system.

If the cruise control speed cannot be set or if the cruise control cancels immediately after being activated, there may be a malfunction in the cruise control system. Have the vehicle inspected by your Toyota dealer.

CAUTION

■ To avoid operating the cruise control by mistake

Switch the cruise control off using the “ON-OFF” button when not in use.

■ Situations unsuitable for cruise control

Do not use cruise control in any of the following situations.

Doing so may result in loss of control and could cause an accident resulting in death or serious injury.

- In heavy traffic
- On roads with sharp bends
- On winding roads
- On slippery roads, such as those covered with rain, ice or snow
- On steep hills
Vehicle speed may exceed the set speed when driving down a steep hill.
- When your vehicle is towing a trailer or during emergency towing

Driving assist systems

To help enhance driving safety and performance, the following systems operate automatically in response to various driving situations. Be aware, however, that these systems are supplementary and should not be relied upon too heavily when operating the vehicle.

■ **ABS (Anti-lock Brake System)**

Helps to prevent wheel lock when the brakes are applied suddenly, or if the brakes are applied while driving on a slippery road surface.

■ **Brake assist**

Generates an increased level of braking force after the brake pedal is depressed, when the system detects a panic stop situation.

■ **VSC (Vehicle Stability Control)**

Helps the driver to control skidding when swerving suddenly or turning on slippery road surfaces.

■ **TRAC (Traction Control)**

Maintains drive power and prevents the front wheels from spinning when starting the vehicle or accelerating on slippery roads.

■ **EPS (Electric Power Steering)**

Employs an electric motor to reduce the amount of effort needed to turn the steering wheel.

■ **Active Torque Control 4WD system (if equipped)**

Automatically switches from front-wheel drive to AWD (All-Wheel Drive) according to driving conditions, helping to ensure reliable handling and stability. Examples of conditions where the system will switch to AWD are when cornering, going uphill, starting off or accelerating, and when the road surface is slippery due to snow or rain etc.

When VSC and TRAC are operating

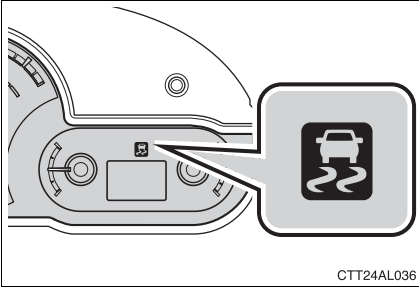

If the vehicle is in danger of slipping or the front wheels (2WD), or 4 wheels (AWD) spin, the indicator flashes to indicate that VSC/TRAC have been engaged.

To disable TRAC and/or VSC

If the vehicle gets stuck in fresh snow or mud, TRAC and VSC may reduce power from the engine to the wheels. You may need to turn the system off to enable you to rock the vehicle in order to free it.

■ Turning off TRAC

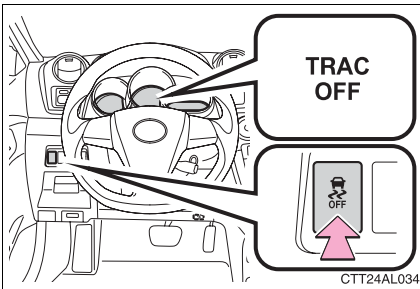

Quickly push and release the switch to turn off TRAC.

The "TRAC OFF" indicator light should come on.

Push the switch again to turn the system back on.

■ Turning off TRAC and VSC

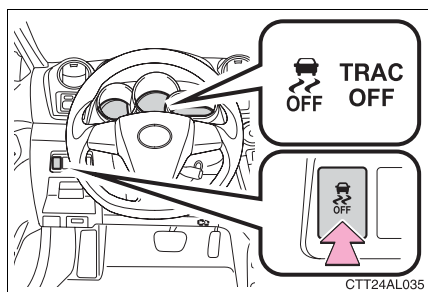

Push and hold the switch while the vehicle is stopped to turn off TRAC and VSC.

The “TRAC OFF” indicator light and VSC off indicator light should come on.

Push the switch again to turn the system back on.

■ When the “TRAC OFF” indicator light comes on even if the VSC off switch has not been pressed

TRAC cannot be operated. Contact your Toyota dealer.

■ Automatic reactivation of TRAC and VSC

Turning the engine switch OFF after turning off the TRAC and VSC systems will automatically re-enable them.

■ Automatic TRAC reactivation

If only the TRAC system is turned off, the TRAC system will turn on when vehicle speed increases.

■ Automatic TRAC and VSC reactivation

If the TRAC and VSC systems are turned off, the systems will not turn on even when vehicle speed increases.

■ Sounds and vibrations caused by ABS, brake assist, VSC and TRAC

- A sound may be heard from the engine compartment when the engine is started or just after the vehicle begins to move. This sound does not indicate that a malfunction has occurred in any of these systems.
- Any of the following conditions may occur when the above systems are operating. None of these indicates that a malfunction has occurred.
 - Vibrations may be felt through the vehicle body and steering.
 - A motor sound may be heard after the vehicle comes to a stop.
 - The brake pedal may pulsate slightly after ABS is activated.
 - The brake pedal may move down slightly after ABS is activated.

■ If the slip indicator light comes on

There is a malfunction in the TRAC and VSC systems. Contact your Toyota dealer and have your Toyota inspected.

■ EPS system operation sound

When the steering wheel is operated, a motor sound (whirring sound) may be heard. This does not indicate a malfunction.

■ Reduced effectiveness of EPS system

The effectiveness of the EPS system is reduced to prevent the system from overheating when there is frequent steering input over an extended period of time. The steering wheel may feel heavy as a result. Should this occur, refrain from excessive steering input or stop the vehicle and turn the engine off. The EPS system should return to normal within 10 minutes.

CAUTION

■ ABS does not operate effectively when

- The limits of tire gripping performance have been exceeded (such as excessively worn tires on a snow covered road).
- The vehicle hydroplanes while driving at high speed on the wet or slick road.

■ Stopping distance when the ABS is operating may exceed that of normal conditions

ABS is not designed to shorten the vehicle's stopping distance. Always maintain a safe distance from the vehicle in front of you, especially in the following situations.

- When driving on dirt, gravel or snow-covered roads
- When driving with tire chains
- When driving over bumps in the road
- When driving over roads with potholes or uneven roads

■ TRAC may not operate effectively when

Directional control and power may not be achievable while driving on slippery road surfaces, even if the TRAC system is operating.

Do not drive the vehicle in conditions where stability and power may be lost.

 **CAUTION**

■ **When VSC is activated**

The slip indicator light flashes. Always drive carefully. Reckless driving may cause an accident. Exercise particular care when the indicator light flashes.

■ **When TRAC and VSC are off**

Be especially careful and drive at a speed appropriate to the road conditions. As these are systems to ensure vehicle stability and driving force, do not turn off TRAC and VSC unless necessary.

■ **Replacing tires**

Make sure that all tires are of the same size, brand, tread pattern and total load capacity. In addition, make sure that the tires are inflated to the recommended tire pressure level.

The ABS and VSC systems will not function correctly if different tires are fitted on the vehicle.

Contact your Toyota dealer for further information when replacing tires or wheels.

■ **Handling of tires and suspension**

Using tires with any kind of problem or modifying the suspension will affect the driving assist systems, and may cause the system to malfunction.

■ **Active Torque Control 4WD system**

● The AWD system of this vehicle is intended to ensure driving stability on normal roads. It is not designed for use in demanding situations such as rally driving.

● Take care when driving on slippery road surfaces.

2-5. Driving information

Cargo and luggage

Take notice of the following information about storage precautions, cargo capacity and load.

- Stow cargo and luggage in the luggage compartment whenever possible. Be sure all items are secured in place.
- Be careful to keep the vehicle level. Placing the weight as far forward as possible helps maintain vehicle balance.
- For better fuel economy, do not carry unnecessary weight.

Capacity and distribution

Cargo capacity depends on the total weight of the occupants.

(Cargo capacity) = (Total load capacity) - (Total weight of occupants)

Steps for Determining Correct Load Limit—

- (1) Locate the statement “The combined weight of occupants and cargo should never exceed XXX kg or XXX lbs.” on your vehicle's placard.
- (2) Determine the combined weight of the driver and passengers that will be riding in your vehicle.
- (3) Subtract the combined weight of the driver and passengers from XXX kg or XXX lbs.
- (4) The resulting figure equals the available amount of cargo and luggage load capacity.
For example, if the “XXX” amount equals 1400 lbs. and there will be five 150 lb passengers in your vehicle, the amount of available cargo and luggage load capacity is 650 lbs. (1400 - 750 (5 × 150) = 650 lbs.)
- (5) Determine the combined weight of luggage and cargo being loaded on the vehicle. That weight may not safely exceed the available cargo and luggage load capacity calculated in Step 4.

(6) If your vehicle will be towing a trailer, load from your trailer will be transferred to your vehicle. Consult this manual to determine how this reduces the available cargo and luggage load capacity of your vehicle.

(→P. 167)

Calculation formula for your vehicle

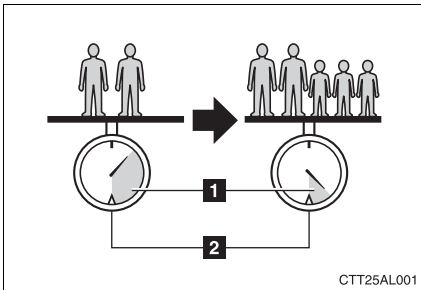

1 Cargo capacity

2 Total load capacity (vehicle capacity weight) (→P. 438)

When 2 people with the combined weight of A lb. (kg) are riding in your vehicle, which has a total load capacity (vehicle capacity weight) of B lb. (kg), the available amount of cargo and luggage load capacity will be C lb. (kg) as follows:

$$B^{*2} \text{ lb. (kg)} - A^{*1} \text{ lb. (kg)} = C^{*3} \text{ lb. (kg)}$$

*1: A = Weight of people

*2: B = Total load capacity

*3: C = Available cargo and luggage load

In this condition, if 3 more passengers with the combined weight of D lb. (kg) get on, the available cargo and luggage load will be reduced E lb. (kg) as follows:

$$C \text{ lb. (kg)} - D^{*4} \text{ lb. (kg)} = E^{*5} \text{ lb. (kg)}$$

*4: D = Additional weight of people

*5: E = Available cargo and luggage load

As shown in the above example, if the number of occupants increases, the cargo and luggage load will be reduced by an amount that equals the increased weight due to the additional occupants. In other words, if an increase in the number of occupants causes an excess of the total load capacity (combined weight of occupants plus cargo and luggage load), you must reduce the cargo and luggage on your vehicle.

 CAUTION

■ **Storage precautions**

Observe the following precautions.

Failing to do so may result in death or serious injury.

- To prevent cargo and luggage from sliding forward during braking, do not stack anything in the luggage compartment. Keep cargo and luggage low, as close to the floor as possible.
- Never allow anyone to ride in the luggage compartment. It is not designed for passengers. They should ride in their seats with their seat belts properly fastened. Otherwise, they are much more likely to suffer death or serious bodily injury, in the event of sudden braking, sudden swerving or an accident.
- Do not place cargo or luggage in or on the following locations as the item may get under the clutch, brake or accelerator pedal and prevent the pedals from being depressed properly, block the driver's vision, or hit the driver or passengers, causing an accident.
 - Driver's feet
 - Front passenger or rear seats (when stacking items)
 - Instrument panel
 - Dashboard
 - Tonneau cover (if equipped)
- Secure all items in the occupant compartment, as they may shift and injure someone during sudden braking, sudden swerving or an accident.

■ **Capacity and distribution**

- Do not exceed the maximum axle weight rating or the total vehicle weight rating.
- Even if the total load of occupant's weight and the cargo load is less than the total load capacity, do not apply the load unevenly. Improper loading may cause deterioration of steering or braking control which may cause death or serious injury.

Vehicle load limits include total load capacity, seating capacity, trailer weight rating and cargo capacity.

■ **Total load capacity (vehicle capacity weight): (→P. 438)**

Total load capacity means the combined weight of occupants, cargo and luggage.

■ **Seating capacity: 5 occupants (Front 2, Rear 3)**

Seating capacity means the maximum number of occupants whose estimated average weight is 150 lb. (68 kg) per person.

■ **Trailer weight rating**

▶ 1.8 L 4-cylinder (2ZR-FE) engine

Toyota does not recommend towing a trailer with your vehicle.

▶ 2.4 L 4-cylinder (2AZ-FE) engine

→P. 171, 438

■ **Cargo capacity**

Cargo capacity may increase or decrease depending on the weight and the number of occupants.

■ **Total load capacity and seating capacity**

These details are also described on the tire and loading information label. (→P. 358)

 **CAUTION**

■ **Overloading the vehicle**

Do not overload the vehicle.

It may not only cause damage to the tires, but also degrade steering and braking ability, resulting in an accident.

2-5. Driving information

Winter driving tips

Carry out the necessary preparations and inspections before driving the vehicle in winter. Always drive the vehicle in a manner appropriate to the prevailing weather conditions.

■ Pre-winter preparations

- Use fluids that are appropriate to the prevailing outside temperatures.
 - Engine oil
 - Engine coolant
 - Washer fluid
- Have a service technician inspect the level and specific gravity of battery electrolyte.
- Have the vehicle fitted with four snow tires or purchase a set of tire chains for the front tires.

Ensure that all tires are the same size and brand, and that chains match the size of the tires.

■ Before driving the vehicle

Perform the following according to the driving conditions.

- Do not try to forcibly open a window or move a wiper that is frozen. Pour warm water over the frozen area to melt the ice. Wipe away the water immediately to prevent it from freezing.
- To ensure proper operation of the climate control system fan, remove any snow that has accumulated on the air inlet vents in front of the windshield.
- Remove any ice that has accumulated on the vehicle chassis.
- Periodically check for and remove any excess ice or snow that may have accumulated in the wheel well or on the brakes.

■ When driving the vehicle

Accelerate the vehicle slowly and drive at a reduced speed suitable to road conditions.

■ When parking the vehicle

Park the vehicle and move the shift lever to P (automatic transmission), 1 or R (manual transmission) without setting the parking brake. The parking brake may freeze up, preventing it from being released. If necessary, block the wheels to prevent inadvertent sliding or creeping.

Selecting tire chains

Snow chains can be mounted on 16- and 17-inch tires. They cannot be mounted on 18-inch tires. Use the correct snow chain size when mounting the snow chains. Chain size is regulated for each tire size.

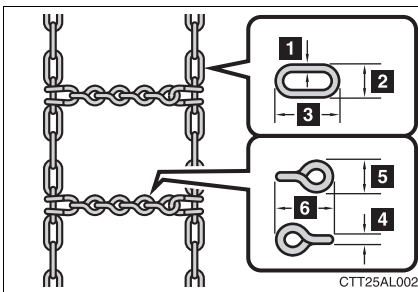

Side chain:

- 1 0.12 in. (3 mm) in diameter
- 2 0.39 in. (10 mm) in width
- 3 1.18 in. (30 mm) in length

Cross chain:

- 4 0.16 in. (4 mm) in diameter
- 5 0.55 in. (14 mm) in width
- 6 0.98 in. (25 mm) in length

Regulations on the use of snow chains

- Regulations regarding the use of tire chains vary according to location and type of road. Always check local regulations before installing chains.
- Install the chains on the front tires.
- Retighten the chains after driving 1/4 - 1/2 mile (0.5 - 1.0 km).

■ **Snow chain installation (vehicles with 16-inch and 17-inch tires)**

Observe the following precautions when installing and removing chains.

- Install and remove tire chains in a safe location.
- Install tire chains on the front tires only. Do not install tire chains on rear tires.
- Install tire chains following the instructions provided in the accompanying manual.

 **CAUTION**

■ **Driving with snow tires**

Observe the following precautions to reduce the risk of accidents.

Failing to do so may result in a loss of vehicle control and cause death or serious injury.

- Use tires of the size specified for your vehicle.
- Maintain the recommended level of air pressure.
- Do not drive in excess of 75 mph (120 km/h), regardless of the type of snow tires being used.
- Use snow tires on all, not just some wheels.

■ **Driving with tire chains**

Observe the following precautions to reduce the risk of accidents.

Failing to do so may result in the vehicle being unable to be driven safely, and may cause death or serious injury.

- Do not drive in excess of the speed limit specified for the tire chains being used or 30 mph (50 km/h), whichever is lower.
- Avoid driving on bumpy road surfaces or over potholes.
- Avoid sudden turns and braking, as use of chains may adversely affect vehicle handling.
- Slow down sufficiently before entering a curve to ensure that vehicle control is maintained.

**NOTICE****■ Repairing or replacing snow tires**

Request repairs of and obtain replacement snow tires from Toyota dealers or legitimate tire retailers.

This is because the removal and attachment of snow tires affects the operation of the tire pressure warning valves and transmitters.

■ Fitting tire chains

The tire pressure warning valves and transmitters may not function correctly when tire chains are fitted.

2-5. Driving information

Trailer towing (1.8 L 4-cylinder [2ZR-FE] engine)

Toyota does not recommend towing a trailer with your vehicle. Toyota also does not recommend the installation of a tow hitch or the use of a tow hitch carrier for a wheelchair, scooter, bicycle, etc. Your Toyota is not designed for trailer towing or for the use of tow hitch mounted carriers.



Your vehicle is designed primarily as a passenger-and-load-carrying vehicle. Towing a trailer can have an adverse impact on handling, performance, braking, durability, and fuel consumption. For your safety and the safety of others, you must not overload your vehicle or trailer. You must also ensure that you are using appropriate towing equipment, that the towing equipment has been installed correctly and used properly, and that you employ the requisite driving habits.

Vehicle-trailer stability and braking performance are affected by trailer stability, brake performance and setting, trailer brakes, the hitch and hitch systems (if equipped).

To tow a trailer safely, use extreme care and drive the vehicle in accordance with your trailer's characteristics and operating conditions.

Toyota warranties do not apply to damage or malfunction caused by towing a trailer for commercial purposes.

Contact your Toyota dealer for further information about additional requirements such as towing kits, etc.

Towing related terms

■ GCWR (Gross Combination Weight Rating)

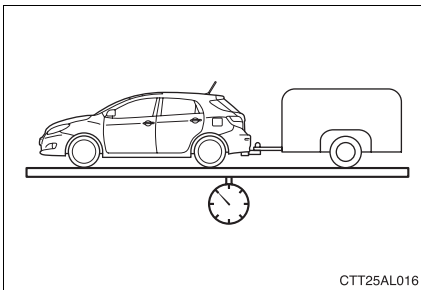

The maximum allowable gross combination weight. The gross combination weight is the sum of the total vehicle weight (including the occupants, cargo and any optional equipment installed on the vehicle) and the weight of the trailer being towed (including the cargo in the trailer).

■ GVWR (Gross Vehicle Weight Rating)

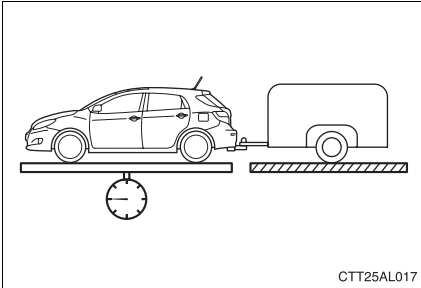

The maximum allowable gross vehicle weight. The gross vehicle weight is the total weight of the vehicle. When towing a trailer, it is the sum of the vehicle weight (including the occupants, cargo and any optional equipment installed on the vehicle) and the tongue weight.

■ GAWR (Gross Axle Weight Rating)

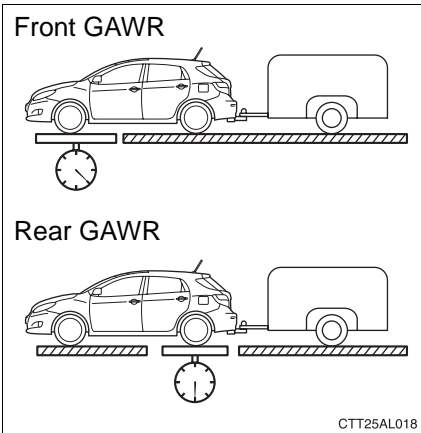

The maximum allowable gross axle weight. The gross axle weight is the load placed on each axle (front and rear).

■ TWR (Trailer Weight Rating)

(With brakes)

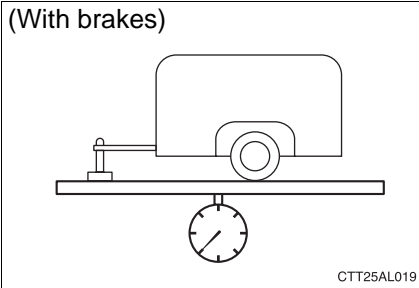

The maximum allowable gross trailer weight. The gross trailer weight is the sum of the trailer weight and the weight of the cargo in the trailer.

TWR is calculated assuming base vehicle with one driver, one front passenger, towing package (if available), hitch and hitch systems (if required).

Additional optional equipment, passengers and cargo in the vehicle will reduce the trailer weight rating so as not to exceed GCWR, GVWR and GAWR.

■ Unbraked TWR (Unbraked Trailer Weight Rating)

(Without brakes)

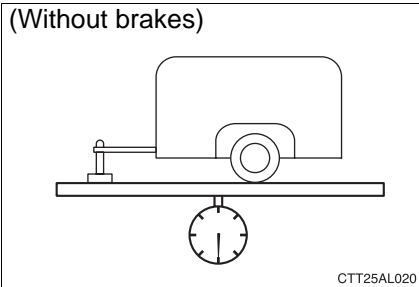

The trailer weight rating for towing a trailer without a trailer service brake system.

■ Tongue Weight

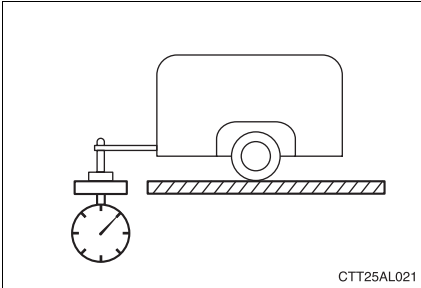

The load placed on the trailer hitch ball. (→P. 171)

Weight limits

- The gross trailer weight must never exceed the TWR described in the table. (→P. 171)
- The gross combination weight must never exceed the GCWR described in the table. (→P. 171)

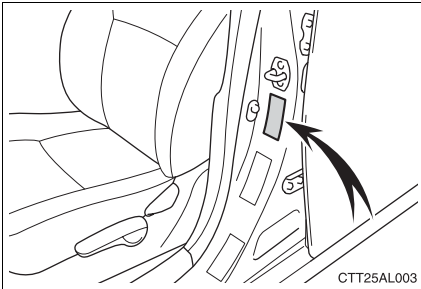

- The gross vehicle weight must never exceed the GVWR indicated on the Certification Label.
 - The gross axle weight on each axle must never exceed the GAWR indicated on the Certification Label.
- If the gross trailer weight is over the unbraked TWR, trailer service brakes are required.

GCWR, TWR and Unbraked TWR

Confirm that the gross trailer weight, gross combination weight, gross vehicle weight, gross axle weight and tongue weight are all within the limits.

■ GCWR* and TWR*

Driving system	Grade	Transmission	GCWR	TWR
2WD	S grade	Automatic transmission	4975 lb. (2257 kg)	1500 lb. (680 kg)
		Manual transmission	4900 lb. (2223 kg)	
	XRS grade	Automatic transmission	5055 lb. (2293 kg)	
		Manual transmission	4975 lb. (2257 kg)	
AWD	—	—	5195 lb. (2356 kg)	

■ Unbraked TWR*

1000 lb. (454 kg)

*: These models meet the tow-vehicle trailering requirement of SAE International per SAE J2807.

Trailer Tongue Weight

- A recommended tongue weight varies in accordance with the types of trailers or towing as described below.
- To ensure the recommended values shown below, the trailer must be loaded by referring to the following instructions.
 - Tongue Weight

The gross trailer weight should be distributed so that the tongue weight is 9% to 11%. (Tongue weight /Gross trailer weight x 100 = 9% to 11%)

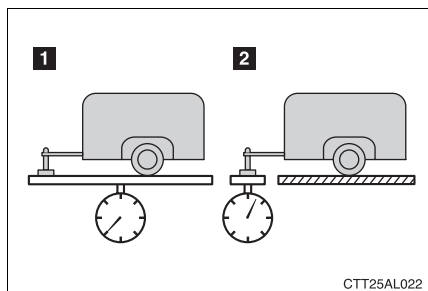

1 Gross trailer weight

2 Tongue weight

If using a weight distributing hitch when towing, return the front axle to the same weight as before the trailer connection.

If front axle weight cannot be measured directly, measure the front fender height above the front axle before connection. Adjust weight distributing hitch torque until front fender is returned to the same height as before connection.

The gross trailer weight, gross axle weight and tongue weight can be measured with platform scales found at a highway weighing station, building supply company, trucking company, junk yard, etc.

Hitch

Trailer hitch assemblies have different weight capacities. Toyota recommends the use of Toyota hitch/bracket for your vehicle. For details, contact your Toyota dealer.

- If you wish to install a trailer hitch, contact your Toyota dealer.
- Use only a hitch that conforms to the gross trailer weight requirement of your vehicle.
- Follow the directions supplied by the hitch manufacturer.
- Lubricate the hitch ball with a light coating of grease.
- Remove the trailer hitch whenever you are not towing a trailer. After removing the hitch, seal any mounting hole in the vehicle body to prevent entry of any substances into the vehicle.

Positions for towing hitch receiver and hitch ball

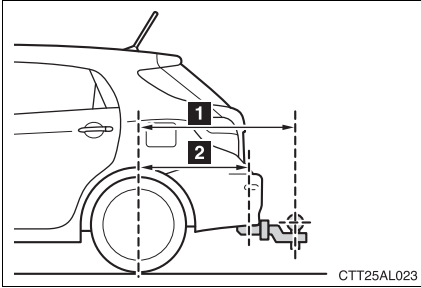

- 1 Weight carrying ball position: 36.2 in. (920.3 mm)
- 2 Hitch receiver pin hole position: 29.1 in. (739.4 mm)

Connecting trailer lights

Please consult your dealer when installing trailer lights, as incorrect installation may cause damage to the vehicle's lights. Please take care to comply with your state's laws when installing trailer lights.

Trailer towing tips

Your vehicle will handle differently when towing a trailer. Help to avoid an accident, death or serious injury, keep the following in mind when towing:

- Speed limits for towing a trailer vary by state or province. Do not exceed the posted towing speed limit.
- Toyota recommends that the vehicle-trailer speed limit is 65 mph (104 km/h) on a flat, straight, dry road. Do not exceed this limit, the posted towing speed limit or the speed limit for your trailer as set forth in your trailer owner's manual, whichever is lowest. Instability of the towing vehicle-trailer combination (trailer sway) increases as speed increases. Exceeding speed limits may cause loss of control.
- Before starting out, check the trailer lights, tires and the vehicle-trailer connections. Recheck after driving a short distance.

- Practice turning, stopping and reversing with the trailer attached in an area away from traffic until you become accustomed to the feel of the vehicle-trailer combination.
- Reversing with a trailer attached is difficult and requires practice. Grip the bottom of the steering wheel and move your hand to the left to move the trailer to the left. Move your hand to the right to move the trailer to the right. (This is generally opposite to reversing without a trailer attached.) Avoid sharp or prolonged turning. Have someone guide you when reversing to reduce the risk of an accident.
- As stopping distance is increased when towing a trailer, vehicle-to-vehicle distance should be increased. For each 10 mph (16 km/h) of speed, allow at least one vehicle and trailer length.
- Avoid sudden braking as you may skid, resulting in the trailer jackknifing and a loss of vehicle control. This is especially true on wet or slippery surfaces.
- Avoid jerky starts or sudden acceleration.
- Avoid jerky steering and sharp turns, and slow down before making a turn.
- Note that when making a turn, the trailer wheels will be closer than the vehicle wheels to the inside of the turn. Compensate by making a wider than normal turning radius.
- Slow down before making a turn, in cross winds, on wet or slippery surfaces, etc.
Increasing vehicle speed can destabilize the trailer.
- Take care when passing other vehicles. Passing requires considerable distance. After passing a vehicle, do not forget the length of your trailer, and be sure you have plenty of room before changing lanes.

- Automatic transmission:

To maintain engine braking efficiency and charging system performance when using engine braking, do not put the transmission in "D". If in the S mode, the transmission shift gear position must be in 4 or lower.

- Manual transmission:

To maintain engine braking efficiency and charging system performance when using engine braking, do not use fifth gear.

- Instability happens more frequently when descending steep or long downhill grades. Before descending, slow down and downshift. Do not make sudden downshifts while descending steep or long downhill grades.

- Avoid holding the brake pedal down too long or applying the brakes too frequently. This could cause the brakes to overheat and result in reduced braking efficiency.

- Due to the added load of the trailer, your vehicle's engine may overheat on hot days (at temperatures over 85°F [30°C]) when driving up a long or steep grade. If the engine coolant temperature gauge indicates overheating, immediately turn off the air conditioning (if in use), pull your vehicle off the road and stop in a safe spot. (→P. 430)

- Always place wheel blocks under both the vehicle's and the trailer's wheels when parking. Apply the parking brake firmly, and put the transmission in P (automatic transmission) or in 1 or R (manual transmission). Avoid parking on a slope, but if unavoidable, do so only after performing the following:

STEP 1 Apply the brakes and keep them applied.

STEP 2 Have someone place wheel blocks under both the vehicle's and trailer's wheels.

STEP 3 When the wheel blocks are in place, release the brakes slowly until the blocks absorb the load.

STEP 4 Apply the parking brake firmly.

STEP 5 Shift into 1 or R (manual transmission) or P (automatic transmission) and turn off the engine.

● When restarting after parking on a slope:

STEP 1 With the transmission in P (automatic transmission) or the clutch pedal (manual transmission) depressed, start the engine. On vehicles with an automatic transmission, be sure to keep the brake pedal depressed.

STEP 2 Shift into a forward gear. If reversing, shift into R.

STEP 3 Release the parking brake (and also the brake pedal on vehicles with an automatic transmission), and slowly pull or back away from the wheel blocks. Stop and apply the brakes.

STEP 4 Have someone retrieve the blocks.

■ Matching trailer ball height to trailer coupler height

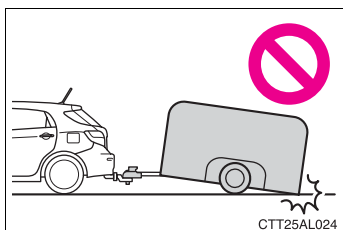

No matter which class of tow hitch applies, for a more safe trailer hookup, the trailer ball setup must be the proper height for the coupler on the trailer.

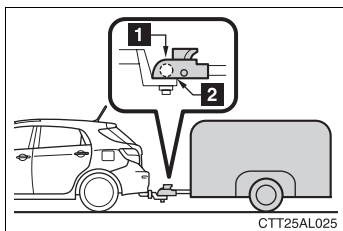

- 1** Coupler
- 2** Trailer ball

■ Before towing

Check that the following conditions are met:

- Ensure that your vehicle's tires are properly inflated. (→P. 451)
- Trailer tires are inflated according to the trailer manufacturer's recommendation.
- All trailer lights work as required by law.
- All lights work each time you connect them.
- The trailer ball is set at the proper height for the coupler on the trailer.
- The trailer is level when it is hitched. Do not drive if the trailer is not level, and check for improper tongue weight, overloading, worn suspension, or other possible causes.
- The trailer cargo is securely loaded.
- The rear view mirrors conform to all applicable federal, state/provincial or local regulations. If they do not, install rear view mirrors appropriate for towing purposes.

■ Break-in schedule

If your vehicle is new or equipped with any new power train components (such as an engine, transmission, differential or wheel bearing), Toyota recommends that you do not tow a trailer until the vehicle has been driven for over 500 miles (800 km).

After the vehicle has been driven for over 500 miles (800 km), you can start towing. However, for the next 500 miles (800 km), drive the vehicle at a speed of less than 50 mph (80 km/h) when towing a trailer, and avoid full throttle acceleration.

■ Maintenance

- If you tow a trailer, your vehicle will require more frequent maintenance due to the additional load. (See "Scheduled Maintenance Guide" or "Owner's Manual Supplement".)
- Retighten the fixing bolts of the towing ball and bracket after approximately 600 miles (1000 km) of trailer towing.

■ If trailer sway occurs

One or more factors (crosswinds, passing vehicles, rough roads, etc.) can adversely affect handling of your vehicle and trailer, causing instability.

● If trailer swaying occurs:

- Firmly grip the steering wheel. Steer straight ahead.
Do not try to control trailer swaying by turning the steering wheel.
- Begin releasing the accelerator pedal immediately but very gradually to reduce speed.

Do not increase speed. Do not apply vehicle brakes.

If you make no extreme correction with the steering or brakes, your vehicle and trailer should stabilize.

● After the trailer swaying has stopped:

- Stop in a safe place. Get all occupants out of the vehicle.
- Check the tires of the vehicle and the trailer.
- Check the load in the trailer.

Make sure the load has not shifted.

Make sure the tongue weight is appropriate, if possible.

- Check the load in the vehicle.

Make sure the vehicle is not overloaded after occupants get in.

If you cannot find any problems, the speed at which trailer swaying occurred is beyond the limit of your particular vehicle-trailer combination.

Drive at a lower speed to prevent instability. Remember that swaying of the towing vehicle-trailer increases as speed increases.

CAUTION

■ Trailer towing precautions

To tow a trailer safely, use extreme care and drive the vehicle in accordance with the trailer's characteristics and operating conditions. Failure to do so could cause an accident resulting in death or serious injury. Vehicle stability and braking performance are affected by trailer stability, brake setting and performance, and the hitch. Your vehicle will handle differently when towing a trailer.

 CAUTION**■ To avoid accident or injury**

- Do not exceed the TWR, unbraked TWR, GCWR, GVWR or GAWR.
- Adjust the tongue weight within the appropriate range. Place heavier loads as close to the trailer axle as possible.
- Do not exceed 65 mph (104 km/h), the posted towing speed limit or the speed limit for your trailer as set forth in your trailer owner's manual, whichever is lowest. Slow down sufficiently before making a turn, in cross winds, on wet or slippery surface, etc. to help avoid an accident. If you experience a vehicle-trailer instability from reducing a certain speed, slow down and make sure you keep your vehicle speed under the speed of which you experience the instability.
- Do not make jerky, abrupt or sharp turns.
- Do not apply the brakes suddenly as you may skid, resulting in jackknifing and loss of vehicle control. This is especially true on wet or slippery surfaces.
- Do not exceed the trailer hitch assembly weight, gross vehicle weight, gross axle weight and trailer tongue weight capacities.
- Do not use cruise control when towing.
- Slow down and downshift before descending steep or long downhill grades. Do not make sudden downshifts while descending steep or long downhill grades.
- Vehicle-trailer instability is more likely on steep long downhills. Before descending steep or long downhill grades, slow down and downshift. Do not make sudden downshifts when descending steep or long downhill grades. Avoid holding the brake pedal down too long or applying the brakes too frequently. This could cause the brakes to overheat and result in reduced braking efficiency.
- Do not tow a trailer when the compact spare tire is installed on your vehicle.

 CAUTION

■ **Hitch**

Trailer hitch assemblies have different weight capacities established by the hitch manufacturer. Even though the vehicle may be physically capable of towing a higher weight, the operator must determine the maximum weight rating of the particular hitch assembly and never exceed the maximum weight rating specified for the trailer-hitch. Exceeding the maximum weight rating set by the trailer-hitch manufacturer can cause an accident resulting in death or serious personal injuries.

■ **When towing a trailer**

Toyota recommends trailers with brakes that conform to any applicable federal and state/provincial regulations.

- If the gross trailer weight exceeds unbraked TWR, trailer brakes are required. Toyota recommends trailers with brakes that conform to all applicable federal and state/provincial regulations.
- Never tap into your vehicle's hydraulic system, as this will lower the vehicle's braking effectiveness.
- Never tow a trailer without using a safety chain securely attached to both the trailer and the vehicle. If damage occurs to the coupling unit or hitch ball, there is danger of the trailer wandering into another lane.

 NOTICE

■ **When installing a trailer hitch**

Use only the position recommended by your Toyota dealer. Do not install the trailer hitch on the bumper; this may cause body damage.

■ **Do not directly splice trailer lights**

Do not directly splice trailer lights. Directly splicing trailer lights may damage your vehicle's electrical system and cause a malfunction.

Dinghy towing (automatic transmission)

Your vehicle is not designed to be dinghy towed (with 4 wheels on the ground) behind a motor home.

NOTICE

■ To avoid serious damage to your vehicle

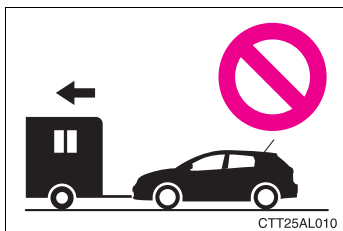

Do not tow your vehicle with 4 wheels on the ground.

■ To prevent causing serious damage to the transmission and Active Torque Control 4WD system (AWD models)

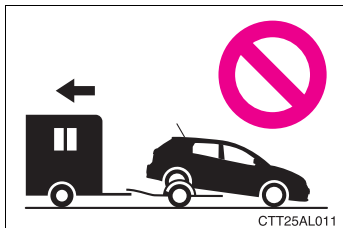

2WD models: Never tow this vehicle from the rear with the front wheels on the ground. This may cause serious damage to the transmission.

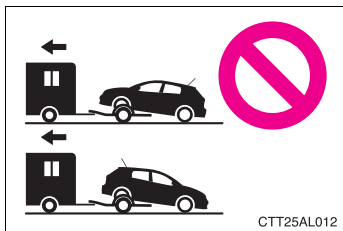

AWD models: Never tow this vehicle with any of the wheels on the ground. This may cause serious damage to the transmission and Active Torque Control 4WD system.

Dinghy towing (manual transmission)

Your vehicle can be dinghy towed in a forward direction (with 4 wheels on the ground) behind a motor home.

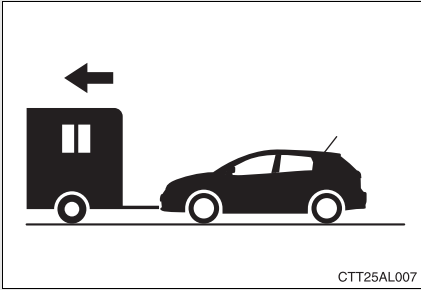

Towing your vehicle with 4 wheels on the ground

To prevent damage to your vehicle, perform the following procedures before towing.

STEP 1 Shift the shift lever to N.

STEP 2 Switch to the “ACC” position. (→P. 118)

Ensure that the audio system and other powered devices have been turned off.

STEP 3 Release the parking brake.

After towing, leave the engine in idle for at least 3 minutes before driving the vehicle.

■ Necessary equipment and accessories

Specialized equipment and accessories are required for dinghy towing. Contact the service branch of the motor home manufacturer regarding recommended equipment.

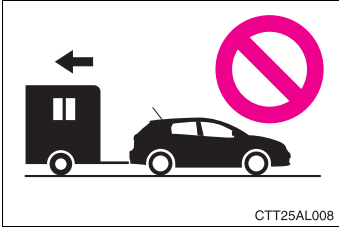
 NOTICE**■ Dinghy towing direction**

Do not tow the vehicle backwards.
Doing so may cause serious damage.

■ To prevent the steering from locking

Ensure the engine switch is in the “ACC” position.

3-1. Using the air conditioning system and defogger

Air conditioning system

► Heater

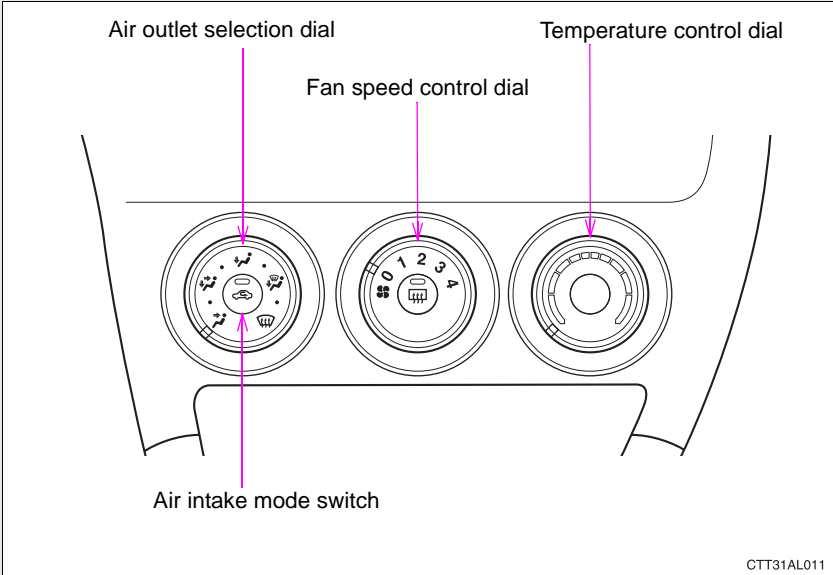

► Air conditioning system

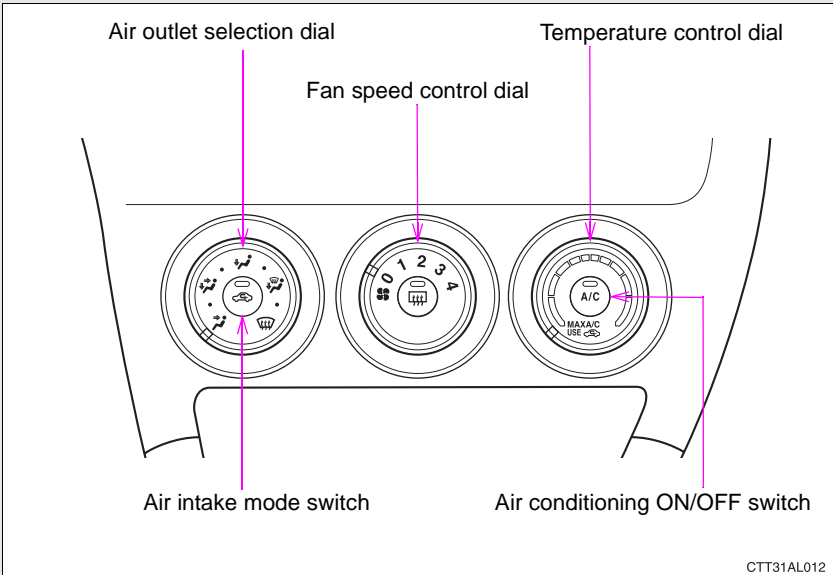

Adjusting the settings

■ Adjusting the temperature setting (heater)

Turn the temperature control dial clockwise to increase the temperature.

■ Adjusting the temperature setting (air conditioning system)

Turn the temperature control dial clockwise (warm) or counterclockwise (cool).

If  is not pressed, the system will blow ambient temperature air or heated air.

■ Adjusting the fan speed

Turn the fan speed control dial clockwise (increase) or counterclockwise (decrease).

Set the dial to "0" to turn the fan off.

■ Selecting the air outlets

Set the air outlet selection dial to an appropriate position.

The positions between the air outlet selections shown below can also be selected for more detailed adjustment.

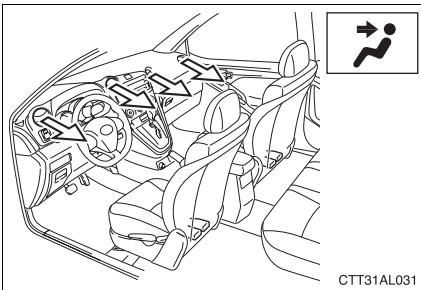

Air flows to the upper body.

3-1. Using the air conditioning system and defogger

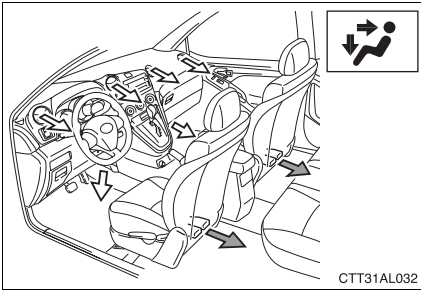

Air flows to the upper body and feet.

➡ : Some models

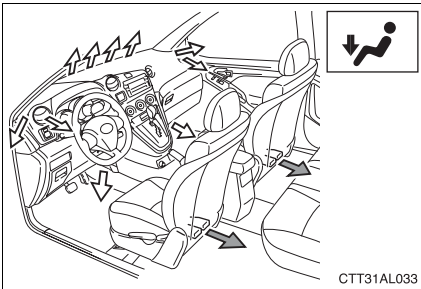

Mainly air flows to the feet.

➡ : Some models

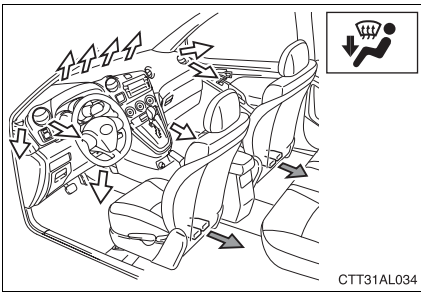

Air flows to the feet and the windshield defogger operates.

The air intake is automatically switched to outside air mode. It is not possible to return to recirculated air mode when the switch is on.

➡ : Some models

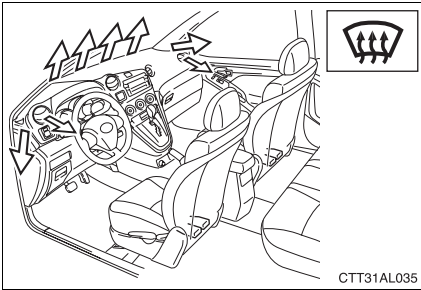

Air flows to the windshield and side windows.

The air intake is automatically switched to outside air mode. It is not possible to return to recirculated air mode when the switch is on.

■ Switching air intake modes

Press  .

The mode switches between outside air mode (indicator off) and recircu-

lated air mode (indicator on) each time  is pressed.

Adjusting the position of and opening and closing the air outlets

► Adjusting the position

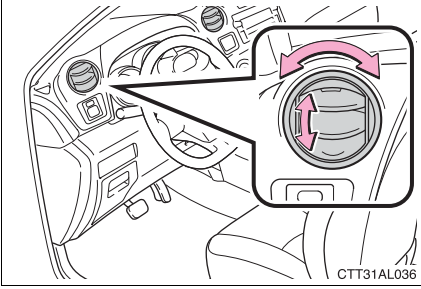

Direct air flow to the left or right, up or down.

► Opening and closing

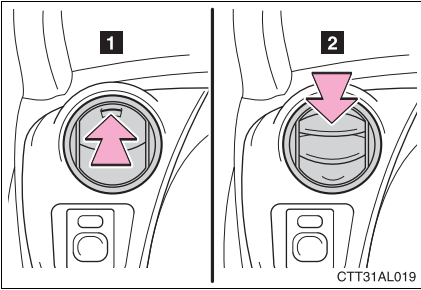

1 Open the vent

2 Close the vent

■ For quick cooling (vehicles with air conditioning system)

Turn the temperature control dial to the “MAX A/C” position and select the recirculated air mode.

■ For quick clearing of the windshield and side windows (vehicles with air conditioning system)

Press  to turn the air conditioning on.

■ Using the recirculated air mode

The windows will fog up more easily if the recirculated air mode is used for an extended period.

■ When outside air temperature approaches 32°F (0°C) (vehicles with air conditioning system)

The air conditioning system may not operate even when  is pressed.

■ When is selected for the air outlets used

For your driving comfort, air flowing to the feet may be warmer than air flowing to the upper body depending on the position of the temperature adjustment dial.

■ Air conditioning odors

- During use, various odors from inside and outside the vehicle may enter into and accumulate in the air conditioning system. This may then cause odor to be emitted from the vents.
- To reduce potential odors from occurring:
It is recommended that the air conditioning system be set to outside air mode prior to turning the vehicle off.

CAUTION

■ To prevent the windshield from fogging up

Do not set the air outlet selection dial to  during cool air operation in extremely humid weather. The difference between the temperature of the outside air and that of the windshield can cause the outer surface of the windshield to fog up, blocking your vision.



NOTICE

■ **To prevent battery discharge**

Do not leave the air conditioning system on longer than necessary when the engine is stopped.

3-1. Using the air conditioning system and defogger Rear window and outside rear view mirror defoggers

Clear the rear window using the defogger.

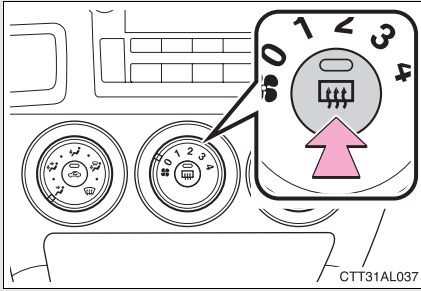

On/off

The defoggers will automatically turn off after approximately 15 minutes.

■ Outside rear view mirror defogger (if equipped)

Turning the rear window defogger on will turn the outside rear view mirror defoggers on.

⚠ CAUTION

■ Outside rear view mirror defogger (if equipped)

The surfaces of the outside rear view mirrors become hot. Do not touch them to prevent from burning yourself.

⚠ NOTICE

■ To prevent battery discharge

Do not leave the rear window defogger on longer than necessary when the engine is not running.

3-2. Using the audio system

Audio system types

► Without Display Audio system

Type A: CD player and AM/FM radio (with CD changer controller)

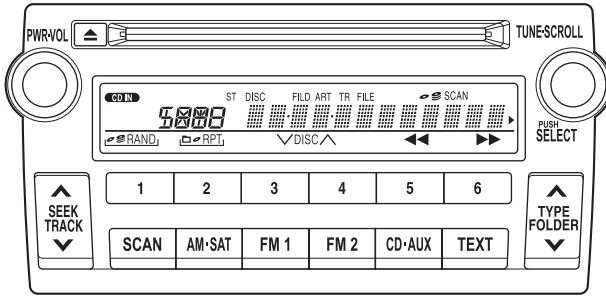

CTT32AL030

Type B: CD player and AM/FM radio

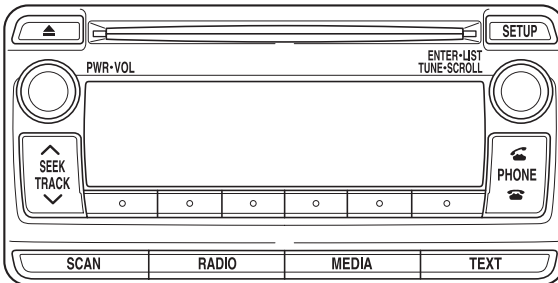

CTN32AK084

Title	Page
Using the radio	P. 203
Using the CD player	P. 207
Playing MP3 and WMA discs	P. 215
Operating an iPod	P. 225
Operating a USB memory	P. 234
Optimal use of the audio system	P. 242
Using the AUX port	P. 246
Using the steering wheel audio switches	P. 248

► With Display Audio system

Owners of models equipped with a Display Audio system should refer to the “Display Audio System Owner's Manual”.

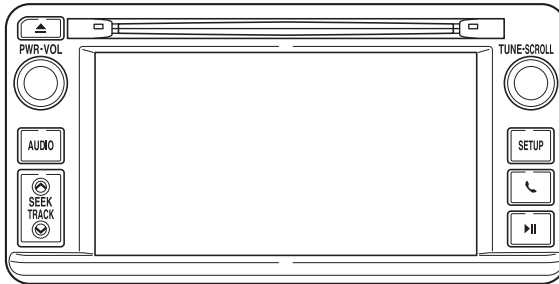

CTN32AK088

■ Using cellular phones

Interference may be heard through the audio system's speakers if a cellular phone is being used inside or close to the vehicle while the audio system is operating.

■ About Bluetooth®

The Bluetooth wordmark and logo are owned by Bluetooth SIG, and permission has been granted to use the trademark of the licensee Panasonic Corporation. Other trademarks and trade names are owned by various different owners.

 **CAUTION****■ For vehicles sold in U.S.A. and Canada (type A)****● Part 15 of the FCC Rules**

FCC Warning:

Any unauthorized changes or modifications to this equipment will void the user's authority to operate this device.

● Laser products

- Do not take this unit apart or attempt to make any changes yourself.
This is an intricate unit that uses a laser pickup to retrieve information from the surface of compact discs. The laser is carefully shielded so that its rays remain inside the cabinet. Therefore, never try to disassemble the player or alter any of its parts since you may be exposed to laser rays and dangerous voltages.
- This product utilizes a laser.
Use of controls or adjustments or performance of procedures other than those specified herein may result in hazardous radiation exposure.

 **CAUTION**

■ **U.S.A. (type B)**

FCC ID: ACJ932PTA184

FCC WARNING:

Changes or modifications not expressly approved by the party responsible for compliance could void the user's authority to operate the equipment.

This transmitter must not be co-located or operated in conjunction with any other antenna or transmitter.

This equipment complies with FCC radiation exposure limits set forth for an uncontrolled environment and meets the FCC radio frequency (RF) Exposure Guidelines in Supplement C to OET65. This equipment has very low levels of RF energy that it deemed to comply without maximum permissive exposure evaluation (MPE). But it is desirable that it should be installed and operated keeping the radiator at least 20cm or more away from person's body (excluding extremities: hands, wrists, feet and ankles).

● **Laser products**

- Do not take this unit apart or attempt to make any changes yourself. This is an intricate unit that uses a laser pickup to retrieve information from the surface of compact discs. The laser is carefully shielded so that its rays remain inside the cabinet. Therefore, never try to disassemble the player or alter any of its parts since you may be exposed to laser rays and dangerous voltages.
- This product utilizes a laser. Use of controls or adjustments or performance of procedures other than those specified herein may result in hazardous radiation exposure.
- The use of optical instruments with this product will increase eye hazard.

 **CAUTION**

■ **U.S.A. (with Display Audio system)**

FCC ID: ACJ932CQ-US70G0

FCC WARNING:

Changes or modifications not expressly approved by the party responsible for compliance could void the user's authority to operate the equipment.

This transmitter must not be co-located or operated in conjunction with any other antenna or transmitter.

This equipment complies with FCC radiation exposure limits set forth for an uncontrolled environment and meets the FCC radio frequency (RF) Exposure Guidelines in Supplement C to OET65. This equipment has very low levels of RF energy that it deemed to comply without maximum permissive exposure evaluation (MPE). But it is desirable that it should be installed and operated keeping the radiator at least 20cm or more away from person's body (excluding extremities: hands, wrists, feet and ankles).

● **Laser products**

- Do not take this unit apart or attempt to make any changes yourself. This is an intricate unit that uses a laser pickup to retrieve information from the surface of compact discs. The laser is carefully shielded so that its rays remain inside the cabinet. Therefore, never try to disassemble the player or alter any of its parts since you may be exposed to laser rays and dangerous voltages.
- This product utilizes a laser. Use of controls or adjustments or performance of procedures other than those specified herein may result in hazardous radiation exposure.
- The use of optical instruments with this product will increase eye hazard.

 CAUTION

■ **Canada (type B and Display Audio system)**

This device complies with Industry Canada licence-exempt RSS standard(s).

Operation is subject to the following two conditions:

- (1) this device may not cause interference, and
- (2) this device must accept any interference, including interference that may cause undesired operation of this device.

Le présent appareil est conforme aux CNR d'Industrie Canada applicables aux appareils radio exempts de licence.

L'exploitation est autorisée aux deux conditions suivantes : (1) l'appareil ne doit pas produire de brouillage, et (2) l'utilisateur de l'appareil doit accepter tout brouillage radioélectrique subi, même si le brouillage est susceptible d'en compromettre le fonctionnement.

Under Industry Canada regulations, this radio transmitter may only operate using an antenna of a type and maximum (or lesser) gain approved for the transmitter by Industry Canada. To reduce potential radio interference to other users, the antenna type and its gain should be so chosen that the equivalent isotropically radiated power (e.i.r.p.) is not more than that necessary for successful communication.

Conformément à la réglementation d'Industrie Canada, le présent émetteur radio peut fonctionner avec une antenne d'un type et d'un gain maximal (ou inférieur) approuvé pour l'émetteur par Industrie Canada. Dans le but de réduire les risques de brouillage radioélectrique à l'intention des autres utilisateurs, il faut choisir le type d'antenne et son gain de sorte que la puissance isotrope rayonnée équivalente (p.i.r.e.) ne dépasse pas l'intensité nécessaire à l'établissement d'une communication satisfaisante.

 **CAUTION**

This equipment complies with IC radiation exposure limits set forth for an uncontrolled environment and meets RSS-102 of the IC radio frequency (RF) Exposure rules. This equipment has very low levels of RF energy that it deemed to comply without maximum permissive exposure evaluation (MPE). But it is desirable that it should be installed and operated keeping the radiator at least 20cm or more away from person's body (excluding extremities: hands, wrists, feet and ankles).

Cet équipement est conforme aux limites d'exposition aux rayonnements énoncées pour un environnement non contrôlé et respecte les règles d'exposition aux fréquences radioélectriques (RF) CNR-102 de l'IC. Cet équipement émet une énergie RF très faible qui est considérée conforme sans évaluation de l'exposition maximale autorisée.

Cependant, cet équipement doit être installé et utilisé en gardant une distance de 20 cm ou plus entre le dispositif rayonnant et le corps (à l'exception des extrémités : mains, poignets, pieds et chevilles).

 NOTICE

■ **To prevent battery discharge**

Do not leave the audio system on longer than necessary with the engine off.

■ **To avoid damaging the audio system**

Take care not to spill drinks or other fluids over the audio system.

3-2. Using the audio system

Using the radio

► Type A

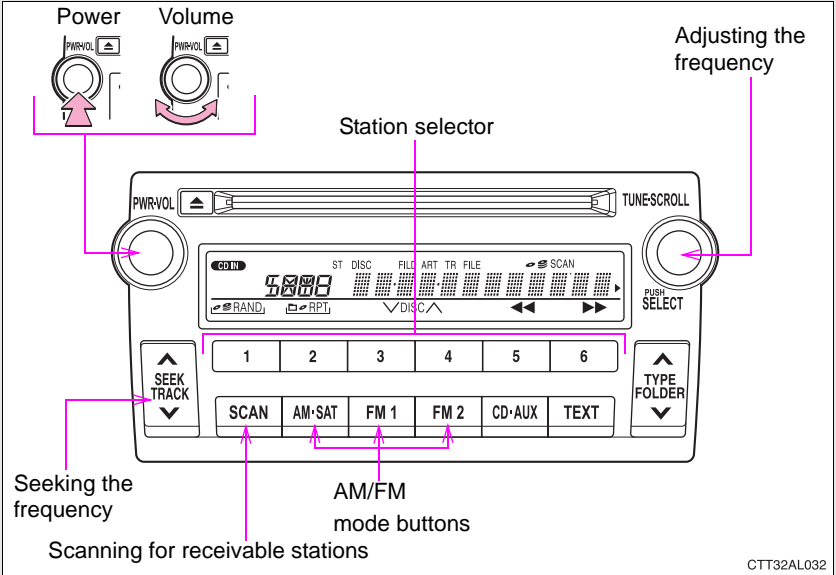

► Type B

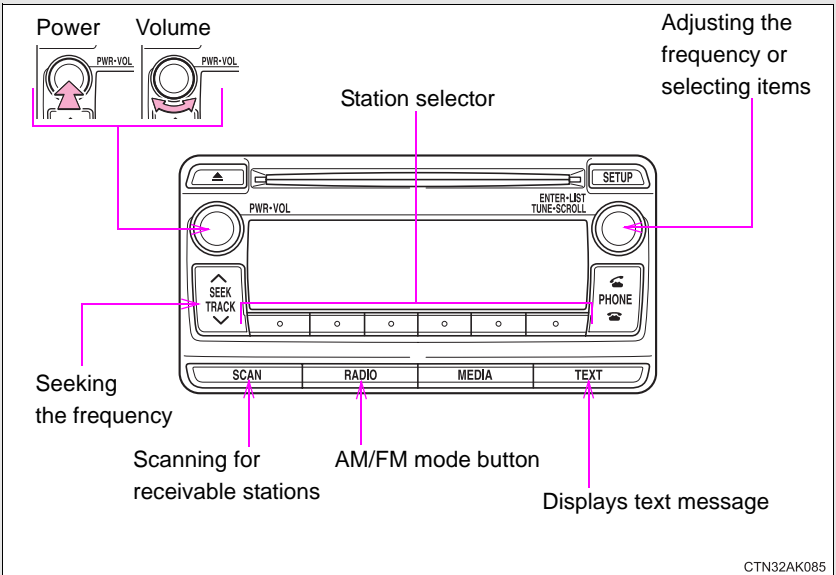



Setting station presets

► Type A

STEP 1 Search for desired stations by turning  or pressing “^” or



“v” on  .

STEP 2 Press and hold the button (from  to ) the station is to be set to until you hear a beep.

► Type B

STEP 1 Search for desired stations by turning  or pressing “^”

or “v” on  .



STEP 2 Press and hold a button (from  to ) until you hear a beep.

Scanning radio stations

■ Scanning the preset radio stations

STEP 1 Press and hold  or  until you hear a beep.



Preset stations will be played for 5 seconds each.

STEP 2 When the desired station is reached, press  or  once again.

■ Scanning all radio stations within range

STEP 1 Press  or  .

All stations with reception will be played for 5 seconds each.

STEP 2 When the desired station is reached, press  or  once again.

Switching the display

► Type A

Press .

Each time  is pressed, the display changes in the following order:

Title (song/program title) → Name (artist name/feature)/Title (song/program title).

► Type B

Press .

If the text continues past the end of the display, “ ► ” is displayed. Press

.

■ Reception sensitivity

- Maintaining perfect radio reception at all times is difficult due to the continually changing position of the antenna, differences in signal strength and surrounding objects, such as trains, transmitters, etc.
- The radio antenna is mounted on the rear roof. The antenna can be removed from the base by turning it.

■ Certifications for the radio tuner

This device complies with Part 15 of the FCC Rules and RSS-210 Rules. Operation is subject to the following two conditions; (1) This device may not cause harmful interference, and (2) this device must accept any interference received, including interference that may cause undesired operation.

CAUTION

■ FCC WARNING

Changes or modifications not expressly approved by the party responsible for compliance could void the user's authority to operate the equipment.

 NOTICE

■ **To prevent damage, remove the antenna in the following cases.**

- The antenna will touch the ceiling of a garage.
- A cover will be put on the roof.

3-2. Using the audio system Using the CD player

► Type A

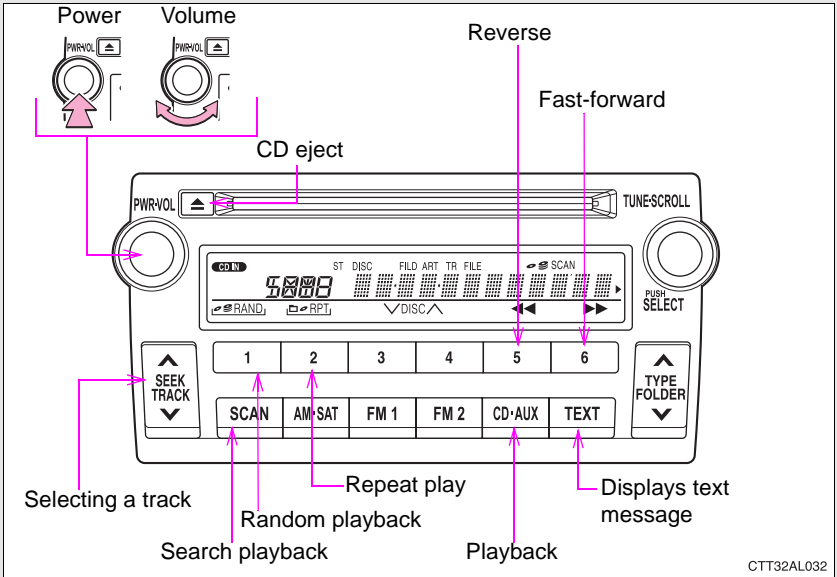

► Type B

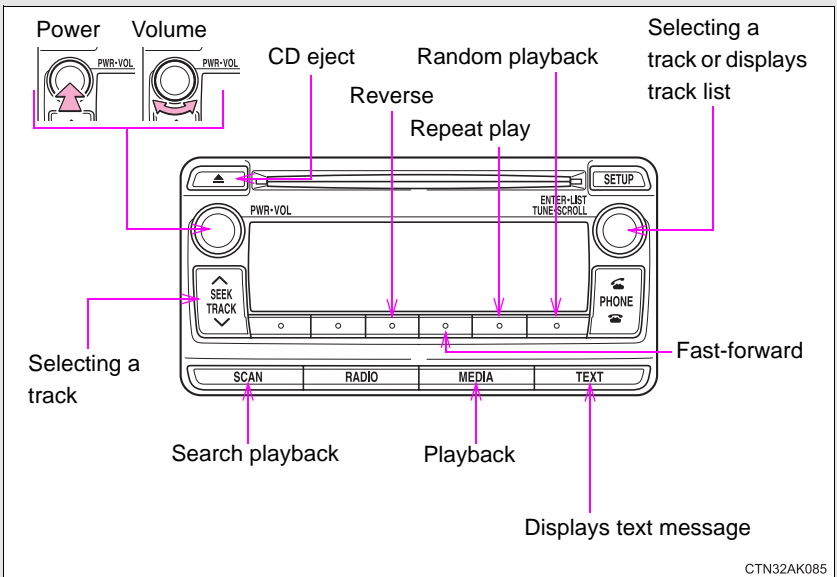

Loading CDs

Insert a CD.

Ejecting CDs



Press  or  and remove the CD.

Selecting a track

► Type A



Press “^” to move up or “v” to move down using  until the desired track number is displayed.

► Type B



Turn  or press “^” to move up or “v” to move down using  until the desired track number is displayed.

Fast-forwarding and reversing tracks

► Type A

Press  (reverse) or  (fast-forward).

► Type B

To fast-forward or reverse, press  (◀◀) or  (▶▶).

Selecting a track from a track list (type B)

STEP 1 Press  .

The track list will be displayed.

STEP 2 Turn and press  to select a track.

To return to the previous display, press  (BACK).

Scanning tracks

► Type A

STEP 1 Press  .

The first ten seconds of each track will be played.

To cancel, press  again.

STEP 2 Press  again when the desired track is reached.

► Type B

STEP 1 Press  .

The first ten seconds of each track will be played.

STEP 2 Press  again when the desired track is reached.

Selecting a CD (with a CD changer) (type A)

Press  .

Repeat play

► Type A

■ Repeating a track

Press  (RPT).

To cancel, press the button once more (without a CD changer), or twice more (with a CD changer).

■ Repeating all of the tracks on a CD (with a CD changer)

Press and hold  (RPT) until you hear a beep.

To cancel, press the button again.

► Type B

Press  (RPT).

To cancel, press the button once more.

Random playback

■ Current CD

► Type A

Press  (RAND).

Songs are played in random order.

To cancel, press the button once more (without a CD changer), or twice more (with a CD changer).

► Type B

Press  (RDM).

To cancel, press the button once more.

■ All CDs (with a CD changer) (type A)

Press and hold  (RAND) until you hear a beep.

Tracks on all loaded CDs are played in a random order.

To cancel, press the button again.

Switching the display

▶ Type A

Press .

Each time  is pressed, the display changes in the following order:

Track no./Elapsed time → CD title → Track name.

▶ Type B



Press .

Track title, Artist name and Disc title are shown on the display.



To return to the previous display, press  or  (BACK).

■ Display

Up to 12 characters can be displayed at a time.

If there are 13 characters or more, pressing and holding  or  for 1 second or more will display the remaining characters.

A maximum of 24 (type A) or 64 (type B) characters can be displayed.

If  or  is pressed for 1 second or more again or has not been pressed for 6 seconds or more, the display will return to the first 12 characters.

Depending on the contents recorded, the characters may not be displayed properly or may not be displayed at all.



■ **Error messages**

“ERROR” (type B): This indicates a problem either in the CD or inside the player.

“CD CHECK” (type A): This indicates a problem either in the CD or inside the player. The CD may be dirty, damaged or inserted up-side down.

“CD CHECK” (type B): The CD may be dirty, damaged or inserted up-side down.

“WAIT” or “PLEASE WAIT”: Operation has stopped due to a high temperature inside the player. Wait for a while and then

press  or  . Contact your Toyota dealer if the CD still cannot be played back.

■ **Discs that can be used**

Discs with the marks shown below can be used.

Playback may not be possible depending on the recording format or disc features, or due to scratches, dirt or deterioration.



CDs with copy-protect features may not be used.

■ **CD player protection feature**

To protect the internal components, playback is automatically stopped when a problem is detected while the CD player is being used.

■ **If CDs are left inside the CD player or in the ejected position for extended periods**

CDs may be damaged and may not play properly.

■ **Lens cleaners**

Do not use lens cleaners. Doing so may damage the CD player

 NOTICE

■ CDs and adapters that cannot be used

Do not use the following types of CDs, 3 in. (8 cm) CD adapters or Dual Disc.

Doing so may damage the CD player and/or the CD insert/eject function.

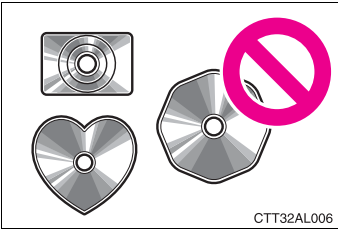

- CDs that have a diameter that is not 4.7 in. (12 cm)

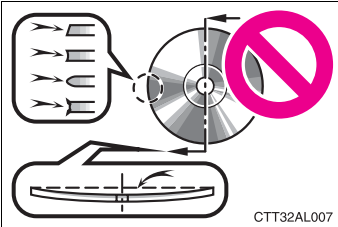

- Low-quality and deformed CDs

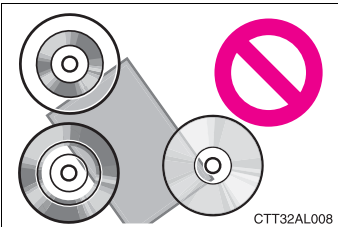

- CDs with a transparent or translucent recording area

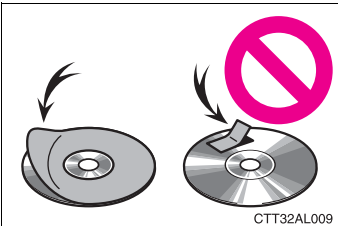

- CDs that have had tape, stickers or CD-R labels attached to them, or that have had the label peeled off

 NOTICE

■ **CD player precautions**

Failure to follow the precautions below may result in serious damage to the CDs or the player itself.

- Do not insert anything other than CDs into the CD slot.
- Do not apply oil to the CD player.
- Store CDs away from direct sunlight.
- Never try to disassemble any part of the CD player.

3-2. Using the audio system Playing MP3 and WMA discs

► Type A

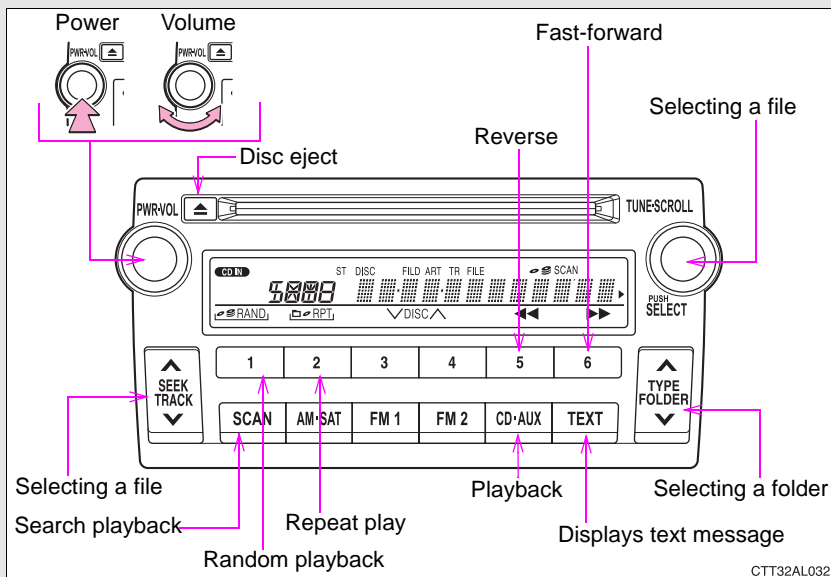

► Type B

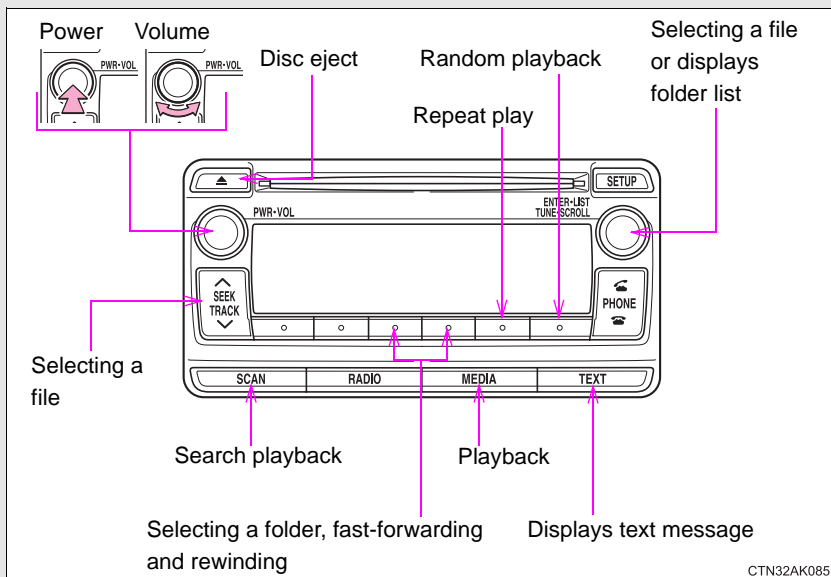

Loading and ejecting MP3 and WMA discs

→P. 208

Selecting MP3 and WMA discs (with a CD changer) (type A)

→P. 209

Selecting and scanning a folder

▶ Type A

■ Selecting folders one at a time

Press “^” or “v” on  to select the desired folder.

■ Scanning the first file of all the folders

STEP 1 Press and hold  until you hear a beep.

The first ten seconds of the first file in each folder will be played.



STEP 2 When the desired folder is reached, press  again.

■ Returning to the first folder

Press and hold “v” on  until you hear a beep.

► Type B

■ Selecting folders one at a time

Press  (<) or  (>) to select the desired folder.

■ Selecting a folder and file from a folder list

STEP 1 Press .

The folder list will be displayed.

STEP 2 Turn and press  to select a folder and a file.

To return to the previous display, press  (BACK).

■ Returning to the first folder

Press and hold  (<) until you hear a beep.

■ Scanning a folder





STEP 1 Press and hold  until you hear a beep.

The first 10 seconds of the first file in the each folder will be played.



STEP 2 When the desired folder is reached, press  again.



Selecting and scanning files

■ Selecting one file at a time

Turn  or  or press “^” or “v” on  or  to select the desired file.

■ Selecting the desired file by cueing the files in the folder

Press  or .

When the desired file is reached, press  or  once again.

Fast-forwarding and reversing files

→P. 208

Repeat play

■ Repeating a file (type A)

Press  (RPT).

To cancel, press the button once more (without a CD changer), or twice more (with a CD changer).

■ Repeating all of the files in a folder

▶ Type A

Press and hold  (RPT) until you hear a beep.

To cancel, press the button again.

▶ Type B

Pressing  (RPT) changes modes in the following order:
File repeat → Folder repeat* → Off

*: Available except when RDM (random playback) is selected

Random playback

► Type A

■ Playing files from a particular folder in random order

Press (RAND).

To cancel, press the button once more (without a CD changer), or twice more (with a CD changer).

■ Playing all of the files on a disc in random order

Press and hold (RAND) until you hear a beep.

To cancel, press the button again.

► Type B

Pressing (RDM) changes modes in the following order:

Folder random → Disc random → Off

Switching the display

► Type A

Press .

Each time is pressed, the display changes in the following order:

Folder no./File no./Elapsed time → Folder name → File name → Album title (MP3 only) → Track title → Artist name.

► Type B

Press .

Track title, Artist name and Album title (MP3 only) are shown on the display.

To return to the previous display, press or (BACK).

■ **Display**

→P. 211

■ **Error messages**

“CD CHECK”: This indicates a problem either in the CD or inside the player.
The CD may be dirty, damaged or inserted up-side down.

“NO MUSIC” (type A): This indicates that MP3/WMA files are not included in the CD.

“WAIT” or “PLEASE WAIT” (type A): Operation has stopped due to a high temperature inside the player. Wait for a while and then press . Contact your Toyota dealer if the CD still cannot be played.

“ERROR” (type B): This indicates a problem either in the CD or inside the player.

“NO SUPPORT” (type B): This indicates that MP3/WMA files are not included in the CD.

■ **Discs that can be used**

→P. 212

■ **CD player protection feature**

→P. 212

■ **If CDs are left inside the CD player or in the ejected position for extended periods**

→P. 212

■ **Lens cleaners**

→P. 212

■ MP3 and WMA files

MP3 (MPEG Audio LAYER3) is a standard audio compression format.

Files can be compressed to approximately 1/10 of their original size by using MP3 compression.

WMA (Windows Media Audio) is a Microsoft audio compression format.

This format compresses audio data to a size smaller than that of the MP3 format.

There is a limit to the MP3 and WMA file standards that can be used and to the media/formats on which the files are recorded.

● MP3 file compatibility

- Compatible standards
MP3 (MPEG1 LAYER3, MPEG2 LSF LAYER3)
- Compatible sampling frequencies
MPEG1 LAYER3: 32, 44.1, 48 (kHz)
MPEG2 LSF LAYER3: 16, 22.05, 24 (kHz)
- Compatible bit rates (compatible with VBR)
MPEG1 LAYER3: 64, 80, 96, 112, 128, 160, 192, 224, 256, 320 (kbps)
MPEG2 LSF LAYER3: 64, 80, 96, 112, 128, 144, 160 (kbps)
- Compatible channel modes: stereo, joint stereo, dual channel and monaural

● WMA file compatibility

- Compatible standards
WMA Ver. 7, 8, 9
- Compatible sampling frequencies
32, 44.1, 48 (kHz)
- Compatible bit rates (only compatible with 2-channel playback)
Ver. 7, 8: CBR 48, 64, 80, 96, 128, 160, 192 (kbps)
Ver. 9: CBR 48, 64, 80, 96, 128, 160, 192, 256, 320 (kbps)

● Compatible media

Media that can be used for MP3 and WMA playback are CD-Rs and CD-RWs.

Playback in some instances may not be possible, depending on the status of the CD-R or CD-RW. Playback may not be possible or the audio may jump if the disc is scratched or marked with fingerprints.

● Compatible disc formats

The following disc formats can be used.

- Disc formats: CD-ROM Mode 1 and Mode 2
CD-ROM XA Mode 2, Form 1 and Form 2
- File formats: ISO9660 Level 1, Level 2, (Romeo, Joliet)
MP3 and WMA files written in any format other than those listed above may not play correctly, and their file names and folder names may not be displayed correctly.

Items related to standards and limitations are as follows.

- Maximum directory hierarchy: 8 levels
- Maximum length of folder names/file names: 32 characters
- Maximum number of folders: 192 (including the root)
- Maximum number of files per disc: 255

● File names

The only files that can be recognized as MP3/WMA and played are those with the extension .mp3 or .wma.

● Multi-sessions

As the audio system is compatible with multi-sessions, it is possible to play discs that contain MP3 and WMA files. However, only the first session can be played.

● ID3 and WMA tags

ID3 tags can be added to MP3 files, making it possible to record the track title, artist name, etc.

The system is compatible with ID3 Ver. 1.0, 1.1, and Ver. 2.2, 2.3 ID3 tags. (The number of characters is based on ID3 Ver. 1.0 and 1.1.)

WMA tags can be added to WMA files, making it possible to record the track title and artist name in the same way as with ID3 tags.

● MP3 and WMA playback

When a disc containing MP3 or WMA files is inserted, all files on the disc are first checked. Once the file check is finished, the first MP3 or WMA file is played. To make the file check finish more quickly, we recommend you do not write in any files other than MP3 or WMA files or create any unnecessary folders.

If the discs contain a mixture of music data and MP3 or WMA format data, only music data can be played.

● Extensions

If the file extensions .mp3 and .wma are used for files other than MP3 and WMA files, they will be mistakenly recognized and played as MP3 and WMA files. This may result in large amounts of interference and damage to the speakers.

● Playback

- To play MP3 files with steady sound quality, we recommend a fixed bit rate of 128 kbps and a sampling frequency of 44.1 kHz.
- CD-R or CD-RW playback may not be possible in some instances, depending on the characteristics of the disc.
- There is a wide variety of freeware and other encoding software for MP3 and WMA files on the market, and depending on the status of the encoding and the file format, poor sound quality or noise at the start of playback may result. In some cases, playback may not be possible at all.
- When files other than MP3 or WMA files are recorded on a disc, it may take more time to recognize the disc. In some cases, playback may not be possible at all.
- Microsoft, Windows, and Windows Media are the registered trademarks of Microsoft Corporation in the U.S. and other countries.

 NOTICE

- **CDs that cannot be used (→P. 213)**
- **CD player precautions (→P. 214)**

3-2. Using the audio system Operating an iPod*

Connecting an iPod enables you to enjoy music from the vehicle speakers.

■ Connecting an iPod

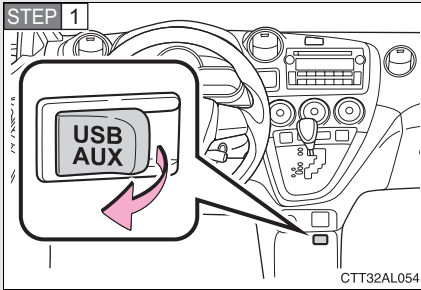

Open the cover and connect an iPod using an iPod cable.

Turn on the power of the iPod if it is not turned on.

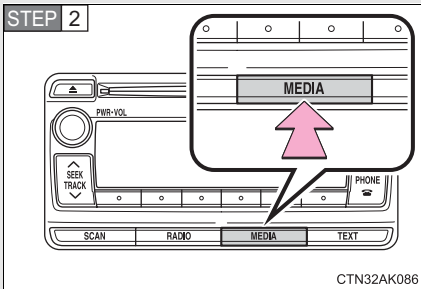

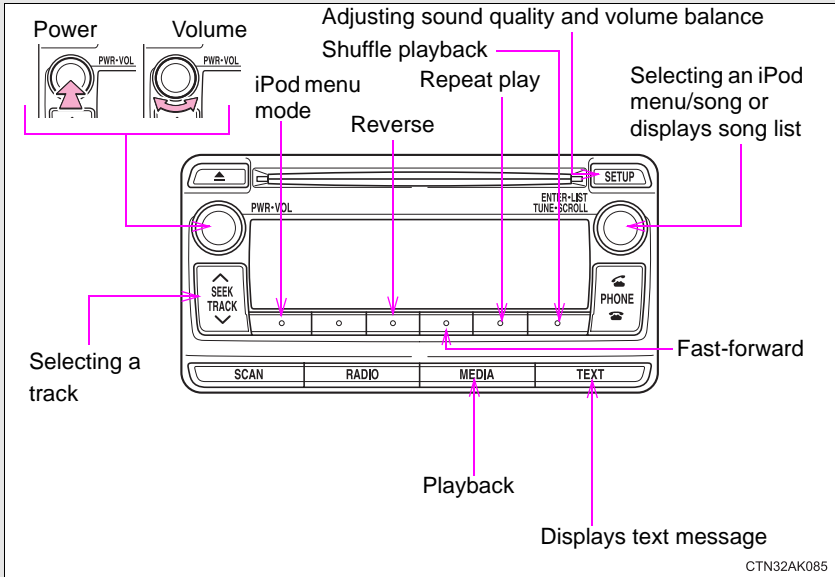

Press  .

■ Control panel



Selecting a play mode

STEP 1 Press  (MENU) to select iPod menu mode.

STEP 2 Turning  clockwise changes the play mode in the following order:

“Playlists”→“Artists”→“Albums”→“Songs”→“Podcasts”→“Genres”
→“Composers”→“Audiobooks”

STEP 3 Press  to select the desired play mode.

■ Play mode list

Play mode	First selection	Second selection	Third selection	Fourth selection
“Playlists”	Playlists select	Songs select	-	-
“Artists”	Artists select	Albums select	Songs select	-
“Albums”	Albums select	Songs select	-	-
“Songs”	Songs select	-	-	-
“Podcasts”	Podcasts select	Episodes select	-	-
“Genres”	Genre select	Artists select	Albums select	Songs select
“Composers”	Composers select	Albums select	Songs select	-
“Audiobooks”	Audiobooks select	Chapters select	-	-

■ Selecting a list

STEP 1 Turn  to display the first selection list.

STEP 2 Press  to select the desired item.

Pressing the knob changes to the second selection list.

STEP 3 Repeat the same procedure to select the desired item.

To return to the previous selection list, press  (BACK).

Selecting songs

Turn  or press “^” or “v” on  to select the desired song.

Selecting a song from the song list

STEP 1 Press .



The song list will be displayed.

STEP 2 Turn  to select a song.

STEP 3 Press  to play the song.

To return to the previous display, press  (BACK).

Fast-forwarding and reversing songs

To fast-forward or reverse, press  (⏩) or  (⏮).

Shuffle playback

Pressing  (RDM) changes modes in the following order:
Track shuffle → Album shuffle → Off



Repeat play

Press  (RPT).

To cancel, press  (RPT) again.

Switching the display

Press  .

To return to the previous display, press  or  (BACK).

Adjusting sound quality and volume balance

STEP 1 Press  to enter iPod menu mode.

STEP 2 Press  to change sound modes. (→P. 242)

■ About iPod

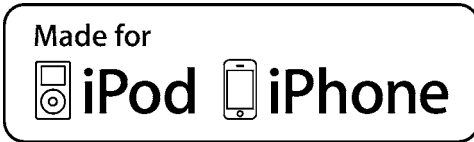

- “Made for iPod” and “Made for iPhone” mean that an electronic accessory has been designed to connect specifically to iPod, or iPhone, respectively, and has been certified by the developer to meet Apple performance standards.
- Apple is not responsible for the operation of this device or its compliance with safety and regulatory standards. Please note that the use of this accessory with iPod or iPhone may affect wireless performance.
- iPhone, iPod, iPod classic, iPod nano and iPod touch are trademarks of Apple Inc., registered in the U.S. and other countries.

■ iPod functions

- When an iPod is connected and the audio source is changed to iPod mode, the iPod will resume play from the same point in which it was last used.
- Depending on the iPod that is connected to the system, certain functions may not be available. If a function is unavailable due to a malfunction (as opposed to a system specification), disconnecting the device and reconnecting it once again may resolve the problem.
- While connected to the system, the iPod cannot be operated with its own controls. It is necessary to use the controls of the vehicle’s audio system instead.

■ iPod problems

To resolve most problems encountered when using your iPod, disconnect your iPod from the vehicle iPod connection and reset it.

For instructions on how to reset your iPod, refer to your iPod Owner's Manual.

■ Display

→P. 211

■ Error messages

- "iPod ERROR": This indicates that the data in the iPod cannot be read.
- "ERROR 3": This indicates that the iPod may be malfunctioning.
- "ERROR 4": This indicates that an overcurrent error has occurred.
- "ERROR 5": This indicates that an iPod communication error has occurred.
- "ERROR 6": This indicates that an authentication error has occurred.
- "NO SONGS": This indicates that there is no music data in the iPod.
- "NO PLAYLIST": This indicates that some available songs are not found in a selected playlist.
- "UPDATE YOUR IPOD": This indicates that the version of the iPod is not compatible. Upgrade your iPod software to the latest version.

■ Compatible models

The following iPod®, iPod nano®, iPod classic®, iPod touch® and iPhone® devices can be used with this system.

● Made for

- iPod touch (4th generation)
- iPod touch (3rd generation)
- iPod touch (2nd generation)
- iPod touch (1st generation)
- iPod classic
- iPod with video
- iPod nano (6th generation)
- iPod nano (5th generation)
- iPod nano (4th generation)
- iPod nano (3rd generation)
- iPod nano (2nd generation)
- iPod nano (1st generation)
- iPhone 4
- iPhone 3GS
- iPhone 3G
- iPhone

Depending on differences between models or software versions etc., some models might be incompatible with this system.

Items related to standards and limitations are as follows:

- Maximum number of lists in device: 9999
- Maximum number of songs in device: 65535
- Maximum number of songs per list: 65535

CAUTION

■ Caution while driving

Do not connect the iPod or operate the controls.

 NOTICE**■ To prevent damage to iPod**

- Do not leave the iPod in the vehicle. The temperature inside may become high, resulting in damage to the player.
- Do not push down on or apply unnecessary pressure to the iPod while it is connected as this may damage the iPod or its terminal.
- Do not insert foreign objects into the port as this may damage the iPod or its terminal.

3-2. Using the audio system Operating a USB memory*

Connecting a USB memory enables you to enjoy music from the vehicle speakers.

■ Connecting a USB memory

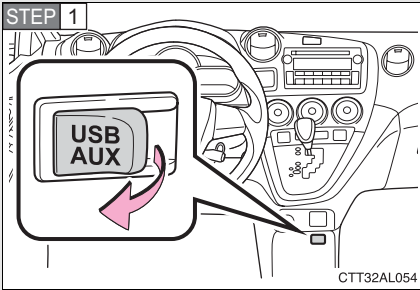

Open the cover and connect a USB memory.

Turn on the power of the USB memory if it is not turned on.

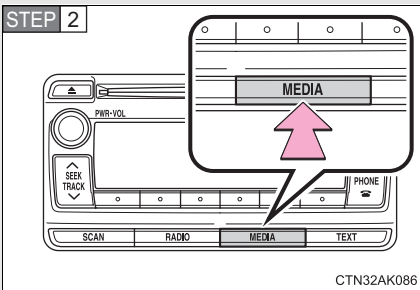

Press  .

*: If equipped

■ Control panel

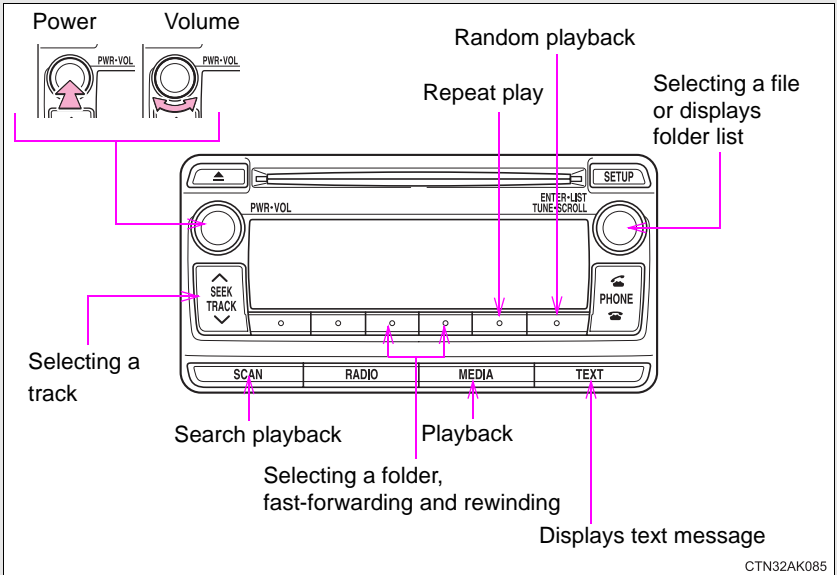

Selecting a folder

■ Selecting folders one at a time

To select the desired folder, press  (<) or  (>).

■ Selecting a folder and file from a folder list

STEP 1 Press  .

The folder list will be displayed.

STEP 2 Turn and press  to select a folder and a file.

To return to the previous display, press  (BACK).

■ Returning to the first folder

Press and hold  (<) until you hear a beep.



Scanning a folder

STEP 1 Press and hold  until you hear a beep.

The first 10 seconds of the first file in the each folder will be played.

STEP 2 When the desired folder is reached, press  again.

Selecting files

Turn  , or press “^” or “v” on  to select the desired file.

Scanning files

STEP 1 Press  .

The first 10 seconds of all files in the folder will be played.

STEP 2 When the desired file is reached, press  again.

Fast-forwarding and reversing files

→P. 229

Random playback

Pressing  (RDM) changes modes in the following order:
Folder random → Disc random → Off

Repeat play

Pressing  (RPT) changes modes in the following order:
File repeat → Folder repeat* → Off

*: Available except when RDM (random playback) is selected

Switching the display

Press  .

Track title, Artist name and Album title (MP3 only) are shown on the display.

To return to the previous display, press  or  (BACK).

■ USB memory functions

- Depending on the USB memory that is connected to the system, the device itself may not be operable and certain functions may not be available. If the device is inoperable or a function is unavailable due to a malfunction (as opposed to a system specification), disconnecting the device and reconnecting it once again may resolve the problem.
- If the USB memory still does not begin operation after being disconnected and reconnected, format the memory.

■ Display

→P. 212

■ Error messages

“ERROR”: This indicates a problem in the USB memory or its connection.

“NO MUSIC”: This indicates that no MP3/WMA files are included in the USB memory.

■ USB memory

- Compatible device

USB memory that can be used for MP3 and WMA playback.

- Compatible device formats

The following device formats can be used:

- USB communication formats: USB2.0 FS (12 mbps)
- File formats: FAT16/32 (Windows)
- Correspondence class: Mass storage class

MP3 and WMA files written in any format other than those listed above may not play correctly, and their file names and folder names may not be displayed correctly.

Items related to standards and limitations are as follows:

- Maximum directory hierarchy: 8 levels
- Maximum number of folder in device: 999 (including the root)
- Maximum number of files in device: 9999
- Maximum number of files per folder: 255

- MP3 and WMA files

MP3 (MPEG Audio LAYER 3) is a standard audio compression format.

Files can be compressed to approximately 1/10 of their original size using MP3 compression.

WMA (Windows Media Audio) is a Microsoft audio compression format.

This format compresses audio data to a size smaller than that of the MP3 format.

There is a limit to the MP3 and WMA file standards that can be used and to the media/formats on which the files are recorded.

- MP3 file compatibility

- Compatible standards
MP3 (MPEG1 AUDIO LAYERII, III, MPEG2 AUDIO LAYERII, III, MPEG2.5)
- Compatible sampling frequencies
MPEG1 AUDIO LAYERII, III: 32, 44.1, 48 (kHz)
MPEG2 AUDIO LAYERII, III: 16, 22.05, 24 (kHz)
MPEG2.5: 8, 11.025, 12 (kHz)
- Compatible bit rates (compatible with VBR)
MPEG1 AUDIO LAYERII, III: 32-320 (kbps)
MPEG2 AUDIO LAYERII, III: 32-160 (kbps)
MPEG2.5: 32-160 (kbps)
- Compatible channel modes: stereo, joint stereo, dual channel and monaural

- WMA file compatibility

- Compatible standards
WMA Ver. 7,8,9
- Compatible sampling frequencies
HIGH PROFILE 32, 44.1, 48 (kHz)
- Compatible bit rates
HIGH PROFILE 32-320 (kbps, VBR)

- File names

The only files that can be recognized as MP3/WMA and played are those with the extension .mp3 or .wma.

● ID3 and WMA tags

ID3 tags can be added to MP3 files, making it possible to record the track title, artist name, etc.

The system is compatible with ID3 Ver. 1.0, 1.1, and Ver. 2.2, 2.3, 2.4 ID3 tags. (The number of characters is based on ID3 Ver. 1.0 and 1.1.)

WMA tags can be added to WMA files, making it possible to record the track title and artist name in the same way as with ID3 tags.

● MP3 and WMA playback

When a device containing MP3 or WMA files is plugged in, all files in the USB memory device are first checked. Once the file check is finished, the first MP3 or WMA file is played. To make the file check finish more quickly, we recommend you do not write in any files other than MP3 or WMA files or create any unnecessary folders.

● Extensions

If the file extensions .mp3 and .wma are used for files other than MP3 and WMA files, they will be mistakenly recognized and played as MP3 and WMA files. This may result in large amounts of interference and damage to the speakers.

● Playback

- To play MP3 files with steady sound quality, we recommend a fixed bit rate of at least 128 kbps and a sampling frequency of 44.1 kHz.
- There is a wide variety of freeware and other encoding software for MP3 and WMA files on the market, and depending on the status of the encoding and the file format, poor sound quality or noise at the start of playback may result. In some cases, playback may not be possible at all.
- Microsoft, Windows, and Windows Media are the registered trademarks of Microsoft Corporation in the U.S.A. and other countries.

CAUTION

Caution while driving

Do not use a USB memory, or connect a USB memory.

 NOTICE**■ To prevent damage to a USB memory**

- Do not leave a USB memory in the vehicle. The temperature inside may become high, resulting in damage to the player.
- Do not push down on or apply unnecessary pressure to the USB memory while it is connected as this may damage the USB memory or its terminal.
- Do not insert foreign objects into the port as this may damage the USB memory or its terminal.

3-2. Using the audio system

Optimal use of the audio system

► Type A

Adjusting the sound quality and ASL

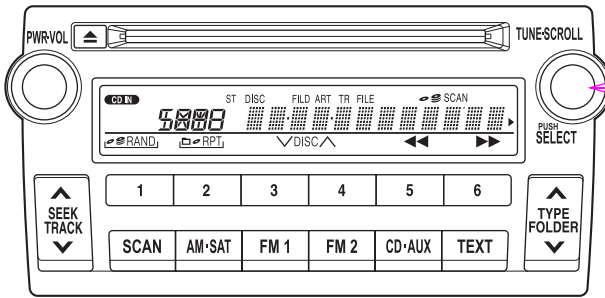

CTT32AL030

► Type B

Menu button

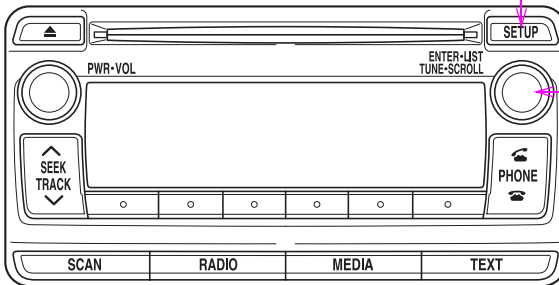

Adjusting the sound quality and ASL

CTN32AK084

Using the audio control function

■ Changing sound quality modes

► Type A

Pressing  selects the mode to be changed in the following order.

“BAS”→“TRE”→“FAD”→“BAL”→“ASL”

► Type B

STEP 1 Press  .

STEP 2 Turn  to select “Sound Setting”.

STEP 3 Press  .

STEP 4 Turn  to select the desired mode.

“BASS”, “TREBLE”, “FADER”, “BALANCE”, or “ASL”

STEP 5 Press  .

■ Adjusting sound quality

Turning  or  adjusts the level.

► Type A

Mode displayed	Sound quality mode	Level	Turn to the left	Turn to the right
"BAS"	Bass*	-5 to 5	Low	High
"TRE"	Treble*	-5 to 5		
"FAD"	Front/rear volume balance	R7 to F7	Shifts to rear	Shifts to front
"BAL"	Left/right volume balance	L7 to R7	Shifts to left	Shifts to right



*: The sound quality level is adjusted individually in each radio mode or CD mode.

► Type B

Mode displayed	Sound quality mode	Level	Turn to the left	Turn to the right
"BASS"	Bass*	-5 to 5	Low	High
"TREBLE"	Treble*	-5 to 5		
"FADER"	Front/rear volume balance	F7 to R7	Shifts to rear	Shifts to front
"BALANCE"	Left/right volume balance	L7 to R7	Shifts to left	Shifts to right

*: The sound quality level is adjusted individually in each audio mode.

■ Adjusting the Automatic Sound Levelizer (ASL)

When "ASL" is selected, turning  or  to the right changes the amount of "ASL" in the order of "LOW", "MID" and "HIGH".

Turning  or  to the left turns "ASL" off.

ASL automatically adjusts the volume and tone quality according to vehicle speed.

3-2. Using the audio system Using the AUX port

This port can be used to connect a portable audio device and listen to it through the vehicle's speakers.

► Type A

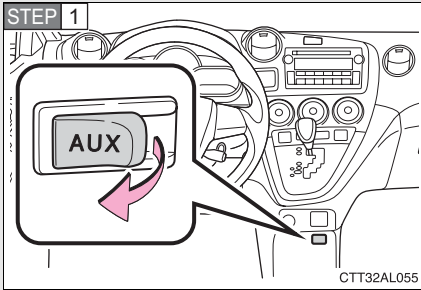

Open the cover and connect the portable audio device.

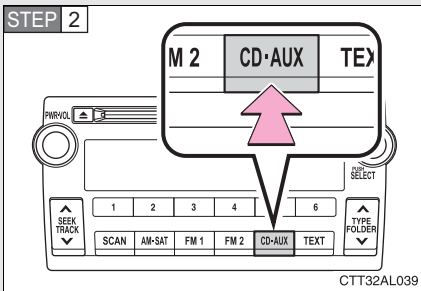

Press **CD-AUX**.

► Type B

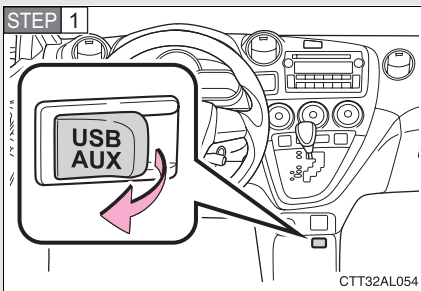

Open the cover and connect the portable audio device.

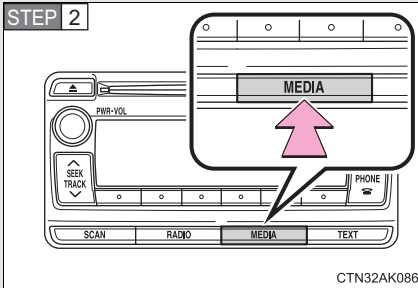

Press  .

■ Operating portable audio devices connected to the audio system

The volume can be adjusted using the vehicle's audio controls. All other adjustments must be made on the portable audio device itself.

■ When using a portable audio device connected to the power outlet

Noise may occur during playback. Use the power source of the portable audio device.

3-2. Using the audio system

Using the steering wheel audio switches

Some audio features can be controlled using the switches on the steering wheel.

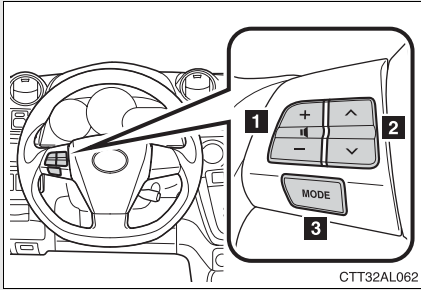



- 1** Volume
- 2** Radio mode: Selects radio stations
CD mode: Selects tracks, files (MP3 and WMA) and discs
iPod mode: Selects songs
USB memory mode:
 Selects files and folders
Bluetooth[®] audio mode:
 Selects tracks and albums
- 3** Turns the power on, selects audio source

Turning on the power

Press  when the audio system is turned off.

The audio system can be turned off by holding  down until you hear a beep.

Changing the audio source

Press  when the audio system is turned on. The audio source changes each time  is pressed. If a mode cannot be used, it will be skipped.

Adjusting the volume

Press “+” on  to increase the volume and “-” to decrease the volume.

Press and hold  to continue increasing or decreasing the volume.

Selecting a radio station

STEP 1 Press  to select the radio mode.

STEP 2 Press  to select a preset station.

To scan for receivable stations, press and hold  until you hear a beep.

Selecting a track/file or song

STEP 1 Press  to select CD, iPod, USB memory or Bluetooth® audio mode.

STEP 2 Press “^” or “v” on  to select the desired track/file or song.

Selecting a folder or album

STEP 1 Press  to select CD, USB memory or Bluetooth® audio mode.

STEP 2 Press and hold “^” or “v” on  until you hear a beep.

Selecting a disc in the CD player (CD player with changer only)

STEP 1 Press  to select CD mode.

STEP 2 Press and hold “^” or “v” on  until you hear a beep.

CAUTION

To reduce the risk of an accident

Exercise care when operating the audio switches on the steering wheel.

3-3. Using the Bluetooth® audio system

Bluetooth® audio/phone*

■ Bluetooth® audio

The Bluetooth® audio system enables you to enjoy music played on a portable digital audio player (portable player) from the vehicle speakers via wireless communication.

This audio system supports Bluetooth®, a wireless data system capable of playing portable audio music without cables. If your portable player does not support Bluetooth®, the Bluetooth® audio system will not function.

■ Bluetooth® phone (hands-free phone system)

This system supports Bluetooth®, which allows you to make or receive calls without using cables to connect a cellular phone and the system, and without operating the cellular phone.

3

Interior features

■ Conditions affecting operation

The Bluetooth® audio/phone may not operate normally in the following situations:

- The portable player does not support Bluetooth®
- The cellular phone is located outside the service area
- The Bluetooth® device is switched off
- The Bluetooth® device has a low battery
- The Bluetooth® device is not connected to the system
- The Bluetooth® device is behind the seat or in the glove box or console box, or metal material covers or touches the device

*: If equipped

■ When transferring ownership of the vehicle

Be sure to initialize the system to prevent personal data from being improperly accessed. (→P. 272)

■ About Bluetooth®



Bluetooth is a registered trademark of Bluetooth SIG, Inc.

■ Compatible models

● Bluetooth® specifications:

Ver. 1.1, or higher (recommended: Ver. 2.1 + EDR or higher)

● Following Profiles:

- A2DP (Advanced Audio Distribution Profile) Ver. 1.0, or higher (recommended: Ver. 1.2 or higher)
- AVRCP (Audio/Video Remote Control Profile) Ver. 1.0 or higher (recommended: Ver. 1.3 or higher)

Portable players must correspond to the above specifications in order to be connected to the Bluetooth® audio system. However, please note that some functions may be limited depending on the type of portable player.

● Cellular phone

- HFP (Hands Free Profile) Ver. 1.0 or higher (recommended: Ver. 1.5)
- OPP (Object Push Profile) Ver. 1.1
- PBAP (Phone Book Access Profile) Ver. 1.0

⚠ CAUTION

■ Caution while driving

- Do not use a cellular phone.
- Do not connect Bluetooth® device or operate the controls.



NOTICE

■ **To prevent damage to Bluetooth® device**

Do not leave Bluetooth® device in the vehicle. The temperature inside the vehicle may become high, resulting in damage to the device.

3-3. Using the Bluetooth® audio system

Using the Bluetooth® audio/phone

■ Audio unit

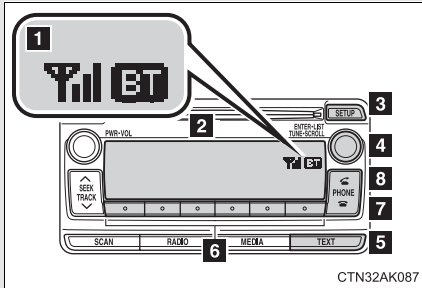

1 Bluetooth® connection condition

If “BT” is not displayed, the Bluetooth® audio/phone cannot be used.

2 Display

A message, name, number, etc. is displayed.

Lower-case characters and special characters cannot be displayed.

3 Displays the set up menu

4 Selects items such as menu and number

Turn: Selects an item

Press: Inputs the selected item

5 Displays information that is too long to be displayed at one time on the display (press and hold)

6 Selects speed dials

7 On-hook switch

Turns the hands-free system off/ends a call/refuses a call

8 Off-hook switch

Turns the hands-free system on/starts a call

■ **Steering wheel switches**

→P. 248

■ **Microphone**

▶ **Vehicles with moon roof**

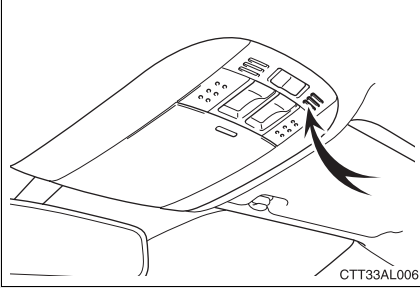

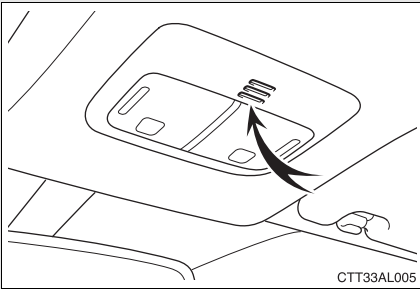

▶ **Vehicles without moon roof**



Using the Bluetooth® audio/phone for the first time

Before using the Bluetooth® audio/phone, it is necessary to register a Bluetooth® device in the system. Follow the procedure below to register (pair) a device:

STEP 1 Press  and select “Bluetooth” using .

STEP 2 Press  and select “Pairing” using .

A passkey will be displayed.

STEP 3 SSP (Secure Simple Pairing) incompatible Bluetooth® devices: Input the passkey into the device.

SSP (Secure Simple Pairing) compatible Bluetooth® devices: Select “Yes” to register the device. Depending on the type of device, it may register automatically.

If a Bluetooth® device has both music player and cellular phone functions, both functions will be registered at the same time. When deleting the device, both functions will be deleted at the same time.

If the off-hook switch is pressed and the “PHONE” mode is entered when no phones have been registered, the registration screen will be automatically displayed.

Menu list of the Bluetooth® audio/phone
--

First menu	Second menu	Third menu	Operation details
"Bluetooth"	"BT Pairing"	-	Registering a Bluetooth® device
	"List Phone"	-	Listing the registered cellular phones
	"List Audio"	-	Listing the registered portable players
	"Passkey"	-	Changing the passkey
	"BT Power"	-	Setting automatic connection of the device on or off
	"Bluetooth info"	"Device Name" "Device Address"	Displaying the device status
	"Display Setting"	-	Setting the automatic connection confirmation display to on or off
	"Initialize"	-	Initializing the settings

First menu	Second menu	Third menu	Operation details
"Phone"	"Phonebook"	"Add contacts"	Adding a new number
		"Add SD"	Registering a speed dial
		"Delete Call History"	Deleting a number stored in the call history
		"Delete contacts"	Deleting a number stored in the phonebook
		"Delete other PB"	Deleting a phonebook's data
	"HF Sound Setting"	"Call volume"	Setting call volume
		"Ring tone volume"	Setting ringtone volume
		"Ringtone"	Setting the ringtone
	"Transfer Histories"	-	Transferring the call histories



■ Bluetooth® audio/phone system functions

Depending on the Bluetooth® device, certain functions may not be available.

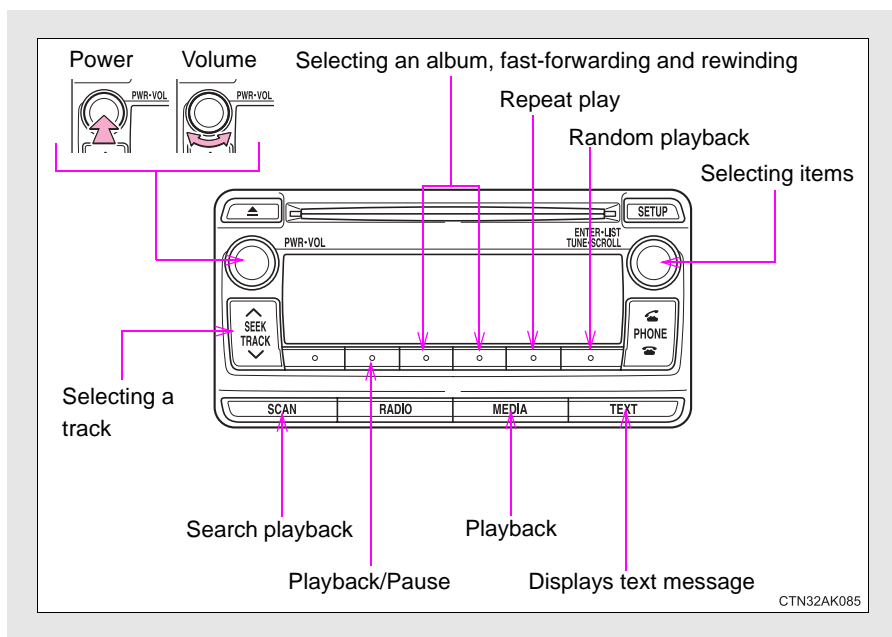
3-3. Using the Bluetooth® audio system Operating a Bluetooth® enabled portable player



Selecting an album

Press  (<) or  (>) to select the desired album.

Scanning an album

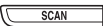
STEP 1 Press and hold  until you hear a beep.

The first 10 seconds of the first track in the each album will be played.

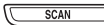
STEP 2 When the desired album is reached, press  again.

Selecting tracks

Press “^” or “v” on  to select the desired track.



Scanning tracks

STEP 1 Press  .

The first 10 seconds of all tracks in the album will be played.

STEP 2 When the desired track is reached, press  again.

Playing and pausing tracks

Press  () to play or pause a track.

Fast-forwarding and reversing tracks

→P. 229

Random playback

Pressing  (RDM) changes modes in the following order:
Album random → All track random → Off

Repeat play

Pressing  (RPT) changes modes in the following order:
Track repeat → Album repeat* → Off

*: Available except when RDM (random playback) is selected

Switching the display

Press  .

Track title and Artist name are displayed on the display.

To return to the previous display, press  or  (BACK).

■ **Bluetooth® audio system functions**

Depending on the portable player that is connected to the system, certain functions may not be available.

Making a phone call

To enter the “PHONE” mode, press the off-hook switch.

■ **Making a phone call**

- Dialing by selecting a name
- Speed dialing
- Dialing by entering the number
- Dialing from call histories

■ **Receiving a phone call**

- Answering the phone
- Refusing the call

■ **Operations during a call**



- Transferring a call
- Muting your voice
- Inputting digits
- Setting call volume

■ **Adjusting the ringtone volume when receiving a call**

Dialing by selecting a name



STEP 1 Select “Phonebook” using .



STEP 2 Select the desired name using  and press the off-hook switch.

By pressing  (Add S. Dial) and one of the speed dial buttons (from  to ) while the desired name is selected, it can be registered as a speed dial.

Speed dialing

STEP 1 Select “Speed dials” using .

STEP 2 Press the desired preset button (from  to ) and press the off-hook switch.

By pressing  (Add S. Dial) and one of the speed dial buttons (from  to ) while the desired name is selected, it can be registered as a speed dial.

Dialing by entering the number

STEP 1 Select “Dial by number” using .

STEP 2 Enter the phone number and press the off-hook switch.



Dialing from call histories

STEP 1 Select “All calls”, “Missed calls”, “Incoming calls” or “Outgoing calls” using .



STEP 2 Select a desired number using  and press the off-hook switch.

The following operations can be performed:

- Registering a number as a speed dial

Press  (Add S. Dial) and then press and hold the desired preset button (from  to ).

- Deleting the selected number

Press  (DELETE) and press  (YES).

When receiving a phone call

- Answering the phone

Press the off-hook switch.

- Refusing the call

Press the on-hook switch.

- Receiving a call when on another call

Press the off-hook switch.

Pressing the off-hook switch again returns you to the previous call.

Operations during a call

● Transferring a call

A call can be transferred between the cellular phone and system while dialing, receiving a call, or during a call. Use one of the following methods:

a. Operate the cellular phone.

Refer to the manual that comes with the cellular phone for the operation of the phone.

b. Press the * (PHONE).



*: This operation can be performed only when transferring a call from the cellular phone to the system during a call.

● Muting your voice

Press  (MUTE).

● Inputting digits

Press  (0-9) and using the  to input the desired digits.

- To send the input digits press  (SEND).
- When finished, press  (EXIT) to return to the previous screen.

● Setting call volume

Change the call volume using .

To decrease the volume: Turn  counterclockwise.

To increase the volume: Turn  clockwise.

Adjusting the ringtone volume when receiving a call

Change the ringtone volume using .

To decrease the volume: Turn  counterclockwise.

To increase the volume: Turn  clockwise.

■ When talking on the phone

- Do not talk simultaneously with the other party.
- Keep the volume of the received voice down. Otherwise, voice echo will increase.

■ Automatic volume adjustment

When vehicle speed is 50 mph (80 km/h) or more, the volume automatically increases. The volume returns to the previous volume setting when vehicle speed drops to 43 mph (70 km/h) or less.

■ Phone call system functions

Depending on the cellular phone, certain functions may not be available.



■ Situations where the system may not recognize your voice



- When driving on a rough road
- When driving at high speeds
- When air is blowing out of the vents onto the microphone
- When the air conditioning fan emits a loud noise

3-4. Using the hands-free phone system (for cellular phone) Using the "SET UP" menu ("Bluetooth" menu)

Registering a Bluetooth® device in the system allows the system to function. The following functions can be used for registered devices:

■ Functions and operation procedures

STEP 1 Press  and select "Bluetooth" using .

STEP 2 Press  and select one of the following functions using .

- Registering a Bluetooth® device
"BT Pairing"
- Listing the registered cellular phones
"List Phone"
- Listing the registered portable players
"List Audio"
- Changing the passkey
"Passkey"
- Setting automatic connection of the device on or off
"BT Power"
- Displaying the device status
"Bluetooth info"
- Setting the automatic connection confirmation display to on or off
"Display Setting"
- Initialization
"Initialize"

Registering a portable player

Select “Pairing” using , and perform the procedure for registering a portable player. (→P. 256)

Listing the registered cellular phones

Select “List Phone” using . The list of registered cellular phones will be displayed.

- Connecting the registered cellular phone to the audio system

STEP 1 Select the name of the cellular phone to be connected

using .

STEP 2 Select “Select” using .

- Deleting a registered cellular phone

STEP 1 Select the name of the cellular phone to be deleted using

.

STEP 2 Select “Delete” using .

STEP 3 Press  (YES).

Listing the registered portable players

Select “List Audio” using . The list of registered portable players will be displayed.

- Connecting the registered portable player to the audio system

STEP 1 Select the name of the portable player to be connected

using .

STEP 2 Select “Select” using .

- Deleting the registered portable player

STEP 1 Select the name of the portable player to be deleted using

.

STEP 2 Select “Delete” using .

STEP 3 Press  (YES).

Changing the passkey

STEP 1 Select “Passkey” using .

STEP 2 Select a 4 to 8-digit passkey using .

Input the number 1 digit at a time.

STEP 3 When the entire number to be registered as a passkey has been input, press  again.

If the passkey to be registered has 8 digits, pressing  again is not necessary.

Setting automatic connection of the device on or off

If “BT Power” is set to on, the registered device will be connected automatically when the engine switch is turned to the “ACC” position.

STEP 1 Select “BT Power” using .

STEP 2 Select “ON” or “OFF” using .

Displaying the device status

Select “Bluetooth info” using



- Displaying the device name

Select “Device Name” using



- Displaying the device address

Select “Device Address” using



Setting the automatic connection confirmation display to on or off

If the “Display Setting” is set to on, the portable player connection status will be displayed when the engine switch is turned to the “ACC” or “ON” position.

STEP 1 Select “Display Setting” using



STEP 2 Select “ON” or “OFF” using



Initialization

Select “Initialize” using  .

● Initializing the sound settings

Select “Sound setting” using  and press  (YES).

For details about sound settings (→P. 242)

● Initializing the device information

Select “Car Device Info” using  and press  (YES).

Automatic connection of a portable device, automatic connection confirmation display and the passkey will be initialized.

● Initializing all the settings



Select “All Initialize” using  and press  (YES).

■ The number of Bluetooth[®] devices that can be registered

Up to 5 Bluetooth[®] devices can be registered in the system.

3-4. Using the hands-free phone system (for cellular phone) Using the "SET UP" menu ("Phone" menu)

■ Functions and operation procedures



To enter the menu of each function, press  and follow the steps below using  :

- Adding a new phone number
 1. "Phone" → 2. "Phonebook" → 3. "Add contacts"
- Setting speed dials
 1. "Phone" → 2. "Phonebook" → 3. "Add SD"
- Deleting call histories
 1. "Phone" → 2. "Phonebook" → 3. "Delete Call History"
- Deleting a registered phone number
 1. "Phone" → 2. "Phonebook" → 3. "Delete contacts"
- Deleting another cellular phone's phonebook
 1. "Phone" → 2. "Phonebook" → 3. "Delete other PB"
- Setting call volume
 1. "Phone" → 2. "HF Sound Setting" → 3. "Call Volume"
- Setting ringtone volume
 1. "Phone" → 2. "HF Sound Setting" → 3. "Ringtone Volume"
- Setting ringtone
 1. "Phone" → 2. "HF Sound Setting" → 3. "Ringtone"
- Transferring call histories
 1. "Phone" → 2. "Transfer Histories"

Adding a new phone number

Select “Add contacts” using .

- Transferring all contacts from the cellular phone

Select “Overwrite all contacts” using  and press  (YES).



- Transferring one contact from the cellular phone

Select “Add one contact” using  and press  (YES).

Setting speed dials

STEP 1 Select “Add SD” using .

STEP 2 Select the desired data using .

STEP 3 Press and hold the desired preset button (from  to ).

For details about setting speed dials from the call history: →P. 264



For details about deleting speed dials: →P. 264



Deleting call histories

Select “Delete Call History” using .

● Deleting outgoing call history



STEP 1 Select “Outgoing Calls” using .



STEP 2 Select the desired phone number using  and press  (YES).

To delete all outgoing call history data, press  (ALL) and then press  (YES).

● Deleting incoming call history



STEP 1 Select “Incoming calls” using .



STEP 2 Select the desired phone number using  and press  (YES).

To delete all incoming call history data, press  (ALL) and then press  (YES).

● Deleting missed call history



STEP 1 Select “Missed Calls” using .



STEP 2 Select the desired phone number using  and press  (YES).

To delete all missed call history data, press  (ALL) and then press  (YES).

● Deleting a number from all call histories (Outgoing calls, Incoming calls and Missed calls)



STEP 1 Select “All Calls” using .



STEP 2 Select the desired phone number using  and press  (YES).

To delete all of the call histories data, press  (ALL) and then press  (YES).

Deleting a registered phone number



STEP 1 Select “Delete contacts” using .

STEP 2 Select the desired phone number using  and press  (YES).

To delete all of the registered phone numbers, select “All delete” using  and press  (YES).

Deleting another cellular phone’s phonebook

STEP 1 Select “Delete other PB” using .

STEP 2 Select the desired phonebook using  and press  (YES).

Setting call volume

STEP 1 Select “Call Volume” using .

STEP 2 Change the call volume.

To decrease the volume: Turn  counterclockwise.

To increase the volume: Turn  clockwise.

Setting ringtone volume

STEP 1 Select “Ringtone Volume” using .



STEP 2 Change the ringtone volume.

To decrease the volume: Turn  counterclockwise.

To increase the volume: Turn  clockwise.

Setting ringtone

STEP 1 Select “Ringtone” using .

STEP 2 Using , select a ringtone (1 - 3). To set the selected ringtone, press .

Transferring call histories

Select “Transfer Histories” using  and press  (YES).

■ Phone number

Up to 1000 names can be stored.

■ Call history

Up to 10 numbers can be stored in each of the outgoing, incoming and missed call history memories.

■ Limitation of number of digits

A phone number that exceeds 24 digits cannot be registered.

Interior lights list

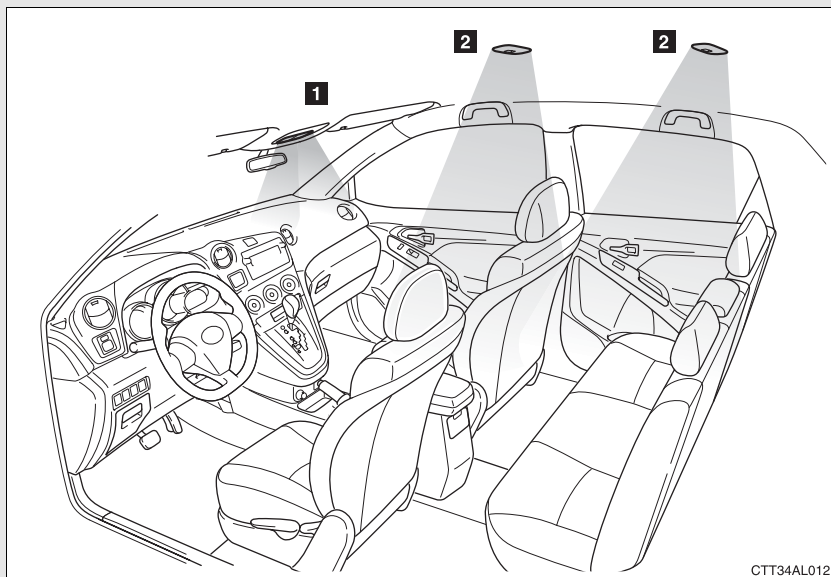

1 Personal/interior lights or personal lights (→P. 281, 282)

2 Interior lights (→P. 280)

■ Illuminated entry system

▶ Vehicles with moon roof

When the light switch is in the “DOOR” position, the interior lights and personal/interior lights automatically turn on/off according to the engine switch position, whether the doors are locked/unlocked (with power door lock system) and whether the doors are open/closed.

▶ Vehicles without moon roof

When the light switch is in the “DOOR” position, the interior lights automatically turn on/off according to the engine switch position, whether the doors are locked/unlocked (with power door lock system) and whether the doors are open/closed.

■ To prevent the battery from being discharged

If the interior lights and personal/interior lights (vehicles with moon roof) remain on when the door is not fully closed and the light switch is in the “DOOR” position, the lights will go off automatically after 20 minutes.

■ Customization that can be configured at Toyota dealer

Settings (e.g. The time elapsed before lights turn off) can be changed.
(Customizable features →P. 469)

Interior light

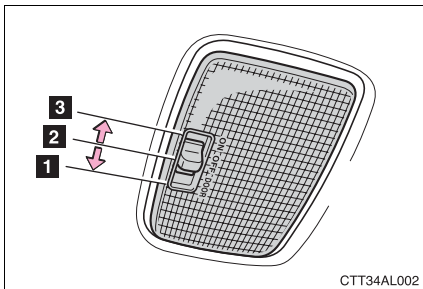

1 “DOOR” position

2 Off

3 On

Personal/interior lights (vehicles with moon roof)

■ Interior lights

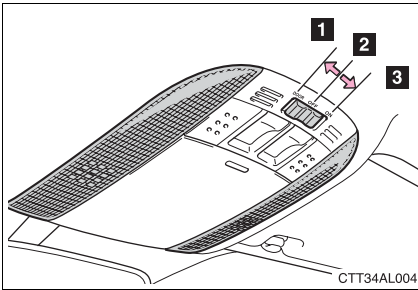

1 "DOOR" position

2 Off

3 On

■ Personal lights

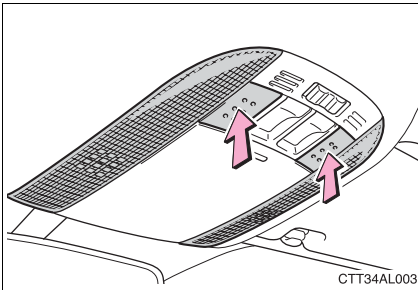

On/off

Personal lights (vehicles without moon roof)

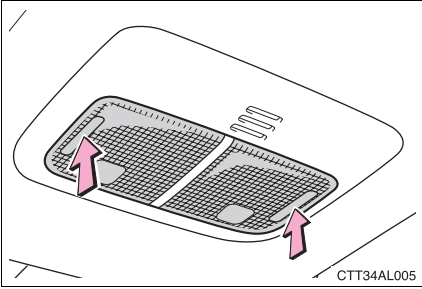

On/off

3-6. Using the storage features

List of storage features

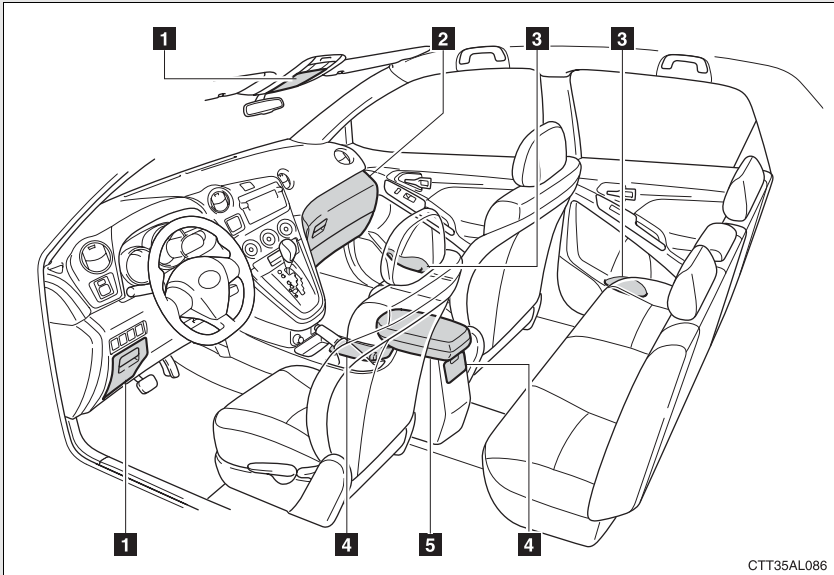

- 1** Auxiliary boxes
- 2** Glove box
- 3** Bottle holders
- 4** Cup holders
- 5** Console box

CAUTION

■ Items that should not be left in the storage spaces

Do not leave glasses, lighters or spray cans in the storage spaces, as this may cause the following when cabin temperature becomes high:

- Glasses may be deformed by heat or cracked if they come into contact with other stored items.
- Lighters or spray cans may explode. If they come into contact with other stored items, the lighter may catch fire or the spray can may release gas, causing a fire hazard.

Glove box

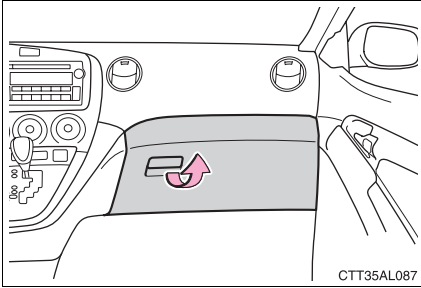

Pull up the lever.

⚠ CAUTION

■ Caution while driving

Keep the glove box closed. In the event of sudden braking or sudden swerving, an accident may occur due to an occupant being struck by the open glove box or the items stored inside.

Console box

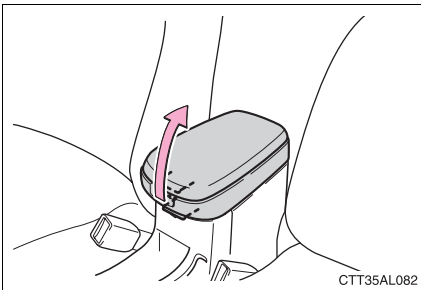

Lift the lid while pulling the lever.

⚠ CAUTION

■ Caution while driving

Keep the console box closed. Injuries may result in the event of an accident or sudden braking.

Cup holders

► Front

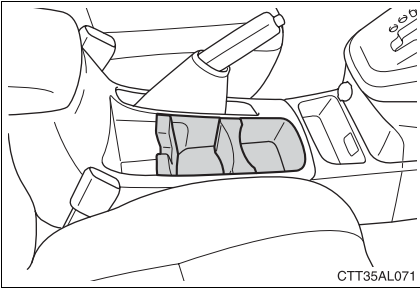

► Rear

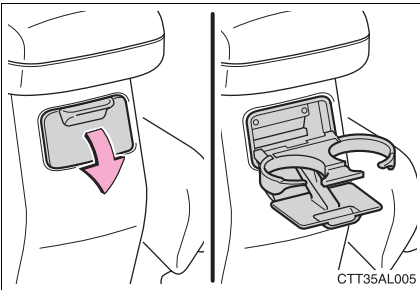

Pull the lid to open.

■ Using the cup holder (front) to store small items

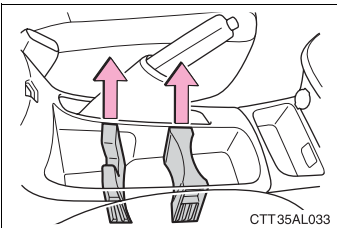

Remove the cup holder inserts.

■ Adjusting the cup holder to the size of the cups or drink-cans

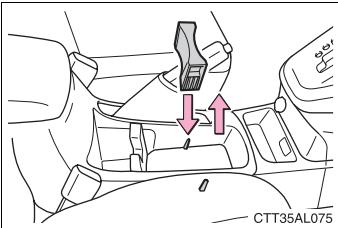

CTT35AL075

Remove the cup holder insert and change the cup holder insert position.

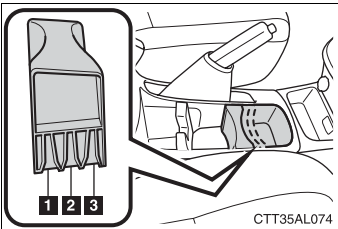

CTT35AL074

- 1** Small size
- 2** Middle size
- 3** Large size

■ Cup holder inserts (front)

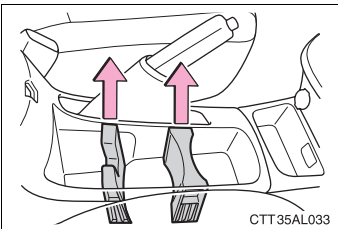

CTT35AL033

The cup holder inserts may be removed for cleaning.

⚠ CAUTION

■ Items unsuitable for the cup holder

Do not place anything other than cups or beverage cans in the cup holders. Other items may be thrown out of the holders in the event of an accident or sudden braking and cause injury. If possible, cover hot drinks to prevent burns.

■ When not in use

Keep the rear cup holders closed. Injuries may result in the event of an accident or sudden braking.

Bottle holders

► Front

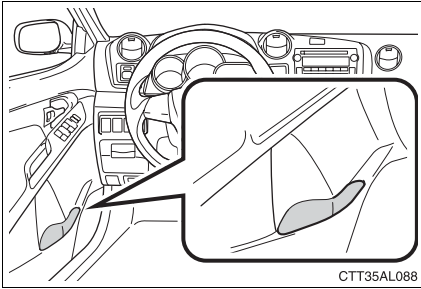

► Rear

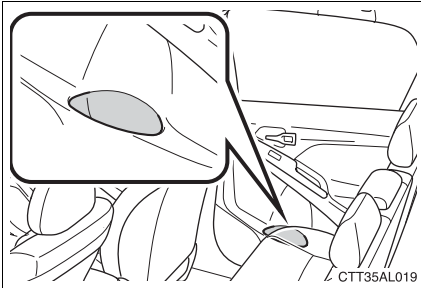

⚠ CAUTION

■ Items unsuitable for the bottle holder

Do not place anything other than pet bottles in the bottle holders. Other items may be thrown out of the holders in the event of an accident or sudden braking and cause injury.

 NOTICE

■ When a pet bottle is in the front bottle holder (vehicles with manual window)

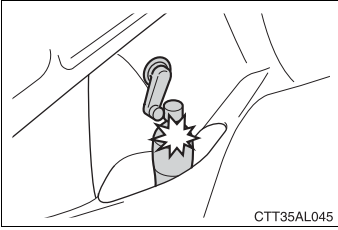

As there is a possibility of interfering with a manual window regulator handle, prevent the window from opening and closing, do not place a pet bottle in the holder when turning the handle.

Auxiliary boxes

► Front

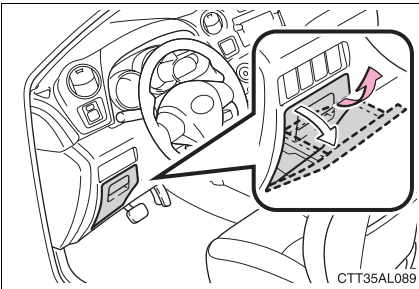

Pull up the lever.

► Overhead console (vehicles with moon roof)

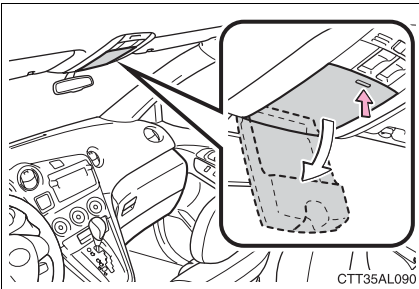

Push the lid.

 **CAUTION****■ Caution while driving**

Keep the auxiliary boxes closed.

Injuries may result in the event of an accident or sudden braking.

■ Items unsuitable for storing (overhead console only)

Do not store items heavier than 0.4 lb. (0.2 kg).

Doing so may cause the auxiliary box to open and the items inside may fall out, resulting in an accident.

Sun visors

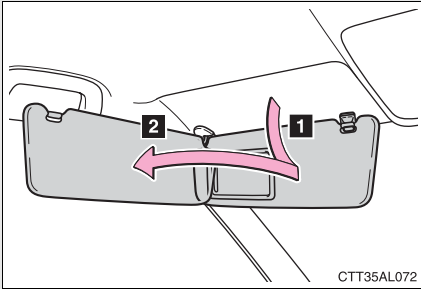

1 Forward position:
Flip down.

2 Side position:
Flip down, unhook, and
swing to the side.

Vanity mirrors

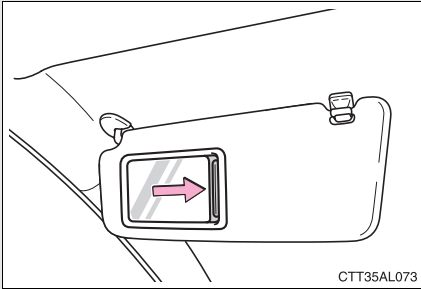

Slide the cover.

Clock

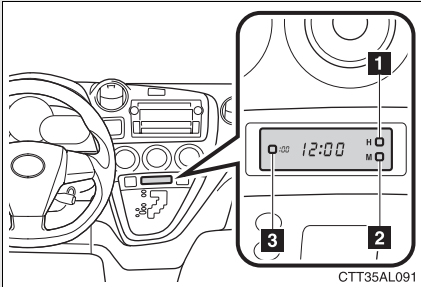

- 1** Adjusts the hour.
- 2** Adjusts the minutes.
- 3** Rounds to the nearest hour.*

*: e.g. 1:00 to 1:29 → 1:00

1:30 to 1:59 → 2:00

■ **The clock is displayed when**

The engine switch is in the “ACC” or “ON” position.

Ashtrays*

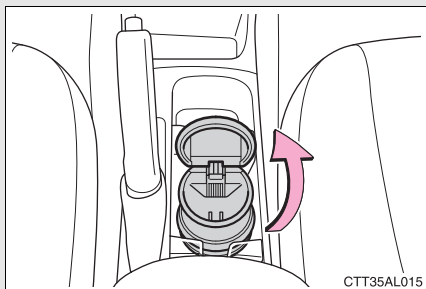

An ashtray can be installed in a cup holder.

CAUTION

■ When not in use

Keep the ashtray closed.

Injuries may result in the event of sudden braking, sudden swerving or an accident.

■ To prevent fire

- Fully extinguish matches and cigarettes before putting them in the ashtray, then make sure the ashtray is fully closed.
- Do not place paper or any other type of flammable object in the ashtray.

Cigarette lighter*

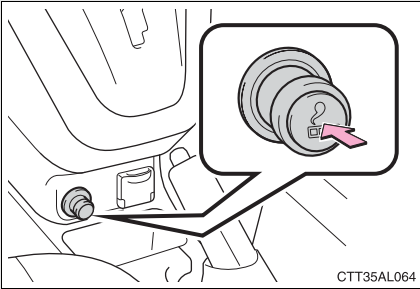

Push the cigarette lighter down.

The cigarette lighter will pop up when it is ready for use.

■ The cigarette lighter can be used when

The engine switch is in the "ACC" or "ON" position.

⚠ CAUTION

■ To avoid burns or fires

- Do not touch the metal parts of the cigarette lighter.
- Do not hold the cigarette lighter down. It could overheat and cause a fire.
- Do not insert anything other than the cigarette lighter into the outlet.

*: If equipped

Power outlet*

The power outlet can be used for a following component.

12 V: Accessories that run on less than 10 A.

115 V: Accessories that uses less than 100 W.

► Type A (12 V)

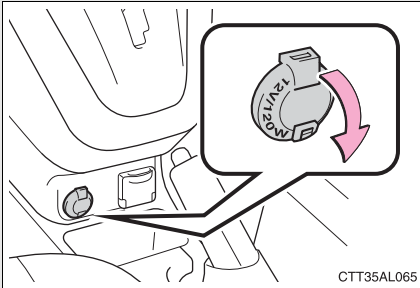

► Type B (115 V)

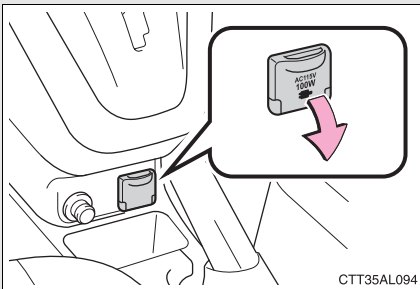

■ **The power outlet can be used when**

► 12 V

The engine switch is in the "ACC" or "ON" position.

► 115 V

The engine switch is in the "ON" position.

*: If equipped

 NOTICE

■ **To avoid damaging the power outlet**

Close the power outlet lid when the power outlet is not in use.

Foreign objects or liquids that enter the power outlet may cause a short circuit.

■ **To prevent the fuse from being blown**

▶ 12 V

Do not use an accessory that uses more than 12 V 10 A.

▶ 115 V

Do not use a 115 V appliance that requires more than 100 W.

If a 115 V appliance that consumes more than 100 W is used, the protection circuit will cut the power supply.

■ **To prevent the battery from being discharged**

Do not use the power outlet longer than necessary when the engine is off.

■ **Appliances that may not operate properly (115 V)**

The following 115 V appliances may not operate properly even if their power consumption is under 100 W.

- Appliances with high initial peak wattage
- Measuring devices that process precise data
- Other appliances that require an extremely stable power supply

Grocery bag hook

This hook is designed to hang things like grocery bag.

► Cabin

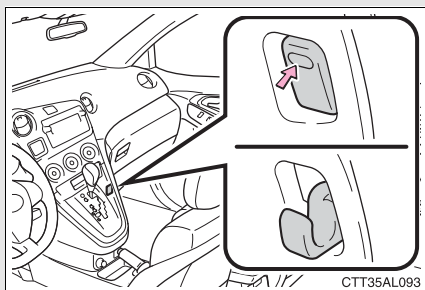

Press the hook.

► Luggage compartment

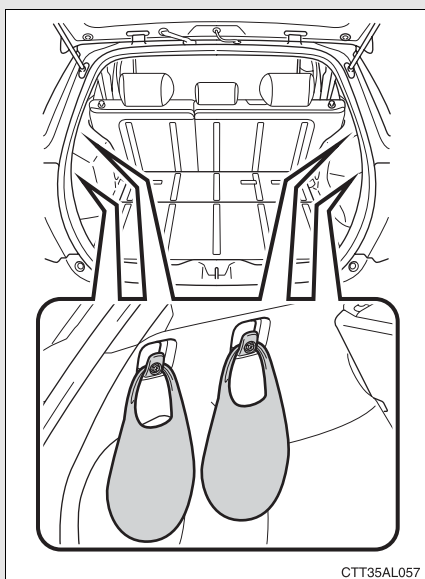

 NOTICE

■ **Grocery bag hook weight capacity**

▶ Cabin

Do not hang any object heavier than 44 lb. (20 kg) on the grocery bag hook.

▶ Luggage compartment

Do not hang any object heavier than 7 lb. (3 kg) on the grocery bag hooks.

Seatback table*

Front passenger's seatback can be used as a temporary table only when the vehicle is stopped.

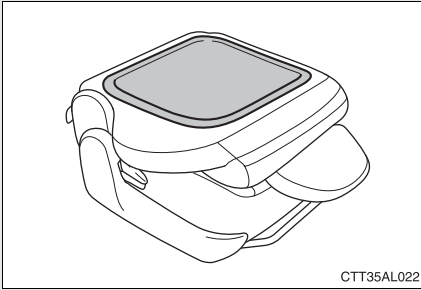

Fold down the front passenger's seat to use the seatback table. (→P. 40)

CAUTION

■ Caution while driving

Observe the following precautions to avoid death or serious injury.

- Do not set up the seatback table.
- Do not sit on or place anything on the seatback table.

NOTICE

■ To prevent damage to the seatback table

Do not put heavy loads on the table.

Assist grips

An assist grip installed on the ceiling can be used to support your body while sitting on the seat.

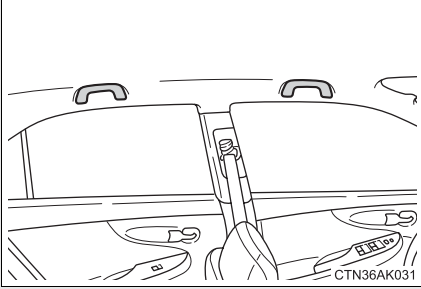

⚠ CAUTION

■ Assist grip

Do not use the assist grip when getting in or out of the vehicle or rising from your seat.

⚠ NOTICE

■ To prevent damage to the assist grip

Do not hang any heavy object or put a heavy load on the assist grip.

Floor mat

Use only floor mats designed specifically for vehicles of the same model and model year as your vehicle. Fix them securely in place onto the carpet.

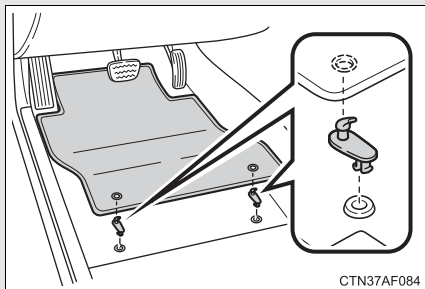

Fix the floor mat in place using the retaining hooks (clips) provided.

The shape of the retaining hooks (clips) and the fixing procedure of the floor mat for your vehicle may differ from those shown in the illustration. For details, refer to the floor mat retention clip installation instructions supplied with the clips.

⚠ CAUTION

Observe the following precautions.

Failure to do so may cause the driver's floor mat to slip, possibly interfering with the pedals while driving. An unexpectedly high speed may result or it may become difficult to stop the vehicle, leading to a serious accident.

■ When installing the driver's floor mat

- Do not use floor mats designed for other models or different model year vehicles, even if they are Toyota Genuine floor mats.
- Only use floor mats designed for the driver's seat.
- Always install the floor mat securely using the retaining hooks (clips) provided.
- Do not use two or more floor mats on top of each other.
- Do not place the floor mat bottom-side up or upside-down.

■ Before driving

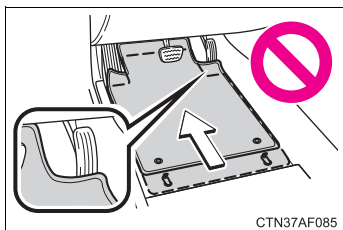

- Check that the floor mat is securely fixed in the correct place with all the provided retaining hooks (clips). Be especially careful to perform this check after cleaning the floor.
- With the engine stopped and the shift lever in P (automatic transmission) or N (manual transmission), fully depress each pedal to the floor to make sure it does not interfere with the floor mat.

3-7. Other interior features

Luggage compartment feature

■ Cargo hooks

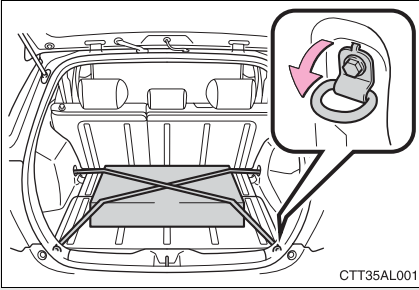

Cargo hooks are provided for securing loose items.

■ Tie-down belts

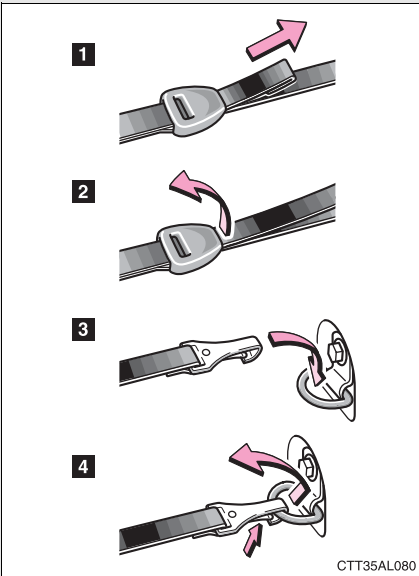

- 1 To tighten
- 2 To loosen
- 3 To hook
- 4 To unhook

■ Auxiliary boxes

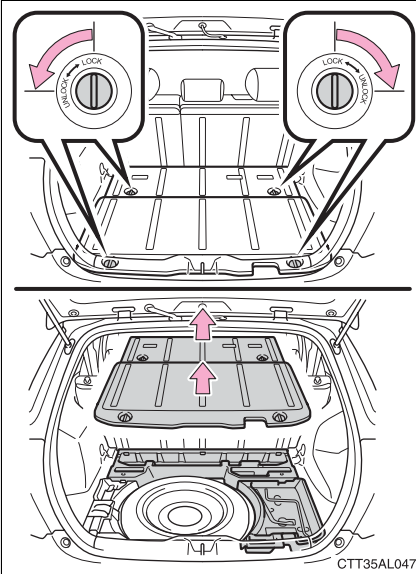

Turn the knobs to the "UNLOCK" position, and remove the deck boards.

■ Grocery bag hooks (→P. 297)

■ Tonneau cover (if equipped)

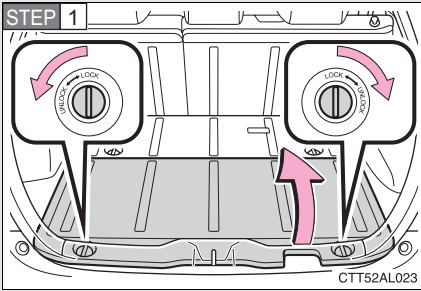

Remove the deck board.

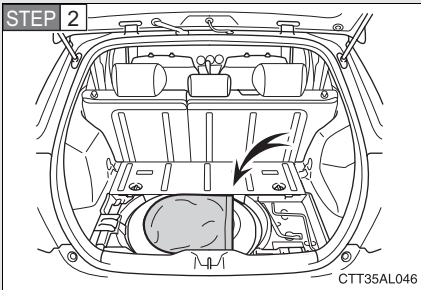

Take out the bag.

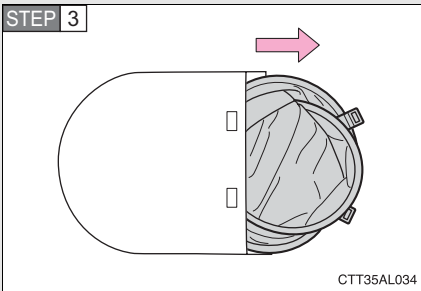

Remove the tonneau cover from the bag.

STEP 4

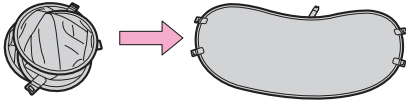

CTT35AL035

Slowly unfold the tonneau cover.

STEP 5

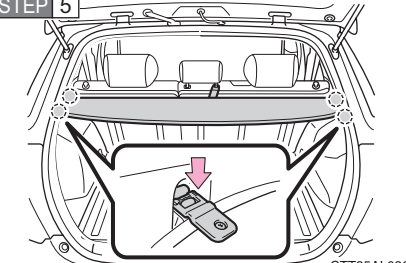

CTT35AL036

Attach the hook to the hook brackets.

STEP 6

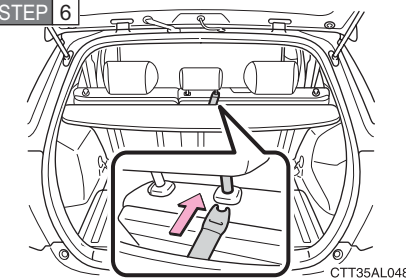

CTT35AL048

Raise the rear center head restraint to attach the hook.

Folding the tonneau cover

STEP 1

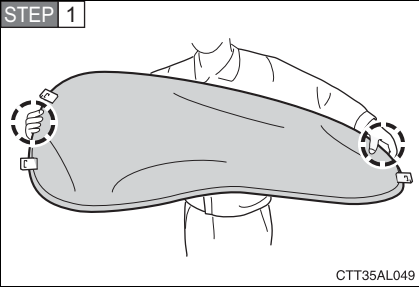

Hold the tonneau cover with both hands. Point your thumbs in opposite directions.

STEP 2

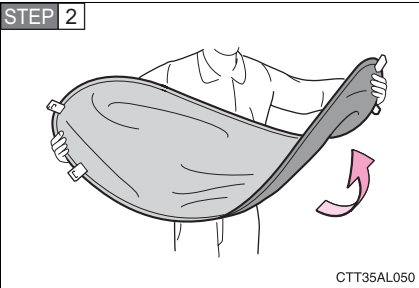

Bend one side of the cover towards you.

STEP 3

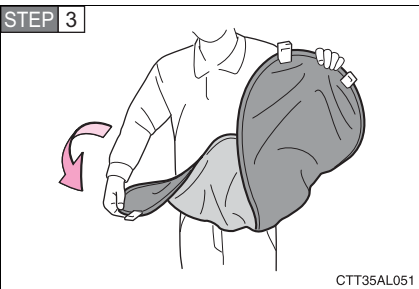

Twist the other side in the opposite direction, as shown in the illustration.

STEP 4

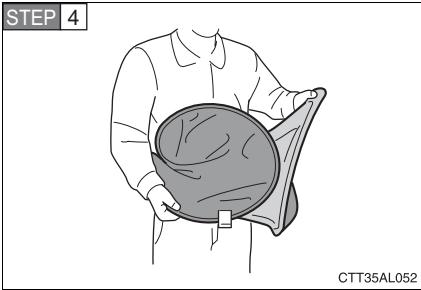

Make a small circle, then fold it inward.

STEP 5

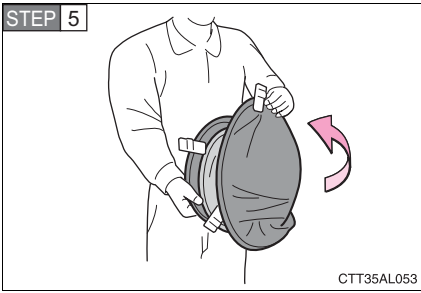

Make sure the three circles are side by side.

STEP 6

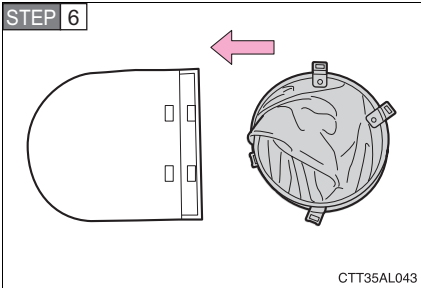

Put it in the bag.

 **CAUTION**

■ **When unfolding the tonneau cover**

Be careful not to hit yourself when unfolding the tonneau cover.

■ **Caution while driving**

Keep the deck boards locked.

Injuries may result in the event of an accident or sudden braking.

Compass*

The compass on the inside rear view mirror indicates the direction in which the vehicle is heading.

■ Operation

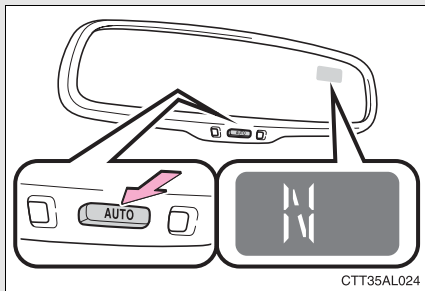

To turn the compass on or off, press and hold “AUTO” for 3 seconds.

■ Displays and directions

Display	Direction
N	North
NE	Northeast
E	East
SE	Southeast
S	South
SW	Southwest
W	West
NW	Northwest

*: If equipped

Calibrating the compass

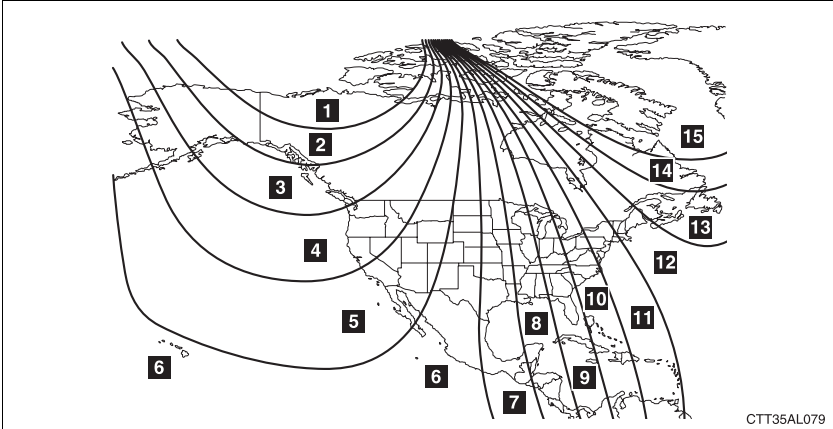

The direction display deviates from the true direction determined by the earth's magnetic field. The amount of deviation varies according to the geographic position of the vehicle.

If you cross over a map boundary shown in the illustration, the compass will deviate.

To obtain higher precision or perfect calibration, refer to the following.

■ Deviation calibration

STEP 1 Stop the vehicle.

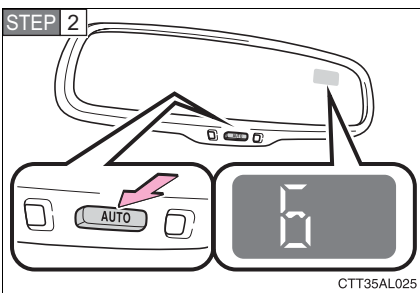

Press and hold "AUTO" for 6 seconds.

A number (1 to 15) appears on the compass display.

STEP 3 Press "AUTO" and, referring to the map above, select the number of the zone where you are.

If the direction is displayed several seconds after adjustment, the calibration is complete.

■ Circling calibration

STEP 1 Stop the vehicle in a place where it is safe to drive in a circle.

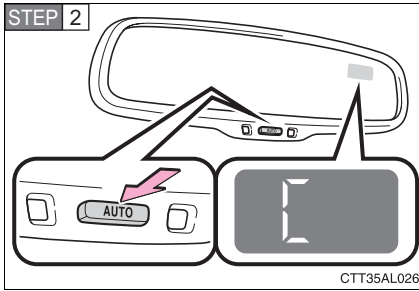

Press and hold “AUTO” for 9 seconds.

C appears on the compass display.

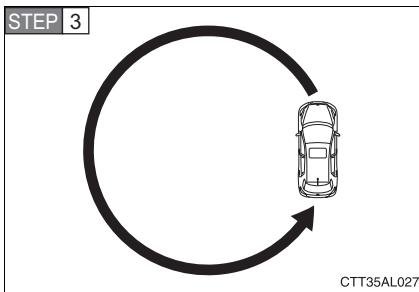

Drive the vehicle at 5 mph (8 km/h) or less in a circle until a direction is displayed.

If there is not enough space to drive in a circle, drive around the block until the direction is displayed.

■ Conditions unfavorable for correct operation

The compass may not show the correct direction in the following situations:

- The vehicle is stopped immediately after turning.
- The vehicle is on an inclined surface.
- The vehicle is in a place where the earth's magnetic field is subject to interference by artificial magnetic fields (underground car park/parking lot, under a steel tower, between buildings, roof car park/parking lot, near an intersection, near a large vehicle, etc.).
- The vehicle has become magnetized.
(There is a magnet or metal object near the anti-glare inside rear view mirror.)
- The battery has been disconnected.
- A door is open.

 CAUTION

■ **While driving the vehicle**

Do not adjust the display. Be sure to adjust the display only when the vehicle is stopped.

■ **When doing the circling calibration**

Be sure to secure a wide space, and watch out for people and vehicles in the neighborhood. Do not violate any local traffic rules while performing circling calibration.

 NOTICE

■ **To avoid compass malfunctions**

Do not place magnets or any metal objects near the anti-glare inside rear view mirror.

Doing this may cause a malfunction of the compass sensor.

■ **To ensure normal operation of the compass**

- Do not perform circling calibration of the compass in a place where the earth's magnetic field is subject to interference by artificial magnetic fields.
- During calibration, do not operate electric systems (moon roof, power windows, etc.) as they may interfere with the calibration.

Cleaning and protecting the vehicle exterior

Perform the following to protect the vehicle and maintain it in prime condition.

- Working from top to bottom, liberally apply water to the vehicle body, wheel wells and underside of the vehicle to remove any dirt and dust.
Wash the vehicle body using a sponge or soft cloth, such as a chamois.
- For hard-to-remove marks, use car wash soap and rinse thoroughly with water.
- Wipe away any water.
- Wax the vehicle when the waterproof coating deteriorates.

If water does not bead on a clean surface, apply wax when the vehicle body is cool.

■ Automatic car washes

- Before washing the vehicle, do the following.
 - Fold the mirrors back.
 - Remove the antenna.
- Brushes used in automatic car washes may scratch the vehicle surface and harm your vehicle's paint.

■ High pressure car washes

- Do not allow the nozzles of the car wash to come within close proximity of the windows.
- Before car wash, check that the fuel filler door on your vehicle is closed properly.

■ Aluminum wheels

- Remove any dirt immediately by using a neutral detergent. Do not use hard brushes or abrasive cleaners. Do not use strong or harsh chemical cleaners.

Use the same mild detergent and wax as used on the paint.

- Do not use detergent on the wheels when they are hot, for example after driving for long distance in the hot weather.

- Wash detergent from the wheels immediately after use.

■ Bumpers

Do not scrub with abrasive cleaners.

CAUTION

■ Caution about the exhaust pipe

Exhaust gasses cause the exhaust pipe to become quite hot.

When washing the vehicle, be careful not to touch the pipe until it has cooled sufficiently, as touching a hot exhaust pipe can cause burns.

 NOTICE

■ **To prevent paint deterioration and corrosion on the body and components (aluminum wheels etc.)**

● Wash the vehicle immediately in the following cases:

- After driving near the sea coast
- After driving on salted roads
- If you see coal tar or tree sap on the paint surface
- If you see dead insects or insect droppings on the paint
- After driving in an area contaminated with soot, oily smoke, mine dust, iron powder or chemical substances
- If the vehicle becomes heavily soiled in dust or mud
- If liquids such as benzene and gasoline are spilled on the paint surface

● If the paint is chipped or scratched, have it repaired immediately.

● To prevent the wheels from corroding, remove any dirt and store in a place with low humidity when storing the wheels.

■ **If the windshield washer nozzle become blocked**

Contact your Toyota dealer. Do not try to clear it with a pin or other object. This may damage the nozzle.

■ **Cleaning the exterior lights**

● Wash carefully. Do not use organic substances or scrub with a hard brush. This may damage the surfaces of the lights.

● Do not apply wax on the surfaces of the lights. Wax may cause damage to the lenses.

■ **Antenna installation and removal precautions**

● Before driving, ensure that the antenna is installed.

● When the antenna is removed, such as before entering an automatic car wash, make sure to store it in a suitable place so as not to lose it. Also, before driving, make sure to reinstall the antenna in its original position.

The following procedures will help protect your vehicle's interior and keep it in top condition:

■ **Protecting the vehicle interior**

Remove dirt and dust using a vacuum cleaner. Wipe dirty surfaces with a cloth dampened with lukewarm water.

■ **Cleaning the leather areas**

- Remove dirt and dust using a vacuum cleaner.
- Wipe any excess dirt and dust with a soft cloth dampened with diluted detergent.

Use a diluted water solution of approximately 5% neutral wool detergent.

- Wring out any excess water from the cloth and thoroughly wipe off all remaining traces of detergent.
- Wipe the surface with a dry, soft cloth to remove any remaining moisture. Allow the leather to dry in a shaded ventilated area.

■ **Synthetic leather areas**

- Remove loose dirt using a vacuum cleaner.
- Apply a mild soap solution to the synthetic leather using a sponge or soft cloth.
- Allow the solution to soak in for a few minutes. Remove the dirt and wipe off the solution with a clean, damp cloth.

■ Caring for leather areas

Toyota recommends cleaning the interior of the vehicle at least twice a year to maintain the quality of the vehicle's interior.

■ Shampooing the carpets

There are several commercial foaming-type cleaners available. Use a sponge or brush to apply the foam. Rub in overlapping circles. Do not apply water. Excellent results are obtained by keeping the carpet as dry as possible.

■ Seat belts

Clean with mild soap and lukewarm water using a cloth or sponge. Also check the belts periodically for excessive wear, fraying or cuts.

CAUTION

■ Water in the vehicle

- Do not splash or spill liquid in the vehicle. Doing so may cause electrical components etc. to malfunction or catch fire.
- Do not get any of the SRS components or wiring in the vehicle interior wet. (→P. 74)

Electrical malfunction may cause the airbags to deploy or not function properly, resulting in death or severe injury.

■ Cleaning the interior (especially instrument panel)

Do not use polish wax or polish cleaner. The instrument panel may reflect off the windshield, obstructing the driver's view and leading to an accident, resulting in death or serious injury.

 NOTICE**■ Cleaning detergents**

- Do not use organic substances such as benzene or gasoline, acidic or alkaline solutions, dye, bleach or other detergent. Doing so may discolor the vehicle interior or cause streaks or damage to painted surfaces.
- Do not use polish wax or polish cleaner. The instrument panel's or other interior part's painted surface may be damaged.

■ Preventing damage to leather surfaces

Observe the following precautions to avoid damage to and deterioration of leather surfaces.

- Remove any dust or dirt on leather surfaces immediately.
- Do not expose the vehicle to direct sunlight for extended periods of time. Park the vehicle in the shade, especially during summer.
- Do not place items made of vinyl, plastic, or that contain wax, on the upholstery, as they may stick to the leather surface if the vehicle interior heats up significantly.

■ Water on the floor

Do not wash the vehicle floor with water.

Vehicle systems such as the audio system may be damaged if water comes into contact with electrical components under the floor of the vehicle, and may also cause the body to rust.

■ Cleaning the inside of the rear window

- Do not use glass cleaner to clean the rear window, as this may cause damage to the rear window defogger heater wires. Use a cloth dampened with lukewarm water to gently wipe the window clean. Wipe the window in strokes running parallel to the heater wires.
- Be careful not to scratch or damage the heater wires.

Maintenance requirements

To ensure safe and economical driving, day-to-day care and regular maintenance is essential. It is the owner's responsibility to perform regular checks. Toyota recommends the following maintenance.

■ General maintenance

Should be performed on a daily basis. This can be done by yourself or by a Toyota dealer.

■ Scheduled maintenance

Should be performed at specified intervals according to the maintenance schedule.

For details about maintenance items and schedules, refer to the "Scheduled Maintenance Guide" or "Owner's Manual Supplement".

■ Do-it-yourself maintenance

You can perform some maintenance procedures yourself. Please be aware that do-it-yourself maintenance may affect warranty coverage.

The use of Toyota Repair Manuals is recommended.

For details about warranty coverage, see the separate "Owner's Warranty Information Booklet" or "Owner's Manual Supplement".

■ Repair and replacement

It is recommended that genuine Toyota parts be used for repair to ensure performance of each system. If non-Toyota parts are used in replacement or if a repair shop other than a Toyota dealer performs repairs, confirm the warranty coverage.

■ Reset the maintenance data (U.S.A. only)

After the required maintenance is performed according to the maintenance schedule, please reset the maintenance data.

To reset the data, follow the procedures described below:

- STEP 1** Turn the engine switch OFF with the trip meter A reading shown.
- STEP 2** While pressing the trip meter reset button (→P. 132), turn the engine switch to the “ON” position.
- STEP 3** Continue to press and hold the button until the trip meter displays 000000.

■ Allow inspection and repairs to be performed by a Toyota dealer

- Toyota technicians are well-trained specialists and are kept up to date with the latest service information. They are well informed about the operations of all systems on your vehicle.
- Keep a copy of the repair order. It proves that the maintenance that has been performed is under warranty coverage. If any problem should arise while your vehicle is under warranty, your Toyota dealer will promptly take care of it.

CAUTION

■ Warning in handling of battery

- Engine exhaust, some of its constituents, and a wide variety of automobile components contain or emit chemicals known to the State of California to cause cancer and birth defects and other reproductive harm. Work in a well ventilated area.
- Oils, fuels and fluids contained in vehicles as well as waste produced by component wear contain or emit chemicals known to the State of California to cause cancer and birth defects or other reproductive harm. Avoid exposure and wash any affected area immediately.
- Battery posts, terminals and related accessories contain lead and lead compounds which are known to cause brain damage. Wash your hands after handling. (→P. 345)

General maintenance

Listed below are the general maintenance items that should be performed at the intervals specified in the “Owner's Warranty Information Booklet” or “Owner's Manual Supplement/Scheduled Maintenance Guide”. It is recommended that any problem you notice should be brought to the attention of your Toyota dealer or qualified service shop for advice.

Engine compartment

Items	Check points
Battery	Check the connections. (→P. 345)
Brake fluid	At the correct level? (→P. 343)
Engine coolant	At the correct level? (→P. 341)
Engine oil	At the correct level? (→P. 337)
Exhaust system	No fumes or strange sounds?
Radiator/condenser/hoses	Not blocked with foreign matter? (→P. 342)
Washer fluid	At the correct level? (→P. 347)

Vehicle interior

Items	Check points
Accelerator pedal	<ul style="list-style-type: none"> • Moves smoothly (without uneven pedal effort or catching)?
Automatic transmission “Park” mechanism	<ul style="list-style-type: none"> • Can the vehicle be held securely on an incline with the shift lever in P?
Brake pedal	<ul style="list-style-type: none"> • Moves smoothly? • Does it have appropriate clearance and correct amount of free play?
Brakes	<ul style="list-style-type: none"> • Not pull to one side when applied? • Loss of brake effectiveness? • Spongy feeling brake pedal? • Pedal almost touches floor?
Clutch pedal	<ul style="list-style-type: none"> • Moves smoothly?
Head restraints	<ul style="list-style-type: none"> • Move smoothly and lock securely?
Indicators/buzzers	<ul style="list-style-type: none"> • Function properly?
Lights	<ul style="list-style-type: none"> • Do all the lights come on?
Parking brake	<ul style="list-style-type: none"> • Moves smoothly? • Can hold the vehicle securely on an incline?
Seat belts	<ul style="list-style-type: none"> • Does the seat belt system operate smoothly? • Are the belts undamaged?
Seats	<ul style="list-style-type: none"> • Do the seat controls operate properly?
Steering wheel	<ul style="list-style-type: none"> • Moves smoothly? • Has correct free play? • No strange noises?

Vehicle exterior

Items	Check points
Doors	<ul style="list-style-type: none"> • Operate smoothly?
Engine hood	<ul style="list-style-type: none"> • The lock system works properly?
Fluid leaks	<ul style="list-style-type: none"> • Is there any leakage after parking?
Tires	<ul style="list-style-type: none"> • Inflation pressure is correct? • Tire surfaces not worn or damaged? • Tires rotated according to the maintenance schedule? • Wheel nuts are not loose?

 **CAUTION**

■ If the engine is running

Turn the engine off and ensure that there is adequate ventilation before performing maintenance checks.

Some states have vehicle emission inspection programs which include OBD (On Board Diagnostics) checks. The OBD system monitors the operation of the emission control system.

■ **If the malfunction indicator lamp comes on**

The OBD system determines that a problem exists somewhere in the emission control system. Your vehicle may not pass the I/M test and may need to be repaired. Contact your Toyota dealer to service the vehicle.

■ **Your vehicle may not pass the I/M test:**

- When the battery is disconnected or discharged

Readiness codes that are set during ordinary driving are erased.

Also, depending on your driving habits, the readiness codes may not be completely set.

- When the fuel tank cap is loose

The malfunction indicator lamp comes on as a temporary malfunction and your vehicle may not pass the I/M test.

■ **When the malfunction indicator lamp goes off after several driving trips**

The error code in the OBD system will not be cleared unless the vehicle is driven 40 or more times.

■ **If your vehicle does not pass the I/M test**

Contact your Toyota dealer to prepare the vehicle for re-testing.

Do-it-yourself service precautions

If you perform maintenance yourself, be sure to follow the correct procedures as given in these sections.

Items	Parts and tools
Battery condition (→P. 345)	<ul style="list-style-type: none"> • Warm water • Baking soda • Grease • Conventional wrench (for terminal clamp bolts)
Brake fluid level (→P. 343)	<ul style="list-style-type: none"> • FMVSS No.116 DOT 3 or SAE J1703 brake fluid • Rag or paper towel • Funnel (used only for adding brake fluid)
Engine coolant level (→P. 341)	<ul style="list-style-type: none"> • “Toyota Super Long Life Coolant” or similar high quality ethylene glycol based non-silicate, non-amine, non-nitrite and non-borate coolant with long-life hybrid organic acid technology. For the U.S.A.: “Toyota Super Long Life Coolant” is pre-mixed with 50% coolant and 50% deionized water. For Canada: “Toyota Super Long Life Coolant” is pre-mixed with 55% coolant and 45% deionized water. • Funnel (used only for adding engine coolant)
Engine oil level (→P. 337)	<ul style="list-style-type: none"> • “Toyota Genuine Motor Oil” or equivalent • Rag or paper towel, funnel (used only for adding oil)

Items	Parts and tools
Fuses (→P. 369)	<ul style="list-style-type: none"> • Fuse with same amperage rating as original
Radiator and condenser (→P. 342)	—
Tire inflation pressure (→P. 358)	<ul style="list-style-type: none"> • Tire pressure gauge • Compressed air source
Washer fluid (→P. 347)	<ul style="list-style-type: none"> • Water washer fluid containing antifreeze (for winter use) • Funnel

 **CAUTION**

The engine compartment contains many mechanisms and fluids that may move suddenly, become hot, or become electrically energized. To avoid death or serious injury observe the following precautions.

■ **When working on the engine compartment**

- Keep hands, clothing, and tools away from the moving fan and engine drive belt.
- Be careful not to touch the engine, radiator, exhaust manifold, etc. right after driving as they may be hot. Oil and other fluids may also be hot.
- Do not leave anything that may burn easily, such as paper or rags, in the engine compartment.
- Do not smoke, cause sparks or expose an open flame to fuel or the battery. Fuel and battery fumes are flammable.
- Be extremely cautious when working on the battery. It contains poisonous and corrosive sulfuric acid.
- Take care because brake fluid can harm your hands or eyes and damage painted surfaces.
If fluid gets on your hands or in your eyes, flush the affected area with clean water immediately.

If you still experience discomfort, see a doctor.

■ **When working near the electric cooling fans or radiator grille**

Be sure the engine switch is OFF. With the engine switch in the "ON" position, the electric cooling fans may automatically start to run if the air conditioning is on and/or the coolant temperature is high. (→P. 342)

■ **Safety glasses**

Wear safety glasses to prevent flying or falling material, fluid spray, etc. from getting in the eyes.

 NOTICE**■ If you remove the air cleaner**

Driving with the air cleaner removed may cause excessive engine wear due to dirt in the air. Also, a backfire could cause a fire in the engine compartment.

4-3. Do-it-yourself maintenance

Hood

Release the lock from the inside of the vehicle to open the hood.

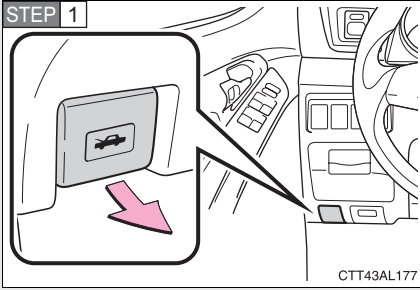

Pull the hood release lever.

The hood will pop up slightly.

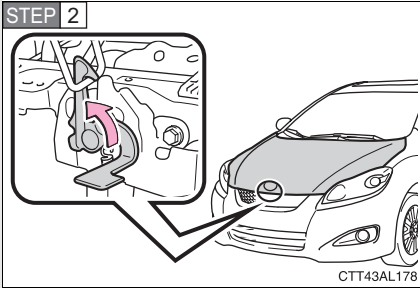

Lift the auxiliary catch lever and lift the hood.

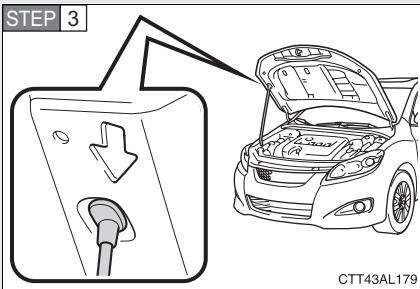

Hold the hood open by inserting the supporting rod into the slot.

 **CAUTION****■ Pre-driving check**

Check that the hood is fully closed and locked.

If the hood is not locked properly, it may open while the vehicle is in motion and cause an accident, which may result in death or serious injury.

■ After installing the support rod into the slot

Make sure the rod supports the hood securely from falling down on to your head or body.

 **NOTICE****■ When closing the hood**

Be sure to return the support rod to its clip before closing the hood. Closing the hood with the support rod up could cause the hood to bend.

4-3. Do-it-yourself maintenance

Positioning a floor jack

When raising your vehicle with a floor jack, position the jack correctly. Improper placement may damage your vehicle or cause injury.

■ Front

▶ 1.8 L 4-cylinder (2ZR-FE) engine

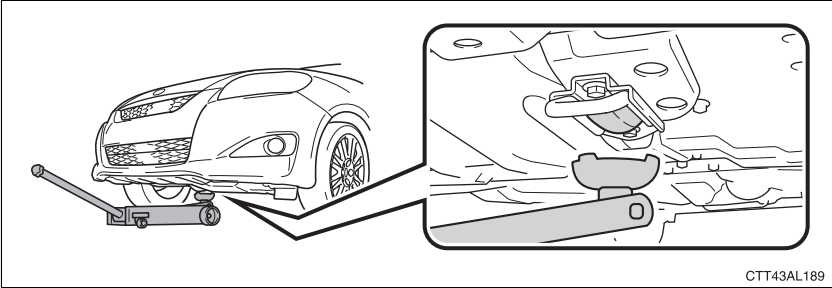

▶ 2.4 L 4-cylinder (2AZ-FE) engine

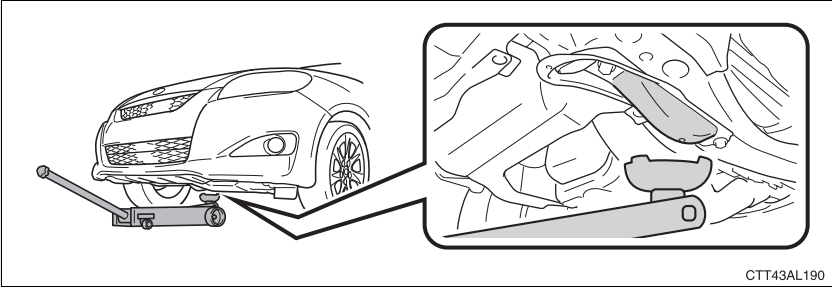

■ **Rear**

▶ **2WD models without 18-inch tires**

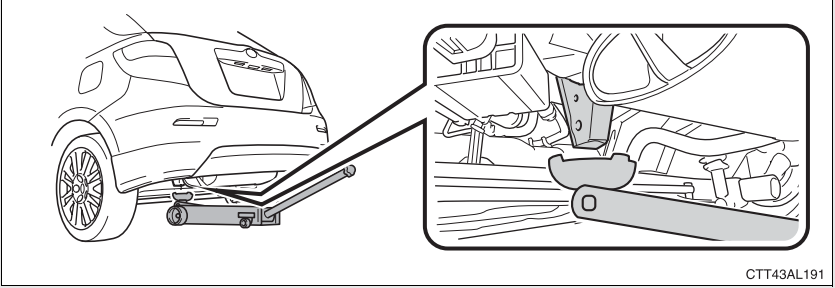

▶ **2WD models with 18-inch tires**

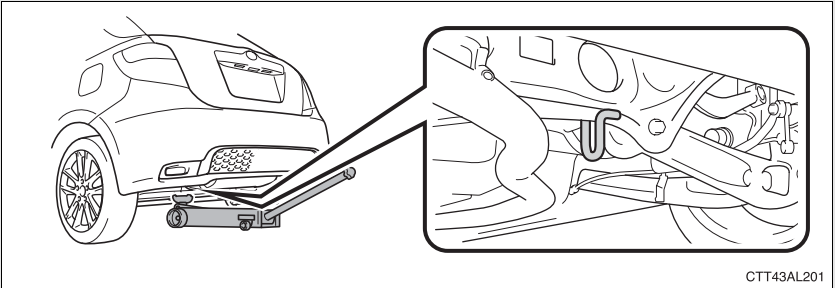

▶ **AWD models**

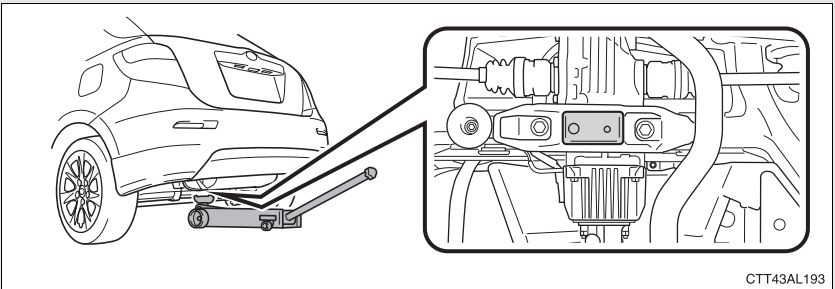

! CAUTION

■ When raising your vehicle

Make sure to observe the following to reduce the possibility of death or serious injury.

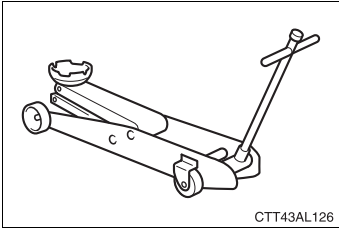

● Lift up the vehicle using a floor jack such as the one shown in the illustration.

- When using a floor jack, follow the instructions of the manual provided with the jack.
- Do not use the jack that was supplied with your vehicle.
- Do not put any part of your body or get underneath the vehicle supported only by the floor jack.
- Always use floor jack and/or automotive jack stands on a solid, flat, level surface.
- Do not start the engine while the vehicle is supported by the floor jack.
- Stop the vehicle on level firm ground, firmly set the parking brake and put the shift lever in P (automatic transmission) or R (manual transmission).
- Make sure to set the floor jack properly at the jack point.
Raising the vehicle with an improperly positioned floor jack will damage the vehicle and may cause the vehicle to fall off the floor jack.
- Do not raise the vehicle while someone is in the vehicle.
- When raising the vehicle, do not place any objects on top of or underneath the floor jack.

4-3. Do-it-yourself maintenance

Engine compartment

► 1.8 L 4-cylinder (2ZR-FE) engine

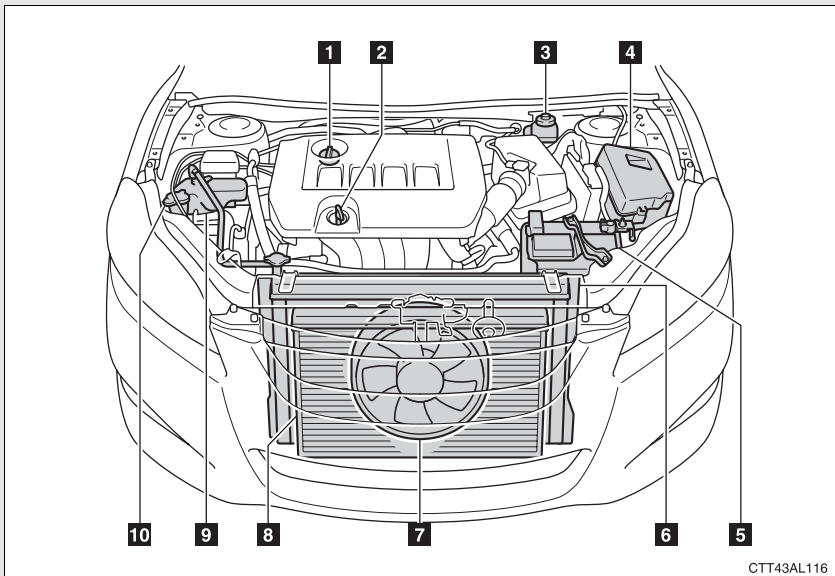

- | | |
|---|--|
| 1 Engine oil filler cap
(→P. 339) | 5 Battery
(→P. 345) |
| 2 Engine oil level dipstick
(→P. 337) | 6 Radiator
(→P. 342) |
| 3 Brake fluid reservoir
(→P. 343) | 7 Electric cooling fan
(→P. 342) |
| 4 Fuse box
(→P. 369) | 8 Condenser
(→P. 342) |
| | 9 Engine coolant reservoir
(→P. 341) |
| | 10 Washer fluid tank (→P. 347) |

► 2.4 L 4-cylinder (2AZ-FE) engine

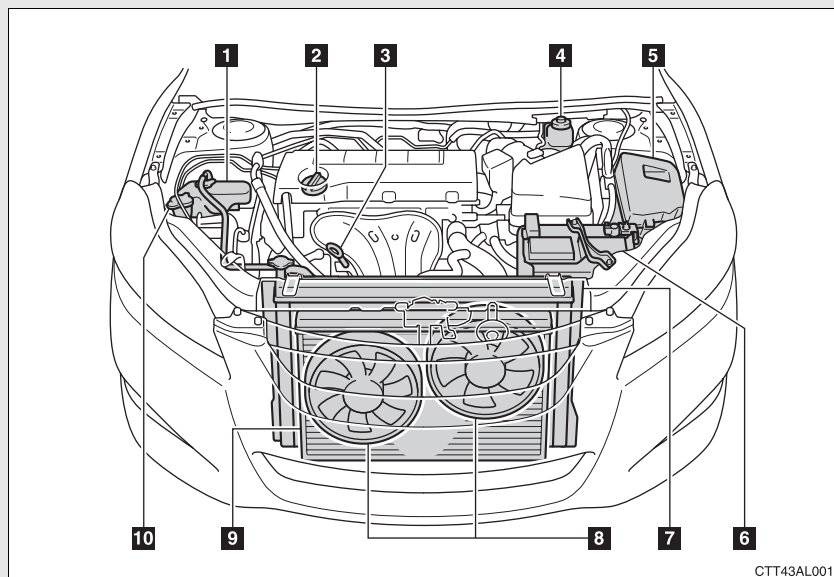

CTT43AL001

- | | |
|---|--|
| 1 Engine coolant reservoir
(→P. 341) | 5 Fuse box
(→P. 369) |
| 2 Engine oil filler cap
(→P. 339) | 6 Battery
(→P. 345) |
| 3 Engine oil level dipstick
(→P. 337) | 7 Radiator
(→P. 342) |
| 4 Brake fluid reservoir
(→P. 343) | 8 Electric cooling fans |
| | 9 Condenser
(→P. 342) |
| | 10 Washer fluid tank
(→P. 347) |

Engine oil

With the engine at operating temperature and turned off, check the oil level on the dipstick.

■ Checking the engine oil

STEP 1 Park the vehicle on level ground. After warming up the engine and turning it off, wait more than 5 minutes for the oil to drain back into the bottom of the engine.

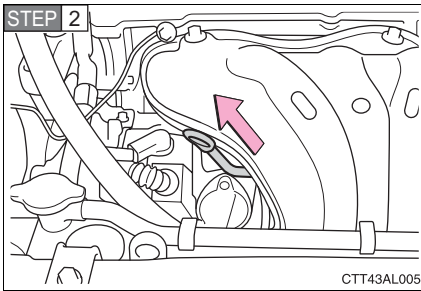

Hold a rag under the end and pull the dipstick out.

STEP 3 Wipe the dipstick clean.

▶ 1.8 L 4-cylinder (2ZR-FE) engine with flat dipstick and 2.4 L 4-cylinder (2AZ-FE) engine

STEP 4 Reinsert the dipstick fully.

▶ 1.8 L 4-cylinder (2ZR-FE) engine with non-flat dipstick

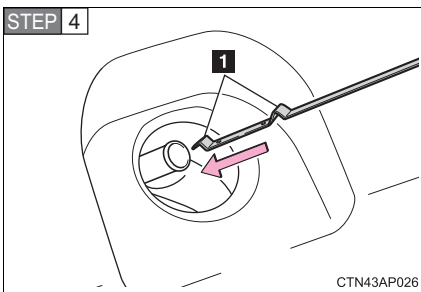

Reinsert the non-flat dipstick fully with its protruding areas (**1** in the illustration) pointing towards the engine.

STEP 5 Holding a rag under the end, pull the dipstick out and check the oil level.

STEP 6 Wipe the dipstick and reinsert it fully.

► 1.8 L 4-cylinder (2ZR-FE) engine with flat dipstick

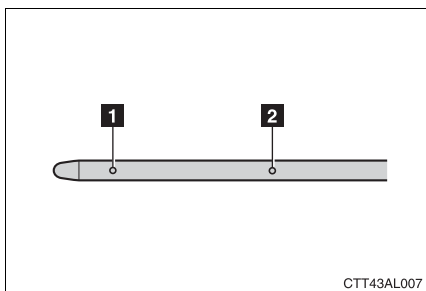

1 Low

2 Full

CTT43AL007

► 1.8 L 4-cylinder (2ZR-FE) engine with non-flat dipstick

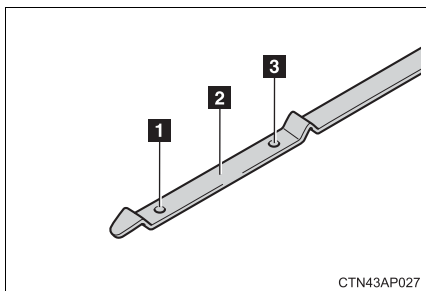

1 Low

2 Measuring side

3 Full

CTN43AP027

► 2.4 L 4-cylinder (2AZ-FE) engine

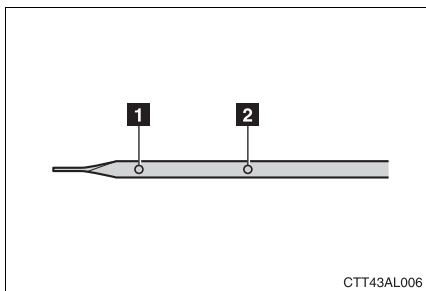

1 Low

2 Full

CTT43AL006

■ Adding engine oil

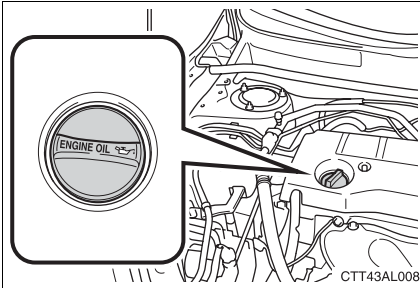

If the oil level is below or near the low level mark, add engine oil of the same type as already in the engine.

Make sure to check the oil type and prepare the items needed before adding oil.

Engine oil selection	→P. 443
Oil quantity (Low → Full)	<ul style="list-style-type: none"> ▶ 1.8 L 4-cylinder (2ZR-FE) engine 1.6 qt. (1.5 L, 1.3 Imp. qt.) ▶ 2.4 L 4-cylinder (2AZ-FE) engine 1.1 qt. (1.0 L, 0.9 Imp. qt.)
Items	Clean funnel

STEP 1 Remove the oil filler cap.

STEP 2 Add engine oil slowly, checking the dipstick.

STEP 3 Install the filler cap, turning it clockwise.

■ Engine oil consumption

A certain amount of engine oil will be consumed while driving. In the following situations, oil consumption may increase, and engine oil may need to be refilled in between oil maintenance intervals.

- When the engine is new, for example directly after purchasing the vehicle or after replacing the engine
- If low quality oil or oil of an inappropriate viscosity is used
- 2.4L 4-cylinder (2AZ-FE) engine: When driving at high engine speeds or with a heavy load, when towing, or when driving while accelerating or decelerating frequently

- 1.8L 4-cylinder (2ZR-FE) engine: When driving at high engine speeds or with a heavy load, or when driving while accelerating or decelerating frequently
- When leaving the engine idling for a long time, or when driving frequently through heavy traffic

 **CAUTION**

■ **Used engine oil**

- Used engine oil contains potentially harmful contaminants which may cause skin disorders such as inflammation or skin cancer, so care should be taken to avoid prolonged and repeated contact. To remove used engine oil from your skin, wash thoroughly with soap and water.
- Dispose of used oil and filters only in a safe and acceptable manner. Do not dispose of used oil and filters in household trash, in sewers or onto the ground. Call your Toyota dealer, service station or auto parts store for information concerning recycling or disposal.
- Do not leave used engine oil within the reach of children.

 **NOTICE**

■ **To prevent serious engine damage**

Check the oil level on a regular basis.

■ **When replacing the engine oil**

- Be careful not to spill engine oil on the vehicle components.
- Avoid overfilling, as the engine could be damaged.
- Check the oil level on the dipstick every time you refill the vehicle.
- Be sure the engine oil filler cap is properly tightened.

Engine coolant

The coolant level is satisfactory if it is between the “FULL” and “LOW” lines on the reservoir when the engine is cold.

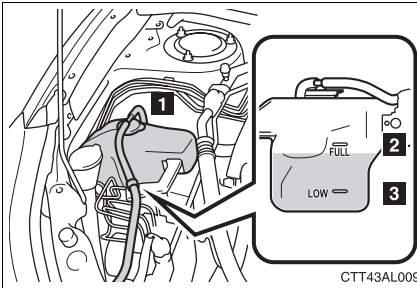

1 Reservoir cap

2 “FULL”

3 “LOW”

If the level is on or below the “LOW” line, add coolant up to the “FULL” line. (→P. 430)

■ If the coolant level drops within a short time after replenishing

Visually check the radiator, hoses, coolant reservoir cap, radiator cap, drain cock and water pump.

If you cannot find a leak, have your Toyota dealer test the cap and check for leaks in the cooling system.

■ Coolant selection

Only use “Toyota Super Long Life Coolant” or similar high quality ethylene glycol based non-silicate, non-amine, non-nitrite, and non-borate coolant with long-life hybrid organic acid technology.

U.S.A.: “Toyota Super Long Life Coolant” is a mixture of 50% coolant and 50% deionized water. (Enabled: -31°F [-35°C])

Canada: “Toyota Super Long Life Coolant” is a mixture of 55% coolant and 45% deionized water. (Enabled: -44°F [-42°C])

For more details about engine coolant, contact your Toyota dealer.

⚠ CAUTION

■ When the engine is hot

Do not remove the coolant reservoir cap.

The cooling system may be under pressure and may spray hot coolant if the cap is removed, causing serious injuries, such as burns.

 NOTICE

■ **When adding engine coolant**

Coolant is neither plain water nor straight antifreeze. The correct mixture of water and antifreeze must be used to provide proper lubrication, corrosion protection and cooling. Be sure to read the antifreeze or coolant label.

■ **If you spill coolant**

Be sure to wash it off with water to prevent damage to parts or paint.

Radiator and condenser

Check the radiator and condenser and remove any foreign objects. If any of the above parts are extremely dirty or you are not sure of their condition, have your vehicle checked by your Toyota dealer.

 CAUTION

■ **When the engine is hot**

Do not touch the radiator or condenser, as they may be hot and may cause serious injuries, such as burns.

Brake fluid

■ Checking fluid level

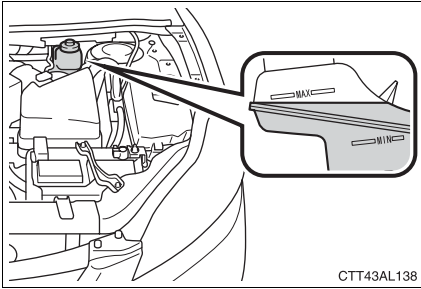

The brake fluid level should be between the “MAX” and “MIN” lines on the tank.

Make sure to check the fluid type and prepare the necessary items.

■ Adding fluid

Make sure to check the fluid type and prepare the necessary items.

Fluid type	FMVSS No.116 DOT 3 or SAE J1703 brake fluid
Items	Clean funnel

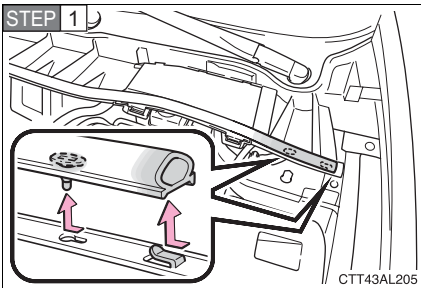

Slide and lift up the rubber strip to partly remove it as shown.

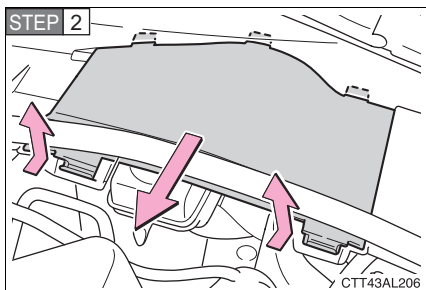

Disconnect the claws and remove the service cover.

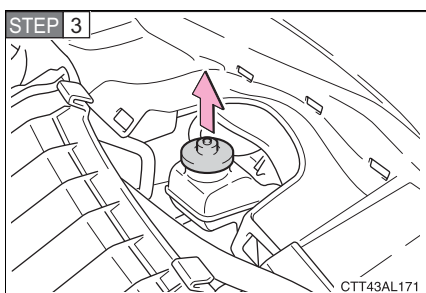

Remove the reservoir cap.

STEP 4 Add brake fluid slowly while checking the fluid level.

■ Brake fluid can absorb moisture from the air

Excess moisture in the fluid can cause a dangerous loss of braking efficiency. Use only newly opened brake fluid.

⚠ CAUTION

■ When filling the reservoir

Take care because brake fluid can harm your hands or eyes and damage painted surfaces.

If fluid gets in your eyes, flush your eyes with clean water immediately.

If you still experience discomfort, see a doctor.

 NOTICE

■ If the fluid level is low or high

It is normal for the brake fluid level to go down slightly as the brake pads wear or when the fluid level in the accumulator is high.

If the reservoir needs frequent refilling, it may indicate a serious problem.

Battery

Check the battery as follows.

■ Battery exterior

Make sure that the battery terminals are not corroded and that there are no loose connections, cracks, or loose clamps.

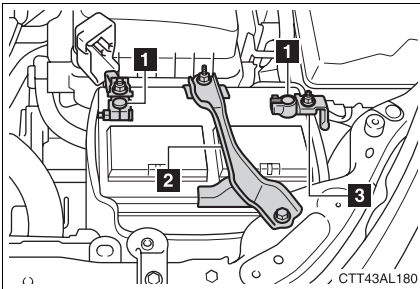

- 1** Terminals
- 2** Hold-down clamp
- 3** Ground cable

■ Before recharging

When recharging, the battery produces hydrogen gas which is flammable and explosive. Therefore, before recharging:

- If recharging with the battery installed on the vehicle, be sure to disconnect the ground cable.
- Make sure the power switch on the charger is off when connecting and disconnecting the charger cables to the battery.

 **CAUTION**

■ **Chemicals in the battery**

A battery contains poisonous and corrosive sulfuric acid and may produce hydrogen gas which is flammable and explosive. To reduce the risk of death or serious injury, take the following precautions while working on or near the battery:

- Do not cause sparks by touching the battery terminals with tools.
- Do not smoke or light a match near the battery.
- Avoid contact with eyes, skin and clothes.
- Never inhale or swallow electrolyte.
- Wear protective safety glasses when working near the battery.
- Keep children away from the battery.

■ **Where to safely charge the battery**

Always charge the battery in an open area. Do not charge the battery in a garage or closed room where there is not sufficient ventilation.

■ **How to recharge the battery**

Only perform a slow charge (5 A or less). The battery may explode if charged at a quicker rate.

■ **Emergency measures regarding electrolyte**

- If electrolyte gets in your eyes
Flush your eyes with clean water for at least 15 minutes and get immediate medical attention. If possible, continue to apply water with a sponge or cloth while traveling to the nearest medical facility.
- If electrolyte gets on your skin
Wash the affected area thoroughly. If you feel pain or burning, get medical attention immediately.
- If electrolyte gets on your clothes
It can soak through clothing on to your skin. Immediately take off the clothing and follow the procedure above if necessary.
- If you accidentally swallow electrolyte
Drink a large quantity of water or milk. Get emergency medical attention immediately.

 NOTICE

■ **When recharging the battery**

Never recharge the battery while the engine is running. Also, be sure all accessories are turned off.

Washer fluid

► For vehicles sold in U.S.A.

If any washer does not work, the washer tank may be empty.

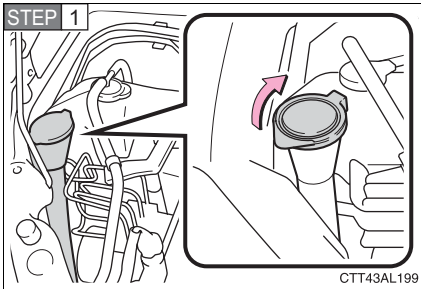

Open the lid.

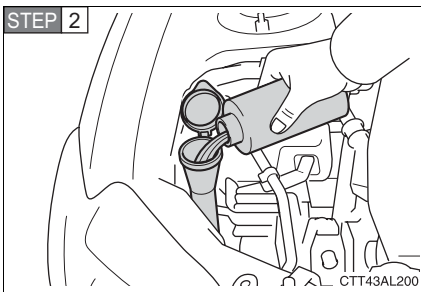

Add washer fluid.

► For vehicles sold in Canada

If any washer does not work or the low windshield washer fluid level warning light comes on, the washer tank may be empty. Add washer fluid.

 CAUTION

■ **When refilling the washer fluid**

Do not refill the washer fluid when the engine is hot or running, as the washer fluid contains alcohol and may catch fire if spilled on the engine etc.

 NOTICE

■ **Do not use any fluid other than washer fluid**

Do not use soapy water or engine antifreeze instead of washer fluid. Doing so may cause streaking on the vehicle's painted surfaces.

■ **Diluting washer fluid**

Dilute washer fluid with water as necessary.

Refer to the freezing temperatures listed on the label of the washer fluid bottle.

Tires

Replace or rotate tires in accordance with maintenance schedules and treadwear.

■ Checking tires

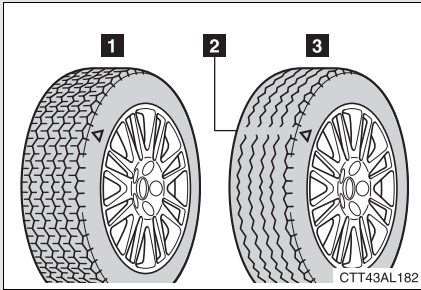

- 1 New tread
- 2 Treadwear indicator
- 3 Worn tread

The location of treadwear indicators is shown by the “TWI” or “△” marks, etc., molded on the sidewall of each tire.

Check spare tire condition and inflation pressure if not rotated.

■ Tire rotation

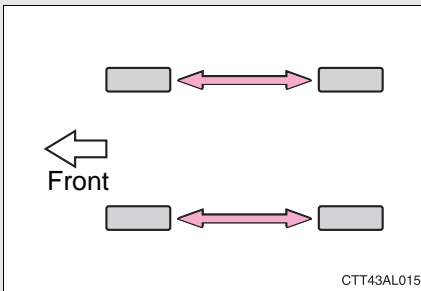

Rotate the tires in the order shown.

To equalize tire wear and extend tire life, Toyota recommends that tire rotation is carried out at the same interval as tire inspection.

AWD models: Do not fail to initialize the tire pressure warning system after tire rotation.

■ The tire pressure warning system (if equipped)

Your Toyota is equipped with a tire pressure warning system that uses tire pressure warning valves and transmitters to detect low tire inflation pressure before serious problems arise. (→P. 400)

The compact spare tire is not equipped with the tire pressure warning valves and transmitters.

Installing tire pressure warning valves and transmitters

When replacing tires or wheels, tire pressure warning valves and transmitters must also be installed.

When new tire pressure warning valves and transmitters are installed, new tire pressure warning valve and transmitter ID codes must be registered in the tire pressure warning computer and the tire pressure warning system must be initialized. Have tire pressure warning valve and transmitter ID codes registered by your Toyota dealer. (→P. 352)

Initializing the tire pressure warning system

■ **The tire pressure warning system must be initialized in the following circumstances:**

- When rotating the tires on vehicles differing with front and rear tire inflation pressure.
- When changing the tire size.

When the tire pressure warning system is initialized, the current tire inflation pressure is set as the pressure benchmark.

■ How to initialize the tire pressure warning system

STEP 1 Park the vehicle in a safe place and turn the engine switch OFF.

While the vehicle is moving, initialization is not performed.

STEP 2 Adjust the tire inflation pressure to the specified cold tire inflation pressure level. (→P. 451)

Make sure to adjust the tire pressure to the specified cold tire inflation pressure level. The tire pressure warning system will operate based on this pressure level.

STEP 3 Turn the engine switch to the “ON” position.

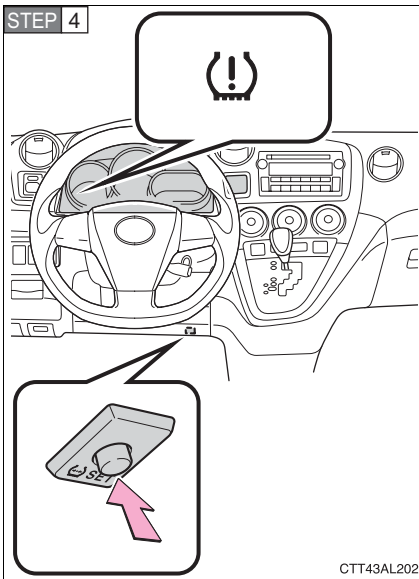

Push and hold the tire pressure warning reset switch until the tire pressure warning light blinks slowly 3 times.

STEP 5 Wait for a few minutes with the engine switch in the “ON” position, and then turn the engine switch to the “LOCK” position.

Registering ID codes

The tire pressure warning valve and transmitter is equipped with a unique ID code. When replacing a tire pressure warning valve and transmitter, it is necessary to register the ID code of tire pressure warning valve and transmitter. Have the ID code registered by your Toyota dealer.

■ When to replace your vehicle's tires

Tires should be replaced if:

- You have tire damage such as cuts, splits, cracks deep enough to expose the fabric, or bulges indicating internal damage
- A tire goes flat repeatedly or cannot be properly repaired due to the size or location of a cut or other damage

If you are not sure, consult with your Toyota dealer.

■ Replacing tires and wheels

If the ID code of the tire pressure warning valve and transmitter is not registered, the tire pressure warning system will not work properly. After driving for about 20 minutes, the tire pressure warning light comes on after blinking for 1 minute to indicate a system malfunction.

■ Tire life

Any tire over 6 years old must be checked by a qualified technician even if they have seldom or never been used or damage is not obvious.

■ If the tread wears down below 0.16 in. (4 mm) on snow tires

The effectiveness of snow tires is lost.

■ If you push the tire pressure warning reset switch accidentally

If initialization is performed, adjust the tire inflation pressure to the specified level and initialize the tire pressure warning system again.

■ When the initialization of the tire pressure warning system has failed

Initialization can be completed in a few minutes. However, in the following cases, the settings have not been recorded and the system will not operate properly. If repeated attempts to record tire inflation pressure settings are unsuccessful, have the vehicle inspected by your Toyota dealer.

- When operating the tire pressure warning reset switch, the tire pressure warning light does not blink 3 times.
- After carrying out the initialization procedure, the tire pressure warning light blinks for 1 minute then stays on after driving for about 20 minutes.

■ Routine tire inflation pressure checks

The tire pressure warning system does not replace routine tire inflation pressure checks. Make sure to check tire inflation pressure as part of your routine of daily vehicle checks.

■ Maximum load of tire

Check that the maximum load of the replacement tire is greater than 1/2 of the Gross Axle Weight Ratings (GAWR) of either the front axle or the rear axle, whichever is greater.

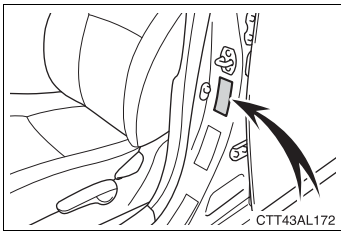

For the GAWR, see the Certification Label. For the maximum load of the tire, see the load limit at maximum cold tire inflation pressure mentioned on the sidewall of the tire. (→P. 457)

■ Low profile tires (models not equipped with 16-inch tires)

Generally, low profile tires will wear more rapidly and tire grip performance will be reduced on snowy and/or icy roads when compared to standard tires. Be sure to use snow tires or tire chains* on snowy and/or icy roads and drive carefully at a speed appropriate for road and weather conditions.

*: Tire chains cannot be mounted on 18-inch tires.

■ Tire types

1 Summer tires

Summer tires are high-speed performance tires best suited to highway driving under dry conditions. Since summer tires do not have the same traction performance as snow tires, summer tires are inadequate for driving on snow-covered or icy roads. For driving on snow-covered roads or icy roads, the use of snow tires is recommended. When installing snow tires, be sure to replace all four tires.

2 All season tires

All season tires are designed to provide better traction in snow and to be adequate for driving in most winter conditions, as well as for use year round. All season tires, however, do not have adequate traction performance compared with snow tires in heavy or loose snow. Also, all season tires fall short in acceleration and handling performance compared with summer tires in highway driving.

3 Snow tires

For driving on snow-covered roads or icy roads, we recommend using snow tires. If you need snow tires, select tires of the same size, construction and load capacity as the originally installed tires. Since your vehicle has radial tires as original equipment, make sure your snow tires also have radial construction. Do not install studded tires without first checking local regulations for possible restrictions. Snow tires should be installed on all wheels. (→P. 162)

■ Initializing the tire pressure warning system

Initialize the tires with the tire inflation pressure adjusted to the specified level.

■ Tire pressure warning system certification

FCC ID: PAXPMV107J

FCC ID: HYQ13BCX

► For vehicles sold in the U.S.A.

This device complies with Part 15 of the FCC Rules. Operation is subject to the following two conditions: (1) This device may not cause harmful interference, and (2) this device must accept any interference received, including interference that may cause undesired operation.

FCC WARNING:

Changes or modifications not expressly approved by the party responsible for compliance could void the user's authority to operate the equipment.

► For vehicles sold in Canada

Operation is subject to the following two conditions: (1) this device may not cause interference, and (2) this device must accept any interference, including interference that may cause undesired operation of the device.

 **CAUTION**

■ **When inspecting or replacing tires**

Observe the following precautions to prevent accidents. Failure to do so may cause damage to parts of the drive train, as well as dangerous handling characteristics, which may lead to an accident resulting in death or serious injury.

- Do not mix tires of different makes, models or tread patterns. Also, do not mix tires of remarkably different treadwear.
- Do not use tire sizes other than those recommended by Toyota.
- Do not mix differently constructed tires (radial, bias-belted or bias-ply tires).
- Do not mix summer, all season and winter tires.

■ **When initializing the tire pressure warning system**

Do not push the tire pressure warning reset switch without first adjusting the tire inflation pressure to the specified level. Otherwise, the tire pressure warning light may not come on even if the tire inflation pressure is low, or it may come on when the tire inflation pressure is actually normal.

 NOTICE**■ Repairing or replacing tires, wheels, tire pressure warning valves, transmitters and tire valve caps**

- When removing or fitting the wheels, tires or the tire pressure warning valves and transmitters, contact your Toyota dealer as the tire pressure warning valves and transmitters may be damaged if not handled correctly.
- When replacing tire valve caps, do not use tire valve caps other than those specified. The cap may become stuck.

■ To avoid damage to the tire pressure warning valves and transmitters

When a tire is repaired with liquid sealants, the tire pressure warning valve and transmitter may not operate properly. If a liquid sealant is used, contact your Toyota dealer or other qualified service shop as soon as possible. Make sure to replace the tire pressure warning valve and transmitter when replacing the tire. (→P. 350)

■ Driving on rough roads

Take particular care when driving on roads with loose surfaces or pot-holes.

These conditions may cause losses in tire air pressure, reducing the cushioning ability of the tires. In addition, driving on rough roads may cause damage to the tires themselves, as well as the vehicle's wheels and body.

■ Low profile tires and wheels

Wheels with profile tires like 17- and 18-inch tires may cause greater damage than usual to the tire wheel when receiving impact from the road surface. Therefore pay attention to the following:

- Be sure to use proper tire inflation pressure. If tires are under-inflated, they may be damaged more severely.
- Avoid pot holes, uneven pavement, curbs and other road hazards. Failure to do so can lead to severe tire and wheel damage.

■ If tire inflation pressures become low while driving

Do not continue driving, or your tires and/or wheels may be ruined.

4-3. Do-it-yourself maintenance

Tire inflation pressure

■ Tire inflation pressure

The recommended cold tire inflation pressure and tire size is displayed on the tire and loading information label. (→P. 451)

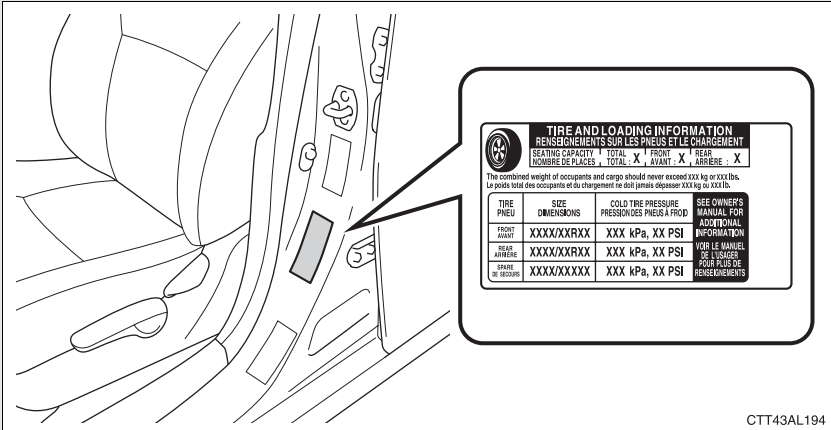

CTT43AL194

■ Inspection and adjustment procedure

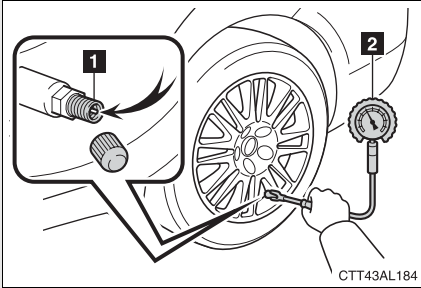

1 Tire valve

2 Tire pressure gauge

STEP 1 Remove the tire valve cap.

STEP 2 Press the tip of the tire pressure gauge onto the tire valve.

STEP 3 Read the pressure using the graduations of the gauge.

STEP 4 If the tire inflation pressure is not at the recommended level adjust the pressure.

If you add too much air, press the center of the valve to lower.

STEP 5 After completing the tire inflation pressure measurement and adjustment, apply soapy water to the valve and check for leakage.

STEP 6 Reinstall the tire valve cap.

■ Tire inflation pressure check interval

You should check tire inflation pressure every two weeks, or at least once a month.

Do not forget to check the spare.

■ **Effects of incorrect tire inflation pressure**

Driving with incorrect tire inflation pressure may result in the following:

- Reduced fuel efficiency
- Reduced driving comfort and tire life
- Reduced safety
- Damage to the drive train

If a tire needs frequent refilling, have it checked by your Toyota dealer.

■ **Instructions for checking tire inflation pressure**

When checking tire inflation pressure, observe the following:

- Check only when the tires are cold.
If your vehicle has been parked for at least 3 hours and has not been driven for more than 1 mile or 1.5 km, you will get an accurate cold tire inflation pressure reading.
- Always use a tire pressure gauge.
The appearance of the tire can be misleading. In addition, tire inflation pressures that are even just a few pounds off can degrade ride and handling.
- Do not bleed or reduce tire inflation pressure after driving. It is normal for the tire inflation pressure to be higher after driving.
- Never exceed the vehicle capacity weight.
Passengers and luggage weight should be placed so that the vehicle is balanced.

 CAUTION**■ Proper inflation is critical to save tire performance**

Keep your tires properly inflated. Otherwise, the following conditions may occur and result in an accident causing death or serious injury.

- Excessive wear
- Uneven wear
- Poor handling
- Possibility of blowouts resulting from overheated tires
- Poor sealing of the tire bead
- Wheel deformation and/or tire separation
- A greater possibility of tire damage from road hazards

 NOTICE**■ When inspecting and adjusting tire inflation pressure**

Be sure to reinstall the tire valve caps.

Without the valve caps, dirt or moisture could get into the valve and cause air leakage, which could result in an accident. If the caps have been lost, replace them as soon as possible.

Wheels

If a wheel is bent, cracked or heavily corroded, it should be replaced.

Otherwise, the tire may separate from the wheel or cause loss of handling control.

■ Wheel selection

When replacing wheels, care should be taken to ensure that they are equivalent to those removed in load capacity, diameter, rim width, and inset*.

Replacement wheels are available at your Toyota dealer.

*: Conventionally referred to as “offset”.

Toyota does not recommend using:

- Wheels of different sizes or types
- Used wheels
- Bent wheels that have been straightened

■ Aluminum wheel precautions

- Use only Toyota wheel nuts and wrenches designed for use with your aluminum wheels.
- When rotating, repairing or changing your tires, check that the wheel nuts are still tight after driving 1000 miles (1600 km).
- Be careful not to damage the aluminum wheels when using tire chains.
- Use only Toyota genuine balance weights or equivalent and use a plastic or rubber hammer when balancing your wheels.

■ When replacing wheels

The wheels of your Toyota, except for the compact spare tire, are equipped with tire pressure warning valves and transmitters that allow the tire pressure warning system to provide advanced warning in the event of a loss in tire inflation pressure. Whenever wheels are replaced, the tire pressure warning valves and transmitters must be installed. (→P. 350)

▲ CAUTION

■ When replacing wheels

- Do not use wheels that are a different size from those recommended in the Owner's Manual, as this may result in loss of handling control.
- Never use an inner tube in a leaking wheel which is designed for a tubeless tire. Doing so may result in an accident, causing serious injury or death.

■ When installing the wheel nuts

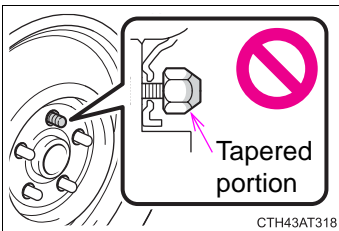

- Be sure to install the wheel nuts with the tapered end facing inward. Installing the nuts with the tapered end facing outward can cause wheel to break and eventually cause a wheel to come off while driving, which could lead to an accident resulting in death or serious injury.

- Never use oil or grease on the wheel bolts or wheel nuts.

Oil and grease may cause the wheel nuts to be excessively tightened, leading to bolt or disc wheel damage. In addition, the oil or grease can cause the wheel nuts to loosen and the wheel may fall off, causing an accident and resulting in death or serious injury. Remove any oil or grease from the wheel bolts or wheel nuts.

 NOTICE

■ **Replacing tire pressure warning valves and transmitters**

- Because tire repair or replacement may affect the tire pressure warning valves and transmitters, make sure to have tires serviced by your Toyota dealer or other qualified service shop. In addition, make sure to purchase your tire pressure warning valves and transmitters at your Toyota dealer.
- Ensure that only genuine Toyota wheels are used on your vehicle. Tire pressure warning valves and transmitters may not work properly with non-genuine wheels.

4-3. Do-it-yourself maintenance

Air conditioning filter

The air conditioning filter must be changed regularly to maintain air conditioning efficiency.

■ Removal method

STEP 1 Turn the engine switch OFF.

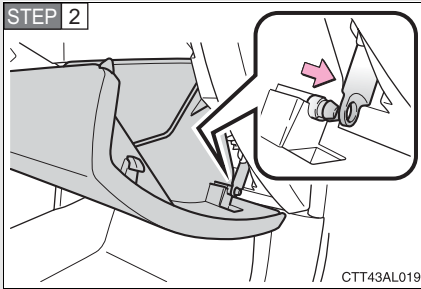

Open the glove box. Slide off the damper.

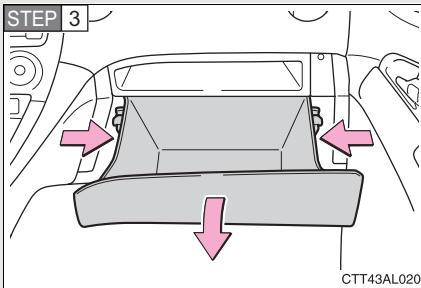

Push in each side of the glove box to disconnect the claws.

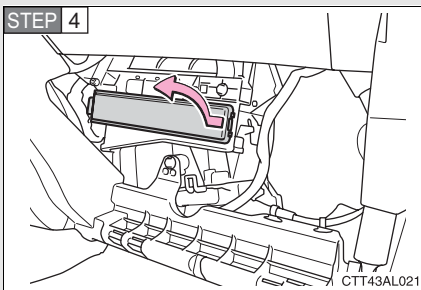

Remove the filter cover.

■ Replacement method

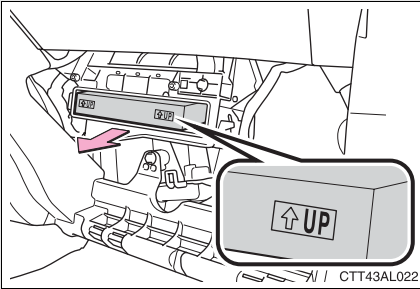

Remove the air conditioning filter and replace it with a new one.

The “↑UP” marks shown on the filter should be pointing up.

■ Checking interval

Replace the air conditioning filter according to the maintenance schedule. In dusty areas or areas with heavy traffic flow, early replacement may be required. (For scheduled maintenance information, please refer to the “Scheduled Maintenance Guide” or “Owner’s Manual Supplement”.)

■ If air flow from the vents decreases dramatically

The filter may be clogged. Check the filter and replace if necessary.

NOTICE

■ When using the air conditioning system

Make sure that a filter is always installed.

Using the air conditioning system without a filter may cause damage to the system.

Replace the battery with a new one if it is discharged.

■ **You will need the following items:**

- Flathead screwdriver (To prevent damage to the key, cover the tip of the screwdriver with a rag.)
- Lithium battery CR2025

■ **Replacing the battery**

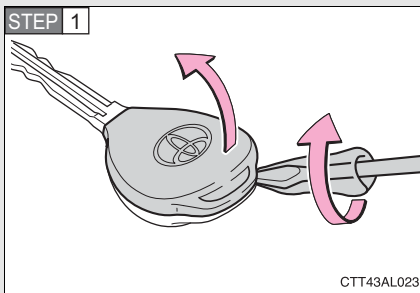

Remove the cover.

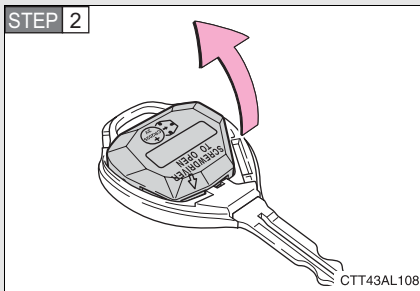

Remove the module.

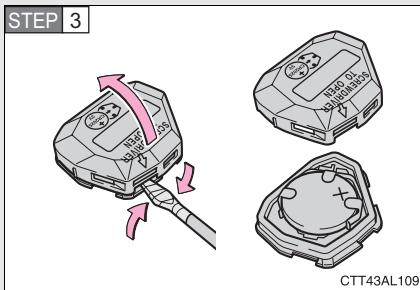

Open the case cover using a flathead screwdriver protected with tape etc. and remove the depleted battery.

Insert a new battery with the "+" terminal facing up.

■ **If the key battery is discharged**

The following symptoms may occur.

- The wireless remote control will not function properly.
- The operational range is reduced.

■ **Use CR2025 lithium battery**

- Batteries can be purchased at your Toyota dealer, jewelers, or camera stores.
- Replace only with the same or equivalent type recommended by your Toyota dealer.
- Dispose of used batteries according to the local laws.

 **CAUTION**

■ **Removed battery and other parts**

Keep away from children. These parts are small and if swallowed by a child, they can cause choking. Failure to do so could result in death or serious injury.

 **NOTICE**

■ **For normal operation after replacing the battery**

Observe the following precautions to prevent accidents.

- Always work with dry hands.
Moisture may cause the battery to rust.
- Do not touch or move any other components inside the remote control.
- Do not bend either of the battery terminals.

4-3. Do-it-yourself maintenance

Checking and replacing fuses

If any of the electrical components do not operate, a fuse may have blown. If this happens, check and replace the fuses as necessary.

STEP 1 Turn the engine switch OFF.

STEP 2 Open the fuse box cover.

► Engine compartment

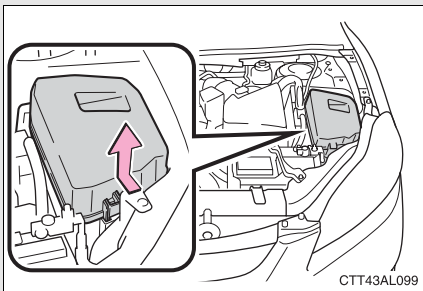

Push the tab in and lift the lid off.

► Under the driver's side instrument panel

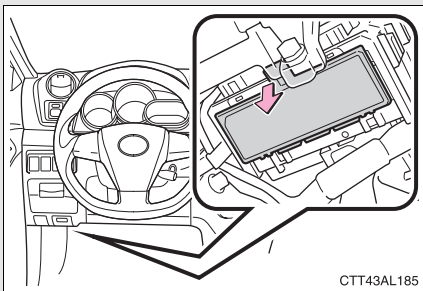

Remove the lid.

STEP 3 After a system failure, see “Fuse layout and amperage ratings” (→P. 372) for details about which fuse to check.

STEP 4

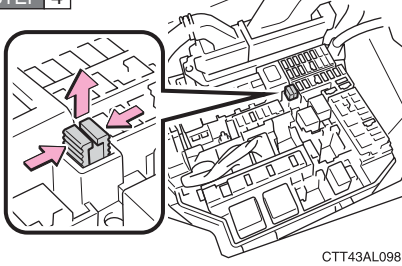

Take out the pullout tool.

Only type A fuse can be removed using the pullout tool.

STEP 5 For type A and B fuses: Remove the fuse.

STEP 6 Check if the fuse has blown.

► Type A

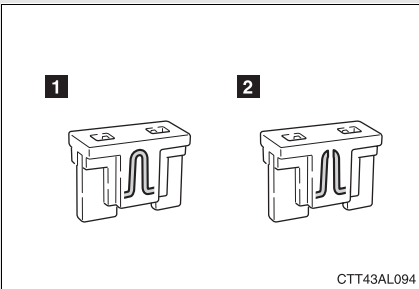

1 Normal fuse

2 Blown fuse

Replace it with one of an appropriate amperage rating. The amperage rating can be found on the fuse box lid.

► Type B

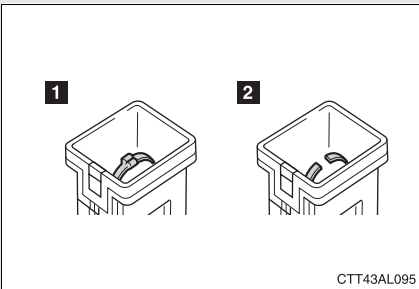

1 Normal fuse

2 Blown fuse

Replace it with one of an appropriate amperage rating. The amperage rating can be found on the fuse box lid.

► Type C

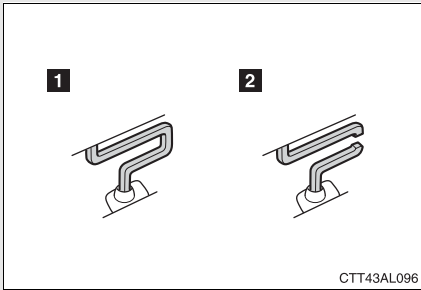

1 Normal fuse

2 Blown fuse

Contact your Toyota dealer.

► Type D

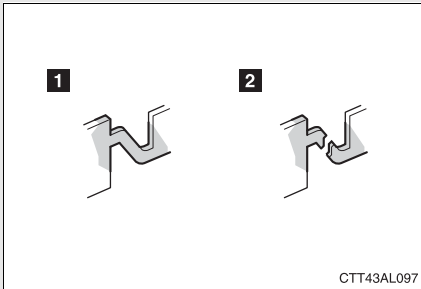

1 Normal fuse

2 Blown fuse

Contact your Toyota dealer.

Fuse layout and amperage ratings

■ Engine compartment

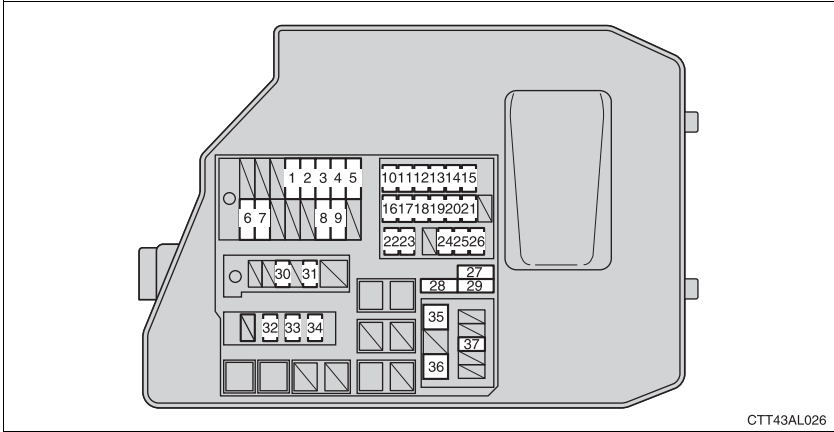

CTT43AL026

Fuse		Ampere	Circuit
1	CDS FAN	30 A	Electric cooling fan(s)
2	RDI FAN	40 A	Electric cooling fan(s)
3	ABS NO. 3	30 A	Anti-lock brake system, vehicle stability control system
4	ABS NO. 1	50 A	Anti-lock brake system, vehicle stability control system
5	HTR	50 A	Air conditioning system
6	ALT	120 A	Charging system, RDI FAN, CDS FAN, ABS NO. 1, ABS NO. 3, PWR OUTLET/INVERTER, HTR, HTR SUB NO. 1, HTR SUB NO. 3, ACC, CIG, ECU-IG NO. 2, HTR-IG, WIPER, RR WIPER, WASHER, ECU-IG NO. 1, AM1, 4WD, DOOR, STOP, FR DOOR, POWER, RR DOOR, RL DOOR, OBD, ACC-B, FR FOG, SUNROOF, DEF, MIR HTR, TAIL, PANEL

Fuse		Ampere	Circuit
7	EPS	60 A	Electric power steering
8	P/I	50 A	EFI MAIN, HORN, IG2
9	H-LP MAIN	50 A	H-LP LH LO, H-LP RH LO, H-LP LH HI, H-LP RH HI
10	EFI NO. 2	10 A	Emission control system
11	EFI NO. 1	10 A	Multiport fuel injection system/ sequential multiport fuel injection system
12	H-LP RH HI	10 A	Right-hand headlight (high beam)
13	H-LP LH HI	10 A	Left-hand headlight (high beam)
14	H-LP RH LO	10 A	Right-hand headlight (low beam)
15	H-LP LH LO	10 A	Left-hand headlight (low beam)
16	ETCS	10 A	Multiport fuel injection system/ sequential multiport fuel injection system
17	TURN-HAZ	10 A	Turn signal lights, emergency flashers
18	ALT-S	7.5 A	Charging system
19	AM2 NO. 2	7.5 A	Starting system, multiport fuel injection system/sequential multiport fuel injection system
20	AM2	30 A	Starting system, multiport fuel injection system/sequential multiport fuel injection system
21	STRG LOCK	20 A	No circuit
22	IG2 NO. 2	7.5 A	Starting system
23	ECU-B2	10 A	PTC heater
24	ECU-B	10 A	Main body ECU, gauge and meters, daytime running light system
25	RAD NO. 1	15 A	Audio system

4-3. Do-it-yourself maintenance

Fuse		Ampere	Circuit
26	DOME	10 A	Interior lights, personal light, clock, wireless remote control
27	SPARE	10 A	Spare fuse
28	SPARE	30 A	Spare fuse
29	SPARE	20 A	Spare fuse
30	AMP	30 A	No circuit
31	MAYDAY	10 A	No circuit
32	EFI MAIN	20 A	Multiport fuel injection system/ sequential multiport fuel injection system, EFI NO. 1, EFI NO. 2
33	HORN	10 A	Horn
34	IG2	15 A	Multiport fuel injection system/ sequential multiport fuel injection system, starting system, IGN, METER
35	HTR SUB NO. 1	30 A	PTC heater
36	HTR SUB NO. 3	30 A	PTC heater
37	PWR OUTLET/ INVERTER	15 A	Power outlet

■ Under the driver's side instrument panel

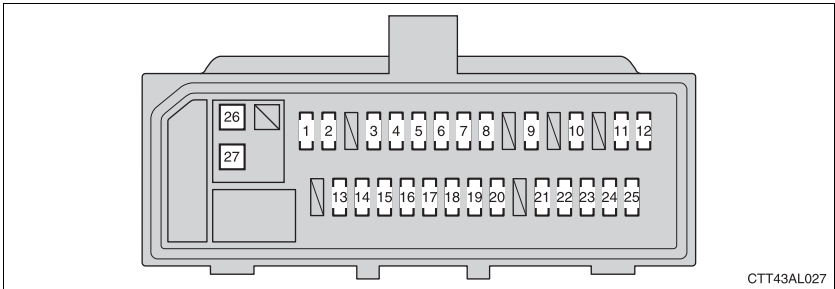

Fuse		Ampere	Circuit
1	TAIL	10 A	Parking lights, tail lights, license plate lights, multiport fuel injection system/sequential multiport fuel injection system, instrument cluster lights
2	PANEL	7.5 A	Switch illumination
3	FR DOOR	20 A	Power windows, electric moon roof
4	RL DOOR	20 A	Power windows
5	RR DOOR	20 A	Power windows
6	SUNROOF	20 A	Electric moon roof
7	CIG	15 A	Cigarette lighter, power outlet
8	ACC	7.5 A	Outside rear view mirrors, audio system, main body ECU, clock, shift lock control system
9	MIR HTR	10 A	Multiport fuel injection system/sequential multiport fuel injection system, outside rear view mirror heaters
10	PWR OUTLET	15 A	No circuit

Fuse		Ampere	Circuit
11	IGN	7.5 A	SRS airbag system, multiport fuel injection system/sequential multiport fuel injection system, front passenger occupant classification system
12	METER	7.5 A	Gauge and meters
13	HTR-IG	10 A	Air conditioning system, rear window defogger, PTC heater
14	WIPER	25 A	Windshield wipers
15	RR WIPER	15 A	Rear window wiper
16	WASHER	15 A	Windshield washer
17	ECU-IG NO. 1	10 A	Main body ECU, electric power steering, electric cooling fan(s), shift lock control system, anti-lock brake system, multiport fuel injection system/sequential multiport fuel injection system, tire pressure warning system, vehicle stability control system, all wheel drive system
18	ECU-IG NO. 2	10 A	Back-up lights, charging system, rear window defogger, auto anti-glare inside rear view mirror
19	OBD	7.5 A	On-board diagnosis system
20	STOP	10 A	Stop lights, high mounted stop-light, anti-lock brake system, vehicle stability control system, multiport fuel injection system/sequential multiport fuel injection system, shift lock control system
21	DOOR	25 A	Power door lock system
22	ACC-B	25 A	CIG, ACC
23	4WD	7.5 A	All wheel drive system

Fuse		Ampere	Circuit
24	FR FOG	15 A	Front fog lights
25	AM1	7.5 A	Starting system, shift lock control system
26	DEF	30 A	Rear window defogger, MIR HTR
27	POWER	30 A	Power windows

■ After a fuse is replaced

- If the lights do not turn on even after the fuse has been replaced, a bulb may need replacing. (→P. 378)
- If the replaced fuse blows again, have the vehicle inspected by your Toyota dealer.

■ If there is an overload in the circuits

The fuses are designed to blow, protecting the wiring harness from damage.

CAUTION

■ To prevent system breakdowns and vehicle fire

Observe the following precautions.

Failing to do so may cause damage, and possibly a fire or injury.

- Never use a fuse of a higher amperage rating than indicated, or use any other object in place of a fuse.
- Always use a genuine Toyota fuse or equivalent.
Never replace a fuse with a wire, even as a temporary fix.
This can cause extensive damage or even fire.
- Do not modify the fuse or the fuse box.

NOTICE

■ Before replacing fuses

Have the cause of electrical overload determined and repaired by your Toyota dealer, as soon as possible.

Light bulbs

You may replace the following bulbs yourself. The difficulty level of replacement varies depending on the bulb. If necessary bulb replacement seems difficult to perform, contact your Toyota dealer.

For more information about replacing other light bulbs, contact your Toyota dealer.

■ Prepare a replacement light bulb.

Check the wattage of the light bulb being replaced. (→P. 453)

■ Front bulb locations

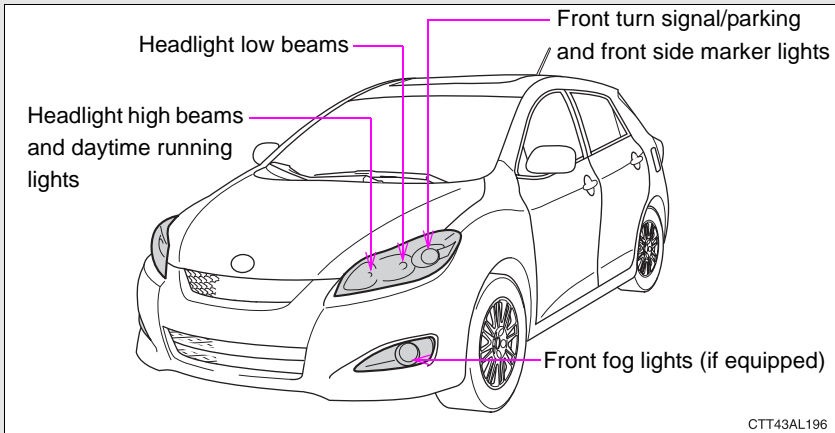

■ Rear bulb locations

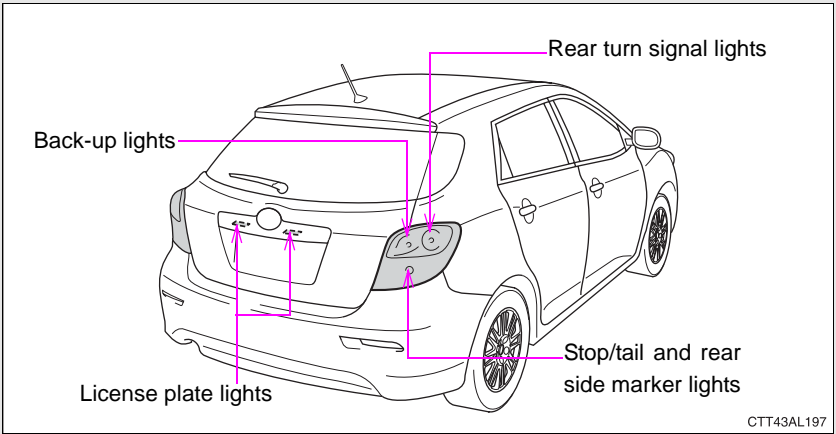

Replacing light bulbs

■ Headlight low beams

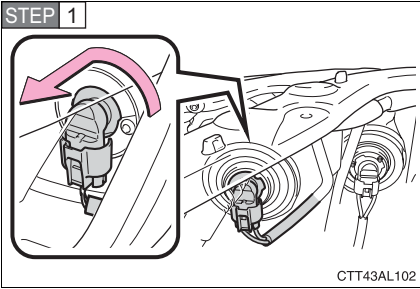

Turn the bulb base counterclockwise.

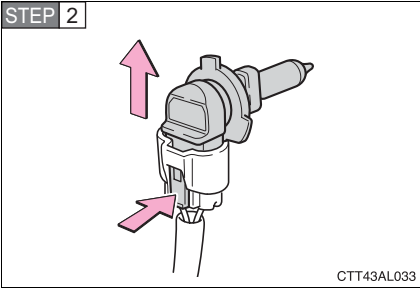

Unplug the bulb while depressing the lock release.

■ Headlight high beams and daytime running lights

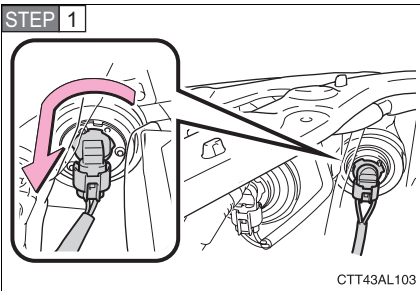

Turn the bulb base counterclockwise.

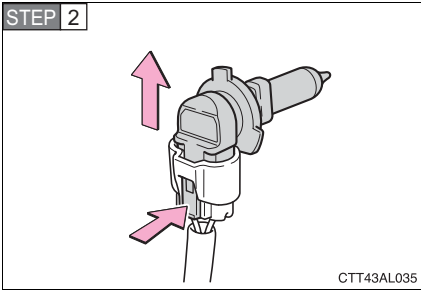

Unplug the bulb while depressing the lock release.

■ **Front fog lights (if equipped)**

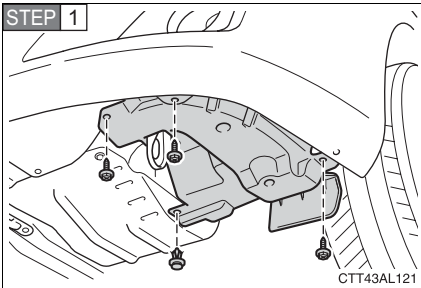

Remove the fender liner bolts and clip.

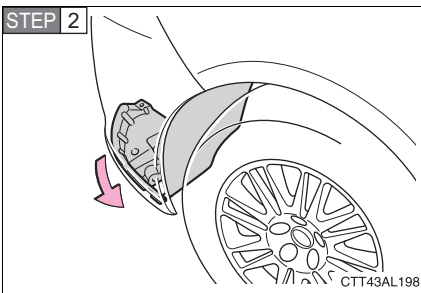

Partly remove the fender liner.

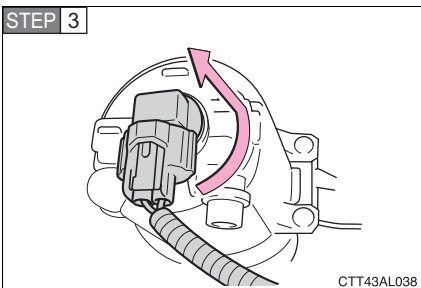

Turn the bulb base counterclockwise.

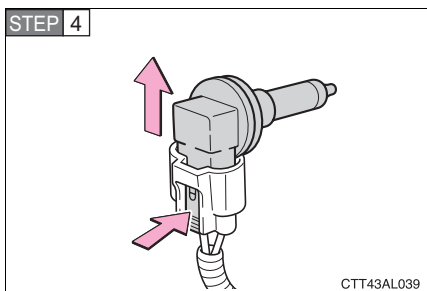

Unplug the bulb while depressing the lock release.

■ Front turn signal/parking and front side marker lights

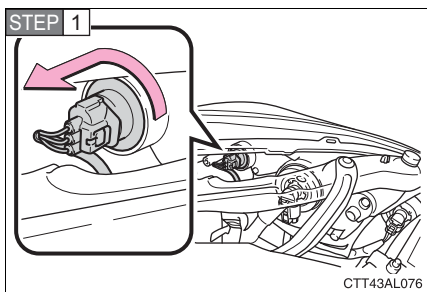

Turn the bulb base counterclockwise.

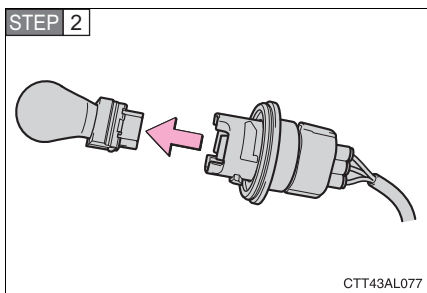

Remove the light bulb.

■ **Stop/tail and rear side marker lights, rear turn signal lights and back-up lights**

STEP 1 Open the back door.

▶ Left side

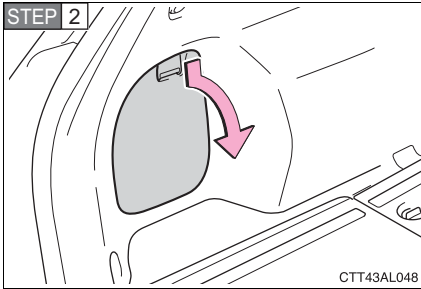

Remove the cover.

▶ Right side (type A)

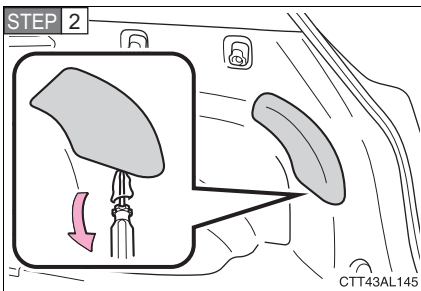

Remove the cover using the flat-head screwdriver.

To protect the cover, place a rag between the flathead screwdriver and the cover.

▶ Right side (type B)

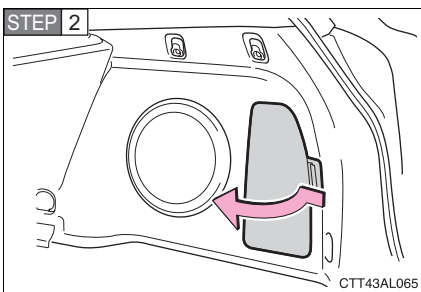

Remove the cover.

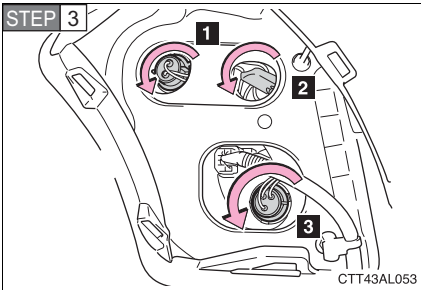

Turn the bulb base counterclockwise.

- 1** Rear turn signal light
- 2** Back-up light
- 3** Stop/tail and rear side marker light

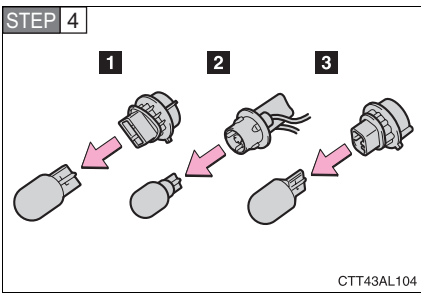

Remove the light bulb.

- 1** Rear turn signal light
- 2** Back-up light
- 3** Stop/tail and rear side marker light

■ License plate lights

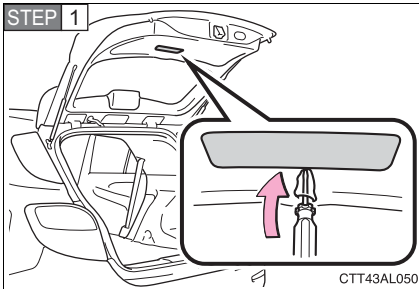

Open the back door and remove the cover.

To protect the cover, place a rag between the flathead screwdriver and the cover, as shown in the illustration.

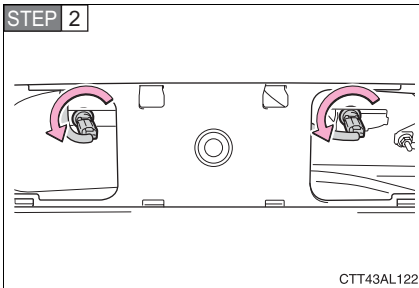

Turn the bulb base counterclockwise.

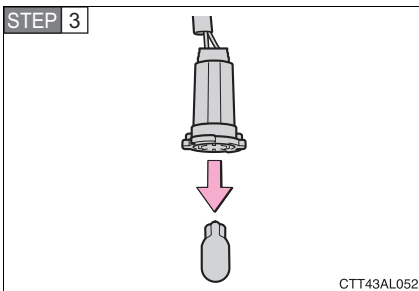

Remove the light bulb.

■ LED high mounted stoplight

The high mounted stoplight consists of a number of LEDs. If any of the LEDs burn out, take your vehicle to your Toyota dealer to have the light replaced.

■ Condensation build-up on the inside of the lens

Contact your Toyota dealer for more information in the following situations. Temporary condensation build-up on the inside of the headlight lens does not indicate a malfunction.

- Large drops of water are built up on the inside of the lens.
- Water has built up inside the headlight.

■ Removing and installing the fender liner clip

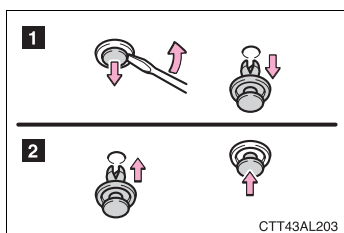

1 Removing

2 Installing

⚠ CAUTION

■ Replacing light bulbs

- Turn off the headlights. Do not attempt to replace the bulb immediately after turning off the headlights. The bulbs become very hot and may cause burns.
- Do not touch the glass portion of the light bulb with bare hands. Hold the bulb by the plastic or metal portion. If the bulb is scratched or dropped it may blow out or crack.
- Fully install light bulbs and any parts used to secure them. Failing to do so may result in heat damage, fire, or water entering the headlight unit. This may damage the headlights or cause condensation to build up on the lens.

■ To prevent damage or fire

Make sure bulbs are fully seated and locked.

5-1. Essential information

Emergency flashers

Use the emergency flashers if the vehicle malfunctions or is involved in an accident.

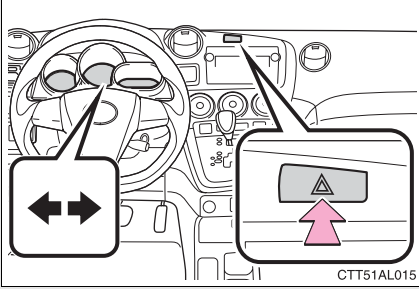

Press the switch to flash all the turn signal lights. To turn them off, press the switch once again.

NOTICE

To prevent battery discharge

Do not leave the emergency flashers on longer than necessary when the engine is not running.

If your vehicle needs to be towed

If towing is necessary, we recommend having your vehicle towed by your Toyota dealer or a commercial towing service, using a lift-type truck or a flat bed truck.

Use a safety chain system for all towing, and abide by all state/provincial and local laws.

2WD models: If towing your vehicle with a wheel-lift type truck from the front, the vehicle's rear wheels and axles must be in good conditions. (→P. 391, 394)

If they are damaged, use a towing dolly or flat bed truck.

AWD models: If towing your vehicle with a wheel-lift type truck, use a towing dolly. (→P. 391, 394)

Before towing

The following may indicate a problem with your transmission. Contact your Toyota dealer before towing.

- The engine is running, but the vehicle will not move.
- The vehicle makes an abnormal sound.

Emergency towing

If a tow truck is not available, in an emergency your vehicle may be temporarily towed using a cable or chain secured to the emergency towing eyelet. This should only be attempted on hard surfaced roads for short distances at low speeds.

A driver must be in the vehicle to steer and operate the brakes. The vehicle's wheels, drive train, axles, steering and brakes must be in good condition.

► 1.8 L 4-cylinder (2ZR-FE) engine

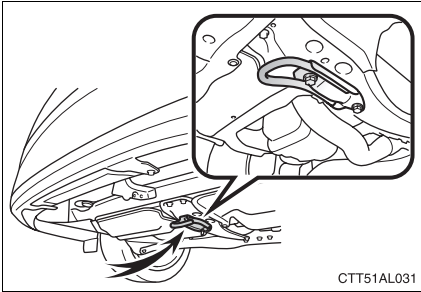

Towing eyelet

► 2.4 L 4-cylinder (2AZ-FE) engine

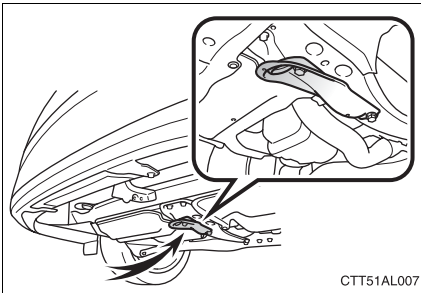

Towing eyelet

Towing with a sling-type truck

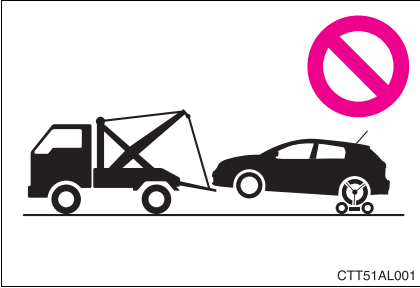

Do not tow with a sling-type truck to prevent body damage.

Towing with a wheel-lift type truck

► From the front (2WD models)

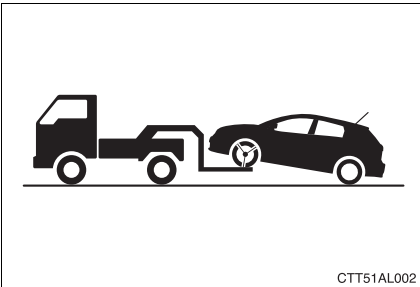

Release the parking brake.

► From the front (AWD models)

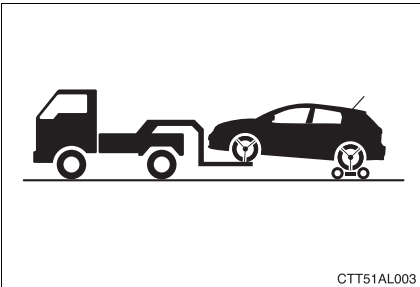

Use a towing dolly under the rear wheels.

► From the rear

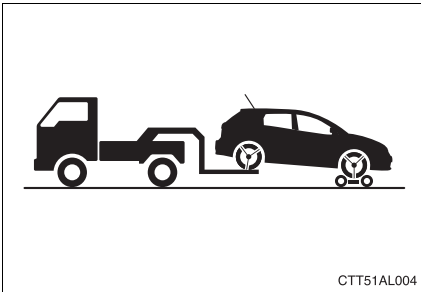

Automatic transmission: Use a towing dolly under the front wheels.

Manual transmission: We recommend to use a towing dolly under the front wheels.

When not using a towing dolly, turn the engine switch to the "ACC" position and shift the shift lever to N.

Using a flat bed truck

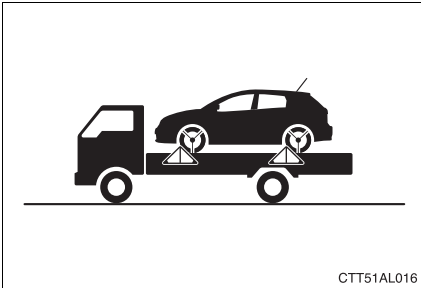

If you use chains or cables to tie down your vehicle, the angles shaded in black must be 45°.

Do not overly tighten the tie downs or the vehicle may be damaged.

■ **Emergency towing procedure**

STEP 1 Release the parking brake.

STEP 2 Shift the shift lever to N.

STEP 3 Turn the engine switch to the "ACC" (engine off) or "ON" (engine running) position.

 **CAUTION****■ Caution while towing**

- Use extreme caution when towing the vehicle.
Avoid sudden starts or erratic driving maneuvers which place excessive stress on the emergency towing eyelet and the cables or chains. Always be cautious of the surroundings and other vehicles while towing.
- If the engine is not running, the power assist for the brakes and steering will not function, making steering and braking more difficult.

 NOTICE

■ To prevent body damage when towing with a sling-type truck

Do not tow with a sling-type truck, either from the front or rear.

■ To prevent causing serious damage to the transmission and Active Torque Control 4WD system (AWD models) when towing using a wheel-lift type truck (vehicles with an automatic transmission)

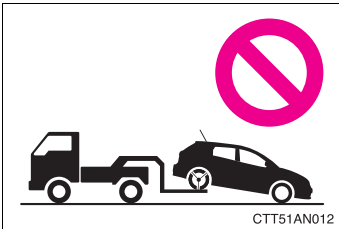

2WD models: Never tow this vehicle from the rear with the front wheels on the ground. This may cause serious damage to the transmission. If towing from the rear, use a towing dolly.

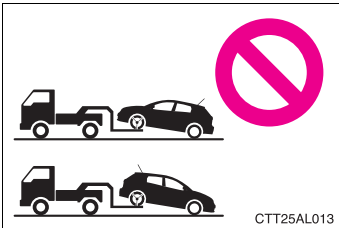

AWD models: Never tow this vehicle with any of the wheels on the ground. This may cause serious damage to the transmission and Active Torque Control 4WD system. Use a towing dolly.

■ To prevent damaging the vehicle when towing using a wheel-lift type truck

● When raising the vehicle, ensure adequate ground clearance for towing at the opposite end of the raised vehicle. Without adequate clearance, the vehicle could be damaged while being towed.

● Vehicles with a manual transmission: Do not tow the vehicle when the engine switch is in the “LOCK” position or the key is removed. The steering lock mechanism is not strong enough to hold the front wheels straight.

■ Recreational towing (behind motor home, etc.)

Vehicles with an automatic transmission: Never dinghy tow your vehicle to prevent causing serious damage to the Active Torque Control 4WD system (AWD models) and transmission. (→P. 181)

If you think something is wrong

If you notice any of the following symptoms, your vehicle probably needs adjustment or repair. Contact your Toyota dealer as soon as possible.

■ Visible symptoms

- Fluid leaks under the vehicle
(Water dripping from the air conditioning after use is normal.)
- Flat-looking tires or uneven tire wear
- Engine coolant temperature gauge needle continually points higher than normal

■ Audible symptoms

- Changes in exhaust sound
- Excessive tire squeal when cornering
- Strange noises related to the suspension system
- Pinging or other noises related to the engine

■ Operational symptoms

- Engine missing, stumbling or running rough
- Appreciable loss of power
- Vehicle pulls heavily to one side when braking
- Vehicle pulls heavily to one side when driving on a level road
- Loss of brake effectiveness, spongy feeling, pedal almost touches the floor

Fuel pump shut off system

To minimize the risk of fuel leakage when the engine stalls or an air-bag inflates upon collision, the fuel pump shut off system stops supplying fuel to the engine.

Follow the procedure below to restart the engine after the system is activated.

STEP 1 Turn the engine switch to the “ACC” or “LOCK” position.

STEP 2 Restart the engine.

 **NOTICE**

■ Before starting the engine

Inspect the ground under the vehicle.

If you find that fuel has leaked on to the ground, the fuel system has been damaged and is in need of repair. Do not restart the engine. Have the vehicle checked and repaired by your Toyota dealer.



5-2. Steps to take in an emergency

If a warning light turns on or a warning buzzer sounds...

Calmly perform the following actions if any of the warning lights turn on or flash. If a light turns on or flashes, but then turns off, this does not necessarily indicate a malfunction in the system.

Stop the vehicle immediately. Continuing to drive the vehicle may be dangerous.



The following warning indicates a possible problem in the brake system. Immediately stop the vehicle in a safe place and contact your Toyota dealer.

Warning light	Warning light/Details
 (U.S.A.)	Brake system warning light (warning buzzer)* <ul style="list-style-type: none">• Low brake fluid• Malfunction in the brake system This light also comes on when the parking brake is not released. If the light turns off after the parking brake is fully released the system is operating normally.
 (Canada)	

*: Parking brake engaged warning buzzer: The buzzer sounds to indicate that the parking brake is still engaged (with the vehicle having reached a speed of 3 mph [5 km/h]).



Stop the vehicle immediately.







The following warning indicates the possibility of damage to the vehicle that may lead to an accident. Immediately stop the vehicle in a safe place and contact your Toyota dealer.

Warning light	Warning light/Details
	Charging system warning light Indicates a malfunction in the vehicle's charging system.
	Low engine oil pressure warning light Indicates that the engine oil pressure is too low.

Have the vehicle inspected immediately.

Failing to investigate the cause of the following warnings may lead to the system operating abnormally and possibly cause an accident. Have the vehicle inspected by your Toyota dealer immediately.

Warning light	Warning light/Details
 (U.S.A.)  (Canada)	Malfunction indicator lamp Indicates a malfunction in: <ul style="list-style-type: none"> • The electronic engine control system; • The electronic throttle control system; or • The electronic automatic transmission control system (if equipped).
	SRS warning light Indicates a malfunction in: <ul style="list-style-type: none"> • The SRS airbag system; • The front passenger occupant classification system; or • The seat belt pretensioner system.

Warning light	Warning light/Details
 (U.S.A.)  (Canada)	ABS warning light Indicates a malfunction in: <ul style="list-style-type: none"> • ABS; or • The brake assist system.
	Electric power steering system warning light (warning buzzer) Indicates a malfunction in the EPS system.
	Slip indicator light Indicates a malfunction in: <ul style="list-style-type: none"> • The VSC system; or • The TRAC system.
 (Flashes)	Cruise control indicator light (if equipped) Indicates a malfunction in the cruise control system.
 (AWD models)	Active Torque Control 4WD system warning light Indicates a malfunction in the Active Torque Control 4WD system.

■ If the malfunction indicator lamp comes on while driving

First check the following:

- Is the fuel tank empty?
If it is, fill the fuel tank immediately.
- Is the fuel tank cap loose?
If it is, tighten it securely.

The malfunction indicator lamp will go off after taking several driving trips. If the malfunction indicator lamp does not go off even after several trips, contact your Toyota dealer as soon as possible.





⚠ CAUTION**■ When the electric power steering warning light comes on**

The steering wheel may become extremely heavy.

If the steering wheel becomes heavier than usual when operating, firmly hold and operate it using more force than usual.

Follow the correction procedures.

After taking the specified steps to correct the suspected problem, check that the warning light turns off.

Warning light	Warning light/Details	Correction procedure
	Open door warning light (warning buzzer)*¹ Indicates that a door is not fully closed.	Check that all doors are closed.
	Low fuel level warning light Indicates that remaining fuel is about 2.0 gal. (7.5 L, 1.6 Imp. gal.) or less.	Refuel the vehicle.
 (on the instrument cluster)	Driver's seat belt reminder light (warning buzzer)*² Warns the driver to fasten his/her seat belt.	Fasten the seat belt.
 (on the center panel)	Front passenger's seat belt reminder light (warning buzzer)*² Warns the front passenger to fasten his or her seat belt.	Fasten the seat belt.
 (Canada)	Low windshield washer fluid level warning light Low level of washer fluid	Fill the tank.

Warning light	Warning light/Details	Correction procedure
	Tire pressure warning light (if equipped)	
	When the light comes on: Low tire inflation pressure such as <ul style="list-style-type: none"> • Natural causes (→P. 403) • Flat tire (→P. 408) 	Adjust the tire inflation pressure to the specified level. The light will turn off after a few minutes. In case the light does not turn off even if the tire inflation pressure is adjusted, have the system checked by your Toyota dealer.
	When the light comes on after blinking for 1 minute: Malfunction in the tire pressure warning system (→P. 404)	Have the system checked by your Toyota dealer.

Warning light	Warning light/Details	Correction procedure
<div style="border: 1px solid black; padding: 2px; display: inline-block; text-align: center; width: 60px;"> MAINT REQD </div> (U.S.A.)	Maintenance required reminder light Indicates that maintenance is required according to the driven distance on the maintenance schedule.* ³	
	Illuminates for about 3 seconds and then flashes for about 15 seconds approximately 4500 miles (7200 km) after the maintenance data has been reset.	If necessary, perform maintenance.
	Comes on and remains on if the distance driven exceeds 5000 miles (8000 km) after the maintenance data has been reset. (The indicator will not work properly unless the maintenance data has been reset.)	Perform the necessary maintenance. Please reset the maintenance data after the maintenance is performed. (→P. 321)

*1: Open door warning buzzer:

A buzzer will sound if the vehicle reaches a speed of 3 mph (5 km/h) with any door open.

*2: Driver's and front passenger's seat belt warning buzzers:

The driver's and front passenger's seat belts warning buzzers sound to alert the driver and front passenger that his or her seat belt is not fastened. The buzzer sounds intermittently for 10 seconds after the vehicle has reached a speed of 12 mph (20 km/h). Then, if the seat belt is still unfastened, the buzzer will sound at a different tone for 20 more seconds.

*3: Refer to the separate "Scheduled Maintenance Guide" or "Owner's Manual Supplement" for the maintenance interval applicable to your vehicle.

■ SRS warning light

This warning light system monitors the airbag sensor assembly, front airbag sensors, side and curtain shield airbag sensors, curtain shield airbag sensors, driver's seat position sensor, driver's seat belt buckle switch, front passenger occupant classification system (ECU and sensors), "AIR BAG ON" indicator light, "AIR BAG OFF" indicator light, front passenger's seat belt buckle switch, seat belt pretensioners and force limiters, airbags, interconnecting wiring and power sources. (→P. 73)

■ Front passenger detection sensor and passenger seat belt reminder

- If luggage is placed on the front passenger seat, the front passenger detection sensor may cause the warning light to flash, even if a passenger is not sitting in the seat.
- If a cushion is placed on the seat, the sensor may not detect a passenger, and the warning light may not operate properly.

■ When the tire pressure warning light comes on

Check the tire inflation pressure and adjust to the appropriate level. Pushing the tire pressure warning reset switch does not turn off the tire pressure warning light.

■ The tire pressure warning light may turn on due to natural causes

The tire pressure warning light may turn on due to natural causes such as natural air leaks or tire inflation pressure changes caused by temperature. In this case, adjusting the tire inflation pressure will turn off the warning light (after a few minutes).

■ When a tire is replaced with a spare tire

The compact spare tire is not equipped with the tire pressure warning valve and transmitter. If a tire goes flat, the tire pressure warning light will not turn off even though the flat tire is replaced with the spare tire. Replace the spare tire with the repaired tire and adjust the proper tire inflation pressure. The tire pressure warning light will turn off after a few minutes.

■ **If the tire pressure warning system is inoperative**

The tire pressure warning system will be disabled in the following conditions:

(When the condition becomes normal, the system will work properly.)

- If tires not equipped with tire pressure warning valves and transmitters are used.
- If the ID code on the tire pressure warning valves and transmitters is not registered in the tire pressure warning computer.
- If the tire inflation pressure is 73 psi (500 kPa, 5.1 kgf/cm² or bar) or higher.

The tire pressure warning system may be disabled in the following conditions:

(When the condition becomes normal, the system will work properly.)

- If electronic devices or facilities using similar radio wave frequencies are nearby.
- If a radio set at similar frequencies is in use in the vehicle.
- If a window tint that affects the radio wave signals is installed.
- If there is a lot of snow or ice on the vehicle, in particular around the wheels or wheel housings.
- If non-genuine Toyota wheels are used. (Even if you use Toyota wheels, the tire pressure warning system may not work properly with some types of tires.)
- If tire chains are used.

■ **If the tire pressure warning light frequently comes on after blinking for 1 minute**

If the tire pressure warning light comes on after blinking for 1 minute frequently when the engine switch is turned to the “ON” position, have it checked by your Toyota dealer.

■ **Customization that can be configured at Toyota dealer**

The vehicle speed linked seat belt reminder buzzer can be disabled.

(Customizable features →P. 469) However, Toyota recommends that the seat belt reminder buzzer be operational to alert the driver and front passenger that the seat belts are not fastened.

 **CAUTION****■ If the tire pressure warning light comes on**

Be sure to observe the following precautions. Failure to do so could cause loss of vehicle control and result in death or serious injury.

- Stop your vehicle in a safe place as soon as possible. Adjust the tire inflation pressure immediately.
- If the tire pressure warning light comes on even after tire inflation pressure adjustment, it is probable that you have a flat tire. Check the tires. If the tire is flat, change to the spare tire and have the flat tire repaired by the nearest Toyota dealer.
- Avoid abrupt maneuvering and braking. If the vehicle tires deteriorate, you could lose control of the steering wheel or the brakes.

■ If a blowout or sudden air leakage should occur

The tire pressure warning system may not activate immediately.

■ Maintenance of the tires

Each tire, including the spare (if provided), should be checked monthly when cold and inflated to the inflation pressure recommended by the vehicle manufacturer on the vehicle placard or tire inflation pressure label (tire and load information label). (If your vehicle has tires of a different size than the size indicated on the vehicle placard or tire inflation pressure label [tire and load information label], you should determine the proper tire inflation pressure for those tires.)

 CAUTION

As an added safety feature, your vehicle has been equipped with a tire pressure monitoring system (TPMS-tire pressure warning system) that illuminates a low tire pressure telltale (tire pressure warning light) when one or more of your tires is significantly under-inflated. Accordingly, when the low tire pressure telltale (tire pressure warning light) illuminates, you should stop and check your tires as soon as possible, and inflate them to the proper pressure. Driving on a significantly under-inflated tire causes the tire to overheat and can lead to tire failure. Under-inflation also reduces fuel efficiency and tire tread life, and may affect the vehicle's handling and stopping ability.

Please note that the TPMS (tire pressure warning system) is not a substitute for proper tire maintenance, and it is the driver's responsibility to maintain correct tire pressure, even if under-inflation has not reached the level to trigger illumination of the TPMS low tire pressure telltale (tire pressure warning light).

Your vehicle has also been equipped with a TPMS (tire pressure warning system) malfunction indicator to indicate when the system is not operating properly. The TPMS (tire pressure warning system) malfunction indicator is combined with the low tire pressure telltale (tire pressure warning light). When the system detects a malfunction, the telltale will flash for approximately one minute and then remain continuously illuminated. This sequence will continue upon subsequent vehicle start-ups as long as the malfunction exists. When the malfunction indicator is illuminated, the system may not be able to detect or signal low tire pressure as intended.

TPMS (tire pressure warning system) malfunctions may occur for a variety of reasons, including the installation of replacement or alternate tires or wheels on the vehicle that prevent the TPMS (tire pressure warning system) from functioning properly. Always check the TPMS (tire pressure warning system) malfunction telltale after replacing one or more tires or wheels on your vehicle to ensure that the replacement or alternate tires and wheels allow the TPMS (tire pressure warning system) to continue to function properly.



NOTICE

■ **Precaution when installing a different tire**

When a tire of a different specification or maker is installed, the tire pressure warning system may not operate properly.

5-2. Steps to take in an emergency If you have a flat tire

Remove the flat tire and replace it with the spare provided.

■ **Before jacking up the vehicle**

- Stop the vehicle on a hard, flat surface.
- Set the parking brake.
- Shift the shift lever to P (automatic transmission) or R (manual transmission).
- Stop the engine.
- Turn on the emergency flashers.

■ **Location of the spare tire, jack and tools**

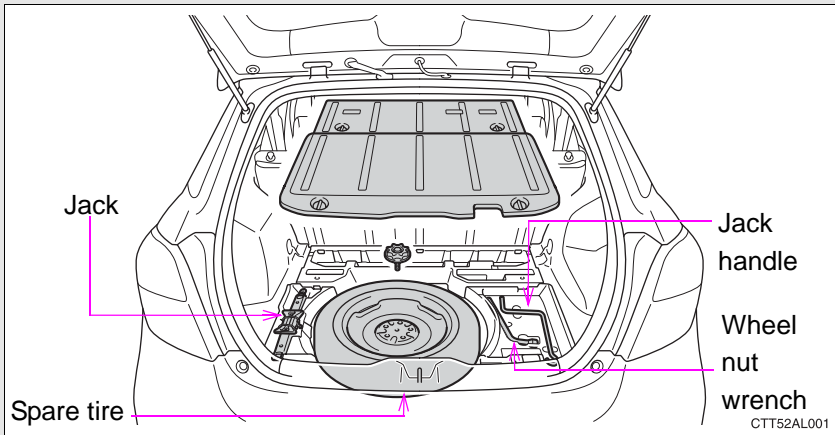

Taking out the jack

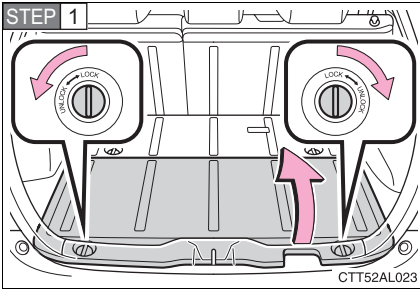

Turn the knobs to the "UNLOCK" position and remove the deck board.

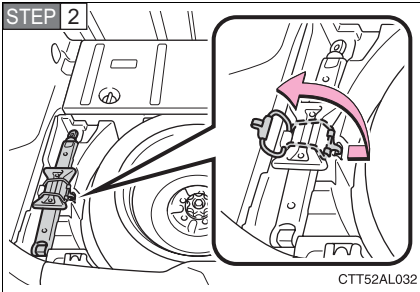

Detach the hook.

Taking out the spare tire

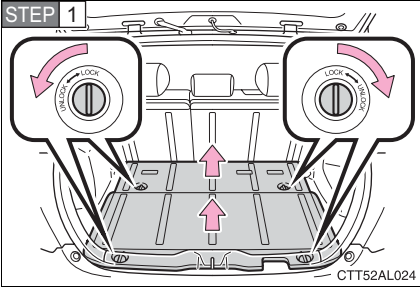

Turn the knobs to the "UNLOCK" position and remove the deck boards.

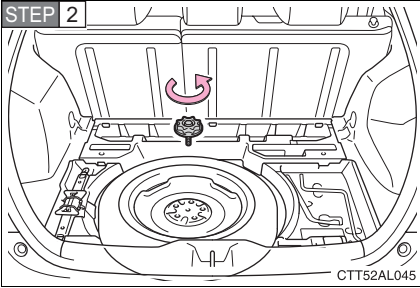

Loosen the center fastener that secures the spare tire.

Replacing a flat tire

STEP 1

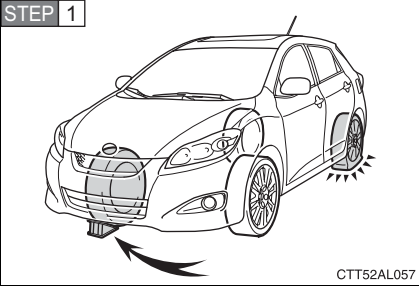

Chock the tires.

Flat tire		Wheel chock positions
Front	Left-hand side	Behind the rear right-hand side tire
	Right-hand side	Behind the rear left-hand side tire
Rear	Left-hand side	In front of the front right-hand side tire
	Right-hand side	In front of the front left-hand side tire

STEP 2

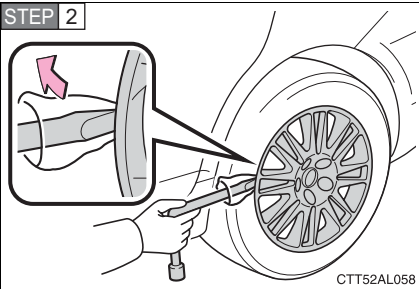

Vehicles with a steel wheel, remove the wheel ornament using the wrench.

To protect the wheel ornament, place a rag between the wrench and the wheel ornament, as shown in the illustration.

5-2. Steps to take in an emergency

STEP 3

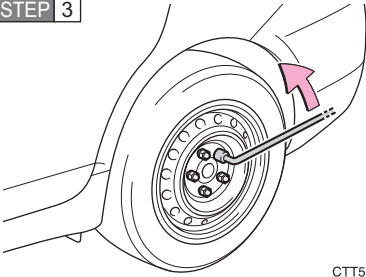

CTT52AL066

Slightly loosen the wheel nuts (one turn).

STEP 4

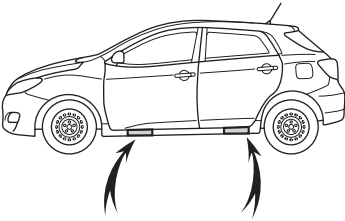

Turn the tire jack portion "A" by hand until the notch of the jack is in contact with the jack point.

The jack point guides are located under the rocker panel. They indicate the jack point positions.

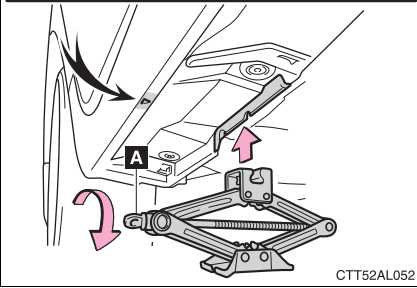

CTT52AL052

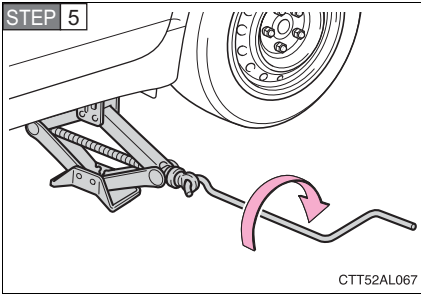

Raise the vehicle until the tire is slightly raised off the ground.

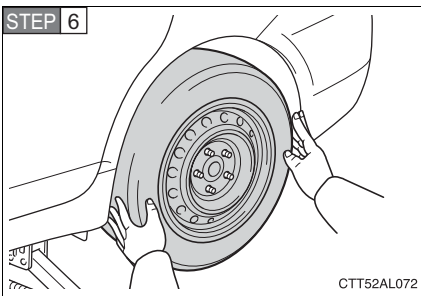

Remove all the wheel nuts and the tire.

When resting the tire on the ground, place the tire so that the wheel design faces up to avoid scratching the wheel surface.

Installing the tire

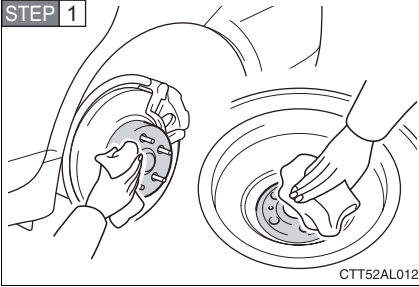

Remove any dirt or foreign matter from the wheel contact surface.

If foreign matter is on the wheel contact surface, the wheel nuts may loosen while the vehicle is in motion, and the tire may come off the vehicle.

STEP 2 Install the tire and loosely tighten each wheel nut by hand by approximately the same amount.

► Replacing a steel wheel with a compact spare tire

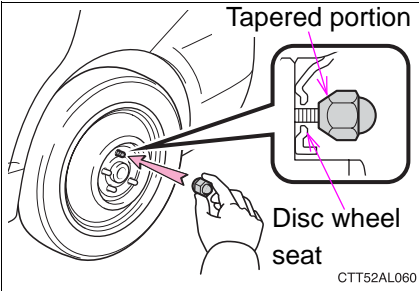

Tighten the nuts until the tapered portion comes into loose contact with the disc wheel seat.

► Replacing an aluminum wheel with a compact spare tire

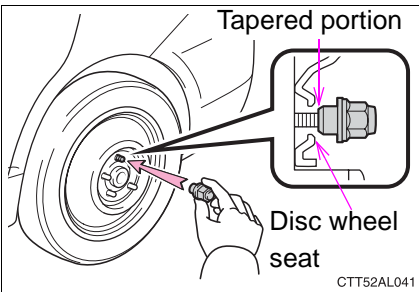

Tighten the nuts until the tapered portion comes into loose contact with the disc wheel seat.

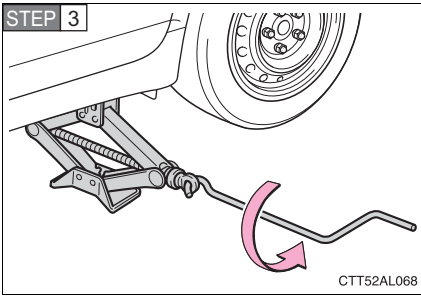

Lower the vehicle.

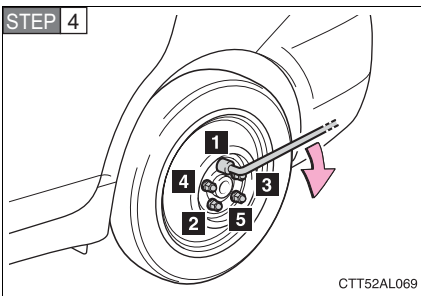

Firmly tighten each nut two or three times in the order shown in the illustration.

Tightening torque:
76 ft•lbf (103 N•m, 10.5 kgf•m)

STEP 5 Stow the flat tire, tire jack and all tools.

Stowing the flat tire

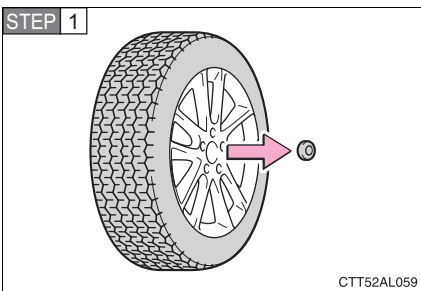

Vehicles with aluminum wheel:
Before stowing the flat tire, remove the center wheel ornament by pushing from the reverse side.

5-2. Steps to take in an emergency

STEP 2

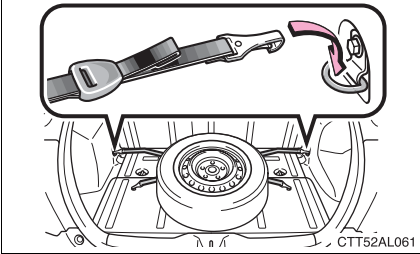

Put the flat tire on the deck boards with the outer side of the wheel facing up. Hook the belt clips closest to the buckles onto the front cargo hooks.

STEP 3

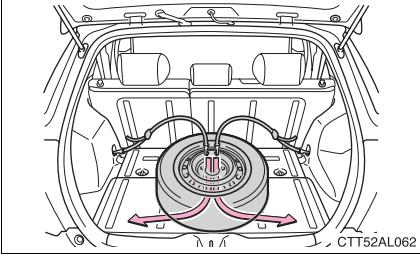

Pass the belts through the center hole of the wheel.

STEP 4

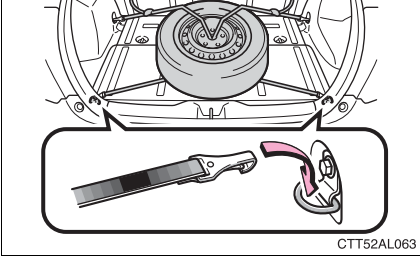

Hook the other side of the clips of the belts to the rear hooks.

STEP 5

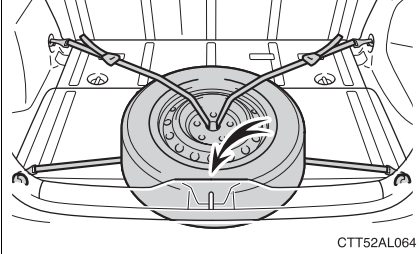

Position the tire edge against the rear center end of the luggage compartment.

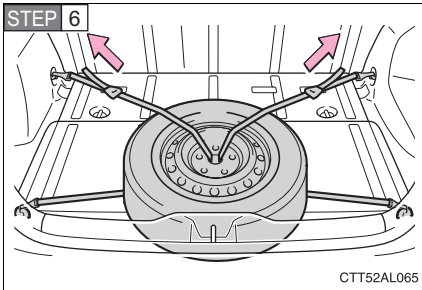

Pull the ends of the belts to secure the tire.

■ The compact spare tire

- The compact spare tire is identified by the label “TEMPORARY USE ONLY” on the tire sidewall.
Use the compact spare tire temporarily only in an emergency.
- Make sure to check the tire pressure of the compact spare tire.
(→P. 451)

■ If you have a flat front tire on a road covered with snow or ice

Install the compact spare tire on the rear of the vehicle. Perform the following steps and fit tire chains to the front tires.

STEP 1 Replace a rear tire with the compact spare tire.

STEP 2 Replace the flat front tire with the tire removed from the rear of the vehicle.

STEP 3 Fit tire chains to the front tires.

■ After completing the tire change (vehicles with tire pressure warning system)

The tire pressure warning system must be reset. (→P. 350)

■ When using the compact spare tire

As the compact spare tire is not equipped with the tire pressure warning valve and transmitter, low inflation pressure of the spare tire will not be warned. Also, if you replace the compact spare tire after the tire pressure warning light comes on, the light remains on.

 **CAUTION**

■ **Using the tire jack**

Improper use of the tire jack may lead to death or serious injuries due to the vehicle suddenly falling off the jack.

- Do not use the tire jack for any purpose other than replacing tires or installing and removing tire chains.
- Only use the tire jack that comes with this vehicle for replacing a flat tire.
Do not use it on other vehicles, and do not use other tire jacks for replacing tires on this vehicle.
- Always check that the tire jack is securely set to the jack point.
- Do not put any part of your body under the vehicle while it is supported by a jack.
- Do not start or run the engine while your vehicle is supported by the jack.
- Do not raise the vehicle while someone is in it.
- When raising the vehicle, do not put an object on or under the jack.
- Do not raise the vehicle to a height greater than that required to replace the tire.
- Use a jack stand if it is necessary to get under the vehicle.

Take particular care when lowering the vehicle to ensure that no one working on or near the vehicle will be injured.

 **CAUTION****■ Replacing a flat tire**

- Do not attach a heavily damaged wheel ornament, as it may fly off the wheel while the vehicle is moving and possibly result in serious injury.
- Failure to follow these precautions could cause the wheel nuts to loosen and the tire to fall off, resulting in death or serious injury.
 - Have the wheel nuts tightened with a torque wrench to 76 ft•lbf (103 N•m, 10.5 kgf•m) as soon as possible after changing wheels.
 - When installing the wheel nuts, be sure to install them with the tapered ends facing inward. (→P. 363)

■ When installing the wheel nuts

Be sure to install the wheel nuts with the tapered end facing inward.
(→P. 363)

■ When using the compact spare tire

- Remember that your compact spare tire is specifically designed for use with your vehicle. Do not use your compact spare tire on another vehicle.
- Do not use two compact spare tires simultaneously.
- Replace the compact spare tire with a standard tire as soon as possible.
- Avoid sudden acceleration, deceleration and braking, as well as sharp cornering.

■ Speed limit when using the compact spare tire

Do not drive at speeds in excess of 50 mph (80 km/h) when a compact spare tire is installed on the vehicle.

The compact spare tire is not designed for driving at high speeds. Failing to observe this precaution may lead to an accident causing death or serious injury.

 CAUTION

■ **When the spare tire is attached**

The vehicle speed may not be correctly detected, and the following systems may not operate correctly:

- ABS & Brake assist
- VSC
- TRAC

Also, not only can the following system not be utilized fully, it may actually negatively effect the drive-train components:

- Active Torque Control 4WD system (if equipped)

■ **When stowing the flat tire**

- Make sure the rear seats are in their original position.
- Secure it using a tire tie-down belt. Otherwise, the flat tire may fly out in case of the sudden braking or an accident, resulting in death or serious injury.

 NOTICE

■ **Do not drive the vehicle with a flat tire**

Do not continue driving with a flat tire.

Driving even a short distance with a flat tire can damage the tire and the wheel beyond repair.

■ **Be careful when driving over bumps with the compact spare tire installed on the vehicle**

The vehicle becomes lower when driving with the compact spare tire compared to when driving with standard tires. Be careful when driving over uneven road surfaces.

■ **Driving with tire chains and the compact spare tire**

Do not fit tire chains to the compact spare tire.

Tire chains may damage the vehicle body and adversely affect driving performance.

 NOTICE**■ When replacing the tires**

When removing or fitting the wheels, tires or the tire pressure warning valve and transmitter, contact your Toyota dealer as the tire pressure warning valve and transmitter may be damaged if not handled correctly.

■ To avoid damage to the tire pressure warning valves and transmitters

When a tire is repaired with liquid sealants, the tire pressure warning valve and transmitter may not operate properly. If a liquid sealant is used, contact your Toyota dealer or other qualified service shop as soon as possible. Make sure to replace the tire pressure warning valve and transmitter when replacing the tire. (→P. 350)

5-2. Steps to take in an emergency If the engine will not start

If the engine still does not start after following the correct starting procedure (→P. 118) or releasing the steering lock (→P. 120), confirm the following points.

■ The engine will not start even when the starter motor operates normally.

One of the following may be the cause of the problem.

- There may not be sufficient fuel in the vehicle's tank.
Refuel the vehicle.
- The engine may be flooded.
Try to restart the engine once more following correct starting procedures. (→P. 118)
- There may be a malfunction in the engine immobilizer system.
(→P. 68)

■ The starter motor turns over slowly, the interior lights and headlights are dim, or the horn does not sound or sounds at a low volume.

One of the following may be the cause of the problem.

- The battery may be discharged. (→P. 425)
- The battery terminal connections may be loose or corroded.

■ The starter motor does not turn over, the interior lights and headlights do not turn on, or the horn does not sound.

One of the following may be the cause of the problem.

- One or both of the battery terminals may be disconnected.
- The battery may be discharged. (→P. 425)

Contact your Toyota dealer if the problem cannot be repaired, or if repair procedures are unknown.

5-2. Steps to take in an emergency

If the shift lever cannot be shifted from P (automatic transmission)

If the shift lever cannot be shifted with your foot on the brake, there may be a problem with the shift lock system (a system to prevent accidental operation of the shift lever). Have the vehicle inspected by your Toyota dealer.

The following steps may be used as an emergency measure to ensure that the shift lever can be shifted.

STEP 1 Set the parking brake.

STEP 2 Turn the engine switch to the “ACC” position.

STEP 3 Depress the brake pedal.

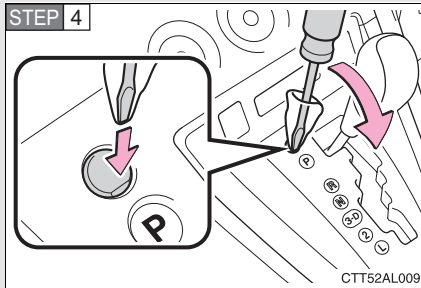

Pry the cover up with a flat-head screwdriver or equivalent.

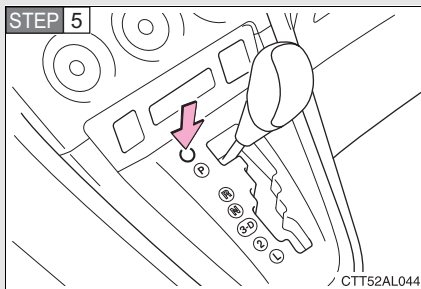

Press the shift lock override button.

The shift lever can be shifted while the button is pressed.

If you lose your keys

New genuine keys can be made by your Toyota dealer. Bring a master key and the key number stamped on the key number plate.

5-2. Steps to take in an emergency If the battery is discharged

The following procedures may be used to start the engine if the vehicle's battery is discharged.

You can call your Toyota dealer or qualified repair shop.

If you have a set of jumper (or booster) cables and a second vehicle with a 12-volt battery, you can jump start your Toyota following the steps below.

► 1.8 L 4-cylinder (2ZR-FE) engine

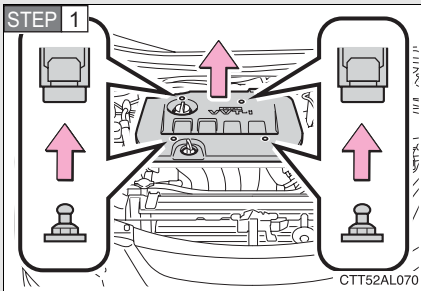

Remove the engine cover.

Raise the rear of the engine cover to remove the two rear clips, and then raise the front of the engine cover to remove the two front clips.

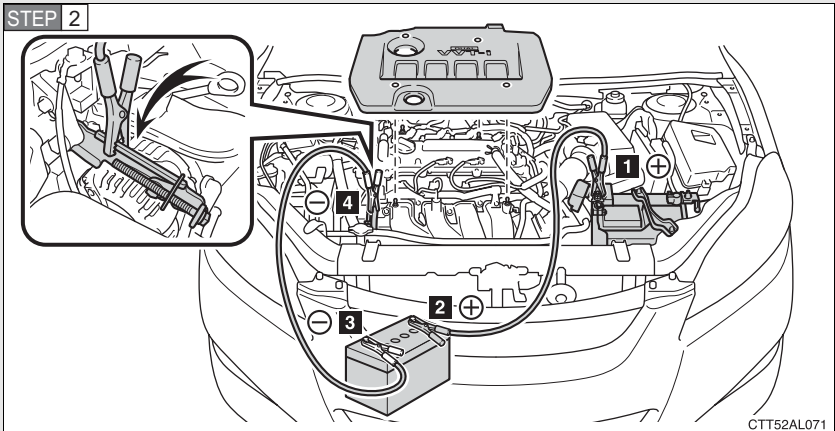

Connecting the jumper cables

- 1** Positive (+) battery terminal on your vehicle
- 2** Positive (+) battery terminal on the second vehicle
- 3** Negative (-) battery terminal on the second vehicle

4 Connect the jumper cable to ground on your vehicle as shown in the illustration.

STEP 3 Start the engine of the second vehicle. Increase the engine speed slightly and maintain at that level for approximately 5 minutes to recharge the battery of your vehicle.

STEP 4 Maintain the engine speed of the second vehicle, and turn the engine switch to the “ON” position then start the vehicle's engine.

STEP 5 Once the vehicle's engine has started, remove the jumper cables in the exact reverse order in which they were connected.

Once the engine starts, have the vehicle checked at your Toyota dealer as soon as possible.

▶ 2.4 L 4-cylinder (2AZ-FE) engine

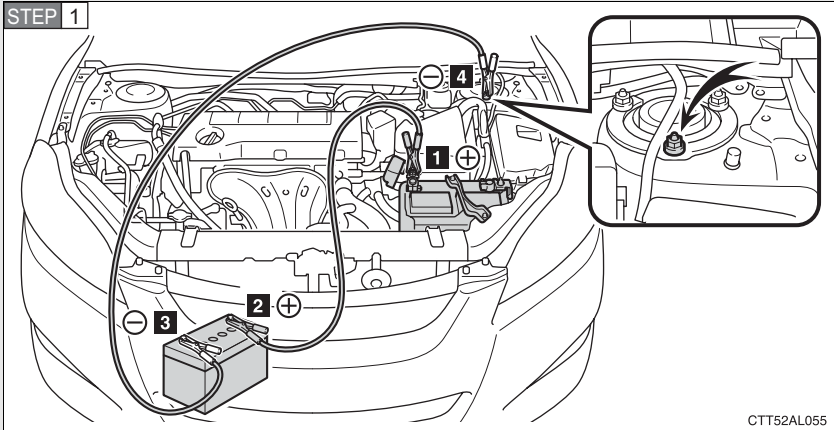

CTT52AL055

Connecting the jumper cables

- 1** Positive (+) battery terminal on your vehicle
- 2** Positive (+) battery terminal on the second vehicle
- 3** Negative (-) battery terminal on the second vehicle
- 4** Connect the jumper cable to ground on your vehicle as shown in the illustration.

STEP 2 Start the engine of the second vehicle. Increase the engine speed slightly and maintain at that level for approximately 5 minutes to recharge the battery of your vehicle.

STEP 3 Maintain the engine speed of the second vehicle, and turn the engine switch to the "ON" position then start the vehicle's engine.

STEP 4 Once the vehicle's engine has started, remove the jumper cables in the exact reverse order in which they were connected.

Once the engine starts, have the vehicle checked at your Toyota dealer as soon as possible.

■ **Avoiding a discharged battery**

- Turn off the headlights and the audio system while the engine is turned off.
- Turn off any unnecessary electrical components when the vehicle is running at a low speed for an extended period, such as in heavy traffic, etc.

■ **Charging the battery**

The electricity stored in the battery will discharge gradually even when the vehicle is not in use, due to natural discharge and the draining effects of certain electrical appliances. If the vehicle is left for a long time, the battery may discharge, and the engine may be unable to start. (The battery recharges automatically during driving.)

 **CAUTION**

■ **Avoiding battery fires or explosions**

Observe the following precautions to prevent accidentally igniting the flammable gas that may be emitted from the battery.

- Make sure the jumper cable is connected to the correct terminal and that it is not unintentionally in contact with any part other than the intended terminal.
- Do not allow the jumper cables to come into contact with the “+” and “-” terminals.
- Do not smoke, use matches, cigarette lighters or allow open flame near the battery.

 **CAUTION**
■ Battery precautions

The battery contains poisonous and corrosive acidic electrolyte, while related parts contain lead and lead compounds. Observe the following precautions when handling the battery.

- When working with the battery, always wear safety glasses and take care not to allow any battery fluids (acid) to come into contact with skin, clothing or the vehicle body.
- Do not lean over the battery.
- In the event that battery fluid comes into contact with the skin or eyes, immediately wash the affected area with water and seek medical attention. Place a wet sponge or cloth over the affected area until medical attention can be received.
- Always wash your hands after handling the battery support, terminals, and other battery-related parts.
- Do not allow children near the battery.

 **NOTICE**
■ To prevent damage to the vehicle

Do not pull- or push-start the vehicle, because the catalytic converter may overheat and become a fire hazard.

■ When handling jumper cables

Be careful that the jumper cables do not become tangled in the cooling fans or any of the belts when connecting or disconnecting them.

■ When attaching the engine cover (1.8 L 4-cylinder [2ZR-FE] engine)

Ensure that the rubber grommets remain attached to the engine cover. If the grommet is attached to the bolts, transfer grommets to the engine cover.

5-2. Steps to take in an emergency If your vehicle overheats

If your engine overheats:

STEP 1 Stop the vehicle in a safe place and turn off the air conditioning system.

STEP 2 Check to see if steam is coming out from under the hood.

If you see steam:

Stop the engine. Carefully lift the hood after the steam subsides and then restart the engine.

If you do not see steam:

Leave the engine running and carefully lift the hood.

STEP 3 Check to see if the cooling fans are operating.

If the fans are operating:

Wait until the temperature of the engine (shown on the instrument cluster) begins to fall and then stop the engine.

If the fans are not operating:

Stop the engine and call your Toyota dealer.

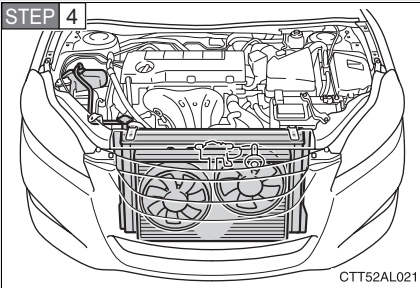

After the engine has cooled down sufficiently, check the engine coolant level and inspect the radiator core (radiator) for any leaks.

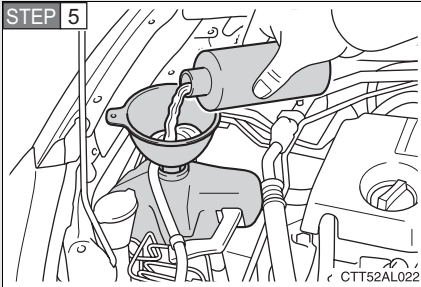

Add engine coolant if necessary.

Water can be used in an emergency if engine coolant is unavailable. (→P. 445)

Have the vehicle checked at the nearest Toyota dealer as soon as possible.

■ Overheating

If you observe the following, your vehicle may be overheating.

- The engine coolant temperature gauge enters the red zone or a loss of power is experienced.
- Steam is coming from under the hood.

▲ CAUTION

■ To prevent an accident or injury when inspecting under the hood of your vehicle

- If steam is seen coming from under the hood, do not open the hood until the steam has subsided. The engine compartment may be very hot, causing serious injury such as burns.
- Keep hands and clothing away from the fan and other belts while the engine is running.
- Do not loosen the coolant reservoir cap while the engine and radiator are hot.
Serious injury, such as burns, may result from hot coolant and steam released under pressure.

 NOTICE

■ **When adding engine coolant**

Wait until the engine has cooled down before adding engine coolant.

When adding coolant, do so slowly. Adding cool coolant to a hot engine too quickly can cause damage to the engine.

5-2. Steps to take in an emergency If the vehicle becomes stuck

Carry out the following procedures if the tires spin or the vehicle becomes stuck in mud, dirt, or snow.

- STEP 1** Stop the engine. Set the parking brake and put the shift lever in P (automatic transmission) or N (manual transmission).
- STEP 2** Remove the mud, snow, or sand from around the stuck tire.
- STEP 3** Place wood, stones or some other material to help provide traction under the tires.
- STEP 4** Restart the engine.
- STEP 5** Shift the shift lever to the D or R position (automatic transmission) or 1 or R position (manual transmission), release the parking brake and carefully apply the accelerator to free the vehicle.

CAUTION

■ **When attempting to free a stuck vehicle**

If you choose to rock the vehicle back and forth to free it, make sure the surrounding area is clear, to avoid striking other vehicles, objects or persons. The vehicle may also lunge forward or lunge back suddenly as it becomes free. Use extreme caution.

■ **When shifting the shift lever**

For vehicles with an automatic transmission, be careful not to shift the shift lever with the accelerator pedal depressed.

This may lead to unexpected rapid acceleration of the vehicle that may cause an accident and result in death or serious injury.

 NOTICE

■ **To avoid damaging the transmission and other components**

- Avoid spinning the wheels and do not rev the engine.
- If the vehicle remains stuck after trying these procedures, the vehicle may require towing to be freed.

5-2. Steps to take in an emergency

If your vehicle has to be stopped in an emergency

Only in an emergency, such as if it becomes impossible to stop the vehicle in the normal way, stop the vehicle using the following procedure:

STEP 1 Steadily step on the brake pedal with both feet and firmly depress it.

Do not pump the brake pedal repeatedly as this will increase the effort required to slow the vehicle.

STEP 2 Shift the shift lever to N.

► If the shift lever is shifted to N

STEP 3 After slowing down, stop the vehicle in a safe place by the road.

STEP 4 Stop the engine.

► If the shift lever cannot be shifted to N

STEP 3 Keep depressing the brake pedal with both feet to reduce vehicle speed as much as possible.

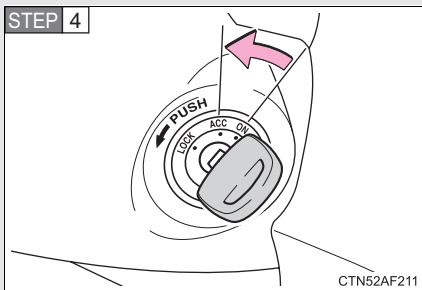

Stop the engine by turning the engine switch to the "ACC" position.

STEP 5 Stop the vehicle in a safe place by the road.

 CAUTION

■ **If the engine has to be turned off while driving**

- Power assist for the brakes and steering wheel will be lost, making the brake pedal harder to depress and the steering wheel heavier to turn. Decelerate as much as possible before turning off the engine.
- Never attempt to remove the key, as doing so will lock the steering wheel.

6-1. Specifications

Maintenance data (fuel, oil level, etc.)

Dimensions and weights

Overall length	171.9 in. (4365 mm) ^{*1}	
	173.0 in. (4395 mm) ^{*2}	
Overall width	69.5 in. (1765 mm)	
Overall height ^{*3}	61.0 in. (1550 mm) ^{*4}	
	61.4 in. (1560 mm) ^{*5}	
Wheelbase	102.4 in. (2600 mm)	
Tread	Front	59.8 in. (1519 mm)
	Rear	59.9 in. (1522 mm)
Vehicle capacity weight (Occupants + luggage)	850 lb. (385 kg)	
Trailer weight rating ^{*6} (Trailer weight + cargo weight)	1500 lb. (680 kg)	

*1: Except S or XRS grade models

*2: S or XRS grade models

*3: Unladen vehicle

*4: Vehicles without double wishbone rear suspension

*5: Vehicles with double wishbone rear suspension

*6: 2.4 L 4-cylinder (2AZ-FE) engine only

Vehicle identification

■ Vehicle identification number

The vehicle identification number (VIN) is the legal identifier for your vehicle. This is the primary identification number for your Toyota. It is used in registering the ownership of your vehicle.

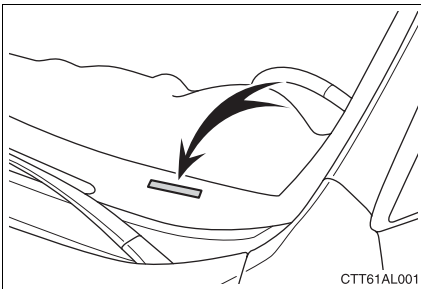

This number is stamped on the top left of the instrument panel.

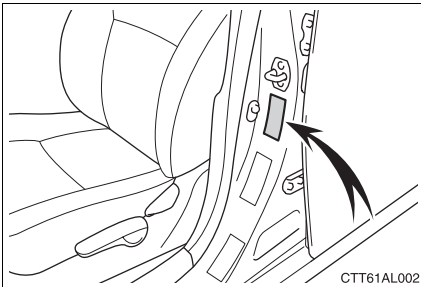

This number is also on the Certification Label on the driver's side center pillar.

■ **Engine number**

The engine number is stamped on the engine block as shown.

▶ 1.8 L 4-cylinder (2ZR-FE) engine

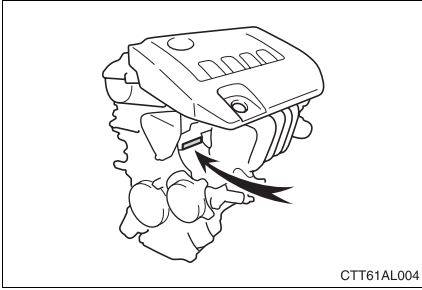

▶ 2.4 L 4-cylinder (2AZ-FE) engine

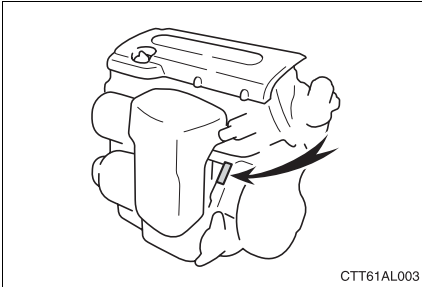

Engine

► 1.8 L 4-cylinder (2ZR-FE) engine

Model	2ZR-FE engine
Type	4 cylinder in line, 4 cycle, gasoline
Bore and stroke	3.17 × 3.48 in. (80.5 × 88.3 mm)
Displacement	109.7 cu.in. (1798 cm ³)
Drive belt tension*	143 ± 22 lbf (650 ± 100 N, 65 ± 10 kgf)
Valve clearance (engine cold) Intake Exhaust	Automatic adjustment

*: Drive belt tension measured with Borroughs drive belt tension gauge No. BT-33-73F (used belt), lb.

▶ 2.4 L 4-cylinder (2AZ-FE) engine

Model	2AZ-FE engine
Type	4 cylinder in line, 4 cycle, gasoline
Bore and stroke	3.48 × 3.78 in. (88.5 × 96.0 mm)
Displacement	144.1 cu.in. (2362 cm ³)
Drive belt tension	Automatic adjustment
Valve clearance (engine cold)	
Intake	0.007 — 0.011 in. (0.19 — 0.29 mm)
Exhaust	0.015 — 0.019 in. (0.38 — 0.48 mm)

Fuel

Fuel type	Unleaded gasoline only
Octane rating	87 (Research Octane Number 91) or higher
Fuel tank capacity (Reference)	13.2 gal. (50 L, 10.9 Imp. gal.)

Lubrication system

Oil capacity (Drain and refill — reference)	
With filter	<ul style="list-style-type: none"> ▶ 1.8 L 4-cylinder (2ZR-FE) engine 4.4 qt. (4.2 L, 3.7 Imp. qt.) ▶ 2.4 L 4-cylinder (2AZ-FE) engine 4.0 qt. (3.8 L, 3.3 Imp. qt.)
Without filter	<ul style="list-style-type: none"> ▶ 1.8 L 4-cylinder (2ZR-FE) engine 4.1 qt. (3.9 L, 3.4 Imp. qt.) ▶ 2.4 L 4-cylinder (2AZ-FE) engine 3.8 qt. (3.6 L, 3.2 Imp. qt.)

■ Engine oil selection

“Toyota Genuine Motor Oil” is used in your Toyota vehicle. Use Toyota approved “Toyota Genuine Motor Oil” or equivalent to satisfy the following grade and viscosity.

Oil grade: ILSAC multigrade engine oil

Recommended viscosity:

- ▶ 1.8 L 4-cylinder (2ZR-FE) engine
SAE 0W-20

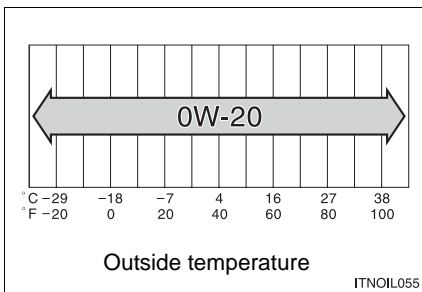

SAE 0W-20 is the best choice for good fuel economy and good starting in cold weather.

If SAE 0W-20 is not available, SAE 5W-20 oil may be used. However, it must be replaced with SAE 0W-20 at the next oil change.

Oil viscosity (0W-20 is explained here as an example):

- The 0W in 0W-20 indicates the characteristic of the oil which allows cold startability. Oils with a lower value before the W allow for easier starting of the engine in cold weather.
- The 20 in 0W-20 indicates the viscosity characteristic of the oil when the oil is at high temperature. An oil with a higher viscosity (one with a higher value) may be better suited if the vehicle is operated at high speeds, or under extreme load conditions.

► 2.4 L 4-cylinder (2AZ-FE) engine

SAE 5W-20 or 0W-20

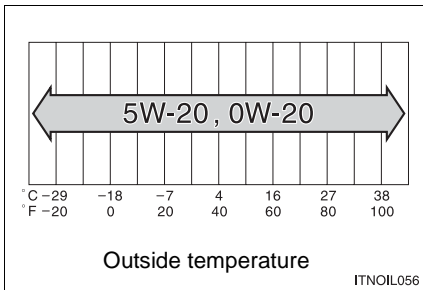

SAE 5W-20 or 0W-20 engine oil may be used. However, SAE 0W-20 is the best choice for good fuel economy and good starting in cold weather.

Oil viscosity (0W-20 is explained here as an example):

- The 0W in 0W-20 indicates the characteristic of the oil which allows cold startability. Oils with a lower value before the W allow for easier starting of the engine in cold weather.
- The 20 in 0W-20 indicates the viscosity characteristic of the oil when the oil is at high temperature. An oil with a higher viscosity (one with a higher value) may be better suited if the vehicle is operated at high speeds, or under extreme load conditions.

How to read oil container label:

The ILSAC (International Lubricant Standardization and Approval Committee) Certification Mark is added to some oil containers to help you select the oil you should use.

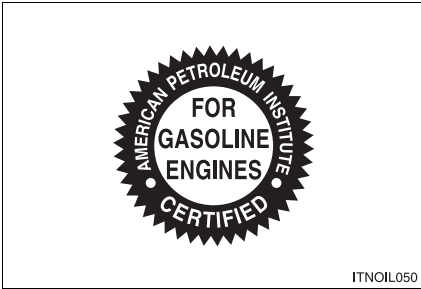

Cooling system

Capacity (Reference)	<ul style="list-style-type: none"> ▶ 1.8 L 4-cylinder (2ZR-FE) engine 5.8 qt. (5.5 L, 4.8 Imp. qt.) ▶ 2.4 L 4-cylinder (2AZ-FE) engine 6.0 qt. (5.7 L, 5.0 Imp. qt.)
Coolant type	<p>Use either of the following.</p> <ul style="list-style-type: none"> • “Toyota Super Long Life Coolant” • Similar high-quality ethylene glycol-based non-silicate, non-amine, non-nitrite, and non-borate coolant with long-life hybrid organic acid technology <p>Do not use plain water alone.</p>

Ignition system

Spark plug	
Make	<ul style="list-style-type: none"> ▶ 1.8 L 4-cylinder (2ZR-FE) engine DENSO SC20HR11 ▶ 2.4 L 4-cylinder (2AZ-FE) engine DENSO SK20R11 DENSO SK16R11 NGK IFR6A11 NGK IFR5A11
Gap	0.043 in. (1.1 mm)

NOTICE

Iridium-tipped spark plugs

Use only iridium-tipped spark plugs. Do not adjust spark plug gap.

Electrical system

Battery	
Open voltage at 68°F (20°C):	12.6 — 12.8 V Fully charged 12.2 — 12.4 V Half charged 11.8 — 12.0 V Discharged (Voltage checked 20 minutes after the engine and all the lights turned off)
Charging rates	5 A max.

Manual transmission

Gear oil capacity (Reference)	<ul style="list-style-type: none"> ▶ 1.8 L 4-cylinder (2ZR-FE) engine 2.0 qt. (1.9 L, 1.7 Imp. qt.) ▶ 2.4 L 4-cylinder (2AZ-FE) engine 2.6 qt. (2.5 L, 2.2 Imp. qt.)
Gear oil type	<p>Use either of the following:</p> <ul style="list-style-type: none"> • “TOYOTA Genuine Manual Transmission Gear Oil LV” • Other gear oil that meets API GL-4 and SAE 75W specifications



NOTICE

Manual transmission gear oil

Please be aware that depending on the particular characteristics of the gear oil used or the operating conditions, idle sound, shift feeling and/or fuel efficiency may be different or affected. Toyota recommends to use “TOYOTA Genuine Manual Transmission Gear Oil LV” to achieve optimal performance.

Automatic transmission

Fluid capacity (Reference)	<ul style="list-style-type: none"> ▶ 1.8 L 4-cylinder (2ZR-FE) engine 6.9 qt. (6.5 L, 5.7 Imp. qt.) ▶ 2.4 L 4-cylinder (2AZ-FE) engine (2WD models) 8.2 qt. (7.8 L, 6.9 Imp. qt.) ▶ 2.4 L 4-cylinder (2AZ-FE) engine (AWD models) 8.6 qt. (8.1 L, 7.1 Imp. qt.)
Fluid type	Toyota Genuine ATF WS

 **NOTICE**

Automatic transmission fluid type

Using automatic transmission fluid other than “Toyota Genuine ATF WS” may cause deterioration in shift quality, locking up of your transmission accompanied by vibration, and ultimately damage the transmission of your vehicle.

Rear differential (AWD models)

Oil capacity	0.5 qt. (0.5 L, 0.4 Imp. qt.)
Oil type	Hypoid gear oil API GL-5
Recommended oil viscosity	Above 0°F (-18°C): SAE 90 Below 0°F (-18°C): SAE 80W or 80W-90

Transfer (AWD models)

Oil capacity	0.8 qt. (0.8 L, 0.7 Imp. qt.)
Oil type	Hypoid gear oil API GL-5
Recommended oil viscosity	Above 0°F (-18°C): SAE 90 Below 0°F (-18°C): SAE 80W or 80W-90

Clutch

Pedal free play	0.2 — 0.6 in. (5 — 15 mm)
Fluid type	SAE J1703 or FMVSS No.116 DOT 3

Brakes

Pedal clearance ^{*1}	<ul style="list-style-type: none"> ▶ 1.8 L 4-cylinder (2ZR-FE) engine 3.4 in. (87 mm) ▶ 2.4 L 4-cylinder (2AZ-FE) engine <ul style="list-style-type: none"> • AWD models: 3.4 in. (87 mm) • 2WD models with P215/45R18 tires: 3.4 in. (87 mm) • 2WD models with tires other than the above: 3.3 in. (85 mm)
Pedal free play	0.04 — 0.24 in. (1 — 6 mm)
Brake pad wear limit	0.04 in. (1.0 mm)
Parking brake lining wear limit ^{*2}	0.04 in. (1.0 mm)
Parking brake lever travel ^{*3}	6 — 9 clicks
Fluid type	SAE J1703 or FMVSS No.116 DOT 3

^{*1}: Minimum pedal clearance when depressed with a force of 66 lbf (294 N, 30 kgf) while the engine is running

^{*2}: 2.4 L 4-cylinder (2AZ-FE) engine with 18-inch tires or AWD models

^{*3}: Parking brake lever travel when pulled up with a force of 44 lbf (200 N, 20 kgf)

Steering

Free play

Less than 1.2 in. (30 mm)

Tires and wheels

▶ 16-inch tires

Tire size	P205/55R16 89H, T135/80R16 101M or T135/70R17 102M
Tire inflation pressure (Recommended cold tire inflation pressure)	<p>▶ 2WD models</p> <p>Front: 32 psi (220 kPa, 2.2 kgf/cm² or bar)</p> <p>Rear: 32 psi (220 kPa, 2.2 kgf/cm² or bar)</p> <p>Spare: 60 psi (420 kPa, 4.2 kgf/cm² or bar)</p> <p>▶ AWD models</p> <p>Front: 35 psi (240 kPa, 2.4 kgf/cm² or bar)</p> <p>Rear: 32 psi (220 kPa, 2.2 kgf/cm² or bar)</p> <p>Spare: 60 psi (420 kPa, 4.2 kgf/cm² or bar)</p>
Wheel size	16 × 6 1/2 J, 16 × 4T or 17 × 4T (compact spare)
Wheel nut torque	76 ft•lbf (103 N•m, 10.5 kgf•m)

▶ 17-inch tires

Tire size	P215/45R17 87W, T135/80R16 101M or T135/70R17 102M
Tire inflation pressure (Recommended cold tire inflation pressure)	<p>▶ 2WD models Front: 32 psi (220 kPa, 2.2 kgf/cm² or bar) Rear: 32 psi (220 kPa, 2.2 kgf/cm² or bar) Spare: 60 psi (420 kPa, 4.2 kgf/cm² or bar)</p> <p>▶ AWD models Front: 35 psi (240 kPa, 2.4 kgf/cm² or bar) Rear: 32 psi (220 kPa, 2.2 kgf/cm² or bar) Spare: 60 psi (420 kPa, 4.2 kgf/cm² or bar)</p>
Wheel size	17 × 7 J, 16 × 4T or 17 × 4T (compact spare)
Wheel nut torque	76 ft•lbf (103 N•m, 10.5 kgf•m)

▶ 18-inch tires

Tire size	P215/45R18 89W, T135/70R17 102M
Tire inflation pressure (Recommended cold tire inflation pressure)	Front: 32 psi (220 kPa, 2.2 kgf/cm ² or bar) Rear: 32 psi (220 kPa, 2.2 kgf/cm ² or bar) Spare: 60 psi (420 kPa, 4.2 kgf/cm ² or bar)
Wheel size	18 × 7 J, 17 × 4T (compact spare)
Wheel nut torque	76 ft•lbf (103 N•m, 10.5 kgf•m)

Light bulbs

	Light Bulbs	Bulb No.	W	Type
Exterior	Headlights			
	Low beam	9006	51	F
	High beam	9005	60	B
	Front turn signal/parking and front side marker lights	3457NA	27/7	D
	Front fog lights (if equipped)	—	55	A
	Rear turn signal lights	—	21	D
	Stop/tail and rear side marker lights	7443	21/5	C
Interior	License plate lights	—	5	C
	Back-up lights	921	16	C
	Personal lights	—	8	C
	Interior light	—	8	E

A: H11 halogen bulbs

C: Wedge base bulbs (clear)

E: Double end bulbs

B: HB3 halogen bulbs

D: Wedge base bulbs (amber)

F: HB4 halogen bulbs

Fuel information

Your vehicle must use only unleaded gasoline.

Select octane rating 87 (Research Octane Number 91) or higher. Use of unleaded gasoline with an octane rating lower than 87 may result in engine knocking. Persistent knocking can lead to engine damage.

At minimum, the gasoline you use should meet the specifications of ASTM D4814 in the U.S.A. and CGSB3.5-M93 in Canada.

■ Fuel tank opening for unleaded gasoline

To help prevent incorrect fueling, your Toyota has a fuel tank opening that only accommodates the special nozzle on unleaded fuel pumps.

■ If your engine knocks

- Consult your Toyota dealer.
- You may occasionally notice light knocking for a short time while accelerating or driving uphill. This is normal and there is no need for concern.

■ Gasoline quality

In very few cases, driveability problems may be caused by the brand of gasoline you are using. If driveability problems persist, try changing the brand of gasoline. If this does not correct the problem, consult your Toyota dealer.

■ Gasoline quality standards

- Automotive manufacturers in the U.S., the Europe and Japan have developed a specification for fuel quality called World-Wide Fuel Charter (WWFC) that is expected to be applied worldwide.
- The WWFC consists of four categories that are based on required emission levels. In the U.S., category 4 has been adopted.
- The WWFC improves air quality by lowering emissions in vehicle fleets, and improves customer satisfaction through better performance.

■ Toyota recommends the use of gasoline containing detergent additives

- Toyota recommends the use of gasoline that contains detergent additives to avoid build-up of engine deposits.
- All gasoline sold in the U.S. contains detergent additives to clean and/or keep clean intake systems.

■ Toyota recommends the use of cleaner burning gasoline

Cleaner burning gasoline, including reformulated gasoline that contains oxygenates such as ethanol or MTBE (Methyl Tertiary Butyl Ether) is available in many areas.

Toyota recommends the use of cleaner burning gasoline and appropriately blended reformulated gasoline. These types of gasoline provide excellent vehicle performance, reduce vehicle emissions and improve air quality.

■ Toyota does not recommend blended gasoline

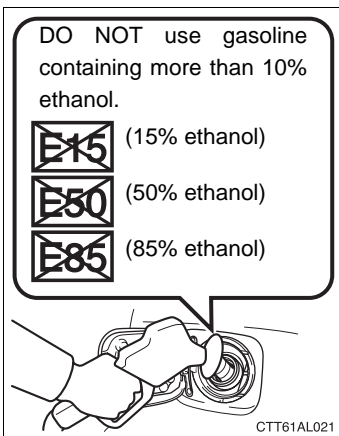

- Use only gasoline containing a maximum of 10% ethanol.

DO NOT use any flex-fuel or gasoline that could contain more than 10% ethanol, including from any pump labeled E15, E30, E50, E85 (which are only some examples of fuel containing more than 10% ethanol).

- If you use gasohol in your Toyota, be sure that it has an octane rating no lower than 87.
- Toyota does not recommend the use of gasoline containing methanol.

■ Toyota does not recommend gasoline containing MMT

Some gasoline contains octane enhancing additive called MMT (Methylcyclopentadienyl Manganese Tricarbonyl).

Toyota does not recommend the use of gasoline that contains MMT. If fuel containing MMT is used, your emission control system may be adversely affected.

The malfunction indicator lamp on the instrument cluster may come on. If this happens, contact your Toyota dealer for service.

 NOTICE

■ **Notice on fuel quality**

- Do not use improper fuels. If improper fuels are used the engine will be damaged.
- Do not use leaded gasoline.
Leaded gasoline can cause damage to your vehicle's catalytic converters causing the emission control system to malfunction.
- Do not use gasohol other than that stated here.
Other gasohol may cause fuel system damage or vehicle performance problems.
- Using unleaded gasoline with an octane number or rating lower than that stated here will cause persistent heavy knocking.
At worst, this will lead to engine damage.

■ **Fuel-related poor driveability**

If after using a different type of fuel, poor driveability is encountered (poor hot starting, vaporization, engine knocking, etc.), discontinue the use of that type of fuel.

■ **When refueling with gasohol**

Take care not to spill gasohol. It can damage your vehicle's paint.

6-1. Specifications

Tire information

Typical tire symbols

► Full-size tire

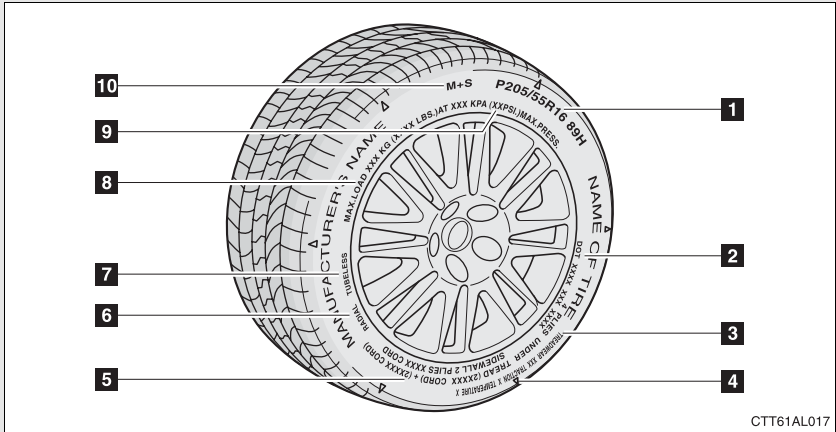

► Compact spare tire

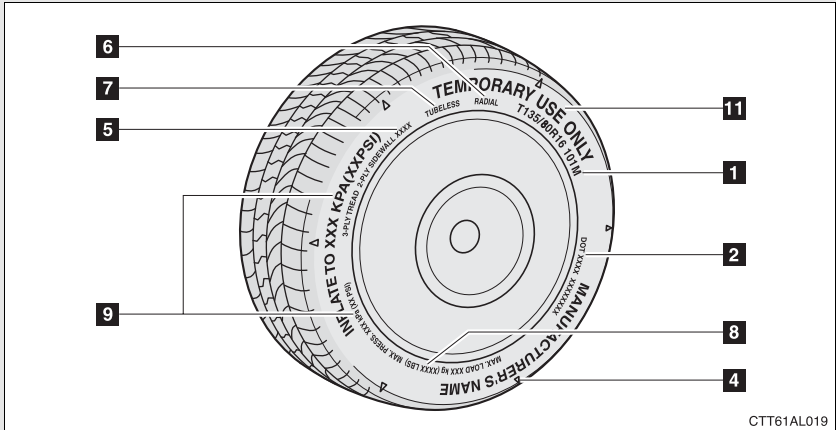

- 1** Tire size (→P. 460)
- 2** DOT and Tire Identification Number (TIN) (→P. 459)
- 3** Uniform tire quality grading
For details, see “Uniform Tire Quality Grading” that follows.
- 4** Location of treadwear indicators (→P. 349)

5 Tire ply composition and materials

Plies are layers of rubber-coated parallel cords. Cords are the strands which form the plies in a tire.

6 Radial tires or bias-ply tires

A radial tire has "RADIAL" on the sidewall. A tire not marked "RADIAL" is a bias-ply tire.

7 TUBELESS or TUBE TYPE

A tubeless tire does not have a tube and air is directly filled in the tire. A tube type tire has a tube inside the tire and the tube maintains the air pressure.

8 Load limit at maximum cold tire inflation pressure (→P. 353)

9 Maximum cold tire inflation pressure (→P. 451)

This means the pressure to which a tire may be inflated.

10 Summer tires or all season tires (→P. 354)

An all season tire has "M+S" on the sidewall. A tire not marked "M+S" is a summer tire.

11 "TEMPORARY USE ONLY" (→P. 417)

A compact spare tire is identified by the phrase "TEMPORARY USE ONLY" molded into its sidewall. This tire is designed for temporary emergency use only.

Typical DOT and Tire Identification Number (TIN)

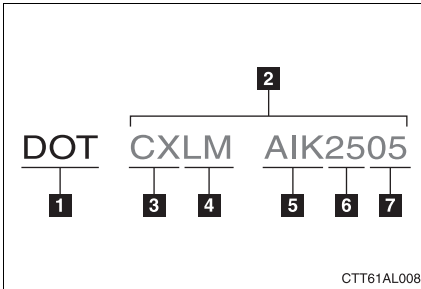

- 1** DOT symbol*
- 2** Tire Identification Number (TIN)
- 3** Tire manufacturer's identification mark
- 4** Tire size code
- 5** Manufacturer's optional tire type code (3 or 4 letters)
- 6** Manufacturing week
- 7** Manufacturing year

*: The DOT symbol certifies that the tire conforms to applicable Federal Motor Vehicle Safety Standards.

Tire size

■ Typical tire size information

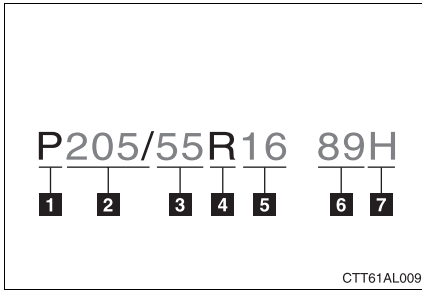

The illustration indicates typical tire size.

- 1 Tire use
(P = Passenger car,
T = Temporary use)
- 2 Section width (millimeters)
- 3 Aspect ratio
(tire height to section width)
- 4 Tire construction code
(R = Radial, D = Diagonal)
- 5 Wheel diameter (inches)
- 6 Load index (2 or 3 digits)
- 7 Speed symbol
(alphabet with one letter)

■ Tire dimensions

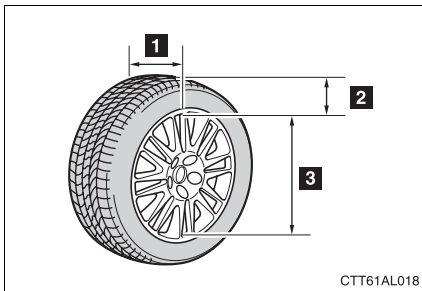

- 1 Section width
- 2 Tire height
- 3 Wheel diameter

Tire section names

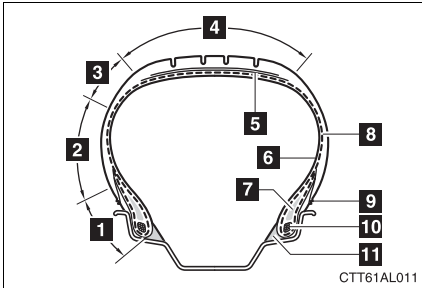

- 1** Bead
- 2** Sidewall
- 3** Shoulder
- 4** Tread
- 5** Belt
- 6** Inner liner
- 7** Reinforcing rubber
- 8** Carcass
- 9** Rim lines
- 10** Bead wires
- 11** Chafer

Uniform Tire Quality Grading

This information has been prepared in accordance with regulations issued by the National Highway Traffic Safety Administration of the U.S. Department of Transportation.

It provides the purchasers and/or prospective purchasers of Toyota vehicles with information on uniform tire quality grading.

Your Toyota dealer will help answer any questions you may have as you read this information.

■ DOT quality grades

All passenger vehicle tires must conform to Federal Safety Requirements in addition to these grades. Quality grades can be found where applicable on the tire sidewall between tread shoulder and maximum section width.

For example: Treadwear 200 Traction AA Temperature A

■ Treadwear

The treadwear grade is a comparative rating based on the wear rate of the tire when tested under controlled conditions on a specified government test course.

For example, a tire graded 150 would wear one and a half (1-1/2) times as well on the government course as a tire graded 100.

The relative performance of tires depends upon the actual conditions of their use, however, and may depart significantly from the norm due to variations in driving habits, service practices and differences in road characteristics and climate.

■ Traction AA, A, B, C

The traction grades, from highest to lowest, are AA, A, B and C, and they represent the tire's ability to stop on wet pavement as measured under controlled conditions on specified government test surfaces of asphalt and concrete.

A tire marked C may have poor traction performance.

Warning: The traction grade assigned to this tire is based on braking (straight ahead) traction tests and does not include cornering (turning) traction.

■ Temperature A, B, C

The temperature grades are A (the highest), B, and C, representing the tire's resistance to the generation of heat and its ability to dissipate heat when tested under controlled conditions on a specified indoor laboratory test wheel.

Sustained high temperature can cause the material of the tire to degenerate and reduce tire life, and excessive temperature can lead to sudden tire failure.

The grade C corresponds to a level of performance which all passenger car tires must meet under the Federal Motor Vehicle Safety Standard No.109.

Grades B and A represent higher levels of performance on the laboratory test wheel than the minimum required by law.

Warning: The temperature grades for this tire are established for a tire that is properly inflated and not overloaded.

Excessive speed, underinflation, or excessive loading, either separately or in combination, can cause heat buildup and possible tire failure.

Glossary of tire terminology

Tire related term	Meaning
Cold tire inflation pressure	Tire pressure when the vehicle has been parked for three hours or more, or has not been driven more than 1 mile or 1.5 km under that condition
Maximum inflation pressure	The maximum cold inflated pressure to which a tire may be inflated, shown on the sidewall of the tire
Recommended inflation pressure	Cold tire inflation pressure recommended by a manufacturer
Accessory weight	The combined weight (in excess of those standard items which may be replaced) of automatic transmission, power steering, power brakes, power windows, power seats, radio and heater, to the extent that these items are available as factory-installed equipment (whether installed or not)
Curb weight	The weight of a motor vehicle with standard equipment, including the maximum capacity of fuel, oil and coolant, and if so equipped, air conditioning and additional weight optional engine
Maximum loaded vehicle weight	The sum of: (a) Curb weight (b) Accessory weight (c) Vehicle capacity weight (d) Production options weight

Tire related term	Meaning
Normal occupant weight	150 lb. (68 kg) times the number of occupants specified in the second column of Table 1* that follows
Occupant distribution	Distribution of occupants in a vehicle as specified in the third column of Table 1* below
Production options weight	The combined weight of installed regular production options weighing over 5 lb. (2.3 kg) in excess of the standard items which they replace, not previously considered in curb weight or accessory weight, including heavy duty brakes, ride levelers, roof rack, heavy duty battery, and special trim
Rim	A metal support for a tire or a tire and tube assembly upon which the tire beads are seated
Rim diameter (Wheel diameter)	Nominal diameter of the bead seat
Rim size designation	Rim diameter and width
Rim type designation	The industry manufacturer's designation for a rim by style or code
Rim width	Nominal distance between rim flanges
Vehicle capacity weight (Total load capacity)	The rated cargo and luggage load plus 150 lb. (68 kg) times the vehicle's designated seating capacity
Vehicle maximum load on the tire	The load on an individual tire that is determined by distributing to each axle its share of the maximum loaded vehicle weight, and dividing by two
Vehicle normal load on the tire	The load on an individual tire that is determined by distributing to each axle its share of curb weight, accessory weight, and normal occupant weight (distributed in accordance with Table 1* below), and dividing by two

Tire related term	Meaning
Weather side	The surface area of the rim not covered by the inflated tire
Bead	The part of the tire that is made of steel wires, wrapped or reinforced by ply cords and that is shaped to fit the rim
Bead separation	A breakdown of the bond between components in the bead
Bias ply tire	A pneumatic tire in which the ply cords that extend to the beads are laid at alternate angles substantially less than 90 degrees to the centerline of the tread
Carcass	The tire structure, except tread and sidewall rubber which, when inflated, bears the load
Chunking	The breaking away of pieces of the tread or sidewall
Cord	The strands forming the plies in the tire
Cord separation	The parting of cords from adjacent rubber compounds
Cracking	Any parting within the tread, sidewall, or innerliner of the tire extending to cord material
CT	A pneumatic tire with an inverted flange tire and rim system in which the rim is designed with rim flanges pointed radially inward and the tire is designed to fit on the underside of the rim in a manner that encloses the rim flanges inside the air cavity of the tire
Extra load tire	A tire designed to operate at higher loads and at higher inflation pressures than the corresponding standard tire
Groove	The space between two adjacent tread ribs
Innerliner	The layer(s) forming the inside surface of a tubeless tire that contains the inflating medium within the tire

Tire related term	Meaning
Innerliner separation	The parting of the innerliner from cord material in the carcass
Intended outboard sidewall	<p>(a) The sidewall that contains a whitewall, bears white lettering, or bears manufacturer, brand, and/or model name molding that is higher or deeper than the same molding on the other sidewall of the tire, or</p> <p>(b) The outward facing sidewall of an asymmetrical tire that has a particular side that must always face outward when mounted on a vehicle</p>
Light truck (LT) tire	A tire designated by its manufacturer as primarily intended for use on lightweight trucks or multipurpose passenger vehicles
Load rating	The maximum load that a tire is rated to carry for a given inflation pressure
Maximum load rating	The load rating for a tire at the maximum permissible inflation pressure for that tire
Maximum permissible inflation pressure	The maximum cold inflation pressure to which a tire may be inflated
Measuring rim	The rim on which a tire is fitted for physical dimension requirements
Open splice	Any parting at any junction of tread, sidewall, or innerliner that extends to cord material
Outer diameter	The overall diameter of an inflated new tire
Overall width	The linear distance between the exteriors of the sidewalls of an inflated tire, including elevations due to labeling, decorations, or protective bands or ribs
Passenger car tire	A tire intended for use on passenger cars, multipurpose passenger vehicles, and trucks, that have a gross vehicle weight rating (GVWR) of 10,000 lb. or less.

Tire related term	Meaning
Ply	A layer of rubber-coated parallel cords
Ply separation	A parting of rubber compound between adjacent plies
Pneumatic tire	A mechanical device made of rubber, chemicals, fabric and steel or other materials, that, when mounted on an automotive wheel, provides the traction and contains the gas or fluid that sustains the load
Radial ply tire	A pneumatic tire in which the ply cords that extend to the beads are laid at substantially 90 degrees to the centerline of the tread
Reinforced tire	A tire designed to operate at higher loads and at higher inflation pressures than the corresponding standard tire
Section width	The linear distance between the exteriors of the sidewalls of an inflated tire, excluding elevations due to labeling, decoration, or protective bands
Sidewall	That portion of a tire between the tread and bead
Sidewall separation	The parting of the rubber compound from the cord material in the sidewall
Snow tire	A tire that attains a traction index equal to or greater than 110, compared to the ASTM E-1136 Standard Reference Test Tire, when using the snow traction test as described in ASTM F-1805-00, Standard Test Method for Signal Wheel Driving Traction in a Straight Line on Snow-and Ice-Covered Surfaces, and which is marked with an Alpine Symbol () on at least one sidewall
Test rim	The rim on which a tire is fitted for testing, and may be any rim listed as appropriate for use with that tire

Tire related term	Meaning
Tread	That portion of a tire that comes into contact with the road
Tread rib	A tread section running circumferentially around a tire
Tread separation	Pulling away of the tread from the tire carcass
Treadwear indicators (TWI)	The projections within the principal grooves designed to give a visual indication of the degrees of wear of the tread
Wheel-holding fixture	The fixture used to hold the wheel and tire assembly securely during testing

*: Table 1 — Occupant loading and distribution for vehicle normal load for various designated seating capacities

Designated seating capacity, Number of occupants	Vehicle normal load, Number of occupants	Occupant distribution in a normally loaded vehicle
2 through 4	2	2 in front
5 through 10	3	2 in front, 1 in second seat
11 through 15	5	2 in front, 1 in second seat, 1 in third seat, 1 in fourth seat
16 through 20	7	2 in front, 2 in second seat, 2 in third seat, 1 in fourth seat

Customizable features

Your vehicle includes a variety of electronic features that can be personalized to your preferences. Programming these preferences requires specialized equipment and may be performed by your Toyota dealer.

Some function settings are changed simultaneously with other functions being customized. Contact your Toyota dealer.

Item	Function	Default setting	Customized setting
Wireless remote control (if equipped) (→P. 28)	Wireless remote control	On	Off
	Unlocking operation	Driver's door unlocked in one step, all doors unlocked in two steps	All doors unlocked in one step
	Automatic door lock function to be activated if door is not opened after being unlocked	On	Off
	Time elapsed before automatic door lock function is activated if door is not opened after being unlocked	60 seconds	30 seconds
			120 seconds
	Operation signal (Emergency flashers)	On	Off
	Operation signal (Buzzer)	On	Off
	Door lock buzzer	On	Off
Panic function	On	Off	

Item	Function	Default setting	Customized setting
Door lock (vehicles with power door lock system) (→P. 31)	Unlocking using a key	Driver's door unlocked in one step, all doors unlocked in two steps	All doors unlocked in one step
	Opening driver's door unlocks all doors	Off	On
	Shifting gears to P unlocks all doors. (vehicles with an automatic transmission)	On	Off
	Shifting gears to position other than P locks all doors. (vehicles with an automatic transmission)	On	Off
Illumination (→P. 279)	Time elapsed before lights turn off	15 seconds	7.5 seconds
			30 seconds
	Operation when the doors are unlocked (vehicles with power door lock system)	On	Off
	Operation after the engine switch is turned to the "LOCK" position	On	Off
Seat belt reminder (→P. 400)	Vehicle speed linked seat belt reminder buzzer	On	Off

Items to initialize

The following items must be initialized for normal system operation in cases such as after maintenance is performed on the vehicle.

Item	When to initialize	Reference
Maintenance data (U.S.A. only)	After the maintenance is performed	P. 321
Tire pressure warning system (if equipped)	<ul style="list-style-type: none"> • When rotating the tires on vehicles differing with front and rear tire inflation pressure. • When changing the tire size. 	P. 350

Reporting safety defects for U.S. owners

If you believe that your vehicle has a defect which could cause a crash or could cause injury or death, you should immediately inform the National Highway Traffic Safety Administration (NHTSA) in addition to notifying Toyota Motor Sales, U.S.A., Inc. (Toll-free: 1-800-331-4331).

If NHTSA receives similar complaints, it may open an investigation, and if it finds that a safety defect exists in a group of vehicles, it may order a recall and remedy campaign. However, NHTSA cannot become involved in individual problems between you, your dealer, or Toyota Motor Sales, U.S.A., Inc.

To contact NHTSA, you may call the Vehicle Safety Hotline toll-free at 1-888-327-4236 (TTY: 1-800-424-9153); go to <http://www.safercar.gov>; or write to: Administrator, NHTSA, 1200 New Jersey Ave, S.E., Washington, DC 20590. You can also obtain other information about motor vehicle safety from <http://www.safercar.gov>.

Seat belt instructions for Canadian owners (in French)

The following is a French explanation of seat belt instructions extracted from the seat belt section in this manual.

See the seat belt section for more detailed seat belt instructions in English.

Utilisation correcte des ceintures de sécurité

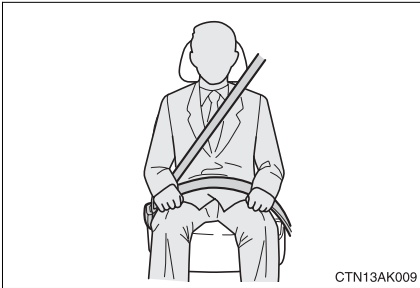

- Déroulez la sangle diagonale de telle sorte qu'elle passe bien sur l'épaule, sans pour autant être en contact avec le cou ou glisser de l'épaule.
- Placez la sangle abdominale le plus bas possible sur les hanches.
- Réglez la position du dossier de siège. Asseyez-vous le dos le plus droit possible et calez-vous bien dans le siège.
- Ne vrillez pas la ceinture de sécurité.

Guide confort de ceinture de sécurité (sièges arrière latéraux)

Si la sangle diagonale est proche du cou d'une personne, utilisez le guide confort de la ceinture de sécurité.

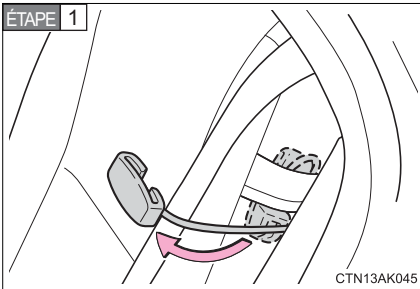

Sortez le guide confort de la pochette.

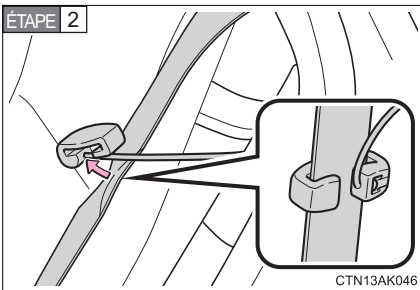

Glissez la ceinture dans la fente du guide.

Le cordon élastique doit être derrière la ceinture de sécurité.

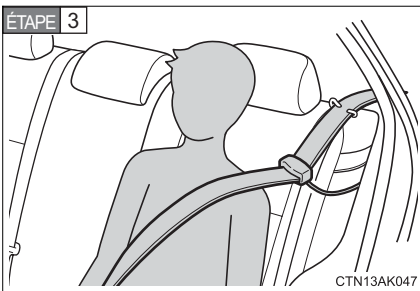

Attachez-vous, positionnez la ceinture et relâchez-la.

■ Ceinture de sécurité latérale arrière

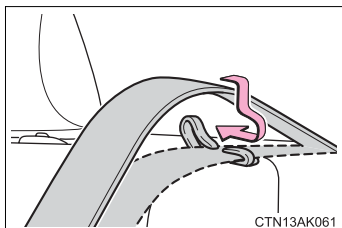

Si la ceinture de sécurité est sortie de son guide, repassez-la dedans avant de l'utiliser.

Entretien et soin

■ Ceintures de sécurité

Nettoyez avec un chiffon ou une éponge humectée d'eau savonneuse tiède. Vérifiez régulièrement que les ceintures ne sont pas effilochées, entaillées ou exagérément usées.

▲ ATTENTION

■ Détérioration et usure des ceintures de sécurité

Inspectez les ceintures de sécurité périodiquement. Contrôlez qu'elles ne sont pas entaillées, effilochées et que leurs ancrages ne sont pas desserrés. Ne pas utiliser une ceinture de sécurité défectueuse avant qu'elle ne soit remplacée. Une ceinture de sécurité défectueuse n'apporte aucune garantie de protection de l'occupant en cas d'accident.

SRS airbag instructions for Canadian owners (in French)

The following is a French explanation of SRS airbag instructions extracted from the SRS airbag section in this manual.

See the SRS airbag section for more detailed SRS airbag instructions in English.

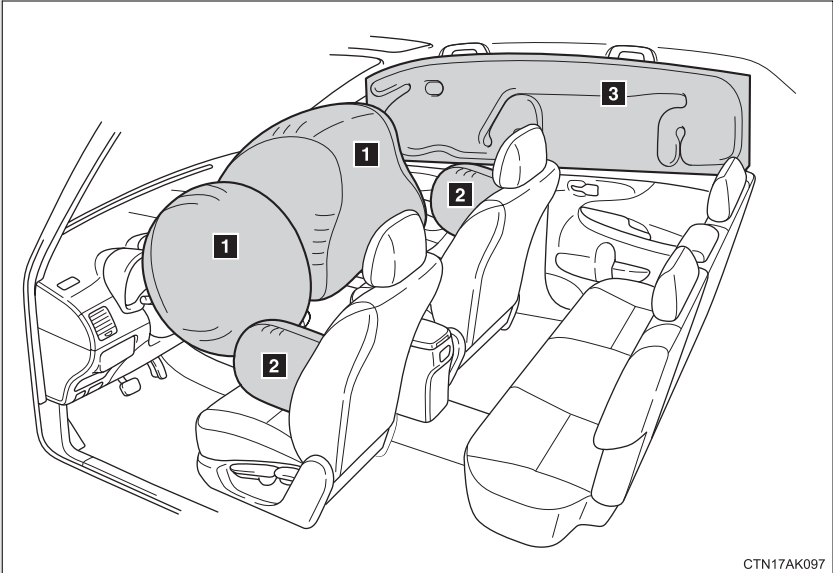

CTN17AK097

► Airbags frontaux

1 Airbag conducteur et passager avant

Participent à la protection de la tête et du thorax du conducteur et du passager avant contre les chocs avec des éléments de l'habitacle.

► Airbags latéraux et rideau

2 Airbags latéraux

Participent à la protection du haut du corps des occupants assis aux places avant.

3 Airbags rideau

Participent principalement à la protection de la tête des occupants assis aux places extérieures.

Composition du système d'airbags

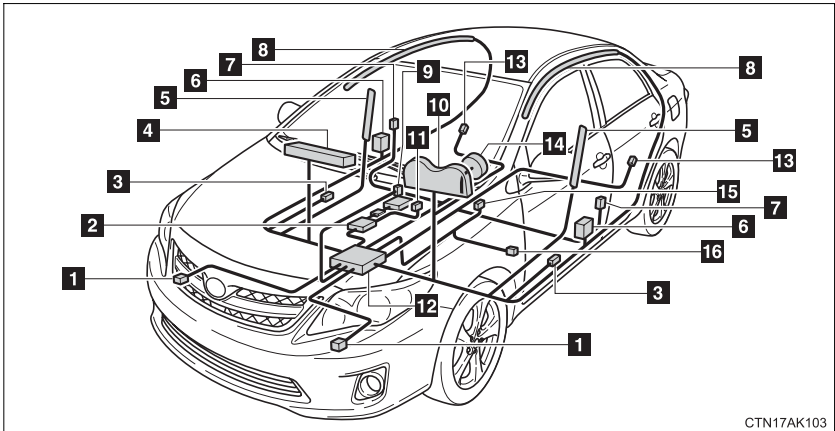

CTN17AK103

- | | |
|--|---|
| 1 Capteurs d'airbag avant | 10 Témoin d'alerte SRS |
| 2 Système de classification de l'occupant du siège passager avant (ECU et capteurs) | 11 Contacteur de boucle de ceinture de sécurité passager avant |
| 3 Capteurs de porte | 12 Boîtier électronique d'airbags |
| 4 Airbag passager avant | 13 Capteurs des airbags rideau |
| 5 Airbags latéraux | 14 Airbag conducteur |
| 6 Prétensionneurs de ceintures de sécurité et limiteurs de force | 15 Contacteur de boucle de ceinture de sécurité conducteur |
| 7 Capteurs d'airbags latéraux et rideau | 16 Capteur de position du siège conducteur |
| 8 Airbags rideau | |
| 9 Témoins indicateurs "PASSENGER AIR BAG ON" et "PASSENGER AIR BAG OFF" | |

Votre véhicule est équipé de ADVANCED AIRBAGS conçus selon les normes de sécurité américaines applicables aux véhicules à moteur (FMVSS208). Le boîtier électronique (ECU) des sacs de sécurité gonflables régule le déploiement de ces derniers sur la base des informations qu'il reçoit des capteurs, etc. indiqués ci-dessus dans le schéma illustrant les composants du système. Parmi ces informations figurent la gravité du choc et l'occupation du véhicule par les passagers. Le déploiement rapide des airbags est obtenu au moyen d'une réaction chimique dans les dispositifs pyrotechniques, qui produit un gaz inoffensif permettant d'amortir le mouvement des occupants.

ATTENTION

■ Précautions avec les airbags SRS

Respectez les précautions suivantes concernant les airbags. Autrement, des blessures graves, voire mortelles, pourraient s'ensuivre.

- Le conducteur et tous les passagers à bord du véhicule doivent porter leur ceinture de sécurité correctement.

Les airbags SRS sont des dispositifs de protection complémentaires aux ceintures de sécurité.

- L'airbag SRS conducteur se déploie avec une violence considérable, qui peut être très dangereuse voire mortelle si le conducteur se trouve très près de l'airbag.

L'autorité fédérale chargée de la sécurité routière aux États-Unis ("NHTSA") conseille:

Sachant que la zone de danger pour l'airbag conducteur se trouve dans les premiers 2 à 3 in. (50 à 75 mm) de déploiement, vous disposez d'une marge de sécurité confortable en vous plaçant à 10 in. (250 mm) de votre airbag conducteur. Cette distance est à mesurer entre le moyeu du volant et le sternum. Si vous êtes assis à moins de 10 in. (250 mm), vous pouvez changer votre position de conduite de différentes façons:

- Reculez votre siège le plus possible, de manière à pouvoir encore atteindre confortablement les pédales.
- Inclinez légèrement le dossier du siège.
Bien que les véhicules puissent être différents les uns des autres, la plupart des conducteurs peuvent s'asseoir à une distance de 10 in. (250 mm), même avec le siège conducteur complètement avancé, simplement en inclinant un peu le dossier de siège. Si vous avez des difficultés à voir la route après avoir incliné votre siège, utilisez un coussin ferme et antidérapant pour vous rehausser ou, si votre véhicule est équipé du réglage en hauteur du siège, remontez-le.
- Si votre volant est réglable, inclinez-le vers le bas. Cela a pour effet d'orienter l'airbag en direction de votre poitrine plutôt que de votre tête et de votre cou.

Régalez votre siège selon ces recommandations de la NHTSA, tout en conservant le contrôle des pédales, du volant et la vue des commandes du tableau de bord.

ATTENTION

■ Précautions avec les airbags SRS

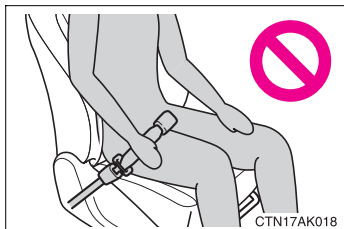

- Si vous attachez une rallonge de ceinture de sécurité aux boucles de ceinture de sécurité avant, mais pas au pêne de la ceinture de sécurité, les airbags SRS frontaux détectent que le conducteur et le passager avant ont attaché leur ceinture de sécurité, alors même que ce n'est pas le cas. Dans ce cas, il se peut que les airbags SRS frontaux ne se déploient pas correctement en cas d'accident, et vous risquez d'être tué ou grièvement blessé. Veillez à porter la ceinture de sécurité avec la rallonge de ceinture de sécurité.
- L'airbag SRS passager avant se déploie également avec une violence considérable, qui peut être très dangereuse voire mortelle si le passager avant se trouve très près de l'airbag. Éloignez le siège passager avant au maximum de l'airbag et réglez le dossier de siège de sorte à être assis bien droit dans le siège.

⚠ ATTENTION

■ Précautions avec les airbags SRS

- Les nourrissons et les enfants qui ne sont pas correctement assis et/ou protégés peuvent être grièvement blessés ou tués par le déploiement d'un airbag. Installez dans un siège de sécurité enfant les enfants trop jeunes pour pouvoir utiliser la ceinture de sécurité. Toyota recommande vivement que les nourrissons et les jeunes enfants soient installés sur le siège arrière du véhicule et convenablement attachés. Les sièges arrière sont les plus sûrs pour les nourrissons et les enfants. (→P. 103)

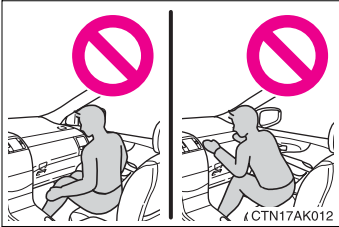

- Ne pas s'asseoir sur le bord du siège et ne pas s'appuyer contre la planche de bord.

! ATTENTION

■ Précautions avec les airbags SRS

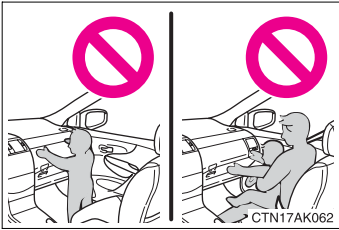

- Ne laissez pas un enfant rester debout devant l'airbag SRS passager avant ou bien s'asseoir sur les genoux du passager avant.



- Ne conduisez pas le véhicule lorsque le conducteur ou le passager avant a quelque chose de posé sur les genoux.

- Ne vous appuyez pas contre la porte, contre le rail latéral de toit ou contre les montants avant, latéraux et arrière.

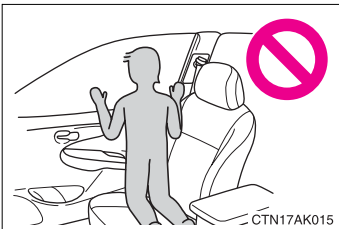

- Interdisez à quiconque de s'agenouiller sur le siège passager en appui contre la porte ou de sortir la tête ou les mains à l'extérieur du véhicule.

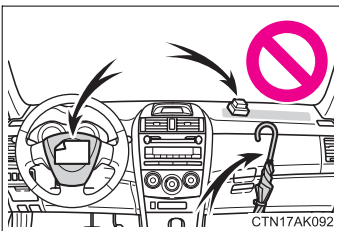

- Ne fixez ni ne posez aucun objet sur la planche de bord ou la garniture centrale du moyeu de volant.

Au déploiement des airbags SRS conducteur et passager avant, ces objets risquent de se transformer en projectiles.

⚠ ATTENTION

■ Précautions avec les airbags SRS

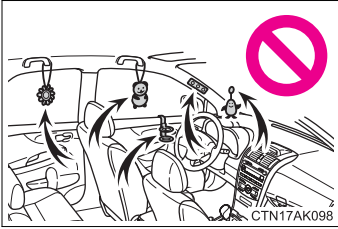

- Ne rien fixer aux portes, à la vitre du pare-brise, aux vitres latérales, aux montants avant et arrière, au rail latéral de toit et à la poignée de maintien.
- Ne suspendez aux crochets à vêtements aucun cintre nu ni aucun objet dur. En cas de déploiement des airbags rideau SRS, tous ces objets pourraient se transformer en projectiles et vous causer des blessures graves, voire mortelles.
- N'utilisez aucun accessoire de siège venant recouvrir les zones de déploiement des airbags SRS latéraux, car il risquerait d'en gêner le déploiement.
- Évitez de faire subir des chocs ou des pressions excessives aux zones renfermant les composants des airbags SRS (→P. 509).
En effet, cela pourrait entraîner un fonctionnement anormal des airbags SRS.
- Ne touchez aucun composant du système immédiatement après le déclenchement (gonflage) des airbags SRS, car ils sont alors encore très chauds.

ATTENTION

■ Précautions avec les airbags SRS

- Si vous avez des difficultés à respirer après le déploiement de l'airbag SRS, ouvrez une porte ou une vitre pour faire entrer de l'air frais, ou bien descendez du véhicule si cela ne présente pas de danger. Essayez tout résidu dès que possible afin d'éviter d'éventuelles irritations de la peau.
- Si les parties renfermant les airbags SRS, telles que la garniture du volant et les garnitures de montants avant et arrière, apparaissent abîmées ou craquelées, faites-les remplacer par votre concessionnaire Toyota.

■ Modification et mise au rebut des éléments du système d'airbags SRS

Consultez impérativement votre concessionnaire Toyota si vous avez besoin d'intervenir sur votre véhicule ou de procéder à l'une des modifications suivantes.

Les airbags SRS risquent de ne pas fonctionner correctement ou de se déployer (gonflage) accidentellement, provoquant ainsi des blessures graves, voire mortelles.

- Installation, dépose, démontage et réparations des airbags SRS.
- Réparations, modifications, démontage ou remplacement du volant, du tableau de bord, de la planche de bord, des sièges ou de leur garnissage, des montants avant, latéraux et arrière ou du rail latéral de toit.
- Réparations ou modifications des ailes avant, du bouclier avant ou des flancs de l'habitacle.
- Installation de chasse-neige, de treuils, etc., sur la calandre (pare-buffle, pare-kangourou, etc.).
- Modification du système de suspension du véhicule.
- Installation d'appareils électroniques, tels qu'un radioémetteur/récepteur ou d'un lecteur CD.
- Aménagements du véhicule visant à permettre sa conduite par une personne atteinte d'un handicap physique.

Abbreviation/Acronym list

ABBREVIATIONS	MEANING
2WD	2 Wheel Drive
4WD	4 Wheel Drive
A/C	Air Conditioning
ABS	Anti-lock Brake System
ACC	Accessory
ALR	Automatic Locking Retractor
AWD	All Wheel Drive
CRS	Child Restraint System
ECU	Electronic Control Unit
EDR	Event Data Recorder
ELR	Emergency Locking Retractor
EPS	Electric Power Steering
GAWR	Gross Axle Weight Rating
GCWR	Gross Combination Weight Rating
GVWR	Gross Vehicle Weight Rating
I/M	Emission inspection and maintenance
LATCH	Lower Anchors and Tethers for Children
LED	Light Emitting Diode
M + S	Mud and Snow
MMT	Methylcyclopentadienyl Manganese Tricarbonyl
MTBE	Methyl Tertiary Butyl Ether
OBD	On Board Diagnostics
SRS	Supplemental Restraint System
TIN	Tire Identification Number
TPMS	Tire Pressure Warning System
TRAC	Traction Control
TWR	Trailer Weight Rating

ABBREVIATIONS	MEANING
VIN	Vehicle Identification Number
VSC	Vehicle Stability Control

What to do if...

What to do if...

A tire punctures	P. 408	If you have a flat tire
The engine does not start	P. 422	If the engine will not start
	P. 68	Engine immobilizer system
	P. 425	If the battery is discharged
The shift lever cannot be moved out	P. 423	If the shift lever cannot be shifted from P
The engine coolant temperature gauge enters the red zone	P. 430	If your vehicle overheats
The key is lost	P. 424	If you lose your keys
The battery runs out	P. 425	If the battery is discharged
The doors cannot be locked	P. 31	Doors
The vehicle is stuck in mud or sand	P. 433	If the vehicle becomes stuck
A warning light or indicator light comes on	P. 397	If a warning light turns on or a warning buzzer sounds...

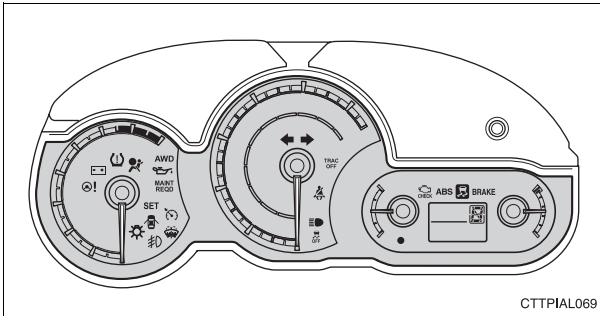

■ Warning lights

BRAKE	Brake system warning light	AWD	Active Torque Control 4WD system warning light P. 398
or		MAINT REQD	Maintenance required reminder light P. 400
	P. 397		Tire pressure warning light P. 400
	Charging system warning light P. 398		Low windshield washer fluid level warning light P. 400
	Low engine oil pressure warning light P. 398		Slip indicator light P. 398
	Malfunction indicator lamp		Cruise control indicator light* P. 398
or			Open door warning light P. 400
	SRS warning light P. 398		Low fuel level warning light P. 400
ABS	ABS warning light		Driver's seat belt reminder light P. 400
or			Front passenger's seat belt reminder light P. 400
	P. 398		Electric power steering system warning light P. 398

*: The light flashes to indicate a malfunction.

GAS STATION INFORMATION

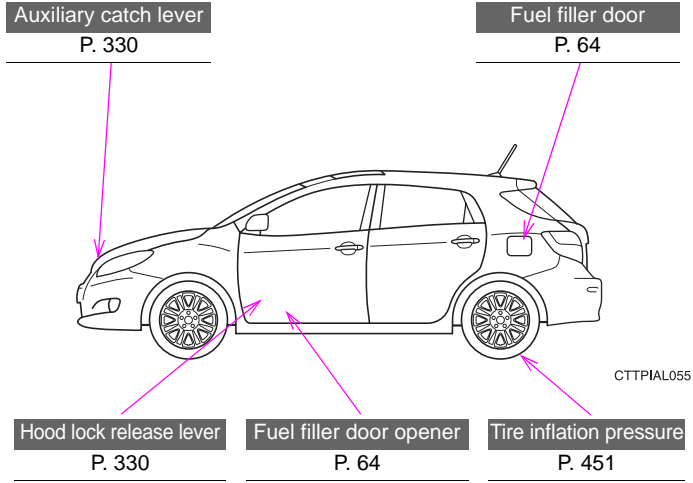

Fuel tank capacity (Reference)		13.2 gal. (50 L, 10.9 Imp. gal.)	
Fuel type		Unleaded gasoline only P. 65, 442	
Cold tire inflation pressure		P. 451	
Engine oil capacity (Drain and refill — reference)	1.8 L 4-cylinder (2ZR-FE) engine	With filter	qt. (L, Imp. qt.) 4.4 (4.2, 3.7)
		Without filter	4.1 (3.9, 3.4)
	2.4 L 4-cylinder (2AZ-FE) engine	With filter	4.0 (3.8, 3.3)
		Without filter	3.8 (3.6, 3.2)
Engine oil type		P. 443	