



CUSTOMER EXPERIENCE CENTER
1-800-331-4331

PRIUS

2 0 1 0



QUICK REFERENCE GUIDE



2010 Prius

This *Quick Reference Guide* is a summary of basic vehicle operations. It contains brief descriptions of fundamental operations so you can locate and use the vehicle's main equipment quickly and easily.

The *Quick Reference Guide* is not intended as a substitute for the *Owner's Manual* located in your vehicle's glove box. We strongly encourage you to review the *Owner's Manual* and supplementary manuals so you will have a better understanding of your vehicle's capabilities and limitations.

Your dealership and the entire staff of Toyota Motor Sales, U.S.A., Inc. wish you many years of satisfied driving in your new Prius.

! A word about safe vehicle operations

This *Quick Reference Guide* is not a full description of Prius operations. Every Prius owner should review the *Owner's Manual* that accompanies this vehicle.

Pay special attention to the boxed information highlighted in color throughout the *Owner's Manual*. Each box contains safe operating instructions to help you avoid injury or equipment malfunction.

All information in this *Quick Reference Guide* is current at the time of printing. Toyota reserves the right to make changes at any time without notice.

Doors-Child safety locks

Rear door

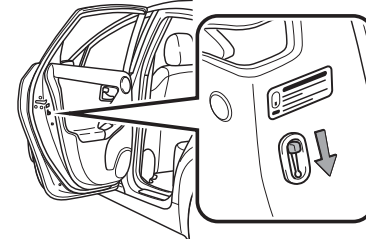

Moving the lever to "LOCK" will allow the door to be opened only from the outside.

Spare tire & tools

Tool location

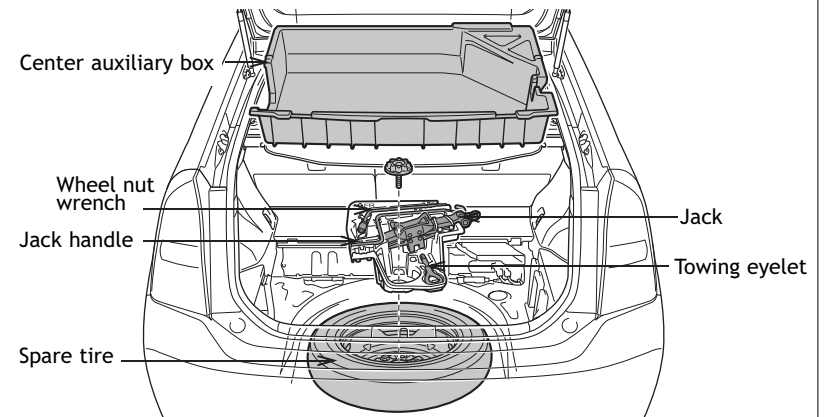

Removing the spare tire

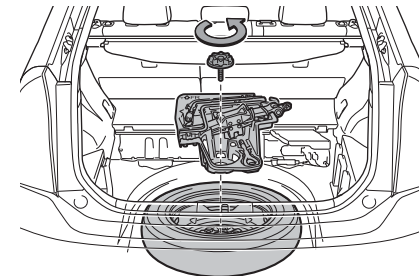

Refer to the *Owner's Manual* for tire changing and jack positioning procedures.

INDEX

OVERVIEW

Engine maintenance	9
Fuel tank door release and cap	8
Hood release	8
Indicator symbols	4-5
Instrument cluster	4
Instrument panel	2-3
Keyless entry¹	6
Light control-Instrument panel	9
Smart Key system^{1,2}	7

FEATURES/OPERATIONS

Air Conditioning/Heating	16
Audio	18-19
Auto lock functions¹	10
Clock	23
Cruise control	20
Dynamic Radar Cruise Control	20-21
EV-Drive Mode	12
Garage door opener (HomeLink [®]) ³	23
Hill start Assist Control (HAC)	23
Hybrid Synergy Drive System	10
Lights¹ & turn signals	15
LKA (Lane Keep Assist)	21
Moonroof	17
Multi-information display²	22
Parking brake	12
Power outlets	19
Seat adjustments-Front	13
Seat heaters	16
Seats-Folding down second row seats	13
Seats-Head restraints	13
Solar ventilation system	17
Steering wheel switches	19
Telephone controls (Bluetooth [®])	22
Tilt and telescopic steering wheel	12
Transmission	11
Windows-Power	14
Windshield wipers & washers	14

SAFETY AND EMERGENCY FEATURES

Doors-Child safety locks	25
Door locks	24
Seatbelts	24
Seatbelts-Shoulder belt anchor	24
Spare tire & tools	25
Tire Pressure Monitoring (warning) System	24

¹ Visit your Toyota dealer for information on customizing this feature.

² Programmable by customer. Refer to the Owner's Manual for instructions and more information.

³ HomeLink[®] is a registered trademark of Johnson Controls, Inc.

OVERVIEW

Instrument panel

Steering wheel controls

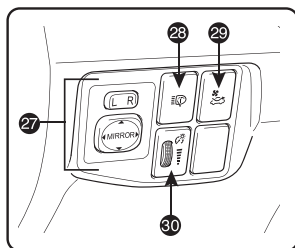
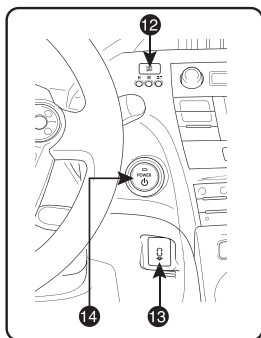
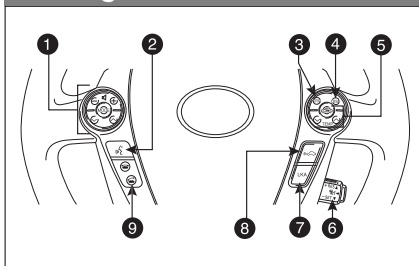

- 1 Steering wheel audio controls
- 2 Voice command button^{1,2}
- 3 "TRIP" button
- 4 Multi-information display button
- 5 Steering wheel climate controls
- 6 Cruise control¹
- 7 "LKA" switch¹
- 8 Distance switch¹
- 9 Telephone controls^{1,2}
- 10 Headlight and turn signal controls/Headlight, turn signal and front fog light controls¹
- 11 Wiper and washer controls¹
- 12 Mph or km/h button
- 13 Advance Parking Guide System/Intelligent Parking Assist pre-support switch^{1,2}
- 14 Power button
- 15 Multi-information display
- 16 Audio system or navigation system-integrated audio system^{1,2}

Automatic Air Conditioning

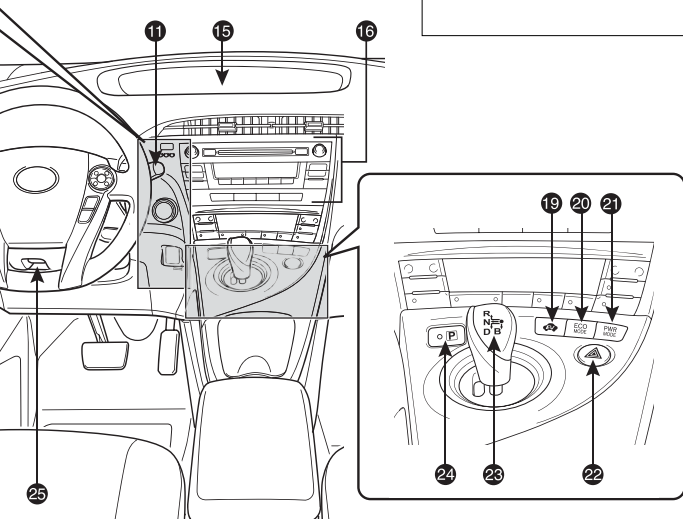
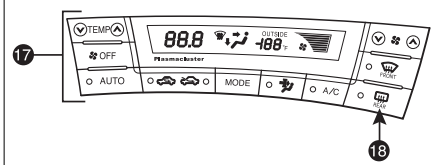

- 17 Air Conditioning controls
- 18 Outside rearview mirror¹/Back window defogger button
- 19 "EV" switch¹
- 20 "ECO MODE" switch
- 21 "PWR MODE" switch
- 22 Emergency flasher button
- 23 Shift lever
- 24 "P" position switch
- 25 Tilt and telescopic steering lock release lever
- 26 Fuel filler door opener
- 27 Power rearview mirror control
- 28 Headlight cleaner switch¹
- 29 Solar ventilation switch¹
- 30 Instrument panel light control

¹ If equipped

² For vehicles with a navigation system, refer to the "Navigation System Owner's Manual."

Instrument cluster

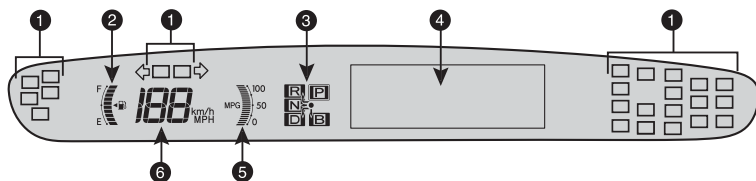



- ❶ Service indicator and reminder
- ❷ Fuel gauge
- ❸ Transmission shift position indicator
- ❹ Multi-information display
- ❺ Instantaneous fuel consumption
- ❻ Speedometer

Indicator symbols

For details, refer to “Indicators and warning lights,” Section 2-2, 2010 *Owner’s Manual*.

BRAKE Brake system warning¹

 Brake system warning light (yellow indicator)¹

 Driver seatbelt reminder
(alarm will sound if speed is over 12 mph)

PASSENGER AIRBAG OFF **AIRBAG ON**  Front passenger seatbelt reminder
(alarm will sound if speed is over 12 mph)

 Charging system warning¹

PASSENGER AIRBAG OFF **AIRBAG ON** Front passenger occupant classification or front passenger airbag ON/OFF indicator¹



















 Malfunction/Check Engine indicator¹

 Low fuel level warning

 Open door warning

 Airbag SRS warning¹

¹ If indicator does not turn off within a few seconds of starting engine, there may be a malfunction. Have vehicle inspected by your Toyota dealer.

	Master warning
	Low Tire Pressure Warning ¹
	Electric power steering system warning ¹
	Theft deterrent/Engine immobilizer system indicator
	Headlight low/high beam indicator
	Turn signal indicator
	READY indicator
	EV Drive Mode indicator
	Eco Mode indicator
	Power Mode indicator
	Front fog light indicator
	Slip indicator/Hill start Assist Control indicator ¹
	Cruise control indicator ²
	Lane Keep Assist indicator
	Anti-lock Brake System warning ¹
	Automatic headlight leveling system warning ¹
	Pre-Collision System warning light ¹
	High coolant temperature warning light ¹

² If this light flashes, refer to "Cruise control," Section 2-4, 2010 Owner's Manual.

Keyless entry

Locking operation

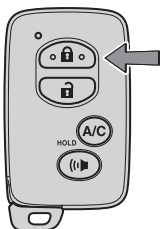

Push



Unlocking operation

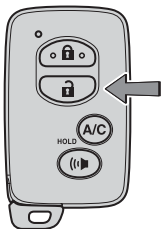

Push ONCE: Driver door
TWICE: All doors



NOTE: If a door is not opened within 60 seconds of unlocking, all doors will relock for safety.

Remote Air Conditioning system operation (if equipped)

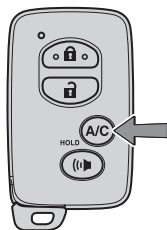

Will automatically shut off after three minutes, or if a door is opened.

Push and hold



Panic button



Push and hold



Smart Key system (if equipped)

Start function

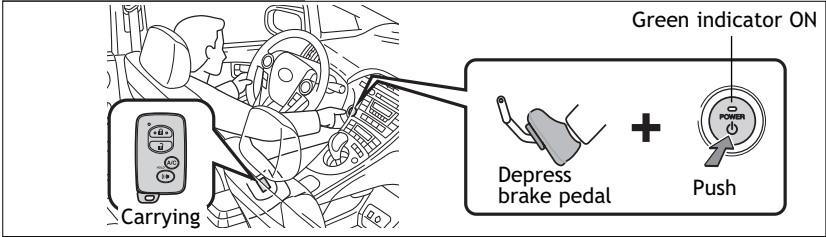

Power (without starting Hybrid System)

Without depressing the brake pedal, pressing the "POWER" switch will change the operation mode in succession from:

ACCESSORY

Accessories such as the radio will operate.

ON

Power ON; Hybrid System is not engaged.

OFF

All systems OFF.

Locking operation (if equipped)

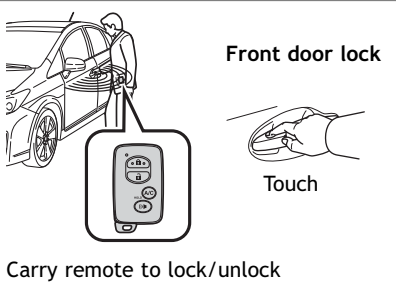

Unlocking operation (if equipped)

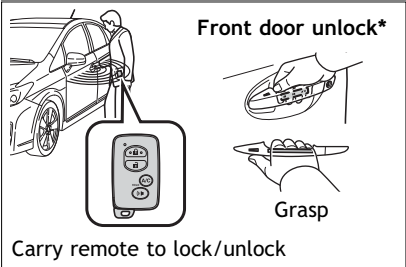

Back door lock/unlock (if equipped)

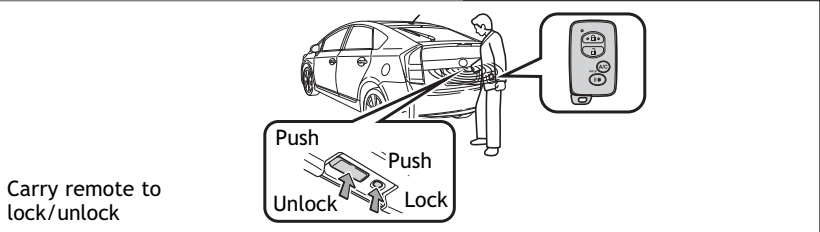

* Driver door unlocking function can be programmed to unlock driver door only, or all doors. Grasping passenger door handle will unlock all doors.

NOTE: Doors may also be locked/unlocked using remote.

Fuel tank door release and cap

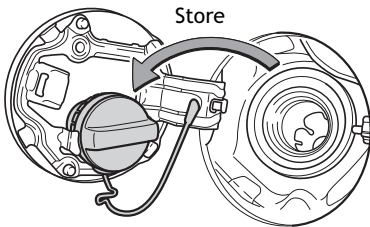
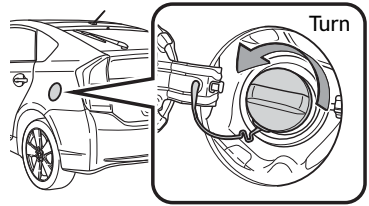
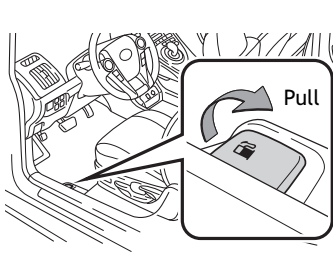

NOTE: Tighten until one click is heard. If the cap is not tightened enough, Check Engine "CHECK" indicator may illuminate.

Hood release

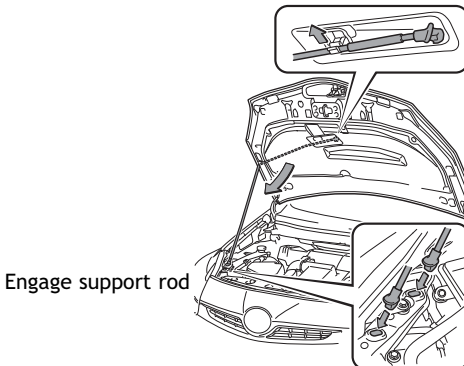
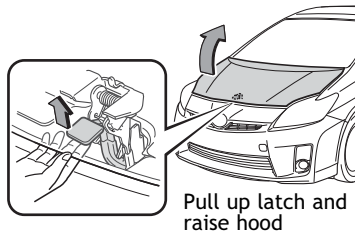
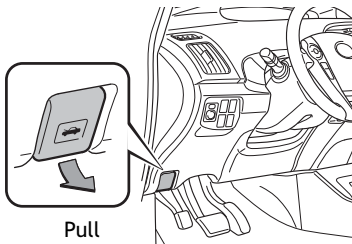

Light control-Instrument panel

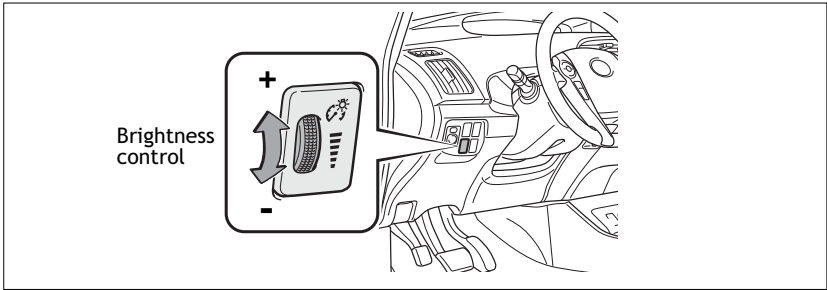

Engine maintenance

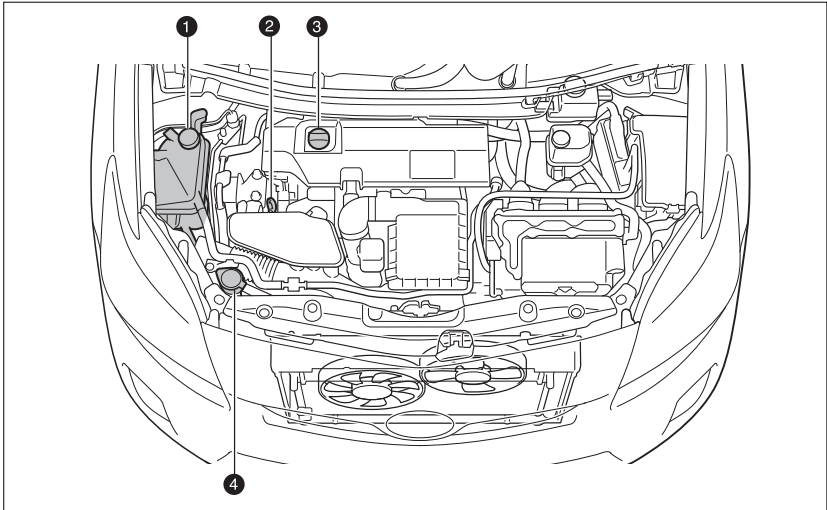

- 1 Engine coolant reservoir
- 2 Engine oil level dipstick
- 3 Engine oil filler cap
- 4 Windshield washer fluid tank

Note: Regularly scheduled maintenance, including oil changes, will help extend the life of your vehicle and maintain performance. Please refer to the "Warranty Maintenance Guide."

FEATURES/OPERATIONS

Hybrid Synergy Drive System

The Hybrid Synergy Drive System utilizes a computer-controlled gasoline engine and electric motor to provide the most efficient combination of power for the vehicle. To conserve energy, when the brakes are applied the braking force generates electricity which is then sent to the traction battery. In addition, the engine shuts off when the vehicle is stopped. The benefits are better fuel economy, reduced vehicle emissions and improved performance.

Note: Fuel consumption and energy information of the Hybrid System are shown on the multi-information display.

Tips for improved fuel economy

- Ensure tire pressures are maintained at levels specified in the *Owner's Manual*.
- When possible, link trips to reduce engine cold starts.
- Avoid driving at speeds that are higher than necessary, especially on the highway.
- When possible, avoid sudden stops to maximize regenerative braking energy.
- Minimize use of the Air Conditioning.

Starting the Hybrid System

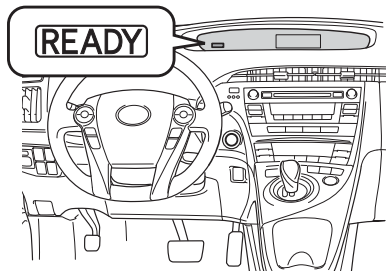

- (1) Depress the brake pedal, and press the "POWER" switch briefly and firmly.
- (2) The "READY" light will blink. After a few seconds, when the light remains steady and a beep sounds, you may begin driving.

Auto lock functions

Automatic door locks can be programmed to operate in two different modes, or turned OFF.

- Doors lock when shifting from Park.
- Doors lock when the vehicle speed is approximately 12 mph or higher.
- Doors unlock when shifting into Park.
- Doors unlock when the driver's door is opened within 10 seconds after turning the "POWER" switch or ignition switch OFF.

Refer to the *Owner's Manual* for more details.

Transmission

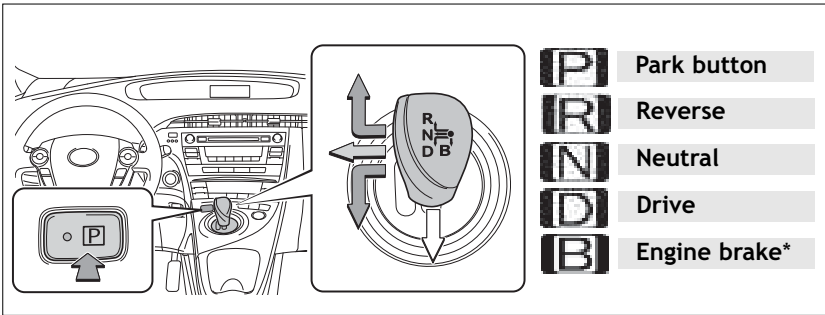

* The engine brake is the equivalent of downshifting. Shift to "B" when engine braking is desired (i.e. downhill driving, coasting to a stop, etc.).

Eco Mode

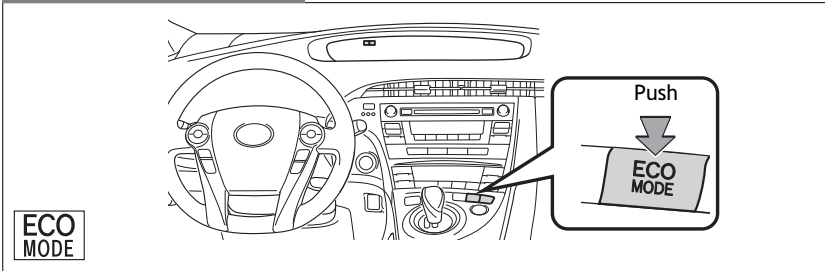

Eco Mode helps achieve low fuel consumption during trips that involve frequent accelerating and braking.

Refer to the *Owner's Manual* for more details.

Power Mode

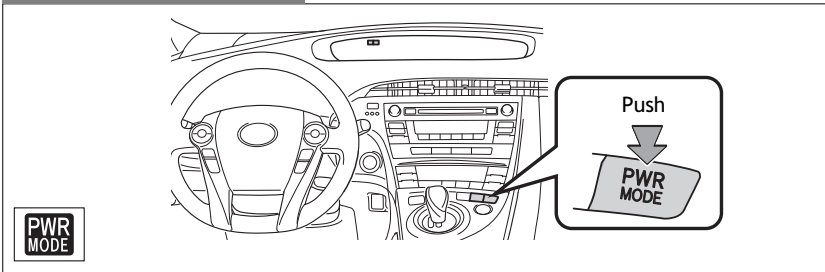

Use when a higher level of response is desired, such as when driving in mountainous regions.

Refer to the *Owner's Manual* for more details.

EV-Drive Mode (if equipped)

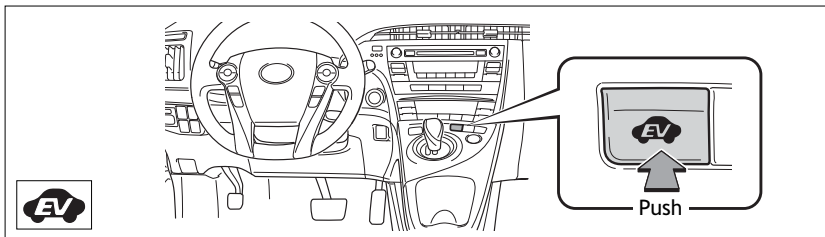

EV-Drive Mode allows the electric motor (traction motor), powered by the hybrid battery (traction battery), to be used to drive the vehicle under certain driving conditions.

Refer to the *Owner's Manual* for more details.

Tilt and telescopic steering wheel

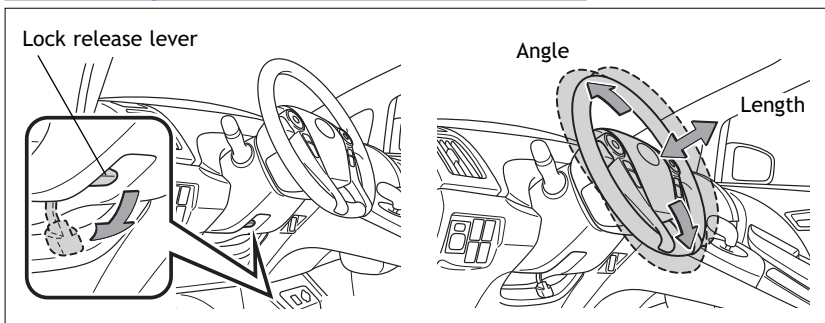

Hold wheel, push lever down, set angle and length, and return lever.

Note: Do not attempt to adjust while the vehicle is in motion.

Parking brake

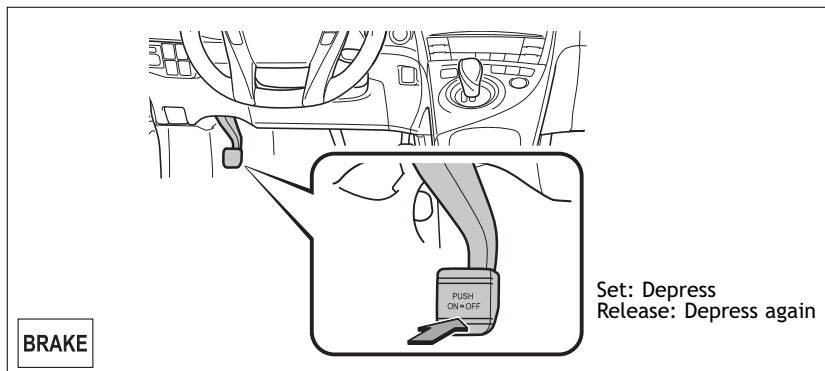

Seat adjustments-Front

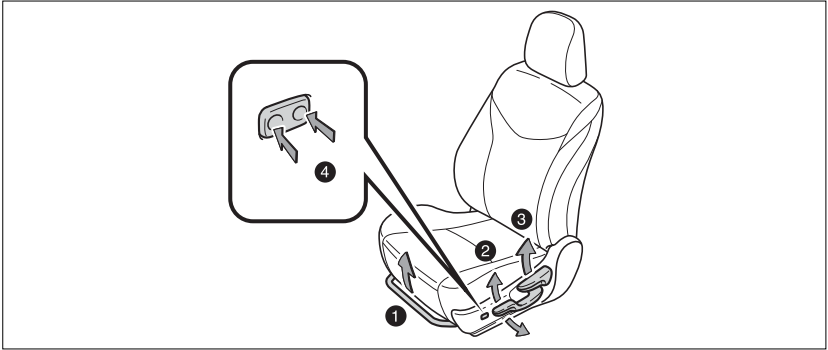

- ① Seat position (forward/backward)
- ② Seatback angle
- ③ Height crank (driver side; if equipped)
- ④ Lumbar support (driver side; if equipped)

Seats-Head restraints

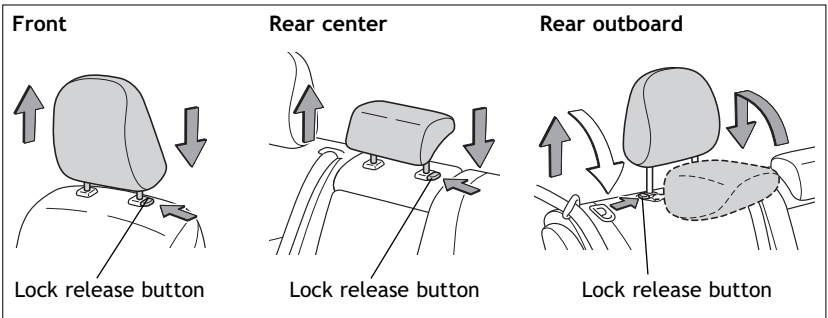

Seats-Folding down second row seats

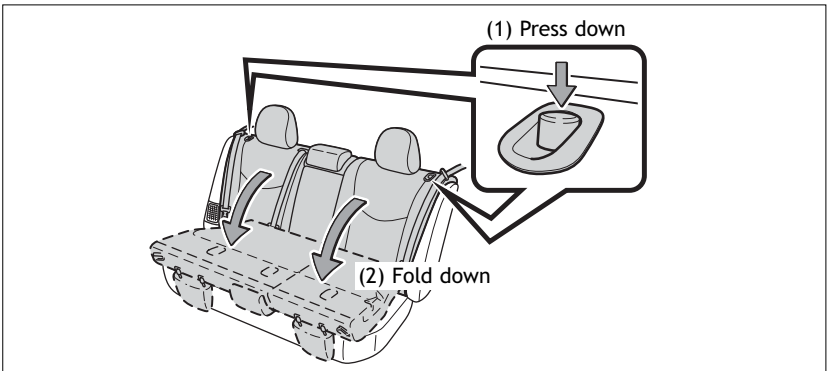

Windows-Power

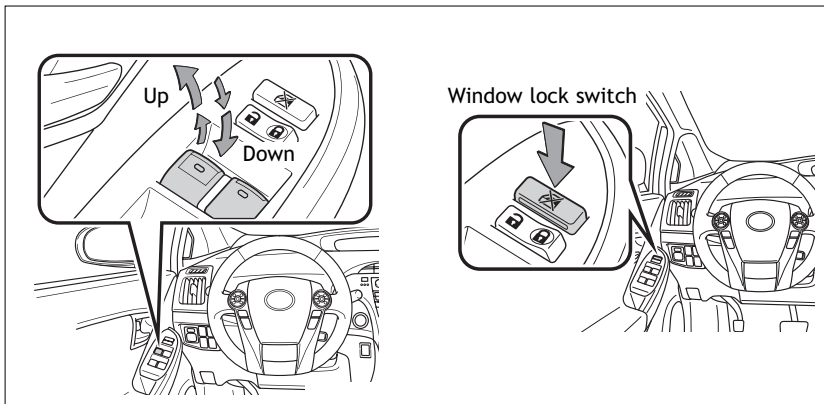

Automatic operation Push the switch completely down or pull it completely up and release to fully open or close. To stop window midway, push the switch in the opposite direction.

Window lock switch Deactivates all passenger windows. Driver's window remains operable.

Windshield wipers & washers

Front

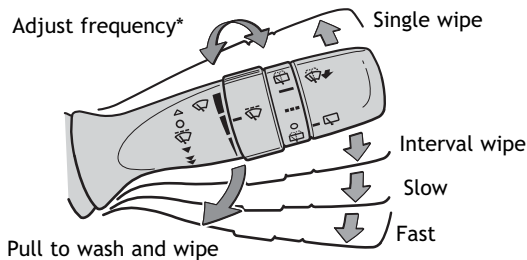

*** Intermittent windshield wiper frequency adjustment**
Rotate to increase/decrease wipe frequency.

Rear (if equipped)

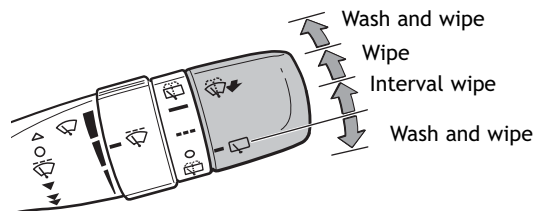

Lights & turn signals

Headlights

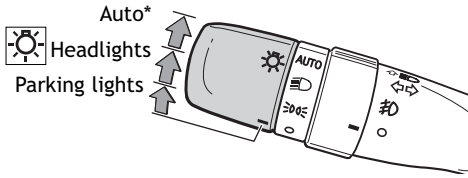

* If equipped

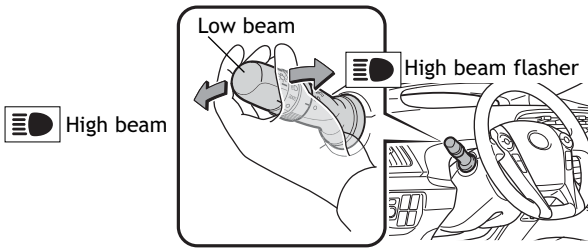

- Daytime Running Light system (DRL) (if equipped) Automatically turns on the headlights at a reduced intensity.
- Automatic light cutoff system (if equipped) Automatically turns lights off after a delay of 30 seconds.

Front fog lights (if equipped)

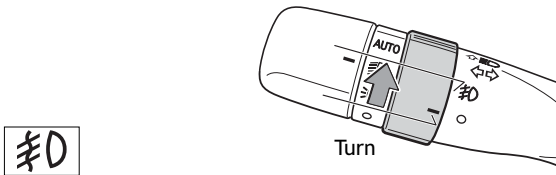

Front fog lights come on only when the headlights are on low beam.

Turn signals

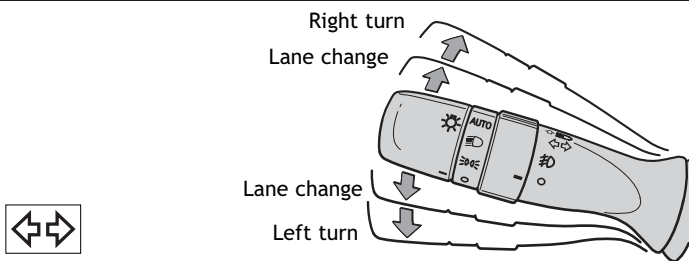

Seat heaters (if equipped)

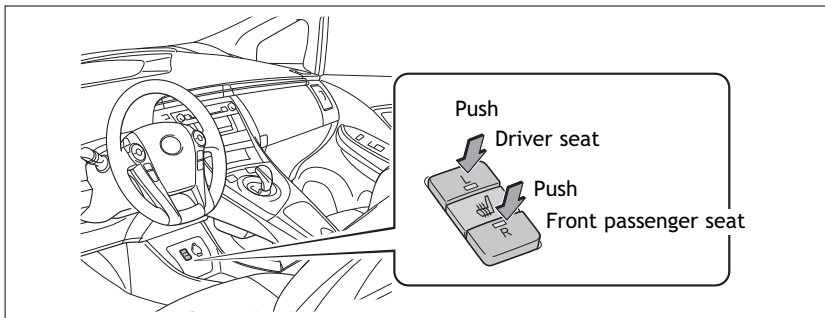

Air Conditioning/Heating

Front automatic Air Conditioning

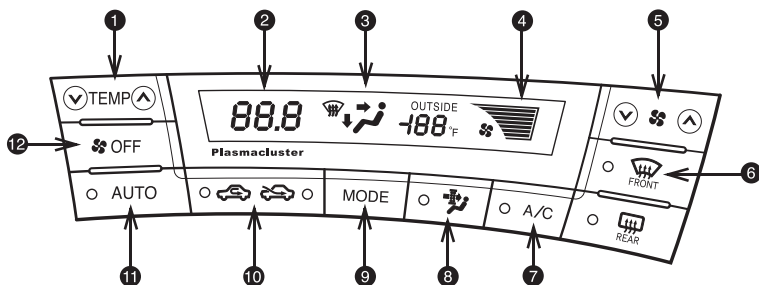

- 1 Temperature selector
- 2 Temperature setting display
- 3 Air outlet display
- 4 Fan speed display
- 5 Fan speed control
- 6 Windshield defogger
- 7 Air Conditioning ON/OFF
- 8 Micro dust and pollen filter mode (turns off automatically after 3 minutes)
- 9 Airflow vent
In " " or " " mode, use fresh air (" " indicator OFF) to reduce window fogging.
- 10 Fresh or recirculated cabin air
- 11 Automatic climate control ON
Adjusting the temperature setting will cause the airflow vents, air intake and fan to adjust automatically.
- 12 Climate control OFF

Solar ventilation system (if equipped)

With the "POWER" switch in ON mode, turn on the solar ventilation switch.

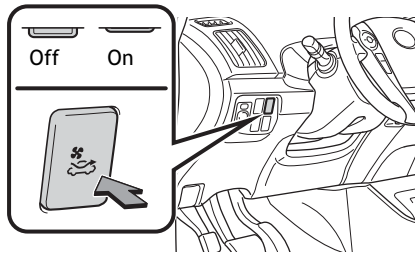

The solar ventilation system allows ventilation of the vehicle interior when the vehicle is parked in direct sunlight.

Refer to the *Owner's Manual* for more details.

Moonroof (if equipped)

Opening operation

Push once to tilt up; again to open partway; again to open completely.

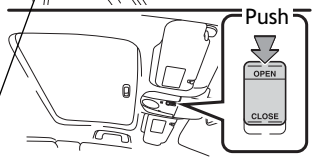
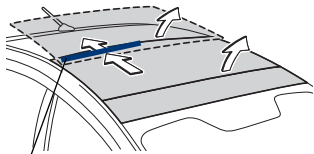

Recommended driving position to minimize wind noise.

Closing operation

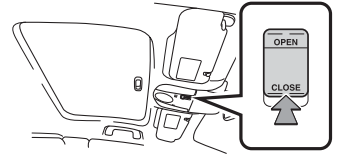
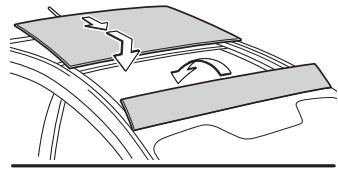

Push and hold

Audio

Type 1

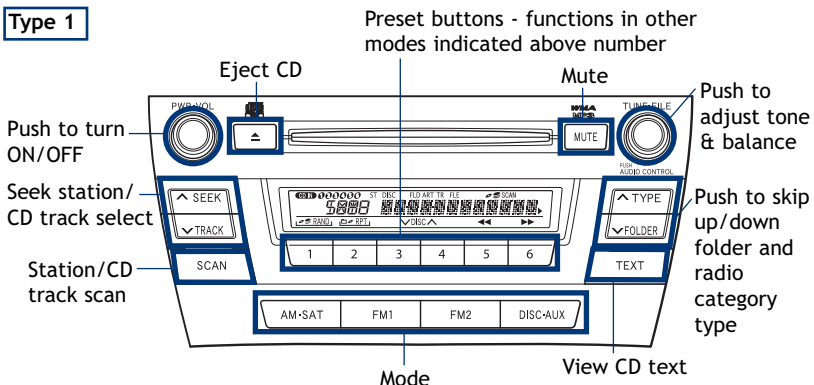

Type 2 (with JBL speakers and Bluetooth® function)

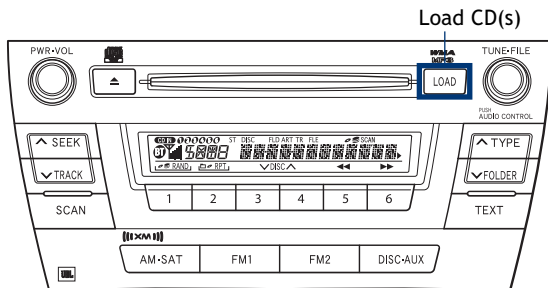

CD PLAYER

To scan tracks on a disc Push and hold "SCAN." Push again to hold selection.

CD changer (Type 2 only)

- To load one disc Push "LOAD" and insert one disc.
- To load multiple discs Push and hold "LOAD" until you hear a beep. Insert one disc. Shutter will close and then re-open for next disc.

To select a file (MP3/WMA only) Turn "TUNE-FILE."

To select a folder (MP3/WMA only) Push either side of "FOLDER."

RADIO

To preset stations Tune in the desired station and hold down a preset button (1-6) until you hear a beep. Push desired preset button (1-6) to select.

To scan stations Push and hold "SCAN" to scan preset stations. Push again to hold selection.

AUX audio jack (if equipped)

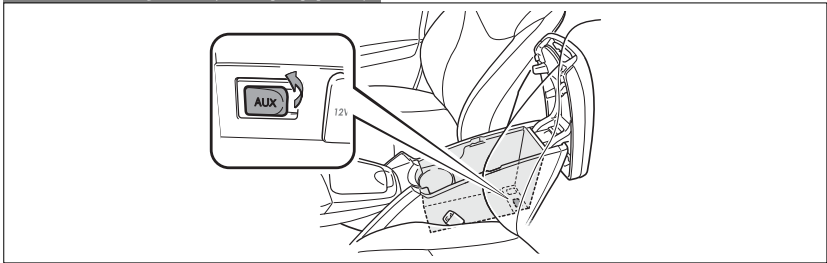

By inserting a mini plug into the AUX audio jack, you can listen to music from a portable audio device through the vehicle's speaker system while in AUX mode.

Power outlets

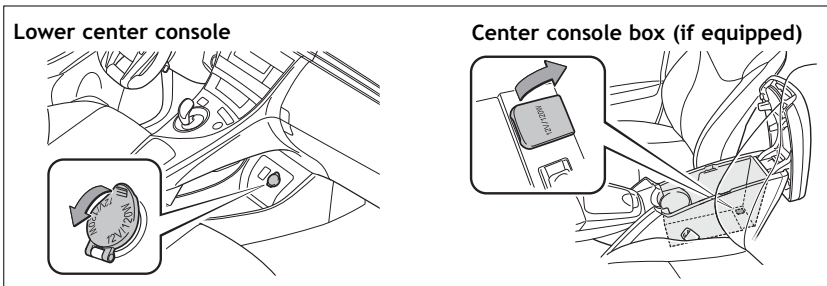

Power switch must be set at "ACCESSORY" or "ON" mode to be used.

Steering wheel switches

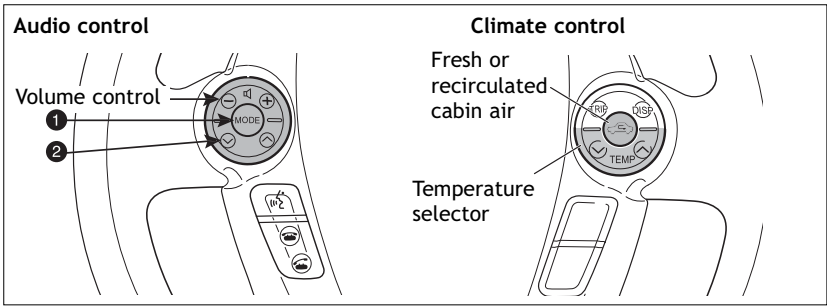

- 1 "MODE"
Push to turn audio ON and select an audio mode. Push and hold to turn the audio system OFF.
- 2 "V A"
-In radio mode Push to select a preset station; push and hold to seek the next strong station.
-In CD mode Push to skip up or down to next/previous track.

Cruise control (if equipped)

Turning system ON/OFF

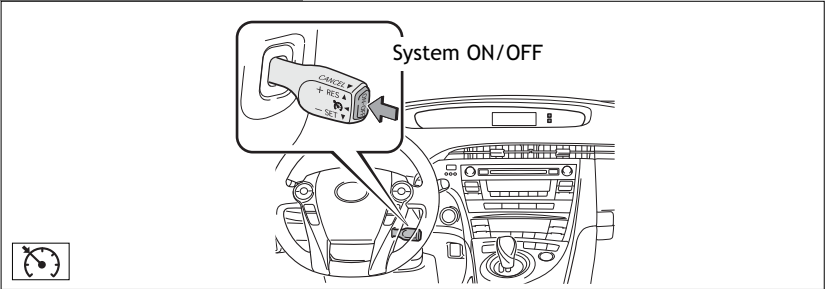

Functions

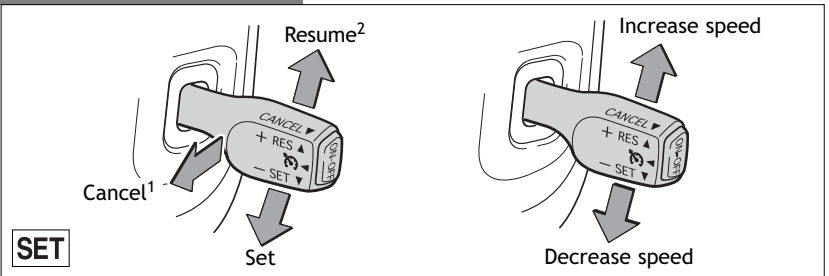

¹ The set speed may also be cancelled by depressing the brake pedal.

² The set speed may be resumed once vehicle speed exceeds 25 mph.

Dynamic Radar Cruise Control (if equipped)

Refer to the *Owner's Manual* for more details and complete safety precautions before attempting to use "Dynamic Radar Cruise Control."

Fixed speed mode

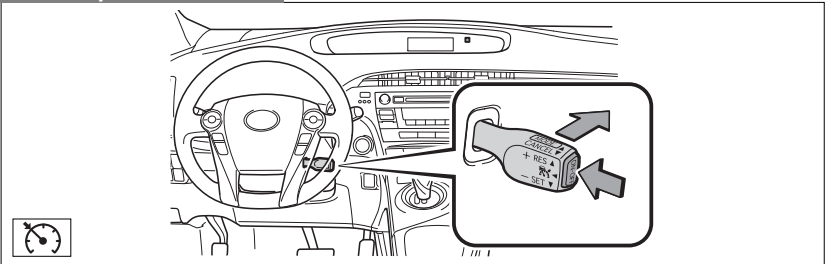

- (1) **To select conventional/fixed speed control** Push the ON-OFF button. Push the lever forward and hold until the "Ⓢ" indicator appears.
- (2) **To set, cancel and resume a speed** Refer to instructions in the *Cruise Control* section.

Distance control mode

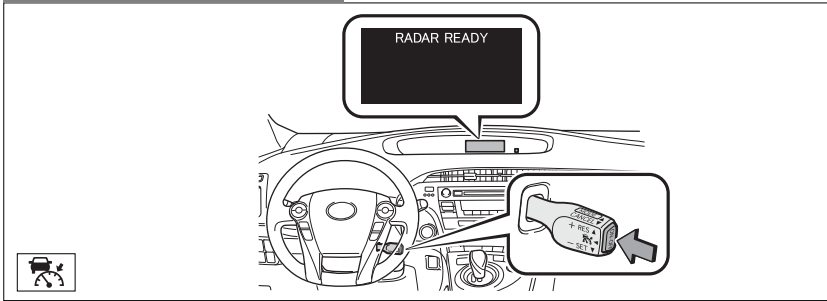

Distance control mode will cruise at a set speed, decelerate to maintain selected distance from a slower vehicle traveling in front of you, and accelerate back up to the selected speed if the vehicle in front of you changes lanes or speeds up.

- (1) **To select distance control mode** Push the ON-OFF button. The "RADAR READY" and "⚠️" will come on.
- (2) **To set, cancel and resume a speed** Refer to instructions for *Cruise Control* on the previous page.

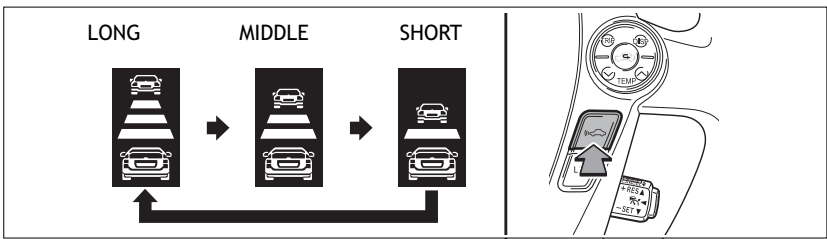

- (3) **To change the vehicle-to-vehicle distance** Push the distance button to cycle through the settings, which will change progressively from LONG to MIDDLE to SHORT.

LKA (Lane Keep Assist) (if equipped)

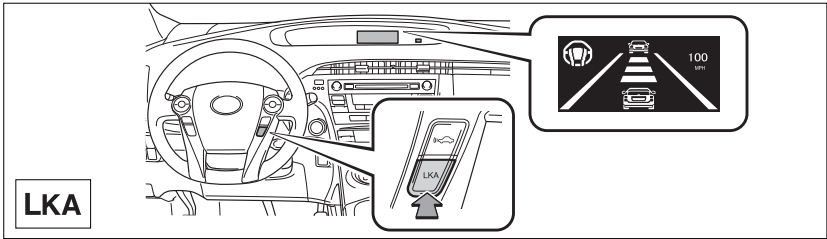

When activated, the LKA system camera detects lane markings and alerts the driver when the vehicle strays from its lane. Driver may also experience a slight steering torque.

Refer to the *Owner's Manual* for more details.

Multi-information display

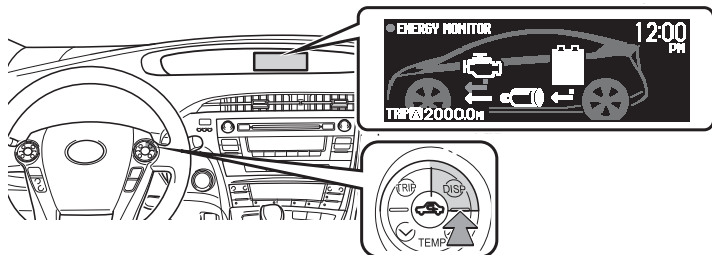

Push "DISP" to change information in the following:

- (1) Energy monitor
- (2) Hybrid System Indicator
- (3) 5-minute/1-minute interval fuel consumption display
- (4) Fuel consumption history display

Push and hold "DISP" to set up the displays.

Telephone controls (Bluetooth®) (if equipped)

Microphone (type A)

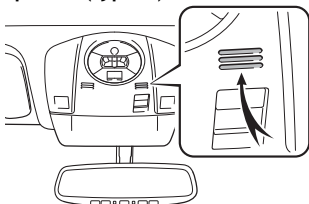

Microphone (type B)

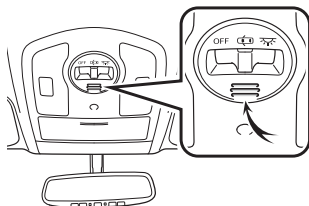

Audio unit

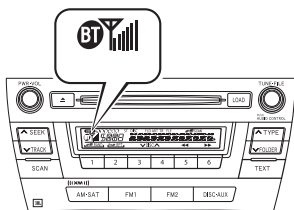

Steering wheel telephone switches

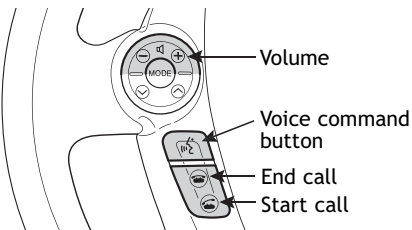

Bluetooth® technology allows dialing or receipt of calls without taking hands from the steering wheel or using a cable to connect the telephone and the system.

Refer to "Hands-free phone system (for cellular phone)," Section 3-3 in the *Owner's Manual* for more details.

Clock

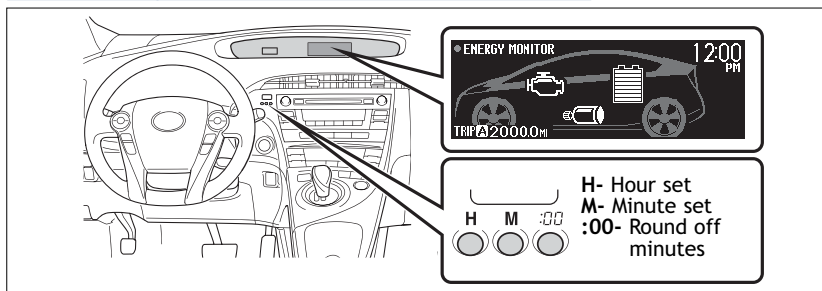

Refer to the *Owner's Manual* for adjusting time.

Hill start Assist Control (HAC)

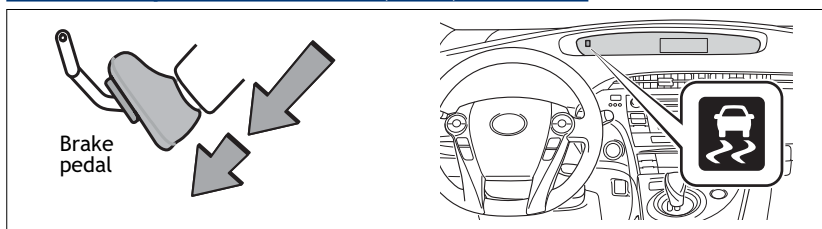

HAC helps prevent rolling backwards on an incline. To engage, push further down on brake pedal while at a complete stop until a beep sounds and slip indicator illuminates. HAC holds for approximately two seconds after releasing brake pedal.

Refer to the *Owner's Manual* for more details.

Garage door opener (HomeLink®)* (if equipped)

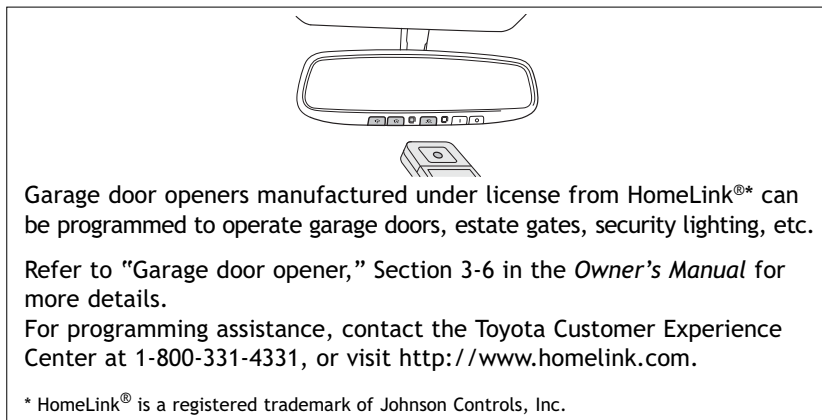

Garage door openers manufactured under license from HomeLink®* can be programmed to operate garage doors, estate gates, security lighting, etc.

Refer to "Garage door opener," Section 3-6 in the *Owner's Manual* for more details.

For programming assistance, contact the Toyota Customer Experience Center at 1-800-331-4331, or visit <http://www.homelink.com>.

* HomeLink® is a registered trademark of Johnson Controls, Inc.

SAFETY AND EMERGENCY FEATURES

Seatbelts

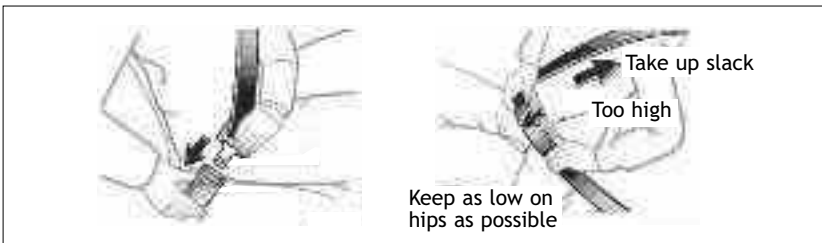

If belt is fully extended, then retracted even slightly, it cannot be re-extended beyond that point, unless fully retracted again. This feature is used to help hold child restraint systems securely.

To find more information about seatbelts, and how to install a child restraint system, refer to the *Owner's Manual*.

Seatbelts-Shoulder belt anchor

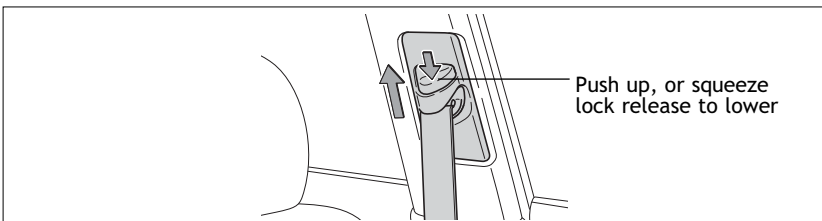

Door locks

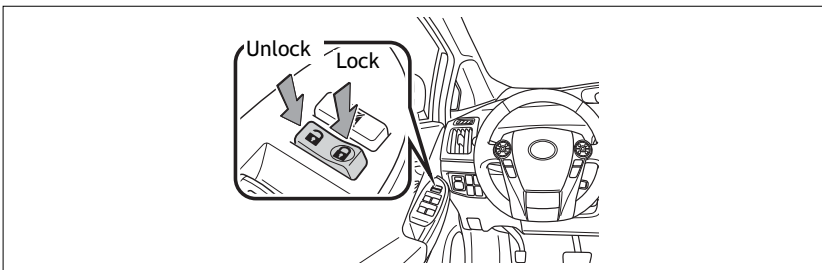

Tire Pressure Monitoring (warning) System

If tire pressure becomes critically low on any of the tires, (⚠) indicator will illuminate. Correctly adjusting tire inflation will turn off the light after a few minutes. If the light does not turn off, have the system checked by your Toyota dealer.

Refer to the *Owner's Manual* for more details.

Doors-Child safety locks

Rear door

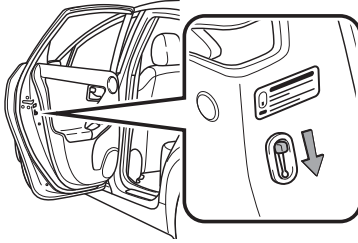

Moving the lever to "LOCK" will allow the door to be opened only from the outside.

Spare tire & tools

Tool location

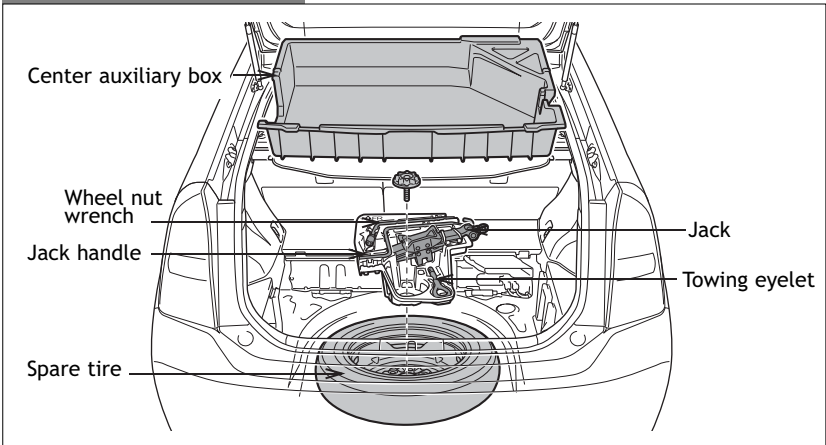

Removing the spare tire

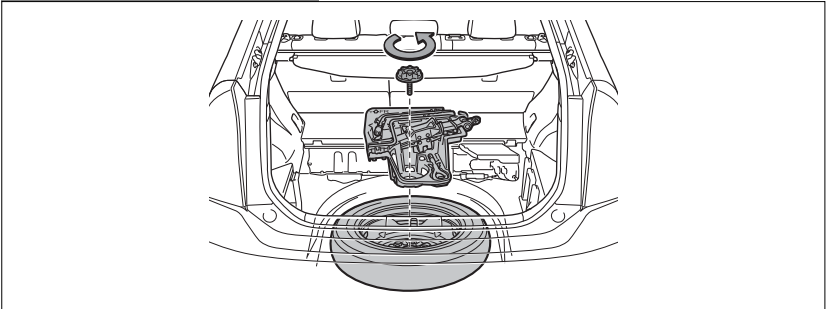

Refer to the *Owner's Manual* for tire changing and jack positioning procedures.

For your information

Main Owner's Manual

Please note that this manual applies to all models and explains all equipment, including options. Therefore, you may find some explanations for equipment not installed on your vehicle.

All specifications provided in this manual are current at the time of printing. However, because of the Toyota policy of continual product improvement, we reserve the right to make changes at any time without notice.

Depending on specifications, the vehicle shown in the illustration may differ from your vehicle in terms of equipment.

Noise from under vehicle after turning off the hybrid system

Approximately five hours after the hybrid system is turned off, you may hear sound coming from under the vehicle for several minutes. This is the sound of a fuel evaporation leakage check and, it does not indicate a malfunction.

Accessories, spare parts and modification of your Toyota

A wide variety of non-genuine spare parts and accessories for Toyota vehicles are currently available in the market. You should know that Toyota does not warrant these products and is not responsible for their performance, repair, or replacement, or for any damage they may cause to, or adverse effect they may have on, your Toyota vehicle.

This vehicle should not be modified with non-genuine Toyota products. Modification with non-genuine Toyota products could affect its performance, safety or durability, and may even violate governmental regulations. In addition, damage or performance problems resulting from the modification may not be covered under warranty.

Installation of a mobile two-way radio system

As the installation of a mobile two-way radio system in your vehicle could affect electronic systems such as the multiport fuel injection system/sequential multiport fuel injection system, cruise control system, anti-lock brake system, vehicle stability control system, SRS airbag system, seat belt pretensioner system or hybrid system, be sure to check with your Toyota dealer for precautionary measures or special instructions regarding installation.

High voltage parts and cables on the hybrid vehicles emit approximately the same amount of electromagnetic waves as the conventional gasoline powered vehicles or home electronic appliances despite of their electromagnetic shielding.

Unwanted noise may occur in the reception of the mobile two-way radio.

Scrapping of your Toyota

The SRS airbag and seat belt pretensioner devices in your Toyota contain explosive chemicals. If the vehicle is scrapped with the airbags and seat belt pretensioners left as they are, this may cause an accident such as fire. Be sure to have the systems of the SRS airbag and seat belt pretensioner removed and disposed of by a qualified service shop or by your Toyota dealer before you scrap your vehicle.

Perchlorate Material

Special handling may apply,
See www.dtsc.ca.gov/hazardouswaste/perchlorate.

Your vehicle has components that may contain perchlorate. These components may include airbag, seat belt pretensioners, and wireless remote control batteries.

 **CAUTION**

■ **General precautions while driving**

Driving under the influence: Never drive your vehicle when under the influence of alcohol or drugs that have impaired your ability to operate your vehicle. Alcohol and certain drugs delay reaction time, impair judgment and reduce coordination, which could lead to an accident that could result in death or serious injury.

Defensive driving: Always drive defensively. Anticipate mistakes that other drivers or pedestrians might make and be ready to avoid accidents.

Driver distraction: Always give your full attention to driving. Anything that distracts the driver, such as adjusting controls, talking on a cellular phone or reading can result in a collision with resulting death or serious injury to you, your occupants or others.

■ **General precaution regarding children's safety**

Never leave children unattended in the vehicle, and never allow children to have or use the key.

Children may be able to start the vehicle or shift the vehicle into neutral. There is also a danger that children may injure themselves by playing with the windows, the moon roof, or other features of the vehicle. In addition, heat build-up or extremely cold temperatures inside the vehicle can be fatal to children.

■ **Dispose of the hybrid battery (traction battery)**

If your vehicle is disposed of without the hybrid battery having been removed, there is a danger of serious electric shock if high voltage parts, cables and their connectors are touched. In the event of that your vehicle must be disposed of, the hybrid battery must be disposed of your Toyota dealer or a qualified service shop. If the hybrid battery is not disposed of properly, they may cause electric shock that can result in death or serious injury.

Symbols used throughout this manual

Cautions & Notices

CAUTION

This is a warning against anything which may cause injury to people if the warning is ignored. You are informed about what you must or must not do in order to reduce the risk of injury to yourself and others.

NOTICE

This is a warning against anything which may cause damage to the vehicle or its equipment if the warning is ignored. You are informed about what you must or must not do in order to avoid or reduce the risk of damage to your Toyota and its equipment.

Symbols used in illustrations



Safety symbol

The symbol of a circle with a slash through it means “Do not”, “Do not do this”, or “Do not let this happen”.

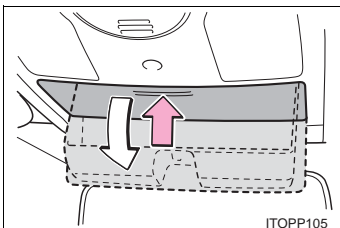

Arrows indicating operations



-  Indicates the action (pushing, turning, etc.) used to operate switches and other devices.
-  Indicates the outcome of an operation (e.g. a lid opens).

TABLE OF CONTENTS

1	Before driving	Adjusting and operating features such as door locks, mirrors, and steering column
2	When driving	Driving, stopping and safe-driving information
3	Interior features	Air conditioning and audio systems, as well as other interior features for a comfortable driving experience
4	Maintenance and care	Cleaning and protecting your vehicle, performing do-it-yourself maintenance, and maintenance information
5	When trouble arises	What to do if the vehicle needs to be towed, gets a flat tire, or is involved in an accident
6	Vehicle specifications	Detailed vehicle information
7	For owners	Reporting safety defects for U.S. owners and seat belt instructions for Canadian owners
	Index	Alphabetical listing of information contained in this manual



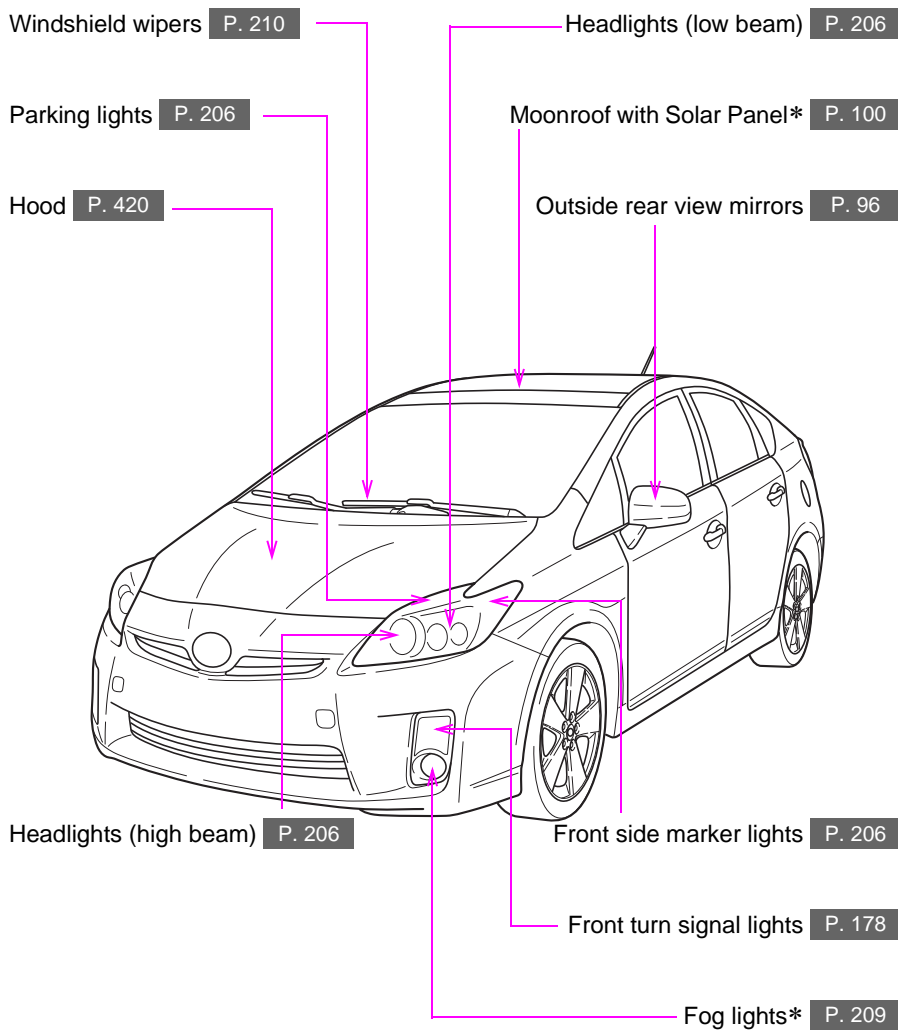
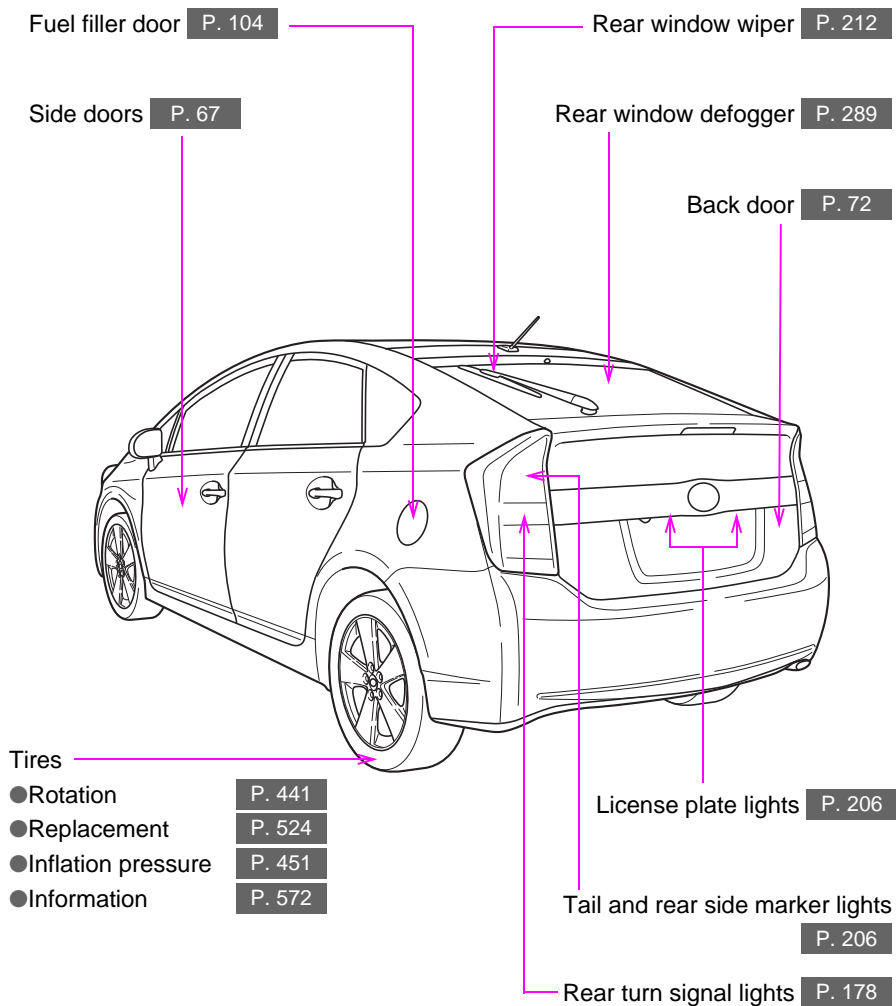

*: If equipped

Head restraints P. 82

Seat belts P. 85

Power window switches P. 98

A

SRS driver airbag P. 113

SRS front passenger airbag P. 113

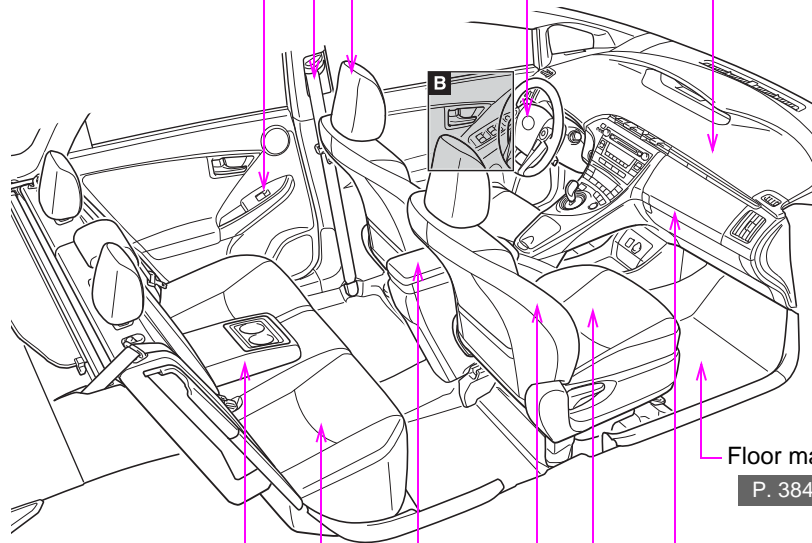

Armrest P. 383

Cup holder P. 372

Rear seat P. 80

Console box P. 369

Floor mat P. 384

ITNPP126

Glove boxes P. 368

Front seat P. 78

SRS side airbag P. 113

A

► **With moon roof**

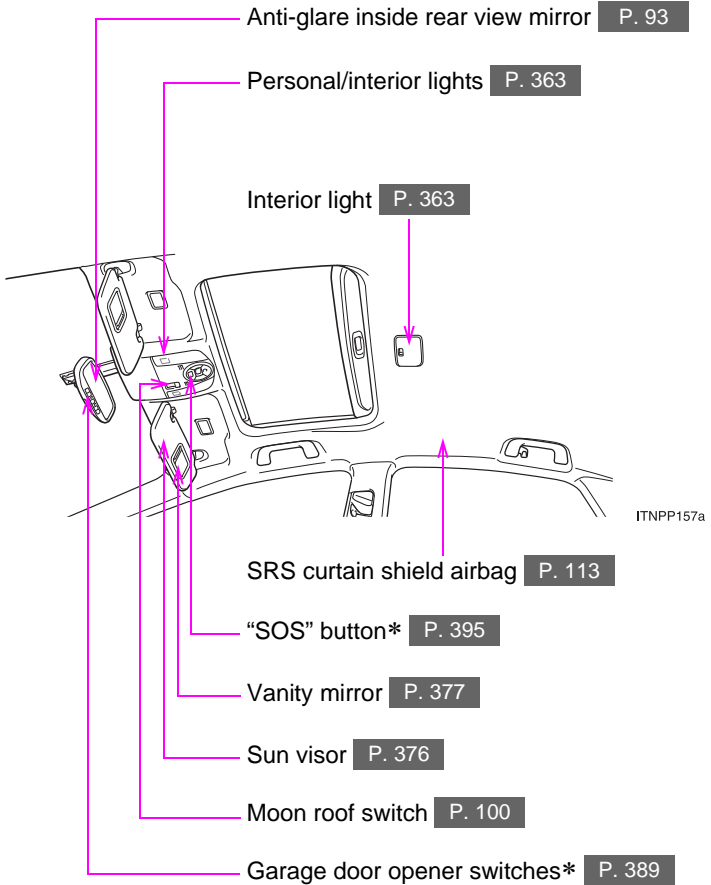

*: If equipped

A

► Without moon roof

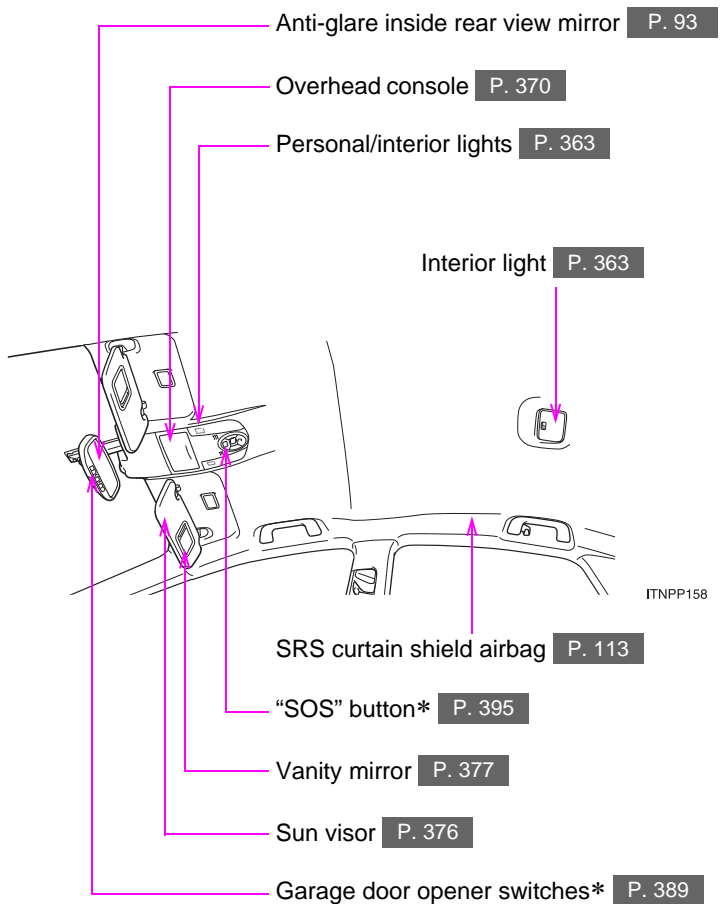

B

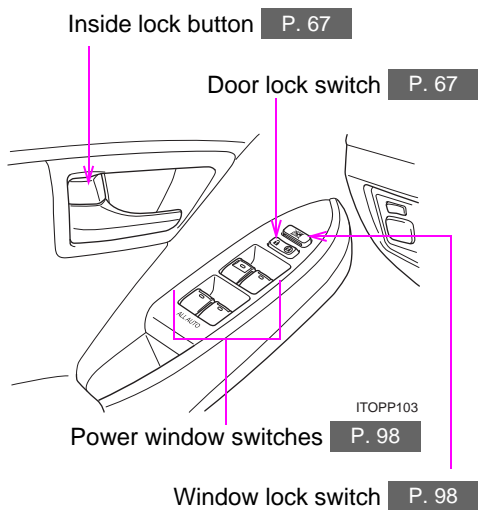

*: If equipped

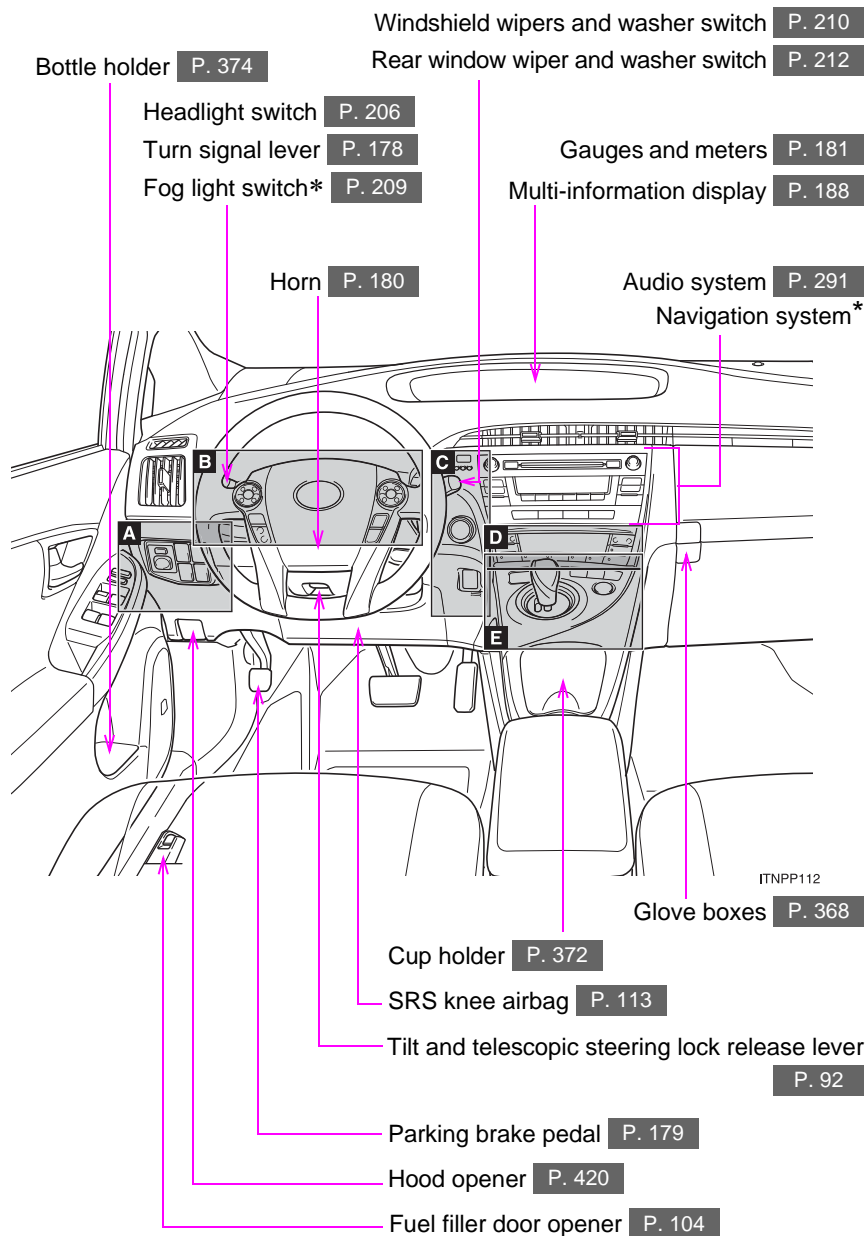

ITNPP112

A

Ventilation switch* P. 282

Headlight cleaner switch* P. 213

Outside rear view mirror switches P. 96

Instrument panel light control dial P. 184

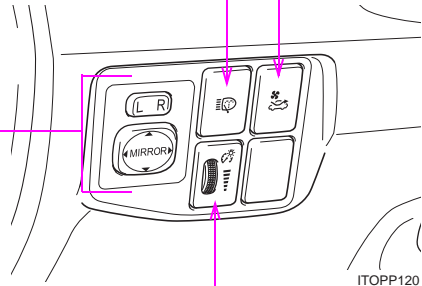

*: If equipped

*: Refer to "Navigation System Owner's Manual".

B

Talk switch** P. 326

Climate remote control switches P. 280

Audio remote control switches P. 323

“DISP” button P. 188

“TRIP” button P. 188

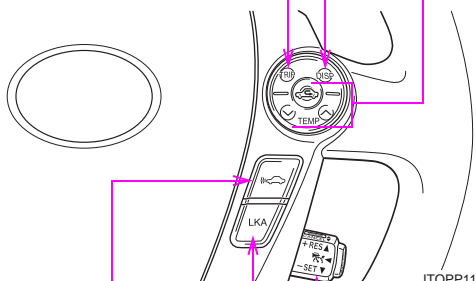
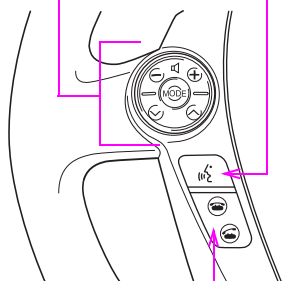

Telephone switch** P. 326

Distance switch* P. 218

“LKA” switch* P. 235

Cruise control switch* P. 214, 218

ITOPP116

C

MPH or km/h button P. 183

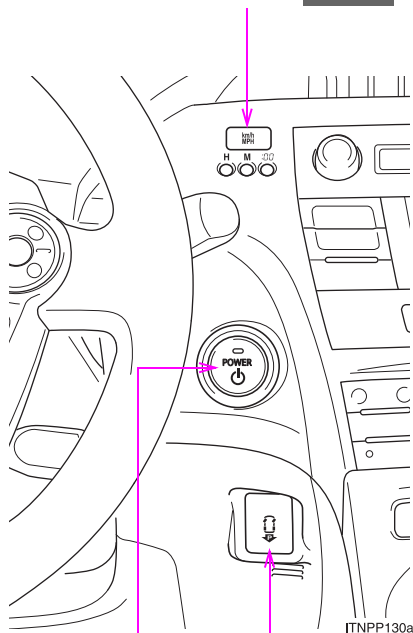

APGS pre-support switch*

Power (ignition) switch P. 162

*: If equipped

*: Refer to "Navigation System Owner's Manual".

D

Air conditioning system P. 270

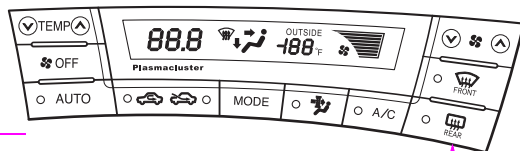

Rear window defogger switch

P. 289

ITO31P101

E

“PWR MODE” switch P. 171

“ECO MODE” switch P. 171

“EV” switch P. 168

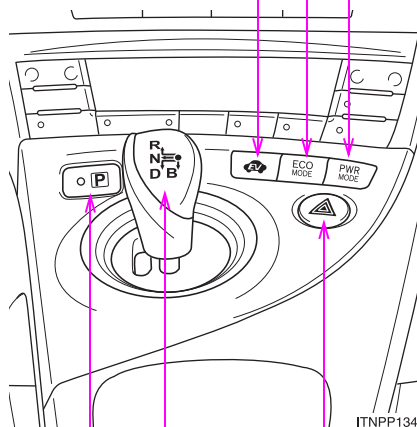

Emergency flasher
switch P. 486

Shift lever P. 171

“P” position switch P. 171

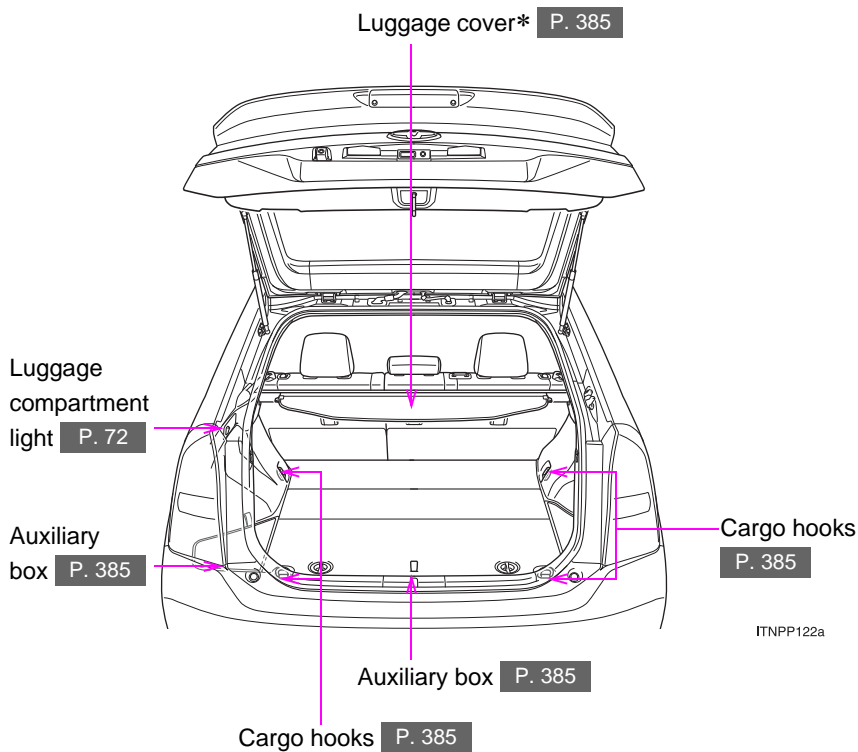

ITNPP122a

*: If equipped

1 Before driving

1-1. Hybrid system
 Hybrid system 28

1-2. Key information
 Keys 41
 Smart key system
 (with entry function)..... 43
 Smart key system
 (without entry function)..... 57

**1-3. Opening, closing and locking
 the doors and back door**
 Wireless remote control 63
 Side doors 67
 Back door 72

**1-4. Adjustable components
 (seats, mirrors, steering
 wheel)**
 Front seats 78
 Rear seats..... 80
 Head restraints 82
 Seat belts 85
 Steering wheel 92
 Inside rear view mirror..... 93
 Outside rear view mirrors 96

**1-5. Opening and closing
 the windows and moon roof**
 Power windows..... 98
 Moonroof
 with Solar Panel 100

1-6. Refueling
 Opening the fuel tank cap... 104

1-7. Theft deterrent system
 Immobilizer system 108
 Theft prevention labels
 (U.S.A.)..... 110

1-8. Safety information
 Correct driving posture 111
 SRS airbags 113
 Front passenger occupant
 classification system..... 126
 Child restraint systems 132
 Installing child restraints 137

2 When driving

2-1. Driving procedures

Driving the vehicle.....	150
Power (ignition) switch	162
EV-Drive Mode.....	168
Transmission.....	171
Turn signal lever	178
Parking brake.....	179
Horn	180

2-2. Instrument cluster

Gauges and meters	181
Indicators and warning lights	185
Multi-information display	188

2-3. Operating the lights and windshield wipers

Headlight switch.....	206
Fog light switch	209
Windshield wipers and washer	210
Rear window wiper and washer	212
Headlight cleaner switch	213

2-4. Using other driving systems

Cruise control	214
Dynamic radar cruise control.....	218
Rear view monitor system.....	231
LKA (Lane-Keeping Assist)	235
Hill-start assist control	243
Driving assist systems.....	245
Pre-Collision System	249

2-5. Driving information

Cargo and luggage.....	255
Vehicle load limits.....	260
Winter driving tips.....	261
Trailer towing.....	266
Dinghy towing.....	267

1

2

3

4

5

6

7

3 Interior features

3-1. Using the air conditioning system and defogger

Air conditioning system 270
 Using the steering wheel climate remote control switches 280
 Solar Ventilation System 282
 Remote Air Conditioning System 285
 Rear window and outside rear view mirror defoggers..... 289

3-2. Using the audio system

Audio system type 291
 Using the radio 294
 Using the CD player 303
 Playing back MP3 and WMA discs 311
 Optimal use of the audio system 319
 Using the AUX adapter 322
 Using the steering switches 323

3-3. Using the hands-free system (for cellular phone)

Hands-free system (for cellular phone) 326
 Using the hands-free system..... 329
 Making a phone call 338
 Setting a cellular phone..... 344
 Security and system setup 350
 Using the phone book 354

3-4. Using the interior lights

Interior lights list..... 363
 • Personal/interior light main switch 364
 • Personal/interior lights 365
 • Interior light..... 365

3-5. Using the storage features

List of storage features 367
 • Glove boxes 368
 • Console box 369
 • Overhead console 370
 • Card holder..... 371
 • Cup holders 372
 • Bottle holders 374
 • Auxiliary box 375

3-6. Other interior features

Sun visors..... 376
 Vanity mirror 377
 Outside temperature display 378
 Power outlets..... 379
 Seat heaters 381
 Armrest..... 383
 Floor mats..... 384
 Luggage compartment features 385
 Garage door opener 389
 Safety Connect..... 395

4 Maintenance and care

4-1. Maintenance and care

- Cleaning and protecting the vehicle's exterior 404
- Cleaning and protecting the vehicle's interior 407

4-2. Maintenance

- Maintenance requirements 410
- General maintenance 412
- Emission inspection and maintenance (I/M) programs 415

4-3. Do-it-yourself maintenance

- Do-it-yourself service precautions 416
- Hood 420
- Positioning a floor jack 423
- Engine compartment 425
- 12 volt battery 436
- Tires 441
- Tire inflation pressure 451
- Wheels 455
- Air conditioning filter 457
- Electronic key battery 460
- Checking and replacing fuses 462
- Light bulbs 472

5 When trouble arises

5-1. Essential information

- Emergency flashers 486
- If your vehicle needs to be towed 487
- If you think something is wrong 493
- Event data recorder 494

5-2. Steps to take in an emergency

- If a warning light turns on or a warning buzzer sounds 496
- If a warning message is displayed 508
- If you have a flat tire 524
- If the hybrid system will not start 538
- If you lose your keys 540
- If the electronic key does not operate properly 541
- If the 12 volt battery is discharged 543
- If your vehicle overheats 548
- If the vehicle becomes stuck 553

6 Vehicle specifications

6-1. Specifications

Maintenance data (fuel, oil level, etc.)	556
Fuel information	568
Tire information	572

6-2. Customization

Customizable features	587
-----------------------------	-----

6-3. Initialization

Items to initialize.....	593
--------------------------	-----

7 For owners

Reporting safety defects for U.S. owners	596
Seat belt instructions for Canadian owners (in French).....	597

Index

Abbreviation list	600
Alphabetical index.....	601
What to do if.....	610

1

2

3

4

5

6

7

1-1. Hybrid system

Hybrid system

Your vehicle is a hybrid vehicle. It has characteristics different from conventional vehicles. Be sure you are closely familiar with the characteristics of your vehicle, and operate with care.

The hybrid system combines a gasoline engine and an electric motor (traction motor) according to driving conditions, improving fuel efficiency and reducing exhaust emissions.

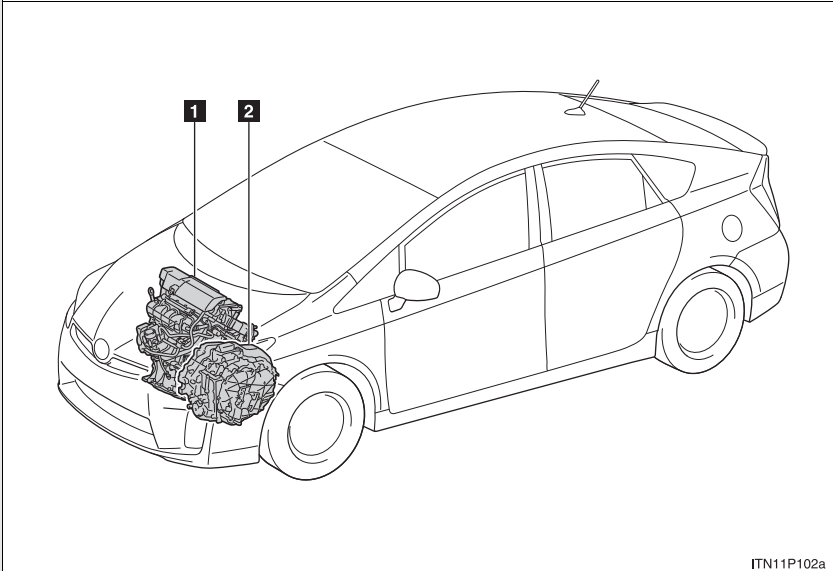

ITN11P102a

- 1** Gasoline engine
- 2** Electric motor (Traction motor)

■ When stopped/during take-off

The gasoline engine stops when the vehicle is stopped. During take-off, the electric motor (traction motor) drives the vehicle. At slow speeds or when traveling down a gentle slope, the engine is stopped and the motor is used.

■ During normal driving

The gasoline engine is predominantly used. The electric motor (traction motor) charges the hybrid battery (traction battery) as necessary.

■ When accelerating sharply

The power of the hybrid battery (traction battery) is added via electric motor (traction motor) to that of the gasoline engine.

■ When braking (Regenerative brake)

The electric motor (traction motor) charges the hybrid battery (traction battery).

■ Regenerative braking

The motor generator converts kinetic energy to electric energy when:

- The accelerator pedal is released.
- The brake pedal is depressed with the shift lever in “D” or “B”.

■ **Conditions in which the gasoline engine may not stop**

The gasoline engine starts and stops automatically. However, the followings are examples of conditions under which the engine may not stop automatically:

- The gasoline engine is warming up.
- The hybrid battery (traction battery) is being charged.
- The hybrid battery (traction battery) temperature is low or high.
- The temperature setting of the air conditioning system is high.

■ **Charging the battery**

- As the gasoline engine or regenerative brake charges the hybrid battery (traction battery), the battery does not need to be charged from an outside source. However, if the vehicle is left parked for a long time the hybrid battery will slowly discharge. For this reason, be sure to drive the vehicle at least once every several months for at least 30 minutes or 10 miles (16 km). If the hybrid battery becomes fully discharged and you are unable to jump-start the vehicle with the 12 volt battery, contact your Toyota dealer.
- If the shift lever is in “N”, the hybrid battery (traction battery) will not be charged. When driving in heavy traffic, operate the vehicle with the shift lever in “D” or “B” to avoid discharging the battery.

■ **After the 12 volt battery has discharged or has been changed or removed**

The gasoline engine may not stop even if the vehicle is running on the hybrid battery (traction battery). If this continues for a few days, contact your Toyota dealer.

■ Sounds and vibrations specific to a hybrid vehicle

There may be no engine sounds or vibration even though the vehicle is able to move. Always push the “P” position switch when parked.

The following sounds or vibrations may occur when the hybrid system is operating, and are not a malfunction.

- Motor sounds may be heard from the engine compartment.
- Sounds may be heard from the hybrid battery (traction battery) behind the rear seat when the hybrid system starts or stops.
- Sounds from the hybrid system may be heard when the back door is open.
- Sounds may be heard from the transmission when the gasoline engine starts or stops, when driving at low speeds, or during idling.
- Engine sounds may be heard when accelerating sharply.
- Sounds may be heard due to regenerative brake when you press the brake pedal or release the accelerator pedal.
- Vibration may be felt when the gasoline engine starts or stops.
- You may hear cooling fan sounds coming from the air intake vents behind the rear seat.

■ Maintenance, repair, recycling, and disposal

Contact your Toyota dealer regarding maintenance, repair, recycling and disposal. Do not dispose of the vehicle yourself.

High voltage components

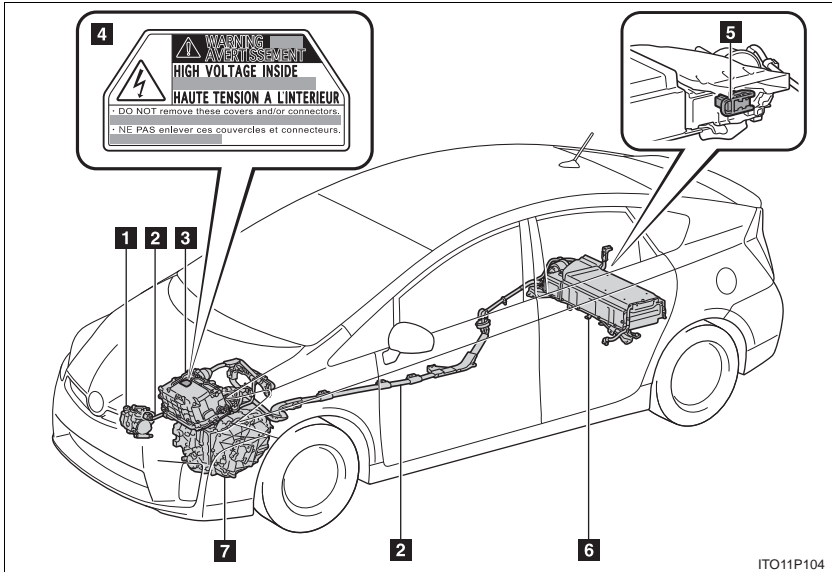

- | | |
|---|--|
| 1 Air conditioning compressor | 5 Service plug |
| 2 High voltage cables (orange color) | 6 Hybrid battery (Traction battery) |
| 3 Power control unit and DC/DC converter | 7 Electric motor (Traction motor) |
| 4 Caution label | |

Take care when handling the hybrid system, as it contains a high voltage system (about 650 V at maximum) as well as parts that become extremely hot when the hybrid system is operating. Obey the caution labels attached to the vehicle.

■ Hybrid battery air vent

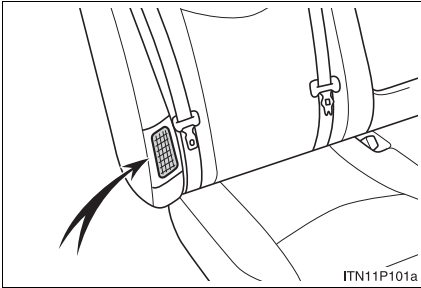

There is an air intake vent on the side of the rear right seatback for the purpose of cooling the hybrid battery (traction battery). If the vent becomes blocked, the hybrid battery may overheat, leading to a reduction in hybrid battery output.

Emergency shut off system

The emergency shut off system blocks off the high voltage current and stops the fuel pump to minimize the risk of electrocution and fuel leakage when a certain level of impact is detected by the impact sensor. If the emergency shut off system activates, your vehicle will not restart. To restart the hybrid system, contact your Toyota dealer.

Eco Drive Monitor

The multi-information display features several screens to assist with environmentally friendly driving. You can drive in an environmentally friendly manner by using these screens effectively.

■ Hybrid system operating condition

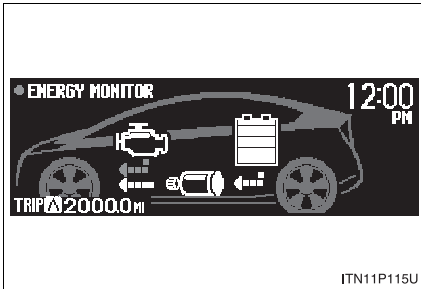

The energy monitor displays the operating condition of the hybrid system, showing such information as the gasoline engine operating status, and the usage and regeneration status of electrical energy. (→P. 190)

■ Driving efficiently

The Hybrid System Indicator changes in real-time in accordance with the driving conditions and operation of the accelerator pedal. Driving that is friendlier to the environment can be achieved by referring to the display and by driving as follows. (→P. 192)

● When accelerating

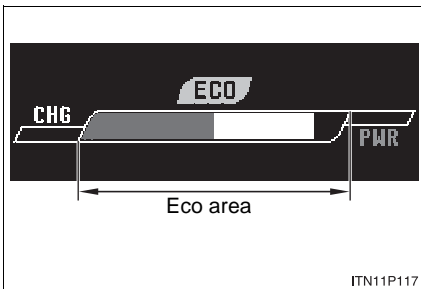

Accelerate to the desired speed while depressing the accelerator pedal slowly and ensuring that the indicator bar does not exceed the Eco area.

- When the desired speed is reached

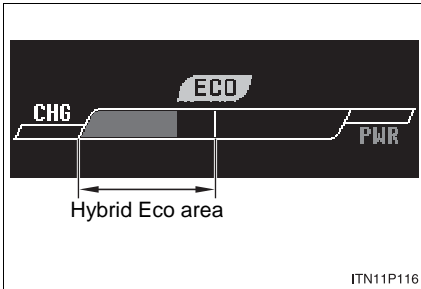

Release the accelerator pedal once. Then, depress the accelerator pedal slowly and drive at a constant speed, keeping the indicator bar within the Eco area.

When aiming to improve fuel economy, try to drive within the Hybrid Eco area. By doing so, the drive force of the electric motor (traction motor) will often be used alone without the need for fuel consumption, thus allowing you to enjoy driving with improved fuel economy.

■ Checking fuel consumption

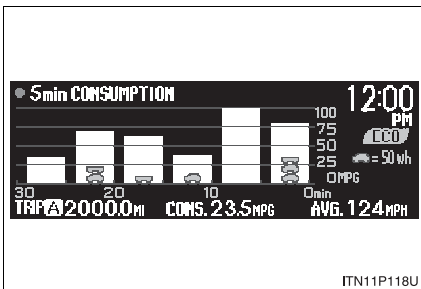

The 5-minute/1-minute interval fuel consumption display shows the average fuel consumption and the regenerated energy amount in 5-minute or 1-minute intervals. (→P. 194)

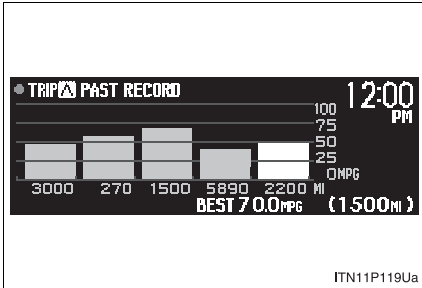

The fuel consumption record display shows a history of the average fuel consumption in sections, based on the driving records of trip meters A and B. Each section represents the interval between each trip meter reset. (→P. 197)

A record of the best consumption is also kept on this screen. The best consumption record is updated whenever a higher record is achieved.

Hybrid warning message

A message is automatically displayed when a malfunction occurs in the hybrid system or an improper operation is attempted.

If a warning message is shown on the multi-information display, read the message and follow the instructions. (→P. 508)

■ If a warning light comes on or a warning message is displayed, or the 12 volt battery is disconnected

The hybrid system may not start. In that case, try to start the system again. If the “READY” indicator does not come on, contact your Toyota dealer.

■ Running out of fuel

When the vehicle has run out of fuel and the hybrid system cannot be started, refuel the vehicle with at least enough gasoline to make the low fuel level warning light go off (→P. 499). If there is only a small amount of fuel, the hybrid system may not be able to start. (The minimum amount of fuel to add to make the low fuel level warning light go out is about 1.6 gal. [6.0 L, 1.3 Imp.gal.], when the vehicle is on a level surface. This value may vary when the vehicle is on a slope.)

■ Hybrid battery (traction battery)

The hybrid battery (traction battery) has a limited service life. The lifespan of the hybrid battery (traction battery) can change in accordance with driving style and driving conditions.

⚠ CAUTION

■ High voltage precautions

The vehicle has high voltage DC and AC systems as well as a 12 volt system. DC and AC high voltage is very dangerous and can cause severe burns and electric shock that may result in death or serious injury.

- Never touch, disassemble, remove or replace the high voltage parts, cables and their connectors.
- The hybrid system will become hot after starting as the system uses high voltage. Be careful of both the high voltage and the high temperature, and always obey the caution labels attached to the vehicle.

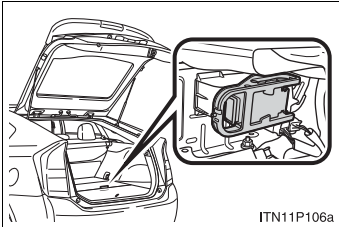

- Never try to open the service plug access hole located in the luggage compartment. The service plug is used only when the vehicle is serviced and is subject to high voltage.
- Do not subject the service plug to strong impacts. Also, avoid splashing large amount of water onto the luggage compartment, for example while in a high-pressure car wash.

■ Hybrid battery (traction battery)

Your vehicle contains a sealed nickel-metal hydride battery. If disposed of improperly, it is hazardous to the environment and there is a risk of severe burns and electrical shock that may result in death or serious injury.

■ Emergency shut off system

- Carefully check to see if there are exposed high voltage parts or cables. Never touch the parts or cables. (→P. 32)
- Carefully inspect the ground under the vehicle. If you find that liquid has leaked onto the ground, the fuel system may have been damaged. Leave the vehicle as soon as possible.

 CAUTION**■ Road accident cautions**

Observe the following precautions to reduce the risk of injury.

- Pull your vehicle off the road, push the “P” position switch, apply the parking brake and turn the hybrid system off.
- Do not touch the high voltage parts, cables and connectors.
- If electric wires are exposed inside or outside your vehicle, an electric shock may occur. Never touch exposed electric wires.
- If a fluid leak occurs, do not touch it as it may be strong alkaline electrolyte from the hybrid battery (traction battery). If it comes into contact with your skin or eyes, wash it off immediately with a large amount of water or if possible, boric acid solution. Seek immediate medical attention.
- If a fire occurs in the hybrid vehicle, leave the vehicle as soon as possible. Never use a fire extinguisher that is not meant for electric fires. Using even a small amount of water may be dangerous.
- If your vehicle needs to be towed, do so with the front wheels raised. If the wheels with the electric motor (traction motor) are on the ground when towing, the motor may continue to generate electricity. This may cause an electricity leakage leading to a fire. (→P. 487)



NOTICE

■ Hybrid battery air vent

- Do not put foreign objects over the air vent. The hybrid battery (traction battery) may overheat and be damaged.
- Clean the air vent regularly to prevent the hybrid battery (traction battery) from overheating.
- Do not wet the air vent. It may cause a short circuit and damage the hybrid battery (traction battery).
- Do not load a large amount of water such as an aquarium into the vehicle. If water spills over the hybrid battery (traction battery), the battery may be damaged.

The following keys are provided with the vehicle.

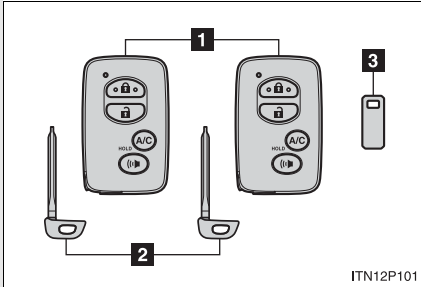

1 Electronic keys

- Operating the smart key system (→P. 43, 57)
- Operating the wireless remote control function (→P. 63)

2 Mechanical keys

3 Key number plate

Using the mechanical key

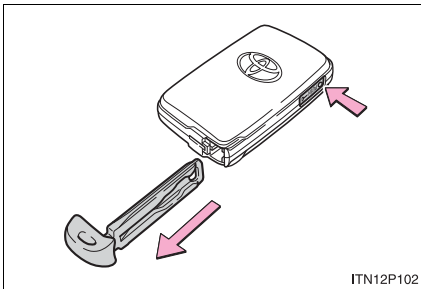

Take out the mechanical key.

After using the mechanical key, store it in the electronic key. Carry the mechanical key together with the electronic key. If the electronic key battery is depleted or the smart key system does not operate properly, you will need the mechanical key.

■ **Key number plate**

Keep the plate in a safe place such as your wallet, not in the vehicle. In the event that a mechanical key is lost, a new key can be made by your Toyota dealer using the key number plate. (→P. 540)

■ **When riding in an aircraft**

When bringing an electronic key onto an aircraft, make sure you do not press any buttons on the electronic key while inside the aircraft cabin. If you are carrying an electronic key in your bag etc., ensure that the buttons are not likely to be pressed accidentally. Pressing a button may cause the electronic key to emit radio waves that could interfere with the operation of the aircraft.



NOTICE

■ **To prevent key damage**

- Do not bend the keys, subject them to storing impact, expose them to high temperatures by placing them in direct sunlight, or get them wet.
- Do not expose the keys to electromagnetic materials or attach any material that blocks electromagnetic waves to the key surface.
- Do not disassemble the electronic key.

Smart key system (with entry function)

The following operations can be performed simply by carrying the electronic key on your person, for example in your pocket. (The driver should always carry the electronic key.)

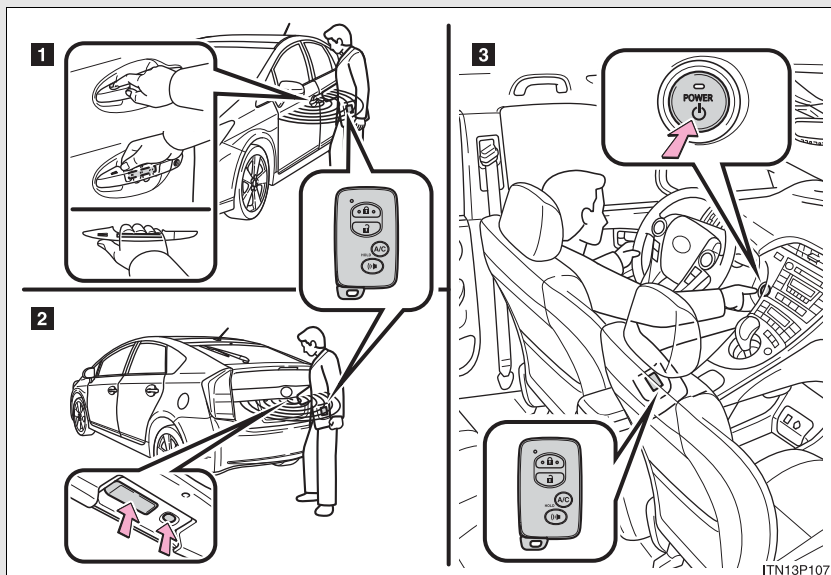

- 1** Locks and unlocks the doors (→P. 44)
- 2** Locks and unlocks the doors (→P. 45)
- 3** Starts and stops the hybrid system (→P. 162)

Unlocking and locking the doors

- ▶ Front door handles (including front passenger door handle if equipped with entry function)

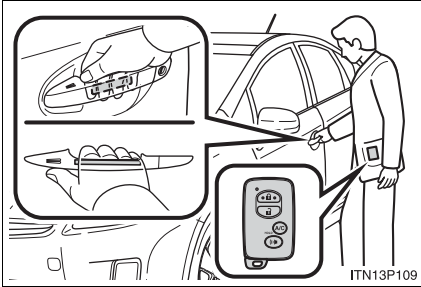

Grip the handle to unlock the door.

Make sure to touch the sensor on the back of the handle.

The door cannot be unlocked for 3 seconds after the door is locked.

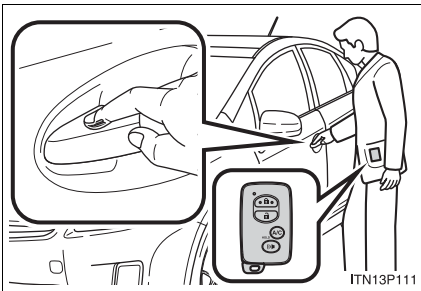

Touch the sensor area to lock the doors.

► Back door (vehicles with entry function of front and back doors)

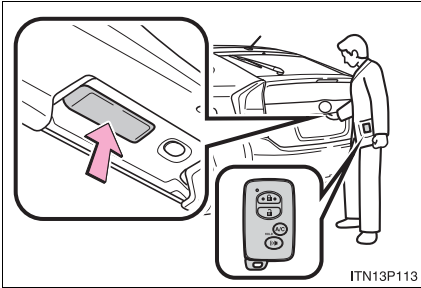

Press the unlock button to unlock the doors.

The door cannot be unlocked for 3 seconds after the door is locked.

Lock the back door again when you leave the vehicle. The back door will not lock automatically after it has been opened and then closed.

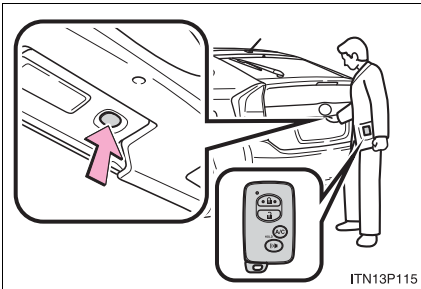

Press the lock button to lock the doors.

Antenna location and effective range

■ Antenna location

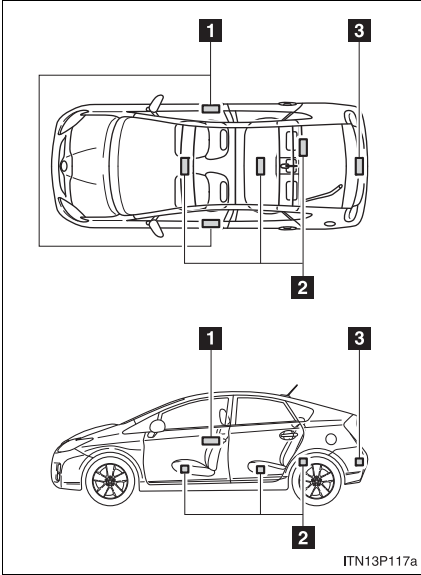

- 1** Antennas outside cabin
- 2** Antennas inside cabin
- 3** Antenna outside luggage compartment

■ Effective range (areas within which the electronic key is detected)

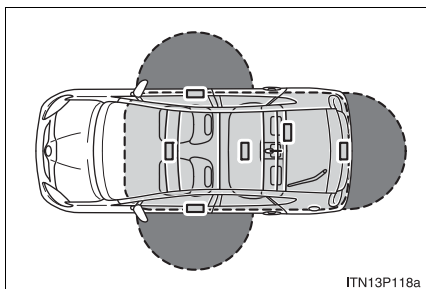

- When locking or unlocking the doors

The system can be operated when the electronic key is within about 2.3 ft. (0.7 m) of outside front and back door handles.

- When starting the hybrid system or changing “POWER” switch modes

The system can be operated when the electronic key is inside the vehicle.

■ Operation signals

A buzzer sounds and the emergency flashers flash to indicate that the doors have been locked/unlocked. (Locked: Once; Unlocked: Twice)

■ When the door cannot be locked using the topside sensor area

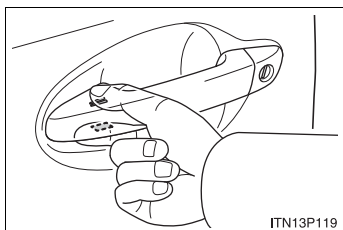

If the door will not lock even when the topside sensor area is touched, try touching both the topside and underside sensor areas at the same time.



■ Conditions affecting operation

→P. 65



■ Switching the door unlock function

It is possible to set which doors the entry function unlocks.

STEP 1 Turn the “POWER” switch OFF.

STEP 2 When the indicator on the key surface is turned off, push and hold  or  for approximately 5 seconds while pushing the  button on the key.

The setting changes each time an operation is performed, as shown below. (When changing the setting continuously, release the buttons, wait for at least 5 seconds, and repeat **STEP 2**.)

Multi-information display	Unlocking doors	Beep
	Hold the driver's door handle to unlock only the driver's door.	Exterior: Beeps three times Interior: Pings once
	Hold the passenger's door handle or back door opener to unlock all the doors.	
	Hold the front door handle or back door opener to unlock all the doors.	Exterior: Beeps twice Interior: Pings once

■ Battery-saving function

In the following circumstances, the entry function is disabled in order to prevent the vehicle battery from discharging and electronic key battery from depleting.

- When the entry function has not been used for 5 days or more
- When the electronic key has been left within approximately 6 ft. (2 m) of the vehicle for 10 minutes or more
- If the entry function has not been used for 9 days or more, the vehicle cannot be unlocked by a door other than the driver's door. To unlock the vehicle, grip the driver's door handle or use the wireless remote control or the mechanical key.

The system will resume operation when...

- The vehicle is locked touching the door handle lock sensor area.
- The vehicle is locked/unlocked using the wireless remote control function (→P. 63) or the mechanical key. (→P. 541)

■ Electronic key battery depletion

→P. 64

■ To operate the system properly

Make sure to carry the electronic key when operating the system. Do not get the electronic key too close to the vehicle when operating the system from the outside of the vehicle.

Depending on the position and holding condition of the electronic key, the key may not be detected correctly and the system may not operate properly. (The alarm may go off accidentally, or the door lock prevention may not function.)

■ Note for the smart key system

- Even when the electronic key is within the effective range (detection areas), the system may not operate properly in the following cases.
 - The electronic key is too close to the window or outside door handle, near the ground, or in a high place when the doors are locked or unlocked.
 - The electronic key is near the ground or in a high place, or too close to the rear bumper center when the back door is locked or unlocked.
 - The electronic key is on the instrument panel, luggage cover, floor or in the glove box when the hybrid system is started or “POWER” switch modes are changed.
- As long as the electronic key is within the effective range, the doors may be locked or unlocked by anyone. However, only the doors detecting the electronic key can be used to unlock the vehicle.
- Even if the electronic key is not inside the vehicle, it may be possible to start the hybrid system if the electronic key is near the window.
- When the lock operation is performed using the lock sensor, recognition signals will be shown up to two consecutive times. After this, no recognition signals will be given.
- The doors may unlock or lock if a large amount of water splashes on the door handle, such as in the rain or in a car wash when the electronic key is within the effective range. (The doors will automatically be locked after approximately 60 seconds if the doors are not opened and closed.)
- If the key is kept near the vehicle while it is being washed, water applied to a door handle may cause the door to lock and unlock repeatedly. In this event, place the key in a location 6 ft. (2 m) or more from the vehicle, taking care not to lose the key.

- If the key is inside the vehicle while it is being washed, water applied to a door handle may cause a buzzer to sound. In this event, locking all doors will cause the buzzer to stop sounding.
- It may not be possible to lock the doors if the sensor area is covered by mud, ice, snow etc. In this event, try locking again after cleaning the area, or lock by touching the sensor area on the underside of the door handle.
- Fingernails may scrape against the door during operation of the door handle. Be careful not to injure fingernails or damage the surface of the door.
- Gripping the door handle when wearing a glove may not unlock or lock the door.
- If the wireless remote control is used to lock the doors when the electronic key is near the vehicle, there is a possibility that the door may not be unlocked by the smart key system. (Use the wireless remote control to unlock the doors.)
- A sudden approach to the effective range or door handle operation may prevent the doors from being unlocked. In this case, return the door handle to the original position and check that the doors unlock before pulling the door handle again.
- If there is another electronic key in the detection area, it may take slightly longer to unlock the doors after the door handle is gripped.

■ When the vehicle is not driven for extended periods

- To prevent theft of the vehicle, do not leave the electronic key within 6 ft. (2 m) of the vehicle.
- The smart key system can be deactivated in advance. (→P. 587)

■ Security feature

→P. 66

■ Alarms and warning indicators

A combination of exterior and interior alarms are used to prevent theft of the vehicle and unforeseeable accidents resulting from erroneous operation. Take appropriate measures according to the warning message shown on the multi-information display. (→P. 508)

The following table describes circumstances and correction procedures when only alarms are sounded.

Alarm	Situation	Correction procedure
Interior alarm pings once and exterior alarm sounds once for 10 seconds*1	An attempt was made to lock the doors using the entry function while the electronic key was still inside the passenger compartment	Retrieve the electronic key from the passenger compartment and lock the doors again
	An attempt was made to exit the vehicle and lock the doors without first turning the "POWER" switch OFF	Turn the "POWER" switch OFF and lock the doors again
Exterior alarm sounds once for 10 seconds	An attempt was made to lock the vehicle while a door is open	Close all of the doors and lock the doors again

Alarm	Situation	Correction procedure
Interior alarm pings continuously*1	The "POWER" switch was turned to ACCESSORY mode while the driver's door was open (or the driver's door was opened while the "POWER" switch was in ACCESSORY mode)	Turn the "POWER" switch OFF and close the driver's door
Interior alarm sounds continuously*1	When the "POWER" switch is in ON mode or ACCESSORY mode, an attempt was made to open the door and exit the vehicle, and the shift position was not in "P"	Push the "P" position switch and turn the "POWER" switch OFF
Interior and exterior alarms sound continuously*1	When the "POWER" switch is in ON mode or ACCESSORY mode, the driver's door was closed after the key was carried outside the vehicle, and the shift position not in "P"	Push the "P" position switch, turn the "POWER" switch OFF and close the driver's door again

Alarm	Situation	Correction procedure
Interior alarm pings once* ¹	The electronic key has a low battery	Replace the electronic key battery
	An attempt was made to start the hybrid system without the electronic key being present, or the electronic key was not functioning normally	Start the hybrid system with the electronic key present* ²
Interior alarm pings once and exterior alarm sounds 3 times* ¹	The driver's door was closed after the key was carried outside the vehicle, and the "POWER" switch was not turned OFF	Turn the "POWER" switch OFF and close the driver's door again
	An occupant carried the electronic key outside the vehicle and closed the door while the "POWER" switch was not OFF	Bring the electronic key back into the vehicle

*¹: A message will be shown on the multi-information display in the instrument cluster.

*²: If the hybrid system does not start when the electronic key is inside the vehicle, the electronic key battery may be depleted or there may be difficulties receiving signal from the key. (→P. 541)

■ If the smart key system does not operate properly

- Locking and unlocking the doors: Use the mechanical key. (→P. 541)
- Starting the hybrid system: →P. 542

■ When the electronic key battery is fully depleted

→P. 460

■ Customization that can be configured at Toyota dealer

Settings (e.g. smart key system) can be changed.
(Customizable features →P. 587)

■ Certification for the smart key system

► For vehicles sold in the U.S.A.

FCC ID: NI4TMLF8-2

FCC ID: HYQ14ACX FCC ID: HYQ14ADF

FCC ID: HYQ13CZD FCC ID: HYQ13CZE

NOTE:

This device complies with Part 15 of the FCC Rules. Operation is subject to the following two conditions: (1) this device may not cause harmful interference, and (2) this device must accept any interference received, including interference that may cause undesired operation.

FCC WARNING:

Changes or modifications not expressly approved by the party responsible for compliance could void the user's authority to operate the equipment.

► For vehicles sold in Canada

NOTE:

Operation is subject to the following two conditions: (1) this device may not cause interference, and (2) this device must accept any interference, including interference that may cause undesired operation of the device.

 CAUTION

■ **Caution regarding interference with electronic devices**

- People with implanted pacemakers or cardiac defibrillators should keep away from the smart key system antennas. (→P. 46)
The radio waves may affect the operation of such devices. If necessary, the entry function can be disabled. Ask your Toyota dealer for details, such as the frequency of radio waves and timing of emitting the radio waves. Then, consult your doctor to see if you should disable the entry function.
- Users of any electrical medical device other than implanted pacemakers and implanted cardiac defibrillators should consult the manufacturer of the device for information about its operation under the influence of radio waves. Radio waves could have unexpected effects on the operation of such medical devices.

Ask your Toyota dealer for details for disabling the entry function.

Smart key system (without entry function)

Starting and stopping the hybrid system can be performed simply by carrying the electronic key on your person, for example in your pocket.

(The driver should always carry the electronic key.)

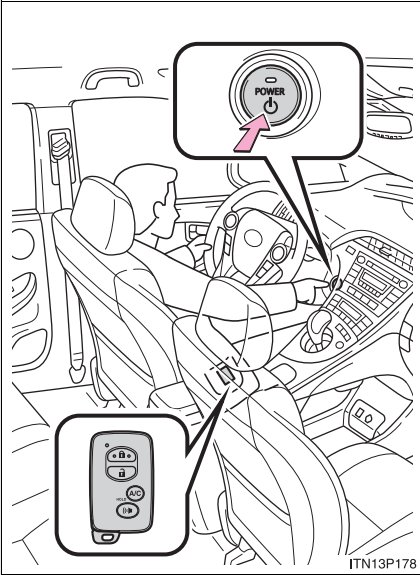

Antenna location and effective range

■ Antenna location

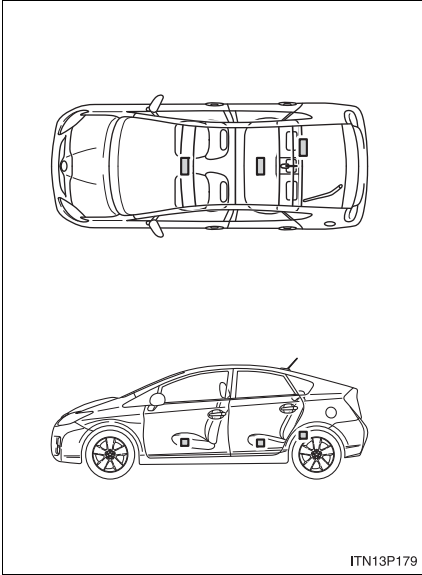

Antennas inside cabin

■ Effective range (areas within which the electronic key is detected)

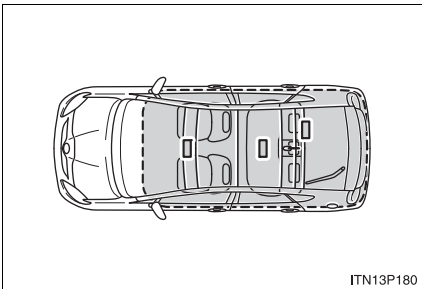

When starting the hybrid system or changing "POWER" switch modes

The system can be operated when the electronic key is inside the vehicle.

■ Conditions affecting operation

→P. 65

■ Electronic key battery depletion

→P. 64

■ To operate the system properly

Make sure to carry the electronic key when operating the system.

Depending on the position and holding condition of the electronic key, the key may not be detected correctly and the system may not operate properly. (The alarm may go off accidentally, or the door lock prevention may not function.)

■ Note for the smart key system

- Even when the electronic key is within the effective range (detection areas), the system may not operate properly.
For example, the electronic key is on the instrument panel, luggage cover, floor or in the glove box when the hybrid system is started or "POWER" switch modes are changed.
- Even if the electronic key is not inside the vehicle, it may be possible to start the hybrid system if the electronic key is near the window.

■ **Alarms and warning indicators**

A combination of exterior and interior alarms are used to prevent theft of the vehicle and unforeseeable accidents resulting from erroneous operation. Take appropriate measures according to the warning message shown on the multi-information display. (→P. 508)

The following table describes circumstances and correction procedures when only alarms are sounded.

Alarm	Situation	Correction procedure
Exterior alarm sounds once for 10 seconds	An attempt was made to lock the vehicle while a door is open	Close all of the doors and lock the doors again
Interior alarm pings continuously*1	The "POWER" switch was turned to ACCESSORY mode while the driver's door was open (or the driver's door was opened while the "POWER" switch was in ACCESSORY mode)	Turn the "POWER" switch OFF and close the driver's door
Interior alarm sounds continuously*1	When the "POWER" switch is in ON mode or ACCESSORY mode, an attempt was made to open the door and exit the vehicle, and the shift position was not in "P"	Push the "P" position switch and turn the "POWER" switch OFF
Interior and exterior alarms sound continuously*1	When the "POWER" switch is in ON mode or ACCESSORY mode, the driver's door was closed after the key was carried outside the vehicle, and the shift position not in "P"	Push the "P" position switch, turn the "POWER" switch OFF and close the driver's door again

Alarm	Situation	Correction procedure
Interior alarm pings once* ¹	The electronic key has a low battery	Replace the electronic key battery
	An attempt was made to start the hybrid system without the electronic key being present, or the electronic key was not functioning normally	Start the hybrid system with the electronic key present* ²
Interior alarm pings once and exterior alarm sounds 3 times* ¹	The driver's door was closed after the key was carried outside the vehicle, and the "POWER" switch was not turned OFF	Turn the "POWER" switch OFF and close the driver's door again
	An occupant carried the electronic key outside the vehicle and closed the door while the "POWER" switch was not OFF	Bring the electronic key back into the vehicle

*¹: A message will be shown on the multi-information display in the instrument cluster.

*²: If the hybrid system does not start when the electronic key is inside the vehicle, the electronic key battery may be depleted or there may be difficulties receiving signal from the key. (→P. 541)

■ **If the smart key system does not operate properly**

→P. 542

■ **When the electronic key battery is fully depleted**

→P. 460

■ **Customization that can be configured at Toyota dealer**

Settings (e.g. smart key system) can be changed.
(Customizable features →P. 587)

■ **Certification for the smart key system**

► For vehicles sold in the U.S.A.

FCC ID: NI4TMLF8-2

FCC ID: HYQ14ACX FCC ID: HYQ14ADF

FCC ID: HYQ13CZD FCC ID: HYQ13CZE

NOTE:

This device complies with Part 15 of the FCC Rules. Operation is subject to the following two conditions: (1) this device may not cause harmful interference, and (2) this device must accept any interference received, including interference that may cause undesired operation.

FCC WARNING:

Changes or modifications not expressly approved by the party responsible for compliance could void the user's authority to operate the equipment.

► For vehicles sold in Canada

NOTE:

Operation is subject to the following two conditions: (1) this device may not cause interference, and (2) this device must accept any interference, including interference that may cause undesired operation of the device.

 **CAUTION**

■ **Caution regarding interference with electronic devices**

→P. 56

1-3. Opening, closing and locking the doors and back door Wireless remote control

The wireless remote control can be used to lock and unlock the vehicle and the back door from outside the vehicle.

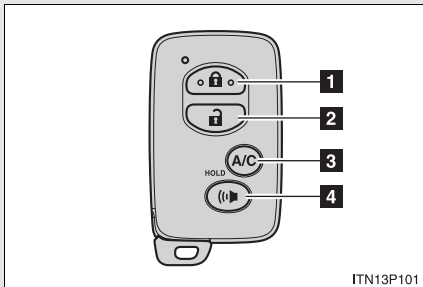

1 Locks all doors

2 Unlocks all doors

Pressing the button unlocks the driver's door. Pressing the button again within 3 seconds unlocks the other doors.

3 Operates Remote Air Conditioning System (if equipped) (→P. 285)

4 Sounds alarm
(push and hold) (→P. 64)

■ Operation signals

A buzzer sounds and the emergency flashers flash to indicate that the doors have been locked/unlocked. (Locked: Once; Unlocked: Twice)

■ Panic mode

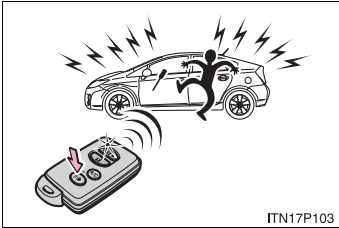

When  is pushed for longer than about one second, an alarm will sound for about 60 seconds and the vehicle lights will flash to deter any person from trying to break into or damage your vehicle.

To stop the alarm, push any button on the wireless remote control.

■ Door lock buzzer (vehicles with entry function)

If a door or back door is not fully closed, a buzzer sounds continuously for 10 seconds if an attempt to lock the door is made. Fully close the door to stop the buzzer, and lock the vehicle once more.

■ Electronic key battery depletion

- The standard battery life is 1 to 2 years. (The battery becomes depleted even if the electronic key is not used.) If the smart key system or the wireless remote control function does not operate, or the detection area becomes smaller, the battery may be depleted. Replace the battery when necessary. (→ P. 460)
- To avoid serious deterioration, do not leave the electronic key within 3 ft. (1 m) of the following electrical appliance that produce a magnetic field.
 - TVs
 - Personal computers
 - Cellular phones, cordless phones and battery chargers
 - Recharging cellular phones or cordless phones
 - Glass top ranges
 - Table lamps

■ Conditions affecting operation

The smart key system and wireless remote control use weak radio waves. In the following situations, the communication between the electronic key and the vehicle may be affected, preventing the smart key system and wireless remote control from operating properly. (Ways of coping: →P. 541)

- When the electronic key battery is depleted
- Near a TV tower, electric power plant, gas station, radio station, large display, airport or other facility that generates strong radio waves or electrical noise
- When carrying a portable radio, cellular phone, cordless phone or other wireless communication devices
- When the electronic key is in contact with, or is covered by the following metallic objects
 - Cards to which aluminum foil is attached
 - Cigarette boxes that have aluminum foil inside
 - Metallic wallets or bags
 - Coins
 - Hand warmers made of metal
 - Media such as CDs and DVDs
- When multiple electronic keys are in the vicinity
- When carrying or using the electronic key together with the following devices that emit radio waves
 - Another vehicle's electronic key
 - A wireless key that emits radio waves
 - Personal computer
 - Digital audio players
 - Portable game systems
- If window tint with a metallic content or metallic objects are attached to the rear window (vehicles with entry function)

■ **Security feature**

If a door is not opened within approximately 60 seconds after the vehicle is unlocked, the security feature automatically locks the vehicle again.

■ **If the wireless remote control does not operate properly**

- Locking and unlocking the doors: Use the mechanical key. (→P. 541)
- Starting the hybrid system (→P. 162)

■ **When the electronic key battery is fully depleted**

→P. 460

■ **Customization that can be configured at Toyota dealer**

Settings (e.g. 2-step unlocking function) can be changed.
(Customizable features →P. 587)

1-3. Opening, closing and locking the doors and back door

Side doors

The vehicle can be locked and unlocked using the entry function, wireless remote control or door lock switch.

■ Entry function (if equipped)

→P. 43

■ Wireless remote control

→P. 63

■ Keys

The doors can also be locked and unlocked with the mechanical key. (→P. 541)

■ Door lock switch

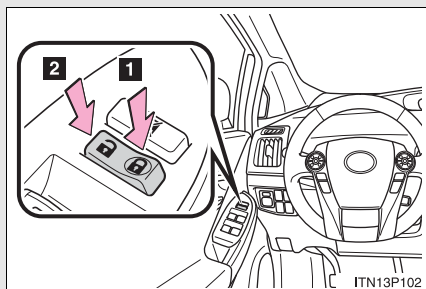

- 1 Locks all doors
- 2 Unlocks all doors

■ Inside lock button

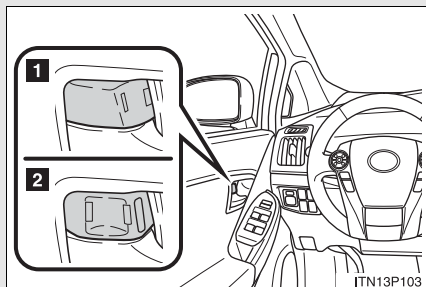

- 1 Locks the door
- 2 Unlocks the door

The front doors can be opened by pulling the inside handles even if the lock buttons are in the lock position.

Locking the front doors from the outside without a key

STEP 1 Move the inside lock button to the lock position.

STEP 2 Close the door.

The door cannot be locked if the “POWER” switch is in ACCESSORY or ON mode, or the electronic key is left inside the vehicle.

Depending on the position of the electronic key, the key may not be detected correctly and the door may be locked.

Rear door child-protector lock

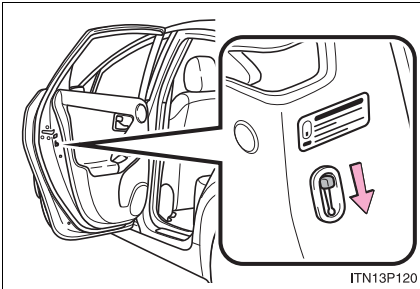

The door cannot be opened from inside the vehicle when the locks are set.

These locks can be set to prevent children from opening the rear doors. Push down on each rear door switch to lock both rear doors.

Automatic door locking and unlocking systems

The following functions can be set or canceled:



Function	Operation
Shift position linked door locking function	Shifting the shift position out of “P” locks all doors.
Shift position linked door unlocking function	Shifting the shift position to “P” unlocks all doors.
Speed linked door locking function	All doors are locked when the vehicle speed is approximately 12 mph (20 km/h) or higher.
Driver’s door linked door unlocking function	All doors are unlocked when the driver’s door is opened within 10 seconds after turning the “POWER” switch OFF.

■ Setting and canceling the functions

To switch between setting and canceling, follow the procedure below:

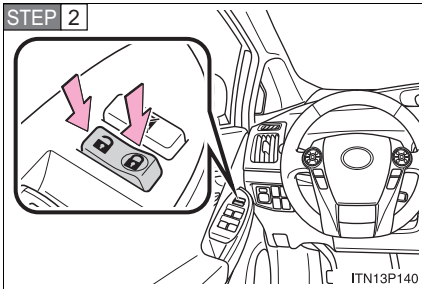



STEP 1 Close all the doors and switch the “POWER” switch to ON mode. (Perform **STEP 2** within 20 seconds.)



Shift the shift lever to “N” or press “P” position switch, and press and hold the driver’s door lock switch ( or ) for about 5 seconds then release.

The shift and switch positions corresponding to the desired function to be set are shown as follows.

Use the same procedure to cancel the function.

Function	Shift position	Driver’s door lock switch position
Shift position linked door locking function	“P”	
Shift position linked door unlocking function		
Speed linked door locking function	“N”	
Driver’s door linked door unlocking function		

When the setting or canceling operation is complete, all doors are locked and then unlocked.

■ Using the mechanical key

The doors can also be locked and unlocked with the mechanical key.
(→P. 541)

■ Customization that can be configured at Toyota dealer

Settings (e.g. unlocking function using a key) can be changed.
(Customizable features →P. 587)

⚠ CAUTION**■ To prevent an accident**

Observe the following precautions while driving the vehicle.

Failing to do so may result in a door opening and an occupant falling out, resulting in death or serious injury.

- Always use a seat belt.
- Always lock all doors.
- Ensure that all doors are properly closed.
- Do not pull the inside handle of the doors while driving.
The doors may be opened and the passengers are thrown out of the vehicle and it may result in death or serious injury.
Be especially careful for the front doors, the door may be opened even if the inside lock button is in locked position.
- Set the rear door child protector locks when children are seated in the rear seat.

1-3. Opening, closing and locking the doors and back door

Back door

The back door can be locked/unlocked and opened by the following procedures.

■ Unlocking and locking the back door

- ▶ Door lock switch
→P. 67
- ▶ Entry function (if equipped)
→P. 43
- ▶ Wireless remote control
→P. 63

■ Opening the back door from outside the vehicle

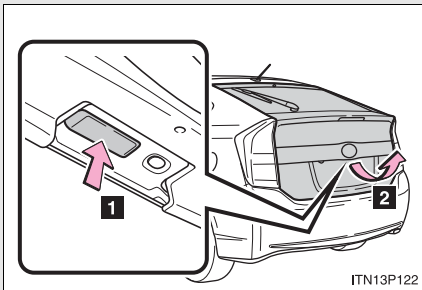

- 1** Press
- 2** Raise

■ **Luggage compartment light**

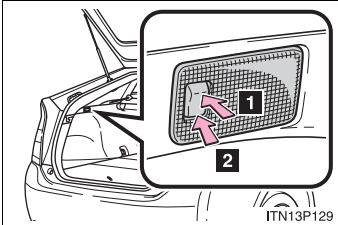

1 Door position

2 Off

■ **When closing the back door**

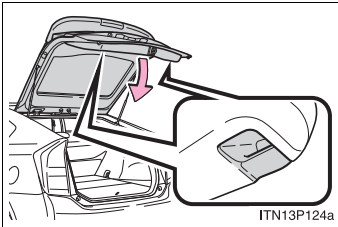

Lower the back door using the back door handles, and make sure to push the back door down from the outside to close it.

Be careful not to pull the back door sideways when closing the back door with the handle.

■ **If the back door opener is inoperative**

The back door can be opened from the inside.

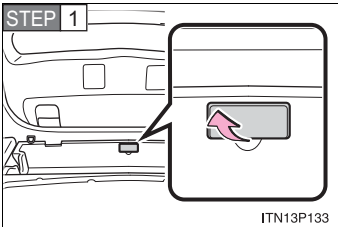

Remove the cover.

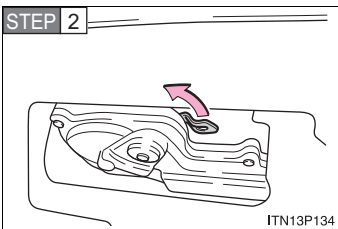

Move the lever.

 **CAUTION**

■ **While driving**

- Keep the back door closed while driving.

If the back door is left open, it may hit near-by objects while driving or luggage may be unexpectedly thrown out, causing an accident.

In addition, exhaust gases may enter the vehicle, causing death or a serious health hazard. Make sure to close the back door before driving.

- Before driving the vehicle, make sure that the back door is fully closed. If the back door is not fully closed, it may open unexpectedly while driving, causing an accident.
- Never let anyone sit in the luggage compartment. In the event of sudden braking or a collision, they are susceptible to death or serious injury.

■ **When children are in the vehicle**

Observe the following precautions.

Failure to do so may result in death or serious injury.

- Do not leave children alone in the luggage compartment.

If a child is accidentally locked in the luggage compartment, they could overheat.

- Do not allow a child to open or close the back door.

Doing so may cause the back door to operate unexpectedly, or cause the child's hands, head, or neck to be caught by the closing back door.

⚠ CAUTION**■ Operating the back door**

Observe the following precautions.

Failure to do so may cause parts of the body to be caught, resulting in serious injury.

- Remove any heavy loads, such as snow and ice, from the back door before opening it. Failure to do so may cause the back door fall closed again after it is opened.
- When opening or closing the back door, thoroughly check to make sure the surrounding area is safe.
- If anyone is in the vicinity, make sure they are safe and let them know that the back door is about to open or close.
- Use caution when opening or closing the back door in windy weather as it may move abruptly in strong wind.

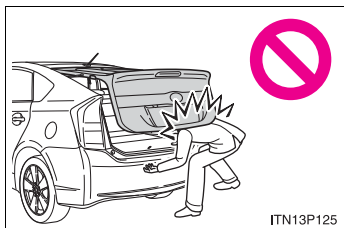

- The back door may fall if it is not opened fully. It is more difficult to open or close the back door on an incline than on a level surface, so beware of the back door unexpectedly opening or closing by itself. Make sure that the back door is fully open and secure before using the luggage compartment.

⚠ CAUTION

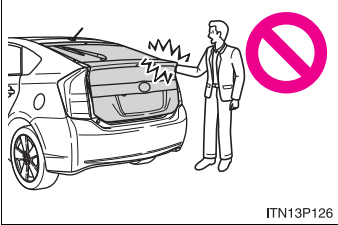

- When closing the back door, take extra care to prevent your fingers etc. from being caught.
- When closing the back door, make sure to press it lightly on its outer surface. If the back door handle is used to fully close the back door, it may result in hands or arms being caught.

- Do not pull on the back door damper stay to close the back door, and do not hang on the back door damper stay. Doing so may cause hands to be caught or the back door damper stay to break, causing an accident.
- Do not attach any accessories other than genuine Toyota parts to the back door. Such additional weight on the back door may cause the back door to fall closed again after it is opened.

 NOTICE**■ Back door damper stays**

The back door is equipped with damper stays that hold the back door in place.

Observe the following precautions.

Failure to do so may cause damage to the back door damper stay, resulting in malfunction.

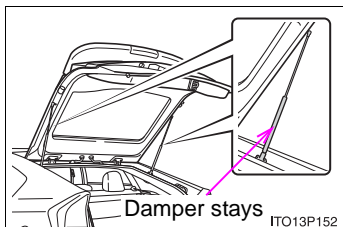

- Do not attach any foreign objects, such as stickers, plastic sheets, or adhesives to the damper stay rod.
- Do not touch the damper stay rod with gloves or other fabric items.
- Do not attach any accessories other than genuine Toyota parts to the back door.
- Do not place your hand on the damper stay or apply lateral forces to it.

1-4. Adjustable components (seats, mirrors, steering wheel)

Front seats

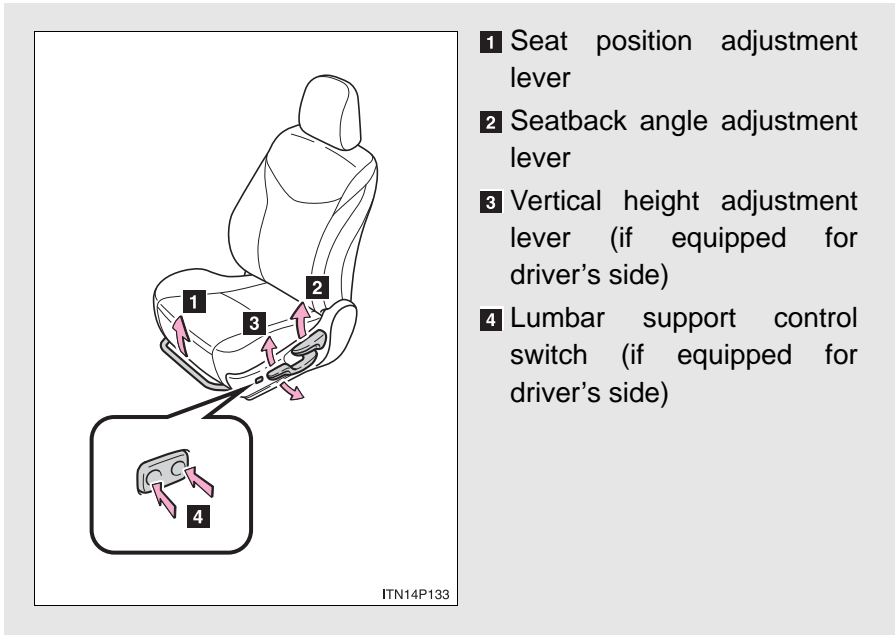

Active head restraints

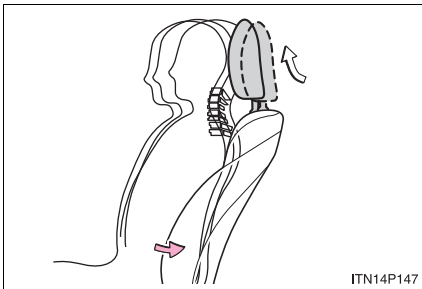

When the occupant's lower back presses against the seatback during a rear-end collision, the head restraint moves slightly forward and upward to help reduce the risk of whiplash on the seat occupant.

■ Active head restraints

Even small forces applied to the seatback may cause the head restraint to move. Pushing up a locked head restraint forcibly may make the inner structure of the head restraint appear. This does not indicate a problem.

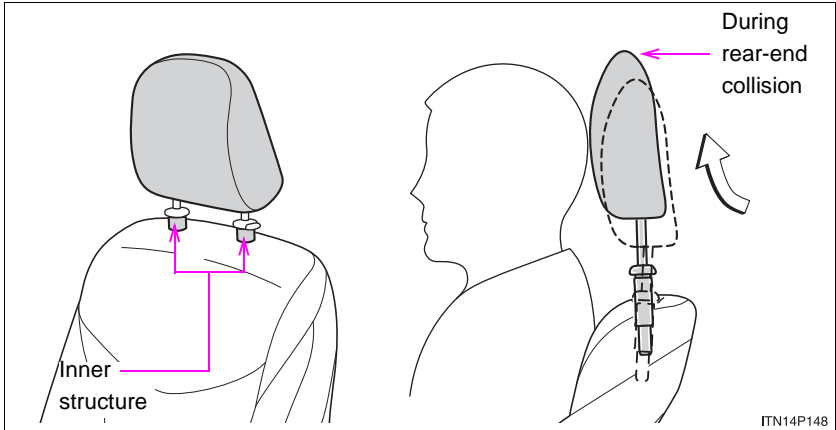

ITN14P148

⚠ CAUTION

■ Seat adjustment

- Be careful that the seat does not hit passengers or luggage.
- Do not recline the seat more than necessary when the vehicle is in motion to reduce the risk of sliding under the lap belt.
If the seat is too reclined, during an accident the lap belt may slide past the hips and apply restraint forces directly to the abdomen or your neck may contact the shoulder belt, increasing the risk of death or serious injury.
- After adjusting the seat, make sure that the seat is locked in position.

1-4. Adjustable components (seats, mirrors, steering wheel)

Rear seats

The seatbacks can be folded down.

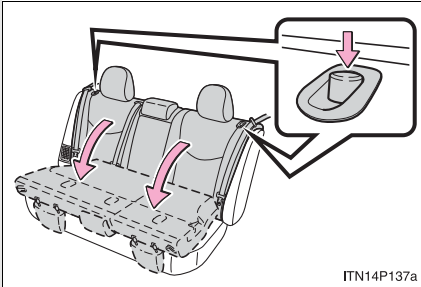

Fold the seatback down while pushing the lock release button.

Press the button until the lock is completely released.

■ Remove the seat belt from the guide

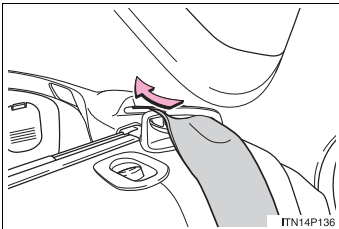

If the seat belt interferes with luggage on the folded seats, remove the seat belt from the guide.

■ Returning rear seatbacks

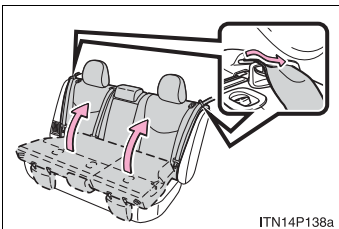

Tilt the rear seatback up until it locks, making sure that you hold the seat belt to prevent it from getting caught between the seatback and the inner side of the vehicle.

If the seat belt is removed from the guide, make sure the belt pass through the guide.

 CAUTION

■ **Before folding down a rear seat**

Do not fold down a rear seat when there are passengers sitting in the rear seats or when there is luggage placed on the rear seats.

■ **After returning the seatback to the upright position**

Observe the following precaution. Failure to do so may result in death or serious injury.

- Check that the seat belts are not twisted or caught under the seat.
- Make sure the seatbacks are securely locked by lightly rocking it back and forth.

1-4. Adjustable components (seats, mirrors, steering wheel)

Head restraints

Head restraints are provided for all seats.

► Front seats

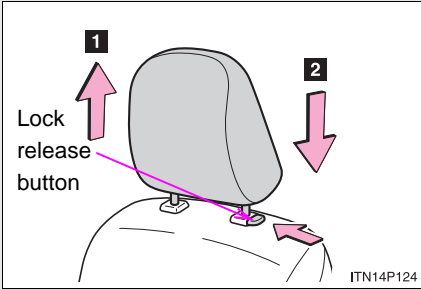

Vertical adjustment

1 Up

Pull the head restraints up.

2 Down

Push and hold the lock release button when lowering the head restraint.

► Rear center seat

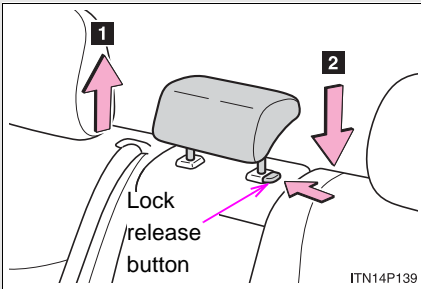

Vertical adjustment

1 Up

2 Down

Push the head restraint up or down while pressing the lock release button.

► Rear outboard seats (foldable type only)

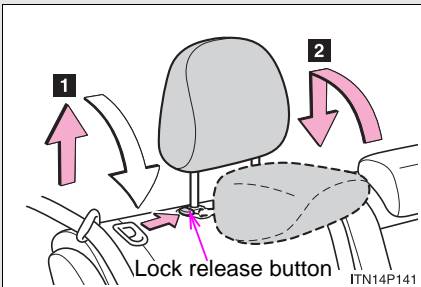

1 To fold

Push the head restraint up while pressing the lock release button.

2 To use

Lift up and push down the head restraint to the lowest lock position.

■ Adjusting the height of the head restraints

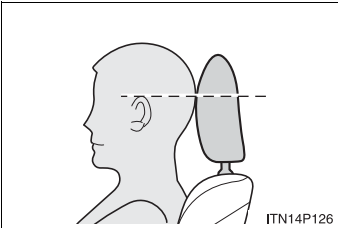

Make sure that the head restraints are adjusted so that the center of the head restraint is closest to the top of your ears.

■ Adjusting the rear center seat head restraint

Always raise the head restraint one level from the stowed position when using.

■ Removing the head restraints

▶ Front and rear center seats

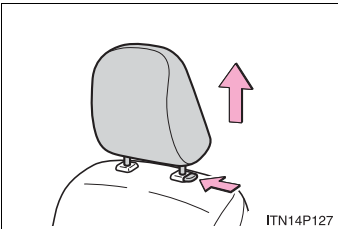

Pull the head restraint up while pressing the lock release button.

▶ Rear outboard seats (foldable type)

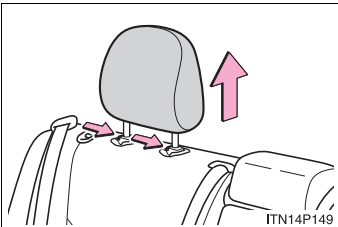

Pull the head restraint up while pressing the lock release buttons.

▶ Rear outboard seats (non-foldable type)

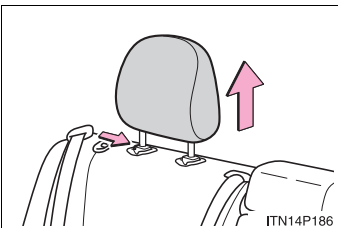

Pull the head restraint up while pressing the lock release button.

■ Installing the head restraints

▶ Front and rear center seats

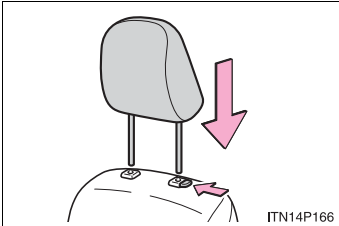

Align the head restraint with the installation holes and push it down to the lock position.

Press and hold the lock release button when lowering the head restraint.

▶ Rear outboard seats

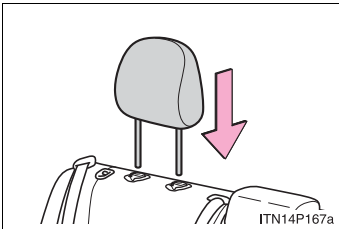

Align the head restraint with the installation holes and push it down to the lowest lock position.

⚠ CAUTION

■ Head restraint precautions

Observe the following precautions regarding the head restraints. Failure to do so may result in death or serious injury.

- Use the head restraints designed for each respective seat.
- Adjust the head restraints to the correct position at all times.
- After adjusting the head restraints, push down on them and make sure they are locked in position.
- Do not drive with the head restraints removed.

Make sure that all occupants are wearing their seat belts before driving the vehicle.

■ **Correct use of the seat belts**

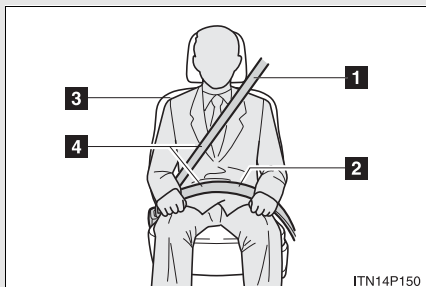

- 1** Extend the shoulder belt so that it comes fully over the shoulder, but does not come into contact with the neck or slide off the shoulder.
- 2** Position the lap belt as low as possible over the hips.
- 3** Adjust the position of the seatback. Sit up straight and well back in the seat.
- 4** Do not twist the seat belt.

■ **Fastening and releasing the seat belt**

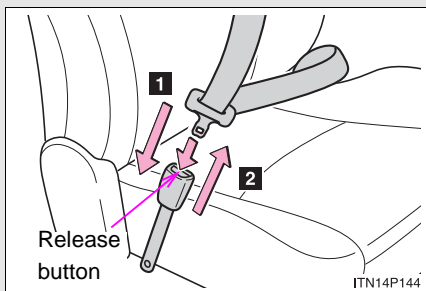

- 1** Fastening the belt
Push the tab into the buckle until a clicking sound is heard.
- 2** Releasing the belt
Press the release button.

■ Adjusting the height of the belt (front seats)

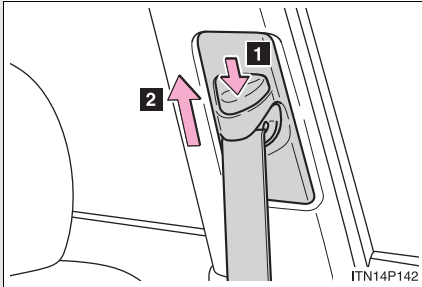

1 Down

2 Up

Move the height adjuster up and down as needed until you hear a click.

Seat belt pretensioners (front seats)

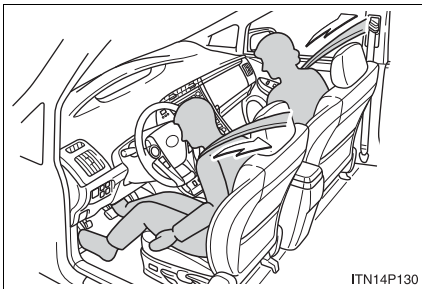

The pretensioner helps the seat belt to quickly restrain the occupant by retracting the seat belt when the vehicle is subjected to certain types of severe frontal collision.

The pretensioner may not activate in the event of a minor frontal impact, a side impact or a rear impact.

Pre-collision seat belts (front seats of vehicles with pre-collision system)

If the pre-collision sensor detects that a collision is unavoidable, the pre-collision system will retract the seat belt, thus enhancing the effectiveness of the seat belt pretensioner in a crash.

The same will happen if the driver makes an emergency braking or loses control of the vehicle. (→P. 249)

■ Emergency locking retractor (ELR)

The retractor will lock the belt during a sudden stop or on impact. It may also lock if you lean forward too quickly. A slow, easy motion will allow the belt to extend so that you can move around fully.

■ Automatic locking retractor (ALR)

When a passenger's shoulder belt is completely extended and then retracted even slightly, the belt is locked in that position and cannot be extended. This feature is used to hold the child restraint system (CRS) firmly. To free the belt again, fully retract the belt and then pull the belt out once more. (→P. 137)

■ Pregnant women

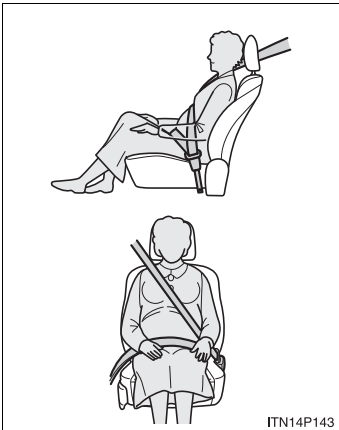

Obtain medical advice and wear the seat belt in the proper way. (→P. 85)

Women who are pregnant should position the lap belt as low as possible over the hips in the same manner as other occupants. Extend the shoulder belt completely over the shoulder and position the belt across the chest. Avoid belt contact over the rounding of the abdominal area.

If the seat belt is not worn properly, not only a pregnant woman, but also the fetus could suffer death or serious injury as a result of sudden braking or a collision.

■ People suffering illness

Obtain medical advice and wear the seat belt in the proper way.

■ Child seat belt usage

The seat belts of your vehicle were principally designed for persons of adult size.

- Use a child restraint system appropriately for the child, until the child becomes large enough to properly wear the vehicle's seat belt. (→P. 132)
- When the child becomes large enough to properly wear the vehicle's seat belt, follow the instructions on P. 85 regarding seat belt usage.

■ Replacing the belt after the pretensioner has been activated

If the vehicle is involved in multiple collisions, the pretensioner will activate for the first collision, but will not activate for the second or subsequent collisions.

■ Seat belt extender

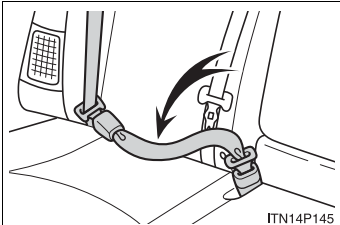

If your seat belts cannot be fastened securely because they are not long enough, a personalized seat belt extender is available from your Toyota dealer free of charge.

 **CAUTION**

Observe the following precautions to reduce the risk of injury in the event of sudden braking, sudden swerving or an accident.

Failing to do so may cause death or serious injury.

■ Wearing a seat belt

- Ensure that all passengers wear a seat belt.
- Always wear a seat belt properly.
- Each seat belt should be used by one person only. Do not use a seat belt for more than one person at the same time, including children.
- Toyota recommends that children should be seated in the rear seat and always use a seat belt and/or an appropriate child restraint system.
- Do not recline the seat any more than necessary to achieve a proper seating position. The seat belt is most effective when the occupants are sitting up straight and well back in the seats.
- Do not wear the shoulder belt under your arm.
- Always wear your seat belt low and snug across your hips.

■ Child restraint lock function belt precaution

Do not allow children to play with the child restraint lock function belt. If the belt becomes twisted around a child's neck, it will not be possible to pull the belt out leading to choking or other serious injuries that could result in death. If this occurs and the buckle cannot be unfastened, scissors should be used to cut the belt.

■ Seat belt damage and wear

- Do not damage the seat belts by allowing the belt, plate or buckle to be jammed in the door.
- Inspect the seat belt system periodically. Check for cuts, fraying, and loose parts. Do not use a damaged seat belt until it is replaced. Damaged seat belts cannot protect an occupant from death or serious injury.

 CAUTION

■ **Seat belt damage and wear**

- Ensure that the belt and tab are locked and the belt is not twisted. If the seat belt does not function correctly, immediately contact your Toyota dealer.
- Replace the seat assembly, including the belts, if your vehicle has been involved in a serious accident, even if there is no obvious damage.
- Do not attempt to install, remove, modify, disassemble or dispose of a seat belt. Have any necessary repairs carried out by your Toyota dealer. Inappropriate handling of the pretensioner may cause it to activate or operate improperly and may cause death or serious injury.

■ **Adjustable shoulder anchor**

Always make sure the shoulder belt is positioned across the center of your shoulder. The belt should be kept away from your neck, but not falling off your shoulder. Failure to do so could reduce the amount of protection in an accident and cause death or serious injuries in the event of a sudden stop, sudden swerve or accident. (→P. 86)

■ **Seat belt pretensioners**

- Do not place anything, such as a cushion, on the front passenger's seat. Doing so will disperse the passenger's weight, which prevents the sensor from detecting the passenger's weight properly. As a result, the seat belt pretensioner for the front passenger's seat may not activate in the event of a collision.
- If the pretensioner has activated, the SRS warning light will come on. In that case, the seat belt cannot be used again and must be replaced at your Toyota dealer.

 **CAUTION****■ Using a seat belt extender**

- Do not wear the seat belt extender, if you can fasten the seat belt without the extender.
- Do not use the seat belt extender when installing a child restraint system, because the belt will not securely hold the child restraint system, increasing the risk of death or serious injury in the event of a sudden stop, sudden swerve or an accident.
- The personalized extender may not be safe on another vehicle, when used by another person, or at a different seating position other than the one originally intended.

■ Precaution for pre-collision seat belts (if equipped)

Do not rely on the pre-collision system to avoid accidents. Always pay attention to the surrounding conditions, and drive safely and responsibly.

 **NOTICE****■ When using a seat belt extender**

When releasing the seat belt, press on the buckle release button on the extender, not on the seat belt.

This helps prevent damage to the vehicle interior and the extender itself.

1-4. Adjustable components (seats, mirrors, steering wheel)

Steering wheel

The steering wheel can be adjusted to a comfortable position.

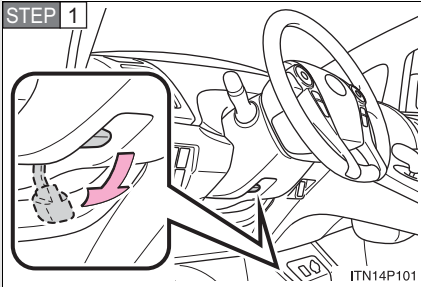

Hold the steering wheel and press the lever down.

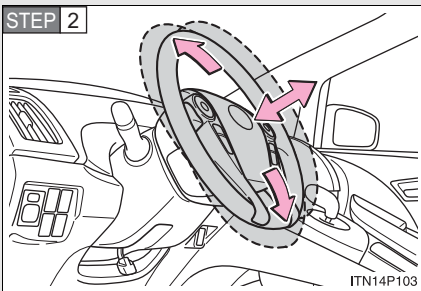

Adjust to the ideal position by moving the steering wheel horizontally and vertically.

After adjustment, pull the lever up to secure the steering wheel.

CAUTION

■ While driving

Do not adjust the steering wheel.

Doing so may cause the driver to mishandle the vehicle and an accident, resulting in death or serious injury.

■ After adjusting the steering wheel

Make sure that the steering wheel is securely locked.

Otherwise, the steering wheel may move suddenly, possibly causing an accident and resulting in death or serious injury.

1-4. Adjustable components (seats, mirrors, steering wheel) Inside rear view mirror

Glare from the headlights of vehicles behind can be reduced by using the following functions.

- ▶ Auto anti-glare inside rear view mirror (vehicles with garage door opener)

In auto mode, sensors are used to detect the headlights of vehicles behind and automatically reduce the reflected light.

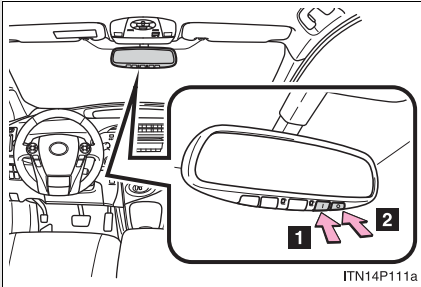

1 On

2 Off

The indicator comes on when auto mode is turned on.

The mirror will revert to the auto mode each time the "POWER" switch is turned to ON mode.

► Auto anti-glare inside rear view mirror (vehicles without garage door opener)

In auto mode, sensors are used to detect the headlights of vehicles behind and automatically reduce the reflected light.

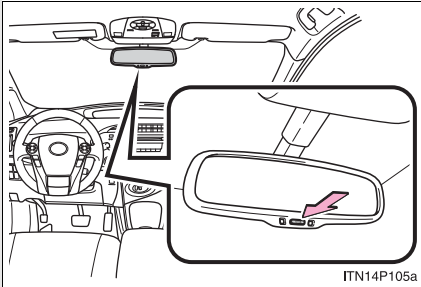

Turns auto mode on/off.

The indicator comes on when auto mode is turned on.

The mirror will revert to the auto mode each time the "POWER" switch is turned to ON mode.

► Manual anti-glare inside rear view mirror

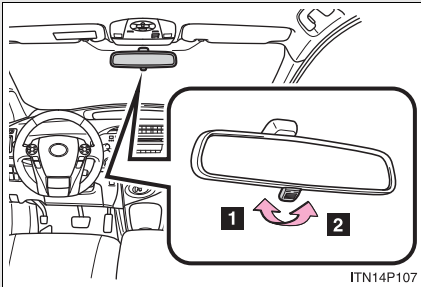

1 Normal position

2 Anti-glare position

■ **To prevent sensor error (vehicles with auto anti-glare inside rear view mirror)**

▶ Vehicles with garage door opener

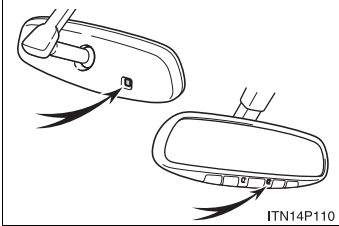

To ensure correct functioning of the sensors, do not touch or cover the sensors.

▶ Vehicles without garage door opener

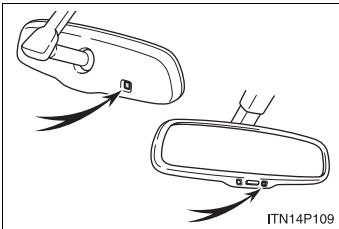

! CAUTION

■ **While driving**

Do not adjust the position of the mirror.

Doing so may lead to mishandling of the vehicle and an accident, or resulting in death or serious injury.

1-4. Adjustable components (seats, mirrors, steering wheel)

Outside rear view mirrors

Mirror angle can be adjusted using the switch.

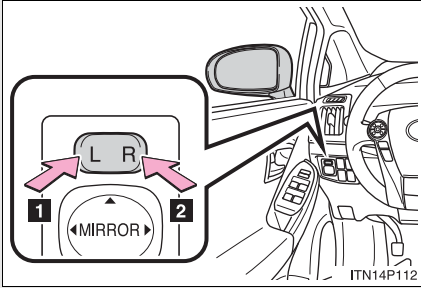

Select a mirror to adjust

- 1 Left
- 2 Right

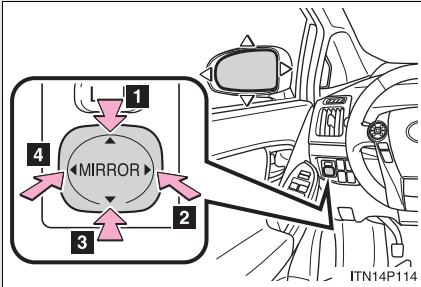

Adjust the mirror

- 1 Up
- 2 Right
- 3 Down
- 4 Left

Folding the mirrors

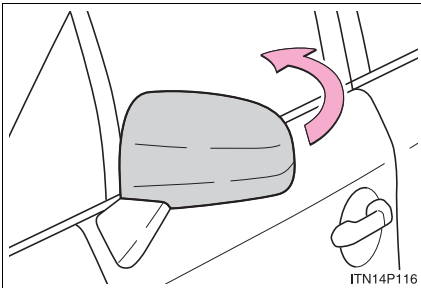

Push backward to fold the mirrors.

■ **Mirror angle can be adjusted when**

The "POWER" switch is in ACCESSORY or ON mode.

■ **When the mirrors are fogged up (vehicles with outside rear view mirror defoggers)**

Turn on the mirror heaters to defog the mirrors. (→P. 289)

 **CAUTION**

■ **While driving**

Observe the following precautions.

Failing to do so may result in losing control of the vehicle and cause an accident, resulting in death or serious injury.

- Do not adjust the mirrors.
- Do not drive with the mirrors folded back.
- Before driving, be sure to extend mirrors and make an adjustment properly.

■ **When the mirror defoggers are operating (vehicle with outside rear view mirror defoggers)**

Do not touch the rear view mirror surfaces, as they can become very hot and burn you.

 **NOTICE**

■ **If ice should jam the mirror**

Do not operate the control or scrape the mirror face. Use a spray de-icer to free the mirror.

1-5. Opening and closing the windows and moon roof

Power windows

The power windows can be opened and closed using the following switches.

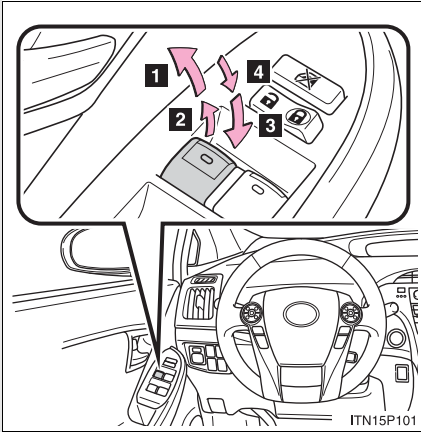

- 1 One-touch closing*
- 2 Closing
- 3 One-touch opening*
- 4 Opening

*: Pushing the switch in the opposite direction will stop window travel partway.

Lock switch

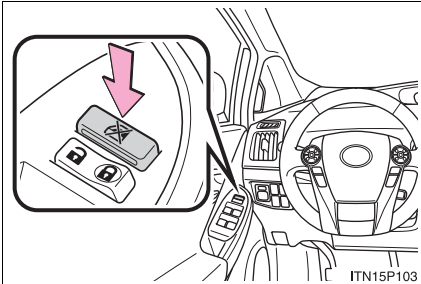

Press the switch down to lock passenger window switches.

Use this switch to prevent children from accidentally opening or closing a passenger window.

■ **The power windows can be operated when**

The “POWER” switch is in ON mode.

■ **Operating the power windows after turning the “POWER” switch OFF**

The power windows can be operated for approximately 45 seconds even after the “POWER” switch is switched to ACCESSORY mode or turned OFF. They cannot, however, be operated once the driver’s or front passenger’s door is opened.

■ **Jam protection function**

If an object becomes caught between the window and the window frame, window travel is stopped and the window is opened slightly.

 **CAUTION**

■ **Closing the windows**

Observe the following precautions.

Failing to do so may result in death or serious injury.

- Check to make sure that all passengers do not have any part of their body in a position where it could be caught when a window is being operated.

- Do not allow children to operate the power windows.

Closing a power window on someone can cause death or serious injury.

■ **Jam protection function**

- Never try jamming any part of your body to activate the jam protection function intentionally.

- The jam protection function may not work if something gets caught just before the window fully closes.

1-5. Opening and closing the windows and moon roof Moonroof with Solar Panel*

Use the overhead switches to open, close, and tilt the moon roof up and down.

■ Open

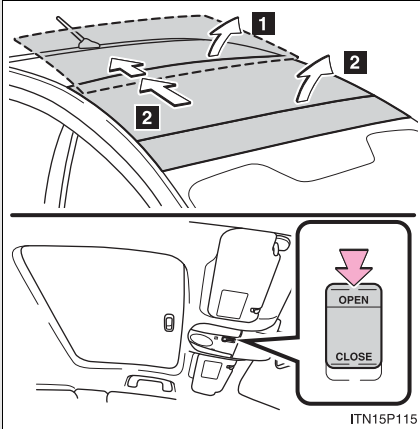

1 Tilt up

Push "OPEN".

The moon roof will open after pausing at the tilt up position, when pushing and holding the switch.

To tilt down, push and hold "CLOSE".

2 Open

Push "OPEN" at the tilt up position.

The moon roof stops just before it is opened fully.

Push "OPEN" again to fully open.

Lightly push on either side of the switch stops the moon roof partway.

*: If equipped

■ **Close**



Push and hold "CLOSE".

The moon roof stops once.
Push and hold the switch again
to fully close.

■ **The moon roof can be operated when**

The “POWER” switch is in ON mode.

■ **Operating the moon roof after turning the hybrid system OFF**

The moon roof can be operated for approximately 45 seconds even after the “POWER” switch is turned to ACCESSORY mode or turned OFF. It cannot, however, be operated once either front door is opened.

■ **Jam protection function**

If an object is detected between the moon roof and the frame while closing or tilting down, travel is stopped and the moon roof opens slightly.

■ **If the moon roof cannot be closed**

If the moon roof cannot be closed, such as when the jam protection function activates accidentally due to a malfunction, pressing and holding “CLOSE” switch closes the moon roof.

After this, to make the automatic opening function and jam protection function available again, press and hold the “OPEN” switch until the moon roof opens fully and then closes slightly.

If the functions do not activate, contact your Toyota dealer.

■ **To reduce moon roof wind noise**

Drive with the moon roof opened to slightly before the fully open position as driving with the moon roof opened fully will cause wind noise.

■ **Sunshade**

The sunshade can be opened and closed manually. However, the sunshade will open automatically when the moon roof is opened.

 **CAUTION****■ Opening the moon roof**

Observe the following precautions.

Failing to do so may cause death or serious injury.

- Do not allow any passengers to put their hands or heads outside the vehicle while it is moving.
- Do not sit on top of the moon roof.

■ Closing the moon roof

Observe the following precautions.

Failing to do so may result in death or serious injury.

- Check to make sure that all passengers do not have any part of their bodies in a position where they could be caught when the moon roof is being operated.
- Do not allow children to operate the moon roof.
Closing the moon roof on someone can cause death or serious injury.

■ Jam protection function

- Never try jamming any part of your body to activate the jam protection function intentionally.
- The jam protection function may not work if something gets caught just before the moon roof fully closes.

 **NOTICE****■ Operating the moon roof**

There is the possibility that water or rain will get into the vehicle if you operate the moon roof after a rainfall, snowfall or car wash. Wipe the moon roof dry with a cloth before operating it.

Opening the fuel tank cap

Perform the following steps to open the fuel tank cap.

■ Before refueling the vehicle

Turn the “POWER” switch OFF and ensure that all the doors and windows are closed.

■ Opening the fuel tank cap

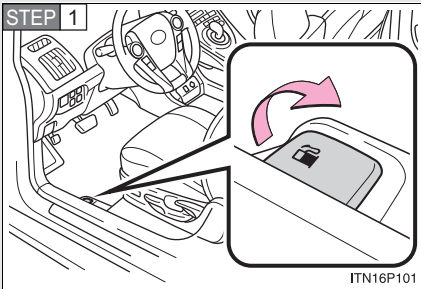

Pull the lever.

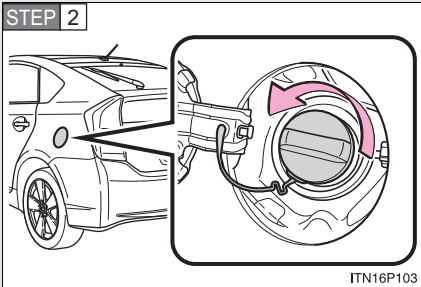

Turn the cap slowly counter-clockwise, then pause slightly before removing it.

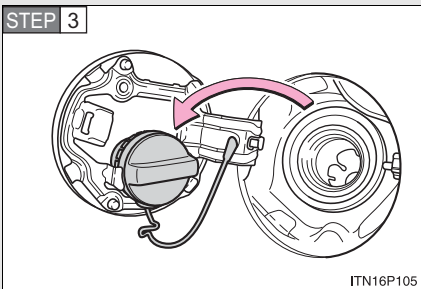

Hang the fuel tank cap on the back of the fuel filler door.

Closing the fuel tank cap

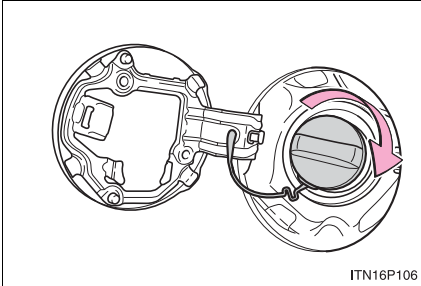

After refueling, turn the fuel tank cap clockwise until you hear a click. The cap will revolve slightly in the opposite direction once released.

■ Fuel types

Use unleaded gasoline. (Octane Rating 87 [Research Octane Number 91] or higher)

■ Fuel tank capacity

Approximately 11.9 gal. (45 L, 9.9 Imp. gal.)

 **CAUTION**

■ **When refueling the vehicle**

Observe the following precautions while refueling the vehicle. Failure to do so, may result in death or serious injury.

- Touch the vehicle or some other metal surface to discharge any static electricity.
Sparks resulting from discharging static electricity may cause the fuel vapors to ignite.
- Always hold the grips on the fuel tank cap and turn it slowly to remove it. A whooshing sound may be heard when the fuel tank cap is loosened. Wait until the sound cannot be heard before fully removing the cap. In hot weather, pressurized fuel may spray out the filler neck and cause injury.
- Do not allow anyone that has not discharged static electricity from their bodies to come close to an open fuel tank.
- Do not inhale vaporized fuel.
Fuel contains substances that are harmful if inhaled.
- Do not smoke while refueling the vehicle.
Doing so may cause the fuel to ignite and cause a fire.
- Do not return to the vehicle or touch any person or object that is statically charged.
This may cause static electricity to build up, resulting in a possible ignition hazard.

■ **When replacing the fuel tank cap**

Do not use anything but a genuine Toyota fuel tank cap designed for your vehicle. Doing so may cause a fire or other incident which may result in death or serious injury.

**NOTICE****■ Refueling**

Do not spill fuel during refueling.

Doing so may damage the vehicle, such as causing the exhaust systems to operate abnormally or damaging fuel system components or the vehicle's painted surface.

1-7. Theft deterrent system Immobilizer system

The vehicle's keys have built-in transponder chips that prevent the hybrid system from starting if the key has not been previously registered in the vehicle's on-board computer.

Never leave the keys inside the vehicle when you leave the vehicle.

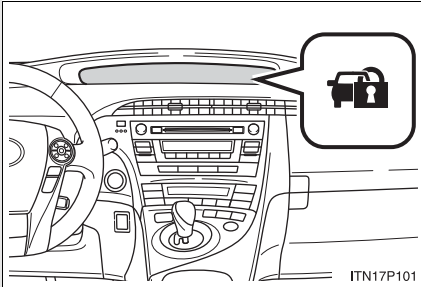

The indicator light flashes after the "POWER" switch has been turned OFF to indicate that the system is operating.

■ System maintenance

The vehicle has a maintenance-free type of immobilizer system.

■ Conditions that may cause the system to malfunction

- If the key is in contact with a metallic object.
- If the key is in close proximity to or touching a key to the security system (key with a built-in transponder chip) of another vehicle.

■ Certifications for the immobilizer system

► For vehicles sold in the U.S.A.

FCC ID: NI4TMIMB-1

NOTE:

This device complies with Part 15 of the FCC Rules. Operation is subject to the following two conditions: (1) this device may not cause harmful interference, and (2) this device must accept any interference received, including interference that may cause undesired operation.

FCC WARNING:

Changes or modifications not expressly approved by the party responsible for compliance could void the user's authority to operate the equipment.

► For vehicles sold in Canada

Operation is subject to the following two conditions: (1) this device may not cause interference, and (2) this device must accept any interference, including interference that may cause undesired operation of the device.



NOTICE

■ For proper system operation

Do not modify, remove or disable the immobilizer system. If any unauthorized changes or modifications are made, the proper operation of the system cannot be guaranteed.

1-7. Theft deterrent system

Theft prevention labels (U.S.A.)

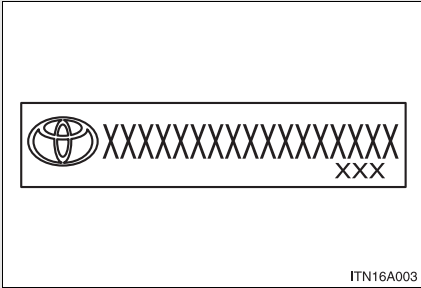

These labels are attached to the vehicle to reduce vehicle theft by facilitating the tracing and recovery of parts from stolen vehicles. Do not remove under penalty of law.

1-8. Safety information

Correct driving posture

Drive with a good posture as follows:

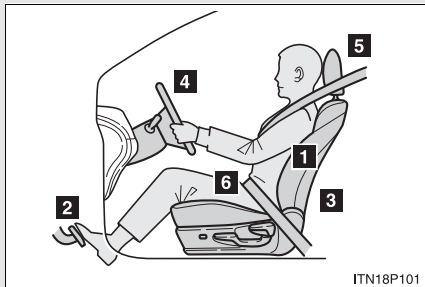

- 1** Sit upright and well back in the seat.
- 2** Adjust the position of the seat forward or backward to ensure the pedals can be reached and easily depressed to the extent required. (→P. 78)
- 3** Adjust the seatback so that the controls are easily operable.
- 4** Adjust the tilt and telescopic positions of the steering wheel downward so the air-bag is facing your chest. (→P. 92)
- 5** Lock the head restraint in place with the center of the head restraint closest to the top of your ears. (→P. 82)
- 6** Wear the seat belt correctly. (→P. 85)

 **CAUTION**

■ **While driving**

- Do not adjust the position of the driver's seat.
Doing so could cause the driver to lose control of the vehicle.
- Do not place a cushion between the driver or passenger and the seatback.
A cushion may prevent correct posture from being achieved, and reduce the effectiveness of the seat belt and head restraint, increasing the risk of death or serious injury to the driver or passenger.
- Do not place anything under the front seats.
Objects placed under the front seats may become jammed in the seat tracks and stop the seat from locking in place. This may lead to an accident. The adjustment mechanism may also be damaged.

■ **Adjusting the seat position**

- Do not recline the seat more than necessary when the vehicle is in motion, to reduce the risk of sliding under the lap belt.
If the seat is too reclined during an accident, the lap belt may slide part the hips and apply restraint forces directly to the abdomen or your neck may contact the shoulder belt, increasing the risk of death or serious injury.
- Take care when adjusting the seat position to ensure that other passengers are not injured by the moving seat.
- Do not put your hands under the seat or near the moving parts to avoid injury.
Fingers or hands may become jammed in the seat mechanism.

1-8. Safety information

SRS airbags

The SRS airbags inflate when the vehicle is subjected to certain types of severe impacts that may cause significant injury to the occupants. They work together with the seat belts to help reduce the risk of death or serious injury.

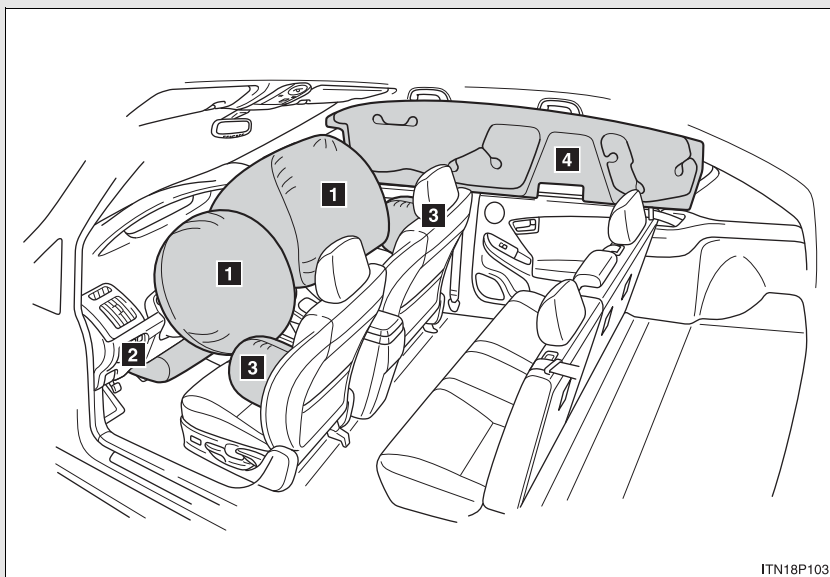

► Front airbags

1 Driver airbag/front passenger airbag

Can help protect the head and chest of the driver and front passenger from impact with interior components.

2 Knee airbag

Can help provide driver protection.

► Side and curtain shield airbags

3 Side airbag

Can help protect the torso of the front seat occupants.

4 Curtain shield airbag

Can help protect primarily the head of front and rear outboard occupants.

Airbag system components

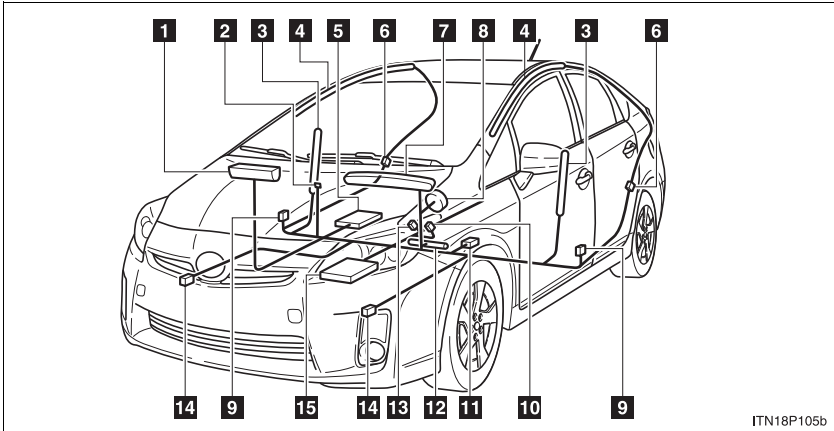

ITN18P105b

- | | |
|--|---|
| 1 Front passenger airbag | 9 Side and curtain shield airbag sensor |
| 2 "AIR BAG ON" and "AIR BAG OFF" indicator lights | 10 Driver's seat belt buckle switch |
| 3 Side airbag | 11 Driver's seat position sensor |
| 4 Curtain shield airbag | 12 Knee airbag |
| 5 Occupant detection sensor | 13 Front passenger's seat belt buckle switch |
| 6 Curtain shield airbag sensor | 14 Front airbag sensor |
| 7 SRS warning light | 15 Airbag sensor assembly |
| 8 Driver airbag | |

Your vehicle is equipped with “ADVANCED AIRBAGS” designed based on US motor vehicle safety standards (FMVSS208). The airbag system controls airbag deployment power for the driver and front passenger. The driver airbag system consists of the driver seat’s position sensor etc. The front passenger’s airbag system consists of the front passenger occupant classification sensor etc.

The main SRS airbag system components are shown above. The SRS airbag system is controlled by the airbag sensor assembly. The airbag sensor assembly consists of a safing sensor and an airbag sensor.

In certain types of severe frontal or side impacts, the SRS airbag system triggers the airbag inflators. A chemical reaction in the inflators quickly fills the airbags with non-toxic gas to help restrain the motion of the occupants.

■ **If the SRS airbags deploy (inflate)**

- Bruising and slight abrasions may result from contact with a deploying (inflating) SRS airbag.
- A loud noise and white powder will be emitted.
- Parts of the airbag module (steering wheel hub, airbag cover and inflator) as well as the front seats, and parts of the front and rear pillars and roof side rail, may be hot for several minutes. The airbag itself may also be hot.
- The windshield may crack.
- For Safety Connect subscribers, if the SRS airbags deploy or in the event of a severe rear-end collision, the system is designed to send an emergency call to the response center, notifying them of the vehicle’s location (without needing to push the “SOS” button) and an agent will attempt to speak with the occupants to ascertain the level of emergency and assistance required. If the occupants are unable to communicate, the agent automatically treats the call as an emergency and helps to dispatch the necessary emergency services. (→P. 395)

■ SRS airbag deployment conditions (front airbags)

- The SRS front airbag will deploy in the event of an impact that exceeds the set threshold level (the level of force corresponding to a 12 - 18 mph [20 - 30 km/h] frontal collision with a fixed wall that does not move or deform).

However, this threshold velocity will be considerably higher if the vehicle strikes an object, such as a parked vehicle or sign pole, which can move or deform on impact, or if the vehicle is involved in an underride collision (e.g. a collision in which the front of the vehicle “underrides”, or goes under, the bed of a truck, etc.).

- It is possible that in some collisions where the forward deceleration of the vehicle is very close to the designed threshold level, the SRS front airbags and the seat belt pretensioners may not activate together.
- The SRS front passenger airbags will not activate, if there is no passenger sitting in the front passenger seat. However, the front passenger airbag may deploy if luggage is put in the seat, or the seat belt is fastened, even if the seat is unoccupied. (→P. 126)

■ SRS airbag deployment conditions (side and curtain shield airbags)

The SRS side and curtain shield airbags will deploy in the event of an impact that exceeds the set threshold level (the level of force corresponding to the impact force produced by a 3300 lb. [1500 kg] vehicle colliding with the vehicle cabin from a direction perpendicular to the vehicle orientation at a speed of 12 - 18 mph [20 - 30 km/h]).

■ **Conditions under which the SRS airbags may deploy (inflate), other than a collision**

The SRS front airbags may also deploy if a serious impact occurs to the underside of your vehicle. Some examples are shown in the illustration.

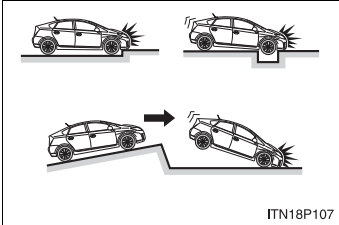

- Hitting a curb, edge of pavement or hard surface
- Falling into or jumping over a deep hole
- Landing hard or vehicle falling

■ **Types of collisions that may not deploy the SRS airbag (front airbags)**

The SRS front airbags are generally not designed to inflate if the vehicle is involved in a side or rear collision, if it rolls over, or if it is involved in a low-speed frontal collision. But, whenever a collision of any type causes sufficient forward deceleration of the vehicle, deployment of the SRS front airbags may occur.

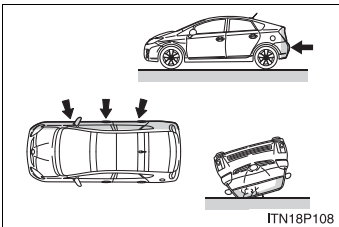

- Collision from the side
- Collision from the rear
- Vehicle rollover

■ Types of collisions that may not deploy the SRS airbag (side and curtain shield airbags)

The SRS side airbag and curtain shield airbag system may not activate if the vehicle is subjected to a collision from the side at certain angles, or a collision to the side of the vehicle body other than the passenger compartment.

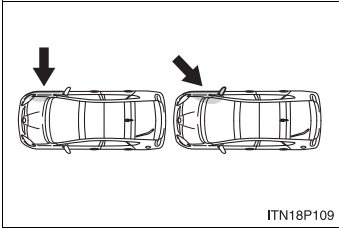

- Collision from the side to the vehicle body other than the passenger compartment
- Collision from the side at an angle

The SRS side airbags and curtain shield airbags are generally not designed to inflate if the vehicle is involved in a frontal or rear collision, if it rolls over, or if it is involved in a low-speed side collision.

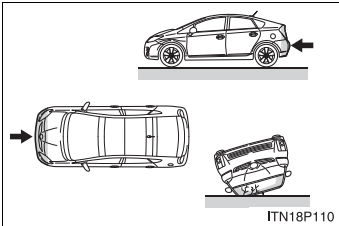

- Collision from the front
- Collision from the rear
- Vehicle rollover

■ When to contact your Toyota dealer

In the following cases, contact your Toyota dealer as soon as possible. Do not disconnect the 12 volt battery cables before contacting your Toyota dealer.

- Any of the SRS airbags have been inflated.

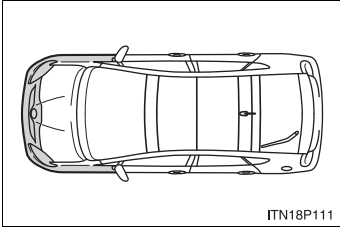

- The front of the vehicle is damaged or deformed, or the vehicle was involved in an accident that was not severe enough to cause the SRS airbags to inflate.

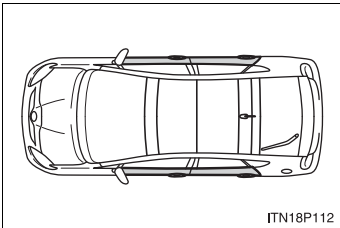

- A portion of the doors is damaged or deformed, or the vehicle was involved in an accident that was not severe enough to cause the SRS side airbags and curtain shield airbags to inflate.

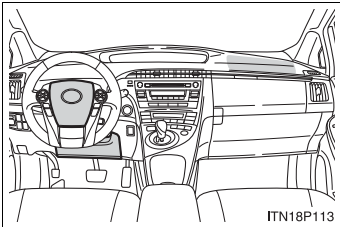

- The pad section of the steering wheel, dashboard near the front passenger airbag or lower portion of the instrument panel is scratched, cracked, or otherwise damaged.

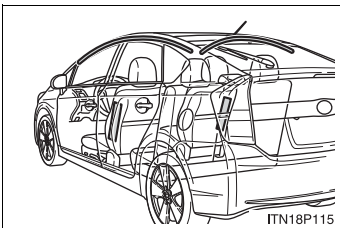

- The surface of the seats with the side airbag is scratched, cracked, or otherwise damaged.
- The portion of the front, center and rear pillars or roof side rail garnishes (padding) containing the curtain shield airbags inside is scratched, cracked, or otherwise damaged.

 CAUTION

■ SRS airbag precautions

Observe the following precautions regarding the airbags.
Failure to do so may cause death or serious injury.

- The driver and all passengers in the vehicle must wear their seat belts properly.

The SRS airbags are supplemental devices to be used with the seat belts.

- The SRS driver airbag deploys with considerable force, and can cause death or serious injury especially if the driver is very close to the airbag. The National Highway Traffic Safety Administration (“NHTSA”) advises:

Since the risk zone for driver airbag is the first 2 - 3 in. (50 - 75 mm) of inflation, placing yourself 10 in. (250 mm) from your driver airbag provides you with a clear margin of safety. This distance is measured from the center of the steering wheel to your breastbone. If you sit less than 10 in. (250 mm) away now, you can change your driving position in several ways:

- Move your seat to the rear as far as you can while still reaching the pedals comfortably.
- Slightly recline the back of the seat.
Although vehicle designs vary, many drivers can achieve the 10 in. (250 mm) distance, even with the driver seat all the way forward, simply by reclining the back of the seat somewhat. If reclining the back of your seat makes it hard to see the road, raise yourself by using a firm, non-slippery cushion, or raise the seat if your vehicle has that feature.
- If your steering wheel is adjustable, tilt it downward. This points the airbag toward your chest instead of your head and neck.

The seat should be adjusted as recommended by NHTSA above, while still maintaining control of the foot pedals, steering wheel, and your view of the instrument panel controls.

⚠ CAUTION

■ SRS airbag precautions

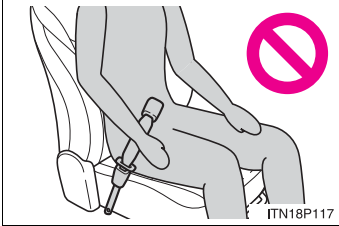

● If the seat belt extender has been connected to the driver's seat belt buckle but the seat belt extender has not also been fastened to the latch plate of the driver's seat belt, the SRS driver's airbag system will judge that the driver is wearing the seat belt even though the seat belt has not been connected. In this case, the driver's airbag may not activate correctly in a collision, resulting in death or serious injury in the event of collision. Be sure to wear the seat belt with the seat belt extender.

- The SRS front passenger airbag also deploys with considerable force, and can cause death or serious injury especially if the front passenger is very close to the airbag. The front passenger seat should be as far from the airbag as possible with the seatback adjusted, so the front passenger sits upright.
- A deploying airbag can cause death or serious injuries to improperly seated and/or restrained infants and children. An infant or child who is too small to use a seat belt should be properly secured using a child restraint system. Toyota strongly recommends that all infants and children be placed in the rear seats of the vehicle and properly restrained. The rear seats are the safest for infants and children. (→P. 132)

 CAUTION

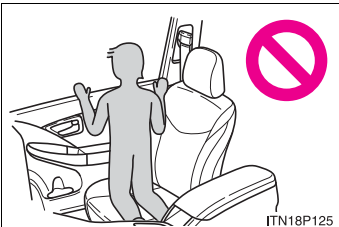
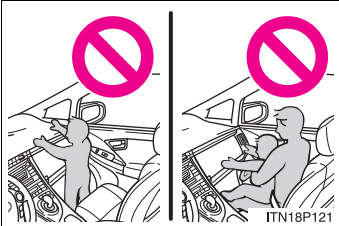
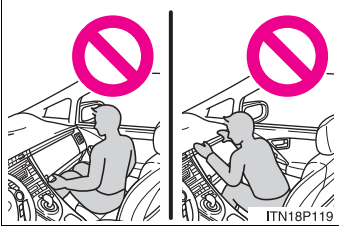
■ SRS airbag precautions

- Do not sit on the edge of the seat or lean against the dashboard.
- Do not allow a child to stand in front of the SRS front passenger airbag unit or sit on the knees of a front passenger.
- Do not drive the vehicle while the driver or passenger have items resting on their knees.
- Do not lean against the door, the roof side rail or the front, side and rear pillars.
- Do not allow anyone to kneel on the passenger seats toward the door or put their head or hands outside the vehicle.

⚠ CAUTION

■ SRS airbag precautions

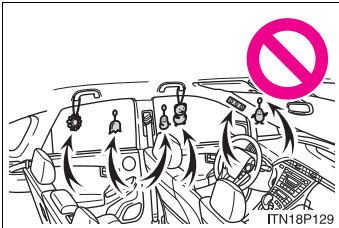
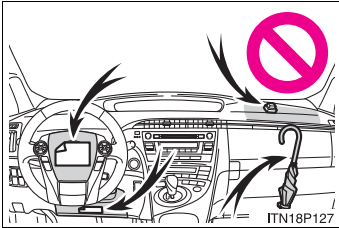

- Do not attach anything to or lean anything against areas such as the dashboard, steering wheel pad or lower portion of the instrument panel. These items can become projectiles when SRS driver and front passenger and knee airbags deploy.
- Do not attach anything to areas such as the door, windshield glass, side door glass, front, center and rear pillars, roof side rail or assist grip.
- Do not hang coat hangers or other hard objects on the coat hooks. All of these items could become projectiles and result in death or serious injury, should the SRS curtain shield airbag deploy.

- If the vinyl cover is put on the area where the SRS knee airbag will deploy, be sure to remove it.
- Do not use seat accessories which cover the parts where the SRS side airbags inflate as they may interfere with inflation of the airbags.
- Do not strike or apply significant levels of force to the area of the SRS airbag components. (→P. 115)
Doing so can cause the SRS airbags to malfunction.
- Do not touch any of the component parts immediately after the SRS airbags have deployed (inflated) as they may be hot.
- If breathing becomes difficult after the SRS airbag has deployed, open a door or window to allow fresh air in, or leave the vehicle if it is safe to do so. Wash off any residue as soon as possible to prevent skin irritation.

 **CAUTION**
■ SRS airbag precautions

- If the areas where the SRS airbags are stored, such as the steering wheel pad and front, center and rear pillar garnishes, are damaged or cracked, have them replaced by your Toyota dealer.
- Do not place anything, such as a cushion, on the front passenger's seat. Doing so will disperse the passenger's weight, which prevents the sensor from detecting the passenger's weight properly. As a result, the SRS front passenger airbag may not deploy in the event of a collision.

■ Modification and disposal of SRS airbag system components

Do not dispose of your vehicle or perform any of the following modifications without consulting your Toyota dealer.

The SRS airbag may malfunction or deploy (inflate) accidentally, causing death or serious injury.

- Installation, removal, disassembly and repair of the SRS airbags
- Repairs, modifications, removal or replacement of the steering wheel, instrument panel, dashboard, seats or seat upholstery, front, center and rear pillars or roof side rail
- Repairs or modifications of the front fender, front bumper, or side of the occupant compartment
- Installation of snow plows, winches, etc. to the front grille (bull bars, kangaroo bar etc.)
- Modifications to the vehicle's suspension system
- Installation of electronic devices such as mobile two-way radios or CD players
- Modifications to your vehicle for a person with a physical disability

Front passenger occupant classification system

Your vehicle is equipped with a front passenger occupant classification system. This system detects the conditions of the front passenger seat and activates or deactivates the devices for front passenger.

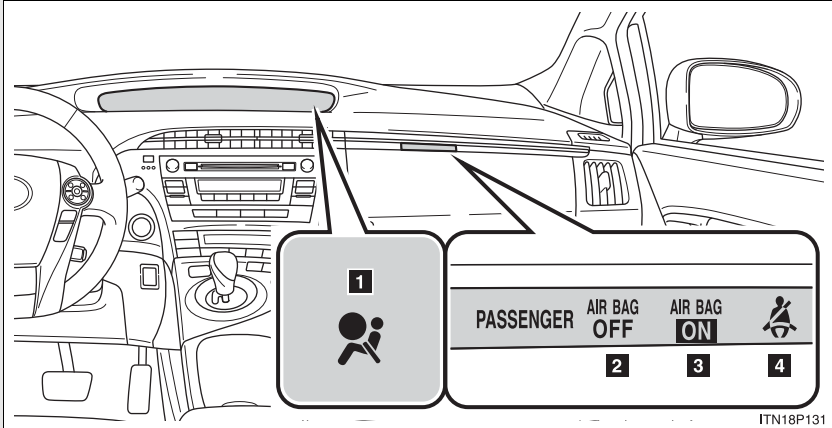

- 1** SRS warning light
- 2** “AIR BAG OFF” indicator light
- 3** “AIR BAG ON” indicator light
- 4** Front passenger’s seat belt reminder light

Condition and operation in the front passenger occupant classification system

■ Adult*1

Indicator/ warning light	“AIR BAG ON” and “AIR BAG OFF” indicator lights	“AIR BAG ON”
	SRS warning light	Off
	Front passenger’s seat belt reminder light	Flashing*2
Devices	Front passenger airbag	Activated
	Side airbag on the front passenger seat	
	Curtain shield airbag in the front passenger side	
	Front passenger’s seat belt pretensioner	

■ Child*3 or child restraint system*4

Indicator/ warning light	“AIR BAG ON” and “AIR BAG OFF” indicator lights	“AIR BAG OFF”*5
	SRS warning light	Off
	Front passenger’s seat belt reminder light	Flashing*2
Devices	Front passenger airbag	Deactivated
	Side airbag on the front passenger seat	Activated
	Curtain shield airbag in the front passenger side	
	Front passenger’s seat belt pretensioner	

■ Unoccupied

Indicator/ warning light	“AIR BAG ON” and “AIR BAG OFF” indicator lights	Not illuminated
	SRS warning light	Off
	Front passenger’s seat belt reminder light	
Devices	Front passenger airbag	Deactivated
	Side airbag on the front passenger seat	Activated
	Curtain shield airbag in the front passenger side	
	Front passenger’s seat belt pretensioner	Deactivated

■ There is a malfunction in the system

Indicator/ warning light	“AIR BAG ON” and “AIR BAG OFF” indicator lights	“AIR BAG OFF”
	SRS warning light	On
	Front passenger’s seat belt reminder light	Off
Devices	Front passenger airbag	Deactivated
	Side airbag on the front passenger seat	Activated
	Curtain shield airbag in the front passenger side	
	Front passenger’s seat belt pretensioner	

- *1: The system judges a person of adult size as an adult. When a smaller adult sits in the front passenger seat, the system may recognize him/her as a child depending on his/her physique and posture.
- *2: In the event the front passenger does not wear a seat belt.
- *3: When a large child who has outgrown a child restraint system sits in the front passenger seat, the system may recognize him/her as an adult depending on his/her physique or posture.
- *4: Never install a rear-facing child restraint system on the front passenger seat. A forward-facing child restraint system should only be installed on the front passenger seat when it is unavoidable. (→P. 132)
- *5: In case the indicator is not illuminated, consult this manual as for installing the child restraint system properly. (→P. 137)

 CAUTION

■ Front passenger occupant classification system precautions

Observe the following precautions regarding front passenger occupant classification system.

Failure to do so may cause death or serious injury.

- Wear the seat belt properly.
- Make sure the front passenger's seat belt tab has not been left inserted into the buckle before someone sits in the front passenger seat.
- Make sure the "AIR BAG OFF" indicator light is not illuminated when using the seat belt extender for the front passenger seat. If the "AIR BAG OFF" indicator light is illuminated, disconnect the extender tongue from the seat belt buckle, then reconnect the seat belt. Reconnect the seat belt extender after making sure the "AIR BAG ON" indicator light is illuminated. If you use the seat belt extender while the "AIR BAG OFF" indicator light is illuminated, the front passenger airbag on the front passenger side may not activate correctly, which could cause death or serious injury in the event of collision.
- Do not apply a heavy load to the front passenger seat or equipment (e.g. seatback pocket).
- Do not put weight on the front passenger seat by putting your hands or feet on the front passenger seatback from the rear passenger seat.
- Do not let a rear passenger lift the front passenger seat with their feet or press on the seatback with their legs.
- Do not put objects under the front passenger seat.
- Do not recline the front passenger seatback so far that it touches a rear seat. This may cause the "AIR BAG OFF" indicator light to be illuminated, which indicates that the passenger's airbags will not deploy in the event of a severe accident. If the seatback touches the rear seat, return the seatback to a position where it does not touch the rear seat. Keep the front passenger seatback as upright as possible when the vehicle is moving. Reclining the seatback excessively may lessen the effectiveness of the seat belt system.

 CAUTION**■ Front passenger occupant classification system precautions**

- If an adult sits in the front passenger seat, the “AIR BAG ON” indicator light is illuminated. If the “AIR BAG OFF” indicator light is illuminated, ask the passenger to sit up straight, well back in the seat, feet on the floor, and with the seat belt worn correctly. If the “AIR BAG OFF” indicator light still remain illuminated, either ask the passenger to move to the rear seat, or if that is not possible, move the front passenger seat fully rearward.
- When it is unavoidable to install the forward-facing child restraint system on the front passenger seat, install the child restraint system on the front passenger seat in the proper order. (→P. 137)
- Do not modify or remove the front seats.
- Do not kick the front passenger seat or subject it to severe impact. Otherwise, the SRS warning light may come on to indicate a malfunction on the detection system. In this case, contact your Toyota dealer immediately.
- Child restraint systems installed on the rear seat should not contact the front seatbacks.
- Do not use a seat accessory, such as a cushion or seat cover, that covers the seat cushion surface.
- Do not modify or replace the upholstery of the front seat.

Child restraint systems

A child restraint system for a small child or baby must itself be properly restrained on the seat with the lap portion of the lap/shoulder belt.

The laws of all 50 states of the U.S.A. and Canada now require the use of child restraint systems.

Points to remember

Studies have shown that installing a child restraint system on a rear seat is much safer than installing one to the front passenger seat.

- Choose a child restraint system that suits your vehicle and is appropriate to the age and size of the child.
- For installation details, follow the instructions provided with the child restraint system.

General installation instructions are provided in this manual.
(→P. 137)

Types of child restraints

Child restraint systems are classified into the following 3 types according to the age and size of the child.

- ▶ Rear facing — Infant seat/convertible seat

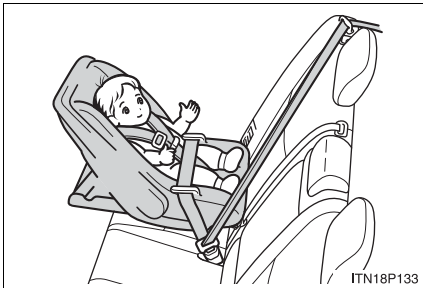

▶ Forward facing — Convertible seat

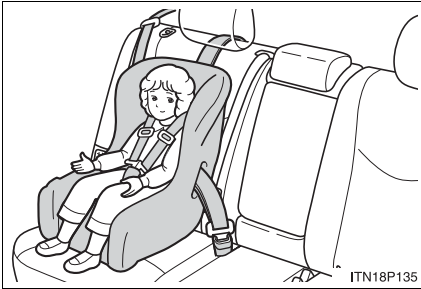

▶ Booster seat



■ **When installing the child restraint system on the front passenger seat**

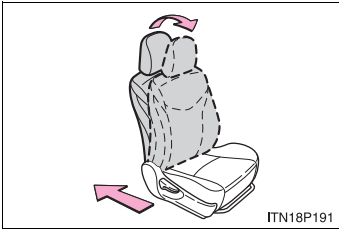

When you have to use a child restraint system on the front passenger seat, adjust the following:

- The seatback to the most upright position
- The seat cushion to the fully rearward position

■ **Selecting an appropriate child restraint system**

- Use a child restraint system appropriate for the child until the child becomes large enough to properly wear the vehicle's seat belt.
- If a child is too large for a child restraint system, sit the child on a rear seat and use the vehicle's seat belt. (→P. 85)

 CAUTION**■ Child restraint precautions**

- For effective protection in automobile accidents and sudden stops, a child must be properly restrained, using a seat belt or child restraint system depending on the age and size of the child. Holding a child in your arms is not a substitute for a child restraint system. In an accident, the child can be crushed against the windshield, or between you and the vehicle's interior.
- Toyota strongly urges the use of a proper child restraint system that conforms to the size of the child, installed on the rear seat. According to accident statistics, the child is safer when properly restrained in the rear seat than in the front seat.
- Never install a rear-facing child restraint system on the front passenger seat even if "AIR BAG OFF" indicator light is illuminated. In the event of an accident, the force of the rapid inflation of the front passenger airbag can cause death or serious injury to the child if the rear-facing child restraint system is installed on the front passenger seat.
- A forward-facing child restraint system may be installed on the front passenger seat only when it is unavoidable. A child restraint system that requires a top tether strap should not be used in the front passenger seat since there is no top tether strap anchor for the front passenger seat. Adjust the seatback as upright as possible and always move the seat as far back as possible even if "AIR BAG OFF" indicator light is illuminated, because the front passenger airbag could inflate with considerable speed and force. Failing to do so may cause death or serious injury to the child.
- Do not use the seat belt extender when installing a child restraint system on the front or rear passenger seat. If installing a child restraint system with the seat belt extender connected to the seat belt, the seat belt will not securely hold the child restraint system, which could cause death or serious injury to the child or other passengers in the event of a sudden stop, sudden swerve or accident.

 **CAUTION**

■ Child restraint precautions

- Do not allow the child to lean his/her head or any part of his/her body against the door or the area of the seat, front, center and rear pillars or roof side rail from which the side airbags or curtain shield airbags deploy even if the child is seated in the child restraint system. It is dangerous if the side airbags and curtain shield airbags inflate, and the impact could cause death or serious injury to the child.
- Make sure you have complied with all installation instructions provided by the child restraint manufacturer and that the system is properly secured. If it is not secured properly, it may cause death or serious injury to the child in the event of a sudden stop, sudden swerve or an accident.

■ Child restraint lock function belt precaution

Do not allow children to play with the child restraint lock function belt. If the belt becomes twisted around a child's neck, it will not be possible to pull the belt out leading to choking or other serious injuries that could result in death. If this occurs and the buckle cannot be unfastened, scissors should be used to cut the belt.

■ When the child restraint system is not in use

- Keep the child restraint system properly secured on the seat even if it is not in use. Do not store the restraint unsecured in the passenger compartment.
- If it is necessary to detach the child restraint system, remove it from the vehicle or store it securely in the luggage compartment. This will prevent it from injuring passengers in the event of a sudden stop, sudden swerve or an accident.

Installing child restraints

Follow the child restraint system manufacturer's instructions. Firmly secure child restraints to the rear seats using the LATCH anchors or a seat belt. Attach the top tether strap when installing a child restraint.

The lap/shoulder belt can be used if your child restraint system is not compatible with the LATCH (Lower Anchors and Tethers for Children) system.

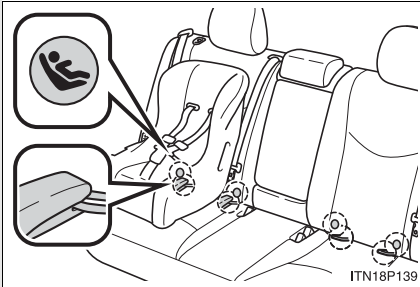

Child restraint LATCH anchors

LATCH anchors are provided for the outboard rear seats. (Buttons displaying the location of the anchors are attached to the seats.)

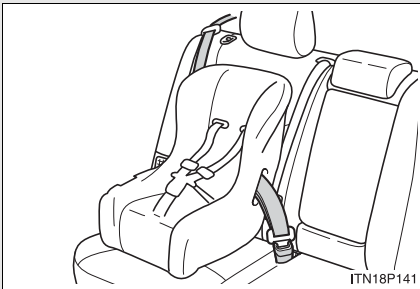

Seat belts equipped with a child restraint locking mechanism (→P. 87)

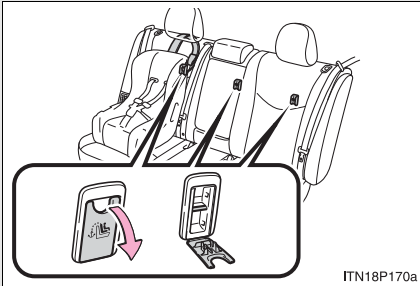

Anchor bracket (for top tether strap)

Anchor brackets are provided for all rear seats.

Installation with LATCH system

► Type A



STEP 1 Widen the gap between the seat cushion and seatback slightly.

STEP 2 Latch the hooks of the lower straps onto the LATCH anchors.

STEP 3 If the child restraint has a top tether strap, the top tether strap should be latched onto the top tether strap anchor.

For owners in Canada:
The symbol on a child restraint system indicates the presence of a lower connector system.

► Type B



STEP 1 Widen the gap between the seat cushion and seatback slightly.

STEP 2 Latch the buckles onto the LATCH anchors.

STEP 3 If the child restraint has a top tether strap, the top tether strap should be latched onto the top tether strap anchor.

For owners in Canada:
The symbol on a child restraint system indicates the presence of a lower connector system.

Installing child restraints using a seat belt (child restraint lock function belt)

■ Rear facing — Infant seat/convertible seat

STEP 1

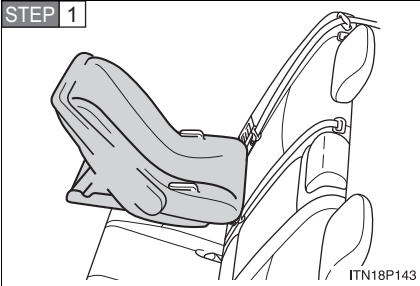

Place the child restraint system on the rear seat facing the rear of the vehicle.

STEP 2

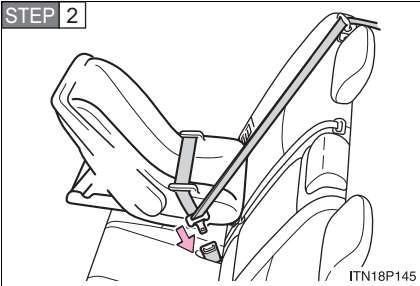

Run the seat belt through the child restraint system and insert the plate into the buckle. Make sure that the belt is not twisted.

STEP 3

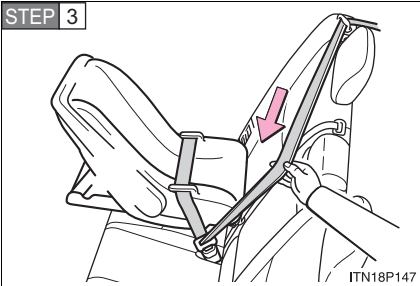

Fully extend the shoulder belt and then allow it to retract slightly in order to activate the ALR lock mode.

Lock mode allows the seat belt to retract only.

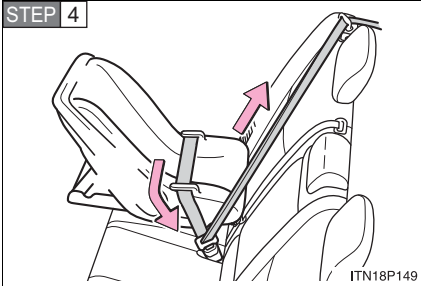

While pushing the child restraint system down into the rear seat, allow the shoulder belt to retract until the child restraint system is securely in place.

After the shoulder belt has retracted to a point where there is no slack in the belt, pull the belt to check that it cannot be extended.

■ Forward facing — Convertible seat

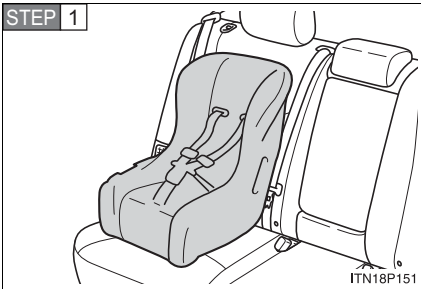

Place the child restraint system on the seat facing the front of the vehicle.

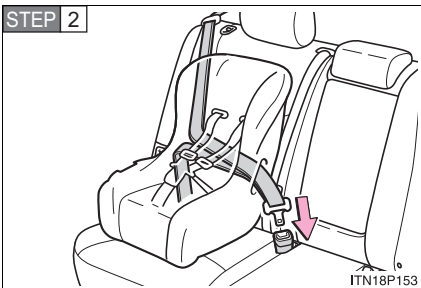

Run the seat belt through the child restraint system and insert the plate into the buckle. Make sure that the belt is not twisted.

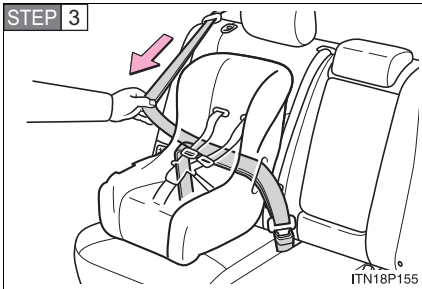

Fully extend the shoulder strap and then allow it to retract slightly into the ALR lock mode.

Lock mode allows the seat belt to retract only.

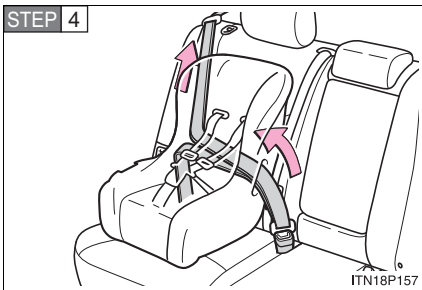

While pushing the child restraint system into the rear seat, allow the shoulder belt to retract until the child restraint system is securely in place.

After the shoulder belt has retracted to a point where there is no slack in the belt, pull the belt to check that it cannot be extended.

STEP 5 If the child restraint has a top tether strap, the top tether strap should be latched onto the top tether strap anchor. (→P. 144)

■ Booster seat

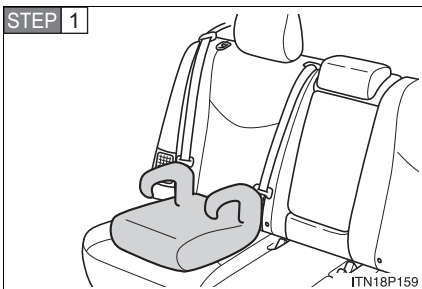

Place the child restraint system on the seat facing the front of the vehicle.

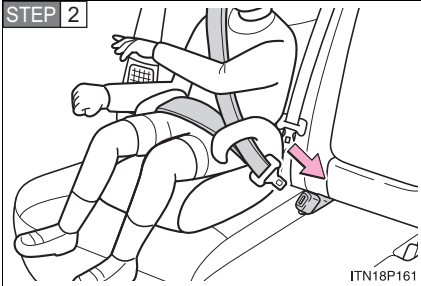

Sit the child in the child restraint system. Fit the seat belt to the child restraint system according to the manufacturer's instructions and insert the plate into the buckle. Make sure that the belt is not twisted.

Check that the shoulder belt is correctly positioned over the child's shoulder, and that the lap belt is as low as possible.
(→P. 85)

1
Before driving

Removing a child restraint system installed with a seat belt

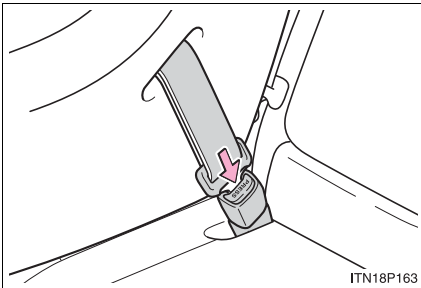

Push the buckle release button and fully retract the seat belt.

Child restraint systems with a top tether strap

STEP 1 Secure the child restraint system using a seat belt or lower anchors, and do the following.

► Outside (foldable type)

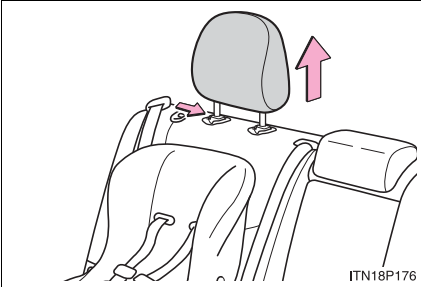

Adjust the head restraint to the upmost position.

► Outside (non-foldable type)

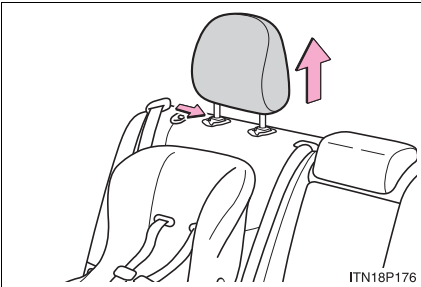

Remove the head restraint.

► Center

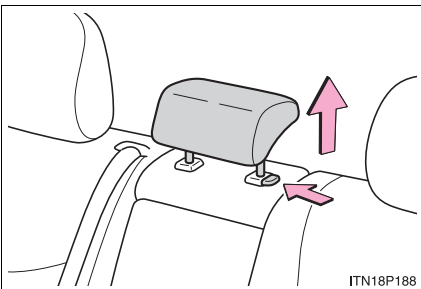

Adjust the head restraint to the upmost position.

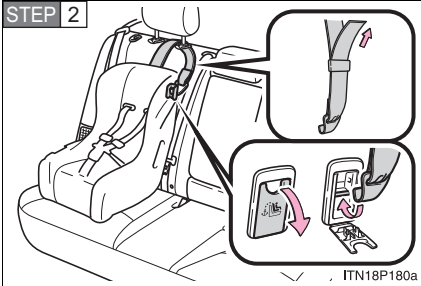

Open the anchor bracket cover, latch the hook onto the anchor bracket and tighten the top tether strap.

Make sure the top tether strap is securely latched.

STEP 3 Outside only: Do the following.

► Foldable type

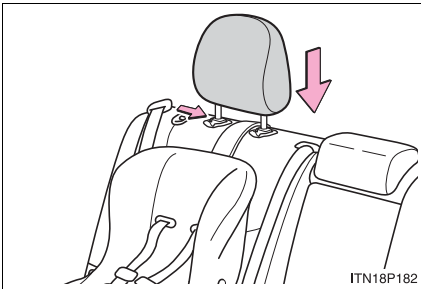

Adjust the head restraint to the downmost position.

► Non-foldable type

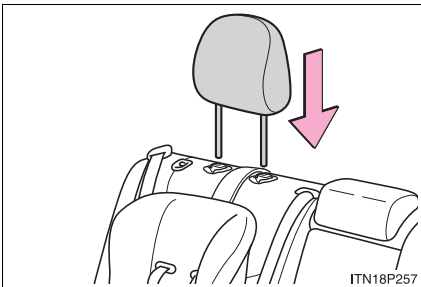

Install the head restraint.

■ Laws and regulations pertaining to anchors

The LATCH system conforms to FMVSS225 or CMVSS210.2.

Child restraint systems conforming to FMVSS213 or CMVSS213 specifications can be used.

This vehicle is designed to conform to the SAE J1819.

⚠ CAUTION

■ When installing a booster seat

Do not fully extend the shoulder belt to prevent the belt from going to ALR lock mode: (→P. 87)

ALR mode causes the belt to tighten only which could cause injury or discomfort to the child.

■ When installing a child restraint system

Follow the directions given in the child restraint system installation manual and fix the child restraint system securely in place.

If the child restraint system is not correctly fixed in place, it may result in death or serious injury to the child or other passengers in the event of sudden braking, sudden swerving or an accident.

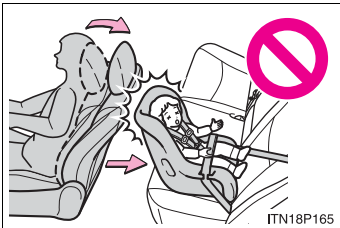

- If the driver's seat interferes with the child restraint system and prevents it from being attached correctly, attach the child restraint system to the right-hand rear seat.
- Adjust the front passenger seat so that it does not interfere with the child restraint system.

 CAUTION

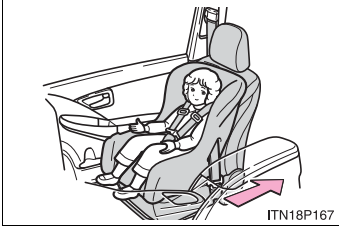
■ When installing a child restraint system

- Only put a forward-facing child restraint system on the front seat when unavoidable. When installing a forward-facing child restraint system on the front passenger seat, move the seat as far back as possible even if “AIR BAG OFF” indicator light is illuminated. Failing to do so may result in death or serious injury if the airbags deploy (inflate).

- When a booster seat is installed, always ensure that the shoulder belt is positioned across the center of the child's shoulder. The belt should be kept away from the child's neck, but not so that it could fall off the child's shoulder. Failing to do so may result in death or serious injury in the event of sudden braking, sudden swerving or an accident.
- Ensure that the belt and tab are securely locked and the seat belt is not twisted.
- Push and pull the child restraint system from side to side and forward to be sure it is secure.
- After securing a child restraint system, never adjust the seat.
- Follow all installation instructions provided by the child restraint system manufacturer.

■ Do not use a seat belt extender

If a seat belt extender is used when installing a child restraint system, the seat belt will not securely hold the child restraint system, which could cause death or serious injury to the child or other passengers in the event of sudden braking, sudden swerving or an accident.

■ To correctly attach a child restraint system to the anchors

When using the LATCH anchors, be sure that there are no foreign objects around the anchors and that the seat belt is not caught behind the child restraint system. Make sure the child restraint system is securely attached, or it may cause death or serious injury to the child or other passengers in the event of a sudden stop, sudden swerve or accident.

2-1. Driving procedures

Driving the vehicle

The following procedures should be observed to ensure safe driving.

■ Starting the hybrid system (→P. 164)

■ Driving

STEP 1 With the brake pedal depressed, shift the shift lever to “D”.
(→P. 173)

STEP 2 Release the parking brake.
(→P. 181)

STEP 3 Gradually release the brake pedal and gently depress the accelerator pedal to accelerate the vehicle.

■ Stopping

STEP 1 With the shift lever in “D”, depress the brake pedal.

STEP 2 If necessary, set the parking brake.

When the vehicle is stopped for an extended period of time, push the “P” position switch.
(→P. 176)

■ Parking the vehicle

STEP 1 With the shift lever in “D”, depress the brake pedal.

STEP 2 Set the parking brake.
(→P. 181)

STEP 3 Push the “P” position switch.
(→P. 176)

When parking on hill, if necessary, block the wheels.

STEP 4 Turn the “POWER” switch OFF and stop the hybrid system.

STEP 5 Lock the door, making sure that you have the electronic key on your person.

Starting on a steep incline

- STEP 1** Firmly set the parking brake and shift the shift lever to “D”.
 - STEP 2** Gently depress the accelerator pedal.
 - STEP 3** Release the parking brake.
-

■ Driving in the rain

- Drive carefully when it is raining, because visibility will be reduced, the windows may become fogged-up, and the road will be slippery.
- Drive carefully when it starts to rain, because the road surface will be especially slippery.
- Refrain from high speeds when driving on an expressway in the rain, because there may be a layer of water between the tires and the road surface, preventing the steering and brakes from operating properly.

■ Breaking in your new Toyota

To extend the life of the vehicle, the following precautions are recommended to observe:

- For the first 200 miles (300 km):
 - Avoid sudden stops.
- For the first 600 miles (1000 km):
 - Do not drive at extremely high speeds.
 - Avoid sudden acceleration.
 - Do not drive at a constant speed for extended periods.

■ Operating your vehicle in a foreign country

Comply with the relevant vehicle registration laws and confirm the availability of the correct fuel. (→P. 558)

■ For efficient use

- Put the shift lever into “D” when driving.
In the “N” position, the gasoline engine operates but electricity cannot be generated.
The hybrid battery (traction battery) will be discharged requiring unnecessary engine power to recharge.
- Drive your vehicle smoothly.
Avoid abrupt acceleration and deceleration. Gradual acceleration and deceleration will make more effective use of the traction motor without having to use gasoline engine power.
- Avoid repeated acceleration.
Repeated acceleration consumes hybrid battery (traction battery) power, resulting in poor acceleration. Battery power can be restored by driving with the accelerator pedal slightly released.
- Push the “P” position switch when parking.
In the “N” position, the hybrid battery (traction battery) does not recharge. Leaving the shift lever in the “N” position for an extended period of the time may discharge the hybrid battery. The vehicle cannot run if the hybrid battery is discharged.

■ Environmentally friendly driving

Environmentally friendly driving can be achieved by driving with the Hybrid System Indicator. (→P. 192)

■ Brake actuator

The brake actuator uses brake fluid pressurized by the pump to power-assist the brakes. If the brake actuator fails during driving, the brake system warning light comes on and the buzzer sounds continuously. In this case, the brakes may not work properly. If they do not work well, depress the brake pedal firmly. If the brake system warning light comes on, immediately stop your vehicle and contact your Toyota dealer.

In the following conditions, you may hear a sound in the engine compartment. This is not a malfunction.

- The driver's door is opened with the hybrid system turned off.
- The brake pedal is depressed with the hybrid system turned off.
- After the hybrid system is turned on.
- The brake pedal is depressed repeatedly with the hybrid system turned on.
- After the hybrid system is turned off.

The brake pedal may be hard to depress or the brake pedal stroke may be short before turning the hybrid system on. This is not a malfunction.

■ When braking the vehicle

When applying brakes, you may hear a sound coming from the motor generator.

However, this does not indicate any trouble.

 CAUTION

■ **When starting the vehicle**

Always keep your foot on the brake pedal while stopped with the hybrid system operating. This prevents the vehicle from creeping.

■ **When driving the vehicle**

- Do not drive if you are unfamiliar with the location of the brake and accelerator pedals to avoid depressing the wrong pedal.
 - Accidentally depressing the accelerator pedal instead of the brake pedal will result in sudden acceleration that may lead to an accident that could result in death or serious injury.
 - When backing up, you may twist your body around, leading to a difficulty in operating the pedals. Make sure to operate the pedals properly.
 - Make sure to keep a correct driving posture even when moving the vehicle only slightly, allowing you to depress the brake and accelerator pedals properly.
 - Depress the brake pedal using your right foot. Depressing the brake pedal using your left foot may delay response in an emergency, resulting in an accident.
- The driver should pay attention to pedestrians when the vehicle is powered only by the electric motor (traction motor). Because there is no hybrid system sounds, the pedestrians may misjudge the vehicle's movement.
- Do not drive the vehicle over or stop the vehicle near flammable materials. The exhaust system and exhaust gases can be extremely hot. this may cause a fire if there is any flammable material nearby.

 CAUTION

- Do not let the vehicle roll backwards while the shift lever is in a driving position, or roll forward while the shift lever is in "R".
Doing so may cause the hybrid system not to operate or lead to poor brake and steering performance, resulting in an accident or damage to the vehicle.
- If the smell of exhaust is noticed inside the vehicle, open the windows and check that the back door is closed. Large amounts of exhaust in the vehicle can cause driver drowsiness and an accident, resulting in death or a serious health hazard. Have the vehicle inspected by your Toyota dealer immediately.
- Do not shift the shift position to "P" while the vehicle is moving.
Doing so can damage the transmission and may result in a loss of vehicle control.
- Do not shift the shift position to "R" while the vehicle is moving forward.
Doing so can damage the transmission and may result in a loss of vehicle control.
- Do not shift the shift position to "D" while the vehicle is moving backward.
Doing so can damage the transmission and may result in a loss of vehicle control.
- Moving the shift position to "N" while the vehicle is moving will disengage the hybrid system. Engine braking is not available with the hybrid system disengaged.
- During normal driving, do not turn off the hybrid system. Turning the hybrid system off while driving will not cause loss of steering or braking control, but the power assist to these systems will be lost. This will make it more difficult to steer and brake, so you should pull over and stop the vehicle as soon as it is safe to do so.
However, in the event of an emergency, such as if it becomes impossible to stop the vehicle in the normal way: →P. 496
- Use engine braking ("B") to maintain a safe speed when driving down a steep hill.
Using the brakes continuously may cause the brakes to overheat and lose effectiveness. (→P. 173)

 **CAUTION**

- When stopped on an inclined surface, use the brake pedal and parking brake to prevent the vehicle from rolling backward or forward and causing an accident.
- Do not adjust the position of the steering wheel, the seat, or the inside or outside rear view mirrors while driving.
Doing so may result in a loss of vehicle control that can cause accidents that may result in death or serious injury.
- Always check that all passengers' arms, heads or other parts of their bodies are not outside the vehicle, as this may result in death or serious injury.
- Do not drive in excess of the speed limit. Even if the legal speed limit permits it, do not drive over 85 mph (140 km/h) unless your vehicle has high-speed capability tires. Driving over 85 mph (140 km/h) may result in tire failure, loss of control and possible injury. Be sure to consult a tire dealer to determine whether the tires on your vehicle are high-speed capability tires or not before driving at such speeds.

■ **When driving on slippery road surfaces**

- Sudden braking, acceleration and steering may cause tire slippage and reduce your ability to control the vehicle, resulting in an accident.
- Sudden changes in engine speed, such as engine braking caused by up-shifting or down-shifting, may cause the vehicle to skid, resulting in an accident.
- After driving through a puddle, lightly depress the brake pedal to make sure that the brakes are functioning properly. Wet brake pads may prevent the brakes from functioning properly. If the brakes on only one side are wet and not functioning properly, steering control may be affected, resulting in an accident.

■ **When shifting the shift lever**

Be careful not to shift the shift lever with the accelerator pedal depressed. This may lead to unexpected rapid acceleration of the vehicle that may cause an accident and result in death or serious injury.

 CAUTION**■ When the vehicle is stopped**

- Do not race the hybrid system.

If the vehicle is in any shift position other than “P” or “N” the vehicle may accelerate suddenly and unexpectedly, and may cause an accident.

- Do not leave the vehicle with the hybrid system on for a long time.

If such a situation cannot be avoided, park the vehicle in an open space and check that exhaust fumes do not enter the vehicle interior.

- Always keep a foot on the brake pedal while the hybrid system is operating to prevent an accident caused by the vehicle moving.

■ When the vehicle is parked

- Do not leave glasses, cigarette lighters, spray cans, or soft drink cans in the vehicle when it is in the sun.

Doing so may result in the following:

- Gas may leak from a cigarette lighter or spray can, and may lead to a fire.
- The temperature inside the vehicle may cause the plastic lenses and plastic material of eye glasses to deform or crack.
- Soft drink cans may fracture, causing the contents to spray over the interior of the vehicle, and may also cause a short circuit in the vehicle’s electrical components.

- Always apply the parking brake, push the “P” position switch, stop the hybrid system and lock the vehicle.

Do not leave the vehicle unattended while the hybrid system is operating.

 **CAUTION**

- Do not touch the exhaust pipe while the hybrid system is operating or immediately after turning the hybrid system off. Doing so may cause burns.
- Do not leave the hybrid system operating in an area with snow build-up, or where it is snowing. If snowbanks build up around the vehicle while the hybrid system is operating, exhaust gases may collect and enter the vehicle. This may lead to death or a serious health hazard.

Exhaust gases

Exhaust gases include harmful carbon monoxide (CO) that is colorless and odorless. Inhaling exhaust gases may lead to death or a serious health hazard.

- If the vehicle is in a poorly ventilated area, stop the hybrid system. In a closed area, such as a garage, exhaust gases may collect and enter the vehicle. This may lead to death or a serious health hazard.
- The exhaust should be checked occasionally. If there is a hole or crack caused by corrosion, damage to a joint or abnormal exhaust noise, be sure to have the vehicle inspected and repaired by your Toyota dealer. Failure to do so may allow exhaust gases to enter the vehicle, resulting in death or a serious health hazard.

 **CAUTION****■ When taking a nap in the vehicle**

Always turn the hybrid system off. Otherwise, you may accidentally move the shift lever or depress the accelerator pedal, which could cause an accident or fire due to hybrid system overheating. Additionally, if the vehicle is parked in a poorly ventilated area, exhaust gases may collect and enter the vehicle, leading to death or a serious health hazard.

■ When braking the vehicle

- When the brakes are wet, drive more cautiously.

Braking distance increases when the brakes are wet, and may cause one side of the vehicle to brake differently than the other side. Also the parking brake may not securely hold the vehicle.

- If the power brake assist function does not operate, do not follow other vehicles closely and avoid downhill or sharp turns that require braking. In this case, braking is still possible, but it will require more force on the pedal than usual. Braking distance may also increase.

- The brake system consists of 3 individual hydraulic systems: if one of the systems fails, the other will still operate. In this case, the brake pedal should be depressed more firmly than usual and braking distance becomes longer.

Do not drive your vehicle with only a single brake system. Have your brakes fixed immediately.

 NOTICE

■ **While driving the vehicle**

Do not use the accelerator pedal or depress accelerator and brake pedals together to hold the vehicle on a hill.

■ **When parking the vehicle**

Always push the “P” position switch. Failure to do so may cause the vehicle to move or the vehicle may accelerate suddenly if the accelerator pedal is accidentally depressed.

■ **Avoiding damage to vehicle parts**

● Do not turn the steering wheel fully in either direction and hold it there for a long time.

Doing so may damage the power steering motor.

● When driving over bumps in the road, drive as slowly as possible to avoid damaging the wheels, underside of the vehicle, etc.

■ **If you hear a squealing or scraping noise (brake pad wear limit indicators)**

Have your Toyota dealer check and replace the brake pads as soon as possible.

The rotor damage can result if the pads are not replaced when needed.

It is dangerous to drive the vehicle when the wear limits of the brake pads and/or that of the brake discs are exceeded.

 NOTICE**■ If you get a flat tire while driving**

A flat or damaged tire may cause the following situations. Hold the steering wheel firmly and gradually press the brake pedal to slow down the vehicle.

- It may be difficult to control your vehicle.
- The vehicle will make abnormal sounds.
- The vehicle will behave abnormally.

Replace a flat tire with a new one. (→P. 527)

■ When encountering flooded roads

Do not drive on a road that has flooded after heavy rain etc. Doing so may cause the following serious damage to the vehicle.

- Engine stalling
- Short in electrical components
- Engine damage caused by water immersion

In the event that you drive on a flooded road and the vehicle is flooded, be sure to have your Toyota dealer check the following.

- Brake function
- Changes in quantity and quality of oil and fluid used for the engine, hybrid system, transmission, etc.
- Lubricant condition for the bearings and suspension joints (where possible) and the function of all joints, bearings, etc.

2-1. Driving procedures

Power (ignition) switch

Performing the following operations when carrying the electronic key on your person starts the hybrid system or changes “POWER” switch modes.

■ Starting the hybrid system

STEP 1 Check that the parking brake is set.

STEP 2 Sit in the driver’s seat and firmly depress the brake pedal.

The “POWER” switch indicator turns green.

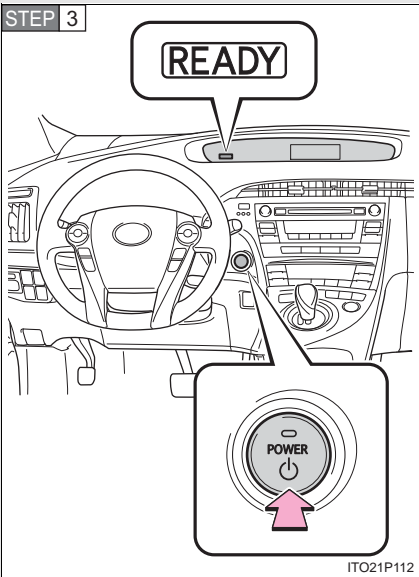

Press the “POWER” switch.

The hybrid system can be started from any mode.

After a few seconds, the “READY” indicator comes on with a beep sound.

The vehicle can move when the “READY” indicator is on, even if the engine is stopped.

■ Stopping the hybrid system

STEP 1 Stop the vehicle.

STEP 2 Press the “POWER” switch.

STEP 3 Check that the shift position indicator on the instrument cluster is set in “P”.

STEP 4 Set the parking brake. (→P. 181)

STEP 5 Release the brake pedal and check that the indicator on the “POWER” switch is off.

If you stop the hybrid system without setting the shift position to “P”, the shift position will be shifted to “P” automatically. You can also shift the shift position to “P” by pressing the “P” position switch.

■ Changing “POWER” switch mode

Modes can be changed by pressing the “POWER” switch with the brake pedal released. (The mode changes each time the switch is pressed.)

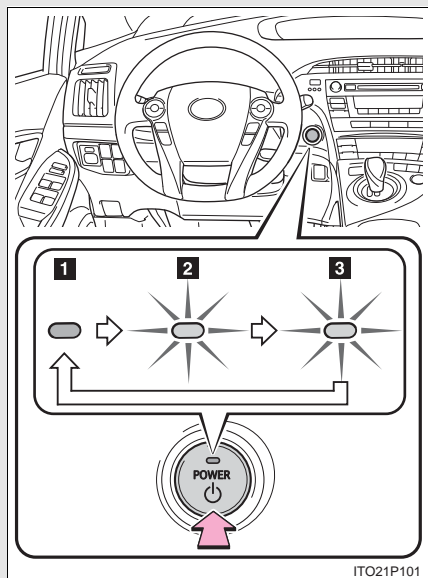

1 OFF

Emergency flashers can be used.

2 ACCESSORY mode

Some electrical components such as the audio system can be used.

The “POWER” switch indicator turns amber.

3 ON mode

All electrical components can be used.

The “POWER” switch indicator turns amber.

ITO21P101

■ If the hybrid system does not start

The immobilizer system may not have been deactivated.
(→P. 108)

■ If the “READY” indicator does not come on

If the “READY” indicator does not come on when you press the “POWER” switch with the shift position in “P” and the brake pedal pressed, contact your Toyota dealer immediately.

■ When the “POWER” switch indicator flashes in amber

The system may be malfunctioning. Have the vehicle inspected by your Toyota dealer immediately.

■ Auto power OFF function

If the vehicle is left in ACCESSORY or ON mode (hybrid system is not operating) for more than an hour with the shift position in “P”, the “POWER” switch will automatically turn OFF. However, this function cannot entirely prevent battery discharge. Do not leave the vehicle with the “POWER” switch in ACCESSORY or ON mode for long periods of time when the hybrid system is not operating.

■ Operation of the “POWER” switch

- When operating the “POWER” switch, one short, firm press is enough. If the switch is pressed improperly, the hybrid system may not start or the “POWER” switch mode may not change. It is not necessary to press and hold the switch.
- Even if the “POWER” switch is turned to off and then quickly re-pressed, the “POWER” switch mode may not change. After turning the “POWER” switch to off, wait for a short time before operating again.

■ When leaving the vehicle

If the indicator on the “POWER” switch is not off, the “POWER” switch is still not in OFF mode.

Turn the “POWER” switch to OFF before you leave the vehicle.

■ Auto “P” position function

● If the “POWER” switch is pressed while the hybrid system is operating and the vehicle is at a complete stop, the shift position will be automatically switched to “P” at the same time as the “POWER” switch is turned to OFF.

When turning the “POWER” switch to OFF while the shift position is not set to “P”, operate the “POWER” switch while pushing down fully on the brake pedal. Then, release the brake pedal after confirming that the shift position indicator on the instrument cluster is set in “P”.

● If the auto “P” position function is malfunctioning, it may not be possible to turn the “POWER” switch to OFF. In this event, the “POWER” switch can be turned to OFF after applying the parking brake.

Have the vehicle inspected by your Toyota dealer immediately.

■ When the ambient temperature is low, such as during winter driving conditions

It may take time until the “READY” indicator comes on.

■ Sounds and vibrations specific to a hybrid vehicle

→P. 31

■ When the hybrid system is malfunctioning

→P. 497

■ Electronic key battery depletion

→P. 64

■ When the electronic key battery is discharged

→P. 460

■ Conditions affecting operation

→P. 65

■ Note for the entry function

→P. 50, 59

■ Leak detection pump

Several hours after the engine is turned off, you may hear a sound coming from underneath the luggage compartment for several minutes. This is normal operation and does not indicate a malfunction.

CAUTION

■ When starting the hybrid system

Always start the hybrid system while sitting in the driver's seat. Do not press the accelerator pedal while starting the hybrid system under any circumstances.

Doing so may cause an accident resulting in death or serious injury.

■ Stopping the hybrid system in an emergency

If you want to stop the hybrid system in an emergency while driving the vehicle, push and hold the "POWER" switch for more than 3 seconds.

However, do not touch the "POWER" switch while driving except in an emergency. Turning the hybrid system off while driving will not cause loss of steering or braking control, but the power assist to these systems will be lost.

This will make it more difficult to steer and brake, so you should pull over and stop the vehicle as soon as it is safe to do so.

NOTICE

■ To prevent 12 volt battery discharge

Do not leave the "POWER" switch in ACCESSORY or ON mode for long periods if the hybrid system is not operating.

■ When starting the hybrid system

If the hybrid system becomes difficult to start or stalls frequently, have the 12 volt battery and electronic key battery checked immediately.

2-1. Driving procedures EV-Drive Mode*

In EV-Drive Mode the electric motor (traction motor), powered by the hybrid battery (traction battery), is used to drive the vehicle.

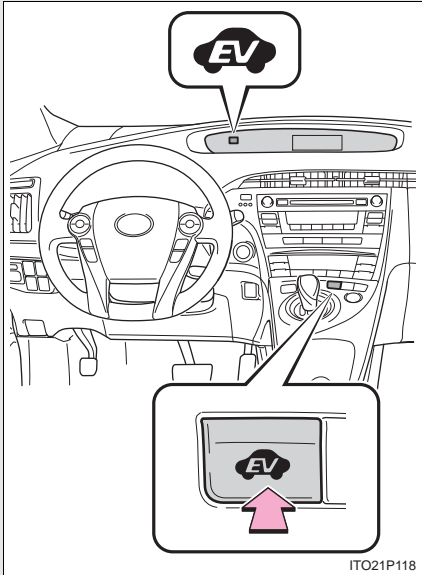

On/off

When EV-Drive Mode is turned on, the EV-Drive Mode indicator will come on. Pressing the switch when in EV-Drive Mode will return to normal driving (using the gasoline engine and electric motor [traction motor]).

*: If equipped

■ Situations in which EV-Drive Mode cannot be turned on

The followings are examples of situations under which the EV-Drive Mode may not be turned on. If it cannot be turned on, a buzzer will sound and a message will be shown on the multi-information display.

- The temperature of the hybrid system is high.
The vehicle has been left in the sun, driven on a hill, driven at high speeds, etc.
- The temperature of the hybrid system is low.
The vehicle has been left in temperatures lower than about 32 °F (0 °C) for a long period of time etc.
- The gasoline engine is warming up.
- The hybrid battery (traction battery) is low.
The remaining battery level indicated in the “Energy Monitor” display is low. (→P. 188)
- Vehicle speed is high.
- The accelerator pedal is depressed firmly or the vehicle is on a hill etc.
- The windshield defogger is in use.

■ Automatic cancelation of EV-Drive Mode

When driving in EV-Drive Mode, the gasoline engine may automatically restart in the following situations. When EV-Drive Mode is canceled, a buzzer will sound and the EV-Drive Mode indicator will flash and go off.

- The hybrid battery (traction battery) becomes low.
The remaining battery level indicated in the “Energy Monitor” display is low. (→P. 188)
- Vehicle speed becomes high.
- The accelerator pedal is depressed firmly or the vehicle is on a hill etc.

■ **Possible driving distance when driving in EV-Drive Mode**

Possible driving distance when driving in EV-Drive Mode is up to about 1/2 mile (1 km) if driven at a speed of about 25 mph (40 km/h) or less. (Possible driving distance depends on the hybrid battery [traction battery] level and driving conditions.)

■ **Fuel economy**

Your Toyota is designed to achieve the best possible fuel economy during normal driving (using the gasoline engine and electric motor [traction motor]). Driving in EV-Drive Mode more than necessary may lower fuel economy.

 **CAUTION**

■ **While driving**

When driving in EV-Drive Mode, pay special attention to the area around the vehicle. Because there is no engine noise, pedestrians, people riding bicycles or other people and vehicles in the area may not be aware of the vehicle starting off or approaching them, so take extra care while driving.

Select a shift position appropriate for the driving conditions.

■ Shifting the shift lever

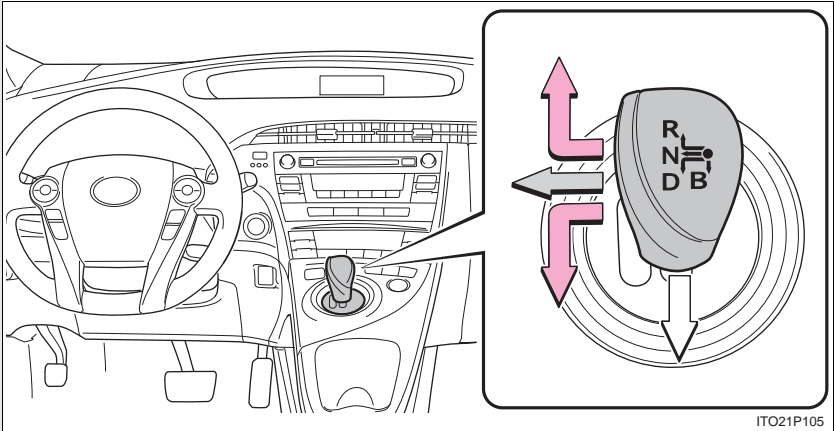

- ↶ You can operate the shift lever only in “D”.
- ↶ Keep the shift lever in “N” for a while after you shift it to that position.
- The shift lever always returns to this original position after shifting operation.

■ **Shift position uses**

Shift position	Function
P	Parking the vehicle or starting the hybrid system
R	Reversing
N	Neutral
D	Normal driving
B	Engine braking position *

*: Shown only while in “D” position.

■ **Selecting a driving mode**

The following patterns can be selected to suit current driving and operating conditions.

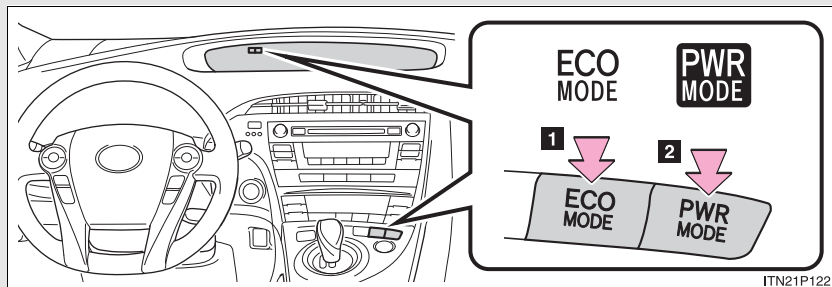

ITN21P122

1 Eco Driving Mode

Use Eco Driving Mode to help achieve low fuel consumption during trips that involve frequent accelerating and braking.

Press the “ECO MODE” switch once more to cancel the Eco Driving Mode.

Eco Driving Mode will not be canceled until the “ECO MODE” switch is pressed, even if the “POWER” switch is turned to OFF.

Press the “PWR MODE” switch to change the driving mode to power mode.

2 Power mode

Use when high levels of response and feeling are desirable, such as when driving in mountainous regions or when overtaking.

Press the “PWR MODE” switch once more to cancel the power mode.

Turning the “POWER” switch to OFF once will cancel power mode.

Press the “ECO MODE” switch to change the driving mode to Eco Driving Mode.

Changing shift ranges to “P” position

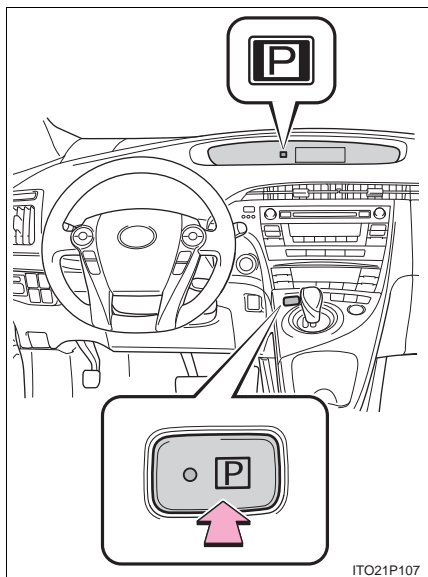

Push the “P” position switch with the brake pedal pressed down.

The “P” position icon is displayed on the instrument cluster, and the indicator on the “P” position switch comes on.

You can only shift to other positions from “P” when the brake pedal is depressed.

When parking, check that the “P” position icon is displayed on the instrument cluster, and release the brake pedal gently after applying the parking brake.

■ Using engine brake

To use the engine braking, shift the shift lever to “B” position.

- During high speed driving, you may feel that deceleration by engine braking is less than that of a typical vehicle.
- Do not continue normal driving with the transmission in “B” for a long time.
This may cause decreased fuel economy. To prevent this, use “D” for normal driving.

■ Reverse warning buzzer

When shifting into “R”, a buzzer will sound to inform the driver that the shift lever is in “R”.

■ When in heavy traffic

If the shift lever is in “N”, the hybrid battery (traction battery) will not be charged. To help prevent the battery from discharging, avoid putting the shift lever in “N” for an extended period of time.

■ Eco Driving Mode

When the accelerator pedal is depressed in Eco Driving Mode, it may take more time to accelerate than usual. This is normal operation.

■ If the system malfunctions

The following situations indicate a problem with the system. Immediately stop the vehicle in a safe place and contact your Toyota dealer.

- The indicator on the “P” position switch flashes. However, this does not indicate a malfunction unless a warning message appears in the multi-information display.
- All frames of the shift position indicators in the instrument cluster flash.
- The parking system error message appears on the multi-information display.
- The instrument cluster does not come on when the “POWER” switch is in ON mode.

■ Alarms

The following table describes circumstances and correction procedures when only alarms sound.

Alarm	Situation	Correction procedure
Interior alarm sounds once	The driver attempts to shift out of the "P" position without pressing the brake pedal.	The transmission will not move out of the "P" position. Press the brake pedal before attempting to shift again.
	The "P" position switch is pressed while the vehicle is moving.	The transmission will automatically be set to the "N" position. Select the appropriate position.
	The driver attempts to shift to the "R" position while the vehicle is in forward motion.	
	The driver attempts to shift to the "D" position while the vehicle is in rearward motion.	
	The driver attempts to select the "B" position while in a shift position other than "D" and "P".	
	The driver attempts to select the "B" position while in the "P" position.	The transmission will not move out of the "P" position.

Alarm	Situation	Correction procedure
Interior alarm beep sounds and warning message*	If the driver's door is opened while the transmission is in "N", "D" or "B".	Push the "P" position switch.

*: Follow the warning message displayed.

CAUTION

■ To avoid an accident

Do not hang objects on or attach objects to the shift lever.
Doing so may cause the shift lever to move and the shift position to change.

2-1. Driving procedures

Turn signal lever

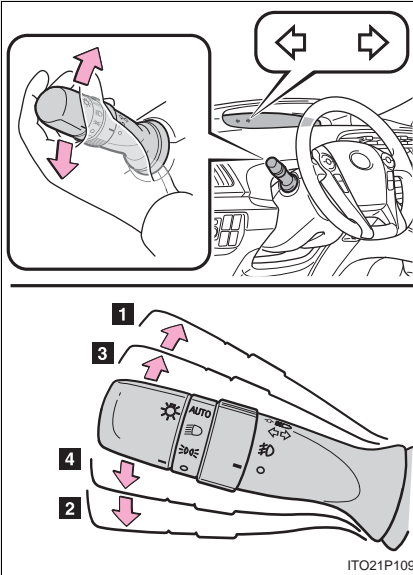

- 1 Right turn
- 2 Left turn
- 3 Move and hold the lever partway to signal a lane change.

The right hand signal will flash until you release the lever.

- 4 Move and hold the lever partway to signal a lane change.

The left hand signal will flash until you release the lever.

■ Turn signals can be operated when

The "POWER" switch is in ON mode.

■ If the indicators flash faster than usual

Check that a light bulb in the front or rear turn signal lights has not burned out.

2-1. Driving procedures

Parking brake

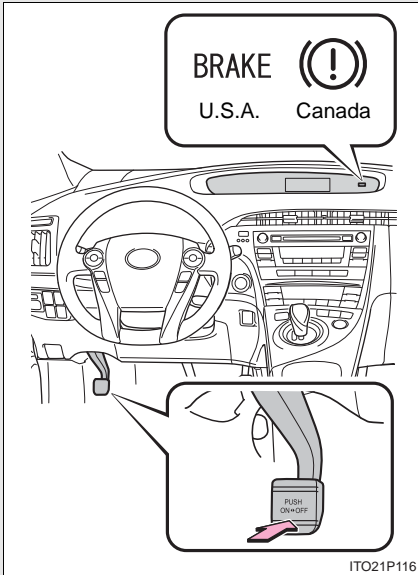

Sets the parking brake*
(Depressing the pedal again releases the parking brake.)

*: Fully depress the parking brake pedal with your left foot while depressing the brake pedal with your right foot.

2

When driving

■ Usage in winter time

See "Winter driving tips" for parking brake usage in winter time. (→P. 261)

⚠ NOTICE

■ Before driving

Fully release the parking brake.

Driving the vehicle with the parking brake set will lead to brake components overheating, which may affect braking performance and increase brake wear.

■ When parking the vehicle

Before you leave the vehicle, set the parking brake, push the "P" position switch and make sure that the vehicle does not move.

Horn

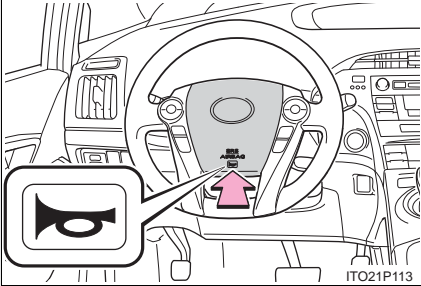

To sound the horn, press on or close to the  mark.

■ After adjusting the steering wheel

Make sure that the steering wheel is securely locked.

The horn may not sound if the steering wheel is not securely locked.

(→P. 92)

2-2. Instrument cluster Gauges and meters

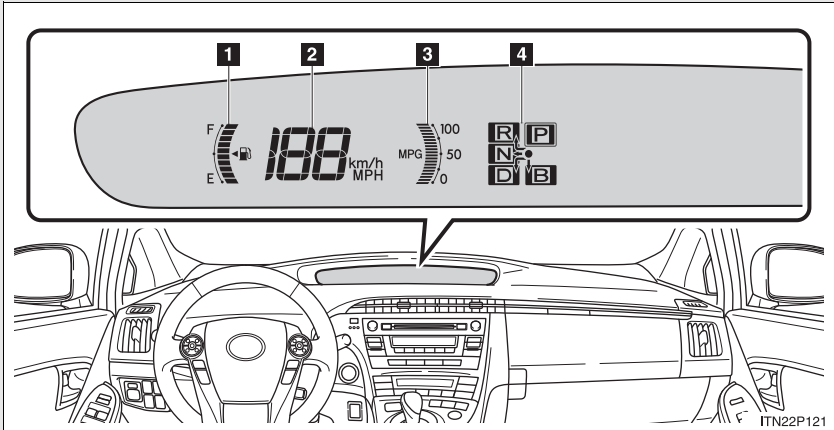

The following gauges and meters illuminate when the “POWER” switch is in ON mode.

- 1 Fuel gauge**
Displays the quantity of fuel remaining in the tank.
- 2 Speedometer**
Displays the vehicle speed.
- 3 Instantaneous fuel consumption**
Displays the current rate of fuel consumption.
- 4 Shift position indicators**
Displays the shift position.

Touch tracer display (if equipped)

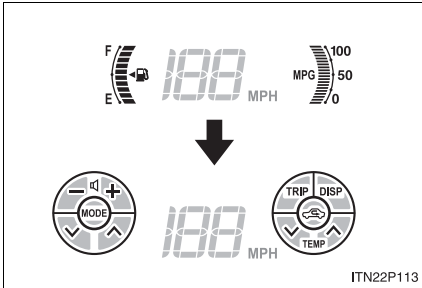

When the audio control switches, climate control switches, “DISP” switch or “TRIP” switch of the steering wheel are touched, the touch tracer display will appear in front of the gauges, with the touched switch highlighted to allow the driver to identify the switch that is being operated.

The switch can then be operated by further presses.

MPH or km/h button

The speed units can be selected MPH or km/h.

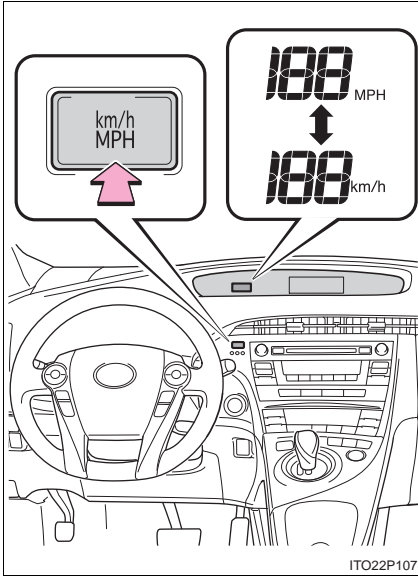

Press the button to switch the display between MPH and km/h.

Instrument panel light control

The brightness of the instrument panel lights can be adjusted.

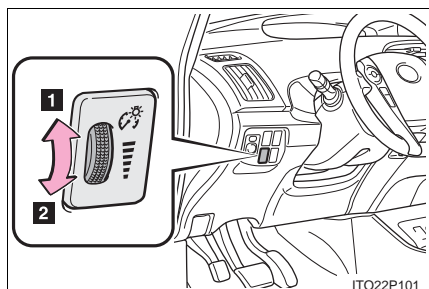

1 Brighter

2 Darker

NOTICE

To prevent damage to the hybrid system and its components

The hybrid system may be overheating if the high coolant temperature warning light comes on. In this case, immediately stop the vehicle in a safe place, and check the hybrid system after it has cooled completely. (→P. 548)

2-2. Instrument cluster

Indicators and warning lights

The indicator and warning lights on the instrument cluster and instrument panel inform the driver of the status of the vehicle's various systems.

► Instrument cluster

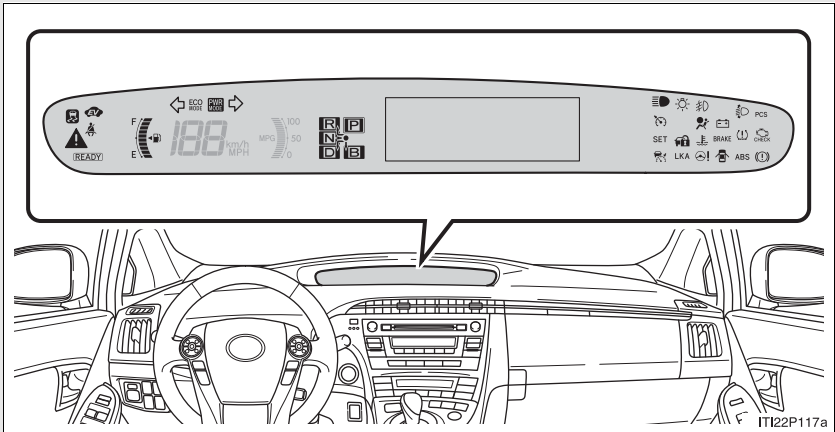

► Instrument panel

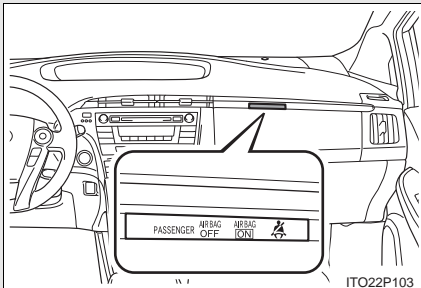

■ Indicators

The indicators inform the driver of the operating state of the vehicle's various systems.



Turn signal indicator
(→P. 178)



Headlight high beam indicator (→P. 206)



(U.S.A.)

Headlight indicator
(→P. 206)



(Canada)

Tail light indicator
(→P. 206)



(if equipped)

Fog light indicator
(→P. 209)



Security indicator
(→P. 108)



Cruise main indicator
(→P. 214)



Cruise "SET" indicator
(→P. 214)



(if equipped)

Cruise main indicator
(vehicle-to-vehicle distance mode)
(→P. 218)



(if equipped)

"LKA" indicator
(→P. 235)



*

Slip indicator (→P. 246)



*

"AIR BAG ON/OFF"
indicator (→P. 126)



Shift position indicators
(→P. 171)



Power mode indicator
(→P. 172)



Eco Driving Mode indicator
(→P. 172)



EV-Drive Mode indicator
(→P. 168)



"READY" indicator
(→P. 162)

■ Warning lights

Warning lights inform the driver of malfunctions in the indicated vehicle's systems. (→P. 496)

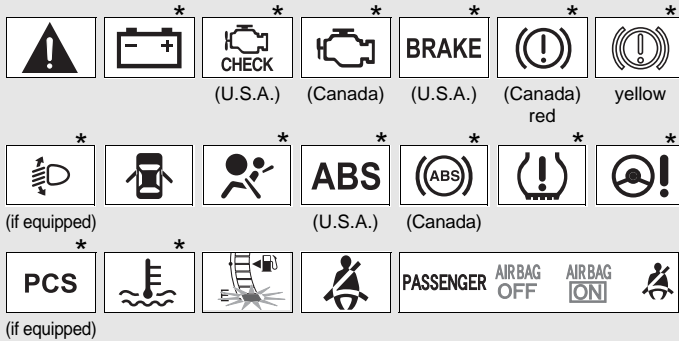

*: These lights turn on when the "POWER" switch is turned to ON mode to indicate that a system check is being performed. They will turn off after the hybrid system is started, or after a few seconds. There may be a malfunction in a system if the lights do not come on, or if the lights do not turn off. Have the vehicle inspected by your Toyota dealer.

CAUTION

■ If a safety system warning light does not come on

Should a safety system light such as the ABS and the SRS airbag warning lights not come on when you start the hybrid system, this could mean that these systems are not available to help protect you in an accident, which could result in death or serious injury. Have the vehicle inspected by your Toyota dealer immediately if this occurs.

2-2. Instrument cluster Multi-information display

The multi-information display presents the driver with a variety of driving-related data, including the clock.

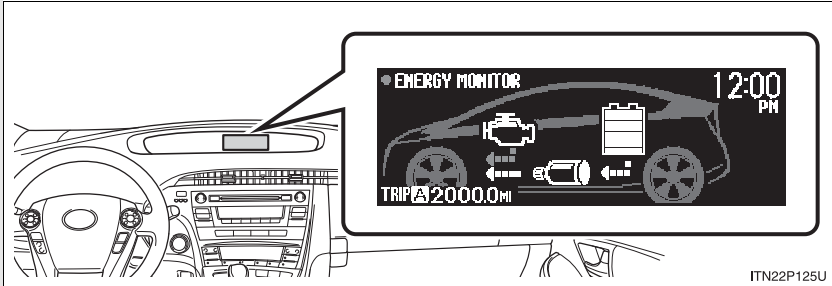

- Clock (→P. 201)
Indicates and sets the time.
- Energy monitor (→P. 190)
Displays the status of the hybrid system.
- Hybrid System Indicator (→P. 192)
Provides assistance for environmentally friendly (fuel efficient) driving.
- Trip information
Displays driving range, fuel consumption and other cruising-related information.
- Odometer/trip meter/distance to empty (→P. 198)

- Dynamic radar cruise control display (if equipped) (→P. 218)
Automatically displayed when using dynamic radar cruise control.
- Lane-keeping assist display (if equipped) (→P. 235)
Automatically displayed when using lane-keeping assist.
- Warning messages (→P. 508)
Automatically displayed when a malfunction occurs in one of the vehicle's systems.

Switching the display

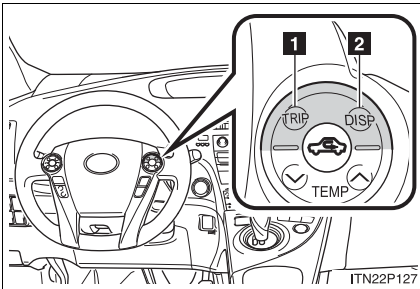

- 1 "TRIP" button
- 2 "DISP" button

On vehicles with touch tracer display, the steering switches operation status is displayed on the instrument cluster for confirmation purposes. (→P. 182)

Energy monitor

The energy monitor displays the operating condition of the hybrid system, showing such information as the gasoline engine operating status, and the usage and regeneration status of electrical energy.

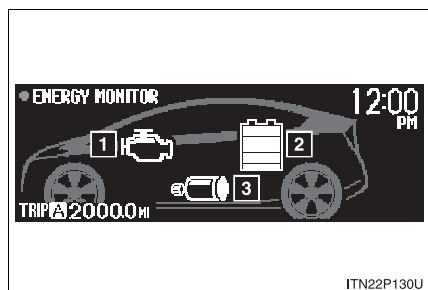

- 1 Gasoline engine
- 2 Hybrid battery (traction battery)
- 3 Electric motor (traction motor)

The energy flow is indicated using arrows which vary in color and direction depending on the driving conditions (when accelerating/decelerating, etc.).

	Multi-information display*
When the vehicle is powered by the electric motor (traction motor)	
When the vehicle is powered by both the gasoline engine and the electric motor (traction motor)	

	Multi-information display*
When the vehicle is powered by the gasoline engine	
When the vehicle is charging the hybrid battery (traction battery)	
When there is no energy flow	

*: The images are examples only, and may vary slightly from actual conditions.

■ Hybrid battery (traction battery) status

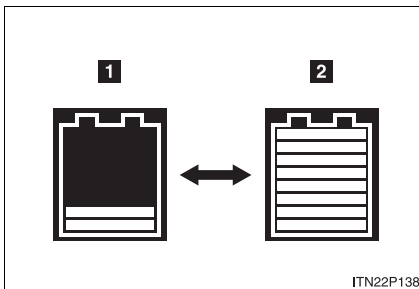

The amount of charge remaining in the hybrid battery (traction battery) is shown by 8 bars.

- 1 Low
- 2 Full

Hybrid System Indicator

The Hybrid System Indicator displays the hybrid system operating condition and provides environmentally friendly (fuel efficient) driving assistance in accordance with the driving conditions and the operation of the accelerator pedal.

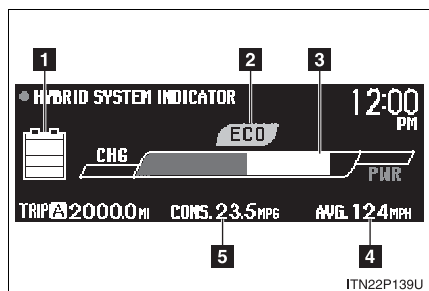

1 Hybrid battery (traction battery) status

2 Eco Driving Indicator Light

Lights up when the vehicle is being driven in an environmentally friendly manner.

3 Hybrid System Indicator

4 Average speed

Displays the average vehicle speed since the function was last reset.

The function can be reset by pressing and holding the “TRIP” button when the average vehicle speed is displayed.

5 Average fuel consumption

Displays the average fuel consumption since the function was last reset.

The function can be reset by pressing and holding the “TRIP” button when the average fuel consumption is displayed.

■ Hybrid System Indicator

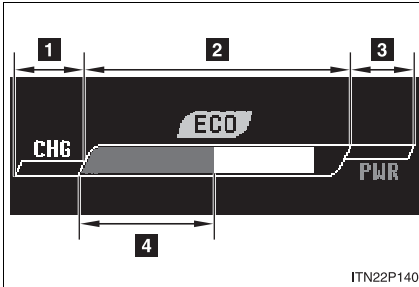



- 1 Charge area
- 2 Eco area
- 3 Power area
- 4 Hybrid Eco area

As shown below, the driving conditions of the vehicle can be confirmed by checking the status of the indicator bar.

2
When driving

	Multi-information display*1	Eco Driving Indicator Light
<p>Charge area: Shows that energy is being recovered via the regenerative brake. (→P. 29)</p>		
<p>Hybrid Eco area: Shows that gasoline engine power is not being used very often.*2</p>		 On
<p>Eco area: Shows that the vehicle is being driven in an environmentally friendly (fuel efficient) manner.</p>		

	Multi-information display*1	Eco Driving Indicator Light
Power area: Shows that an environmentally friendly driving range is being exceeded (during full power driving etc.).		 Off

*1: The images are examples only, and may vary slightly from actual conditions.

*2: The gasoline engine will automatically stop and restart under various conditions.

5-minute/1-minute interval fuel consumption display

The fuel consumption display shows the average fuel consumption and the regenerated energy amount in 5-minute or 1-minute intervals.

■ Switching between 5-minute and 1-minute intervals

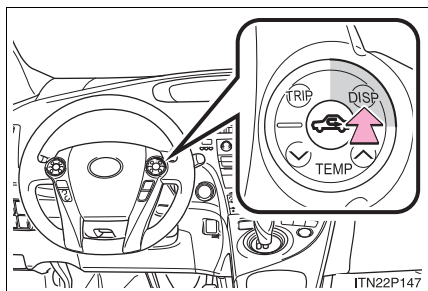

Press and hold the “DISP” switch while either the 5-minute interval or 1-minute interval display is being shown.

The display will alternate with each press of the button.

■ Display

▶ 5-minute interval fuel consumption

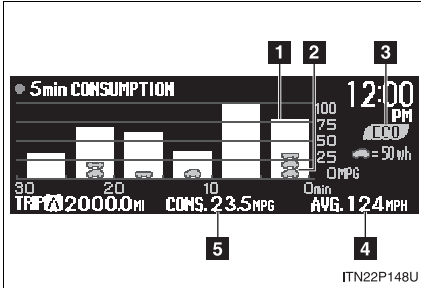

- 1** Fuel consumption in the past 30 minutes*

Displays the average fuel consumption for the last 30 minutes in intervals of 5 minutes.

- 2** Regenerated energy in the past 30 minutes*

Displays the amount of energy generated over the last 30 minutes in intervals of 5 minutes.

One symbol indicates 50 Wh. Up to 8 symbols are shown.

- 3** Eco Driving Indicator Light

- 4** Average speed*

Displays the average vehicle speed since the function was last reset.

- 5** Average fuel consumption*

Displays the average fuel consumption since the function was last reset.

*: The function can be reset by pressing and holding the “TRIP” button when either the 5-minute or 1-minute interval fuel consumption display is being shown.

► 1-minute interval fuel consumption

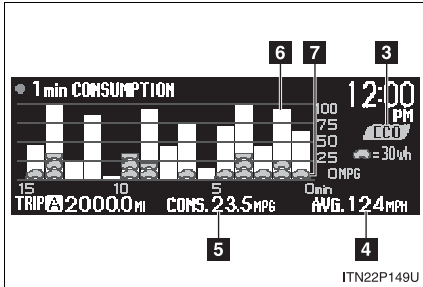

6 Fuel consumption in the past 15 minutes

Displays the average fuel consumption for the last 15 minutes in intervals of 1 minute.

7 Regenerated energy in the past 15 minutes

Displays the amount of energy generated over the last 15 minutes in intervals of 1 minute.

One symbol indicates 30 Wh. Up to 8 symbols are shown.

Fuel consumption history display

The fuel consumption record display shows a history of the average fuel consumption in sections, based on the driving records of trip meters A and B. Each section represents the interval between each trip meter reset. (→P. 200)

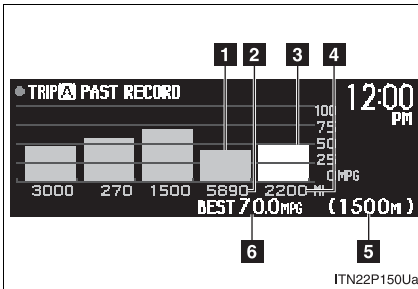

- 1** Average fuel consumption prior to the previous trip meter reset
- 2** Driving distance prior to the previous trip meter reset
- 3** Average fuel consumption since the previous trip meter reset
- 4** Driving distance since the previous trip meter reset
- 5** Trip distance at the time best consumption was recorded
- 6** Best consumption at the previous trip meter reset

Displays the best fuel consumption out of all previous trips.

■ Resetting the best consumption

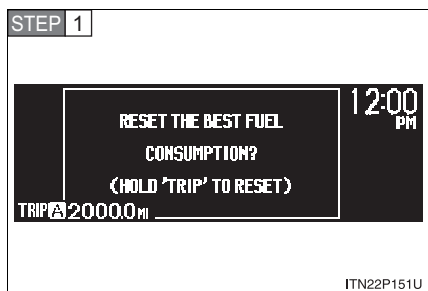

Press and hold the “TRIP” switch while the fuel consumption history is displayed.

A confirmation message will be displayed.

STEP 2 Press and hold the “TRIP” switch again.

The best consumption will be reset.

To cancel the reset operation, press the “DISP” switch.

Odometer/trip meter/distance to empty

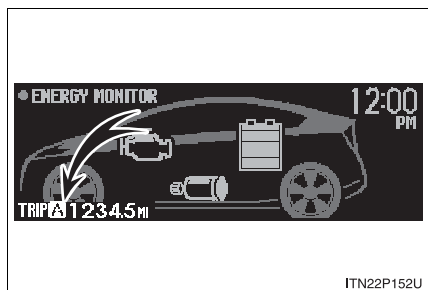

The display changes as follows each time the “TRIP” button is pressed.

Odometer → Trip meter A* →
Trip meter B* → Distance to empty → Off

*: Pushing and holding the “TRIP” button will reset the trip meter.

● Odometer



Displays the total distance the vehicle has been driven.

● Trip meter



Displays the distance the vehicle has been driven since the meter was last reset. Trip meters A and B can be used to record and display different distances independently.

● Distance to empty



Displays the estimated maximum distance that can be driven with the quantity of fuel remaining.

- This distance is computed based on your average fuel consumption. As a result, the actual distance that can be driven may differ from that displayed.
- When only a small amount of fuel is added to the tank, the display may not be updated.

Setting up the displays

STEP 1 Press the “DISP” switch until the “SETTINGS” screen appears.

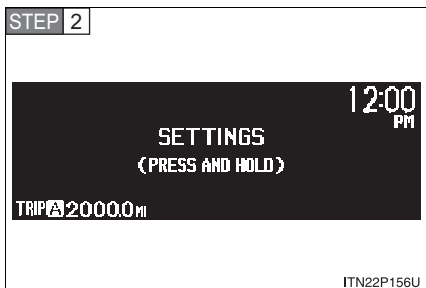

While the vehicle is stopped, press and hold the “DISP” switch until the screen changes.

■ Switching the Eco Driving Indicator Light/steering switch operation display on/off

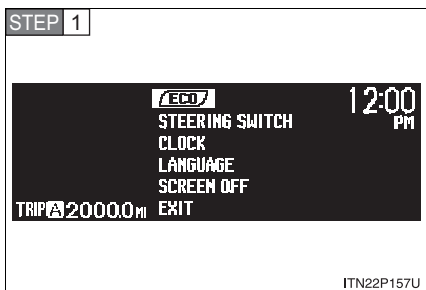

Select “ECO” or “STEERING SWITCH” on the screen by pressing the “DISP” switch.

Press and hold the “DISP” switch to enter the setting mode.

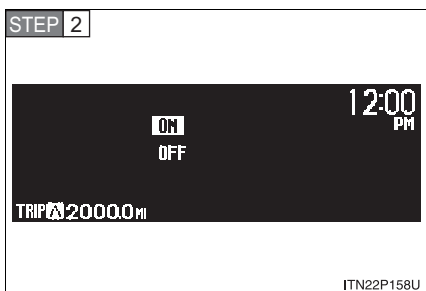

Select “ON” or “OFF” by pressing the “DISP” switch.

Press and hold the “DISP” switch to finish setting.

■ Selecting 12h/24h clock display

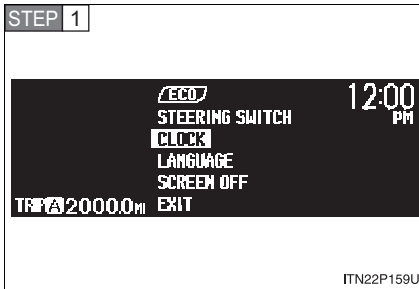

Select “CLOCK” by pressing the “DISP” switch.

Press and hold the “DISP” switch to enter the setting mode.

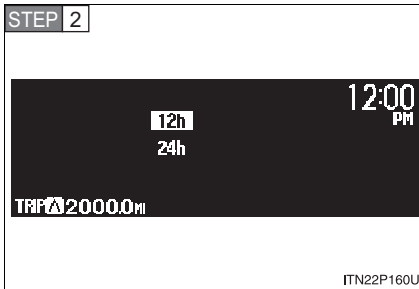

Select “12h” or “24h” by pressing the “DISP” switch.

Press and hold the “DISP” switch to finish setting.

■ Setting the clock

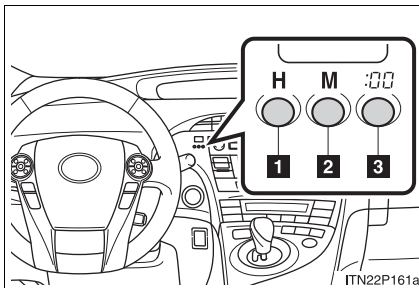

- 1** Adjust hours.
- 2** Adjust minutes.
- 3** Round the nearest hour.*

*: e.g. 1:00 to 1:29 → 1:00
1:30 to 1:59 → 2:00

■ Selecting the language

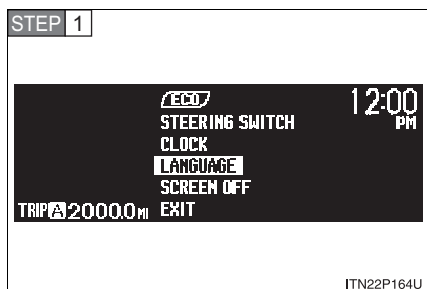

Select “LANGUAGE” on the screen by pressing the “DISP” switch.

Press and hold the “DISP” switch to enter the setting mode.

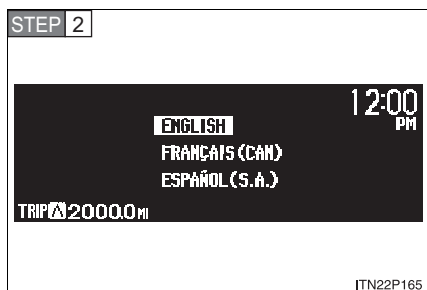

Select the language you want to read by pressing the “DISP” switch.

Press and hold the “DISP” switch to set the language.

■ Turning off the multi-information display

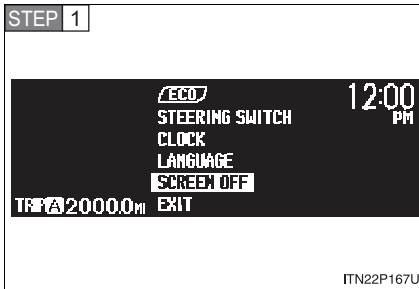

Select “SCREEN OFF” on the screen by pressing the “DISP” switch.

Press and hold the “DISP” switch to enter the setting mode.

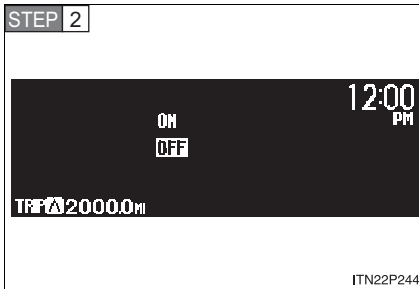

Select “OFF” on the screen by pressing the “DISP” switch.

Press and hold the “DISP” switch to turn off the multi-information display.

To re-display the multi-information display, press the “DISP” switch to display the “SETTINGS” screen and follow the same procedure, selecting “ON” instead of “OFF”.

■ Returning to the previous screen

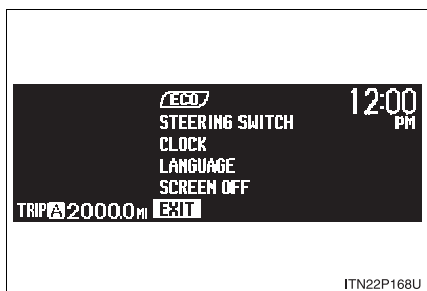

Select "EXIT" on the screen by pressing the "DISP" switch, and press and hold the "DISP" switch.

The screen will revert to the "SETTINGS" screen.

■ System check display

After switching the "POWER" switch to ON mode, "PRIUS" is displayed while system operation is checked. When the system check is complete, the normal screen will return.

■ Vacuum fluorescent display

Small spots or light spots may appear on the display. This phenomenon is characteristic of vacuum fluorescent displays, and there is no problem to continue using the display.

■ Eco Driving Indicator Light

This indicator will not turn on if the following conditions are met while driving:

- The shift position is anything other than "D".
- The driving mode is set to power mode or EV-Drive Mode.

■ 5-minute interval/1-minute interval fuel consumption display

If the "POWER" switch is turned OFF, average fuel consumption and regenerated energy data will be reset.

■ Odometer/trip meter/distance to empty

The odometer/trip meter/distance to empty will not be displayed while the fuel consumption history is being displayed.

■ Fuel consumption history display

- Each time a trip meter is reset, the old data will move to the left by 1 column.
- A maximum of 5 history items can be displayed (including the current history). If the history exceeds 5 items, the oldest item will be deleted.

■ Driving in Eco Driving Mode

The multi-information display will automatically switch the display to the Hybrid System Indicator, regardless of which display is currently being shown. (→P. 172)

■ Display settings can be changed when

The vehicle speed is less than approximately 5 mph (8 km/h).

■ When the 12 volt battery is disconnected

The following data will be reset.

- Average fuel consumption
- Distance to empty
- Average vehicle speed
- Clock
- Display settings

Headlight switch

The headlights can be operated manually or automatically.

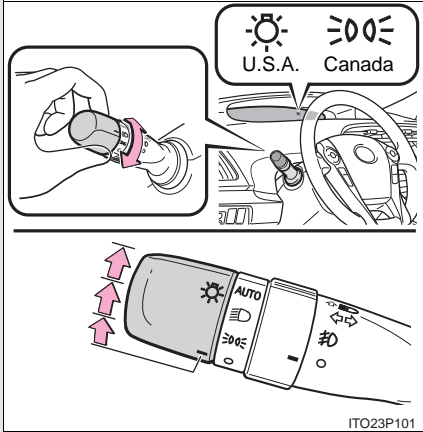

The side marker, parking, tail, license plate and instrument panel lights turn on.



The headlights and all lights listed above turn on.

AUTO

(Canada only, if equipped)

The headlights and all the lights listed above turn on and off automatically.

(When the "POWER" switch is in ON mode.)

Turning on the high beam headlights

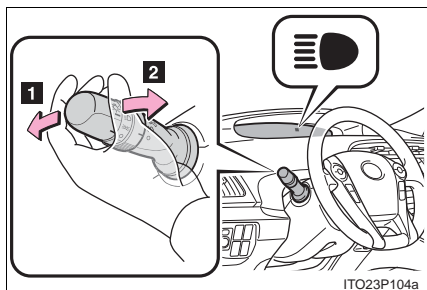

1 With the headlights on, push the lever forward to turn on the high beams.

Pull the lever back to the center position to turn the high beams off.

2 Pull the lever toward you to turn on the high beams.

Release the lever to turn them off. You can flash the high beams with the headlights on or off.

2

When driving

■ Daytime running light system (if equipped)

To make your vehicle more visible to other drivers, the headlights turn on automatically (at a reduced intensity) whenever the hybrid system is started and the parking brake is released. Daytime running lights are not designed for use at night.

■ Headlight control sensor (if equipped)

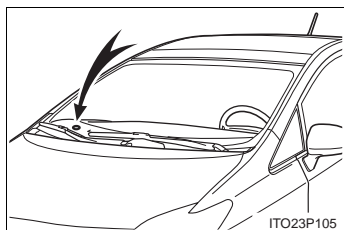



The sensor may not function properly if an object is placed on the sensor, or anything that blocks the sensor is affixed to the windshield.

Doing so interferes with the sensor detecting the level of ambient light and may cause the automatic headlight control system to malfunction.

■ Automatic light off system

- When the headlights are on: The headlights and tail lights turn off 30 seconds after a door is opened and closed if the “POWER” switch has been switched to ACCESSORY mode or OFF.
- When only the tail lights are on: The tail lights turn off automatically if the “POWER” switch is switched to ACCESSORY mode or OFF and driver’s door is opened.

To turn the lights on again, turn the “POWER” switch to ON mode, or turn the light switch off once and then back to the  or  position.

■ Automatic headlight leveling system (vehicles with LED headlights)

The level of the headlights is automatically adjusted according to the number of passengers and the loading condition of the vehicle to ensure that the headlights do not interfere with other road users.

■ If the indicator flashes... (vehicles with LED headlights)

It may indicate a malfunction in the system. Contact your Toyota dealer.

■ Customization that can be configured at Toyota dealer

Settings (e.g. light sensor sensitivity) can be changed.
(Customizable features →P. 587)

NOTICE

■ To prevent 12 volt battery discharge

Do not leave the lights on longer than necessary if the hybrid system is not operating.

2-3. Operating the lights and windshield wipers Fog light switch*

The fog lights improve visibility in difficult driving conditions, such as in rain or fog. The fog lights can be used when the headlights are on low beam.

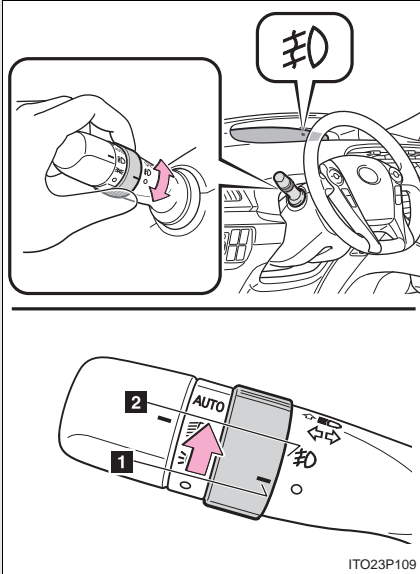

- 1 Off
- 2 On

2-3. Operating the lights and windshield wipers

Windshield wipers and washer

Wiper intervals can be adjusted for intermittent operation (when



is selected).

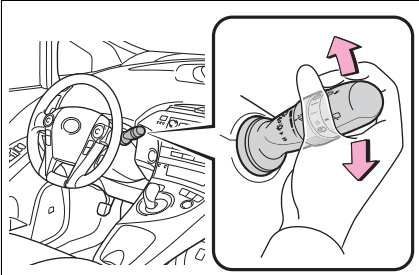

- 1** Intermittent wiper operation
- 2** Low speed wiper operation
- 3** High speed wiper operation
- 4** Temporary operation

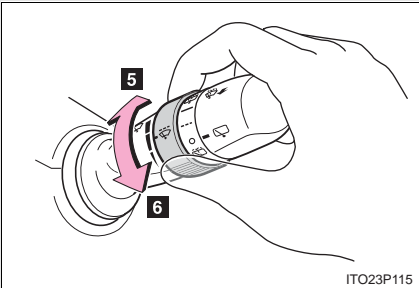
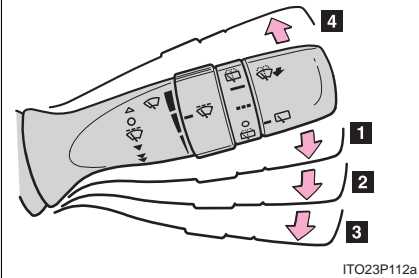

- 5** Increases the intermittent windshield wiper frequency (if equipped)
- 6** Decreases the intermittent windshield wiper frequency (if equipped)

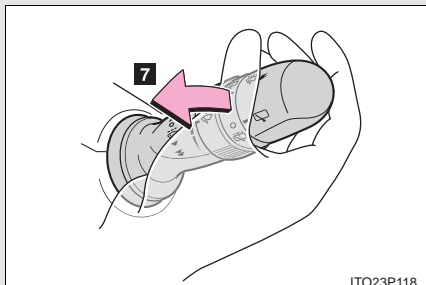

7 Wash/wipe operation

Wipers operate automatically.

■ The windshield wipers and washer can be operated when

The "POWER" switch is in ON mode.

■ If no windshield washer fluid sprays

Check that the washer nozzles are not blocked if there is washer fluid in the windshield washer fluid reservoir.

NOTICE

■ When the windshield is dry

Do not use the wipers, as they may damage the windshield.

■ When there is no washer fluid spray from the nozzle

Damage to the washer fluid pump may be caused if the lever is pulled toward you and held continually.

2-3. Operating the lights and windshield wipers

Rear window wiper and washer*

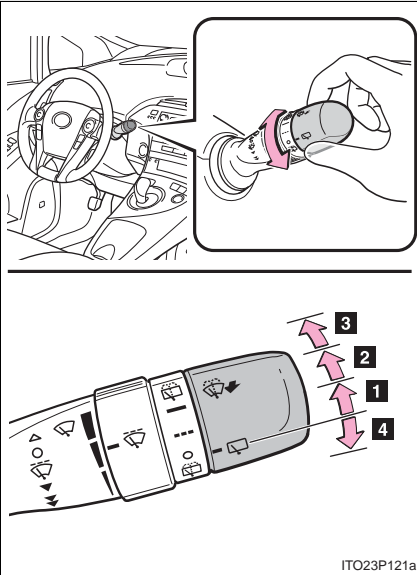

- 1 Intermittent window wiper operation
- 2 Normal window wiper operation
- 3 Washer/wiper dual operation
- 4 Washer/wiper dual operation

■ The rear window wiper and washer can be operated when

The "POWER" switch is in ON mode.

⚠ NOTICE

■ When the rear window is dry

Do not use the wipers, as they may damage the rear window.

*: If equipped

2-3. Operating the lights and windshield wipers Headlight cleaner switch*

Washer fluid can be sprayed on the headlights.

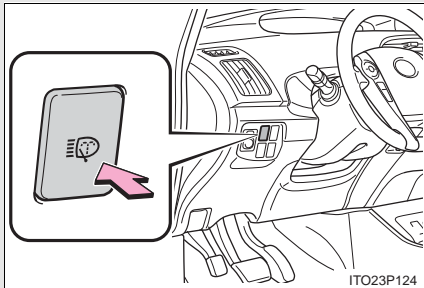

Press the switch to clean the headlights.

■ The headlight cleaner can be operated when

The "POWER" switch is in ON mode and the headlight switch is turned on.

If equipped, the headlight switch is in the "AUTO" position and the headlight is on.

■ Windshield washer linked operation

When the windshield washer is operated with the "POWER" switch in ON mode and the low beam headlights on, the headlight cleaner will operate once. (→P. 210)

NOTICE

■ When the washer fluid tank is empty

Do not use this function when the washer fluid tank is empty. This may cause the washer fluid pump to overheat.

2-4. Using other driving systems Cruise control*

Use the cruise control to maintain a set speed without using the accelerator.

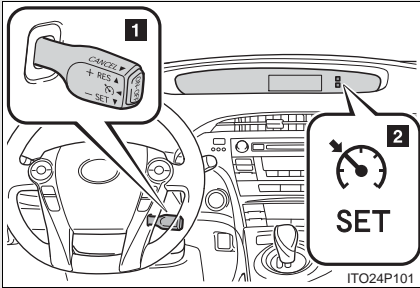

- 1 Cruise control switch
- 2 Indicators

■ Set the vehicle speed

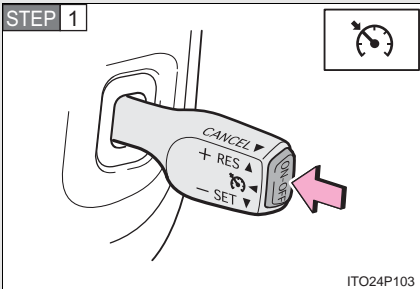

Press the “ON-OFF” button to activate the cruise control.

Press the button once more to deactivate the cruise control.

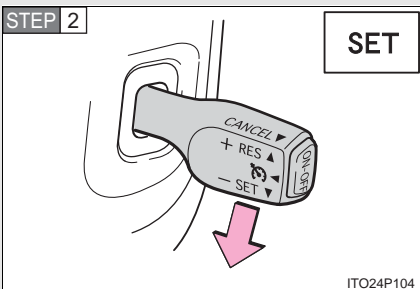

Accelerate or decelerate to the desired speed and press the lever down to set the cruise control speed.

*: If equipped

■ Adjusting the speed setting

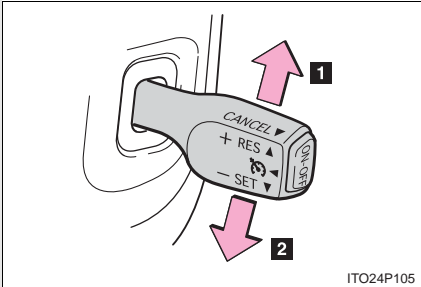

- 1** Increase speed
- 2** Decrease speed

Hold the lever until the desired speed setting is obtained.

Fine adjustment of the set speed can be made by lightly pushing the lever up or down and releasing it.

■ Canceling and resuming regular acceleration

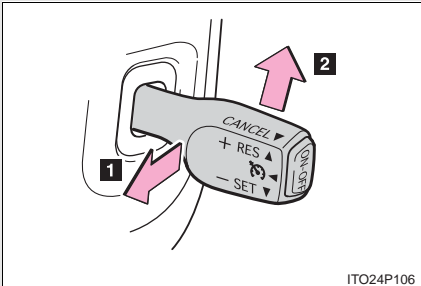

- 1** Cancel

Pull the lever towards you to cancel cruise control.

The speed setting is also canceled when the brakes are applied.

- 2** Resume

To resume cruise control and return to the set speed, push the lever up.

■ **Cruise control can be set when**

- The shift lever is in “D”.
- Vehicle speed is more than approximately 25 mph (40 km/h).

■ **Accelerating**

The vehicle can be accelerated normally. After acceleration, the set speed resumes.

■ **Automatic cruise control cancelation**

The set speed is automatically canceled in any of the following situations.

- Actual vehicle speed falls more than 10 mph (16 km/h) below the preset vehicle speed
- Actual vehicle speed is below 25 mph (40 km/h)
- Enhanced VSC is activated

■ **If the cruise main indicator light flashes**

Press the “ON-OFF” button once, and then press the button again to reactivate the system.

If the cruise control speed cannot be set or if the cruise control cancels immediately after being activated, there may be a malfunction in the cruise control system. Contact your Toyota dealer, and have your Toyota inspected.

 **CAUTION****■ To avoid operating the cruise control by mistake**

Keep the "ON-OFF" button off when not in use.

■ Situations unsuitable for cruise control

Do not use cruise control in any of the following situations.

Doing so may result in control of the vehicle being lost and could cause an accident resulting in death or serious injury.

- In heavy traffic
- On roads with sharp bends
- On slippery roads, such as those covered with rain, ice or snow
- On steep hills
Vehicle speed may exceed the set speed when driving down a steep hill.
- On winding roads

Dynamic radar cruise control*

Dynamic radar cruise control supplements conventional cruise control with a vehicle-to-vehicle distance control. In vehicle-to-vehicle distance control mode, the vehicle automatically accelerates or decelerates in order to maintain a set following distance from vehicles ahead.

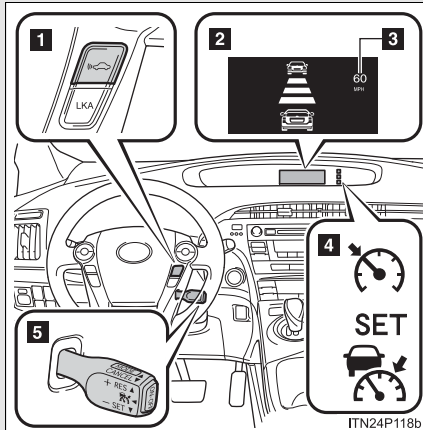

- 1 Vehicle-to-vehicle distance button
- 2 Display
- 3 Set speed
- 4 Indicators
- 5 Cruise control switch

*: If equipped

■ Setting the vehicle speed (vehicle-to-vehicle distance control mode)

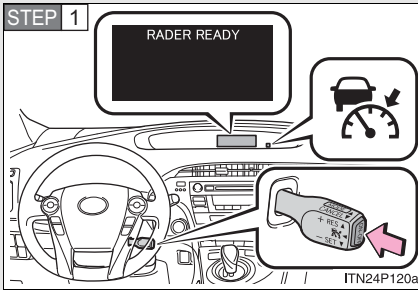

Press the “ON-OFF” button to activate the cruise control.

Press the button again to deactivate the cruise control.

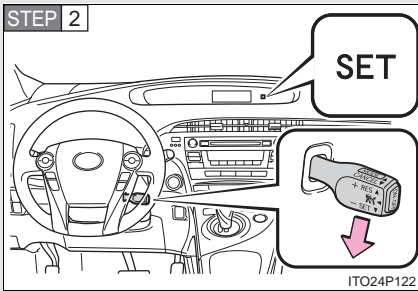

Accelerate or decelerate the vehicle to the desired speed, and push the lever down to set the speed.

Cruise “SET” indicator will come on.

■ Adjusting the set speed

To change the set speed, operate the lever until the desired set speed is displayed.

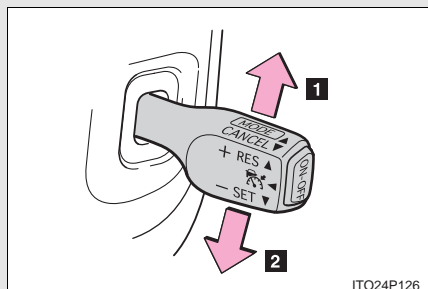

1 Increases the speed

2 Decreases the speed

Fine adjustment: Momentarily move the lever in the desired direction.

Large adjustment: Hold the lever in the desired direction.

In the vehicle-to-vehicle distance control mode, the set speed will be increased or decreased as follows:

▶ When the set speed is shown in “MPH”

Fine adjustment: By approximately 1 mph (1.6 km/h) each time the lever is operated

Large adjustment: By approximately 5 mph (8 km/h) for each 0.75 seconds the lever is held

▶ When the set speed is shown in “km/h”

Fine adjustment: By approximately 0.6 mph (1 km/h) each time the lever is operated

Large adjustment: By approximately 3.1 mph (5 km/h) for each 0.75 seconds the lever is held

In the constant speed control mode (→P. 224), the set speed will be increased or decreased as follows:

Fine adjustment: By approximately 1 mph (1.6 km/h) each time the lever is operated

Large adjustment: The set speed can be increased or decreased continually until the lever is released.

■ Changing the vehicle-to-vehicle distance

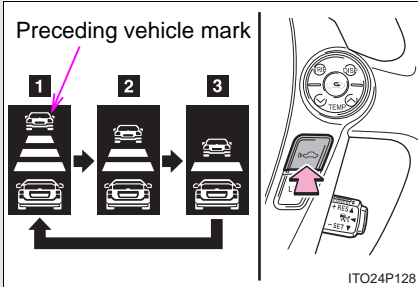

Pressing the button changes the vehicle-to-vehicle distance as follows:

- 1 Long
- 2 Medium
- 3 Short

The vehicle-to-vehicle distance is set automatically to long mode when the "POWER" switch is turned to ON mode.

If a vehicle is running ahead of you, the preceding vehicle mark will also be displayed.

■ Canceling and resuming the speed control

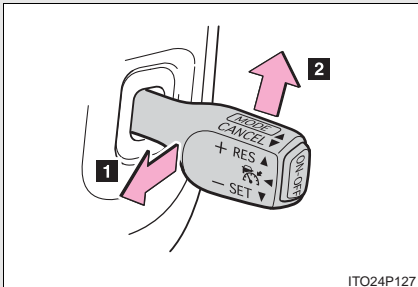

- 1 Pulling the lever toward you cancels the cruise control.

The speed setting is also canceled when the brakes are applied.

- 2 Pushing the lever up resumes the cruise control and returns vehicle speed to the set speed.

Resuming is available when the vehicle speed is more than approximately 25 mph (40 km/h).

Driving in vehicle-to-vehicle distance control mode

This mode employs a sensor to detect the presence of vehicles up to approximately 400 ft. (120 m) ahead and to judge the distance between your vehicle and those the vehicle ahead of you.

Note that vehicle-to-vehicle distance will close in when traveling on long downhill slopes.

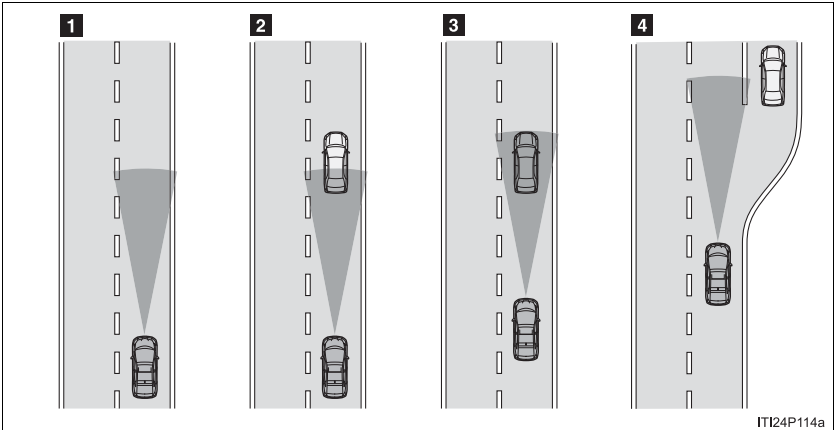

1 Example of constant speed cruising

When there are no vehicles ahead

The vehicle travels at the speed set by the driver. The desired vehicle-to-vehicle distance can also be set by operating the vehicle-to-vehicle distance control.

2 Example of deceleration cruising

When the vehicle ahead is driving slower than the set speed

When a vehicle is detected running ahead of you, the system automatically decelerates your vehicle. When a greater reduction in vehicle speed is necessary, the system applies the brakes. A warning tone warns you when the system cannot decelerate sufficiently to prevent your vehicle from closing in on the vehicle ahead.

3 Example of follow-up cruising

When following a vehicle driving slower than the set speed

The system continues follow-up cruising while adjusting for changes in the speed of the vehicle ahead in order to maintain the vehicle-to-vehicle distance set by the driver.

4 Example of acceleration

When there are no longer any vehicles ahead driving slower than the set speed

The system accelerates until the set speed is reached. The system then returns to constant speed cruising.

Approach warning

When your vehicle is too close to a vehicle ahead, and sufficient automatic deceleration via the cruise control is not possible, the display will flash and the buzzer will sound to alert the driver. An example of this would be if another driver cuts in front of you while you are following a vehicle. Apply the brakes to ensure an appropriate vehicle-to-vehicle distance.

Selecting conventional constant speed control mode

Dynamic radar cruise control can be used as conventional cruise control if you select constant speed control mode.

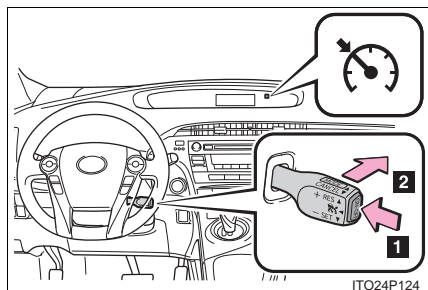

- 1** Press the “ON-OFF” button to activate the cruise control.

Press the button again to deactivate the cruise control.

- 2** Switch to constant speed control mode.

(Push the lever forward and hold for approximately one second.)

Cruise main indicator will come on.

Adjusting the speed setting:
→P. 220

Canceling and resuming the speed setting: →P. 221

■ Dynamic radar cruise control can be set when

- The shift position is in “D”.
- Vehicle speed is above approximately 30 mph (50 km/h).

■ Switching modes

The mode cannot be switched to constant speed control mode if vehicle-to-vehicle distance control mode has been used. The mode also cannot be switched from constant speed control to vehicle-to-vehicle distance control mode. Turn the system off by pressing the “ON-OFF” button, and turn it on again.

■ Accelerating

The vehicle can accelerate normally. After acceleration, the set speed resumes. However, during vehicle-to-vehicle distance control mode, the vehicle speed may decrease below the set speed in order to maintain the distance to the vehicle ahead.

■ Automatic cancelation of vehicle-to-vehicle distance control

Vehicle-to-vehicle distance control driving is automatically canceled in the following situations:

- Actual vehicle speed falls below approximately 25 mph (40 km/h).
- Enhanced VSC is activated.
- The sensor cannot operate correctly because it is covered in some way.
- The windshield wipers are operating at high speed.

If vehicle-to-vehicle distance control driving is automatically canceled for any other reason, there may be a malfunction in the system. Contact your Toyota dealer.

■ Automatic cancelation of constant speed control

The cruise control will stop maintaining the vehicle speed in the following situations:

- Actual vehicle speed is more than approximately 10 mph (16 km/h) below the set vehicle speed.
At this time, the memorized set speed is not retained.
- Vehicle speed falls below 25 mph (40 km/h).
- Enhanced VSC is activated.

■ Vehicle-to-vehicle distance settings

Select a distance from the table below. Note that the distances shown correspond to a vehicle speed of 50 mph (80 km/h). Vehicle-to-vehicle distance increases/decreases in accordance with vehicle speed.

Distance options	Vehicle-to-vehicle distance
Long	Approximately 160 ft. (50 m)
Medium	Approximately 130 ft. (40 m)
Short	Approximately 100 ft. (30 m)

■ Radar sensor and grille cover

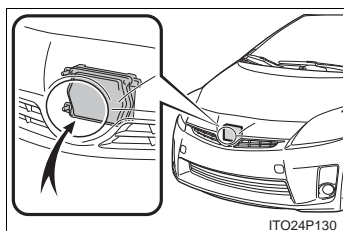

Always keep the sensor and grille cover clean to ensure that the vehicle-to-vehicle distance control operates properly. (Some obstructions, such as snow, ice and plastic objects, cannot be detected by the obstruction sensor.)
Dynamic radar cruise control is canceled if an obstruction is detected.

■ Warning lights, messages and buzzers for dynamic radar cruise control

Warning lights, messages and buzzers are used to indicate a system malfunction or to inform the driver of the need for caution while driving.
(→P. 508)

■ Approach warning

In the following instances, there is a possibility that the warnings will not occur:

- When the speed of the vehicle ahead matches or exceeds your vehicle speed
- When the vehicle ahead is traveling at an extremely slow speed
- Immediately after the cruise control speed was set
- At the instant the accelerator is applied

■ Certification

- ▶ For vehicles sold in the U.S.A.

FCC ID: HYQDNMWR004

FCC WARNING

Changes or modifications not expressly approved by the party responsible for compliance could void the user's authority to operate the equipment.

FCC RF exposure Information

This device complies with the FCC RF exposure requirements.

This device complies with Part 15 of the FCC Rules and RSS-210. Operation is subject to the following two conditions: (1) this device may not cause harmful interference, and (2) this device must accept any interference received, including interference that may cause undesired operation.

- ▶ For vehicles sold in Canada

Operation is subject to the following two conditions: (1) this device may not cause interference, and (2) this device must accept any interference, including interference that may cause undesired operation of the device.

 **CAUTION**

■ Before using dynamic radar cruise control

Do not overly rely on vehicle-to-vehicle distance control.

Be aware of the set speed. If automatic deceleration/acceleration is not appropriate, adjust the vehicle speed, as well as the distance between your vehicle and vehicles ahead by applying the brakes etc.

■ Cautions regarding the driving assist systems

Observe the following precautions.

Failure to do so may cause an accident resulting in death or serious injury.

● Assisting the driver to measure following distance

The dynamic radar cruise control is only intended to help the driver in determining the following distance between the driver's own vehicle and a designated vehicle traveling ahead. It is not a mechanism that allows careless or inattentive driving, and it is not a system that can assist the driver in low-visibility conditions. It is still necessary for driver to pay close attention to the vehicle's surroundings.

● Assisting the driver to judge proper following distance

The dynamic radar cruise control determines whether the following distance between the driver's own vehicle and a designated vehicle traveling ahead is appropriate or not. It is not capable of making any other type of judgement. Therefore, it is absolutely necessary for the driver to remain vigilant and to determine whether or not there is a possibility of danger in any given situation.

● Assisting the driver to operate the vehicle

The dynamic radar cruise control has no capability to prevent or avoid a collision with a vehicle traveling ahead. Therefore, if there is ever any danger, the driver must take immediate and direct control of the vehicle and act appropriately in order to ensure the safety of all involved.

■ To avoid inadvertent cruise control activation

Switch the cruise control off using the "ON-OFF" button when not in use.

 CAUTION**■ Situations unsuitable for dynamic radar cruise control**

Do not use dynamic radar cruise control in any of the following situations. Doing so may result in inappropriate speed control and could cause an accident resulting in death or serious injury.

- In heavy traffic
- On roads with sharp bends
- On winding roads
- On slippery roads, such as those covered with rain, ice and snow
- On steep downhill, or where there are sudden changes between sharp up and down gradients
Vehicle speed may exceed the set speed when driving down a steep hill.
- At entrances to expressways
- When weather conditions are bad enough that they may prevent the sensors from functioning correctly (fog, snow, sandstorm, heavy rain, etc.)
- When an approach warning buzzer can be heard often

■ When the sensor may not be correctly detecting the vehicle ahead

Apply the brakes as necessary when any of the following types of vehicles are in front of you.

As the sensor may not be able to correctly detect these types of vehicles, the approach warning (→P. 227) will not be activated, and a fatal or serious accident may result.

- Vehicles that cut in suddenly
- Vehicles traveling at low speeds
- Vehicles that are not moving
- Vehicles with small rear ends (trailers with no load on board etc.)
- Motorcycles traveling in the same lane

 **CAUTION**

■ Conditions under which the vehicle-to-vehicle distance control may not function correctly

Apply the brakes as necessary in the following conditions as the radar sensor may not be able to correctly detect vehicles ahead, and a fatal or serious accident may result:

- When water or snow thrown up by the surrounding vehicles hinders the functioning of the sensor
- When your vehicle is pointing upwards (caused by a heavy load in the luggage compartment etc.)
- When the road curves or when the lanes are narrow
- When steering wheel operation or your position in the lane is unstable
- When the vehicle ahead of you decelerates suddenly

■ Handling the radar sensor

Observe the following to ensure the cruise control system can function effectively.

Otherwise, the system may not function correctly and could result in an accident.

- Keep the sensor and front grille cover clean at all times.
Clean the sensor and front grille cover with a soft cloth so you do not mark or damage them.
- Do not subject the sensor or surrounding area to a strong impact .
If the sensor moves even slightly off position, the system may malfunction.
If the sensor or surrounding area is subject to a strong impact, always have the area inspected and adjusted by a Toyota dealer.
- Do not disassemble the sensor.
- Do not attach accessories or stickers to the sensor, grille cover or surrounding area.
- Do not modify or paint the sensor and grille cover.
- Do not replace them with non-genuine parts.

2-4. Using other driving systems Rear view monitor system*

The rear view monitor system assists the driver by displaying an image of the view behind the vehicle while reversing. The image is displayed in reverse on the screen. This allows the image to appear in the same manner as that of the rear view mirror.

► With navigation system

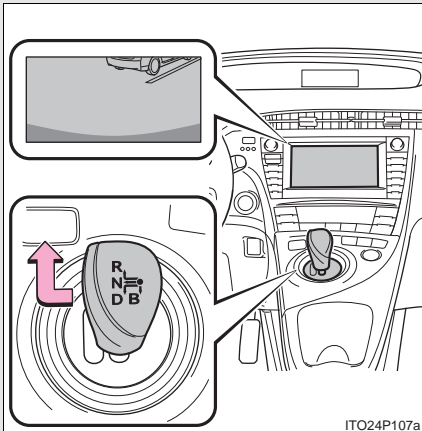

Rear view image is displayed when the shift lever is in "R".

If you move the lever out of "R", the screen returns to the previous one.

► Without navigation system

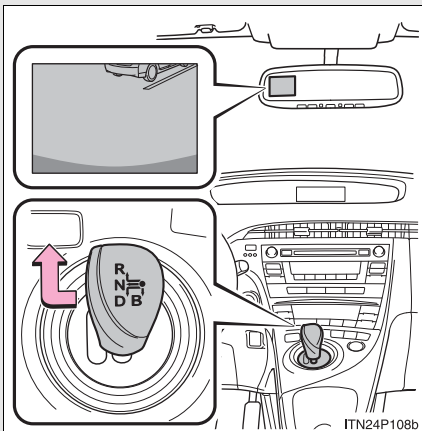

Rear view image is displayed on the inside rear view mirror when the shift lever is in "R".

This reversed image is a similar image to the one on the inside rear view mirror.

If you move the lever out of "R", the screen is turned off.

*: If equipped

■ **Switching the screen (vehicles without navigation system)**

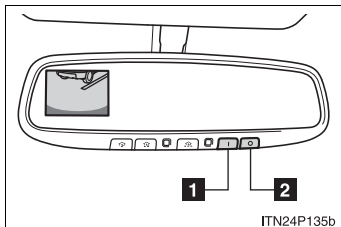

1 On

Green indicator comes on.

2 Off

Orange indicator comes on.

■ **When using the rear view monitor system (vehicles without navigation system)**

The anti-glare function of the inside rear view mirror will be canceled.

■ **Automatic shut off (vehicles without navigation system)**

The display will be turned off automatically after 5 minutes.

■ **Displayed area**

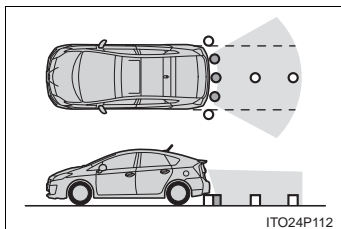

The area covered by the camera is limited. Objects which are close to either corner of the bumper or under the bumper cannot be seen on the screen.

The area displayed on the screen may vary according to vehicle orientation or road conditions.

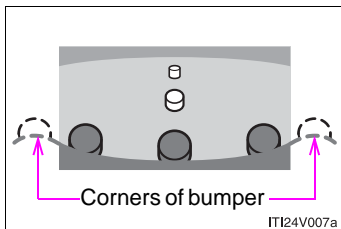

■ Rear view monitor system camera

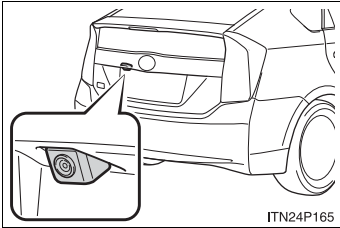

In the following cases, it may be difficult to see the images on the screen, even when the system is functioning correctly.

- In the dark (e.g. at night).
- If the temperature near the lens is extremely high or low.
- If water droplets get on the camera, or when humidity is high (e.g. when it rains).
- If foreign matter (e.g. snow or mud) get on the camera lens.
- If the sun or headlights are shining directly into the camera lens.

■ Smear effect

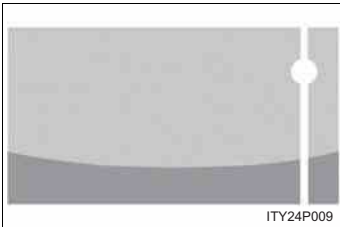

If a bright light (for example, sunlight reflected off the vehicle body) is picked up by the camera, a smear effect* peculiar to the camera may occur.

*:Smear effect—A phenomenon that occurs when a bright light (for example, sunlight reflected off the vehicle body) is picked up by the camera; when transmitted by the camera, the light source appears to have a vertical streak above and below it.

 **CAUTION**

■ **When using the rear view monitor system**

Observe the following precautions to avoid an accident that could result in death or serious injuries.

- Never depend solely on the monitor system when reversing.
- Always check visually and with the mirrors to confirm your intended path is clear.
- Depicted distances between objects and flat surfaces differ from actual distances.
- Do not use the system if the back door is not completely closed.

■ **Conditions which may affect the rear view monitor system**

- If the back of the vehicle is hit, the camera's position and mounting angle may change. Contact your Toyota dealer.
- Rapid temperature changes, such as when hot water is poured on the vehicle in cold weather, may cause the system to function abnormally.
- If the camera lens is dirty, it cannot transmit a clear image. Rinse with water and wipe with a soft cloth. If extremely dirty, wash with a mild cleanser and rinse.
- The displayed image may be darker and moving images may be slightly distorted when the system is cold.

LKA (Lane-Keeping Assist)*

While driving on a freeway or motor highway that has lane markings, this system recognizes the lanes using a camera as a sensor to assist the driver with staying in the lane. The LKA system has two functions.

■ Lane departure warning function

If the system judges that the vehicle may deviate from its lane, it alerts the driver using rapid beeping, indications on the multi-information display, and a sensory warning* given via the steering wheel.

*: A slight steering torque is applied for a short period of time in the direction of the center of the lane.

■ Lane keeping assist function

This function will be active when the vehicle-to-vehicle distance control mode of the cruise control (→P. 218) is set with vehicle speed above approx. 50 mph (approx. 75 km/h) and while the lane departure warning function is active. When the lane keeping assist function is active, a slight steering torque will be applied, to help the driver maintain the vehicle inside the lane.

*: If equipped

■ Turning the LKA system on

The lane departure warning function and lane keeping assist function will be automatically activated depending on the recognition condition of lane markings, vehicle speed and the setting of radar cruise control (vehicle-to-vehicle distance control mode).

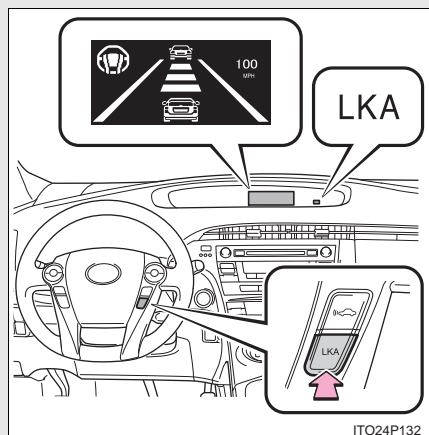

Press the “LKA” switch to activate the system.

Press the switch again to turn the LKA system off.

■ Operating conditions for each function

"LKA" switch	Cruise control (vehicle-to-vehicle distance control mode)	Lane departure warning function* ¹	Lane keeping assist function* ²
On	Off	Available	Not available
	On (While cruising in vehicle-to-vehicle distance control mode with the set vehicle speed approx. 45 mph [approx. 70 km/h] or less)	Available	Not available
	On (While cruising in vehicle-to-vehicle distance control mode with the set vehicle speed approx. 50 mph [approx. 75 km/h] or more)	Available	Available

*1: Vehicle speed is between about 30 and 124 mph (50 and 200 km/h).

*2: Vehicle speed is between about 50 and 112 mph (75 and 180 km/h).

Indication on the multi-information display

While the LKA system is on, the lane line display and steering wheel display (in case of lane keeping assist function) are shown on the multi-information display to inform that the LKA system is on.

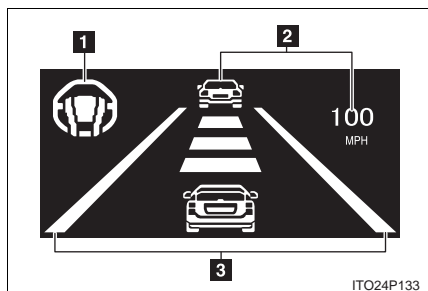

1 Steering wheel display

The lane keeping assist function is active.

2 Dynamic radar cruise control display

3 Lane line display

When thin lines are shown:
A lane marking is not recognized by the system, or the LKA system functions are temporarily canceled. (When the lane keeping assist function is canceled, buzzer will beep twice.)

When solid lane lines are shown:
The lane departure warning function is active.

■ Temporary cancellation of the LKA system functions

If any of the following occurs, the LKA system functions will be temporarily canceled. The functions will resume after the necessary operating conditions have returned.

- The turn signal lever is operated.
- The steering wheel is turned as far as necessary to cause the vehicle to change lanes.
- The brake pedal is depressed.
The lane keeping assist function will not resume even after the brake pedal is released because depressing the brake pedal also cancels the dynamic radar cruise control.
- The vehicle speed deviates from the operating range of the LKA system functions. (The buzzer will beep twice when the lane keeping assist function is being canceled.)
- When the lane lines cannot be recognized while driving. (The buzzer will beep twice when the lane keeping assist function is being canceled.)
- Low speed or high speed wiper operation states. (The buzzer will beep twice when the lane keeping assist function is being canceled.)
The buzzer may not beep when the LKA system functions are canceled because the notification of dynamic radar cruise control cancellation takes priority over the LKA system and cancels the function.
- The no-handed driving warning activates while the lane keeping assist function is active. (The buzzer will beep twice.)

■ **No-handed driving warning**

If the steering wheel is not operated for about 15 seconds on a straight road or about 5 seconds on a curve, the buzzer will beep twice, indicators on the multi-information display will flash, and the lane keeping assist function will be temporarily canceled. If you drive the vehicle with your hands lightly touching the steering wheel, this may also be detected as no-handed driving.

■ **When the vehicle has been parked in the sun**

The LKA system functions may not be available for a while after driving has started. In such cases, turn the LKA system off and turn it on again after normal temperature returns. When the temperature in the cabin decreases and the temperature around the camera sensor becomes suitable for its operation, the functions will begin to operate.

 **CAUTION**

■ **Before using the LKA system**

Do not rely on the LKA system to remain within a selected lane. The LKA system is not designed to enable inattentive driving. The steering wheel should be operated by the driver to maintain the vehicle in a suitable position within its lane. Always drive carefully.

 CAUTION**■ Situations unsuitable for the LKA system**

Using the LKA system in any of the following situations may result in improper operation of the system and could lead to an accident, causing death or serious injury. Turn the LKA system off while driving in any of the following situations.

- When it is difficult to see lane markings because they are dirty or not clear
- When it is difficult to see lane markings due to rain, snow, fog or glare
- When the headlights are not bright enough due to dirt on the lenses or if the headlight aim is not adjusted appropriately
- When a lane marking is not present, such as before tollbooths on a freeway
- When sudden changes in the light level occur repetitively
- When there are misleading lines such as shadows, lines of snow, wheel ruts with rain collected in them, or lines that remain after road repairs
- When driving in lanes other than the driving lane or passing lane on freeway or motor highways
- When there is a lane closure due to road repairs or when driving in a makeshift lane
- When the lanes are narrow or wide
- When the distance from the vehicle ahead of you is short
- When the vehicle leans to one side an unusual amount due to a heavy load or improper tire inflation pressure
- When driving on winding roads or on uneven roads
- When driving on slippery roads, such as those covered with rain, ice or snow
- The tires have been exchanged (including snow tires), or the suspension has been modified

 NOTICE

■ Camera sensor

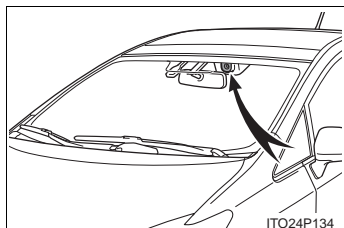

Observe the following to ensure that the LKA system functions correctly.

- Keep the windshield clean at all times.
LKA performance may deteriorate due to the presence of raindrops, condensation, ice or snow on the windshield.
- Do not subject the camera sensor to strong impact or force, and do not disassemble the camera sensor.
- Do not change the installation position of the camera sensor or remove it. The direction of the camera sensor is precisely adjusted.
- When it is cold, using the heater with air blowing to the feet may allow the upper part of the windshield to fog up. This will have a negative effect on the images. In such a case, use the windshield defogger to provide warm, dry air to the windshield.
- Do not place anything on the dashboard.
The camera sensor may recognize the image reflected on the windshield as lane markings by mistake.
- Do not scratch the camera lens, or let it get dirty.
- Do not attach a sticker or other items to the windshield near the camera sensor.

2-4. Using other driving systems

Hill-start assist control

Hill-start assist control helps to prevent the vehicle from rolling backwards when starting on incline or slippery slope.

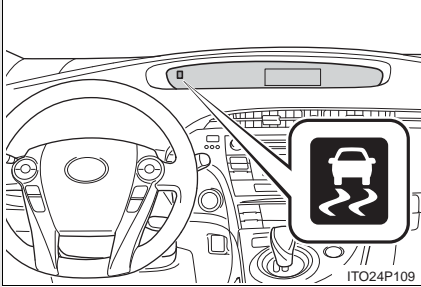

To engage hill-start assist control, further depress the brake pedal when the vehicle is stopped completely.

A buzzer will sound once to indicate the system is activated. The slip indicator will also start flashing.

2

When driving

■ Hill-start assist control operating conditions

The system operates in the following situations:

- The shift position is in other than “P”.
- The parking brake is not applied.
- The accelerator pedal is not depressed.

■ Hill-start assist control

- While hill-start assist control is operating, the brakes remain automatically applied after the driver releases the brake pedal. The stop lights and the high mounted stoplight turn on.
- Hill-start assist control operates for about 2 seconds after the brake pedal is released.
- If the slip indicator does not flash and the buzzer does not sound when the brake pedal is further depressed, slightly reduce the pressure on the brake pedal (do not allow the vehicle to roll backward) and then firmly depress it again. If the system still does not operate, check that the operating conditions explained above have been met.

■ **Hill-start assist control buzzer**

- When hill-start assist control is activated, the buzzer will sound once.
- In the following situations, hill-start assist control will be canceled and the buzzer will sound twice.
 - No attempt is made to drive the vehicle within approximately 2 seconds of releasing the brake pedal.
 - The “P” position switch is pressed.
 - The parking brake is applied.
 - The brake pedal is depressed again.

■ **If the slip indicator comes on...**

It may indicate a malfunction in the system. Contact your Toyota dealer.

 **CAUTION**

■ **Hill-start assist control**

- Do not overly rely on hill-start assist control. Hill-start assist control may not operate effectively on extremely steep inclines or roads covered in ice.
- Unlike the parking brake, hill-start assist control is not intended to hold the vehicle stationary for an extended period of time. Do not attempt to use hill-start assist control to hold the vehicle on an incline for an extended period of time, as doing so may lead to an accident.

To help enhance driving safety and performance, the following systems operate automatically in response to various driving situations. Be aware, however, that these systems are supplementary and should not be relied upon too heavily when operating the vehicle.

■ **ABS (Anti-lock Brake System)**

Helps to prevent wheel lock when the brakes are applied suddenly, or if the brakes are applied while driving on a slippery road surface.

■ **Brake assist**

Generates an increased level of braking force after the brake pedal is depressed, when the system detects a panic stop situation.

■ **Enhanced VSC (Vehicle Stability Control)**

Helps the driver to control skidding when swerving suddenly or turning on slippery road surfaces.

■ **TRAC (Traction Control)**

Maintains drive power and prevents the front wheels from spinning when starting the vehicle or accelerating on slippery roads.

■ **Hill-start assist control**

→P. 243

■ **EPS (Electric Power Steering)**

Employs an electric motor to reduce the amount of effort needed to turn the steering wheel.

■ **Pre-Collision System (if equipped)**

→P. 249

When the Enhanced VSC/TRAC is operating

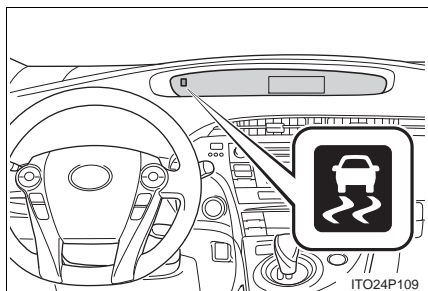

If the vehicle is in danger of slipping or if the front wheels spin, the slip indicator light flashes to indicate that the Enhanced VSC/TRAC have been engaged.

A buzzer (intermittent) sounds to indicate that Enhanced VSC is operating.

■ Sounds and vibrations caused by the ABS, brake assist, TRAC and Enhanced VSC

- A sound may be heard from the engine compartment when the hybrid system is started, just after the vehicle begins to move, if the brake pedal is depressed forcefully or repeatedly, or 1 - 2 minutes after the hybrid system is stopped. This sound does not indicate that a malfunction has occurred in any of these systems.
- Any of the following conditions may occur when the above systems are operating. None of these indicates that a malfunction has occurred.
 - Vibrations may be felt through the vehicle body and steering.
 - A motor sound may be heard after the vehicle comes to a stop.
 - The brake pedal may pulsate slightly after the ABS is activated.
 - The brake pedal may move down slightly after the ABS is activated.

■ EPS operation sound

When the steering wheel operates, a motor sound (whirring sound) may be heard.

This does not indicate a malfunction.

■ Reduced effectiveness of EPS

The effectiveness of EPS is reduced to prevent the system from overheating when there is frequent steering input over an extended period of time. The steering wheel may feel heavy as a result. Should this occur, refrain from excessive steering input or stop the vehicle and turn the hybrid system off. The system should return to normal within 10 minutes.

CAUTION

■ The ABS does not operate effectively when

- The limits of tire gripping performance have been exceeded.
- The vehicle hydroplanes while driving at high speed on the wet or slick road.

■ Stopping distance when the ABS is operating on the wet or slick roads

The ABS is not designed to shorten the vehicle's stopping distance. Always maintain a safe distance from the vehicle in front of you in the following situations.

- When driving on dirt, gravel or snow-covered roads
- When driving with tire chains
- When driving over bumps in the road
- When driving over roads with potholes or roads with uneven pavement

■ TRAC may not operate effectively when

Directional control and power may not be achievable while driving on slippery road surfaces, even if the TRAC is operating.

Do not drive the vehicle in conditions where stability and power may be lost.

 **CAUTION**

■ **When the Enhanced VSC is activated**

The slip indicator light flashes and a warning buzzer sounds. Always drive carefully.

Reckless driving may cause an accident. Exercise particular care when the indicator light flashes and a buzzer sounds.

■ **Replacing tires**

Make sure that all tires are of the same size, brand, tread pattern and total load capacity. In addition, make sure that the tires are inflated to the specified tire pressure level.

The ABS and Enhanced VSC will not function correctly if different tires are fitted on the vehicle.

Contact your Toyota dealer for further information when replacing tires or wheels.

■ **Handling of tires and suspension**

Using tires with any kind of problem or modifying the suspension will affect the driving assist systems, and may cause the system to malfunction.

Safety systems such as the brakes and seat belts are automatically engaged to lessen impact and injuries to occupants as well as vehicle damage when the radar sensor detects an unavoidable frontal collision.

■ **Pre-collision seat belts**

If the pre-collision sensor detects that a collision is unavoidable, the pre-collision system will retract the seat belt before the collision occurs.

The same will happen if the driver makes an emergency braking or loses control of the vehicle. (→P. 86)

■ **Pre-collision brake assist**

When there is a high possibility of a frontal collision, the system applies greater braking force in relation to how strongly the brake pedal is depressed.

■ **Pre-collision braking**

When there is a high possibility of a frontal collision, the system warns the driver using a warning light, warning display and buzzer. If the system determines that a collision is unavoidable, the brakes are automatically applied to reduce the collision speed. Pre-collision braking can be disabled using the pre-collision braking off button.

*: If equipped

Disabling pre-collision braking

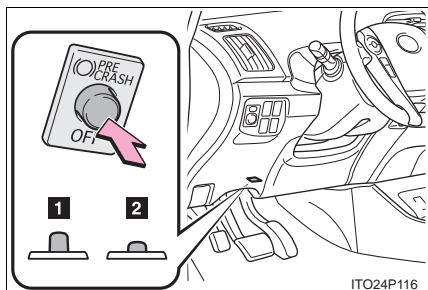

1 Enabled

2 Disabled

The "PCS" warning light comes on when the pre-collision braking is disabled.

Radar sensor

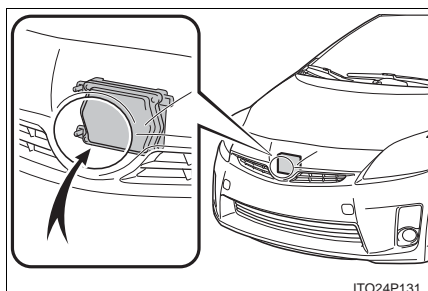

Detects vehicles or other obstacles on or near the road ahead and determines whether a collision is imminent based on the position, speed, and heading of the obstacles.

■ Obstacles not detected

The sensor cannot detect plastic obstacles such as pylons. There may also be occasions when the radar sensor cannot detect pedestrians, animals, bicycles, motorcycles, trees, or snowdrifts.

■ The pre-collision system is operational when

● Pre-collision seat belts:

- Vehicle speed is above 3 mph (5 km/h).
- The relative speed difference between your vehicle and another vehicle that is ahead of your vehicle, or the speed at which your vehicle is approaching an obstacle is greater than 18 mph (30 km/h).
- The front occupants are wearing a seat belt.

● Pre-collision brake assist:

- Vehicle speed is above 18 mph (30 km/h).
- The relative speed difference between your vehicle and another vehicle that is ahead of your vehicle, or the speed at which your vehicle is approaching an obstacle is greater than 18 mph (30 km/h).
- The brake pedal is depressed.

● Pre-collision braking:

- The pre-collision braking off button is not pressed.
- Vehicle speed is above 9 mph (15 km/h).
- The relative speed difference between your vehicle and another vehicle that is ahead of your vehicle, or the speed at which your vehicle is approaching an obstacle is greater than 9 mph (15 km/h).

■ **Conditions that may trigger the system even if there is no danger of collision**

- When there is an object by the roadside at the entrance to a curve
- When passing an oncoming vehicle on a curve
- When driving over a narrow iron bridge
- When there is a metal object on the road surface
- When driving on an uneven road surface
- When passing an oncoming vehicle on a left-turn
- When your vehicle rapidly closes on the vehicle in front

When the system is activated in the situations described above there is also a possibility that the seat belts will retract quickly and the brakes will be applied with a force greater than normal. When the seat belt is locked in the restricted position, stop the vehicle in a safe place, release the seat belt and refasten.

■ **When there is a malfunction in the system**

Warning lights and/or warning messages will turn on or flash. (→P. 508)

■ Certification

- ▶ For vehicles sold in the U.S.A.

FCC ID: HYQDNMWR004

FCC WARNING

Changes or modifications not expressly approved by the party responsible for compliance could void the user's authority to operate the equipment.

FCC RF exposure Information

This device complies with the FCC RF exposure requirements.

This device complies with Part 15 of the FCC Rules and RSS-210. Operation is subject to the following two conditions: (1) this device may not cause harmful interference, and (2) this device must accept any interference received, including interference that may cause undesired operation.

- ▶ For vehicles sold in Canada

Operation is subject to the following two conditions: (1) this device may not cause interference, and (2) this device must accept any interference, including interference that may cause undesired operation of the device.

 **CAUTION**

■ Handling the radar sensor

Observe the following to ensure the pre-collision system can function effectively.

- Keep the sensor and grille cover clean at all time.
Clean the sensor and grille cover with a soft cloth so you do not mark or damage them.
- Do not subject the sensor or surrounding area to a strong impact.
If the sensor moves even slightly off position, the system may malfunction.
If the sensor or surrounding area is subject to a strong impact, always have the area inspected and adjusted by your Toyota dealer.
- Do not disassemble the sensor.
- Do not attach accessories or stickers to the sensor, grille cover or surrounding area.
- Do not modify or paint the sensor and grille cover.

■ Limitations of the pre-collision system

Do not rely on the pre-collision system. Always drive safely, taking care to observe your surroundings and checking for any obstacles or other road hazards.

Take notice of the following information about storage precautions, cargo capacity and load.

- Stow cargo and luggage in the luggage compartment whenever possible. Be sure all items are secured in place.
- Be careful to keep the vehicle level. Placing the weight as far forward as possible helps maintain vehicle balance.
- For better fuel economy, do not carry unnecessary weight.

Capacity and distribution

Cargo capacity depends on the total weight of the occupants.

(Cargo capacity) = (Total load capacity) — (Total weight of occupants)

Steps for Determining Correct Load Limit—

- (1) Locate the statement “The combined weight of occupants and cargo should never exceed XXX kg or XXX lbs.” on your vehicle’s placard.
- (2) Determine the combined weight of the driver and passengers that will be riding in your vehicle.
- (3) Subtract the combined weight of the driver and passengers from XXX kg or XXX lbs.
- (4) The resulting figure equals the available amount of cargo and luggage load capacity.

For example, if the “XXX” amount equals 1400 lbs. and there will be five 150 lb passengers in your vehicle, the amount of available cargo and luggage load capacity is 650 lbs. (1400 - 750 (5 × 150) = 650 lbs.)

- (5) Determine the combined weight of luggage and cargo being loaded on the vehicle.

That weight may not safely exceed the available cargo and luggage load capacity calculated in Step 4.

- (6) If your vehicle will be towing a trailer, load from your trailer will be transferred to your vehicle. Consult this manual to determine how this reduces the available cargo and luggage load capacity of your vehicle. (→P. 260)

Toyota does not recommend towing a trailer with your vehicle. Your vehicle is not designed for trailer towing.

Example on your vehicle

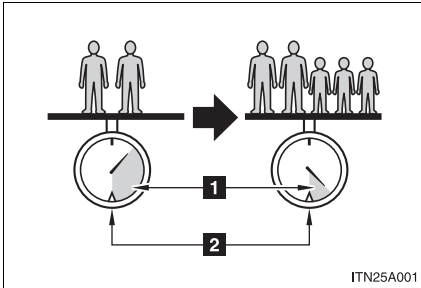

- 1** Cargo capacity
- 2** Total load capacity

When 2 people with the combined weight of 366 lb. (166 kg) are riding in your vehicle, which has a total load capacity of 825 lb. (370 kg), the available amount of cargo and luggage load capacity will be as follows:

$$825 \text{ lb.} - 366 \text{ lb.} = 459 \text{ lb.} \quad (370 \text{ kg} - 166 \text{ kg} = 204 \text{ kg})$$

In this condition, if 3 more passengers with the combined weight of 388 lb. (176 kg) get on, the available cargo and luggage load will be reduced as follows:

$$459 \text{ lb.} - 388 \text{ lb.} = 71 \text{ lb.} \quad (204 \text{ kg} - 176 \text{ kg} = 28 \text{ kg})$$

As shown in the above example, if the number of occupants increases, the cargo and luggage load equaling the combined weight of the occupants who got on later, by an amount. In other words, if an increase in the number of occupants causes an excess of the total load capacity (combined weight of occupants plus cargo and luggage load), you must reduce the cargo and luggage on your vehicle.

 **CAUTION**

■ **Things that must not be carried in the luggage compartment**

The following things may cause a fire if loaded in the luggage compartment.

- Receptacles containing gasoline
- Aerosol cans

■ **Storage precautions**

Observe the following precautions.

Failing to do so may result in death or serious injury.

- Do not place cargo or luggage in or on the following locations as the item may get under the brake or accelerator pedal and prevent the pedals from being depressed properly, block the driver's vision, or hit the driver or passengers, causing an accident.
 - Driver's feet
 - Front passenger or rear seats (when stacking items)
 - Luggage cover (if equipped)
 - Instrument panel
 - Dashboard
 - Auxiliary box or tray that has no lid
- Secure all items in the occupant compartment, as they may shift and injure someone during sudden braking, sudden swerving or an accident.
- Never allow anyone to ride in the luggage compartment. It is not designed for passengers. They should ride in their seats with their seat belts properly fastened. Otherwise, they are much more likely to suffer death or serious injury, in the event of sudden braking, sudden swerving or an accident.

 CAUTION**■ Weight of the load**

- Do not exceed the maximum axle weight rating or the total vehicle weight rating.
- Even if the total load of occupant's weight and the cargo load is less than the total load capacity, do not apply the load unevenly. Improper loading may cause deterioration of steering or braking control which may cause death or serious injury.

2-5. Driving information

Vehicle load limits

Vehicle load limits include total load capacity, seating capacity, towing capacity and cargo capacity.

■ **Total load capacity: 825 lb. (370 kg)**

Total load capacity means the combined weight of occupants, cargo and luggage.

■ **Seating capacity: 5 occupants (Front 2, Rear 3)**

Seating capacity means the maximum number of occupants whose estimated average weight is 150 lb. (68 kg) per person.

Even if the number of occupants are within the seating capacity, do not exceed the total load capacity.

■ **Towing capacity**

Toyota does not recommend towing a trailer with your vehicle.

■ **Cargo capacity**

Cargo capacity may increase or decrease depending on the weight and the number of occupants.

■ **Total load capacity and seating capacity**

These details are also described on the tire and loading information label. (→P. 451)

 **CAUTION**

■ **Overloading the vehicle**

Do not overload the vehicle.

It may not only cause damage to the tires, but also degrade steering and braking ability, resulting in an accident.

Carry out the necessary preparations and inspections before driving the vehicle in winter. Always drive the vehicle in a manner appropriate to the prevailing weather conditions.

■ **Pre-winter preparations**

- Use fluids that are appropriate to the prevailing outside temperatures.
 - Engine oil
 - Engine/power control unit coolant
 - Washer fluid
- Have a service technician inspect the level and specific gravity of 12 volt battery electrolyte.
- Have the vehicle fitted with four snow tires or purchase a set of tire chains for the front tires.

Ensure that all tires are the same size and brand, and that chains match the size of the tires.

■ Before driving the vehicle

Perform the following according to the driving conditions.

- Do not try to forcibly open a window or move a wiper that is frozen. Pour warm water over the frozen area to melt the ice. Wipe away the water immediately to prevent it from freezing.
- To ensure proper operation of the climate control system fan, remove any snow that has accumulated on the air inlet vents in front of the windshield.
- Remove any ice that has accumulated on the vehicle chassis.
- Periodically check for and remove any excess ice or snow that may have accumulated in the wheel well or on the brakes.

■ When driving the vehicle

Accelerate the vehicle slowly and drive at a reduced speed suitable to road conditions.

■ When parking the vehicle

Park the vehicle and push the “P” position switch without setting the parking brake. The parking brake may freeze up, preventing it from being released. If necessary block the wheels to prevent inadvertent sliding or creeping.

Selecting tire chains

► Vehicles with 17-inch tires

Use the correct tire chain size when mounting the tire chains.
Chain size is regulated for each tire size.

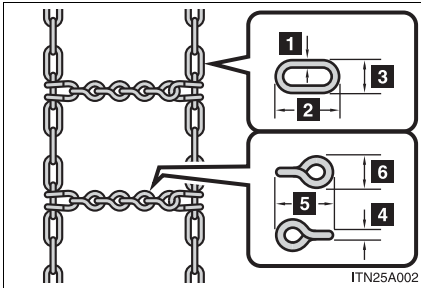

Side chain:

- 1** 0.12 in. (3.0 mm)
- 2** 1.18 in. (30.0 mm)
- 3** 0.39 in. (10.0 mm)

Cross chain:

- 4** 0.16 in. (4.0 mm)
- 5** 0.98 in. (25.0 mm)
- 6** 0.55 in. (14.0 mm)

► Vehicles with 15-inch tires

Use the tire chains of correct size and type.

Use SAE Class “S” type radial tire chains except radial cable chains or V-bar type chains.

Regulations on the use of tire chains

- Regulations regarding the use of tire chains vary according to location and type of road. Always check local regulations before installing chains.
- Retighten the chains after driving 1/4 - 1/2 mile (0.5 - 1.0 km).

■ Tire chains

Observe the following precautions when installing and removing chains.

- Install and remove tire chains in a safe location.
- Install tire chains on the front tires.
- Install tire chains following the instructions provided in the accompanying manual.

CAUTION

■ Driving with snow tires

Observe the following precautions to reduce the risk of accidents. Failing to do so may result in a loss of vehicle control and cause death or serious injury.

- Use tires of the size specified for your vehicle.
- Maintain the specified level of tire inflation pressure.
- Do not drive in excess of 75 mph (120 km/h), regardless of the type of snow tires being used.
- Snow tires should be installed on all wheels.

 CAUTION**■ Driving with tire chains**

Observe the following precautions to reduce the risk of accidents. Failing to do so may result in the vehicle being unable to be driven safely, and may cause death or serious injury.

- Do not drive in excess of the speed limit specified for the tire chains being used, or 30 mph (50 km/h), whichever is lower.
- Avoid driving on bumpy road surfaces or over potholes.
- Avoid sudden turns and braking, as use of chains may adversely affect vehicle handling.
- Slow down sufficiently before entering a curve to ensure that vehicle control is maintained.

 NOTICE**■ Repairing or replacing snow tires**

Request repairs of and obtain replacement snow tires from Toyota dealers. This is because the removal and attachment of snow tires affects the operation of the tire pressure warning valves and transmitters.

■ Fitting tire chains

The tire pressure warning valves and transmitters may not function correctly when tire chains are fitted.

Trailer towing

Toyota does not recommend towing a trailer with your vehicle. Toyota also does not recommend the installation of a tow hitch or the use of a tow hitch carrier for a wheelchair, scooter, bicycle, etc. Your Toyota is not designed for trailer towing or for the use of tow hitch mounted carriers.



2-5. Driving information

Dinghy towing

Your vehicle is not designed to be dinghy towed (with 4 wheels on the ground) behind a motor home.

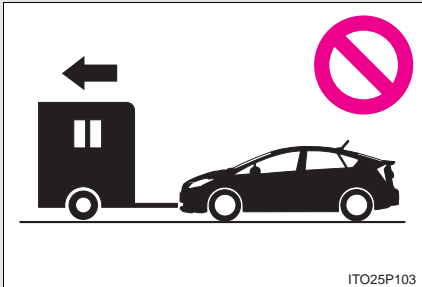

 NOTICE

■ To avoid serious damage to your vehicle

Do not tow your vehicle with four wheels on the ground.

3-1. Using the air conditioning system and defogger

Air conditioning system

Airflow and outlets are automatically adjusted according to the temperature setting.

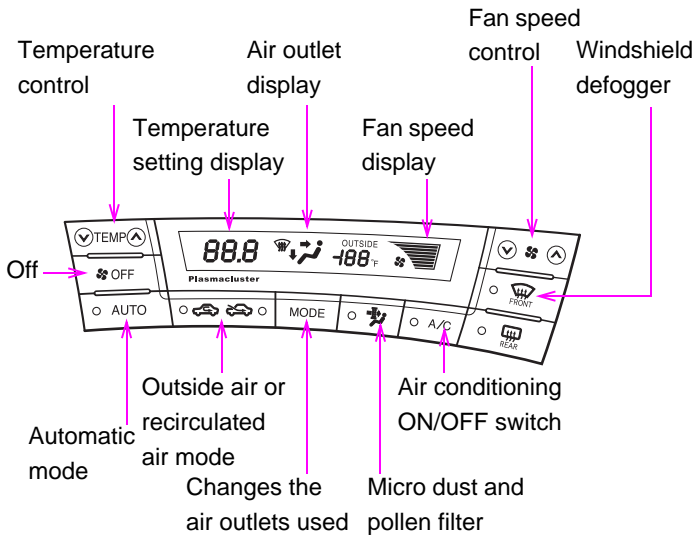

ITO31P101

Using the automatic mode

STEP 1 Press .

The air conditioning system will begin to operate. Air outlets and fan speed are automatically adjusted according to the temperature setting.

STEP 2 Press \wedge to increase the temperature and \vee to decrease the temperature on the .

Adjusting the settings

■ Adjusting the temperature setting

Press \wedge to increase the temperature and \vee to decrease the temperature on the .

■ Adjusting the fan speed

Press \wedge (increase) or \vee (decrease) on .

The fan speed is shown on the display. (7 levels)

Press  to turn the fan off.

■ Changing the air outlets

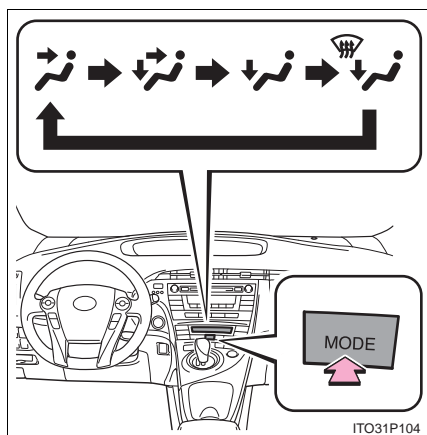

Press  .

The air outlets switch each time the button is pressed.

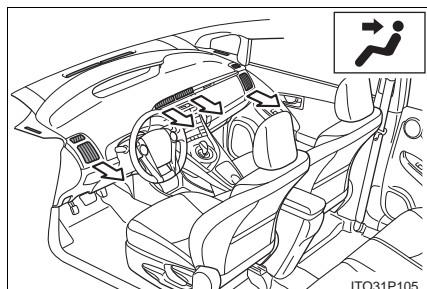

Air flows to the upper body.

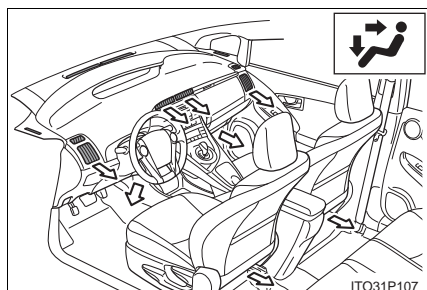

Air flows to the upper body and feet.

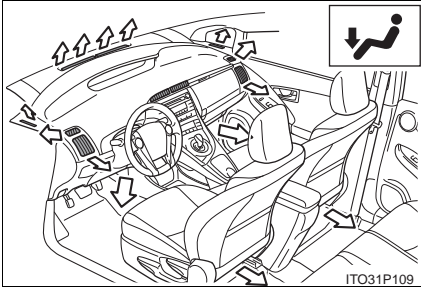

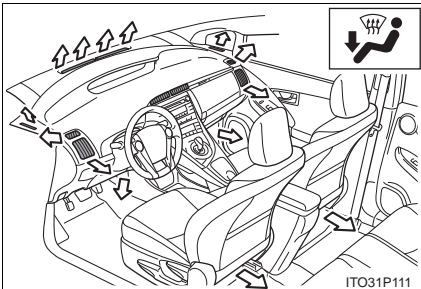

Mainly air flows to the feet.



Air flows to the feet and the windshield defogger operates.

■ Switching between outside air and recirculated air modes

Press  .

The modes switches between  (recycles air inside the vehicle) and  (introduces air from outside the vehicle) modes each time the button is pressed.

Defogging the windshield

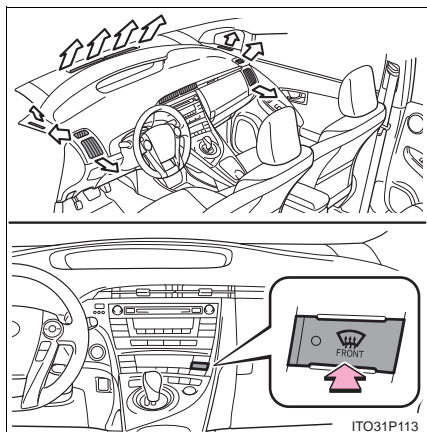

Press  .

The air conditioning system control operates automatically.

Recirculated air mode will automatically switch to outside air mode.

Micro dust and pollen filter

Press  .

Outside air mode switches to recirculated air mode. Pollen is removed from the air and the air flows to the upper part of the body.

Usually the system will turn off automatically approximately 3 minutes later.

To stop the operation, press  again.

Adjusting the position of the air outlets

► Center outlets

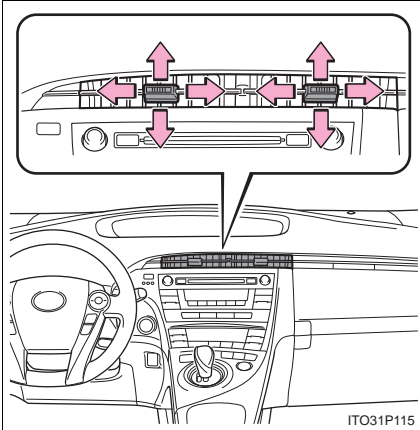

Direct air flow to the left or right, up or down.

► Right and left side outlets

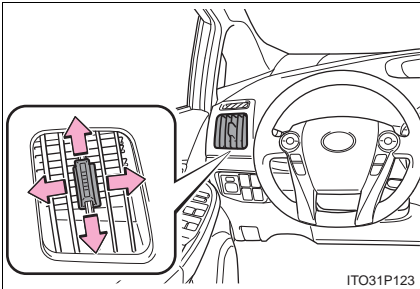

Direct air flow to the left or right, up or down.

Opening and closing the air outlets

► Center outlets

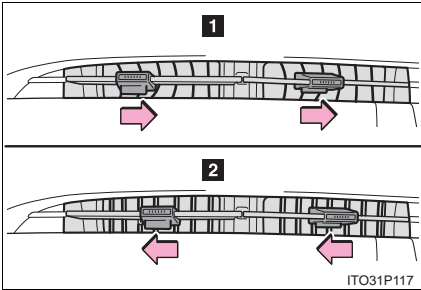

- 1 Open the vent.
- 2 Close the vent.

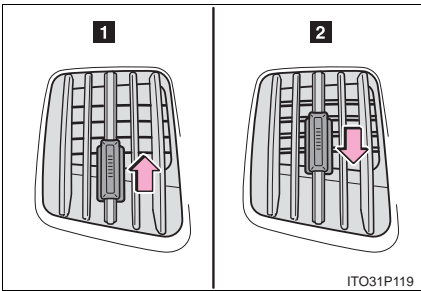

► Right and left side outlets



- 1 Open the vent.
- 2 Close the vent.

■ Using the automatic mode

Fan speed is adjusted automatically in accordance with the temperature setting and ambient conditions. As a result, the following may occur.

- Immediately after  is pressed, the fan may stop for a while until warm or cool air is ready to flow.
- Cool air may flow to the area around the upper body when the heater is on.
-  does not operate even if it pushes .

■ Using the system in recirculated air mode

The windows will fog up more easily if the recirculated air mode is used for an extended period.

■ Switching between outside air and recirculated air modes

Recirculated air mode or outside air mode may be automatically switched to in accordance with under these condition, such as temperature setting and inside temperature.

■ Window defogger feature

Recirculated air mode may automatically switch to outside air mode in situations where the windows need to be defogged.

■ When outside temperature approaches 32 °F (0 °C)

The air conditioning system may not operate even when  is pressed.

■ Micro dust and pollen filter

- In order to prevent the windows from fogging up when the outside air is cold, the following may occur.
 - Outside air mode does not switch to recirculated air mode.
 - The air conditioning system operates automatically.
 - The operation cancels after 1 minute.
- In rainy weather, the windows may fog up. Press .

■ When Eco Driving mode is on

- If the outside temperature exceeds a preset temperature, the system will switch to recirculated air mode.
- The effectiveness of the air conditioning will be lower than normal.
- The fan speed level drops below the normal rate.

■ Plasmacluster™* (if equipped)

Plasmacluster will operate in conjunction with the air conditioning fan motor when it is turned on.

This air conditioning system adopts plasmacluster technology, which helps to keep good air quality in the cabin by emitting positive and negative ions through the driver's side vent.

A slight noise may be heard during operation. This is not a malfunction. Also, static electricity may be discharged near the driver's side vent due to the high voltage used to operate the system.

To clean the driver's side vent, turn the system off and wipe the vent using a soft cloth.

*: Plasmacluster technology is manufactured under license from the SHARP Corporation.

“Plasmacluster™” is a trademark of the SHARP Corporation.

■ Air conditioning odors

- During use, various odors from inside and outside the vehicle may enter into and accumulate in the air conditioning system. This may then cause odor to be emitted from the vents.
- To reduce potential odors from occurring:
 - It is recommended that the air conditioning system be set to outside air mode prior to turning the vehicle off.

- The start timing of the blower may be delayed for a short period of time immediately after the air conditioning system is started in automatic mode.

⚠ CAUTION**■ To prevent the windshield from fogging up**

Do not use  during cool air operation in extremely humid weather. The difference between the temperature of the outside air and that of the windshield can cause the outer surface of the windshield to fog up, blocking your vision.

■ Plasmacluster™

Do not disassemble or repair the system because it contains high voltage parts. Call your Toyota dealer if the system needs repair.

⚠ NOTICE**■ To prevent 12 volt battery discharge**

Do not leave the air conditioning system on longer than necessary when the hybrid system is not operating.

■ To prevent damage to the Plasmacluster™

Do not insert anything into the driver's side vent, attach anything to it, or use sprays around the driver's side vent. These things may cause the system no to work properly.

3-1. Using the air conditioning system and defogger Using the steering wheel climate remote control switches

Some air conditioning features can be controlled using the switches on the steering wheel.

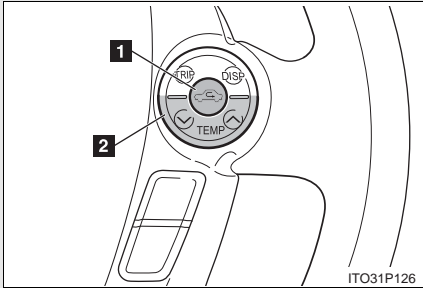

- 1** Outside air or recirculated air mode
- 2** Temperature control

Adjusting the temperature setting

Press “^” on  to increase the temperature and “v” to decrease the temperature.

Changing the recirculated air mode

Press .

The mode switches between outside air mode and recirculated air mode each time the switch is pressed.

■ When operating the steering switches

On vehicles with touch tracer display, the steering switches operation status is displayed on the instrument cluster for confirmation purposes. (→P. 182)

CAUTION

■ To reduce the risk of an accident

Exercise care when operating the air conditioning switches on the steering wheel.

3-1. Using the air conditioning system and defogger Solar Ventilation System*

The Solar Ventilation System uses energy provided by solar panel built into the roof to operate a fan contained within the air conditioning system, allowing ventilation of the vehicle interior when the vehicle is parked in direct sunlight.

■ Activating the Solar Ventilation System

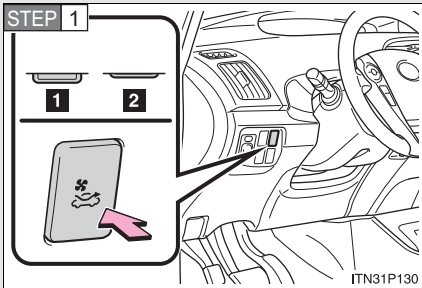

With the “POWER” switch in ON mode, turn on the ventilation switch.

- 1** Off
- 2** On

STEP 2 Turn the “POWER” switch OFF.

After approximately 1 minute, outside air mode will be selected and the air vents will be put into FACE mode.

After approximately 10 minutes, the ventilation operation will commence.

The ventilation operation will be canceled if the “POWER” switch is turned to ON mode or the ventilation switch is turned off.

*: If equipped

■ Efficient use of the Solar Ventilation System

Efficient control of temperature increase can be achieved by using the system in conjunction with the Remote Air Conditioning System. (→P. 285)

■ Operating conditions

The Solar Ventilation System may not operate under the following circumstances due to a lack of power from the solar panel:

- Low amount of sunlight
- Ever when a part of the solar panel is cast by a shadow.
- Ever when a part of the solar panel is covered by fallen leaves or dirt.
- The solar panel is not at a high temperature.

■ When using the Solar Ventilation System

- Make sure that the “POWER” switch is in ON mode when turning the ventilation switch on. If the ventilation switch is turned on while the “POWER” switch is OFF, the air mode and the status of the air vents will remain unchanged.
- Remove dirt or fallen leaves from the solar panel in order to ensure sufficient electrical output.
- If the Solar Ventilation System is not needed, be sure to turn the ventilation switch off, otherwise the following problems may occur:
 - Dirty air and exhaust fumes from other vehicles may be drawn from outside.
 - Use in winter may cause heated interior air to leave the vehicle, thus leading to a drop in temperature.

■ Noises when using the Solar Ventilation System

If the amount of sunlight is insufficient, you may hear a sound coming from the air conditioning system. This is the sound of a control function to preserve the fan and does not indicate a malfunction.

 CAUTION

■ **Solar Ventilation System precautions**

- Do not use the system if people are inside the vehicle.
The Solar Ventilation System is not intended to ensure the performance of the air conditioning system. Do not leave children or pets in the vehicle. The temperature of the interior will remain high, possibly resulting in heat-stroke, dehydration, or even death.
- This system should be used only for the relief of discomfort when entering the vehicle, and should not be used for other purposes.
- Be careful not to touch the solar panel surface in scorching sun weather conditions as it will rise very high in temperature and may cause burns.

3-1. Using the air conditioning system and defogger Remote Air Conditioning System*

The Remote Air Conditioning System uses electrical energy stored in the hybrid battery (traction battery) and allows the air conditioning to be operated by remote control.

■ Activating the Remote Air Conditioning System

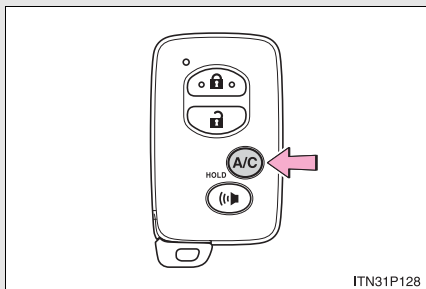

Press and hold the  to operate the Remote Air Conditioning System.

- The system will shut off if a door is opened.
- The system can be stopped by pressing the  twice.

■ Using the Remote Air Conditioning System effectively

Efficiency can be increased by using the system in conjunction with the Solar Ventilation System. (→P. 282)

*: If equipped

■ Operating conditions

The system will only operate if all of the following conditions are met:

- The shift position is in “P”.
- The “POWER” switch is OFF.
- All doors are closed.
- The hood is closed.
- The brake pedal is not being depressed.
- The air conditioning is not set to MAX HOT.

■ When leaving the vehicle

- Check that the headlights are switched to either off or “AUTO”.
- Check that the wiper switch is turned off.
- Check that all windows are closed.
- Check the temperature setting of the air conditioning system.
The Remote Air Conditioning System will operate in accordance with the temperature settings of the air conditioning system.

■ Remote Air Conditioning System automatic shut-off

The system will automatically shut off under the following conditions:

- About 3 minutes have passed since operation began
- Any one of the operating conditions is not met

The system may also shut off if the charge level of the hybrid battery (traction battery) drops to low. (→P. 188)

■ Conditions affecting operation

The system may not start in the following situations:

- The charge level of the hybrid battery (traction battery) is low (→P. 188)
- The air conditioning temperature is set at a high level

■ **Security feature**

Any unlocked doors will be automatically locked when the system is operating. The buzzer will beep and the emergency flashers flash when the doors have been locked or the system has been turned off.

(The doors locked: Once; The system turned off: Twice)

■ **If the wireless remote control does not function properly**

→P. 65

■ **Customization that can be configured at Toyota dealer**

Setting (e.g.Operation using the  on the wireless remote control) can be changed.

(Customizable features →P. 587)

 CAUTION

■ **Precautions for the Remote Air Conditioning System**

Do not use the system if people are in the vehicle.

- Even when the system is in use, the internal temperature may still reach a high level due to features such as the automatic shut-off. Children and pets left inside the vehicle may suffer heatstroke or dehydration, or could result in death or serious injury.
- The wipers can be operated during system operation. Children or pets left inside the vehicle may mistakenly operate these and cause an accident.
- Turn the wipers off. If the Remote Air Conditioning System operates while the wiper switch is in the on position, the wipers may operate and objects may get caught in the wiper blades.
- Do not operate the  if the hood is open. The air conditioning may operate unintentionally and objects may be drawn into the electrical cooling fan.
- Depending on the surrounding environment, signals from the wireless switch may transmit further than expected. Pay appropriate attention to the vehicle's surroundings and use the switch only when necessary.

 NOTICE

■ **To prevent the hybrid battery (traction battery) from being discharged through incorrect operation**

Use the  only when necessary.

3-1. Using the air conditioning system and defogger Rear window and outside rear view mirror defoggers

Clear the rear window using the defogger. (Turning the rear window defogger on will turn the outside rear view mirror defoggers on. The outside rear view mirror is used to remove raindrops, dew and frost from the outside rear view mirrors.) (vehicles with mirror defoggers)

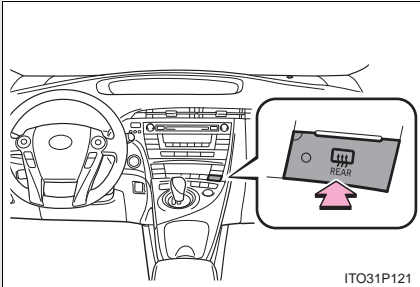

The defoggers will automatically turn off after approximately 15 minutes. Pressing the switch again also turns the rear window defogger off.

■ **The rear window and outside rear view mirror defoggers can be operated when**

The “POWER” switch must be in the ON mode.

 **CAUTION**

■ **When the outside rear view mirror defoggers are on (vehicles with mirror defoggers)**

Do not touch the rear view mirror surfaces, as they can become very hot and burn you.

 **NOTICE**

■ **To prevent 12 volt battery discharge**

Turn the defoggers off when the hybrid system is not operating.

3-2. Using the audio system

Audio system type

▶ With navigation system

Owners of models equipped with a navigation system should refer to the “Navigation System Owner’s Manual”.

▶ Without navigation system

Type A: CD player with changer and AM/FM radio

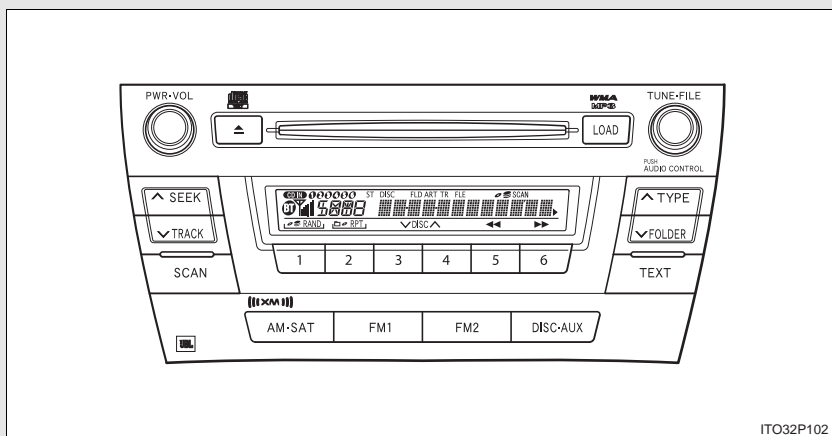

Type B: CD player and AM/FM radio (with CD changer controller)

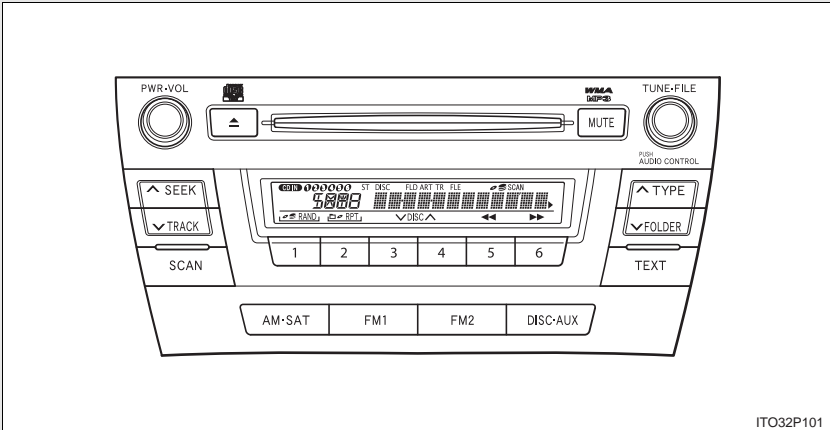

Title	Page
Using the radio	P. 294
Using the CD player	P. 303
Playing back MP3 and WMA discs	P. 311
Optimal use of the audio system	P. 319
Using the AUX adapter	P. 322
Using the steering switches	P. 323

■ Using cellular phones

Interference may be heard through the audio system's speakers if a cellular phone is being used inside or close to the vehicle while the audio system is operating.

 **CAUTION****■ For vehicles sold in the U.S.A.****● Part 15 of the FCC Rules****FCC Warning:**

Any unauthorized changes or modifications to this equipment will void the user's authority to operate this device.

● Laser products

- Do not take this unit apart or attempt to make any changes yourself. This is an intricate unit that uses a laser pickup to retrieve information from the surface of compact discs. The laser is carefully shielded so that its rays remain inside the cabinet. Therefore, never try to disassemble the player or alter any of its parts since you may be exposed to laser rays and dangerous voltages.
- This product utilizes a laser. Use of controls or adjustments or performance of procedures other than those specified herein may result in hazardous radiation exposure.

 **NOTICE****■ To prevent 12 volt battery discharge**

Do not leave the audio system on longer than necessary with the hybrid system is not operating.

■ To avoid damaging the audio system

Take care not to spill drinks or other fluids over the audio system.

3-2. Using the audio system

Using the radio

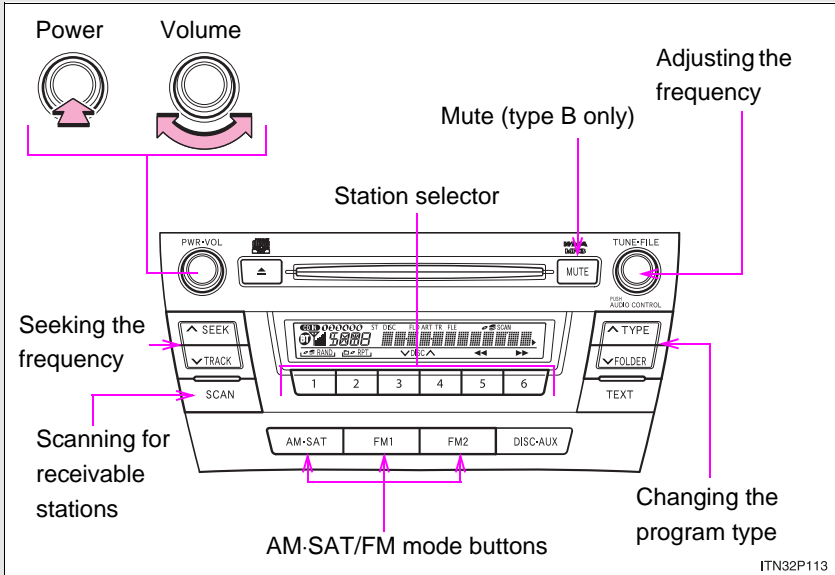

Press **AM-SAT**, **FM1** or **FM2** to choose either an AM or FM band.



Setting station presets (excluding XM[®] Satellite Radio)

STEP 1 Search for desired stations by turning  or pressing “^” or



STEP 2 Press and hold the button (from  to ) the station is to be set to, and you hear a beep.

Scanning radio stations (excluding XM[®] Satellite Radio)

■ Scanning the preset radio stations

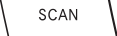
STEP 1 Press and hold  until you hear a beep.

Preset stations will be played for a few seconds each.

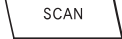
STEP 2 When the desired station is reached, press  once again.

■ Scanning all radio stations within range

STEP 1 Press  .

“SCAN” appears on the display and all stations with reception will be played for a few seconds each.

STEP 2 When the desired station is reached, press  once again.

XM[®] Satellite Radio (if equipped)

■ Receiving XM[®] Satellite Radio

STEP 1 Press  until “SAT” shows in the display.

The display changes as follows each time the button is pressed.



“AM” → “SAT1” → “SAT2” → “SAT3”



STEP 2 Turn  to select a desired channel from all the categories

or press “^” or “v” on  to select a desired channel in the current category.

■ Presetting XM[®] Satellite Radio channels

Select the desired channel. Press and hold the button (from  to ) until you hear a beep.

■ Changing the channel category

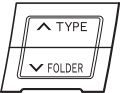
Press “^” or “v” on  .

■ Scanning XM[®] Satellite Radio channels

- Scanning channels in the current category

STEP 1 Press  .

STEP 2 When the desired channel is reached, press the button again.

- Scanning preset channels

STEP 1 Press and hold  until you hear a beep.

STEP 2 When the desired channel is reached, press the button again.

■ Displaying text information

Press  .

The display will show up to 10 characters.

The display changes as follows each time the button is pressed.

- CH NAME
- TITLE (SONG/PROGRAM TITLE)
- NAME (ARTIST NAME/FEATURE)
- CH NUMBER

Silencing the sound (type B only)

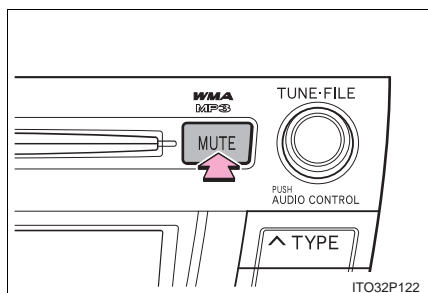

Press .

Push the button again to turn the system back on.

■ When the 12 volt battery is disconnected

All preset stations are erased.

■ Reception sensitivity

- Maintaining perfect radio reception at all times is difficult due to the continually changing position of the antenna, differences in signal strength and surrounding objects, such as trains, transmitters, etc.
- The radio antenna is mounted on the rear roof. The antenna can be removed from the base by turning.

■ Receiving XM[®] Satellite Radio

An XM[®] Satellite Radio is a tuner designed exclusively to receive broadcasts provided under a separate subscription. Availability is limited to the 48 contiguous states and 10 Canadian provinces.

● XM[®] subscriptions

For detailed information about XM[®] Satellite Radio or to subscribe:
U.S.A—

Visit on the web at www.xmradio.com or call 1-800-967-2346.

Canada—

Visit on the web at www.xmradio.ca or call 1-877-438-9677.

● Radio ID

You will need the radio ID when activating XM[®] service or reporting a problem. Select “CH000” using , and the receiver's 8-character ID number will appear.

● Satellite tuner

The tuner supports only Audio Services (Music and Talk) and the accompanying Text Information of XM[®] Satellite Radio.

■ If the satellite radio does not operate normally

If a problem occurs with the XM[®] tuner, a message will appear on the display. Refer to the table below to identify the problem, and take the suggested corrective action.

ANTENNA	The XM [®] antenna is not connected. Check whether the XM [®] antenna cable is attached securely.
	There is a short-circuit in the antenna or the surrounding antenna cable. See a Toyota certified dealer.
UPDATING	You have not subscribed to XM [®] Satellite Radio. The radio is being updated with the latest encryption code. Contact XM [®] Satellite Radio for subscription information. When a contract is canceled, you can choose "CH000" and all free-to-air channels.
	The premium channel you selected is not authorized. Wait for about 2 seconds until the radio returns to the previous channel or "CH001". If it does not change automatically, select another channel. If you want to listen to the premium channel, contact XM [®] Satellite Radio.
NO SIGNAL	The XM [®] signal is too weak at the current location. Wait until your vehicle reaches a location with a stronger signal.
LOADING	The unit is acquiring audio or program information. Wait until the unit has received the information.
OFF AIR	The channel you selected is not broadcasting any programming. Select another channel.

-----	There is no song/program title or artist name/feature associated with the channel at that time. No action needed.
---	The channel you selected is no longer available. Wait for about 2 seconds until the radio returns to the previous channel or "CH001". If it does not change automatically, select another channel.

Contact the XM[®] Listener Care Center at 1-800-967-2346 (U.S.A.) or 1-877-438-9677 (Canada).

■ Certifications for the radio tuner

This equipment has been tested and found to comply with the limits for a class B digital device, pursuant to Part 15 of the FCC Rules. These limits are designed to provide reasonable protection against harmful interference in a residential installation. This equipment generates, uses and can radiate radio frequency energy and, if not installed and used in accordance with the instructions, may cause harmful interference to radio communications. However, there is no guarantee that interference will not occur in a particular installation.

If this equipment does cause harmful interference to radio or television reception, which can be determined by turning the equipment off and on, the user is encouraged to try to correct the interference by trying one or more of the following:

- Reorienting or relocating the receiving antenna.
- Increasing the separation between the equipment and receiver.
- Connecting the equipment into an outlet on a circuit different from that to which the receiver is connected.
- Consulting the dealer or an experienced radio/TV technician for help.

 NOTICE

■ **To prevent damage, remove the antenna in the following cases**

- The antenna will touch the ceiling of a garage.
- A cover will be put on the roof.
- When driving through an automatic car wash.
- Any other cases where there is a risk of touching surrounding parts.

3-2. Using the audio system

Using the CD player

Insert a CD or press **DISC-AUX** with a CD inserted.

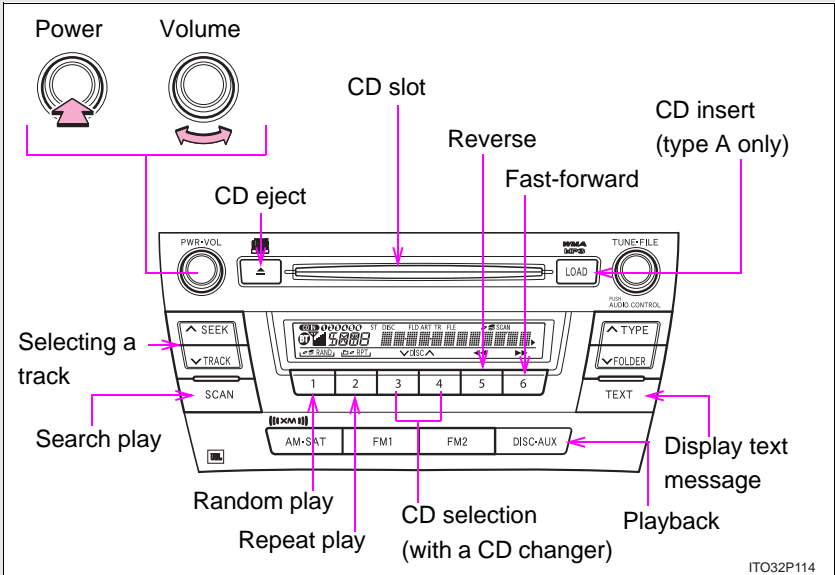

Loading a CDs

■ Loading a single CD

▶ Type A

STEP 1 Press .

STEP 2 Insert a CD when the indicator on the slot turns from amber to green.

▶ Type B

Insert a CD.

■ Loading multiple CDs (type A only)

STEP 1 Press and hold  until you hear a beep.

STEP 2 Insert a CD when the indicator on the slot turns from amber to green.

The indicator on the slot turns to amber when the CD is inserted.

STEP 3 Insert the next CD when the indicator on the slot turns from amber to green again.



Repeat the procedure for the remaining CDs.

To cancel the operation, press .

Ejecting CDs

■ Ejecting a CD

▶ Type A

STEP 1 To select the CD to be ejected, press  (√ DISC) or  (DISC ^).

The number of the CD selected is shown on the display.

STEP 2 Press  and remove the CD.

▶ Type B



Press  and remove the CD.

■ Ejecting all CDs (type A only)

Press and hold  until you hear a beep, then remove the CDs.

Selecting a CD (with a CD changer)

■ To select a CD to play

Press  (√ DISC) or  (DISC ^) until the desired CD number appears on the display.

■ To scan loaded CDs

STEP 1 Press and hold  until you hear a beep.

The first 10 seconds of the first track on each CD will be played.

STEP 2 Press  once again when the desired CD is reached.

Selecting a track

Press “^” to move up or “v” to move down using  until the desired track number appears on the display.

Fast forwarding and rewinding tracks

Press and hold  (rewind) or  (fast forward).

Scanning a CD

STEP 1 Press .

The first 10 seconds of each track will be played.

STEP 2 Press  once again when the desired track is reached.

Random playback

■ Current CD

Touch  (RAND).

Tracks are played in random order until the button is pressed once again.

■ All CDs (with a CD changer)

Press and hold  (RAND) until you hear a beep.

Tracks on all loaded CDs are played in random order until the button is pressed once again.

Repeating a track or a disc

■ Repeating a track

Press  (RPT).

■ Repeating a disc (with a CD changer)

Press and hold  (RPT) until you hear a beep.

Switching the display

Press .

Each time the button is pressed, the display changes in the order of Track no./Elapsed time → CD title → Track name.

Silencing the sound (type B only)

→P. 298

■ Display

Up to 12 characters can be displayed at a time.

If there are 13 characters or more, pressing and holding  for 1 second or more will display the remaining characters.

A maximum of 24 characters can be displayed.

If  is pressed for 1 second or more again or has not been pressed for 6 seconds or more, the display will return to the first 12 characters.

Depending on the contents recorded, the characters may not be displayed properly or may not be displayed at all.

■ Canceling random, repeat and scan playback

Press  (RAND),  (RPT) or  again.

■ Error messages

“ERROR”: This indicates a trouble either in the CD or inside the player. The CD may be dirty, damaged or inserted up-side down.

“WAIT”: Operation has stopped due to a high temperature inside the player. Wait for a while and then press . Contact your Toyota dealer if the CD still cannot be played back.

■ Discs that can be used

Discs with the marks shown below can be used.

Playback may not be possible depending on recording format or disc features, or due to scratches, dirt or deterioration.



CDs with copy-protect features may not play correctly.

■ CD player protection feature

To protect the internal components, playback is automatically stopped when a problem is detected while the CD player is being used.

■ If CDs are left inside the CD player or in the ejected position for extended periods

CDs may be damaged and may not play properly.

■ Lens cleaners

Do not use lens cleaners. Doing so may damage the CD player.

 NOTICE

■ CDs and adapters that cannot be used

Do not use the following types of CDs, 3 in. (8 cm) CD adapters or Dual Disc.

Doing so may damage the player and/or the CD insert/eject function.

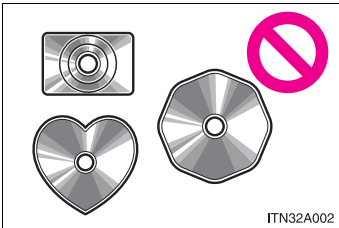

- CDs that have a diameter that is not 4.7 in. (12 cm).

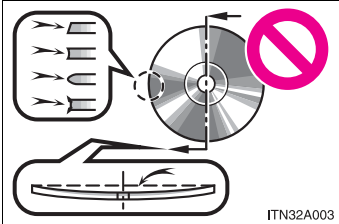

- Low-quality and deformed CDs.

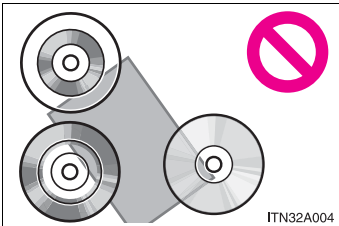

- CDs with a transparent or translucent recording area.

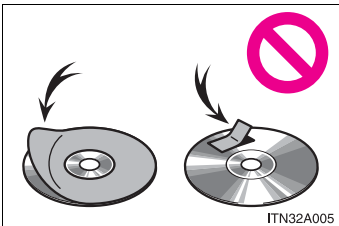

- CDs that have tape, stickers or CD-R labels attached to them, or that have the label peeled off.

 NOTICE

■ **Player precautions**

Failure to follow the precautions below may result in damage to the CDs or the player itself.

- Do not insert anything other than CDs into the CD slot.
- Do not apply oil to the player.
- Store CDs away from direct sunlight.
- Never try to disassemble any part of the player.

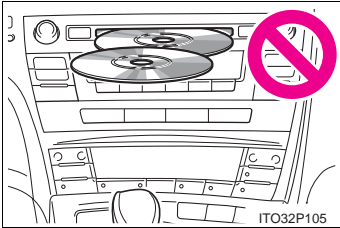

- Do not insert more than one CD at a time.

Playing back MP3 and WMA discs

Insert an MP3 or WMA disc or press **DISC-AUX** with a disc inserted.

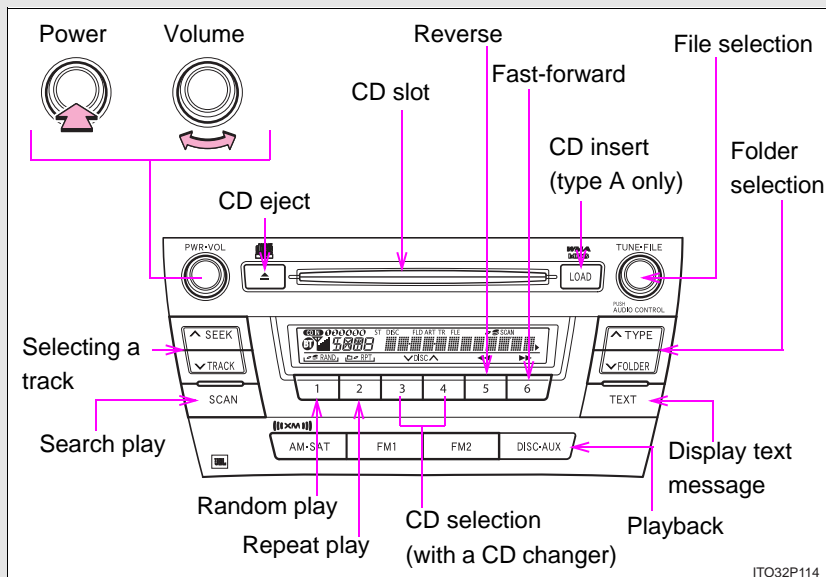

Loading and ejecting MP3 and WMA discs

Refer to the section entitled "Using the CD player" for details.
(→P. 303)

Selecting a CD (with a CD changer)

Refer to the section entitled "Using the CD player" for details.
(→P. 303)

Selecting and scanning a folder

■ Selecting folders one at a time

Press “^” or “v” on

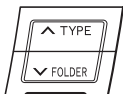

to select the desired folder.

To return to the first folder, press and hold “v” on

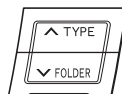

until you hear a beep.

■ Selecting the desired folder by cueing the first file of each folder

Press and hold



until you hear a beep.

When the desired folder is reached, press the switch once again.

Selecting and scanning a file

■ Selecting one file at a time

Turn  or press “^” or “v” on



to select the desired file.

■ Selecting the desired file by cueing the files in the folder

Press



When the desired file is reached, press



once again.

Fast forwarding and reversing files

Press and hold  (reverse) or  (fast forward).

Random playback

- **To play files from a particular folder in random order**

Press  (RAND).

- **To play all of the files on a disc in random order**

Press and hold  (RAND) until you hear a beep.

Repeating a file or a folder

- **Repeating a file**

Press  (RPT).

- **Repeating a folder**

Press and hold  (RPT) until you hear a beep.

Switching the display

Press  .

Each time the switch is pressed, the display changes in the order of Folder no./File no./Elapsed time→Folder name→File name→Album title (MP3 only)→Track title→Artist name.

Silencing the sound (type B only)

→P. 298

■ **Display**

→P. 307

■ **Canceling random, repeat and scan playback**

→P. 308

■ **Error messages**

“ERROR”:
This indicates a trouble either in the CD or inside the player. The CD may be dirty, damaged or inserted up-side down.

“WAIT”:
Operation has stopped due to a high temperature inside the player. Wait for a while and then press . Contact your Toyota dealer if the CD still cannot be played.

“NO MUSIC”:
This indicates that the MP3/WMA file is not included in the CD.

■ **Discs that can be used**

Discs with the marks shown below can be used.

Playback may not be possible depending on recording format or disc features, or due to scratches, dirt or deterioration.



■ **CD player protection feature**

→P. 308

■ **If CDs are left inside the CD player or in the ejected position for extended periods**

→P. 308

■ Lens cleaners

→P. 308

■ MP3 and WMA files

MP3 (MPEG Audio LAYER3) is a standard audio compression format.

Files can be compressed to approximately 1/10 of their original size by using MP3 compression.

WMA (Windows Media™ Audio) is a Microsoft audio compression format.

This format compresses audio data to a size smaller than that of the MP3 format.

There is a limit to the MP3 and WMA file standards and to the media/formats recorded by them that can be used.

● MP3 file compatibility

- Compatible standards
MP3 (MPEG1 LAYER3, MPEG2 LSF LAYER3)
- Compatible sampling frequencies
MPEG1 LAYER3: 32, 44.1, 48 (kHz)
MPEG2 LSF LAYER3: 16, 22.05, 24 (kHz)
- Compatible bit rates
MPEG1 LAYER3: 64, 80, 96, 112, 128, 160, 192, 224, 256, 320 (kbps)
- MPEG2 LSF LAYER3: 64, 80, 96, 112, 128, 144, 160 (kbps)
* Compatible with VBR
- Compatible channel modes: stereo, joint stereo, dual channel and monaural

● WMA file compatibility

- Compatible standards
WMA Ver. 7, 8, 9
- Compatible sampling frequencies
32, 44.1, 48 (kHz)
- Compatible bit rates (only compatible with 2-channel playback)
Ver. 7, 8: CBR 48, 64, 80, 96, 128, 160, 192 (kbps)
Ver. 9: CBR 48, 64, 80, 96, 128, 160, 192, 256, 320 (kbps)

● Compatible media

Media that can be used for MP3 and WMA playback are CD-Rs and CD-RWs.

Playback in some instances may not be possible, depending on the status of the CD-R or CD-RW. Playback may not be possible or the audio may jump if the disc is scratched or marked with fingerprints.

● Compatible disc formats

The following disc formats can be used.

- Disc formats: CD-ROM Mode 1 and Mode 2
CD-ROM XA Mode 2, Form 1 and Form 2
- File formats: ISO9660 Level 1, Level 2, (Romeo, Joliet)
MP3 and WMA files written in any format other than those listed above may not play correctly, and their file names and folder names may not be displayed correctly.

Items related to standards and limitations are as follows.

- Maximum directory hierarchy: 8 levels
- Maximum length of folder names/file names: 32 characters
- Maximum number of folders: 192 (including the root)
- Maximum number of files per disc: 255

- File names

The only files that can be recognized as MP3/WMA and played are those with the extension .mp3 or .wma.

- Multi-sessions

As the audio system is compatible with multi-sessions, it is possible to play discs that contain MP3 and WMA files. However, only the first session can be played.

- ID3 and WMA tags

ID3 tags can be added to MP3 files, making it possible to record the track title and artist name, etc.

The system is compatible with ID3 Ver. 1.0, 1.1, and Ver. 2.2, 2.3 ID3 tags. (The number of characters is based on ID3 Ver. 1.0 and 1.1.)

WMA tags can be added to WMA files, making it possible to record the track title and artist name in the same way as with ID3 tags.

- MP3 and WMA playback

When a disc containing MP3 or WMA files is inserted, all files on the disc are first checked. Once the file check is finished, the first MP3 or WMA file is played. To make the file check finish more quickly, we recommend you do not write in any files other than MP3 or WMA files or create any unnecessary folders.

If the discs contain a mixture of music data and MP3 or WMA format data, only music data can be played.

● Extensions

If the file extensions .mp3 and .wma are used for files other than MP3 and WMA files, they will be mistakenly recognized and played as MP3 and WMA files. This may result in large amounts of interference and damage to the speakers.

● Playback

- To play MP3 file with steady sound quality, we recommend a fixed bit rate of 128 kbps and a sampling frequency of 44.1 kHz.
- CD-R or CD-RW playback may not be possible in some instances, depending on the characteristics of the disc.
- There is a wide variety of freeware and other encoding software for MP3 and WMA files on the market, and depending on the status of the encoding and the file format, poor sound quality or noise at the start of playback may result. In some cases, playback may not be possible at all.
- When files other than MP3 or WMA files are recorded on a disc, it may take more time to recognize the disc and in some cases, playback may not be possible at all.
- Microsoft, Windows, and Windows Media are the registered trademarks of Microsoft Corporation in the U.S. and other countries.



NOTICE

■ CDs and adapters that cannot be used

→P. 309

■ Player precautions

→P. 310

Optimal use of the audio system

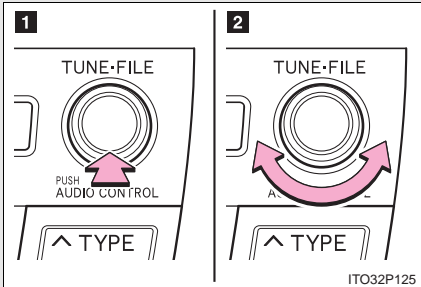

- 1 Displays the current mode
- 2 Changes the following settings

- Sound quality and volume balance

The sound quality and balance setting can be changed to produce the best sound.

- Volume and tone quality level (Automatic Sound Levelizer)

Using the AUDIO CONTROL function

■ Changing modes

Pressing  selects the mode to be change in the following order.

“BAS” → “MID” → “TRE” → “FAD” → “BAL” → “ASL”

■ Adjusting sound quality

Turning  adjusts the level.

Sound quality mode	Mode displayed	Level	Turn to the left	Turn to the right
Low-pitched tones*	BAS	-5 to 5	Low	High
Mid-pitched tones*	MID (type A only)	-5 to 5		
High pitched tones*	TRE	-5 to 5		
Front/rear volume balance	FAD	F7 to R7	Shifts to rear	Shifts to front
Left/right volume balance	BAL	L7 to R7	Shifts to left	Shifts to right

*: The sound quality level is adjusted individually in each radio or CD mode.

■ Adjusting the Automatic Sound Levelizer (ASL)

▶ Type A

When “ASL” is selected, turning  to the right turns ASL on,

and turning  to the left turns ASL off.

ASL automatically adjusts the volume and tone quality according to the noise level as you drive your vehicle.

▶ Type B

When “ASL” is selected, turning  to the right changes the ASL level in the order of “LOW”, “MID” and “HIGH”.

Turning  to the left turns off the ASL.

ASL automatically adjusts the volume and tone quality according to vehicle speed.

3-2. Using the audio system Using the AUX adapter*

This adapter can be used to connect a portable audio device and listen to it through the vehicle's speakers.

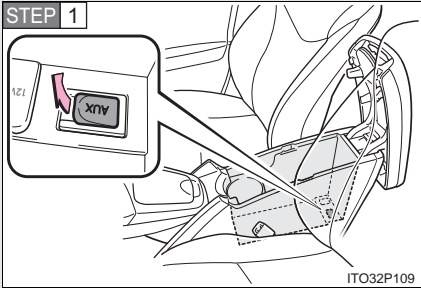

Connect the portable audio device.

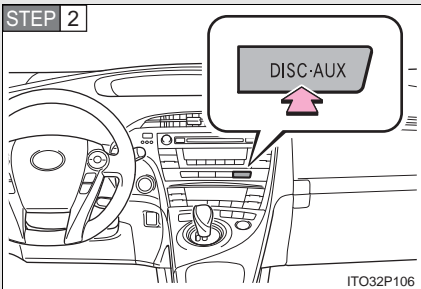

Press **DISC-AUX** .

■ Operating portable audio devices connected to the audio system

The volume can be adjusted using the vehicle's audio controls. All other adjustments must be made on the portable audio device itself.

■ When using a portable audio device connected to the power outlet

Noise may occur during playback. Use the power source of the portable audio device.

*: If equipped

Using the steering switches

Some audio features can be controlled using the switches on the steering wheel.

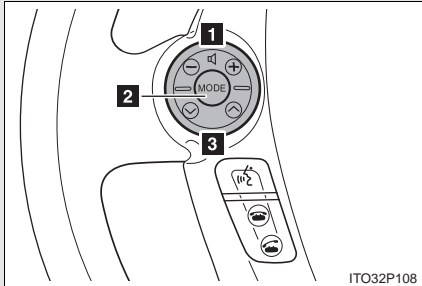

- 1** Volume
- 2** Power on, select audio source
- 3** Radio: Select radio stations
CD: Select tracks, discs and folder

Turning on the power

Press  when the audio system is turned off.

The audio system can be turned off by holding the switch down for 1 second or more.

Changing the audio source

Press  when the audio system is turned on. The audio source changes as follows each time the button is pressed. If a CD is not inserted, that mode will be skipped.

FM (1, 2) → CD player → AM → SAT (1, 2, 3)

Adjusting the volume

Press “+” on  to increase the volume and “-” to decrease the volume.

Hold down the button to continue increasing or decreasing the volume.

Selecting a radio station

STEP 1 Press  to select the radio mode.

STEP 2 Press \wedge or \vee on  to select a radio station.

To scan for receivable stations, press and hold the switch until you hear a beep.

Selecting a track

STEP 1 Press  to select the CD mode.

STEP 2 Press \wedge or \vee on  to select the desired track.

Selecting a disc or folder in the CD player (Folder selection is available only when MP3/WMA disc is in use.)

STEP 1 Press  to select the CD player.

STEP 2 Press and hold \wedge or \vee on  until you hear a beep.

■ Canceling automatic selection of a radio station

Push the same switch.

■ When operating the steering switches

On vehicles with touch tracer display, the steering switches operation status is displayed on the instrument cluster for confirmation purposes. (→P. 182)

 CAUTION**■ To reduce the risk of an accident**

Exercise care when operating the audio switches on the steering wheel.

Hands-free system (for cellular phone)*

▶ With navigation system

Owners of models equipped with a navigation system should refer to the “Navigation System Owner’s Manual”.

▶ Without navigation system

This system supports Bluetooth[®], which allows you to make or receive calls without using cables to connect a cellular phone and the system, and without operating the cellular phone.

Title	Page
Using the hands-free system	P. 329
Making a phone call	P. 338
Setting a cellular phone	P. 344
Security and system setup	P. 350
Using the phone book	P. 354

■ Conditions affecting operation

The hands-free phone system may not operate normally in the following situations:

- The cellular phone is turned off, or located outside the service area.
- The cellular phone has a low battery.
- The cellular phone is not connected to the system.
- The cellular phone is behind the seat or in the glove box, or metal material covers or touches the phone.

*: If equipped

■ **When transferring ownership of the vehicle**

Be sure to initialize the system to prevent the personal data from being improperly accessed.

■ **About Bluetooth®**

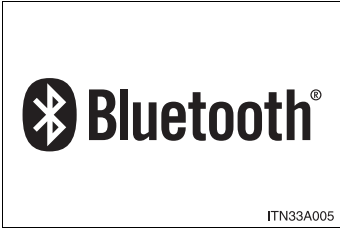

Bluetooth is a registered trademark of Bluetooth SIG, Inc.

■ **Compatible models**

Compatible with HFP (Hands Free Profile) Ver. 1.0 and OPP (Object Push Profile) Ver. 1.1.

If your cellular phone does not support HFP, you cannot enter the Bluetooth® phone, and take OPP service individually.

■ **Certification for the hands-free system**

FCC ID: ACJ932C5ZZZ035

IC ID: 216J-C5ZZZ035

NOTE:

This device complies with Part 15 of the FCC Rules. Operation is subject to the following two conditions: (1) this device may not cause harmful interference, and (2) this device must accept any interference received, including interference that may cause undesired operation.

FCC WARNING:

Changes or modifications not expressly approved by the party responsible for compliance could void the user's authority to operate the equipment.

 CAUTION

■ **While driving**

Do not use a cellular phone, or connect the Bluetooth® phone.

 NOTICE

■ **To prevent damage to a cellular phone**

Do not leave a cellular phone in the vehicle. The temperature inside may become high resulting in damage to the phone.

3-3. Using the hands-free system (for cellular phone)

Using the hands-free system

■ Audio unit

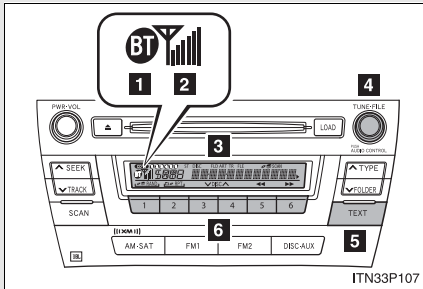

- 1** Displays Bluetooth® connection condition

If “BT” is not displayed, the hands-free system cannot be used.

- 2** Displays the reception level
- 3** Displays such items as message, name, and phone number

Lower-case characters and special characters, such as an umlaut, cannot be displayed.

- 4** Selects items such as menu or number

Turn: Selects an item

Press: Inputs the selected item

- 5** Push and hold: Displays information that is too long to be displayed at one time on the display

- 6** Selects speed dials

■ Steering wheel

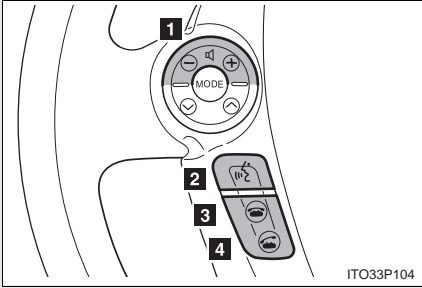

1 Volume

The voice guidance volume cannot be adjusted by using this button.

2 Press: Voice command system on

Press and hold: Voice command system off

3 Hands-free phone system off/ends a call/refuses a call

4 Hands-free phone system on/starts a call

■ **Microphone**

▶ **Type A**

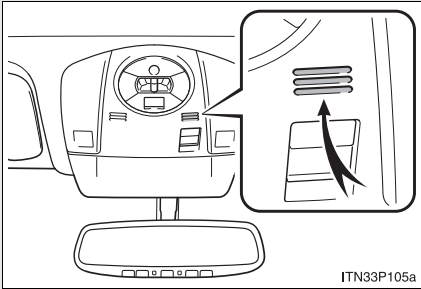

▶ **Type B**

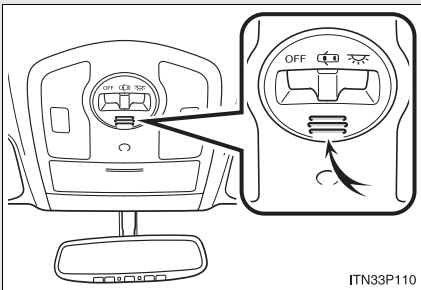

Operating the system by using a voice command

By following voice guidance instructions output from the speaker, voice commands can be given to allow for operation of the hands-

free system without checking the display or operating .

■ Operation procedure when using a voice command

Press  and say a command for a desired function.
(→P. 334)

■ Auxiliary commands when using a voice command

The following auxiliary commands can be used:

Cancel: Exits the hands-free system

Repeat: Repeats the previous voice guidance instruction

Go back: Returns to the previous procedure

Help: Reads aloud the function summary if a help comment is registered for the selected function

Using the hands-free system for the first time

Before using the hands-free system, it is necessary to register a cellular phone in the system. The phone registration mode will be entered automatically when starting the system with no cellular phone registered. Follow the procedure below to register a cellular phone:

STEP 1 Press  or .

The introductory guidance and phone name registration instructions are heard.

STEP 2 Register a phone name by either of the following methods.

a. Select “Record Name” by using , and say a name to be registered.

b. Press  and say a name to be registered.

A voice guidance instruction to confirm the input is heard.

STEP 3 Select “Confirm” by using a voice command or .

A passkey is displayed and heard, and a voice guidance instruction for inputting the passkey into the cellular phone is heard.

STEP 4 Input the passkey into the cellular phone.

Refer to the manual that comes with the cellular phone for the operation of the phone.

Guidance for registration completion is heard.

Menu list of the hands-free system

■ Normal operation

First menu	Second menu	Third menu	Operation detail
Callback	—	—	Dialing a number stored in the incoming call history memory
Redial	—	—	Dialing a number stored in the outgoing call history memory
Dial by number	—	—	Dialing by inputting a number
Dial by name	—	—	Dialing by inputting a name registered in the phone book
Phone-book	Add Entry	—	Adding a new number
	Change Name	—	Changing a name in the phone book
	Delete Entry	—	Deleting the phone book data
	Delete Speed Dial (Del Spd Dial)	—	Deleting a registered speed dial
	List Names	—	List the phone book data
	Set Speed Dial (Speed Dial)	—	Registering a speed dial

First menu	Second menu	Third menu	Operation detail
Setup	Security	Set PIN	Setting a PIN code
		Phonebook Lock	Locking the phone book
		Phonebook Unlock	Unlocking the phone book
	Phone Setup	Pair Phone	Registering a cellular phone to be used
		Change Name	Changing a registered name of a cellular phone
		Delete	Deleting a registered cellular phone
		List phones	Listing the registered cellular phones
		Select phone	Selecting a cellular phone to be used
	System Setup	Set Passkey	Changing the passkey
		Guidance Volume (Guidance Vol)	Setting voice guidance volume
		Initialize	Initialization

■ Using a short cut key

First menu	Second menu	Operation detail
Dial "XXX (name)"	—	Dialing a number registered in the phone book
Phone book add entry	—	Adding a new number
Phone book change name	—	Changing a name of a phone number in the phone book
Phone book delete entry	—	Deleting phone book data
Phone book set speed dial	—	Registering a speed dial
Phone book delete speed dial	—	Deleting a speed dial
Phonebook	Phonebook Unlock	Unlocking the phone book
	Phonebook Lock	Locking the phone book

■ Automatic adjustment of volume

When vehicle speed is 50 mph (80 km/h) or more, the volume automatically increases. The volume returns to the previous volume setting when vehicle speed drops to 43 mph (70 km/h) or less.

■ When using a voice command

- For numbers, say a combination of single digits from zero to nine, # (pound), * (star), and + (plus).
- Say a command correctly and clearly.

■ The system may not recognize your voice in the following situations:

- When driving on a rough road
- When driving at high speeds
- When air is blowing out of the vents onto the microphone
- When the air conditioning fan emits a loud noise

■ The following cannot be performed while driving:

- Operating the system with  TUNE-FILE
- Registering a cellular phone to the system

■ Changing the passkey

→P. 349

Making a phone call

■ Making a phone call

- Dialing by inputting a number
“Dial by number”
- Dialing by inputting a name
“Dial by name”
- Speed dialing
- Dialing a number stored in the outgoing history memory
“Redial”
- Dialing a number stored in the incoming history memory
“Call back”

■ Receiving a phone call

- Answering the phone
- Refusing the call

■ Transferring a call

■ Using a call history memory

- Dialing
- Storing data in the phone book
- Deleting

Dialing by inputting a number

STEP 1 Press  and say “Dial by number”.

STEP 2 Press  and say the phone number.

STEP 3 Dial by one of the following methods:

a. Press .

b. Press  and say “Dial”.



c. Select “Dial” by using .

Dialing by inputting a name

STEP 1 Press  and say “Dial by name”.

STEP 2 Select a registered name to be input by either of the following methods:

a. Press  and say a registered name.

b. Press  and say “List names”. Press  while the desired name is being read aloud.

STEP 3 Dial by one of the following methods:

- a. Press .
- b. Press  and say "Dial".
- c. Select "Dial" by using .

Speed dialing

STEP 1 Press .

STEP 2 Press the preset button in which the desired number is registered.

STEP 3 Press .

When receiving a phone call

■ Answering the phone

Press .

■ Refusing the call

Press .

Transferring a call

A call can be transferred between the cellular phone and system while dialing, receiving a call, or during a call. Use one of the following methods:

- a. Operate the cellular phone.

Refer to the manual that comes with the cellular phone for the operation of the phone.

- b. Press  *1.

- c. Press  and say "Call Transfer" *2.

*1: This operation can be performed only when transferring a call from the cellular phone to the system during a call.

*2: While the vehicle is in motion, a call cannot be transferred from the system to the cellular phone.

Using the call history memory

Follow the procedure below to use a number stored in the call history memory:

STEP 1 Press  and say “Redial” (when using a number stored in the outgoing call history memory) or “Call back” (when using a number stored in the incoming call history memory).

STEP 2 Select the number by either of the following methods:

- Say “Previous” or “Go back” until the desired number is displayed.

- Select the desired number by using .

TUNE-FILE





The following operations can be performed:

Dialing: Press  or select “Dial” by using a voice command or



Storing the number in the phone book: Select “Store” by using a

voice command or .

Deleting: Select “Delete” by using a voice command or .

■ Call history

Up to 5 numbers can be stored in each of the outgoing and incoming history memories.

■ When talking on the phone

- Do not talk simultaneously with the other party.
- Keep the volume of the receiving voice down. Otherwise, voice echo will increase.

Setting a cellular phone

Registering a cellular phone in the hands-free system allows the system to function. The following functions can be used for registered cellular phones:

■ Functions and operation procedures

To enter the menu for each function, follow the steps below by

using a voice command or .

- Registering a cellular phone
 1. "Setup" → 2. "Phone Setup" → 3. "Pair Phone"
- Selecting a cellular phone to be used
 1. "Setup" → 2. "Phone Setup" → 3. "Select Phone"
- Changing a registered name
 1. "Setup" → 2. "Phone Setup" → 3. "Change Name"
- Listing the registered cellular phones
 1. "Setup" → 2. "Phone Setup" → 3. "List Phones"
- Deleting a cellular phone
 1. "Setup" → 2. "Phone Setup" → 3. "Delete"
- Changing the passkey
 1. "Setup" → 2. "Phone Setup" → 3. "Set Passkey"

Registering a cellular phone

Select “Pair Phone” by using a voice command or , and do the procedure for registering a cellular phone. (→P. 332)



Selecting a cellular phone to be used

STEP 1 Select “Select Phone” by using a voice command or .

► Pattern A

STEP 2 Select a cellular phone to be used by either of the following methods, and select “Confirm” by using a voice command or



- Press  and say the desired phone name.
- Press  and say “List phones”. While the name of the desired cellular phone is being read aloud, press .

► Pattern B

STEP 2 Select a cellular phone to be used by using .



Changing a registered name

STEP 1 Select “Change Name” by using a voice command or .



STEP 2 Select a name of cellular phone to be changed by either of the following methods:

a. Press  and say the desired phone name, and select

“Confirm” by using a voice command or .

b. Press  and say “List phones”. While the desired phone name is being read aloud, press .

c. Select the desired phone name by using .

STEP 3 Press  or select “Record Name” by using , and say a new name.

STEP 4 Select “Confirm” by using a voice command or .

Listing the registered cellular phones

Selecting “List Phones” by using a voice command or  causes the list of registered cellular phones to be read aloud. When listing is complete, the system returns to “Phone Setup”.

Pressing  while a name of cellular phone is being read selects the cellular phone, and the following functions will be available:

- Selecting a cellular phone: “Select Phone”
- Changing a registered name: “Change Name”
- Deleting a cellular phone: “Delete”



Deleting a cellular phone

STEP 1 Select “Delete” by using a voice command or .

► Pattern A

STEP 2 Select the cellular phone to be deleted by either of the following methods and select “Confirm” by using a voice command

or :

- Press  and say the name of the desired cellular phone.
- Press  and say “List phones”. While the name of the desired cellular phone is being read aloud, press .

► Pattern B

STEP 2 Select a desired cellular phone to be deleted by using .

Changing the passkey

STEP 1 Select “Set Passkey” by using a voice command or .

► Pattern A

STEP 2 Press , say a 4 to 8-digit number, and select “Confirm”

by using a voice command or .

► Pattern B

STEP 2 Select a 4 to 8-digit number by using .

The number should be input 1 digit at a time.

STEP 3 When the entire number to be registered as a passkey has

been input, press  again.

■ The number of cellular phone that can be registered

Up to 6 cellular phones can be registered in the system.

3-3. Using the hands-free system (for cellular phone)

Security and system setup

To enter the menu of each setting, follow the steps below:

■ Security setting items and operation procedure

● Setting or changing the PIN (Personal Identification Number)

1. "Setup" → 2. "Security" → 3. "Set PIN"

● Locking the phone book

1. "Setup" → 2. "Security" → 3. "Phonebook Lock"

● Unlocking the phone book

1. "Setup" → 2. "Security" → 3. "Phonebook Unlock"

■ System setup items and operation procedure

● Setting voice guidance volume

1. "Setup" → 2. "System Setup" → 3. "Guidance Vol"

● Initialization

1. "Setup" → 2. "System Setup" → 3. "Initialize"





can only be used for system setup operation.

Setting or changing the PIN

■ Setting a PIN

STEP 1 Select “Set PIN” by using a voice command or .

STEP 2 Enter a PIN by using a voice command or .

When using , input the code 1 digit at a time.

■ Changing the PIN

STEP 1 Select “Set PIN” by using a voice command or .

STEP 2 Enter the registered PIN by using a voice command or .

STEP 3 Enter a new PIN by using a voice command or .

When using , input the code 1 digit at a time.

Locking or unlocking the phone book

STEP 1 Select “Phonebook Lock (Phbk Lock)” or “Phonebook Unlock (Phbk Unlock)” by using a voice command or .

STEP 2 Input the PIN by either of the following methods and select “Confirm” by using a voice command or :

a. Press  and say the registered PIN.

b. Input a new PIN by using .

Setting voice guidance volume

STEP 1 Select “Guidance Vol” by using .

STEP 2 Change the voice guidance volume.

To decrease the volume: Turn  counterclockwise.

To increase the volume: Turn  clockwise.

Initialization

STEP 1 Select “Initialize” and then “Confirm” by using  .

STEP 2 Select “Confirm” by using a voice command or  again.

■ Initialization

- The following data in the system can be initialized:
 - Phone book
 - Outgoing and incoming call history
 - Speed dials
 - Registered cellular phone data
 - Security code
- Once the initialization has been completed, the data cannot be restored to its original state.

■ When the phone book is locked

The following functions cannot be used:

- Dialing by inputting a name
- Speed dialing
- Dialing a number stored in the call history memory
- Using the phone book

Using the phone book

To enter the menu of each setting, follow the steps below:

- Adding a new phone number
 1. "Phonebook" → 2. "Add Entry"
- Setting speed dial
 1. "Phonebook" → 2. "Set Speed Dial (Speed Dial)"
- Changing a registered name
 1. "Phonebook" → 2. "Change Name"
- Deleting registered data
 1. "Phonebook" → 2. "Delete Entry"
- Deleting speed dial
 1. "Phonebook" → 2. "Delete Speed Dial (Del Spd Dial)"
- Listing the registered data
 1. "Phonebook" → 2. "List Names"

Adding a new phone number

The following methods can be used to add a new phone number:

- Inputting a phone number by using a voice command
- Transferring data from the cellular phone
- Inputting a phone number by using .
- Selecting a phone number from outgoing or incoming call history

■ Adding procedure

STEP 1 Select “Add Entry” by using a voice command or .

STEP 2 Use one of the following methods to input a telephone number:

- ▶ Inputting a telephone number by using a voice command

STEP2-1 Select “By Voice” by using a voice command or



STEP2-2 Press , say the desired number, and select “Confirm” by using a voice command.

▶ Transferring data from the cellular phone

STEP2-1 Select "By Phone" and then "Confirm" by using a

voice command or  .

STEP2-2 Transfer the data from the cellular phone.

Refer to the manual that comes with the cellular phone for the details of transferring data.

STEP2-3 Select the data to be registered by either of the following methods:

a. Say "Previous" or "Next" until the desired data is displayed, and select "Confirm" by using a voice

command or  .

b. Select the desired data by using  .

▶ Inputting a phone number by using 

STEP2-1 Select "Manual Input" by using  .

STEP2-2 Input a phone number by using  , and press

 again.

Input the phone number 1 digit at a time.

► Selecting a phone number from outgoing or incoming call history

STEP2-1 Select “Call History” by using a voice command or



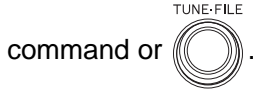

STEP2-2 Select “Outgoing” or “Incoming” by using a voice

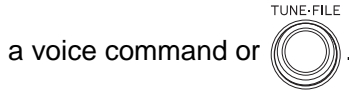

STEP2-3 Select the data to be registered by either of the following methods:

a. Say “Previous” or “Go back” until the desired data is displayed, and select “Confirm” by using





b. Select the desired data by using 

 A circular icon consisting of three concentric rings. The text "TUNE-FILE" is positioned above the icon.

STEP 3 Select the name to be registered by either of the following methods, and select “Confirm” by using a voice command or



a. Press  and say the desired name.

b. Select “Record Name” by using , and say the desired name.

STEP 4 Select “Confirm” by using a voice command or  again.

In **STEP 3**, selecting “Set Speed Dial (Speed Dial)” instead of “Confirm” registers the newly added phone number as speed dial.

Setting speed dials



STEP 1 Select “Set Speed Dial (Speed Dial)” by using a voice com-

mand or .

STEP 2 Select the data to be registered as a speed dial by either of the following methods:

a. Press , say desired number, and select “Confirm” by

using a voice command or .

b. Press , and say “List names”. While the desired name is being read aloud, press , and select “Con-

firm” by using a voice command or .

c. Select the desired data by using .

STEP 3 Select the desired preset button, and register the data into speed dial by either of the following methods:

a. Press the desired preset button, and select “Confirm” by

using a voice command or .

b. Press and hold the desired preset button.



Changing a registered name

STEP 1 Select “Change Name” by using a voice command or .

STEP 2 Select the name to be changed by either of the following methods.



a. Press , say desired name, and select “Confirm” by

using a voice command or .

b. Press , and say “List names”. While the desired name is being read aloud, press , and select “Con-

firm” by using a voice command or .

c. Select the desired name by using .

STEP 3 Select “Record Name” with  or .

STEP 4 Say a new name, and select “Confirm” by using a voice command or .



Deleting registered data

STEP 1 Select “Delete Entry” by using a voice command or .

► Pattern A

STEP 2 Select the data to be deleted by either of the following methods, and select “Confirm” by using a voice command or



- Press , and say the name of the desired phone number to be deleted.
- Press , say “List phones”. While the name of the desired phone number is being read aloud, press .

► Pattern B

STEP 2 Select the data to be deleted by using .

Deleting speed dials

STEP 1 Select “Delete Speed Dial (Del Spd Dial)” by using a voice

command or  .

STEP 2 Press the preset button in which the desired speed dial is registered, and select “Confirm” by using a voice command or

 .

Listing the registered data

Selecting “List names” by using a voice command causes a list of the registered data to be read aloud.

When listing is complete, the system returns to “Phonebook”.

Pressing  while the desired data is being read aloud selects the data, and the following function will be available.

- Dialing: “Dial”
- Changing a registered name: “Change Name”
- Deleting an entry: “Delete Entry”
- Setting speed dial: “Set Speed Dial (Speed Dial)”

■ Limitation of number of digits

A phone number that exceeds 24 digits cannot be registered.

3-4. Using the interior lights

Interior lights list

Your Toyota is equipped with an illuminated entry system to assist in entering the vehicle. Due to the function of the system, the lights shown in the following illustration automatically turn on/off according to the presence of the electronic key, whether the doors are locked/unlocked, whether the doors are opened/closed, and the “POWER” switch mode.

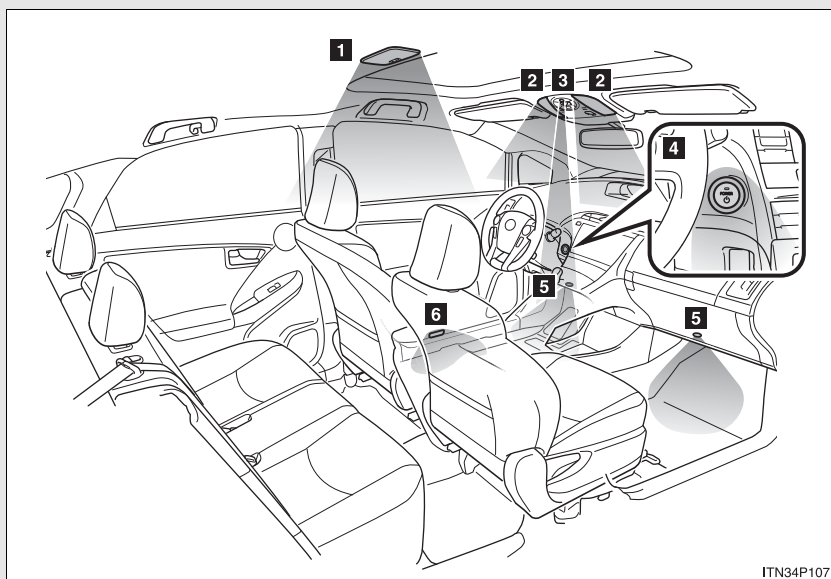

- 1** Interior light (→P. 365)
- 2** Personal/interior light (→P. 365)
- 3** Shift lever lighting
- 4** “POWER” switch lighting
- 5** Foot lights (if equipped)
- 6** Front door courtesy lights

ITN34P107

Personal/interior light main switch

► Type A

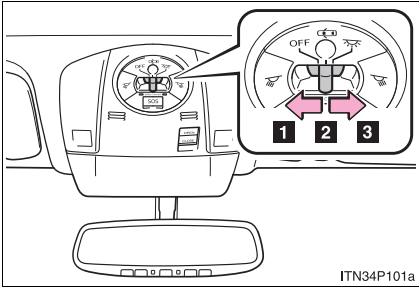

1 “OFF”

The personal/interior lights and interior light can be individually turned on or off.

2 Door position

The personal/interior lights and interior light automatically turn on/off according to the presence of the electronic key, whether the doors are locked/unlocked, whether the doors are opened/closed, and the “POWER” switch mode.

► Type B

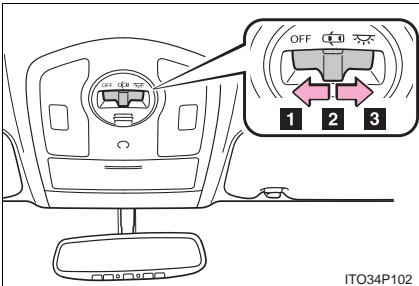

3 On

The personal/interior lights and interior light cannot be individually turned off.

Personal/interior lights

► Type A

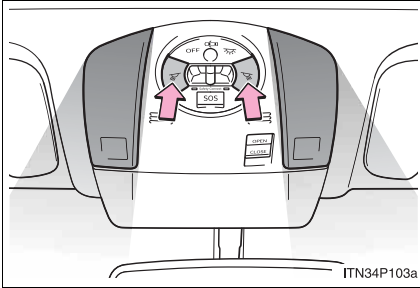

On/off

The illuminated entry system is activated even if the light is turned off when the personal/interior light main switch is in door position.

► Type B

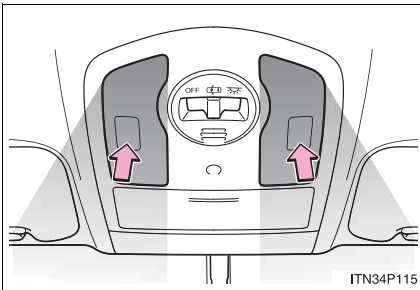

On/off

The illuminated entry system is activated even if the light is turned off when the personal/interior light main switch is in door position.

Interior light

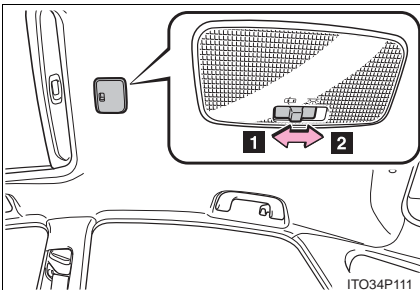

1 Door position

2 On

The interior lights are turned on/off by the illuminated entry system. When the personal/interior light main switch is in the "OFF" position, the lights will not turn on even if the door is opened with the interior light switch in door position.

■ **To prevent 12 volt battery discharge**

If the interior lights and personal lights are on when the door is not fully closed or the interior light switch is in door position, the lights will go off automatically after 20 minutes.

■ **Customization that can be configured at Toyota dealer**

Setting (e.g. The time elapsed before lights turn off) can be changed.
(Customizable features →P. 587)

3-5. Using the storage features

List of storage features

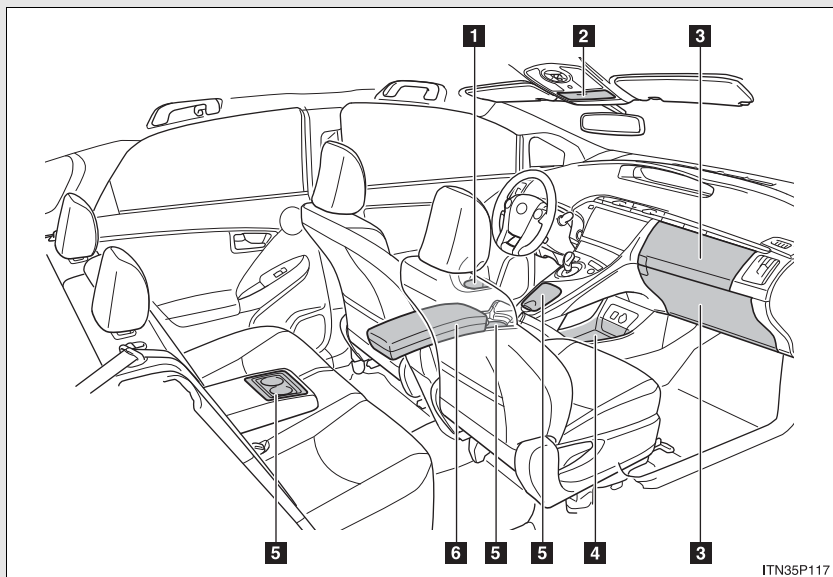

- 1** Bottle holder
- 2** Overhead console (if equipped)
- 3** Glove boxes
- 4** Auxiliary box
- 5** Cup holders
- 6** Console box

Glove boxes

► Upper glove box

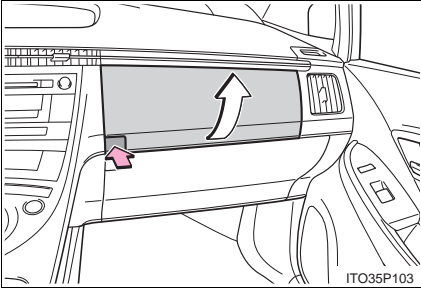

Push the button.

► Lower glove box

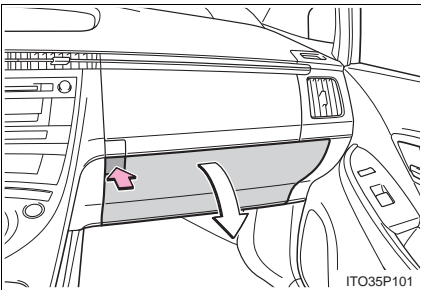

Push the button.

■ Glove box light (lower glove box only)

The glove box light turns on when the tail lights are on.

⚠ CAUTION

■ While driving

Keep the glove box closed.

Injuries may result in the event of sudden braking, sudden swerving or an accident.

Console box

► Type A

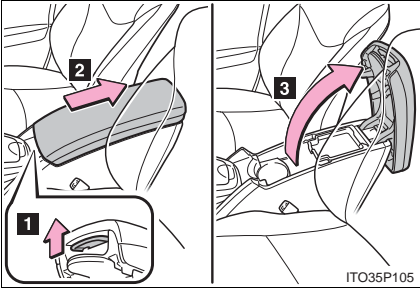

- 1** Pull up the lever to release the lock.
- 2** Slide the console box lid fully rearward.
- 3** Lift the console box lid to open.

► Type B

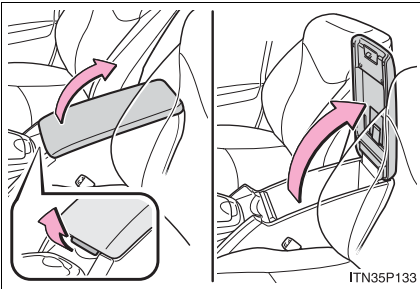

Lift the lid while pulling the lever.

■ Tray in the console box (type A only)

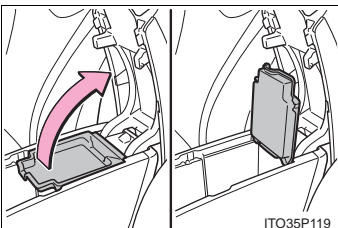

The tray can be raise backward.

⚠ CAUTION**■ While driving**

Keep the console box closed.

Injuries may result in the event of sudden braking, sudden swerving or an accident.

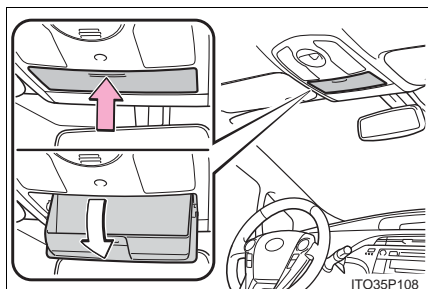
Overhead console (vehicles without the moon roof)

Push the lid.

The overhead console is useful for temporarily storing small items.

⚠ CAUTION**■ Items that should not be left in the overhead console**

Do not leave glasses or lighters in the console.

If the interior of the vehicle becomes hot, lighters may explode and glasses may warp or become cracked.

■ While driving

Do not leave the overhead console open.

Items may fall out and cause injury.

■ Maximum storage weight

Do not place any object heavier than 0.4 lb. (200 g) in it. The console may be opened and cause injury.

Card holder (vehicles with type B console box)

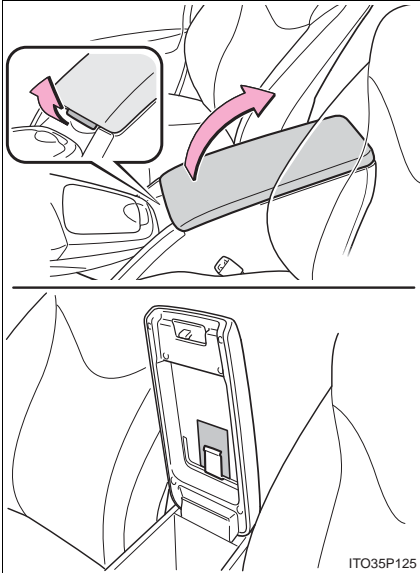

Pull the knob up and lift the lid.

Cup holders

► Front type A

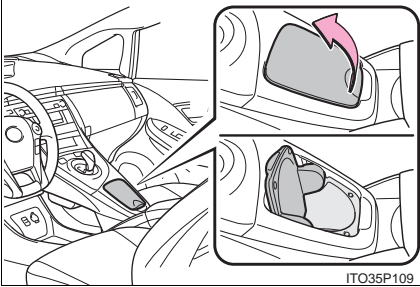

Lift the lid.

► Front type B (if equipped)

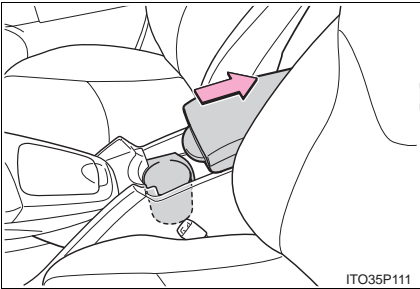

Slide the console box lid.

► Rear (if equipped)

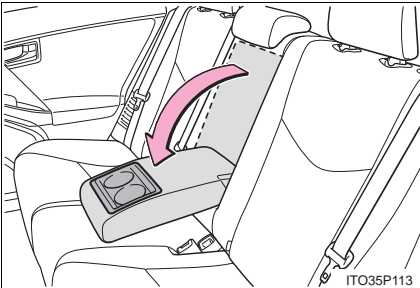

Pull down the armrest.

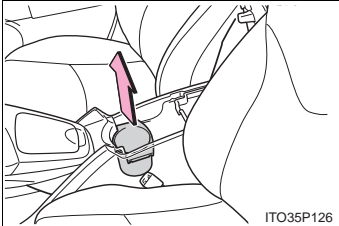
■ Removing the cup holder (front type B only)

Pull up.

⚠ CAUTION**■ Items unsuitable for the cup holder**

Do not place anything other than cups or aluminum cans in the cup holders. Other items may be thrown out of the holders in the event of sudden braking, sudden swerving or an accident and cause injury. If possible, cover hot drinks to prevent burns.

■ When not in use

Keep the cup holders closed.

Injuries may result in the event of sudden braking, sudden swerving or an accident.

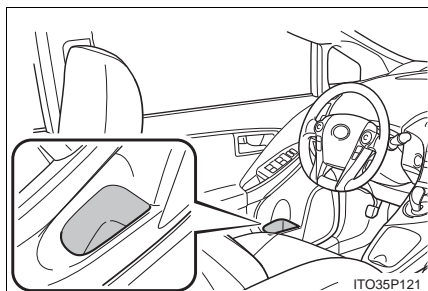
Bottle holders**⚠ CAUTION****■ Items unsuitable for the bottle holder**

Do not place anything other than pet bottles in the bottle holders. Other items may be thrown out of the holders in the event of sudden braking, sudden swerving or an accident and cause injury.

⚠ NOTICE**■ Items that should not be stowed in the bottle holders**

Put the cap on before stowing a bottle. Do not place open bottles in the bottle holders, or glasses and paper cups containing liquid. The contents may spill and glasses may break.

Auxiliary box

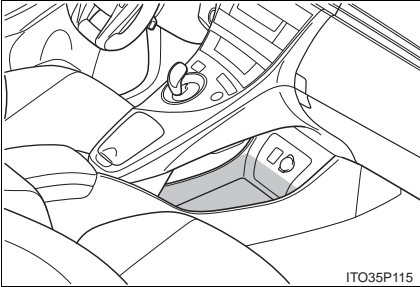

3-6. Other interior features

Sun visors

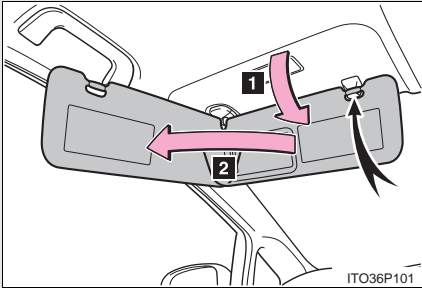

- 1** Forward position:
Flip down.
- 2** Side position:
Flip down, unhook, and swing to the side.

Vanity mirror

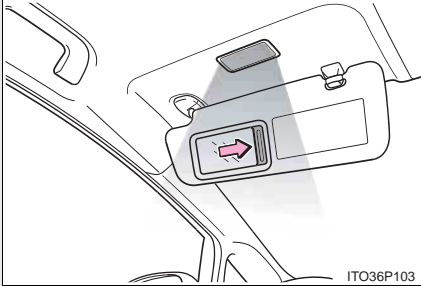

Slide the cover.

The light turns on when the cover is opened.

Outside temperature display

The displayed temperature ranges from -22 °F (-30 °C) up to 122 °F (50 °C).

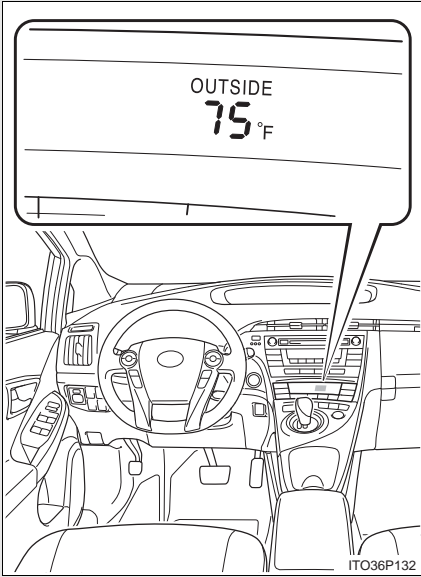

■ Operating conditions

The "POWER" switch is in ON mode.

■ When --- is displayed

The system may be malfunctioning. Take your vehicle to your Toyota dealer.

■ Display

In the following situations, the correct outside temperature may not be displayed, or the display may take longer than normal to change.

- When stopped, or driving at low speeds (less than 12 mph [20 km/h])
- When the outside temperature has changed suddenly (at the entrance/exit of a garage, tunnel, etc.)

3-6. Other interior features

Power outlets

The power outlets can be used for 12 V accessories that run on less than 10 A.

► Instrument panel

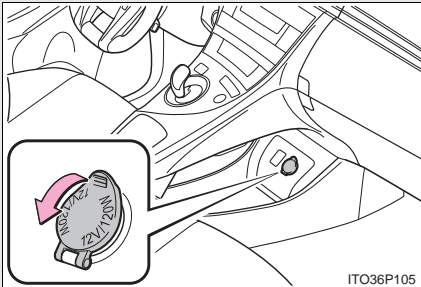

► Rear console box (if equipped)

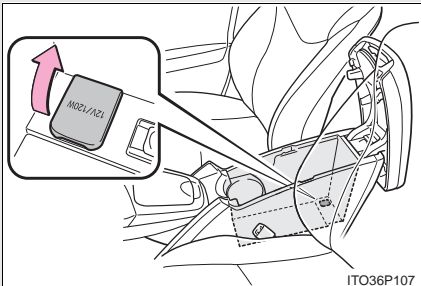

■ The power outlets can be used when

The "POWER" switch is in ACCESSORY or ON mode.

 NOTICE

■ **To avoid damaging the power outlets**

Close the power outlets lid when not in use.

Foreign objects or liquids that enter the power outlets may cause a short circuit.

■ **To prevent the fuse from being blown**

Do not use an accessory that uses more than 12 V/10 A.

■ **To prevent 12 volt battery discharge**

Do not use the power outlets longer than necessary when the hybrid system is not operating.

Seat heaters*

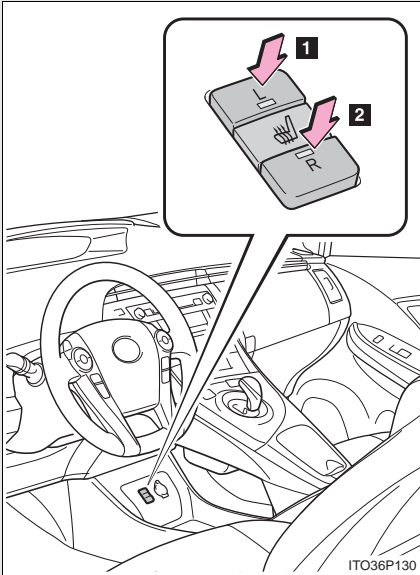

- 1 Heats the left front seat
- 2 Heats the right front seat

The indicator light comes on.

■ **The seat heaters can be used when**

The "POWER" switch is in ON mode.

■ **When not in use**

Turn the seat heater off. The indicator light turns off.

*: If equipped

 **CAUTION**

■ Burns

- Use caution when seating the following persons in a seat with the seat heater on to avoid the possibility of burns:
 - Babies, small children, the elderly, the sick and the disabled
 - Persons with sensitive skin
 - Persons who are fatigued
 - Persons who have taken alcohol or drugs that induce sleep (sleeping drugs, cold remedies, etc.)
- Do not cover the seat with anything when using the seat heater.
Using the seat heater with a blanket or cushion increases the temperature of the seat and may lead to overheating.

 **NOTICE**

■ To prevent seat heater damage

Do not put unevenly weighted objects on the seat and do not stick sharp objects (needles, nails, etc.) into the seat.

■ To prevent 12 volt battery discharge

Turn the switches off when the hybrid system is not operating.

3-6. Other interior features

Armrest*

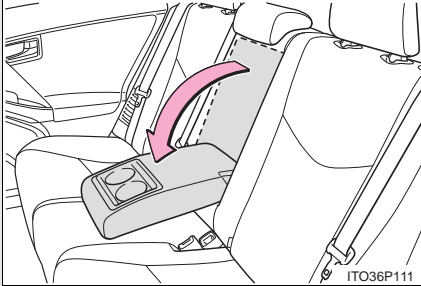

Pull the armrest down for use.

NOTICE

- **To prevent damage to the armrest**
Do not place too much strain on the armrest.

Floor mats

Securely place a mat that matches the size of the space on the carpet.

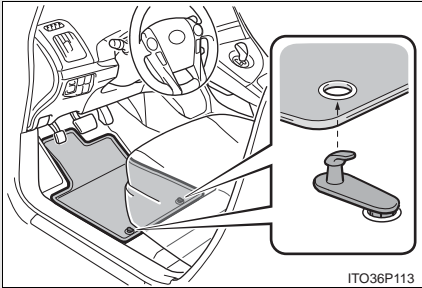

Secure the floor mat using the hooks provided.

CAUTION

■ When inserting the floor mat

Observe the following precautions.

Failure to do so may result in the floor mat slipping and interfering with the movement of the pedals during driving, resulting in an accident.

- Make sure the floor mat is properly placed on the vehicle carpet and the correct side faces upward.
- Do not place floor mats on top of existing mats.

Luggage compartment features

■ Cargo hooks

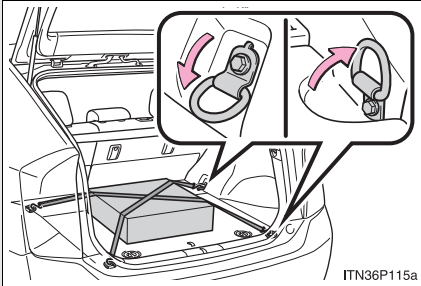

Cargo hooks are provided for securing loose items.

■ Auxiliary box

► Center type A

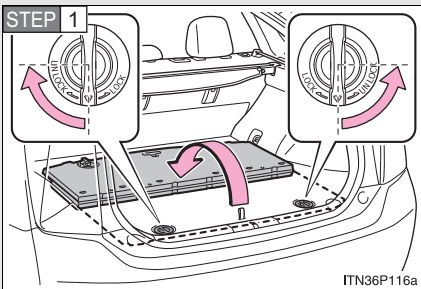

Turn the knob to the "UNLOCK" position and open the lid.

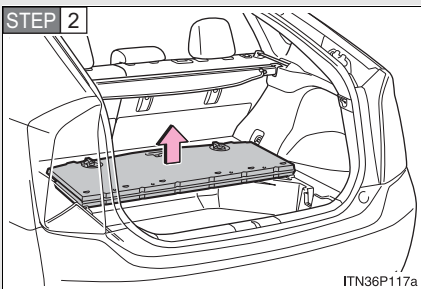

Lift the center deck board.

► Center type B

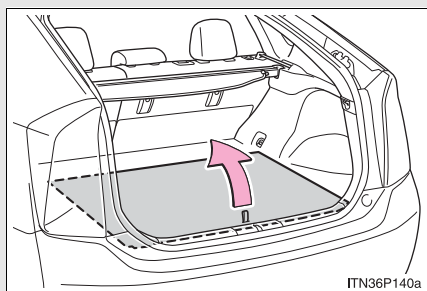

Lift the center deck board.

► Side

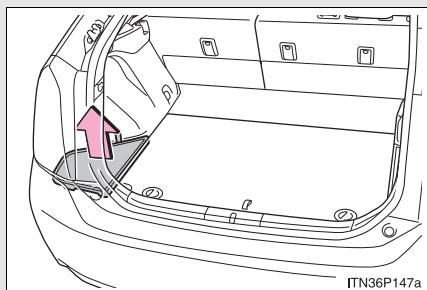

Lift the side deck board.

■ Luggage cover (If equipped)

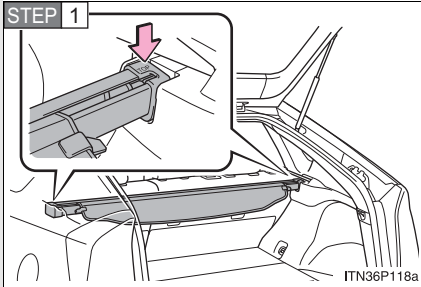

Adjust the cover so that “TOP” is facing upwards.

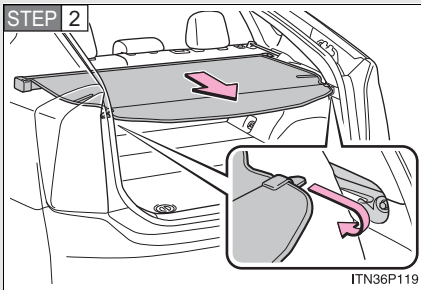

Pull out the luggage cover and secure it to the hook brackets.

3

Interior features

Removing the luggage cover

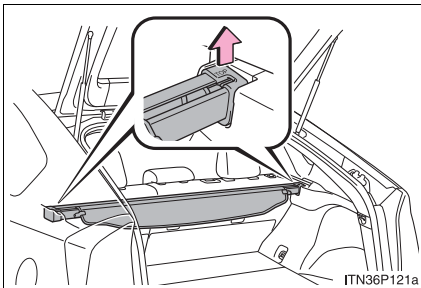

Lift it up.

■ **Stowing the luggage cover (vehicles with center auxiliary box type A only)**

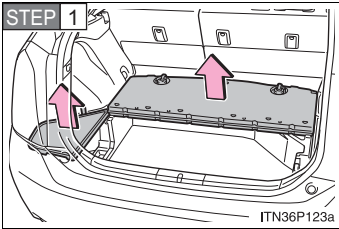

Remove the side deck boards and open the center auxiliary box.

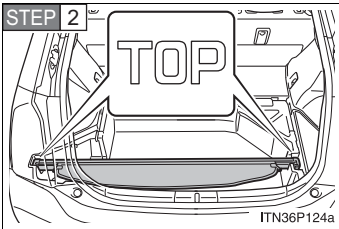

Adjust the cover so that "TOP" is facing up.

■ **When not using the luggage cover**

Place the cover in a horizontal position.

! CAUTION

■ **When the cargo hooks are not in use**

To avoid injury, always return the cargo hooks to their positions when they are not in use.

■ **While driving**

Do not place anything on the luggage cover. Such items may be thrown about and possibly injure people in the vehicle during sudden braking or an accident.

3-6. Other interior features

Garage door opener

The garage door opener can be programmed to operate garage doors, gates, entry doors, door locks, home lighting systems, and security systems, and other devices.

The garage door opener (HomeLink[®] Universal Transceiver) is manufactured under license from HomeLink[®].

Programming the HomeLink[®] (for U.S.A. owners)

The HomeLink[®] compatible transceiver in your vehicle has 3 buttons which can be programmed to operate 3 different devices. Refer to the programming method below appropriate for the device.

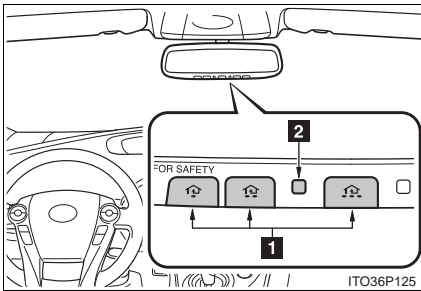

- 1** Buttons
- 2** Indicator

■ Programming the HomeLink[®]

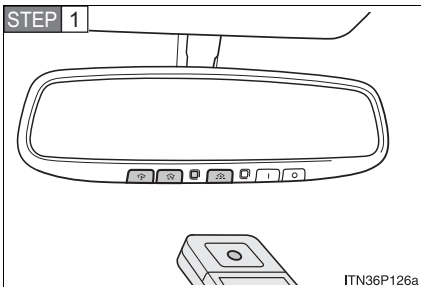

Point the remote control for the device 1 to 3 in. (25 to 75 mm) from the HomeLink[®] control buttons.

Keep the indicator light on the HomeLink[®] in view while programming.

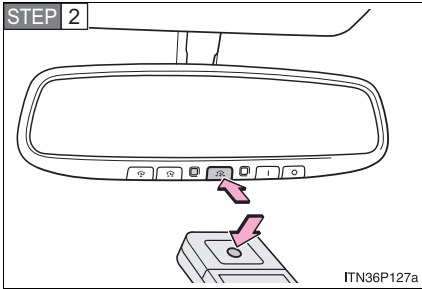

Press and hold down one of the buttons on the HomeLink® and the button on the transmitter. When the indicator light on the HomeLink® changes from a slow to a rapid flash after 20 seconds, you can release both buttons.

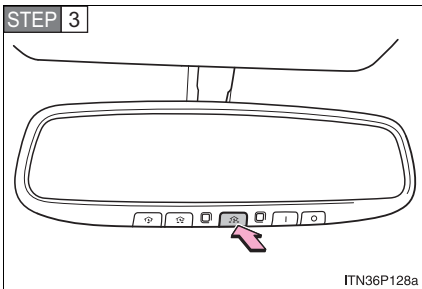

Test the operation of the HomeLink® by pressing the newly programmed button.

If programming a garage door opener, check to see if the garage door opens and closes. If the garage door does not operate, see if your garage transmitter is of the Rolling Code type. Press and hold the programmed HomeLink® button. The garage door has the rolling code feature if the indicator light (on the HomeLink®) flashes rapidly for 2 seconds and then remains lit. If your transmitter is the Rolling Code type, proceed to the heading “Programming a rolling code system”.

STEP 4 Repeat the steps above to program another device for each of the remaining HomeLink® buttons.

■ Programming a Rolling Code system (for U.S.A. owners)

If your device is Rolling Code equipped, follow the steps under the heading “Programming the HomeLink[®]” before proceeding with the steps listed below.

STEP 1 Locate the learn button on the ceiling mounted garage door opener motor. The exact location and color of the button may vary by brand of garage door opener.

Refer to the operation manual supplied with the garage door opener for the location of the learn button.

STEP 2 Press the learn button.

STEP 3 Press and hold the vehicle's programmed HomeLink[®] button for 2 seconds and release it. Repeat this step one again. The garage door may open.

If the garage door opens, the programming process is complete. If the door does not open, press and release the button a third time. This third press and release will complete the programming process by opening the garage door.

The ceiling mounted garage door opener motor should now recognize the HomeLink[®] transceiver and operate the garage door.

STEP 4 Repeat the steps above to program another rolling code system for any of the remaining HomeLink[®] buttons.

■ Programming an entry gate (for U.S.A. owners)/Programming all devices in the Canadian market

STEP 1 Place your transmitter 1 to 3 in. (25 to 75 mm) away from the surface of the HomeLink®.

Keep the indicator light on the HomeLink® in view while programming.

STEP 2 Press and hold the selected HomeLink® button.

STEP 3 Repeatedly press and release (cycle) the device's remote control button for two seconds each until step 4 is complete.

STEP 4 When the indicator light on the HomeLink® compatible transceiver start to flashing rapidly, release the buttons.

STEP 5 Test the operation of the HomeLink® by pressing the newly programmed button. Check to see if the gate/device operates correctly.

STEP 6 Repeat the steps above to program another device for each of the remaining HomeLink® buttons.

■ Programming other devices

To program other devices such as home security systems, home door locks or lighting, contact your authorized Toyota dealer for assistance.

■ Reprogramming a button

The individual HomeLink® buttons cannot be erased but can be reprogrammed. To reprogram a button, follow the "Basic programming" instructions.

Operating the HomeLink®

Press the appropriate HomeLink® button. The HomeLink® indicator light on the HomeLink® transceiver should turn on.

The HomeLink® continues to send a signal for up to 20 seconds as long as the button is pressed.

Erasing the entire HomeLink® memory (all three programs)

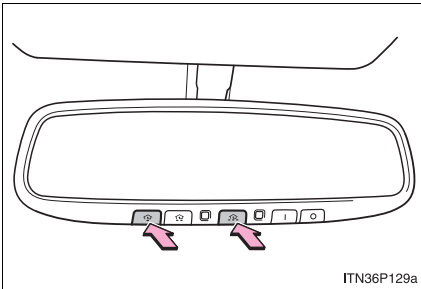

Press and hold down the 2 outside buttons for 20 seconds until the indicator light flashes.

If you sell your vehicle, be sure to erase the programs stored in the HomeLink® memory.

■ **Before programming**

- Install a new battery in the transmitter.
- The battery side of the transmitter must be pointed away from the HomeLink®.

■ **Certification for the garage door opener**

FCC ID: NZLZTVHL3

IC ID: 4112A-ZTVHL3

This device complies with Part 15 of the FCC Rules and with RSS-210 of the IC Rules.

Operation is subject to the following two conditions: (1) this device may not cause harmful interference, and (2) this device must accept any interference received, including interference that may cause undesired operation.

WARNING: This transmitter has been tested and complies with FCC and IC rules. Changes or modifications not expressly approved by the party responsible for compliance could void the user's authority to operate the equipment.

 **CAUTION**

■ **When programming a garage door or other remote control device**

The garage door or other devices may operate, so ensure people and objects are out of danger to prevent potential harm.

■ **Conforming to federal safety standards**

Do not use the HomeLink® Compatible Transceiver with any garage door opener or device that lacks safety stop and reverse features as required by federal safety standards.

This includes any garage door that cannot detect an obstruction object. A door or device without these features increases the risk of death or serious injury.

Safety Connect*

Safety Connect is a subscription-based telematics service that uses Global Positioning System (GPS) data and embedded cellular technology to provide safety and security features to subscribers. Safety Connect is supported by Toyota's designated response center, which operates 24 hours per day, 7 days per week.

Safety Connect service is available by subscription on select, telematics hardware-equipped vehicles.

By using the Safety Connect service, you are agreeing to be bound by the Telematics Subscription Service Agreement and its Terms and Conditions, as in effect and amended from time to time, a current copy of which is available at Toyota.com. All use of the Safety Connect service is subject to such then-applicable Terms and Conditions.

■ System components

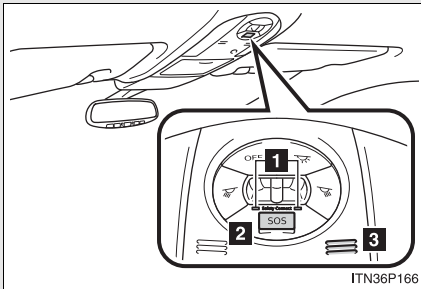

- 1** LED light indicators
- 2** “SOS” button
- 3** Microphone

*: If equipped

■ Services

Subscribers have the following Safety Connect services available:

- Automatic Collision Notification*

Helps drivers receive necessary response from emergency service providers. (→P. 398)

*: U.S. Patent No. 7,508,298 B2

- Stolen Vehicle Location

Helps drivers in the event of vehicle theft. (→P. 399)

- Emergency Assistance Button (SOS)

Connects drivers to response-center support. (→P. 399)

- Roadside Assistance

Provides drivers various on-road assistance. (→P. 399)

■ Subscription

After you have signed the Telematics Subscription Service Agreement and are enrolled, you can begin receiving services.

A variety of subscription terms is available for purchase. Contact your Toyota dealer, call 1-800-331-4331, or push the “SOS” button in your vehicle for further subscription details.

■ Safety Connect Services Information

- Phone calls using the vehicles Bluetooth® technology will not be possible during Safety Connect.
- Safety Connect is available beginning Fall 2009 on select Toyota models. Contact with the Safety Connect response center is dependent upon the telematics device being in operative condition, cellular connection availability, and GPS satellite signal reception, which can limit the ability to reach the response center or receive emergency service support. Enrollment and Telematics Subscription Service Agreement required. A variety of subscription terms is available; charges vary by subscription term selected.
- Safety Connect services will function in the United States, including Hawaii and Alaska, and in Canada. The services will not function outside of the United States in countries other than Canada. For details about the service, contact your Toyota dealer.
- Safety Connect services are not subject to section 255 of the Telecommunications Act and the device is not TTY compatible.

■ Languages

The Safety Connect response center will offer support in multiple languages. The Safety Connect system will offer voice prompts in English and Spanish. Please indicate your language of choice when enrolling.

■ When contacting the response center

You may be unable to contact the response center if the network is busy.

Safety Connect LED light Indicators

When the “POWER” switch is turned to ON mode, the red indicator light comes on for 2 seconds then turns off. Afterward, the green indicator light comes on, indicating that the service is active.

The following indicator light patterns indicate specific system usage conditions:

- Green indicator light on = Active service
- Green indicator light flashing = Safety Connect call in process
- Red indicator light (except at vehicle start-up) = System malfunction (contact your Toyota dealer)
- No indicator light (off) = Safety Connect service not active

Safety Connect services

■ Automatic Collision Notification

In case of either airbag deployment or severe rear-end collision, the system is designed to automatically call the response center. The responding agent receives the vehicle’s location and attempts to speak with the vehicle occupants to assess the level of emergency. If the occupants are unable to communicate, the agent automatically treats the call as an emergency, contacts the nearest emergency services provider to describe the situation, and requests that assistance be sent to the location.

■ **Stolen Vehicle Location**

If your vehicle is stolen, Safety Connect can work with local authorities to assist them in locating and recovering the vehicle. After filing a police report, call the Safety Connect response center at 1-800-331-4331 and follow the prompts for Safety Connect to initiate this service.

In addition to assisting law enforcement with recovery of a stolen vehicle, Safety-Connect-equipped vehicle location data may, under certain circumstances, be shared with third parties to locate your vehicle. Further information is available at Toyota.com.

■ **Emergency Assistance Button (“SOS”)**

In the event of an emergency on the road, push the “SOS” button to reach the Safety Connect response center. The answering agent will determine your vehicle’s location, assess the emergency, and dispatch the necessary assistance required.

If you accidentally press the “SOS” button, tell the response-center agent that you are not experiencing an emergency.

■ **Roadside Assistance**

Subscribers can press the “SOS” button to reach a Safety Connect response-center agent, who can help with a wide range of needs, such as: towing, flat tire, fuel delivery, etc. For a description of the Roadside Assistance services and their limitations, please see the Safety Connect Terms and Conditions, which are available at Toyota.com.

Safety information for Safety Connect

Important! Read this information before using Safety Connect.

■ **Exposure to radio frequency signals**

The Safety Connect system installed in your vehicle is a low-power radio transmitter and receiver. It receives and also sends out radio frequency (RF) signals.

In August 1996, the Federal Communications Commission (FCC) adopted RF exposure guidelines with safety levels for mobile wireless phones. Those guidelines are consistent with the safety standards previously set by the following U.S. and international standards bodies.

- ANSI (American National Standards Institute) C95.1 [1992]
- NCRP (National Council on Radiation Protection and Measurement) Report 86 [1986]
- ICNIRP (International Commission on Non-Ionizing Radiation Protection) [1996]

Those standards were based on comprehensive and periodic evaluations of the relevant scientific literature. Over 120 scientists, engineers, and physicians from universities, and government health agencies and industries reviewed the available body of research to develop the ANSI Standard (C95.1).

The design of Safety Connect complies with the FCC guidelines in addition to those standards.

■ License

Licensed by QUALCOMM Incorporated under one or more of the following United States Patents and/or their counterparts in other nations:

4,901,307	5,490,165	5,056,109	5,504,773	5,101,501
5,506,865	5,109,390	5,511,073	5,228,054	5,535,239
5,267,261	5,544,196	5,267,262	5,568,483	5,337,338
5,600,754	5,414,796	5,657,420	5,416,797	5,659,569
5,710,784	5,778,338			

Cleaning and protecting the vehicle's exterior

Perform the following to protect the vehicle and maintain it in prime condition.

- Working from top to bottom, liberally apply water to the vehicle body, wheel wells and underside of the vehicle to remove any dirt and dust.

Wash the vehicle body using a sponge or soft cloth, such as a cham-
ois.

- For hard-to-remove marks, use car wash soap and rinse thoroughly with water.
- Wipe away any water.
- Wax the vehicle when the waterproof coating deteriorates.

If water does not bead on a clean surface, apply wax when the vehicle body is cool.

■ Automatic car washes

- Before washing the vehicle, do the following.
 - Fold the mirrors back.
 - Remove the antenna.
- Brushes used in automatic car washes may scratch the vehicle surface and harm your vehicle's paint.

■ High pressure automatic car washes

- Do not allow the nozzles of the car wash to come within close proximity of the windows.
- Before car wash, check that the fuel filler door on your vehicle is closed properly.

■ Aluminum wheels

Remove any dirt immediately by using a neutral detergent. Do not use hard brushes or abrasive cleaners. Do not use strong or harsh chemical cleaners. Use the same mild detergent and wax as used on the paint.

■ Bumpers and side moldings

Do not scrub with abrasive cleaners.

■ To prevent paint deterioration and corrosion on the body

- Wash the vehicle immediately in the following cases:
 - After driving near the sea coast
 - After driving on salted roads
 - If you see coal tar or tree sap on the paint surface
 - If you see dead insects or insect droppings on the paint
 - After driving in an area contaminated with soot, oily smoke, mine dust, iron powder or chemical substances
 - If the vehicle becomes heavily soiled in dust or mud
 - If liquids such as benzine and gasoline are spilled on the paint surface
- If the paint is chipped or scratched, have it repaired immediately.

 **CAUTION**

■ **Caution about the exhaust pipe**

Exhaust gasses cause the exhaust pipe to become quite hot.

When washing the vehicle, be careful not to touch the pipe until it has cooled sufficiently, as touching a hot exhaust pipe can cause burns.

 **NOTICE**

■ **To protect your vehicle's painted surfaces**

Do not use organic cleaners such as benzine or gasoline.

■ **Cleaning the exterior lights**

● Wash carefully. Do not use organic substances or scrub with a hard brush. This may damage the surfaces of the lights.

● Do not apply wax on the surface of the lights. Wax may cause damage to the lenses.

The following procedures will help protect your vehicle's interior and keep it in top condition:

■ **Protecting the vehicle interior**

Remove dirt and dust using a vacuum cleaner. Wipe dirty surfaces with a cloth dampened with lukewarm water.

■ **Cleaning the leather areas**

- Remove dirt and dust using a vacuum cleaner.
- Wipe any excess dirt and dust with a soft cloth dampened with diluted detergent.

Use a diluted water solution of approximately 5 % neutral wool detergent.

- Wring out any excess water from the cloth and thoroughly wipe off all remaining traces of detergent.
- Wipe the surface with a dry, soft cloth to remove any remaining moisture. Allow the leather to dry in shaded and ventilated area.

■ **Synthetic leather areas**

- Remove loose dirt using a vacuum cleaner.
- Apply a mild soap solution to the synthetic leather using a sponge or soft cloth.
- Allow the solution to soak in for a few minutes. Remove the dirt and wipe off the solution with a clean, damp cloth.

■ Caring for leather areas

Toyota recommends cleaning the interior of the vehicle at least twice a year to maintain the quality of the vehicle's interior.

■ Shampooing the carpets

There are several commercial foaming-type cleaners available. Use a sponge or brush to apply the foam. Rub in overlapping circles. Do not apply water. Excellent results are obtained by keeping the carpet as dry as possible.

■ Seat belts

Clean with mild soap and lukewarm water using a cloth or sponge. Also check the belts periodically for excessive wear, fraying or cuts.

CAUTION

■ Water in the vehicle

- Do not splash or spill liquid in the vehicle, such as on the floor, in the hybrid battery (traction battery) air vents, or in the luggage compartment. Doing so may cause the hybrid battery, electrical components etc. to malfunction or catch fire.
- Do not get any of the SRS components or wiring in the vehicle interior wet. (→P. 115)
An electrical malfunction may cause the airbags to deploy or not function properly, resulting in death or serious injury.

 NOTICE**■ Cleaning detergents**

Do not use the following types of detergent, as they may discolor the vehicle interior or cause streaks or damage to painted surfaces.

- Non-seat portions: Organic substances such as benzine or gasoline, alkaline or acidic solutions, dye, or bleach.
- Seats: Acidic solutions, such as thinner, benzine, or alcohol.

■ Preventing damage to leather surfaces

Observe the following precautions to avoid damage to and deterioration of leather surfaces.

- Remove any dust or dirt on leather surfaces immediately.
- Do not expose the vehicle to direct sunlight for extended periods of time. Park the vehicle in the shade, especially during summer.
- Do not place items made of vinyl, plastic, or that contain wax on the upholstery, as they may stick to the leather surface if the vehicle interior heats up significantly.

■ Water on the floor

Do not wash the vehicle floor with water.

Vehicle systems such as the audio system may be damaged if water comes into contact with electrical components under the floor of the vehicle, and may also cause the body to rust.

■ Cleaning the inside of the rear window

- Do not use glass cleaner to clean the rear window, as this may cause damage to the rear window defogger heater wires. Use a cloth dampened with lukewarm water to gently wipe the window clean. Wipe the window in strokes running parallel to the heater wires.
- Be careful not to scratch or damage the heater wires.

Maintenance requirements

To ensure safe and economical driving, day-to-day care and regular maintenance is essential. It is the owner's responsibility to perform regular checks. Toyota recommends the following maintenance.

■ General maintenance

Should be performed on a daily basis. This can be done by yourself or by a Toyota dealer.

■ Scheduled maintenance

Should be performed at specified intervals according to the maintenance schedule.

For details about maintenance items and schedules, refer to the "Scheduled Maintenance Guide" or "Owner's Manual Supplement".

■ Do-it-yourself maintenance

You can perform some maintenance procedures yourself.

Please be aware that do-it-yourself maintenance may affect warranty coverage.

The use of Toyota Repair Manuals are recommended.

For details about warranty coverage, see the separate "Owner's Warranty Information Booklet" or "Owner's Manual Supplement".

■ Repair and replacement

It is recommended that genuine Toyota parts be used for repair to ensure performance of each system. If non-Toyota parts are used in replacement or if a repair shop other than a Toyota dealer performs repairs, confirm the warranty coverage.

■ Allow inspection and repairs to be performed by a Toyota dealer

- Toyota technicians are well-trained specialists and are kept up to date with the latest service information. They are well informed about the operations of all systems on your vehicle.
- Keep a copy of the repair order. It proves that the maintenance that has been performed is under warranty coverage. If any problem should arise while your vehicle is under warranty, your Toyota dealer will promptly take care of it.

CAUTION

■ Warning in handling of 12 volt battery, oils, fuels, and fluids

- Engine exhaust, some of its constituents, and a wide variety of automobile components contain or emit chemicals known to the State of California to cause cancer and birth defects and other reproductive harm. Work in a well ventilated area.
- Oils, fuels and fluids contained in vehicles as well as waste produced by component wear contain or emit chemicals known to the State of California to cause cancer and birth defects or other reproductive harm. Avoid exposure and wash any affected area immediately.
- 12 volt battery posts, terminals and related accessories contain lead and lead compounds which are known to cause brain damage. Wash your hands after handling. (→P. 436)
- Used engine oil contains chemicals that have been shown to cause cancer in laboratory animals. Avoid prolonged and repeated contact. Always protect your skin by washing thoroughly with soap and water.

General maintenance

Listed below are the general maintenance items that should be performed at the intervals specified in the “Scheduled Maintenance Guide” or “Owner’s Manual Supplement”. It is recommended that any problem you notice should be brought to the attention of your Toyota dealer or qualified service shop for advice.

Listed below are the general maintenance items that should be performed at the intervals specified in the “Owner’s Warranty Information”. It is recommended that any problem you notice should be brought to the attention of your Toyota dealer or qualified service shop for advice.

Engine compartment

Items	Check points
Brake fluid	• At the correct level? (→P. 432)
Engine/power control unit coolant	• At the correct level? (→P. 430)
Engine oil	• At the correct level? (→P. 426)
Exhaust system	• No fumes or strange sounds?
Radiator/condenser/hoses	• Not blocked with foreign matter? (→P. 432)
Washer fluid	• At the correct level? (→P. 434)

Luggage compartment

Items	Check points
12 volt battery	• Maintenance-free (→P. 436)

Vehicle interior

Items	Check points
Accelerator pedal	<ul style="list-style-type: none"> • Moves smoothly (without uneven pedal effort or catching)?
Automatic transmission "Park" mechanism	<ul style="list-style-type: none"> • Can the vehicle be hold securely on an incline with the shift position in "P"?
Brake pedal	<ul style="list-style-type: none"> • Moves smoothly? • Does it have appropriate clearance and correct amount of free play?
Brakes	<ul style="list-style-type: none"> • Pulls to one side when applied? • Loss of brake effectiveness? • Spongy feeling brake pedal? • Pedal almost touches floor?
Head restraints	<ul style="list-style-type: none"> • Move smoothly and lock securely?
Indicators/buzzers	<ul style="list-style-type: none"> • Function properly?
Lights	<ul style="list-style-type: none"> • Do all the lights come on?
Parking brake	<ul style="list-style-type: none"> • Moves smoothly? • Can hold the vehicle securely on an incline?
Seat belts	<ul style="list-style-type: none"> • Does the seat belt system operate smoothly? • Are the belts undamaged?
Seats	<ul style="list-style-type: none"> • Do the seat controls operate properly?
Steering wheel	<ul style="list-style-type: none"> • Moves smoothly? • Has correct free play? • No strange noises?

Vehicle exterior

Items	Check points
Doors	<ul style="list-style-type: none"> • Operate smoothly?
Hood	<ul style="list-style-type: none"> • The lock system works properly?
Fluid leaks	<ul style="list-style-type: none"> • Is there any leakage after parking?
Tire	<ul style="list-style-type: none"> • Inflation pressure is correct? • Tire surfaces not worn or damaged? • Tires rotated according to the maintenance schedule? • Wheel nuts are not loose?



CAUTION

■ If the hybrid system is operating

Turn off the hybrid system and ensure that there is adequate ventilation before performing maintenance checks.

Some states have vehicle emission inspection programs which include OBD (On Board Diagnostics) checks. The OBD system monitors the operation of the emission control system.

■ **If the malfunction indicator lamp comes on**

The OBD system determines that a problem exists somewhere in the emission control system. Your vehicle may not pass the I/M test and may need to be repaired. Contact your Toyota dealer to service the vehicle.

■ **Your vehicle may not pass the I/M test:**

- When the 12 volt battery is disconnected or discharged

Readiness codes that are set during ordinary driving are erased.

Also, depending on your driving habits, the readiness codes may not be completely set.

- When the fuel tank cap is loose

The malfunction indicator lamp comes on as a temporary malfunction and your vehicle may not pass the I/M test.

■ **When the malfunction indicator lamp goes off after several driving trips**

The error code in the OBD system will not be cleared unless the vehicle is driven 40 or more times.

■ **If your vehicle does not pass the I/M test**

Contact your Toyota dealer to prepare the vehicle for re-testing.

Do-it-yourself service precautions

If you perform maintenance yourself, be sure to follow the correct procedure given in these sections.

Items	Parts and tools
12 volt battery condition (→P. 436)	<ul style="list-style-type: none"> • Grease • Conventional wrench (for terminal clamp bolts)
Engine/power control unit coolant level (→P. 430)	<ul style="list-style-type: none"> • “Toyota Super Long Life Coolant” or similar high quality ethylene glycol based non-silicate, non-amine, non-nitrite and non-borate coolant with long-life hybrid organic acid technology. For the U.S.A.: “Toyota Super Long Life Coolant” is pre-mixed with 50 % coolant and 50 % deionized water. For Canada: “Toyota Super Long Life Coolant” is pre-mixed with 55 % coolant and 45 % deionized water. • Funnel (used only for adding coolant)

Items	Parts and tools
Brake fluid level (→P. 432)	<ul style="list-style-type: none"> • FMVSS No.116 DOT 3 or SAE J1703 brake fluid • Rag or paper towel • Funnel (used only for adding brake fluid)
Engine oil level (→P. 426)	<ul style="list-style-type: none"> • “Toyota Genuine Motor Oil” or equivalent • Rag or paper towel • Funnel (used only for adding engine oil)
Fuses (→P. 462)	<ul style="list-style-type: none"> • Fuse with same amperage rating as original
Radiator and condenser (→P. 432)	—
Tire inflation pressure (→P. 451)	<ul style="list-style-type: none"> • Tire pressure gauge • Compressed air source
Washer fluid (→P. 434)	<ul style="list-style-type: none"> • Water or washer fluid containing antifreeze (for winter use) • Funnel (used only for adding washer fluid)

 **CAUTION**

The engine compartment contains many mechanisms and fluids that may move suddenly, become hot, or become electrically energized. To avoid death or serious injury observe the following precautions.

■ **When working on the engine compartment**

- Keep hands, clothing, and tools away from the moving fan.
- Be careful not to touch the engine, power control unit, radiator, exhaust manifold, etc. right after driving as they may be hot. Oil and other fluids may also be hot.
- Do not leave anything that may burn easily, such as paper or rags, in the engine compartment.
- Do not smoke, cause sparks or expose an open flame to fuel. Fuel fumes are flammable.
- Never touch, disassemble, remove or replace the high voltage parts, cables and their connectors. It can cause severe burns or electric shock that may result in death or serious injury.
- When the hybrid system is operating with the “READY” indicator on, the engine may suddenly start in some cases. When you inspect the engine compartment, be sure to turn off the hybrid system.

■ **When working near the electric cooling fan or radiator grille**

Be sure the “POWER” switch is OFF.

With the “POWER” switch in ON mode, the electric cooling fan may automatically start to run if the air conditioning is on and/or the coolant temperature is high. (→P. 432)

■ **Safety glasses**

Wear safety glasses to prevent flying or falling material, fluid spray, etc. from getting in the eyes.

**NOTICE****■ If you remove the air cleaner filter**

Driving with the air cleaner filter removed may cause excessive engine wear due to dirt in the air. Also a backfire could cause a fire in the engine compartment.

4-3. Do-it-yourself maintenance

Hood

Release the lock from the inside of the vehicle to open the hood.

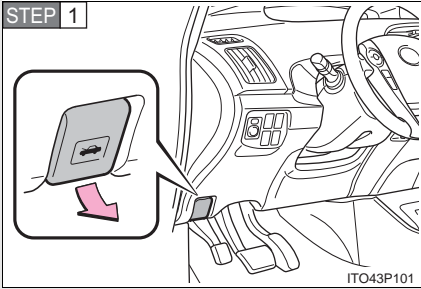

Pull the hood release lever.

The hood will pop up slightly.

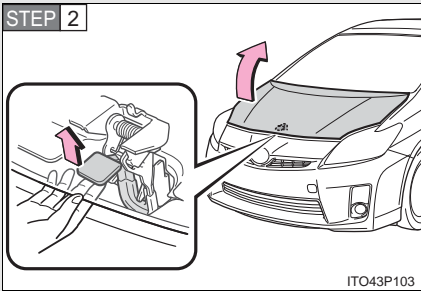

Lift the hood catch and lift the hood.

STEP 3

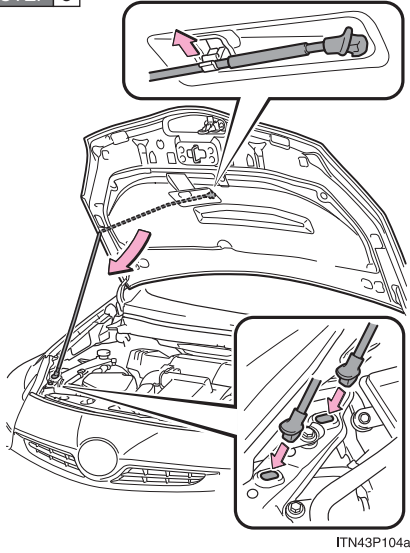

Hold the hood open by inserting the supporting rod into either of the slots.

 **CAUTION**

■ **Pre-driving check**

Check that the hood is fully closed and locked.

If the hood is not locked properly it may open while the vehicle is in motion and cause an accident, which may result in death or serious injury.

■ **After installing the support rod into the slot**

Make sure the rod supports the hood securely from falling down on to your head or body.

 **NOTICE**

■ **When closing the hood**

Be sure to return the support rod to its clip before closing the hood. Closing the hood with the support rod up could cause the hood to bend.

4-3. Do-it-yourself maintenance

Positioning a floor jack

When raising your vehicle with a floor jack, position the jack correctly. Improper placement may damage your vehicle or cause injury.

► Front

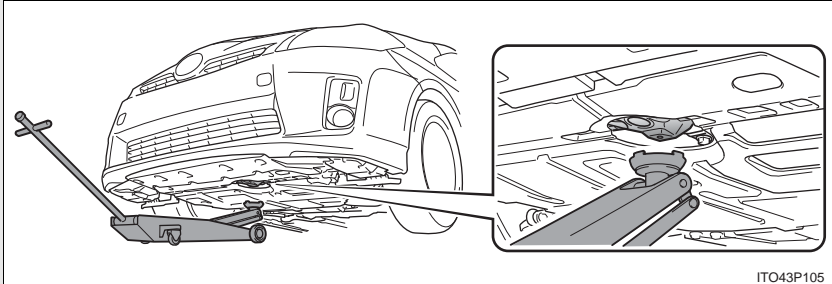

► Rear

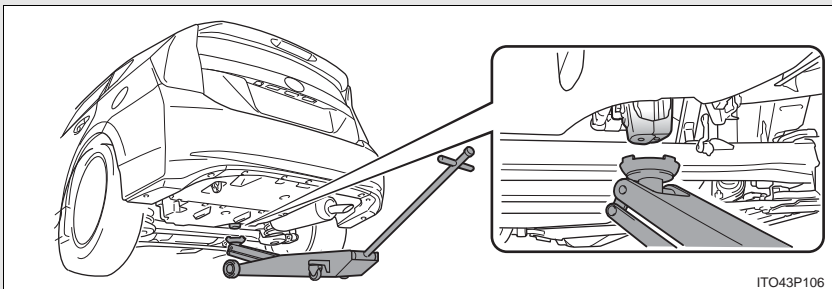

! CAUTION

■ When raising your vehicle

Make sure to observe the following to reduce the possibility of death or serious injury.

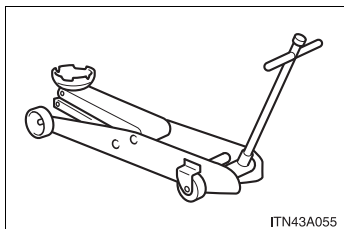

● Lift up the vehicle using a floor jack such as the one shown in the illustration.

- When using a floor jack, follow the instructions of the manual provided with the jack.
- Do not use the jack that was supplied with your vehicle.
- Do not put any part of your body or get underneath the vehicle supported only by the floor jack.
Always use automotive jack stands or a solid, flat, level surface.
- Do not start the hybrid system while the vehicle is supported by the floor jack.
- Stop the vehicle on level firm ground, firmly set the parking brake and push the "P" position switch.
- Make sure to set the floor jack properly at the jack point.
Raising the vehicle with an improperly positioned floor jack will damage the vehicle and may cause the vehicle to fall off the floor jack.
- Do not raise the vehicle while someone is in the vehicle.
- When raising the vehicle, do not place any objects on top of or underneath the floor jack.

Engine oil

With the engine at operating temperature and turned off, check the oil level on the dipstick.

■ Checking the engine oil

STEP 1 Park the vehicle on level ground. After turning off the hybrid system, wait more than 5 minutes for the oil to drain back into the bottom of the engine.

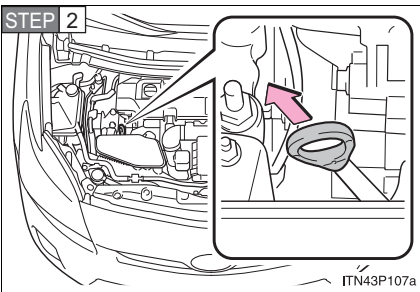

Hold a rag under the end and pull the dipstick out.

STEP 3 Wipe the dipstick clean.

STEP 4 Reinsert the dipstick fully.

STEP 5 Holding a rag under the end, pull the dipstick out and check the oil level.

STEP 6 Wipe the dipstick and reinsert it fully.

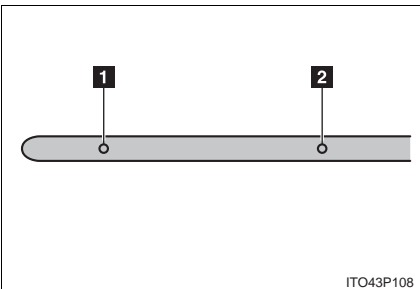

1 Low

2 Full

■ Adding engine oil

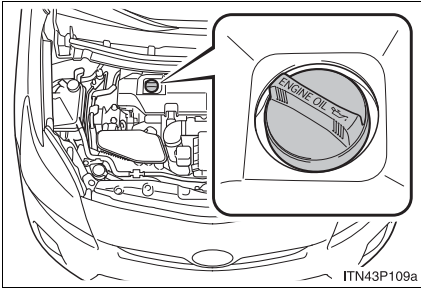

If the oil level is below or near the low level mark, add engine oil of the same type as already in the engine.

Make sure to check the oil type and prepare the items needed before adding oil.

Engine oil selection	→P. 560
Oil quantity (Low → Full)	1.6 qt. (1.5 L, 1.3 Imp. qt.)
Items	Clean funnel

- STEP 1** Remove the oil filler cap.
- STEP 2** Add engine oil slowly, checking the dipstick.
- STEP 3** Install the filler cap, turning it clockwise.

■ Engine oil consumption

- The amount of engine oil consumed depends on the oil viscosity, the quality of the oil and the way the vehicle is driven.
- More oil is consumed under driving conditions such as high speeds, frequent acceleration and deceleration.
- A new engine consumes more oil.
- When judging the amount of oil consumption, keep in mind that the oil may have become diluted, making it difficult to judge the true level accurately.
- Oil consumption: Max. 1.1 qt./600 miles, 0.9 Imp. qt./600 miles (1.0 L per 1000 km).
- If the vehicle consumes more than 1.1 qt. (1.0 L, 0.9 Imp.qt.) every 600 miles (1000 km), contact your Toyota dealer.

■ After changing the engine oil (U.S.A. only)

The oil change system should be reset. Perform the following steps:

STEP 1 Turn the “POWER” switch OFF with the trip meter A shown.

STEP 2 Turn the “POWER” switch ON with the MPH or km/h button (→P. 183) held down.

STEP 3 Keep pressing the button until the odometer indicates “000000” and the multi-information display indicates that the reset is complete.

 **CAUTION****■ Used engine oil**

- Used engine oil contains potentially harmful contaminants which may cause skin disorders such as inflammation or skin cancer, so care should be taken to avoid prolonged and repeated contact. To remove used engine oil from your skin, wash thoroughly with soap and water.
- Dispose of used oil and filters only in a safe and acceptable manner. Do not dispose of used oil and filters in household trash, in sewers or onto the ground.
Call your Toyota dealer, service station or auto parts store for information concerning recycling or disposal.
- Do not leave used engine oil within the reach of children.

 **NOTICE****■ To prevent serious engine damage**

Check the oil level on regular basis.

■ When replacing the engine oil

- Be careful not to spill engine oil on the vehicle components.
- Avoid overfilling, or the engine could be damaged.
- Check the oil level on the dipstick every time you refill the vehicle.
- Be sure the engine oil filler cap is properly retightened.

Engine/power control unit coolant

The coolant level is satisfactory if it is between the “FULL” and “LOW” lines on the reservoir when the hybrid system is cold.

► Engine coolant reservoir

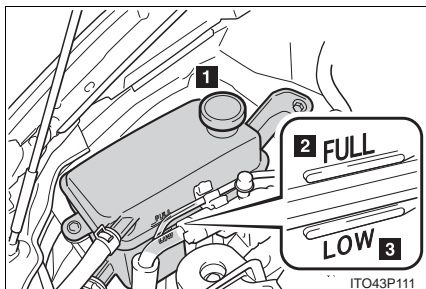

1 Reservoir cap

2 “FULL”

3 “LOW”

If the level is on or below the “LOW” line, add coolant up to the “FULL” line.

► Power control unit coolant reservoir

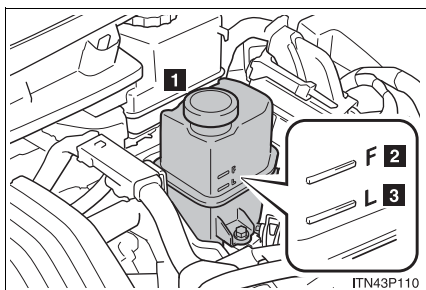

1 Reservoir cap

2 Full

3 Low

If the level is on or below the “L” line, add coolant up to the “F” line.

■ If the coolant level drops within a short time after replenishing

Visually check the radiator, hoses, reservoir cap, radiator cap, drain cock and water pump.

If you cannot find a leak, have your Toyota dealer pressure test the cap and check for leaks in the cooling system.

■ Coolant selection

Only use “Toyota Super Long Life Coolant” or similar high quality ethylene glycol based non-silicate, non-amine, non-nitrite, and non-borate coolant with long-life hybrid organic acid technology.

U.S.A.: “Toyota Super Long Life Coolant” is a mixture of 50 % coolant and 50 % deionized water. (Enabled: -31 °F [-35 °C])

Canada: “Toyota Super Long Life Coolant” is a mixture of 55 % coolant and 45 % deionized water. (Enabled: -44 °F [-42 °C])

For more details about engine coolant, contact your Toyota dealer.

CAUTION

■ When the hybrid system is hot

Do not remove the coolant reservoir cap.

The cooling system may be under pressure and may spray hot coolant if the cap is removed, causing burns or other injuries.

NOTICE

■ When adding the coolant

Coolant is neither plain water not straight antifreeze. The correct mixture of water and anti freeze must be used to provide proper lubrication, corrosion protection and cooling. Be sure to read the antifreeze or coolant label.

■ If you spill coolant

Be sure to wash it off with water to prevent it damage to parts or paint.

Radiator and condenser

Check the radiator and condenser and clear any foreign objects. If either of the above parts are extremely dirty or you are not sure of their condition, have your vehicle checked by your Toyota dealer.

CAUTION

When the hybrid system is hot

Do not touch the radiator or condenser, as they may be hot and may cause burns.

Brake fluid

Checking fluid level

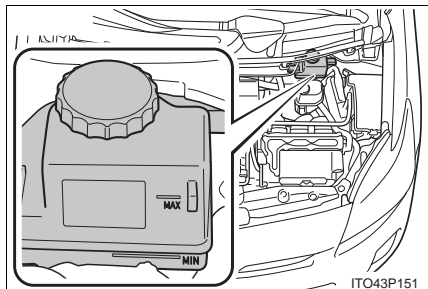

The brake fluid level should be between the "MAX" and "MIN" lines on the tank.

■ Adding fluid

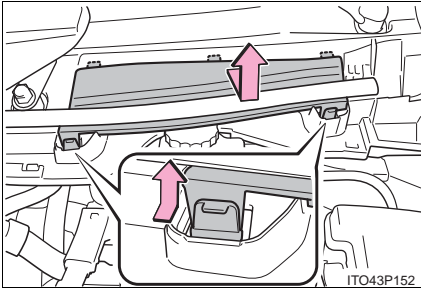

Push the tab in and lift the cover off.

Make sure to check the fluid type and prepare the necessary items.

Fluid type	FMVSS No.116 DOT 3 or SAE J1703 brake fluid
Items	Clean funnel

■ Brake fluid can absorb moisture from the air

Excess moisture in the fluid can cause a dangerous loss of braking efficiency. Use only newly opened brake fluid.

⚠ CAUTION

■ When filling the reservoir

Take care because brake fluid can harm your hands or eyes and damage painted surfaces.

If fluid gets in your eyes, flush your eyes with clean water immediately.

If you still experience discomfort, see a doctor.

 NOTICE

■ If the fluid level is low

It is normal for the brake fluid level to go down slightly as the brake pads wear or when the fluid level in the accumulator is high.

If the reservoir needs frequent refilling, it may indicate a serious problem.

Washer fluid

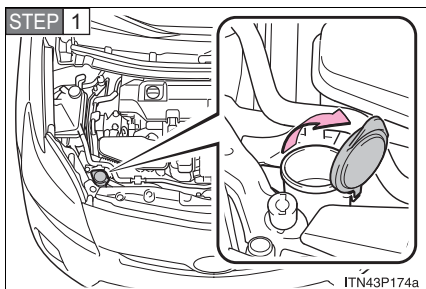

Open the lid.

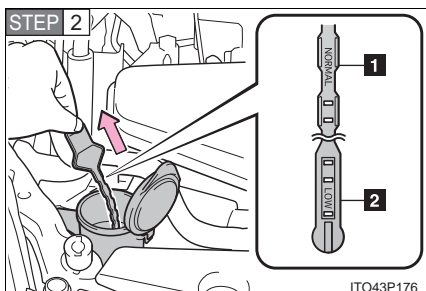

Check the washer fluid level on the level gauge.

1 "NORMAL"

2 "LOW"

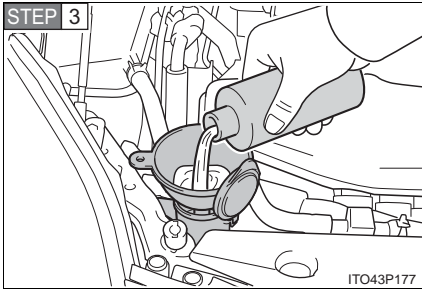

If the washer fluid level is at “LOW”, add washer fluid.

⚠ CAUTION

■ When refilling the washer fluid

Do not refill the washer fluid when the hybrid system is hot or operating, as the washer fluid contains alcohol and may catch fire if spilled on the hybrid system etc.

⚠ NOTICE

■ Do not use any fluid other than washer fluid

Do not use soapy water or engine antifreeze instead of washer fluid. Doing so may cause streaking on the vehicle's painted surfaces.

■ Diluting washer fluid

Dilute washer fluid with water as necessary. Refer to the freezing temperatures listed on the washer fluid tank.

4-3. Do-it-yourself maintenance

12 volt battery

■ Location

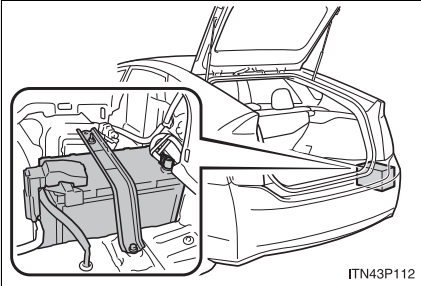

The 12 volt battery is located in the right-hand side of luggage compartment.

■ Removing the 12 volt battery cover

STEP 1 Open the center auxiliary box. (→P. 385)

STEP 2 Remove the center auxiliary box. (→P. 526)

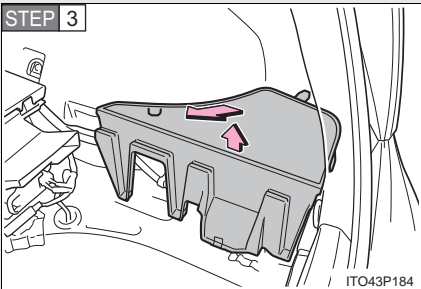

Remove the 12 volt battery cover.

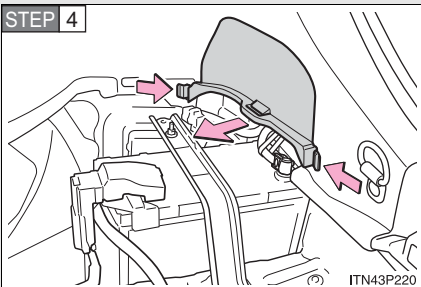

Remove the 12 volt battery maintenance cover.

■ 12 volt battery exterior

Make sure that the 12 volt battery terminals are not corroded and that there are no loose connections, cracks, or loose clamps.

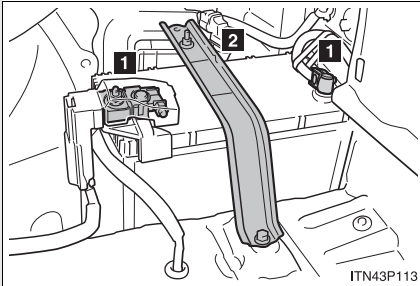

1 Terminals

2 Hold-down clamp

■ Before recharging

When recharging, the 12 volt battery produces hydrogen gas which is flammable and explosive. Therefore, before recharging:

- If recharging with the 12 volt battery installed on the vehicle, be sure to disconnect the ground cable.
- Make sure the power switch on the charger is off when connecting and disconnecting the charger cables to the 12 volt battery.

■ After recharging/reconnecting the 12 volt battery

- Unlocking the doors using the smart key system may not be possible immediately after disconnecting the 12 volt battery. If this happens, use the wireless remote control or the mechanical key to lock/unlock the doors.
- Start the hybrid system with the “POWER” switch in ACCESSORY mode. The hybrid system may not start with the “POWER” switch turned OFF. However, the hybrid system will operate normally from the second attempt.
- The “POWER” switch mode is recorded by the vehicle. If the battery is reconnected, the vehicle will return the “POWER” switch mode to the status it was in before the battery was disconnected. Make sure to turn off the power before disconnect the battery. Take extra care when connecting the battery if the “POWER” switch mode prior to discharge is unknown.

If the system will not start even after multiple attempts, contact your Toyota dealer.

CAUTION

■ Chemicals in the 12 volt battery

The 12 volt battery contains poisonous and corrosive sulfuric acid and may produce hydrogen gas which is flammable and explosive. To reduce the risk of death or serious injury, take the following precautions while working on or near the 12 volt battery:

- Do not cause sparks by touching the 12 volt battery terminals with tools.
- Do not smoke or light a match near the 12 volt battery.
- Avoid contact with eyes, skin and clothes.
- Never inhale or swallow electrolyte.
- Wear protective safety glasses when working near the 12 volt battery.
- Keep children away from the 12 volt battery.

 **CAUTION****■ Where to safely charge the 12 volt battery**

Always charge the 12 volt battery in an open area. Do not charge the 12 volt battery in a garage or closed room where there is not sufficient ventilation.

■ How to recharge the 12 volt battery

Only perform a slow charge (4.2 A or less). The 12 volt battery may explode if charged at a quicker rate.

■ Emergency measures regarding electrolyte**● If electrolyte gets in your eyes**

Flush your eyes with clean water for at least 15 minutes and get immediate medical attention. If possible, continue to apply water with a sponge or cloth while traveling to the nearest medical facility.

● If electrolyte gets on your skin

Wash the affected area thoroughly. If you feel pain or a burning sensation, seek medical attention immediately.

● If electrolyte gets on your clothes

It can soak through clothing on to your skin. Immediately take off the clothing and follow the procedure above if necessary.

● If you accidentally swallow electrolyte

Drink a large quantity of water or milk. Get emergency medical attention immediately.

⚠ CAUTION

■ When disconnecting the 12 volt battery

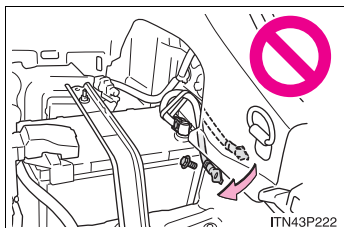

Do not disconnect the negative (-) terminal on the body side as shown. The disconnected negative (-) terminal may touch the positive (+) terminal, which may cause a short and result in death or serious injury.

⚠ NOTICE

■ When recharging the 12 volt battery

Never recharge the 12 volt battery while the hybrid system is operating. Also, be sure all accessories are turned off.

Replace or rotate tires in accordance with maintenance schedules and treadwear.

■ Checking tires

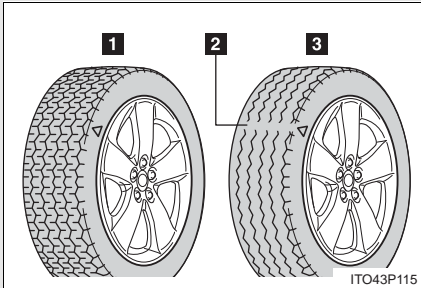

- 1 New tread
- 2 Treadwear indicator
- 3 Worn tread

The location of treadwear indicators is shown by the “TWI” or “Δ” marks, etc., molded on the sidewall of each tire.

Check spare tire condition and inflation pressure if not rotated.

■ Tire rotation

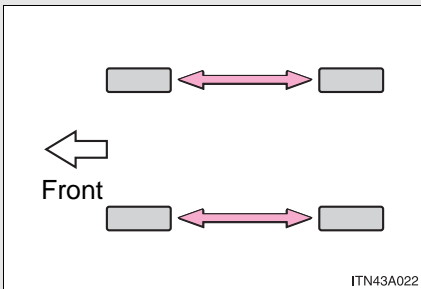

Rotate the tires in the order shown.

To equalize tire wear and extend tire life, Toyota recommends that tire rotation is carried out at the same interval as tire inspection.

Do not fail to initialize the tire pressure warning system after tire rotation.

■ The tire pressure warning system

Your Toyota is equipped with a tire pressure warning system that uses tire pressure warning valves and transmitters to detect low tire inflation pressure before serious problems arise. (→P. 499)

The compact spare tire is not equipped with a tire pressure warning valve and transmitter.

Installing tire pressure warning valves and transmitters

When replacing tires or wheels, tire pressure warning valves and transmitters must also be installed.

When new tire pressure warning valves and transmitters are installed, new tire pressure warning valve and transmitter ID codes must be registered in the tire pressure warning computer and tire pressure warning system must be initialized. Have tire pressure warning valve and transmitter ID codes registered by Toyota dealer. (→P. 444)

Initializing the tire pressure warning system

■ The tire pressure warning system must be initialized in the following circumstances

- When rotating the tires on vehicles differing with front and rear tire inflation pressures.
- When changing the tire inflation pressure by changing traveling speed or load weight, etc.
- When changing the tire size.

When the tire pressure warning system is initialized, the current tire inflation pressure is set as the pressure benchmark.

■ How to initialize the tire pressure warning system

STEP 1 Park the vehicle in safe place and turn the “POWER” switch OFF.

While the vehicle is moving, initialization is not performed.

STEP 2 Adjust the tire inflation pressure to the specified cold tire inflation pressure level. (→P. 565)

Make sure to adjust the tire pressure to the specified cold tire inflation pressure level. The tire pressure warning system will operate based on this pressure level.

STEP 3 Turn the “POWER” switch to ON mode.

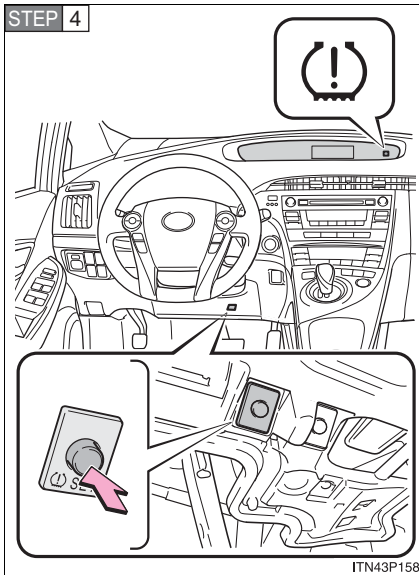

Push and hold the tire pressure warning reset switch until the tire pressure warning light blinks slowly 3 times.

STEP 5 Wait for a few minutes with the ON mode, and then turn “POWER” switch OFF.

Registering ID codes

The tire pressure warning valve and transmitter is equipped with a unique ID code. When replacing a tire pressure warning valve and transmitter, it is necessary to register the ID code of tire pressure warning valve and transmitter. Have the ID code registered by your Toyota dealer.

■ When to replace your vehicle's tires

Tires should be replaced if:

- You have tire damage such as cuts, splits, cracks deep enough to expose the fabric or bulges indicating internal damage
- A tire goes flat repeatedly or cannot be properly repaired due to the size or location of a cut or other damage

If you are not sure, consult with your Toyota dealer.

■ Replacing tires and wheels

If the ID code of the tire pressure warning valve and transmitter is not registered, the tire pressure warning system will not work properly. After driving for about 20 minutes, the tire pressure warning light comes on after blinking for 1 minute to indicate a system malfunction.

■ Tire life

Any tire over 6 years old must be checked by a qualified technician even if they have seldom or never been used or damage is not obvious.

■ If the tread wears down below 0.16 in. (4 mm) on snow tires

The effectiveness of snow tires is lost.

■ Low profile tires (vehicles with 17-inch tires)

Generally, low profile tires will wear more rapidly and tire grip performance will be reduced on snowy and/or icy roads when compared to standard tires. Be sure to use snow tires or tire chains on snowy and/or icy roads and drive carefully at a speed appropriate for road and weather conditions.

■ Maximum load of tire

Check that the maximum load of the replacement tire is greater than 1/2 of the Gross Axle Weight Ratings (GAWR) of either the front axle or the rear axle, whichever is greater.

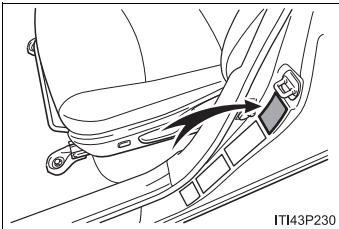

For the GAWR, see the Certification Label. For the maximum load of the tire, see the load limit at maximum cold tire inflation pressure mentioned on the sidewall of the tire.(→P. 572)

■ Tire types

1 Summer tires

Summer tires are high-speed performance tires best suited to highway driving under dry conditions. Since summer tires do not have the same traction performance as snow tires, summer tires are inadequate for driving on snow-covered or icy roads. For driving on snow-covered roads or icy roads, the use of snow tires is recommended. When installing snow tires, be sure to replace all four tires.

2 All season tires

All season tires are designed to provide better traction in snow and to be adequate for driving in most winter conditions, as well as for use year round. All season tires, however, do not have adequate traction performance compared with snow tires in heavy or loose snow. Also, all season tires fall short in acceleration and handling performance compared with summer tires in highway driving.

3 Snow tires

For driving on snow-covered roads or icy roads, we recommend using snow tires. If you need snow tires, select tires of the same size, construction and load capacity as the originally installed tires. Since your vehicle has radial tires as original equipment, make sure your snow tires also have radial construction. Do not install studded tires without first checking local regulations for possible restriction. Snow tires should be installed on all wheels. (→P. 261)

■ Initializing the tire pressure warning system

Initialize the tires with the tire inflation pressure adjusted to the specified level.

■ If you push the tire pressure warning reset switch accidentally

If initialization is performed, adjust the tire inflation pressure to the specified level and initialize the tire pressure warning system again.

■ When the initialization of the tire pressure warning system has failed

Initialization can be completed in a few minutes. However, in the following cases, the settings have not been recorded and the system will not operate properly. If repeated attempts to record tire inflation pressure settings are unsuccessful, have the vehicle inspected by your Toyota dealer.

- When operating the tire pressure warning reset switch, the tire pressure warning light does not flash 3 times.
- After carrying out the initialization procedure, the tire pressure warning light blinks for 1 minute then stays on after driving 20 minutes.

■ Routine tire inflation pressure checks

The tire pressure warning system does not replace routine tire inflation pressure checks. Make sure to check tire inflation pressure as part of your routine of daily vehicle checks.

■ Tire pressure warning system certification

FCC ID: PAXPMV107J

FCC ID: PAXPMV108J

FCC ID: HYQ13BDE

IC ID: 3729A-PMV107J

IC ID: 3729A-PMV108J

IC ID: 1551A-13BDE

- ▶ For vehicles sold in the U.S.A.

NOTE:

This device complies with Part 15 of the FCC Rules. Operation is subject to the following two conditions: (1) this device may not cause harmful interference, and (2) this device must accept any interference received, including interference that may cause undesired operation.

FCC WARNING:

Changes or modifications not expressly approved by the party responsible for compliance could void the user's authority to operate the equipment.

- ▶ For vehicles sold in Canada

NOTE:

Operation is subject to the following two conditions: (1) this device may not cause interference, and (2) this device must accept any interference, including interference that may cause undesired operation of the device.

 **CAUTION****■ When inspecting or replacing tires**

Observe the following precautions to prevent accidents. Failure to do so may cause damage to parts of the drive train, as well as dangerous handling characteristics, which may lead to an accident resulting in death or serious injury.

- Do not mix tires of different makes, models or tread patterns.
Also, do not mix tires of remarkably different treadwear.
- Do not use tire sizes other than those recommended by Toyota.
- Do not mix differently constructed tires (radial, bias-belted or bias-ply tires).
- Do not mix summer, all season and winter tires.
- Do not use tires that have been used on another vehicle.
Do not use tires if you do not know how they were used previously.

■ When initializing the tire pressure warning system

Do not push the tire pressure warning reset switch without first adjusting the tire inflation pressure to the specified level. Otherwise, the tire pressure warning light may not come on even if the tire inflation pressure is low, or it may come on when the tire inflation pressure is actually normal.

 NOTICE

■ **Repairing or replacing tires, wheels and tire pressure warning valves and transmitters**

When removing or fitting the wheels, tires or the tire pressure warning valve and transmitter, contact your Toyota dealer as the tire pressure warning valve and transmitter may be damaged if not handled correctly.

■ **To avoid damaging the tire pressure warning valves and transmitters**

Do not use liquid sealants on flat tires.

■ **Driving on rough roads**

Take particular care when driving on roads with loose surfaces or pot-holes.

These conditions may cause losses in tire inflation pressure, reducing the cushioning ability of the tires. In addition driving on rough roads may cause damage to the tires themselves, as well as the vehicle's wheels and body.

■ **Low profile tires (215/45R17 tires)**

Low profile tires may cause greater damage than usual to the wheel when receiving impact from the road surface. Therefore pay attention to the following:

- Be sure to use proper tire inflation pressure. If tires are under-inflated, they may be damaged more severely.
- Avoid pot holes, uneven pavement, curbs and other road hazards. Failure to do so can lead to severe tire and wheel damage.

■ **If tire inflation pressures become low while driving**

Do not continue driving, or your tires and/or wheels may be ruined.

4-3. Do-it-yourself maintenance

Tire inflation pressure

■ Tire inflation pressure

The recommended cold tire inflation pressure and tire size is displayed on the tire and loading information label. (→P. 565)

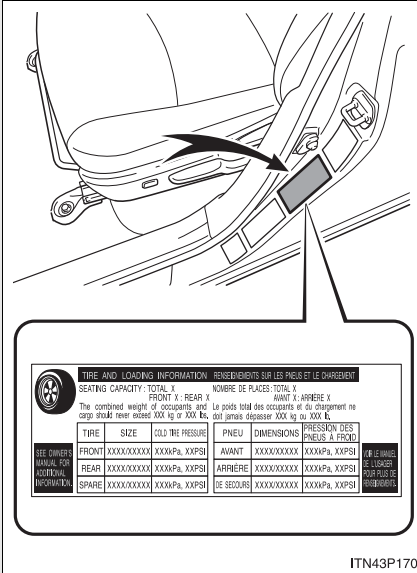

■ Inspection and adjustment procedure

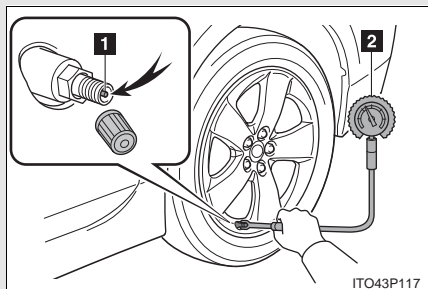

1 Tire valve

2 Tire pressure gauge

STEP 1 Remove the tire valve cap.

STEP 2 Press the tip of the tire pressure gauge onto the tire valve.

STEP 3 Read the pressure using the graduations of the gauge.

STEP 4 If the tire inflation pressure is not within the recommended levels, adjust tire pressure.

If you add too much air, press the center of the valve to lower.

STEP 5 After completing the tire inflation pressure measurement and adjustment, apply soapy water to the valve and check for leakage.

STEP 6 Reinstall the tire valve cap.

■ Tire inflation pressure check interval

You should check tire inflation pressure every 2 weeks, or at least once a month.

Do not forget to check the spare.

■ Effects of incorrect tire inflation pressure

Driving with incorrect tire inflation pressure may result in the following:

- Reduced fuel efficiency
- Reduced driving comfort and tire life
- Reduced safety
- Damage to the drive train

If a tire needs frequent refilling, have it checked by your Toyota dealer.

■ Instructions for checking tire inflation pressure

When checking tire inflation pressure, observe the following:

- Check only when the tires are cold.
If your vehicle has been parked for at least 3 hours and has not been driven for more than 1 mile or 1.5 km, you will get an accurate cold tire inflation pressure reading.
- Always use a tire pressure gauge.
The appearance of the tire can be misleading. In addition, tire inflation pressures that are even just a few pounds off can degrade ride and handling.
- Do not bleed or reduce tire inflation pressure after driving. It is normal for the tire inflation pressure to be higher after driving.
- Never exceed the vehicle capacity weight.
Passengers and luggage weight should be placed so that the vehicle is balanced.

 CAUTION

■ **Proper inflation is critical to save tire performance**

Keep your tires properly inflated. Otherwise, the following conditions may occur and result in an accident causing death or serious injury.

- Excessive wear
- Uneven wear
- Poor handling
- Possibility of blowouts resulting from overheated tires
- Poor sealing of the tire bead
- Wheel deformation and/or tire separation
- A greater possibility of tire damage from road hazards

 NOTICE

■ **When inspecting and adjusting tire inflation pressure**

Be sure to reinstall the tire valve caps.

Without the valve caps, dirt or moisture could get into the valve and cause air leakage, which could result in an accident. If the caps have been lost, replace them as soon as possible.

Wheels

If a wheel is bent, cracked or heavily corroded, it should be replaced.

Otherwise, the tire may separate from the wheel or cause loss of handling control.

■ Wheel selection

When replacing wheels, care should be taken to ensure that they are equivalent to those removed in load capacity, diameter, rim width, and inset*.

Replacement wheels are available at your Toyota dealer.

*: Conventionally referred to as “offset”.

Toyota does not recommend using:

- Wheels of different sizes or types
- Used wheels
- Bent wheels that have been straightened

■ Aluminum wheel precautions

- Use only Toyota wheel nuts and wrenches designed for use with your aluminum wheels.
- When rotating, repairing or changing your tires, check that the wheel nuts are still tight after driving 1000 miles (1600 km).
- Be careful not to damage the aluminum wheels when using tire chains.
- Use only Toyota genuine balance weights or equivalent and a plastic or rubber hammer when balancing your wheels.

■ When replacing wheels

The wheels of your Toyota are equipped with tire pressure warning valves and transmitters that allow the tire pressure warning system to provide advanced warning in the event of a loss in tire inflation pressure. Whenever wheels are replaced, the tire pressure warning valves and transmitters must be installed. (→P. 442)

CAUTION

■ When replacing wheels

- Do not use wheels that are a different size from those recommended in the Owner's Manual, as this may result in loss of handling control.
- Never use an inner tube in a leaking wheel which is designed for a tubeless tire. Doing so may result in an accident, causing death or serious injury.

NOTICE

■ Replacing tire pressure warning valves and transmitters

- Because tire repair or replacement may affect the tire pressure warning valves and transmitters, make sure to have tires serviced by your Toyota dealer or other qualified service shop. In addition, make sure to purchase your tire pressure warning valves and transmitters at your Toyota dealer.
- Ensure that only genuine Toyota wheels are used on your vehicle. Tire pressure warning valves and transmitters may not work properly with non-genuine wheels.

4-3. Do-it-yourself maintenance

Air conditioning filter

The air conditioning filter must be cleaned or changed regularly to maintain air conditioning efficiency.

■ Removal method

STEP 1 Turn the “POWER” switch OFF.

Vehicles with Solar Ventilation System: Turn the Solar Ventilation System off and make sure not to operate the Remote Air Conditioning System.

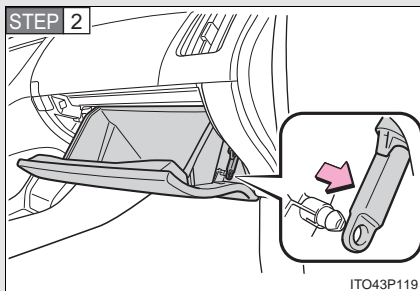

Open the glove box. Slide off the damper.

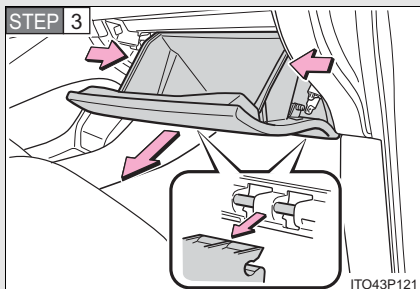

Push each side of the glove box to release the pins. Then disconnect the claws at the bottom and remove the glove box.

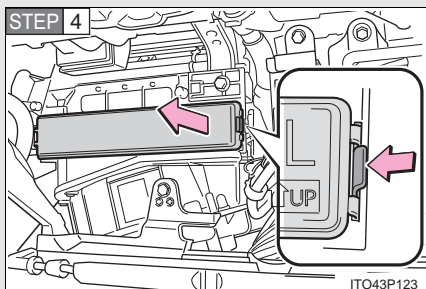

Remove the filter cover.

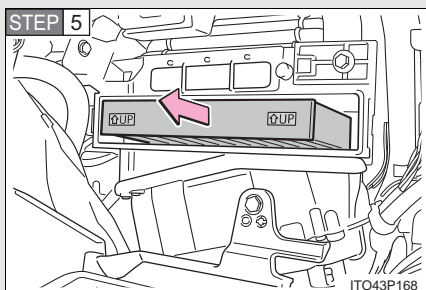

Remove the filter.

■ Cleaning method

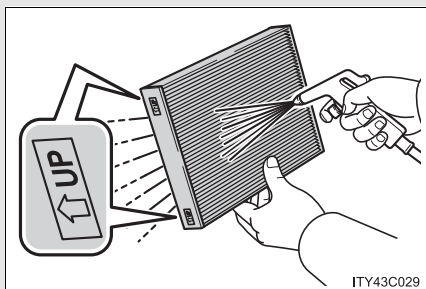

If the filter is dirty, clean by blowing compressed air through the filter from the downward side.

Hold the air gun 2 in. (5 cm) from the filter and blow for approximately 2 minutes at 72 psi (500 kPa, 5.0 kgf/cm² or bar).

If it is not available, have the filter cleaned by your Toyota dealer.

■ Replacement method

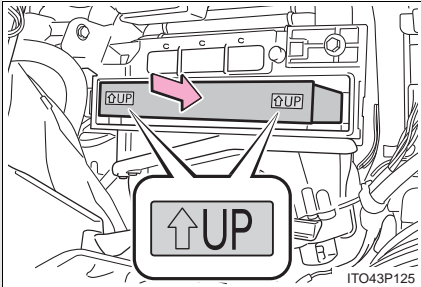

Replace the air conditioning filter with a new one.

The “↑UP” marks shown on the filter should be pointing up.

■ Checking interval

Inspect, clean and replace the air conditioning filter according to the maintenance schedule. In dusty areas or areas with heavy traffic flow, early replacement may be required. (For scheduled maintenance information, refer to the “Owner’s Manual Supplement/Scheduled Maintenance Guide”.)

■ If air flow from the vents decreases dramatically

The filter may be clogged. Check the filter and replace if necessary.

NOTICE

■ To prevent damage to the system

- When using the air conditioning system, make sure that a filter is always installed.
- When cleaning the filter, do not clean the filter with water.

4-3. Do-it-yourself maintenance

Electronic key battery

Replace the battery with a new one if it is discharged.

■ You will need the following items:

- Flathead screwdriver (To prevent damage to the key, cover the tip of the screwdriver with rag)
- Small Phillips-head screwdriver
- Lithium battery (CR1632)

■ Replacing the battery

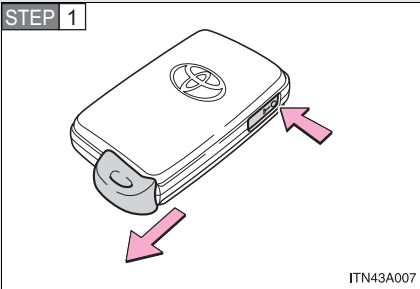

Take out the mechanical key.

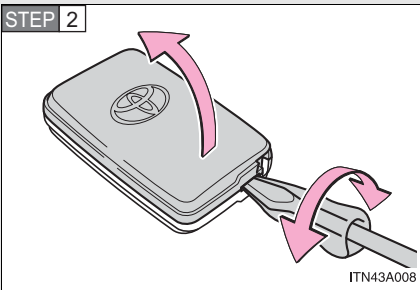

Remove the cover.

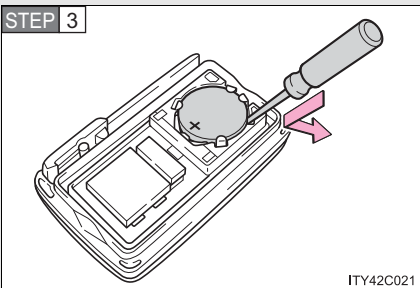

Remove the depleted battery.

Insert a new battery with the “+” terminal facing up.

■ If the electronic key battery is discharged

The following symptoms may occur.

- The smart key system and wireless remote control will not function properly.
- The operational range is reduced.

■ Use a CR1632 lithium battery

- Batteries can be purchased at your Toyota dealer, jewelers, or camera stores.
- Replace only with the same or equivalent type recommended by a Toyota dealer.
- Dispose of used batteries according to the local laws.

CAUTION

■ Removed battery and other parts

Keep away from children.

These parts are small and if swallowed by a child they can cause choking.

NOTICE

■ For normal operation after replacing the battery

Observe the following precautions to prevent accidents.

- Always work with dry hands.
Moisture may cause the battery to rust.
- Do not touch or move any other components inside the electronic key.
- Do not bend the battery terminals.

4-3. Do-it-yourself maintenance

Checking and replacing fuses

If any of the electrical components do not operate, a fuse may have blown. If this happens, check and replace the fuses as necessary.

STEP 1 Turn the “POWER” switch OFF.

Vehicles with Solar Ventilation System: Turn the Solar Ventilation System off and make sure not to operate the Remote Air Conditioning System.

STEP 2 Open the fuse box cover.

► Engine compartment

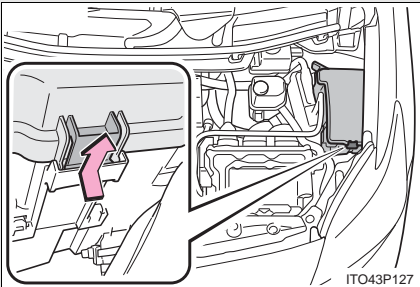

Push the tabs in and lift the lid off.

► Left side instrument panel

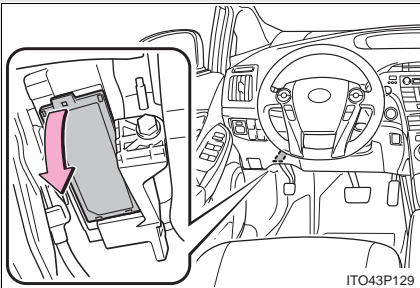

Remove the lid.

STEP 3 After a system failure, see “Fuse layout and amperage ratings” (→P. 465) for details about which fuse to check.

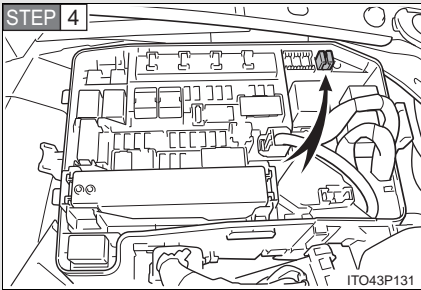

Remove the fuse with the pull-out tool.

STEP 5 Check if the fuse has blown.

► Type A

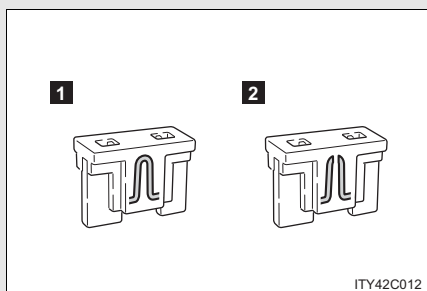

1 Normal fuse

2 Blown fuse

Replace it with one of an appropriate amperage rating. The amperage rating can be found on the fuse box lid.

► Type B

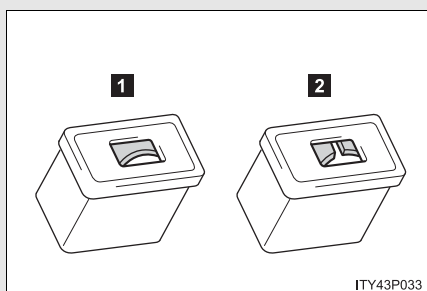

1 Normal fuse

2 Blown fuse

Replace it with one of an appropriate amperage rating. The amperage rating can be found on the fuse box lid.

► Type C

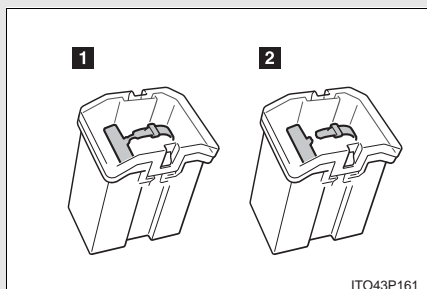

1 Normal fuse

2 Blown fuse

Contact your Toyota dealer.

Fuse layout and amperage ratings

■ Engine compartment

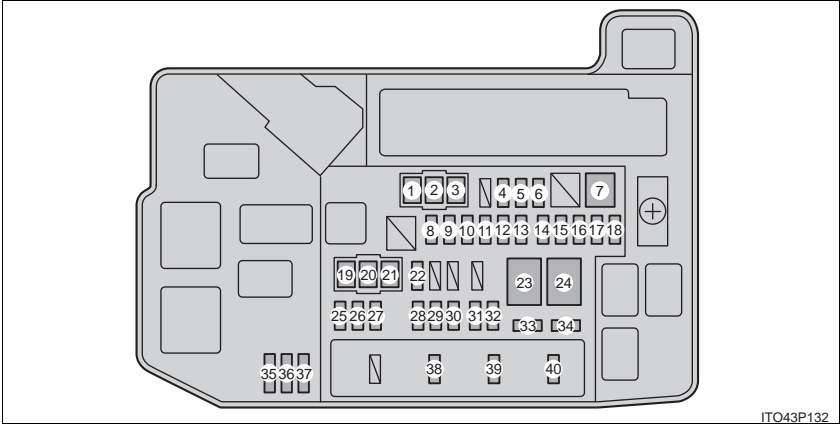

ITO43P132

FUSE		Ampere	Circuit
1	HTR	50A	Air conditioning system
2	RDI	30A	Electric cooling fans
3	CDS	30A	Electric cooling fans
4	S-HORN	10A	No circuit
5	ENG W/P	30A	Cooling system
6	ABS MAIN NO.2	7.5A	Anti-lock brake system
7	H-LP CLN	30A	Headlight cleaner
8	AMP	30A	Audio system
9	IGCT	30A	PCU, IGCT NO.2, IGCT NO.3
10	DC/DC-S	5A	Inverter and converter
11	P CON MAIN	7.5A	Parking control system, transmission

FUSE		Ampere	Circuit
12	AM2	7.5A	Power windows
13	ECU-B2	7.5A	Smart key system
14	MAYDAY	10A	No circuit
15	ECU-B3	10A	Air conditioning system
16	TURN & HAZ	10A	Turn signal lights
17	ETCS	10A	Multiport fuel injection system/ sequential multiport fuel injection system
18	ABS MAIN NO.1	20A	Anti-lock brake system
19	P/I 2	40A	Parking control system, horn, right-hand headlight (low beam), left-hand headlight (low beam), back-up lights
20	ABS MTR 1	30A	Anti-lock brake system
21	ABS MTR 2	30A	Anti-lock brake system
22	H-LP HI MAIN	20A	H-LP HI RH, H-LP HI LH, headlight switch, daytime running light system
23	P/I 1	60A	IG2, EFI MAIN, BATT FAN
24	EPS	60A	Electric power steering
25	PCU	10A	Inverter and converter
26	IGCT NO.2	10A	Hybrid system, parking control system, power windows, inverter and converter

FUSE		Ampere	Circuit
27	MIR HTR	10A	Outside rear view mirror defoggers
28	RAD NO.1	15A	Audio system, navigation system
29	DOME	10A	Door courtesy lights, personal lights, interior lights, front foot lights, vanity lights, inside rear view mirror, garage door opener, electric power steering
30	ECU-B	7.5A	Smart key system, multiplex communication system, personal lights, gauges and meters
31	H-LP LH HI	10A	Left-hand headlight (high beam)
32	H-LP RH HI	10A	Right-hand headlight (high beam)
33	EFI NO.2	10A	Multiport fuel injection system/ sequential multiport fuel injection system
34	IGCT NO.3	10A	Cooling system
35	SPARE	30A	Spare fuses
36	SPARE	15A	Spare fuses
37	SPARE	7.5A	Spare fuses
38	EFI MAIN	20A	Multiport fuel injection system/ sequential multiport fuel injection system, EFI NO.2
39	BATT FAN	10A	Battery cooling fan
40	IG2	20A	Multiport fuel injection system/ sequential multiport fuel injection system, MET-IGN, IGN, power windows

■ Left side instrument panel

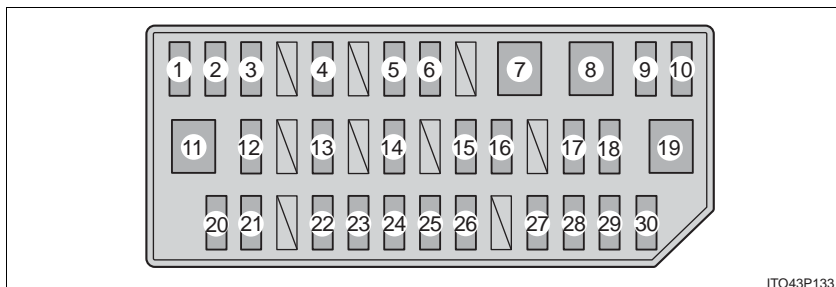

FUSE		Ampere	Circuit
1	CIG	15A	Power outlets
2	ECU-ACC	10A	Multiplex communication system, outside rear view mirrors, driver support system, audio system, navigation system
3	PWR OUTLET	15A	Power outlets
4	SEAT HTR FR	10A	Seat heater
5	SEAT HTR FL	10A	Seat heater
6	DOOR NO.1	25A	Power door lock system
7	PSB	30A	Pre-Collision System
8	PWR SEAT FR	30A	Front seat lumbar support
9	DBL LOCK	25A	Tilt & telescopic steering
10	FR FOG	15A	Front fog lights
11	PWR SEAT FL	30A	Front seat lumbar support
12	OBD	7.5A	On-board diagnosis system
13	RR FOG	7.5A	No circuit
14	STOP	10A	Stop lights, high mounted stop-light, brake system, power windows, driver support system

FUSE		Ampere	Circuit
15	P FR DOOR	25A	Power windows
16	D FR DOOR	25A	Power windows
17	DOOR RR	25A	Power windows
18	DOOR RL	25A	Power windows
19	S/ROOF	30A	Electric moon roof
20	ECU-IG NO.1	10A	Electric cooling fans, multiplex communication system
21	ECU-IG NO.2	10A	Driver support system, Pre-Collision System, LKA system, inside rear view mirror, garage door opener, yaw rate & G sensor, brake system, electric power steering, navigation system, electric moon roof, tire pressure warning system, seat belt pretensioners, audio system, emergency flashers, turn signal lights, windshield wipers, headlight cleaner
22	GAUGE	10A	Headlight leveling system, front passenger's seat belt reminder light, gauges and meters
23	A/C	10A	Air conditioning system, Solar Ventilation System, Remote Air Conditioning System
24	WASHER	15A	Windshield washer

FUSE		Ampere	Circuit
25	RR WIP	20A	Rear window wiper and washer
26	WIP	30A	Windshield wipers
27	MET	7.5A	Gauges and meters
28	IGN	10A	Brake system, driver support system, multiport fuel injection system/sequential multiport fuel injection system, SRS airbag system, occupant detection sensor, power windows, smart key system
29	PANEL	10A	Air conditioning system, emergency flashers, seat heaters, transmission, "P" position switch, navigation system, Solar Ventilation System, Remote Air Conditioning System, advanced parking guidance system, headlight cleaner, front passenger's seat belt reminder light, headlight leveling system, glove box light, clock, audio system
30	TAIL	10A	Headlight leveling system, parking lights, tail lights, license plate lights, front fog lights, side marker lights

■ After a fuse is replaced

- If the lights do not turn on even after the fuse has been replaced, a bulb may need replacement. (→P. 472)
- If the replaced fuse blows again, have the vehicle inspected by your Toyota dealer.

■ If there is an overload in the circuits

The fuses are designed to blow before the entire wiring harness is damaged.

CAUTION

■ To prevent system breakdowns and vehicle fire

Observe the following precautions.

Failing to do so may cause damage, and possibly a fire or injury.

- Never use a fuse of a higher amperage rating than indicated, or use any other object in place of a fuse.
- Always use a genuine Toyota fuse or equivalent.
Never replace a fuse with a wire, even as a temporary fix.
This can cause extensive damage or even fire.
- Do not modify fuses or the fuse box.

NOTICE

■ Before replacing fuses

Have the cause of electrical overload determined and repaired by your Toyota dealer.

Light bulbs

You may replace the following bulbs yourself. The difficulty level of replacement varies depending on the bulb. If necessary bulb replacement seems difficult to perform, contact your Toyota dealer.

For more information about replacing other light bulbs, contact your Toyota dealer.

■ Prepare a replacement light bulb.

Check the wattage of the light bulb being replaced. (→P. 567)

■ Front bulb locations

▶ Vehicles with LED headlights

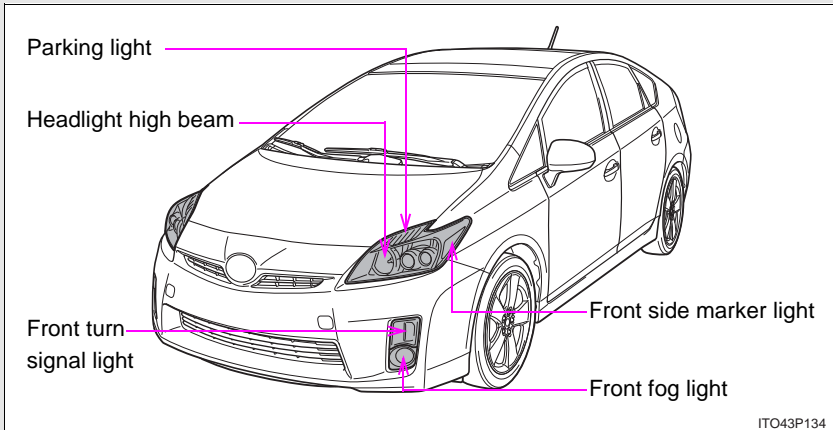

► Vehicles with halogen headlights

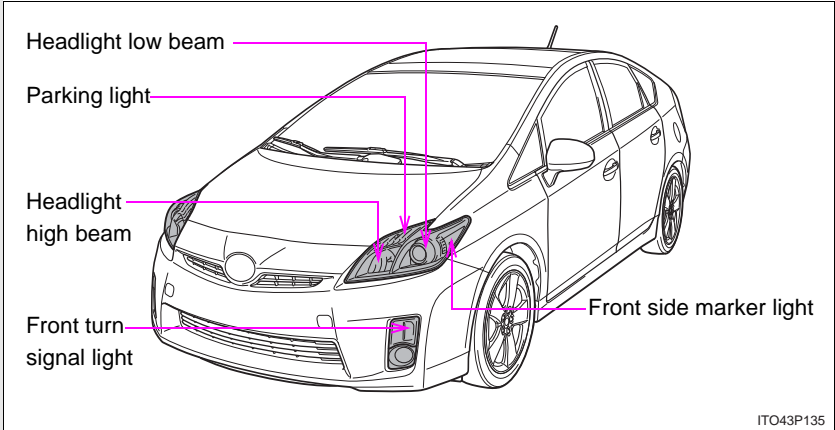

■ Rear bulb locations

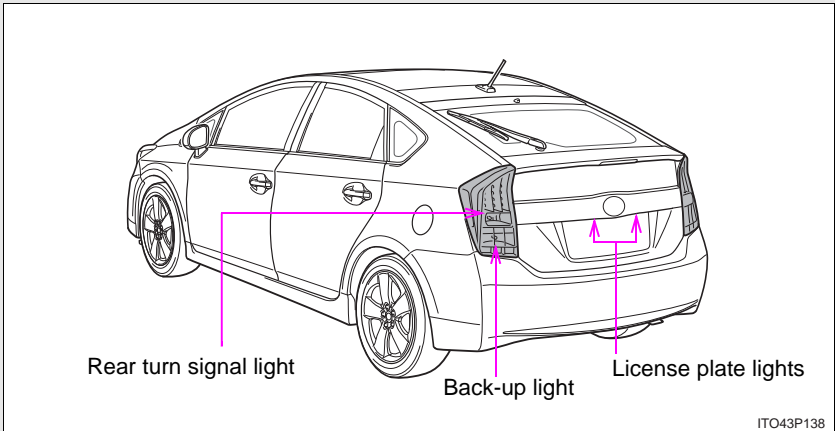

Replacing light bulbs

■ Headlight low beams (halogen bulbs)

STEP 1

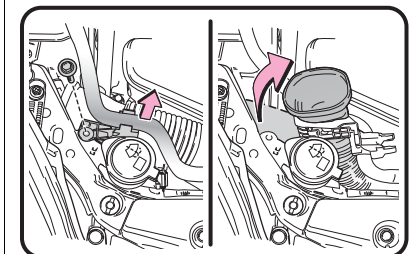

ITN43P199a

For the right side only:
Remove the bolt and unclip the engine coolant reservoir hose. Then lift up the air cleaner inlet duct.

STEP 2

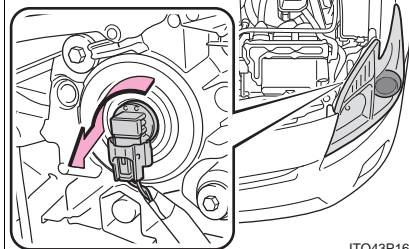

ITO43P162

Turn the bulb base counterclockwise.

STEP 3

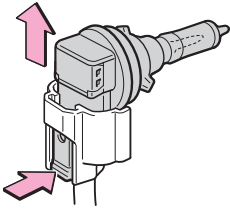

ITO43P163

Unplug the connector while pushing the lock release.

■ Headlight high beams

STEP 1 For the right side only: Remove the bolt and unclip the engine coolant reservoir hose. Then lift up the air cleaner inlet duct. (→P. 474)

STEP 2 Turn the bulb base counterclockwise.

▶ Vehicles with LED headlights

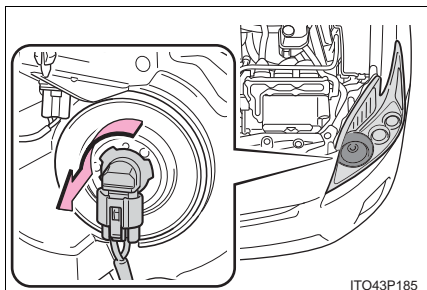

▶ Vehicles with halogen headlights

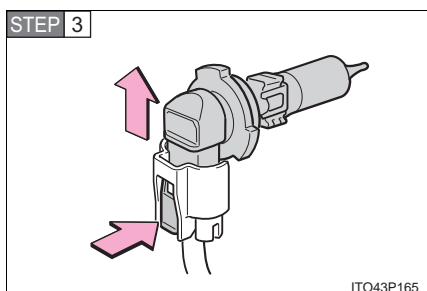
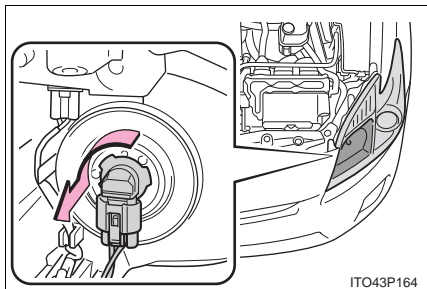

Unplug the connector while pushing the lock release.

■ Parking lights

STEP 1 For the right side only: Remove the bolt and unclip the engine coolant reservoir hose. Then lift up the air cleaner inlet duct. (→P. 474)

STEP 2 Turn the bulb base counterclockwise.

▶ Vehicles with LED headlights

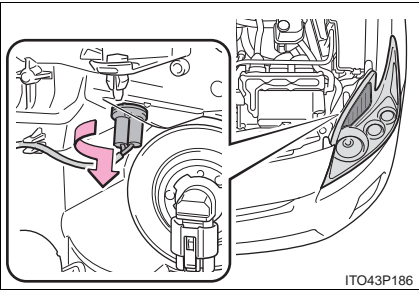

▶ Vehicles with halogen headlights

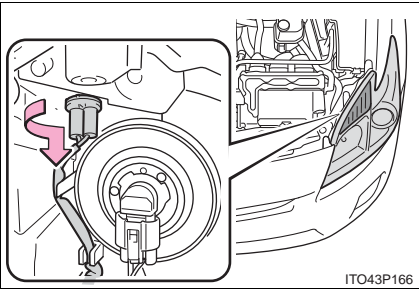

STEP 3

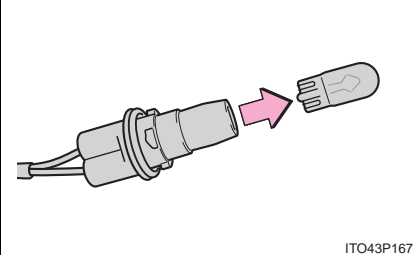

Remove the light bulb.

■ Front side marker lights

STEP 1 For the right side only: Remove the bolt and unclip the engine coolant reservoir hose. Then lift up the air cleaner inlet duct. (→P. 474)

STEP 2 Turn the bulb base counterclockwise.

▶ Vehicles with LED headlights

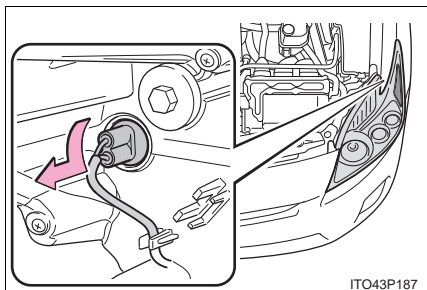

▶ Vehicles with halogen headlights

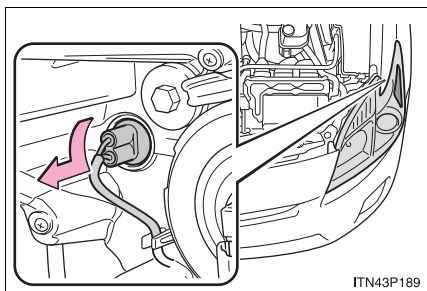

STEP 3

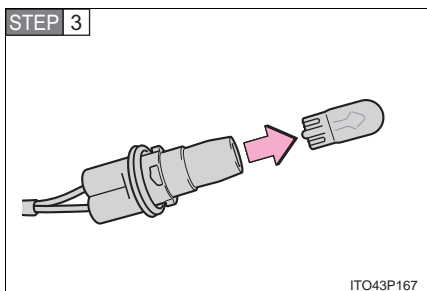

Remove the light bulb.

■ Front fog lights (vehicles with LED headlights)

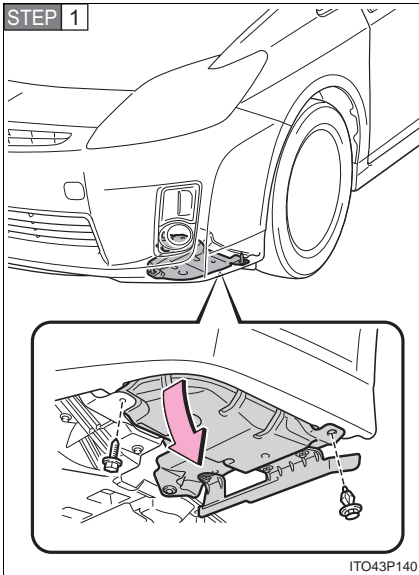

Remove the engine under cover bolt and clip and pull down the engine under cover.

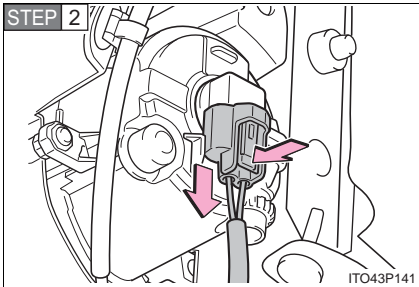

Unplug the connector while pushing the lock release.

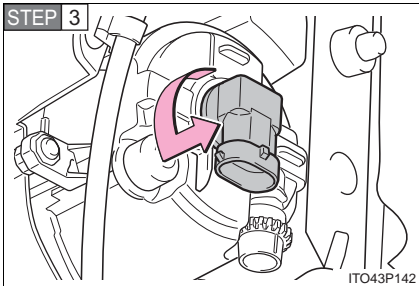

Turn the bulb base counterclockwise.

■ Front turn signal lights

STEP 1 Remove the engine under cover bolt and clip and pull down the engine under cover. (→P. 479)

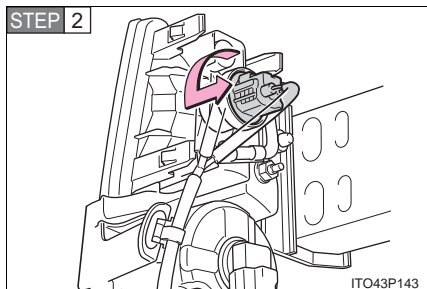

Unplug the connector while pushing the lock release.

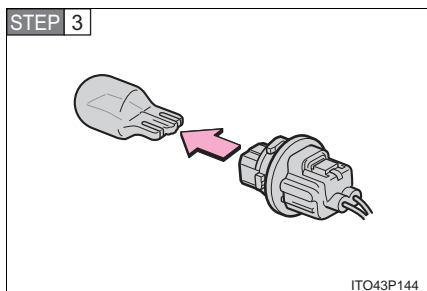

Remove the light bulb.

■ Rear turn signal lights and back-up lights

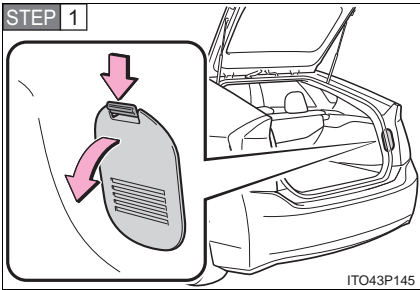

Open the back door and remove the cover.

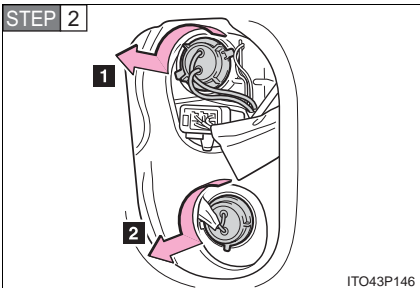

Turn the bulb base counterclockwise.

- 1** Rear turn signal light
- 2** Back-up light

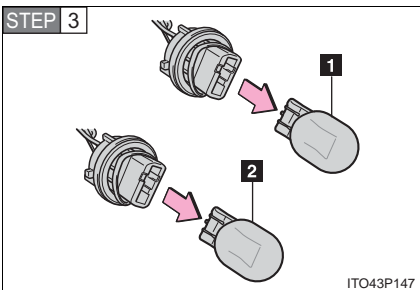

Remove the light bulb.

- 1** Rear turn signal light
- 2** Back-up light

■ License plate lights

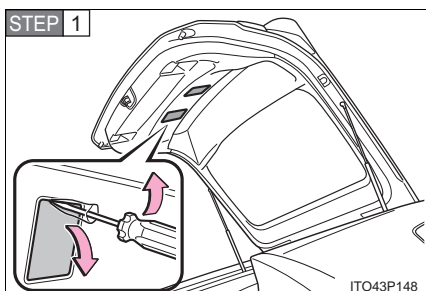

Open the back door and remove the cover.

To protect the cover, place a rag between the flathead screwdriver and cover as shown in the illustration.

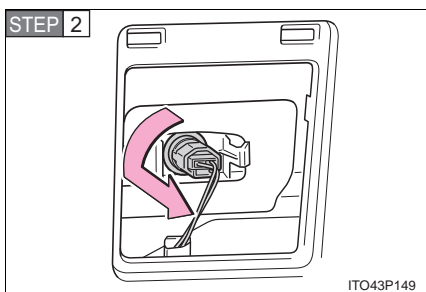

Turn the bulb base counterclockwise.

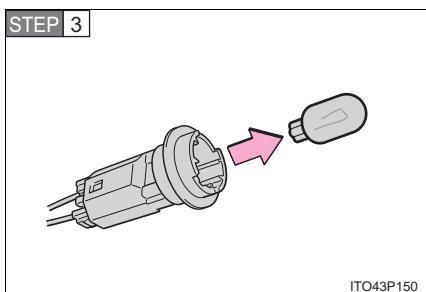

Remove the light bulb.

■ Lights other than the above

If any of the lights listed below has burnt out, have your Toyota dealer replace it.

- Headlight low beams (LED type)
- Stop/tail lights
- High mounted stoplight

■ Condensation build-up on the inside of the lens

Contact your Toyota dealer for more information in the following situations. Temporary condensation build-up on the inside of the headlight lens does not indicate a malfunction.

- Large drops of water are built up on the inside of the lens.
- Water has built up inside the headlight.

■ LED lights

The headlight low beams (LED type), stop/tail lights and high mounted stoplight consist of a number of LEDs. If any of the LEDs burn out, take your vehicle to your Toyota dealer to have the light replaced.

■ Installing the engine under cover clip

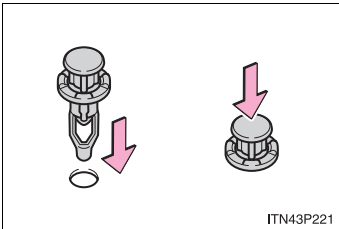

Insert the clip.

 **CAUTION**

■ **Replacing light bulbs**

- Turn off the headlights. Do not attempt to replace the bulb immediately after turning off the headlights.
The bulbs become very hot and may cause burns.
- Do not touch the glass portion of the light bulb with bare hands. Hold the bulb by the plastic or metal portion.
If the bulb is scratched or dropped it may blow out or crack.
- Fully install light bulbs and any parts used to secure them. Failing to do so may result in heat damage, fire, or water entering the headlight unit. This may damage the headlights or cause condensation to build up on the lens.
- Do not attempt to repair or disassemble light bulbs, connectors, electric circuits or component parts.
Doing so may result in death or serious injury due to electric shock.

■ **To prevent damage or fire**

Make sure bulbs are fully seated and locked.

5-1. Essential information

Emergency flashers

Use the emergency flashers if the vehicle malfunctions or is involved in an accident.

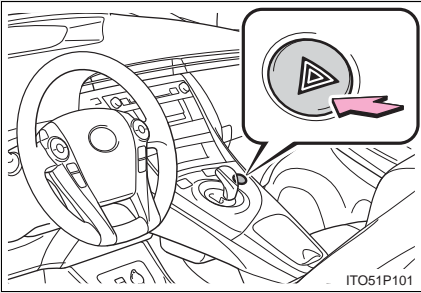

Press the switch to flash all the turn signal lights. To turn them off, press the switch once again.

NOTICE

■ To prevent 12 volt battery discharge

Do not leave the emergency flashers on longer than necessary when the hybrid system is not operating.

If your vehicle needs to be towed

If towing is necessary, we recommend having your vehicle towed by your Toyota dealer or a commercial towing service, using a lift-type truck or a flat bed truck.

Use a safety chain system for all towing, and abide by all state/provincial and local laws.

If towing from the front, the vehicle's rear wheel and axles must be in good condition. (→P. 491)

If they are damaged, use a towing dolly or flat bed truck.

Before towing

The following may indicate a problem with your transmission. Contact your Toyota dealer before towing.

- The hybrid system is operating, but the vehicle will not move.
- The vehicle makes an abnormal sound.

Emergency towing

If a tow truck is not available, in an emergency your vehicle may be temporarily towed using a cable or chain secured to the emergency towing eyelet. This should only be attempted on hard, surfaced roads for short distances below 18 mph (30 km/h).

A driver must be in the vehicle to steer and operate the brakes. The vehicle's wheels, drive train, axles, steering and brakes must be in good condition.

► Towing eyelet

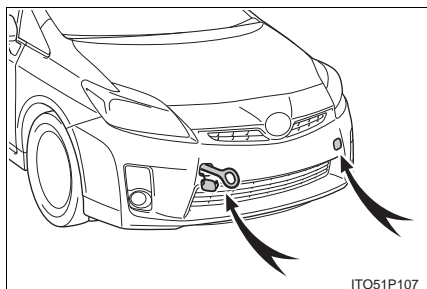

■ **Emergency towing procedure**

- STEP 1** Release the parking brake.
- STEP 2** Turn the “POWER” switch to ON mode.
- STEP 3** Put the shift lever in “N”.

⚠ CAUTION

■ **While towing**

- Use extreme caution when towing the vehicle.
Avoid sudden starts or erratic driving maneuvers which place excessive stress on the emergency towing eyelet and the cable or chain.
- If the hybrid system is not operating, the power assist for the brakes and steering will not function, making steering and braking more difficult.

⚠ NOTICE

■ **To prevent causing serious damage to the transmission**

Never tow this vehicle from the rear with the four wheels on the ground.
This may cause serious damage to the transmission.

Installing towing eyelet

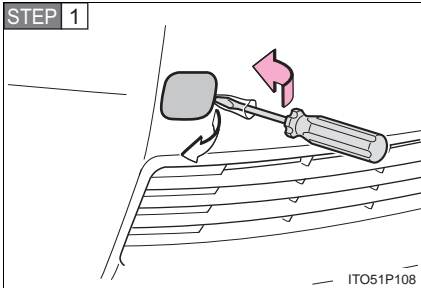

Remove the eyelet cover using a flathead screwdriver.

To protect the bodywork, place a rag between the screwdriver and the vehicle body, as shown in the illustration.

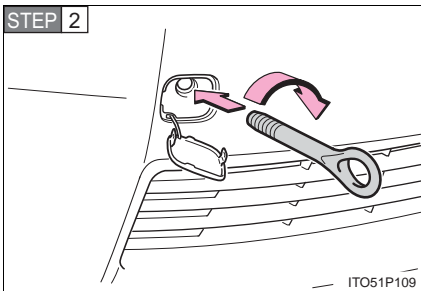

Insert the towing eyelet into the hole and tighten partially by hand.

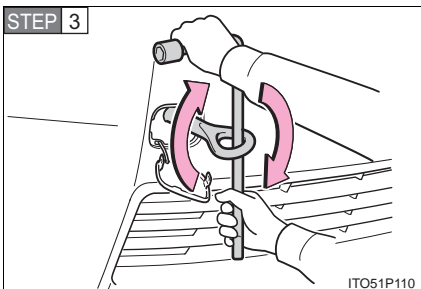

Tighten down the towing eyelet securely using a wheel nut wrench.

■ Location of the emergency towing eyelet

→P. 524

⚠ CAUTION

■ Installing towing eyelet to the vehicle

Make sure that towing eyelet is installed securely.

If not securely installed, towing eyelet may come loose during towing. This may lead to accidents that cause serious injury or even death.

Towing with a sling-type truck

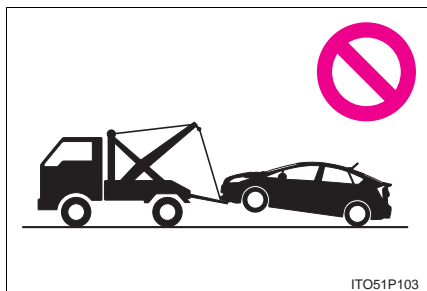

⚠ NOTICE

■ To prevent body damage

Do not tow with a sling-type truck, either from the front or rear.

Towing with a wheel lift-type truck

▶ From front

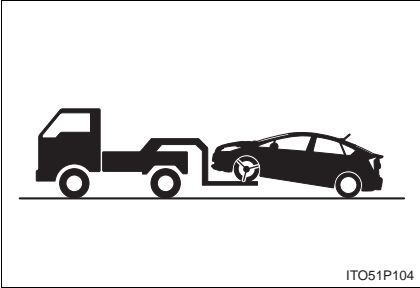

Release the parking brake.

▶ From rear

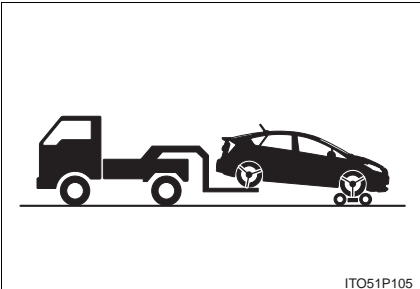

Use a towing dolly under the front wheel.

 NOTICE

■ **To prevent causing serious damage to the transmission**

Never tow this vehicle from the rear with the front wheels on the ground.

■ **To prevent damaging the vehicle**

When raising the vehicle, ensure adequate ground clearance for towing at the opposite end of the raised vehicle. Without adequate clearance, the vehicle could be damaged while being towed.

Using a flat bed truck

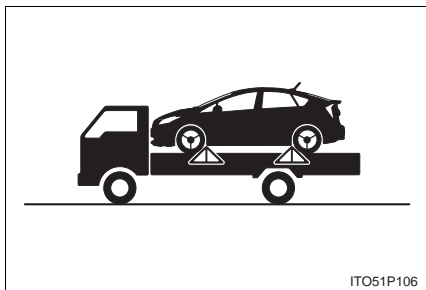

If you use chains or cables to tie down your vehicle, the angles shaded in black must be 45°.

Do not overly tighten the tie downs or the vehicle may be damaged.

If you think something is wrong

If you notice any of the following symptoms, your vehicle probably needs adjustment or repair. Contact your Toyota dealer as soon as possible.

■ Visible symptoms

- Fluid leaks under the vehicle
(Water dripping from the air conditioning after use is normal.)
- Flat-looking tires or uneven tire wear

■ Audible symptoms

- Changes in exhaust sound
- Excessive tire squeal when cornering
- Strange noises related to the suspension system
- Pinging or other noises related to the hybrid system

■ Operational symptoms

- Engine missing, stumbling or running rough
- Appreciable loss of power
- Vehicle pulls heavily to one side when braking
- Vehicle pulls heavily to one side when driving on a level road
- Loss of brake effectiveness, spongy feeling, pedal almost touches the floor

5-1. Essential information

Event data recorder

Your vehicle has computers that monitor and control certain aspects of your vehicle. These computers assist in driving and maintaining optimal vehicle performance.

Besides storing data useful for troubleshooting, there is an event data recorder (EDR) that records data in a crash or a near car crash event.

In a crash or a near car crash event

The SRS airbag sensor assembly contains the EDR. In a crash or a near car crash event, this device may record some or all of the following information:

- Gasoline engine speed
- Whether the brake pedal was applied or not
- Vehicle speed
- To what extent the accelerator pedal was depressed
- Position of the transmission shift lever
- Whether the driver and front passenger wore seat belts or not
- Driver's seat position
- SRS airbag deployment data
- SRS airbag system diagnostic data
- Front passenger's occupant classification

The information above is intended to be used for the purpose of improving vehicle safety performance. Unlike general data recorders, the EDR does not record sound data such as conversation between passengers.

Disclosure of the data

Toyota will not disclose the data recorded in an EDR to a third party except when:

- An agreement from the vehicle's owner (or the leasing company for a leased vehicle) is obtained
- Officially requested by the police or other authorities
- Used as a defense for Toyota in a law suit
- Ordered by a court

However, if necessary Toyota will:

- Use the data for research on Toyota vehicle safety performance
- Disclose the data to a third party for research purposes without disclosing details of the vehicle owner, and only when it is deemed necessary
- Disclose summarized data cleared of vehicle identification information to a non-Toyota organization for research purposes



5-2. Steps to take in an emergency

If a warning light turns on or a warning buzzer sounds...

Calmly perform the following actions if any of the warning lights turn on or flash. If a light turns on or flashes, but then turns off, this does not necessarily indicate a malfunction in the system.

Stop the vehicle immediately. Continuing to drive the vehicle may be dangerous.

The following warning indicates a possible problem in the brake system. Immediately stop the vehicle in a safe place and contact your Toyota dealer.

Warning light	Warning light/Details
 (U.S.A.)  (Canada)	Brake system warning light and warning buzzer* (red indicator) <ul style="list-style-type: none">• Low brake fluid• Malfunction in the brake system This light also comes on when the parking brake is not released. If the light turns off after the parking brake is fully released, the system is operating normally.

*: Parking brake engaged warning buzzer:

A buzzer will sound if the vehicle is driven at a speed of approximately 3 mph (5 km/h) or more.



Stop the vehicle immediately.







The following warning indicates the possibility of damage to the vehicle that may lead to an accident. Immediately stop the vehicle in a safe place and contact your Toyota dealer.

Warning light	Warning light/Details
	<p>Charging system warning light</p> <p>Indicates a malfunction in the vehicle's charging system.</p>

Have the vehicle inspected immediately.





Failing to investigate the cause of the following warnings may lead to the system operating abnormally and possibly cause an accident. Have the vehicle inspected by your Toyota dealer immediately.



Warning light	Warning light/Details
 (U.S.A.)  (Canada)	<p>Malfunction indicator lamp</p> <p>Malfunction in:</p> <ul style="list-style-type: none"> • The emission control system; • The electronic engine control system; • The electronic hybrid system control system; or • The electronic throttle control system.
	<p>SRS warning light</p> <p>Malfunction in:</p> <ul style="list-style-type: none"> • The SRS airbag system; • Front passenger occupant classification system; or • The seat belt pretensioner system.

Warning light	Warning light/Details
	<p>Automatic headlight leveling system warning light (if equipped) Indicates a malfunction in the automatic headlight leveling system.</p>
 (U.S.A.)  (Canada)	<p>ABS warning light Malfunction in: • The ABS; or • The brake assist system.</p>
	<p>Brake system warning light (yellow indicator) Malfunction in the electronically controlled brake system.</p>
	<p>Electric power steering system warning light Malfunction in the EPS (Electric Power Steering).</p>
	<p>Pre-collision system warning light (if equipped) Indicates a malfunction in the pre-collision system.</p>

Follow the correction procedures.

After taking the specified steps to correct the suspected problem, check that the warning light turns off.

Warning light	Warning light/Details	Correction procedure
	<p>Open door warning light (warning buzzer)*¹ A door or a back door is not fully closed.</p>	<p>Check that all doors and the back door are closed.</p>
	<p>Low fuel level warning light Remaining fuel (Approximately 1.6 gal. [6.0 L, 1.3 Imp.gal.] or less)</p>	<p>Refuel the vehicle.</p>
	<p>Driver's seat belt reminder light (warning buzzer)*² Warns the driver to fasten his/her seat belt.</p>	<p>Fasten the seat belt.</p>
 <p>(On the instrument panel)</p>	<p>Front passenger's seat belt reminder light (warning buzzer)*² Warns the front passenger to fasten his/her seat belt.</p>	<p>Fasten the seat belt.</p>

Warning light	Warning light/Details	Correction procedure
	<p>Tire pressure warning light</p>	
	<p>When the light comes on: Low tire inflation pressure.</p>	<p>Adjust the tire inflation pressure.</p>
	<p>When the light comes on after blinking for 1 minute: Malfunction in the tire pressure warning system.</p>	<p>Have the system checked by your Toyota dealer.</p>
	<p>High coolant temperature warning light Indicates high engine coolant temperature</p>	<p>→P. 548</p>
	<p>Master warning light A buzzer sounds and the warning light comes on and flashes to indicate that the master warning system has detected a malfunction.</p>	<p>→P. 508</p>

*1: Open door warning buzzer:

The open door warning buzzer sounds to alert one or more of the doors is not fully closed (with the vehicle having reached a speed of 3 mph [5 km/h]).

*2: Driver's and front passenger's seat belt reminder buzzer:

The driver's and front passenger's seat belts reminder sounds to alert the driver and front passenger that his or her seat belt is not fastened. The buzzer sounds intermittently for 10 seconds after the vehicle has reached a speed of at least 12 mph (20 km/h). Then, if the seat belt is still unfastened, the buzzer will sound in a different tone for 20 more seconds.

■ **If the malfunction indicator lamp comes on while driving**

First check whether the fuel tank cap is loose. If it is, tighten it securely.

The light will go off after taking several driving trips.

If the light does not go off even after several trips, contact your Toyota dealer as soon as possible.

■ **Electric power steering warning light**

When the voltage is low or drops, the electric power steering warning light may come on.

■ SRS warning light

This warning light system monitors the following:

- The airbag sensor assembly
- Front airbag sensors
- The curtain shield airbag sensors
- The side and curtain shield airbag sensor assemblies
- The driver's seat position sensor
- Driver's seat belt buckle switch
- The front passenger occupant classification ECU
- The pressure sensor
- The belt tension sensor
- "AIR BAG ON" and "AIR BAG OFF" indicator lights
- Front passenger's seat belt buckle switch
- The inflators
- The warning light
- The interconnecting wiring and power sources

■ Open moon roof reminder buzzer

The buzzer indicates that the moon roof is not fully closed with the hybrid system off and the driver's door opened.

■ Front passenger detection sensor and passenger seat belt reminder

- If luggage is placed on the front passenger seat, the front passenger detection sensor may cause the warning light to flash, even if a passenger is not sitting in the seat.
- If a cushion is placed on the seat, the sensor may not detect a passenger, and the warning light may not operate properly.

■ When the tire pressure warning light comes on

Check the tire inflation pressure and adjust to the appropriate level. Pushing the tire pressure warning reset switch does not turn off the tire pressure warning light.

■ The tire pressure warning light may turn on due to natural causes

The tire pressure warning light may turn on due to natural causes such as natural air leaks or tire inflation pressure changes caused by temperature. In this case, adjusting the tire inflation pressure will turn off the warning light (after a few minutes).

■ When a tire is replaced with a spare tire

The compact spare tire is not equipped with the tire pressure warning valve and transmitter. If a tire goes flat, the tire pressure warning light will not turn off even though the flat tire is replaced with the spare tire. Replace the spare tire with the repaired tire and adjust the proper tire inflation pressure. The tire pressure warning light will turn off after a few minutes.

■ **If the tire pressure warning system is inoperative**

The tire pressure warning system will be disabled in the following conditions:

(When the condition becomes normal, the system will work properly.)

- If tires not equipped with tire pressure warning valves and transmitters are used.
- If the ID code on the tire pressure warning valves and transmitters is not registered in the tire pressure warning computer.
- If the tire inflation pressure is 73 psi (500 kPa, 5.1 kgf/cm² or bar) or higher.

The tire pressure warning system may be disabled in the following conditions:

(When the condition becomes normal, the system will work properly.)

- If electronic devices or facilities using similar radio wave frequencies are nearby.
- If a radio set at similar frequencies is in use in the vehicle.
- If a window tint that affects the radio wave signals is installed.
- If there is a lot of snow or ice on the vehicle, in particular around the wheels or wheel housings.
- If non-genuine Toyota wheels are used. (Even if you use Toyota wheels, the tire pressure warning system may not work properly with some types of tires.)
- If tire chains are used.

■ **If the tire pressure warning light comes on after blinking for 1 minute frequently**

If the tire pressure warning light comes on after blinking for 1 minute frequently when the “POWER” switch is turned to ON mode, have it checked by your Toyota dealer.

■ **Customization that can be configured at Toyota dealer**

The vehicle speed linked seat belt reminder buzzer can be disabled. (Customizable features →P. 587)

However, Toyota recommends that the seat belt reminder buzzer be operational to alert the driver and front passenger that the seat belts are not fastened.

 **CAUTION**

■ **When the electric power steering warning light comes on**

The steering wheel may become extremely heavy.

If the steering wheel becomes heavier than usual when operating, firmly hold and operate it using more force than usual.

■ **If the tire pressure warning light comes on**

Be sure to observe the following precautions. Failure to do so could cause loss of vehicle control and result in death or serious injury.

- Stop your vehicle in a safe place as soon as possible. Adjust the tire inflation pressure immediately.
- If the tire pressure warning light comes on even after tire inflation pressure adjustment, it is probable that you have a flat tire. Check the tires. If the tire is flat, change to the spare tire and have the flat tire repaired by the nearest Toyota dealer.
- Avoid abrupt maneuvering and braking. If the vehicle tires deteriorate, you could lose control of the steering wheel or the brakes.

■ **If a blowout or sudden air loss should occur**

The tire pressure warning system may not activate immediately.

 **CAUTION**

■ **Maintenance of the tires**

Each tire, including the spare (if provided), should be checked monthly when cold and inflated to the inflation pressure recommended by the vehicle manufacturer on the vehicle placard or tire inflation pressure label (tire and load information label). (If your vehicle has tires of a different size than the size indicated on the vehicle placard or tire inflation pressure label [tire and load information label], you should determine the proper tire inflation pressure for those tires.)

As an added safety feature, your vehicle has been equipped with a tire pressure monitoring system (TPMS-tire pressure warning system) that illuminates a low tire pressure telltale (tire pressure warning light) when one or more of your tires is significantly under-inflated. Accordingly, when the low tire pressure telltale (tire pressure warning light) illuminates, you should stop and check your tires as soon as possible, and inflate them to the proper pressure. Driving on a significantly under-inflated tire causes the tire to overheat and can lead to tire failure. Under-inflation also reduces fuel efficiency and tire tread life, and may affect the vehicle's handling and stopping ability.

Please note that the TPMS (tire pressure warning system) is not a substitute for proper tire maintenance, and it is the driver's responsibility to maintain correct tire pressure, even if under-inflation has not reached the level to trigger illumination of the TPMS low tire pressure telltale (tire pressure warning light).

 CAUTION

Your vehicle has also been equipped with a TPMS (tire pressure warning system) malfunction indicator to indicate when the system is not operating properly. The TPMS (tire pressure warning system) malfunction indicator is combined with the low tire pressure telltale (tire pressure warning light). When the system detects a malfunction, the telltale will flash for approximately one minute and then remain continuously illuminated. This sequence will continue upon subsequent vehicle start-ups as long as the malfunction exists. When the malfunction indicator is illuminated, the system may not be able to detect or signal low tire pressure as intended.

TPMS (tire pressure warning system) malfunctions may occur for a variety of reasons, including the installation of replacement or alternate tires or wheels on the vehicle that prevent the TPMS (tire pressure warning system) from functioning properly. Always check the TPMS (tire pressure warning system) malfunction telltale after replacing one or more tires or wheels on your vehicle to ensure that the replacement or alternate tires and wheels allow the TPMS (tire pressure warning system) to continue to function properly.

 NOTICE**■ Precaution when installing a different tire**

When a tire of a different specification or maker is installed, the tire pressure warning system may not operate properly.

5-2. Steps to take in an emergency

If a warning message is displayed

If a warning is shown on the multi-information display, stay calm and perform the following actions:

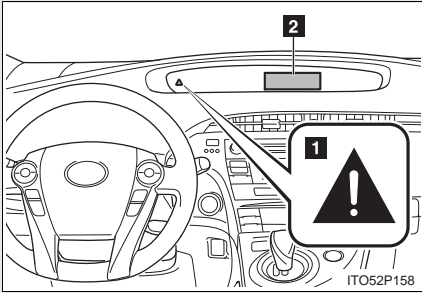





- 1** Master warning light
- 2** Multi-information display

The master warning light also comes on or flashes in order to indicate that a message is currently being displayed on the multi-information display.

If any of the warning light turns on again after performing the following actions, contact your Toyota dealer.





Stop the vehicle immediately.



A buzzer sounds and a warning message is shown on the multi-information display. The following warnings indicate the possibility of damage to the vehicle that may lead to an accident. Immediately stop the vehicle in a safe place and contact your Toyota dealer.

Warning message	Details
 	<p>Indicates an abnormal engine oil pressure. The warning light may turn on if the engine oil pressure is too low.</p>
 	<p>Indicates a malfunction in the hybrid system.</p>

Have the vehicle inspected immediately.



Failure to investigate the cause of the following warnings may lead to the system operating abnormally and possibly cause an accident. Have the vehicle inspected by your Toyota dealer immediately.







Warning message	Details
<div data-bbox="80 467 309 581" style="background-color: black; color: white; padding: 5px; text-align: center;">CHECK HEADLIGHT SYSTEM</div> <div data-bbox="80 591 173 654" style="text-align: center;">  </div> <p data-bbox="118 657 263 688">(If equipped)</p>	<p data-bbox="338 570 932 599">Indicates a malfunction in the LED headlight system.</p>
<div data-bbox="80 735 309 849" style="background-color: black; color: white; padding: 5px; text-align: center;">  LOCK MALFUNCTION WHEN PARKING, PARK IN FLAT PLACE AND APPLY PARKING BRAKE SECURELY </div> <div data-bbox="80 860 173 924" style="text-align: center;">  </div>	<p data-bbox="338 812 905 841">Indicates a malfunction in the parking lock system.</p>
<div data-bbox="80 948 309 1062" style="background-color: black; color: white; padding: 5px; text-align: center;">CHECK PCS SYSTEM</div> <div data-bbox="80 1071 288 1135" style="border: 1px solid black; padding: 5px; display: inline-block;"> PCS (Flashing) </div> <div data-bbox="80 1144 173 1208" style="text-align: center;">  </div> <p data-bbox="118 1211 263 1242">(If equipped)</p>	<p data-bbox="338 1071 905 1130">Indicates a malfunction in the pre-collision system. A buzzer also sounds.</p>



Warning message	Details
<div data-bbox="110 264 341 378" style="background-color: black; color: white; padding: 5px; text-align: center;"> <p>CHECK CRUISE CONTROL SYSTEM</p> </div> <div data-bbox="110 386 203 451" style="display: inline-block; border: 1px solid black; padding: 2px;">  </div> <div data-bbox="203 394 317 431" style="display: inline-block; vertical-align: middle;">(Flashing)</div> <div data-bbox="110 459 203 524" style="display: inline-block; border: 1px solid black; padding: 2px;">  </div> <div data-bbox="150 524 295 561" style="display: inline-block; vertical-align: middle;">(If equipped)</div>	<p>Indicates a malfunction in the radar cruise control system.</p> <p>A buzzer also sounds.</p> <p>Stop the vehicle in a safe place. Turn the “POWER” switch to OFF and then to ON mode again to reset the cruise control system.</p>



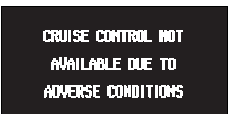



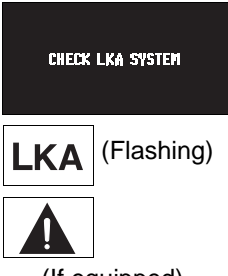

Follow the correction procedures.



After taking the specified steps to correct the suspected problem, check that the warning message turns off.

Warning message	Details	Correction procedure
 <p>(U.S.A. only)</p>	<p>Indicates that the engine oil is scheduled to be changed. A buzzer also sounds.</p> <p>Comes on approximately 4500 miles (7200 km) after the engine oil is changed. (The indicator will not work properly unless the oil maintenance data has been reset).</p>	<p>Check the engine oil, and change if necessary.</p>
 <p>(U.S.A. only)</p>	<p>Indicates that the engine oil should be changed. A buzzer also sounds.</p> <p>Comes on approximately 5000 miles (8000 km) after the engine oil is changed (and the oil maintenance data has been reset).</p>	<p>Check and change the engine oil.</p>

Warning message	Details	Correction procedure
 <p>PCS NOT CURRENTLY AVAILABLE</p>  <p>PCS (If equipped)</p>	<p>Indicates that the pre-collision system is not currently functional because the grille or the sensor is dirty.</p> <p>This message also appears when the pre-collision system is not functional due to overheating.</p>	<p>Check the grille and the sensor and clean them if they are dirty. In case of overheating, the system will become functional once the system cools down.</p>
 <p>CLEAN RADAR SENSOR</p>  <p>(Flashing)</p>  <p>(If equipped)</p>	<p>Indicates that the radar cruise control sensor is dirty or covered with ice.</p>	<p>Clean the sensor.</p>
 <p>CRUISE CONTROL NOT AVAILABLE DUE TO ADVERSE CONDITIONS</p>  <p>(Flashing)</p>  <p>(If equipped)</p>	<p>Indicates that the radar cruise control system is unable to judge vehicle-to-vehicle distance.</p>	<p>If the windshield wipers are on, turn them off or set them to either the intermittent or the slow mode.</p>

Warning message	Details	Correction procedure
 <p>(If equipped)</p>	<p>Indicates that there is a high risk of a collision, or that the pre-collision brake function is operating.</p>	<p>Slow the vehicle by applying the brakes.</p>
 <p>(If equipped)</p>	<p>Indicates that there is a high risk of a collision.</p>	<p>Slow the vehicle by applying the brakes.</p>
 <p>(If equipped, flashing)</p>	<p>Your vehicle is nearing the vehicle ahead (in radar cruise mode).</p>	<p>Slow the vehicle by applying the brakes.</p>
 <p>(If equipped)</p>	<p>Indicates a malfunction the LKA. A buzzer also sounds.</p>	<p>Restart the LKA after restarting the hybrid system.</p>

Warning message	Details	Correction procedure
 <p>(If equipped)</p>	Indicates that the LKA is not currently functional.	Restart the LKA.
 	The hybrid system has overheated.	Stop and check. (→P. 548)
  (Flashing)	The hybrid battery (traction battery) is low.	Stop the vehicle and push the “P” position switch.
  (Flashing)	The transmission is out of “P” when attempting to start the hybrid system.	Push the “P” position switch before pressing the “POWER” switch.
  (Flashing)	The driver’s door is opened when the transmission is out of “P” with the hybrid system on.	Push the “P” position switch.

Warning message	Details	Correction procedure
	EV-Drive Mode cannot be switched to. A buzzer also sounds.	Use the EV-Drive Mode when it becomes available.
	The EV-Drive Mode has been automatically cancelled. A buzzer also sounds.	Drive normally for a short time.

■ After changing the engine oil (U.S.A. only)

Make sure to reset the oil maintenance data. (→P. 428)





■ Approach warning message





In the following instances, there is the possibility that the approach warning will not activate even when the vehicle-to-vehicle distance decreases.

- When your vehicle and the vehicle ahead are traveling at the same speed or the vehicle ahead is traveling more quickly than your vehicle.
- When the vehicle ahead is traveling at very low speed.
- Immediately after cruise control speed is set.
- At the instant the accelerator pedal is depressed.

Have the malfunction repaired immediately.

After taking the specified steps to correct the suspected problem, check that the warning message and light turn off.







Interior buzzer	Exterior buzzer	Warning message	Details	Correction procedure
Once	—	 (Comes on for 10 seconds.)  (Flashing)	The electronic key is not detected when attempting to start the hybrid system.	Confirm the location of the electronic key.
Once	3 times	  (Flashing)	An open door other than the driver's door is closed while the electronic key is outside the detection range and the "POWER" switch is in ACCESSORY or ON mode.	Confirm the location of the electronic key.



Interior buzzer	Exterior buzzer	Warning message	Details	Correction procedure
Once	3 times	  (Flashing)	An open door other than the driver's door is closed while the electronic key is outside the detection range and the "POWER" switch is in ACCESSORY or ON mode with the shift position in "P".	Turn the "POWER" switch to OFF or confirm the location of the electronic key.
Continuous	—	  (Flashing)	The driver's door has been opened with the shift position in a position other than "P" and without first turning the "POWER" switch is OFF.	Put the shift position into "P".

Interior buzzer	Exterior buzzer	Warning message	Details	Correction procedure
Once	Continuous	<div data-bbox="359 305 589 418" style="background-color: black; color: white; text-align: center; padding: 5px;">KEY NOT DETECTED</div> <div data-bbox="359 435 589 548" style="background-color: black; color: white; text-align: center; padding: 5px;">TURN POWER OFF</div> <p data-bbox="344 553 601 581">(Displayed alternately)</p> <div data-bbox="359 589 451 651" style="border: 1px solid black; padding: 5px; display: inline-block;">  </div> <p data-bbox="458 602 572 630">(Flashing)</p>	<p data-bbox="628 289 806 667">The electronic key has been taken outside the vehicle and the doors have been locked without first turning the “POWER” switch to OFF. (vehicles with entry function)</p>	<p data-bbox="852 370 969 586">Turn the “POWER” switch to OFF and lock the doors again.</p>

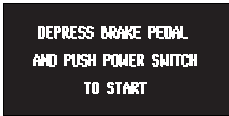
5-2. Steps to take in an emergency

Interior buzzer	Exterior buzzer	Warning message	Details	Correction procedure
Once	Continuous	<div data-bbox="327 646 558 760" style="background-color: black; color: white; padding: 5px; text-align: center; margin-bottom: 5px;">KEY DETECTED IN VEHICLE</div> <div data-bbox="327 769 423 831" style="border: 1px solid black; padding: 5px; display: inline-block;">  </div> (Flashing)	<p data-bbox="599 289 777 634">An attempt to lock the doors has been made using the smart key system while the electronic key is inside the vehicle. (vehicles with entry function)</p> <p data-bbox="599 656 777 1164">With the key inside the vehicle, a front door has been opened, the lock lever has been pulled in the lock direction, the door has been closed while the door handle is being pulled, and an attempt has been made to lock the door.</p>	Take the electronic key outside the vehicle, and lock the doors again.

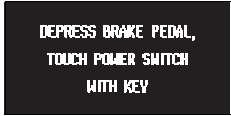
Interior buzzer	Exterior buzzer	Warning message	Details	Correction procedure
Continuous	Continuous	  (Displayed alternately)  (Flashing)	An open door other than the driver's door is closed while the electronic key is outside the detection range and the "POWER" switch is in ACCESSORY or ON mode with the shift position not in "P".	<ul style="list-style-type: none"> • Push the "P" position switch. • Confirm the location of the electronic key.
Once	—	 	The electronic key battery is low.	Replace the battery. (→P. 460)
Once	—	  (Flashing)	An open door has been closed and the "POWER" switch has been turned twice to the ACCESSORY mode from OFF.	Press the "POWER" switch while applying the brakes.

Interior buzzer	Exterior buzzer	Warning message	Details	Correction procedure
Once	—	  (Flashing)	The electronic key does not operate properly.	→P. 542
—	—		Power was turned off due to the automatic power off function.	Next time when starting the hybrid system, increase the engine speed slightly and maintain that level for approximately 5 minutes to recharge the battery.

■ Changing the engine oil

Make sure to reset oil change system.

**NOTICE****■ While the engine oil level warning is displayed**

Continued engine operation with low engine oil will damage the engine.

■ Engine oil maintenance message

The warning message is based on the projected driving range after engine oil maintenance message is reset.

The system does not monitor the purity of the engine oil.

5-2. Steps to take in an emergency If you have a flat tire

Remove the flat tire and replace it with the spare provided.

■ **Before jacking up the vehicle**

- Stop the vehicle on a hard, flat surface.
- Set the parking brake.
- Shift the shift position to “P”.
- Stop the hybrid system.
- Turn on the emergency flashers.

■ **Location of the spare tire, jack and tools**

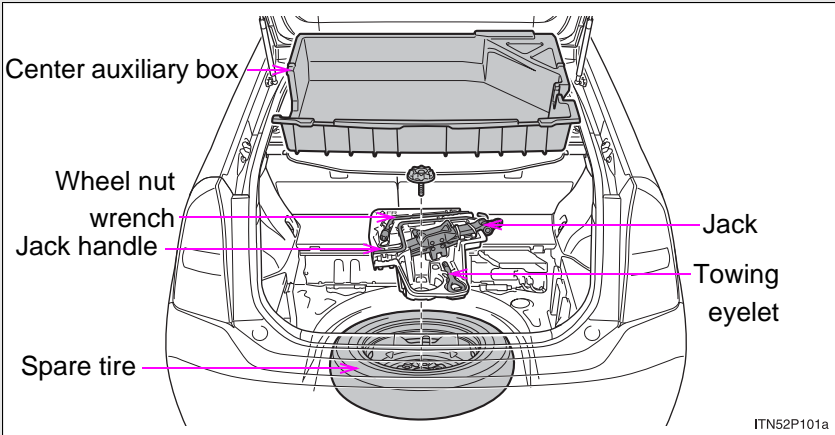

■ Compact spare tire

The compact spare tire saves space in your luggage compartment, and its lighter weight helps to enhance fuel economy and permits easier installation in case of a flat tire.

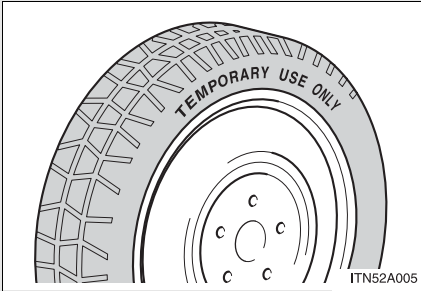

The compact spare tire is designed for temporary emergency use only.

Taking out the jack

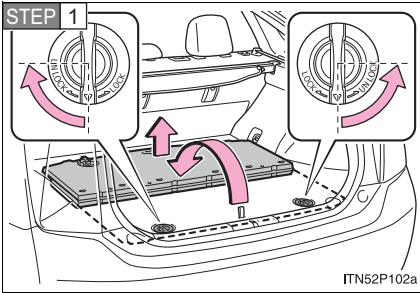

Remove the center deck board.

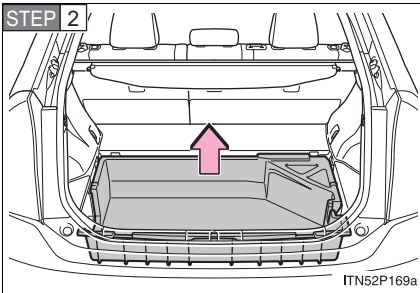

Remove the center auxiliary box.

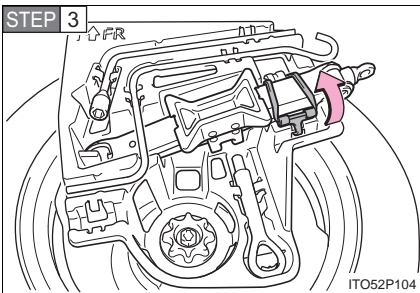

Unhook the tightening strap.

After storing the jack, make sure it is securely held by the tightening strap.

Taking out the spare tire

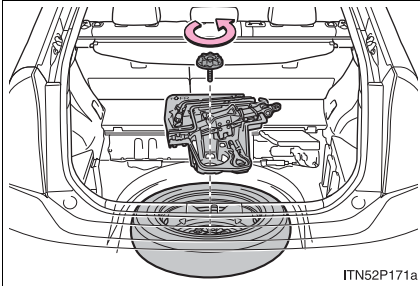

Loosen the center fastener that secures the spare tire.

Replacing a flat tire

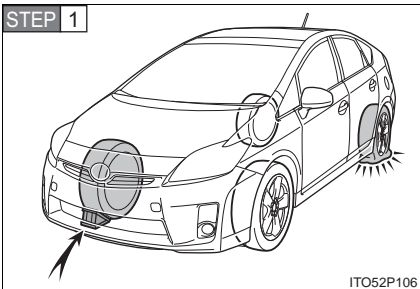

Chock the tires.

	Flat tire	Wheel chock positions
Front	Left-hand side	Behind the rear right-hand side tire
	Right-hand side	Behind the rear left-hand side tire
Rear	Left-hand side	In front of the front right-hand side tire
	Right-hand side	In front of the front left-hand side tire

5-2. Steps to take in an emergency

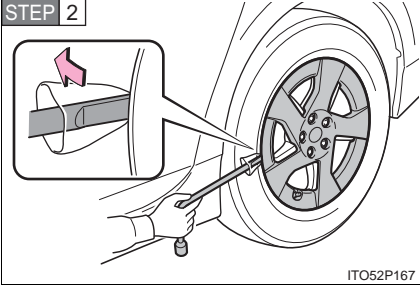

Vehicles with a 15 inch wheel, remove the wheel ornament using the wrench.

To protect the wheel ornament, place a rag between the wrench and the wheel ornament, as shown in the illustration.

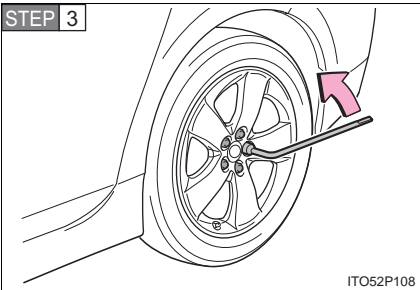

Slightly loosen the wheel nuts (one turn).

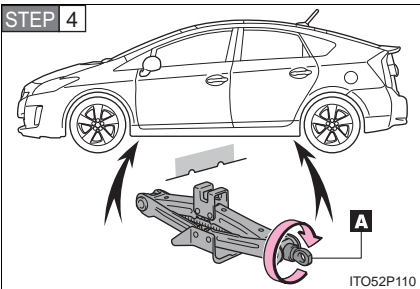

Turn the tire jack portion "A" by hand until the notch of the jack is in contact with the jack point.

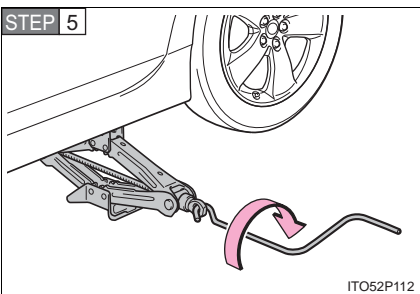

Raise the vehicle until the tire is slightly raised off the ground.

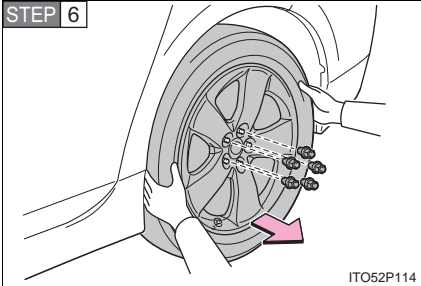

Remove all the wheel nuts and the tire.

When resting the tire on the ground, place the tire so that the wheel design faces up to avoid scratching the wheel surface.

Installing the spare tire

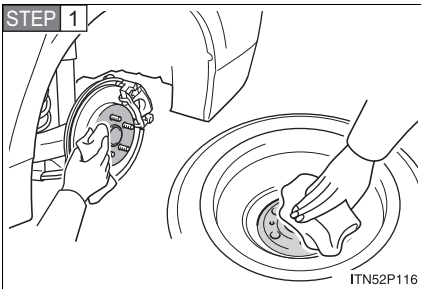

Remove any dirt or foreign matter from the wheel contact surface.

If foreign matter is on the wheel contact surface, the wheel nuts may loosen while the vehicle is in motion, and the tire may come off the vehicle.

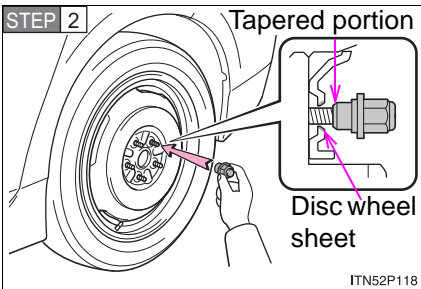

Install the spare tire and loosely tighten each nut by hand to approximately the same amount.

Tighten the wheel nuts until the tapered portion comes into loose contact with the disc wheel sheet.

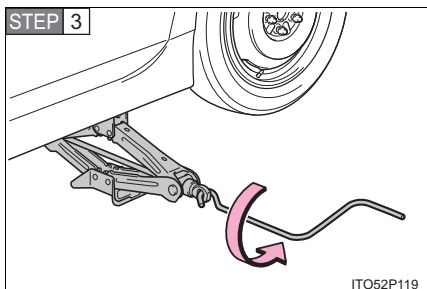

Lower the vehicle.

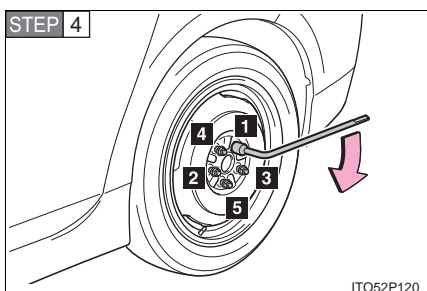

Firmly tighten each nut two or three times in the order shown in the illustration.

Tightening torque:
76 ft•lb (103 N•m, 10.5 kgf•m)

STEP 5 Stow the flat tire, the tire jack and all tools.

Stowing the flat tire

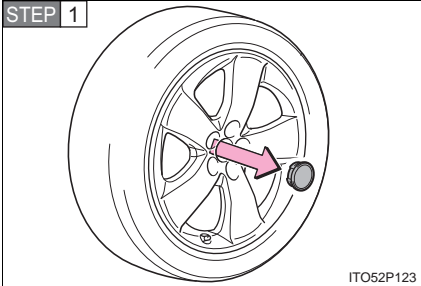

Vehicles with a 17 inch wheel:
Before stowing the flat tire, remove the center wheel ornament by pushing from the reverse side.

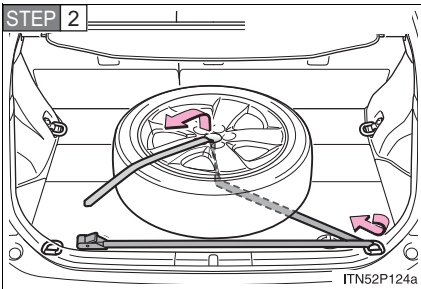

Place the flat tire on the deck board, and pass the belt through the lower-right cargo hook and then through the hole in the center of the tire.

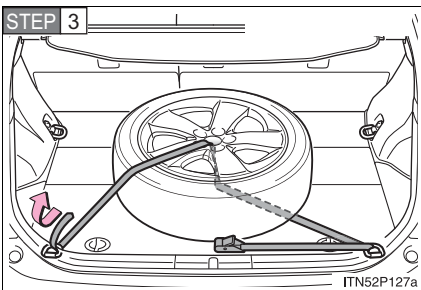

Pass the belt through the lower-left cargo hook.

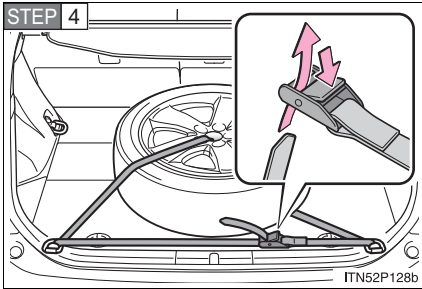

Pass the belt through the buckle and secure the tire firmly. Check that the belt is securely held by the buckle.

The belt cannot be fastened securely if the buckle is facing the wrong direction.

■ The compact spare tire

- The compact spare tire is identified by the label “TEMPORARY USE ONLY” on the tire sidewall. Use the compact spare tire temporarily only in an emergency.
- Make sure to check the tire inflation pressure of the compact spare tire. (→P. 565)

■ Tread life

The compact spare tire can be used many times, if necessary. It has tread life of up to 3000 miles (4800 km) depending on road conditions and your driving habits. When treadwear indicators appear on the tire, replace the tire. (→P. 441)

■ When using the compact spare tire

As the compact spare tire is not equipped with the tire pressure warning valve and transmitter, low inflation pressure of the spare tire will not be warned. Also, if you replace the compact spare tire after the tire pressure warning light comes on, the light remains on.

■ If you have a flat front tire on a road covered with snow or ice

Install the compact spare tire on the rear of the vehicle. Perform the following steps and fit tire chains to the front tires.

STEP 1 Replace a rear tire with the compact spare tire.

STEP 2 Replace the flat front tire with the tire removed from the rear of the vehicle.

STEP 3 Fit tire chains to the front tires.

■ After completing the tire change

The tire pressure warning system must be reset. (→P. 442)

■ Jack point guide

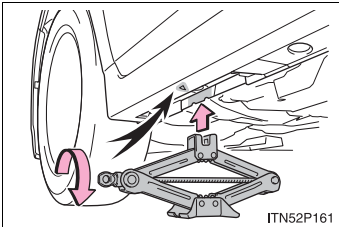

The jack point guides are located under the rocker panel. They indicate the jack point positions.

 CAUTION

■ **Using the tire jack**

Improper use of the tire jack may lead to death or serious injuries due to the vehicle suddenly falling off the jack.

- Do not use the tire jack for any purpose other than replacing tires or installing and removing tire chains.
- Only use the tire jack that comes with this vehicle for replacing a flat tire.
Do not use it on other vehicles, and do not use other tire jacks for replacing tires on this vehicle.
- Always check that the tire jack is securely set to the jack point.
- Do not raise the vehicle while someone is in it.
- When raising the vehicle, do not put an object on or under the jack.
- Do not raise the vehicle to a height greater than that required to replace the tire.
- Use a jack stand if it is necessary to get under the vehicle.
- Do not put any part of your body under the vehicle supported by a jack.
- Do not start or operate the hybrid system while your vehicle is supported by the jack.

Take particular care when lowering the vehicle to ensure that no one working on or near the vehicle may be injured.

 **CAUTION**
■ Replacing a flat tire

Observe the following precautions to reduce the risk of death or serious injury.

- Do not try to remove the wheel ornament by hand. Take due care in handling the ornament to avoid unexpected personal injury.
- Never use oil or grease on the wheel bolts or wheel nuts.
Oil and grease may cause the wheel nuts to be excessively tightened, leading to bolt or disc wheel damage. In addition, the oil or grease can cause the wheel nuts to loosen and the wheel may fall off, causing a serious accident. Remove any oil or grease from the wheel bolts or wheel nuts.
- Have the wheel nuts tightened with a torque wrench to 76 ft•lbf (103 N•m, 10.5 kgf•m) as soon as possible after changing wheels.
Failure to follow these precautions could cause the nuts to loosen and the wheels may fall off, which could lead to an accident causing death or serious injury.
- Do not attach a heavily damaged wheel ornament, as it may fly off the wheel while the vehicle is moving.

■ When using the compact spare tire

- Remember that your spare tire is specifically designed for use with your vehicle. Do not use your spare tire on another vehicle.
- Do not use two spare tires simultaneously.
- Replace the compact spare tire with a standard tire as soon as possible.
- Avoid sudden acceleration, deceleration and braking, as well as sharp cornering.

■ Speed limit when using the compact spare tire

Do not drive at speeds in excess of 50 mph (80 km/h) when a compact spare tire is installed on the vehicle.

The compact spare tire is not designed for driving at high speeds. Failing to observe this precaution may lead to an accident causing death or serious injury.

 **CAUTION**

■ **When the spare tire is attached**

The vehicle speed may not be correctly detected, and the following systems may not operate correctly:

- ABS & Brake assist
- Enhanced VSC
- Navigation system (if equipped)
- TRAC
- Dynamic radar cruise control (if equipped)
- Cruise control (if equipped)
- PCS (if equipped)
- LKA (if equipped)
- Rear view monitor system (if equipped)
- Advanced parking guidance system (if equipped)

■ **After using the tools and jack**

Before driving, make sure all the tools and jack are securely in place in their storage location to reduce the possibility of personal injury during a collision or sudden braking.

■ **When stowing the flat tire**

- Make sure the rear seats are in their original position.
- Secure it using a tire tie-down belt. Otherwise, the flat tire may fly out in case of the sudden braking or an accident, resulting in death or serious injury.

 NOTICE**■ Do not drive the vehicle with a flat tire**

Do not continue driving with a flat tire.

Driving even a short distance with a flat tire can damage the tire and the wheel beyond repair.

■ Be careful when driving over bumps with the compact spare tire installed on the vehicle

The vehicle becomes lower when driving with the compact spare tire compared to when driving with standard tires. Be careful when driving over uneven road surfaces.

■ Driving with tire chains and the compact spare tire

Do not fit tire chains to the compact spare tire.

Tire chains may damage the vehicle body and adversely affect driving performance.

■ When replacing the tires

When removing or fitting the wheels, tires or the tire pressure warning valve and transmitter, contact your Toyota dealer as the tire pressure warning valve and transmitter may be damaged if not handled correctly.

■ To avoid damaging the tire pressure warning valves and transmitters

Do not use liquid sealants on flat tires.

If the hybrid system will not start

If the hybrid system still does not start after following the correct starting procedure (→P. 164), confirm the following points.

■ **The hybrid system will not start even if you are carrying the correct key.**

One of the following may be the cause of the problem.

- There may not be sufficient fuel in the vehicle's tank.
Refuel the vehicle.
- The electronic key battery may be discharged. (→P. 541)
- The hybrid system may be malfunctioning due to an electrical problem such as an open circuit or a blown fuse. However, depending on the type of malfunction, an interim measure is available to start the hybrid system. (→P. 539)
- There may be a malfunction in the immobilizer system.
(→P. 108)

■ **The interior lights and headlights are dim, or the horn does not sound or sounds at a low volume.**

One of the following may be the cause of the problem.

- The 12 volt battery may be discharged. (→P. 543)
- The 12 volt battery terminal connections may be loose or corroded.

■ **The interior lights and headlights do not turn on, or the horn does not sound.**

One of the following may be the cause of the problem.

- One or both of the 12 volt battery terminals may be disconnected.
- The 12 volt battery may be discharged. (→P. 543)

Contact your Toyota dealer if the problem cannot be repaired, or if repair procedures are unknown.

Emergency start function

When the hybrid system does not start, the following steps can be used as an interim measure to start the hybrid system if the “POWER” switch is functioning normally.

STEP 1 Set the parking brake.

STEP 2 Set the “POWER” switch to the ACCESSORY mode.

STEP 3 Push and hold the “POWER” switch for about 15 seconds while depressing the brake pedal firmly.

Even if the hybrid system can be started using the above steps, the system may be malfunctioning. Have the vehicle checked by your Toyota dealer.

5-2. Steps to take in an emergency If you lose your keys

New genuine Toyota keys can be made by your Toyota dealer using other key and the key number stamped on your key number plate.

If communication between the electronic key and vehicle is interrupted (→P. 43, 57) or the electronic key cannot be used because the battery is depleted, the smart key system and wireless remote control cannot be used. In such cases, the doors can be opened or the hybrid system can be started by following the procedure below.

Locking and unlocking the doors

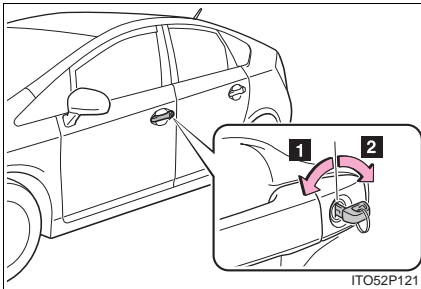

Using the mechanical key (→P. 41) in order to perform the following operations:

- 1** Locks all doors
- 2** Unlocks the door

Turning the key rearward unlocks the driver's door. Turning the key once again within 3 seconds unlocks the other doors.

Changing “POWER” switch modes and starting the hybrid system

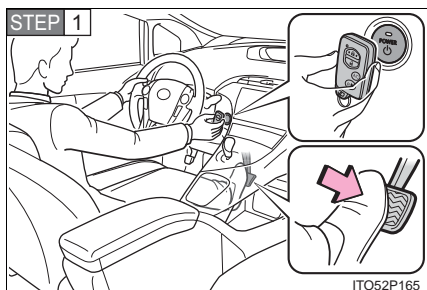

Apply the brakes and touch the Toyota emblem side of the electronic key to the “POWER” switch.

An alarm will sound to indicate that the start function cannot detect the electronic key that is touched to the “POWER” switch if any of the doors is opened and closed while the key is touched to the switch.

STEP 2 To change “POWER” switch modes: Within 10 seconds of the buzzer sounding, release the brake pedal and press the “POWER” switch. Modes can be changed each time the switch is pressed. (→P. 164)

To start the hybrid system: Press the “POWER” switch within 10 seconds after the buzzer sounds, keeping the brake pedal depressed.

In the event that the “POWER” switch still cannot be operated, contact your Toyota dealer.

■ Stopping the hybrid system

Push the “P” position switch and press the “POWER” switch as you normally do when stopping the hybrid system.

■ Replacing the key battery

As this procedure is the temporary measure, it is recommended that the electronic key battery be replaced immediately when the battery depletes. (→P. 460)

5-2. Steps to take in an emergency If the 12 volt battery is discharged

The following procedures may be used to start the hybrid system if the vehicle's 12 volt battery is discharged.

You can call your Toyota dealer or qualified repair shop.

If you have a set of jumper (or booster) cables and a second vehicle with a 12 volt battery, you can jump start your Toyota following the steps below.

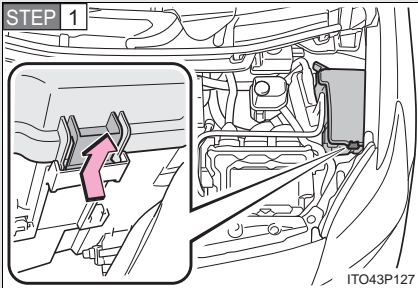

Open the hood and fuse block cover.

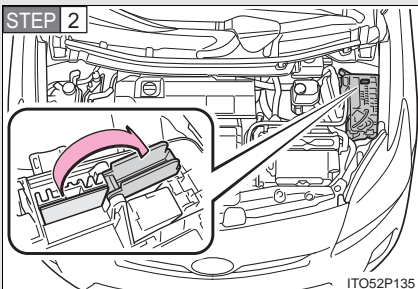

Open the exclusive jump starting terminal cover.

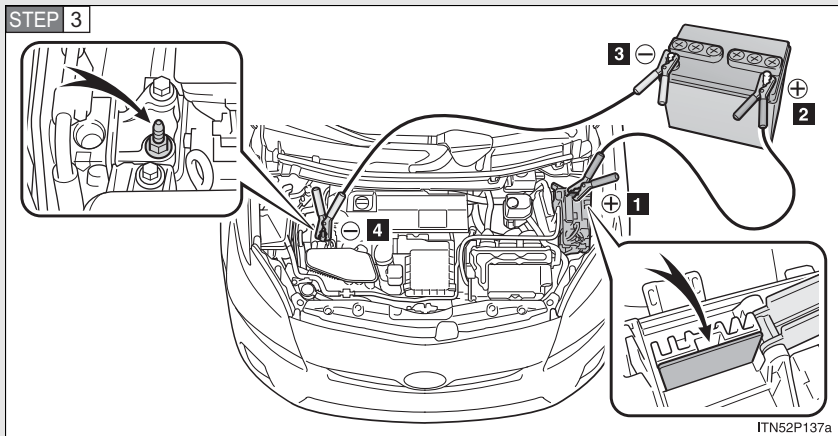

Connecting the jumper cables.

- 1 Exclusive jump starting terminal on your vehicle
- 2 Positive (+) battery terminal on the second vehicle
- 3 Negative (-) battery terminal on the second vehicle
- 4 Connect the jumper cable to ground on your vehicle as shown in the illustration.

- STEP 4** Start the engine of the second vehicle. Increase the engine speed slightly and maintain at that level for approximately 5 minutes to recharge the 12 volt battery of your vehicle.
- STEP 5** Turn the “POWER” switch to ACCESSORY mode.
- STEP 6** Maintain the engine speed on the second vehicle and turn the “POWER” switch to ON mode, then start your vehicle’s hybrid system.
- STEP 7** Make sure the “READY” indicator comes on. If the indicator does not come on, contact your Toyota dealer.
- STEP 8** Once the vehicle’s hybrid system has started, remove the jumper cables in the exact reverse order in which they were connected.

Once the hybrid system starts, have the vehicle checked at your Toyota dealer as soon as possible.

■ Starting the hybrid system when the 12 volt battery is discharged

The hybrid system cannot be started by push-starting. In addition, the shift position may not be changed from “P”.

■ Avoiding a discharged 12 volt battery

- Turn off the headlights and the audio system while the hybrid system is turned off.
- Turn off any unnecessary electrical components when the vehicle is running at a low speed for an extended period, such as in heavy traffic, etc.

■ When the 12 volt battery is removed or discharged

The hybrid system may not start. (→P. 438)

 **CAUTION**

■ **Avoiding 12 volt battery fires or explosions**

Observe the following precautions to prevent accidentally igniting the flammable gas that may be emitted from the 12 volt battery.

- Make sure the jumper cable is connected to the correct terminal and that it is not unintentionally in contact with any part other than the intended terminal.
- Do not allow the jumper cables to come into contact with the “+” and “-” terminals.
- Do not allow open flame or use matches, cigarette lighters or smoke near the 12 volt battery.

■ **12 volt battery precautions**

The 12 volt battery contains poisonous and corrosive acidic electrolyte, while related parts contain lead and lead compounds. Observe the following precautions when handling the 12 volt battery:

- When working with the 12 volt battery, always wear safety glasses and take care not to allow any battery fluids (acid) to come into contact with skin, clothing or the vehicle body.
- Do not lean over the 12 volt battery.
- In the event that battery fluid comes into contact with the skin or eyes, immediately wash the affected area with water and seek medical attention. Place a wet sponge or cloth over the affected area until medical attention can be received.
- Always wash your hands after handling the battery support, terminals, and other battery-related parts.
- Do not allow children near the 12 volt battery.

**NOTICE****■ To prevent damaging the vehicle**

The exclusive jump starting terminal is to be used when charging the 12 volt battery from another vehicle in an emergency. It cannot be used to jump start another vehicle.

■ When handling jumper cables

Be careful that the jumper cables do not become tangled in the cooling fan or any of the belts when connecting or disconnecting them.

5-2. Steps to take in an emergency If your vehicle overheats

The following may indicate that your vehicle is overheating:

- The high coolant temperature warning light comes on or flashes:
The engine may be overheating.
- “HYBRID SYSTEM OVERHEAT” is shown on the multi-information display:
The power control unit may be overheating.

Follow the correction procedure as described below.

Correction procedures

■ If the high coolant temperature warning light comes on or flashes

STEP 1 Stop the vehicle in a safe place and turn off the air conditioning system.

STEP 2 Check to see if steam is coming out from under the hood.

If you see steam:

Stop the hybrid system. Carefully lift the hood after the steam subsides and then restart the hybrid system.

If you do not see steam:

Leave the hybrid system operating and carefully lift the hood.

STEP 3 Check to see if the cooling fans are operating.

If the fans are operating:

Wait until the high coolant temperature warning light goes off and then stop the hybrid system.

If the fans are not operating:

Stop the hybrid system immediately and call your local Toyota dealer.

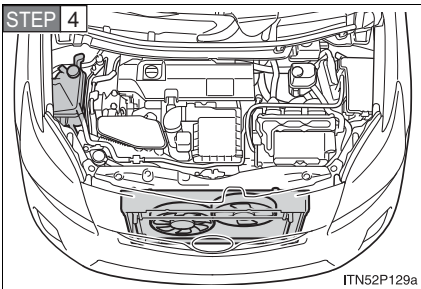

After the hybrid system has cooled down sufficiently, check the engine coolant level and inspect the radiator core (radiator) for any leaks.

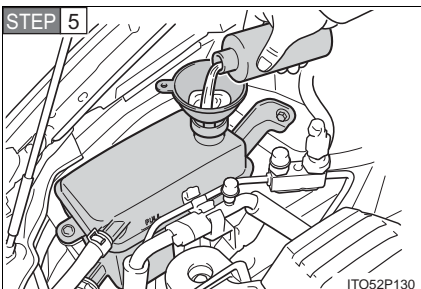

If necessary, add engine coolant up to the "FULL" line.

Water can be used in an emergency measure if engine coolant is unavailable. (→P. 562)

■ If “HYBRID SYSTEM OVERHEAT” is shown on the multi-information display

STEP 1 Stop the vehicle in a safe place and turn off the air conditioning system.

STEP 2 Leave the hybrid system operating and carefully lift the hood.

STEP 3 Check if the cooling fans are operating.

If the fans are operating:

Wait until “HYBRID SYSTEM OVERHEAT” disappears and then stop the hybrid system.

If the message does not disappear, call your Toyota dealer.

If the fans are not operating:

Stop the hybrid system immediately and call your Toyota dealer.

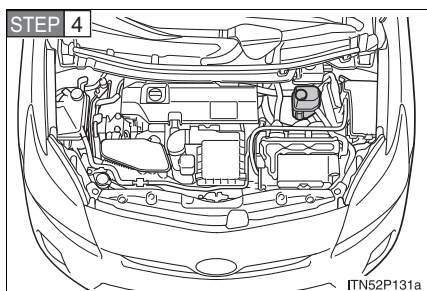

After the hybrid system has cooled down, check the power control unit coolant level and inspect the cooling system for leaks.

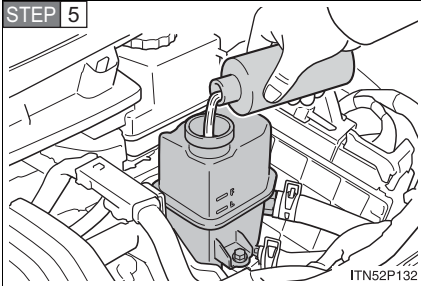

If necessary, add power control unit coolant up to the full line.

Water can be used in an emergency measure if power control unit coolant is unavailable.
(→P. 562)

Have the vehicle checked at nearest Toyota dealer as soon as possible.

■ Overheating

The following symptoms may occur when your vehicle is overheating:

- Hybrid system output decrease.
- Steam is coming from under the hood.

 CAUTION

■ **To prevent an accident or injury when inspecting under the hood of your vehicle**

- If steam is seen coming from under the hood, do not open the hood until the steam has subsided. The engine compartment may be very hot, causing serious injury such as burns.
- With a hybrid vehicle, there are times when the gasoline engine automatically starts to run or the cooling fans suddenly start to operate. Do not touch or approach the rotating parts of the belt or fans. Doing so may lead to fingers, clothes or tools getting caught, resulting in an accidental injury.
- Do not loosen the coolant reservoir cap while the hybrid system and radiator are hot.
Serious injury, such as burns, may result from hot coolant and steam released under pressure.

 NOTICE

■ **When adding engine/power control unit coolant**

Wait until the hybrid system has cooled down before adding engine/power control unit coolant.

When adding coolant, do so slowly. Adding cool coolant to a hot hybrid system too quickly can cause damage to the hybrid system.

5-2. Steps to take in an emergency If the vehicle becomes stuck

Carry out the following procedures if the tires spin or the vehicle becomes stuck in mud, dirt, or snow.

- STEP 1** Stop the hybrid system. Set the parking brake and push the “P” position switch.
- STEP 2** Remove the mud, snow, or sand from around the stuck tire.
- STEP 3** Place wood, stones or some other material to help provide traction under the tires.
- STEP 4** Restart the hybrid system.
- STEP 5** Shift the shift lever to “D” or “R” and carefully apply the accelerator to free the vehicle.

CAUTION

■ **When attempting to free a stuck vehicle**

If you choose to rock the vehicle back and forth to free it, make sure the surrounding area is clear, to avoid striking other vehicles, objects or persons. The vehicle may also lunge forward or lunge back suddenly as it becomes free. Use extreme caution.

■ **When shifting the shift lever**

Be careful not to shift the shift lever with the accelerator pedal depressed. This may lead to unexpected rapid acceleration of the vehicle that may cause an accident and result in death or serious injury.

 NOTICE

■ **To avoid damaging the transmission and other components**

- Avoid spinning the wheels.
- If the vehicle remains stuck after trying these procedures, the vehicle may require towing to be freed.

Dimensions and weight

Overall length		175.6 in. (4460 mm)
Overall width		68.7 in. (1745 mm)
Overall height *1		58.7 in. (1490 mm)
Wheelbase		106.3 in. (2700 mm)
Tread	Front	59.6 in. (1515 mm) ^{*2} 60.0 in. (1525 mm) ^{*3}
	Rear	59.4 in. (1510 mm) ^{*2} 59.8 in. (1520 mm) ^{*3}
Vehicle capacity weight (Occupants + luggage)		825 lb. (370 kg)

*1:Unladen vehicle

*2:Vehicles with 17-inch tires

*3:Vehicles with 15-inch tires

Vehicle identification

■ Vehicle identification number

The vehicle identification number (VIN) is the legal identifier for your vehicle. This is the primary identification number for your Toyota. It is used in registering the ownership of your vehicle.

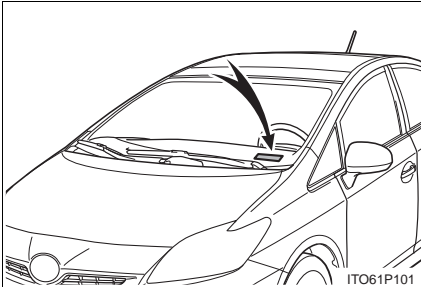

This number is stamped on the top left of the instrument panel.

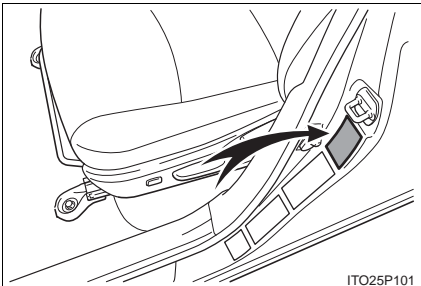

This number is also on the Certification Label.

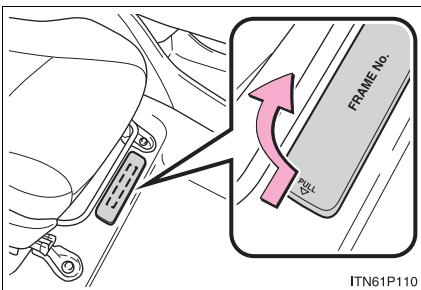

This number is also stamped under the right-hand front seat.

■ Engine number and electric motor (traction motor) number

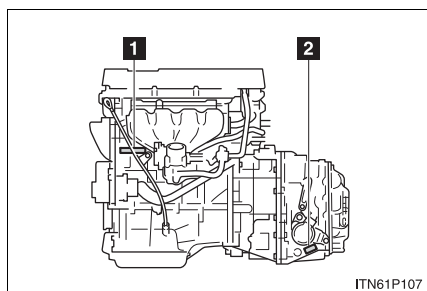

The gasoline engine number and electric motor (traction motor) number are stamped as shown.

- 1** Gasoline engine number
- 2** Electric motor (traction motor) number

Engine

Model	2ZR-FXE
Type	4-cylinder in line, 4-cycle, gasoline
Bore and stroke	3.17 × 3.48 in. (80.5 × 88.3 mm)
Displacement	109.7 cu. in. (1798 cm ³)
Valve clearance (engine cold)	Automatic adjustment

Fuel

Fuel type	Unleaded gasoline only
Octane Rating	87 (Research Octane Number 91) or higher
Fuel tank capacity	11.9 gal. (45 L, 9.9 Imp.gal.)

Electric motor (Traction motor)

Type	Permanent magnet motor
Maximum output	60 kW
Maximum torque	153 ft•lbf (207 N•m, 21.1 kgf•m)

Hybrid battery (Traction battery)

Type	Nickel-Metal hydride battery
Voltage	7.2 V/module
Capacity	6.5 Ah (3HR)
Quantity	28 modules
Overall voltage	201.6 V

Lubrication system

Oil capacity

Drain and refill (reference)

▶ With filter

4.4 qt. (4.2 L, 3.7 Imp.qt.)

▶ Without filter

4.1 qt. (3.9 L, 3.4 Imp.qt.)

■ Engine oil selection

“Toyota Genuine Motor Oil” is used in your Toyota vehicle. Use Toyota approved “Toyota Genuine Motor Oil” or equivalent to satisfy the following grade and viscosity.

Oil grade: ILSAC multigrade engine oil

Recommended viscosity: SAE 0W-20

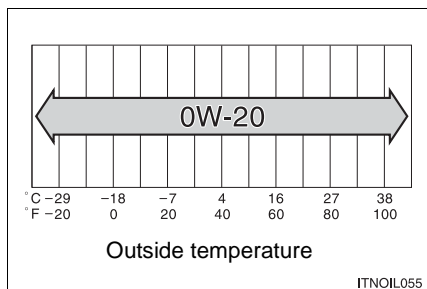

SAE 0W-20 is the best choice for good fuel economy and good starting in cold weather.

If SAE 0W-20 is not available, SAE 5W-20 may be used. However, it must be replaced with SAE 0W-20 at the next oil change.

The 0W portion of the oil viscosity rating indicates the characteristic of the oil which allows cold startability. Oils with a lower value before the W allow for easier starting of the engine in cold weather.

The 20 in 0W-20 indicates the oil viscosity when the oil is at its operating temperature. An oil with a higher viscosity may be better suited if the vehicle is operated at high speeds, or under extreme load conditions.

How to read oil container labels:

The ILSAC (International Lubricant Standardization and Approval Committee) Certification Mark is added to some oil containers to help you select the oil you should use.



Cooling system

Capacity	
▶ Gasoline engine With an exhaust heat recovery system	7.6 qt. (7.2 L, 6.3 Imp.qt.)
Without exhaust heat recovery system	6.9 qt. (6.5 L, 5.7 Imp.qt.)
▶ Power control unit	2.1 qt. (2.0 L, 1.8 Imp.qt.)
Coolant type	Use either of the following: <ul style="list-style-type: none"> • “Toyota Super Long Life Coolant” • Similar high-quality ethylene glycol-based non-silicate, non-amine, non-nitrite, and non-borate coolant with long-life hybrid organic acid technology Do not use plain water alone.

Ignition system

Spark plug	
Make DENSO	SC20HR11
Gap	0.043 in. (1.1 mm)

NOTICE

■ Iridium-tipped spark plugs

Use only iridium-tipped spark plugs. Do not adjust gap when tuning engine.

Electrical system

12 volt battery	
Open voltage at 68 °F (20 °C):	12.6 — 12.8 V Fully charged 12.2 — 12.4 V Half charged 11.5 — 11.9 V Discharged (Voltage is checked 20 minutes after the hybrid system and all lights are turned off.)
Charging rates	4.2 A max.

Transmission

Fluid capacity*	3.5 qt. (3.3 L, 2.9 Imp.qt.)
Fluid type	Toyota Genuine ATF WS

*: The fluid capacity is the quantity of reference. If replacement is necessary, contact your Toyota dealer.

NOTICE

■ Transmission fluid type

Using transmission fluid other than “Toyota Genuine ATF WS” may cause ultimately damage the transmission of your vehicle.

Brakes

Pedal clearance ^{*1}	3.07 in. (78 mm) Min.
Pedal free play	0.04 — 0.24 in. (1.0 — 6.0 mm)
Brake pad wear limit	0.04 in. (1.0 mm)
Parking brake pedal travel ^{*2}	8 — 11 clicks
Fluid type	SAE J1703 or FMVSS No. 116 DOT 3

^{*1}:Minimum pedal clearance when depressed with a force of 44.1 lbf (196 N, 20.0 kgf) while the hybrid system is operating.

^{*2}:Parking brake pedal travel when depressed with a force of 67.5 lbf (300 N, 30.6 kgf).

Steering

Free play	Less than 1.2 in. (30 mm)
-----------	---------------------------

Tires and wheels

► Type A

Tire size	P215/45R17 87V
Front and rear tire inflation pressure (Recommended cold tire inflation pressure)	Front tire: 33 psi (230 kPa, 2.3 kgf/cm ² or bar) Rear tire: 32 psi (220 kPa, 2.2 kgf/cm ² or bar)
Wheel size	17 × 7J
Wheel nut torque	76 ft•lbf (103 N•m, 10.5 kgf•m)

► Type B

Tire size	P195/65R15 89S
Front and rear tire inflation pressure (Recommended cold tire inflation pressure)	Front tire: 35 psi (240 kPa, 2.4 kgf/cm ² or bar) Rear tire: 33 psi (230 kPa, 2.3 kgf/cm ² or bar)
Wheel size	15 × 6J
Wheel nut torque	76 ft•lbf (103 N•m, 10.5 kgf•m)

► Compact spare tire

Tire size	T135/80D16 101M
Spare tire inflation pressure (Recommended cold tire inflation pressure)	60 psi (420 kPa, 4.2 kgf/cm ² or bar)
Wheel size	16 × 4T
Wheel nut torque	76 ft•lbf (103 N•m, 10.5 kgf•m)

Light bulbs

	Light Bulbs	Bulb No.	W	Type
Exterior	Headlights	— 9005	55	A
	Low beam (halogen bulbs)*		60	B
	High beam			
	Front fog lights*	—	55	A
	Parking lights	W5W	5	C
	Front side marker lights	W5W	5	C
	Front turn signal lights	WY21W	21	D
	Rear turn signal lights	WY21W	21	D
Interior	Back-up lights	W21W	21	C
	License plate lights	W5W	5	C
	Personal/interior lights	—	5	C
	Rear interior lights	—	8	E
	Door courtesy lights	—	5	C
	Vanity lights	—	8	C
	Luggage compartment light	—	5	E

- A: H11 halogen bulbs
 B: HB3 halogen bulbs
 C: Wedge base bulbs (clear)
 D: Wedge base bulbs (amber)
 E: Double end bulbs
 *: If equipped

Your vehicle must use only unleaded gasoline.

Select octane rating 87 (Research Octane Number 91) or higher. Use of unleaded gasoline with an octane rating lower than 87 may result in engine knocking. Persistent knocking can lead to engine damage.

At minimum, the gasoline you use should meet the specifications of ASTM D4814 in the U.S.A. and CGSB3.5-M93 in Canada.

■ **Fuel tank opening for unleaded gasoline**

To help prevent incorrect fueling, your Toyota has a fuel tank opening that only accommodates the special nozzle on unleaded fuel pumps.

■ **If your engine knocks**

- Consult your Toyota dealer.
- You may occasionally notice light knocking for a short time while accelerating or driving uphill. This is normal and there is no need for concern.

■ **Gasoline quality**

In very few cases, driveability problems may be caused by the brand of gasoline you are using. If driveability problems persist, try changing the brand of gasoline. If this does not correct the problem, consult your Toyota dealer.

■ Gasoline quality standards

- Automotive manufacturers in the US, Europe and Japan have developed a specification for fuel quality called World-Wide Fuel Charter (WWFC) that is expected to be applied worldwide.
- The WWFC consists of four categories that are based on required emission levels. In the US, category 4 has been adopted.
- The WWFC improves air quality by lowering emissions in vehicle fleets, and customer satisfaction through better performance.

■ Toyota recommends the use of gasoline containing detergent additives

- Toyota recommends the use of gasoline that contains detergent additives to avoid build-up of engine deposits.
- All gasoline sold in the US contains detergent additives to clean and/or keep clean intake systems.

■ Toyota recommends the use of cleaner burning gasoline

Cleaner burning gasoline, including reformulated gasoline that contains oxygenates such as ethanol or MTBE (Methyl Tertiary Butyl Ether) is available in many areas.

Toyota recommends the use of cleaner burning gasoline and appropriately blended reformulated gasoline. These types of gasoline provide excellent vehicle performance, reduce vehicle emissions and improve air quality.

■ **Toyota does not recommend blended gasoline**

- Toyota allows the use of oxygenate blended gasoline where the oxygenate content is up to 10 % ethanol or 15 % MTBE.
- If you use gasohol in your Toyota, be sure that it has an octane rating no lower than 87.
- Toyota DOES NOT recommend the use of gasoline containing methanol.

■ **Toyota does not recommend gasoline containing MMT**

Some gasoline contains octane enhancing additive called MMT (Methylcyclopentadienyl Manganese Tricarbonyl).

Toyota DOES NOT recommend the use of gasoline that contains MMT. If fuel containing MMT is used, your emission control system may be adversely affected.

The malfunction indicator lamp on the instrument cluster may come on. If this happens, contact your Toyota dealer for service.

**NOTICE****■ Notice on fuel quality**

- Do not use improper fuels. If improper fuels are used, the engine will be damaged.
- Do not use leaded gasoline.
Leaded gasoline can cause damage to your vehicle's three-way catalytic converters causing the emission control system to malfunction.
- Do not use gasohol other than that stated here.
Other gasohol may cause fuel system damage or vehicle performance problems.
- Using unleaded gasoline with an octane number or rating lower than that stated here will cause persistent heavy knocking.
At worst, this will lead to engine damage.

■ Fuel-related poor driveability

If after using a different type of fuel, poor driveability is encountered (poor hot starting, vaporization, engine knocking, etc.), discontinue the use of that type of fuel.

■ When refueling with gasohole

Take care not to spill gasohol. It can damage your vehicle's paint.

4 Tire ply composition and materials

Plies are layers of rubber-coated parallel cords. Cords are the strands which form the plies in a tire.

5 Summer tire or all season tire (→P. 446)

An all season tire has “M+S” on the sidewall. A tire not marked “M+S” is a summer tire.

6 Radial tires or bias-ply tires

A radial tire has RADIAL on the sidewall. A tire not marked RADIAL is a bias-ply tire.

7 TUBELESS or TUBE TYPE

A tubeless tire does not have a tube and air is directly filled in the tire. A tube type tire has a tube inside the tire and the tube maintains the air pressure.

8 Load limit at maximum cold tire inflation pressure (→P. 579)**9** Maximum cold tire inflation pressure (→P. 579)

This means the pressure to which a tire may be inflated.

10 Uniform Tire Quality Grading

For details, see “Uniform Tire Quality Grading” that follows.

11 “TEMPORARY USE ONLY” (→P. 525)

A compact spare tire is identified by the phrase “TEMPORARY USE ONLY” molded into its sidewall. This tire is designed for temporary emergency use only.

Typical DOT and tire identification number (TIN)

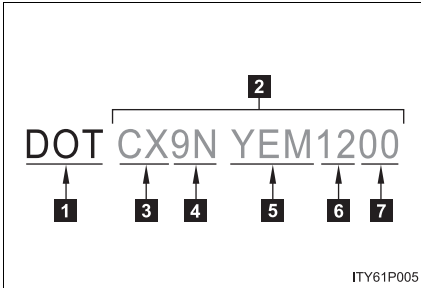

- 1** DOT symbol*
- 2** Tire Identification Number (TIN)
- 3** Tire manufacturer's identification mark
- 4** Tire size code
- 5** Manufacturer's optional tire type code (3 or 4 letters)
- 6** Manufacturing week
- 7** Manufacturing year

*:The DOT symbol certifies that the tire conforms to applicable Federal Motor Vehicle Safety Standards.

Tire size

■ Typical tire size information

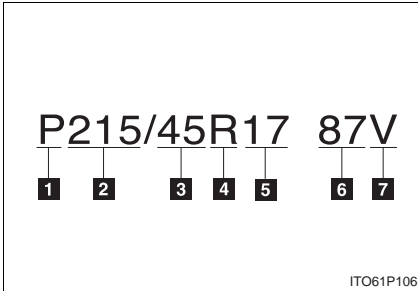

The illustration indicates typical tire size.

- 1** Tire use
(P = Passenger car,
T = Temporary use)
- 2** Section width (millimeters)
- 3** Aspect ratio
(tire height to section width)
- 4** Tire construction code
(R = Radial, D = Diagonal)
- 5** Wheel diameter (inches)
- 6** Load index (2 or 3 digits)
- 7** Speed symbol
(alphabet with one letter)

■ Tire dimensions

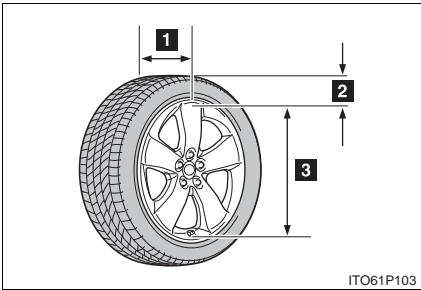

- 1 Section width
- 2 Tire height
- 3 Wheel diameter

Tire section names

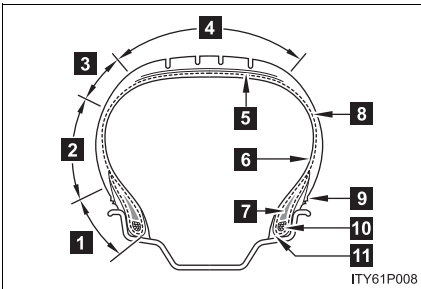

- 1 Bead
- 2 Sidewall
- 3 Shoulder
- 4 Tread
- 5 Belt
- 6 Inner liner
- 7 Reinforcing rubber
- 8 Carcass
- 9 Rim lines
- 10 Bead wires
- 11 Chafer

Uniform Tire Quality Grading

This information has been prepared in accordance with regulations issued by the National Highway Traffic Safety Administration of the U.S. Department of Transportation.

It provides the purchasers and/or prospective purchasers of Toyota vehicles with information on uniform tire quality grading.

Your Toyota dealer will help answer any questions you may have as you read this information.

■ DOT quality grades

All passenger vehicle tires must conform to Federal Safety Requirements in addition to these grades. Quality grades can be found where applicable on the tire sidewall between tread shoulder and maximum section width.

For example: Treadwear 200 Traction AA Temperature A

■ Treadwear

The treadwear grade is a comparative rating based on the wear rate of the tire when tested under controlled conditions on a specified government test course.

For example, a tire graded 150 would wear one and a half (1 - 1/2) times as well on the government course as a tire graded 100.

The relative performance of tires depends upon the actual conditions of their use, however, and may depart significantly from the norm due to variations in driving habits, service practices and differences in road characteristics and climate.

■ **Traction AA, A, B, C**

The traction grades, from highest to lowest, are AA, A, B and C, and they represent the tire's ability to stop on wet pavement as measured under controlled conditions on specified government test surfaces of asphalt and concrete.

A tire marked C may have poor traction performance.

Warning: The traction grade assigned to this tire is based on braking (straight ahead) traction tests and does not include cornering (turning) traction.

■ **Temperature A, B, C**

The temperature grades are A (the highest), B, and C, representing the tire's resistance to the generation of heat and its ability to dissipate heat when tested under controlled conditions on a specified indoor laboratory test wheel.

Sustained high temperature can cause the material of the tire to degenerate and reduce tire life, and excessive temperature can lead to sudden tire failure.

The grade C corresponds to a level of performance which all passenger car tires must meet under the Federal Motor Vehicle Safety Standard No. 109.

Grades B and A represent higher levels of performance on the laboratory test wheel than the minimum required by law.

Warning: The temperature grades for this tire are established for a tire that is properly inflated and not overloaded.

Excessive speed, underinflation, or excessive loading, either separately or in combination, can cause heat buildup and possible tire failure.

Glossary of tire terminology

Tire related term	Meaning
Cold tire inflation pressure	Tire pressure when the vehicle has been parked for three hours or more, or has not been driven more than 1 mile or 1.5 km under that condition
Maximum inflation pressure	The maximum cold inflated pressure to which a tire may be inflated, shown on the sidewall of the tire
Recommended inflation pressure	Cold tire inflation pressure recommended by a manufacturer.
Accessory weight	The combined weight (in excess of those standard items which may be replaced) of transmission, power steering, power brakes, power windows, power seats, radio and heater, to the extent that these items are available as factory-installed equipment (whether installed or not)
Curb weight	The weight of a motor vehicle with standard equipment, including the maximum capacity of fuel, oil and coolant, and if so equipped, air conditioning and additional weight optional engine
Maximum loaded vehicle weight	The sum of: (a) Curb weight (b) Accessory weight (c) Vehicle capacity weight (d) Production options weight

Tire related term	Meaning
Normal occupant weight	150 lb. (68 kg) times the number of occupants specified in the second column of Table 1* that follows
Occupant distribution	Distribution of occupants in a vehicle as specified in the third column of Table 1* below
Production options weight	The combined weight of installed regular production options weighing over 5 lb. (2.3 kg) in excess of the standard items which they replace, not previously considered in curb weight or accessory weight, including heavy duty brakes, ride levelers, roof rack, heavy duty battery, and special trim
Rim	A metal support for a tire or a tire and tube assembly upon which the tire beads are seated
Rim diameter (Wheel diameter)	Nominal diameter of the bead seat
Rim size designation	Rim diameter and width
Rim type designation	The industry manufacturer's designation for a rim by style or code
Rim width	Nominal distance between rim flanges
Vehicle capacity weight (Total load capacity)	The rated cargo and luggage load plus 150 lb. (68 kg) times the vehicle's designated seating capacity

Tire related term	Meaning
Vehicle maximum load on the tire	The load on an individual tire that is determined by distributing to each axle its share of the maximum loaded vehicle weight, and dividing by two
Vehicle normal load on the tire	The load on an individual tire that is determined by distributing to each axle its share of curb weight, accessory weight, and normal occupant weight (distributed in accordance with Table 1* below), and dividing it by two
Weather side	The surface area of the rim not covered by the inflated tire
Bead	The part of the tire that is made of steel wires, wrapped or reinforced by ply cords and that is shaped to fit the rim
Bead separation	A breakdown of the bond between components in the bead
Bias ply tire	A pneumatic tire in which the ply cords that extend to the beads are laid at alternate angles substantially less than 90 degrees to the centerline of the tread
Carcass	The tire structure, except tread and sidewall rubber which, when inflated, bears the load
Chunking	The breaking away of pieces of the tread or sidewall

Tire related term	Meaning
Cord	The strands forming the plies in the tire
Cord separation	The parting of cords from adjacent rubber compounds
Cracking	Any parting within the tread, sidewall, or innerliner of the tire extending to cord material
CT	A pneumatic tire with an inverted flange tire and rim system in which the rim is designed with rim flanges pointed radially inward and the tire is designed to fit on the underside of the rim in a manner that encloses the rim flanges inside the air cavity of the tire
Extra load tire	A tire designed to operate at higher loads and at higher inflation pressures than the corresponding standard tire
Groove	The space between two adjacent tread ribs
Innerliner	The layer(s) forming the inside surface of a tubeless tire that contains the inflating medium within the tire
Innerliner separation	The parting of the innerliner from cord material in the carcass

Tire related term	Meaning
Intended outboard sidewall	(a)The sidewall that contains a whitewall, bears white lettering, or bears manufacturer, brand, and/or model name molding that is higher or deeper than the same molding on the other sidewall of the tire, or (b)The outward facing sidewall of asymmetrical tire that has a particular side that must always face outward when mounted on a vehicle
Light truck (LT) tire	A tire designated by its manufacturer as primarily intended for use on lightweight trucks or multipurpose passenger vehicles
Load rating	The maximum load that a tire is rated to carry for a given inflation pressure
Maximum load rating	The load rating for a tire at the maximum permissible inflation pressure for that tire
Maximum permissible inflation pressure	The maximum cold inflation pressure to which a tire may be inflated
Measuring rim	The rim on which a tire is fitted for physical dimension requirements
Open splice	Any parting at any junction of tread, sidewall, or innerliner that extends to cord material
Outer diameter	The overall diameter of an inflated new tire
Overall width	The linear distance between the exteriors of the sidewalls of an inflated tire, including elevations due to labeling, decorations, or protective bands or ribs

Tire related term	Meaning
Passenger car tire	A tire intended for use on passenger cars, multipurpose passenger vehicles, and trucks, that have a gross vehicle weight rating (GVWR) of 10,000 lb. or less
Ply	A layer of rubber-coated parallel cords
Ply separation	A parting of rubber compound between adjacent plies
Pneumatic tire	A mechanical device made of rubber, chemicals, fabric and steel or other materials, that, when mounted on an automotive wheel, provides the traction and contains the gas or fluid that sustains the load
Radial ply tire	A pneumatic tire in which the ply cords that extend to the beads are laid at substantially 90 degrees to the centerline of the tread
Reinforced tire	A tire designed to operate at higher loads and at higher inflation pressures than the corresponding standard tire
Section width	The linear distance between the exteriors of the sidewalls of an inflated tire, excluding elevations due to labeling, decoration, or protective bands
Sidewall	That portion of a tire between the tread and bead
Sidewall separation	The parting of the rubber compound from the cord material in the sidewall

Tire related term	Meaning
Snow tire	A tire that attains a traction index equal to or greater than 110, compared to the ASTM E-1136 Standard Reference Test Tire, when using the snow traction test as described in ASTM F-1805-00, Standard Test Method for Single Wheel Driving Traction in a Straight Line on Snow-and Ice-Covered Surfaces, and which is marked with an Alpine Symbol () on at least one sidewall
Test rim	The rim on which a tire is fitted for testing, and may be any rim listed as appropriate for use with that tire
Tread	That portion of a tire that comes into contact with the road
Tread rib	A tread section running circumferentially around a tire
Tread separation	Pulling away of the tread from the tire carcass
Treadwear indicators (TWI)	The projections within the principal grooves designed to give a visual indication of the degrees of wear of the tread
Wheel-holding fixture	The fixture used to hold the wheel and tire assembly securely during testing

*: Table 1 — Occupant loading and distribution for vehicle normal load for various designated seating capacities

Designated seating capacity, Number of occupants	Vehicle normal load, Number of occupants	Occupant distribution in a normally loaded vehicle
2 through 4	2	2 in front
5 through 10	3	2 in front, 1 in second seat
11 through 15	5	2 in front, 1 in second seat, 1 in third seat, 1 in fourth seat
16 through 20	7	2 in front, 2 in second seat, 2 in third seat, 1 in fourth seat

Customizable features

Your vehicle includes a variety of electronic features that can be personalized to your preferences. Programming these preferences requires specialized equipment and may be performed by an authorized Toyota dealership.

Some function settings are changed simultaneously with other functions being customized. Contact your Toyota dealer for further details.

Item	Function	Default setting	Customized setting
Smart key system (→P. 43, 57)	Smart key system	ON	OFF
	Operation signals (Emergency flashers)*	ON	OFF
	Operation signals (Buzzer)*	ON	OFF

*: Vehicles with the entry function

Item	Function	Default setting	Customized setting
Wireless remote control (→P. 63)	Wireless remote control	ON	OFF
	Unlocking operation	Driver's door unlocked in 1-step, all doors unlocked in 2-step	All doors unlocked in 1-step
	Time elapsed before automatic door lock function is activated if door is not opened after being unlocked	60 seconds	OFF
			30 seconds
			120 seconds
	Operation signals (Emergency flashers)	ON	OFF
	Operation signals (Buzzer)	ON	OFF
	Operation signals (Buzzer volume)	Level 7	Level 1 to 6
			OFF
	Panic function	ON	OFF
Buzzer sounds when pushing  with any door not closed	ON	OFF	

Item	Function	Default setting	Customized setting
Door lock (→P. 69, 541)	Unlocking using a key	Driver's door unlocked in 1-step, all doors unlocked in 2-step	All doors unlocked in 1-step
	Speed-detecting automatic door lock function	OFF	ON
	Shifting the shift position to any position other than "P" locks all doors	ON	OFF
	Shifting the shift position to "P" unlocks all doors	ON	OFF
	Opening driver's door unlocks all doors	OFF	ON
Automatic light control system (→P. 206)	Light sensor sensitivity	Level 3	Levels 1 to 5
	Time elapsed before headlights automatically turn off after doors are closed	30 seconds	0 seconds
			60 seconds
			90 seconds

Item	Function	Default setting	Customized setting
Illumination (→P. 363)	Time elapsed before lights turn off	15 seconds	7.5 seconds
			30 seconds
	Operation when the doors are unlocked	ON	OFF
	Operation after the "POWER" switch turned OFF	ON	OFF
	Operation when you approach the vehicle with the electric key on your person (When the personal/interior light main switch is door position)	ON	OFF
	Foot lights	ON	OFF
Foot lights operation when the vehicle is running	ON	OFF	

Item	Function	Default setting	Customized setting
Meter, navigation system, instrument panel (→P. 181)	Sensor sensitivity for darkening the brightness of the meter, navigation system and instrument panel depending on the outside brightness	0	-2 to +2
	Sensor sensitivity for returning the brightness of the meter, navigation system and instrument panel to the original level depending on the outside brightness	0	-2 to +2
Remote Air Conditioning System (→P. 285)	Operation using the "A/C" button on the wireless remote control	Push and hold for 0.8 seconds	Push once
			Push twice
			Push and hold for 2.4 seconds
			OFF
	Stopping the operation using the "A/C" button on the wireless remote control	Push twice	Push once
			Push and hold for 0.8 seconds
			Push and hold for 2.4 seconds
			OFF

Item	Function	Default setting	Customized setting
Reverse warning buzzer (→P. 175)	Operation signals (Buzzer) when shifting into "R"	Beeps repeatedly	Beeps once
Seat belt reminder (→P. 499)	Vehicle speed linked seat belt reminder buzzer	ON	OFF

Multi-information display (→P. 188)

Available languages	English, French and Spanish
---------------------	-----------------------------

6-3. Initialization

Items to initialize

The following items must be initialized for normal system operation in case such as after the 12 volt battery is reconnected, or maintenance is performed on the vehicle.

Item	When to initialize	Reference
Engine oil maintenance data	<ul style="list-style-type: none">• After changing engine oil	P. 428
Tire pressure warning system	<ul style="list-style-type: none">• When rotating the tires on vehicles differing with front and rear tire inflation pressures.• When changing the tire inflation pressure by changing traveling speed or load weight, etc.• When changing the tire size.	P. 443

Reporting safety defects for U.S. owners

If you believe that your vehicle has a defect which could cause a crash or could cause injury or death, you should immediately inform the National Highway Traffic Safety Administration (NHTSA) in addition to notifying Toyota Motor Sales, U.S.A., Inc. (Toll-free: 1-800-331-4331).

If NHTSA receives similar complaints, it may open an investigation, and if it finds that a safety defect exists in a group of vehicles, it may order a recall and remedy campaign. However, NHTSA cannot become involved in individual problems between you, your dealer, or Toyota Motor Sales, U.S.A., Inc.

To contact NHTSA, you may call the Vehicle Safety Hotline toll-free at 1-888-327-4236 (TTY: 1-800-424-9153); go to <http://www.safercar.gov>; or write to: Administrator, NHTSA, 1200 New Jersey Ave, S.E., Washington, DC 20590. You can also obtain other information about motor vehicle safety from <http://www.safercar.gov>.

The following is a French explanation of seat belt instructions extracted from the seat belt section in this manual.

See the seat belt section for more detailed seat belt instructions in English.

Utilisation adéquate des ceintures de sécurité

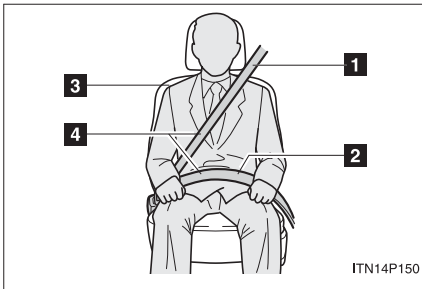

- 1** Tirez sur la ceinture épaulière jusqu'à ce qu'elle recouvre entièrement l'épaule; elle ne doit cependant pas toucher le cou ni glisser de l'épaule.
- 2** Placez la ceinture abdominale le plus bas possible sur les hanches.
- 3** Réglez la position du dossier du siège. Tenez-vous assis au fond du siège, le dos droit.
- 4** Ne vrillez pas la ceinture de sécurité.

Utilisation adéquate des ceintures de sécurité

■ Ceintures de sécurité

Avec un tissu ou une éponge, nettoyez à l'aide d'un savon doux et de l'eau tiède. Vérifiez aussi les ceintures régulièrement pour vous assurer qu'elles ne présentent pas d'usure excessive, d'effilochage ou de coupures.

ATTENTION

■ Dommages et usure de la ceinture de sécurité

Vérifiez périodiquement le système de ceintures de sécurité. Assurez-vous qu'il n'y a pas de coupures, d'effilochures ni de pièces desserrées. N'utilisez pas une ceinture de sécurité endommagée avant qu'elle soit remplacée. Les ceintures de sécurité endommagées ne peuvent pas protéger les occupants contre les blessures.

Abbreviation/Acronym list

ABBREVIATIONS	MEANING
A/C	Air Conditioning
ABS	Anti-lock Brake System
ALR	Automatic Locking Retractor
APGS	Advanced Parking Guidance System
CRS	Child Restraint System
ECU	Electronic Control Unit
EDR	Event Data Recorder
ELR	Emergency Locking Retractor
EPS	Electronic Power Steering
EV	Electric Vehicle
GAWR	Gross Axle Weight Ratings
I/M	Emission inspection and maintenance
LATCH	Lower Anchors and Tethers for Children
LED	Light Emitting Diode
MMT	Methylcy clopentadienyl Manganese Tricarbonyl
M + S	Mud and Snow
MTBE	Methyl Tertiary Butyl Ether
OBD	On Board Diagnostics
PCS	Pre-Collision System
SRS	Supplemental Restraint System
TIN	Tire Identification Number
TPMS	Tire Pressure Monitoring (Warning) System
TRAC	Traction Control
VIN	Vehicle Identification Number
VSC	Vehicle Stability Control

A	A/C	270
	ABS	245
	Active head restraint	78
	Air conditioning filter	457
	Air conditioning system	
	Air conditioning filter	457
	Automatic air conditioning system.....	270
	Remote Air Conditioning System	285
	Steering wheel climate remote control switches	280
	Airbags	
	Airbag operating conditions..	117
	Airbag precautions for your child.....	121
	Airbag warning light.....	497
	Curtain shield airbag precautions	121
	Front passenger occupant classification system	126
	General airbag precautions..	121
	Locations of airbags	113
	Modification and disposal of airbags	125
	Side airbag precautions.....	121
	Side and curtain shield airbags operating conditions.....	117
	SRS airbags	113
	Antenna	298
	Anti-lock brake system	245
	Armrest	383
	Audio input	322
	Audio system	
	Antenna	298
	Audio input	322
	AUX adapter.....	322
	CD player/changer	303
	MP3/WMA disc.....	311
	Optimal use	319
	Portable music player.....	322
	Radio	294
	Steering switches	323

B	Automatic headlight leveling system	206
	Automatic light control system	206
	AUX adapter	322
	Auxiliary boxes	375
	Back door	
	Back door	72
	Smart key system.....	43
	Wireless remote control	63
	Back-up lights	
	Replacing light bulbs	472
	Wattage.....	567
	Battery	
	Checking	436
	Hybrid battery (traction battery).....	32
	If the vehicle 12 volt battery is discharged	543
	Preparing and checking before winter	261
	Bluetooth®	326
	Bottle holder	374
	Brake	
	Fluid	432
	Parking brake	179
	Brake assist	245
	Break-in tips	151
	Brightness control	
	Instrument light control	184

C

Care
 Exterior 404
 Interior 407
 Seat belts 408
Cargo capacity 260
Cargo hooks 385
CD player/changer 303
Chains 263
Child-protectors 68
Child restraint system
 Booster seats, definition 132
 Booster seats, installation 137
 Convertible seats,
 definition 132
 Convertible seats,
 installation 137
 Front passenger occupant
 classification system 126
 Infant seats, definition 132
 Infant seats, installation 137
 Installing child restraint
 system with
 LATCH system 138
 Installing child restraint
 system with seatbelts 140
 Installing child restraint
 system with top straps 144
Child safety
 Airbag precautions 121
 Child restraint system 132
 Child-protectors 68
 How your child should wear
 the seatbelt 88
 Installing child restraints 137
 Moon roof precautions 100
 Power window lock switch 98
 Power window precautions 99
 Removed electronic key
 battery precautions 461
 Seat belt precautions 89
 Back door 72

Cleaning
 Exterior 404
 Interior 407
 Seat belts 408
Clock 201
Condenser 432
Console box 369
Cooling system
 Hybrid system overheating ... 548
Cruise control
 Cruise control 214
 Dynamic radar
 cruise control 218
Cup holders 372
Curtain shield airbags 113
Customizable features 587

D

**Daytime running light
 system** 207
Defogger
 Rear window 289
 Side mirror 289
Dimension 556
Dinghy towing 267
Display
 Trip information 188
 Warning messages 508
Do-it-yourself maintenance 416
Door courtesy lights 363
Door lock
 Back door 72
 Side doors 67
 Smart key system 43
 Wireless remote control 63
Doors
 Back door 72
 Side doors 67
 Rear door child protector 68

Driver's seat belt reminder light 499

Driving

Break-in tips 151
 Correct posture..... 111
 Procedures..... 150
 Winter driving tips..... 261

E Electric Power Steering 245

Electronic key

Replacing battery 460
 When the electronic key battery is discharged..... 541

Emergency flashers 486

Emergency, in case of

If a warning buzzer sounds 496
 If a warning light turns on 496
 If a warning message is displayed 508
 If the electronic key does not operate properly..... 541
 If the hybrid system will not start..... 538
 If the 12 volt battery is discharged 543
 If you have a flat tire 524
 If you lose your keys..... 540
 If you think something is wrong 493
 If your vehicle becomes stuck..... 553
 If your vehicle needs to be towed 487
 If your vehicle overheats 548

Engine

Compartment425
 Hood.....420
 How to start the hybrid system 162
 If the hybrid system will not start.....538
 Ignition switch..... 162
 Overheating.....548
 "POWER" switch 162

Engine oil

Capacity560
 Checking426
 Preparing and checking before winter261

Engine/power control unit coolant

Capacity562
 Checking430
 Preparing and checking before winter261

Engine oil maintenance

data428

Enhanced VSC (Vehicle Stability Control).....245

EPS.....245

Event data recorder494

F Floor mats.....384

Fluid

Brake432
 Washer.....434

Fog lights

Replacing light bulbs472
 Switch.....209
 Wattage.....567

Front passenger occupant classification system 126

Front passenger's seat belt reminder light.....499

Front seats

Adjustment78

Front side marker lights

- Replacing light bulbs472
- Wattage.....567

Front turn signal lights

- Replacing light bulbs472
- Wattage.....567

Fuel

- Capacity558
- Fuel gauge 181
- Information568
- Refueling 104
- Type568

Fuel door.....104

Fuel filler door104

Fuses.....462

G

Garage door opener.....389

Gauges.....181

Glove box.....368

H

Hands-free system

- (for cellular phone)326

Hazard lights

- Switch.....486

Head restraints.....82

Headlight cleaner213

Headlights

- Replacing light bulbs472
- Switch.....206
- Wattage.....567

Heaters

- Seat heaters381
- Side mirror.....289

Hood.....420

Hooks

- Cargo385

Horn.....180

Hybrid system

- Emergency shut off system.....33
- Energy monitor/
consumption screen 190
- High-voltage components32
- Power switch..... 162

I

I/M test415

Identification

- Engine.....557
- Vehicle557

Ignition switch.....162

Illuminated entry system.....363

Immobilizer system108

Indicator lights185

Initialization

- Items to initialize593

Inside rear view mirror93

Instrument panel light

- control184

Interior lights

- Interior lights363
- Switch363
- Wattage.....567

J

Jack

- Positioning a floor jack423
- Vehicle-equipped jack524

Jack handle524

K	Keyless entry	63
	Keys	
	Electronic key	63
	If you lose your keys.....	540
	If your electronic key	
	battery is discharged.....	541
	Key number plate	42
	Keyless entry.....	63
	Keys	41
	“POWER” switch	162
	Mechanical key.....	41
	Wireless remote control key ...	63
	Knee airbag	113
L	Lane keeping assist	235
	Language	
	Multi-information	
	display.....	188
	License plate lights	
	Replacing light bulbs	472
	Wattage.....	567
	Light bulbs	
	Replacing	472
	Wattage.....	567
	Lights	
	Emergency flasher switch	486
	Fog light switch.....	209
	Hazard light switch	486
	Headlights switch	206
	Interior lights.....	363
	Replacing light bulbs	472
	Turn signal lever.....	178
	Vanity lights.....	377
	Wattage.....	567
	LKA	235
	Load capacity	260
	Luggage compartment light	
	Switch.....	73
	Wattage.....	567
	Luggage cover	385

M	Maintenance	
	Do-it-yourself	
	maintenance	416
	General maintenance.....	412
	Maintenance data.....	556
	Maintenance	
	requirements.....	410
	Meter	
	Instrument panel light	
	control	184
	Meters	181
	Micro dust and	
	pollen filter	274
	Mirrors	
	Inside rear view mirror.....	93
	Side mirror heater	289
	Side mirrors.....	96
	Vanity mirrors	377
	Moon roof	100
	MP3 disc	311
	Multi-information display	188
N	Noise from under vehicle	22
O	Odometer	181
	Oil	
	Engine oil	426
	Opener	
	Back door.....	72
	Fuel filler door	104
	Hood.....	420
	Outside rear view mirrors	
	Adjusting and folding.....	96
	Outside temperature	
	display	378
	Overhead console	370
	Overheating, Hybrid	
	system	548

P	Parking brake	179
	Parking lights	
	Replacing light bulbs	472
	Switch.....	206
	Wattage.....	567
	PCS	249
	Personal lights	363
	Power outlet	379
	Power windows	98
	Pre-Collision System	249
R	Radiator	432
	Radio	294
	Rear turn signal lights	
	Replacing light bulbs	472
	Wattage.....	567
	Rear view monitor system	231
	Rear window defogger	289
	Rear window wiper	
	and washer.....	212
	Remote Air Conditioning	
	System.....	285
	Replacing	
	Electronic key battery.....	460
	Fuses	462
	Light bulbs.....	472
	Tires	524
	Reporting safety defects for	
	U.S. owners.....	596

S	Safety Connect	395
	Seat belts	
	Adjusting the seat belt.....	85
	Automatic Locking Retractor	
	(ALR)	87
	Child restraint system	
	installation.....	137
	Cleaning and maintaining	
	the seat belts	408
	Emergency Locking Retractor	
	(ELR)	87
	How to wear your seat belt	85
	How your child should wear	
	the seat belt.....	88
	Pregnant women,	
	proper seat belt use.....	87
	Reminder light.....	499
	Seat belt extenders.....	88
	Seat belt pretensioners	86
	Seat heaters	381
	Seating capacity	260
	Seats	
	Adjustment	78
	Adjustment precautions	79
	Child seats/child restraint	
	system installation	137
	Cleaning.....	407
	Head restraint	82
	Properly sitting in the seat.....	111
	Seat heaters.....	381
	Service reminder	
	indicators	185
	Shift lever	
	Transmission.....	171
	Side airbags	113
	Side marker lights	
	Replacing light bulbs.....	472
	Switch	206
	Wattage.....	567
	Side mirror	
	Adjusting and folding.....	96

Smart key system

- Antenna location..... 46, 58
- Entry function 43
- Starting the hybrid system.... 162

Solar Ventilation

- System 282**

Spare tire

- Inflation pressure..... 565
- Storage location 524

Spark plug..... 562

Specifications 556

Speedometer 181

Steering wheel

- Adjustment 92
- Audio switches 323

Storage compartment 367

Storage feature..... 367

Stuck

- If your vehicle becomes stuck..... 553

Sun visors..... 376

Switch

- Driving mode select switch 172
- Emergency flasher switch 486
- Fog light switch..... 209
- Ignition switch..... 162
- Light switches..... 206
- Power door lock switch..... 67
- “POWER” switch 162
- Power window switch 98
- Ventilation switch..... 282
- Window lock switch 98
- Wipers and washer switch.... 210

T

Tail lights

- Switch..... 206

Talk switch..... 329

Telephone switch 329

Theft deterrent system

- Immobilizer system 108

Theft prevention labels..... 110

Tire inflation pressure 565

Tire information

- Glossary 579
- Size 575
- Tire identification number..... 574
- Uniform tire quality grading ... 577

Tires

- Chains 263
- Checking 441
- Compact spare tire..... 525
- If you have a flat tire 524
- Inflation pressure..... 565
- Information 572
- Pressure warning system..... 442
- Replacing 524
- Rotating tires 441
- Size 565
- Snow tires 264
- Spare tire..... 525

Tonneau cover 385

Tools 524

Total load capacity..... 260

Towing

- Dinghy towing..... 267
- Emergency towing..... 487
- Trailer towing..... 266

TRAC 245

Traction control..... 245

Trailer towing 266

Transmission

- “P” position switch 174
- Transmission 171

Trip information 188

Trip meter 188

Turn signal lights

- Replacing light bulbs 472
- Switch..... 178
- Wattage 567

V

Vanity lights
 Vanity lights.....377
 Wattage.....567
Vanity mirrors.....377
Vehicle identification
 number557
Vehicle load limits.....260

W

Warning buzzers
 Brake system496
 Open door499
 Seat belt reminder.....499
Warning lights
 Anti-lock brake
 system (ABS).....497
 Automatic headlight
 leveling system497
 Brake system496
 Charging system497
 Electric power steering497
 High coolant temperature.....499
 Low fuel level499
 Malfunction indicator lamp497
 Master warning.....499
 Open door499
 Pre-Collision system497
 Seat belt reminder.....499
 SRS airbags497
 Tire pressure499
Warning messages508
Washer
 Checking434
 Preparing and checking
 before winter261
 Switch.....210
Washing and waxing404

Weight

Cargo capacity260
 Load limits.....260
 Weight.....556
Wheels455
Window glasses98
Window lock switch.....98
Windows
 Power windows98
 Rear window defogger289
 Washer.....210
Windshield wipers210
Winter driving tips261
Wireless remote control key
 Locking/Unlocking.....63
 Replacing the battery460
WMA disc.....311

What to do if...

What to do if...

A tire punctures

P. 524 If you have a flat tire

The hybrid system does not start

P. 108 Immobilizer system

P. 538 If the hybrid system will not start

P. 543 If the 12 volt battery is discharged

The high coolant temperature warning light comes on

P. 548 If your vehicle overheats

Steam can be seen coming from under the hood

The key is lost

P. 540 If you lose your keys

The 12 volt battery runs out

P. 543 If the 12 volt battery is discharged

The doors cannot be locked

P. 67 Side doors

P. 72 Back door

The vehicle is stuck in mud or sand

P. 553 If the vehicle becomes stuck

The warning light or indicator light comes on

P. 496

If a warning light turns on or a warning buzzer sounds...

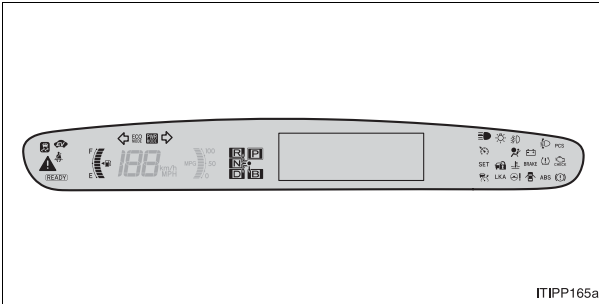

■ Warning lights

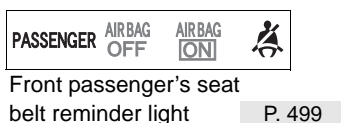
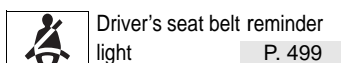
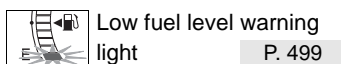
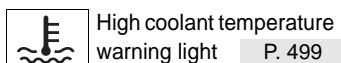
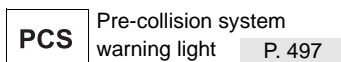
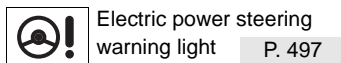
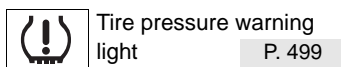
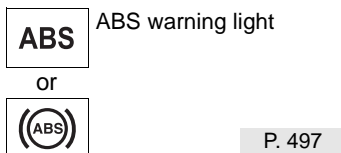
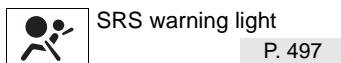
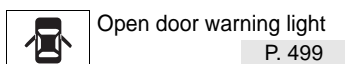
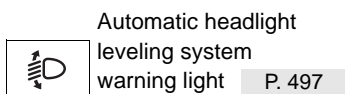
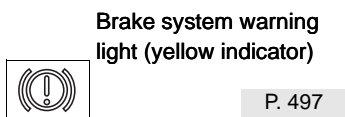
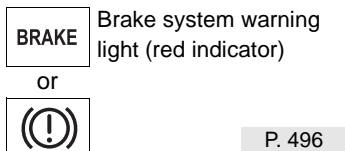
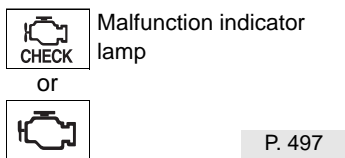
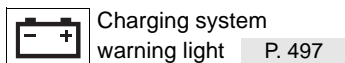
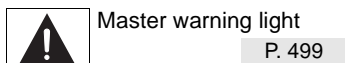





GAS STATION INFORMATION

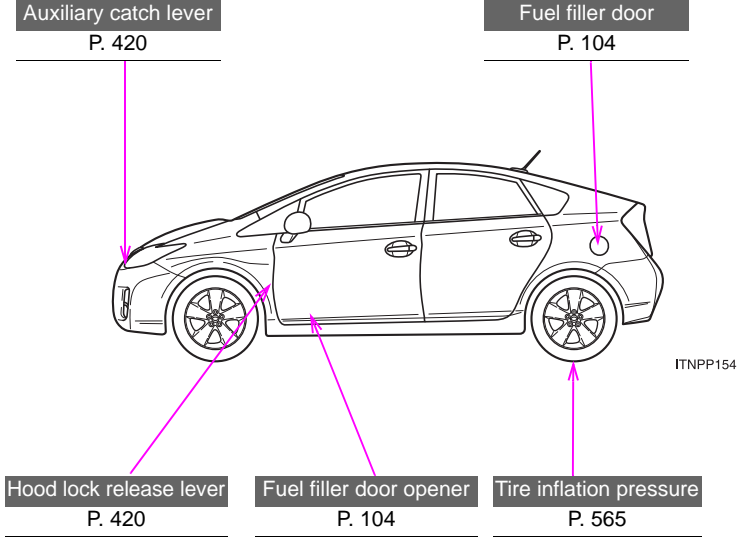

Fuel tank capacity	11.9 gal. (45 L, 9.9 Imp.gal.)	
Fuel type	Unleaded gasoline only	P. 105, 568
Cold tire inflation pressure	P. 565	
Engine oil capacity (Drain and refill)	With filter	qt. (L, Imp.qt.) 4.4 (4.2, 3.7)
	Without filter	4.1 (3.9, 3.4)
Engine oil type	“Toyota Genuine Motor Oil” or equivalent Oil grade: ILSAC multigrade engine oil Recommended oil viscosity: SAE 0W-20	P. 560