



Customer Experience Center
1-800-331-4331

YARIS LIFTBACK

2009 Quick Reference Guide

2009 Yaris Liftback

This *Quick Reference Guide* is a summary of basic vehicle operations. It contains brief descriptions of fundamental operations so you can locate and use the vehicle's main equipment quickly and easily.

The *Quick Reference Guide* is not intended as a substitute for the *Owner's Manual* located in your vehicle's glove box. We strongly encourage you to review the *Owner's Manual* and supplementary manuals so you will have a better understanding of your vehicle's capabilities and limitations.

Your dealership and the entire staff of Toyota Motor Sales, U.S.A., Inc. wish you many years of satisfied driving in your new Yaris.

! A word about safe vehicle operations

This *Quick Reference Guide* is not a full description of Yaris operations. Every Yaris owner should review the *Owner's Manual* that accompanies this vehicle.

Pay special attention to the boxed information highlighted in color throughout the *Owner's Manual*. Each box contains safe operating instructions to help you avoid injury or equipment malfunction.

All information in this *Quick Reference Guide* is current at the time of printing. Toyota reserves the right to make changes at any time without notice.

Child comfort guide

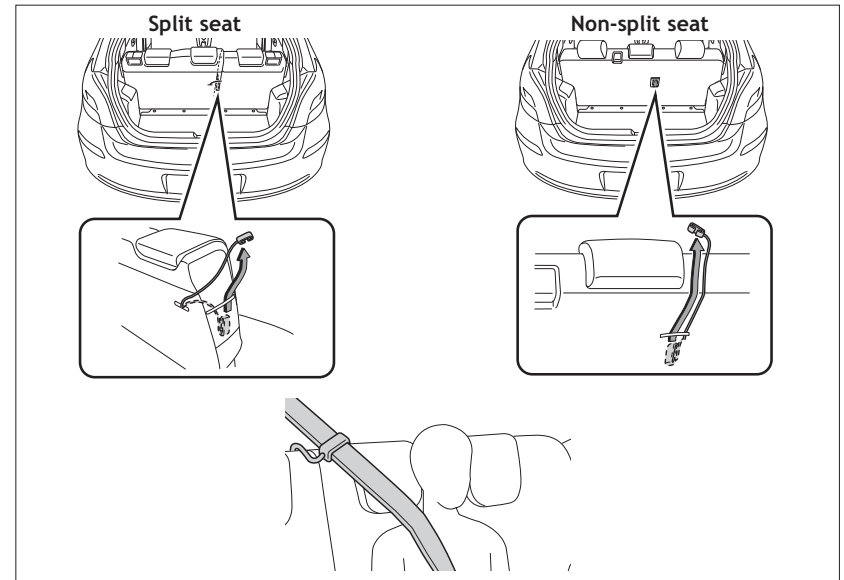

Rear seat center position guides provide added comfort for children who have outgrown child restraints.

Spare tire & tools

Tool location

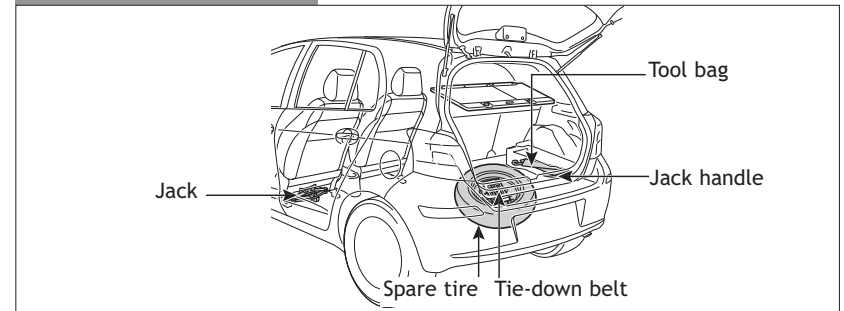

Removing the spare tire

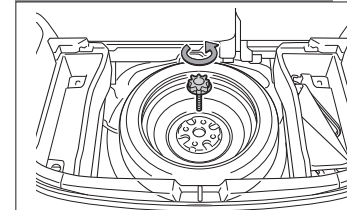

Loosen and remove the bolt.
Refer to the *Owner's Manual* for tire changing and jack positioning procedures.

INDEX

OVERVIEW

Engine maintenance	7
Fuel tank door release and cap	6
Hood release	7
Indicator symbols	4-5
Instrument cluster	4
Instrument panel	2-3
Keyless entry*	6

FEATURES/OPERATIONS

Air Conditioning/Heating	13
Audio	14-15
Automatic Transmission	8
Clock	15
Cruise control	14
Door-Back	12
Light control-Instrument panel	9
Lights & turn signals	11
Luggage storage box	15
Parking brake	8
Power outlet	15
Seat adjustments-Front	9
Seat adjustments-Rear	9
Seat-Folding rear seat	10-11
Seats-Head restraints	12
Tilt steering wheel	8
Windows-Power	12
Windshield wipers & washers	13

SAFETY AND EMERGENCY FEATURES

Child comfort guide	17
Door locks-Power	16
Seatbelts	16
Spare tire & tools	17
Tire Pressure Monitoring (warning) System	16

* Visit your Toyota dealer for information on customizing this feature.

OVERVIEW

Instrument panel

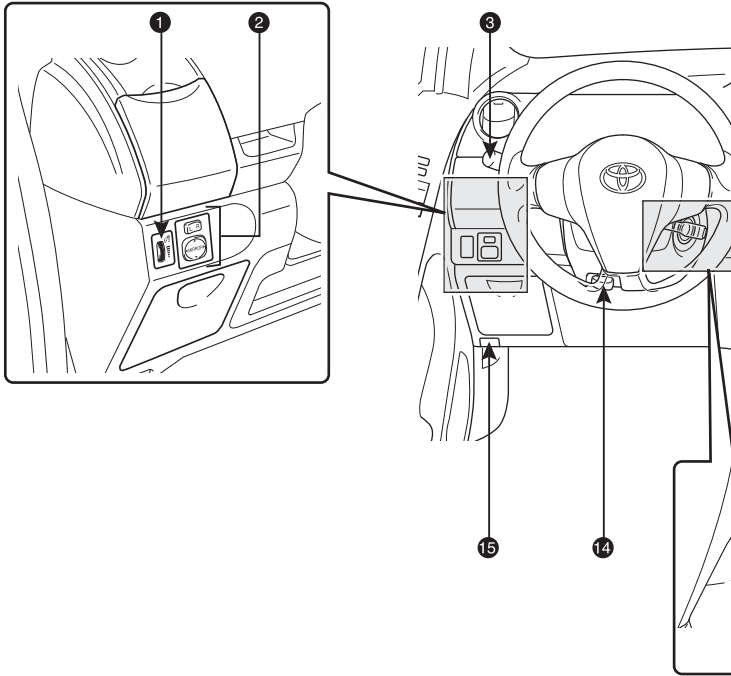

- ① Instrument panel light control
- ② Power rearview mirror control switches
- ③ Headlight, turn signal and front fog light* controls
- ④ Wiper and washer controls
- ⑤ Emergency flasher switch
- ⑥ “AIR BAG ON” and “AIR BAG OFF” indicator
- ⑦ Front passenger seatbelt reminder light
- ⑧ Audio system*

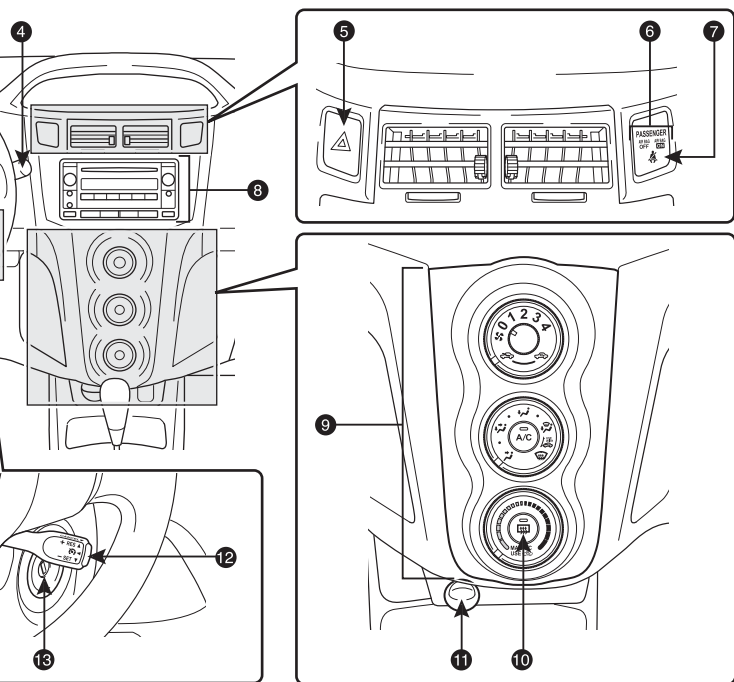

- ⑨ Air Conditioning controls
- ⑩ Rear window defogger switch*
- ⑪ 12V DC Power outlet
- ⑫ Cruise control
- ⑬ Engine (ignition) switch
- ⑭ Tilt steering lock release lever
- ⑮ Hood release

* If equipped

Instrument cluster

Without tachometer

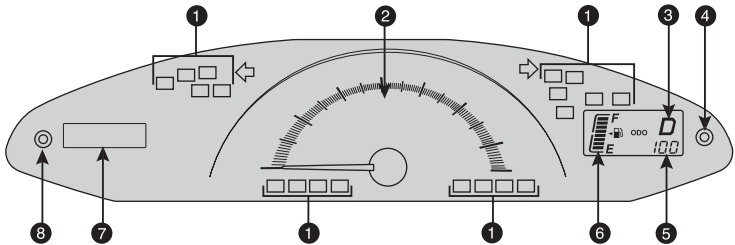

With tachometer

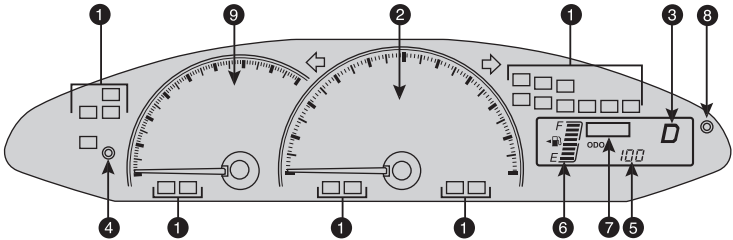

- ① Service indicator and reminder
- ② Speedometer
- ③ Automatic Transmission shift position indicator
- ④ Trip meter reset knob
- ⑤ Odometer and two trip meters
- ⑥ Fuel gauge
- ⑦ Clock
- ⑧ Clock reset knob
- ⑨ Tachometer

Indicator symbols

For details, refer to “Indicators and warning lights,” Section 2-2, 2009 Owner’s Manual.

BRAKE Brake system warning^{1,2}























Driver seatbelt reminder²
(alarm will sound if speed is over 12 mph)



Front passenger seatbelt reminder²
(alarm will sound if speed is over 12 mph)

¹ If indicator does not turn off within a few seconds of starting engine, there may be a malfunction. Have vehicle inspected by your Toyota dealer.

	Charging system warning ^{1,2}
	Malfunction/Check Engine indicator ^{1,2}
	Low engine oil pressure warning ^{1,2}
	Open door warning ²
	Airbag SRS warning ^{1,2}
	Electric power steering system warning ^{1,2}
	Low windshield washer fluid level warning ²
	Low Tire Pressure Warning ^{1,2}
	Engine oil replacement reminder ^{1,2}
	AIR BAG ON indicator
	AIR BAG OFF indicator
	Headlight low beam indicator
	Headlight high beam indicator
	Front fog light indicator
	Turn signal indicator
	Low fuel level warning ²
	High engine coolant temperature warning ^{1,2}
	Low engine coolant temperature indicator ³
	Anti-lock Brake System warning ^{1,2}
	Cruise control main indicator
	Cruise control SET indicator

² For details, refer to "If a warning light turns on or a warning buzzer sounds," Section 5-2, 2009 Owner's Manual.



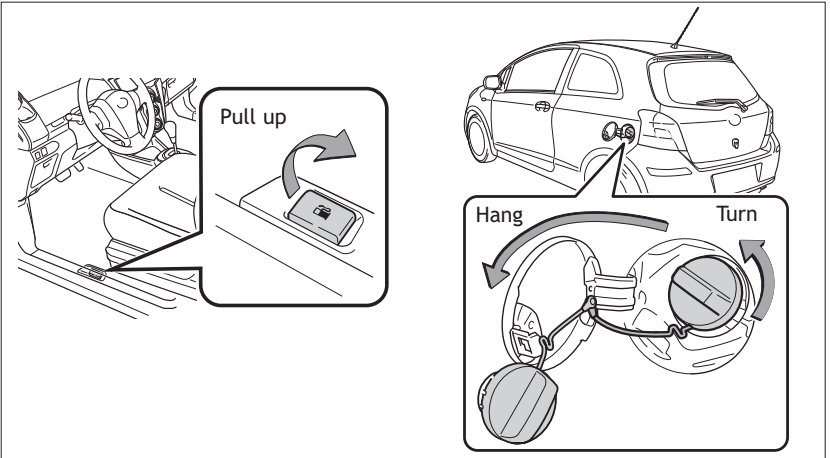

³ For details, refer to "If your vehicle overheats," Section 5-2, 2009 Owner's Manual.

Fuel tank door release and cap

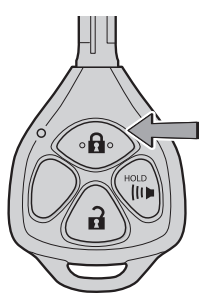

NOTE: Tighten until one click is heard. If the cap is not tightened enough, Check Engine "CHECK" indicator may illuminate.

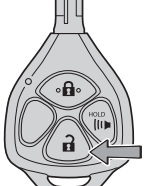
Keyless entry (if equipped)

Locking operation	Unlocking operation
 <p>Push </p>	 <p>Push ONCE: Driver door TWICE: All doors </p> <p>NOTE: If a door is not opened within 30 seconds of unlocking, all doors will relock for safety.</p>

Panic button



Push and hold 

The diagram shows a hand holding the key fob with the panic button (a red triangle) being pressed and held. A car is shown with a person being thrown out of the driver's side door, and a dog is running away from the car, indicating an emergency escape scenario.

Hood release

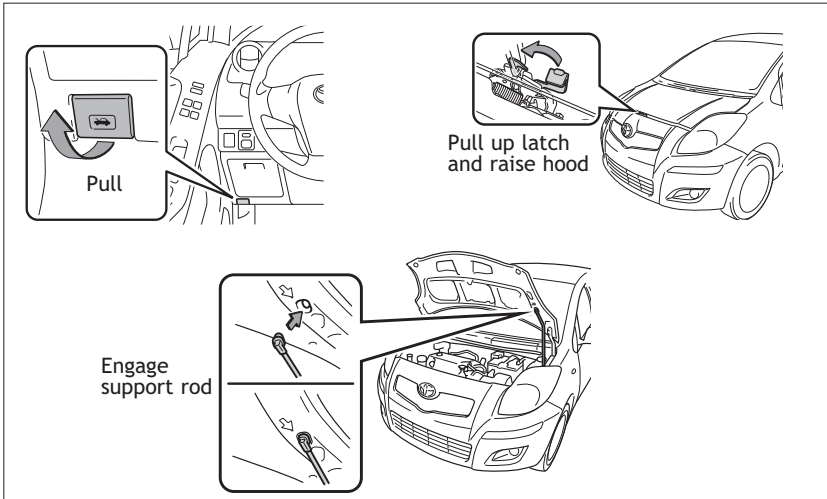

Engine maintenance

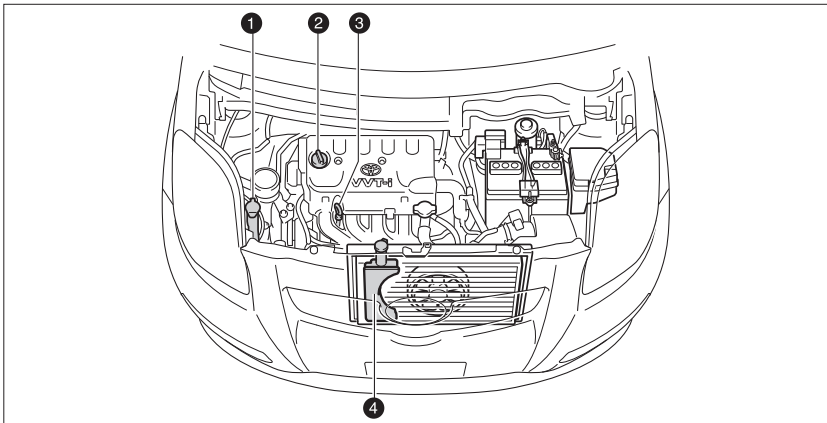

- 1 Windshield washer and rear window washer fluid tank
- 2 Engine oil filler cap
- 3 Engine oil level dipstick
- 4 Engine coolant reservoir

Note: Regularly scheduled maintenance, including oil changes, will help extend the life of your vehicle and maintain performance. Please refer to the “Owner’s Warranty Information Booklet,” “Scheduled Maintenance Guide” or “Owner’s Manual Supplement.”

FEATURES/OPERATIONS

Automatic Transmission (if equipped)

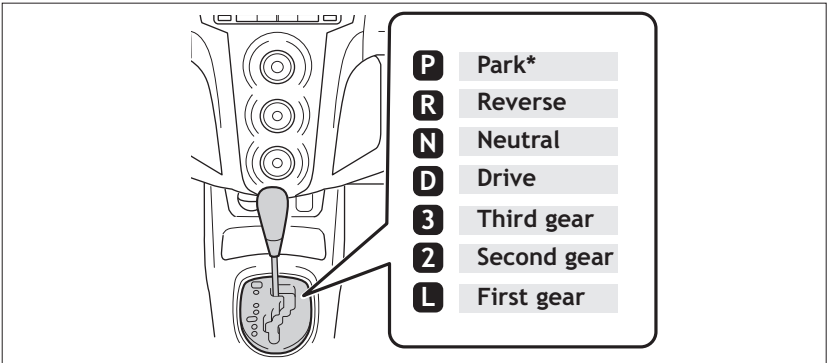

* The ignition switch must be “ON” and the brake pedal depressed to shift from Park.

Downshifting increases power going uphill, or provides engine braking downhill. For best fuel economy during normal driving conditions, always drive with the shift lever in the “D” position.

Tilt steering wheel

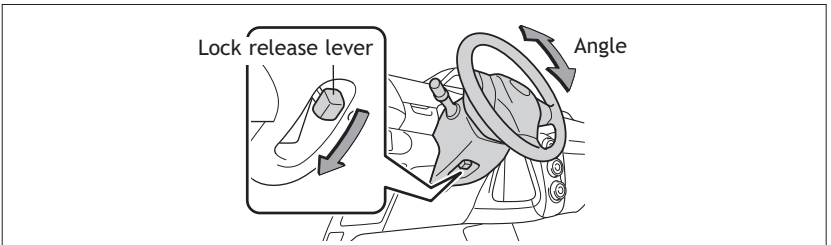

Hold wheel, push lever down, set angle and return lever.

Note: Do not attempt to adjust while the vehicle is in motion.

Parking brake

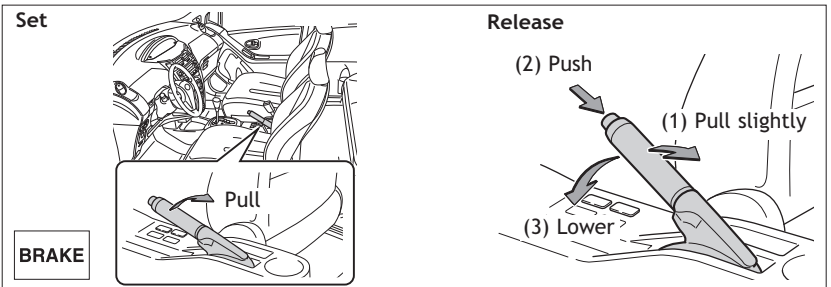

Light control-Instrument panel

Brightness control

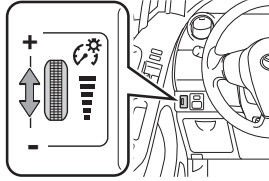

Seat adjustments-Front

Seat position



Seatback angle

Seat adjustments-Rear

Non-split seat

Angle

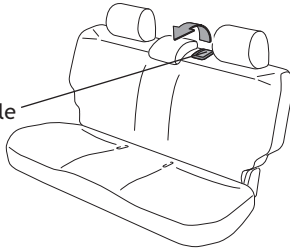

Split seat (type A)

Seatback angle/Fold

Position

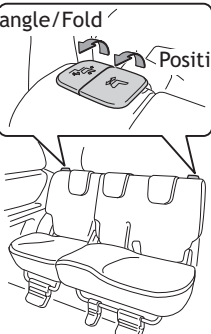

Split seat (type B)

Seatback angle



Seat-Folding rear seat

Before folding

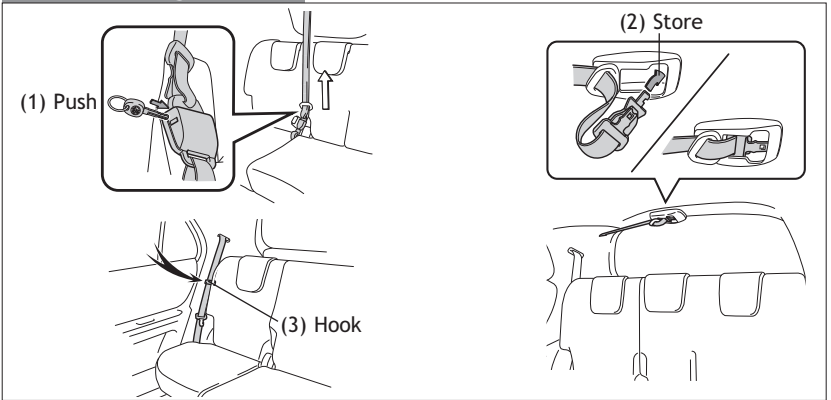

Fold (split seat - type A)

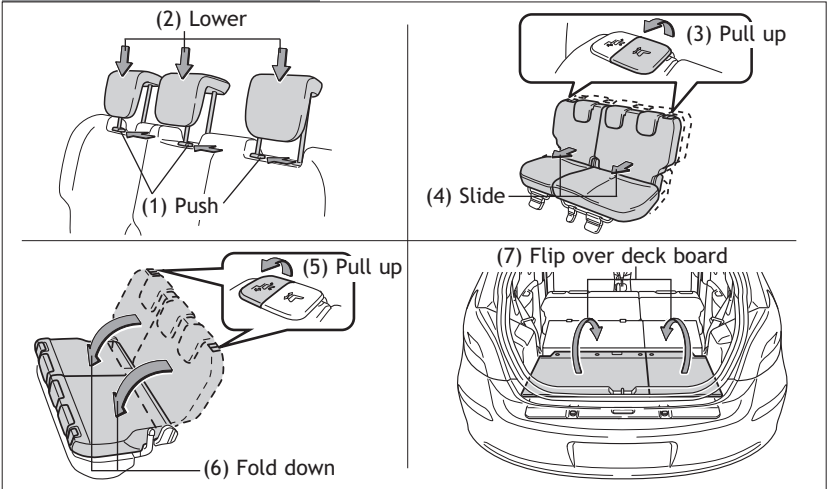

Fold (split seat - type B)

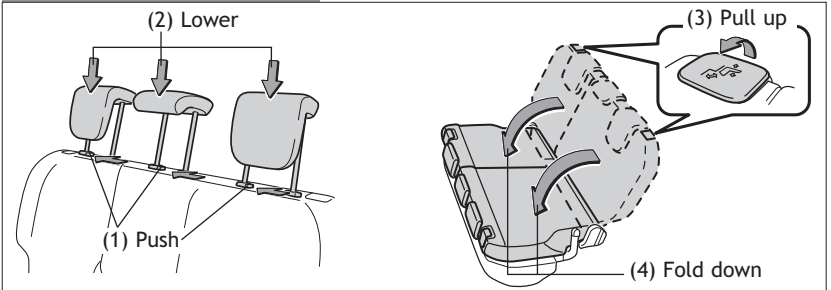

Fold (non-split seat)

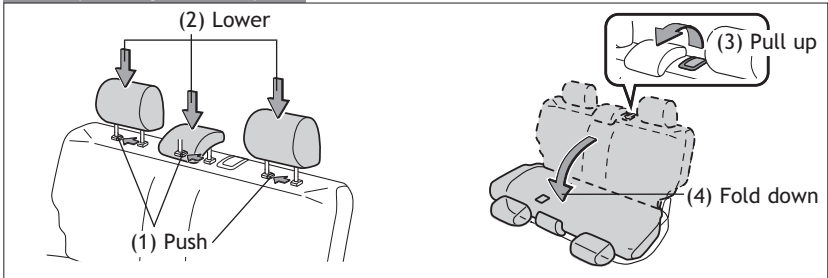

Lights & turn signals

Headlights

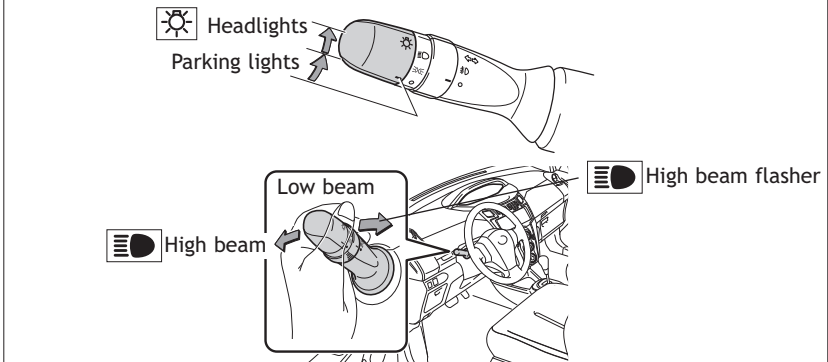

-Daytime Running Light system (DRL)(if equipped) Automatically turns on the headlights at a reduced intensity.

Turn signals

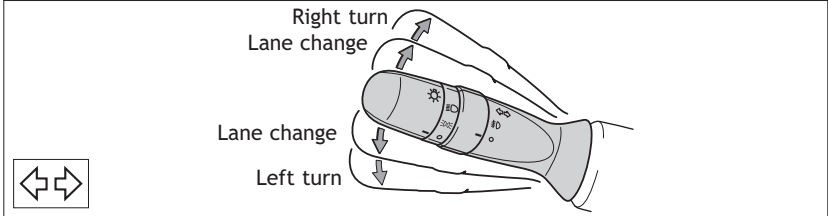

Front fog lights (if equipped)

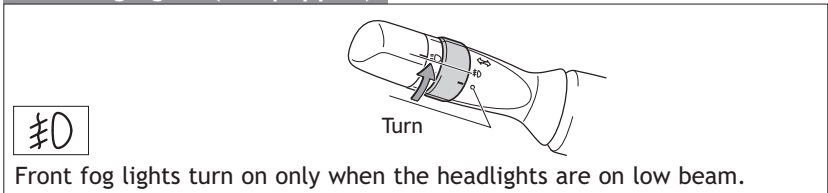

Seats-Head restraints

Front seats

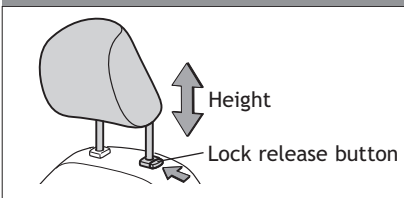

Rear seats (non-split seat)

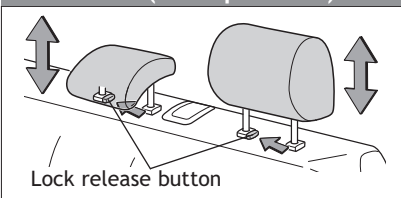

Rear seat (split seat - type A)



Rear seat (split seat - type B)

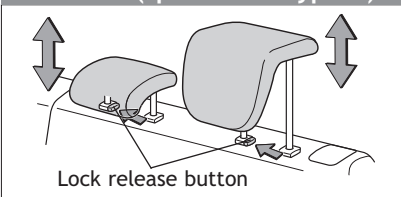

Windows-Power (if equipped)

Driver side

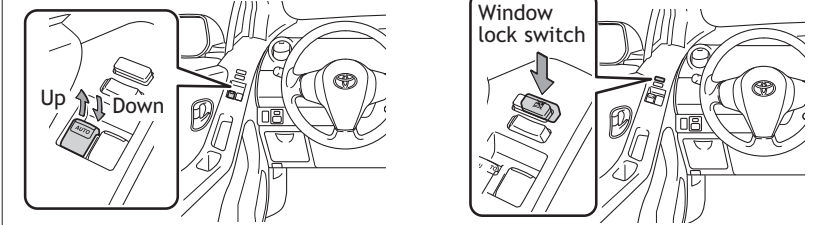

Window operation

Automatic operation (driver's window only) Push the switch completely down and release to fully open. To stop window midway, lightly pull the switch up.

Window lock switch Deactivates all passenger windows. Driver's window remains operable.

Door-Back

Open/Close

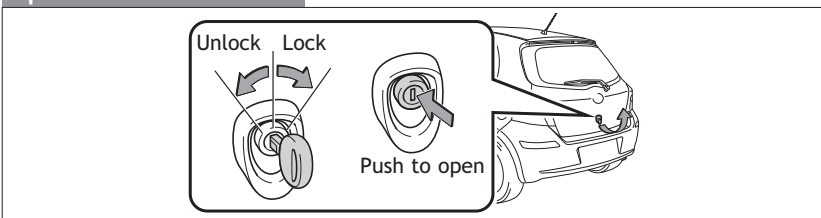

Air Conditioning (if equipped)/Heating

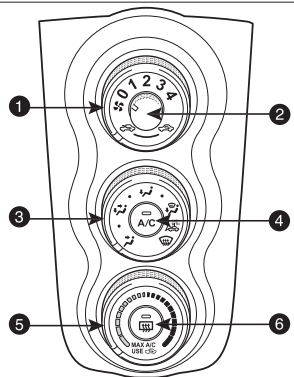

- ❶ Fresh or recirculated cabin air
- ❷ Fan speed
- ❸ Airflow vent
- ❹ In “” or “” mode, use fresh air to reduce window fogging.
- ❺ Air Conditioning ON/OFF (if equipped)
- ❻ Temperature selector
- ❼ Outside rear view mirror/Rear window defogger (if equipped)

Windshield wipers & washers

Front

*** Intermittent windshield wiper frequency adjustment (if equipped)**
 Rotate to increase/decrease wiper frequency.

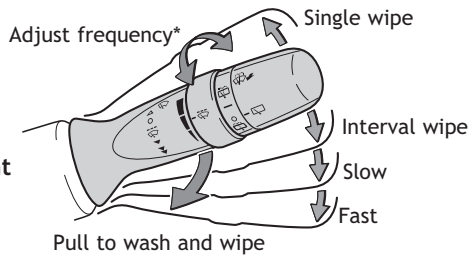

Rear

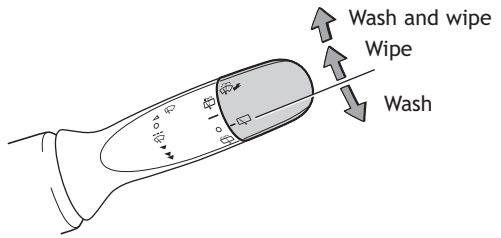

Cruise control (if equipped)

Turning system ON/OFF

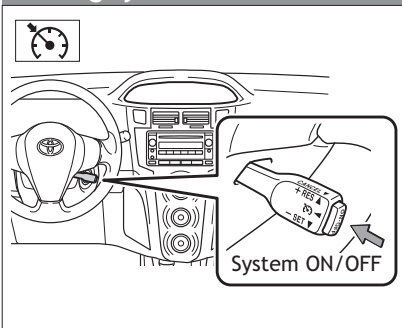

Functions

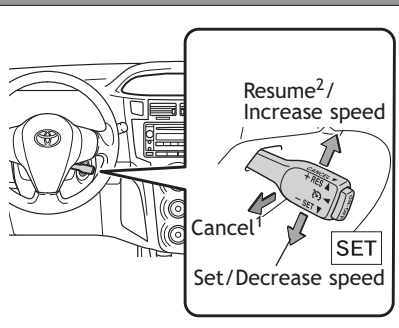

¹ The set speed may also be cancelled by depressing the brake pedal.

² Unless vehicle speed drops below 10 mph, the set speed may be resumed once vehicle exceeds 25 mph.

Refer to the *Owner's Manual* for more details.

Audio (if equipped)

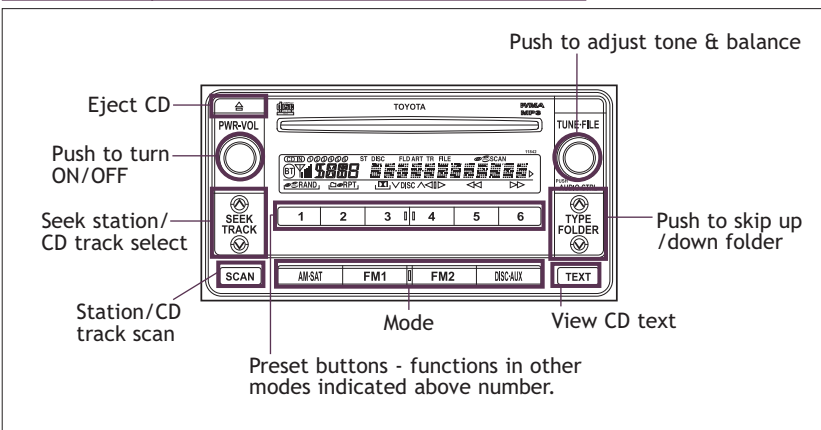

CD PLAYER

To scan tracks on a disc Push and hold "SCAN." Push again to hold selection.

RADIO

To preset stations Tune in the desired station and hold down a preset button (1-6) until you hear a beep. Push desired preset button (1-6) to select.

To scan stations Push "SCAN." Push and hold to scan preset stations. Push again to hold selection.

AUX audio jack (if equipped)

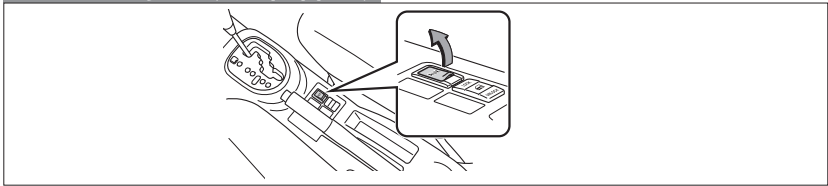

By inserting a mini plug of a commercially available component into the AUX audio jack, you can listen to music from a portable audio device through the vehicle's speaker system while in AUX mode.

Clock

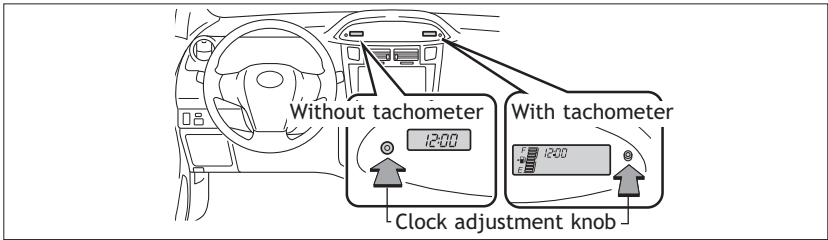

Press and hold clock reset button for adjustment mode. Press again to adjust minutes and hours, waiting 5 seconds after each.

Refer to the *Owner's Manual* for adjustment instructions.

Power outlet

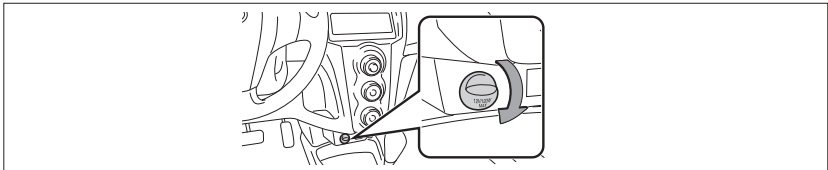

Designed for 12V car accessories. Key must be in the "ACC" or "ON" position to be used.

Luggage storage box

Open

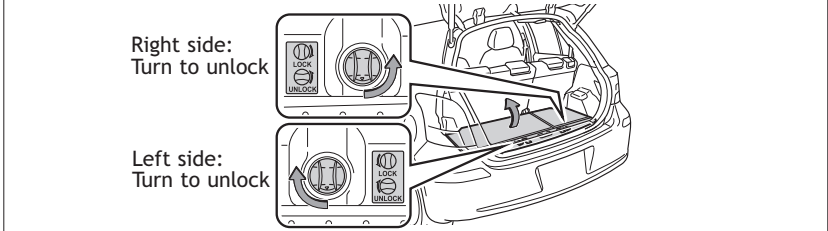

SAFETY AND EMERGENCY FEATURES

Door locks-Power (if equipped)

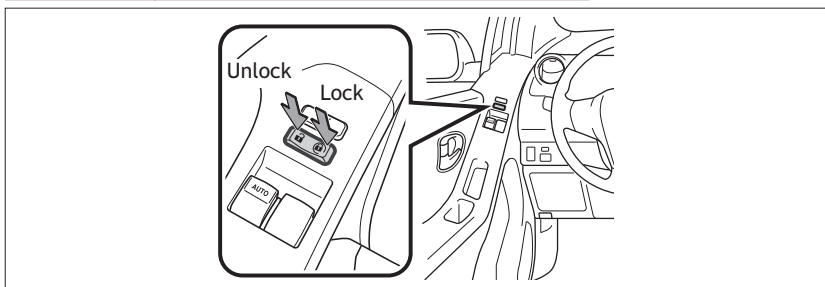

Seatbelts

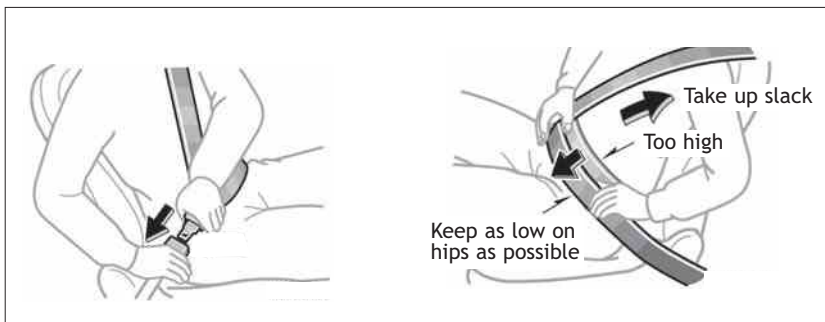

If belt is fully extended, then retracted even slightly, it cannot be re-extended beyond that point, unless fully retracted again. This feature is used to help hold child restraint systems securely.

To find more information about seatbelts, and how to install a child restraint system, refer to the *Owner's Manual*.

Tire Pressure Monitoring (warning) System

If tire pressure becomes critically low on any of the tires (excluding the spare), (⚠) indicator will illuminate. Correctly adjusting tire inflation will turn off the light after a few minutes. If the light does not turn off, have the system checked by your Toyota dealer.

Refer to the *Owner's Manual* for more details.

Abbreviation/Acronym list

ABBREVIATIONS	MEANING
ABS	Anti-Lock Brake System
ACC	Accessory
ALR	Automatic Locking Retractor
CRS	Child Restraint System
ECU	Electronic Control Unit
EDR	Event Data Recorder
ELR	Emergency Locking Retractor
EPS	Electric Power Steering
GAWR	Gross Axle Weight Ratings
GVWR	Gross Vehicle Weight Rating
I/M	Emission inspection and maintenance
LATCH	Lower Anchors and Tethers for Children
LED	Light Emitting Diode
LT	Light truck
M + S	Mud + Snow
MMT	Methylcy clopentadienyl Manganese Tricarbonyl
MTBE	Methyl Tertiary Butyl Ether
OBD	On Board Diagnostics
SRS	Supplemental Restraint System
TIN	Tire Identification Number
TPMS	Tire Pressure Warning System
TWI	Treadwear Indicators
VIN	Vehicle Identification Number

For your information

Main Owners Manual

Please note that this manual applies to all models explains and all equipment, including options. Therefore, you may find some explanations for equipment not installed on your vehicle.

All specifications provided in this manual are current at the time of printing. However, because of the Toyota policy of continual product improvement, we reserve the right to make changes at any time without notice.

Depending on specifications, the vehicle shown in the illustrations may differ from your vehicle in terms of equipment.

Accessories, spare parts and modification of your Toyota

A wide variety of non-genuine spare parts and accessories for Toyota vehicles are currently available in the market. You should know that Toyota does not warrant these products and is not responsible for their performance, repair, or replacement, or for any damage they may cause to, or adverse effect they may have on, your Toyota vehicle.

This vehicle should not be modified with non-genuine Toyota products. Modification with non-genuine Toyota products could affect its performance, safety or durability, and may even violate governmental regulations. In addition, damage or performance problems resulting from the modification may not be covered under warranty.

Installation of a mobile two-way radio system

As the installation of a mobile two-way radio system in your vehicle could affect electronic systems such as the multiport fuel injection system/sequential multiport fuel injection system, anti-lock brake system, SRS airbag system and seat belt pretensioner system, be sure to check with your Toyota dealer for precautionary measures or special instructions regarding installation.

Scrapping your Toyota

The SRS airbag and seat belt pretensioner devices in your Toyota contain explosive chemicals. If the vehicle is scrapped with the airbags and seat belt pretensioners left as they are, this may cause an accident such as fire. Be sure to have the systems of the SRS airbag and seat belt pretensioner removed and disposed of by a qualified service shop or by your Toyota dealer before you scrap your vehicle.

Perchlorate Material

Special handling may apply,
See www.dtsc.ca.gov/hazardouswaste/perchlorate.

Your vehicle has components that may contain perchlorate. These components may include airbag, seat belt pretensioners, and wireless remote control batteries.

 CAUTION

n General precautions while driving

Driving under the influence: Never drive your vehicle when under the influence of alcohol or drugs that have impaired your ability to operate your vehicle. Alcohol and certain drugs delay reaction time, impair judgment and reduce coordination, which could lead to an accident that could result in death or serious injury.

Defensive driving: Always drive defensively. Anticipate mistakes that other drivers or pedestrians might make and be ready to avoid accidents.

Driver distraction: Always give your full attention to driving. Anything that distracts the driver, such as adjusting controls, talking on a cellular phone or reading can result in a collision with resulting death or serious injury to you, your occupants or others.

n General precaution regarding children's safety

Never leave children unattended in the vehicle, and never allow children to have or use the key.

Children may be able to start the vehicle or shift the vehicle into neutral. There is also a danger that children may injure themselves by playing with the cigarette lighter, the windows, or other features of the vehicle. In addition, heat build-up or extremely cold temperatures inside the vehicle can be fatal to children.

Symbols used throughout this manual

Cautions & Notices

CAUTION

This is a warning against anything which may cause injury to people if the warning is ignored. You are informed about what you must or must not do in order to reduce the risk of injury to yourself and others.

NOTICE

This is a warning against anything which may cause damage to the vehicle or its equipment if the warning is ignored. You are informed about what you must or must not do in order to avoid or reduce the risk of damage to your Toyota and its equipment.

Symbols used in illustrations



Safety symbol

The symbol of a circle with a slash through it means “Do not”, “Do not do this”, or “Do not let this happen”.

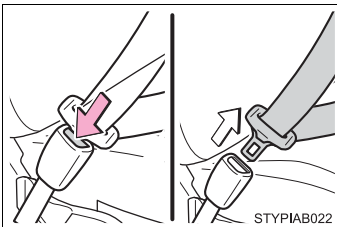

Arrows indicating operations



-  Indicates the action (pushing, turning, etc.) used to operate switches and other devices.
-  Indicates the outcome of an operation (e.g. a lid opens).

TABLE OF CONTENTS

1	Before driving	Adjusting and operating features such as door locks, mirrors, and steering column.
2	When driving	Driving, stopping and safe-driving information.
3	Interior features	Air conditioning and audio systems, as well as other interior features for a comfortable driving experience.
4	Maintenance and care	Cleaning and protecting your vehicle, performing do-it-yourself maintenance, and maintenance information.
5	When trouble arises	What to do if the vehicle needs to be towed, gets a flat tire, or is involved in an accident.
6	Vehicle specifications	Detailed vehicle information.
7	For owners	Reporting safety defects for U.S. owners and seat belt instructions for Canadian owners
	Index	Alphabetical listing of information contained in this manual.

► 3-door models



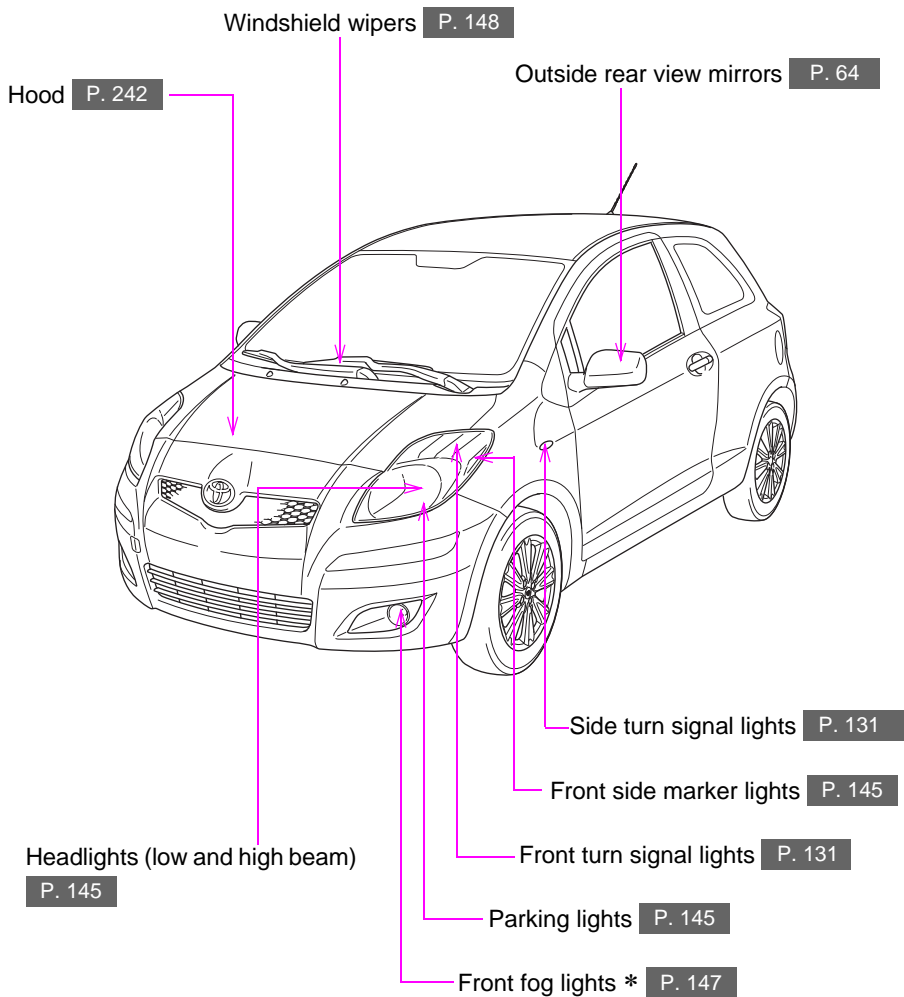
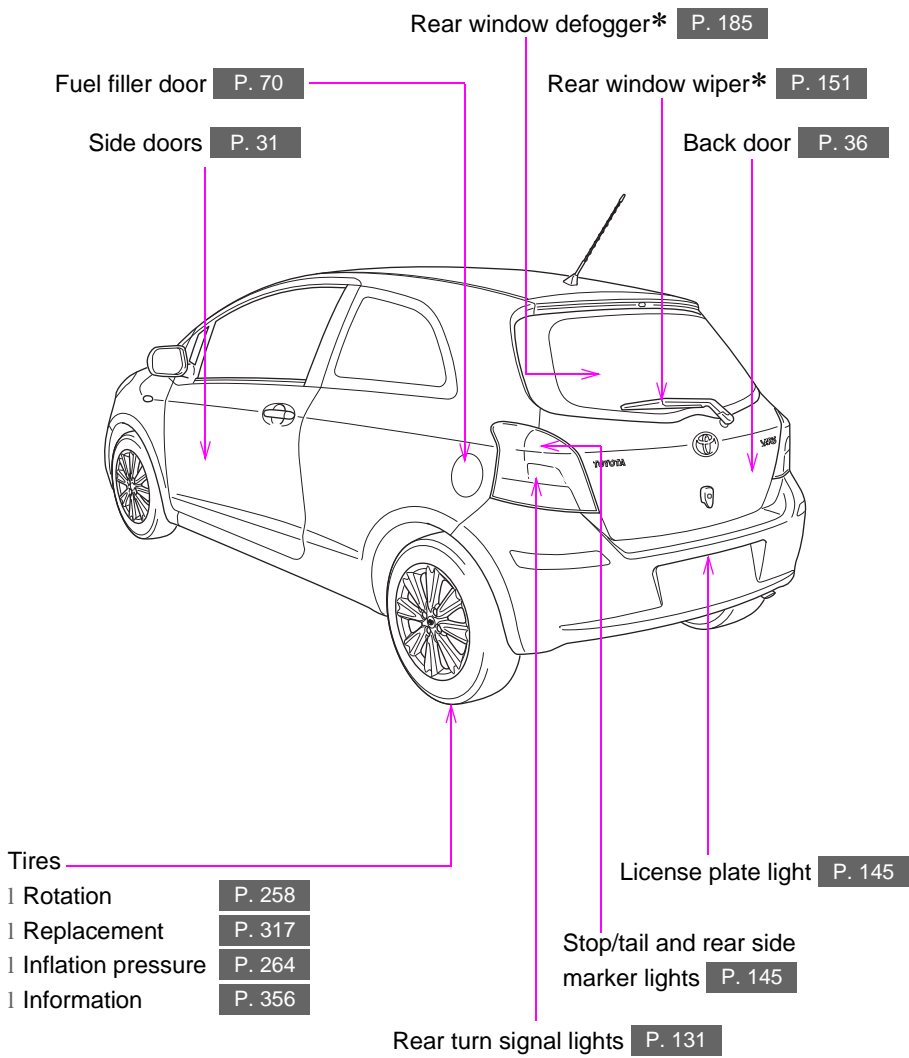

*: If equipped

► 5-door models

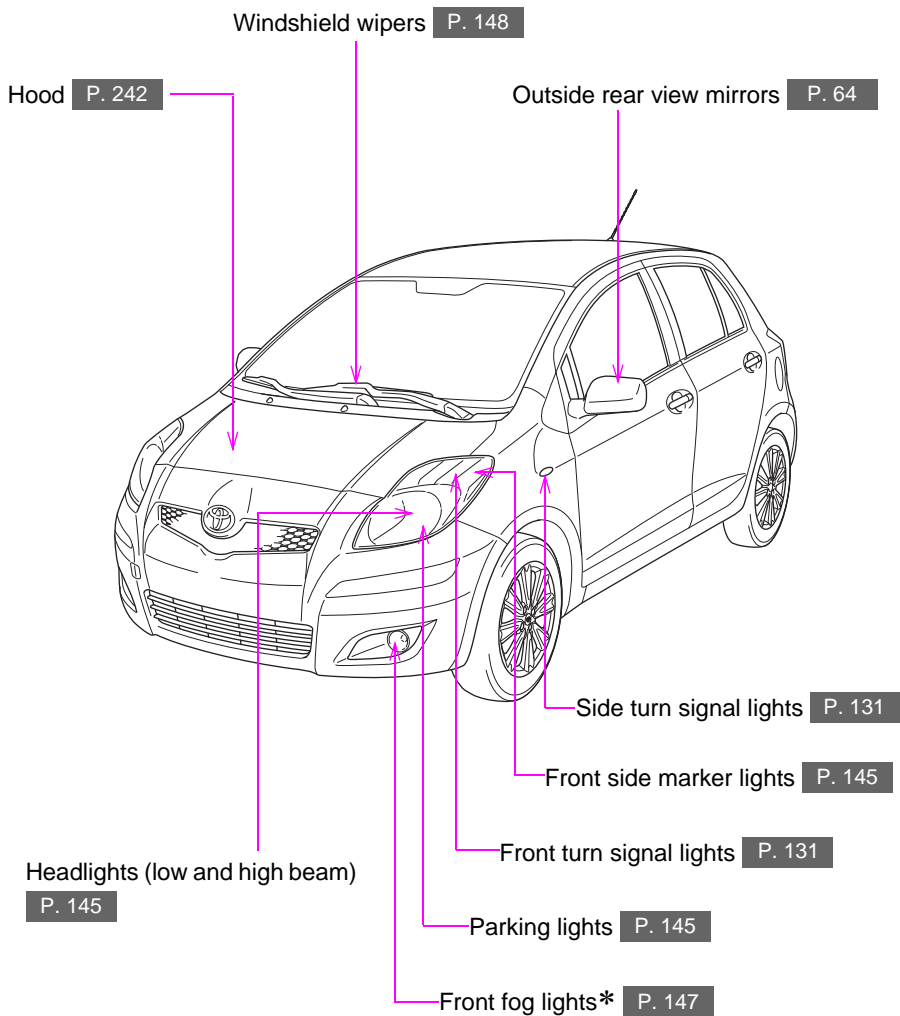

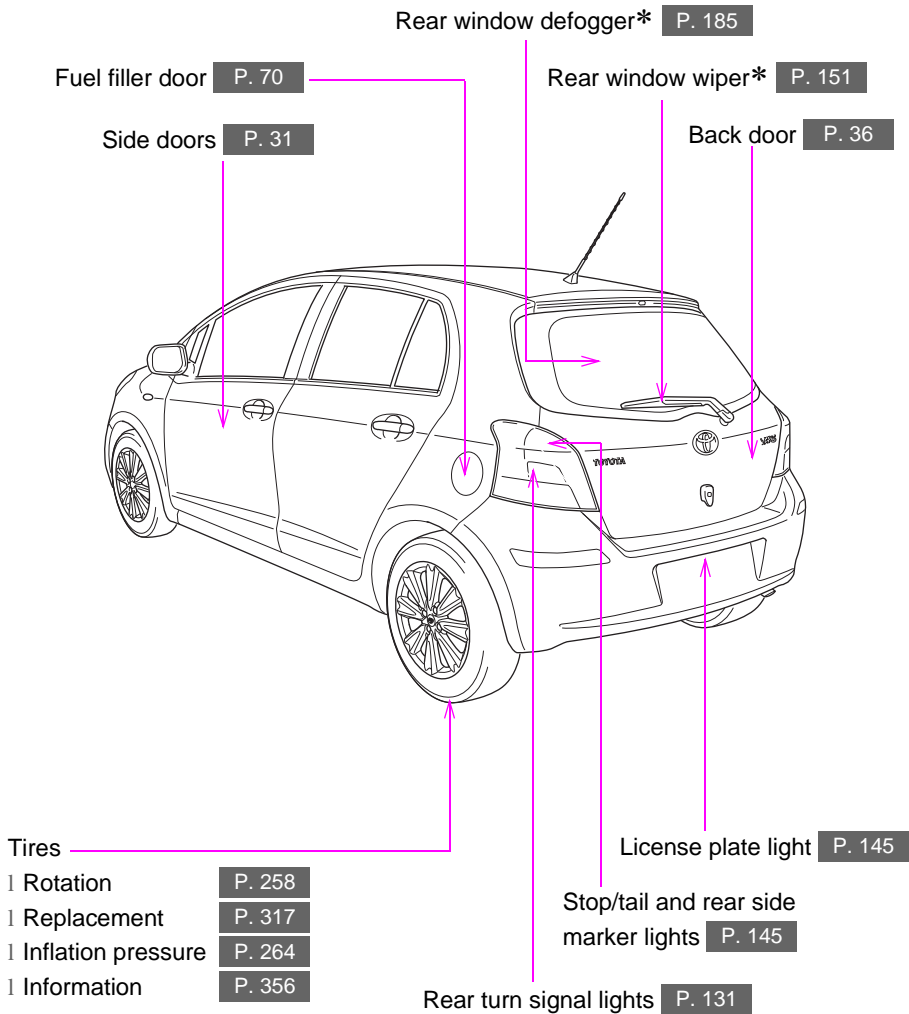

*: If equipped

► 3-door models

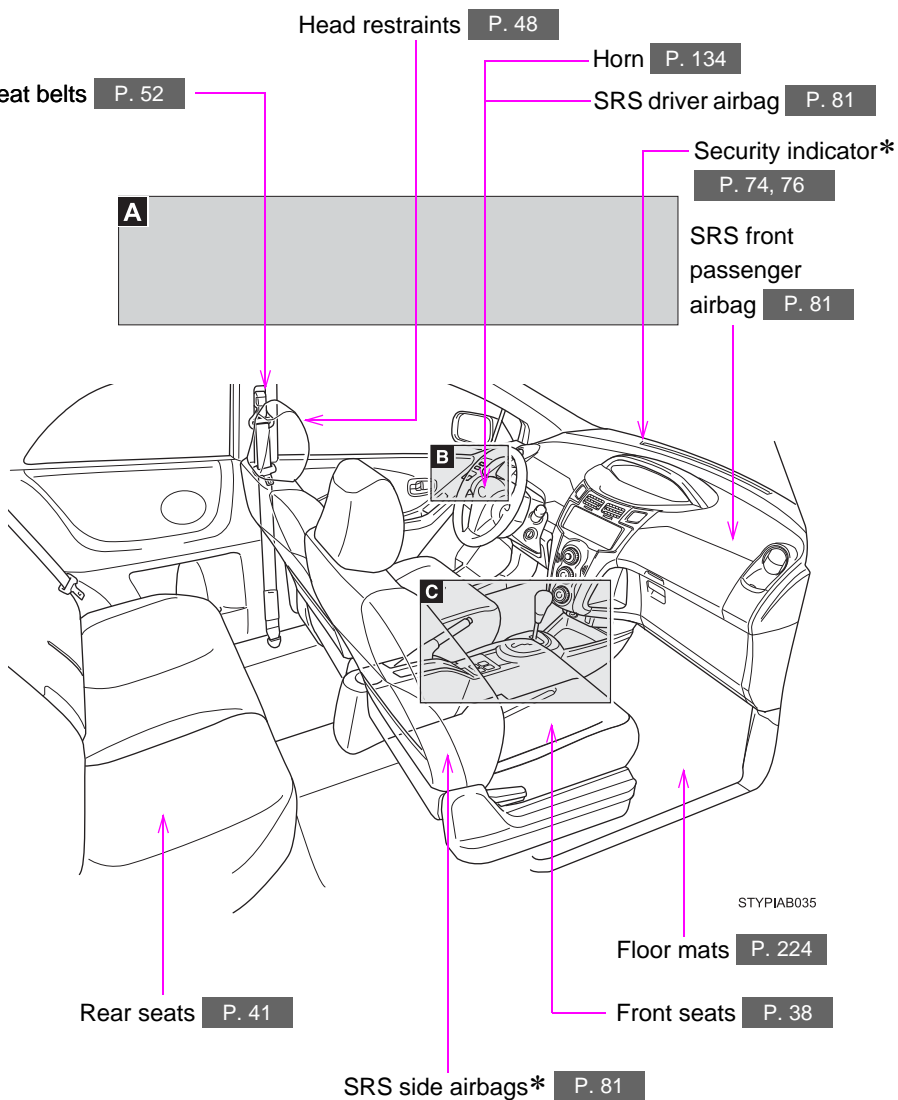

► 5-door models

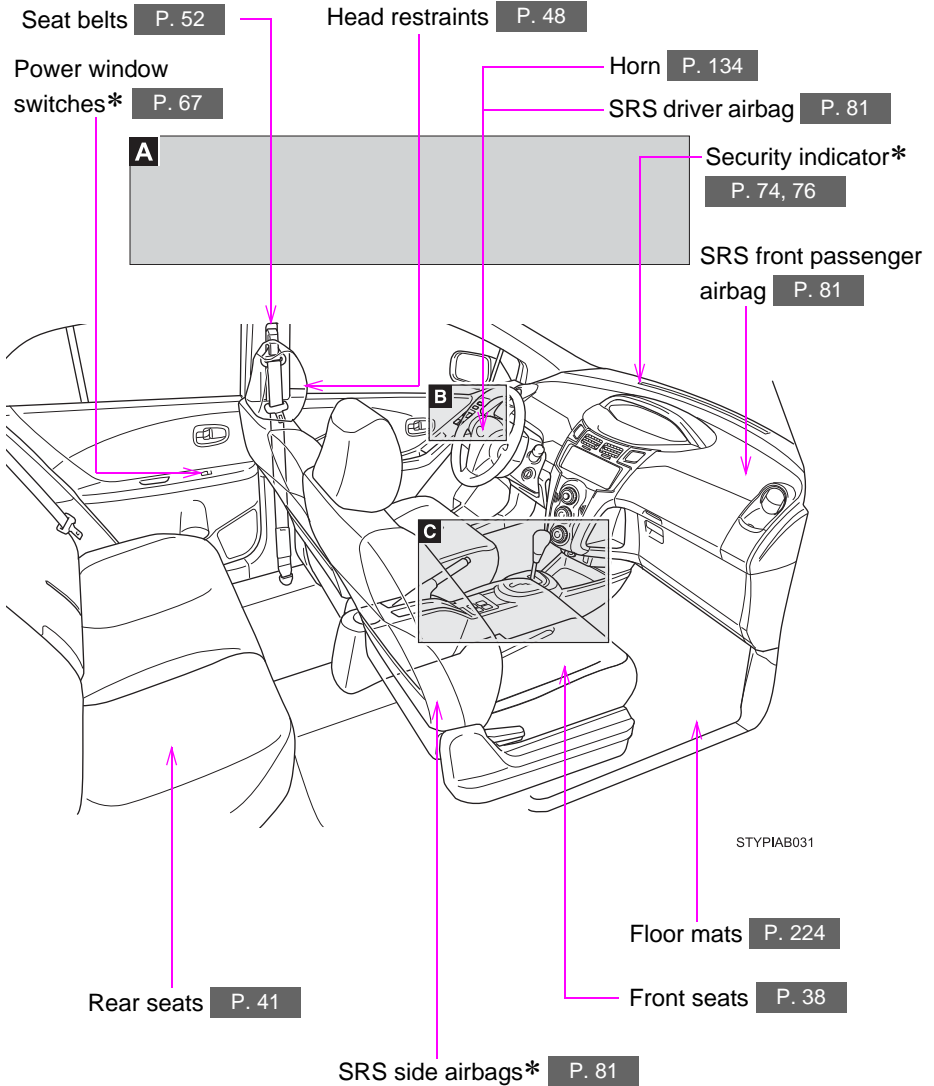

*: If equipped

A

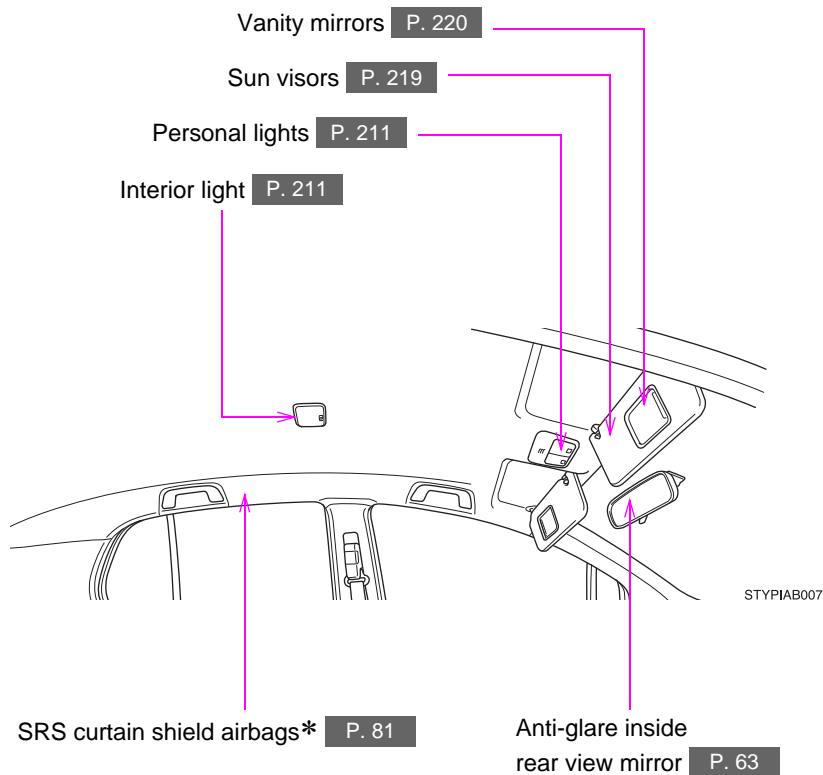

C

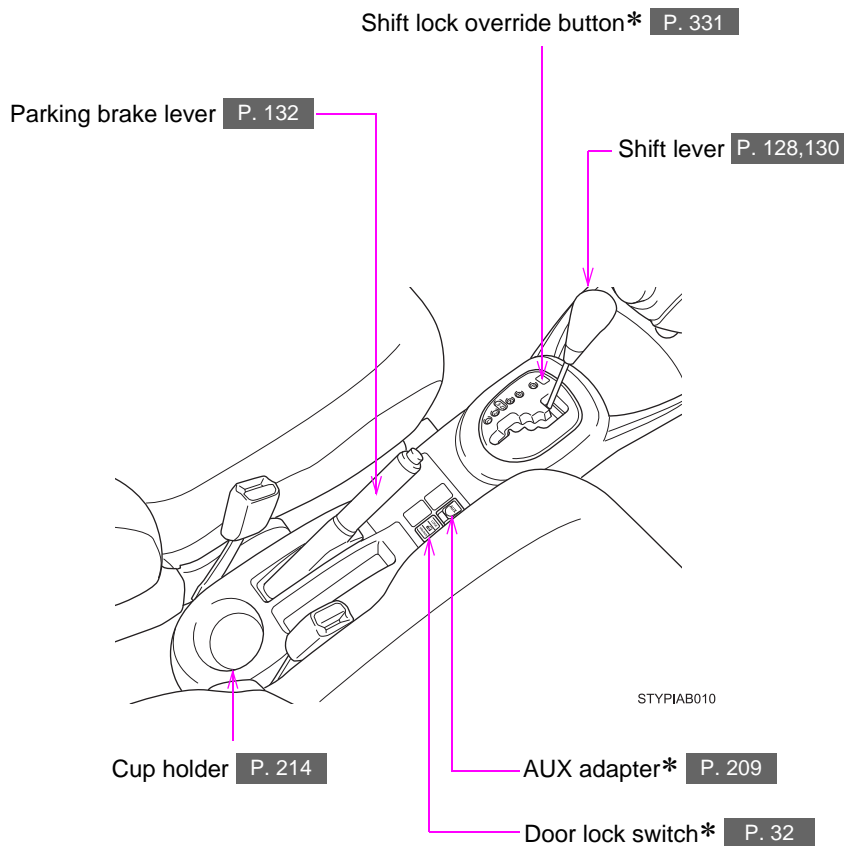

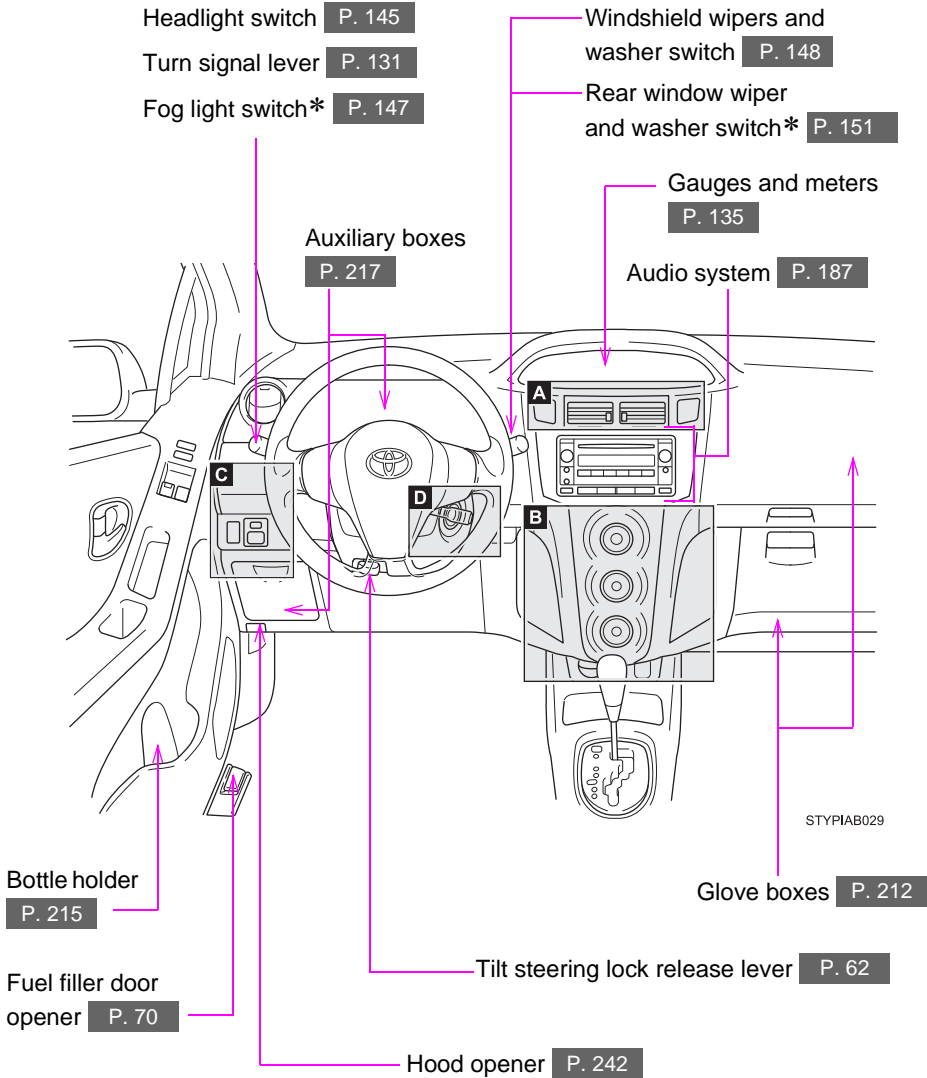

*: If equipped

A

Emergency flasher switch **P. 296**

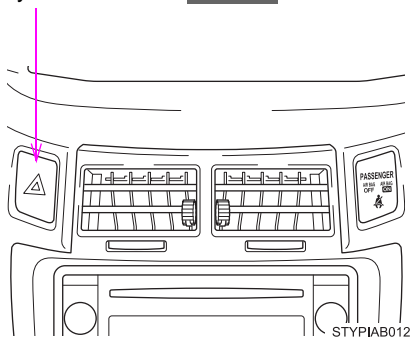

B

Air conditioning system P. 178

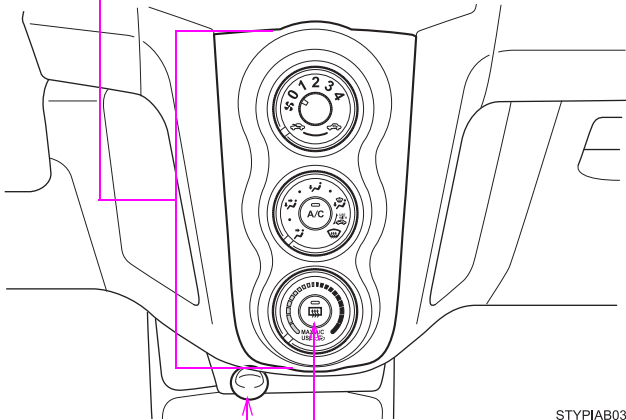

STYPIAB036

Rear window defogger switch*/rear window defogger and outside rear view mirror defogger switch* P. 185

Power outlet P. 223

*: If equipped

C

Cup holders **P. 214**

Outside rear view mirror switches* **P. 64**

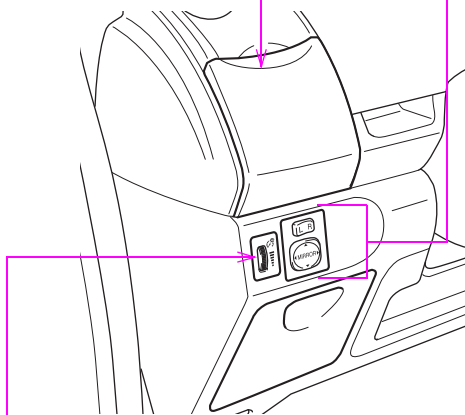

Instrument panel light control dial **P. 139**

STYPIAB014

D

Cruise control switch* **P. 152**

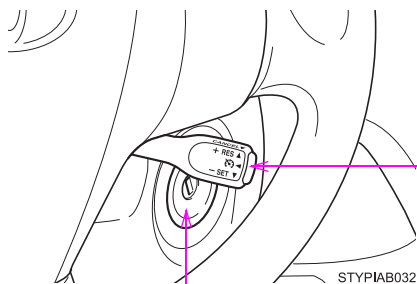

STYPIAB032

Engine (ignition) switch **P. 125**

*: If equipped



Keys

The following keys are provided with the vehicle.

► Vehicles without engine immobilizer system

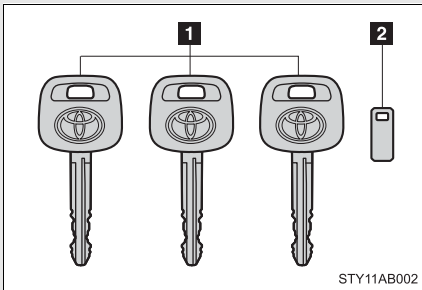

- 1** Master keys
- 2** Key number plate

► Vehicles with engine immobilizer system (type A)

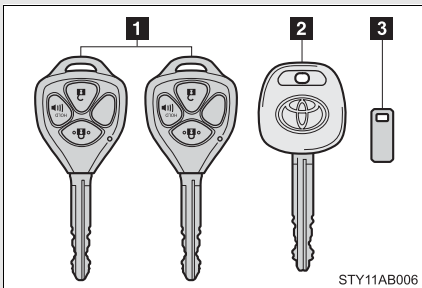

- 1** Master keys (with wireless remote control function)

Operating the wireless remote control function (→P. 28)

- 2** Valet key
- 3** Key number plate

► Vehicles with engine immobilizer system (type B)

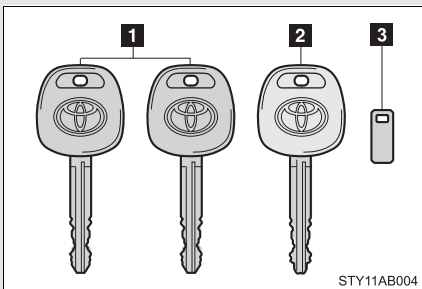

- 1** Master keys
- 2** Valet key
- 3** Key number plate

n Key number plate

Keep the plate in a safe place such as your wallet, not in the vehicle. In the event that a key is lost, a new key can be made by your Toyota dealer using the key number plate. (→P. 332)

**NOTICE****n To prevent key damage (vehicles with engine immobilizer system)**

- I** Do not subject the keys to strong shocks, expose them to high temperatures by placing them in direct sunlight, or get them wet.
- I** Do not expose the keys to electromagnetic materials or attach any material that blocks electromagnetic waves to the key surface.

1-2. Opening, closing and locking the doors

Wireless remote control (if equipped)

The wireless remote control can be used to lock/unlock the vehicle from outside the vehicle.

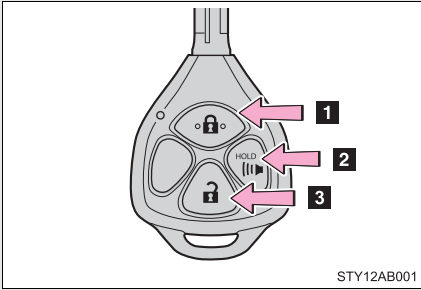

- 1 Locks all doors
- 2 Sounds alarm (push and hold)
- 3 Unlocks all doors

Pressing the button unlocks the driver's door. Pressing the button again within 3 seconds unlocks the other doors.

▮ Operation signals

The emergency flashers flash to indicate that the doors have been locked/unlocked. (Locked: Once; Unlocked: Twice)

▮ Panic mode

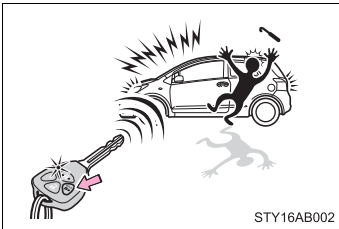

When **HOLD** is pushed for longer than about one second, an alarm will sound for about 60 seconds and the vehicle lights will flash to deter any person from trying to break into or damage your vehicle.

To stop the alarm, push any button on the wireless remote control.

▮ Key battery depletion

The standard battery life is 1 to 2 years. (The battery becomes depleted even if the key is not used.) If the wireless remote control function does not operate, the battery may be depleted. Replace the battery when necessary. (→P. 273)

▮ Security feature

If a door is not opened within approximately 30 seconds after the vehicle is unlocked, the security feature automatically locks the vehicle again.

n **Conditions affecting operation**

The wireless remote control function may not operate normally in the following situations.

- l Near a TV tower, radio station, electric power plant, airport, gas station or other facility that generates strong radio waves
- l When carrying a portable radio, cellular phone or other wireless communication device
- l When multiple wireless keys are in the vicinity
- l When the wireless key has come into contact with, or is covered by a metallic object
- l When a wireless key (that emits radio waves) is being used nearby
- l When the wireless key has been left near an electrical appliance such as a personal computer

n **When riding in an aircraft**

When bringing an wireless key onto an aircraft, make sure you do not press any buttons on the wireless key while inside the aircraft cabin. If you are carrying an wireless key in your bag etc., ensure that the buttons are not likely to be pressed accidentally. Pressing a button may cause the wireless key to emit radio waves that could interfere with the operation of the aircraft.

n **Customization that can be configured at Toyota dealer**

Settings (e.g. wireless remote control system) can be changed.
(Customizable features →P. 369)

▮ **Certification for wireless remote control**

► For vehicles sold in U.S.A.

FCC ID:MOZB41TG

FCC ID:MOZB21RG

NOTE:

This device complies with Part 15 of the FCC Rules. Operation is subject to the following two conditions: (1) This device may not cause harmful interference, and (2) this device must accept any interference received, including interference that may cause undesired operation.

FCC WARNING:

Changes or modifications not expressly approved by the party responsible for compliance could void the user's authority to operate the equipment.

► For vehicles sold in Canada

NOTE:

This device complies with RSS-210 of Industry Canada.

Operation is subject to the following two conditions: (1) This device may not cause interference, and (2) this device must accept any interference, including interference that may cause undesired operation of the device.

1-2. Opening, closing and locking the doors

Side doors

The vehicle can be locked and unlocked using the wireless remote control, key or door lock switch.

n **Wireless remote control (if equipped)**

→P. 28

n **Key**

► Vehicles with power door lock

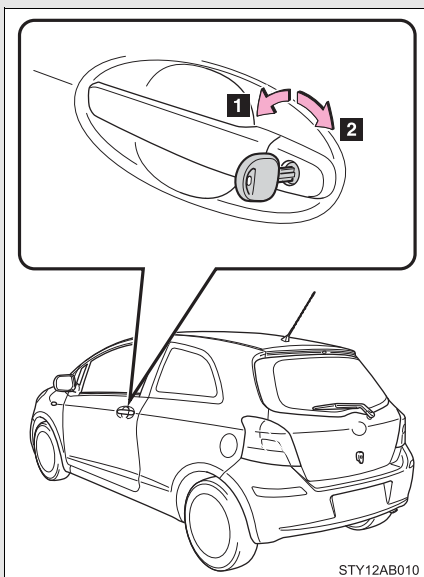

1 Locks all doors

2 Unlocks all doors

Turning the key a single time in the driver's door unlocks the driver's door, and turning the key again unlocks the other doors.

1-2. Opening, closing and locking the doors

► Vehicles without power door lock

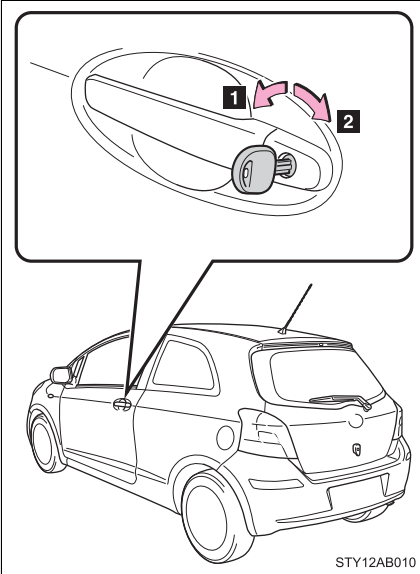

- 1** Locks the door
- 2** Unlocks the door

n Door lock switch (if equipped)

► For driver's use

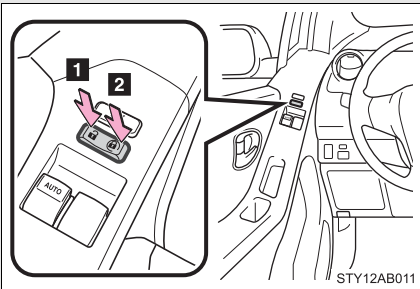

- 1** Unlocks all doors
- 2** Locks all doors

► For front passenger's use

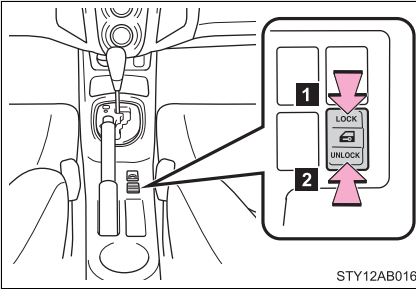

- 1** Locks all doors
- 2** Unlocks all doors

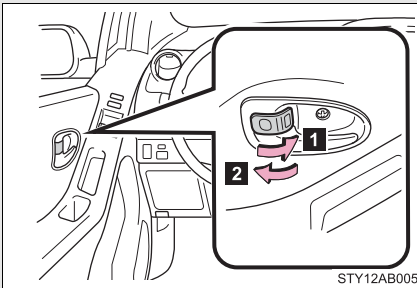
n **Inside door lock button**

- 1** Locks the door
- 2** Unlocks the door

Pulling the inside handle can open the front door even if the lock button is in the lock position.

Locking the front doors from the outside without a key

STEP 1 Move the inside door lock button to the lock position.

STEP 2 Close the door.

► Vehicles with power door lock

The door cannot be locked if the driver's door is open and the key is in the engine switch.

Rear door child-protector lock (5-door models only)

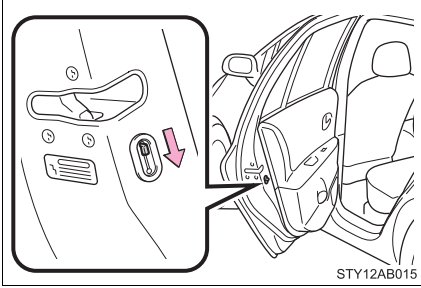

The door cannot be opened from inside the vehicle when the locks are set.

These locks can be set to prevent children from opening the rear doors. Push down on each rear door switch to lock both rear doors.

■ **Key reminder buzzer**

A buzzer sounds if the driver's door is opened, while the engine switch is in the ACC or LOCK position to remind you to remove the key.

■ **Customization that can be configured at Toyota dealer**

Settings (e.g. unlocking function using a key) can be changed.
(Customizable features →P. 369)

 **CAUTION****n To prevent an accident**

Observe the following precautions while driving the vehicle.

Failing to do so may result in a door opening and an occupant falling out, resulting in death or serious injury.

- I Always use a seat belt.
- I Always lock all doors.
- I Ensure that all doors are properly closed.
- I Do not pull the inside handle of the doors while driving.
The doors may be opened and the passengers are thrown out of the vehicle and it may result in serious injury or death.
- I Be especially careful for the front doors, the doors may be opened even if the inside lock buttons are in locked position.
- I Set the rear door child protector locks when children are seated in the rear seat.

1-2. Opening, closing and locking the doors

Back door

The back door can be opened using the back door opener. The back door can be locked/unlocked using a key, wireless remote control or door lock switch.

n Back door opener

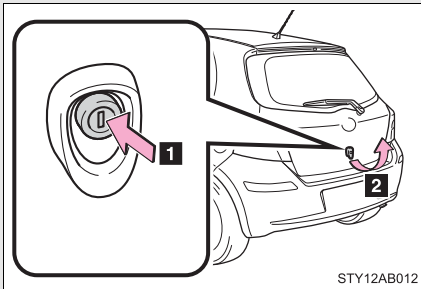

1 Push

2 Raise

n Wireless remote control (if equipped)

→P. 28

n Key

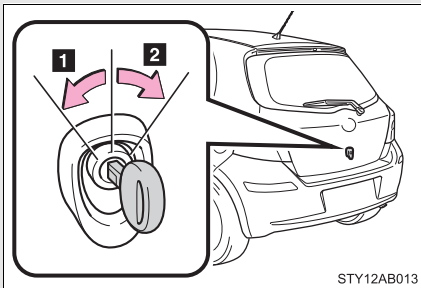

1 Unlocks the back door

2 Locks the back door

n Door lock switches (if equipped)

→P. 32

n When closing the back door

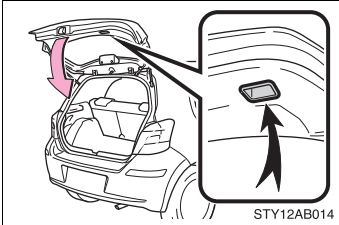

Lower the back door using the back door handle, and make sure to push the back door down from the outside to close it.

1

Before driving

⚠ CAUTION

n Caution while driving

Keep the back door closed.

This not only keeps personal belongings from being thrown out, but also prevents exhaust gases from entering the vehicle.

n To avoid accident or injury

Push the back door to shut from the outside. Do not use only the back door handle to close the back door.

Front seats

► Driver's seat

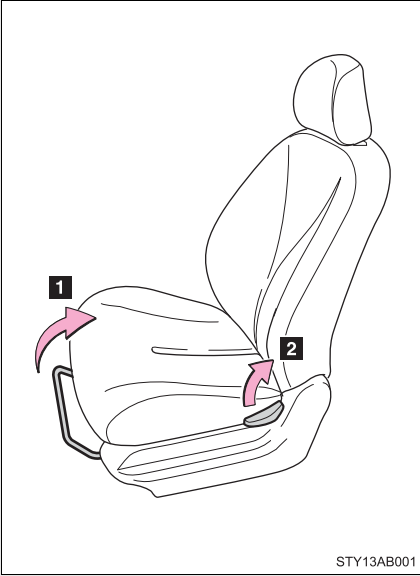

1 Seat position adjustment lever

2 Seatback angle adjustment lever

► Front passenger's seat

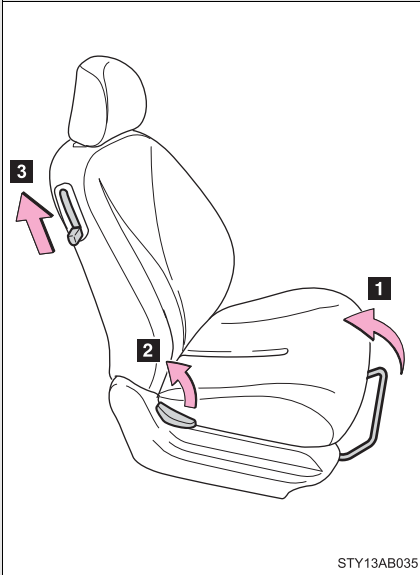

- 1** Seat position adjustment lever
- 2** Seatback angle adjustment lever
- 3** Seatback lock release lever (3-door models only)

1

Before driving

n **Moving the front passenger's seat (3-door models only)**

For easy access to the rear seat.

STEP 1 Lift up the seatback lock release lever.

The seat will slide forward.

STEP 2 Move the seat to the front-most position.

After rear passengers are in, lift up the seatback and return the seat until it locks.

 **CAUTION**

n Seat adjustment

I Do not recline the seat more than necessary when the vehicle is in motion to reduce the risk of sliding under the lap belt.

If the seat is too reclined, the lap belt may slide past the hips and apply restraint forces directly to the abdomen or your neck may contact the shoulder belt, increasing the risk of death or serious injury in the event of an accident.

I After adjusting the seat, make sure that the seat is locked in position.

n After returning the seatback

Push and pull the seatback to confirm that it is securely locked.

n Caution while driving

Never operate the seatback lock release lever.

1-3. Adjustable components (seats, mirrors, steering wheel)

Rear seats

► Split rear seats (type A)

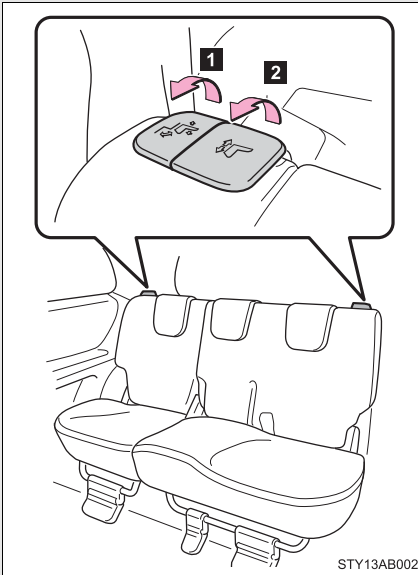

- 1** Seatback angle adjustment lever
- 2** Seat position adjustment lever

► Split rear seats (type B)



- 1** Seatback angle adjustment lever

► Non-split rear seat

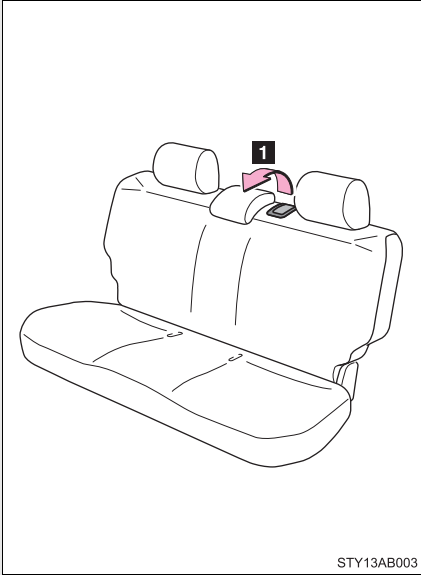

1 Seatback angle adjustment lever

Folding down rear seatbacks

n Before folding down rear seatbacks

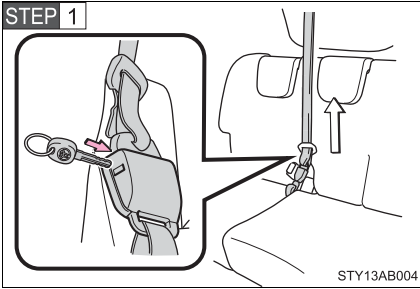

Insert the key into the hole on the center seat belt buckle to release tab (with hooked end), and allow the belt to retract.

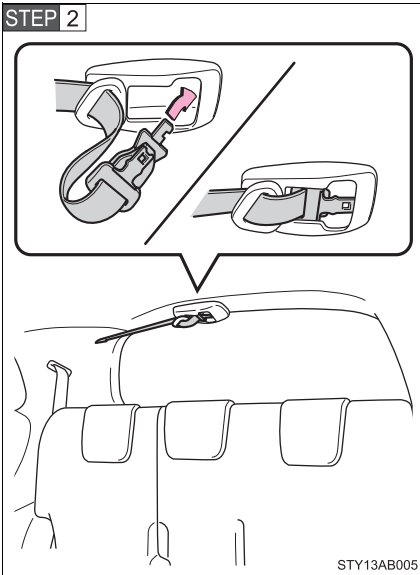

Stow the seat belt tabs in the cover set in the roof as shown.

1

Before driving

1-3. Adjustable components (seats, mirrors, steering wheel)

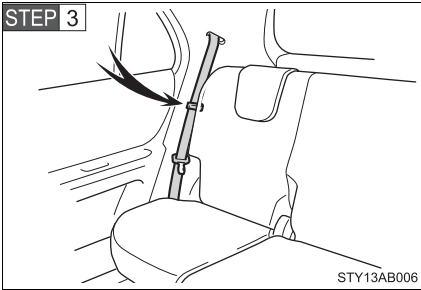

Use the seat belt hangers to prevent the belts from being tangled.

n Folding down rear seatbacks (split rear seats: type A)

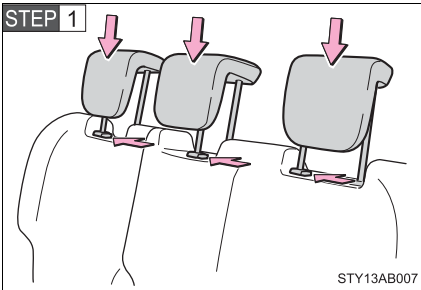

Lower the head restraints to the lowest position.

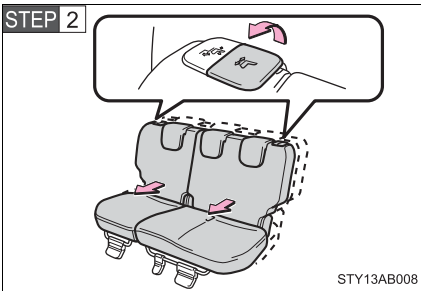

Pull the seat position adjustment lever up. Then slide the rear seat fully forward.

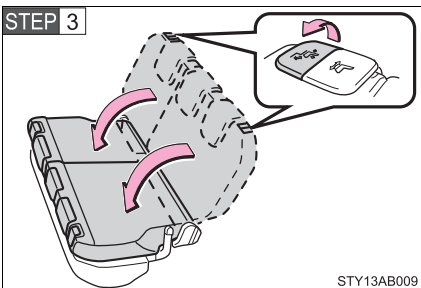

Pull the seatback angle adjustment lever up and fold the seatback down.

Each seatback may be folded separately.

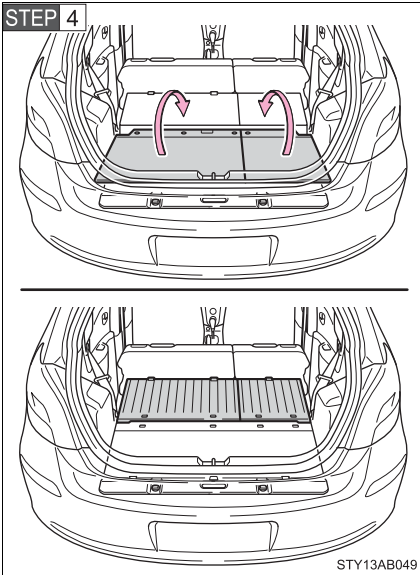

Flip over the deck board.

n Folding down rear seatbacks (split rear seats: type B)

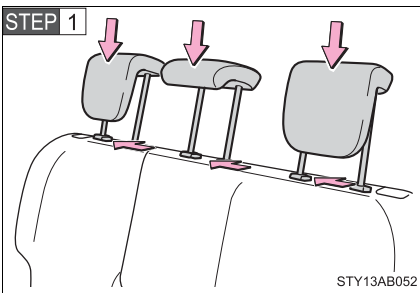

Lower the head restraints to the lowest position.

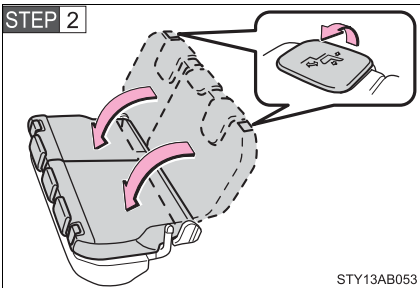

Pull the seatback angle adjustment lever up and fold the seatback down.

n Folding down rear seatback (non-split rear seat)

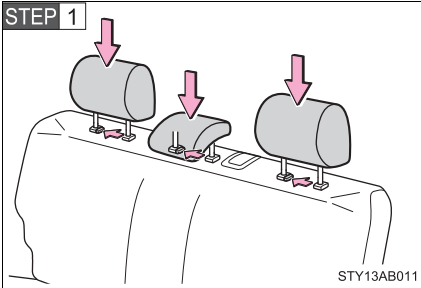

Lower the head restraints to the lowest position.

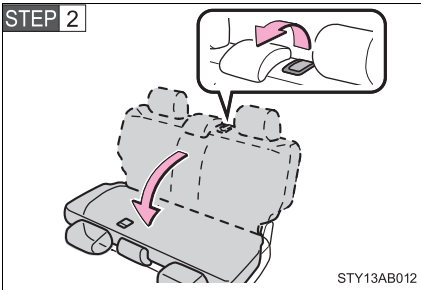

Pull the seatback angle adjustment lever up and fold the seatback down.

 CAUTION

n Seat adjustment

- I** Do not recline the seat more than necessary when the vehicle is in motion to reduce the risk of sliding under the lap belt. If the seat is too reclined, the lap belt may slide past the hips and apply restraint forces directly to the abdomen or your neck may contact the shoulder belt, increasing the risk of death or serious injury in the event of an accident.
- I** After adjusting the seat, make sure that the seat is locked in position.

n After returning the seatback to the upright position

Observe the following precautions. Failure to do so may result in death or serious injury.

- I** Make sure that the seatback is securely locked in position by lightly rocking it back and forth.
- I** Check that the seat belts and buckles are not twisted or caught under the seat.
- I** Arrange the seat belts in the proper positions for ready use.

 NOTICE

n Stowing the seat belts

The seat belts and the buckles must be stowed before you fold down the rear seat backs.

n When returning the seatback to the upright position

Do not pull the pocket that stores the seat belt comfort guide.

1-3. Adjustable components (seats, mirrors, steering wheel)

Head restraints

► Front seats

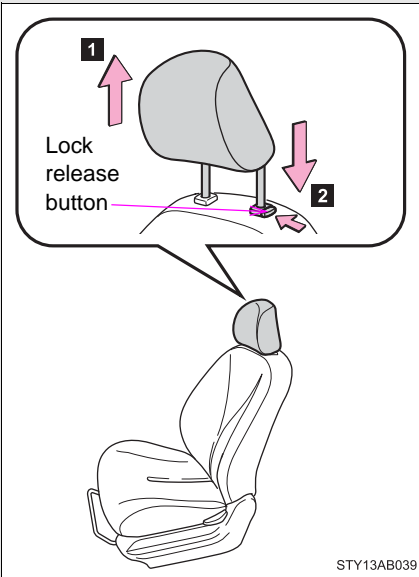

Vertical adjustment

1 Up

Pull the head restraints up.

2 Down

Push the head restraints down while pushing the lock release button.

► Rear seats (split rear seats: type A)

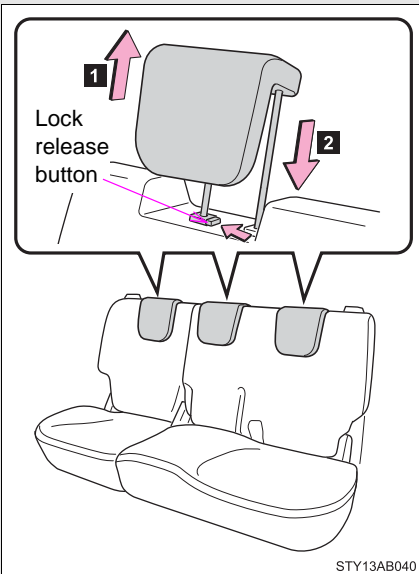

Vertical adjustment

1 Up

Pull the head restraints up.

2 Down

Push the head restraints down while pushing the lock release button.

► Rear seats (split rear seats: type B)

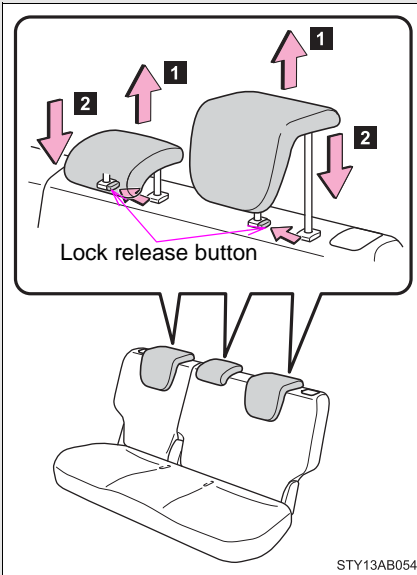

Vertical adjustment

1 Up

Pull the head restraints up.

2 Down

Push the head restraints down while pushing the lock release button.

► Rear seats (non-split rear seat)

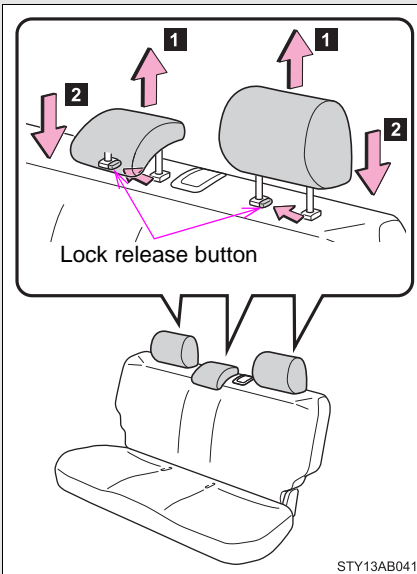

Vertical adjustment

1 Up

Pull the head restraints up.

2 Down

Push the head restraints down while pushing the lock release button.

■ Removing the head restraints

► Front seats

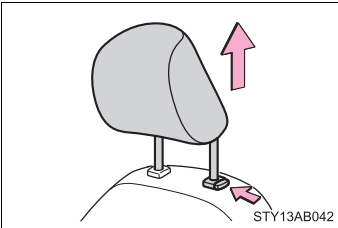

Pull the head restraint up while pushing the lock release button.

► Rear seats (split rear seats: type A)

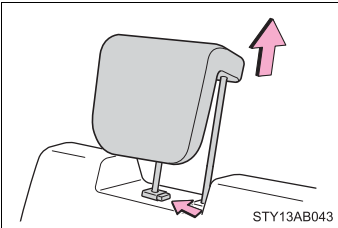

Pull the head restraint up while pushing the lock release button.

► Rear seats (split rear seats: type B)

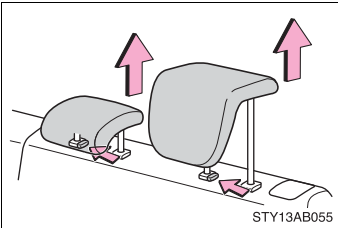

Pull the head restraint up while pushing the lock release button.

► Rear seats (non-split rear seat)

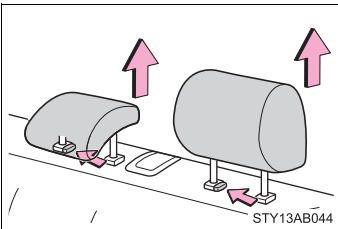

Pull the head restraint up while pushing the lock release button.

n **Adjusting the height of the head restraints**

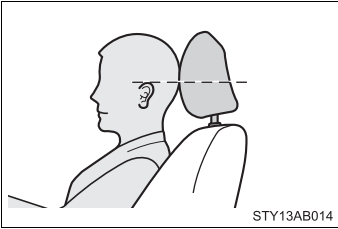

Make sure that the head restraints are adjusted so that the center of the head restraint is closest to the top of your ears.

n **Adjusting the rear seat head restraints**

Always raise the head restraint one level from the stowed position when using.

⚠ CAUTION

n **Head restraint precautions**

Observe the following precautions regarding the head restraints. Failure to do so may result in death or serious injury.

- l Use the head restraints designed for each respective seat.
- l Adjust the head restraints to the correct position at all times.
- l Do not drive with the head restraints removed.

Seat belts

Make sure that all occupants are wearing their seat belts before driving the vehicle.

n Correct use of the seat belts

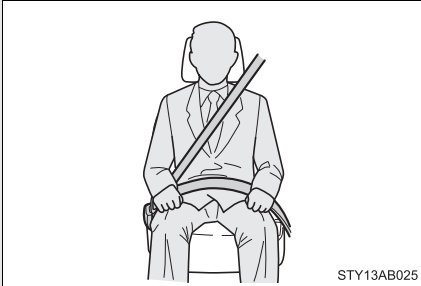

- 1 Extend the shoulder belt so that it comes fully over the shoulder, but does not come into contact with the neck or slide off the shoulder.
- 1 Position the lap belt as low as possible over the hips.
- 1 Adjust the position of the seatback. Sit up straight and well back in the seat.
- 1 Do not twist the seat belt.

n Fastening and releasing the seat belt

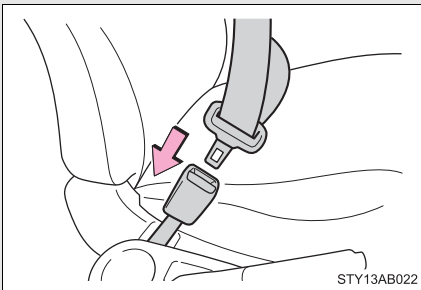

Fastening the belt

Push the tab into the buckle until a clicking sound is heard.

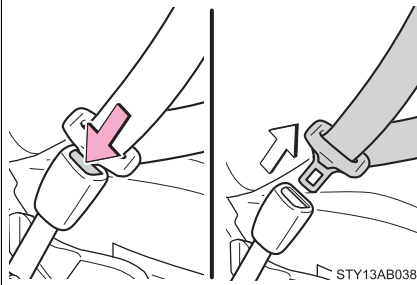

Releasing the belt

Press the release button.

n Adjusting the height of the front seat belt (5-door models only)

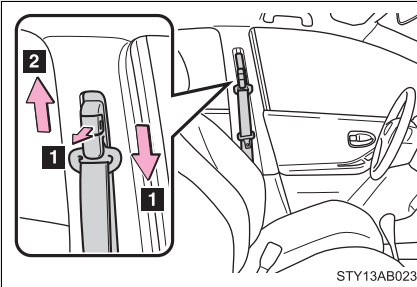

1 Down

Pull the lock release knob and slide the height adjuster down.

2 Up

Move the height adjuster up as needed until you hear a click.

Rear center seat belt

The rear center seat belt is a 3-point type restraint with 2 buckles. Both seat belt buckles must be correctly located and securely latched for proper operation.

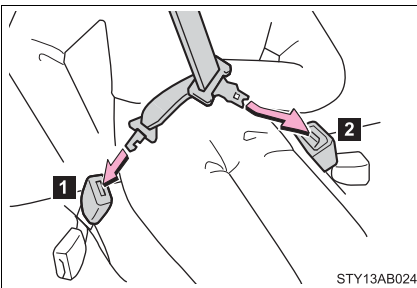

Make sure that the buckle **1** is securely latched for ready use of the center seat belt.

1 Matches the tab with the hooked end

2 Matches the tab with the concave end

n Release method

The belt can be completely released when not required, such as when folding down the rear seat.

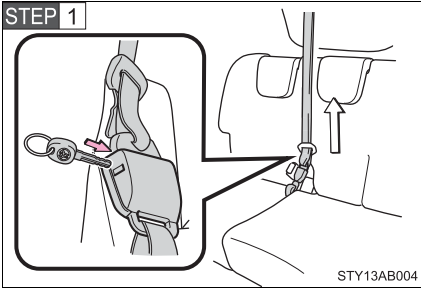

To release the hooked end tab, insert the vehicle's key into the hole on the buckle.

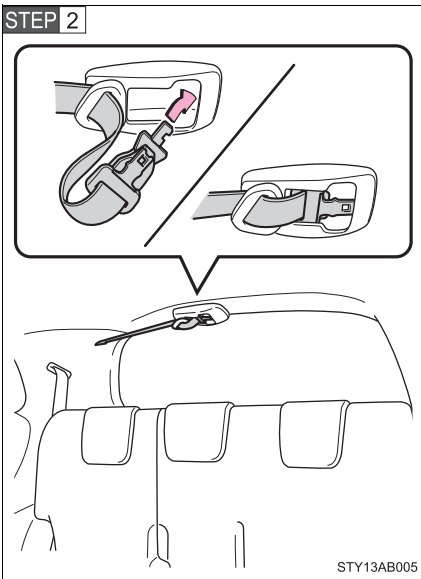

Stow the seat belt tabs in the cover set in the roof as shown.

n Extracting the belt

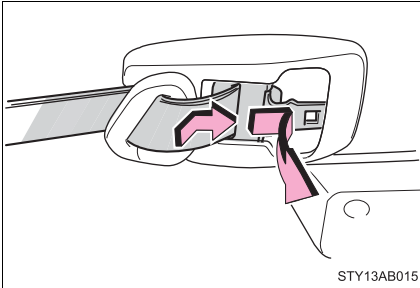

Push the tab and then pull the tabs out from the cover.

1

Before driving

Seat belt comfort guide (rear center seat)

If the shoulder belt sits close to a person's neck, use the seat belt comfort guide.

► Split rear seats

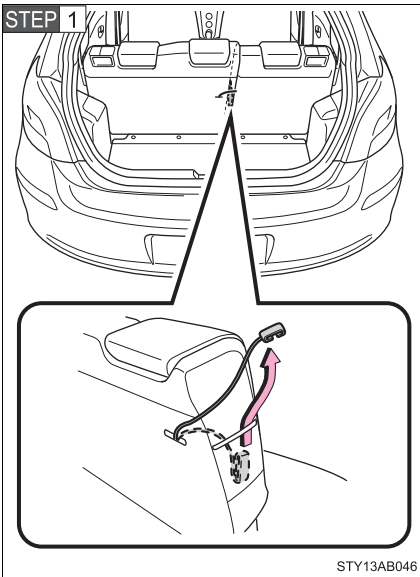

Pull the comfort guide.

► Non-split rear seat

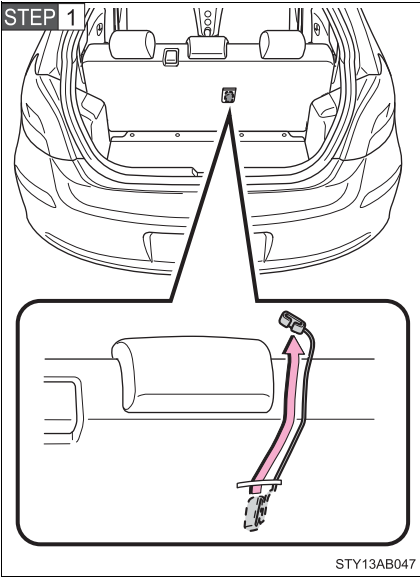

Pull the comfort guide.

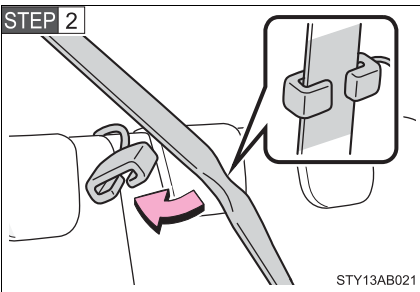

Slide the belt past the slot of the guide.

The elastic cord must be behind the seat belt.

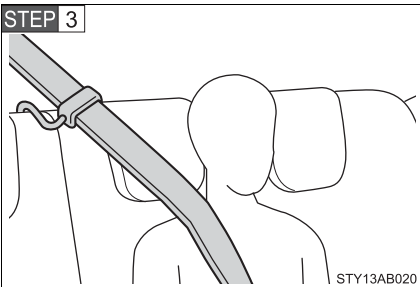

Buckle, position and release the seat belt.

Seat belt pretensioners (front seats)

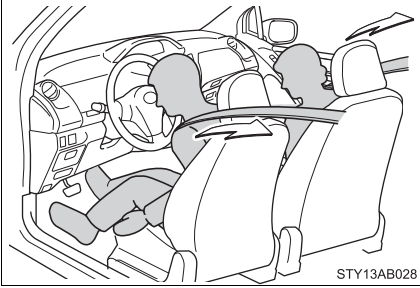

The pretensioner helps the seat belt to quickly restrain the occupant by retracting the seat belt when the vehicle is subjected to certain types of severe frontal collision.

The pretensioner may not activate in the event of a minor frontal impact, a side impact or a rear impact.

1

Before driving

n **Emergency locking retractor (ELR)**

The retractor will lock the belt during a sudden stop or on impact. It may also lock if you lean forward too quickly. A slow, easy motion will allow the belt to extend so that you can move around fully.

n **Automatic locking retractor (ALR)**

When a passenger's shoulder belt is completely extended and then retracted even slightly, the belt is locked in that position and cannot be extended. This feature is used to hold the child restraint system (CRS) firmly. To free the belt again, fully retract the belt and then pull the belt out once more. (→P. 102)

n Pregnant women

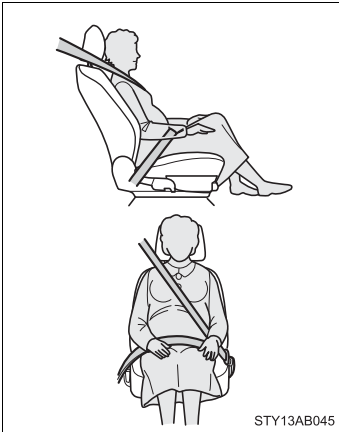

Obtain medical advice and wear the seat belt in the proper way. (→P. 52)

Women who are pregnant should position the lap belt as low as possible over the hips in the same manner as other occupants. Extend the shoulder belt completely over the shoulder and position the belt across the chest. Avoid belt contact over the rounding of the abdominal area.

If the seat belt is not worn properly, not only a pregnant woman, but also the fetus could suffer death or serious injury as a result of sudden braking or a collision.

n People suffering illness

Obtain medical advice and wear the seat belt in the proper way.

n Child seat belt usage

The seat belts of your vehicle were principally designed for persons of adult size.

- l Use a child restraint system appropriate for the child, until the child become large enough to properly wear the vehicle's seat belt. (→P. 98)
- l When the child becomes large enough to properly wear the vehicle's seat belt, follow the instructions on P. 52 regarding seat belt usage.

n Replacing the belt after the pretensioner has been activated

If the vehicle is involved in multiple collisions, the pretensioner will activate for the first collision, but will not activate for the second or subsequent collisions.

n Seat belt extender

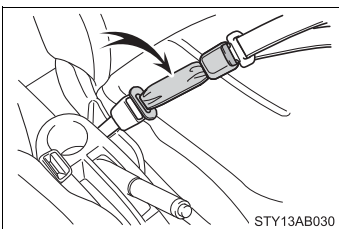

If your seat belts cannot be fastened securely because they are not long enough, a personalized seat belt extender is available from your Toyota dealer free of charge.

⚠ CAUTION

Observe the following precautions to reduce the risk of injury in the event of sudden braking or an accident.

Failing to do so may cause death or severe injury.

n Wearing a seat belt

- l Ensure that all passengers wear a seat belt.
- l Always wear a seat belt properly.
- l Each seat belt should be used by one person only. Do not use a seat belt for more than one person at once, including children.
- l Toyota recommends that children be seated in the rear seat and always use a seat belt and/or an appropriate child restraint system.
- l Do not recline the seat any more than necessary to achieve a proper seating position. The seat belt is most effective when the occupants are sitting up straight and well back in the seats.
- l Do not wear the shoulder belt under your arm.
- l Always wear your seat belt low and snug across your hips.

n Adjustable shoulder anchor

Always make sure the shoulder belt is positioned across the center of your shoulder. The belt should be kept away from your neck, but not falling off your shoulder. Failure to do so could reduce the amount of protection in an accident and cause death or serious injuries in a collision. (→P. 53)

n Seat belt pretensioners

- l Do not place anything, such as a cushion, on the front passenger's seat. Doing so will disperse the passenger's weight, which prevents the sensor from detecting the passenger's weight properly. As a result, the seat belt pretensioner for the front passenger's seat may not activate in the event of a collision.
- l If the pretensioner has activated, the seat belt becomes locked: it cannot be further extended, nor will it return to the stowed position. The seat belt cannot be used again and must be replaced at your Toyota dealer.

! CAUTION

n Seat belt damage and wear

- I** Do not damage the seat belts by allowing the belt, plate, or buckle to be jammed in the door.
- I** Inspect the seat belt system periodically. Check for cuts, fraying, and loose parts. Do not use a damaged seat belt until it is replaced. Damaged seat belt cannot protect an occupant from death or serious injury.
- I** Ensure that the belt and tab are locked and the belt is not twisted. If the seat belt does not function correctly, immediately contact your Toyota dealer.
- I** Replace the seat assembly, including the belts, if your vehicle has been involved in a serious accident, even if there is no obvious damage.
- I** Do not attempt to install, remove, modify, disassemble or dispose of the seat belts. Have any necessary repairs carried out by your Toyota dealer. Inappropriate handling of the pretensioner may prevent it from operating properly resulting in death or serious injury.

n Child restraint lock function belt

Do not allow children to play with the child restraint lock function belt.

n When using the rear center seat belt



Do not use the rear center seat belt with either buckle released. Fastening only one of the buckles may result in death or serious injury in case of sudden braking or a collision.

n Using a seat belt comfort guide

- I** Make sure the belt is not twisted and that it lies flat. The elastic cord must be behind the belt and the guide must be on the front.
- I** To reduce the chance of injury in case of an accident or a sudden stop while driving, remove and store the comfort guide in its pocket when it is not in use.

 CAUTION

n Using a seat belt comfort guide

I Always make sure the shoulder belt is positioned across the center of the shoulder. The belt should be kept away from the neck, and should not fall off the shoulder.

Failure to observe these precautions could reduce the effectiveness of the seat belt in an accident, causing death or serious injury.

n Using a seat belt extender

I Do not wear the seat belt extender, if you can fasten the seat belt without the extender.

I Do not use the seat belt extender when installing a child restraint system, because the belt will not securely hold the child restraint system, increasing the risk of death or serious injury in the event of a collision.

I The personalized extender may not be safe on another vehicle, when used by another person, or at a different seating position other than the one originally intended.

 NOTICE

n When using a seat belt extender

When releasing the seat belt, press on the buckle release button on the extender, not on the seat belt.

This helps prevent damage to the vehicle interior and the extender itself.

Steering wheel

The steering wheel can be adjusted to a comfortable position.

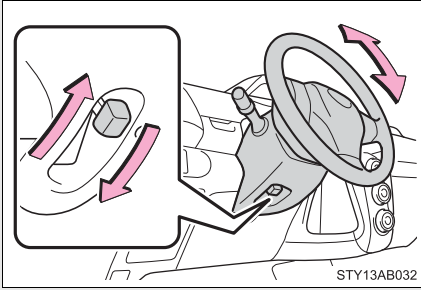

STEP 1 Hold the steering wheel and press the lever down.

STEP 2 Adjust to the ideal position by moving the steering wheel vertically.

STEP 3 Pull the lever up.

⚠ CAUTION

n Caution while driving

Do not adjust the steering wheel while driving.

Doing so may cause the driver to mishandle the vehicle and an accident may occur resulting in death or serious injury.

n After adjusting the steering wheel

Make sure that the steering wheel is securely locked.

Otherwise, the steering wheel may move suddenly, possibly causing an accident and resulting in death or serious injury.

1-3. Adjustable components (seats, mirrors, steering wheel) Anti-glare inside rear view mirror

Glare from the headlights of vehicles behind can be reduced by using the following functions.

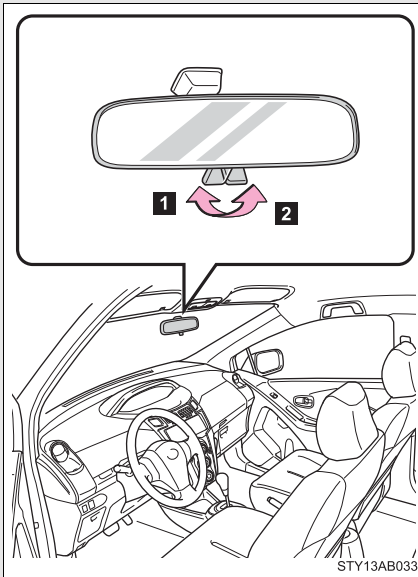

- 1 Normal position
- 2 Anti-glare position

1

Before driving

CAUTION

n Caution while driving

Do not adjust the position of the mirror while driving.

Doing so may lead to mishandling of the vehicle and an accident, resulting in death or serious injury.

1-3. Adjustable components (seats, mirrors, steering wheel)

Outside rear view mirrors

Mirror angle can be adjusted.

► Power-adjustable type

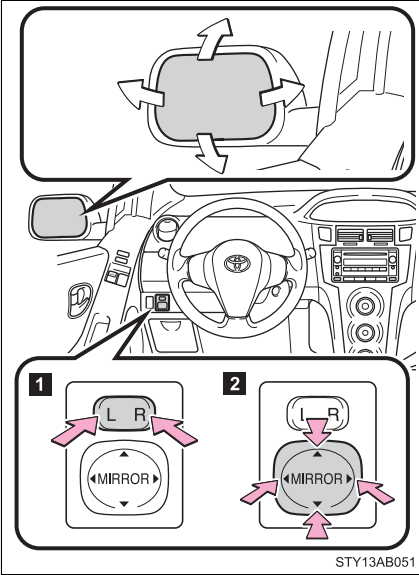

1 Select a mirror to adjust.

(L: left or R: right)

2 Adjust the mirror up, down, in or out using the switch.

► Manually adjustable type

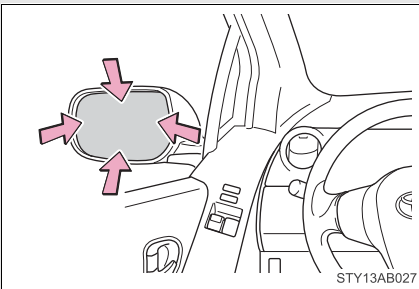

Adjust the mirror up, down, in or out by pushing the mirror surface.

Folding back the mirrors

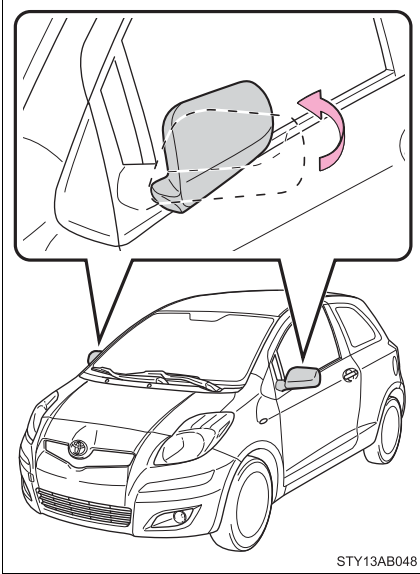

Push backward to fold the mirrors.

1

Before driving

n **Mirror operating conditions (with power-adjustable type only)**

The engine switch is in the ACC or ON position.

CAUTION

n **When driving the vehicle**

Observe the following precautions while driving.

Failing to do so may result in loss of control of the vehicle and cause an accident, resulting in death or serious injury.

- I Do not adjust the mirrors while driving.
- I Do not drive with the mirrors folded back.
- I Both the driver and passenger side mirrors must be extended and properly adjusted before driving.



NOTICE

n If ice should jam the mirror

Do not operate the control or scrape the mirror face. Use a spray de-icer to free the mirror.

1-4. Opening and closing the windows Power windows (if equipped)

The power windows can be opened/closed using the following switches.

► Driver's power window switches (3-door models)

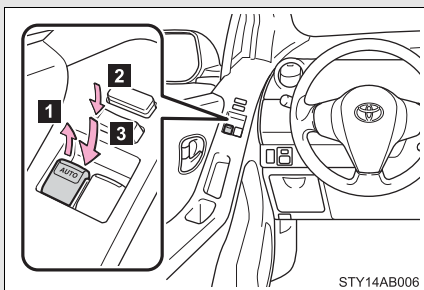

- 1 Closing
- 2 Opening
- 3 One-touch opening (driver's window only)*

*: Pressing the switch in the opposite direction will stop window travel partway.

► Driver's power window switches (5-door models)

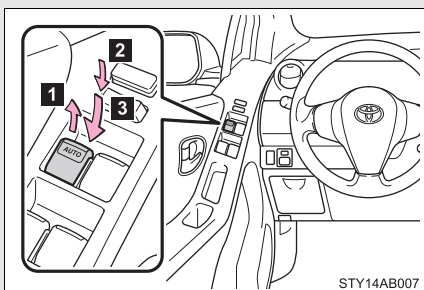

- 1 Closing
- 2 Opening
- 3 One-touch opening (driver's window only)*

*: Pressing the switch in the opposite direction will stop window travel partway.

► Front passenger's power window switch

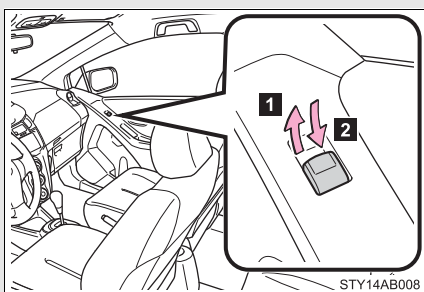

- 1 Closing
- 2 Opening

► Rear passenger's power window switch (5-door models)

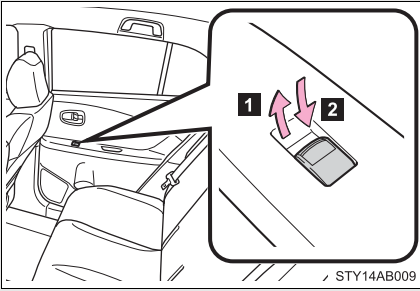

- 1 Closing
- 2 Opening

Lock switch

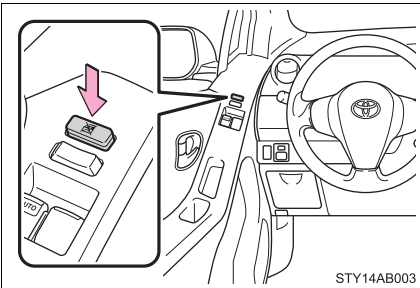

Press the switch down to lock passenger window switches.

Use this switch to prevent children from accidentally opening or closing a passenger window.

■ **The power windows can be operated when**

The engine switch is in the ON position.

■ **Operating the power windows after turning the engine switch off (driver's window only)**

The power windows can be operated for approximately 45 seconds even after the engine switch is turned off. They cannot, however, be operated once either front door is opened.

 **CAUTION****n Closing the windows**

Observe the following precautions.

Failing to do so may result in death or serious injury.

- I** Check to make sure that all passengers do not have any part of their body in a position where it could be caught when a window is being operated.
- I** Do not allow children to operate the power windows.
Closing a power window on someone can cause serious injury, and in some instances, even death.

Opening the fuel tank cap

Perform the following steps to open the fuel tank cap.

n **Before refueling the vehicle**

Turn the engine switch off and ensure that all the doors and windows are closed.

n **Opening the fuel tank cap**

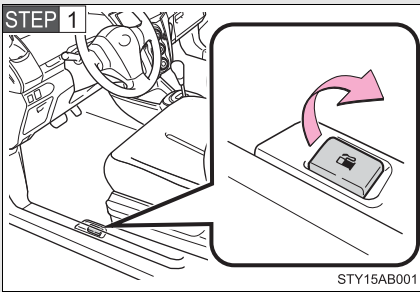

Open the fuel filler door.

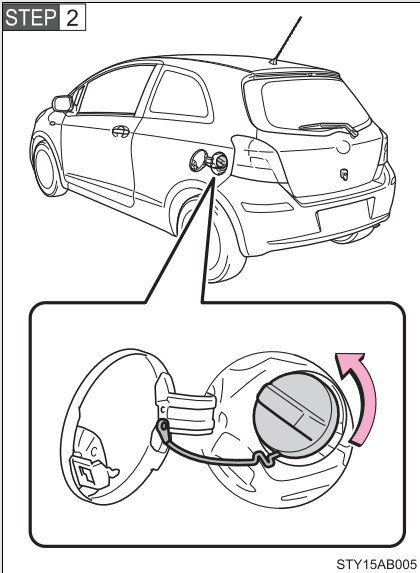

Turn the fuel tank cap slowly to open.

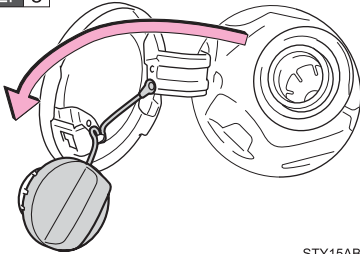
STEP 3

STY15AB003

Hang the tether as shown in the illustration.

Closing the fuel tank cap

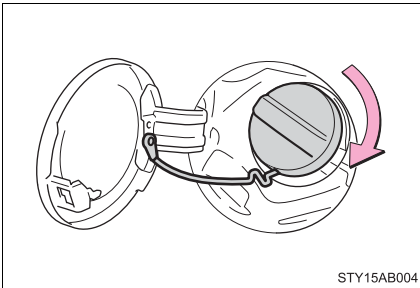

STY15AB004

When replacing the fuel tank cap, turn it until a clicking sound is heard.

After releasing your hand, the cap will turn slightly to the opposite direction.

n Fuel types

Unleaded gasoline. (Octane rating 87 [Research Octane Number 91] or higher)

n Fuel tank capacity

Approximately 11.1 gal. (42.0 L, 9.2 Imp. gal.)

 CAUTION

n Refueling the vehicle

Observe the following precautions while refueling the vehicle.
Failure to do so may result in death or serious injury.

- I** Touch the vehicle or some other metal surface to discharge any static electricity.
Sparks resulting from discharging static electricity may cause the fuel vapors to ignite.
- I** Always hold the grips on the fuel tank cap and turn it slowly to remove it.
A whooshing sound may be heard when the fuel tank cap is loosened.
Wait until the sound cannot be heard before fully removing the cap.
In hot weather, pressurized fuel may spray out of the filler neck and cause injury.
- I** Do not allow anyone that has not discharged static electricity from their bodies to come close to an open fuel tank.
- I** Do not inhale vaporized fuel.
Fuel contains substances that are harmful if inhaled.
- I** Do not smoke while refueling the vehicle.
Doing so may cause the fuel to ignite and cause a fire.
- I** Do not return to the vehicle or touch any person or object that is statically charged.
This may cause static electricity to build up, resulting in a possible ignition hazard.

n When replacing the fuel tank cap

Do not use anything but a genuine Toyota fuel tank cap designed for your vehicle. Doing so may cause a fire or other incident which may result in death or serious injury.

**NOTICE****n Refueling**

Do not spill fuel during refueling.

Doing so may damage the vehicle, such as causing the exhaust systems to operate abnormally or damaging fuel system components or the vehicle's painted surface.

1

Before driving

1-6. Theft deterrent system

Engine immobilizer system (if equipped)

The vehicle's keys have built-in transponder chips that prevent the engine from starting if the key has not been previously registered in the vehicle's on-board computer.

Never leave the keys inside the vehicle when you leave the vehicle.

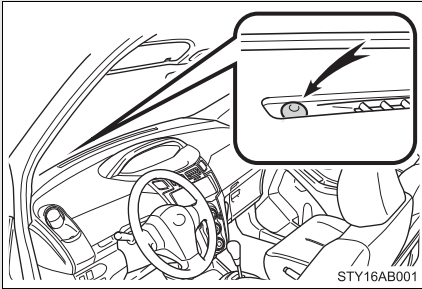

The indicator light flashes after the key has been removed from the engine switch to indicate that the system is operating.

n **System maintenance**

The vehicle has a maintenance-free type of engine immobilizer system.

n **Conditions that may cause the system to malfunction**

- l If the key is in contact with a metallic object
- l If the key is in close proximity to or touching a key to the security system (key with a built-in transponder chip) of another vehicle

n **Certifications for the engine immobilizer system**

► For vehicles sold in U.S.A.

FCC ID: MOZRI-20BTY

This device complies with Part 15 of the FCC Rules. Operation is subject to the following two conditions: (1) This device may not cause harmful interference, and (2) this device must accept any interference received, including interference that may cause undesired operation.

FCC WARNING:

Changes or modifications not expressly approved by the party responsible for compliance could void the user's authority to operate the equipment.

► For vehicles sold in Canada

This device complies with RSS-210 of Industry Canada. Operation is subject to the following two conditions: (1) This device may not cause interference, and (2) this device must accept any interference, including interference that may cause undesired operation of the device.



NOTICE

n To prevent damage to the key

Do not modify, remove or disable the engine immobilizer system. If any unauthorized changes or modifications are made, the proper operation of the system cannot be guaranteed.

1-6. Theft deterrent system Alarm (Puerto Rico)

The system sounds the alarm and flashes lights when forcible entry is detected.

n **Triggering of the alarm**

The alarm is triggered in the following situations.

- 1 A locked door is unlocked or opened in any way other than using the key.
- 1 The hood is opened while the vehicle is locked.

n **Setting the alarm system**

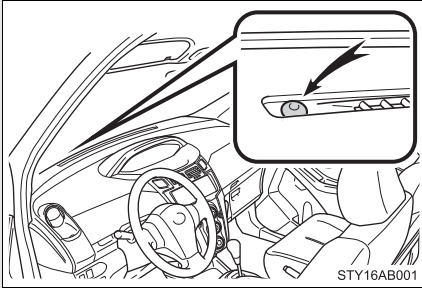

STEP 1 Close the doors and hood, and lock all doors using the key.

Use the key to lock the last door. When the back door is the last, turn the key to the unlock position and then turn to the door lock position.

STEP 2 The system will be set automatically after 30 seconds.

The indicator light changes from being on to flashing when the system is set.

n **Deactivating or stopping the alarm**

- 1 Unlock any door using the key.
- 1 Turn the engine switch to the ON position. (The alarm will be deactivated or stopped after a few seconds.)

n **Items to check before locking the vehicle**

To prevent unexpected triggering of the alarm and vehicle theft, make sure of the following.

- l Nobody is in the vehicle.
- l The windows are closed before the alarm is set.
- l No valuables or other personal items are left in the vehicle.

n **Triggering of the alarm**

The alarm may be triggered in the following situations.
(Stopping the alarm deactivates the system.)

- l A person inside the vehicle opens a door or hood.

1-6. Theft deterrent system

Theft prevention labels (except Canada)

Drive in a good posture as follows:

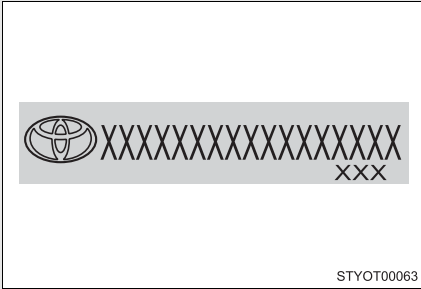

These labels are attached to the vehicle to reduce vehicle theft by facilitating the tracing and recovery of parts from stolen vehicles. Do not remove under penalty of law.

Drive in a good posture as follows:

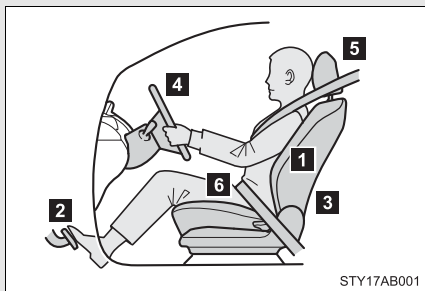

- 1 Sit upright and well back in the seat. (→P. 38)
- 2 Adjust the position of the seat forward or backward to ensure the pedals can be reached and easily depressed to the extent required. (→P. 38)
- 3 Adjust the seatback so that the controls are easily operable.
- 4 Adjust the tilt positions of the steering wheel downward so the airbag is facing your chest. (→P. 62)
- 5 Lock the head restraint in place with the center of the head restraint closest to the top of your ears. (→P. 48)
- 6 Wear the seat belt correctly. (→P. 52)

 **CAUTION**

n While driving

- I** Do not adjust the position of the driver's seat while driving. Doing so could cause the driver to lose control of the vehicle.
- I** Do not place a cushion between the driver or passenger and the seatback. A cushion may prevent correct posture from being achieved, and reduce the effectiveness of the seat belt and head restraint, increasing the risk of death or serious injury to the driver or passenger.
- I** Do not place anything under the front seats. Objects placed under the front seats may become jammed in the seat tracks and stop the seat from locking in place. This may lead to an accident. The adjustment mechanism may also be damaged.

n Adjusting the seat position

- I** Take care when adjusting the seat position to ensure that other passengers are not injured by the moving seat.
- I** Do not put your hands under the seat or near the moving parts to avoid injury. Fingers or hands may become jammed in the seat mechanism.

SRS airbags

The SRS airbags inflate when the vehicle is subjected to certain types of severe impacts that may cause significant injury to the occupants. They work together with the seat belts to help reduce the risk of death or serious injury.

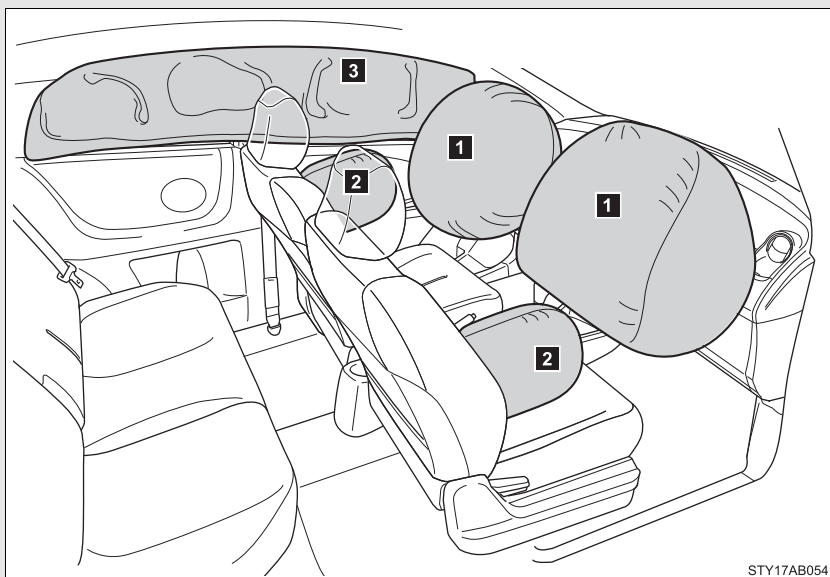

► Front airbags

1 Driver airbag/front passenger airbag

Can help protect the head and chest of the driver and front passenger from impact with interior components.

► Side and curtain shield airbags

2 Side airbags (if equipped)

Can help protect the torso of the front seat occupants.

3 Curtain shield airbags (if equipped)

Can help protect primarily the head of outside occupants.

Airbag system components

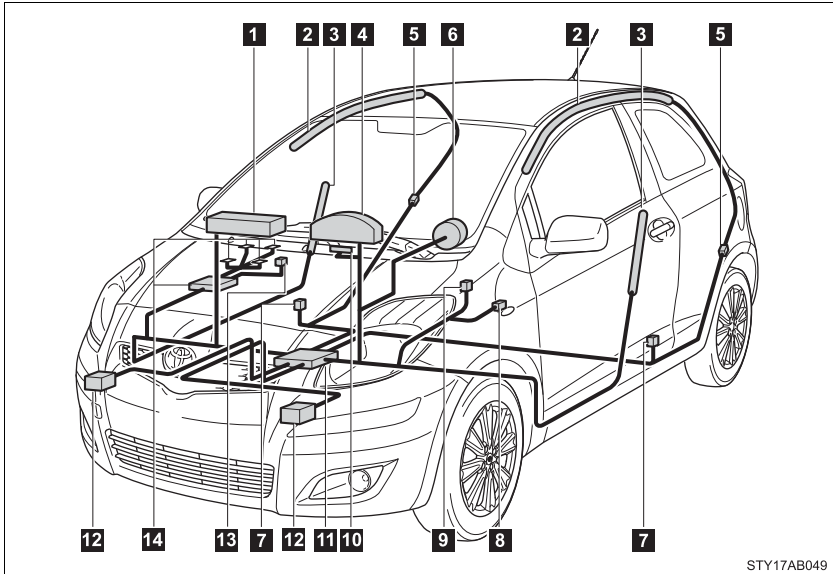

STY17AB049

- | | |
|---|---|
| 1 Front passenger airbag | 8 Driver's seat position sensor |
| 2 Curtain shield airbags (if equipped) | 9 Driver's seat belt buckle switch |
| 3 Side airbags (if equipped) | 10 AIR BAG ON and AIR BAG OFF indicator lights |
| 4 SRS warning light | 11 Airbag sensor assembly |
| 5 Curtain shield airbag sensors (if equipped) | 12 Front airbag sensors |
| 6 Driver airbag | 13 Front passenger's seat belt buckle switch |
| 7 Side and curtain shield airbag sensors (if equipped) | 14 Occupant detection system (ECU and sensors) |

Your vehicle is equipped with ADVANCED AIRBAGS designed based on US motor vehicle safety standards (FMVSS208). The airbag system controls airbag deployment power for the driver and front passenger. The driver airbag system consists of the driver seat's position sensor etc. The front passenger's airbag system consists of the front passenger occupant classification sensor etc.

The main SRS airbag system components are shown above. The SRS airbag system is controlled by the airbag sensor assembly. The airbag sensor assembly consists of a safing sensor and an airbag sensor.

In certain types of severe frontal or side impacts, the SRS airbag system triggers the airbag inflators. A chemical reaction in the inflators quickly fills the airbags with non-toxic gas to help restrain the motion of the occupants.

n SRS warning light

This warning light system monitors the airbag sensor assembly, front airbag sensors, side and curtain shield airbag sensors, curtain shield airbag sensors, driver's seat position sensor, driver's seat belt buckle switch, front passenger occupant classification system, AIR BAG ON indicator light, AIR BAG OFF indicator light, front passenger's seat belt buckle switch, seat belt pretensioner assemblies, inflators, interconnecting wiring and power sources. (→P. 308)

n If the SRS airbags deploy (inflate)

- l Bruising and slight abrasions may result from contact with a deploying (inflating) SRS airbag.
- l A loud noise and white powder will be emitted.
- l Vehicles with side and curtain shield airbags: Parts of the airbag module (steering wheel hub, airbag cover and inflator) as well as the front seats, and parts of the front and rear pillars and roof side rail, may be hot for several minutes. The airbag itself may also be hot.
- l Vehicles without side and curtain shield airbags: Parts of the airbag module (steering wheel hub, airbag cover and inflator) as well as the front seats may be hot for several minutes. The airbag itself may also be hot.

■ **If the SRS airbags deploy (inflate)**

- l The front windshield may crack.

■ **Operating conditions (front airbags)**

- l The SRS front airbags will deploy if the severity of the frontal impact is above the designed threshold level, comparable to an approximate 15 mph (25 km/h) collision when the vehicle impacts straight into a fixed barrier that does not move or deform.

However, this threshold velocity will be considerably higher if the vehicle strikes an object, such as a parked vehicle or sign pole, which can move or deform on impact, or if the vehicle is involved in an underride collision (e.g. a collision in which the front of the vehicle “underrides”, or goes under, the bed of a truck, etc.).

- l It is possible that in some collisions where the forward deceleration of the vehicle is very close to the designed threshold level, the SRS front airbags and the seat belt pretensioners may not activate together.
- l The SRS front passenger airbag will not activate if there is no passenger sitting in the front passenger seat. However, the front passenger airbag may deploy if luggage is put in the seat, even if the seat is unoccupied. (→P. 93)

■ **Operating conditions (side airbags and curtain shield airbags [if equipped])**

- l The SRS side airbags and curtain shield airbags are designed to inflate when the passenger compartment is subjected to a severe impact from the side.
- l The SRS side airbag on the passenger seat will not activate if there is no passenger sitting in the front passenger seat. However, the side airbag on the passenger seat may deploy if luggage is put in the seat, even if the seat is unoccupied. (→P. 93)

n Conditions under which the SRS airbags may deploy (inflate), other than a collision

The SRS front airbags may also deploy if a serious impact occurs to the underside of your vehicle. Some examples are shown in the illustration.

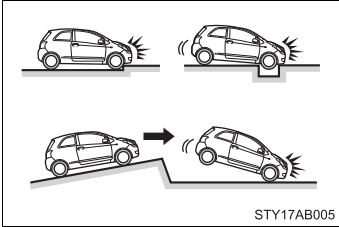

- 1 Hitting a curb, edge of pavement or hard surface
- 1 Falling into or jumping over a deep hole
- 1 Landing hard or vehicle falling

n Types of collisions that may not deploy the SRS airbag (front airbags)

The SRS front airbags are generally not designed to inflate if the vehicle is involved in a side or rear collision, if it rolls over, or if it is involved in a low-speed frontal collision. But, whenever a collision of any type causes sufficient forward deceleration of the vehicle, deployment of the SRS front airbags may occur.

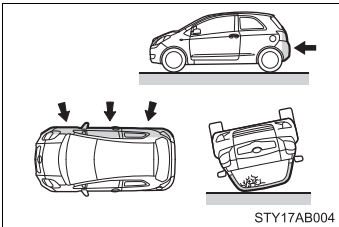

- 1 Collision from the side
- 1 Collision from the rear
- 1 Vehicle rollover

▮ **Types of collisions that may not deploy the SRS airbag (side airbags and curtain shield airbags [if equipped])**

The SRS side airbag and curtain shield airbag system may not activate if the vehicle is subjected to a collision from the side at certain angles, or a collision to the side of the vehicle body other than the passenger compartment.

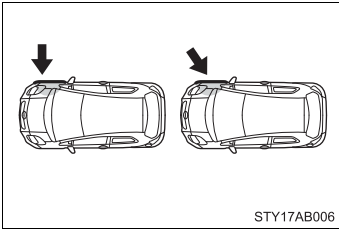

- | Collision from the side to the vehicle body other than the passenger compartment
- | Collision from the side at an angle

The SRS side airbags and curtain shield airbags are not generally designed to inflate if the vehicle is involved in a frontal or rear collision, if it rolls over, or if it is involved in a low-speed side collision.

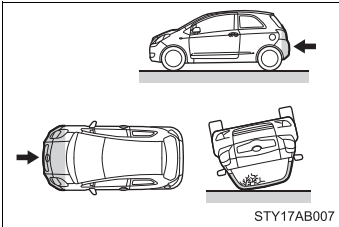

- | Collision from the front
- | Collision from the rear
- | Vehicle rollover

11 When to contact your Toyota dealer

In the following cases, contact your Toyota dealer as soon as possible. Do not disconnect the battery cables before contacting your Toyota dealer.

1 Any of the SRS airbags have been inflated.

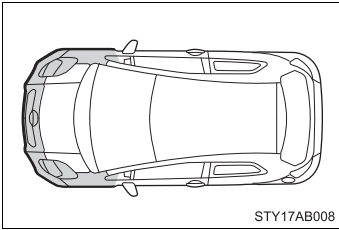

- 1 The front of the vehicle is damaged or deformed, or was involved in an accident that was not severe enough to cause the SRS airbags to inflate.

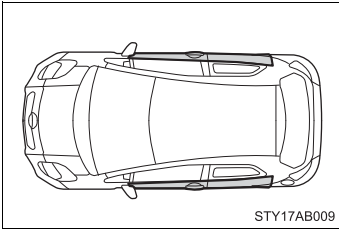

- 1 Vehicles with side airbags and curtain shield airbags: A portion of a door is damaged or deformed, or the vehicle was involved in an accident that was not severe enough to cause the SRS side airbags and curtain shield airbags to inflate.

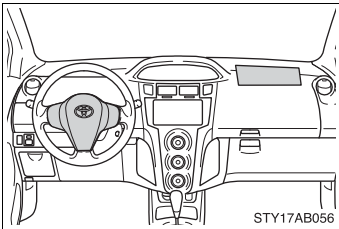

- 1 The pad section of the steering wheel or dashboard near the front passenger airbag is scratched, cracked, or otherwise damaged.

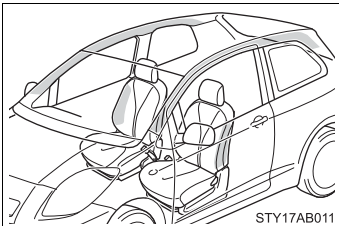

- 1 Vehicles with side airbags and curtain shield airbags: The surface of the seats with the side airbag is scratched, cracked or otherwise damaged.
- 1 Vehicles with side airbags and curtain shield airbags: The portion of the front pillars, rear pillars or roof side rail garnishes (padding) containing the curtain shield airbags inside is scratched, cracked or otherwise damaged.

 CAUTION

n SRS airbag precautions

Observe the following precautions regarding the airbags.
Failure to do so may cause death or serious injury.

I The driver and all passengers in the vehicle must wear their seat belts properly.

The SRS airbags are supplemental devices to be used with the seat belts.

I The SRS driver airbag deploys with considerable force, and can cause death or serious injury especially if the driver is very close to the airbag.

The National Highway Traffic Safety Administration (“NHTSA”) advises:

Since the risk zone for driver airbag is the first 2 - 3 in. (50 - 75 mm) of inflation, placing yourself 10 in. (250 mm) from your driver airbag provides you with a clear margin of safety. This distance is measured from the center of the steering wheel to your breastbone. If you sit less than 10 in. (250 mm) away now, you can change your driving position in several ways:

- Move your seat to the rear as far as you can while still reaching the pedals comfortably.
- Slightly recline the back of the seat.
Although vehicle designs vary, many drivers can achieve the 10 in. (250 mm) distance, even with the driver seat all the way forward, simply by reclining the back of the seat somewhat. If reclining the back of your seat makes it hard to see the road, raise yourself by using a firm, non-slippery cushion, or raise the seat if your vehicle has that feature.
- If your steering wheel is adjustable, tilt it downward. This points the airbag toward your chest instead of your head and neck.

The seat should be adjusted as recommended by NHTSA above, while still maintaining control of the foot pedals, steering wheel, and your view of the instrument panel controls.

⚠ CAUTION

n SRS airbag precautions

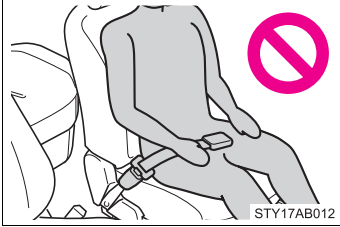

- I If the seat belt extender has been connected to the driver's seat belt buckle but the seat belt extender has not also been fastened to the latch plate of the driver's seat belt, the SRS driver's airbag system will judge that the driver is wearing the seat belt even though the seat belt has not been connected. In this case, the driver's airbag may not activate correctly in a collision, resulting in death or serious injury in the event of collision. Be sure to wear the seat belt with the seat belt extender.
- I The SRS front passenger airbag also deploys with considerable force, and can cause death or serious injury especially if the front passenger is very close to the airbag. The front passenger seat should be as far from the airbag as possible with the seatback adjusted, so the front passenger sits upright.
- I Improperly seated and/or restrained infants and children can be killed or seriously injured by a deploying airbag. An infant or child who is too small to use a seat belt should be properly secured using a child restraint system. Toyota strongly recommends that all infants and children be placed in the rear seats of the vehicle and properly restrained. The rear seats are the safest for infants and children. (→P. 98)

! CAUTION

n SRS airbag precautions

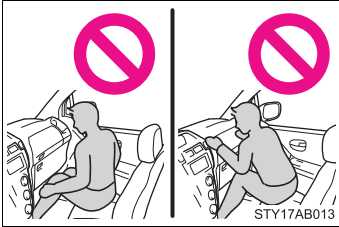

I Do not sit on the edge of the seat or lean against the dashboard.

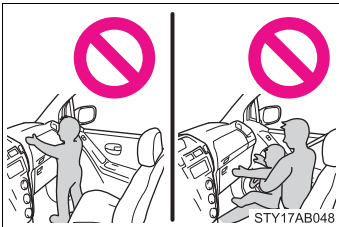

I Do not allow a child to stand in front of the SRS front passenger airbag unit or sit on the knees of a front passenger.

I Do not drive the vehicle while the driver or passenger has items resting on their knees.



I Vehicles with side airbags and curtain shield airbags: Do not lean against the door, the roof side rail or the front, side and rear pillars.



I Vehicles with side airbags and curtain shield airbags: Do not allow anyone to kneel on the passenger seat toward the door or put their head or hands outside the vehicle.

⚠ CAUTION

n SRS airbag precautions

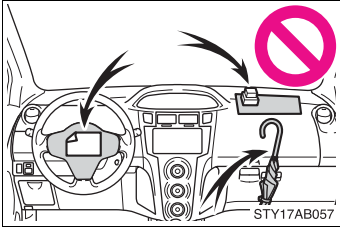

- I Do not attach anything to or lean anything against areas such as the dashboard or steering wheel pad. These items can become projectiles when SRS driver and front passenger airbags deploy.

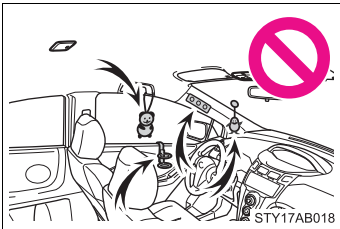

- I Vehicles with side airbags and curtain shield airbags: Do not attach anything to areas such as the door, windshield glass, side door glass, front and rear pillars, roof side rail or assist grip.

- I Vehicles with side airbags: Do not use seat accessories which cover the parts where the SRS side airbags inflate as they may interfere with inflation of the airbags.
- I Do not strike or apply significant levels of force to the area of the SRS airbag components shown on P. 82. Doing so can cause the SRS airbags to malfunction.
- I Do not touch any of the component parts immediately after the SRS airbags have deployed (inflated) as they may be hot.
- I If breathing becomes difficult after the SRS airbag has deployed, open a door or window to allow fresh air in, or leave the vehicle if it is safe to do so. Wash off any residue as soon as possible to prevent skin irritation.
- I Vehicles with curtain shield airbags: If the areas where the SRS airbags are stored, such as the steering wheel pad and front and rear pillar garnishes, are damaged or cracked, have them replaced by your Toyota dealer.
- I Vehicles without curtain shield airbags: If the areas where the SRS airbags are stored, such as the steering wheel pad are damaged or cracked, have them replaced by your Toyota dealer.

 CAUTION

n Modification and disposal of SRS airbag system components

Do not dispose of your vehicle or perform any of the following modifications without consulting your Toyota dealer.

The SRS airbags may malfunction or deploy (inflate) accidentally, causing death or serious injury.

- I Installation, removal, disassembly and repair of the SRS airbags.
- I Repairs, modifications, removal or replacement of the steering wheel, instrument panel, dashboard, seats or seat upholstery, front, side and rear pillars or roof side rail.
- I Repairs or modifications of the front fender, front bumper, or side of the occupant compartment.
- I Installation of snow plows, winches, etc. to the front grille (bull bars, kangaroo bar etc.).
- I Modifications to the vehicle's suspension system.
- I Installation of electronic devices such as mobile two-way radios or CD players.
- I Modifications to your vehicle for a person with a physical disability.

Front passenger occupant classification system

Your vehicle is equipped with a front passenger occupant classification system. This system detects the conditions of the front passenger seat and activates or deactivates the devices for front passenger.

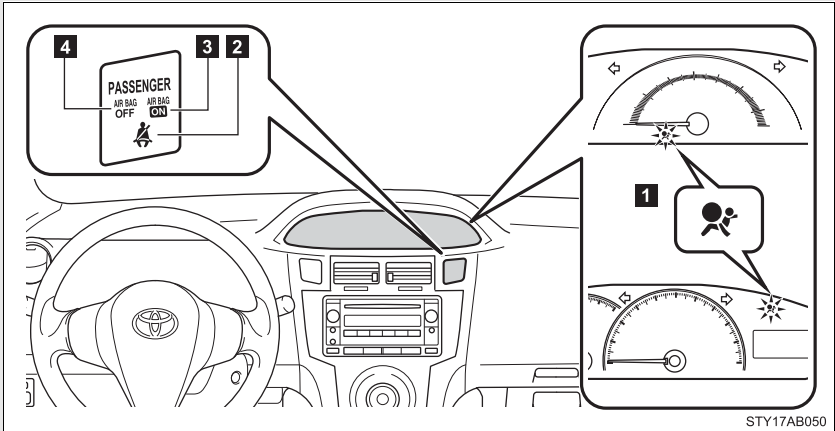

- 1 SRS warning light
- 2 Front passenger's seat belt reminder light
- 3 AIR BAG ON indicator light
- 4 AIR BAG OFF indicator light

Condition and operation in the front passenger occupant classification system

n Adult*¹

Indicator/ warning light	AIR BAG ON and AIR BAG OFF indicator lights	AIR BAG ON
	SRS warning light	Off
	Front passenger's seat belt reminder light	Flashing* ²
Devices	Front passenger airbag	Activated
	Side airbag on the front passenger seat	
	Curtain shield airbag in the front passenger side	
	Front passenger's seat belt pretensioner	

n Child*³ or child restraint system*⁴

Indicator/ warning light	AIR BAG ON and AIR BAG OFF indicator lights	AIR BAG OFF* ⁵
	SRS warning light	Off
	Front passenger's seat belt reminder light	Flashing* ²
Devices	Front passenger airbag	Deactivated
	Side airbag on the front passenger seat	Activated
	Curtain shield airbag in the front passenger side	
	Front passenger's seat belt pretensioner	

n Unoccupied

Indicator/ warning light	AIR BAG ON and AIR BAG OFF indicator lights	Not illuminated
	SRS warning light	Off
	Front passenger's seat belt reminder light	
Devices	Front passenger airbag	Deactivated
	Side airbag on the front passenger seat	Activated
	Curtain shield airbag in the front passenger side	
	Front passenger's seat belt pretensioner	Deactivated

n There is a malfunction in the system

Indicator/ warning light	AIR BAG ON and AIR BAG OFF indicator lights	AIR BAG OFF
	SRS warning light	On
	Front passenger's seat belt reminder light	Off
Devices	Front passenger airbag	Deactivated
	Side airbag on the front passenger seat	Activated
	Curtain shield airbag in the front passenger side	
	Front passenger's seat belt pretensioner	

*1: The system judges a person of adult size as an adult. When a smaller adult sits in the front passenger seat, the system may recognize him/her as a child depending on his/her physique and posture.

*2: In the event the front passenger does not wear a seat belt.

*3: When a larger child who has outgrown a child restraint system sits in the front passenger seat, the system may recognize him/her as an adult depending on his/her physique or posture.

*4: Never install a rear-facing child restraint system on the front passenger seat. A forward-facing child restraint system should only be installed on the front passenger seat when it is unavoidable. (→P. 98)

*5: In case the indicator is not illuminated, consult this manual as for installing the child restraint system properly. (→P. 102)

 CAUTION

n Front passenger occupant classification system precautions

Observe the following precautions regarding front passenger occupant classification system.

Failure to do so may cause death or serious injury.

- I Wear the seat belt properly.
- I Make sure the front passenger's seat belt tab has not been left inserted into the buckle before someone sits in the front passenger seat.
- I Make sure the AIR BAG OFF indicator light is not illuminated when using the seat belt extender for the front passenger seat. If the AIR BAG OFF indicator light is illuminated, disconnect the extender tongue from the seat belt buckle, then reconnect the seat belt. Reconnect the seat belt extender after making sure the AIR BAG ON indicator light is illuminated. If you use the seat belt extender while the AIR BAG OFF indicator light is illuminated, the front passenger airbag and side airbag on the front passenger side may not activate correctly, which could cause death or serious injury in the event of collision.
- I Do not apply a heavy load to the front passenger seat or equipment.
- I Do not put weight on the front passenger seat by putting your hands or feet on the front passenger seat seatback from the rear passenger seat.
- I Do not let a rear passenger lift the front passenger seat with their feet or press on the seatback with their legs.
- I Do not put objects under the front passenger seat.
- I Do not recline the front passenger seatback so far that it touches a rear seat. This may cause the AIR BAG OFF indicator light to be illuminated, which indicates that the passenger's airbags will not deploy in the event of a severe accident. If the seatback touches the rear seat, return the seatback to a position where it does not touch the rear seat. Keep the front passenger seatback as upright as possible when the vehicle is moving. Reclining the seatback excessively may lessen the effectiveness of the seat belt system.

 **CAUTION****n Front passenger occupant classification system precautions**

- I** If an adult sits in the front passenger seat, the AIR BAG ON indicator light is illuminated. If the AIR BAG OFF indicator is illuminated, ask the passenger to sit up straight, well back in the seat, feet on the floor, and with the seat belt worn correctly. If the AIR BAG OFF indicator still remain illuminated, either ask the passenger to move to the rear seat, or if that is not possible, move the front passenger seat fully rearward.
- I** When it is unavoidable to install the forward-facing child restraint system on the front passenger seat, install the child restraint system on the front passenger seat in the proper order. (→P. 102)
- I** Do not modify or remove the front seats.
- I** Do not kick the front passenger seat or subject it to severe impact. Otherwise, the SRS warning light may come on to indicate a malfunction of the detection system. In this case, contact your Toyota dealer immediately.
- I** Child restraint systems installed on the rear seat should not contact the front seatbacks.

Child restraint systems

A child restraint system for a small child or baby must itself be properly restrained on the seat with the lap portion of the lap/shoulder belt.

The laws of all 50 states of the U.S.A. and Canada now require the use of child restraint systems.

Points to remember

Studies have shown that installing a child restraint on a rear seat is much safer than installing one to the front passenger seat.

1 Choose a child restraint system that suits your vehicle and is appropriate to the age and size of the child.

1 For installation details, follow the instructions provided with the child restraint system.

General installation instructions are provided in this manual.

(→P. 102)

Types of child restraints

Child restraint systems are classified into the following 3 types according to the age and size of the child.

▶ Rear facing — Infant seat/convertible seat

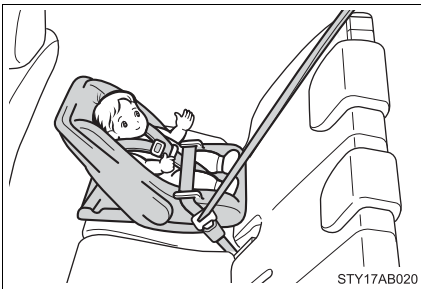

► Forward facing — Convertible seat

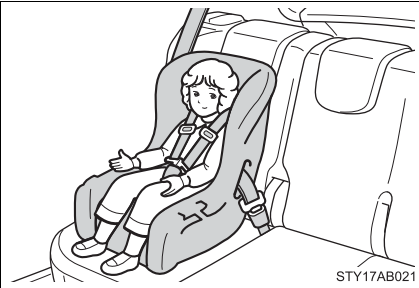

► Booster seat

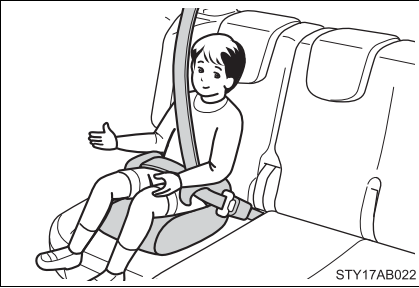

n **Selecting an appropriate child restraint system**

- 1 Use a child restraint system appropriate for the child until the child becomes large enough to properly wear the vehicle's seat belts.
- 1 If a child is too large for a child restraint system, sit the child on a rear seat and use the vehicle's seat belt.(→P. 52)

 CAUTION

n Child restraint precautions

- I** For effective protection in automobile accidents and sudden stops, a child must be properly restrained, using a seat belt or child restraint system depending on the age and size of the child. Holding a child in your arms is not a substitute for a child restraint system. In an accident, the child can be crushed against the windshield, or between you and the vehicle's interior.
- I** Toyota strongly urges the use of a proper child restraint system that conforms to the size of the child, installed on the rear seat. According to accident statistics, the child is safer when properly restrained in the rear seat than in the front seat.
- I** Never install a rear-facing child restraint system on the front passenger seat even if AIR BAG OFF indicator light is illuminated. In the event of an accident, the force of the rapid inflation of the front passenger airbag can cause death or serious injury to the child if the rear-facing child restraint system is installed on the front passenger seat.
- I** A forward-facing child restraint system may be installed on the front passenger seat only when it is unavoidable. A child restraint system that requires a top tether strap should not be used in the front passenger seat since there is no top tether strap anchor for the front passenger seat. Adjust the seatback as upright as possible and always move the seat as far back as possible even if the AIR BAG OFF indicator light is illuminated, because the front passenger airbag could inflate with considerable speed and force. Otherwise, the child may be killed or seriously injured.
- I** Do not use the seat belt extender when installing a child restraint system on the front or rear passenger seat. If installing a child restraint system with the seat belt extender connected to the seat belt, the seat belt will not securely hold the child restraint system, which could cause death or serious injury to the child or other passengers in the event of collision.
- I** Vehicles with side airbags and curtain shield airbags: Do not allow the child to lean his/her head or any part of his/her body against the door or the area of the seat, front and rear pillars or roof side rail from which the side airbags or curtain shield airbags deploy even if the child is seated in the child restraint system. It is dangerous if the side airbags and curtain shield airbags inflate, and the impact could cause death or serious injury to the child.

 **CAUTION****n Child restraint precautions**

- I** Make sure you have complied with all installation instructions provided by the child restraint manufacturer and that the system is properly secured. If it is not secured properly, it may cause death or serious injury to the child in the event of a sudden stop or accident.

n Child restraint lock function belt precaution

Do not allow children to play with the child restraint lock function belt. If the belt becomes twisted around a child's neck, it will not be possible to pull the belt out leading to choking or other serious injuries that could result in death.

If this occurs and the buckle cannot be unfastened, scissors should be used to cut the belt.

n When the child restraint system is not in use

- I** Keep the child restraint system properly secured on the seat even if it is not in use. Do not store the restraint unsecured in the passenger compartment.
- I** If it is necessary to detach the child restraint system, remove it from the vehicle or store it securely in the luggage compartment. This will prevent it from injuring passengers in the event of a sudden stop or accident.

Installing child restraints

Follow the child restraint system manufacturer's instructions. Firmly secure child restraints to the rear seats using the LATCH anchors or a seat belt. Attach the top tether strap when installing a child restraint.

The lap/shoulder belt can be used if your child restraint system is not compatible with the LATCH (Lower Anchors and Tethers for Children) system.

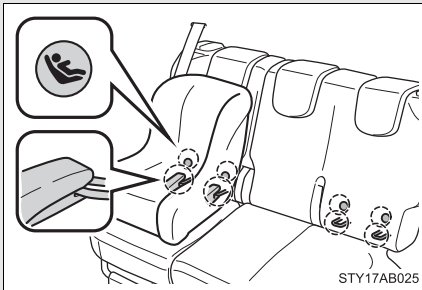

Child restraint LATCH anchors

LATCH anchors are provided for the outside rear seats. (Buttons displaying the location of the anchors are attached to the seats.)

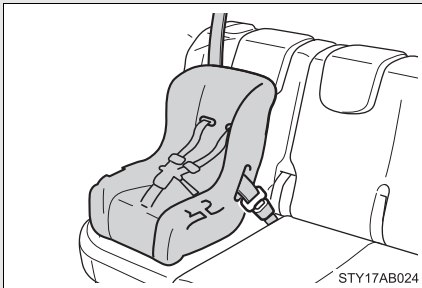

Seat belts equipped with a child restraint locking mechanism (ALR/ELR belts except driver's seat belt) (→P. 52)

► Split rear seats (type A), Non-split rear seat

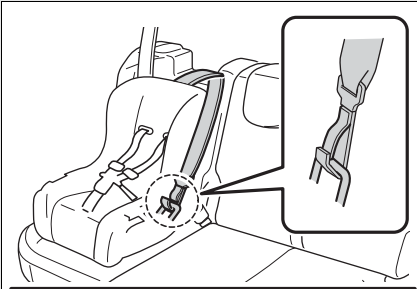

Anchor bracket (for top tether strap)

Anchor brackets are provided for all rear seats.

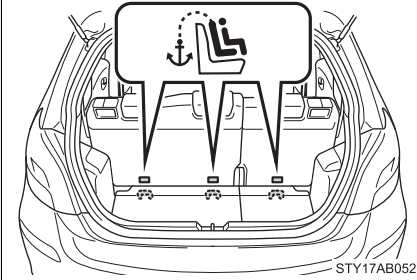

STY17AB052

► Split rear seats (type B)

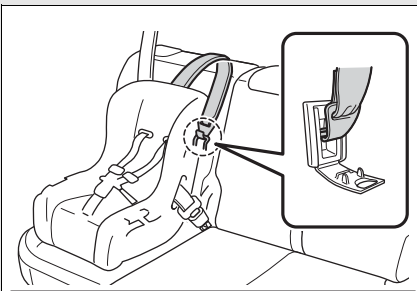

Anchor bracket (for top tether strap)

Anchor brackets are provided for all rear seats.

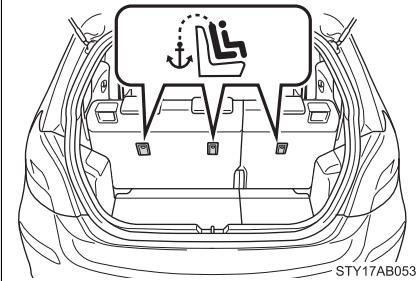

STY17AB053

Installation with LATCH system

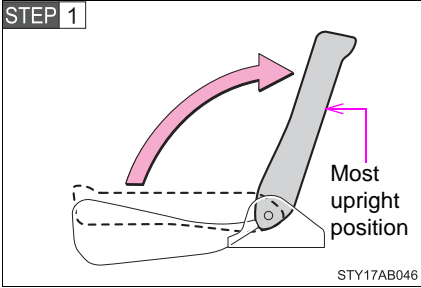

Fold down the seatback and back to the most upright position until it locks into place.

► Type A

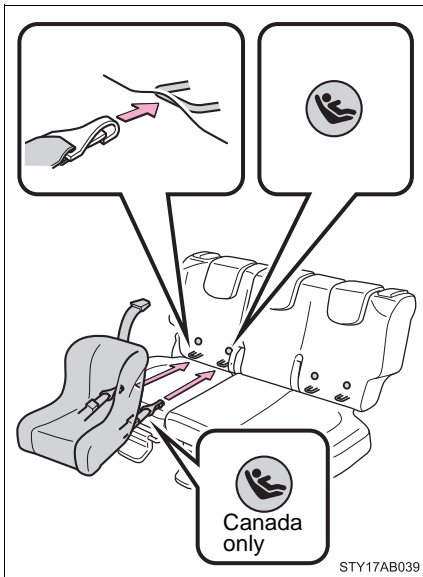

STEP 2 Widen the gap between the seat cushion and seatback slightly.

STEP 3 Latch the hooks of the lower straps onto the LATCH anchors and tighten the lower straps.

STEP 4 If the child restraint has a top tether strap, the top tether strap should be latched onto the top tether strap anchor. (→P. 109)

For owners in Canada:
The symbol on a child restraint system indicates the presence of a lower connector system.

► Type B

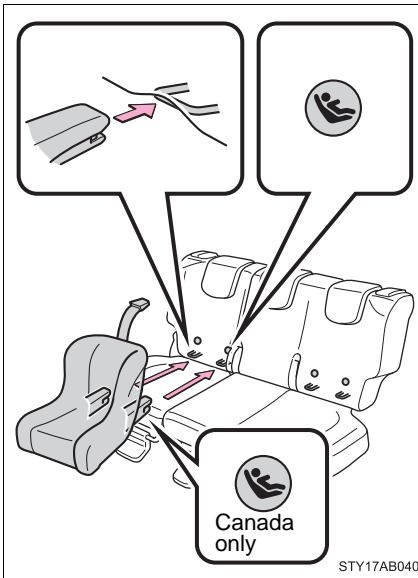

STEP 2 Widen the gap between the seat cushion and seatback slightly.

STEP 3 Latch the buckles onto the LATCH anchors.

STEP 4 If the child restraint has a top tether strap, the top tether strap should be latched onto the top tether strap anchor. (→P. 109)

For owners in Canada:
The symbol on a child restraint system indicates the presence of a lower connector system.

Installing child restraints using a seat belt (child restraint lock function belt)

n Rear facing — Infant seat/convertible seat

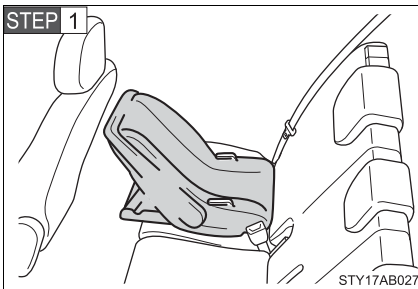

Place the child seat on the rear seat facing the rear of the vehicle.

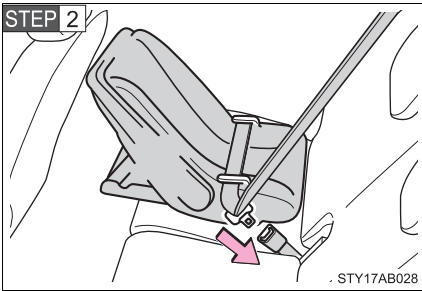

Run the seat belt through the child seat and insert the plate into the buckle. Make sure that the belt is not twisted.

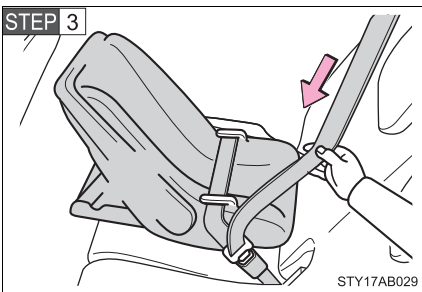

Fully extend the shoulder belt and then allow it to retract slightly in order to activate the ALR lock mode.

Lock mode allows the seat belt to retract only.

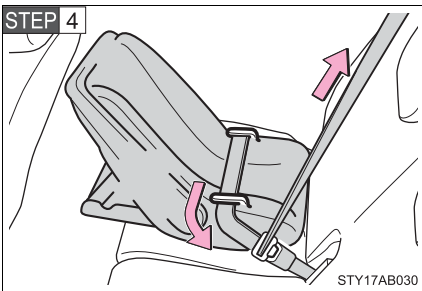

While pushing the child seat down into the rear seat, allow the shoulder belt to retract until the child seat is securely in place.

After the shoulder belt has retracted to a point where there is no slack in the belt, pull the belt to check that it cannot be extended.

n Forward facing — Convertible seat

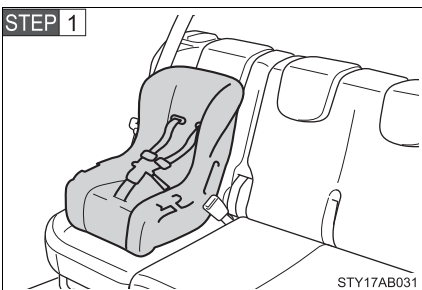

Place the child seat on the seat facing the front of the vehicle.

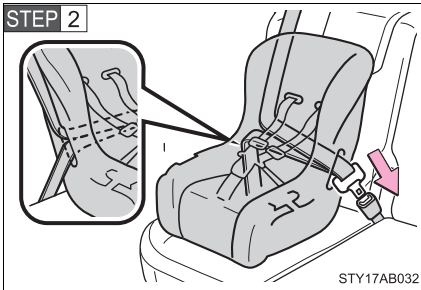

Run the seat belt through the child seat and insert the plate into the buckle. Make sure that the belt is not twisted.

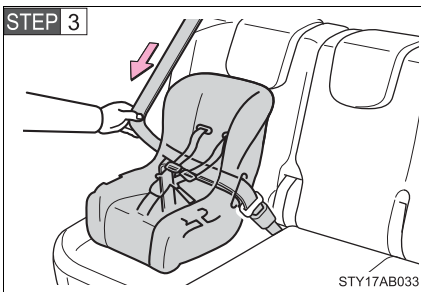

Fully extend the shoulder belt and then allow it to retract slightly in order to activate the ALR lock mode.

Lock mode allows the seat belt to retract only.

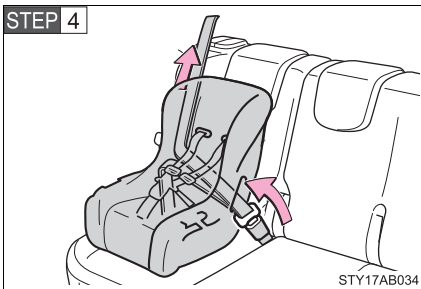

While pushing the child seat down into the rear seat, allow the shoulder belt to retract until the child seat is securely in place.

After the shoulder belt has retracted to a point where there is no slack in the belt, pull the belt to check that it cannot be extended.

STEP 5 If the child restraint has a top tether strap, the top tether strap should be latched onto the top tether strap anchor. (→P. 109)

n Booster seat

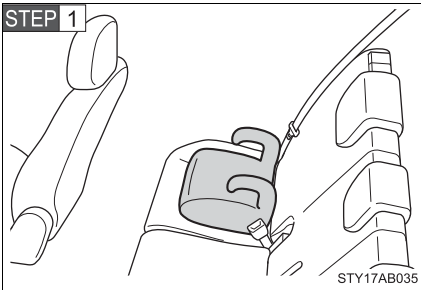

Place the booster seat on the seat facing the front of the vehicle.



Sit the child in the booster seat. Fit the seat belt to the booster seat according to the manufacturer's instructions and insert the plate into the buckle. Make sure that the belt is not twisted.

Check that the shoulder belt is correctly positioned over the child's shoulder, and that the lap belt is as low as possible.

(→P. 52)

Removing a child restraint installed with a seat belt

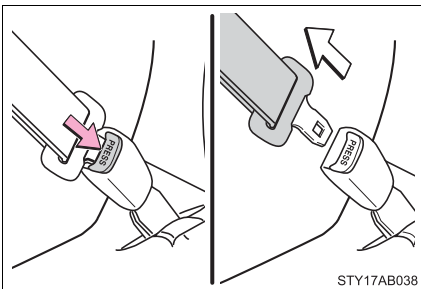

Push the buckle release button and fully retract the seat belt.

Child restraint systems with a top tether strap

STEP 1 Remove the luggage cover. (→P. 226)

STEP 2 Remove the deck board and auxiliary boxes. (→P. 225)

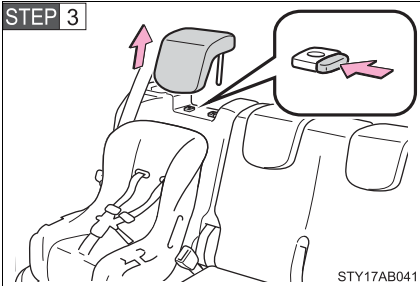

Remove the head restraint.

► Split rear seats (type A), Non-split rear seat

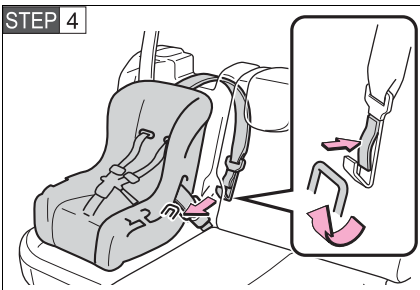

Latch the hook onto the anchor bracket and tighten the top tether strap.

Make sure the top tether strap is securely latched.

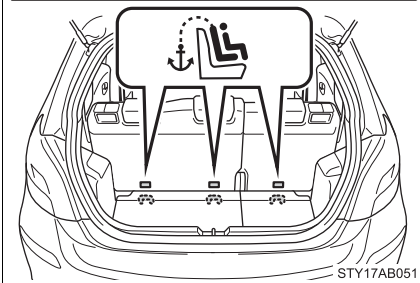

► Split rear seats (type B)

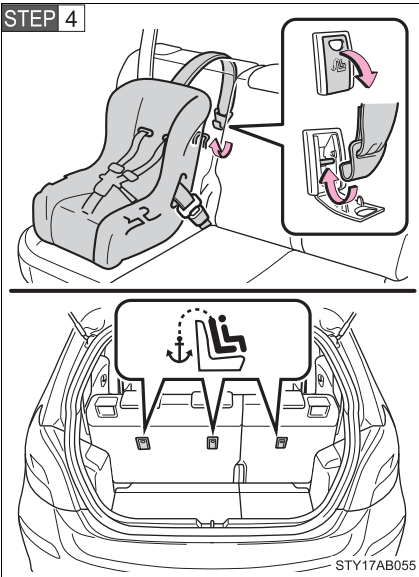

Latch the hook onto the anchor bracket and tighten the top tether strap.

Make sure the top tether strap is securely latched.

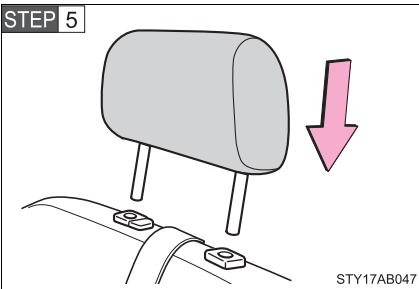

Non-split rear seat only:
Reinstall the head restraint.

STEP 6 Reinstall the auxiliary boxes, deck board and luggage cover.

▮ **Laws and regulations pertaining to anchorages**

The LATCH system conforms to FMVSS225 or CMVSS210.2.

Child restraint systems conforming to FMVSS213 or CMVSS213 specifications can be used.

This vehicle is designed to conform to the SAE J1819.

⚠ CAUTION

n When installing a booster seat

Do not fully extend the shoulder belt to prevent the belt from going to ALR lock mode. (→P. 57)

ALR mode causes the belt to tighten only which could cause injury or discomfort to the child.

n When installing a child restraint system

Follow the directions given in the child restraint system installation manual and fix the child restraint system securely in place.

If the child restraint system is not correctly fixed in place, the child or other passengers may be seriously injured or even killed in the event of sudden braking or an accident.

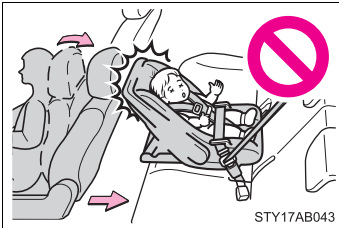

! If the driver's seat interferes with the child restraint system and prevents it from being attached correctly, attach the child restraint system to the right-hand rear seat.

! Adjust the front passenger seat so that it does not interfere with the child restraint system.

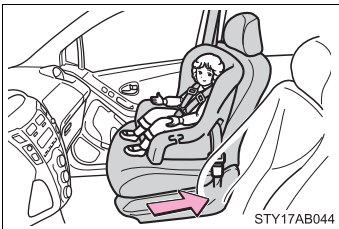

! Only put a forward-facing or booster child seat on the front seat when unavoidable. When installing a forward-facing or booster child seat on the front passenger seat, move the seat as far back as possible even if AIR BAG OFF indicator light is illuminated. Failing to do so may result in death or serious injury if the airbags deploy (inflate).

 CAUTION

n When installing a child restraint system

- I** Split rear seats: When installing a child restraint system in the rear center seat, adjust both seat cushions to the same position and align seatbacks at the same angle. The seatbacks must be adjusted to the same angle. Otherwise, the child restraint system cannot be securely restrained and this may cause death or serious injuries in a collision.
- I** Split rear seats: When using the LATCH anchors for a child restraint system, move the seat as far back as possible and adjust the seatback as upright as possible.
- I** When a booster seat is installed, always ensure that the shoulder belt is positioned across the center of the child's shoulder. The belt should be kept away from the child's neck, but not so that it could fall off the child's shoulder. Failing to do so may result in death or serious injury in the event of an accident or sudden braking.
- I** Ensure that the belt and tab are securely locked and the seat belt is not twisted.
- I** Push and pull the child restraint system from side to side and forward to be sure it is secure.
- I** After securing a child restraint system, never adjust the seat.
- I** Follow all installation instructions provided by the child restraint system manufacturer.
- I** Split rear seats: When a child restraint system with a top tether strap is installed, do not install the head restraint. The head restraint may interfere with the top tether strap preventing secure installation of the child restraint system.
- I** Split rear seats: Make sure to properly store the removed head restraint in a secure place when you use the child restraint system on the rear seats.

 **CAUTION****n Do not use a seat belt extender**

If a seat belt extender is used when installing a child restraint system, the seat belt will not securely hold the child restraint system, which could cause death or serious injury to the child or other passengers in the event of a collision.

n To correctly attach a child restraint system to the anchors

When using the LATCH anchors, be sure that there are no foreign objects around the anchors and that the seat belt is not caught behind the child restraint. Make sure the child restraint system is securely attached, or it may cause death or serious injury to the child or other passengers in the event of a sudden stop or accident.

2-1. Driving procedures

Driving the vehicle

The following procedures should be observed to ensure safe driving.

n Starting the engine (→ P. 125)

n Driving

▶ Automatic transmission

STEP 1 With the brake pedal depressed, shift the shift lever to D. (→P. 128)

STEP 2 Release the parking brake. (→P. 132)

STEP 3 Gradually release the brake pedal and gently depress the accelerator pedal to accelerate the vehicle.

▶ Manual transmission

STEP 1 With the clutch pedal fully depressed, shift the shift lever to 1. (→P. 130)

STEP 2 Release the parking brake. (→P. 132)

STEP 3 Gradually release the clutch pedal. At the same time, gently depress the accelerator pedal to accelerate the vehicle.

n Stopping

▶ Automatic transmission

STEP 1 With the shift lever in D, depress the brake pedal.

STEP 2 If necessary, set the parking brake.

When the vehicle is stopped for an extended period of time, shift the shift lever to P or N. (→P. 128)

▶ Manual transmission

STEP 1 With the clutch pedal fully depressed, depress the brake pedal.

STEP 2 If necessary, set the parking brake.

When the vehicle is stopped for an extended period of time, shift the shift lever to N. (→P. 130)

n Parking the vehicle

► Automatic transmission

STEP 1 With the shift lever in D, depress the brake pedal.

STEP 2 Set the parking brake. (→P. 132)

STEP 3 Shift the shift lever to P. (→P. 128)

When parking on a hill, if necessary, block the wheels.

STEP 4 Turn the engine switch off to stop the engine.

STEP 5 Lock the door, making sure that you have the key on your person.

► Manual transmission

STEP 1 With the clutch pedal fully depressed, depress the brake pedal.

STEP 2 Set the parking brake. (→P. 132)

STEP 3 Shift the shift lever to N. (→P. 130)

When parking on a hill, shift the shift lever to 1 or R. If necessary, block the wheels.

STEP 4 Turn the engine switch off to stop the engine.

STEP 5 Lock the door, making sure that you have the key on your person.

Starting on a steep uphill

► Automatic transmission

STEP 1 With the brake pedal depressed, firmly set the parking brake and shift the shift lever to D.

STEP 2 Gently depress the accelerator pedal.

STEP 3 Release the parking brake.

► Manual transmission

STEP 1 With the parking brake firmly set and the clutch pedal fully depressed, shift the shift lever to 1.

STEP 2 Lightly depress the accelerator pedal at the same time as gradually releasing the clutch pedal.

STEP 3 Release the parking brake.

▢ **Driving in the rain**

- l Drive carefully when it is raining, because visibility will be reduced, the windows may become fogged-up, and the road will be slippery.
- l Drive carefully when it starts to rain, because the road surface will be especially slippery.
- l Refrain from high speeds when driving on an expressway in the rain, because there may be a layer of water between the tires and the road surface, preventing the steering and brakes from operating properly.

▢ **Breaking in your new Toyota**

To extend the life of the vehicle, the following precautions are recommended to observe:

- l For the first 200 miles (300 km):
Avoid sudden stops.
- l For the first 500 miles (800 km):
Do not tow a trailer.
- l For the first 1000 miles (1600 km):
 - Do not drive at extremely high speeds.
 - Avoid sudden acceleration.
 - Do not drive continuously in the low gears.
 - Do not drive at a constant speed for extended periods.

▢ **Operating your vehicle in a foreign country**

Comply with the relevant vehicle registration laws and confirm the availability of the correct fuel. (→P. 346)

▢ **Normal characteristics after turning off the engine**

Approximately five hours after the engine is turned off, you may hear sound coming from under the vehicle for several minutes. This is the sound of a fuel evaporation leakage check and, it does not indicate a malfunction.

 **CAUTION**
n When starting the vehicle

Vehicles with an automatic transmission, always keep your foot on the brake pedal while stopped with the engine running. This prevents the vehicle from creeping.

n When driving the vehicle

I Do not drive if you are unfamiliar with the location of the clutch, brake and accelerator pedals to avoid depressing the wrong pedal.

- Accidentally depressing the accelerator pedal instead of the brake pedal will result in sudden acceleration that may lead to an accident that could result in death or serious injury.
- When backing up, you may twist your body around, leading to a difficulty in operating the pedals. Make sure to operate the pedals properly.
- Make sure to keep a correct driving posture even when moving the vehicle only slightly, allowing you to depress the brake and accelerator pedals properly.
- Depress the brake pedal using your right foot. Depressing the brake pedal using your left foot may delay response in an emergency, resulting in an accident.

I Do not drive the vehicle over or stop the vehicle near flammable materials. The exhaust system and exhaust gases can be extremely hot. This may cause a fire if there is any flammable material nearby.

I Vehicles with an automatic transmission, do not let the vehicle roll backwards while the shift lever is in a driving position, or roll forward while the shift lever is in R.

Doing so may cause the engine to stall or lead to poor brake and steering performance, resulting in an accident or damage to the vehicle.

I If the smell of exhaust is noticed inside the vehicle, open the windows and check that the back door is closed. Large amounts of exhaust in the vehicle can cause driver drowsiness and an accident, resulting in death or a serious health hazard. Have the vehicle inspected by your Toyota dealer immediately.

I Do not under any circumstances shift the shift lever to P, R or N (automatic transmission) or R (manual transmission) while the vehicle is moving.

Doing so can cause significant damage to the transmission system and may result in a loss of vehicle control.

 CAUTION

n When driving the vehicle

- I** Do not shift the shift lever to N while the vehicle is moving.
Doing so may cause the engine brake to not operate properly and lead to an accident.
- I** Do not turn the engine off while driving.
The power steering and brake booster systems will not operate properly if the engine is not running.
- I** Use engine braking (downshift) to maintain a safe speed when driving down a steep hill.
Using the brakes continuously may cause the brakes to overheat and lose effectiveness. (→P. 128,130)
- I** When stopped on an inclined surface, use the brake pedal and parking brake to prevent the vehicle from rolling backward or forward and causing an accident.
- I** Do not adjust the position of the steering wheel, the seat, or the inside or outside rear view mirrors while driving.
Doing so may result in a loss of vehicle control that can cause accidents that may result in death or serious injury.
- I** Always check that all passengers' arms, heads or other parts of their bodies are not outside the vehicle, as this may result in death or serious injury.
- I** Do not drive in excess of the speed limit. Even if the legal speed limit permits it, do not drive over 85 mph (140 km/h) unless your vehicle has high-speed capability tires. Driving over 85 mph (140 km/h) may result in tire failure, loss of control and possible injury. Be sure to consult a tire dealer to determine whether the tires on your vehicle are high-speed capability tires or not before driving at such speeds.

n When driving on slippery road surfaces

- I** Sudden braking, acceleration and steering may cause tire slippage and reduce your ability to control the vehicle, resulting in an accident.
- I** Sudden changes in engine speed, such as engine braking caused by up-shifting or down-shifting, may cause the vehicle to skid, resulting in an accident.

 **CAUTION****n When driving on slippery road surfaces**

- I** After driving through a puddle, lightly depress the brake pedal to make sure that the brakes are functioning properly. Wet brake pads may prevent the brakes from functioning properly. If the brakes on only one side are wet and not functioning properly, steering control may be affected, resulting in an accident.

n When shifting the shift lever

Vehicles with an automatic transmission, be careful not to shift the shift lever with the accelerator pedal depressed.

This may lead to unexpected rapid acceleration of the vehicle that may cause an accident and result in death or serious injury.

n When the vehicle is stopped

- I** Do not race the engine.

If the vehicle is in any gear other than P (automatic transmission only) or N, the vehicle may accelerate suddenly and unexpectedly, and may cause an accident.

- I** Do not leave the vehicle with the engine running for a long time.

If such a situation cannot be avoided, park the vehicle in an open space and check that exhaust fumes do not enter the vehicle interior.

- I** Vehicles with an automatic transmission, always keep a foot on the brake pedal while the engine is running to prevent an accident caused by the vehicle moving.

n When the vehicle is parked

- I** Do not leave glasses, cigarette lighters, spray cans, or soft drink cans in the vehicle when it is in the sun.

Doing so may result in the following.

- Gas may leak from a cigarette lighter or spray can, and may lead to a fire.
- The temperature inside the vehicle may cause the plastic lenses and plastic material of eye glasses to deform or crack.
- Soft drink cans may fracture, causing the contents to spray over the interior of the vehicle, and may also cause a short circuit in the vehicle's electrical components.

 **CAUTION**

n When the vehicle is parked

- I** Always apply the parking brake, shift the shift lever to P (automatic transmission only), stop the engine and lock the vehicle.
Do not leave the vehicle unattended while the engine is running.
- I** Do not touch the exhaust pipe while the engine is running or immediately after turning the engine off.
Doing so may cause burns.
- I** Do not leave the engine running in an area with snow build-up, or where it is snowing. If snowbanks build up around the vehicle while the engine is running, exhaust gases may collect and enter the vehicle. This may lead to death or a serious health hazard.

n Exhaust gases

Exhaust gases include harmful carbon monoxide (CO) that is colorless and odorless. Inhaling exhaust gases may lead to death or a serious health hazard.

- I** If the vehicle is in a poorly ventilated area, stop the engine. In a closed area, such as a garage, exhaust gases may collect and enter the vehicle. This may lead to death or a serious health hazard.
- I** The exhaust should be checked occasionally. If there is a hole or crack caused by corrosion, damage to a joint or abnormal exhaust noise, be sure to have the vehicle inspected and repaired by your Toyota dealer. Failure to do so may allow exhaust gases to enter the vehicle, resulting in death or a serious health hazard.

n When taking a nap in the vehicle

Always turn the engine off. Otherwise, you may accidentally move the shift lever or depress the accelerator pedal, which could cause an accident or fire due to engine overheating. Additionally, if the vehicle is parked in a poorly ventilated area, exhaust gases may collect and enter the vehicle, leading to death or a serious health hazard.

n When braking the vehicle

- I** When the brakes are wet, drive more cautiously.
Braking distance increases when the brakes are wet, and may cause one side of the vehicle to brake differently than the other side. Also the parking brake may not securely hold the vehicle.

 **CAUTION**
n When braking the vehicle

- I** If the power brake assist function does not operate, do not follow other vehicles closely and avoid downhills or sharp turns that require braking. In this case, braking is still possible, but it will require more force on the pedal than usual. Braking distance may also increase.
- I** Do not pump the brake pedal if the engine stalls.
Each push on the brake pedal uses up the reserve for the power-assisted brakes.
- I** The brake system consists of 2 individual hydraulic systems: If one of the systems fails, the other will still operate. In this case, the brake pedal should be depressed more firmly than usual and braking distance becomes longer.
Do not drive your vehicle with only a single brake system. Have your brakes fixed immediately.

 **NOTICE**
n When driving the vehicle
► Vehicles with a manual transmission

- I** Do not rest your foot on the clutch pedal while driving.
Doing so may cause clutch trouble.
- I** Do not use any gears other than the first gear when starting off and moving forward.
Doing so may damage the clutch.
- I** Do not use the clutch to hold the vehicle when stopping on an uphill grade.
Doing so may damage the clutch.

► Vehicles with an automatic transmission

- I** Do not use the accelerator pedal or depress accelerator and brake pedals together to hold the vehicle on a hill.

n When parking the vehicle

Vehicles with an automatic transmission: Always put the shift lever in P. Failure to do so may cause the vehicle to move or the vehicle may accelerate suddenly if the accelerator pedal is accidentally depressed.

 NOTICE

n Avoiding damage to vehicle parts

- ! Do not turn the steering wheel fully in either direction and hold it there for a long time.
Doing so may damage the power steering motor.
- ! When driving over bumps in the road, drive as slowly as possible to avoid damaging the wheels, underside of the vehicle, etc.

n If you hear a squealing or scraping noise while driving (brake pad wear limit indicators)

Have the brake pads checked and replaced by your Toyota dealer as soon as possible.

The rotor damage can result if the pads are not replaced when needed.

It is dangerous to drive the vehicle when the wear limits of the brake pads and/or that of the brake discs are exceeded.

n If you get a flat tire while driving

A flat or damaged tire may cause the following situations. Hold the steering wheel firmly and gradually press the brake pedal to slow down the vehicle.

- ! It may be difficult to control your vehicle.
- ! The vehicle will make abnormal sounds.
- ! The vehicle will behave abnormally.

Replace a flat tire with a new one. (→P. 320)

n When encountering flooded roads

Do not drive on a road that has flooded after heavy rain etc. Doing so may cause the following serious damage to the vehicle.

- ! Engine stalling
- ! Short in electrical components
- ! Engine damage caused by water immersion

In the event that you drive on a flooded road and the vehicle is flooded, be sure to have your Toyota dealer check the following.

- ! Brake function
- ! Changes in quantity and quality of engine oil, transaxle fluid, etc.
- ! Lubricant condition for the bearings and suspension joints (where possible) and the function of all joints, bearings, etc.

2-1. Driving procedures

Engine (ignition) switch

n Engine switch

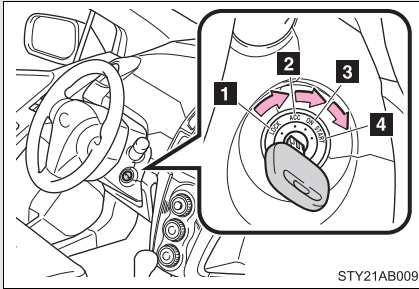

1 LOCK

The steering wheel is locked and the key can be removed.

2 ACC

Some electrical components such as the audio system can be used.

3 ON

All electrical components can be used.

4 START

For starting the engine.

n Starting the engine

► Automatic transmission

STEP 1 Check that the parking brake is set.

STEP 2 Check that the shift lever is set in P.

STEP 3 Sit in the driver's seat and firmly depress the brake pedal.

STEP 4 Turn the engine switch to the START position and start the engine.

The engine will crank until it starts or for up to 20 seconds, whichever is less.

Continue depressing the brake pedal until the engine is completely started.

► Manual transmission

STEP 1 Check that the parking brake is set.

STEP 2 Check that the shift lever is set in N.

STEP 3 Firmly depress the brake pedal and clutch pedal.

STEP 4 Turn the engine switch to the START position and start the engine.

The engine will crank until it starts or for up to 20 seconds, whichever is less.

Continue depressing the brake pedal and clutch pedal until the engine is completely started.

□ Turning the key from ACC to LOCK

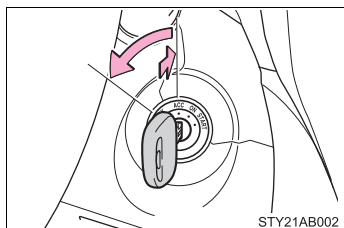

STEP 1 Shift the shift lever to P (automatic transmission) or N (manual transmission).
(→P. 128, 130)

STEP 2 Push in the key and turn to the LOCK position.

□ Steering lock release

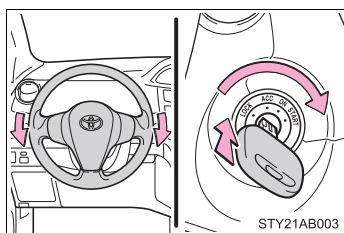

When starting the engine, the engine switch may seem stuck in the LOCK position. To free it, turn the key while turning the steering wheel slightly in either direction.

□ If the engine does not start (vehicles with engine immobilizer system)

The engine immobilizer system may not have been deactivated. (→P. 74)

n Key reminder function

A buzzer sounds if the driver's door is opened, while the engine switch is in the ACC or LOCK position to remind you to remove the key.

CAUTION

n When starting the engine

Always start the engine while sitting in the driver's seat. Do not depress the accelerator while starting the engine under any circumstances.

Doing so may cause an accident resulting in death or serious injury.

n Caution while driving

Do not turn the engine switch to the LOCK position.

If in an emergency, you must turn the engine off while the vehicle is moving, turn the key only to the ACC position.

NOTICE

n To prevent battery discharge

Do not leave the key in the ACC or ON position for long periods if the engine is not running.

n When starting the engine

l Do not crank for more than 30 seconds at a time. This may overheat the starter and wiring systems.

l Do not race a cold engine.

l If the engine becomes difficult to start or stalls frequently, have the engine checked immediately.

Select a shift position appropriate for the driving conditions.

n **Shifting the shift lever**

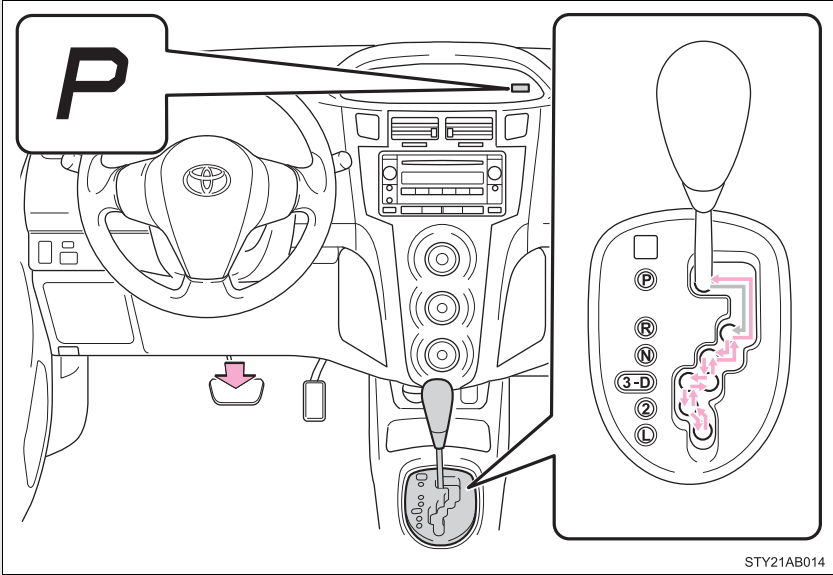

← While the engine switch is on, depress the brake pedal and move the shift lever.

n Shift position uses

Shift position	Function
P	Parking the vehicle or starting the engine
R	Reversing
N	Neutral
D	Normal driving*
3	Position for engine braking
2	Position for more powerful engine braking
L	Position for maximum engine braking

*: To improve fuel consumption and reduce noises, set the shift lever in D for normal driving.

n Downshifting restrictions

The shift lever cannot be downshifted if the following speeds are exceeded.

mph (km/h)

Downshifting	Maximum speed
3→2	53 (86)
2→L	26 (43)

n If the shift lever cannot be shifted from P (→P. 331)

n Shifting the shift lever

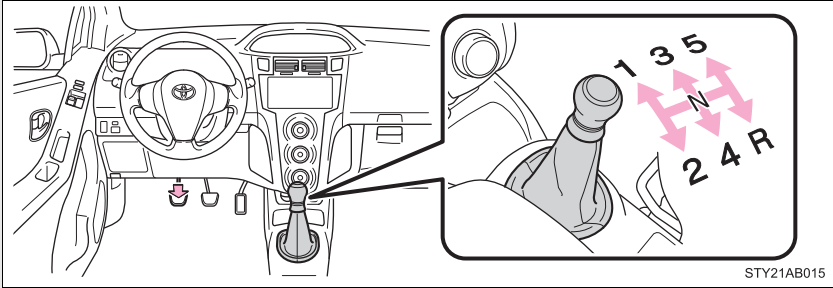

Fully depress the clutch pedal before operating the shift lever, and then release it slowly.

n Maximum allowable speeds

Observe the following maximum allowable speeds in each gear when maximum acceleration is necessary.

mph (km/h)

Shift position	Maximum speed
1	31 (51)
2	59 (95)
3	86 (139)

2-1. Driving procedures

Turn signal lever

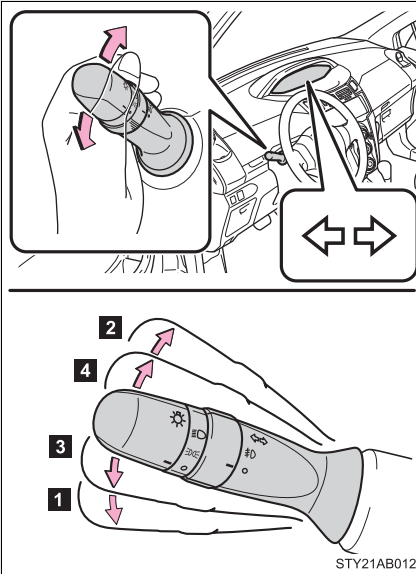

1 Left turn

2 Right turn

3 Move and hold the lever partway to signal a lane change.

The left hand signal will flash until you release the lever.

4 Move and hold the lever partway to signal a lane change.

The right hand signal will flash until you release the lever.

2

When driving

n **Turn signals can be operated when**

The engine switch is in the ON position.

n **If the indicators flash faster than usual**

Check that a light bulb in the front or rear turn signal lights has not burned out.

2-1. Driving procedures

Parking brake

n Set the parking brake

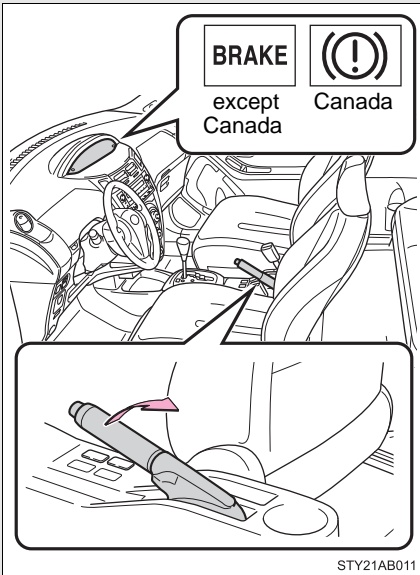

Fully set the parking brake while depressing the brake pedal.

At this time, the indicator will come on.

n Release the parking brake

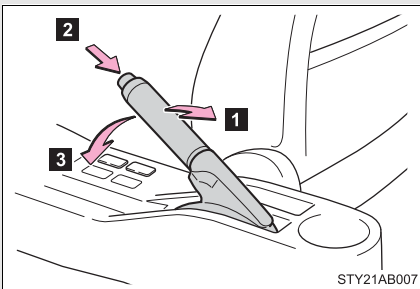

1 Slightly raise the lever

2 Press the button

3 Lower it completely

**NOTICE****n Before driving**

Fully release the parking brake.

Driving the vehicle with the parking brake set will lead to brake components overheating, which may affect braking performance and increase brake wear.

I Parking brake engaged warning buzzer (→P. 307)

Horn

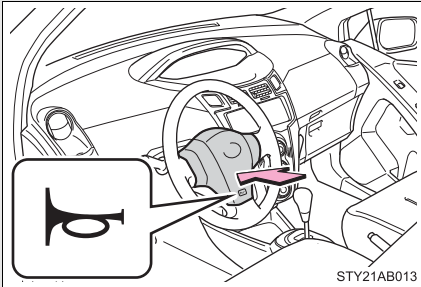

To sound the horn, press on or close to the  mark.

■ **After adjusting the steering wheel**

Make sure that the steering wheel is securely locked.

The horn may not sound if the steering wheel is not securely locked.

(→P. 62)

2-2. Instrument cluster

Gauges and meters

► Vehicles with tachometer

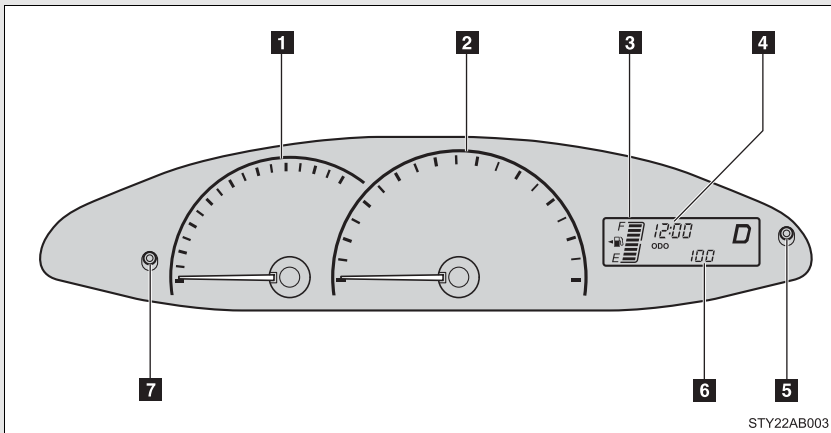

The following gauges, meters and displays illuminate when the engine switch is in the ON position.

1 Tachometer

Displays the engine speed in revolutions per minute.

2 Speedometer

Displays the vehicle speed.

3 Fuel gauge

Displays the quantity of fuel remaining in the tank.

4 Clock

Indicates the time.

5 Clock reset button

Adjusts the time. (→P. 221)

6 Odometer/trip meter

Odometer:

Displays the total distance the vehicle has been driven.

Trip meter:

Displays the distance the vehicle has been driven since the meter was last reset. Trip meters A and B can be used to record and display different distances independently.

7 Odometer/trip meter switching and trip meter resetting button

Switches between odometer and trip meter displays. Pushing and holding the button will reset the trip meter when the trip meter is being displayed.

► Vehicles without tachometer

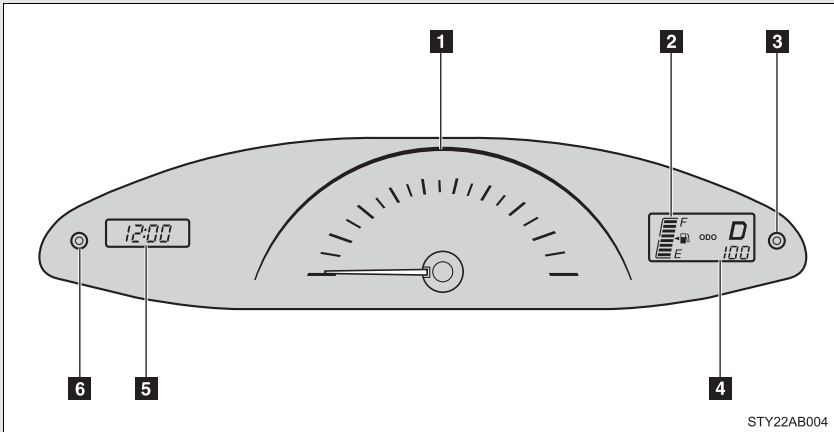

1 Speedometer

Displays the vehicle speed.

2 Fuel gauge

Displays the quantity of fuel remaining in the tank.

3 Odometer/trip meter switching and trip meter resetting button

Switches between odometer and trip meter displays. Pushing and holding the button will reset the trip meter when the trip meter is being displayed.

4 Odometer/trip meter

Odometer:

Displays the total distance the vehicle has been driven.

Trip meter:

Displays the distance the vehicle has been driven since the meter was last reset. Trip meters A and B can be used to record and display different distances independently.

5 Clock

Indicates the time.

6 Clock reset button

Adjusts the time. (→P. 221)

Odometer and trip meter display button

Pressing this button switches between odometer and trip meter displays.

► Vehicles with tachometer

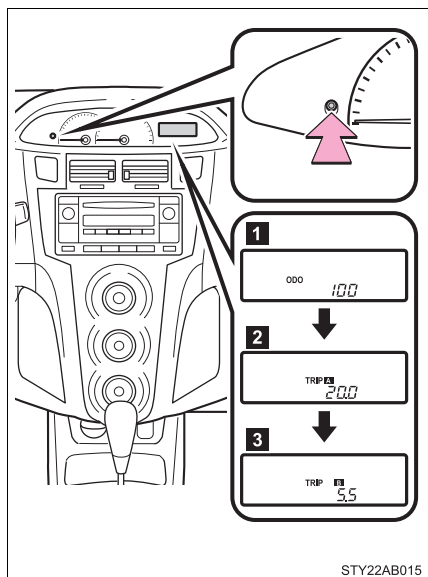

1 Odometer

2 Trip meter A *

3 Trip meter B *

*:Pushing and holding the button will reset the trip meter.

► Vehicles without tachometer

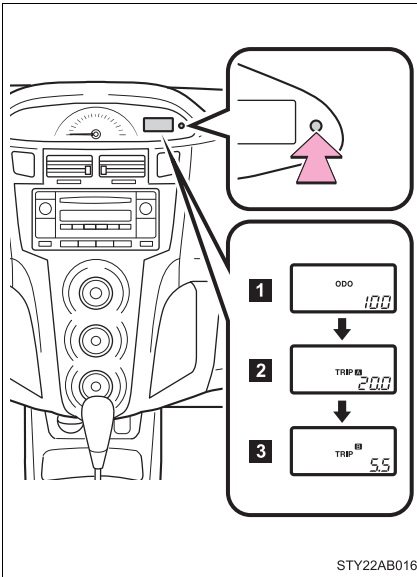

- 1 Odometer
- 2 Trip meter A*
- 3 Trip meter B*

*:Pushing and holding the button will reset the trip meter.

Instrument panel light control

The brightness of the instrument panel lights can be adjusted.

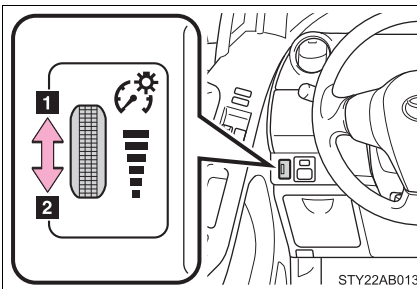

- 1 Brighter
- 2 Darker

With the dial turned fully up, the intensity of the instrument panel lights will not be reduced even when the tail lights/headlights are turned on.



NOTICE

n To prevent damage to the engine and its components

- l** Do not let the indicator needle of the tachometer enter the red zone, which indicates the maximum engine speed.
- l** The engine may be overheating if the high engine coolant temperature warning light comes on. In this case, immediately stop the vehicle in a safe place, and check the engine after it has cooled completely. (→P. 337)

Indicators and warning lights

The indicator and warning lights on the instrument cluster and center panel inform the driver of the status of the vehicle's various systems.

► Instrument cluster (vehicles with tachometer)

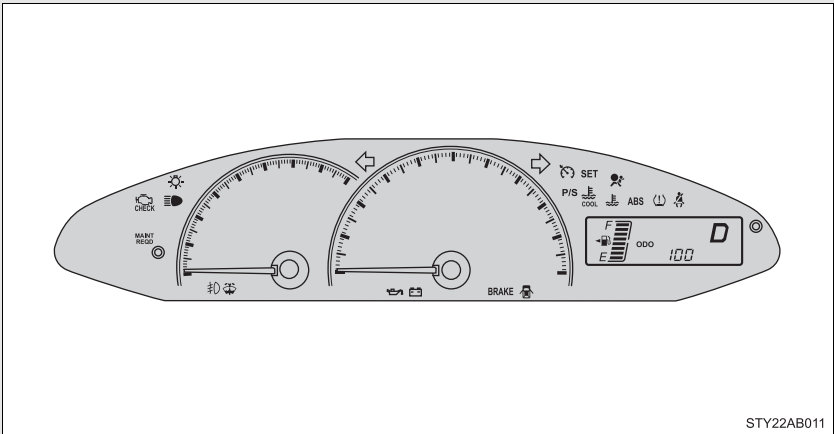

► Instrument cluster (vehicles without tachometer)

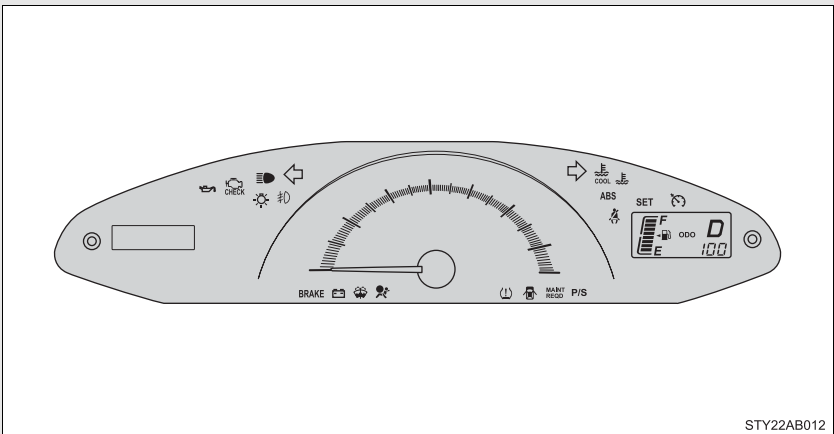

► Center panel

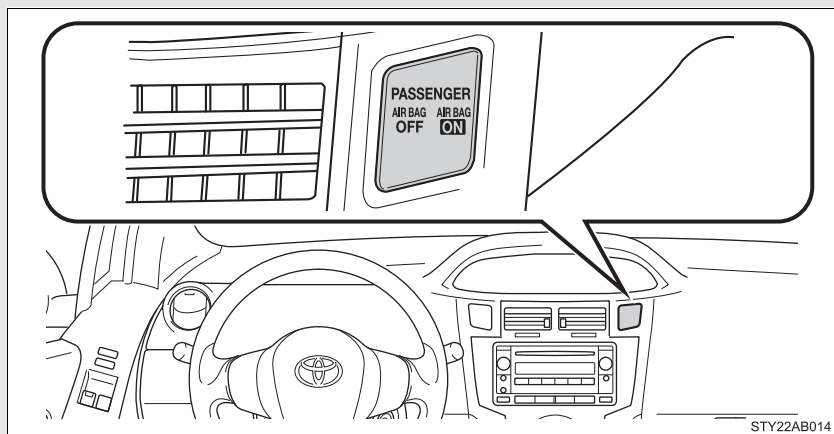

n Indicators

The indicators inform the driver of the operating state of the vehicle's various systems.



Turn signal indicator
(→P. 131)



Headlight high beam indicator (→P. 145)



(except
Canada)

Headlight indicator
(→P. 145)



(Canada)

Tail light indicator
(→P. 145)



(if equipped)

Front fog light indicator
(→P. 147)



(Automatic transmission vehicles)
Shift position and shift range indicators (→P. 128)



Low engine coolant temperature indicator
Indicates the engine coolant temperature is cool.



(vehicles with
tachometer)

Low fuel level indicator
Remaining fuel

- Flash
(Approximately 1.6 gal. [6.3 L, 1.3 Imp.gal.] or less)
- Fast flash
(Approximately 1.1 gal. [4.2 L, 0.9 Imp.gal.] or less)



(vehicles
without
tachometer)



(if equipped)

Cruise control main indicator (→P. 152)



(if equipped)

Cruise control set indicator (→P. 152)



AIR BAG ON indicator
(→P. 93)



AIR BAG OFF indicator
(→P. 93)

n Warning lights

Warning lights inform the driver of malfunctions in any of the vehicle's systems. (→P. 307)

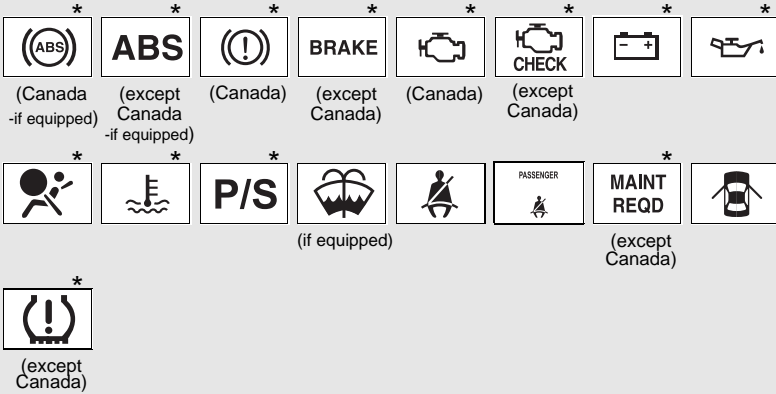

*: These lights turn on when the engine switch is turned to the ON position to indicate that a system check is being performed. They will turn off after the engine is started, or after a few seconds. There may be a malfunction in a system if a light does not come on, or if the lights do not turn off. Have the vehicle inspected by your Toyota dealer.

⚠ CAUTION

n If a safety system warning light does not come on

Should a safety system light such as ABS and the SRS airbag warning light not come on when you start the engine, this could mean that these systems are not available to help protect you in an accident, which could result in death or serious injury. Have the vehicle inspected by your Toyota dealer immediately if this occurs.

2-3. Operating the lights and wipers

Headlight switch

The headlights can be operated manually or automatically.

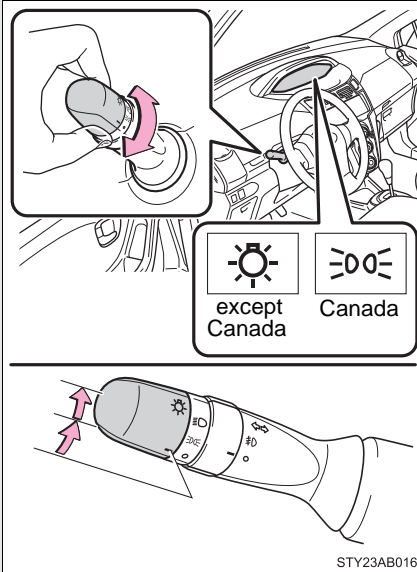

 The side marker, parking, tail, license plate and instrument panel lights turn on.

 The headlights and all lights listed above turn on.

2

When driving

Turning on the high beam headlights

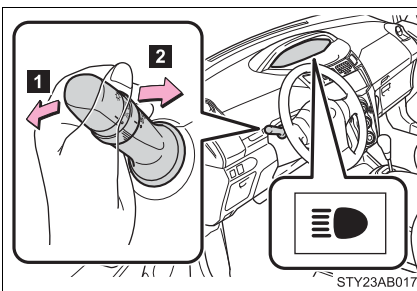

1 With the headlights on, push the lever forward to turn on the high beams.

Pull the lever back to the center position to turn the high beams off.

2 Pull the lever toward you to turn on the high beams.

Release the lever to turn them off. You can flash the high beams with the headlights on or off.

■ **Daytime running light system (if equipped)**

To make your vehicle more visible to other drivers, the headlights turn on automatically (at a reduced intensity) whenever the engine is started and the parking brake is released. Daytime running lights are not designed for use at night.

■ **Light reminder buzzer**

A buzzer sounds when the key is removed and the driver's door is opened while the lights are turned on.

 **NOTICE**

■ **To prevent battery discharge**

Do not leave the lights on longer than necessary when the engine is not running.

2-3. Operating the lights and wipers Fog light switch (if equipped)

The fog lights improve visibility in difficult driving conditions, such as in rain or fog. They can be turned on only when the headlights are on low beam.

n Front fog light switch

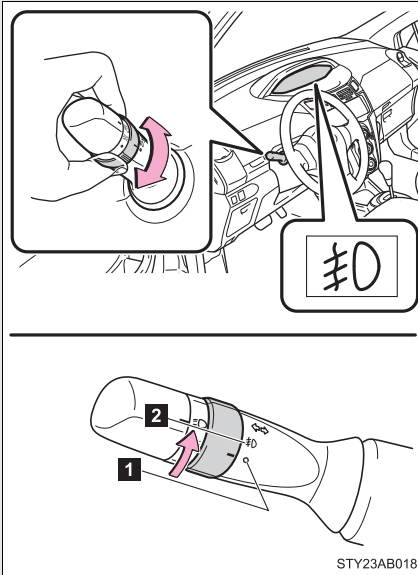

1 OFF

2 Front fog lights ON

2-3. Operating the lights and wipers Windshield wipers and washer

n Intermittent wiper without interval adjuster

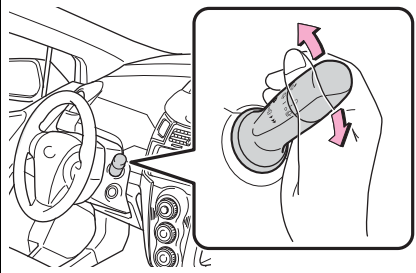

1 Intermittent windshield wiper operation

2 Low speed windshield wiper operation

3 High speed windshield wiper operation

4 Temporary operation

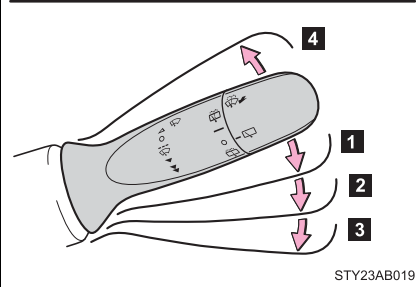

STY23AB019

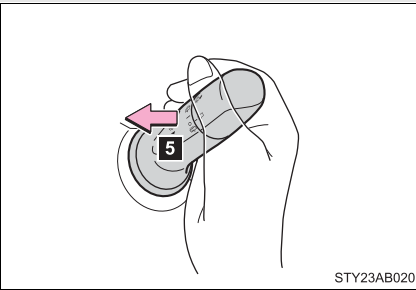

STY23AB020

5 Washer/wiper dual operation

Wipers will automatically operate a couple of times after the washer squirts.

n Intermittent wiper with interval adjuster

Wiper intervals can be adjusted for intermittent operation (when  is selected).

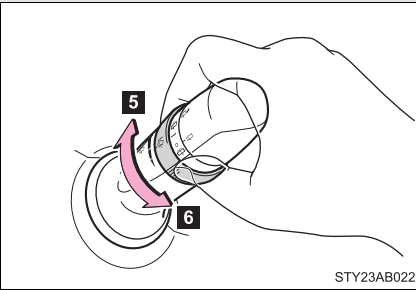
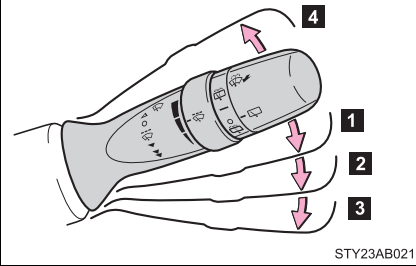
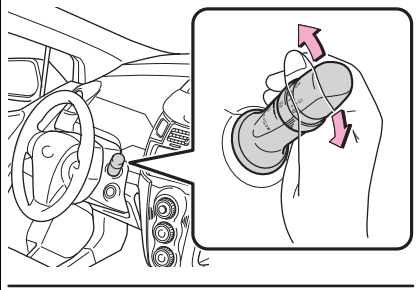

1 Intermittent windshield wiper operation

2 Low speed windshield wiper operation

3 High speed windshield wiper operation

4 Temporary operation

5 Intermittent wiper interval adjustment (decrease)

6 Intermittent wiper interval adjustment (increase)

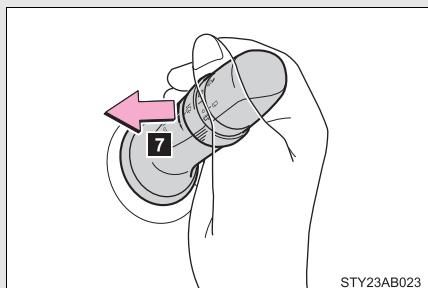

7 Washer/wiper dual operation

Wipers will automatically operate a couple of times after the washer squirts.

n The windshield wiper and washer can be operated when

The engine switch must be in the ON position.

n If no windshield washer fluid sprays

Check that the washer nozzles are not blocked and if there is washer fluid in the windshield washer fluid reservoir.

! NOTICE

n When the windshield is dry

Do not use the wipers, as they may damage the windshield.

n When there is no washer fluid spray from the nozzle

Damage to the washer fluid pump may be caused if the lever is pulled toward you and held continually.

n When a nozzle becomes block

Do not try to clear it with a pin or other object. The nozzle will be damaged.

Rear window wiper and washer (if equipped)

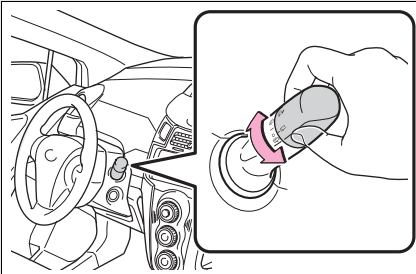

- 1 Normal window wiper operation
- 2 Washer/wiper dual operation
- 3 Washer operation

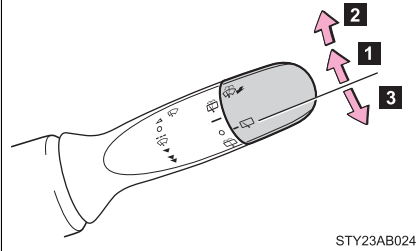

STY23AB024

n The rear window wiper and washer can be operated when

The engine switch must be in the ON position.

⚠ NOTICE

n When the rear window is dry

Do not use the wipers, as they may damage the rear window.

2-4. Using other driving systems Cruise control (if equipped)

Use cruise control to maintain a set speed without using the accelerator.

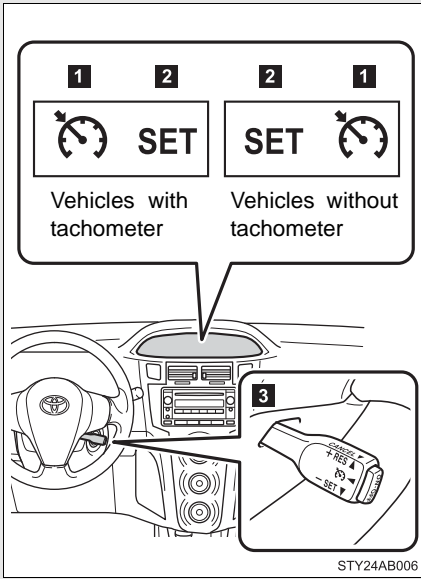

1 Cruise control main indicator

2 Cruise control set indicator

3 Cruise control switch

n Set the vehicle speed

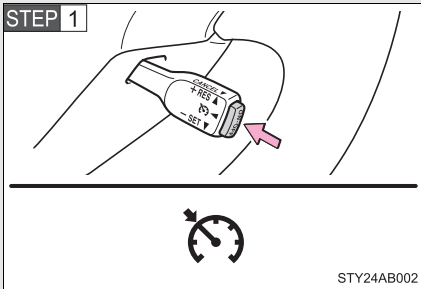

Press the ON-OFF button to turn the cruise control on.

At this time, the cruise control main indicator will come on.

Press the button once more to deactivate the cruise control.

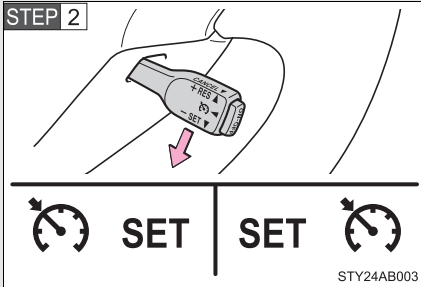

n Adjusting the speed setting

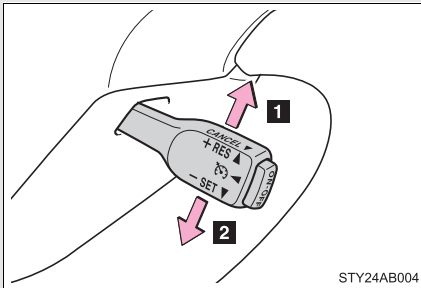

n Canceling and resuming regular acceleration

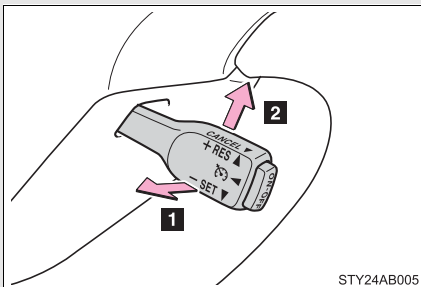

Accelerate or decelerate to the desired speed and push the lever down to set the cruise control speed.

At this time, the cruise control set indicator will come on.

- 1 Increase speed
- 2 Decrease speed

Hold the lever until the desired speed setting is obtained.

Fine adjustment of the set speed (approximately 1.0 mph [1.6 km/h]) can be made by lightly pushing the lever up or down and releasing it.

- 1 Cancel

Push the lever towards you to cancel cruise control.

The speed setting is also canceled when the brakes are applied or the clutch depressed (manual transmission).

- 2 Resume

To resume cruise control and return to the set speed, push the lever up.

n Cruise control can be set when

- | The shift lever is in D or 3 (vehicles with an automatic transmission).
- | Vehicle speed is above approximately 25 mph (40 km/h).

n Accelerating

The vehicle can be accelerated normally. After acceleration, the set speed resumes.

n Automatic cruise control cancellation

The set speed is automatically canceled in any of the following situations.

- | Actual vehicle speed falls more than 10 mph (16 km/h) below the preset vehicle speed.
At this time, the memorized set speed is not retained.
- | Actual vehicle speed is below 25 mph (40 km/h).

n If the cruise control main indicator flashes

Press the ON-OFF button to turn the cruise control off, and then reactivate the system.

If the cruise control speed cannot be set or if the cruise control cancels immediately after being activated, there may be a malfunction in the cruise control system. Have the vehicle inspected by your Toyota dealer.

 **CAUTION**

n To avoid operating the cruise control by mistake

Keep the ON-OFF button off when not in use.

n Situations unsuitable for cruise control

Do not use cruise control in any of the following situations. Doing so may result in control of the vehicle being lost and could cause serious or fatal accident.

- | In heavy traffic
- | On roads with sharp bends
- | On winding roads
- | On slippery roads, such as those covered with rain, ice or snow
- | On steep hills
- | When towing a trailer

To help enhance driving safety and performance, the following systems operate automatically in response to various driving situations. Be aware, however, that these systems are supplementary and should not be relied upon too heavily when operating the vehicle.

n ABS (Anti-lock Brake System) (if equipped)

Helps to prevent wheel lock when the brakes are applied suddenly, or if the brakes are applied while driving on a slippery road surface.

n EPS (Electric Power Steering)

Employs an electric motor to reduce the amount of effort needed to turn the steering wheel.

n Sounds and vibrations caused by the ABS

l A sound may be heard from the engine compartment when the engine is started or just after the vehicle begins to move. This sound does not indicate that a malfunction has occurred in this system.

l Any of the following conditions may occur when the above systems are operating. None of these indicates that a malfunction has occurred.

- Vibrations may be felt through the vehicle body and steering.
- A motor sound may be heard after the vehicle comes to a stop.
- The brake pedal may pulsate slightly after the ABS is activated.
- The brake pedal may move down slightly after the ABS is activated.

n EPS operation sound

When the steering wheel operates, a motor sound (whirring sound) may be heard.

This does not indicate a malfunction.

n Reduced effectiveness of EPS

The effectiveness of EPS is reduced to prevent the system from overheating when there is frequent steering input over an extended period of time. The steering wheel may feel heavy as a result. Should this occur, refrain from excessive steering input or stop the vehicle and turn the engine off. The system should return to normal within 10 minutes.

 **CAUTION**

n The ABS does not operate effectively when

- l** Tires with inadequate gripping ability are used (such as excessively worn tires on a snow covered road).
- l** The vehicle hydroplanes while driving at high speed on the wet or slick road.

n Stopping distance when the ABS is operating on the wet or slick roads

The ABS is not designed to shorten the vehicle's stopping distance. Always maintain a safe distance from the vehicle in front of you in the following situations.

- l** When driving on dirt, gravel or snow-covered roads
- l** When driving with tire chains
- l** When driving over bumps in the road
- l** When driving over roads with potholes or uneven roads

n Replacing tires

Make sure that all tires are of the same size, brand, tread pattern and total load capacity. In addition, make sure that the tires are inflated to the appropriate tire pressure level.

The ABS will not function correctly if different tires are fitted on the vehicle.

Contact your Toyota dealer for further information when replacing tires or wheels.

n Handling of tires and suspension

Using tires with any kind of problem or modifying the suspension will affect the driving assist systems, and may cause the system to malfunction.

2-5. Driving information

Cargo and luggage

Take notice of the following information about storage precautions, cargo capacity and load.

- 1 Stow cargo and luggage in the luggage compartment whenever possible.
- 1 Be sure all items are secured in place.
- 1 Be careful to keep the vehicle level. Placing the weight as far forward as possible helps maintain vehicle balance.
- 1 For better fuel economy, do not carry unnecessary weight.

Capacity and distribution

Cargo capacity depends on the total weight of the occupants.

(Cargo capacity) = (Total load capacity) – (Total weight of occupants)

Steps for Determining Correct Load Limit—

- (1) Locate the statement “The combined weight of occupants and cargo should never exceed XXX kg or XXX lbs.” on your vehicle’s placard.
- (2) Determine the combined weight of the driver and passengers that will be riding in your vehicle.
- (3) Subtract the combined weight of the driver and passengers from XXX kg or XXX lbs.
- (4) The resulting figure equals the available amount of cargo and luggage load capacity.
For example, if the “XXX” amount equals 1400 lbs. and there will be five 150 lb passengers in your vehicle, the amount of available cargo and luggage load capacity is 650 lbs. (1400 – 750 (5 × 150) = 650 lbs.)
- (5) Determine the combined weight of luggage and cargo being loaded on the vehicle. That weight may not safely exceed the available cargo and luggage load capacity calculated in Step 4.

(6) If your vehicle will be towing a trailer, load from your trailer will be transferred to your vehicle. Consult this manual to determine how this reduces the available cargo and luggage load capacity of your vehicle.

Except Canada:

Toyota does not recommend towing a trailer with your vehicle. Your vehicle is not designed for trailer towing.

Example on your vehicle

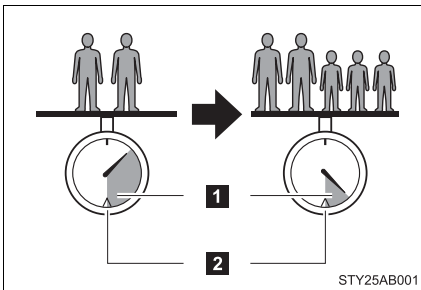

- 1 Cargo capacity
- 2 Total load capacity

When 2 people with the combined weight of 366 lb. (166 kg) are riding in your vehicle, which has a total load capacity of 845 lb. (383 kg), the available amount of cargo and luggage load capacity will be as follows:

$$845 \text{ lb.} - 366 \text{ lb.} = 479 \text{ lb.} \quad (383 \text{ kg} - 166 \text{ kg} = 217 \text{ kg})$$

In this condition, if 3 more passengers with the combined weight of 388 lb. (176 kg) get on, the available cargo and luggage load will be reduced as follows:

$$479 \text{ lb.} - 388 \text{ lb.} = 91 \text{ lb.} \quad (217 \text{ kg} - 176 \text{ kg} = 41 \text{ kg})$$

As shown in the above example, if the number of occupants increases, the cargo and luggage load will be reduced by an amount that equals the increased weight due to the additional occupants. In other words, if an increase in the number of occupants causes an excess of the total load capacity (combined weight of occupants plus cargo and luggage load), you must reduce the cargo and luggage on your vehicle.

⚠ CAUTION**n Things that must not be carried in the luggage compartment**

The following things may cause a fire if loaded in the luggage compartment.

- I Receptacles containing gasoline
- I Aerosol cans

n Storage precautions

- I Do not place anything on the luggage cover, and do not stack anything in the luggage compartment higher than the seatbacks. Such items may be thrown about and possibly injure people in the vehicle during sudden braking or in an accident.
- I Do not drive with objects on top of the instrument panel. They may interfere with the driver's field of view or move during sharp acceleration or turning, thus impairing the driver's control of the vehicle. In an accident they may injure the vehicle occupants.
- I Secure all items in the occupant compartment, as they may shift and injure someone during an accident or sudden braking.
- I Never allow anyone to ride in the luggage compartment. It is not designed for passengers. They should ride in their seats with their seat belts properly fastened. Otherwise, they are much more likely to suffer serious bodily injury, in the event of sudden braking or a collision.

n Capacity and distribution

- I Do not exceed the maximum axle weight rating or the total vehicle weight rating.
- I Even if the total load of occupant's weight and the cargo load is less than the total load capacity, do not apply the load unevenly. Improper loading may cause deterioration of steering or braking control which may cause death or serious injury.

2-5. Driving information

Vehicle load limits

Vehicle load limits include total load capacity, seating capacity, towing capacity and cargo capacity.

n Total load capacity: 845 lb. (383 kg)

Total load capacity means the combined weight of occupants, cargo and luggage.

n Seating capacity: 5 occupants (Front 2, Rear 3)

Seating capacity means the maximum number of occupants whose estimated average weight is 150 lb. (68 kg) per person.

Even if the number of occupants are within the seating capacity, do not exceed the total load capacity.

n Towing capacity (Canada): 700 lb. (318 kg)

Towing capacity means the maximum gross trailer weight (trailer weight plus its cargo weight) that your vehicle is able to tow.

n Towing capacity (except Canada)

Toyota does not recommend towing a trailer with your vehicle.

n Cargo capacity

Cargo capacity may increase or decrease depending on the weight and the number of occupants.

n Total load capacity and seating capacity

These details are also described on the tire and loading information label.(→P. 264)

⚠ CAUTION

n Overloading the vehicle

Do not overload the vehicle.

It may not only cause damage to the tires, but also degrade steering and braking ability, resulting in an accident.

Carry out the necessary preparations and inspections before driving the vehicle in winter. Always drive the vehicle in a manner appropriate to the prevailing weather conditions.

n Pre-winter preparations

- 1 Use fluids that are appropriate to the prevailing outside temperatures.
 - Engine oil
 - Engine coolant
 - Washer fluid
- 1 Have a service technician inspect the level and specific gravity of battery electrolyte.
- 1 Have the vehicle fitted with four snow tires or purchase a set of tire chains for the front tires.

Ensure that all tires are the same size and brand, and that chains match the size of the tires.

n Before driving the vehicle

Perform the following according to the driving conditions.

- 1 Do not try to forcibly open a window, scrape an outside rear view mirror surface or move a wiper or outside rear view mirror that is frozen. Pour warm water over the frozen area to melt the ice. Wipe away the water immediately to prevent it from freezing.
- 1 To ensure proper operation of the climate control system fan, remove any snow that has accumulated on the air inlet vents in front of the windshield.
- 1 Remove any ice that has accumulated on the vehicle chassis.
- 1 Periodically check for and remove any excess ice or snow that may have accumulated in the wheel well or on the brakes.

n When driving the vehicle

Accelerate the vehicle slowly and drive at a reduced speed suitable to road conditions.

n When parking the vehicle

Park the vehicle and move the shift lever to P (automatic transmission) or to 1 or R (manual transmission) without setting the parking brake. The parking brake may freeze up, preventing it from being released.

Regulations on the use of snow chains

- 1 Regulations regarding the use of tire chains vary according to location and type of road. Always check local regulations before installing chains.
- 1 Use SAE Class “S” type radial tire chains, with the exception of radial cable chains or V-bar type chains.
 - Install the chains on the front tires.
 - Refer to the explanation that comes with the tire chains for installation instructions.
- 1 Retighten the chains after driving 1/4 - 1/2 mile (0.5 - 1.0 km).

n Snow chain installation

Observe the following precautions when installing and removing chains.

- 1 Install and remove tire chains in a safe location.
- 1 Install tire chains on the front tires only. Do not install tire chains on the rear tires.
- 1 Install the tire chains on front tires as tightly as possible.
- 1 Install tire chains following the instructions provided in the accompanying instructions.
- 1 If wheel ornaments are used, they will be scratched by the chain band, so remove the ornaments before putting on the chains. (→P. 320)

 **CAUTION**
n Driving with snow tires

Observe the following precautions to reduce the risk of accidents. Failing to do so may result in a loss of vehicle control and cause death or serious injury.

- I Use tires of the size specified for your vehicle.
- I Maintain the recommended level of air pressure.
- I Do not drive in excess of 75 mph (120 km/h) regardless of the type of snow tires being used.
- I Snow tires should be installed on all wheels.

n Driving with snow chains

Observe the following precautions to reduce the risk of accidents. Failing to do so may result in the vehicle being unable to be driven safely, and may cause death or serious injury.

- I Do not drive in excess of the speed limit specified for the tire chains being used or 30 mph (50 km/h), whichever is lower.
- I Avoid driving on bumpy road surfaces or over potholes.
- I Avoid sudden turns and braking.
- I Slow down sufficiently before entering a curve to ensure that vehicle control is maintained.

 **NOTICE**
n Repairing or replacing snow tires

Request repairs of and obtain replacement snow tires from Toyota dealers or legitimate tire retailers.

This is because the removal and attachment of snow tires affects the operation of the tire pressure warning valves and transmitters.

n Fitting tire chains

The tire pressure warning valves and transmitters may not function correctly when tire chains are fitted.

2-5. Driving information

Trailer towing (except Canada)

Toyota does not recommend towing a trailer with your vehicle. Toyota also does not recommend the installation of a tow hitch or the use of a tow hitch carrier of a wheelchair, scooter, bicycle, etc. Your Toyota is not designed for trailer towing or for the use of tow hitch mounted carriers.

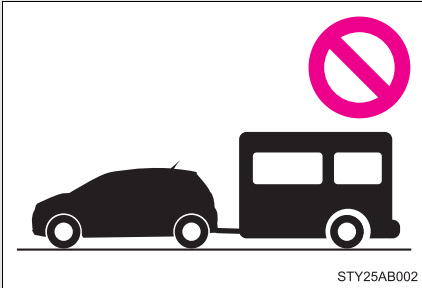

Trailer towing (Canada)

Your vehicle is designed primarily as a passenger-carrying vehicle, thus towing a trailer will have an adverse effect on handling, performance, braking, durability, and fuel consumption. For your safety and the safety of others, do not overload the vehicle or trailer.

Toyota warranties do not apply to damage or malfunction caused by towing a trailer for commercial purposes.

n **Weight limits**

Confirm the total trailer weight, gross vehicle weight, gross axle weight and trailer tongue load are all within the limits.

n **Gross vehicle weight**

The gross vehicle weight must not exceed the Gross Vehicle Weight Rating (GVWR) indicated on the Certification Label. The gross vehicle weight is the sum of weights of the unloaded vehicle, driver, passengers, luggage, hitch, and the trailer tongue load. It also includes the weight of any special equipment installed on your vehicle.

n **Gross axle weight**

The load on either the front or rear axle resulting from distribution of the gross vehicle weight on both axles must not exceed the Gross Axle Weight Rating (GAWR) listed on the Certification Label.

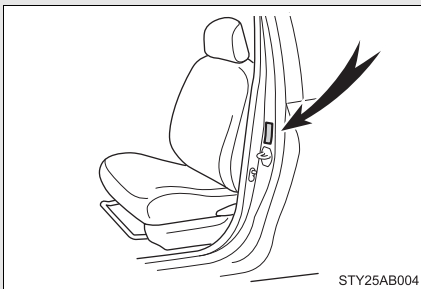

Certification label

STY25AB004

n Trailer tongue load

The trailer cargo load should be distributed so that the tongue load is 9 to 11% of the total trailer weight, not exceeding the maximum 70 lb. (32 kg) ($\text{Tongue load} / \text{Total trailer weight} \times 100 = 9 \text{ to } 11\%$)

The total trailer weight and tongue load can be measured with platform scales found at a highway weighing station, building supply company, trucking company, junk yard, etc.

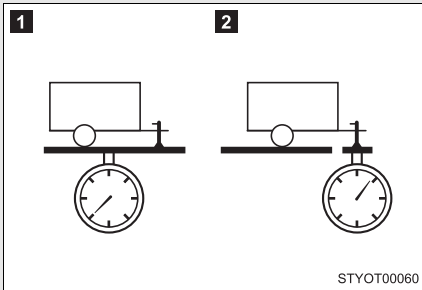

1 Total trailer weight

2 Tongue load

Towing a trailer

Consult your Toyota dealer for further information about additional requirements such as a towing kits, etc.

n **Before towing**

Check that the following conditions are met:

- l Ensure that your vehicle's tires are properly inflated. (→P. 351)
- l Trailer tires should be inflated according to the trailer manufacturer's recommendation.
- l All trailer lights work to be legal.
- l Confirm all lights work each time you connect them.
- l Check that your vehicle remains level when a loaded or unloaded trailer is hitched. Do not drive if the vehicle is not level, and check for improper tongue load, overloading, worn suspension, or other possible causes.
- l Make sure the trailer cargo is securely loaded.
- l Check that your rear view mirrors conform to any federal, state/provincial or local regulations. If they do not, install rear view mirrors appropriate for towing purposes.

n **Break-in schedule**

- l Toyota recommends that you do not use a new vehicle or a vehicle with any new power train components (engine, transmission, differential, wheel bearings, etc.) to tow a trailer for the first 500 miles (800 km) of driving.

n **Maintenance**

- l If you tow a trailer, your vehicle will require more frequent maintenance due to the additional load. (See "Scheduled Maintenance Guide" or "Owner's Manual Supplement".)
- l Retighten the fixing bolts of the towing ball and bracket after approximately 600 miles (1000 km).

 **CAUTION**

n To avoid accident or injury

- l** The total trailer weight (trailer weight plus the weight of cargo) must not exceed 700 lb. (318 kg)
- l** Do not exceed the trailer hitch assembly weight, gross vehicle weight, gross axle weight and trailer tongue load capacities.

n Hitches

Trailer hitch assemblies have different weight capacities established by the hitch manufacturer. Even though the vehicle may be rated for towing a higher weight, the operator must never exceed the maximum weight rating specified for the trailer hitch.

- l** If you wish to install a trailer hitch, your Toyota dealer should be consulted.
- l** Use only a hitch that conforms to the total trailer weight requirement.
- l** Follow the directions supplied by the hitch manufacturer.
- l** Lubricate the hitch ball with a light coat of grease.
- l** Remove the trailer hitch whenever you are not towing a trailer to reduce the possibility of additional damage caused by the hitch if your vehicle is struck from behind.

n When towing a trailer

- l** Never tap into your vehicle's hydraulic system, as this will lower the vehicle's braking effectiveness.
- l** Never tow a trailer without using a safety chain securely attached to both the trailer and the vehicle. If damage occurs to the coupling unit or hitch ball, there is danger of the trailer wandering into another lane.

 NOTICE

n When installing a trailer hitch

Use only the position recommended by your Toyota dealer. Do not install the trailer hitch on the bumper; this may cause body damage.

n Brakes

Toyota recommends trailers with brakes that conform to any applicable federal and state/provincial regulations.

n Safety chain

A safety chain must always be used between the towing vehicle and the trailer. Leave sufficient slack in the chain for turns. The chain should cross under the trailer tongue to prevent the tongue from dropping to the ground in the case that it becomes damaged or separated. For the correct safety chain installation procedure, ask your Toyota dealer.

n Do not directly splice trailer lights

Directly splicing may damage your vehicle's electrical system and cause a malfunction.

Trailer towing tips

Your vehicle will handle differently when towing a trailer. The three main causes of vehicle-trailer accidents are driver error, excessive speed and improper trailer loading. Keep these in mind when towing.

- 1 Before starting out, check the trailer's light and the vehicle-trailer connections. Recheck after driving a short distance.
- 1 Practice turning, stopping and reversing with the trailer attached in an area away from traffic until you become accustomed to the feel of the vehicle.

- 1 Reversing with a trailer attached is difficult and requires practice. Grip the bottom of the steering wheel and move your hand to the left to move the trailer to the left. Move your hand to the right to move the trailer to the right. (This is generally opposite to reversing without a trailer attached.) Avoid sharp or prolonged turning. Have someone guide you when reversing to reduce the risk of an accident.
- 1 As stopping distance is increased when towing a trailer, vehicle-to-vehicle distance should be increased. For each 10 mph (16 km/h) of speed, allow at least one vehicle and trailer length.
- 1 Avoid sudden braking as you may skid, resulting in jackknifing and loss of control. This is especially true on wet or slippery surfaces.
- 1 Avoid jerky starts or sudden acceleration. Vehicles with a manual transmission, prevent excessive clutch slippage by keeping engine rpm low and not racing the engine. Always start out in first gear.
- 1 Avoid jerky steering and sharp turns, and slow down before making a turn.
- 1 Note that when making a turn, the trailer wheels will be closer than the vehicle wheels to the inside of the turn. Compensate by making a larger than normal turning radius.
- 1 Crosswinds and rough roads will adversely affect handling of your vehicle and trailer, causing sway. Periodically check the rear to prepare for being passed by large trucks or buses, which may cause your vehicle and trailer to sway. If swaying occurs, firmly grip the steering wheel, reduce speed immediately but gradually, and steer straight ahead. Never increase speed. If you make no extreme correction with the steering or brakes, your vehicle and trailer will stabilize.
- 1 Take care when passing other vehicles. Passing requires considerable distance. After passing a vehicle, do not forget the length of your trailer, and be sure you have plenty of room before changing lanes.

- 1 In order to maintain engine braking efficiency, do not use the transmission in D (automatic transmission) or 5 (manual transmission).
- 1 Due to the added load of the trailer, your vehicle's engine may overheat on hot days (at temperatures over 85°F [30°C]) when driving up a long or steep grade. If the engine coolant temperature gauge indicates overheating, immediately turn off the air conditioning (if in use), pull your vehicle off the road and stop in a safe spot. (→P. 337)
- 1 Always place wheel blocks under both the vehicle and the trailer wheels when parking. Apply the parking brake firmly, and put the transmission in P (automatic transmission) or in 1 or R (manual transmission). Avoid parking on a slope, but if unavoidable, do so only after performing the following:

STEP 1 Apply the brakes and keep them applied.

STEP 2 Have someone place wheel blocks under both the vehicle and trailer wheels.

STEP 3 When the wheel blocks are in place, release the brakes slowly until the blocks absorb the load.

STEP 4 Apply the parking brake firmly.

STEP 5 Shift into 1 or R (manual transmission) or P (automatic transmission) and turn off the engine.

- 1 When restarting after parking on a slope:

STEP 1 With the transmission in P (automatic transmission) or the clutch pedal (manual transmission) depressed, start the engine. On vehicles with an automatic transmission, be sure to keep the brake pedal pressed.

STEP 2 Shift into a forward gear. If reversing, shift into R.

STEP 3 Release the parking brake (also brake pedal on vehicles with an automatic transmission), and slowly pull or back away from the wheel blocks. Stop and apply the brakes.

STEP 4 Have someone retrieve the blocks.

 CAUTION

n To avoid an accident

- I** Do not exceed 45 mph (72 km/h) or posted towing speed limit, whichever is lower. As instability (swaying) of the towing vehicle-trailer combination increases as speed increases, exceeding 45 mph (72 km/h) may cause loss of control.
- I** Slow down and downshift before descending steep or long downhill grades. Do not make sudden downshifts.
- I** Avoid holding the brake pedal down too long or too frequently. This could cause the brakes to overheat and result in reduced braking efficiency.

Your vehicle is not designed to be dinghy towed (with 4 wheels on the ground) behind a motor home.

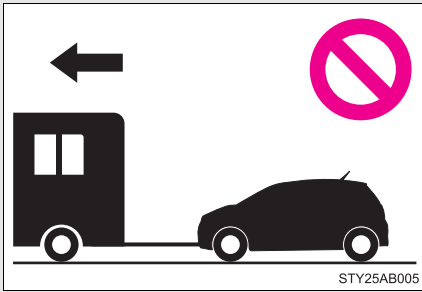

 **NOTICE**

n To avoid serious damage to your vehicle

Do not tow your vehicle with four wheels on the ground.

Dinghy towing (vehicles with a manual transmission)

Your vehicle can be dinghy towed in a forward direction (with 4 wheels on the ground) behind a motor home.

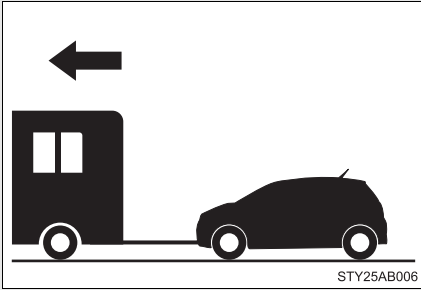

Dinghy towing does not eliminate the possibility of damage to your vehicle.

Towing your vehicle with 4 wheels on the ground

To prevent damage to your vehicle, perform the following procedures before towing.

STEP 1 Shift the shift lever to N.

STEP 2 Turn the engine switch to the ACC position.

Ensure that the audio system and other powered devices have been turned off.

STEP 3 Release the parking brake.

After towing, leave the engine in idle for at least 3 minutes before driving the vehicle.

n Necessary equipment and accessories

Specialized equipment and accessories are required for dinghy towing. Contact the service branch of the motor home manufacturer regarding recommended equipment.

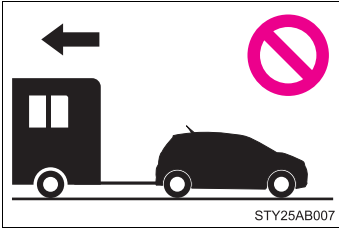
 NOTICE**n Dinghy towing direction**

Do not tow the vehicle backwards.
Doing so may cause serious damage.

n To prevent the steering from locking

Ensure the engine switch is in the ACC position.

3-1. Using the air conditioning system and defogger

Air conditioning system

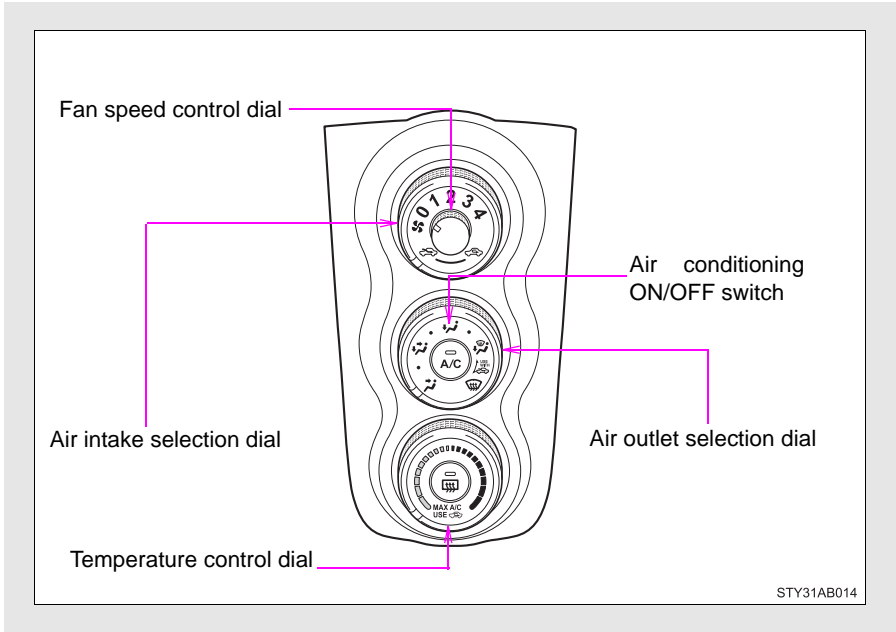

Adjusting the settings

n Adjusting the temperature setting

Turn the temperature control dial clockwise (warm) or counter-clockwise (cool).

If  is not pressed, the system will blow ambient temperature air or heated air.

For quick cooling, turn the temperature control dial to the "MAX A/C" position and set the air intake selection dial to  (recirculated air) mode.

n Adjusting the fan speed

Turn the fan speed control dial clockwise (increase) or counter-clockwise (decrease).

Set the dial to "0" to turn the fan off.

n Selecting the air outlets

Set the air outlet selection dial to an appropriate position.

The positions between the air outlet selections shown below can also be selected for more detailed adjustment.

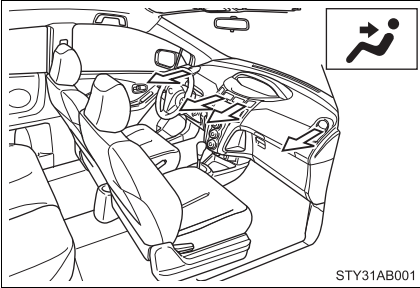

When the dial is set to , air flows to the upper body.

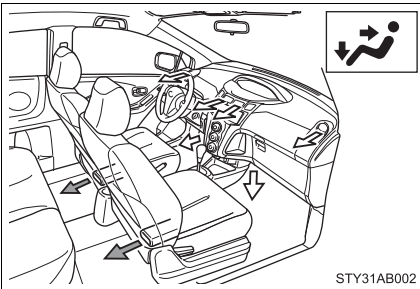



When the dial is set to , air flows to the upper body and feet.

 : Some models

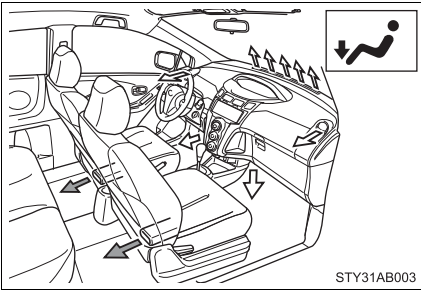
3-1. Using the air conditioning system and defogger



When the dial is set to , mainly air flows to the feet.

 : Some models

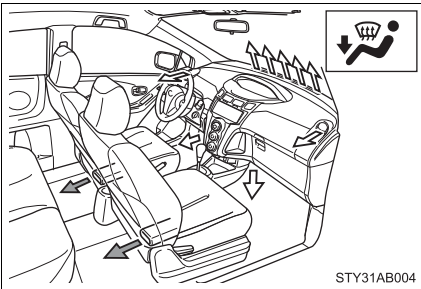

When the dial is set to , air flows to the feet and the windshield defogger operates.

 : Some models

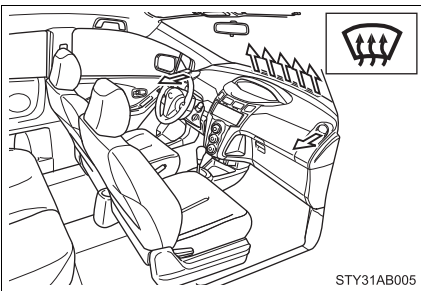

When the dial is set to , air flows to the windshield and side windows to defog them.

Set the air intake selection dial to

 (outside air) mode.

Pressing  to turn the air conditioning on clears the windshield and side windows faster.

n Selecting the air intake modes

Set the air intake selection dial to  (outside air) mode or

 (recirculated air) mode.

Adjusting the position of the air outlets

► Center outlets

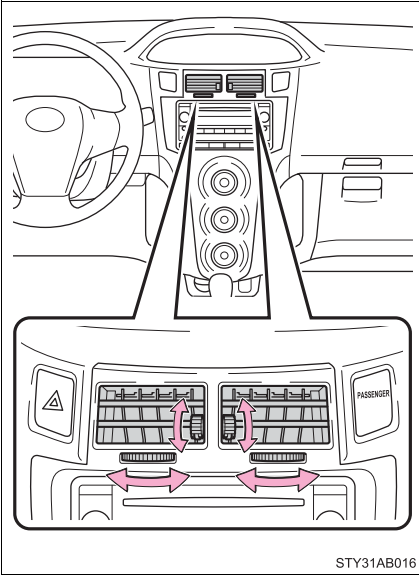

Direct air flow to the left or right, up or down.

► Right and left side outlets

3-1. Using the air conditioning system and defogger

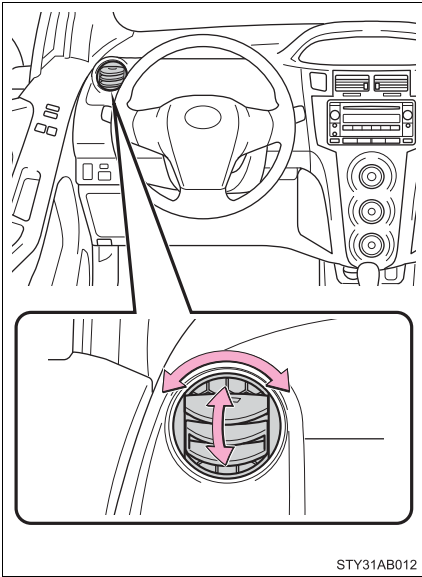

Direct air flow to the left or right, up or down.

When defrosting the side windows, face the right and left side outlets toward them.

Opening and closing the air outlets

► Center outlets

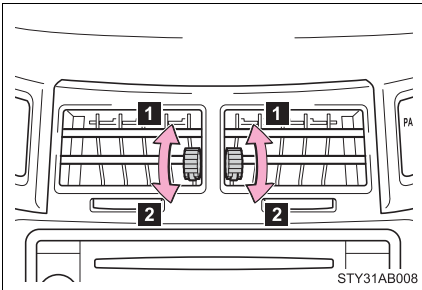

1 Open the vent.

2 Close the vent.

► Right and left side outlets

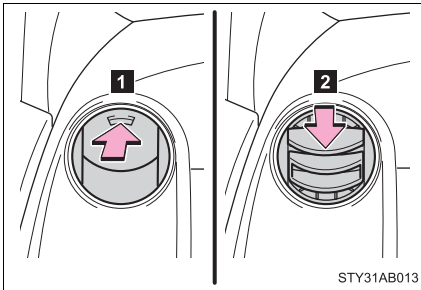

- 1 Open the vent.
- 2 Close the vent.

n **Using the system in recirculated air mode**

The windows will fog up more easily if the recirculated air mode is used for an extended period.

n **When outside air temperature approaches 32°F (0°C)**

The air conditioning system may not operate even when  is pressed.

n **When  is selected for the air outlets used**

For your driving comfort, air flowing to the feet may be warmer than air flowing to the upper body depending on the position of the temperature adjustment dial.

 **CAUTION**

n **To prevent the windshield from fogging up**

Do not set the air outlet selection dial to  during cool air operation in extremely humid weather. The difference between the temperature of the outside air and that of the windshield can cause the outer surface of the windshield to fog up, blocking your vision.

 NOTICE

n To prevent battery discharge

Do not leave the air conditioning system on longer than necessary when the engine is stopped.

3-1. Using the air conditioning system and defogger Rear window and outside rear view mirror defoggers (if equipped)

These features are used to defog the rear window, and to remove raindrops, dew and frost from the outside rear view mirrors.

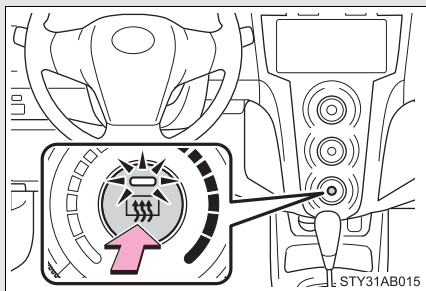

On/off

Press the button to turn on the rear window defogger. The indicator light will come on. Pressing the button again also turns the defoggers off.

Vehicles with timer: The defoggers will automatically turn off after approximately 15 minutes.

3

Interior features

n **The rear window and outside rear view mirror defoggers can be operated when**

The engine switch is in the ON position.

n **Outside rear view mirror defoggers (vehicles with outside rear view mirror defoggers)**

Turning the rear window defogger on will turn the outside rear view mirror defoggers on.

⚠ CAUTION

n **When the outside rear view mirror defoggers are on (vehicles with outside rear view mirror defoggers)**

Do not touch the rear view mirror surfaces, as they can become very hot and burn you.



NOTICE

n To prevent battery discharge

Do not leave the rear window defogger on longer than necessary when the engine is stopped.

3-2. Using the audio system

Audio system type

CD player with CD changer controller and AM/FM radio.

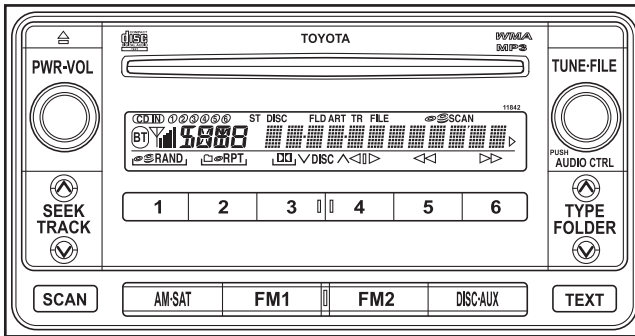

STY32AB009

Title	Page
Using the radio	P. 189
Using the CD player	P. 195
Playing back MP3 and WMA discs	P. 200
Optimal use of the audio system	P. 207
Using the AUX adapter	P. 209

n Using cellular phones

Interference may be heard through the audio system's speakers if a cellular phone is being used inside or close to the vehicle while the audio system is operating.

 **CAUTION**

n For vehicles sold in U.S.A. and Canada

I Part 15 of the FCC Rules

FCC Warning:

Any unauthorized changes or modifications to this equipment will void the user's authority to operate this device.

I Laser products

Do not take this unit apart or attempt to make any changes yourself.

This is an intricate unit that uses a laser pickup to retrieve information from the surface of compact discs. The laser is carefully shielded so that its rays remain inside the cabinet. Therefore, never try to disassemble the player or alter any of its parts since you may be exposed to laser rays and dangerous voltages.

I CAUTION

This product utilizes a laser.

Use of controls or adjustments or performance of procedures other than those specified herein may result in hazardous radiation exposure.

 **NOTICE**

n To prevent battery discharge

Do not leave the audio system on longer than necessary with the engine off.

n To avoid damaging the audio system



Take care not to spill drinks or other fluids over the audio system.

3-2. Using the audio system

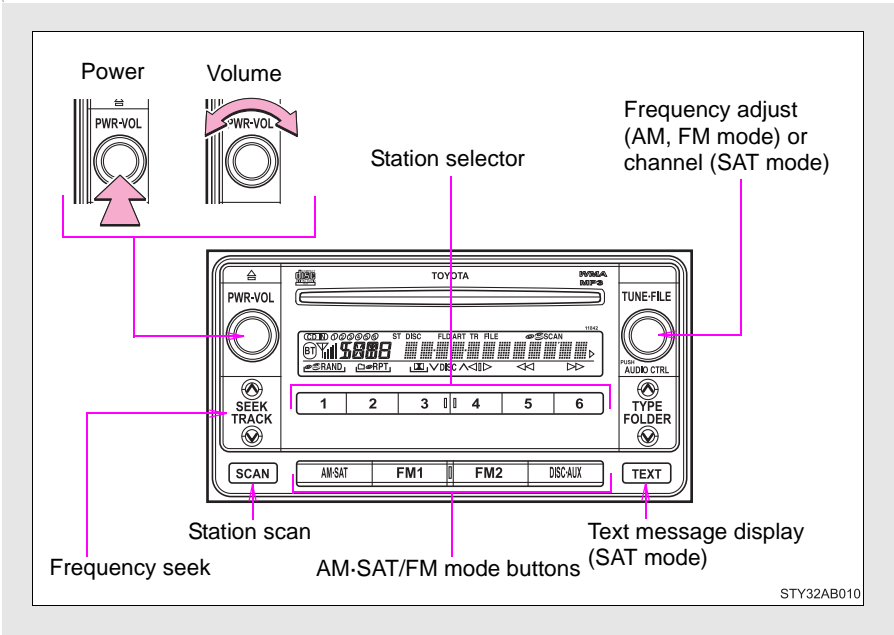
Using the radio



Setting station presets (excluding XM[®] Satellite Radio)

STEP 1 Search for desired stations by turning  or pressing “^” or “v” on .

STEP 2 Press and hold the button (from to) that the station is to be set to until you hear a beep.

Scanning radio stations (excluding XM[®] Satellite Radio)

n Scanning the preset radio stations

STEP 1 Press and hold until you hear a beep.

Preset stations will be played for 5 seconds each.

STEP 2 When the desired station is reached, press the button once again.

n Scanning all radio stations within range

STEP 1 Press  .

All stations with reception will be played for 5 seconds each.

STEP 2 When the desired station is reached, press the button once again.



XM[®] Satellite Radio* (if equipped)

n Receiving XM[®] Satellite Radio



STEP 1 Press  and select the XM[®] band.

The display changes as follows each time  is pressed.

AM → SAT1 → SAT2 → SAT3

STEP 2 Turn  to select the desired channel in the all categories or press “^” or “v” on  to select the desired channel in the current category.

n Setting XM[®] Satellite Radio channel presets

Select the desired channel. Press and hold the button (from  to ) that the channel is to be set to until you hear a beep.

n Changing the channel category

Press “^” or “v” on the  .

n Scanning XM[®] Satellite Radio channels

1 Scanning channels in the current category

STEP 1 Press  .

STEP 2 When the desired channel is reached, press  again.

1 Scanning preset channels

STEP 1 Press and hold **SCAN** until you hear a beep.

STEP 2 When the desired channel is reached, press **SCAN** again.

n **Displaying text information**

Press **TEXT** .

The display will show up to 10 characters.

The display changes as follows each time the button is pressed.

1 CH NAME

1 TITLE (SONG/PROGRAM TITLE)

1 NAME (ARTIST NAME/FEATURE)

1 CH NUMBER

*: Use of XM[®] Satellite Radio requires XM[®] tuner and service.
Contact your Toyota dealer.

n **When the battery is disconnected**

Stations presets are erased.

n **Reception sensitivity**

- 1 Maintaining perfect radio reception at all times is difficult due to the continually changing position of the antenna, differences in signal strength and surrounding objects, such as trains, transmitters, etc.
- 1 The radio antenna is mounted on the rear roof. The antenna can be removed from the base by turning it.

n **XM[®] Satellite Radio**

An XM[®] Satellite Radio is a tuner designed exclusively to receive broadcasts provided under a separate subscription. Availability is limited to the 48 contiguous states and 10 Canadian provinces.

l XM[®] subscriptions

For detailed information about XM[®] Satellite Radio or to subscribe:

U.S.A.—

Visit on the web at www.xmradio.com or call 1-800-967-2346.

Canada—

Visit on the web at www.xmradio.ca or call 1-877-438-9677.

l Radio ID

You will need the radio ID when activating XM[®] service or reporting a problem. Select “CH000” using  , and the receiver’s 8-character ID number will appear.

l Satellite tuner

The tuner supports only Audio Services (Music and Talk) and the accompanying Text Information of XM[®] Satellite Radio.

n **If the satellite radio does not operate normally**

If a problem occurs with the XM[®] tuner, a message will appear on the display. Refer to the table below to identify the problem, and take the suggested corrective action.

ANTENNA	The XM [®] antenna is not connected. Check whether the XM [®] antenna cable is attached securely.
	There is a short-circuit in the antenna or the surrounding antenna cable. See a Toyota certified dealer.

UPDATING	You have not subscribed to the XM [®] Satellite Radio. The radio is being updated with the latest encryption code. Contact the XM [®] Satellite Radio for subscription information. When a contract is canceled, you can choose the “CH000” and all free-to-air channels.
	The premium channel you selected is not authorized. Wait for about 2 seconds until the radio returns to the previous channel or “CH001”. If it does not change automatically, select another channel. If you want to listen to the premium channel, contact the XM [®] Satellite Radio.
NO SIGNAL	The XM [®] signal is too weak at the current location. Wait until your vehicle reaches a location with a stronger signal.
LOADING	The unit is acquiring audio or program information. Wait until the unit has received the information.
OFF AIR	The channel you selected is not broadcasting any programming. Select another channel.
-----	There is no song/program title or artist name/feature associated with the channel at that time. No action needed.
---	The channel you selected is no longer available. Wait for about 2 seconds until the radio returns to the previous channel or “CH001”. If it does not change automatically, select another channel.

Contact the XM[®] Listener Care Center at 1-800-967-2346 (U.S.A.) or 1-877-438-9677 (Canada).

n Certifications for the radio tuner

This equipment has been tested and found to comply with the limits for a class B digital device, pursuant to Part 15 of the FCC Rules. These limits are designed to provide reasonable protection against harmful interference in a residential installation. This equipment generates, uses and can radiate radio frequency energy and, if not installed and used in accordance with the instructions, may cause harmful interference to radio communications. However, there is no guarantee that interference will not occur in a particular installation.

If this equipment does cause harmful interference to radio or television reception, which can be determined by turning the equipment off and on, the user is encouraged to try to correct the interference by trying one or more of the following:

- 1 Reorienting or relocate the receiving antenna.
- 1 Increasing the separation between the equipment and receiver.
- 1 Connecting the equipment into an outlet on a circuit different from that to which the receiver is connected.
- 1 Consulting the dealer or an experienced radio/TV technician for help.

 NOTICE
--

n To prevent damage, remove the antenna in the following cases.
--

- | |
|---|
| <ul style="list-style-type: none">1 The antenna will touch the ceiling of a garage.1 A cover will be put on the vehicle. |
|---|

3-2. Using the audio system Using the CD player

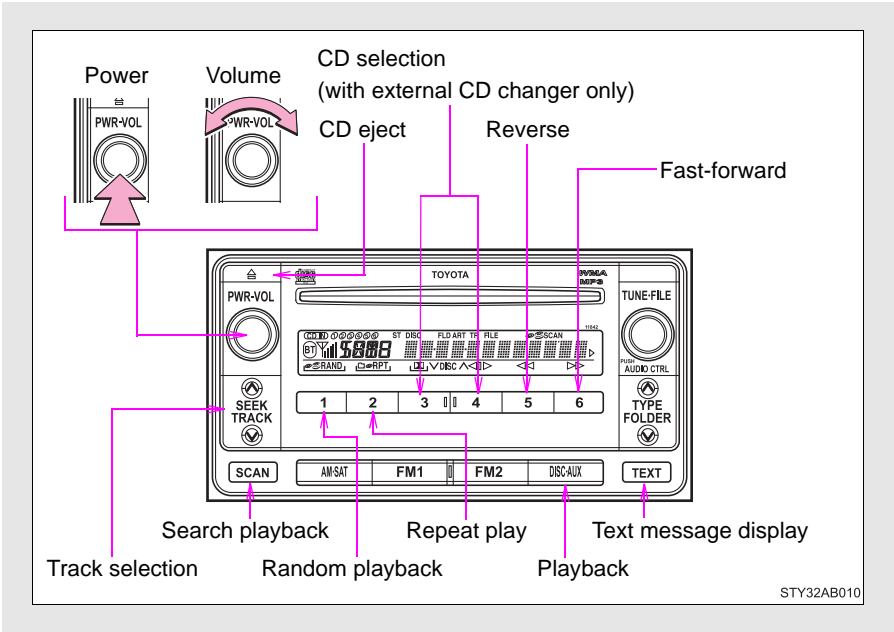

Loading a CD

Insert a CD.

Ejecting a CD

Press  and remove the CD.

Selecting and scanning a track

n Selecting a track

Press “^” to move up or “v” to move down using  until the desired track number is displayed.

n Scanning tracks

STEP 1 Press **SCAN**.

The first 10 seconds of each track will be played.

STEP 2 Press the switch again when the desired track is reached.

Fast-forwarding and reversing tracks

To fast-forward or reverse, press and hold **6** (**▶▶**) or **5** (**◀◀**).

Selecting a CD (with external CD changer only)

n Selecting the desired CD

Press **3** (**∨**) or **4** (**∧**).

n Scanning loaded CDs

STEP 1 Press and hold **SCAN** until you hear a beep.

The first 10 seconds of the first track on each CD will be played.

STEP 2 Press the switch again when the desired CD is reached.

Repeat play

n Repeating a track

Press **2** (RPT).

n Repeating all of the tracks on a CD (with external CD changer only)

Press and hold **2** (RPT) until you hear a beep.

Random playback

n Current CD

Press **1** (RAND).

Tracks are played in a random order until the button is pressed once more.

n All CDs (with external CD changer only)

Press and hold (RAND) until you hear a beep.

Tracks on all loaded CDs are played in a random order until the button is pressed once more.

Switching the display

Press .

Each time the switch is pressed, the display changes in the order of Track no./Elapsed time→CD title→Track name.

n Display

Up to 12 characters can be displayed at a time.

If there are 13 characters or more, pressing and holding for 1 second or more will display the remaining characters.

A maximum of 24 characters can be displayed.

If is pressed for 1 second or more again or has not been pressed for 6 seconds or more, the display will return to the first 12 characters.

Depending on the contents recorded, the characters may not be displayed properly or may not be displayed at all.

n Canceling random playback

Press (RAND) again.

n Canceling repeat play

Press (RPT) again.

n Error messages

“ERROR”: This indicates a trouble either in the CD or inside the player.
The CD may be dirty, damaged or inserted up-side down.

n Discs that can be used

Discs with the marks shown below can be used.
Playback may not be possible depending on recording format or disc features, or due to scratches, dirt or deterioration.



CDs with copy-protect features may not be used.

n CD player protection feature

To protect the internal components, playback is automatically stopped when a problem is detected while the CD player is being used.

n If CDs are left inside the CD player or in the ejected position for extended periods

CDs may be damaged and may not play properly.

n Lens cleaners

Do not use lens cleaners. Doing so may damage the CD player.

 **NOTICE**

n CDs and adapters that cannot be used

Do not use the following types of CDs or 3 in. (8 cm) CD adapters or Dual Disc.

Doing so may damage the CD player and/or the CD insert/eject function.

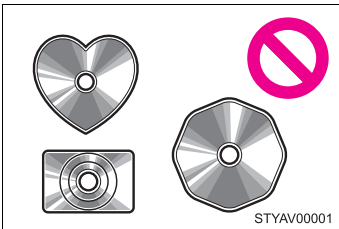

i CDs that have a diameter that is not 4.7 in. (12 cm)

 NOTICE

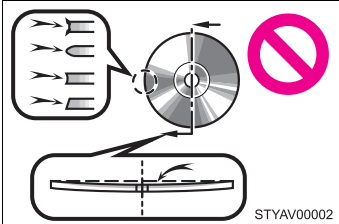

! Low-quality and deformed CDs

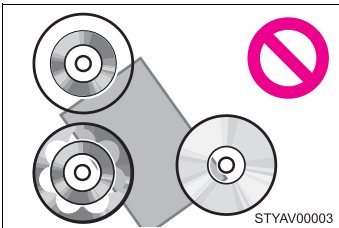

! CDs with a transparent or translucent recording area

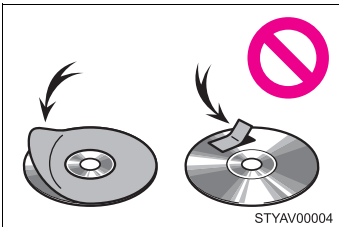

! CDs that have had tape, stickers or CD-R labels attached to them, or that have had the label peeled off

n CD player precautions

Failure to follow the precautions below may result in serious damage to the CDs or the player itself.

- ! Do not insert anything other than CDs into the CD slot.
- ! Do not apply oil to the CD player.
- ! Store CDs away from direct sunlight.
- ! Never try to disassemble any part of the CD player.

3-2. Using the audio system

Playing back MP3 and WMA discs

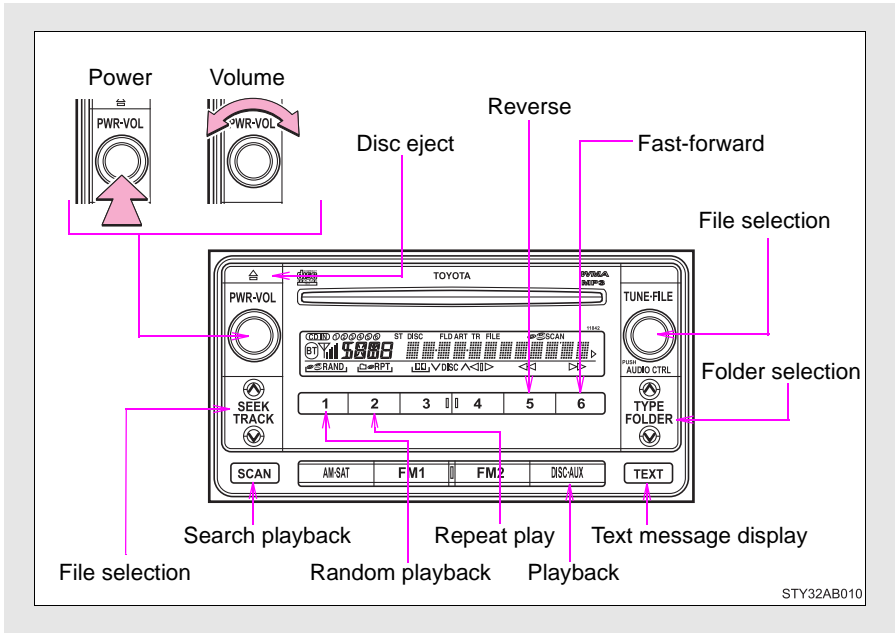

Loading MP3 and WMA discs

Insert a disc.

Ejecting MP3 and WMA discs

Press  and remove the disc.

Selecting a folder

n Selecting folders one at a time

To select the desired folder, press “^” or “v” on



n Selecting the desired folder by cueing the first file of each folder

Press and hold  until you hear a beep.

The first 10 seconds of the first file in the each folder will be played.
When the desired folder is reached, press the switch once again.

n Returning to the first folder

Press and hold “√” on  until you hear a beep.

Selecting and scanning files

n Selecting one file at a time

To select the desired file, turn  or press “^” or “√” on .

n Selecting the desired file by cueing the files in the folder

Press .

The first 10 seconds of all files in the folder will be played.
When the desired file is reached, press the switch once again.

Fast-forwarding and reversing files

To fast-forward or reverse.

Press and hold  () or  ().

Repeat play

n Repeating a file

Press  (RPT).

n Repeating all of the files in the folder

Press and hold  (RPT) until you hear a beep.

Random playback

n To play files from a particular folder in random order

Press (RAND).

n To play all of the files on a disc in random order

Press and hold (RAND) until you hear a beep.

Switching the display

Press .

Each time the switch is pressed, the display changes in the order of Folder no./File no./Elapsed time→Folder name→File name→Album title (MP3 only)→Track title→Artist name.

n Display

Up to 12 characters can be displayed at a time.

If there are 13 characters or more, pressing and holding for 1 second or more will display the remaining characters.

A maximum of 24 characters can be displayed.

If is pressed for 1 second or more again or has not been pressed for 6 seconds or more, the display will return to the first 12 characters.

Depending on the contents recorded, the characters may not be displayed properly or may not be displayed at all.

n Canceling random playback

Press (RAND) again.

n Canceling repeat play

Press (RPT) again.

n Error messages

“ERROR”: This indicates a trouble either in the CD or inside the player.
The CD may be dirty, damaged or inserted up-side down.

“NO MUSIC”: This indicates that the MP3/WMA file is not included in the CD.

n Discs that can be used

Discs with the marks shown below can be used.

Playback may not be possible depending on recording format or disc features, or due to scratches, dirt or deterioration.



n CD player protection feature

To protect the internal components, playback is automatically stopped when a problem is detected while the CD player is being used.

n If CDs are left inside the CD player or in the ejected position for extended periods

CDs may be damaged and may not play properly.

n Lens cleaners

Do not use lens cleaners. Doing so may damage the CD player.

n MP3 and WMA files

MP3 (MPEG Audio LAYER3) is a standard audio compression format.

Files can be compressed to approximately 1/10 of their original size by using MP3 compression.

WMA (Windows Media TM Audio) is a Microsoft audio compression format.

This format compresses audio data to a size smaller than that of the MP3 format.

There is a limit to the MP3 and WMA file standards and to the media/formats recorded by them that can be used.

l MP3 file compatibility

- Compatible standards
MP3 (MPEG1 LAYER3, MPEG2 LSF LAYER3)
- Compatible sampling frequencies
MPEG1 LAYER3: 32, 44.1, 48 (kHz)
MPEG2 LSF LAYER3: 16, 22.05, 24 (kHz)
- Compatible bit rates (compatible with VBR)
MPEG1 LAYER3: 64, 80, 96, 112, 128, 160, 192, 224, 256, 320 (kbps)
MPEG2 LSF LAYER3: 64, 80, 96, 112, 128, 144, 160 (kbps)

- Compatible channel modes: stereo, joint stereo, dual channel and monaural

I WMA file compatibility

- Compatible standards
WMA Ver. 7, 8, 9
- Compatible sampling frequencies
32, 44.1, 48 (kHz)
- Compatible bit rates (only compatible with 2-channel playback)
Ver. 7, 8: CBR 48, 64, 80, 96, 128, 160, 192 (kbps)
Ver. 9: CBR 48, 64, 80, 96, 128, 160, 192, 256, 320 (kbps)

I Compatible media

Media that can be used for MP3 and WMA playback are CD-Rs and CD-RWs.

Playback in some instances may not be possible, depending on the status of the CD-R or CD-RW. Playback may not be possible or the audio may jump if the disc is scratched or marked with fingerprints.

I Compatible disc formats

The following disc formats can be used.

- Disc formats: CD-ROM Mode 1 and Mode 2
CD-ROM XA Mode 2, Form 1 and Form 2
- File formats: ISO9660 Level 1, Level 2, (Romeo, Joliet)
MP3 and WMA files written in any format other than those listed above may not play correctly, and their file names and folder names may not be displayed correctly.

Items related to standards and limitations are as follows.

- Maximum directory hierarchy: 8 levels
- Maximum length of folder names/file names: 32 characters
- Maximum number of folders: 192 (including the root)
- Maximum number of files per disc: 255

I File names

The only files that can be recognized as MP3/WMA and played are those with the extension .mp3 or .wma.

I Multi-sessions

As the audio system is compatible with multi-sessions, it is possible to play discs that contain MP3 and WMA files. However, only the first session can be played.

1 ID3 and WMA tags

ID3 tags can be added to MP3 files, making it possible to record the track title and artist name, etc.

The system is compatible with ID3 Ver. 1.0, 1.1, and Ver. 2.2, 2.3 ID3 tags. (The number of characters is based on ID3 Ver. 1.0 and 1.1.)

WMA tags can be added to WMA files, making it possible to record the track title and artist name in the same way as with ID3 tags.

1 MP3 and WMA playback

When a disc containing MP3 or WMA files is inserted, all files on the disc are first checked. Once the file check is finished, the first MP3 or WMA file is played. To make the file check finish more quickly, we recommend you do not write in any files other than MP3 or WMA files or create any unnecessary folders.

If the discs contain a mixture of music data and MP3 or WMA format data, only music data can be played.

1 Extensions

If the file extensions .mp3 and .wma are used for files other than MP3 and WMA files, they will be mistakenly recognized and played as MP3 and WMA files. This may result in large amounts of interference and damage to the speakers.

1 Playback

- To play MP3 file with steady sound quality, we recommend a fixed bit rate of 128 kbps and a sampling frequency of 44.1 kHz.
- CD-R or CD-RW playback may not be possible in some instances, depending on the characteristics of the disc.
- There is a wide variety of freeware and other encoding software for MP3 and WMA files on the market, and depending on the status of the encoding and the file format, poor sound quality or noise at the start of playback may result. In some cases, playback may not be possible at all.
- When files other than MP3 or WMA files are recorded on a disc, it may take more time to recognize the disc and in some cases, playback may not be possible at all.
- Microsoft, Windows, and Windows Media are the registered trademarks of Microsoft Corporation in the U.S. and other countries.



NOTICE

- n CDs and adapters that cannot be used (→P. 198)**
- n CD player precautions (→P. 199)**

3-2. Using the audio system

Optimal use of the audio system

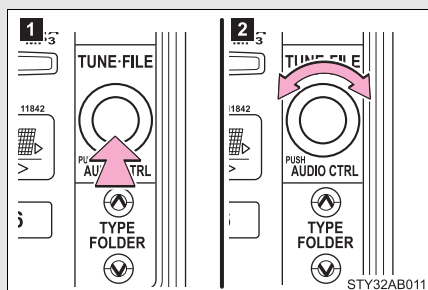

1 Displays the current mode

2 Changes the following setting

Sound quality and volume balance.

The sound quality and balance setting can be changed to produce the best sound.

Using the AUDIO CONTROL function

n Changing sound quality modes

Pressing  selects the mode to be changed in the following order.

BAS → TRE → FAD → BAL → ASL

n Adjusting sound quality

Turning  adjusts the level.

Sound quality mode	Mode displayed	Level	Turn to the left	Turn to the right
Bass	BAS	-5 to 5	Low	High
Treble	TRE	-5 to 5		
Front/rear balance	FAD	R7 to F7	Shifts to rear	Shifts to front
Left/right balance	BAL	L7 to R7	Shifts to left	Shifts to right

n Adjusting the Automatic Sound Levelizer (ASL)

When “ASL” is selected, turning  to the right changes the “ASL level in the order of the “LOW”, “MID” and “HIGH”.

Turning  to the left turns “ASL” off.

ASL automatically adjusts the volume and tone quality according to the vehicle speed.

n Trademark owned by SRS Labs, Inc.



The audio system utilizes SRS FOCUS[®] and SRS TruBass[®] audio enhancement technologies, under license from SRS Labs, Inc., in all modes except AM radio mode.

FOCUS, TruBass, SRS and  symbols are trademarks of SRS Labs, Inc. FOCUS and TruBass technologies are incorporated under license from SRS Labs, Inc.

3-2. Using the audio system

Using the AUX adapter (if equipped)

This adapter can be used to connect a portable audio device and listen to it through the vehicle's speakers.

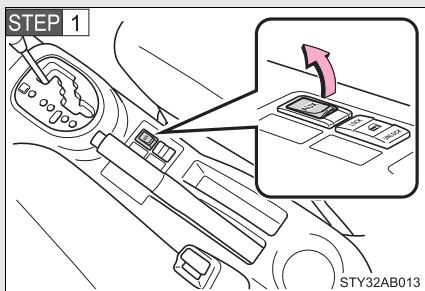

Connect the portable audio device.

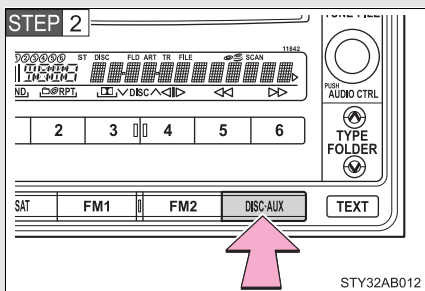

Press **DISC/AUX**.

n Operating portable audio devices connected to the audio system

The volume can be adjusted using the vehicle's audio controls. All other adjustments must be made on the portable audio device itself.

n When using a portable audio device connected to the power outlet

Noise may occur during playback. Use the power source of the portable audio device.

3-3. Using the interior lights

Interior lights list

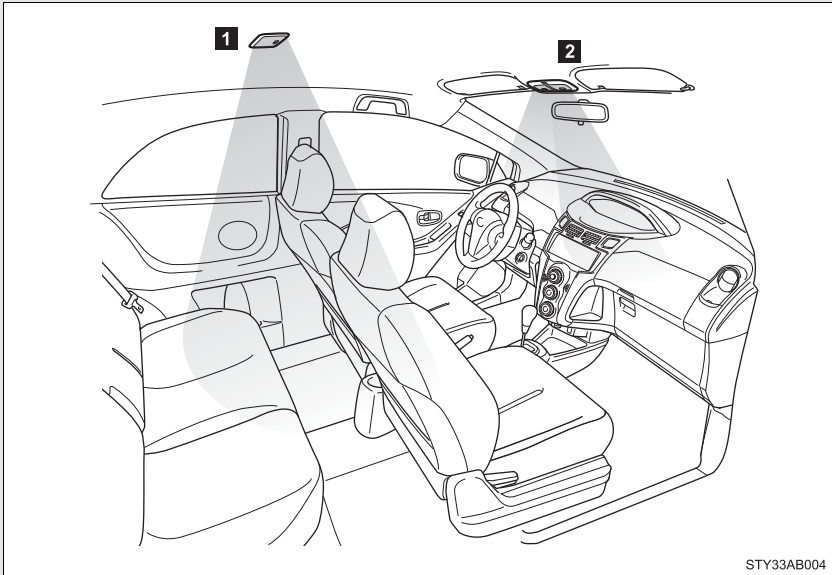

STY33AB004

1 Interior light (→P. 211)

2 Personal lights (→P. 211)

■ **Illuminated entry system (if equipped)**

When the interior light switch is in the DOOR position, the interior light automatically turns on/off according to whether the doors are locked/unlocked and whether the doors are open/closed and the engine switch position.

■ **To prevent the battery from being discharged**

If the interior light remains on when the door is not fully closed and the interior light switch is in the DOOR position, the light will go off automatically after 20 minutes.

■ **Customization that can be configured at Toyota dealer**

Settings (e.g. The time elapsed before lights turn off) can be changed.
(Customizable features →P. 369)

Interior light

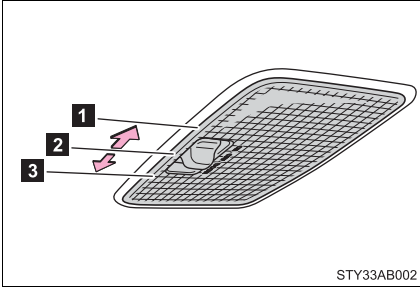

- 1** ON
- 2** OFF
- 3** DOOR position

Personal lights

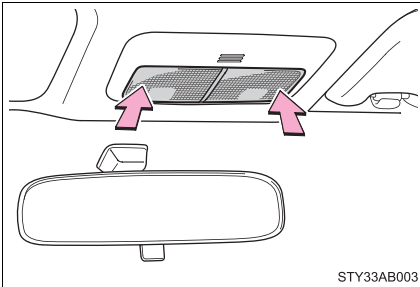

On/off

3-4. Using the storage features

List of storage features

Glove boxes

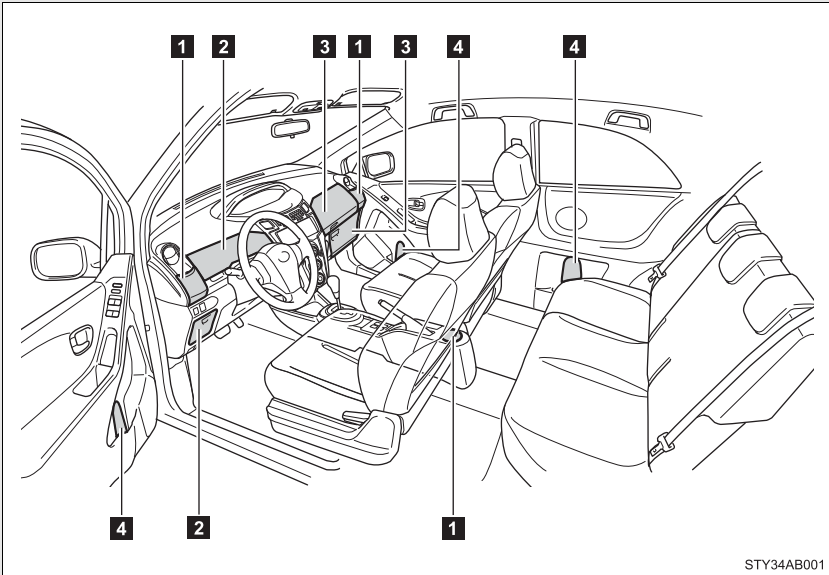

- 1** Cup holders
- 2** Auxiliary boxes
- 3** Glove boxes
- 4** Bottle holders

Glove boxes

► Upper glove box

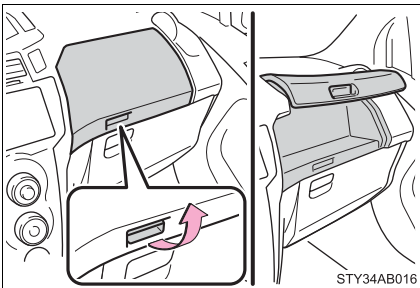

Pull up the lever.

► Lower glove box

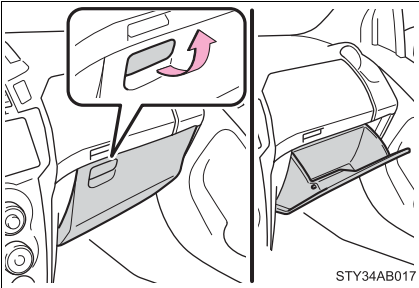

Pull up the lever.

⚠ CAUTION

n Upper glove box: Items that should not be left in the upper glove box

Do not leave anything flammable or deformable such as a lighter, glasses, etc. in the box.

If the interior of the vehicle becomes hot, they may explode, warp or crack.

n Caution while driving

Keep the glove boxes closed.

Injuries may result in the event of an accident or sudden braking.

Cup holders

► Front

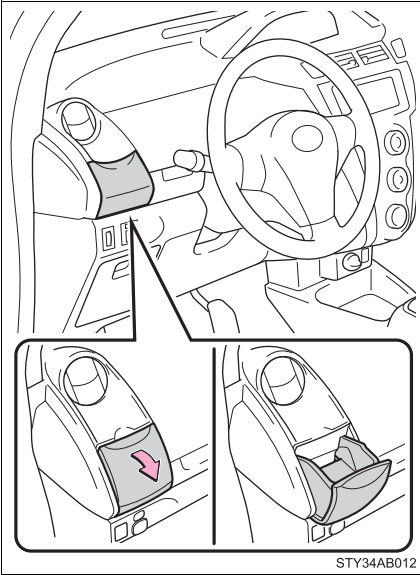

Pull the lid down.

► Rear

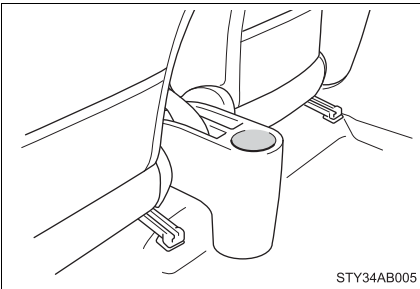

⚠ CAUTION**n Items unsuitable for the cup holder**

Do not place anything other than cups or aluminum cans in the cup holders. Other items may be thrown out of the holders in the event of an accident or sudden braking and cause injury. If possible, cover hot drinks to prevent burns.

n When not in use

Front cup holders: Keep the cup holders closed.

Injuries may result in the event of an accident or sudden braking.

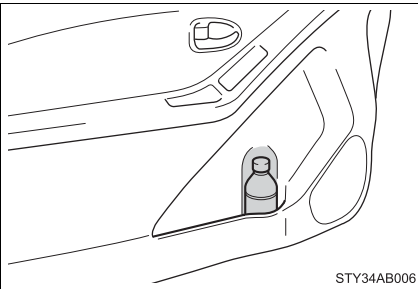
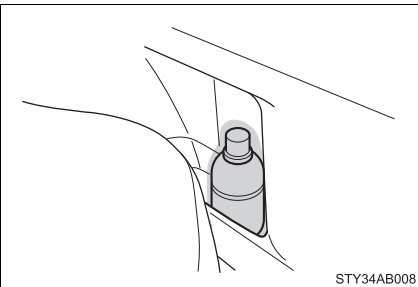
Bottle holders**► Front****► Rear (3-door models)**

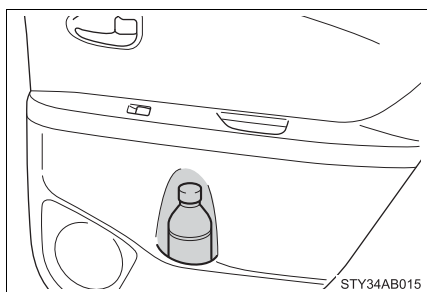
► Rear (5-door models)**n Bottle holders**

Depending on their size or shape, some bottles may not fit in the holders.

⚠ NOTICE**n Items that should not be stowed in the bottle holders**

Put the cap on before stowing a bottle. Do not place open bottles in the bottle holders, or glasses and paper cups containing liquid. The contents may spill and glasses may break.

Auxiliary boxes

► Type A

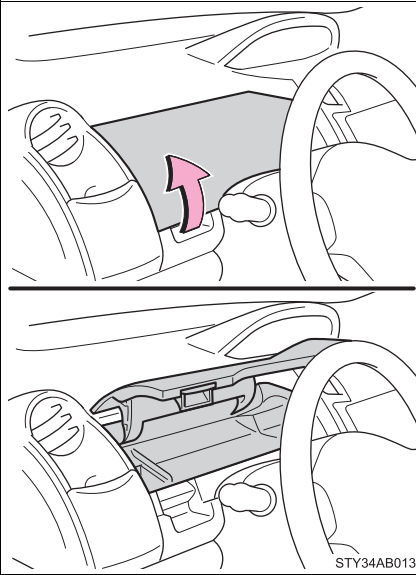

Pull the lid up.

► Type B

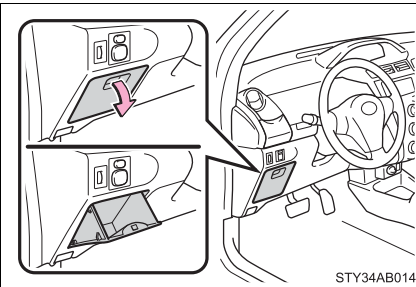

Pull the lid down.

 **CAUTION**

n Type A: Items that should not be left in the auxiliary box

Do not leave anything flammable or deformable such as a lighter, glasses, etc. in the box.

If the interior of the vehicle becomes hot, they may explode, warp or crack.

n Caution while driving

Keep the auxiliary box closed.

Injuries may result in the event of an accident or sudden braking.

Sun visors

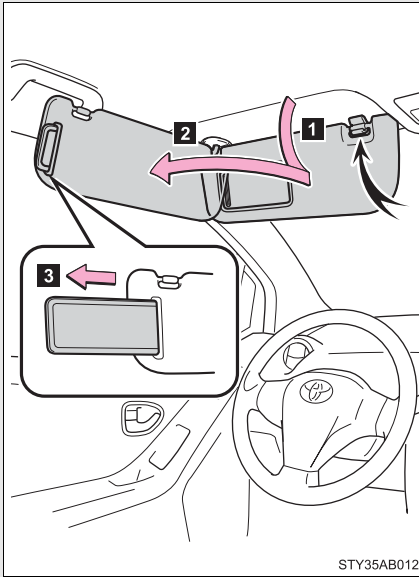

- 1** Forward position:
Flip down.
- 2** Side position:
Flip down, unhook, and swing to the side.
- 3** Side extender:
Place in side position then slide backwards.

⚠ CAUTION

n When the sun visor is in the forward position

Do not extend the side extender. It can cover the anti-glare inside rear view mirror and obstruct the rear view.

3-5. Other interior features

Vanity mirrors

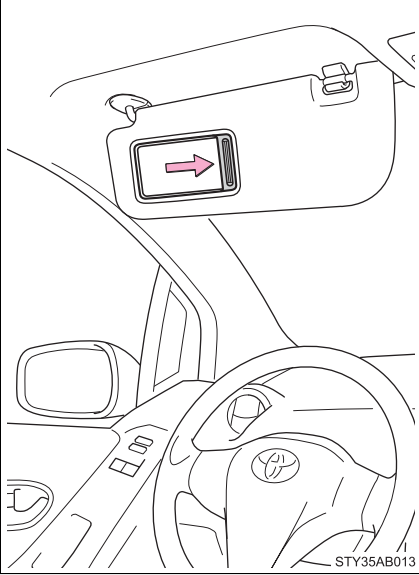

Slide the cover.

Clock

► Vehicles with tachometer

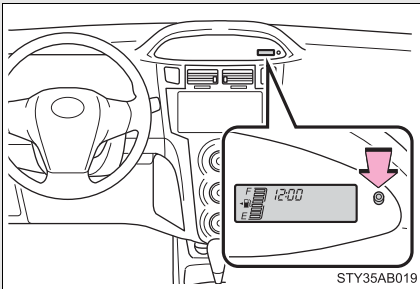

STEP 1 Press and hold the clock reset button to enter the adjustment mode for the clock.

STEP 2 Press the clock reset button to adjust the hours.

After adjusting the hours, wait 5 seconds to allow the hours to be automatically input.

STEP 3 Press the clock reset button to adjust the minutes.

After adjusting the minutes, wait 5 seconds to allow the minutes to be automatically input and then return to normal mode.

► Vehicles without tachometer

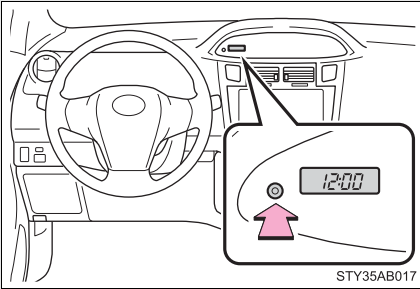

STEP 1 Press and hold the clock reset button to enter the adjustment mode for the clock.

STEP 2 Press the clock reset button to adjust the minutes.

After adjusting the minutes, wait 5 seconds to allow the minutes to be automatically input.

STEP 3 Press the clock reset button to adjust the hours.

After adjusting the hours, wait 5 seconds to allow the hours to be automatically input and then return to normal mode.

n **The clock is displayed when**

The engine switch is in the ON position.

n **When disconnecting and reconnecting battery terminals**

The time display will automatically be set to 1:00.

n **Adjusting to a full hour (vehicles without tachometer)**

If you press the clock reset button, the minute values will be rounded to the nearest hour. So, minute values from “:00” to “:29” are rounded down, and values from “:30” to “:59” are rounded up.*

*: e.g.

1:00 to 1:29 → 1:00

1:30 to 1:59 → 2:00

Power outlet

The power outlet can be used for 12 V accessories that run on less than 10 A.

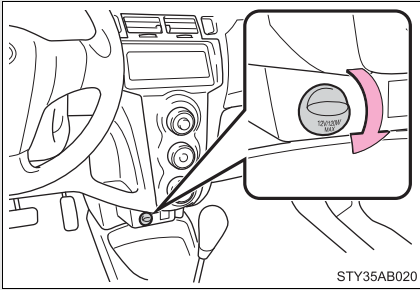

n The power outlet can be used when

The engine switch is in the ACC or ON position.

! NOTICE

n To avoid damaging the power outlet

Close the power outlet lid when the power outlet is not in use. Foreign objects or liquids that enter the power outlet may cause a short circuit.

n To prevent the fuse from being blown

Do not use an accessory that uses more than 12 V 10 A.

n To prevent the battery from being discharged

Do not use the power outlet longer than necessary when the engine is not running.

Floor mat

Securely place a mat that matches the size of the space on the carpet.

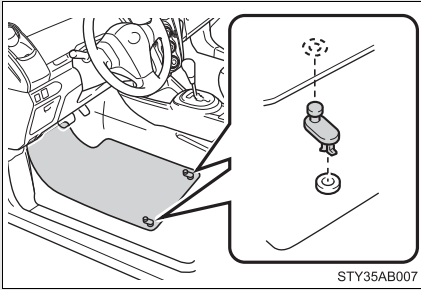

Secure the driver's floor mat using the hooks provided.

⚠ CAUTION

n When inserting the floor mat

Observe the following precautions.

Failure to do so may result in the floor mat slipping and interfering with the movement of the pedals during driving, resulting in an accident.

- I** Make sure the floor mat is properly placed on the vehicle carpet and the correct side faces upward.
- I** Do not place floor mats on top of existing mats.

Luggage compartment features

n Auxiliary boxes

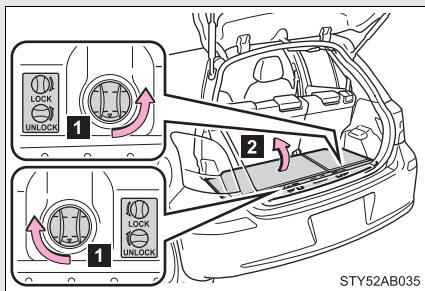

- 1 Turn the knobs to the UNLOCK position.
- 2 Lift the deck board.

After lowering the deck board, turn the knobs to the LOCK position.

n Removing the auxiliary boxes

The auxiliary boxes can be removed by following the procedure below.

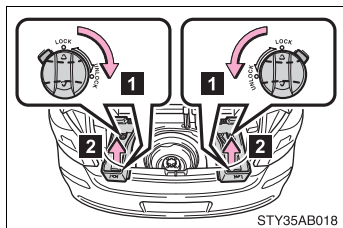

- 1 Turn the knobs to the UNLOCK position.
- 2 Remove the auxiliary boxes.

When reinstall the auxiliary boxes, turn the knobs to the LOCK position.

■ **Removing the luggage cover**

The luggage cover can be removed by following the procedure below.

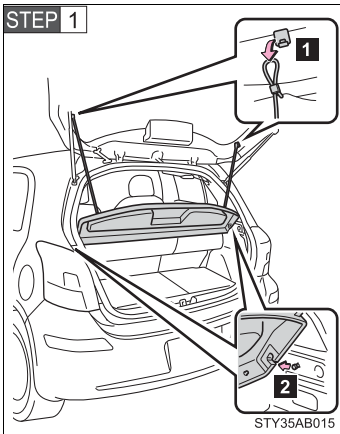

1 Unhook the cords.

2 Remove the cover out of the retainers.

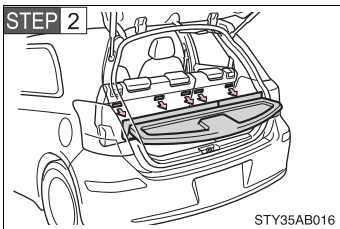

Remove the luggage cover from the seat-back.

⚠ CAUTION

■ **Caution while driving**

Keep the auxiliary boxes closed and locked. Injuries may result in the event of an accident or sudden braking.

Cleaning and protecting the vehicle exterior

Perform the following to protect the vehicle and maintain it in prime condition.

- 1 Working from top to bottom, liberally apply water to the vehicle body, wheel wells and underside of the vehicle to remove any dirt and dust.

Wash the vehicle body using a sponge or soft cloth, such as a chamois.

- 1 For hard-to-remove marks, use car wash soap and rinse thoroughly with water.

- 1 Wipe away any water.

- 1 Wax the vehicle when the waterproof coating deteriorates.

If water does not bead on a clean surface, apply wax when the vehicle body is cool.

n **Automatic car washes**

- 1 Before washing the vehicle, do the following.

- Fold the mirrors back.
- Remove the antenna.

- 1 Brushes used in automatic car washes may scratch the vehicle surface and harm your vehicle's paint.

n **High pressure car washes**

Do not allow the nozzles of the car wash to come within close proximity of the windows. Before entering an automatic car wash, check that the fuel filler door on your vehicle is closed properly.

n **Aluminum wheels (if equipped)**

Remove any dirt immediately by using a neutral detergent. Do not use hard brushes or abrasive cleaners. Do not use strong or harsh chemical cleaners. Use the same mild detergent and wax as used on the point.

n **Bumpers and side moldings**

Do not scrub with abrasive cleaners.

n To prevent deterioration and body corrosion

- l Wash the vehicle immediately in the following cases:
 - After driving near the sea coast
 - After driving on salted roads
 - If you see coal tar or tree sap on the paint surface
 - If you see dead insects or insect droppings on the paint
 - After driving in an area contaminated with soot, oily smoke, mine dust, iron powder or chemical substances
 - If the vehicle becomes heavily soiled in dust or mud
 - If liquids such as benzene and gasoline are spilled on the paint surface
- l If the paint is chipped or scratched, have it repaired immediately.

CAUTION

n Caution about the exhaust pipe

Exhaust gasses cause the exhaust pipe to become quite hot.

When washing the vehicle, be careful not to touch the pipe until it has cooled sufficiently, as touching a hot exhaust pipe can cause burns.

NOTICE

n To protect your vehicle's painted surfaces

Do not use organic cleaners such as benzene or gasoline.

n Cleaning the exterior lights

l Wash carefully. Do not use organic substances or scrub with a hard brush. This may damage the surfaces of the lights.

l Do not apply wax on the surfaces of the lights. Wax may cause damage to the lenses.

n To prevent damage to the windshield wiper arms

When lifting the wiper arms away from the windshield, pull the driver side wiper arm upward first, and repeat for the passenger side. When returning the wipers to their original position, do so from the passenger side first.

Cleaning and protecting the vehicle interior

The following procedures will help protect your vehicle's interior and keep it in top condition:

n Protecting the vehicle interior

Remove dirt and dust using a vacuum cleaner. Wipe dirty surfaces with a cloth dampened with lukewarm water.

n Cleaning the leather areas

1 Remove dirt and dust using a vacuum cleaner.

1 Wipe any excess dirt and dust with a soft cloth dampened with diluted detergent.

Use a diluted water solution of approximately 5% neutral wool detergent.

1 Wring out any excess water from the cloth and thoroughly wipe off all remaining traces of detergent.

1 Wipe the surface with a dry, soft cloth to remove any remaining moisture. Allow the leather to dry in a shaded and ventilated area.

n **Cleaning the inside of the rear window**

Do not use glass cleaner to clean the rear window, as this may cause damage to the rear window defogger heater wires. Use a cloth dampened with lukewarm water to gently wipe the window clean. Wipe the window in strokes running parallel to the heater wires.

n **Caring for leather areas**

Toyota recommends cleaning the interior of the vehicle at least twice a year to maintain the quality of the vehicle's interior.

n **Shampooing the carpets**

There are several commercial foaming-type cleaners available. Use a sponge or brush to apply the foam. Rub in overlapping circles. Do not apply water. The excellent results are obtained when keeping the carpet as dry as possible.

n **Seat belts**

Clean with mild soap and lukewarm water using a cloth or sponge. Also check the belts periodically for excessive wear, fraying or cuts.

CAUTION

n **Water in the vehicle**

- I Do not splash or spill liquid in the vehicle. Doing so may cause the electrical components etc. to malfunction or catch fire.
- I Do not get any of the SRS components or wiring in the vehicle interior wet. (→P. 82)

Electrical malfunction may cause the airbags to deploy or not function properly, resulting in death or severe injury.

 NOTICE

n Cleaning detergents

Do not use organic substances such as benzene or gasoline, acidic or alkaline solutions, dye, bleach or other detergent. Doing so may discolor the vehicle interior or cause streaks or damage to painted surfaces.

n Preventing damage to leather surfaces

Observe the following precautions to avoid damage to and deterioration of leather surfaces.

I Remove any dust or dirt on leather surfaces immediately.

I Do not expose the vehicle to direct sunlight for extended periods of time. Park the vehicle in the shade, especially during summer.

I Do not place items made of vinyl, plastic, or that contain wax on the upholstery, as they may stick to the leather surface if the vehicle interior heats up significantly.

n Water on the floor

Do not wash the vehicle floor with water.

Vehicle systems such as the audio system may be damaged if water comes into contact with electrical components under the floor of the vehicle, and may also cause the body to rust.

n Cleaning the inside of the rear window

Be careful not to scratch or damage the heater wires.

Maintenance requirements

To ensure safe and economical driving, day-to-day care and regular maintenance is essential. It is the owner's responsibility to perform regular checks. Toyota recommends the following maintenance.

n General maintenance

Should be performed on a daily basis. This can be done by yourself or by a Toyota dealer.

n Scheduled maintenance

Should be performed at specified intervals according to the maintenance schedule.

For details about maintenance items and schedules, refer to the "Scheduled Maintenance Guide" or "Owner's Manual Supplement".

n Do-it-yourself maintenance

You can perform some maintenance procedures yourself. Please be aware that do-it-yourself maintenance may affect warranty coverage.

The use of Toyota Repair Manuals is recommended.

For details about warranty coverage, see the separate "Owner's Warranty Information Booklet", "Owner's Manual Supplement".

n Repair and replacement

It is recommended that genuine Toyota parts be used for repair to ensure performance of each system. If non-Toyota parts are used in replacement or if a repair shop other than Toyota dealer performs repairs, confirm the warranty coverage.

n Allow inspection and repairs to be performed by a Toyota dealer

- l Toyota technicians are well-trained specialists and are kept up to date with the latest service information. They are well informed about the operations of all systems on your vehicle.
- l Keep a copy of the repair order. It proves that the maintenance that has been performed is under warranty coverage. If any problem should arise while your vehicle is under warranty, your Toyota dealer will promptly take care of it.

⚠ CAUTION

n Warning in handling of battery

- l Engine exhaust, some of its constituents, and a wide variety of automobile components contain or emit chemicals known to the State of California to cause cancer and birth defects and other reproductive harm. Work in a well ventilated area.
- l Oils, fuels and fluids contained in vehicles as well as waste produced by component wear contain or emit chemicals known to the State of California to cause cancer and birth defects or other reproductive harm. Avoid exposure and wash any affected area immediately.
- l Battery posts, terminals and related accessories contain lead and lead compounds which are known to cause brain damage. Wash your hands after handling. (→P. 253)

General maintenance

Listed below are the general maintenance items that should be performed at the intervals specified in the “Scheduled Maintenance Guide” or “Owner’s Manual Supplement”. It is recommended that any problem you notice should be brought to the attention of your Toyota dealer or qualified service shop for advice.

Engine compartment

Items	Check points
Battery	Maintenance-free. (→P. 253)
Brake fluid	At the correct level? (→P. 252)
Engine coolant	At the correct level? (→P. 250)
Engine oil	At the correct level? (→P. 246)
Exhaust system	No fumes or strange sounds?
Radiator/condenser/hoses	Not blocked with foreign matter? (→P. 252)
Washer fluid	At the correct level? (→P. 256)

Vehicle interior

Items	Check points
Accelerator pedal	<ul style="list-style-type: none"> • Moves smoothly (without uneven pedal effort or catching)?
Automatic transmission “Park” mechanism	<ul style="list-style-type: none"> • Can the vehicle be hold securely on an incline with the shift lever in P?
Brake pedal	<ul style="list-style-type: none"> • Moves smoothly? • Does it have appropriate clearance and correct amount of free play?
Brakes	<ul style="list-style-type: none"> • Not pull to one side when applied? • Loss of brake effectiveness? • Spongy feeling brake pedal? • Pedal almost touches floor?
Clutch pedal	<ul style="list-style-type: none"> • Moves smoothly? • Does it have correct amount of free play?
Head restraints	<ul style="list-style-type: none"> • Move smoothly and lock securely?
Indicators/buzzers	<ul style="list-style-type: none"> • Function properly?
Lights	<ul style="list-style-type: none"> • Do all the lights come on? • Headlights aimed correctly?
Parking brake	<ul style="list-style-type: none"> • Moves smoothly? • Can hold the vehicle securely on an incline?
Seat belts	<ul style="list-style-type: none"> • Does the seat belt system operate smoothly? • Are the belts undamaged?
Seats	<ul style="list-style-type: none"> • Do the seat controls operate properly?

Items	Check points
Steering wheel	<ul style="list-style-type: none"> • Moves smoothly? • Has correct free play? • No strange noises?

Vehicle exterior

Items	Check points
Doors	<ul style="list-style-type: none"> • Operate smoothly?
Engine hood	<ul style="list-style-type: none"> • The lock system works properly?
Fluid leaks	<ul style="list-style-type: none"> • Is there any leakage after parking?
Tire	<ul style="list-style-type: none"> • Inflation pressure is correct? • Tire surfaces not worn or damaged? • Tires rotated according to the maintenance schedule? • Wheel nuts are not loose?

CAUTION

n If the engine is running

Turn the engine off and ensure that there is adequate ventilation before performing maintenance checks.

Some states have vehicle emission inspection programs which include OBD (On Board Diagnostics) checks. The OBD system monitors the operation of the emission control system.

n If the malfunction indicator lamp comes on

The OBD system determines that a problem exists somewhere in the emission control system. Your vehicle may not pass the I/M test and may need to be repaired. Contact your Toyota dealer to service the vehicle.

n Your vehicle may not pass the I/M test:

l When the battery is disconnected or discharged

Readiness codes that are set during ordinary driving are erased.

Also, depending on your driving habits, the readiness codes may not be completely set.

l When the fuel tank cap is loose

The malfunction indicator lamp comes on as a temporary malfunction and your vehicle may not pass the I/M test.

n When the malfunction indicator lamp goes off after several driving trips

The error code in the OBD system will not be cleared unless the vehicle is driven 40 or more times.

n If your vehicle does not pass the I/M test

Contact your Toyota dealer to prepare the vehicle for re-testing.

Do-it-yourself service precautions

If you perform maintenance yourself, be sure to follow the correct procedures as given in these sections.

Items	Parts and tools
Battery condition (→P. 253)	<ul style="list-style-type: none"> • Warm water • Baking soda • Grease • Conventional wrench (for terminal clamp bolts)
Brake fluid level (→P. 252)	<ul style="list-style-type: none"> • FMVSS No.116 DOT 3 or SAE J1703 brake fluid • Rag or paper towel
Engine coolant level (→P. 250)	<ul style="list-style-type: none"> • “Toyota Super Long Life Coolant” or similar high quality ethylene glycol based non-silicate, non-amine, non-nitrite and non-borate coolant with long-life hybrid organic acid technology. Except Canada: “Toyota Super Long Life Coolant” is pre-mixed with 50% coolant and 50% deionized water. Canada: “Toyota Super Long Life Coolant” is pre-mixed with 55% coolant and 45% deionized water. • Funnel (used only for adding engine coolant)
Engine oil level (→P. 246)	<ul style="list-style-type: none"> • Toyota Genuine Motor Oil or equivalent • Rag or paper towel • Funnel (used only for adding oil)
Fuses (→P. 275)	<ul style="list-style-type: none"> • Fuse with same amperage rating as original

Items	Parts and tools
Light bulbs (→P. 286)	<ul style="list-style-type: none"> • Bulb with same number and wattage rating as original • Flathead screwdriver
Radiator and condenser (→P. 252)	—
Tire inflation pressure (→P. 264)	<ul style="list-style-type: none"> • Tire pressure gauge • Compressed air source
Washer fluid (→P. 256)	<ul style="list-style-type: none"> • Water • Washer fluid containing antifreeze (for winter use) • Funnel (used only for adding washer fluid)

CAUTION

The engine compartment contains many mechanisms and fluids that may move suddenly, become hot, or become electrically energized. To avoid death or serious injury observe the following precautions.

n When working on the engine compartment

- 1** Keep hands, clothing, and tools away from the moving fan and engine drive belt.
- 1** Be careful not to touch the engine, radiator, exhaust manifold, etc. right after driving as they may be hot. Oil and other fluids may also be hot.
- 1** Do not leave anything that may burn easily, such as paper or rags, in the engine compartment.
- 1** Do not smoke, cause sparks or expose an open flame to fuel or the battery. Fuel and battery fumes are flammable.
- 1** Be extremely cautious when working on the battery. It contains poisonous and corrosive sulfuric acid.

 **CAUTION**
n When working on the engine compartment

I Take care because brake fluid can harm your hands or eyes and damage painted surfaces.

If fluid gets on your hands or in your eyes, flush the affected area with clean water immediately.

If you still experience discomfort, see a doctor.

n When working near the electric cooling fan or radiator grille

Be sure the engine switch is off.

With the engine switch on, the electric cooling fan may automatically start to run if the air conditioning is on and/or the coolant temperature is high.

n Safety glasses

Wear safety glasses to prevent flying or falling material, fluid spray, etc. from getting in the eyes.

 **NOTICE**
n If you remove the air cleaner

Driving with the air cleaner removed may cause excessive engine wear due to dirt in the air. Also a backfire could cause a fire in the engine compartment.

n If the brake fluid level is low or high

It is normal for the brake fluid level to go down slightly as the brake pads wear or when the fluid level in the accumulator is high.

If the reservoir needs frequent refilling, it may indicate a serious problem.

4-3. Do-it-yourself maintenance

Hood

Release the lock from the inside of the vehicle to open the hood.

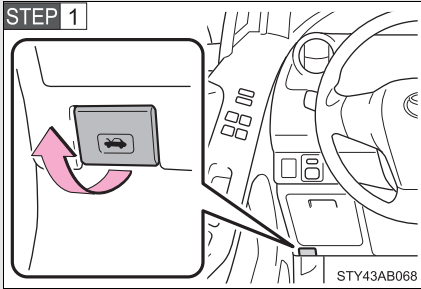

Pull the hood release lever.

The hood will pop up slightly.

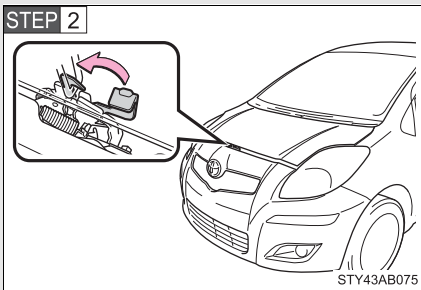

Pull up the hood catch lever and lift the hood.

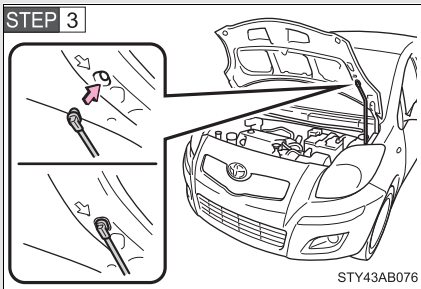

Hold the hood open by inserting the supporting rod into the slot.

⚠ CAUTION

■ Pre-driving check

Check that the hood is fully closed and locked.

If the hood is not locked properly, it may open while the vehicle is in motion and cause an accident, which may result in death or serious injury.

4-3. Do-it-yourself maintenance

Positioning a floor jack

When raising your vehicle with a floor jack, position the jack correctly. Improper placement may damage your vehicle or cause injury.

n Front

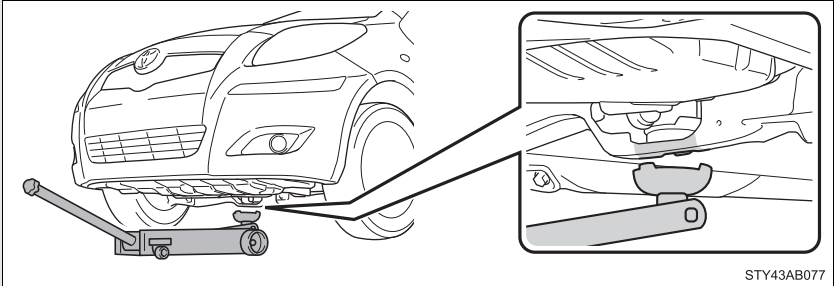

n Rear

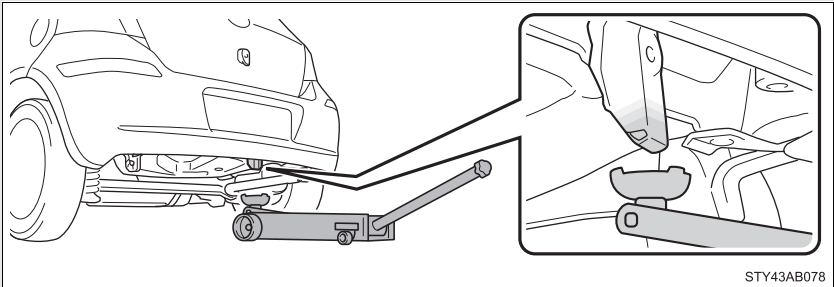

! CAUTION

n When raising your vehicle

Make sure to observe the following to reduce the possibility of death or serious injury.

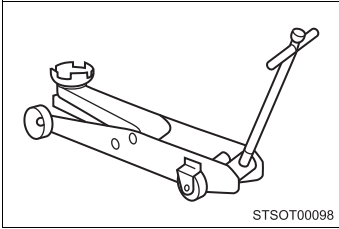

! Lift up the vehicle using a floor jack such as the one shown in the illustration.

- !** Do not use the jack that was supplied with your vehicle.
- !** Do not put any part of your body or get underneath the vehicle supported only by the floor jack.
Always use automotive jack stands on a solid, level surface.
- !** Do not start the engine while the vehicle is supported by the floor jack.
- !** Stop the vehicle on level firm ground, firmly set the parking brake and put the shift lever in P (automatic transmission) or R (manual transmission).
- !** Make sure to set the floor jack properly at the jack point.
Raising the vehicle with an improperly positioned floor jack will damage the vehicle and may cause the vehicle to fall off the floor jack.
- !** Do not raise the vehicle while someone is in the vehicle.
- !** When raising the vehicle, do not place any objects on top of or underneath the floor jack.

Engine compartment

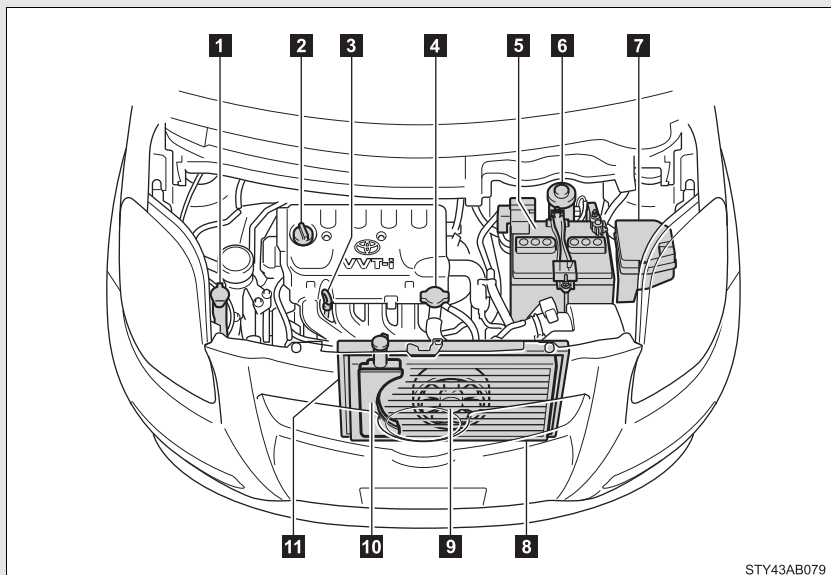

STY43AB079

1 Washer fluid tank (→P. 256)

2 Engine oil filler cap
(→P. 246)

3 Engine oil level dipstick
(→P. 246)

4 Radiator cap

5 Battery (→P. 253)

6 Brake fluid reservoir
(→P. 252)

7 Fuse box (→P. 275)

8 Condenser (→P. 252)

9 Electric cooling fan

10 Engine coolant reservoir
(→P. 250)

11 Radiator (→P. 252)

Engine oil

With the engine at operating temperature and turned off, check the oil level on the dipstick.

n Checking the engine oil

STEP 1 Park the vehicle on level ground. After turning off the engine, wait more than 5 minutes for the oil to drain back into the bottom of the engine.

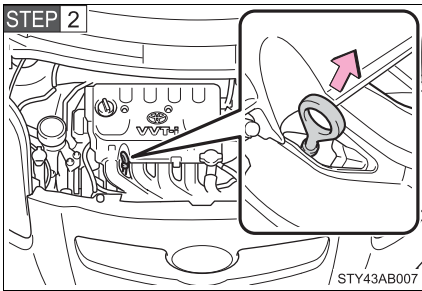

Hold a rag under the end and pull the dipstick out.

STEP 3 Wipe the dipstick clean.

STEP 4 Reinsert the dipstick fully.

STEP 5 Holding a rag under the end, pull the dipstick out and check the oil level.

STEP 6 Wipe the dipstick and reinsert it fully.

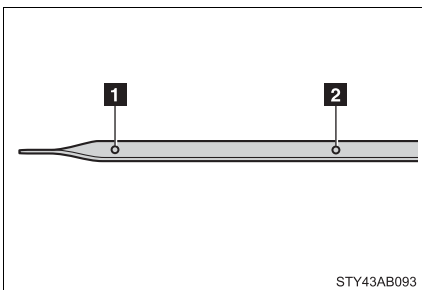

1 Low

2 Full

n Adding engine oil

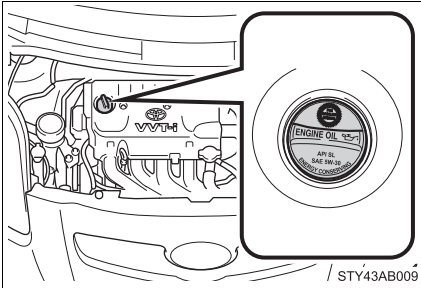

If the oil level is below or near the low level mark, add engine oil of the same type as already in the engine.

Make sure to check the oil type and prepare the items needed before adding oil.

Oil grade	ILSAC multigrade engine oil
Items	Clean funnel

STEP 1 Remove the oil filler cap, turning it counterclockwise.

STEP 2 Add engine oil slowly.

STEP 3 Checking the dipstick.

STEP 4 Reinstall the filler cap, turning it clockwise.

The approximate quantity of oil needed to raise the level between low and full on the dipstick is indicated as follows:

1.6 qt. (1.5 L, 1.3 Imp. qt.)

n Recommended viscosity

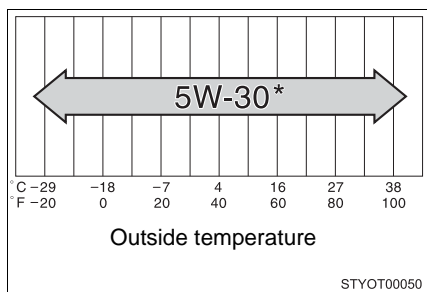

SAE 5W-30 is the best choice, for good fuel economy, and good starting in cold weather.

*: If SAE 5W-30 oil is not available, SAE 10W-30 oil may be used. However, it should be replaced with SAE 5W-30 at the next oil change.

n How to read oil container labels

The ILSAC (International Lubricant Standardization and Approval Committee) Certification Mark is added to some oil containers to help you select the oil you should use.



n Engine oil consumption

- 1 The amount of engine oil consumed depends on the oil viscosity, the quality of the oil and the way the vehicle is driven.
- 1 More oil is consumed under driving conditions such as high speeds and frequent acceleration and deceleration.
- 1 A new engine consumes more oil.
- 1 When judging the amount of oil consumption, keep in mind that the oil may have become diluted, making it difficult to judge the true level accurately.
- 1 Oil consumption: Max. 1.1 qt./600 miles, 0.9 Imp.qt./600 miles (1.0 L per 1000 km)

n Engine oil consumption

- l If you consume more than 1.1 qt. (1.0 L, 0.9 Imp.qt.) every 600 miles (1000 km), contact your Toyota dealer.

n After changing the engine oil (except Canada)

The oil change system should be reset. Perform the following procedures:

STEP 1 Turn the engine switch off with the Trip A reading shown.(→P. 135)

STEP 2 Turn the engine switch to the ON position while holding down the trip meter reset button.

STEP 3 Continue to press and hold the button until the trip meter displays 000000.

If the system fails to reset, the light will continue flashing.

CAUTION

n Used engine oil

- l Used engine oil contains potentially harmful contaminants which may cause skin disorders such as inflammation or skin cancer, so care should be taken to avoid prolonged and repeated contact. To remove used engine oil from your skin, wash thoroughly with soap and water.
- l Dispose of used oil and filters only in a safe and acceptable manner. Do not dispose of used oil and filters in household trash, in sewers or onto the ground. Call your Toyota dealer, service station or auto parts store for information concerning recycling or disposal.
- l Do not leave used engine oil within the reach of children.

 NOTICE

n To prevent serious engine damage

Check the oil level on regular basis.

n When replacing the engine oil

- !** Be careful not to spill engine oil on the vehicle components.
- !** Avoid overfilling, as the engine could be damaged.
- !** Check the oil level on the dipstick every time you refill the vehicle.
- !** Be sure the engine oil filler cap is properly tightened.

Engine coolant

The coolant level is satisfactory if it is between the FULL and LOW lines on the reservoir when the engine is cold.

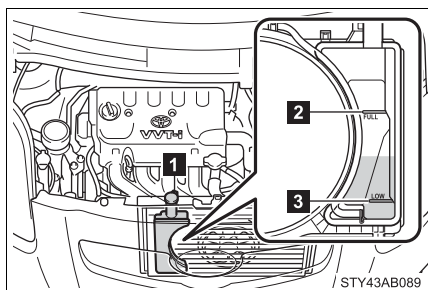

1 Reservoir cap

2 FULL

3 LOW

If the level is on or below the LOW line, add coolant up to the FULL line.

n If the coolant level drops within a short time after replenishing

Visually check the radiator, hoses, reservoir cap, radiator cap, drain cock and water pump.

If you cannot find a leak, have your Toyota dealer pressure test the cap and check for leaks in the cooling system.

n Coolant selection

Only use “Toyota Super Long Life Coolant” or similar high quality ethylene glycol based non-silicate, non-amine, non-nitrite and non-borate coolant with long-life hybrid organic acid technology.

Except Canada: “Toyota Super Long Life Coolant” is a mixture of 50% coolant and 50% deionized water. (Enabled: -31°F [-35°C])

Canada: “Toyota Super Long Life Coolant” is a mixture of 55% coolant and 45% deionized water. (Enabled: -44°F [-42°C])

For more details about engine coolant, contact your Toyota dealer.

⚠ CAUTION

n When the engine is hot

Do not remove the radiator cap.

The cooling system may be under pressure and may spray hot coolant if the cap is removed, causing burns or other injuries.

⚠ NOTICE

n When adding engine coolant

Coolant is neither plain water nor straight antifreeze. The correct mixture of water and antifreeze must be used to provide proper lubrication, corrosion protection and cooling. Be sure to read the antifreeze or coolant label.

n If you spill coolant

Be sure to wash it off with water to prevent damage to parts or paint.

Radiator and condenser

Check the radiator and condenser and clear any foreign objects. If either of the above parts are extremely dirty or you are not sure of their condition, have your vehicle checked by your Toyota dealer.

⚠ CAUTION

n When the engine is hot

Do not touch the radiator or condenser as they may be hot and may cause burns.

Brake fluid

n Checking fluid level

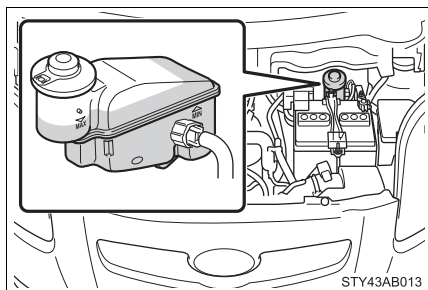

The brake fluid level should be between the MAX and MIN lines on the reservoir.

n Adding fluid

Make sure to check the fluid type and prepare the necessary items.

Fluid type	FMVSS No.116 DOT 3 or SAE J1703 brake fluid
------------	---

n Brake fluid can absorb moisture from the air

Excess moisture in the fluid can cause a dangerous loss of braking efficiency. Use only newly opened brake fluid.

⚠ CAUTION**n When filling the reservoir**

Take care because brake fluid can harm your hands or eyes and damage painted surfaces.

If fluid gets on your hands or in your eyes, flush the affected area with clean water immediately.

If you still experience discomfort, see a doctor.

⚠ NOTICE**n If the fluid level is low or high**

It is normal for the brake fluid level to go down slightly as the brake pads wear or when the fluid level in the accumulator is high.

If the reservoir needs frequent refilling, it may indicate a serious problem.

n If you spill fluid

Be sure to wash it off with water to prevent damage to parts or paint.

Battery**n Battery exterior**

Make sure that the battery terminals are not corroded and that there are no loose connections, cracks, or loose clamps.

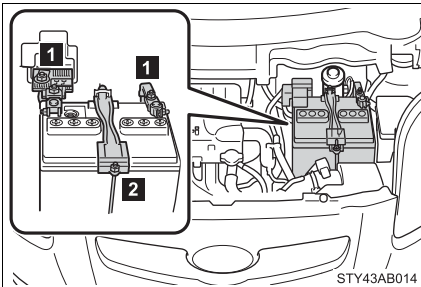
**1** Terminals**2** Hold-down clamp

n Checking battery condition

Check the battery condition using the indicator color.

► Type A

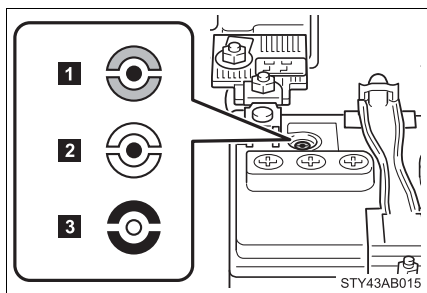

- 1 Blue: Good condition
- 2 White: Charging is necessary. Have the vehicle inspected by your Toyota dealer.
- 3 Red: Not working properly, have the battery checked by your Toyota dealer.

► Type B

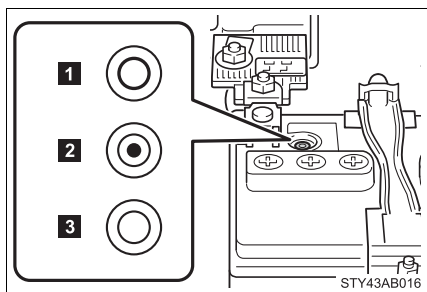

- 1 Green: Good condition
- 2 Dark: Charging is necessary. Have the vehicle inspected by your Toyota dealer.
- 3 Clear or light yellow: Not working properly, have the battery checked by your Toyota dealer.

n Before recharging

When recharging, the battery produces hydrogen gas which is flammable and explosive. Therefore, before recharging:

- 1 If recharging with the battery installed on the vehicle, be sure to disconnect the ground cable.
- 1 Make sure the power switch on the charger is off when connecting and disconnecting the charger cables to the battery.

 **CAUTION**
n Chemicals in the battery

A battery contains poisonous and corrosive sulfuric acid and may produce hydrogen gas which is flammable and explosive. To reduce the risk of death or serious injury, take the following precautions while working on or near battery:

- I Do not cause sparks by touching the battery terminals with tools.
- I Do not smoke or light a match near the battery.
- I Avoid contact with eyes, skin and clothes.
- I Never inhale or swallow electrolyte.
- I Wear protective safety glasses when working near the battery.
- I Keep children away from the battery.

n Where to safety charge the battery

Always charge the battery in an open area. Do not charge the battery in a garage or closed room where there is not sufficient ventilation.

n How to recharge the battery

Only perform a slow charge (5A or less).
The battery may explode if charged at a quicker rate.

n Emergency measures regarding electrolyte

- I If electrolyte gets in your eyes
Flush your eyes with clean water for at least 15 minutes and get immediate medical attention. If possible, continue to apply water with a sponge or cloth while traveling to the nearest medical facility.
- I If electrolyte gets on your skin
Wash the affected area thoroughly. If you feel pain or burning, get medical attention immediately.
- I If electrolyte gets on your clothes
It can soak through clothing on to your skin. Immediately take off the clothing and follow the procedure above if necessary.
- I If you accidentally swallow electrolyte
Drink a large quantity of water or milk. Follow with milk of magnesia, beaten raw egg or vegetable oil. Get emergency medical attention immediately.

 NOTICE

n When recharging the battery

Never recharge the battery while the engine is running. Also, be sure all accessories are turned off.

Washer fluid

If any washer does not work or the low washer fluid warning light comes on (if equipped), the washer tank may be empty.

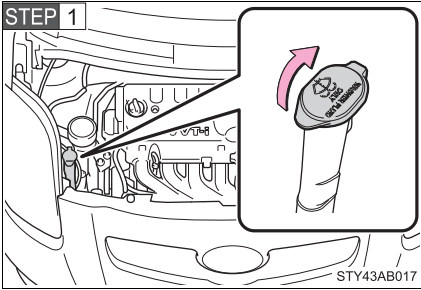

Open the lid.

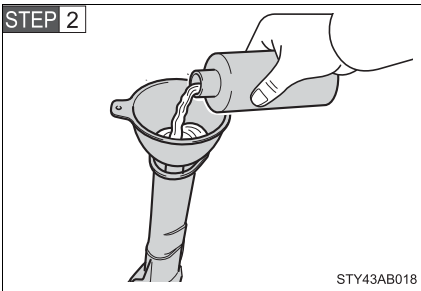

Add washer fluid.

 **CAUTION****n When refilling the washer fluid**

Do not refill the washer fluid when the engine is hot or running, as the washer fluid contains alcohol and may catch fire if spilled on the engine etc.

 **NOTICE****n Do not use any fluid other than washer fluid**

Do not use soapy water or engine antifreeze instead of washer fluid. Doing so may cause streaking on the vehicle's painted surfaces.

n Diluting washer fluid

Dilute washer fluid with water as necessary.
Refer to the freezing temperatures listed on the washer fluid tank.

4-3. Do-it-yourself maintenance

Tires

Replace or rotate tires in accordance with maintenance schedules and treadwear.

n Checking tires

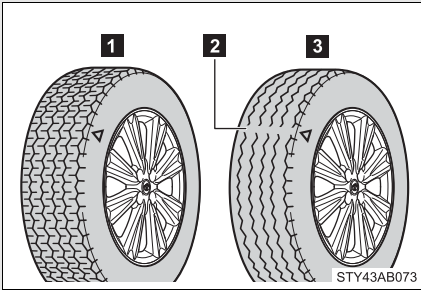

- 1 New tread
- 2 Treadwear indicator
- 3 Worn tread

The location of treadwear indicators is shown by the “TWI” or “△” marks, etc., molded on the sidewall of each tire.

Check spare tire condition and inflation pressure if not rotated.

n Tire rotation

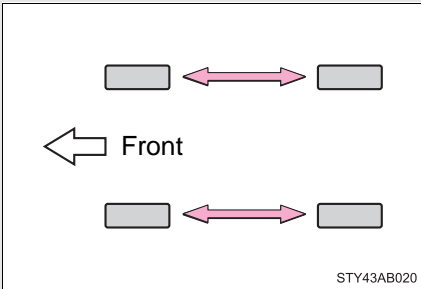

Rotate the tires in the order shown.

To equalize tire wear and extend tire life, Toyota recommends that tire rotation is carried out at the same interval as tire inspection.

n The tire pressure warning system

Your Toyota is equipped with a tire pressure warning system that uses tire pressure warning valves and transmitters to detect low tire inflation pressure before serious problems arise. (→P. 310)

Installing tire pressure warning valves and transmitters

When replacing tires or wheels, tire pressure warning valves and transmitters must also be installed.

When new tire pressure warning valves and transmitters are installed, new tire pressure warning valve and transmitter ID codes must be registered in the tire pressure warning computer and tire pressure warning system must be initialized. Have tire pressure warning valve and transmitter ID codes registered by your Toyota dealer.

Registering ID codes

The tire pressure warning valve and transmitter is equipped with a unique ID code. When replacing a tire pressure warning valve and transmitter, it is necessary to register the ID code of tire pressure warning valve and transmitter. Have the ID code registered by your Toyota dealer.

n **When to replace your vehicle's tires**

Tires should be replaced if:

- l You have tire damage such as cuts, splits, cracks deep enough to expose the fabric or bulges indicating internal damage
- l A tire goes flat repeatedly or cannot be properly repaired due to the size or location of a cut or other damage

If you are not sure, consult with your Toyota dealer.

n **Replacing tires and wheels**

If the ID code of the tire pressure warning valve and transmitter is not registered, the tire pressure warning system will not work properly. After driving for about 20 minutes, the tire pressure warning light comes on after blinking for 1 minute to indicate a system malfunction.

n **Tire life**

Any tire over 6 years old must be checked by a qualified technician even if they have seldom or never been used or damage is not obvious.

■ **If the tread wears down below 0.16 in. (4 mm) on snow tires**

The effectiveness of snow tires is lost.

■ **Maximum load of tire**

Check that the maximum load of the replaced tire is greater than 1/2 of the Gross Axle Weight Ratings (GAWR) of either the front axle or the rear axle, whichever is greater.

As for the maximum load of the tire, see the load limit at maximum cold tire inflation pressure mentioned on the sidewall of the tire, and as for the Gross Axle Weight Ratings (GAWR), see the Certification Label. (→P. 264, 356).

■ **Tire types**

1 Summer tires

Summer tires are high-speed performance tires best suited to highway driving under dry conditions. Since summer tires do not have the same traction performance as snow tires, summer tires are inadequate for driving on snow-covered or icy roads. For driving on snow-covered roads or icy roads, the use of snow tires is recommended. When installing snow tires, be sure to replace all four tires.

2 All season tires

All season tires are designed to provide better traction in snow and to be adequate for driving in most winter conditions, as well as for use year round. All season tires, however, do not have adequate traction performance compared with snow tires in heavy or loose snow. Also, all season tires fall short in acceleration and handling performance compared with summer tires in highway driving.

3 Snow tires

For driving on snow-covered roads or icy roads, we recommend using snow tires. If you need snow tires, select tires of the same size, construction and load capacity as the originally installed tires. Since your vehicle has radial tires as original equipment, make sure your snow tires also have radial construction. Do not install studded tires without first checking local regulations for possible restriction. Snow tires should be installed on all wheels. (→P. 161)

n **Routine tire inflation pressure checks**

The tire pressure warning system does not replace routine tire inflation pressure checks. Make sure to check tire inflation pressure as part of your routine of daily vehicle checks.

n **Tire pressure warning system certification**

MODEL/FCC IDs:

Transmitter: PAXPMV107J

Receiver: HYQ13BCX

► For vehicles sold in U.S.A.

NOTE:

This device complies with Part 15 of the FCC Rules. Operation is subject to the following two conditions: (1) This device may not cause harmful interference, and (2) this device must accept any interference received, including interference that may cause undesired operation.

FCC WARNING:

Changes or modifications not expressly approved by the party responsible for compliance could void the user's authority to operate the equipment.

 CAUTION

n Tire pressure warning system operation

The tire pressure warning system may not provide warning immediately if a tire bursts or if sudden air leakage occurs.

n When inspecting or replacing tires

Observe the following precautions to prevent accidents. Failure to do so may cause damage to parts of the drive train, as well as dangerous handling characteristics, which may lead to fatal or injury accidents.

- I** Do not mix tires of different makes, models, tread patterns or tread-wear.
- I** Do not use tire sizes other than those recommended by Toyota.
- I** Do not mix radial, bias-belted, or bias-ply tires.
- I** Do not mix summer, all season and winter tires.
- I** Do not use tires that have been used on another vehicle.
- I** Do not use tires if you do not know how they were used previously.

 NOTICE**n Repairing or replacing tires, wheels and tire pressure warning valves and transmitters**

When removing or fitting the wheels, tires or the tire pressure warning valve and transmitter, contact your Toyota dealer as the tire pressure warning valve and transmitter may be damaged if not handled correctly.

n To avoid damaging the tire pressure warning valves and transmitters

Do not use liquid sealants on flat tires.

n Driving on rough roads

Take particular care when driving on roads with loose surfaces or pot-holes.

These conditions may cause losses in tire inflation pressure, reducing the cushioning ability of the tires. In addition driving on rough roads may cause damage to the tires themselves, as well as the vehicle's wheels and body.

n If tire inflation pressures become low while driving

Do not continue driving, or your tires and/or wheels may be ruined.

4-3. Do-it-yourself maintenance

Tire inflation pressure

n Tire inflation pressure

The recommended cold tire inflation pressure and tire size is displayed on the tire and loading information label. (→P. 356)

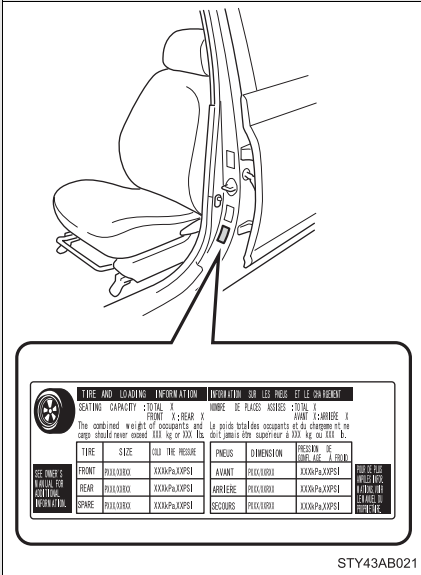

n Inspection and adjustment procedure

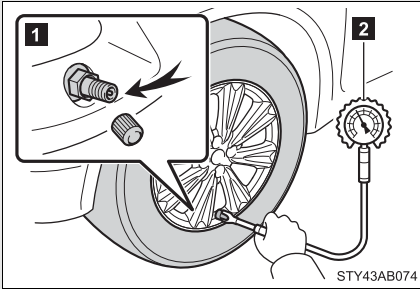

1 Tire valve

2 Tire pressure gauge

STEP 1 Remove the tire valve cap.

STEP 2 Press the tip of the tire pressure gauge onto the tire valve.

STEP 3 Read the pressure using the graduations of the gauge.

STEP 4 If the tire inflation pressure is not within the recommended levels, adjust inflate the tire.

If you add too much air, press the center of the valve to lower.

STEP 5 After completing the tire inflation pressure measurement and adjustment, apply soapy water to the valve and check for leakage.

STEP 6 Reinstall the tire valve cap.

n Tire inflation pressure check interval

You should check tire pressure every two weeks, or at least once a month.

Do not forget to check the spare tire.

n Effects of incorrect tire inflation pressure

Driving with incorrect tire inflation pressure may result in the following:

- l Reduced fuel efficiency
- l Reduced driving comfort and tire life
- l Reduced safety
- l Damage to the drive train

If a tire needs frequent refilling, have it checked by your Toyota dealer.

n Instructions for checking tire inflation pressure

When checking tire inflation pressure, observe the following:

- l Check only when the tires are cold.

If your vehicle has been parked for at least 3 hours and has not been driven for more than 1 mile or 1.5 km, you will get an accurate cold tire inflation pressure reading.

- l Always use a tire pressure gauge.

The appearance of the tire can be misleading. In addition, tire inflation pressures that are even just a few pounds off can degrade ride and handling.

- l Do not bleed or reduce tire inflation pressure after driving. It is normal for the tire inflation pressure to be higher after driving.

- l Never exceed the vehicle capacity weight.

Passengers and luggage weight should be placed so that the vehicle is balanced.

 **CAUTION****n Proper inflation is critical to save tire performance**

Keep your tires properly inflated.

Otherwise, the following conditions may occur and result in an accident causing death or serious injury.

- I Excessive wear
- I Uneven wear
- I Poor handling
- I Possibility of blowouts resulting from overheated tires
- I Poor sealing of the tire bead
- I Wheel deformation and/or tire separation
- I A greater possibility of tire damage from road hazards

 **NOTICE****n When inspecting and adjusting tire inflation pressure**

Be sure to reinstall the tire valve caps.

Without the valve caps, dirt or moisture could get into the valve and cause air leakage, which could result in an accident. If the caps have been lost, replace them as soon as possible.

Wheels

If a wheel is bent, cracked or heavily corroded, it should be replaced.

Otherwise, the tire may separate from the wheel or cause loss of handling control.

n Wheel selection

When replacing wheels, care should be taken to ensure that they are equivalent to those removed in load capacity, diameter, rim width, and offset.

Replacement wheels are available at your Toyota dealer.

Toyota does not recommend using:

- 1 Wheels of different sizes or types
- 1 Used wheels
- 1 Bent wheels that have been straightened

n Aluminum wheel precautions (if equipped)

- 1 Use only Toyota wheel nuts and wrench designed for use with your aluminum wheels.
- 1 When rotating, repairing or changing your tires, check that the wheel nuts are still tight after driving 1000 miles (1600 km).
- 1 Be careful not to damage the aluminum wheels when using tire chains.
- 1 Use only Toyota genuine balance weights or equivalent and a plastic or rubber hammer when balancing your wheels.

n When replacing wheels

The wheels of your Toyota are equipped with tire pressure warning valves and transmitters that allow the tire pressure warning system to provide advanced warning in the event of a loss in tire inflation pressure. Whenever wheels are replaced, the tire pressure warning valves and transmitters must be installed. (→P. 259)

 CAUTION**n When replacing wheels**

- I** Do not use wheels that are a different size from those recommended in the Owner's Manual, as this may result in loss of handling control.
- I** Never use an inner tube in a leaking wheel which is designed for a tubeless tire. Doing so may result in an accident, causing death or serious injury.

 NOTICE**n Replacing tire pressure warning valves and transmitters**

- I** Because tire repair or replacement may affect the tire pressure warning valves and transmitters, make sure to have tires serviced by your Toyota dealer or other qualified service shop. In addition, make sure to purchase your tire pressure warning valves and transmitters at your Toyota dealer.
- I** Ensure that only genuine Toyota wheels are used on your vehicle. Tire pressure warning valves and transmitters may not work properly with non-genuine wheels.

4-3. Do-it-yourself maintenance

Air conditioning filter (if equipped)

The air conditioning filter must be changed regularly to maintain air conditioning efficiency.

n Removal method

STEP 1 Turn the engine switch off.

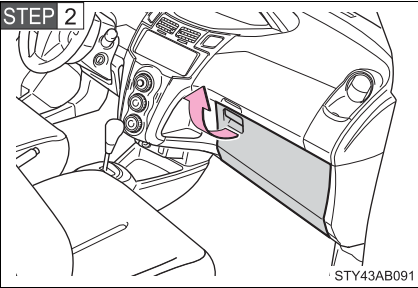

Open the glove box.

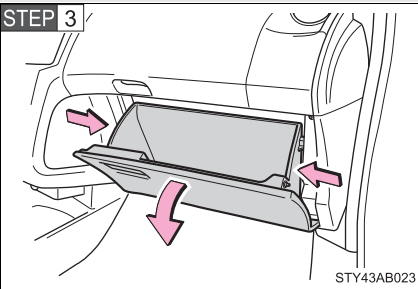

Push in each side of the glove box to disconnect the claws.

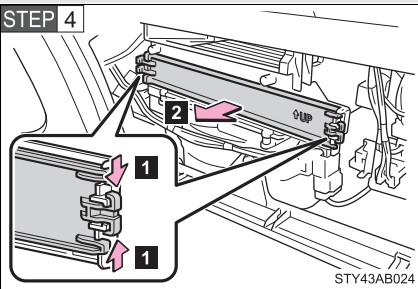

1 Pinch the latches.

2 Remove the filter cover.

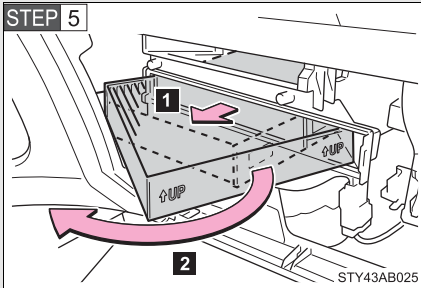

- 1 Pull out the filter.
- 2 Rotate the filter to remove it.

n Installing method

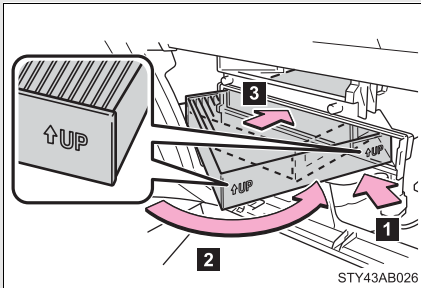

- 1 Set a new filter.
The "↑UP" marks shown on the filter should be pointing up.
- 2 Rotate the filter.
- 3 Push in the filter.

n Checking interval

Inspect and replace the air conditioning filter according to the maintenance schedule. In dusty areas or areas with heavy traffic flow, early replacement may be required. (For scheduled maintenance information, please refer to the "Scheduled Maintenance Guide" or "Owner's Manual Supplement".)

n If air flow from the vents decreases dramatically

The filter may be clogged. Check the filter and replace if necessary.



NOTICE

n When using the air conditioning system

Make sure that a filter is always installed.

Using the air conditioning system without a filter may cause damage to the system.

Key battery

Replace the battery with a new one if it is discharged.

n You will need the following items:

- 1 Flathead screwdriver (To prevent damage to the key, cover the tip of the screwdriver with plastic tape.)
- 1 Lithium battery CR2016

n Replacing the battery

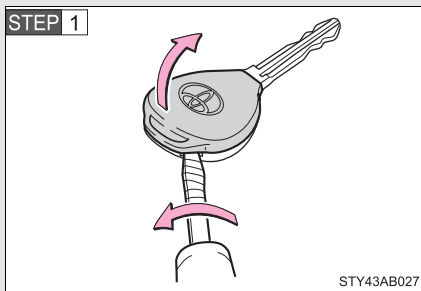

Remove the cover.

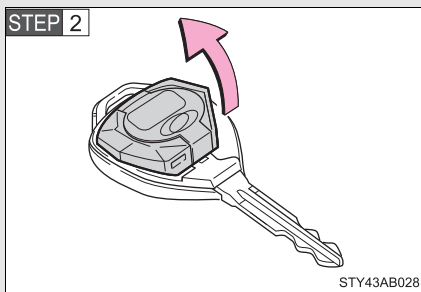

Remove the module.

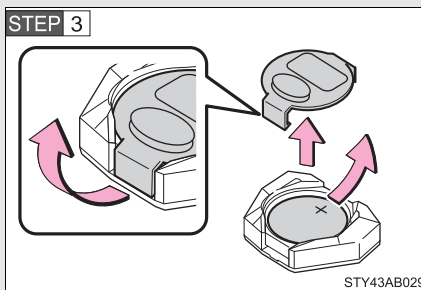

Remove the battery cover and the depleted battery.

Insert a new battery with the “+” terminal facing up.

n If the key battery is discharged

The following symptoms may occur.

- l The wireless remote control will not function properly.
- l The operational range is reduced.

n Use a CR2016 lithium battery

- l Batteries can be purchased at your Toyota dealer, jewelers, or camera stores.
- l Replace only with the same or equivalent type recommended by your Toyota dealer.
- l Dispose of used batteries according to the local laws.

 **CAUTION**

n Removed battery and other parts

Keep away from children.

These parts are small and if swallowed by a child they can cause choking.

 **NOTICE**

n For normal operation after replacing the battery

Observe the following precautions to prevent accidents.

- l Always work with dry hands.
Moisture may cause the battery to rust.
- l Do not touch or move any other components inside the remote control.
- l Do not bend either of the battery terminals.

4-3. Do-it-yourself maintenance

Checking and replacing fuses

If any of the electrical components do not operate, a fuse may have blown. If this happens, check and replace the fuses as necessary.

STEP 1 Turn the engine switch off.

STEP 2 The fuses are located in the following places. To check the fuses, follow the instructions below.

n Engine compartment

► Type A

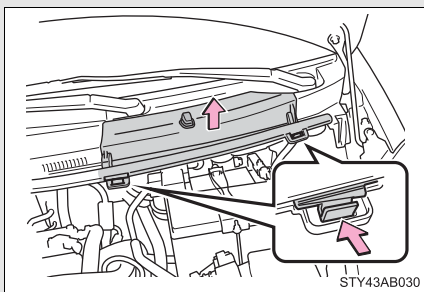

1. Push the tab in and lift the cover off.

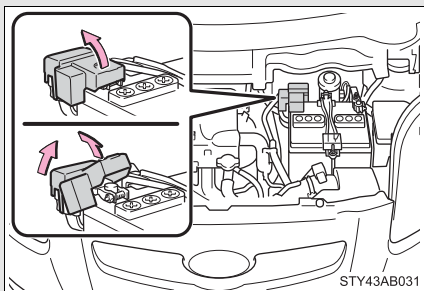

2. Remove the cover.

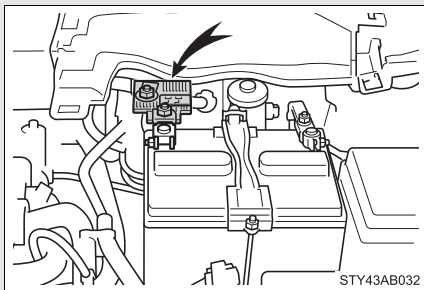

► Type B

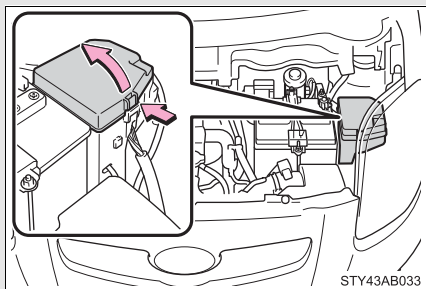

Push the tab in and lift the lid off.

n Under the instrument panel

► Type A

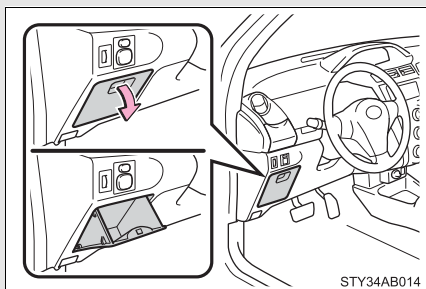

1. Open the auxiliary box.

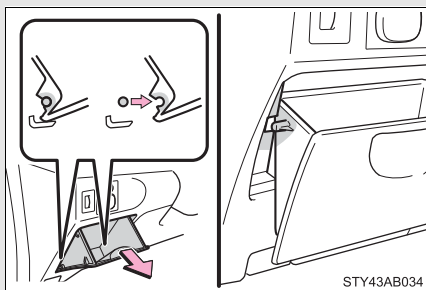

2. Pull up the box and disengage the claws. Remove the stoppers from the cutouts and remove the box.

▶ Type B

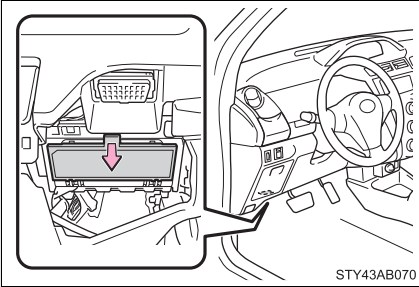

Remove the lid.

STEP 3 After a system failure, see “Fuse layout and amperage ratings” (→P. 279) for details about which fuse to check.

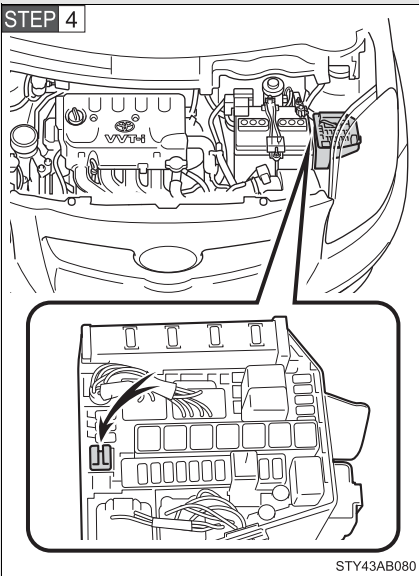

Remove the fuse with the pull-out tool.

STEP 5 Check if the fuse has blown.

► Type A

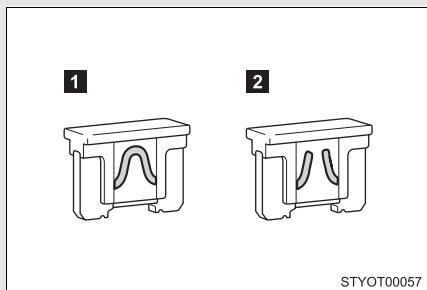

1 Normal fuse

2 Blown fuse

Replace it with one of an appropriate amperage rating. The amperage rating can be found on the fuse box lid.

► Type B

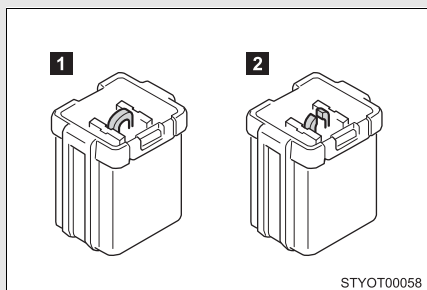

1 Normal fuse

2 Blown fuse

Replace it with one of an appropriate amperage rating. The amperage rating can be found on the fuse box lid.

► Type C

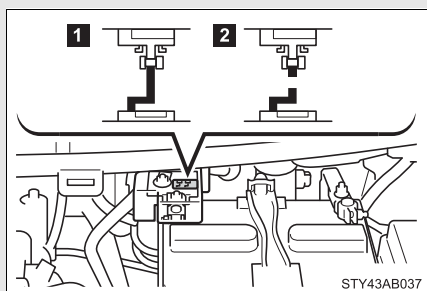

1 Normal fuse

2 Blown fuse

Contact your Toyota dealer.

Fuse layout and amperage ratings

n Engine compartment (type A)

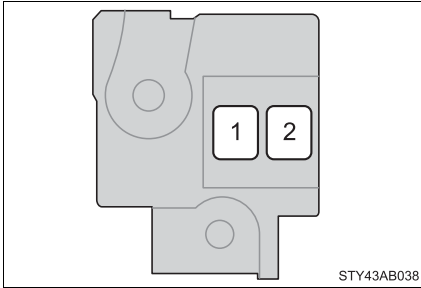

Fuse		Ampere	Circuit
1	ALT	120 A	Charging system, HTR SUB2, EPS, ABS1/VSC1, HTR, ABS2/VSC2, HTR SUB1, RDI, DEF, FR FOG, OBD2, D/L, POWER, RR DOOR, RL DOOR, STOP and AM1
2	MAIN	60 A	EFI, HORN, AM2, ALT-S, DOME, ST, ECU-B, ETCS, HAZ, H-LP LH/H-LP LO LH and H-LP RH/H-LP LO RH fuses

n Engine compartment (type B)

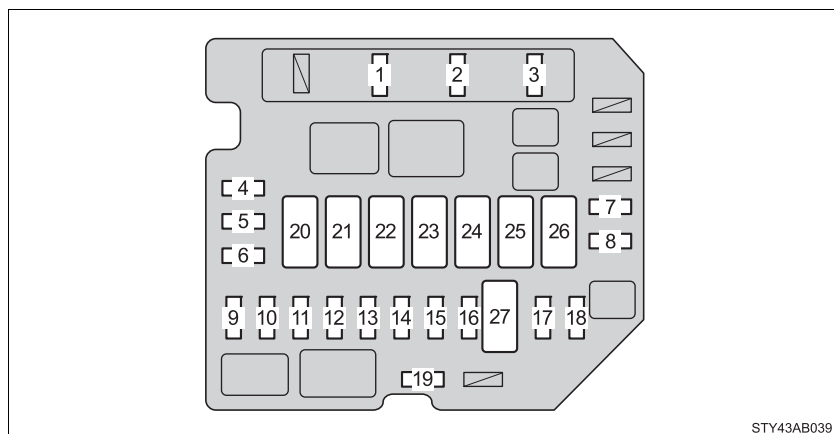

STY43AB039

Fuse		Ampere	Circuit
1	AM2	15 A	Starting system, multiport fuel injection system/sequential multiport fuel injection system
2	HORN	10 A	Horn
3	EFI	20 A	Multiport fuel injection system/sequential multiport fuel injection system
4	SPARE	30 A	Spare fuse
5	SPARE	15 A	Spare fuse
6	SPARE	10 A	Spare fuse
7	FR DEF	20 A	No circuit
8	ABS2/VSC2	30 A	Anti-lock brake system
9	H-LP MAIN	30 A	No circuit
10	ST	30 A	Starting system
11	S-LOCK	20 A	No circuit
12	DOME	15 A	Interior light, personal lights, theft deterrent system, audio system, wireless remote control system

Fuse		Ampere	Circuit
13	ECU-B	7.5 A	Engine immobilizer system, day-time running light system, front passenger occupant classification system, power windows, door lock system, theft deterrent system, meter and gauge
14	ALT-S	7.5 A	Charging system
15	ETCS	10 A	Multiport fuel injection system/ sequential multiport fuel injection system, electronic throttle control system
16	HAZ	10 A	Turn signal lights, emergency flashers
17	H-LP RH/H-LP LO RH	10 A	Right-hand headlight
18	H-LP LH/H-LP LO LH	10 A	Left-hand headlight
19	EFI2	10 A	Multiport fuel injection system/ sequential multiport fuel injection system
20	HTR SUB2	40 A	Air conditioning system
21	EPS	50 A	Electric power steering system
22	ABS1/VSC1	50 A	Anti-lock brake system
23	HTR	40 A	Air conditioning system
24	RDI	30 A	Electric cooling fan
25	HTR SUB1	30 A	Air conditioning system
26	H-LP CLN/PWR HTR	30 A	No circuit
27	AMT	50 A	No circuit

n Under the instrument panel (type A)

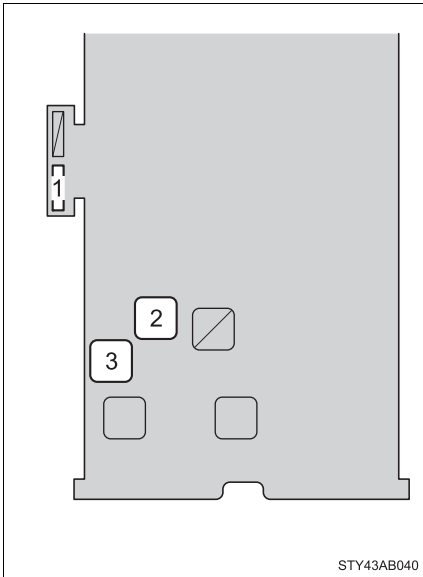

Fuse		Ampere	Circuit
1	ACC2	7.5 A	Shift lock system
2	DEF	40 A	Rear window defogger
3	POWER	30 A	Power windows

n Under the instrument panel (type B)

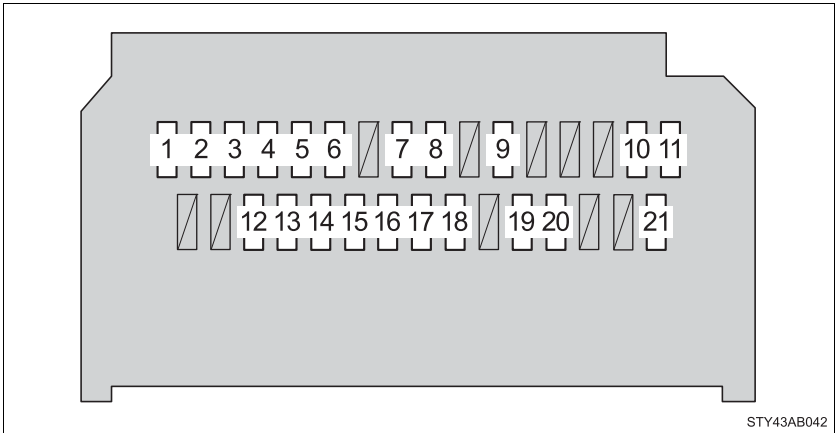

Fuse		Ampere	Circuit
1	TAIL	10 A	Side marker lights, parking lights tail lights, license plate lights, multi- port fuel injection system/sequen- tial multiport fuel injection system
2	PANEL 1	7.5 A	Illuminations, instrument panel light control, meter and gauge
3	A/C	7.5 A	Rear window defogger, air condi- tioning system
4	D DOOR	20 A	No circuit
5	RL DOOR	20 A	Rear passenger's power window (left side)
6	RR DOOR	20 A	Rear passenger's power window (right side)
7	CIG	15 A	Power outlet
8	ACC	7.5 A	Door lock system, outside rear view mirrors, audio system

Fuse		Ampere	Circuit
9	ID/UP/MIR HTR	10 A	Multiport fuel injection system/ sequential multiport fuel injection system, outside rear view mirror control, outside rear view mirror heaters
10	IGN	7.5 A	Multiport fuel injection system/ sequential multiport fuel injection system, engine immobilizer sys- tem, SRS airbag system, front pas- senger occupant classification system
11	MET	7.5 A	Meter and gauge
12	WIP	25 A	Windshield wiper
13	RR WIP	15 A	Rear wiper
14	WSH	15 A	Windshield washer
15	ECU-IG	10 A	Daytime running light system, anti- lock brake system, electric power steering system, power windows, door lock system, theft deterrent system, electric cooling fan
16	GAUGE	10 A	Charging system, turn signal lights, emergency flashers, buck-up lights, instrument panel light con- trol, shift lock system, rear window defogger, air conditioning system, automatic transmission system
17	OBD2	7.5 A	On-board diagnosis system
18	STOP	10 A	Stop lights, high mounted stop- light, multiport fuel injection sys- tem/sequential multiport fuel injection system, shift lock system, anti-lock brake system
19	D/L	25 A	Door lock system
20	FR FOG	15 A	Front fog lights

Fuse		Ampere	Circuit
21	AM1	25 A	Multiport fuel injection system/ sequential multiport fuel injection system

n After a fuse is replaced

- l If the lights do not turn on even after the fuse has been replaced, a bulb may need replacement. (→P. 286)
- l If the replaced fuse blows again, have the vehicle inspected by your Toyota dealer.

n If there is an overload in the circuits

The fuses are designed to blow before the entire wiring harness is damaged.

⚠ CAUTION

n To prevent system breakdowns and vehicle fire

Observe the following precautions.

Failing to do so may cause damage, and possibly a fire or injury.

- l Never use a fuse of a higher amperage rating than indicated, or use any other object in place of a fuse.
- l Always use a genuine Toyota fuse or equivalent.
Never replace a fuse with a wire, even as a temporary fix.
This can cause extensive damage or even fire.
- l Do not modify the fuse or the fuse box.

⚠ NOTICE

n Before replacing fuses

Have the cause of electrical overload determined and repaired by your Toyota dealer as soon as possible.

Light bulbs

You may replace the following bulbs yourself. The difficulty level of replacement varies depending on the bulb. If necessary bulb replacement seems difficult to perform, contact your Toyota dealer.

For more information about replacing other light bulbs, contact your Toyota dealer.

n Prepare a replacement light bulb.

Check the wattage of the light bulb being replaced. (→P. 352)

n Front bulb locations

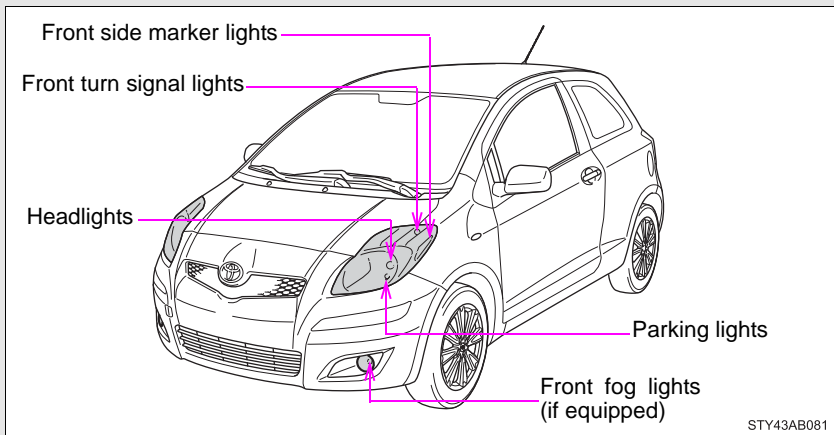

n Rear bulb locations

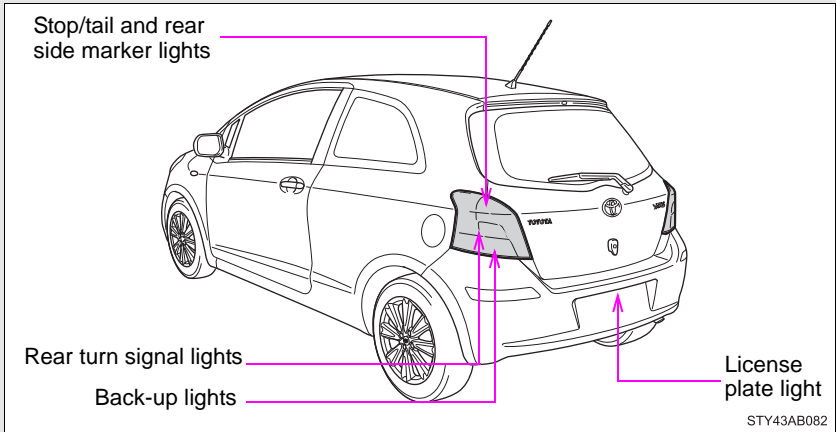

Replacing light bulbs

n Headlights

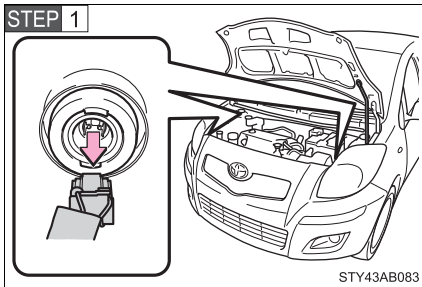

Unplug the connector.

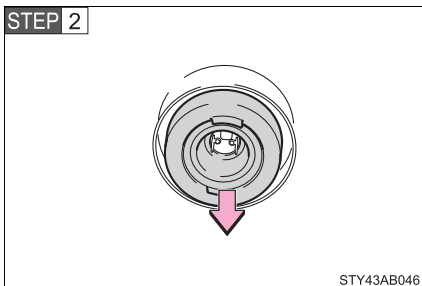

Remove the rubber cover.

STEP 3

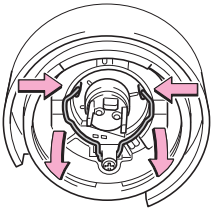

STY43AB047

Release the bulb retaining spring.

STEP 4

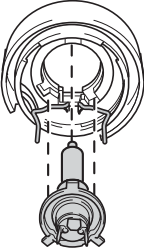

STY43AB048

Remove the bulb.

To install a new bulb, align the tabs of the bulb with the cutouts of the mounting hole.

n Front fog lights (if equipped)

STEP 1

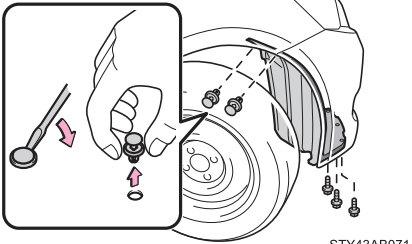

STY43AB071

Remove the bolts and clips.

STEP 2

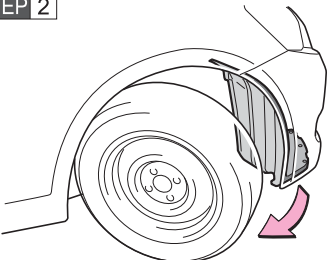

STY43AB072

Partly remove the fender liner.

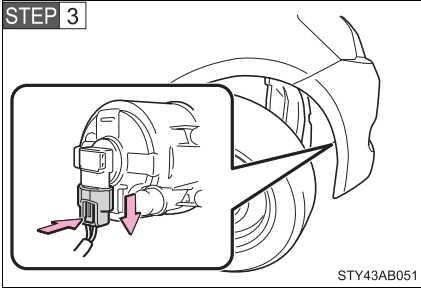

Unplug the connector while depressing the lock release.

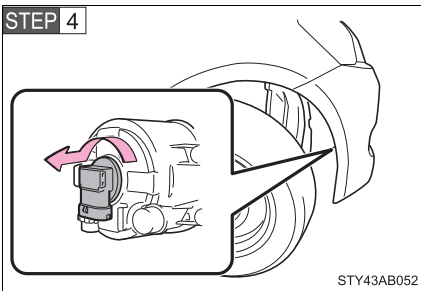

Turn the bulb counterclockwise.

n Front side marker lights

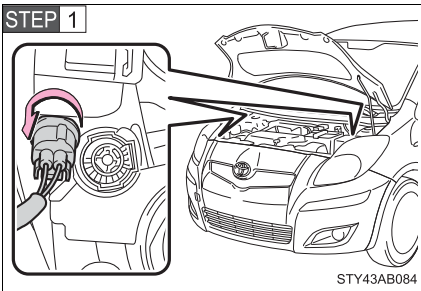

Turn the bulb base counterclockwise.

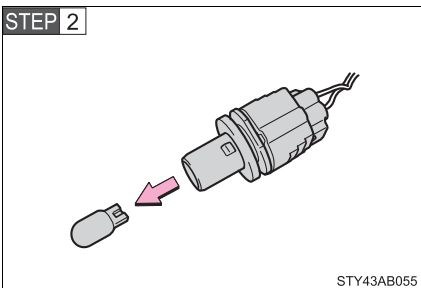

Remove the light bulb.

n Front turn signal lights

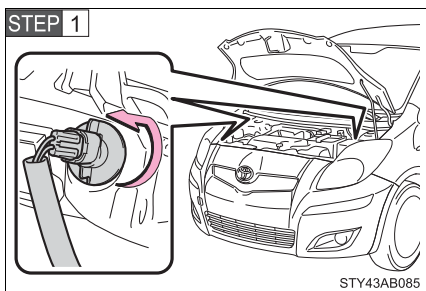

Turn the bulb base counterclockwise.

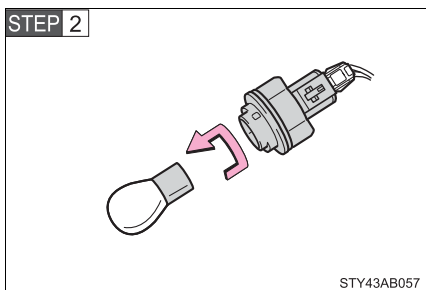

Remove the light bulb.

n Parking lights

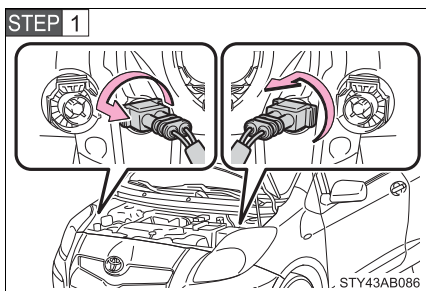

Turn the bulb base counterclockwise.

STEP 2

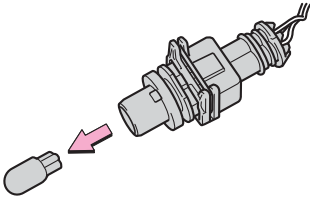

STY43AB059

Remove the light bulb.

11 Back-up lights, stop/tail and rear side marker lights and rear turn signal lights

STEP 1

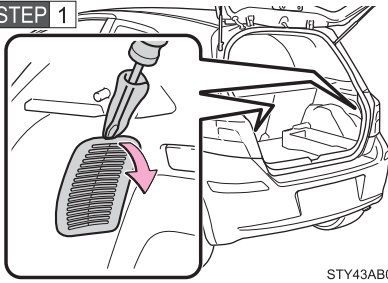

STY43AB087

Open the back door and remove the cover.

Use a flathead screwdriver which is wrapped with a cloth.

STEP 2

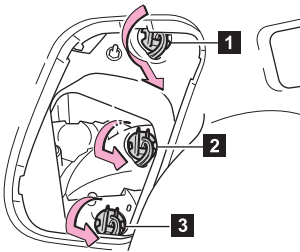

STY43AB094

Turn the bulb base counterclockwise.

- 1** Stop/tail and rear side marker lights
- 2** Rear turn signal light
- 3** Back-up light

STEP 3

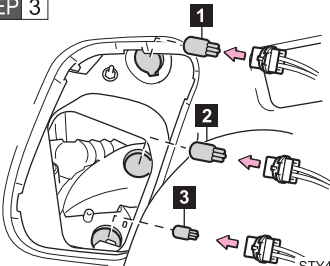

STY43AB092

Remove the light bulb.

- 1** Stop/tail and rear side marker lights
- 2** Rear turn signal light
- 3** Back-up light

n License plate light

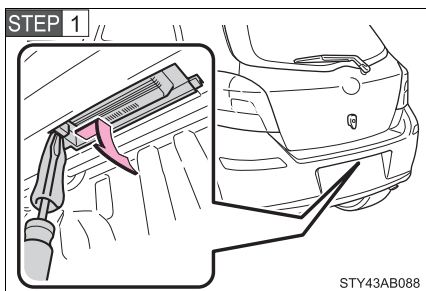

Disengage the claws and remove the license plate light.

Use a flathead screwdriver which is wrapped with a cloth.

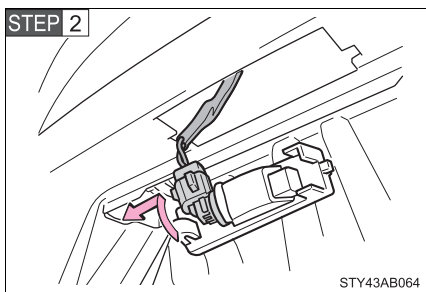

Turn the bulb base counterclockwise.

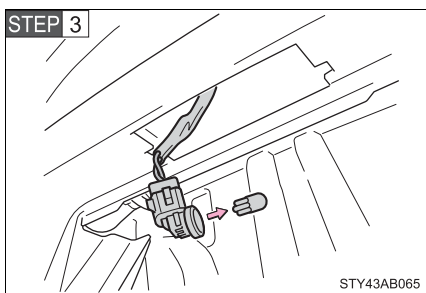

Remove the light bulb.

n Lights other than the above

If any of the lights listed below has burnt out, have it replaced by your Toyota dealer.

- Side turn signal lights
- High mounted stoplight

n **Condensation build-up on the inside of the lens**

Contact your Toyota dealer for more information in the following situations. Temporary condensation build-up on the inside of the headlight lens does not indicate a malfunction.

- l Large drops of water are built up on the inside of the lens.
- l Water has built up inside the headlight.

n **LED high mounted stoplight**

The high mounted stoplight consists of a number of LEDs. If any of the LEDs burn out, take your vehicle to your Toyota dealer to have the light replaced.

n **Installing the clips**

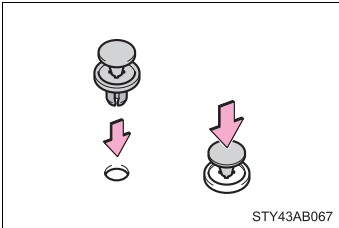

Insert the clips.

⚠ CAUTION

n **Replacing light bulbs**

Turn off the headlights. Do not attempt to replace the bulb immediately after turning off the headlights.

The bulbs become very hot and may cause burns.

n **To prevent damage or fire**

Make sure bulbs are fully seated and locked.

 NOTICE

- I Halogen bulbs have pressurized gas inside and require special handling. Do not touch the glass portion of the light bulb with bare hands. Hold the bulb by the plastic or metal portion.
If the bulb is scratched or dropped it may blow out or crack.
- I Fully install light bulbs and any parts used to secure them. Failing to do so may result in heat damage, fire, or water entering the headlight unit. This may damage the headlights or cause condensation to build up on the lens.

5-1. Essential information

Emergency flashers

Use the emergency flashers if the vehicle malfunctions or is involved in an accident.

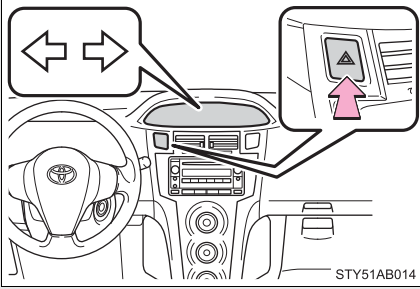

Press the switch to flash all the turn signal lights. To turn them off, press the switch once again.

NOTICE

n To prevent battery discharge

Do not leave the emergency flashers on longer than necessary when the engine is not running.

If your vehicle needs to be towed

If towing is necessary, we recommend having your vehicle towed by your Toyota dealer or a commercial towing service, using a lift-type truck or a flat bed truck.

Use a safety chain system for all towing, and abide by all state/provincial and local laws.

If towing from the front, the vehicle's rear wheels and axles must be in good condition. (→P. 300)

If they are damaged, use a towing dolly or flat bed truck.

Before towing

The following may indicate a problem with your transmission. Contact your Toyota dealer before towing.

- 1 The engine is running, but the vehicle will not move.
- 1 The vehicle makes an abnormal sound.

Emergency towing

If a tow truck is not available, in an emergency your vehicle may be temporarily towed using a cable or chain secured to the emergency towing eyelet. This should only be attempted on hard, surfaced roads for short distances at low speeds.

A driver must be in the vehicle to steer and operate the brakes. The vehicle's wheels, drive train, axles, steering and brakes must be in good condition.

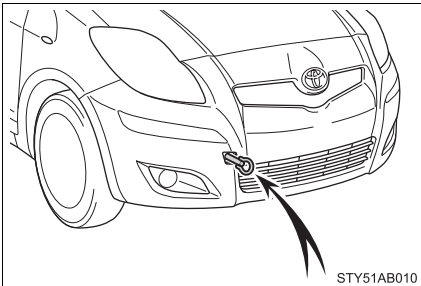

Towing eyelet

n Emergency towing procedure

STEP 1 Release the parking brake.

STEP 2 Put the transmission in N.

STEP 3 Turn the engine switch to the ACC (engine off) or ON (engine running) position.

⚠ CAUTION

n Caution while towing

- I** Use extreme caution when towing the vehicle.
Avoid sudden starts or erratic driving maneuvers which place excessive stress on the emergency towing eyelet and the cables or chains.
- I** If the engine is not running, the power assist for the brakes and steering will not function, making steering and braking more difficult.

⚠ NOTICE

n To prevent causing serious damage to the transmission (vehicles with an automatic transmission)

Never tow this vehicle from the rear with the front wheels on the ground. This may cause serious damage to the transmission.

n When towing a vehicle without using a towing dolly (vehicles with a manual transmission)

Do not tow with the key removed or in the LOCK position.

Installing towing eyelet

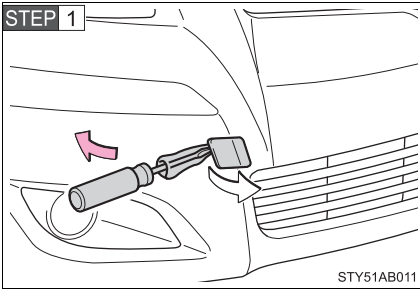

Remove the eyelet cover using a flathead screwdriver.

To protect the bodywork, place a rag between the screwdriver and the vehicle body, as shown in the illustration.

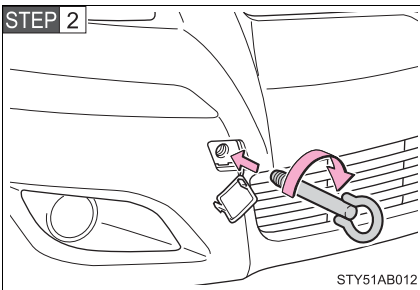

Insert the towing eyelet into the hole and tighten partially by hand.

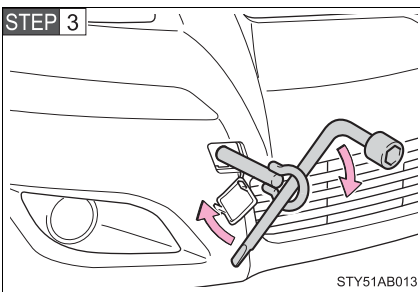

Tighten down the towing eyelet securely using a wheel nut wrench.

n Location of the emergency towing eyelet

→P. 317

⚠ CAUTION

n Installing towing eyelet to the vehicle

Make sure that towing eyelet is installed securely.

If not securely installed, towing eyelet may come loose during towing. This may lead to accidents that cause serious injury or even death.

Towing with a sling-type truck

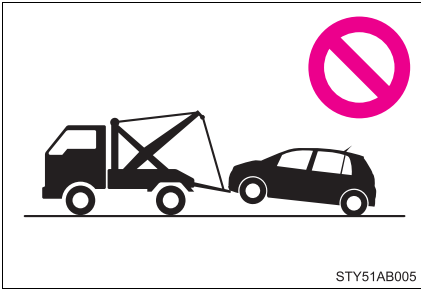

⚠ NOTICE

n To prevent body damage

Do not tow with a sling-type truck, either from the front or rear.

Towing with a wheel lift-type truck from the front

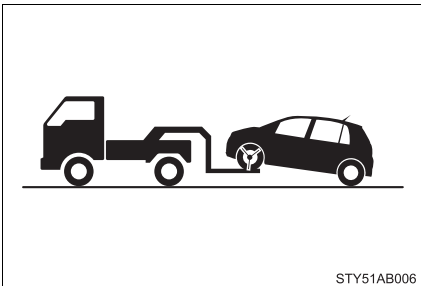

Release the parking brake.

 NOTICE

n To prevent damaging the vehicle

When raising the vehicle, ensure adequate ground clearance for towing at the opposite end of the raised vehicle. Without adequate clearance, the vehicle could be damaged while being towed.

Towing with a wheel lift-type truck from the rear

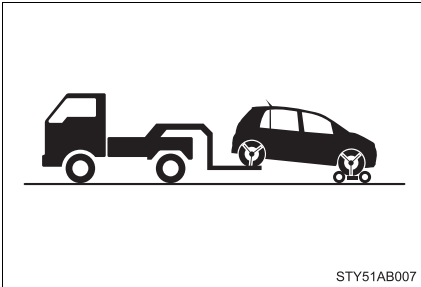

Vehicles with an automatic transmission: Use a towing dolly under the front wheels.

Vehicles with a manual transmission: We recommend to use a towing dolly under the front wheels.

When not using a towing dolly, turn the engine switch to the ACC position and shift the shift lever to N.

 NOTICE

n To prevent causing serious damage to the transmission (vehicles with an automatic transmission)

Never tow this vehicle from the rear with the front wheels on the ground.

n To prevent damaging the vehicle (vehicles with a manual transmission)

- l** Do not tow the vehicle with the key removed or in the LOCK position. The steering lock mechanism is not strong enough to hold the front wheel straight.
- l** When raising the vehicle, ensure adequate ground clearance for towing at the opposite end of the raised vehicle. Without adequate clearance, the vehicle could be damaged while being towed.

Using a flat bed truck

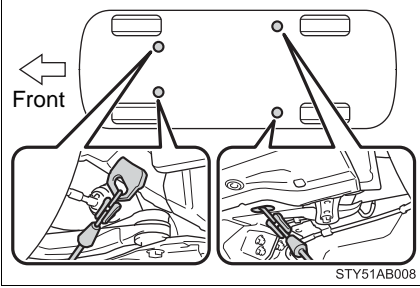

If your Toyota is transported by a flat bed truck, it should be tied down at the locations shown in the illustration.

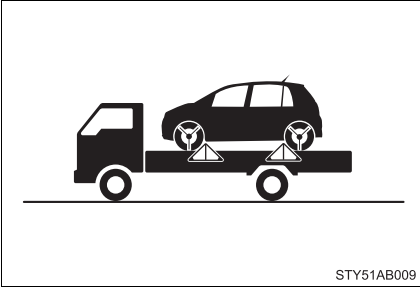

If you use chains or cables to tie down your vehicle, the angles shaded in black must be 45°.

Do not overly tighten the tie downs or the vehicle may be damaged.

Apply the parking brake firmly.

If you think something is wrong

If you notice any of the following symptoms, your vehicle probably needs adjustment or repair. Contact your Toyota dealer as soon as possible.

n Visible symptoms

- 1 Fluid leaks under the vehicle
(Water dripping from the air conditioning after use is normal.)
- 1 Flat-looking tires or uneven tire wear
- 1 High engine coolant temperature warning light flashes or comes on
- 1 Low engine coolant temperature indicator comes on or does not come on continuously

n Audible symptoms

- 1 Changes in exhaust sound
- 1 Excessive tire squeal when cornering
- 1 Strange noises related to the suspension system
- 1 Pinging or other noises related to the engine

n Operational symptoms

- 1 Engine missing, stumbling or running rough
- 1 Appreciable loss of power
- 1 Vehicle pulls heavily to one side when braking
- 1 Vehicle pulls heavily to one side when driving on a level road
- 1 Loss of brake effectiveness, spongy feeling, pedal almost touches the floor

5-1. Essential information

Fuel pump shut off system

To minimize the risk of fuel leakage when the engine stalls or an air-bag inflates upon collision, the fuel pump shut off system stops supplying fuel to the engine.

Follow the procedure below to restart the engine after the system is activated.

STEP 1 Turn the engine switch to the ACC or LOCK position.

STEP 2 Restart the engine.



NOTICE

n Before starting the engine

Inspect the ground under the vehicle.

If you find that fuel has leaked onto the ground, the fuel system has been damaged and is in need of repair. Do not restart the engine.

Your vehicle has computers that monitor and control certain aspects of your vehicle. These computers assist in driving and maintaining optimal vehicle performance.

Besides storing data useful for troubleshooting, there is an event data recorder (EDR) that records data in a crash or a near car crash event.

In a crash or a near car crash event

The SRS airbag sensor assembly contains the EDR. In a crash or a near car crash event, this device may record some or all of the following information:

- 1 Engine speed
- 1 Whether the brake pedal was applied or not
- 1 Vehicle speed
- 1 To what extent the accelerator pedal was depressed
- 1 Position of the transmission shift lever
- 1 Whether the driver and front passenger wore seat belts or not
- 1 Driver's seat position
- 1 SRS airbag deployment data
- 1 SRS airbag system diagnostic data
- 1 Front passenger's occupant classification

The information above is intended to be used for the purpose of improving vehicle safety performance. Unlike general data recorders, the EDR does not record sound data such as conversation between passengers.

Disclosure of the data

Toyota will not disclose the data recorded in an EDR to a third party except when:

- 1 An agreement from the vehicle's owner (or the leasing company for a leased vehicle) is obtained
- 1 Officially requested by the police or other authorities
- 1 Used as a defense for Toyota in a law suit
- 1 Ordered by a court of law

However, if necessary Toyota will:

- 1 Use the data for research on Toyota vehicle safety performance
- 1 Disclose the data to a third party for research purposes without disclosing details of the vehicle owner, and only when it is deemed necessary
- 1 Disclose summarized data cleared of vehicle identification information to a non-Toyota organization for research purposes



5-2. Steps to take in an emergency

If a warning light turns on or a warning buzzer sounds...

Calmly perform the following actions if any of the warning lights turn on or flash. If a light turns on or flashes, but then turns off, this does not necessarily indicate a malfunction in the system.

Stop the vehicle immediately. Continuing to drive the vehicle may be dangerous.

The following warning indicates a possible problem in the brake system. Immediately stop the vehicle in a safe place and contact your Toyota dealer.



Warning light	Warning light/Details
 (except Canada)	Brake system warning light (warning buzzer)* <ul style="list-style-type: none">• Low brake fluid• Malfunction in the brake system (vehicles with the ABS) This light also comes on when the parking brake is not released. If the light turns off after the parking brake is fully released, the system is operating normally.
 (Canada)	

*: Parking brake engaged warning buzzer:

The buzzer sounds to indicate that parking brake is still engaged (with the vehicle having reach a speed of approximately 3 mph [5 km/h])

Stop the vehicle immediately.



The following warnings indicate the possibility of damage to the vehicle that may lead to an accident. Immediately stop the vehicle in a safe place and contact your Toyota dealer.



Warning light	Warning light/Details
	Charging system warning light Indicates a malfunction in the vehicle's charging system.
	Low engine oil pressure warning light Indicates that the engine oil pressure is too low*.
	High engine coolant temperature warning light Indicate a engine is almost overheating.(→P. 337)

*: The light may come on when the oil level is extremely low. It is not designed to indicate low oil level, and the oil level must be checked using the engine oil level dipstick.

Have the vehicle inspected immediately.





Failing to investigate the cause of the following warnings may lead to the system operating abnormally and possibly cause an accident. Have the vehicle inspected by your Toyota dealer immediately.

Warning light	Warning light/Details
 (except Canada)	Malfunction indicator lamp Indicates a malfunction in: <ul style="list-style-type: none"> • The electronic engine control system; • The electronic throttle control system; • The electronic automatic transmission control system; or • Emission control system.
 (Canada)	

Warning light	Warning light/Details
	<p>SRS warning light</p> <p>Indicates a malfunction in:</p> <ul style="list-style-type: none"> • The SRS airbag system; • The front passenger occupant classification system; or • The seat belt pretensioner system.
<p>ABS</p> <p>(except Canada)</p>  <p>(Canada)</p>	<p>ABS warning light (if equipped)</p> <p>Indicates a malfunction in the ABS.</p>
<p>P/S</p>	<p>Electric power steering warning light</p> <p>Indicates a malfunction in the EPS (Electric Power Steering) system.</p>

Follow the correction procedures.

After taking the specified steps to correct the suspected problem, check that the warning light turns off.

Warning light	Warning light/Details	Correction procedure
	<p>Open door warning light Indicates that a door is not fully closed.</p>	<p>Check that all doors are closed.</p>
 (On the instrument cluster)	<p>Driver's seat belt reminder light (warning buzzer)^{*1} Warns the driver to fasten his/her seat belt.</p>	<p>Fasten the seat belt.</p>
 (On the center panel)	<p>Front passenger's seat belt reminder light (warning buzzer)^{*2} Warns the front passenger to fasten his/her seat belt.</p>	<p>Fasten the seat belt.</p>
 (except Canada)	<p>Tire pressure warning light</p> <ul style="list-style-type: none"> • When the light comes on: Indicates low tire inflation pressure. • When the light comes on after blinking for 1 minute: Malfunction in the tire pressure warning system. 	<p>Adjust the tire inflation pressure.</p> <p>Have the system checked by your Toyota dealer.</p>
 (if equipped)	<p>Low washer fluid warning light Low level of washer fluid</p>	<p>Fill the tank.</p>

Warning light	Warning light/Details	Correction procedure
<div style="border: 1px solid black; padding: 5px; width: fit-content; margin: 0 auto;"> MAINT REQD </div> <p>(except Canada)</p>	<p>Engine oil replacement reminder light</p> <ul style="list-style-type: none"> • Illuminates for about 3 seconds and then flashes for about 12 seconds: Indicates that the engine oil is scheduled to be changed. • Comes on and remains: Indicates that the engine oil should be changed. 	<p>Check the engine oil, and change if necessary.</p> <p>Check and change the engine oil.</p>

*1: Driver's seat belt reminder:

The driver's seat belt reminder sounds to alert the driver that his or her seat belt is not fastened. Once the engine switch is turned to the ON or START position, the buzzer sounds for 6 seconds. If the vehicle has reached a speed of at least 12 mph (20 km/h), the buzzer sounds intermittently for approximately 10 seconds. Then, if the seat belt is still unfastened, the buzzer will sound in a different tone for approximately 20 more seconds.

*2: Front passenger's seat belt reminder:

The front passenger's seat belt reminder sounds to alert the front passenger that his or her seat belt is not fastened. The buzzer sounds intermittently for approximately 10 seconds after the vehicle has reached a speed of at least 12 mph (20 km/h). Then, if the seat belt is still unfastened, the buzzer will sound in a different tone for approximately 20 more seconds.

n **Key reminder buzzer**

The buzzer indicates that the key has not been removed (with the engine switch in the ACC or LOCK position and the driver's door opened).

n **Light reminder buzzer**

The buzzer indicates that the headlight switch is left on (with the key removed and the driver's door opened).

n **If the malfunction indicator lamp comes on while driving**

First check the following:

- l Is your vehicle low on gas?
If it is, refuel the vehicle immediately.
- l Is the fuel tank cap loose?
If it is, tighten it securely.

The light will go off after taking several driving trips.

If the light does not go off even after several trips, contact your Toyota dealer as soon as possible.

n **Front passenger detection sensor and passenger seat belt reminder**

If luggage or other load is placed on the front passenger seat, depending on its weight, the reminder light to flash and buzzer to sound.

n **When the tire pressure warning light comes on**

Check the tire inflation pressure and adjust to the appropriate level.

n **The tire pressure warning light may turn on due to natural causes**

The tire pressure warning light may turn on due to natural causes such as natural air leaks or tire inflation pressure changes caused by temperature. In this case, adjusting the tire inflation pressure will turn off the warning light (after a few minutes).

n **When a tire is replaced with a spare tire**

The compact spare tire is not equipped with the tire pressure warning valve and transmitter. If a tire goes flat, the tire pressure warning light will not turn off even though the flat tire is replaced with the spare tire. Replace the spare tire with the repaired tire and adjust the proper tire inflation pressure. The tire pressure warning light will turn off after a few minutes.

n **If the tire pressure warning system is inoperative**

The tire pressure warning system will be disabled in the following conditions:

(When the condition becomes normal, the system will work properly.)

- l If tires not equipped with tire pressure warning valves and transmitters are used.
- l If the ID code on the tire pressure warning valves and transmitters is not registered in the tire pressure warning computer.
- l If the tire inflation pressure is 73 psi (500 kPa, 5.1 kgf/cm² or bar) or higher.

The tire pressure warning system may be disabled in the following conditions:

(When the condition becomes normal, the system will work properly.)

- l If electronic devices or facilities using similar radio wave frequencies are nearby.
- l If a radio set at similar frequencies is in use in the vehicle.
- l If a window tint that affects the radio wave signals is installed.
- l If there is a lot of snow or ice on the vehicle, in particular around the wheels or wheel housings.
- l If non-genuine Toyota wheels are used. (Even if you use Toyota wheels, the tire pressure warning system may not work properly with some types of tires.)
- l If tire chains are used.

n **If the tire pressure warning light comes on after blinking for 1 minute frequently**

If the tire pressure warning light comes on after blinking for 1 minute frequently when the engine switch is turned to the ON position, have it checked by your Toyota dealer.

n **After changing the engine oil (except Canada)**

Make sure to reset the oil maintenance data. (→P. 249)

n Customization that can be configured at Toyota dealer

- 1 The vehicle speed linked seat belt reminder buzzer can be disabled. (Customizable features →P. 369)
- 1 The key reminder buzzer can be disabled. (Customizable features →P. 369)
- 1 The light reminder buzzer can be disabled. (Customizable features →P. 369)

⚠ CAUTION

n If the tire pressure warning light comes on

Be sure to observe the following precautions. Failure to do so could cause loss of vehicle control and result in death or serious injury.

- 1 Stop your vehicle in a safe place as soon as possible. Adjust the tire inflation pressure immediately.
- 1 If the tire pressure warning light comes on even after tire inflation pressure adjustment, it is probable that you have a flat tire. Check the tires. If the tire is flat, change to the spare tire and have the flat tire repaired by the nearest Toyota dealer.
- 1 Avoid abrupt maneuvering and braking. If the vehicle tires deteriorate, you could lose control of the steering wheel or the brakes.

n If a blowout or sudden air leakage should occur

The tire pressure warning system may not activate immediately.

n Maintenance of the tire

Each tire, including the spare (if provided), should be checked monthly when cold and inflated to the inflation pressure recommended by the vehicle manufacturer on the vehicle placard or tire inflation pressure label (tire and load information label). (If your vehicle has tires of a different size than the size indicated on the vehicle placard or tire inflation pressure label [tire and load information label], you should determine the proper tire inflation pressure for those tires.)

 CAUTION

As an added safety feature, your vehicle has been equipped with a tire pressure monitoring system (TPMS-tire pressure warning system) that illuminates a low tire pressure telltale (tire pressure warning light) when one or more of your tires is significantly under-inflated. Accordingly, when the low tire pressure telltale (tire pressure warning light) illuminates, you should stop and check your tires as soon as possible, and inflate them to the proper pressure. Driving on a significantly under-inflated tire causes the tire to overheat and can lead to tire failure. Under-inflation also reduces fuel efficiency and tire tread life, and may affect the vehicle's handling and stopping ability.

Please note that the TPMS (tire pressure warning system) is not a substitute for proper tire maintenance, and it is the driver's responsibility to maintain correct tire pressure, even if under-inflation has not reached the level to trigger illumination of the TPMS low tire pressure telltale (tire pressure warning light).

Your vehicle has also been equipped with a TPMS (tire pressure warning system) malfunction indicator to indicate when the system is not operating properly. The TPMS (tire pressure warning system) malfunction indicator is combined with the low tire pressure telltale (tire pressure warning light). When the system detects a malfunction, the telltale will flash for approximately one minute and then remain continuously illuminated. This sequence will continue upon subsequent vehicle start-ups as long as the malfunction exists. When the malfunction indicator is illuminated, the system may not be able to detect or signal low tire pressure as intended.

TPMS (tire pressure warning system) malfunctions may occur for a variety of reasons, including the installation of replacement or alternate tires or wheels on the vehicle that prevent the TPMS (tire pressure warning system) from functioning properly. Always check the TPMS (tire pressure warning system) malfunction telltale after replacing one or more tires or wheels on your vehicle to ensure that the replacement or alternate tires and wheels allow the TPMS (tire pressure warning system) to continue to function properly.



NOTICE

n Precaution when installing a different tire

When a tire of a different specification or maker is installed, the tire pressure warning system may not operate properly.

5-2. Steps to take in an emergency If you have a flat tire

Remove the flat tire and replace it with the spare provided.

n Before jacking up the vehicle

- 1 Stop the vehicle on a hard, flat surface.
- 1 Set the parking brake.
- 1 Shift the shift lever to P (automatic transmission) or R (manual transmission).
- 1 Stop the engine.
- 1 Turn on the emergency flashers.

n Location of the spare tire, jack and tools

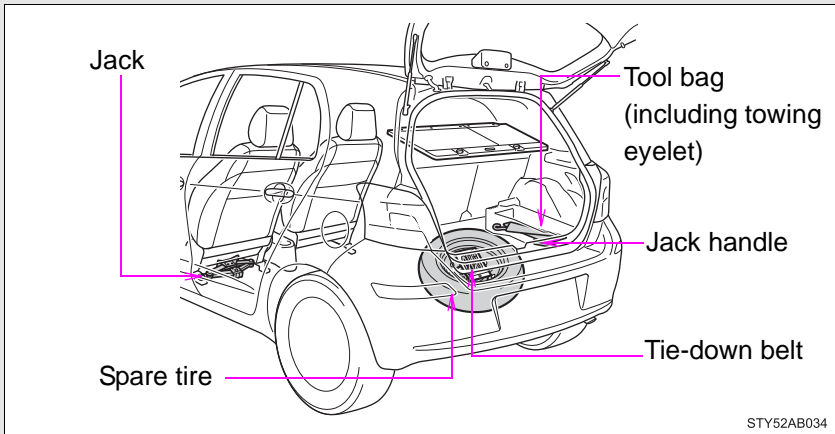

Taking out the jack

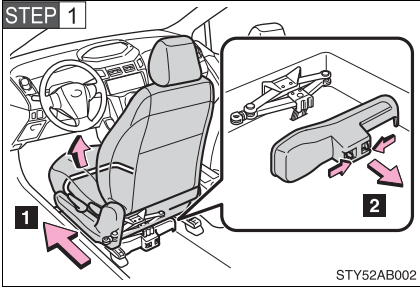

- 1 Move the driver seat to the front-most position.
- 2 Remove the cover.

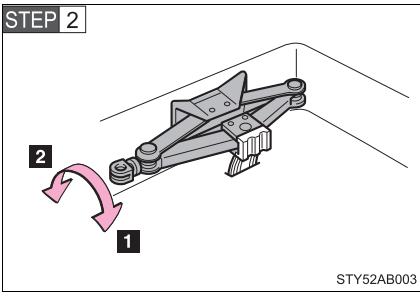

- 1 Tighten
- 2 Loosen

Taking out the spare tire

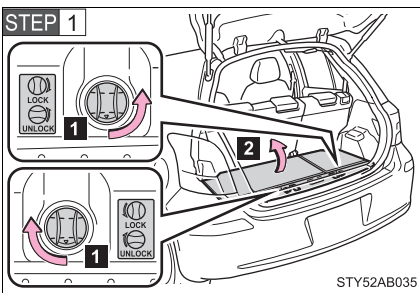

- 1 Turn the knobs to the UNLOCK position
- 2 Remove the deck board.

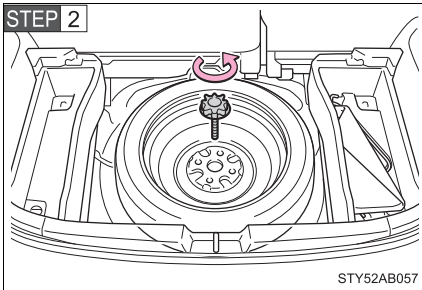

Loosen the center fastener that secures the spare tire.

n Compact spare tire

The compact spare tire saves space in your luggage compartment, and its lighter weight helps to enhance fuel economy and permits easier installation in case of a flat tire.

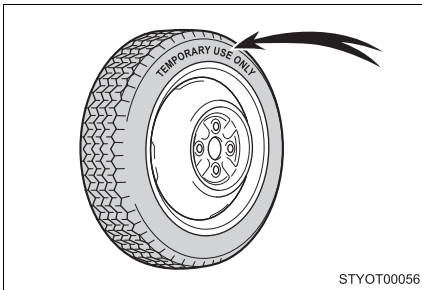

The compact spare tire is designed for temporary emergency use only.

The compact spare tire is identified by the distinctive wording "TEMPORARY USE ONLY" molded into the sidewall of the tire.

n When using the compact spare tire

As the compact spare tire is not equipped with the tire pressure warning valve and transmitter, low inflation pressure of the compact spare tire will not be warned. Also, if you replace the compact spare tire after the tire pressure warning light comes on, the light remains on.

n Check the tire inflation pressure of the compact spare tire. (→P. 351)

Replacing a flat tire

STEP 1

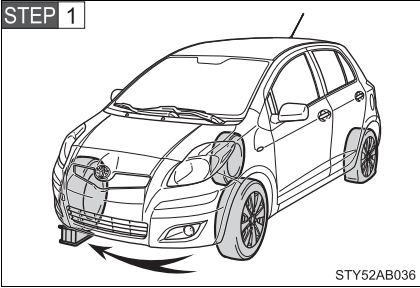

Chock the tires.

Flat tire		Wheel chock positions
Front	Left-hand side	Behind the rear right-hand side tire
	Right-hand side	Behind the rear left-hand side tire
Rear	Left-hand side	In front of the front right-hand side tire
	Right-hand side	In front of the front left-hand side tire

STEP 2

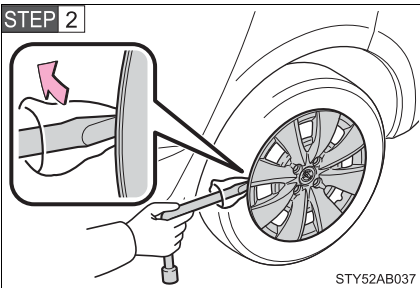

Vehicles with a steel wheel, remove the wheel ornament using the wrench.

To protect the wheel ornament, place a rag between the wrench and the wheel ornament, as shown in the illustration.

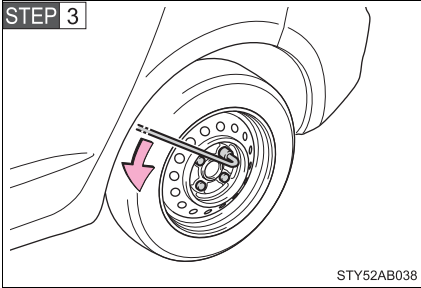

Slightly loosen the wheel nuts (one turn).

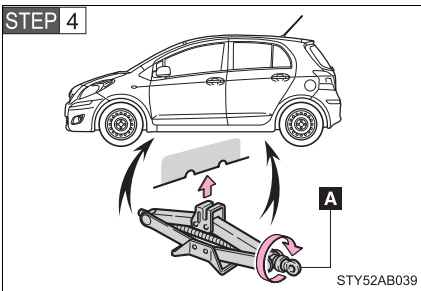

Turn the jack portion "A" by hand until the notch of the jack is in contact with the jack point.

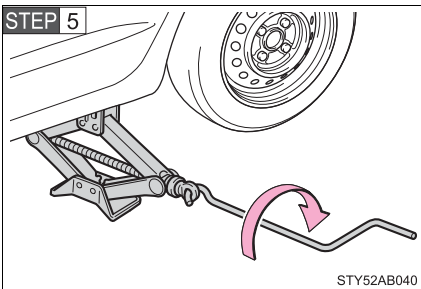

Raise the vehicle until the tire is slightly raised off the ground.

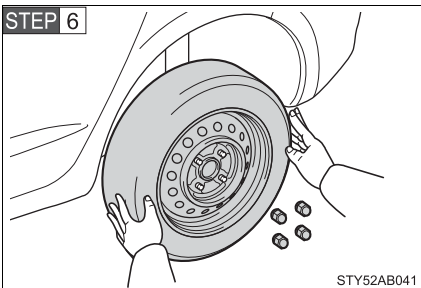

Remove all the wheel nuts and the tire.

When resting the tire on the ground, place the tire so that the wheel design faces up to avoid scratching the wheel surface.

Installing the tire

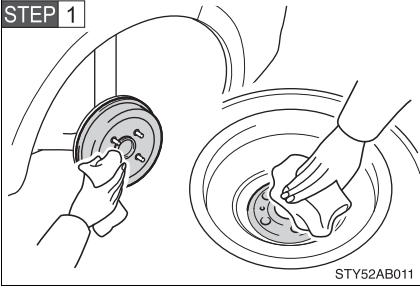

Remove any dirt or foreign matter from the wheel contact surface.

If foreign matter is on the wheel contact surface, the wheel nuts may loosen while the vehicle is in motion, and the tire may come off the vehicle.

STEP 2 Install the tire and loosely tighten each wheel nut by hand by approximately the same amount.

► Replacing a steel wheel

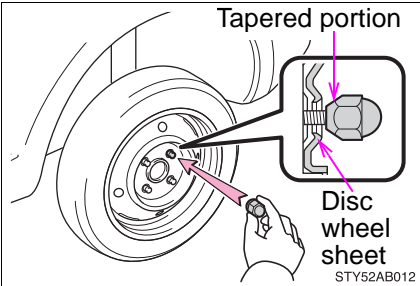

Tighten the nuts until the tapered portion comes into loose contact with the disc wheel sheet.

► Replacing an aluminum wheel

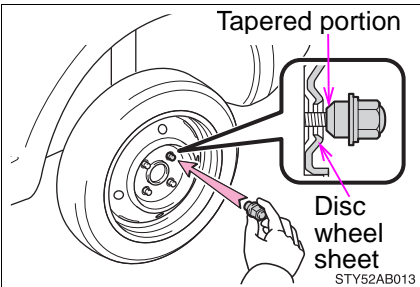

Tighten the nuts until the tapered portion comes into loose contact with the disc wheel sheet.

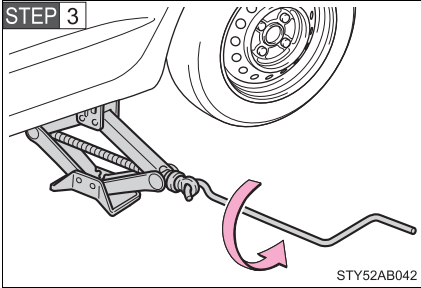

Lower the vehicle.

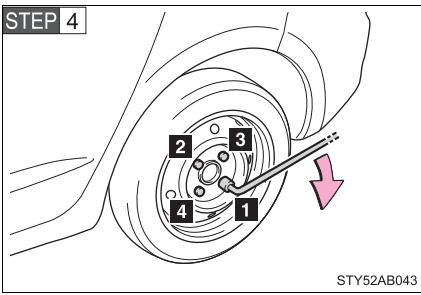

Firmly tighten each nut two or three times in the order shown in the illustration.

Tightening torque:
76 ft·lbf (103 N·m, 10.5 kgf·m)

Stowing the flat tire, jack and all tools

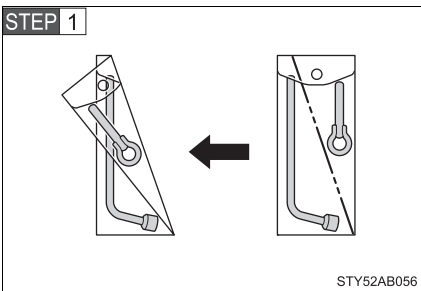

Position the tools as shown in the illustration. Fold the tool bag over.

STEP 2 Stow the jack and all tools.

5-2. Steps to take in an emergency

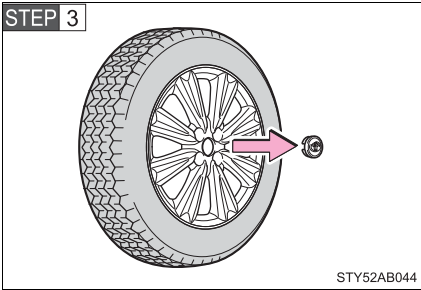

Vehicles with an aluminum wheels, remove the center wheel ornament by pushing from the reverse side.

Be careful not to lose the wheel ornament.

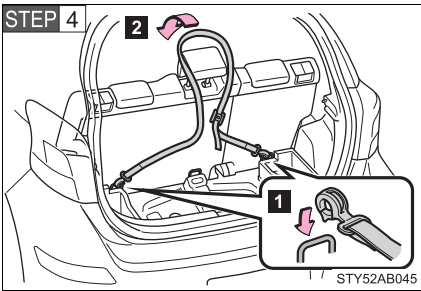

- 1 Hook each belt end to the corresponding anchor brackets.
- 2 Put the center portion of the belt onto the rear center head restraint.

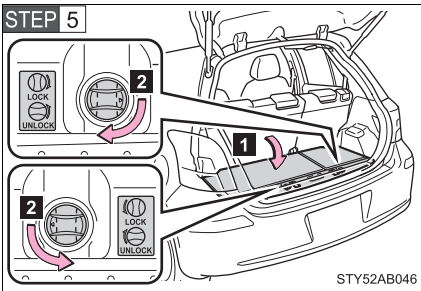

- 1 Return the deck board.
- 2 Lock the deck board.

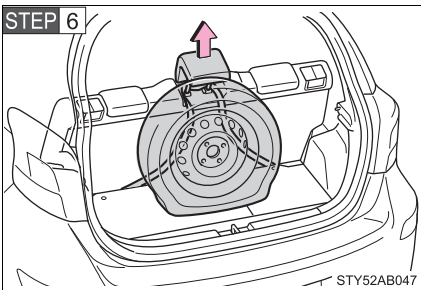

Lay the flat tire on the luggage floor so that the outer side of the tire wheel faces toward the rear of the vehicle. Detach the rear center head restraint from the seat and release the belt.

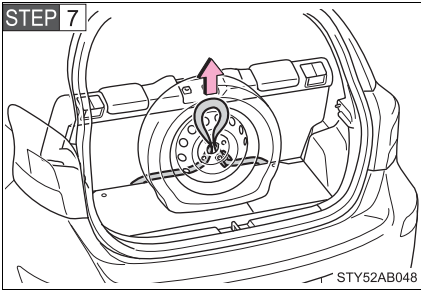

Pass the belt through the center hole of the flat tire wheel.

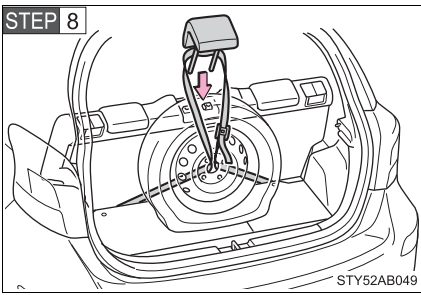

Put the center portion of the belt onto the rear center head restraint position and then return the rear center head restraint.

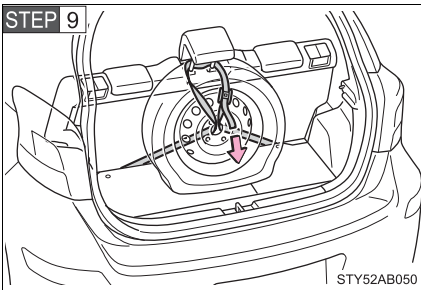

Hold the buckle and pull the belt to secure the tire.

After stowing the flat tire, check that the tire and belt are secured.

n If you have a flat front tire on a road covered with snow or ice

Install the compact spare tire on the rear of the vehicle. Perform the following steps and fit tire chains to the front tires.

STEP 1 Replace a rear tire with the compact spare tire.

STEP 2 Replace the flat front tire with the tire removed from the rear of the vehicle.

STEP 3 Fit tire chains to the front tires.

 **CAUTION**

n Using the jack

Improper use of the jack may lead to death or injuries due to the vehicle suddenly falling off the jack.

- I Do not use the jack for any purpose other than replacing tires or installing and removing tire chains.
- I Only use the jack that comes with this vehicle for replacing a flat tire. Do not use it on other vehicles, and do not use other jacks for replacing tires on this vehicle.
- I Always check that the jack is securely set to the jack point.
- I Do not put any part of your body under the vehicle supported by a jack.
- I Do not start or run the engine while your vehicle is supported by the jack.
- I Do not raise the vehicle while someone is in it.
- I When raising the vehicle, do not put an object on or under the jack.
- I Do not raise the vehicle to a height greater than that required to replace the tire.
- I Use a jack stand if it is necessary to get under the vehicle.

Take particular care when lowering the vehicle to ensure that no one working on or near the vehicle will be injured.

n Replacing a flat tire

Observe the following precautions to reduce the risk of death or serious injury.

- I Never use oil or grease on the wheel bolts or wheel nuts. The oil or grease can cause the wheel nuts to loosen, causing a serious accident. Remove any oil or grease on the wheel bolts or wheel nuts.
- I Have the wheel nuts tightened with a torque wrench to 76 ft·lbf (103 N·m, 10.5 kgf·m) as soon as possible after changing wheels. Failure to follow these precautions could cause the nuts to loosen and the wheel may fall off, which could lead to an accident causing death or serious injury.

 **CAUTION****n When using the compact spare tire**

- l** Remember that your compact spare tire is specifically designed for use with your vehicle. Do not use your compact spare tire on another vehicle.
- l** Do not use two compact spare tires simultaneously.
- l** Replace the compact spare tire with a standard tire as soon as possible.
- l** Avoid sudden acceleration, deceleration and braking, as well as sharp cornering.

n Speed limit when using the compact spare tire

Do not drive at speeds in excess of 50 mph (80 km/h) when a compact spare tire is installed on the vehicle.

The compact spare tire is not designed for driving at high speeds. Failing to observe this precaution may lead to an accident causing death or serious injury.

n When the spare tire is attached

The vehicle speed may not be correctly detected, and the following systems may not operate correctly:

- l** ABS
- l** Cruise Control

 NOTICE

n Do not drive the vehicle with a flat tire.

Do not continue driving with a flat tire.

Driving even a short distance with a flat tire can damage the tire and the wheel beyond repair.

n Be careful when driving over bumps with the compact spare tire installed on the vehicle.

The vehicle becomes lower when driving with the compact spare tire compared to when driving with standard tires. Be careful when driving over uneven road surfaces.

n Driving with tire chains and the compact spare tire

Do not fit tire chains to the compact spare tire.

Tire chains may damage the vehicle body and adversely affect driving performance.

n When replacing the tires

I When removing or fitting the wheels, tires or the tire pressure warning valve and transmitter, contact your Toyota dealer as the tire pressure warning valve and transmitter may be damaged if not handled correctly.

I Replace the grommets for the tire pressure warning valves and transmitters as well.

n To avoid damaging the tire pressure warning valves and transmitters

Do not use liquid sealants on flat tires.

5-2. Steps to take in an emergency If the engine will not start

If the engine still does not start after following the correct starting procedure (→P. 125) or releasing the steering lock (→P. 126), confirm the following points.

n The engine will not start even when the starter motor operates normally.

One of the following may be the cause of the problem.

- 1 There may not be sufficient fuel in the vehicle's tank.
Refuel the vehicle.
- 1 The engine may be flooded.
Try to restart the engine once more following correct starting procedures. (→P. 125)
- 1 Vehicles with engine immobilizer system: There may be a malfunction in the engine immobilizer system.
(→P. 74)

n The starter motor turns over slowly, the interior lights and headlights are dim, or the horn does not sound or sounds at a low volume.

One of the following may be the cause of the problem.

- 1 The battery may be discharged. (→P. 333)
- 1 The battery terminal connections may be loose or corroded.

n The starter motor does not turn over, the interior lights and headlights do not turn on, or the horn does not sound.

One of the following may be the cause of the problem.

- 1 One or both of the battery terminals may be disconnected.
- 1 The battery may be discharged. (→P. 333)

Contact your Toyota dealer if the problem cannot be repaired, or if repair procedures are unknown.

5-2. Steps to take in an emergency

If the shift lever cannot be shifted from P

If the shift lever cannot be shifted with your foot on the brake, there may be a problem with the shift lock system (a system to prevent accidental operation of the shift lever). Have the vehicle inspected by your Toyota dealer immediately.

The following steps may be used as an emergency measure to ensure that the shift lever can be shifted.

STEP 1 Set the parking brake.

STEP 2 Turn the engine switch to the ACC or ON position.

STEP 3 Depress the brake pedal.

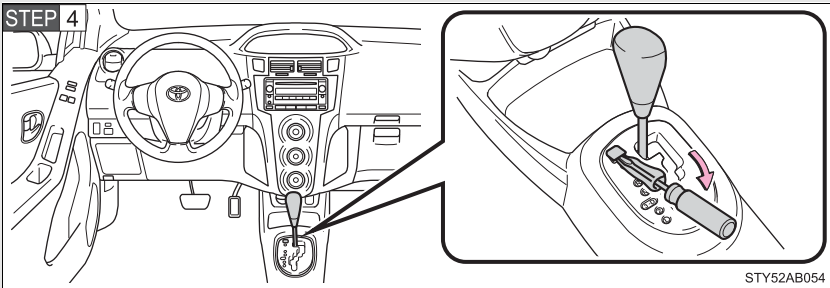

Pry the cover up with a flathead screwdriver or equivalent.

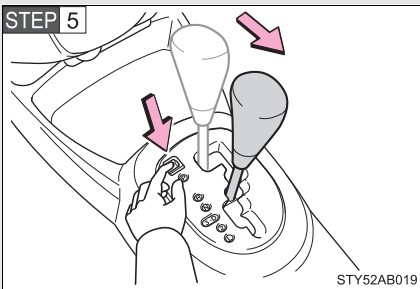

Press the shift lock override button.

The shift lever can be shifted while the button is pressed.

If you lose your keys

New genuine Toyota keys can be made by your Toyota dealer using the key number stamped on your key number plate. Vehicles with engine immobilizer system, the dealer will also need the master key. (→P. 27)

n If you lose all your master keys. (vehicles with engine immobilizer system)

You cannot make new keys, the whole engine immobilizer system must be replaced.

5-2. Steps to take in an emergency

If the vehicle battery is discharged

The following procedures may be used to start the engine if the vehicle's battery is discharged.

You can call your Toyota dealer or qualified repair shop.

If you have a set of jumper (or booster) cables and a second vehicle with a 12-volt battery, you can jump start your Toyota following the steps below.

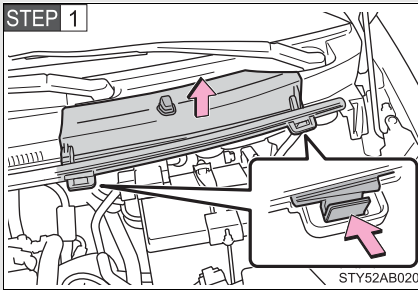

Push the tab in and lift the cover off.

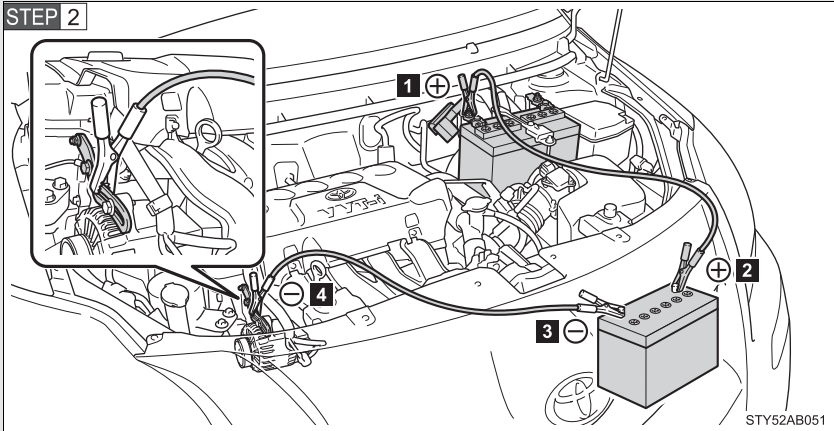

Connecting the jumper cables

- 1** Positive (+) battery terminal on your vehicle
- 2** Positive (+) battery terminal on the second vehicle
- 3** Negative (-) battery terminal on the second vehicle
- 4** Connect the jumper cable to ground on your vehicle as shown in the illustration.

STEP 3 Start the engine of the second vehicle. Increase the engine speed slightly and maintain at that level for approximately 5 minutes to recharge the battery of your vehicle.

STEP 4 Maintain the engine speed of the second vehicle and start the vehicle's engine.

STEP 5 Once the vehicle's engine has started, remove the jumper cables in the exact reverse order in which they were connected.

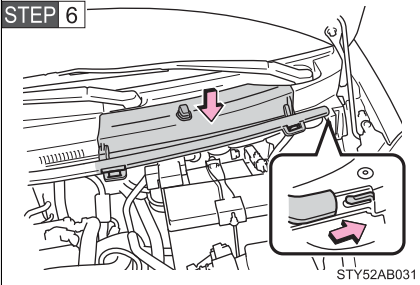
STEP 6

Reinstall the cover.

Once the engine starts, have the vehicle checked at your Toyota dealer as soon as possible.

n Starting the engine when the battery is discharged (vehicles with an automatic transmission)

The engine cannot be started by push-starting.

n Avoiding a discharged battery

- l Turn off the headlights and the audio system while the engine is turned off.
- l Turn off any unnecessary electrical components when the vehicle is running at a low speed for an extended period, such as in heavy traffic, etc.

⚠ CAUTION

n Avoiding battery fires or explosions

Observe the following precautions to prevent accidentally igniting the flammable gas that may be emitted from the battery.

- l Make sure the jumper cable is connected to the correct terminal and that it is not unintentionally in contact with any part other than the intended terminal.
- l Do not allow the jumper cables to come into contact with the “+” and “-” terminals.
- l Do not smoke, use matches, cigarette lighters or allow open flame near the battery.

 **CAUTION**

n Battery precautions

The battery contains poisonous and corrosive acidic electrolyte, while related parts contain lead and lead compounds. Observe the following precautions when handling the battery.

- I When working with the battery, always wear safety glasses and take care not to allow any battery fluids (acid) to come into contact with skin, clothing or the vehicle body.
- I Do not lean over the battery.
- I In the event that battery fluid comes into contact with the skin or eyes, immediately wash the affected area with water and seek medical attention. Place a wet sponge or cloth over the affected area until medical attention can be received.
- I Always wash your hands after handling the battery support, terminals, and other battery-related parts.
- I Do not allow children near the battery.

 **NOTICE**

n To prevent damaging the vehicle (vehicles with a manual transmission)

Do not pull- or push-start the vehicle, because the three-way catalytic converter may overheat and become a fire hazard.

n When handling jumper cables

Be careful that the jumper cables do not become tangled in the cooling fan or any of the belts when connecting or disconnecting them.

5-2. Steps to take in an emergency If your vehicle overheats

If your engine overheats:

STEP 1 Stop the vehicle in a safe place and turn off the air conditioning system.

STEP 2 Check to see if steam is coming out from under the hood.

If you see steam:

Stop the engine. Carefully lift the hood after the steam subsides and then restart the engine.

If you do not see steam:

Leave the engine running and carefully lift the hood.

STEP 3 Check to see if the cooling fan is operating.

If the fan is operating:

Wait until the high engine coolant temperature warning light goes off and then stop the engine.

If the fan is not operating:

Stop the engine immediately and call your local Toyota dealer.

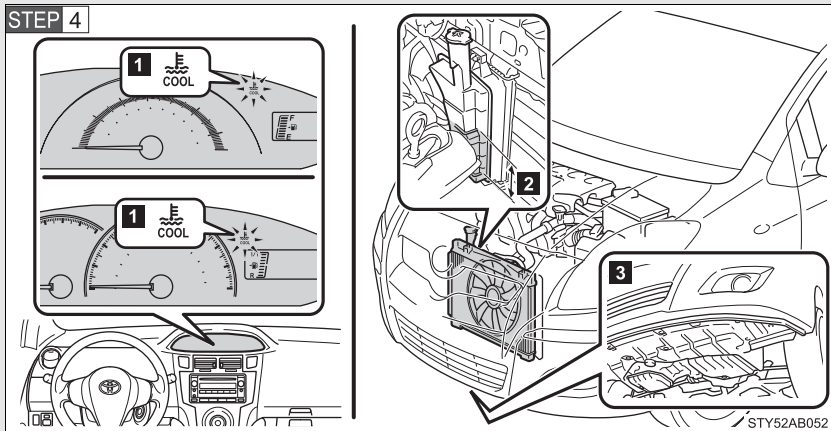

- 1** The engine has cooled down sufficiently.
Low engine coolant temperature indicator comes on.
- 2** Check the engine coolant level.
- 3** Look for obvious coolant leaks from the radiator, hoses and under the vehicle.
Note that water draining from the air conditioning is normal if it has been used.

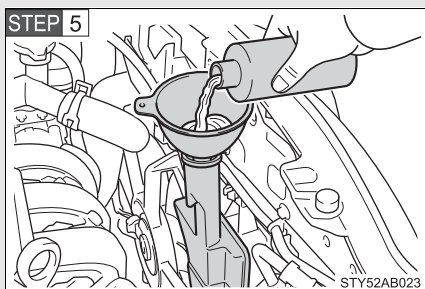

Add engine coolant if required.

Water can be used in an emergency if engine coolant is unavailable. (→P. 348)

Have the vehicle checked at your nearest Toyota dealer as soon as possible.

n **Overheating**

If you observe the following, your vehicle may be overheating.

- I The high engine coolant temperature warning light flashes or comes on or a loss of power is experienced.
- I Steam is coming from under the hood.

CAUTION

n **To prevent an accident or injury when inspecting under the hood of your vehicle**

- I If steam is seen coming from under the hood, do not open the hood until the steam has subsided. The engine compartment may be very hot, causing serious injury such as burns.
- I Keep hands and clothing away from the fan and other belts while the engine is running.
- I Do not loosen the radiator cap while the engine and radiator are hot. Serious injury, such as burns, may result from hot coolant and steam released under pressure.

NOTICE

n **When adding engine coolant**

Wait until the engine has cooled down before adding engine coolant. When adding coolant, do so slowly. Adding cool coolant to a hot engine too quickly can cause damage to the engine.

5-2. Steps to take in an emergency

If the vehicle becomes stuck

Carry out the following procedures if the tires spin or the vehicle becomes stuck in mud, dirt, or snow.

STEP 1 Stop the engine. Set the parking brake and put the shift lever in P (vehicles with an automatic transmission) or N (vehicles with a manual transmission).

STEP 2 Remove the mud, snow, or sand from around the stuck tire.

STEP 3 Place wood, stones or some other material to help provide traction under the tires.

STEP 4 Restart the engine.

STEP 5 Shift the shift lever to D or R (automatic transmission) or 1 or R (manual transmission) and carefully apply the accelerator to free the vehicle.

n Emergency hook

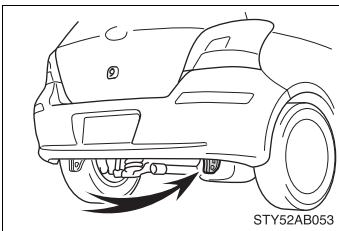

When your vehicle becomes stuck and cannot move, the emergency hook is used for another vehicle to pull your vehicle out in an emergency.

Your vehicle is not designed to tow another vehicle.

Do not use the left rear hook. It is not designed for towing.

 **CAUTION****n When attempting to free a stuck vehicle**

If you choose to rock the vehicle back and forth to free it, make sure the surrounding area is clear, to avoid striking other vehicles, objects or persons. The vehicle may also lunge forward or lunge back suddenly as it becomes free. Use extreme caution.

n When shifting the shift lever

Vehicles with automatic transmission: Be careful not to shift the shift lever with the accelerator pedal depressed.

This may lead to unexpected rapid acceleration of the vehicle that may cause an accident and result in death or serious injury.

 **NOTICE****n To avoid damaging the transmission and other components**

l Avoid spinning the wheels and do not rev the engine.

l If the vehicle remains stuck after trying these procedures, the vehicle may require towing to be freed.

6-1. Specifications

Maintenance data (fuel, oil level, etc.)

Dimensions and weight

Overall length	150.6 in. (3825 mm)	
Overall width	66.7 in. (1695 mm)	
Overall height	60.2 in. (1530 mm)	
Wheelbase	96.9 in. (2460 mm)	
Tread	Front	58.3 in. (1480 mm) ^{*1} 57.9 in. (1470 mm) ^{*2}
	Rear	57.9 in. (1470 mm) ^{*1} 57.5 in. (1460 mm) ^{*2}
Vehicle capacity weight (Occupants + luggage)	845 lb. (383 kg)	
Towing capacity ^{*3} (Trailer weight + cargo)	700 lb. (318 kg)	

*1: P175/65R14 tires

*2: P185/60R15 tires

*3: Canada only

Vehicle identification

n Vehicle identification number

The vehicle identification number (VIN) is the legal identifier for your vehicle. This is the primary identification number for your Toyota. It is used in registering the ownership of your vehicle.

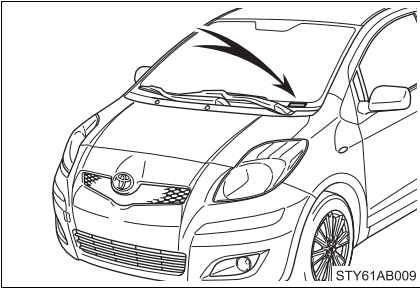

This number is stamped on the top left of the instrument panel.

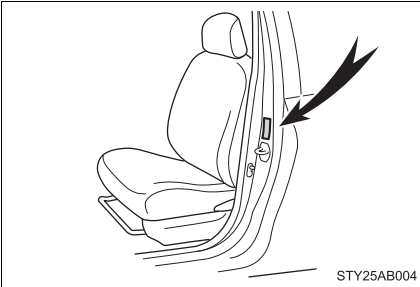

This number is also on the Certification Label.

n Engine number

The engine number is stamped on the engine block as shown.

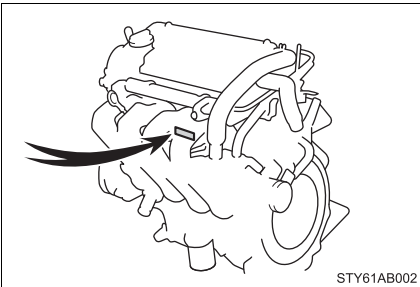

Engine

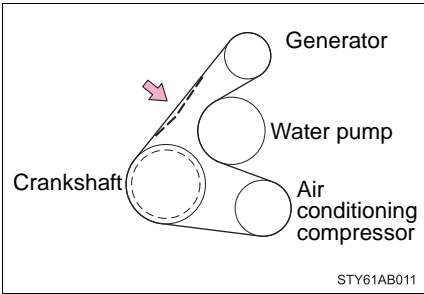
Model	1NZ-FE
Type	4-cylinder in line, 4-cycle, gasoline
Bore and stroke	2.95 × 3.33 in. (75.0 × 84.7 mm)
Displacement	91.3 cu.in. (1497 cm ³)
Drive belt tension	<p>68 — 90 lbf (300 — 400 N, 31 — 41kgf)*</p>  <p>STY61AB011</p> <p>*: Drive belt tension measured with Boroughs drive belt tension gauge No. BT-33-73F when the engine is cold (used belt)</p>

Fuel

Fuel type	Unleaded gasoline only
Octane rating	87 (Research octane number 91) or higher
Fuel tank capacity (Reference)	11.1 gal. (42.0 L, 9.2 Imp.gal.)

Lubrication system

Oil capacity Drain and refill (Reference) ▶ With filter ▶ Without filter	3.9 qt. (3.7 L, 3.3 Imp.qt.) 3.6 qt. (3.4 L, 3.0 Imp.qt.)
Oil grade	ILSAC multigrade engine oil
Recommended oil viscosity	<p>Use Toyota approved "Toyota Genuine Motor Oil" or equivalent to satisfy the grade and viscosity shown below.</p> <div data-bbox="499 656 926 946" style="border: 1px solid black; padding: 10px; text-align: center;"> <p style="text-align: center;">C -29 -18 -7 4 16 27 38 F -20 0 20 40 60 80 100</p> <p style="text-align: center;">Outside temperature</p> <p style="text-align: right; font-size: small;">STYOT00050</p> </div>

*: 5W-30 is an oil that provides optimal levels of fuel efficiency.

Oil viscosity

- 1 The 5W portion of the oil viscosity rating indicates the characteristic of the oil which allows cold startability. Oils with a lower value before the W allow for easier starting of the engine in cold weather.
- 1 The 30 in 5W-30 indicates the oil viscosity when the oil is at its operating temperature. An oil with a higher viscosity may be better suited if the vehicle is operated at high speeds, or under extreme load condition.

Cooling system

Capacity	<ul style="list-style-type: none"> ▶ Vehicles with an automatic transmission 5.0 qt. (4.7 L, 4.1 Imp.qt.) ▶ Vehicles with a manual transmission 5.1 qt. (4.8 L, 4.2 Imp. qt.)
Coolant type	<p>Use either of the following.</p> <ul style="list-style-type: none"> • “Toyota Super Long Life Coolant” • Similar high-quality ethylene glycol-based non-silicate, non-amine, non-nitrite and non-borate coolant with long-life hybrid organic acid technology <p>Do not use plain water alone.</p>

Ignition system

Spark plug		
Make	DENSO	SK16R11
	NGK	IFR5A11
Gap		0.043 in. (1.1 mm)

NOTICE

n Iridium-tipped spark plugs

Use only iridium-tipped spark plugs. Do not adjust gap when tuning engine.

Electrical system

Battery	
Open voltage at 68°F (20°C):	12.6 — 12.8 V Fully charged 12.2 — 12.4 V Half charged 11.8 — 12.0 V Discharged (Voltage checked 20 minutes after the key is removed with all the lights turned off)
Charging rates	5 A max.

Automatic transaxle

Fluid capacity (Drain and refill)	2.6 qt. (2.5 L, 2.2 Imp.qt.)
Fluid type	Toyota Genuine ATF WS

NOTICE

n Automatic transmission fluid type

Using automatic transmission fluid other than “Toyota Genuine ATF WS” may cause deterioration in shift quality, locking up of your transmission accompanied by vibration, and ultimately damage the automatic transmission of your vehicle.

Manual transaxle

Gear oil capacity (Reference)	2.0 qt. (1.9 L, 1.7 Imp.qt.)
Gear oil type	Gear oil API GL-4 or GL-5
Recommended gear oil viscosity	SAE 75W-90

Clutch

Clutch free play	0.2 — 0.6 in. (5 — 15 mm)
Fluid type	FMVSS No.116 DOT 3 or SAE J1703

Brakes

Pedal clearance ^{*1}	<ul style="list-style-type: none"> ▶ Vehicles with the ABS 2.9 in. (73 mm) Min. ▶ Vehicles without the ABS 2.8 in. (70 mm) Min.
Pedal free play	0.04 — 0.24 in. (1 — 6 mm)
Brake pad wear limit	0.04 in. (1.0 mm)
Brake lining wear limit	0.04 in. (1.0 mm)
Parking brake lever travel ^{*2}	6 — 9 clicks
Fluid type	FMVSS No. 116 DOT 3 or SAE J1703

*1: Minimum pedal clearance when depressed with the pressure of 67.4 lbf (300 N, 31kgf) with the engine running.

*2: Parking brake adjustment when pulled with the force of 45 lbf (200 N, 20 kgf).

Steering

Free play	Less than 1.2 in. (30 mm)
-----------	---------------------------

Tires and wheels

Tire size	P175/65R14 81S, P185/60R15 84T
Tire inflation pressure (Recommended cold tire inflation pressure)	<p>Driving under normal conditions</p> <p>Front tires: 32 psi (220 kPa, 2.2 kgf/cm² or bar)</p> <p>Rear tires: 32 psi (220 kPa, 2.2 kgf/cm² or bar)</p> <p>Driving at high speeds above 100 mph (160 km/h) (in countries where such speeds are permitted by law)</p> <p>Add 3 psi (20 kPa, 0.2 kgf/cm² or bar) to the front tires and rear tires. Never exceed the maximum cold tire inflation pressure indicated on the tire sidewall.</p>
Wheel size	14 × 5 J, 15 × 5 1/2 J
Wheel nut torque	76 ft·lbf (103 N·m, 10.5 kgf·m)

Spare

Tire size	T125/70D15 95M
Tire inflation pressure	60 psi (420 kPa, 4.2 kgf/cm ² or bar)
Wheel size	15 × 4T
Wheel nut torque	76 ft·lbf (103 N·m, 10.5 kgf·m)

Light bulbs

	Light Bulbs	Bulb No	W	Type
Exterior	Headlights	9003	60/55	A
	Parking lights	168	5	E
	Front fog lights (if equipped)	—	55	B
	Front side marker lights	168	5	E
	Front turn signal lights	—	21	D
	Side turn signal lights	—	5	F
	Rear turn signal lights	7440	21	E
	Stop/tail and rear side marker lights	7443	21/5	E
	Back-up lights	921	16	E
	License plate light	168	5	E
Interior	Interior light	—	8	G
	Personal lights	—	8	E
	Luggage compart- ment light	—	5	G

- A: HB2 halogen bulbs
 B: H11 halogen bulbs
 C: Single end bulbs
 D: Single end bulbs (amber)
 E: Wedge base bulbs
 F: Wedge base bulbs (amber)
 G: Double end bulbs

Your vehicle must use only unleaded gasoline.

Select octane rating 87 (Research Octane Number 91) or higher. Use of unleaded gasoline with an octane rating lower than 87 may result in engine knocking. Persistent knocking can lead to engine damage.

At minimum, the gasoline you use should meet the specifications of ASTM D4814 in the U.S.A. and CGSB3.5-M93 in Canada.

n Fuel tank opening for unleaded gasoline

To help prevent incorrect fueling, your Toyota has a fuel tank opening that only accommodates the special nozzle on unleaded fuel pumps.

n If your engine knocks

l Consult your Toyota dealer.

l You may occasionally notice light knocking for a short time while accelerating or driving uphill. This is normal and there is no need for concern.

n Gasoline quality

In very few cases, driveability problems may be caused by the brand of gasoline you are using. If driveability problems persist, try changing the brand of gasoline. If this does not correct the problem, consult your Toyota dealer.

n Gasoline quality standards

l Automotive manufacturers in the US, Europe and Japan have developed a specification for fuel quality called World-Wide Fuel Charter (WWFC) that is expected to be applied worldwide.

l The WWFC consists of four categories that are based on required emission levels. In the US, category 4 has been adopted.

l The WWFC improves air quality by lowering emissions in vehicle fleets, and customer satisfaction through better performance.

■ **Toyota recommends the use of gasoline containing detergent additives**

- ┆ Toyota recommends the use of gasoline that contains detergent additives to avoid build-up of engine deposits.
- ┆ All gasoline sold in the US contains detergent additives to clean and/or keep clean intake systems.

■ **Toyota recommends the use of cleaner burning gasoline**

Cleaner burning gasoline, including reformulated gasoline that contains oxygenates such as ethanol or MTBE (Methyl Tertiary Butyl Ether) is available in many areas.

Toyota recommends the use of cleaner burning gasoline and appropriately blended reformulated gasoline. These types of gasoline provide excellent vehicle performance, reduce vehicle emissions and improve air quality.

■ **Toyota does not recommend blended gasoline**

- ┆ Toyota allows the use of oxygenate blended gasoline where the oxygenate content is up to 10 % ethanol or 15 % MTBE.
- ┆ If you use gasohol in your Toyota, be sure that it has an octane rating no lower than 87.
- ┆ Toyota does not recommend the use of gasoline containing methanol.

■ **Toyota does not recommend gasoline containing MMT**

Some gasoline contains octane enhancing additive called MMT (Methylcyclopentadienyl Manganese Tricarbonyl).

Toyota does not recommend the use of gasoline that contains MMT. If fuel containing MMT is used, your emission control system may be adversely affected.

The malfunction indicator lamp on the instrument cluster may come on. If this happens, contact your Toyota dealer for service.

 **NOTICE****n Notice on fuel quality**

- I** Do not use improper fuels. If improper fuels are used the engine will be damaged.
- I** Do not use leaded gasoline.
Leaded gasoline can cause damage to your vehicle's three-way catalytic converters causing the emission control system to malfunction.
- I** Do not use gasohol other than that stated here.
Other gasohol may cause fuel system damage or vehicle performance problems.
- I** Use of unleaded gasoline with an octane rating lower than 87 may result in engine knocking. Persistent knocking can lead to engine damage and should be corrected by refueling with higher octane unleaded gasoline.

n Fuel-related poor driveability

If after using a different type of fuel, poor driveability is encountered (poor hot starting, vaporization, engine knocking, etc.), discontinue the use of that type of fuel.

n When refueling with gasohol

Take care not to spill gasohol.
It can damage your vehicle's paint.

6-1. Specifications

Tire information

Typical tire symbols

► Standard tire

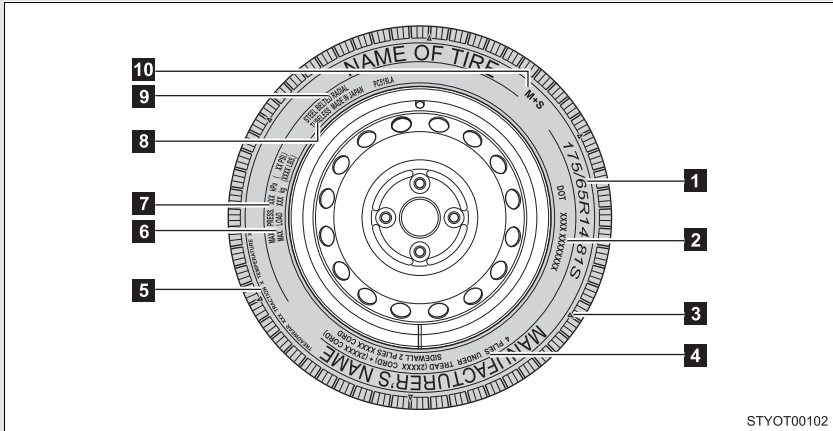

- 1 Tire size (→P. 360)
- 2 DOT and Tire Identification Number (TIN) (→P. 359)
- 3 Location of treadwear indicators (→P. 361)
- 4 Tire ply composition and materials

Ply is a layer of rubber-coated parallel cords. Cords are the strands which form the plies in a tire.

- 5 Uniform tire quality grading
- 6 Load limit at maximum cold tire inflation pressure (→P. 363)
- 7 Maximum cold tire inflation pressure (→P. 363)

This means the pressure to which a tire may be inflated.

- 8 TUBELESS or TUBE TYPE

A tubeless tire does not have a tube and air is directly filled in the tire. A tube type tire has a tube inside the tire and the tube maintains the air pressure.

9 Radial tires or bias-ply tires

A radial tire has RADIAL on the sidewall. A tire not marked RADIAL is a bias-ply tire.

10 Summer tire or all season tire (→P. 361)

An all season tire has M+S on the sidewall. A tire not marked M+S is a summer tire.

► Compact spare tire

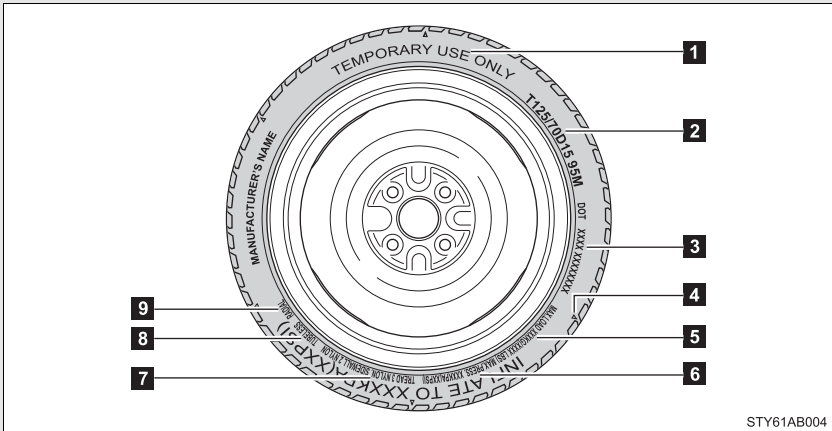

STY61AB004

1 TEMPORARY USE ONLY (→P. 319)

A compact spare tire is identified by the phrase TEMPORARY USE ONLY molded into its sidewall. This tire is designed for temporary emergency use only.

2 Tire size (→P. 360)

3 DOT and Tire Identification Number (TIN) (→P. 359)

4 Location of treadwear indicators (→P. 361)

5 Load limit at maximum cold tire inflation pressure (→P. 363)

6 Maximum cold tire inflation pressure (→P. 363)

This means the pressure to which a tire may be inflated.

7 Tire ply composition and materials

Plies are layers of rubber-coated parallel cords. Cords are the strands which form the plies in a tire.

8 TUBELESS or TUBE TYPE

A tubeless tire does not have a tube and air is directly filled in the tire. A tube type tire has a tube inside the tire and the tube maintains the air pressure.

9 Radial tires or bias-ply tires

A radial tire has RADIAL on the sidewall. A tire not marked RADIAL is a bias-ply tire.

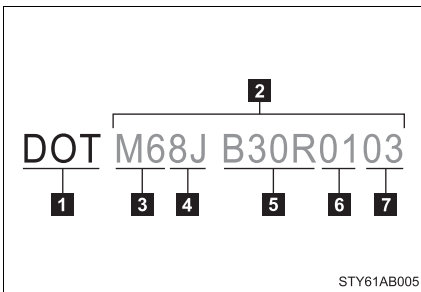
Typical DOT and tire identification number (TIN)

- 1** DOT symbol*
- 2** Tire Identification Number (TIN)
- 3** Tire manufacturer's identification mark
- 4** Tire size code
- 5** Manufacturer's optional tire type code (3 or 4 letters)
- 6** Manufacturing week
- 7** Manufacturing year

*:The DOT symbol certifies that the tire conforms to applicable Federal Motor Vehicle Safety Standards.

Tire size

n Typical tire size information

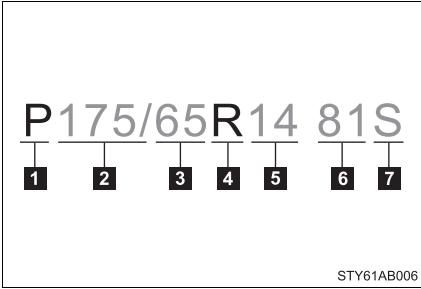

The illustration indicates typical tire size.

- 1** Tire use
(P = Passenger car,
T = Temporary use)
- 2** Section width (millimeters)
- 3** Aspect ratio
(tire height to section width)
- 4** Tire construction code
(R = Radial, D = Diagonal)
- 5** Wheel diameter (inches)
- 6** Load index (2 digits or 3 digits)
- 7** Speed symbol
(alphabet with one letter)

n Tire dimensions

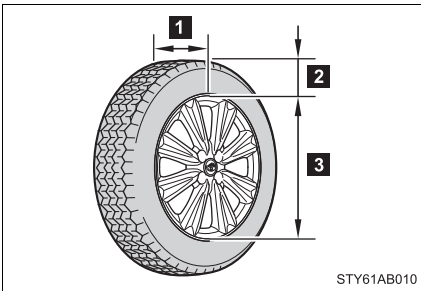

- 1** Section width
- 2** Tire height
- 3** Wheel diameter

Tire section names

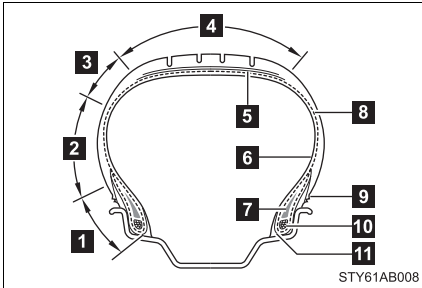

- 1** Bead
- 2** Sidewall
- 3** Shoulder
- 4** Tread
- 5** Belt
- 6** Inner liner
- 7** Reinforcing rubber
- 8** Carcass
- 9** Rim lines
- 10** Bead wires
- 11** Chafer

Uniform Tire Quality Grading

This information has been prepared in accordance with regulations issued by the National Highway Traffic Safety Administration of the U.S. Department of Transportation.

It provides the purchasers and/or prospective purchasers of Toyota vehicles with information on uniform tire quality grading.

Your Toyota dealer will help answer any questions you may have as you read this information.

n DOT quality grades

All passenger vehicle tires must conform to Federal Safety Requirements in addition to these grades. Quality grades can be found where applicable on the tire sidewall between tread shoulder and maximum section width.

For example: Treadwear 200 Traction AA Temperature A

n **Treadwear**

The treadwear grade is a comparative rating based on the wear rate of the tire when tested under controlled conditions on a specified government test course.

For example, a tire graded 150 would wear one and a half (1 - 1/2) times as well on the government course as a tire graded 100.

The relative performance of tires depends upon the actual conditions of their use, however, and may depart significantly from the norm due to variations in driving habits, service practices and differences in road characteristics and climate.

n **Traction AA, A, B, C**

The traction grades, from highest to lowest, are AA, A, B and C, and they represent the tire's ability to stop on wet pavement as measured under controlled conditions on specified government test surfaces of asphalt and concrete.

A tire marked C may have poor traction performance.

Warning: The traction grade assigned to this tire is based on braking (straight ahead) traction tests and does not include cornering (turning) traction.

n **Temperature A, B, C**

The temperature grades are A (the highest), B, and C, representing the tire's resistance to the generation of heat and its ability to dissipate heat when tested under controlled conditions on a specified indoor laboratory test wheel.

Sustained high temperature can cause the material of the tire to degenerate and reduce tire life, and excessive temperature can lead to sudden tire failure.

The grade C corresponds to a level of performance which all passenger car tires must meet under the Federal Motor Vehicle Safety Standard No. 109.

Grades B and A represent higher levels of performance on the laboratory test wheel than the minimum required by law.

Warning: The temperature grades for this tire are established for a tire that is properly inflated and not overloaded.

Excessive speed, underinflation, or excessive loading, either separately or in combination, can cause heat buildup and possible tire failure.

Glossary of tire terminology

Tire related term	Meaning
Cold tire inflation pressure	Tire pressure when the vehicle has been parked for three hours or more, or has not been driven more than 1 mile or 1.5 km under that condition
Maximum inflation pressure	The maximum cold inflated pressure to which a tire may be inflated, shown on the sidewall of the tire
Recommended inflation pressure	Cold tire inflation pressure recommended by a manufacturer
Accessory weight	The combined weight (in excess of those standard items which may be replaced) of transmission, power steering, power brakes, power windows, power seats, radio and heater, to the extent that these items are available as factory-installed equipment (whether installed or not)
Curb weight	The weight of a motor vehicle with standard equipment, including the maximum capacity of fuel, oil and coolant, and if so equipped, air conditioning and additional weight optional engine
Maximum loaded vehicle weight	The sum of: (a) Curb weight (b) Accessory weight (c) Vehicle capacity weight (d) Production options weight
Normal occupant weight	150 lb. (68 kg) times the number of occupants specified in the second column of Table 1* that follows

Tire related term	Meaning
Occupant distribution	Distribution of occupants in a vehicle as specified in the third column of Table 1* below
Production options weight	The combined weight of installed regular production options weighing over 5 lb. (2.3 kg) in excess of the standard items which they replace, not previously considered in curb weight or accessory weight, including heavy duty brakes, ride levelers, roof rack, heavy duty battery, and special trim
Rim	A metal support for a tire or a tire and tube assembly upon which the tire beads are seated
Rim diameter (Wheel diameter)	Nominal diameter of the bead seat
Rim size designation	Rim diameter and width
Rim type designation	The industry manufacturer's designation for a rim by style or code
Rim width	Nominal distance between rim flanges
Vehicle capacity weight (Total load capacity)	The rated cargo and luggage load plus 150 lb. (68 kg) times the vehicle's designated seating capacity
Vehicle maximum load on the tire	The load on an individual tire that is determined by distributing to each axle its share of the maximum loaded vehicle weight, and dividing by two
Vehicle normal load on the tire	The load on an individual tire that is determined by distributing to each axle its share of curb weight, accessory weight, and normal occupant weight (distributed in accordance with Table 1* below), and dividing it by two
Weather side	The surface area of the rim not covered by the inflated tire

Tire related term	Meaning
Bead	The part of the tire that is made of steel wires, wrapped or reinforced by ply cords and that is shaped to fit the rim
Bead separation	A breakdown of the bond between components in the bead
Bias ply tire	A pneumatic tire in which the ply cords that extend to the beads are laid at alternate angles substantially less than 90 degrees to the centerline of the tread
Carcass	The tire structure, except tread and sidewall rubber which, when inflated, bears the load
Chunking	The breaking away of pieces of the tread or sidewall
Cord	The strands forming the plies in the tire
Cord separation	The parting of cords from adjacent rubber compounds
Cracking	Any parting within the tread, sidewall, or innerliner of the tire extending to cord material
CT	A pneumatic tire with an inverted flange tire and rim system in which the rim is designed with rim flanges pointed radially inward and the tire is designed to fit on the underside of the rim in a manner that encloses the rim flanges inside the air cavity of the tire
Extra load tire	A tire designed to operate at higher loads and at higher inflation pressures than the corresponding standard tire
Groove	The space between two adjacent tread ribs
Innerliner	The layer(s) forming the inside surface of a tubeless tire that contains the inflating medium within the tire
Innerliner separation	The parting of the innerliner from cord material in the carcass

Tire related term	Meaning
Intended outboard sidewall	(a)The sidewall that contains a whitewall, bears white lettering, or bears manufacturer, brand, and/or model name molding that is higher or deeper than the same molding on the other sidewall of the tire, or (b)The outward facing sidewall of asymmetrical tire that has a particular side that must always face outward when mounted on a vehicle
Light truck (LT) tire	A tire designated by its manufacturer as primarily intended for use on lightweight trucks or multipurpose passenger vehicles
Load rating	The maximum load that a tire is rated to carry for a given inflation pressure
Maximum load rating	The load rating for a tire at the maximum permissible inflation pressure for that tire
Maximum permissible inflation pressure	The maximum cold inflation pressure to which a tire may be inflated
Measuring rim	The rim on which a tire is fitted for physical dimension requirements
Open splice	Any parting at any junction of tread, sidewall, or innerliner that extends to cord material
Outer diameter	The overall diameter of an inflated new tire
Overall width	The linear distance between the exteriors of the sidewalls of an inflated tire, including elevations due to labeling, decorations, or protective bands or ribs
Passenger car tire	A tire intended for use on passenger cars, multipurpose passenger vehicles, and trucks, that have a gross vehicle weight rating (GVWR) of 10,000 lb. or less
Ply	A layer of rubber-coated parallel cords

Tire related term	Meaning
Ply separation	A parting of rubber compound between adjacent plies
Pneumatic tire	A mechanical device made of rubber, chemicals, fabric and steel or other materials, that, when mounted on an automotive wheel, provides the traction and contains the gas or fluid that sustains the load
Radial ply tire	A pneumatic tire in which the ply cords that extend to the beads are laid at substantially 90 degrees to the centerline of the tread
Reinforced tire	A tire designed to operate at higher loads and at higher inflation pressures than the corresponding standard tire
Section width	The linear distance between the exteriors of the sidewalls of an inflated tire, excluding elevations due to labeling, decoration, or protective bands
Sidewall	That portion of a tire between the tread and bead
Sidewall separation	The parting of the rubber compound from the cord material in the sidewall
Snow tire	A tire that attains a traction index equal to or greater than 110, compared to the ASTM E-1136 Standard Reference Test Tire, when using the snow traction test as described in ASTM F-1805-00, Standard Test Method for Single Wheel Driving Traction in a Straight Line on Snow-and Ice-Covered Surfaces, and which is marked with an Alpine Symbol () on at least one sidewall
Test rim	The rim on which a tire is fitted for testing, and may be any rim listed as appropriate for use with that tire

Tire related term	Meaning
Tread	That portion of a tire that comes into contact with the road
Tread rib	A tread section running circumferentially around a tire
Tread separation	Pulling away of the tread from the tire carcass
Treadwear indicators(TWI)	The projections within the principal grooves designed to give a visual indication of the degrees of wear of the tread
Wheel-holding fixture	The fixture used to hold the wheel and tire assembly securely during testing

*:Table 1 — Occupant loading and distribution for vehicle normal load for various designated seating capacities

Designated seating capacity, Number of occupants	Vehicle normal load, Number of occupants	Occupant distribution in a normally loaded vehicle
2 through 4	2	2 in front
5 through 10	3	2 in front, 1 in second seat
11 through 15	5	2 in front, 1 in second seat, 1 in third seat, 1 in fourth seat
16 through 20	7	2 in front, 2 in second seat, 2 in third seat, 1 in fourth seat

Customizable features

Your vehicle includes a variety of electronic features that can be personalized to your preferences. Programming these preferences requires specialized equipment and may be performed by an authorized Toyota dealership.

Some function settings are changed simultaneously with other functions being customized. Contact your Toyota dealer for further details.

Item	Function	Default setting	Customized setting
Wireless remote control (→P. 28)	Wireless remote control	ON	OFF
	Unlocking operation	Driver's door unlocked in one step, all doors unlocked in two steps	All doors unlocked in one step
	Time elapsed before automatic door lock function is activated if door is not opened after being unlocked	30 seconds	60 seconds
	Operation signal (Emergency flashers)	ON	OFF
	Panic function	ON	OFF
Door lock (→P. 31)	Unlocking using a key	Driver's door unlocked in one step, all doors unlocked in two steps	All doors unlocked in one step

Item	Function	Default setting	Customized setting
Illumination (→P. 210)	Time elapsed before lights turn off	15 seconds	7.5 seconds 30 seconds
	Operation after the engine switch is turned to the LOCK position	ON	OFF
	Operation when the doors are unlocked	ON	OFF
Seat Belt Reminder Buzzer (→P. 310)	Vehicle speed linked seat belt reminder buzzer	ON	OFF
Key Reminder Buzzer (→P. 127)	Remind driver to remove the key	Cycle time 1.2 seconds	0.9 seconds
			0.6 seconds
Light Reminder Buzzer (→P. 146)	Remind driver to turn off the headlights and others	ON	OFF

6-2. Customization

Items to initialize

The following items must be initialized for normal system operation in cases such as after the battery is reconnected, or maintenance is performed on the vehicle.

Item	When to initialize	Reference
Engine oil maintenance data	After changing engine oil	P. 249

Reporting safety defects for U.S. owners

If you believe that your vehicle has a defect which could cause a crash or could cause injury or death, you should immediately inform the National Highway Traffic Safety Administration (NHTSA) in addition to notifying Toyota Motor Sales, U.S.A., Inc. (Toll-free: 1-800-331-4331).

If NHTSA receives similar complaints, it may open an investigation, and if it finds that a safety defect exists in a group of vehicles, it may order a recall and remedy campaign. However, NHTSA cannot become involved in individual problems between you, your dealer, or Toyota Motor Sales, U.S.A., Inc.

To contact NHTSA, you may call the Vehicle Safety Hotline toll-free at 1-888-327-4236 (TTY: 1-800-424-9153); go to <http://www.safercar.gov>; or write to: Administrator, NHTSA, 1200 New Jersey Ave, S.E., Washington, DC 20590. You can also obtain other information about motor vehicle safety from <http://www.safercar.gov>.

Seat belt instructions for Canadian owners (in French)

The following is a French explanation of seat belt instructions extracted from the seat belt section in this manual.

See the seat belt section for more detailed seat belt instructions in English.

Utilisation adéquate des ceintures de sécurité

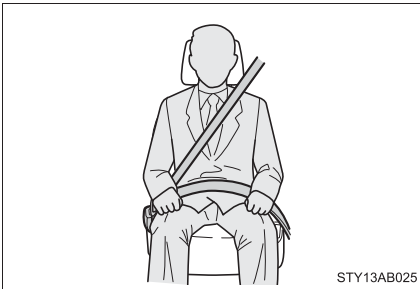

- Tirez sur la ceinture épaulière jusqu'à ce qu'elle recouvre entièrement l'épaule; elle ne doit cependant pas toucher le cou ni glisser de l'épaule.
- Placez la sangle abdominale de la ceinture de sécurité le plus bas possible sur les hanches.
- Réglez la position du dossier du siège. Tenez-vous assis dans le fond du siège, le dos droit.
- Ne tournez pas la ceinture de sécurité.

ATTENTION

■ Lorsque vous utilisez la ceinture de sécurité centrale du siège arrière



N'utilisez pas la ceinture de sécurité centrale arrière si l'une des boucles est retirée. Fixer une seule boucle pourrait occasionner des blessures graves, voire mortelles, en cas de freinage brusque ou de collision.

Guide des ceintures de sécurité (siège arrière central)

Si la ceinture épaulière est trop près du cou d'une personne, utilisez le guide de la ceinture de sécurité.

► Sièges arrière divisés

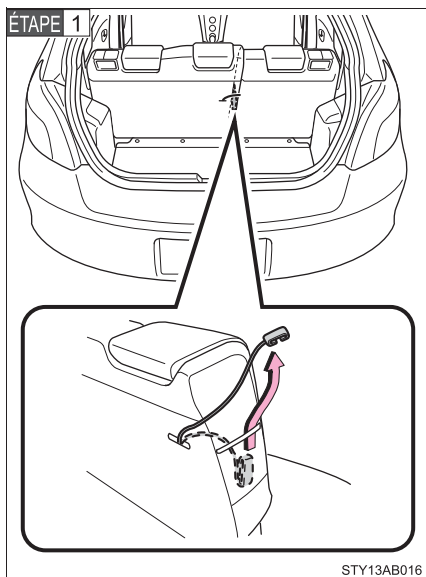

Tirez sur le guide de la ceinture.

► Sièges arrière non divisés

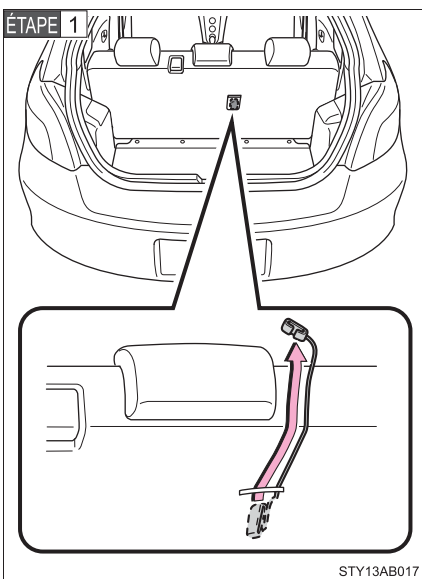

Tirez sur le guide de la ceinture.

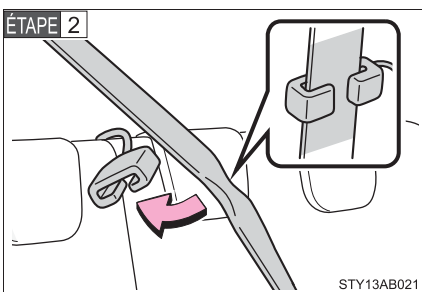

Faites glisser la ceinture au-delà de la fente du guide.

L'élastique doit être placé derrière la ceinture de sécurité.

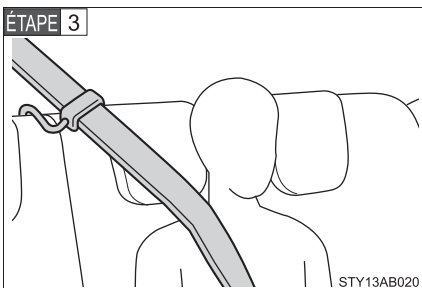

L'élastique doit être placé derrière la ceinture de sécurité.

Entretien et soins

■ Ceintures de sécurité

Avec un tissu ou une éponge, nettoyez à l'aide d'un savon doux et de l'eau tiède. Vérifiez aussi les ceintures régulièrement pour vous assurer qu'elles ne présentent pas d'usure excessive, d'effilochage ou de coupures.

ATTENTION

■ Dommages et usure de la ceinture de sécurité

Vérifiez périodiquement le système de ceintures de sécurité. Assurez-vous qu'il n'y a pas de coupures, d'effilochures ni de pièces desserrées. N'utilisez pas une ceinture de sécurité endommagée avant qu'elle soit remplacée. Une ceinture de sécurité endommagée ne peut pas protéger les occupants contre les blessures.

A

A/C 178

ABS

 ABS 155

 Warning light 308

Air conditioning filter 270

Air conditioning system

 Air conditioning filter 270

 Air conditioning system 178

Airbags

 Airbag operating conditions 84

 Airbag precautions for your child 88

 Curtain shield airbag operating conditions 84

 Curtain shield airbag precautions 88

 Front passenger occupant classification system 93

 General airbag precautions 88

 Indicators 93

 Locations of airbags 81

 Modification and disposal of airbags 92

 Proper driving posture 79, 88

 Side airbag operating conditions 84

 Side airbag precautions 88

 SRS airbags 81

 Warning light 308

Alarm 76

Antenna 191, 228

Anti-lock brake system

 Anti-lock brake system 155

 Warning light 308

Audio input 209

Audio system

 Antenna 191

 Audio input 209

 AUX adapter 209

 CD player 195

 MP3/WMA disc 200

 Optimal use 207

 Portable music player 209

 Radio 189

 Type 187

Automatic transmission

 Automatic transmission 128

 Fluid 349

 If the shift lever cannot be shifted from P 331

 Indicators 128

 Shift lock system 331

AUX adapter 209

Auxiliary boxes 217, 225

B

Back-up lights

 Replacing light bulbs 286

 Wattage 352

Back door 36

Battery

 Checking 253

 If the vehicle battery is discharged 333

 Preparing and checking before winter 161

 Voltage 349

 Warning light 308

Bottle holders 215

Brakes

 Fluid 252

 Parking brake 132

 Specifications 350

 Warning light 307

Break-in tips 118

C

Care

 Exterior 228

 Interior 230

 Seat belts 231

Cargo capacity 157

CD player 195

Chains 161

Child restraint system
 Booster seats, definition98
 Booster seats, installation 102
 Convertible seats, definition98
 Convertible seats,
 installation 102
 Front passenger occupant
 classification system93
 Infant seat, definition98
 Infant seats, installation 102
 Installing CRS with LATCH
 system 104
 Installing CRS with seat
 belts 105
 Installing CRS with top
 tether straps 109

Child safety
 Airbag precautions88
 Battery precautions255, 336
 Child restraint system98
 Child-protectors34
 How your child should wear
 the seat belt58
 Installing child restraints 102
 Power window lock switch68
 Power window precautions69
 Removed key battery
 precautions274
 Seat belt extender
 precautions61
 Seat belt precautions59

Child-protectors34

Cleaning
 Exterior228
 Interior230
 Seat belts231

Clock135, 137, 221

Clutch
 Fluid350
 Pedal116,130

Comfort guide55

Condenser252

CRS98

Cruise control
 Cruise control 152
 Indicator 152

Cup holders214

Curtain shield airbags81

Customizable features369

D **Daytime running light
 system 146**

Defogger
 Rear window 185
 Side mirrors 185

Dimension 344

Do-it-yourself maintenance 239

Doors
 Back door 36
 Door glasses67
 Door lock31
 Side doors31
 Side mirrors64
 Warning light 310

**Driver's seat belt reminder
 light 310**

Driving
 Break-in tips 118
 Correct posture79
 Procedures 116
 Winter driving tips 161

E **Electric power steering**
 Electric power steering 155
 Warning light 308

Emergency flashers
 Switch 296

Emergency, in case of
 If the engine will not start 329
 If the shift lever cannot be
 shifted from P 331
 If the vehicle battery is
 discharged 333
 If the warning buzzer
 sounds 307

If the warning light turns on	307
If you have a flat tire	317
If you lose your keys.....	332
If you think something is wrong	303
If the vehicle becomes stuck.....	340
If your vehicle needs to be towed	297
If your vehicle overheats	337
Engine	
Compartment.....	245
Engine switch	125
Hood.....	242
How to start the engine	125
Identification number	345
If the engine will not start.....	329
Ignition switch.....	125
Immobilizer system.....	74
Overheating.....	337
Specifications	346
Warning light	308
Engine coolant	
Capacity	348
Checking	250
Indicator.....	141
Preparing and checking before winter	161
Type	348
Warning light	308
Engine immobilizer system.....	74
Engine oil	
Capacity	347
Checking	246
Grade	347
Initializing the maintenance data	249
Preparing and checking before winter	161
Warning light	308, 310
Engine switch	125

F

Engine oil maintenance	
data	249
EPS	
EPS	155
Warning light	308
Event data recorder	305
Floor mat.....	224
Fluid	
Automatic transmission	349
Brake	252
Clutch	350
Warning light	307, 310
Washer.....	256
Fog lights	
Indicator	147
Replacing light bulbs	286
Switch.....	147
Wattage.....	352
Front fog lights	
Indicator	147
Replacing light bulbs	286
Switch.....	147
Wattage.....	352
Front passenger's seat belt	
reminder light.....	310
Front seats	
Adjustment	38
Front side marker lights	
Replacing light bulbs	286
Switch.....	145
Wattage.....	352
Front turn signal lights	
Indicator	131
Lever	131
Replacing light bulbs	286
Switch.....	131
Wattage.....	352
Fuel	
Capacity	346
Fuel pump shut off system....	304
Gas station information	392
Gauge	135

	Indicator	143
	Information	353
	Refueling	70
	Type	346
	Fuel door.....	70
	Fuel filler door	70
	Fuel gauge	135
	Fuel pump shut off system	304
	Fuses.....	275
G	Gas station information.....	392
	Gauges.....	135
	Glove boxes.....	212
H	Hazard lights	
	Switch.....	296
	Head restraints	
	Adjusting	48
	Headlights	
	Indicator	145
	Replacing light bulbs	286
	Switch.....	145
	Wattage.....	352
	Hood.....	242
	Horn.....	134
I	I/M test.....	238
	Identification	
	Engine	345
	Tire	356
	Vehicle	345
	Ignition switch.....	125
	Illuminated entry system.....	210
	Immobilizer system.....	74
	Indicator lights	141
	Initialization	
	Items to initialize.....	371
	Inside rear view mirror	63
	Interior light	
	Switch.....	211
	Wattage.....	352

J	Jack	
	Positioning a floor jack	243
	Vehicle-equipped jack	317
	Jack handle	317
K	Keys	
	Electronic key.....	26
	Engine switch.....	125
	If you lose your keys	332
	Ignition switch	125
	Key battery.....	273
	Key number plate.....	26
	Keys	26
	Mechanical key	26
	Wireless remote control	28
L	License plate lights	
	Replacing light bulbs.....	286
	Switch	145
	Wattage.....	352
	Light bulbs	
	Replacing.....	286
	Wattage.....	352
	Lights	
	Emergency flashers	
	switch.....	296
	Fog lights switch	147
	Hazard lights switch	296
	Headlights switch	145
	Instrument panel lights	
	switch.....	145
	Interior light switch	211
	License plate lights switch	145
	Parking lights switch	145
	Personal lights switch	211
	Replacing light bulbs.....	286
	Side marker lights switch	145
	Tail lights switch.....	145
	Turn signal lights switch.....	131
	Load capacity	160
	Lock steering column.....	126

	Luggage compartment features	
	Auxiliary boxes	225
	Luggage cover.....	226
	Luggage compartment light	
	Wattage	352
M	Maintenance	
	Do-it-yourself	
	maintenance	239
	Emission inspection and	
	maintenance (I/M)	
	programs.....	238
	General maintenance	235
	Maintenance data.....	344
	Maintenance requirements...	233
	Vehicle exterior.....	228
	Vehicle interior.....	230
	Manual transmission	
	Manual transmission	130
	Oil.....	349
	Meter	
	Instrument panel light	
	control	139
	Meters	135
	Mirrors	
	Inside rear view mirror.....	63
	Side mirror heaters.....	185
	Side mirrors.....	64
	Vanity mirrors	220
	MP3 disc.....	200
O	Odometer	138
	Oil	
	Engine oil.....	246
	Manual transmission	349
	Warning light	308, 310
	Opener	
	Fuel door	70
	Fuel filler door.....	70
	Hood.....	242

	Outside rear view mirrors	
	Adjusting	64
	Folding	65
	Overheating, Engine.....	337
P	Parking brake	132
	Parking lights	
	Replacing light bulbs	286
	Switch.....	145
	Wattage.....	352
	Personal lights	
	Switch.....	211
	Wattage.....	352
	Power outlet	223
	Power windows	67
R	Radiator	252
	Radio	189
	Rear seat	
	Folding down.....	43
	Rear side marker lights	
	Replacing light bulbs	286
	Switch.....	145
	Wattage.....	352
	Rear turn signal lights	
	Indicator	131
	Lever	131
	Replacing light bulbs	286
	Switch.....	131
	Wattage.....	352
	Rear window defogger	185
	Rear window wiper	151
	Replacing	
	Key battery	273
	Fuses	275
	Light bulbs.....	286
	Tires	258, 317
	Reporting safety defects	
	for U.S. owners	374

S

Seat belts

Adjustment53
 ALR57
 Automatic Locking Retractor ...57
 Child restraint system
 installation.....98, 102
 Cleaning and maintaining.....231
 Comfort guide.....55
 ELR57
 Emergency Locking
 Retractor 57
 How to wear your seat belt.....52
 How your child should wear
 the seat belt58
 Pregnant women, proper seat
 belt use58
 Reminder light.....310
 Seat belt extenders58
 Seat belt pretensioners57

Seats

Adjustment38
 Adjustment precautions.....40
 Child seats/child restraint
 system installation98, 102
 Cleaning230
 Folding down the rear seat.....43
 Folding down the rear seat
 precautions47
 Front seat adjustment38
 Front seat adjustment
 precautions40
 Head restraint.....48
 Properly sitting in the seat.....79

Service reminder

indicators141

Shift lever

Automatic transmission 128
 If the shift lever cannot be
 shifted from P.....331
 Manual transmission 130

Shift lock system331

Side airbags.....81

Side marker lights

Replacing light bulbs286
 Switch145
 Wattage.....352

Side mirror

Adjusting64
 Defogger185
 Folding65

Spare tire

Identification number.....356
 Inflation pressure264, 351
 Information356
 Replacing317
 Size351
 Storage location317

Spark plug348

Specifications344

Speedometer135

Steering wheel

Adjustment62
 Column lock release126
 Electric power steering.....155
 EPS.....155
 Specification.....350
 Warning light308

Stop lights

Replacing light bulbs286
 Wattage.....352

Storage features

Auxiliary boxes.....212, 217
 Bottle holders212, 215
 Cup holders.....212, 214
 Glove boxes212

Storage precautions159

Stuck

If the vehicle becomes
 stuck340

Sun visors219

Switch

Cruise control.....152
 Emergency flashers
 switch.....296
 Engine switch.....125

	Fog lights switch.....	147
	Hazard lights switch	296
	Ignition switch.....	125
	Headlights switch	145
	Light switch.....	145
	Power door lock switch.....	32
	Power window switch	67
	Turn signal lights	131
	Window lock switch	68
	Wiper and washer	148, 151
T	Tachometer.....	135
	Tail lights	
	Indicator.....	145
	Replacing light bulbs	286
	Switch.....	145
	Wattage.....	352
	Theft deterrent system	
	Alarm	76
	Engine immobilizer system.....	74
	Theft prevention labels.....	78
	Theft prevention labels.....	78
	Tire inflation pressure	264
	Tire information	
	Glossary	363
	Size	360
	Tire identification number	359
	Uniform tire quality grading.....	361
	Tires	
	Chains	161
	Checking	258
	If you have a flat tire	317
	Identification number	356
	Inflation pressure.....	264, 351
	Inflation pressure sensor	259
	Information	356
	Replacing	258, 317
	Rotating tires	258
	Size	351
	Snow tires.....	161
	Spare tire.....	317

	Tire pressure warning system	258, 310
	Warning light	310
	Tools	317
	Total load capacity.....	160
	Towing	
	Dinghy towing.....	173, 174
	Emergency towing.....	297
	Trailer towing.....	164, 165
	Trip meter	138
	Turn signal lights	
	Indicator	131
	Lever	131
	Replacing light bulbs	286
	Switch.....	131
	Wattage.....	352
V	Vanity mirrors.....	220
	Vehicle identification number	345
W	Warning buzzers	
	Brake system	307
	Seat belt reminder.....	310
	Warning lights	
	ABS	308
	Airbag system	308
	Anti-lock brake system	308
	Brake system	307
	Charging system	308
	Driver's seat belt	310
	Electric power steering system	308
	Electronic engine control system	308
	Engine oil replacement.....	310
	EPS system.....	308
	Front passenger occupant classification system	308
	Front passenger's seat belt...310	
	High engine coolant temperature	308

Low brake fluid	307
Low engine oil pressure	308
Low tire inflation pressure	310
Low washer fluid	310
Malfunction.....	308
Open door	310
Seat belt	310
Seat belt pretensioner	
system	308
SRS.....	308
SRS airbag system	308
Tire pressure	310
Tire pressure warning	
system	310
Washer	
Checking	256
Preparing and checking	
before winter	161
Switch.....	148
Warning light	310
Washing and waxing	228
Weight	
Cargo capacity	157
Load limits	160
Weight.....	344
Wheels	268
Window	
glasses	67, 185, 228, 230
Window lock switch.....	68
Windows	
Cleaning and	
protecting.....	228, 230
Power windows	67
Rear window defogger	185
Washer.....	148
Windshield wipers	148
Wireless remote control key	
Replacing the key battery.....	273
Wireless remote control	28
WMA disc.....	200

What to do if...

What to do if...

A tire punctures

P. 317 If you have a flat tire

The engine does not start

P. 329 If the engine will not start

P. 74 Engine immobilizer system

P. 333 If the vehicle battery is discharged

The shift lever cannot be moved out

P. 331 If the shift lever cannot be shifted from P

The engine coolant temperature warning light flashes or comes on

P. 337 If your vehicle overheats

Steam can be seen coming from under the hood

The key is lost

P. 332 If you lose your keys

The battery runs out

P. 333 If the vehicle battery is discharged

The doors cannot be locked

P. 31 Side doors

The horn begins to sound

P. 76 Alarm

The vehicle is stuck in mud or sand

P. 340 If the vehicle becomes stuck

The warning light or indicator light comes on

P. 307 If a warning light turns on

n Instrument cluster

► Vehicles with tachometer

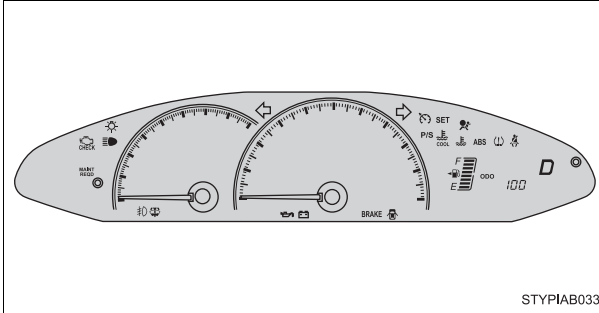

► Vehicles without tachometer

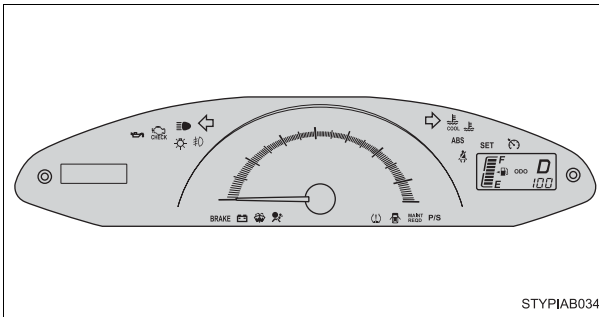

n Center panel

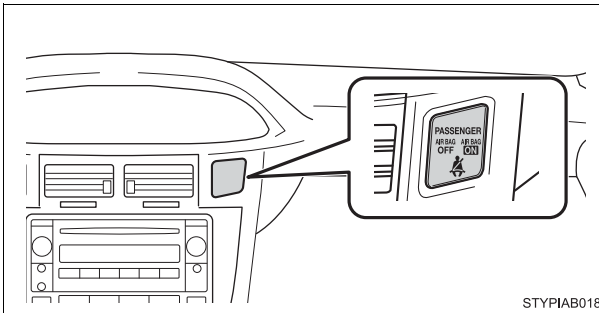

nWarning lights



Brake system warning light

or



P. 307



Charging system warning light

P. 308



Low engine oil pressure warning light

P. 308



High engine coolant temperature warning light

P. 308



Malfunction indicator lamp

or



P. 308



ABS warning light

or



P. 308



Engine oil replacement reminder light

P. 310



SRS warning light

P. 308



Electric power steering warning light

P. 308



Open door warning light

P. 310



Low washer fluid warning light

P. 310



Driver's seat belt reminder light

P. 310



Front passenger's seat belt reminder light

P. 310



Tire pressure warning light

P. 310

GAS STATION INFORMATION

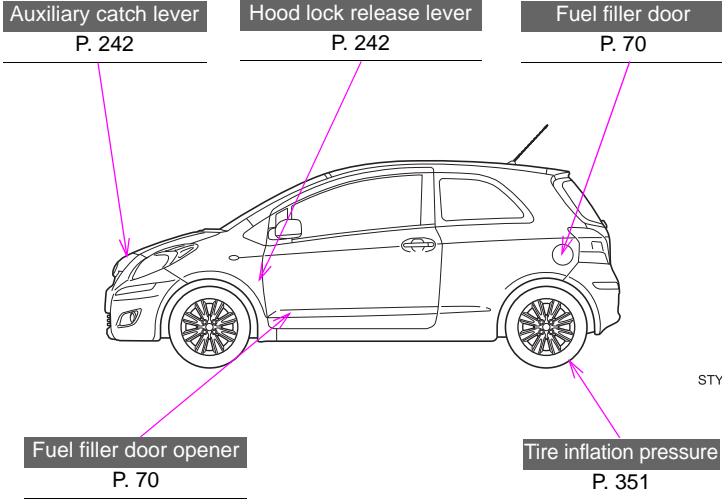

STYPIAB030

Fuel tank capacity	11.1 gal. (42.0 L, 9.2 Imp.gal.)						
Fuel type	Unleaded gasoline, Octane Rating 87 (Research Octane Number 91) or higher						
Cold tire inflation pressure	P. 351						
Engine oil capacity (Drain and refill)	<table style="width: 100%; border: none;"> <tr> <td style="width: 60%;"></td> <td style="text-align: right;">qt. (L, Imp.qt.)</td> </tr> <tr> <td>With filter</td> <td style="text-align: right;">3.9 (3.7, 3.3)</td> </tr> <tr> <td>Without filter</td> <td style="text-align: right;">3.6 (3.4, 3.0)</td> </tr> </table>		qt. (L, Imp.qt.)	With filter	3.9 (3.7, 3.3)	Without filter	3.6 (3.4, 3.0)
	qt. (L, Imp.qt.)						
With filter	3.9 (3.7, 3.3)						
Without filter	3.6 (3.4, 3.0)						
Engine oil type	Toyota Genuine Motor Oil or equivalent Oil grade: ILSAC multigrade engine oil. P. 347 Recommended oil viscosity: SAE 5W-30						

1 Before driving

1-1. Key information
 Keys 26

1-2. Opening, closing and locking the doors
 Wireless remote control 28
 Side doors 31
 Back door 36

1-3. Adjustable components (seats, mirrors, steering wheel)
 Front seats 38
 Rear seats 41
 Head restraints 48
 Seat belts 52
 Steering wheel 62
 Anti-glare inside rear view mirror 63
 Outside rear view mirrors 64

1-4. Opening and closing the windows
 Power windows 67

1-5. Refueling
 Opening the fuel tank cap 70

1-6. Theft deterrent system
 Engine immobilizer system 74
 Alarm (Puerto Rico) 76
 Theft prevention labels (except Canada) 78

1-7. Safety information

Correct driving posture 79
 SRS airbags 81
 Front passenger occupant classification system 93
 Child restraint systems 98
 Installing child restraints 102

2 When driving

2-1. Driving procedures
 Driving the vehicle 116
 Engine (ignition) switch 125
 Automatic Transmission 128
 Manual Transmission 130
 Turn signal lever 131
 Parking brake 132
 Horn 134

2-2. Instrument cluster
 Gauges and meters 135
 Indicators and warning lights 141

2-3. Operating the lights and wipers
 Headlight switch 145
 Fog light switch 147
 Windshield wipers and washer 148
 Rear window wiper and washer 151

2-4. Using other driving systems

Cruise control.....	152
Driving assist systems	155

2-5. Driving information

Cargo and luggage	157
Vehicle load limits	160
Winter driving tips	161
Trailer towing (except Canada)	164
Trailer towing (Canada)	165
Dinghy towing (vehicles with an automatic transmission)	173
Dinghy towing (vehicles with a manual transmission)	174

3 Interior features

3-1. Using the air conditioning system and defogger

Air conditioning system	178
Rear window and outside rear view mirror defoggers	185

3-2. Using the audio system

Audio system type.....	187
Using the radio.....	189
Using the CD player.....	195
Playing back MP3 and WMA discs	200
Optimal use of the audio system	207
Using the AUX adapter	209

3-3. Using the interior lights

Interior lights list	210
• Interior light	211
• Personal lights.....	211

3-4. Using the storage features

List of storage features.....	212
• Glove boxes	212
• Cup holders.....	214
• Bottle holders	215
• Auxiliary boxes	217

3-5. Other interior features

Sun visors.....	219
Vanity mirrors	220
Clock	221
Power outlet	223
Floor mat	224
Luggage compartment features	225

4 Maintenance and care

4-1. Maintenance and care

Cleaning and protecting the vehicle exterior.....	228
Cleaning and protecting the vehicle interior	230

4-2. Maintenance

Maintenance requirements	233
General maintenance	235
Emission inspection and maintenance (I/M) programs	238

4-3. Do-it-yourself maintenance

Do-it-yourself service precautions 239
 Hood..... 242
 Positioning a floor jack 243
 Engine compartment 245
 Tires 258
 Tire inflation pressure..... 264
 Wheels 268
 Air conditioning filter 270
 Key battery 273
 Checking and replacing fuses 275
 Light bulbs..... 286

5 When trouble arises

5-1. Essential information

Emergency flashers 296
 If your vehicle needs to be towed 297
 If you think something is wrong 303
 Fuel pump shut off system..... 304
 Event data recorder..... 305

5-2. Steps to take in an emergency

If a warning light turns on or a warning buzzer sounds... 307
 If you have a flat tire 317
 If the engine will not start ... 329
 If the shift lever cannot be shifted from P 331
 If you lose your keys 332

If the vehicle battery is discharged..... 333
 If your vehicle overheats..... 337
 If the vehicle becomes stuck 340

6 Vehicle specifications

6-1. Specifications

Maintenance data (fuel, oil level, etc.) 344
 Fuel information..... 353
 Tire information..... 356

6-2. Customization

Customizable features..... 369
 Items to initialize 371

7 For owners

Reporting safety defects for U.S. owners..... 374
 Seat belt instructions for Canadian owners (in French) 375

Index

Abbreviation list 380
Alphabetical index 381
What to do if... 389

1

2

3

4

5

6

7