



Customer Experience Center  
1-800-331-4331

# TACOMA

2009 Quick Reference Guide

# 2009 Tacoma

This *Quick Reference Guide* is a summary of basic vehicle operations. It contains brief descriptions of fundamental operations so you can locate and use the vehicle's main equipment quickly and easily.

The *Quick Reference Guide* is not intended as a substitute for the *Owner's Manual* located in your vehicle's glove box. We strongly encourage you to review the *Owner's Manual* and supplementary manuals so you will have a better understanding of your vehicle's capabilities and limitations.

Your dealership and the entire staff of Toyota Motor Sales, U.S.A., Inc. wish you many years of satisfied driving in your new Tacoma.

## ! A word about safe vehicle operations

This *Quick Reference Guide* is not a full description of Tacoma operations. Every Tacoma owner should review the *Owner's Manual* that accompanies this vehicle.

Pay special attention to the boxed information highlighted in color throughout the *Owner's Manual*. Each box contains safe operating instructions to help you avoid injury or equipment malfunction.

All information in this *Quick Reference Guide* is current at the time of printing. Toyota reserves the right to make changes at any time without notice.

## Doors-Child safety locks (double cab only)

### Rear door

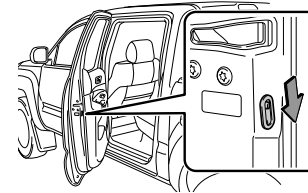

Moving the lever to "LOCK" will allow the door to be opened only from the outside.

## Spare tire & tools

### Tool location

Regular cab models  
-behind the seatback

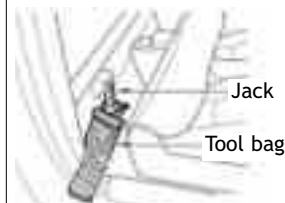

Double cab models  
-under the rear seat

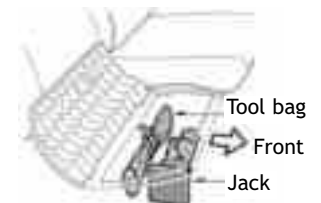

Access cab models  
-under the rear seat

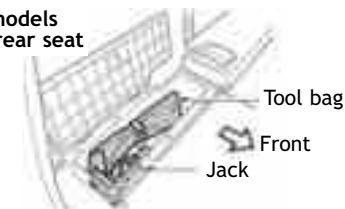

### Removing the spare tire

(1)



(2)

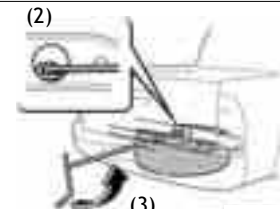

(3)

- (1) Assemble the jack handle.
- (2) Insert the jack handle end into the lowering screw.
- (3) Turn the jack handle counterclockwise.

Refer to the *Owner's Manual* for tire changing and jack positioning procedures.

# INDEX

## OVERVIEW

Engine maintenance	7
Fuel tank door and cap	6
Hood release	6
Indicator symbols	4-5
Instrument cluster	4
Instrument panel	2-3
Keyless entry	6

## FEATURES/OPERATIONS

Accessory meter	15
Air Conditioning/Heating	16
Audio	14-15
Automatic Transmission	8
Clock	10
Cruise control	19
Door locks-Power	18
Four-wheel drive	9
Lights & turn signals	17
Light control-Instrument panel	8
Parking brake	13
Power outlets	13
Rear differential lock	16
Seat adjustments-Front	10
Seats-Folding rear	11
Seats-Head restraints	10
Telephone controls (Bluetooth®)	18
Tilt and telescopic steering wheel	9
“VSC OFF” button	19
Windows-Power	12
Windshield wipers & washers	12

## SAFETY AND

## EMERGENCY FEATURES

Doors-Child safety locks	21
Seat belts	20
Seat belts-Shoulder belt anchor	20
Spare tire & tools	21
Tire Pressure Monitoring (warning) System	20

# OVERVIEW

## Instrument panel

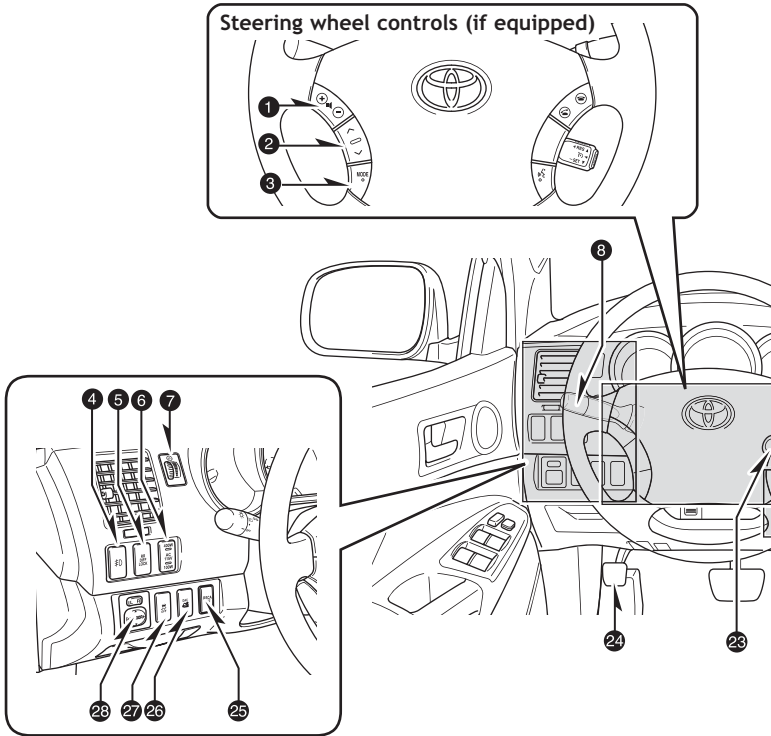

- ❶ Volume control buttons (for audio)
- ❷ “ $\wedge$   $\vee$ ” buttons (for audio)
- ❸ “MODE” button (for audio)
- ❹ Front fog light switch<sup>1</sup>
- ❺ Rear differential lock switch<sup>1</sup>
- ❻ 115V AC Power outlet ON/OFF switch<sup>1</sup>
- ❼ Instrument panel light control
- ❽ Headlight and turn signal controls
- ❾ Windshield wiper and washer controls
- ❿ Two-wheel/Four-wheel drive selector<sup>1</sup>
- ⓫ Audio system
- ⓬ Clock
- ⓭ Theft deterrent system/Engine immobilizer indicator<sup>1</sup>
- ⓮ Front passenger seat belt reminder
- ⓯ Front passenger occupant classification indicator<sup>1</sup> or front passenger airbag ON/OFF indicator<sup>1</sup>



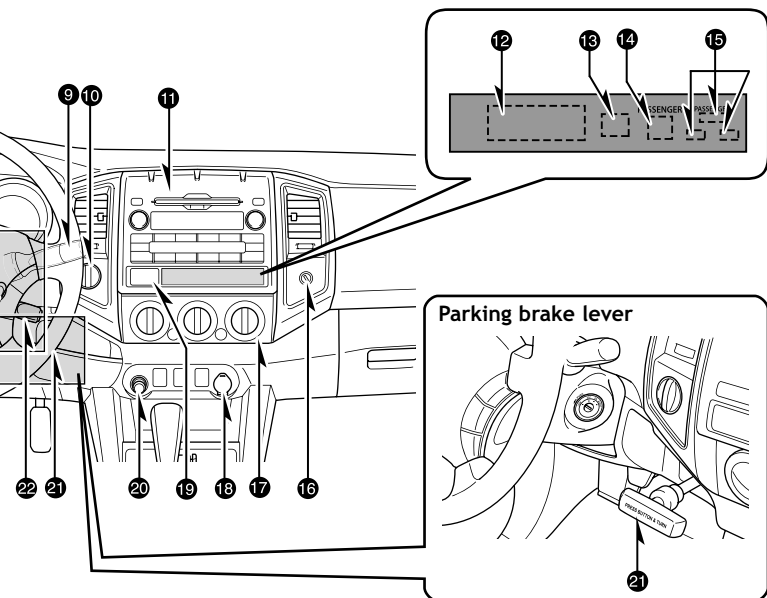

- 16 Front passenger airbag manual ON/OFF switch<sup>1</sup>
- 17 Air Conditioning controls
- 18 12V DC Power outlet
- 19 Emergency flasher button
- 20 12V DC Power outlet/Cigarette lighter
- 21 Parking brake lever (stick type)<sup>2</sup>
- 22 Cruise control<sup>1</sup>
- 23 Engine ignition switch
- 24 Parking brake pedal<sup>3</sup>
- 25 "RSCA OFF" (Roll Sensing Curtain shield Airbags OFF) switch
- 26 "DAC" (Downhill Assist Control) button<sup>1</sup> or clutch start cancel switch<sup>1</sup>
- 27 "VSC OFF" (Vehicle Stability Control OFF) switch<sup>1</sup>
- 28 Power rearview mirror control switches<sup>1</sup>

<sup>1</sup> If equipped

<sup>2</sup> Manual Transmission only

<sup>3</sup> Automatic Transmission only

## Instrument cluster

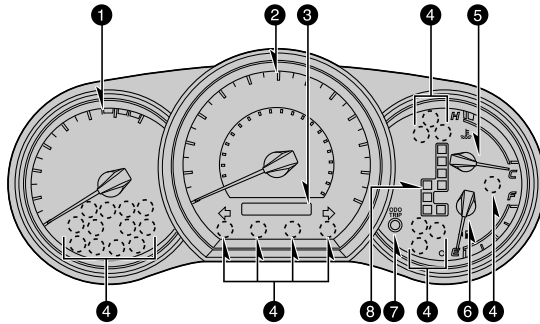

- ❶ Tachometer
- ❷ Speedometer
- ❸ Odometer and two trip meters
- ❹ Service indicator and reminder
- ❺ Engine coolant temperature
- ❻ Fuel gauge
- ❼ Trip meter reset knob
- ❽ Gear shift position indicator (if equipped)

















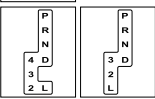

## Indicator symbols

	Brake system warning <sup>1</sup>
	Driver/Front passenger seat belt reminder <sup>1</sup>
	Charging system warning <sup>1</sup>
	Front passenger occupant classification indicator/ Front passenger airbag ON/OFF indicator
	Low engine oil pressure warning <sup>1</sup>
	Malfunction/Check Engine indicator <sup>1</sup>
	Engine oil replacement reminder <sup>1</sup>
	Open door warning <sup>1</sup>

<sup>1</sup> For details, refer to “Indicators and warning lights,” Section 2-2, 2009 Owner’s Manual.

<sup>2</sup> If this light flashes, refer to “SRS airbag,” Section 1-7-, 2009 Owner’s Manual.

<sup>3</sup> If this light flashes, refer to “Four-wheel drive system,” Section 2-4, 2009 Owner’s Manual.

	Airbag SRS warning <sup>1</sup>
	Automatic Transmission fluid temperature warning <sup>1</sup>
	Low Tire Pressure Warning <sup>1</sup>
	Theft deterrent/Engine immobilizer system indicator
	Roll Sensing Curtain shield Airbags OFF indicator <sup>2</sup>
	Headlight low beam indicator
	Headlight high beam indicator
	Turn signal indicator
	Automatic Transmission indicator (5-speed)/(4-speed)
	Four-wheel drive indicator <sup>3</sup>
	Low speed four-wheel drive indicator <sup>3</sup>
	Rear differential lock indicator <sup>4</sup>
	Slip indicator
	Vehicle Stability Control "OFF" indicator warning <sup>1</sup>
	Downhill assist control system indicator
	AUTO Limited Slip Differential indicator
	Cruise control indicator <sup>5</sup>
	Anti-lock Brake System warning <sup>1</sup>

<sup>4</sup> If this light flashes, refer to "Rear differential lock system," Section 2-4, 2009 Owner's Manual.

<sup>5</sup> If this light flashes, refer to "Cruise control," Section 2-4, 2009 Owner's Manual.

# OVERVIEW

## Keyless entry (if equipped)

### Locking operation

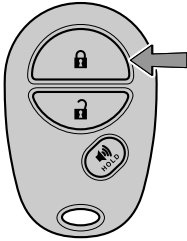

Push



### Unlocking operation

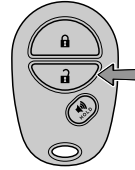

Push ONCE: Driver door  
TWICE: All doors



**NOTE:** If a door is not opened within 60 seconds of unlocking, all doors will relock for safety.

### Panic button

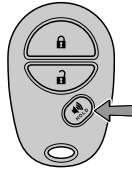

Push and hold



## Fuel tank door and cap

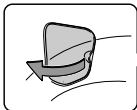

Pull

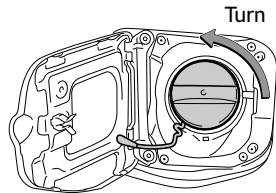
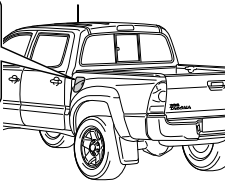

Turn

**NOTE:** Tighten until one click is heard. If the cap is not tightened enough, Check Engine “ CHECK” indicator may illuminate.

## Hood release



Pull

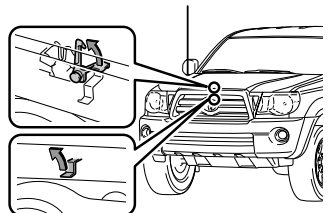

Pull up latch and raise hood

## Engine maintenance

### 4 cylinder (2TR-FE) engine

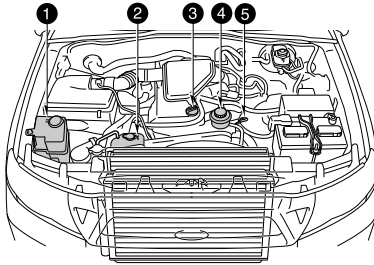

### 6 cylinder (1GR-FE) engine

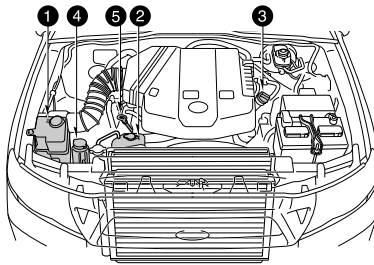

- ❶ Windshield washer fluid tank
- ❷ Engine coolant reservoir
- ❸ Engine oil filler cap
- ❹ Power steering fluid reservoir
- ❺ Engine oil level dipstick

**Note:** Regularly scheduled maintenance, including oil changes, will help extend the life of your vehicle and maintain performance. Please refer to the “Owner’s Warranty Information Booklet,” “Scheduled Maintenance Guide” or “Owner’s Manual Supplement.”

# FEATURES/OPERATIONS

## Automatic Transmission (if equipped)

### 5-speed models

- P** Park\*
- R** Reverse
- N** Neutral
- D** Drive
- 4** Fourth gear
- 3** Third gear
- 2** Second gear
- L** First gear



### 4-speed models

- P** Park\*
- R** Reverse
- N** Neutral
- D** Drive
- 3** Third gear
- 2** Second gear
- L** First gear



\* The engine switch must be “ON” and the brake pedal depressed to shift from Park.

Downshifting increases power going uphill, or provides engine braking downhill. For best fuel economy during normal driving conditions, always drive with the shift lever in the “D” position.

## Light control-Instrument panel

Brightness control

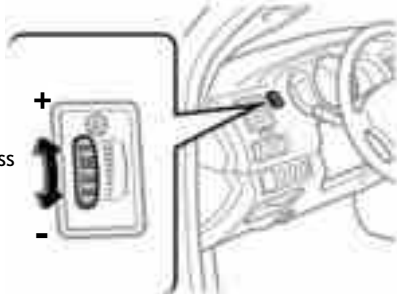

## Four-wheel drive (if equipped)

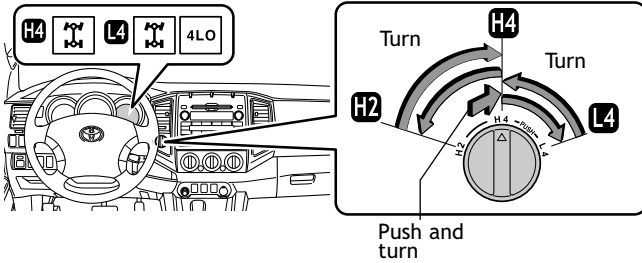

- H2** High speed (2WD)
- H4** High speed (4WD)  
Shift when speed is below 62 mph.
- L4** Low speed (4WD)  
Shift into neutral while stopped, or depress clutch pedal at speeds below 2 mph.

For best fuel economy and performance under normal driving conditions, keep in “H2” position.

## Tilt and telescopic steering wheel

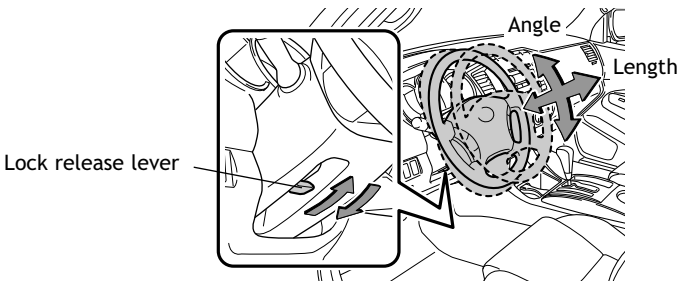

Hold wheel, push lever down, set angle and length, and return lever.

**Note:** Do not attempt to adjust while the vehicle is in motion.

## Seat adjustments-Front

Separate seat



Bench seat



- ① Position
- ② Driver's seat lumbar support (if equipped)
- ③ Seatback angle

## Seats-Head restraints

Separate seats-Front

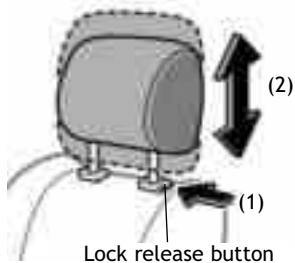

Bench seat-Front

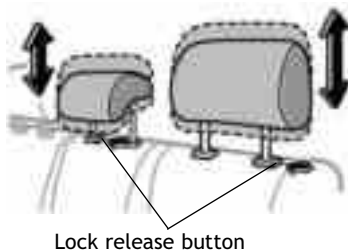

## Clock

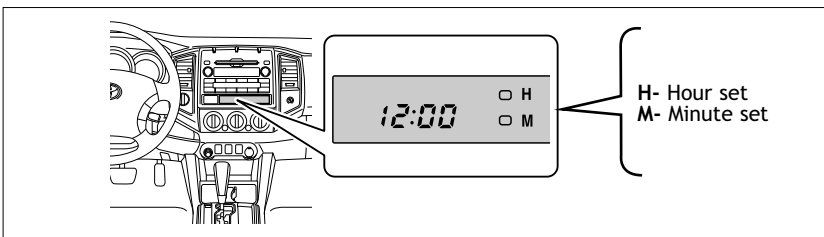



## Seats-Folding rear

### Access cab

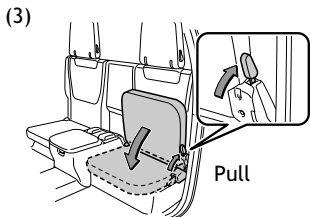
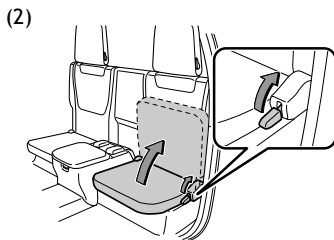
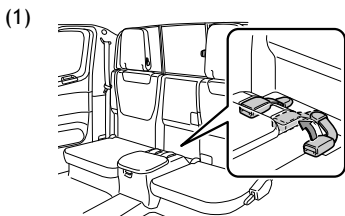

- (1) Stow the seat belt buckles.
- (2) Raise the bottom cushion up while pulling the lever until it locks.
- (3) Push the bottom cushion down.

### Double cab

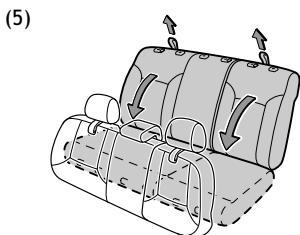
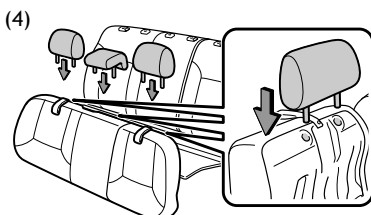
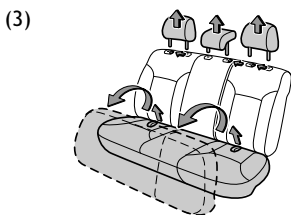
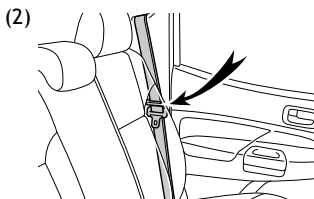
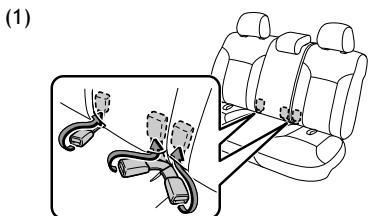

- (1) Stow the seat belt buckles.
- (2) Pass the seat belt through the seat belt hangers.
- (3) Remove the head restraint and swing the bottom cushion.
- (4) Attach the head restraints.
- (5) Fold down the seatback.

### Windshield wipers & washers

#### With intermittent wiper

**\* Intermittent windshield wiper interval adjustment**  
Rotate up to increase interval, down to decrease interval.

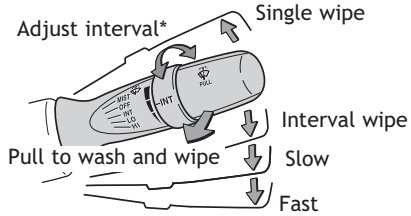

#### Without intermittent wiper

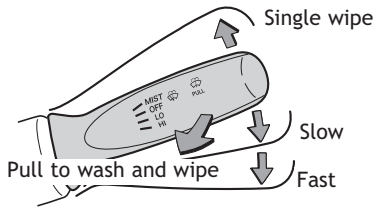

### Windows-Power (if equipped)

#### Access cab models

Driver side

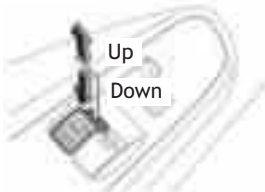

Window lock switch



#### Double cab models

Driver side



Window lock switch



#### Automatic down operation (driver side only)

Push the switch completely down and release to fully open. To stop window midway, lightly pull up on the switch.

**Window lock switch** Deactivates all passenger windows. Driver's window remains operable.

## Parking brake

### Automatic Transmission

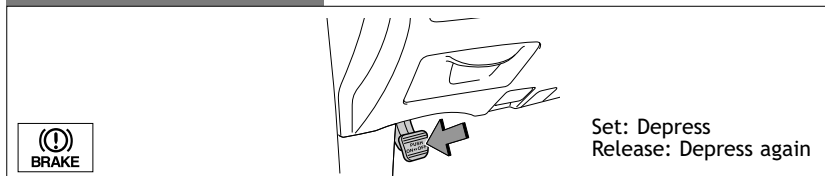

### Manual Transmission

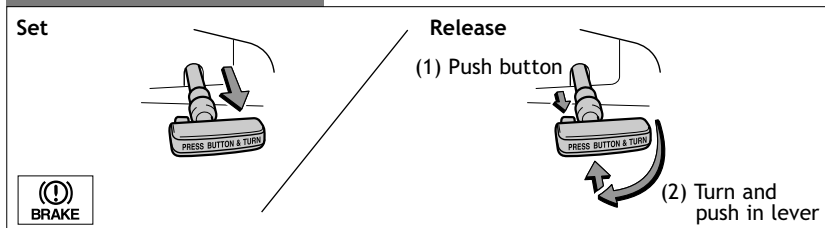

## Power outlets

### 12V DC

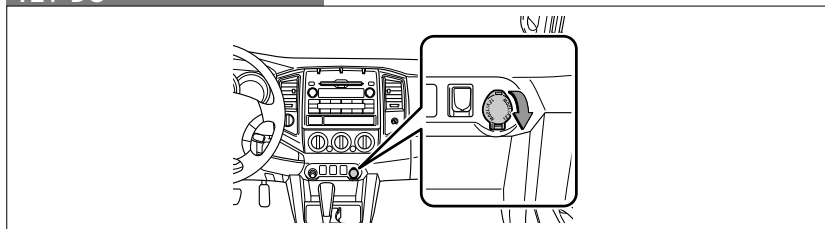

Key must be in the "ACC" or "ON" position to be used.

### 115V AC (if equipped)

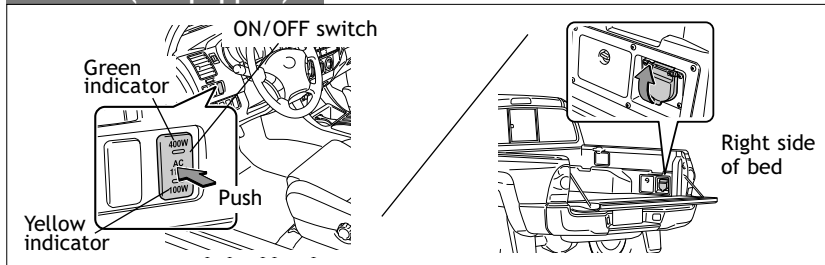

The engine must be running for use.

**Yellow Light Only** Max Capacity 115V AC/100W

**Green & Yellow Lights** Max Capacity 115V AC/400W

Refer to the *Owner's Manual* for more details.

## Audio

### Type 1

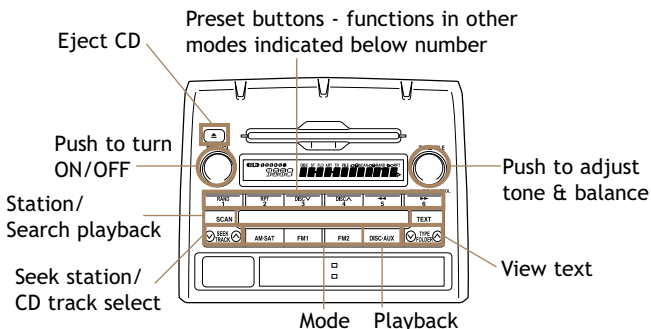

### Type 2 additional functions

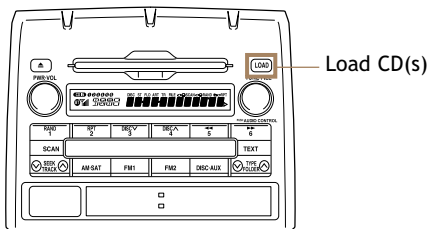

## CD PLAYER

**To scan tracks on a disc** Push and hold “SCAN.” Push again to hold selection.

### CD changer (Type 2 only)

-To load one disc Push “LOAD” and insert one disc.

-To load multiple discs Push and hold “LOAD” until you hear a beep. Insert one disc. Shutter will close and then re-open for next disc.

## RADIO

**To preset stations** Tune in the desired station and hold down a preset button (1-6) until you hear a beep. Push desired preset button (1-6) to select.

**To scan stations** Push and hold “SCAN” to scan preset stations. Push again to hold selection.

### Steering wheel switches (if equipped)

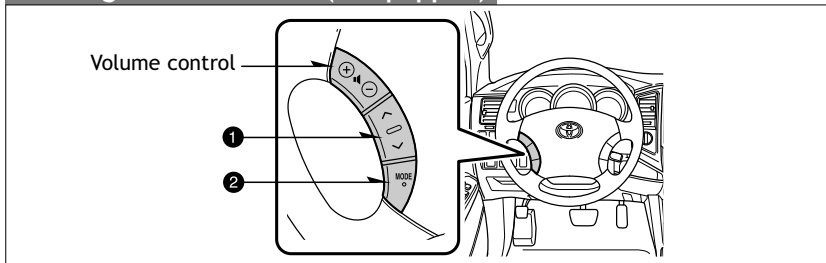

**1 “Λ V”**

-In radio mode

Push to select a preset station; push and hold to seek the next strong station.

-In CD mode

Push to skip up or down to the next/previous track.

**2 “MODE”**

Push to turn audio ON and select an audio mode. Push and hold to turn the audio system OFF.

### AUX audio jack

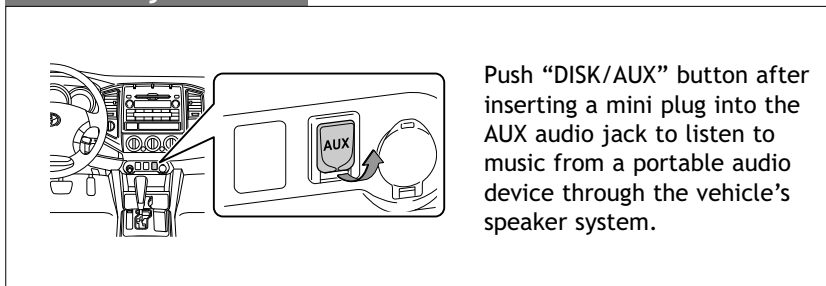

Push “DISK/AUX” button after inserting a mini plug into the AUX audio jack to listen to music from a portable audio device through the vehicle’s speaker system.

### Accessory meter (if equipped)

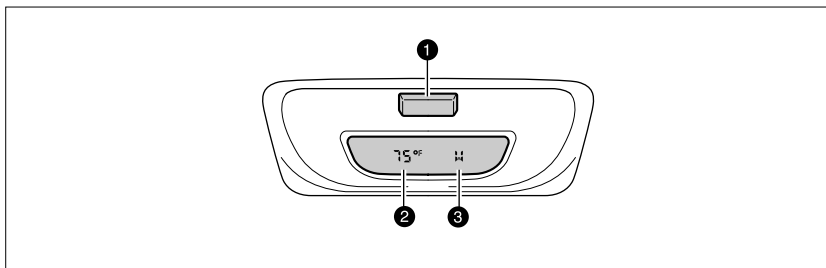

**1** Display button

**2** Outside temperature

**3** Compass

### Air Conditioning (if equipped)/Heating

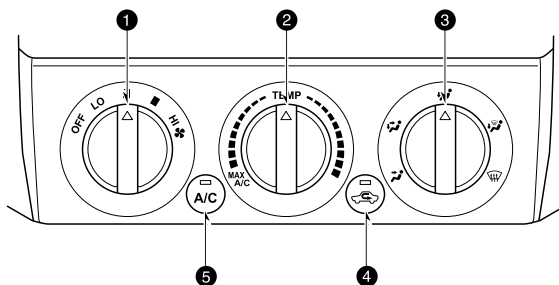

- ❶ Fan speed
- ❷ Temperature
- ❸ Airflow vent  
In “” or “” mode, use fresh air (“” indicator OFF) to reduce window fogging.
- ❹ Fresh or recirculated cabin air
- ❺ Air Conditioning ON/OFF (if equipped)  
Use fresh air to quickly cool interior, then change to recirculate for cooler air.

### Rear differential lock (if equipped)

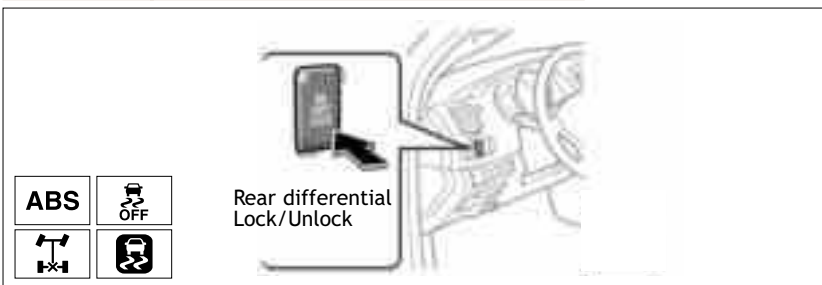

Use **ONLY** when wheel spinning occurs in a ditch, or on slippery or unpaved surfaces. **DO NOT USE THE REAR DIFFERENTIAL LOCK IN CONDITIONS OTHER THAN SPECIFIED IN THE OWNER'S MANUAL.** UNLOCK THE DIFFERENTIAL ONCE THE VEHICLE MOVES OUT OF THE TROUBLE SPOT.

Refer to your *Owner's Manual* for complete details on this system before attempting to use it.

## Lights & turn signals

### Headlights

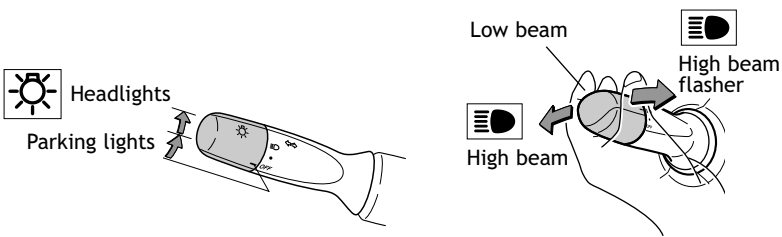

- Daytime Running Light system (if equipped)** Automatically turns on the turn signal lights at a reduced intensity.
- Automatic light cutoff system** Automatically turns lights off when driver's door is opened with the engine switch in the "ACC" or "LOCK" position.

### Front fog lights (if equipped)

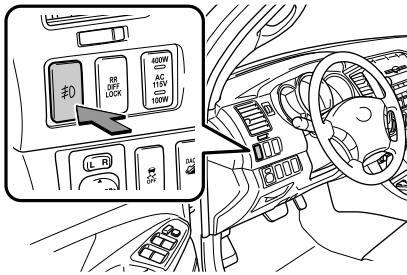

Front fog lights come on only when the headlights are on low beam.

### Turn signals

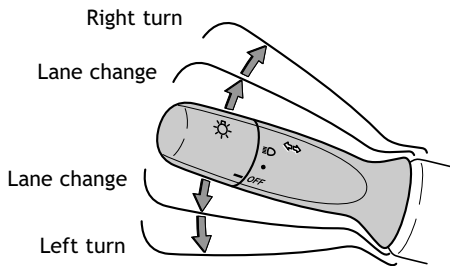

## Telephone controls (Bluetooth®) (if equipped)

Audio unit

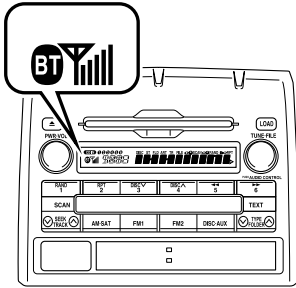

Microphone

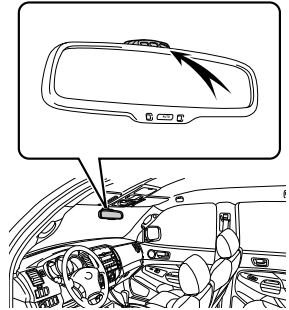

Steering wheel telephone switches

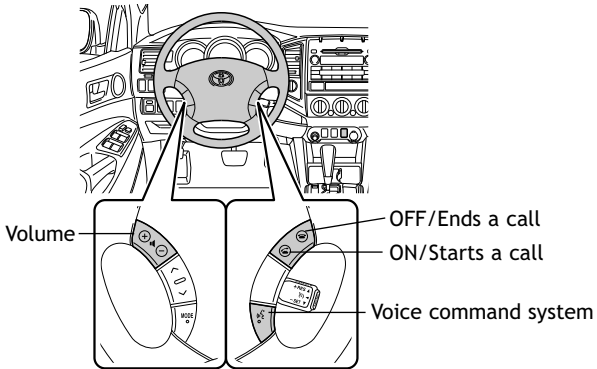

Bluetooth® technology allows you to place or receive calls without taking your hands from the steering wheel or using a cable to connect the telephone and the system.

Refer to “Using the hands-free phone system (for cellular phone),” Section 3-3 in the *Owner’s Manual* for more details.

## Door locks-Power (if equipped)

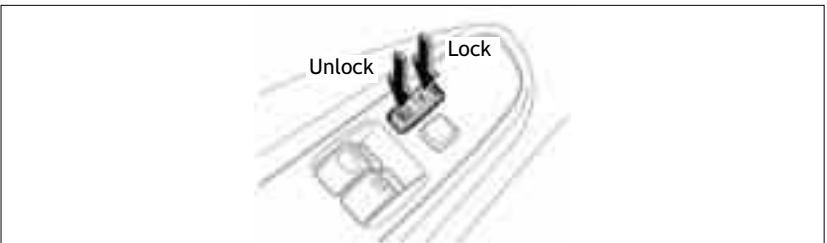



## “VSC OFF” button

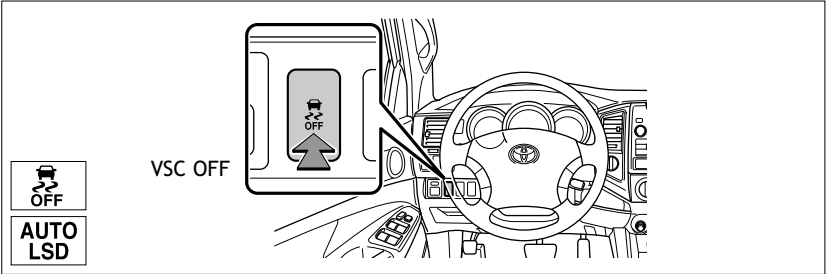

The “VSC OFF” button is used to switch between modes related to the TRAC, VSC and Auto LSD functions.

Refer to the *Owner’s Manual* for more information.

## Cruise control (if equipped)

### Turning system ON/OFF

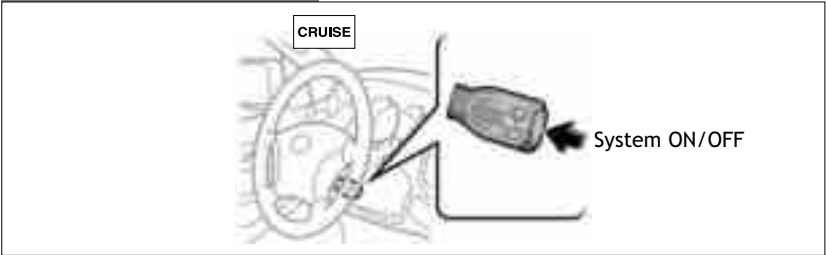

### Functions

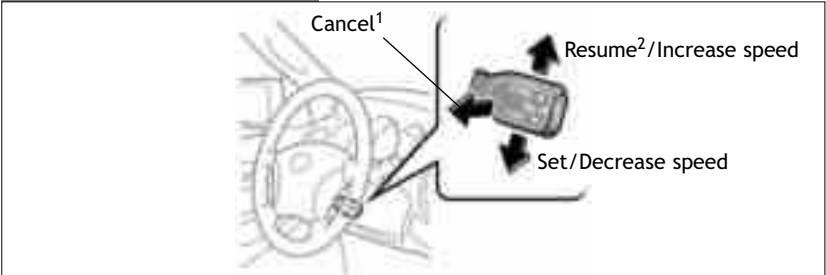

<sup>1</sup> The set speed may also be cancelled by depressing the brake pedal.

<sup>2</sup> The set speed may be resumed once vehicle speed exceeds 25 mph.

# SAFETY AND EMERGENCY FEATURES

## Seat belts

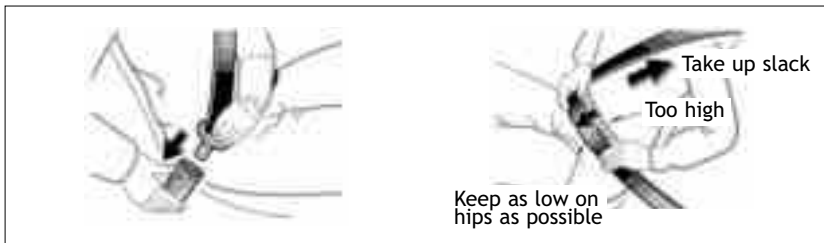

If belt is fully extended, then retracted even slightly, it cannot be re-extended beyond that point, unless fully retracted again. This feature is used to help hold child restraint systems securely.

To find more information about seat belts, and how to install a child restraint system, refer to the *Owner's Manual*.

## Seat belts-Shoulder belt anchor

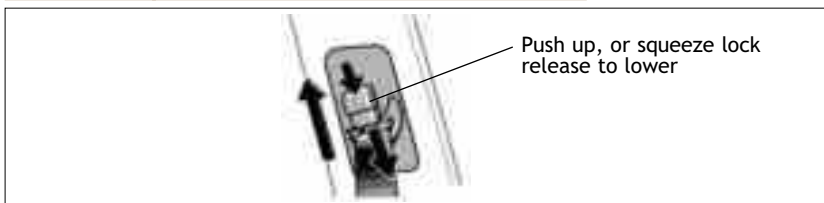

## Tire Pressure Monitoring (warning) System

If tire pressure indicator light is on, check/adjust each tire.

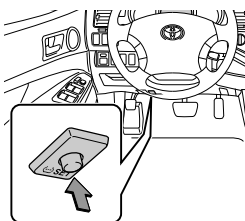

After adjusting tire pressures, or after tires have been rotated or replaced, turn the ignition switch to "ON" and press and hold the "SET" button until indicator blinks three times. Let the vehicle sit for a few minutes to allow initialization to complete.

Refer to the load label on the door jamb or the *Owner's Manual* for tire inflation specifications.

If the tire pressure indicator flashes for more than 60 seconds and then remains on, take the vehicle to your local Toyota dealer.

## Abbreviation/Acronym list

ABBREVIATIONS	MEANING
2WD	Two Wheel Drive
4WD	Four Wheel Drive
ABS	Anti-Lock Brake System
ACC	Accessory
ALR	Automatic Locking Retractor
A-TRAC	Active Traction Control
AUTO LSD	Automatic Limited Slip Differential
CRS	Child Restraint System
DAC	Downhill assist control
ECU	Electronic Control Unit
EDR	Event Data Recorder
ELR	Emergency Locking Retractor
GAWR	Gross Axle Weight Rating
GVWR	Gross Vehicle Weight Rating
I/M	Emission inspection and maintenance
INT	Intermittent
LED	Light Emitting Diode
LT	Light truck
M + S	Mud + Snow
MMT	Methylcy clopentadienyl Manganese Tricarbonyl
MTBE	Methyl Tertiary Butyl Ether
OBD	On Board Diagnostics
RES	Resume
RR DIFF LOCK	Rear differential lock
RSCA	Roll sensing of curtain shield airbag
SRS	Supplemental Restraint System
TIN	Tire Identification Number

ABBREVIATIONS	MEANING
TPMS	Tire Pressure Warning System
TRAC	Traction Control
TWI	Treadwear indicators
VIN	Vehicle Identification Number
VSC	Vehicle Stability Control

## For your information

### **Main Owners Manual**

Please note that this manual applies to all models explains and all equipment, including options. Therefore, you may find some explanations for equipment not installed on your vehicle.

All specifications provided in this manual are current at the time of printing. However, because of the Toyota policy of continual product improvement, we reserve the right to make changes at any time without notice.

Depending on specifications, the vehicle shown in the illustrations may differ from your vehicle in terms of equipment.

### **Accessories, spare parts and modification of your Toyota**

A wide variety of non-genuine spare parts and accessories for Toyota vehicles are currently available in the market. You should know that Toyota does not warrant these products and is not responsible for their performance, repair, or replacement, or for any damage they may cause to, or adverse effect they may have on, your Toyota vehicle.

This vehicle should not be modified with non-genuine Toyota products. Modification with non-genuine Toyota products could affect its performance, safety or durability, and may even violate governmental regulations. In addition, damage or performance problems resulting from the modification may not be covered under warranty.

### **Installation of a mobile two-way radio system**

As the installation of a mobile two-way radio system in your vehicle could affect electronic systems such as the multiport fuel injection system/sequential multiport fuel injection system, cruise control system, anti-lock brake system, SRS airbag system and seat belt pretensioner system, be sure to check with your Toyota dealer for precautionary measures or special instructions regarding installation.

## Scrapping your Toyota

The SRS airbag and seat belt pretensioner devices in your Toyota contain explosive chemicals. If the vehicle is scrapped with the airbags and seat belt pretensioners left as they are, this may cause an accident such as fire. Be sure to have the systems of the SRS airbag and seat belt pretensioner removed and disposed of by a qualified service shop or by your Toyota dealer before you scrap your vehicle.

## Perchlorate Material

Special handling may apply,  
See [www.dtsc.ca.gov/hazardouswaste/perchlorate](http://www.dtsc.ca.gov/hazardouswaste/perchlorate).

Your vehicle has components that may contain perchlorate. These components may include airbag, seat belt pretensioners, and wireless remote control batteries.

### CAUTION

#### **n General precautions while driving**

**Driving under the influence:** Never drive your vehicle when under the influence of alcohol or drugs that have impaired your ability to operate your vehicle. Alcohol and certain drugs delay reaction time, impair judgment and reduce coordination, which could lead to an accident that will hurt or kill you, your occupants or others.

**Defensive driving:** Always drive defensively. Anticipate mistakes that other drivers or pedestrians might make and be ready to avoid accidents.

**Driver distraction:** Always give your full attention to driving. Anything that distracts the driver, such as adjusting controls, talking on a cellular phone or reading can result in a collision with resulting death or serious injury to you, your occupants or others.



## CAUTION

### **n General precaution regarding children's safety**

Never leave children unattended in the vehicle, and never allow children to have or use the key.

Children may be able to start the vehicle or shift the vehicle into neutral. There is also a danger that children may injure themselves by playing with the cigarette lighter, the windows, or other features of the vehicle. In addition, heat build-up or extremely cold temperatures inside the vehicle can be fatal to children.

# Symbols used throughout this manual

## Cautions & Notices

### CAUTION

This is a warning against anything which may cause injury to people if the warning is ignored. You are informed about what you must or must not do in order to reduce the risk of injury to yourself and others.

### NOTICE

This is a warning against anything which may cause damage to the vehicle or its equipment if the warning is ignored. You are informed about what you must or must not do in order to avoid or reduce the risk of damage to your Toyota and its equipment.



## Safety symbol

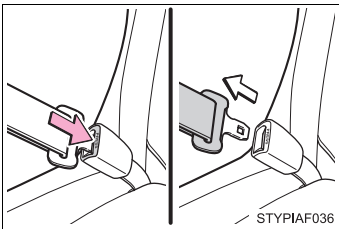

The symbol of a circle with a slash through it means “Do not”, “Do not do this”, or “Do not let this happen”.



### Arrows indicating operations

-  Indicates the action (pushing, turning, etc.) used to operate switches and other devices.
-  Indicates the outcome of an operation (e.g. a lid opens).





# TABLE OF CONTENTS

1	<b>Before driving</b>	Adjusting and operating features such as door locks, mirrors, and steering column.
2	<b>When driving</b>	Driving, stopping and safe-driving information.
3	<b>Interior and exterior features</b>	Air conditioning and audio systems, as well as other interior features for a comfortable driving experience.
4	<b>Maintenance and care</b>	Cleaning and protecting your vehicle, performing do-it-yourself maintenance, and maintenance information.
5	<b>When trouble arises</b>	What to do if the vehicle needs to be towed, gets a flat tire, or is involved in an accident.
6	<b>Vehicle specifications</b>	Detailed vehicle information.
7	<b>For owners</b>	Reporting safety defects for U.S. owners, seat belt instructions for Canadian owners and camper information.
	<b>Index</b>	Alphabetical listing of information contained in this manual.

► Regular Cab models

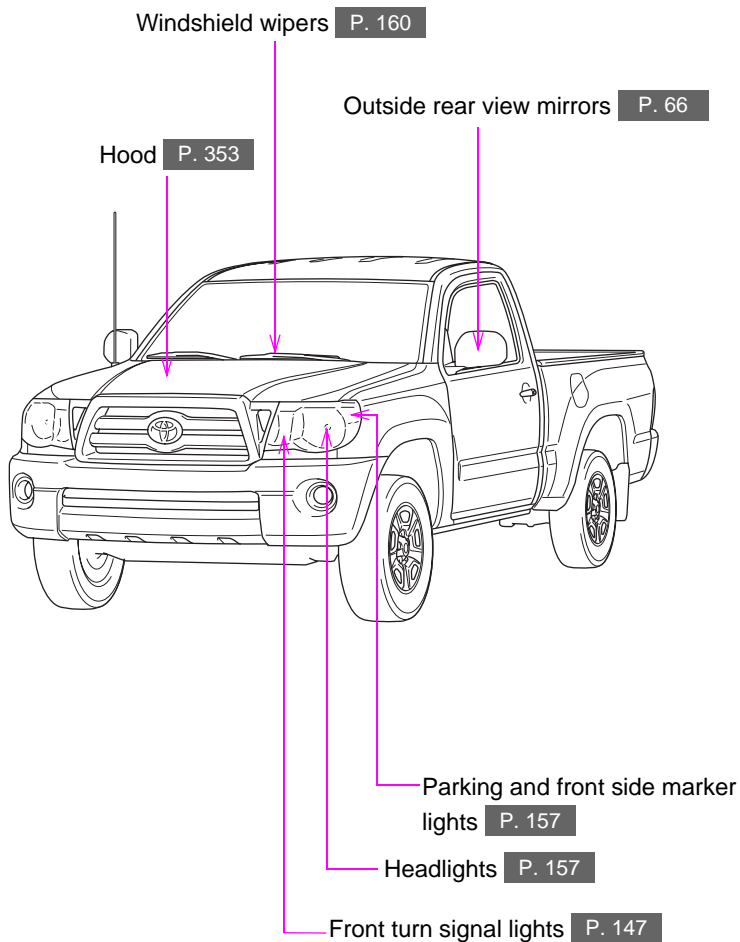

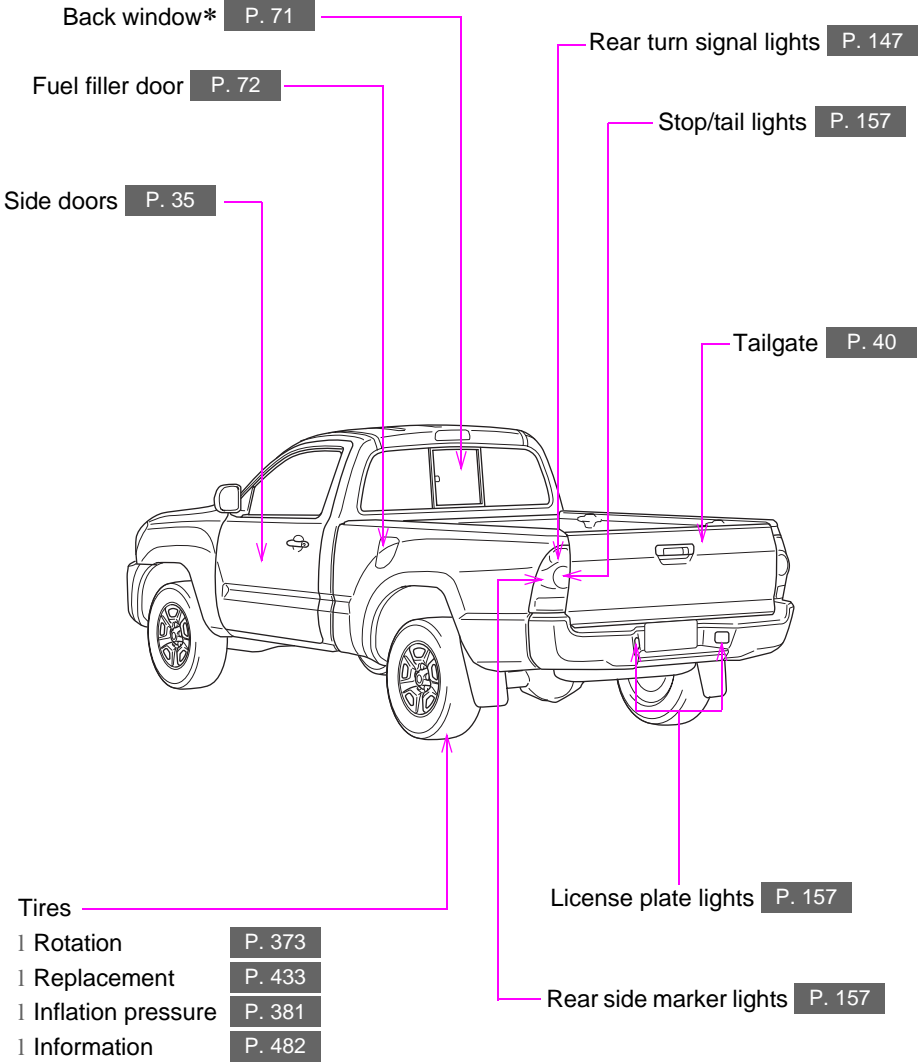

\*: If equipped

► Access Cab models

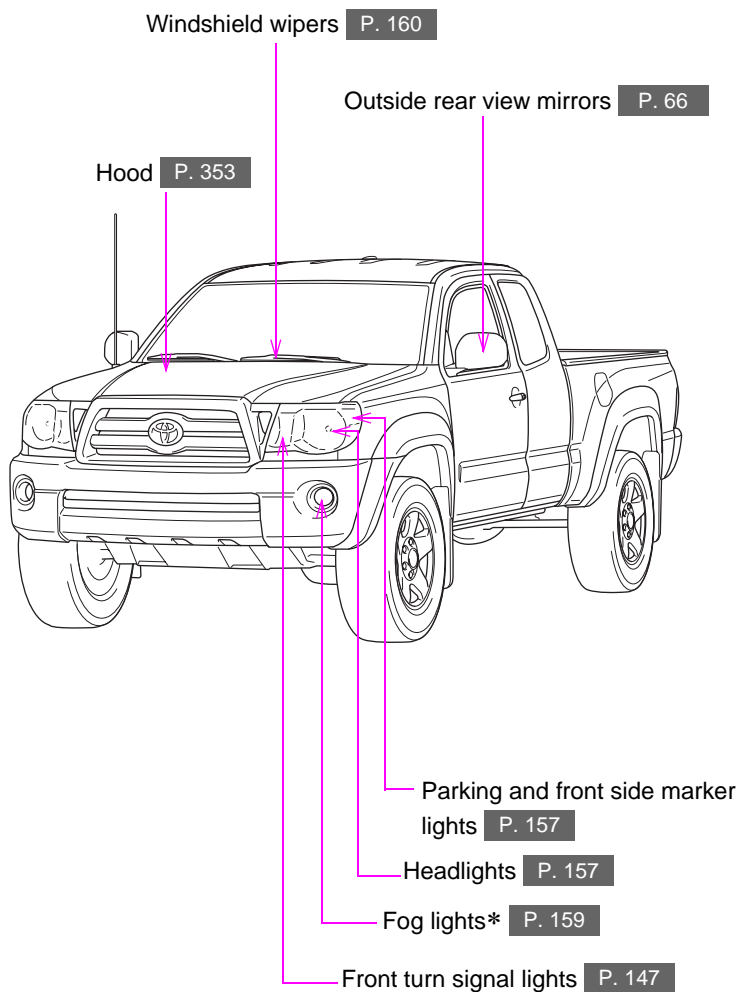

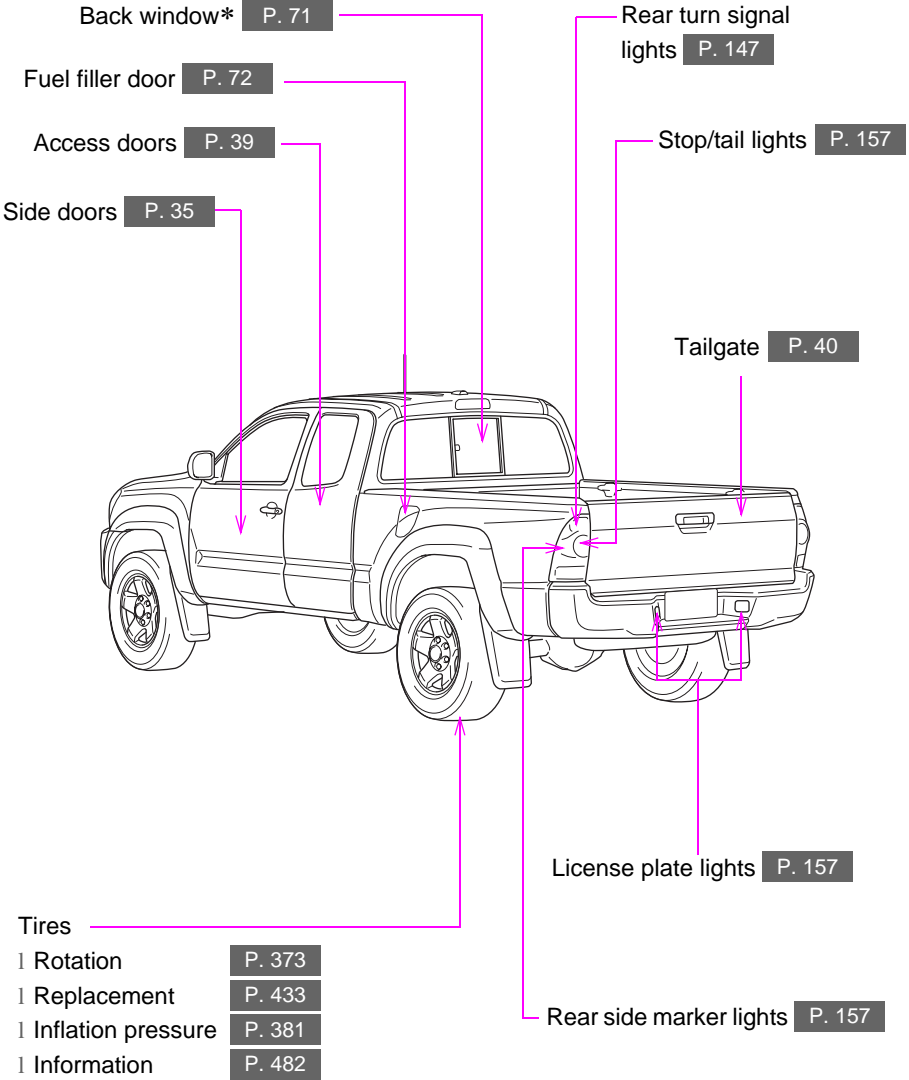

\*: If equipped

► Double Cab models

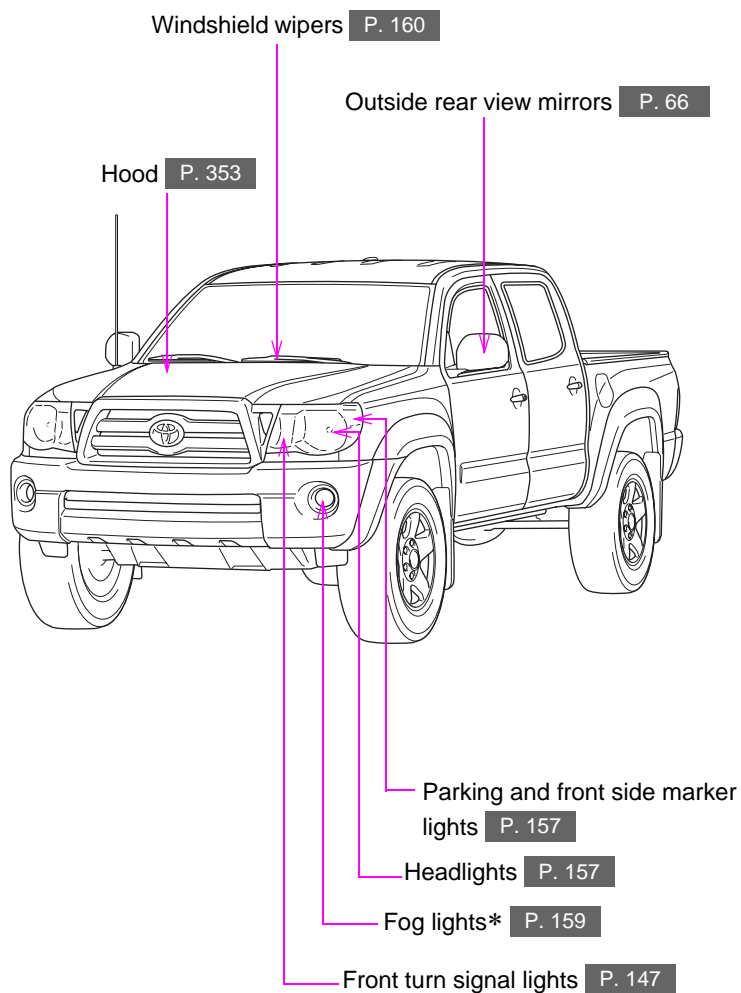

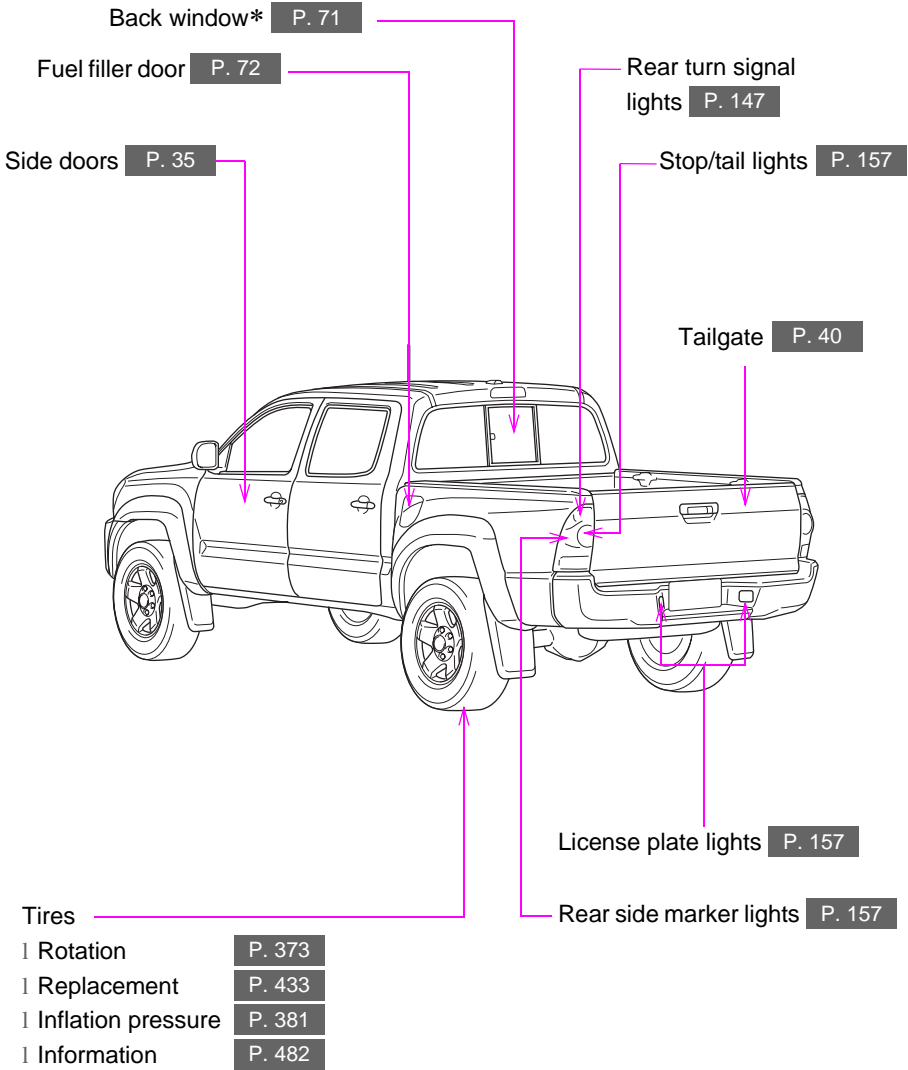

\*: If equipped



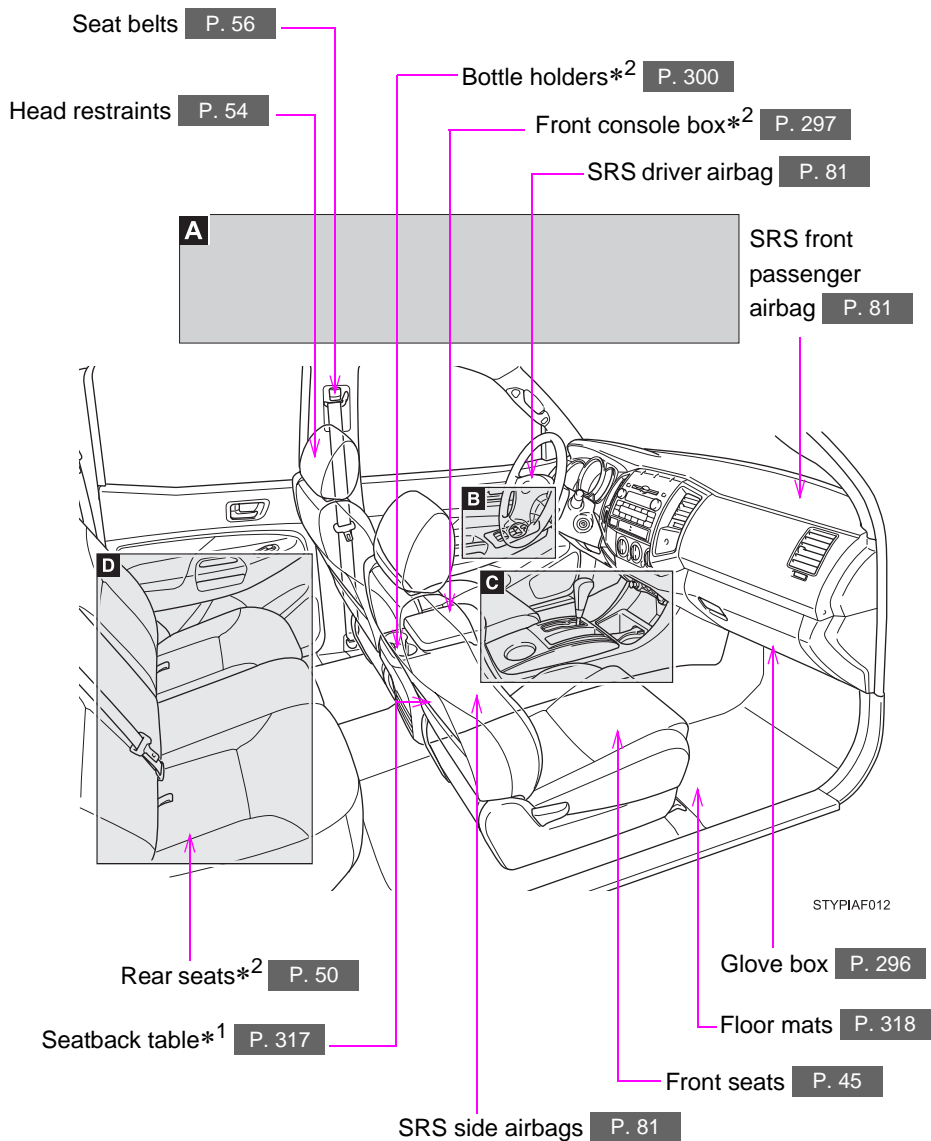

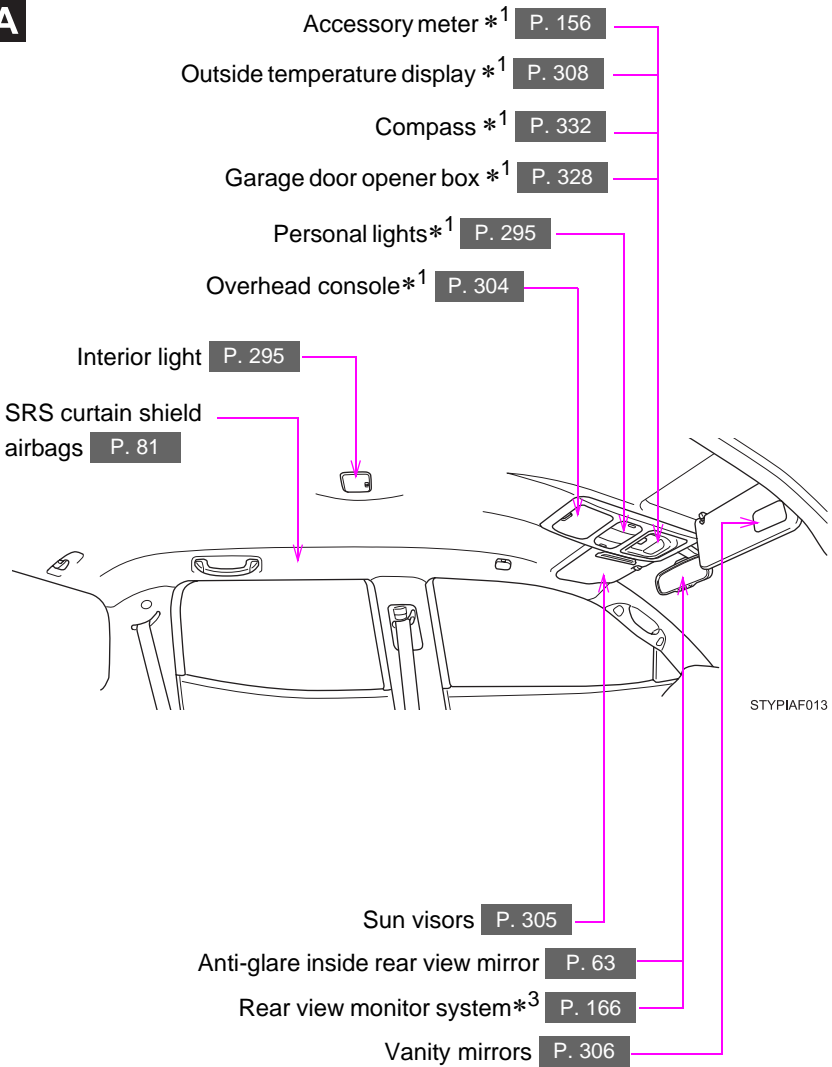
**A**

\*<sup>1</sup>: If equipped

\*<sup>2</sup>: Access Cab and Double Cab models

\*<sup>3</sup>: Vehicles with auto anti-glare inside rear view mirror

**B**

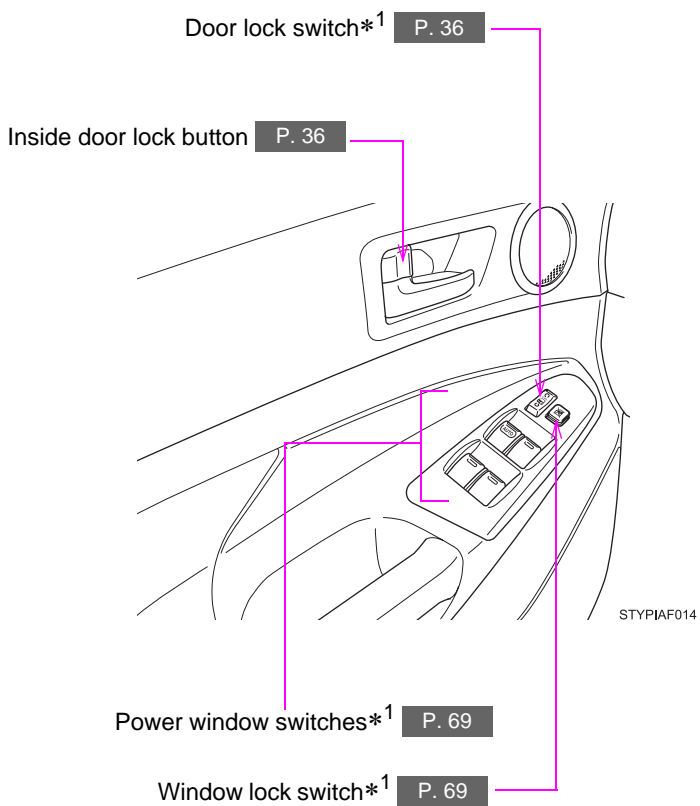

**C**

► **Bench type front seat**

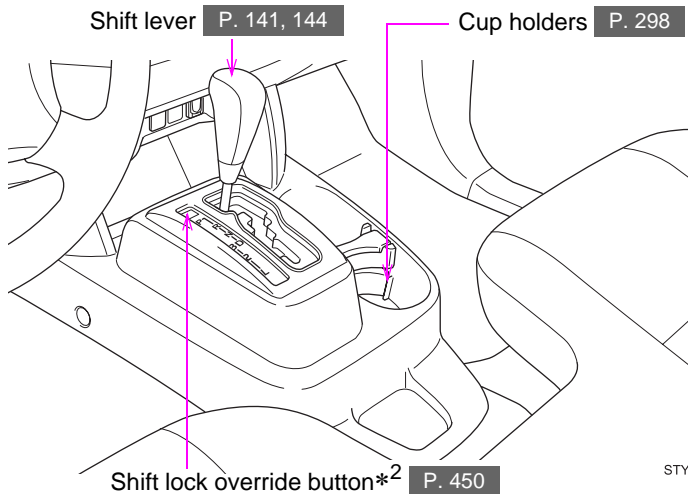

► **Separated type front seats with an automatic transmission**

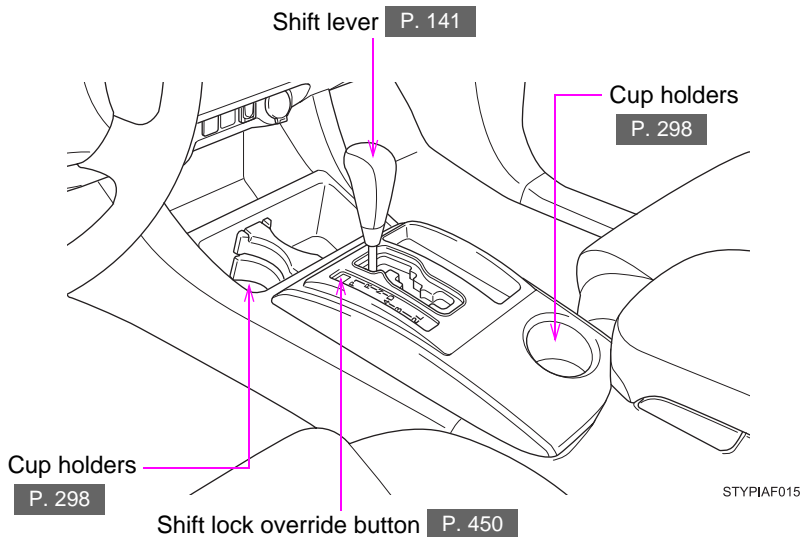

\*1: If equipped

\*2: Vehicles with an automatic transmission

**C**

► Separated type front seats with a manual transmission

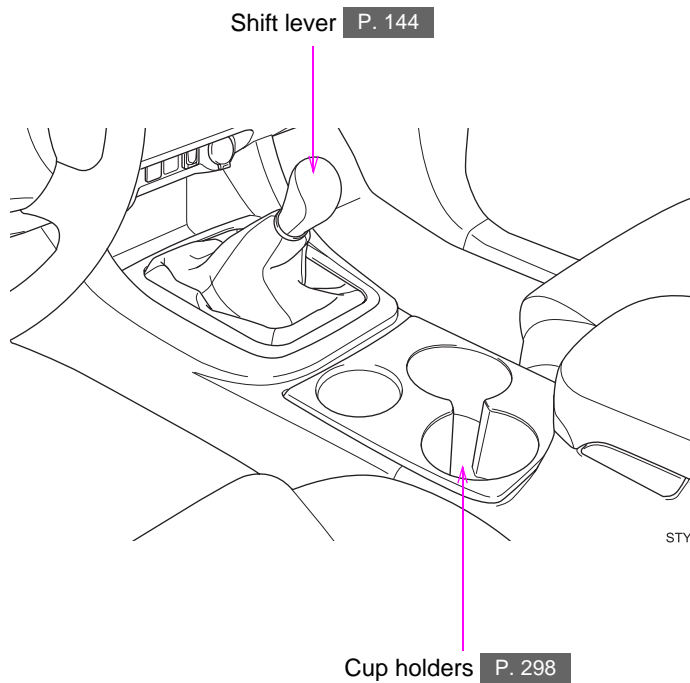

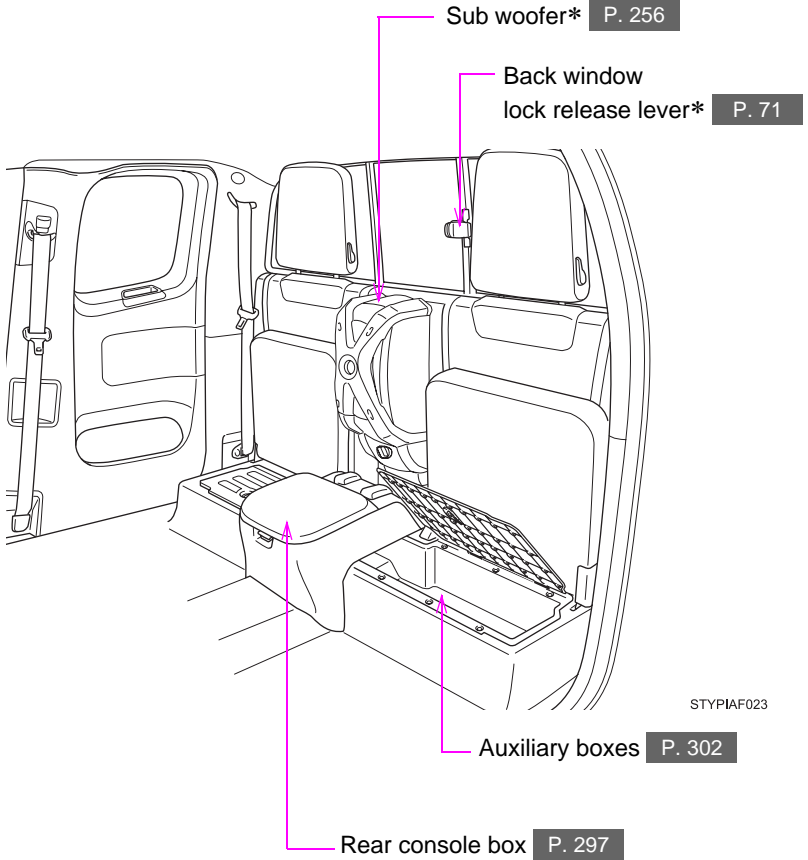
**D****► Access Cab models**

\*: If equipped

**D**

► Double Cab models

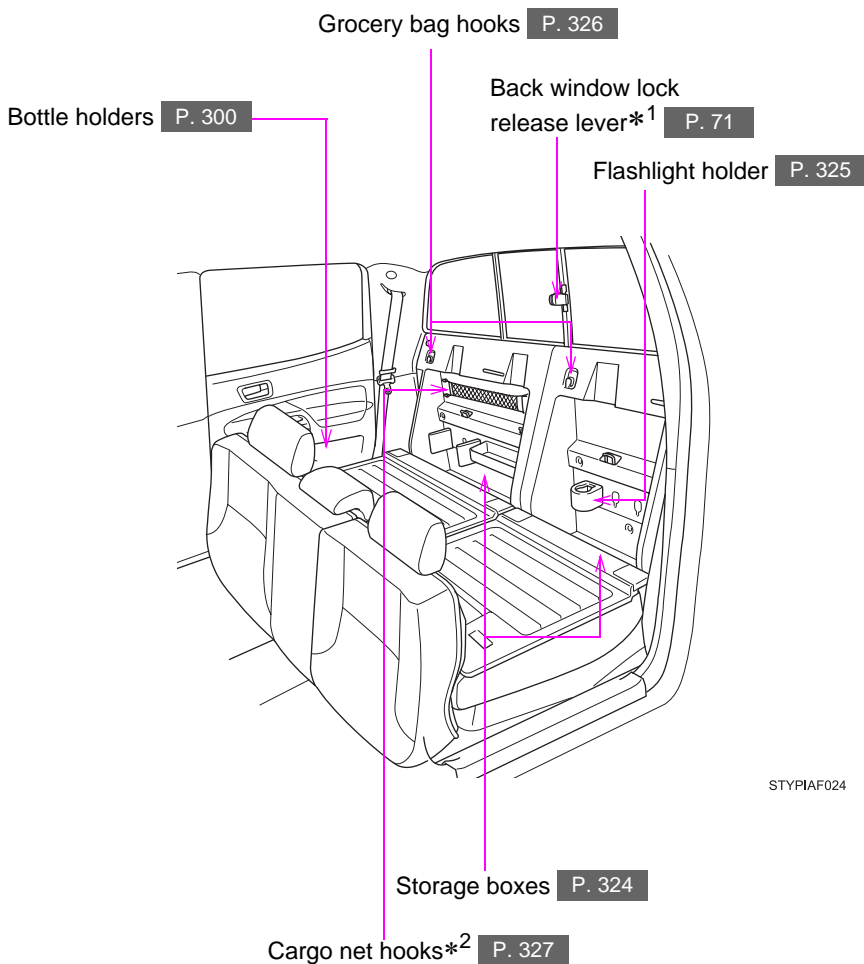

STYPIAF024

\*<sup>1</sup>: If equipped

\*<sup>2</sup>: Vehicles with sub woofer

Gauges and meters P. 150

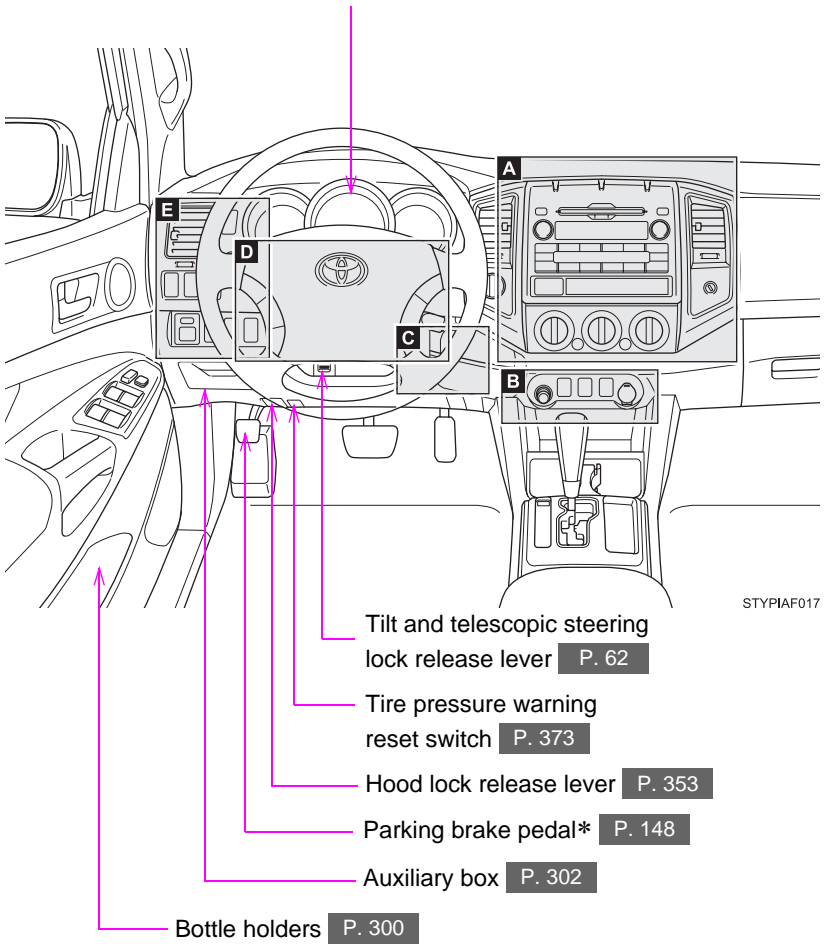

STYPIAF017

\*: Vehicles with an automatic transmission



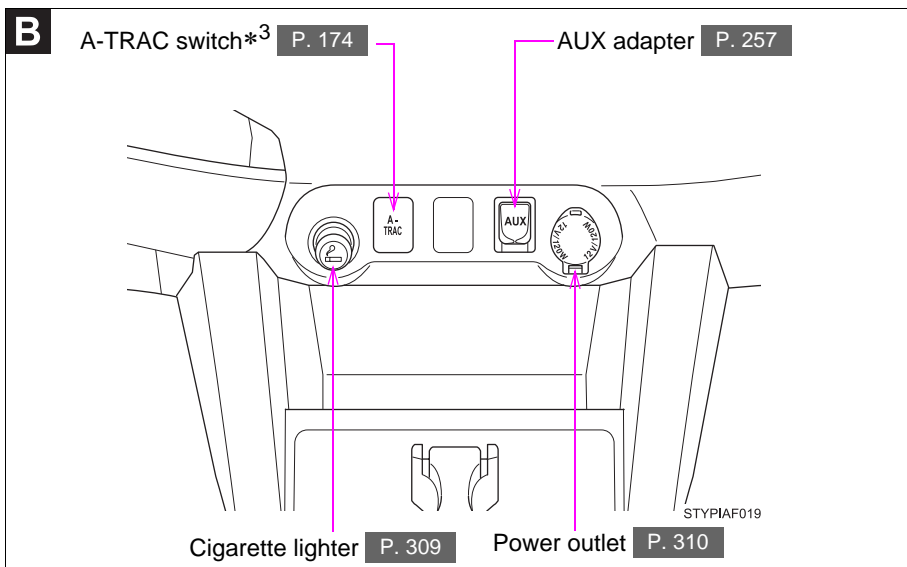
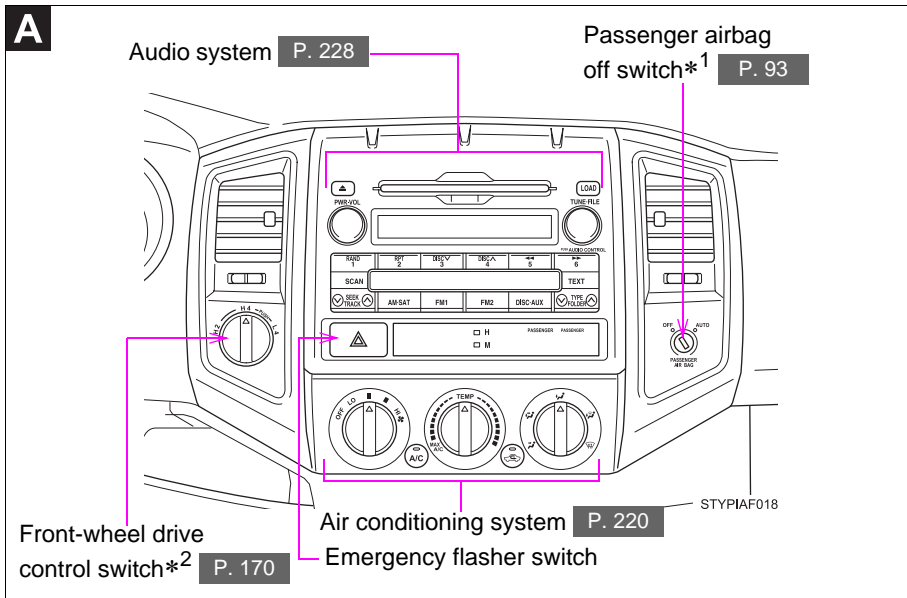

**C**

Windshield wipers and washer switch **P. 160**

Engine (ignition) switch **P. 138**

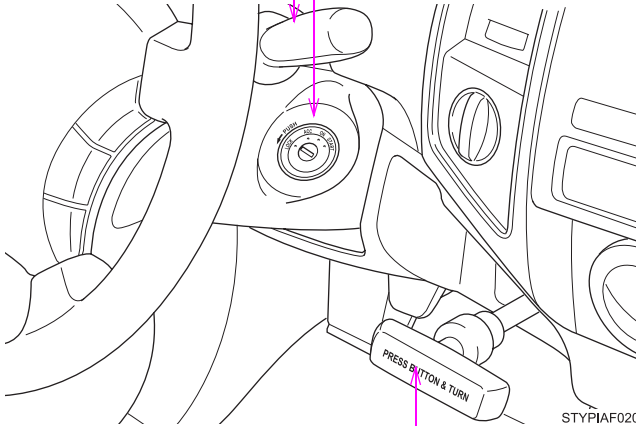

Parking brake lever\*<sup>4</sup> **P. 148**

**D**

Audio remote control switches\*<sup>3</sup> **P. 259**

Telephone switches\*<sup>3</sup> **P. 267**

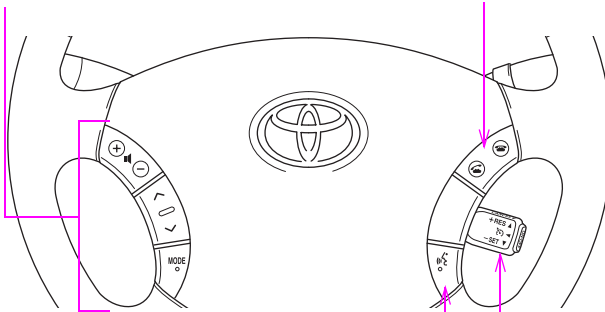

Talk switch\*<sup>3</sup> **P. 267**

Cruise control switch\*<sup>3</sup> **P. 163**

\*<sup>1</sup>: Access Cab models only

\*<sup>3</sup>: If equipped

\*<sup>2</sup>: 4WD models

\*<sup>4</sup>: Vehicles with a manual transmission

**E**

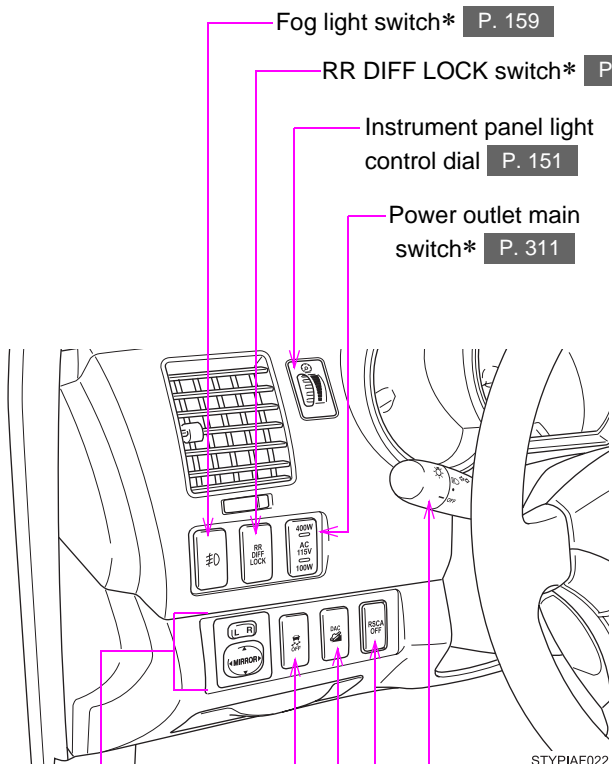

STYPIAF022

- Fog light switch\* P. 159
- RR DIFF LOCK switch\* P. 178
- Instrument panel light control dial P. 151
- Power outlet main switch\* P. 311
- Headlight switch P. 157
- Turn signal lever P. 147
- RSCA OFF switch P. 95
- CLUTCH START CANCEL switch\* P. 183
- DAC switch\* P. 181
- VSC OFF switch P. 176, 185
- Outside rear view mirror switches\* P. 66

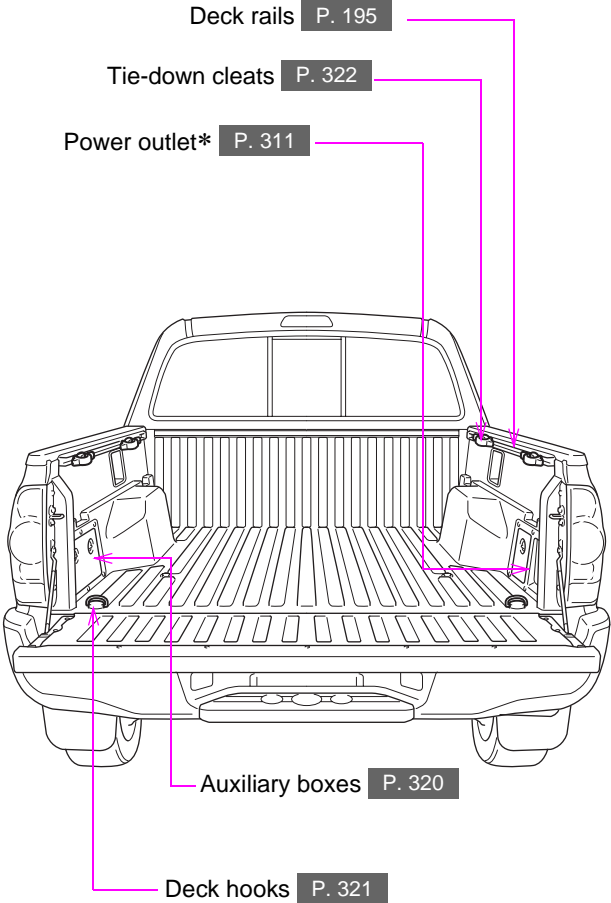

STYPIAF025

\*: If equipped

# Keys

The following keys are provided with the vehicle.

► Vehicles without engine immobilizer system

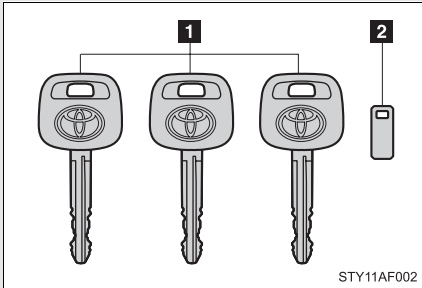

- 1 Master keys
- 2 Key number plate

► Vehicles with engine immobilizer system

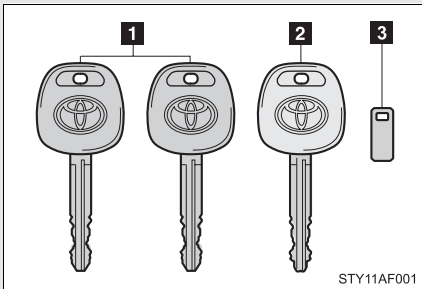

- 1 Master keys
- 2 Valet key
- 3 Key number plate

■ **Key number plate**

Keep the plate in a safe place such as your wallet, not in the vehicle. In the event that a key is lost, a new key can be made by your Toyota dealer using the key number plate. (→P. 451)

**NOTICE****n To prevent key damage (vehicles with engine immobilizer system)**

- l** Do not subject the keys to strong shocks, expose them to high temperatures by placing them in direct sunlight, or get them wet.
- l** Do not expose the keys to electromagnetic materials or attach any material that blocks electromagnetic waves to the key surface.

## 1-2. Opening, closing and locking the doors

### Wireless remote control (if equipped)

The wireless remote control can be used to lock and unlock the vehicle from outside the vehicle.

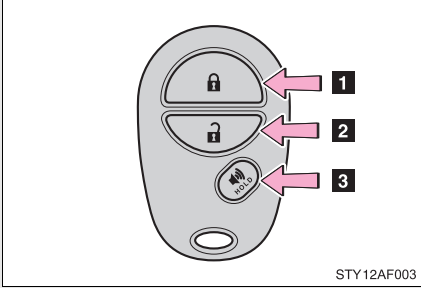

**1** Locks all doors

**2** Unlocks all doors

Pressing the button unlocks the driver's door. Pressing the button again within 3 seconds unlocks the other doors.

**3** Sounds alarm  
(push and hold)

#### ▮ Operation signals

A buzzer sounds and the emergency flashers flash to indicate that the doors have been locked/unlocked. (Locked: Once; Unlocked: Twice)

#### ▮ Panic mode

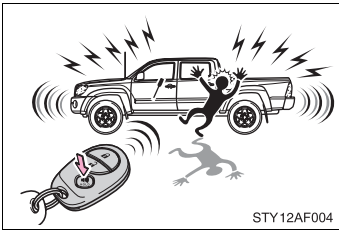

When  is pushed for longer than about one second, an alarm will sound for about 60 seconds and the vehicle lights will flash to deter any person from trying to break into or damage your vehicle.

To stop the alarm, push any button on the wireless remote control.

#### ▮ Door lock buzzer

If a door is not fully closed, a buzzer sounds for 10 seconds if an attempt to lock the door is made. Fully close the door to stop the buzzer, and lock the vehicle once more.

**n Wireless remote control depletion**

The standard battery life is 1 to 2 years. (The battery becomes depleted even if the key is not used.) If the wireless remote control function does not operate, the battery may be depleted. Replace the battery when necessary. (→P. 391)

**n If the wireless remote control does not operate**

Locking and unlocking the doors: Use the key. (→P. 35)

**n Security feature**

If a door is not opened within approximately 30 seconds after the vehicle is unlocked, the security feature automatically locks the vehicle again.

**n Conditions affecting operation**

The wireless remote control function may not operate normally in the following situations.

- l Near a TV tower, radio station, electric power plant, airport or other facility that generates strong radio waves
- l When carrying a portable radio, cellular phone or other wireless communication device
- l When multiple wireless keys are in the vicinity
- l When the wireless key has come into contact with, or is covered by a metallic object
- l When a wireless key (that emits radio waves) is being used nearby
- l When the wireless key has been left near an electrical appliance such as a personal computer

**n Customization that can be configured at Toyota dealer**

Settings (e.g. wireless remote control system) can be changed. (Customizable features →P. 493)



□ **Certification for wireless remote control**

**MODEL/FCC IDs:**

**Transmitter: GQ43VT20T**

**Receiver: GQ43VT29R**

**IC (Canada) IDs:**

**Transmitter: 1470A-1T**

**Receiver: 1470A-1R**

**MADE IN U.S.A.**

This complies with Part 15 of the FCC Rules. Operation is subject to the following two conditions:

(1) this device may not cause harmful interference, and (2) this device must accept any interference received, including interference that may cause undesired operation.

## 1-2. Opening, closing and locking the doors

### Side doors

The vehicle can be locked/unlocked using the wireless remote control, key or door lock switch.

#### n Wireless remote control (if equipped)

→P. 32

#### n Key

##### ► Regular Cab models

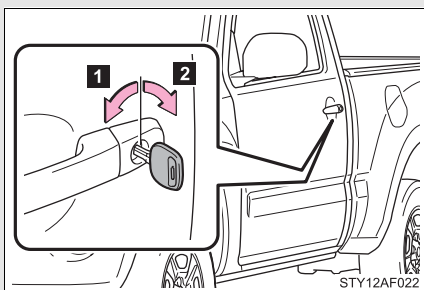

**1** Locks the door

**2** Unlocks the door

##### ► Access Cab and Double Cab models

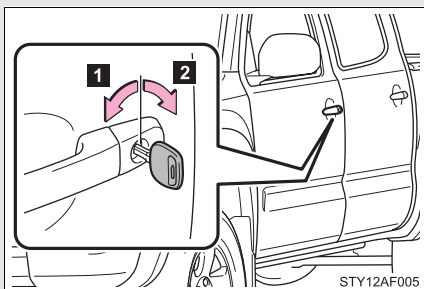

**1** Locks all doors

**2** Unlocks all doors

Turning the key a single time in the driver's door unlocks the driver's door, and turning the key again unlocks the other doors.

**n Door lock switch (if equipped)**

► **Driver's door lock switch**

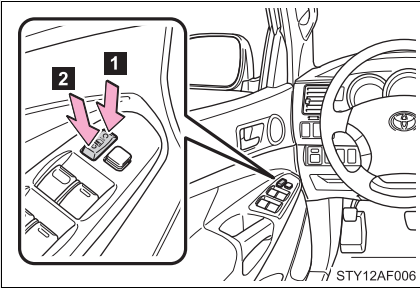

- 1** Locks all doors
- 2** Unlocks all doors

► **Passenger's door lock switch**

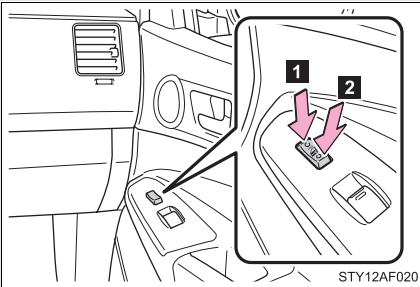

- 1** Locks all doors
- 2** Unlocks all doors

**n Inside door lock button**

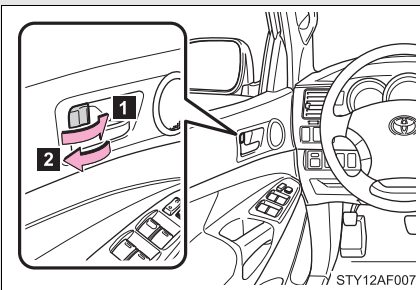

- 1** Locks the door
- 2** Unlocks the door

Pulling the inside handle can open the front door even if the inside door lock button is in the lock position.

### Locking the front doors from the outside without a key

**STEP 1** Move the inside door lock button to the lock position.

**STEP 2** Close the door.

► Vehicles with power door lock system

The door cannot be locked if a front door is open and the key is in the engine switch.

### Rear door child-protector lock (Double Cab models only)

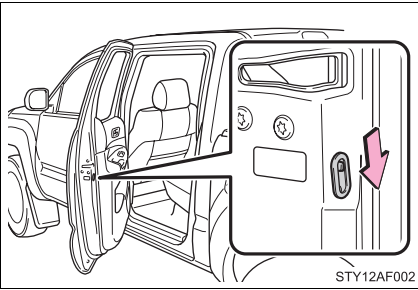

The door cannot be opened from inside the vehicle when the locks are set.

These locks can be set to prevent children from opening the rear doors. Push down on each rear door switch to lock both rear doors.

#### n Key reminder buzzer

A buzzer sounds if the driver's door is opened, while the engine switch is in the ACC or LOCK position to remind you to remove the key.

 CAUTION

**n To prevent an accident**

Observe the following precautions while driving the vehicle.

Failing to do so may result in a door opening and an occupant falling out, resulting in death or serious injury.

- | Always use a seat belt.
- | Always lock all doors.
- | Ensure that all doors are properly closed.
- | Do not pull the inside handle while driving.
- | Set the rear door child protector locks when children are seated in the rear seat.

## Access doors (Access Cab models only)

The access door (rear door) can be opened using the inside handle.

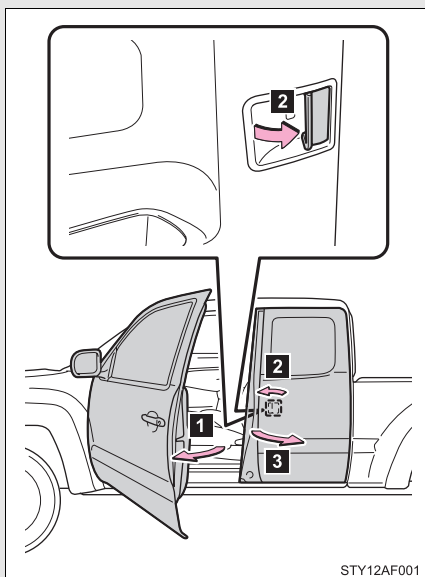

- 1 Open the front door widely
- 2 Pull (from the outside) or push (from the inside) the inside handle of the access door.
- 3 Open the access door

You can open and close the access door only when the front door is widely opened.

1

Before driving

### NOTICE

#### **n When opening or closing the front door and access door**

The front door and access door could be damaged if they hit each other when being opened or closed.

## Tailgate

The tailgate can be opened.

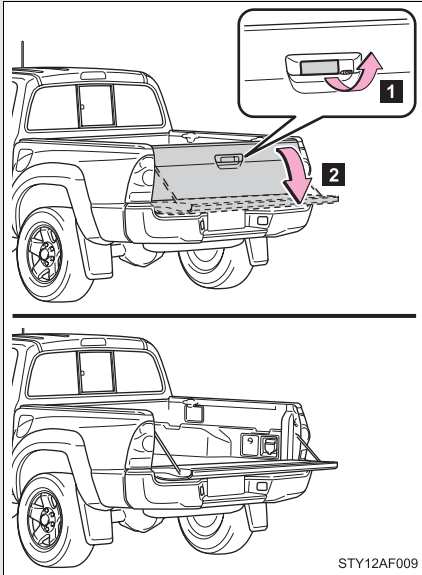

- 1** Pull the handle
- 2** Open the tailgate slowly

The support cables will hold the tailgate horizontal.

After closing the tailgate, try pulling it toward you to make sure it is securely locked.

### Removing the tailgate

#### n Before removing the tailgate

These connector covers are used when removing the tailgate, to prevent the back-up camera wire harness connectors from being contaminated.

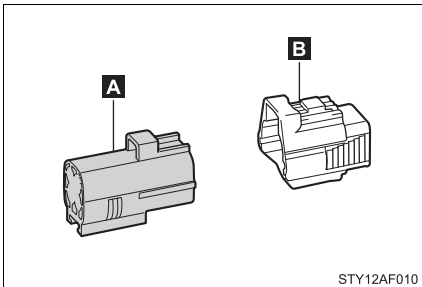

- A** Connector cover (Gray)
- B** Connector cover (White)

Store the connector covers in the glove box in a plastic bag when not using.

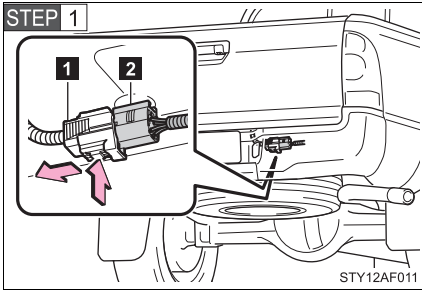

To disconnect the wire harness connectors (1 and 2), press and hold the lock of the tailgate wire harness connector (White) and pull apart.

- 1 Tailgate wire harness connector (White)
- 2 Frame wire harness connector (Gray)

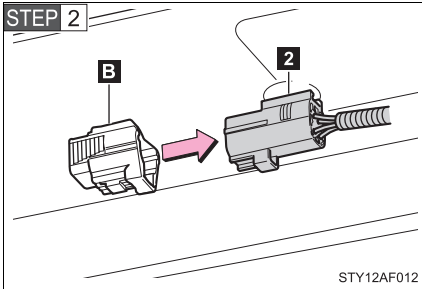

Attach the connector cover (white) to the frame wire harness connector (Gray).

- B Connector cover (White)
- 2 Frame wire harness connector (Gray)

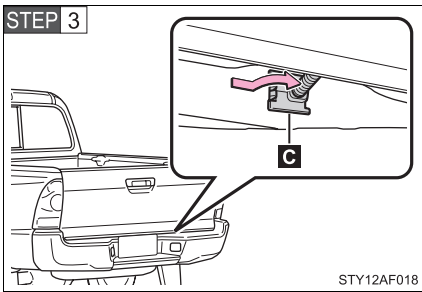

Pull out the plastic wire protector located in the vehicle bed by pressing the tabs and pulling the protector.

Be careful not to pull out all of the tailgate wire harness. Failure to do so may result in damage to vehicle components.

- C Plastic wire protector

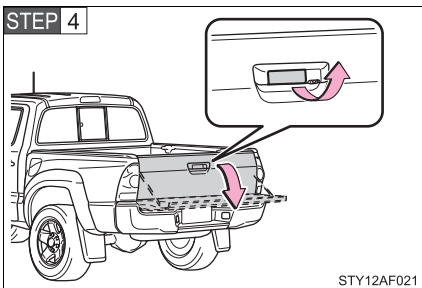

Open the tailgate.



## 1-2. Opening, closing and locking the doors

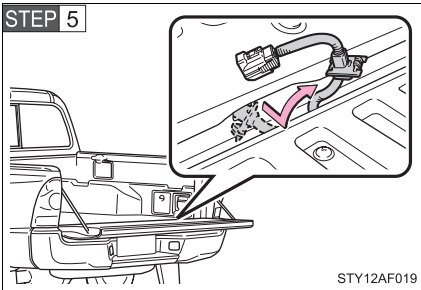

Pull out the wire harness from the vehicle bed.

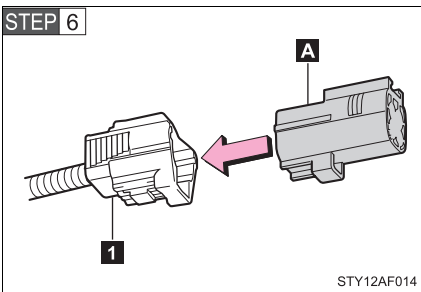

Attach the connector cover (Gray) to the tailgate wire harness connector (White).

**1** Tailgate wire harness connector (White)

**A** Connector cover (Gray)

### n Removing the tailgate

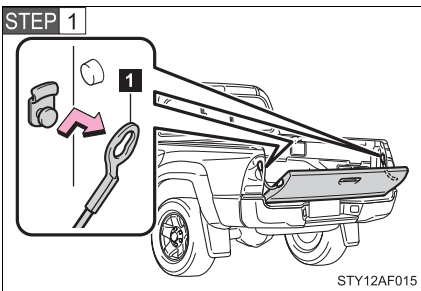

Open the tailgate to the angle where you can release the brackets on the support cables from the lugs on both sides.

Lift the support cable bracket up and slide it off.

**1** Support cable bracket

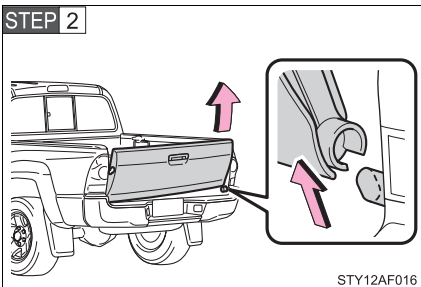

Tilt the tailgate to about 30° from vertical and pull up the right side of the tailgate to unhook the right side.

**STEP 3**

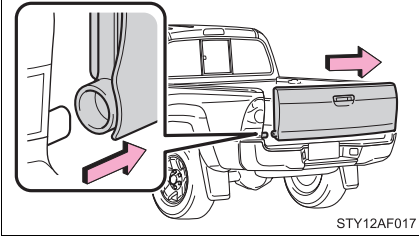

Slide the tailgate a little to the right to unhook the left side.

To attach the tailgate, follow the removal procedure in reverse order.

1

Before driving

**Rear step bumper**

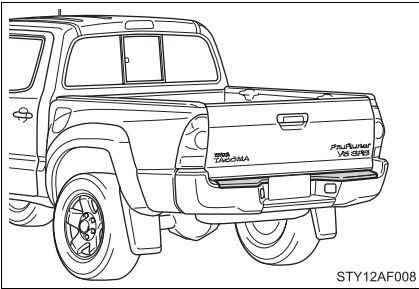

For rear end protection and easier step-up loading.

To get on the rear step bumper, use the shaded area in the illustration.

**⚠ CAUTION**

**n Before removing the tailgate**

Disconnect the wire harness between the back-up camera and the vehicle. Failure to do so may result in serious personal injury or damage to the vehicle components.

**n Caution while driving**

Observe the following precautions. Failure to do so may result in death or serious personal injury.

- I** Do not drive with the tailgate open.
- I** Do not get on the rear step bumper.



**NOTICE**

**n To prevent damage to the tailgate wire harness**

Do not pull out all of the tailgate wire harness before open the tailgate.

**n To prevent damage to the camera lens (vehicles with rear view monitor system)**

Store the removed tailgate with the back-up camera lens facing upward.

**n After closing the tailgate**

Try pulling it toward you to make sure it is securely locked.

**n To prevent damage to the rear step bumper**

Do not allow more than one person to get on the rear step bumper at a time.

# 1-3. Adjustable components (seats, mirrors, steering wheel)

## Front seats

### ► Bench type seat

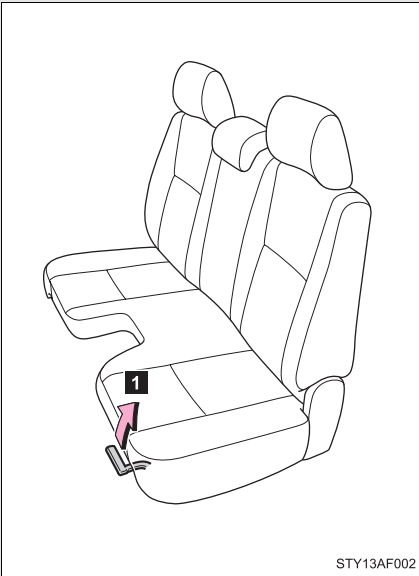

- 1** Seat position adjustment lever

### ► Separated type seats

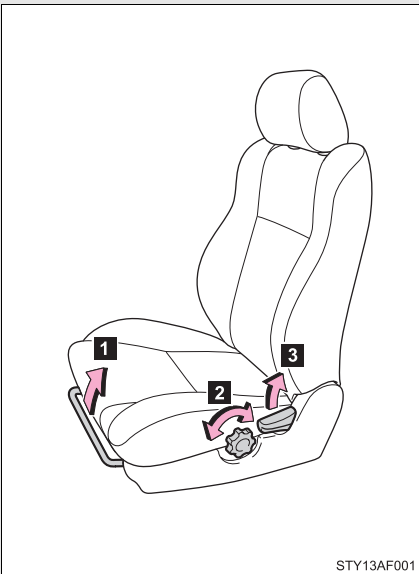

- 1** Seat position adjustment lever
- 2** Driver's seat lumbar support adjustment knob (if equipped)
- 3** Seatback angle adjustment lever

### Moving passenger's seat for rear seat entry (if equipped)

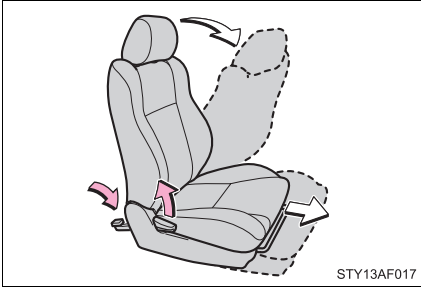

Lift the seatback angle adjusting lever or press the pedal behind the seatback. The seat will slide forward.

Move the seat to the front-most position.

**n After passengers are in the vehicle**

Lift the seatback and return the seat until it locks.

### Folding seatback (Bench type seat)

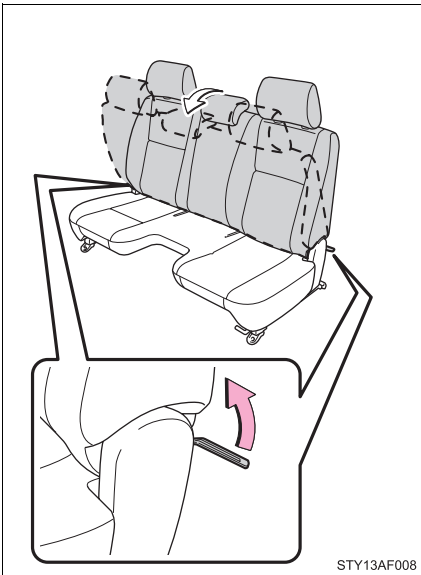

Pull the seatback lock release lever and fold down the seatback.

Hold the lever until you have swung the seatback forward slightly.

### Folding passenger's seat (vehicles with seatback table)

STEP 1

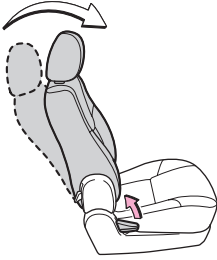

STY35AF001

Pull the seatback angle adjusting lever and raise the seatback to its upright position.

STEP 2

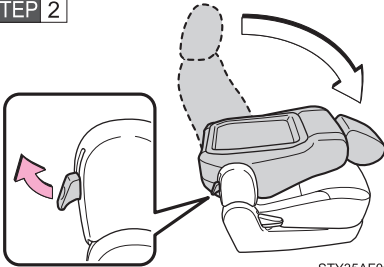

STY35AF002

Pull the seatback folding lever and fold the seatback down.

1

Before driving

**Active head restraints (Access Cab and Double Cab models only)**

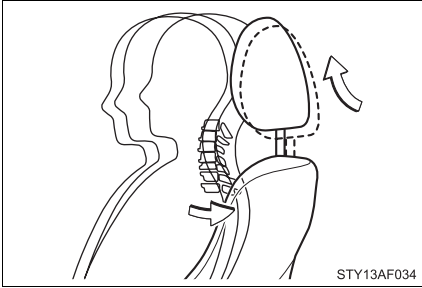

When the occupant's back presses against the seatback during a rear-end collision, the head restraint moves slightly forward to help reduce the risk of whiplash on the seat occupant.

**Active head restraints**

Even small forces applied to the seatback may cause the head restraint to move. Pushing up a locked head restraint forcibly may show the head restraint inner structure. These do not indicate problems.

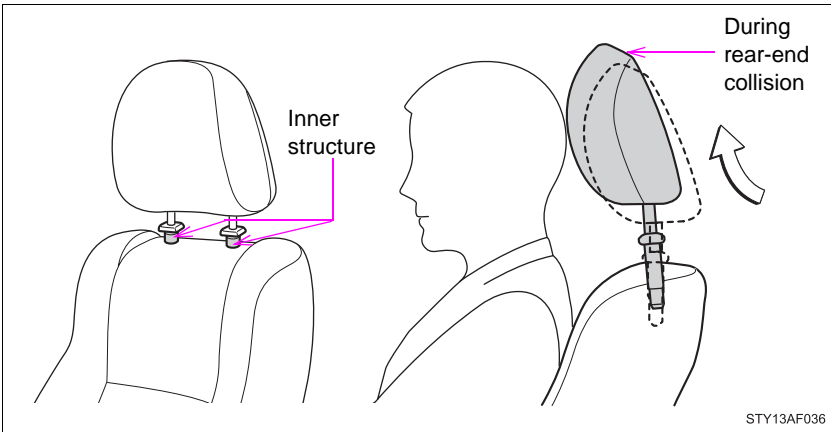

 CAUTION

**n Seat adjustment**

- I** Be careful that the seat does not hit passengers or luggage.
- I** Do not recline the seat more than necessary when the vehicle is in motion to reduce the risk of sliding under the lap belt.  
If the seat is too reclined, the lap belt may slide past the hips and apply restraint forces directly to the abdomen or your neck may contact the shoulder belt, increasing the risk of death or serious injury in the event of an accident.
- I** After adjusting the seat, make sure that the seat is locked in position.

**n After returning the seatback to the upright position**

Observe the following precautions. Failure to do so may result in death or serious injury.

- I** Make sure the seatback is securely locked.
- I** Check that the seat belts are not twisted or caught in the seatback.
- I** Arrange the seat belts in the proper positions for ready use.

**n Caution while driving**

- I** Vehicles with seatback table: Do not sit on or place anything on the folded seatback.
- I** Access Cab models only: Do not rest your foot on the press pedal behind the passenger seat.



# 1-3. Adjustable components (seats, mirrors, steering wheel) Rear seats (Access Cab and Double Cab models)

## ► Access Cab models

The bottom cushion of the rear seats can be raised and lowered.

### n Before raising the bottom cushion

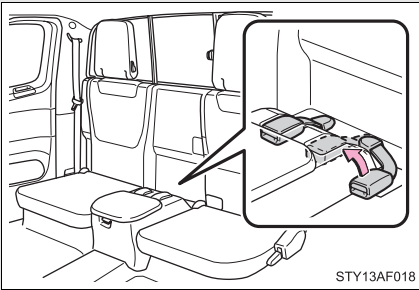

Stow the seat belt buckles.

This prevents the seat belt buckles from falling out when you fold the seatback.

### n Raising the bottom cushion

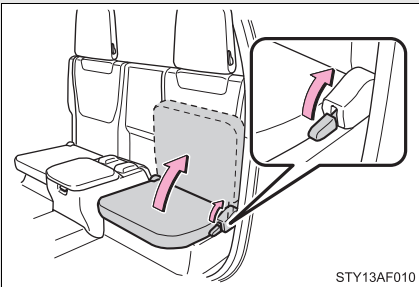

Raise the bottom cushion up while pulling the lever until it locks.

### n Lowering the bottom cushion

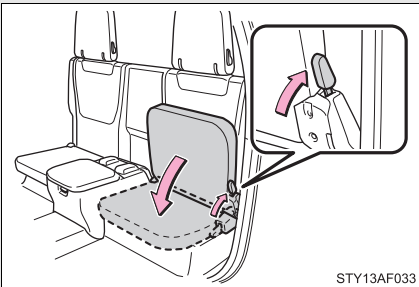

Push the bottom cushion down while pulling the lever until the bottom cushion locks into the seat position.

► Double Cab models

The seatback of the rear seat can be folded.

n **Before folding rear seats**

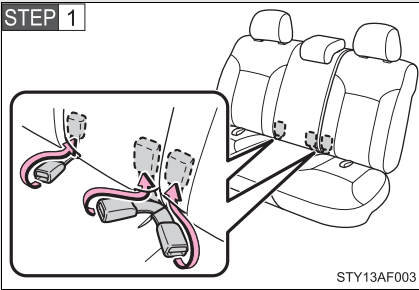

Stow the rear seat belt buckles.

This prevents the seat belt buckles from falling out when you fold the seatback.

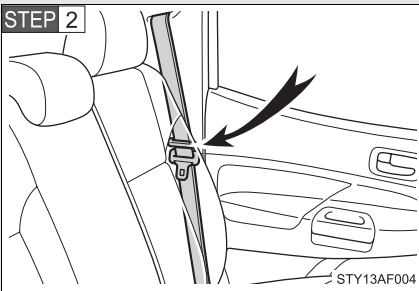

Pass the seat belts through the seat belt hangers.

This prevents the shoulder belt from being damaged.

Make sure that the seat belts are removed from the hangers before using them.

n **Folding rear seats**

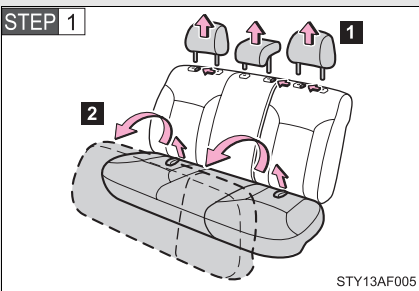

**1** Remove the head restraint

**2** Swing the bottom cushion up by pulling the lock release strap

**STEP 2**

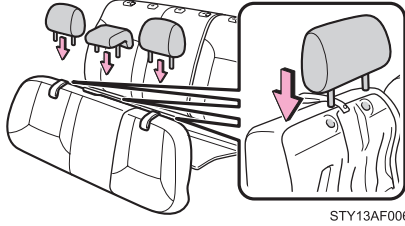

Attach the head restraints to the holders located on the back sides of the bottom cushions.

**STEP 3**

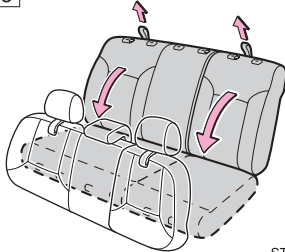

Fold down the seatback by pulling the lock release strap.

**! CAUTION**

**n When the seatback is folded/the bottom cushion is raised**

Do not sit on or place anything on the seatback or auxiliary box while driving.

**n When returning the seats to their original position**

Observe the following precautions. Failure to do so may result in death or serious injury.

- I** Be careful not to get your hands or feet pinched in the seat.
- I** Make sure the seatbacks and bottom cushions are securely locked. Failure to do so will prevent the seat belt from operating properly.
- I** Check that the seat belts are not twisted or caught under the seat.
- I** Arrange the seat belts in the proper positions for ready use.



**NOTICE**

**n Before folding the seats**

The seat belts buckles must be stowed.

# 1-3. Adjustable components (seats, mirrors, steering wheel)

## Head restraints

### n Adjusting the head restraints

#### ► Bench type front seat

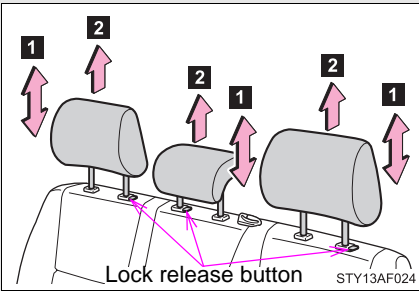

#### 1 Vertical adjustment

Push and hold the lock release button when lowering the head restraint.

#### 2 Removal

Pull the head restraint up while pushing the lock release button.

#### ► Separated type front seat

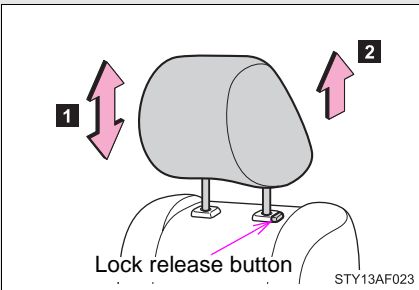

#### 1 Vertical adjustment

Push and hold the lock release button when lowering the head restraint.

#### 2 Removal

Pull the head restraint up while pushing the lock release button.

#### ► Rear seat (Double Cab models only)

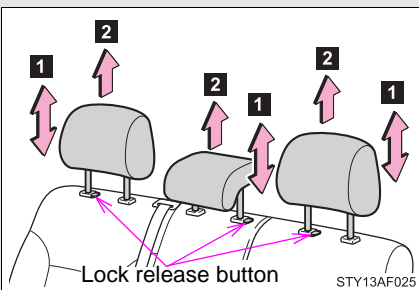

#### 1 Vertical adjustment

Push and hold the lock release button when lowering the head restraint.

#### 2 Removal

Pull the head restraint up while pushing the lock release button.

**n When using the rear head restraints (Access Cab models only)**

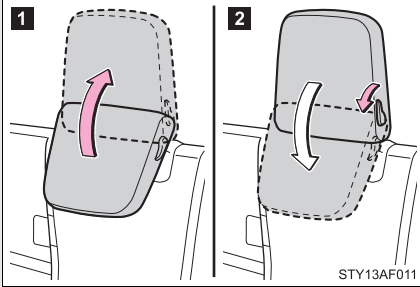

**1 To use**

Lift up the head restraint until it locks.

**2 To fold**

Pull the head restraint lock release lever to fold the head restraint.

**n Adjusting the height of the head restraints**

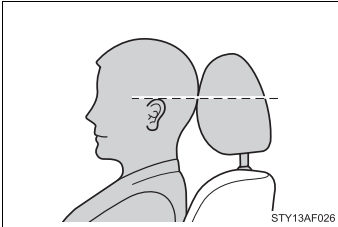

Make sure that the head restraints are adjusted so that the center of the head restraint is closest to the top of your ears.

**n Adjusting the front center seat (Regular Cab models) and rear center seat head restraints (Double Cab models)**

Always raise the head restraint one level from the stowed position when using.

**⚠ CAUTION**

**n Head restraint precautions**

Observe the following precautions regarding the head restraints. Failure to do so may result in death or serious injury.

- I** Use the head restraints designed for each respective seat.
- I** Adjust the head restraints to the correct position at all times.
- I** Do not drive with the head restraints removed.

## Seat belts

**Make sure that all occupants are wearing their seat belts before driving the vehicle.**

### n Correct use of the seat belts

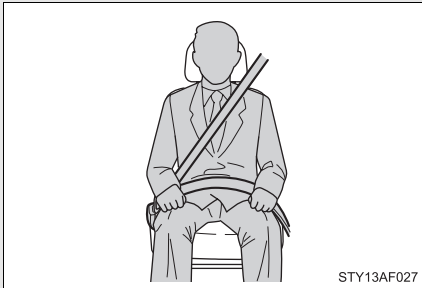

- 1 Extend the shoulder belt so that it comes fully over the shoulder, but does not come into contact with the neck or slide off the shoulder.
- 1 Position the lap belt as low as possible over the hips.
- 1 Adjust the position of the seatback. Sit up straight and well back in the seat.
- 1 Do not twist the seat belt.

### n Fastening and releasing the seat belt

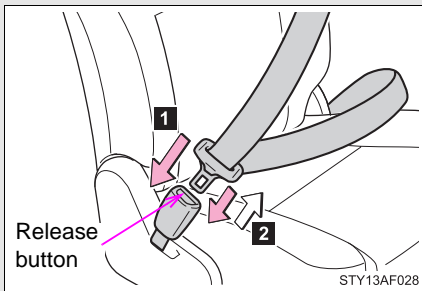

#### 1 Fastening the belt

Push the tab into the buckle until a clicking sound is heard.

#### 2 Releasing the belt

Press the release button.

### n Adjusting the height of the belt (front seats)

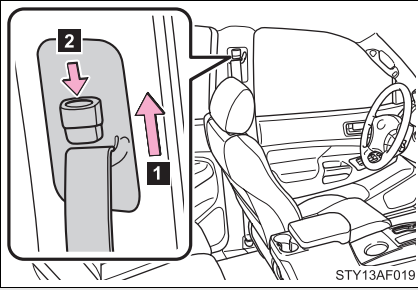

#### 1 Up

Move the height adjuster up as needed until you hear a click.

#### 2 Down

Push the lock release button and slide the height adjuster down.

### n Center seat belt of the bench seat (Regular Cab models only)

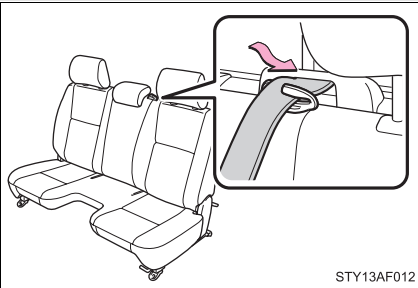

Make sure the shoulder belt pass through the guide when using the center seat belt.

### Seat belt pretensioners (front seats)

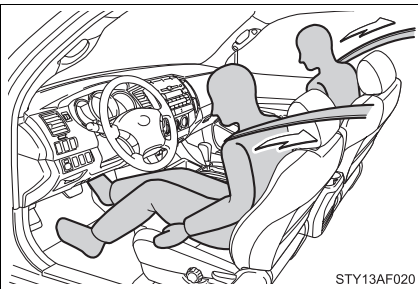

The pretensioner helps the seat belt to quickly restrain the occupant by retracting the seat belt when the vehicle is subjected to certain types of severe frontal collision or a vehicle rollover.

The pretensioner may not activate in the event of a minor frontal impact, a side impact or a rear impact.



▫ **Emergency locking retractor (ELR)**

The retractor will lock the belt during a sudden stop or on impact. It may also lock if you lean forward too quickly. A slow, easy motion will allow the belt to extend so that you can move around fully.

▫ **Automatic locking retractor (ALR)**

When a passenger's shoulder belt is completely extended and then retracted even slightly, the belt is locked in that position and cannot be extended. This feature is used to hold the child restraint system (CRS) firmly. To free the belt again, fully retract the belt and then pull the belt out once more. (→P. 104)

▫ **Pregnant women**

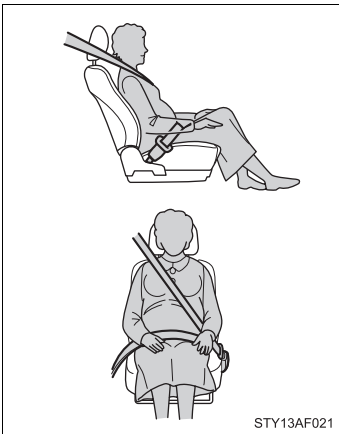

Obtain medical advice and wear the seat belt in the proper way. (→P. 56)

Women who are pregnant should position the lap belt as low as possible over the hips in the same manner as other occupants. Extend the shoulder belt completely over the shoulder and position the belt across the chest. Avoid belt contact over the rounding of the abdominal area.

If the seat belt is not worn properly, not only a pregnant woman, but also the fetus could suffer death or serious injury as a result of sudden braking or a collision.

▫ **People suffering illness**

Obtain medical advice and wear the seat belt in the proper way.

▫ **Child seat belt usage**

The seat belts of your vehicle were principally designed for persons of adult size.

1 Use a child restraint system appropriate for the child, until the child become large enough to properly wear the vehicle's seat belt. (→P. 104)

1 When the child becomes large enough to properly wear the vehicle's seat belt, follow the instructions on P. 56 regarding seat belt usage.

### n Replacing the belt after the pretensioner has been activated

If the vehicle is involved in multiple collisions, the pretensioner will activate for the first collision, but will not activate for the second or subsequent collisions.

### n Seat belt extender

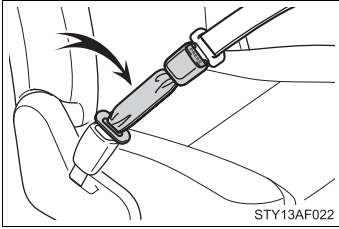

If your seat belts cannot be fastened securely because they are not long enough, a personalized seat belt extender is available from your Toyota dealer free of charge.

## ⚠ CAUTION

Observe the following precautions to reduce the risk of injury in the event of sudden braking or an accident.

Failing to do so may cause death or severe injury.

### n Wearing a seat belt

- l Ensure that all passengers wear a seat belt.
- l Always wear a seat belt properly.
- l Each seat belt should be used by one person only. Do not use a seat belt for more than one person at once, including children.
- l Toyota recommends that children be seated in the rear seat and always use a seat belt and/or an appropriate child restraint system.
- l Do not recline the seat any more than necessary to achieve a proper seating position. The seat belt is most effective when the occupants are sitting up straight and well back in the seats.
- l Do not wear the shoulder belt under your arm.
- l Always wear your seat belt low and snug across your hips.

 **CAUTION**

**n Seat belt pretensioners**

- I** Do not place anything, such as a cushion, on the front passenger's seat. Doing so will disperse the passenger's weight, which prevents the sensor from detecting the passenger's weight properly. As a result, the seat belt pretensioner for the front passenger's seat may not activate in the event of a collision.
- I** If the pretensioner has activated, the seat belt becomes locked: it cannot be further extended, nor will it return to the stowed position. The seat belt cannot be used again and must be replaced at your Toyota dealer.

**n Seat belt damage and wear**

- I** Do not damage the seat belts by allowing the belt, plate, or buckle to be jammed in the door.
- I** Inspect the seat belt system periodically. Check for cuts, fraying, and loose parts. Do not use a damaged seat belt until it is replaced. Damaged seat belts cannot protect an occupant from death or serious injury.
- I** Ensure that the belt and tab are locked and the belt is not twisted. If the seat belt does not function correctly, immediately contact your Toyota dealer.
- I** Replace the seat assembly, including the belts, if your vehicle has been involved in a serious accident, even if there is no obvious damage.
- I** Do not attempt to install, remove, modify, disassemble or dispose of the seat belts. Have any necessary repairs carried out by your Toyota dealer. Inappropriate handling of the pretensioner may prevent it from operating properly resulting in death or serious injury.

**n Using a seat belt extender**

- I** Do not wear the seat belt extender, if you can fasten the seat belt without the extender.
- I** Do not use the seat belt extender when installing a child restraint system, because the belt will not securely hold the child restraint system, increasing the risk of death or serious injury in the event of a collision.
- I** The personalized extender may not be safe on another vehicle, when used by another person, or at a different seating position other than the one originally intended.



## NOTICE

### **n When using a seat belt extender**

When releasing the seat belt, press on the buckle release button on the extender, not on the seat belt.

This helps prevent damage to the vehicle interior and the extender itself.

## 1-3. Adjustable components (seats, mirrors, steering wheel)

### Steering wheel

The steering wheel can be adjusted to a comfortable position.

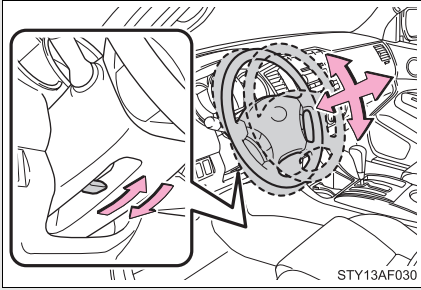

**STEP 1** Hold the steering wheel and press the lever down.

**STEP 2** Adjust to the ideal position by moving the steering wheel horizontally and vertically.

**STEP 3** Pull the lever up.

#### **! CAUTION**

##### **n Caution while driving**

Do not adjust the steering wheel while driving.

Doing so may cause the driver to mishandle the vehicle and an accident may occur resulting in death or serious injury.

##### **n After adjusting the steering wheel**

Make sure that the steering wheel is securely locked.

Otherwise, the steering wheel may move suddenly, possibly causing an accident and resulting in death or serious injury.

## Anti-glare inside rear view mirror

Glare from the headlights of vehicles behind can be reduced by using the following functions.

► Manual anti-glare inside rear view mirror

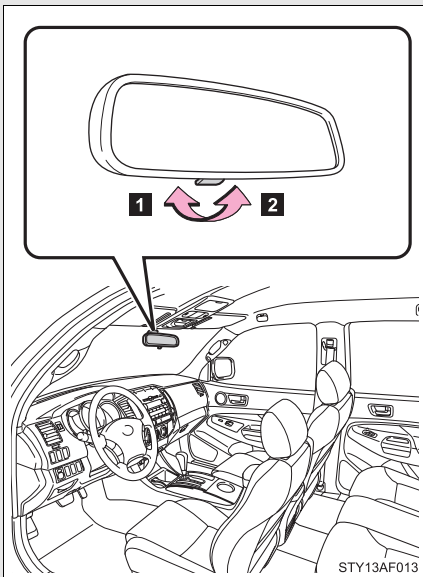

**1** Normal position

**2** Anti-glare position

► Auto anti-glare inside rear view mirror

In automatic mode, sensors are used to detect the headlights of vehicles behind and automatically reduces the reflected light.

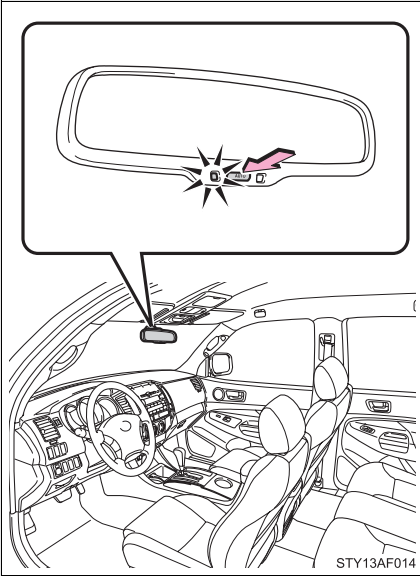

Turns automatic mode ON/OFF

The indicator comes on when automatic mode is turned on.

The mirror will revert to the automatic mode each time the engine switch is turned on.

n To prevent sensor error (vehicles with auto anti-glare inside rear view mirror)

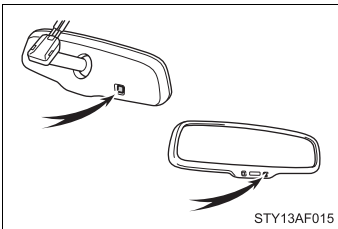

To ensure that the sensors operate properly, do not touch or cover them.

 CAUTION

**n Caution while driving**

Do not adjust the position of the mirror while driving.

Doing so may lead to mishandling of the vehicle and an accident, resulting in death or serious injury.



# 1-3. Adjustable components (seats, mirrors, steering wheel)

## Outside rear view mirrors

**Mirror angle can be adjusted.**

► Power-adjustable type

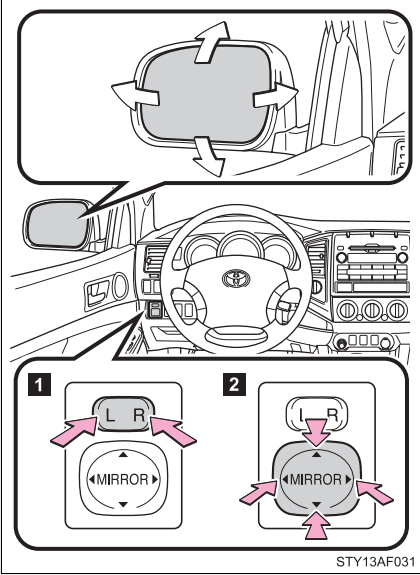

**1** Select a mirror to adjust.

(L: left or R: right)

**2** Adjust the mirror up, down, in or out using the switch.

► Manually adjustable type

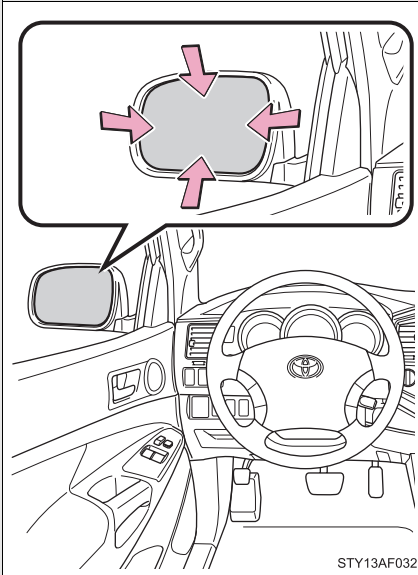

Adjust the mirror up, down, in or out by pushing the mirror surface.

**Folding back the mirrors**

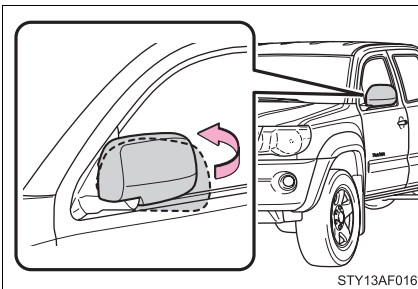

Push backward to fold the mirrors.

■ **Mirror operating conditions (vehicles with power-adjustable type only)**

The engine switch is in the ACC or ON position.

 CAUTION

**n When driving the vehicle**

Observe the following precautions while driving.

Failing to do so may result in loss of control of the vehicle and cause an accident, resulting in death or serious injury.

- I** Do not adjust the mirrors while driving.
- I** Do not drive with the mirrors folded back.
- I** Both the driver and passenger side mirrors must be extended and properly adjusted before driving.

 NOTICE

**n If ice should jam the mirror**

Do not operate the control or scrape the mirror face. Use a spray de-icer to free the mirror.

# 1-4. Opening and closing the windows

## Power windows (if equipped)

The power windows can be opened/closed using the following switches.

### ▶ Driver's power window switches

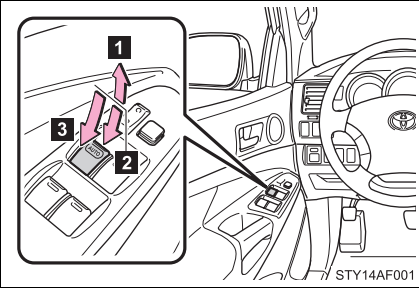

- 1 Closing
- 2 Opening
- 3 One-touch opening (driver's window only)\*

\*:Pressing the switch in the opposite direction will stop window travel partway.

### ▶ Front and rear passenger's power window switch

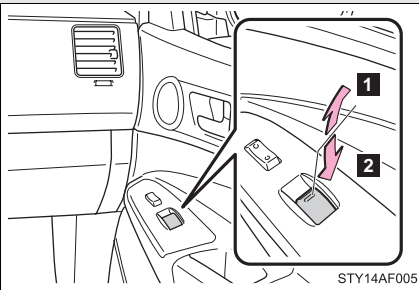

- 1 Closing
- 2 Opening

## Lock switch

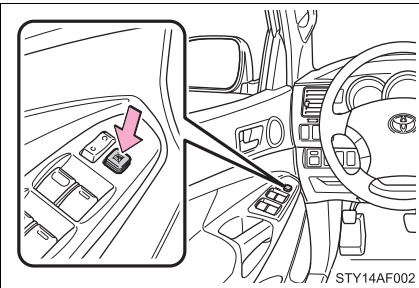

Press the switch down to lock passenger window switches.

Use this switch to prevent children from accidentally opening or closing a passenger window.

**n The power windows can be operated when**

The engine switch is in the ON position.

**n Operating the power windows after turning the engine switch off**

The power windows can be operated for approximately 43 seconds even after the engine switch is turned off. They cannot, however, be operated once either front door is opened.

**⚠ CAUTION**

**n Closing the windows**

Observe the following precautions.

Failing to do so may result in death or serious injury.

**I** Check to make sure that all passengers do not have any part of their body in a position where it could be caught when a window is being operated.

**I** Do not allow children to operate the power windows.

Closing a power window on someone can cause serious injury, and in some instances, even death.

## 1-4. Opening and closing the windows

### Back window (vehicles with sliding type)

The back window can be opened and closed using the lock release lever.

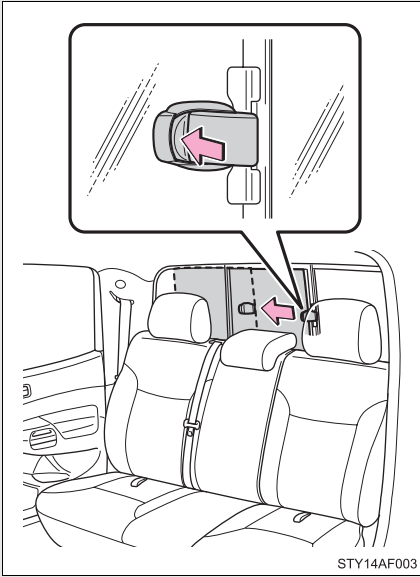

#### OPEN/CLOSE

Push the lock release lever and slide the back window.

1

Before driving

#### n Closing the back window

Make sure that the back window is securely closed after closing it.

#### CAUTION

#### n While driving

Keep the back window closed.

This not only keeps personal belongings from being thrown out, but also prevents exhaust gases from entering the vehicle.

## Opening the fuel tank cap

Perform the following steps to open the fuel tank cap.

n **Before refueling the vehicle**

Turn the engine switch off and ensure that all the doors and windows are closed.

n **Opening the fuel tank cap**

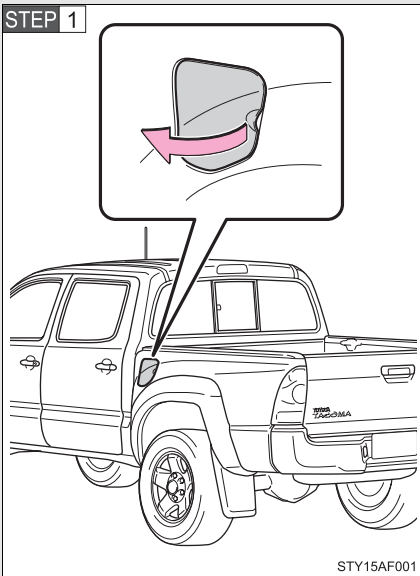

Open the fuel filler door.

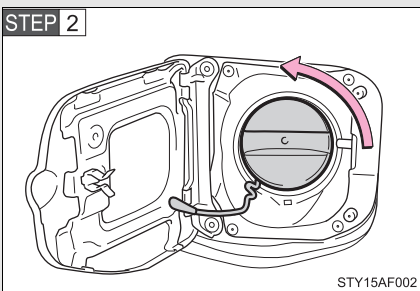

Turn the fuel tank cap slowly to open.

## Closing the fuel tank cap

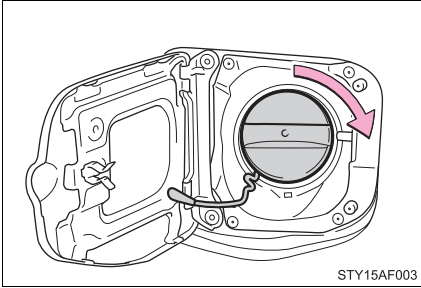

When replacing the fuel tank cap, turn it until a clicking sound is heard.

After releasing your hand, the cap will turn slightly to the opposite direction.

1

Before driving

### n Fuel types

Use unleaded gasoline. (87 Octane Rating [Research Octane Number 91] or higher)

### n Fuel tank capacity

Approximately 21.1 gal. (80.0 L, 17.6 Imp. gal.)



 CAUTION

**n Refueling the vehicle**

Observe the following precautions while refueling the vehicle. Failure to do so, may result in death or serious injury.

- I** Touch the vehicle or some other metal surface to discharge any static electricity.  
Sparks resulting from discharging static electricity may cause the fuel vapors to ignite.
- I** Always hold the grips on the fuel tank cap and turn it slowly to remove it. A whooshing sound may be heard when the fuel tank cap is loosened. Wait until the sound cannot be heard before fully removing the cap. In hot weather, pressurized fuel may spray out of the filler neck and cause injury.
- I** Do not allow anyone that has not discharged static electricity from their bodies to come close to an open fuel tank.
- I** Do not inhale vaporized fuel.  
Fuel contains substances that are harmful if inhaled.
- I** Do not smoke while refueling the vehicle.  
Doing so may cause the fuel to ignite and cause a fire.
- I** Do not return to the vehicle or touch any person or object that is statically charged.  
This may cause static electricity to build up, resulting in a possible engine hazard.

**n When replacing the fuel tank cap**

Do not use anything but a genuine Toyota fuel tank cap designed for your vehicle. Doing so may cause a fire or other incident which may result in death or serious injury.

**NOTICE****n Refueling**

Do not spill fuel during refueling.

Doing so may damage the vehicle, such as causing the exhaust systems to operate abnormally or damaging fuel system components or the vehicle's painted surface.

**n To prevent damage to the fuel filler door**

Do not apply excessive force.

## 1-6. Theft deterrent system

### Engine immobilizer system (if equipped)

The vehicle's keys have built-in transponder chips that prevent the engine from starting if the key has not been previously registered in the vehicle's on-board computer.

**Never leave the keys inside the vehicle when you leave the vehicle.**

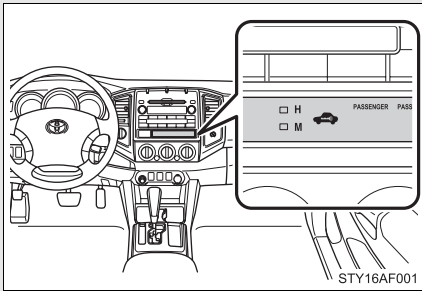

The indicator light flashes after the key has been removed from the engine switch to indicate that the system is operating.

#### ▫ **System maintenance**

The vehicle has a maintenance-free type of engine immobilizer system.

#### ▫ **Conditions that may cause the system to malfunction**

- If the key is in contact with a metallic object
- If the key is in close proximity to or touching a key to the security system (key with a built-in transponder chip) of another vehicle

#### ▫ **Certifications for the engine immobilizer system**

▶ For vehicles sold in U.S.A.

FCC ID: MOZRI-21BTY

This device complies with Part 15 of the FCC Rules. Operation is subject to the following two conditions: (1) this device may not cause harmful interference, and (2) this device must accept any interference received, including interference that may cause undesired operation.

**FCC WARNING:**

Changes or modifications not expressly approved by the party responsible for compliance could void the user's authority to operate the equipment.

► For vehicles sold in Canada

This device complies with RSS-210 of Industry Canada. Operation is subject to the following two conditions: (1) this device may not cause interference, and (2) this device must accept any interference, including interference that may cause undesired operation of the device.



## NOTICE

**n To prevent damage to the key**

Do not modify, remove or disable the engine immobilizer system. If any unauthorized changes or modifications are made, the proper operation of the system cannot be guaranteed.

## 1-6. Theft deterrent system

### Theft prevention labels (U.S.A.)

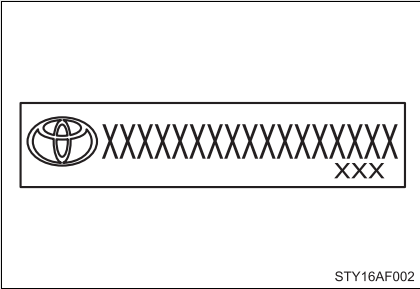

These labels are attached to the vehicle to reduce vehicle theft by facilitating the tracing and recovery of parts from stolen vehicles. Do not remove under penalty of law.

## 1-7. Safety information

### Correct driving posture

Drive in a good posture as follows:

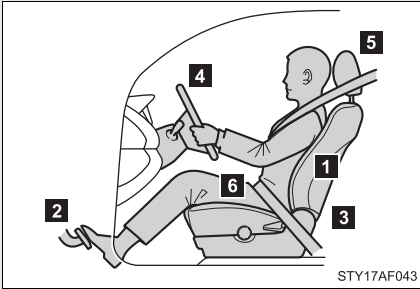

- 1** Sit upright and well back in the seat. (→P. 45)
- 2** Adjust the position of the seat forward or backward to ensure the pedals can be reached and easily depressed to the extent required. (→P. 45)
- 3** Adjust the seatback so that the controls are easily operable.
- 4** Adjust the tilt and telescopic positions of the steering wheel downward so the air-bag is facing your chest. (→P. 62)
- 5** Lock the head restraint in place with the center of the head restraint closest to the top of your ears. (→P. 54)
- 6** Wear the seat belt correctly. (→P. 56)

 **CAUTION**

**n While driving**

- I** Do not adjust the position of the driver's seat while driving. Doing so could cause the driver to lose control of the vehicle.
- I** Do not place a cushion between the driver or passenger and the seatback. A cushion may prevent correct posture from being achieved, and reduce the effectiveness of the seat belt and head restraint, increasing the risk of death or serious injury to the driver or passenger.
- I** Do not place anything under the front seats. Objects placed under the front seats may become jammed in the seat tracks and stop the seat from locking in place. This may lead to an accident. The adjustment mechanism may also be damaged.

**n Adjusting the seat position**

- I** Take care when adjusting the seat position to ensure that other passengers are not injured by the moving seat.
- I** Do not put your hands under the seat or near the moving parts to avoid injury. Fingers or hands may become jammed in the seat mechanism.

## SRS airbags

The SRS airbags inflate when the vehicle is subjected to certain types of severe impacts that may cause significant injury to the occupants. They work together with the seat belts to help reduce the risk of death or serious injury.

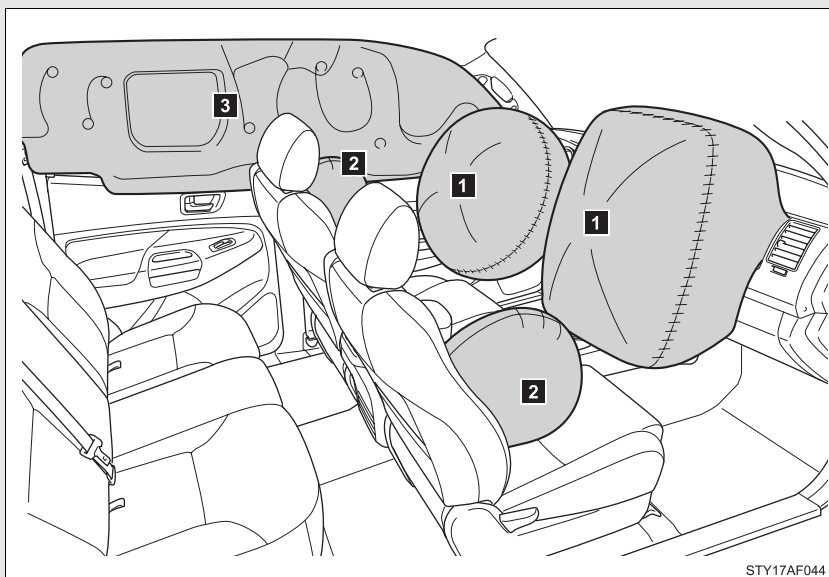

### ► Front airbags

#### **1** Driver airbag/front passenger airbag

Can help protect the head and chest of the driver and right front passenger from impact with interior components.

### ► Side and curtain shield airbags

#### **2** Side airbags

Can help protect the torso of the front seat occupants.

#### **3** Curtain shield airbags

Can help protect primarily the head of outside occupants.



## Airbag system components

### ► Regular Cab models

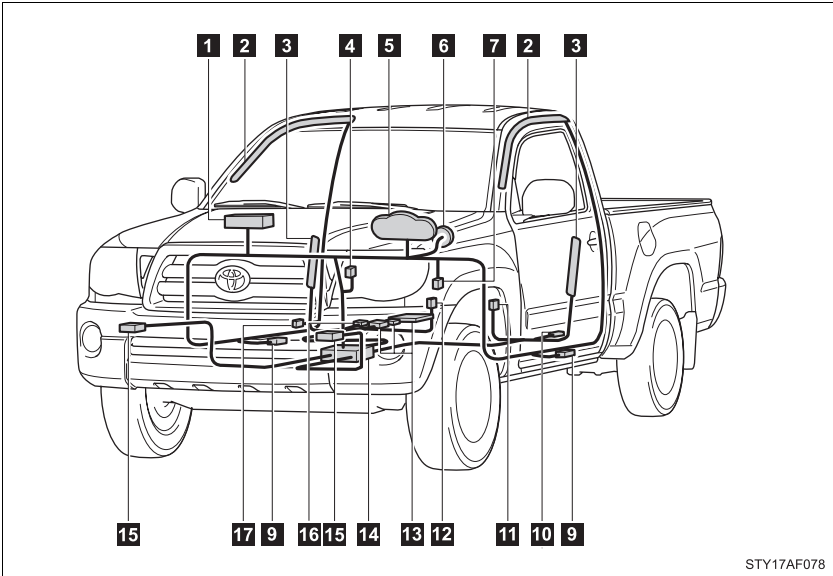

### ► Access Cab and Double Cab models

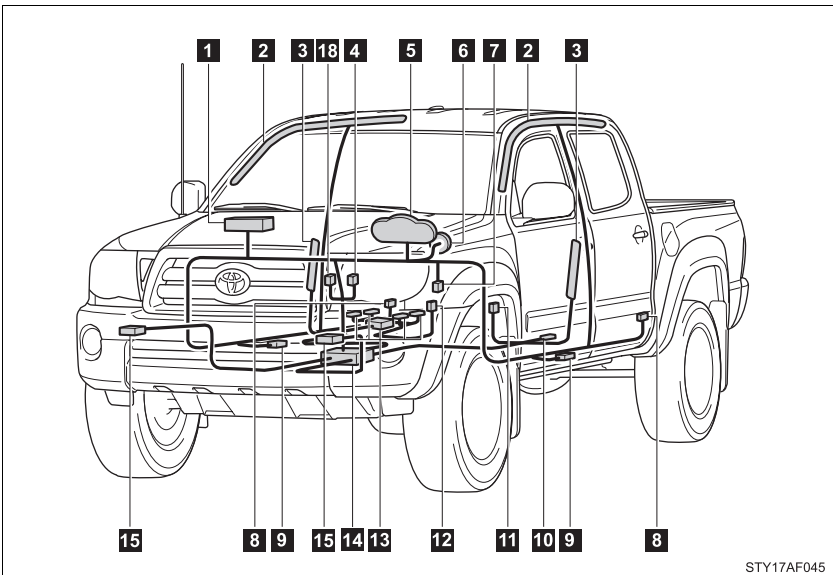

- |   |   |
|---|---|
| <b>1</b> Front passenger airbag   | <b>11</b> Driver's seat belt buckle switch                            |
| <b>2</b> Curtain shield airbags   | <b>12</b> Front passenger's seat belt buckle switch                   |
| <b>3</b> Side airbags   | <b>13</b> Occupant detection system (ECU and sensors)                 |
| <b>4</b> AIR BAG ON and AIR BAG OFF indicator lights                      | <b>14</b> Airbag sensor assembly                                      |
| <b>5</b> SRS warning light and RSCA OFF indicator light                   | <b>15</b> Front airbag sensors  |
| <b>6</b> Driver airbag  | <b>16</b> Front passenger's seat position sensor (Regular Cab models) |
| <b>7</b> RSCA OFF switch  | <b>17</b> Belt tension sensor (Regular Cab models)                    |
| <b>8</b> Curtain shield airbag sensors (Access Cab and Double Cab models) | <b>18</b> Passenger airbag off switch (Access Cab models)             |
| <b>9</b> Side and curtain shield airbag sensors                           |   |
| <b>10</b> Driver's seat position sensor                                   |   |

Your vehicle is equipped with ADVANCED AIRBAGS designed based on US motor vehicle safety standards (FMVSS208). The airbag system controls airbag deployment power for the driver and right front passenger. The driver airbag system consists of the driver seat's position sensor etc. The front passenger's airbag system consists of the front passenger occupant classification sensor etc.

The main SRS airbag system components are shown above. The SRS airbag system is controlled by the airbag sensor assembly. The airbag sensor assembly consists of a safing sensor and an airbag sensor.

Regular Cab models: The SRS airbags are designed to protect the driver and right front passenger, and they are not designed to protect an occupant in the front center seating position.

In certain types of severe frontal or side impacts, the SRS airbag system triggers the airbag inflators. A chemical reaction in the inflators quickly fills the airbags with non-toxic gas to help restrain the motion of the occupants.

**n SRS warning light**

This warning light system monitors the airbag sensor assembly, front airbag sensors, side and curtain shield airbag sensor assemblies, curtain shield airbag sensor assemblies (Access Cab and Double cab models), driver's seat position sensor, driver's seat belt buckle switch, front passenger occupant classification system, AIR BAG ON and AIR BAG OFF indicator lights, front passenger's seat position sensor (Regular Cab models), front passenger's seat belt buckle switch, passenger airbag off switch (Access Cab models), front seat belt pretensioner assemblies, belt tension sensor (Regular Cab models), RSCA OFF indicator light, inflators, interconnecting wiring and power sources. (→P. 425)

**n If the SRS airbags deploy (inflate)**

- l Bruising and slight abrasions may result from contact with a deploying (inflating) SRS airbag.
- l A loud noise and white powder will be emitted.
- l Parts of the airbag module (steering wheel hub, airbag cover and inflator) as well as the front seats, and parts of the front and rear pillars and roof side rail, may be hot for several minutes. The airbag itself may also be hot.
- l The front windshield may crack.

**n Operating conditions (front airbags)**

- l The SRS front airbags will deploy if the severity of the frontal impact is above the designed threshold level, comparable to an approximate 15 mph (25 km/h) collision when the vehicle impacts straight into a fixed barrier that does not move or deform.

However, this threshold velocity will be considerably higher if the vehicle strikes an object, such as a parked vehicle or sign pole, which can move or deform on impact, or if the vehicle is involved in an underride collision (e.g. a collision in which the front of the vehicle "underrides", or goes under, the bed of a truck, etc.).

- l It is possible that in some collisions where the forward deceleration of the vehicle is very close to the designed threshold level, the SRS front airbags and the seat belt pretensioners may not activate together.

- 1 The SRS front passenger airbag will not activate if there is no passenger sitting in the right front passenger seat. However, the front passenger airbag may deploy if luggage is put in the seat, or the seat belt is fastened, even if the seat is unoccupied. (→P. 97)

#### n **Operating conditions (side airbags)**

- 1 The SRS side airbags are designed to inflate when the passenger compartment is subjected to a severe impact from the side.
- 1 The SRS side airbag on the passenger seat will activate even if there is no passenger sitting in the right front passenger seat. (→P. 97)

#### n **Operating conditions (curtain shield airbags)**

The SRS curtain shield airbags are designed to inflate when the passenger compartment is subjected to a severe impact from the side or vehicle roll-over.

#### n **Conditions under which the SRS airbags may deploy (inflate), other than a collision**

The SRS front airbags may also deploy if a serious impact occurs to the underside of your vehicle. Some examples are shown in the illustration.

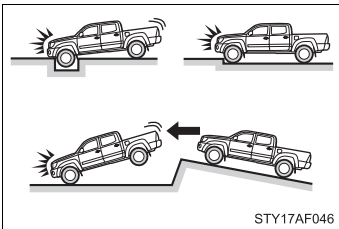

- 1 Hitting a curb, edge of pavement or hard surface
- 1 Falling into or jumping over a deep hole
- 1 Landing hard or vehicle falling

The SRS curtain shield airbags may also deploy under the situation shown in the illustration.

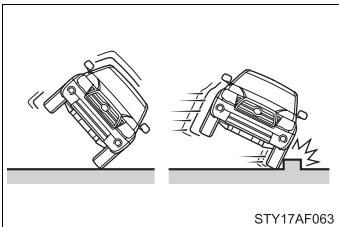

- 1 The angle of vehicle tip-up is marginal.
- 1 The vehicle skids and hits a curb stone.

**ii Types of collisions that may not deploy the SRS airbag (front airbags)**

The SRS front airbags are generally not designed to inflate if the vehicle is involved in a side or rear collision, if it rolls over, or if it is involved in a low-speed frontal collision. But, whenever a collision of any type causes sufficient forward deceleration of the vehicle, deployment of the SRS front airbags may occur.

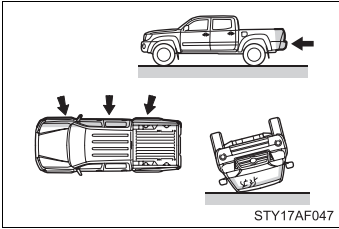

- | Collision from the side
- | Collision from the rear
- | Vehicle rollover

**ii Types of collisions that may not deploy the SRS airbag (side airbags and curtain shield airbags)**

The SRS side airbag and curtain shield airbag system may not activate if the vehicle is subjected to a collision from the side at certain angles, or a collision to the side of the vehicle body other than the passenger compartment.

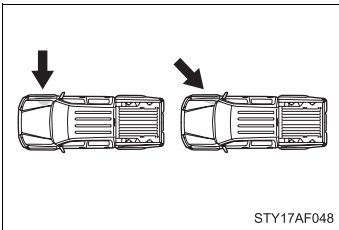

- | Collision from the side to the vehicle body other than the passenger compartment
- | Collision from the side at an angle

The SRS side airbags are not generally designed to inflate if the vehicle is involved in a frontal or rear collision, if it rolls over, or if it is involved in a low-speed side collision.

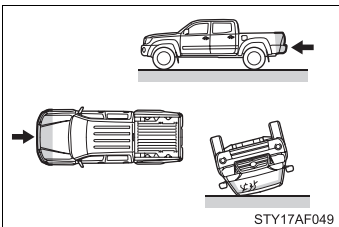

- | Collision from the front
- | Collision from the rear
- | Vehicle rollover

The SRS curtain shield airbags are not generally designed to inflate if the vehicle is involved in a frontal or rear collision, if it pitches end over end, or if it is involved in a low-speed side collision.

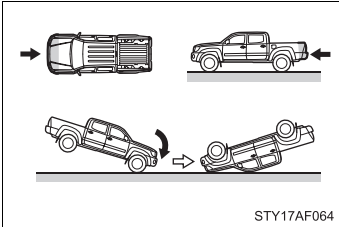

- 1 Collision from the front
- 1 Collision from the rear
- 1 Pitching end over end

### 11 When to contact your Toyota dealer

In the following cases, contact your Toyota dealer as soon as possible. Do not disconnect the battery cables before contacting your Toyota dealer.

- 1 Any of the SRS airbags have been inflated.

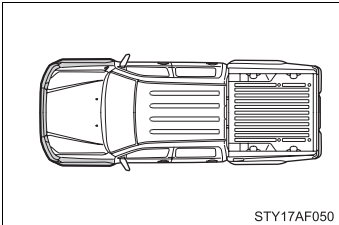

- 1 The front of the vehicle is damaged or deformed, or was involved in an accident that was not severe enough to cause the SRS airbags to inflate.

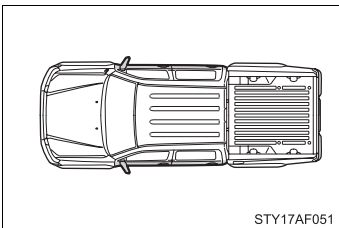

- 1 A portion of a door is damaged or deformed, or the vehicle was involved in an accident that was not severe enough to cause the SRS side airbags and curtain shield airbags to inflate.

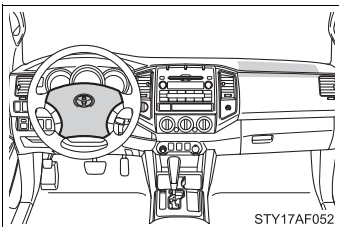

- 1 The pad section of the steering wheel or dashboard near the front passenger airbag is scratched, cracked, or otherwise damaged.

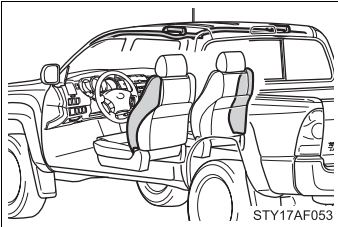

- I The surface of the seats with the side airbag is scratched, cracked or otherwise damaged.
- I The portion of the front pillars, rear pillars or roof side rail garnishes (padding) containing the curtain shield airbags inside is scratched, cracked or otherwise damaged.

**⚠ CAUTION**

**n SRS airbag precautions**

Observe the following precautions regarding the airbags.  
Failure to do so may cause death or serious injury.

- I The driver and all passengers in the vehicle must wear their seat belts properly.

The SRS airbags are supplemental devices to be used with the seat belts.

- I The SRS driver airbag deploys with considerable force, and can cause death or serious injury especially if the driver is very close to the airbag. The National Highway Traffic Safety Administration (“NHTSA”) advises:

Since the risk zone for the driver’s airbag is the first 2 - 3 in. (50 - 75 mm) of inflation, placing yourself 10 in. (250 mm) from your driver airbag provides you with a clear margin of safety. This distance is measured from the center of the steering wheel to your breastbone. If you now sit less than 10 in. (250 mm) away, you can change your driving position in several ways:

- Move your seat to the rear as far as you can while still reaching the pedals comfortably.
- Slightly recline the back of the seat.  
Although vehicle designs vary, many drivers can achieve the 10 in. (250 mm) distance, even with the driver seat all the way forward, simply by reclining the back of the seat somewhat. If reclining the back of your seat makes it hard to see the road, raise yourself by using a firm, non-slippery cushion, or raise the seat if your vehicle has that feature.
- If your steering wheel is adjustable, tilt it downward. This points the airbag toward your chest instead of your head and neck.

**⚠ CAUTION****n SRS airbag precautions**

The seat should be adjusted as recommended by NHTSA above, while still maintaining control of the foot pedals and steering wheel, and your view of the instrument panel controls.

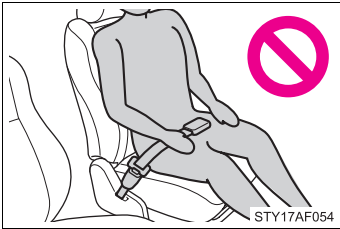

- !** If the seat belt extender has been connected to the driver's seat belt buckle but the seat belt extender has not also been fastened to the latch plate of the driver's seat belt, the SRS driver's airbag system will judge that the driver is wearing the seat belt even though the seat belt has not been connected. In this case, the driver's airbag may not activate correctly in a collision, resulting in death or serious injury in the event of collision. Be sure to wear the seat belt with the seat belt extender.
- !** The SRS front passenger airbag also deploys with considerable force, and can cause death or serious injury especially if the front passenger is very close to the airbag. The front passenger seat should be as far from the airbag as possible with the seatback adjusted, so the front passenger sits upright.
- !** Improperly seated and/or restrained infants and children can be killed or seriously injured by a deploying airbag. An infant or child who is too small to use a seat belt should be properly secured using a child restraint system. Toyota strongly recommends that all infants and children be placed in the rear seats of the vehicle and properly restrained. The rear seats are the safest for infants and children. (→P. 104)



**CAUTION**

**n SRS airbag precautions**

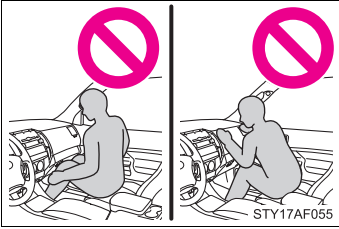

**I** Do not sit on the edge of the seat or lean against the dashboard.

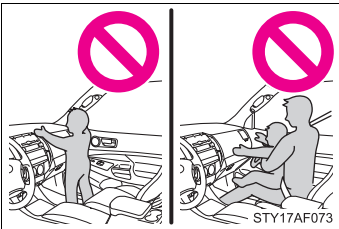

**I** Do not allow a child to stand in front of the SRS front passenger airbag unit or sit on the knees of a front passenger.

**I** Do not drive the vehicle while the driver or passenger has items resting on their knees.



**I** Do not lean against the door, the roof side rail or the front, side and rear pillars.

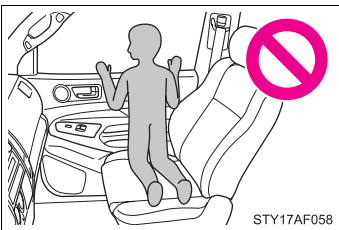

**I** Do not allow anyone to kneel on the passenger seat toward the door or put their head or hands outside the vehicle.

## ⚠ CAUTION

### n SRS airbag precautions

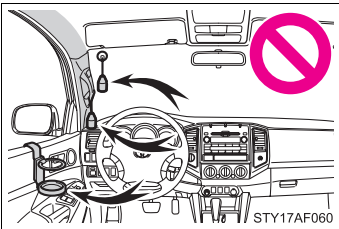
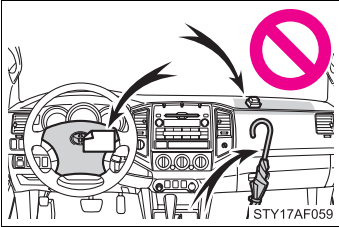

- I Do not attach anything to or lean anything against areas such as the dashboard or steering wheel pad. These items can become projectiles when SRS driver and front passenger airbags deploy.
- I Do not attach anything to areas such as the door, windshield glass, side door glass, front and rear pillars, roof side rail or assist grip.
- I Do not hang coat hangers or other hard objects on the coat hooks. All of these items could become projectiles and seriously injure or kill you, should the SRS curtain shield airbag deploy.
- I Regular Cab models: Do not use a seat accessory, such as a cushion or seat cover, that covers the seat cushion surface.
- I Do not use seat accessories which cover the parts where the SRS side airbags inflate as they may interfere with inflation of the airbags.
- I Do not strike or apply significant levels of force to the area of the SRS airbag components (→P. 82). Doing so can cause the SRS airbags to malfunction.
- I Do not touch any of the component parts immediately after the SRS airbags have deployed (inflated) as they may be hot.
- I If breathing becomes difficult after the SRS airbag has deployed, open a door or window to allow fresh air in, or leave the vehicle if it is safe to do so. Wash off any residue as soon as possible to prevent skin irritation.
- I If the areas where the SRS airbags are stored, such as the steering wheel pad and front and rear pillar garnishes, are damaged or cracked, have them replaced by your Toyota dealer.

 CAUTION

**n Modification and disposal of SRS airbag system components**

Do not dispose of your vehicle or perform any of the following modifications without consulting your Toyota dealer.

The SRS airbags may malfunction or deploy (inflate) accidentally, causing death or serious injury.

- I Installation, removal, disassembly and repair of the SRS airbags.
- I Repairs, modifications, removal or replacement of the steering wheel, instrument panel, dashboard, seats or seat upholstery, front, side and rear pillars or roof side rails.
- I Repairs or modifications of the front fender, front bumper, or side of the occupant compartment.
- I Installation of snow plows, winches, etc. to the front grille (bull bars, kangaroo bar etc.).
- I Modifications to the vehicle's suspension system.
- I Do not use tires or wheels other than the manufacturer's recommended size. (→P. 373, 475)
- I Installation of electronic devices such as mobile two-way radios or CD players.
- I Modifications to your vehicle for a person with a physical disability.

## Passenger airbag off switch (Access Cab models)

The passenger airbag off switch is designed to disable the front passenger airbag in order to allow usage, if necessary, of the front passenger seat by a member of a passenger risk group identified in TABLE 1 is occupying the front passenger seating position (→P. 94).

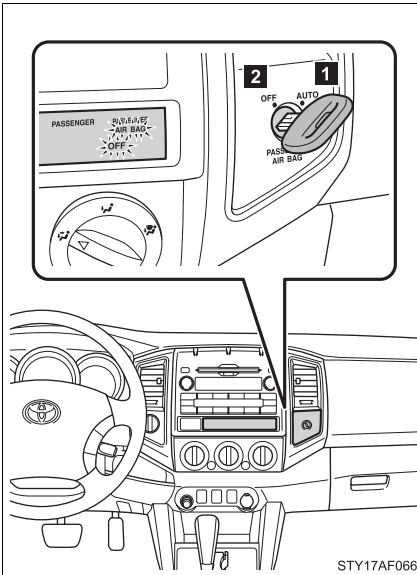

### 1 AUTO position

This position makes the front passenger airbag system operational.

At this time, the indicator light condition varies depending on the size of the occupant in the front passenger seat.

### 2 OFF position

The front passenger airbag is disabled.

At this time, the AIR BAG OFF indicator light will come on.

## Operation of the passenger airbag off switch

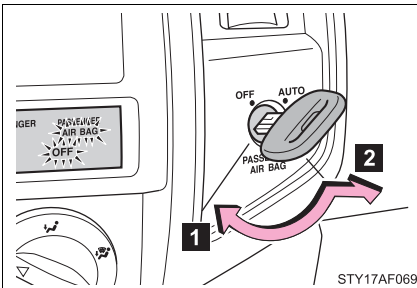

1 Turn the key clockwise to the AUTO position.

2 Turn the key counterclockwise to the OFF position and remove it.

If the key is removed at any other position than OFF, the switch will automatically return to the AUTO position.

n **Passenger risk group**

TABLE 1: A PASSENGER RISK GROUP

**Infant.** An infant (less than 1 year old) who must ride in the front seat because:

- Vehicle has no rear seat;
- Vehicle has a rear seat too small to accommodate a rear-facing infant seat; or
- The infant has a medical condition which, according to the infant's physician, makes it necessary for the infant to ride in the front seat so that the driver can constantly monitor the child's condition.

**Child age 1 to 12.** A child age 1 to 12 must ride in the front seat because:

- Vehicle has no rear seat;
- Although children ages 1 to 12 ride in the rear seat(s) whenever possible, children ages 1 to 12 sometimes must ride in the front because no space is available in the rear seat(s) of vehicle; or
- The child has a medical condition which, according to the child's physician, makes it necessary for the child to ride in the front seat so that the driver can constantly monitor the child's condition.

**Medical condition.** A passenger has a medical condition which according to his or her physician:

- Causes the passenger airbag to pose a special risk for the passenger: and
- Makes the potential harm from the passenger airbag in a crash greater than the potential harm from turning off the airbag and allowing the passenger, even if belted, to hit the dashboard, or windshield in a crash.

For more detailed information concerning about the passenger risk group, please contact NHTSA at 1-888-327-4236 or Transport Canada at 1-800-333-0371.

**⚠ CAUTION****n When the passenger airbag off switch is turned off**

- l Do not turn the passenger airbag off switch to the OFF position except when a member of a passenger risk group identified in TABLE 1 is occupying the front passenger seating position.
- l The front passenger airbag will not inflate in a collision and turning off the front passenger airbag can reduce the occupant protection which your vehicle safety systems can provide to you in certain accidents and increase the likelihood of death or serious injuries.

1

Before driving

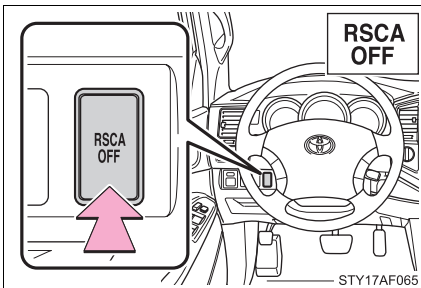
**Deactivating the curtain shield airbags in a vehicle rollover**

ON/OFF (hold for a few seconds)

The RSCA OFF indicator turns on (only when the engine switch is in the ON position.)

The roll sensing function for the curtain shield airbags and seat belt pretensioners will turn back on automatically each time the engine switch is turned on.

**n The switch only should be used**

In a situation where inflation is not desired (such as during extreme off-road driving).

**n Operating conditions when the RSCA OFF indicator is on**

- l The curtain shield airbag and seat belt pretensioner will not activate in a vehicle rollover.
- l The curtain shield airbag will activate in a severe side impact.

 CAUTION

**n For normal driving**

Make sure the RSCA OFF indicator is not turned on. If it is left on, the curtain shield airbag will not activate in the event of an accident, which may result in death or serious injury.

## Front passenger occupant classification system

Your vehicle is equipped with a front passenger occupant classification system. This system detects the conditions of the right front passenger seat and activates or deactivates the devices for the front passenger.

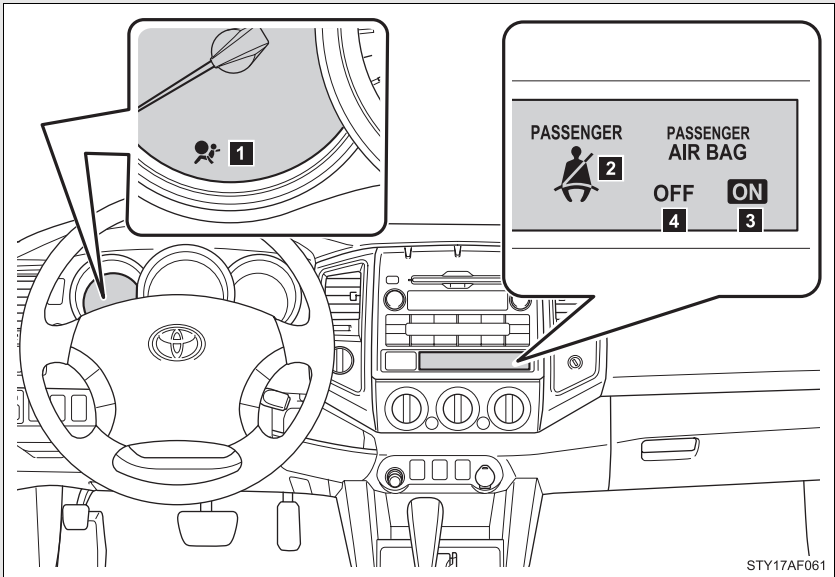

- 1** SRS warning light
- 2** Front passenger's seat belt reminder light
- 3** AIR BAG ON indicator light
- 4** AIR BAG OFF indicator light



**Conditions and operation of the front passenger occupant classification system**

► Regular Cab and Double Cab models

1 Indicator/warning light

Condition detected by the front passenger occupant classification system*1	AIR BAG ON and AIR BAG OFF indicator lights	SRS warning light	Front passenger's seat belt reminder light
Adult*2	AIR BAG ON	Off	Flashing*5
Child*3 or child restraint system*4	AIR BAG OFF*6	Off	Flashing*5
Unoccupied	Not illuminated	Off	Off
There is a malfunction in the system	AIR BAG OFF	On	Off

1 Devices

Condition detected by the front passenger occupant classification system*1	Front passenger air-bag	Side air-bag on the front passenger seat	Curtain shield air-bag in the front passenger side	Front passenger's seat belt pretensioner
Adult*2	Activated			
Child*3 or child restraint system*4	Deactivated	Activated		
Unoccupied	Deactivated	Activated	Deactivated	
There is a malfunction in the system	Deactivated	Activated		

- \*1: The right front passenger on the bench seat. (Regular Cab models)
- \*2: The system judges a person of adult size as an adult. When a smaller adult sits in the front passenger seat, the system may recognize him/her as a child depending on his/her physique and posture.
- \*3: When a larger child who has outgrown a child restraint system sits in the front passenger seat, the system may recognize him/her as an adult depending on his/her physique or posture.
- \*4: Never install a rear-facing child restraint system on the front passenger seat. A forward-facing child restraint system should only be installed on the front passenger seat when it is unavoidable. (→P. 104)
- \*5: In the event the front passenger does not wear a seat belt.
- \*6: In case the indicator is not illuminated, consult this manual for installing the child restraint system properly. (→P. 104)

► Access Cab models

1 Indicator/warning light

Condition detected by the front passenger occupant classification system	Passenger airbag off switch position	AIR BAG ON and AIR BAG OFF indicator lights	SRS warning light	Front passenger's seat belt reminder light
Adult*1	AUTO	AIR BAG ON	Off	Flashing*4
	OFF	AIR BAG OFF		
Child*2 or child restraint system*3	AUTO	AIR BAG OFF*5	Off	Flashing*4
	OFF			
Unoccupied	AUTO	Not illuminated	Off	Off
	OFF	AIR BAG OFF		
There is a malfunction in the system	AUTO	AIR BAG OFF	On	Off
	OFF			

## 1 Devices

Condition detected by the front passenger occupant classification system	Passenger air-bag off switch position	Front passenger air-bag	Side air-bag on the front passenger seat	Curtain shield air-bag in the front passenger side	Front passenger's seat belt pretensioner
Adult* <sup>1</sup>	AUTO	Activated	Activated		
	OFF	Deactivated			
Child* <sup>2</sup> or child restraint system* <sup>3</sup>	AUTO	Deactivated	Activated		
	OFF				
Unoccupied	AUTO	Deactivated	Activated	Deactivated	
	OFF				
There is a malfunction in the system	AUTO	Deactivated	Activated		
	OFF				

\*<sup>1</sup>: The system judges a person of adult size as an adult. When a smaller adult sits in the front passenger seat, the system may recognize him/her as a child depending on his/her physique and posture.

\*<sup>2</sup>: When a larger child who has outgrown a child restraint system sits in the front passenger seat, the system may recognize him/her as an adult depending on his/her physique or posture.

\*<sup>3</sup>: Never install a rear-facing child restraint system on the front passenger seat. A forward-facing child restraint system should only be installed on the front passenger seat when it is unavoidable. (→P. 123)

\*<sup>4</sup>: In the event the front passenger does not wear a seat belt.

\*5: In case the indicator is not illuminated, consult this manual for installing the child restraint system properly. (→P. 104)

 CAUTION

**n Front passenger occupant classification system precautions**

Observe the following precautions regarding front passenger occupant classification system.

Failure to do so may cause death or serious injury.

- I Wear the seat belt properly.
- I Make sure the front passenger's seat belt tab has not been left inserted into the buckle before someone sits in the front passenger seat.
- I Make sure the AIR BAG OFF indicator light is not illuminated when using the seat belt extender for the front passenger seat. If the AIR BAG OFF indicator light is illuminated, disconnect the extender tongue from the seat belt buckle, then reconnect the seat belt. Reconnect the seat belt extender after making sure the AIR BAG ON indicator light is illuminated. If you use the seat belt extender while the AIR BAG OFF indicator light is illuminated, the front passenger airbag may not activate correctly, which could cause death or serious injury in the event of collision.
- I Do not place a heavy load on the front passenger seat or equipment (e.g. seatback table).
- I Do not apply pressure to the front passenger seat by resting hands or legs on the seatback.
- I Do not let a rear passenger lift the front passenger seat with their feet or press on the seatback with their legs.
- I Do not put objects under the front passenger seat.
- I Do not recline the front passenger seatback so far that it touches a rear seat or a back wall. This may cause the AIR BAG OFF indicator light to be illuminated, which indicates that the passenger's airbags will not deploy in the event of a severe accident. If the seatback touches the rear seat or back wall, return the seatback to a position where it does not touch the rear seat or back wall. Keep the front passenger seatback as upright as possible when the vehicle is moving. Reclining the seatback excessively may lessen the effectiveness of the seat belt system.

 CAUTION**n Front passenger occupant classification system precautions**

- I** If an adult sits in the front passenger seat, the AIR BAG ON indicator light is illuminated. If the AIR BAG OFF indicator is illuminated, ask the passenger to sit up straight, well back in the seat, feet on the floor, and with the seat belt worn correctly. If the AIR BAG OFF indicator still remains illuminated, either ask the passenger to move to the rear seat, or if that is not possible, move the front passenger seat fully rearward.
- I** When it is unavoidable to install the forward-facing child restraint system on the front passenger seat, install the child restraint system on the front passenger seat in the proper order. (→P. 109)
- I** Do not modify or remove the front seats.
- I** Do not kick the front passenger seat or subject it to severe impact. Otherwise, the SRS warning light may come on to indicate a malfunction of the detection system. In this case, contact your Toyota dealer immediately.
- I** Child restraint systems installed on the rear seat should not contact the front seatbacks.
- I** Do not use a seat accessory, such as a cushion or seat cover, that covers the seat cushion surface.
- I** Access Cab and Double Cab models: Do not attach a commercial seat-back table or other heavy item to the back of the front passenger seat.
- I** Do not modify or replace the upholstery of the front seat.

## Child restraint systems

**A child restraint system for a small child or baby must itself be properly restrained on the seat with the lap portion of the lap/shoulder belt.**

**The laws of all 50 states of the U.S.A. and Canada now require the use of child restraint systems.**

### Points to remember

Studies have shown that installing a child restraint on a rear seat is much safer than installing one to the front passenger seat.

1 Choose a child restraint system appropriate to the age and size of the child.

1 For installation details, follow the instructions provided with the child restraint system.

General installation instructions are provided in this manual.

(→P. 109)

### Types of child restraints

Child restraint systems are classified into the following 3 types according to the age and size of the child.

► Infant seat (Access Cab and Double Cab models only)

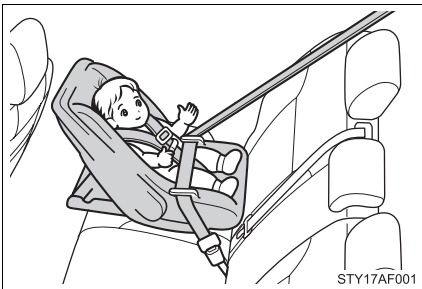

### ► Convertible seat

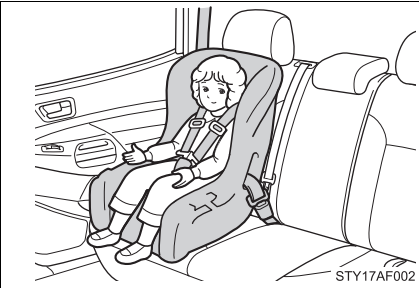

### ► Booster seat

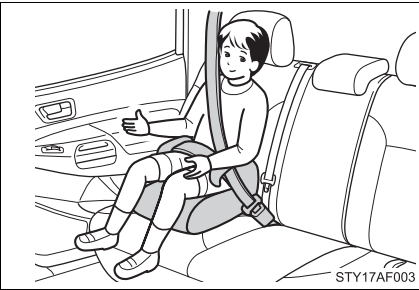

## n Selecting an appropriate child restraint system

Get an appropriate child restraint system for the child. If a child is too large for a child restraint system, sit the child on a rear seat and use the vehicle's seat belt. (→P. 56)

## ⚠ CAUTION

### n Child restraint precautions

**I** For effective protection in automobile accidents and sudden stops, a child must be properly restrained, using a seat belt or child restraint system depending on the age and size of the child. Holding a child in your arms is not a substitute for a child restraint system. In an accident, the child can be crushed against the windshield, or between you and the vehicle's interior.

**I** Regular Cab models: Toyota strongly urges use of a proper child restraint system which conforms to the size of the child.



**⚠ CAUTION**

**n Child restraint precautions**

- I** Access Cab and Double Cab models: Toyota strongly urges the use of a proper child restraint system that conforms to the size of the child, installed on the rear seat. According to accident statistics, the child is safer when properly restrained in the rear seat than in the front seat.
- I** Access Cab models: Never put infant or child age 1 to 12 in a passenger risk group on the front passenger seat with the passenger airbag off switch in the AUTO position. In the event of an accident, the force of the rapid inflation of the front passenger airbag can cause death or serious injury to the child. If you must put infant or child age 1 to 12 in a passenger risk group on the front passenger seat, make sure that the passenger airbag off switch is in the OFF position with the key removed and that the indicator light is on. (→P. 94)
- I** Regular Cab and Double Cab models: Never install a rear-facing child restraint system on the front passenger seat even if the AIR BAG OFF indicator light is illuminated. In the event of an accident, the force of the rapid inflation of the front passenger airbag can cause death or serious injury to the child if the rear-facing child restraint system is installed on the front passenger seat.

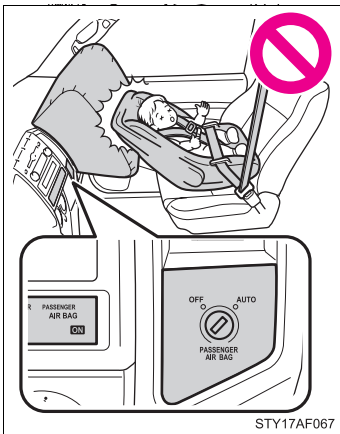

- I** Access Cab models: Never install a rear-facing child restraint system on the front passenger seat with the passenger airbag off switch in the AUTO position. In the event of an accident, the force of the rapid inflation of the front passenger airbag can cause death or serious injury to the child if the rear-facing child restraint system is installed on the front passenger seat.
- I** Access Cab models: If you must install a rear-facing child restraint system on the front passenger seat, make sure that the passenger airbag off switch is in the OFF position with the key removed and that the indicator light is on.

 CAUTION**n Child restraint precautions**

- I** A forward-facing child restraint system should be allowed to be installed on the front passenger seat only when it is unavoidable. Always move the seat as far back as possible even if AIR BAG OFF indicator light is illuminated, because the front passenger airbag could inflate with considerable speed and force. Otherwise, the child may be killed or seriously injured.
- I** Access Cab models: A forward-facing child restraint system which belongs to a passenger risk group should never be installed on the front passenger seat with the passenger airbag off switch in the AUTO position, because the force of the deploying airbag could cause death or serious injury to the child in forward seating position. (→P. 94)
- I** Regular Cab models: Do not install a child restraint system on the center seat if it interferes with driving operations such as gear shifting. In this case, install the child restraint system on the right passenger seat.
- I** Regular Cab models: The driver and passengers sit on a bench seat in this vehicle. Therefore, when installing a child restraint system, the seat must be moved back from the SRS airbag as far as possible while also maintaining the driver's seating position. Otherwise, the force of the rapid inflation of the airbag could cause death or serious injury to the child.
- I** Do not use the seat belt extender when installing a child restraint system on the front or rear passenger seat. If installing a child restraint system with the seat belt extender connected to the seat belt, the seat belt will not securely hold the child restraint system, which could cause death or serious injury to the child or other passengers in the event of collision.
- I** Do not allow the child to lean his/her head or any part of his/her body against the door or the area of the seat, front and rear pillars or roof side rail from which the side airbags or curtain shield airbags deploy even if the child is seated in the child restraint system. It is dangerous if the side airbags and curtain shield airbags inflate, and the force of the rapid inflation could cause death or serious injury to the child.
- I** Make sure you have complied with all installation instructions provided by the child restraint manufacturer and that the system is properly secured. If it is not secured properly, it may cause death or serious injury to the child in the event of a sudden stop or accident.

 CAUTION

**n When the child restraint system is not in use**

- l** Keep the child restraint system properly secured on the seat even if it is not in use. Do not store the restraint unsecured in the passenger compartment.
- l** If it is necessary to detach the child restraint system, remove it from the vehicle. This will prevent it from injuring passengers in the event of a sudden stop or accident.

## Installing child restraints

**Follow the child restraint system manufacturer's instructions. Firmly secure child restraints to the seats using a seat belt or a child restraint lower anchor belt. Attach the top strap when installing a child restraint.**

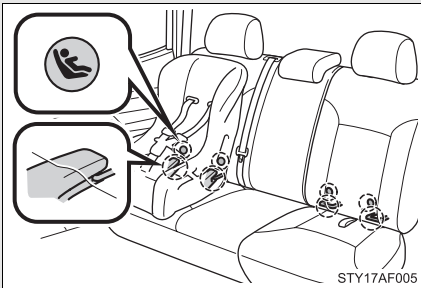
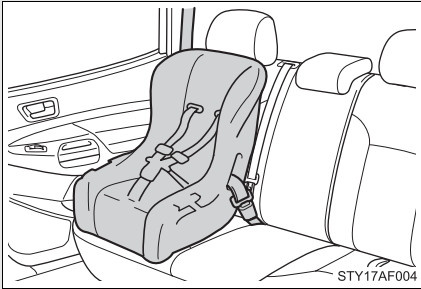

Seat belts equipped with a child restraint locking mechanism (ALR/ELR belts except driver's seat belt) (→P. 56)

Child restraint lower anchorages

► Access Cab models

Lower anchorages are provided for the front passenger seat and left rear passenger seats.

Buttons displaying the location of the anchorages are attached to the seats. (if equipped)

► Double Cab models

Lower anchorages are provided for the outside rear seats.

Buttons displaying the location of the anchorages are attached to the seats.

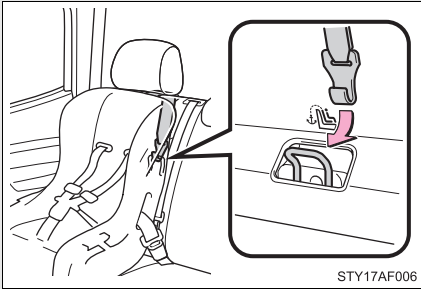

Anchor bracket (for top strap)

- ▶ Regular Cab models  
Anchor brackets are provided for all passenger seats.
- ▶ Access Cab models  
Anchor brackets are provided for the front passenger seat and left rear passenger seat.
- ▶ Double Cab models  
Anchor brackets are provided for all rear passenger seats.

**Installing the child restraint system on the front passenger seat (Access Cab models)**

When you install a child restraint system which belongs to a passenger risk group on the front passenger seat, do the following procedure.

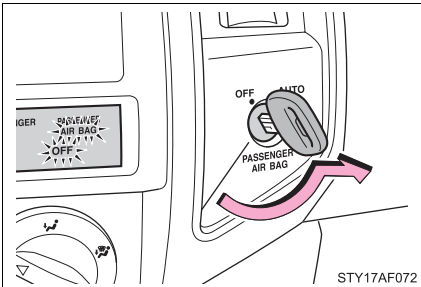

Turn the passenger airbag off switch counterclockwise to the OFF position and remove the key.

The AIR BAG OFF indicator light comes on when the front passenger airbag system is off. (→P. 93)

**⚠ CAUTION****n Rear-facing child restraint system**

If you must install a rear-facing child restraint system on the front passenger seat, make sure that the passenger airbag off switch is in the OFF position with the key removed and that the indicator light is on.

**n Forward-facing child restraint system**

A forward-facing child restraint system which belongs to a passenger risk group should never be installed on the front passenger seat with the passenger airbag off switch in the AUTO position, because the force of the deploying airbag could cause death or serious injury to the child in forward seating position. (→P. 94)

1

Before driving

**Installing child restraints using a seat belt (child restraint lock function belt)****n Rear-facing (Regular Cab models) — Infant seat/convertible seat**

Never install a rear-facing child restraint. Your vehicle is not designed to carry an infant.

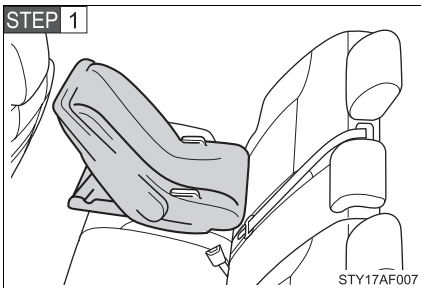
**n Rear-facing (Access Cab and Double Cab models only) — Infant seat/convertible seat**

Place the child seat on the rear seat facing the rear of the vehicle.

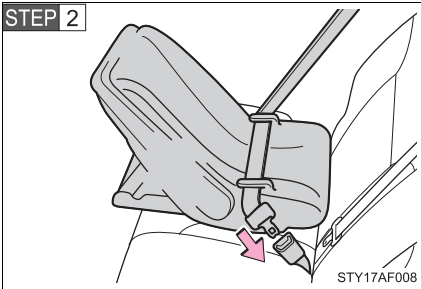

Run the seat belt through the child seat and insert the plate into the buckle. Make sure that the belt is not twisted.

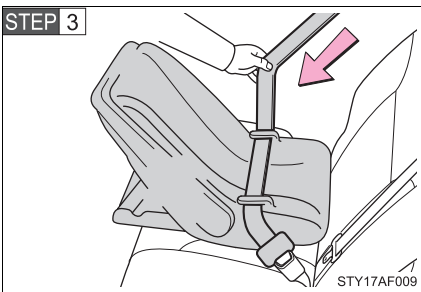

Fully extend the shoulder belt and then allow it to retract slightly in order to activate the ALR lock mode.

Lock mode allows the seat belt to retract only.

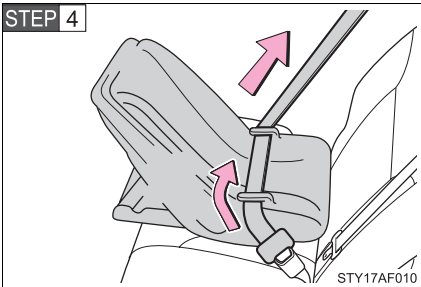

While pushing the child seat down into the rear seat, allow the shoulder belt to retract until the child seat is securely in place.

After the shoulder belt has retracted to a point where there is no slack in the belt, pull the belt to check that it cannot be extended.

### n Forward-facing — Convertible seat

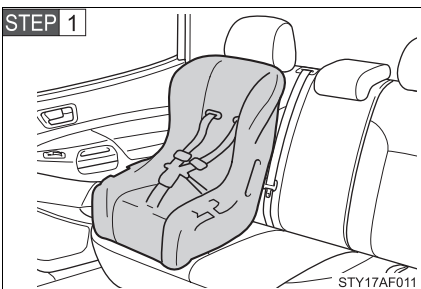

Place the child seat on the seat facing the front of the vehicle.

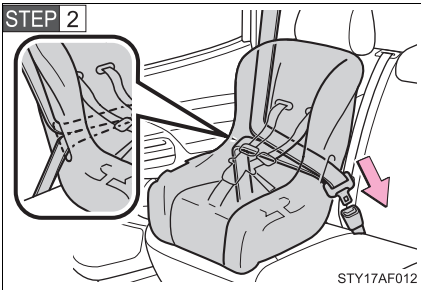

Run the seat belt through the child seat and insert the plate into the buckle. Make sure that the belt is not twisted.

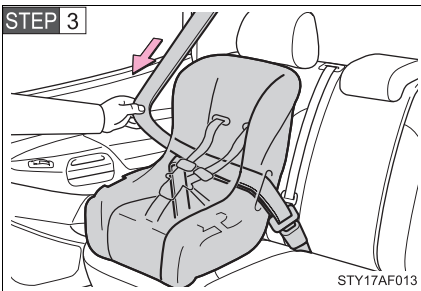

Fully extend the shoulder belt and then allow it to retract slightly in order to activate the ALR lock mode.

Lock mode allows the seat belt to retract only.

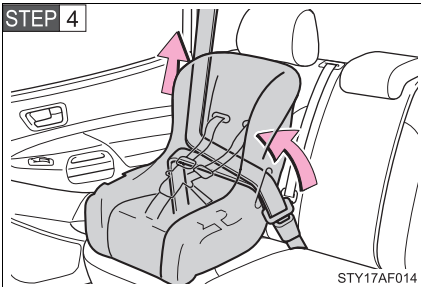

While pushing the child seat into the rear seat, allow the shoulder belt to retract until the child seat is securely in place.

After the shoulder belt has retracted to a point where there is no slack in the belt, pull the belt to check that it cannot be extended

## n Booster seat

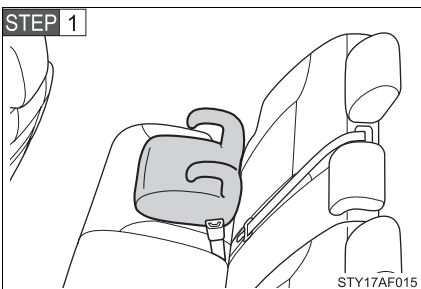

Place the booster seat on the seat facing the front of the vehicle.



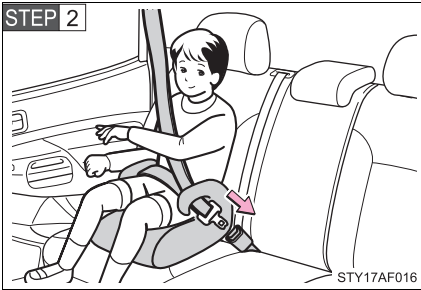

Sit the child in the booster seat. Fit the seat belt to the booster seat according to the manufacturer's instructions and insert the plate into the buckle. Make sure that the belt is not twisted.

Check that the shoulder belt is correctly positioned over the child's shoulder, and that the lap belt is as low as possible.

(→P. 56)

### Removing a child restraint installed with a seat belt

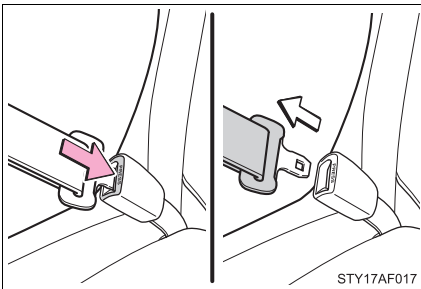

Push the buckle release button and fully retract the seat belt.

### Installation with child restraint lower anchors (Access Cab models)

#### n Installing on the front seat

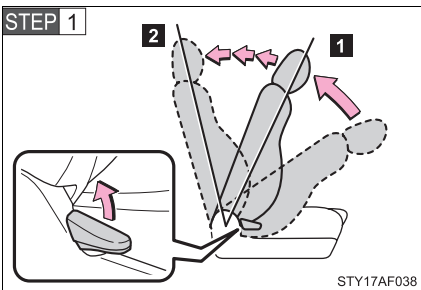

Fold down the front seat seatback and back to the 1st lock position (most upright position) until it locks into place. Adjust the seatback to the 10th lock position.

**1** 1st lock position

**2** 10th lock position

► Vehicles without seatback table (Type A)

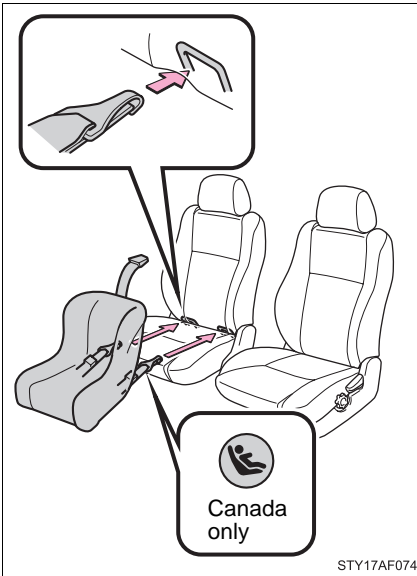

**STEP 2** Widen the gap between the seat cushion and seatback slightly.

**STEP 3** Latch the hooks of the lower straps onto the anchorages and tighten the lower straps.

If the child restraint has a top strap, the top strap should be latched onto the anchorages.

For owners in Canada:  
The symbol on a child restraint system indicates the presence of a lower connector system.

► Vehicles without seatback table (Type B)



**STEP 2** Widen the gap between the seat cushion and seatback slightly.

**STEP 3** Latch the buckles onto the anchorages.

If the child restraint has a top strap, the top strap should be latched onto the anchorages.

For owners in Canada:  
The symbol on a child restraint system indicates the presence of a lower connector system.

► Vehicles with seatback table (Type A)

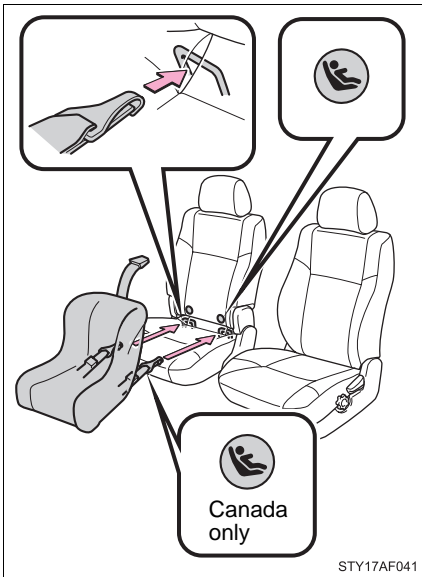

**STEP 2** Widen the slits of the seat cushion slightly.

**STEP 3** Latch the hooks of the lower straps onto the anchorages and tighten the lower straps.

If the child restraint has a top strap, the top strap should be latched onto the anchorages.

For owners in Canada:

The symbol on a child restraint system indicates the presence of a lower connector system.

► Vehicles with seatback table (Type B)

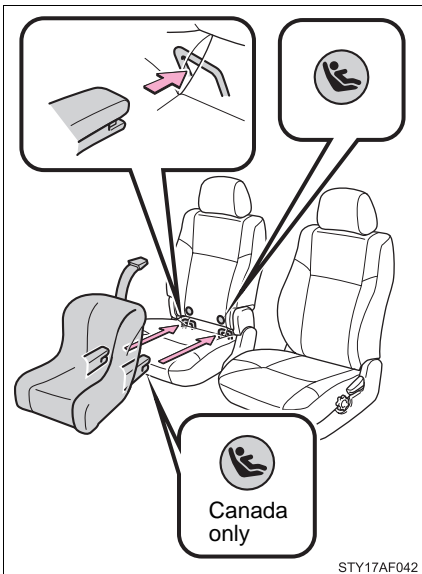

**STEP 2** Widen the slits of the seat cushion slightly.

**STEP 3** Latch the buckles onto the anchorages.

If the child restraint has a top strap, the top strap should be latched onto the anchorages.

For owners in Canada:

The symbol on a child restraint system indicates the presence of a lower connector system.

## n Installing on the rear seat

### ► Type A

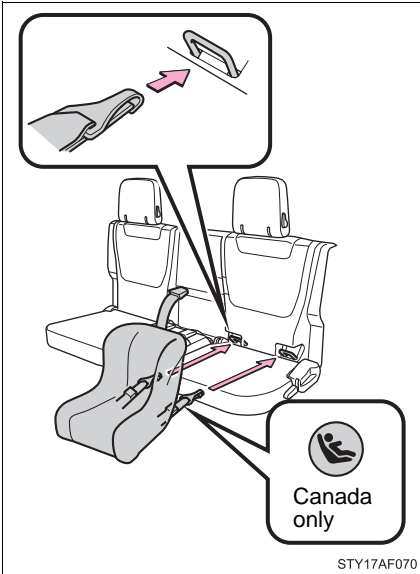

Latch the hooks of the lower straps onto the anchorages and tighten the lower straps.

If the child restraint has a top strap, the top strap should be latched onto the anchorages.

For owners in Canada:

The symbol on a child restraint system indicates the presence of a lower connector system.

### ► Type B

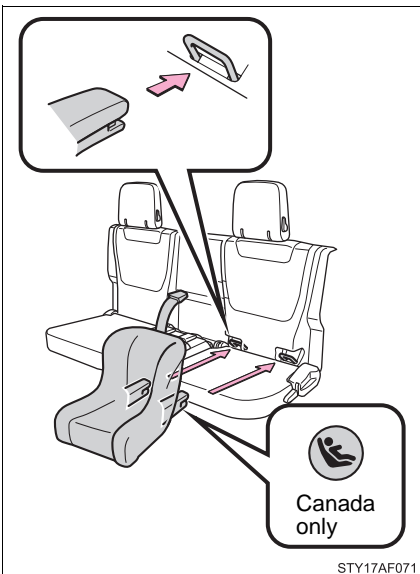

Latch the buckles onto the anchorages.

If the child restraint has a top strap, the top strap should be latched onto the anchorages.

For owners in Canada:

The symbol on a child restraint system indicates the presence of a lower connector system.

## Installation with child restraint lower anchors (Double Cab models)

### ► Type A

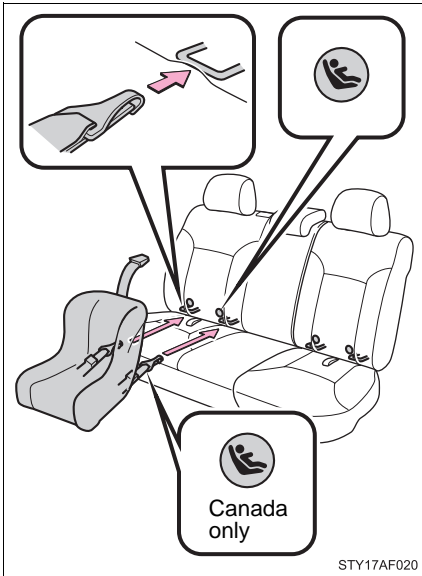

**STEP 1** Widen the gap between the seat cushion and seatback slightly.

**STEP 2** Latch the hooks of the lower straps onto the anchorages and tighten the lower straps.

If the child restraint has a top strap, the top strap should be latched onto the anchorages.

For owners in Canada:  
The symbol on a child restraint system indicates the presence of a lower connector system.

## ► Type B

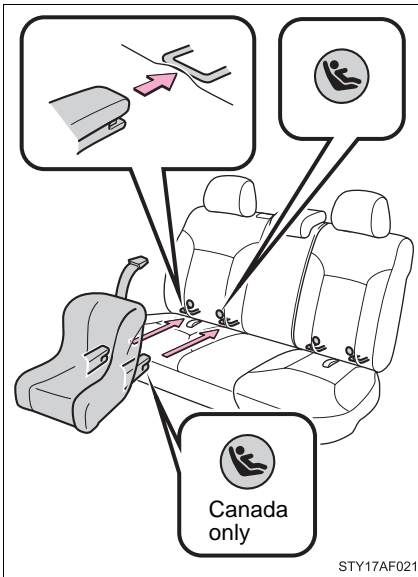

**STEP 1** Widen the gap between the seat cushion and seatback slightly.

**STEP 2** Latch the buckles onto the anchorages.

If the child restraint has a top strap, the top strap should be latched onto the anchorages.

For owners in Canada:  
The symbol on a child restraint system indicates the presence of a lower connector system.

### Child restraint systems with a top strap (Regular Cab models)

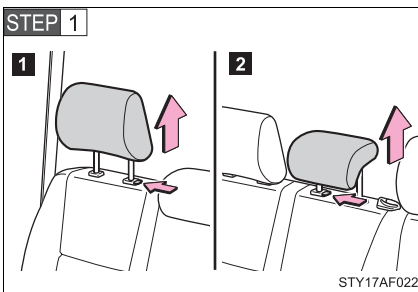

Remove the head restraint.

Installing position:

- 1** Right side passenger seat
- 2** Center passenger seat

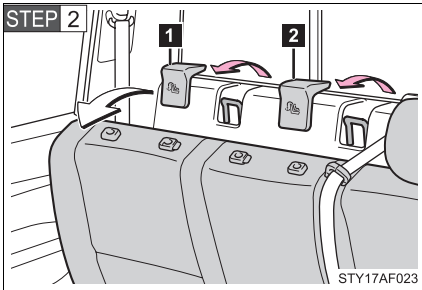

Swing the seatback forward slightly (→P. 46) and remove the anchor bracket covers.

Installing position:

- 1 Right side passenger seat
- 2 Center passenger seat

Store the removed cover in a safe place such as the glove box.

► Right side passenger seat

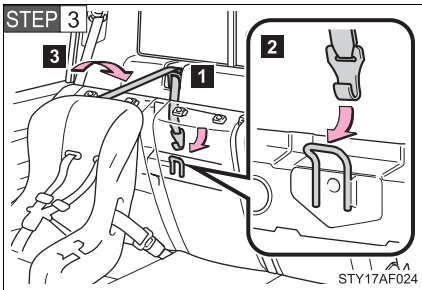

- 1 Route the top strap through the routing device as shown in the illustration.

Make sure the top strap is not twisted.

- 2 Latch the hook onto the anchor bracket.
- 3 Return the seatback to its original position.

Make sure the seatback is securely locked by pushing forward and rearward on the top of the seatback.

### ► Center passenger seat

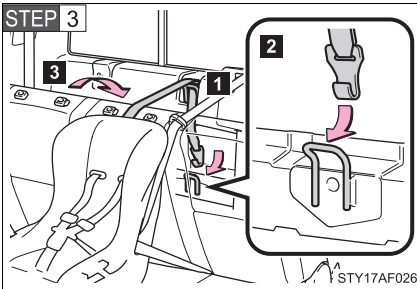

- 1 Route the top strap through the routing device as shown in the illustration.

Make sure the top strap is not twisted.

- 2 Latch the hook onto the anchor bracket.
- 3 Return the seatback to its original position.

Make sure the seatback is securely locked by pushing forward and rearward on the top of the seatback.

- 4 Secure the child restraint using a seat belt or lower anchors, and tighten the top strap.

Make sure the top strap is securely latched.

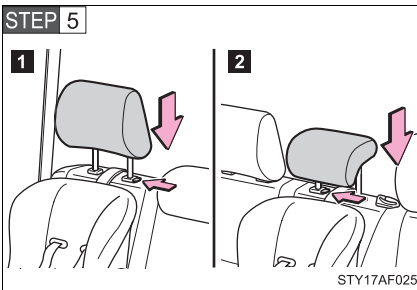

Replace the head restraint.

Installing position:

- 1 Right side passenger seat
- 2 Center passenger seat



## Child restraint systems with a top strap (Access Cab models)

### n Installing on the front seat

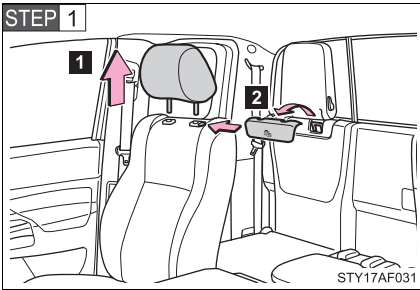

1 Remove the head restraint.

2 Remove the anchor bracket cover.

Store the removed cover in a safe place such as the glove box.

STEP 2 Secure the child restraint using a seat belt or lower anchors.

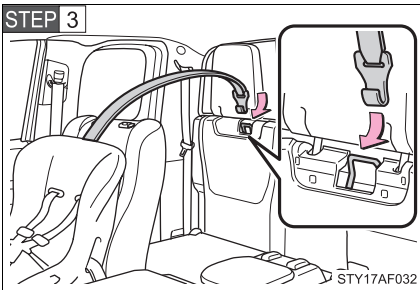

Latch the hook onto the anchor bracket and tighten the top strap.

Make sure the top strap is securely latched.

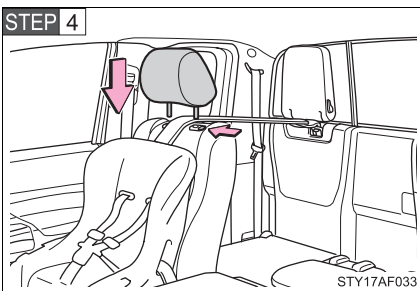

Replace the head restraint.

## n Installing on the rear seat

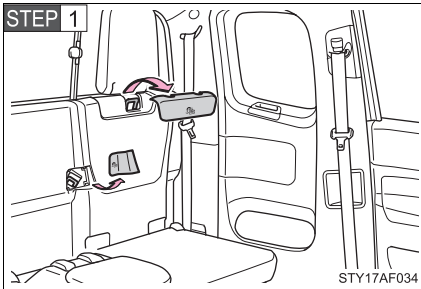

Remove the anchor bracket covers.

Store the removed covers in a safe place such as the glove box.

**STEP 2** Secure the child restraint using a seat belt or lower anchors.

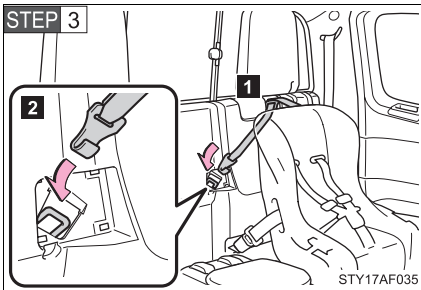

**1** Route the top strap through the routing device as shown in the illustration.

Make sure the top strap is not twisted.

**2** Latch the hook onto the anchor bracket and tighten the top strap.

Make sure the top strap is securely latched.

## Child restraint systems with a top strap (Double Cab models)

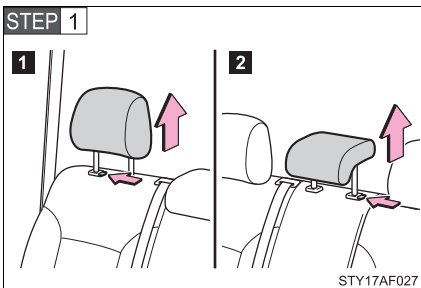

Remove the head restraint.

Installing position:

**1** Outside passenger seat

**2** Center passenger seat

► Outside passenger seat

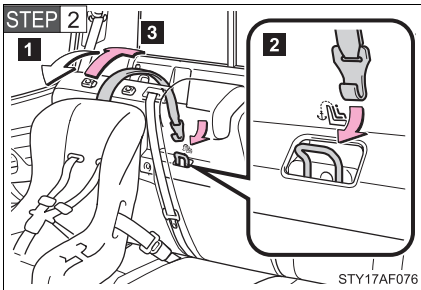

- 1 Swing the seatback forward slightly. (→P. 51)
- 2 Latch the hook onto the anchor bracket.
- 3 Return the seatback to its original position.

Make sure the seatback is securely locked by pushing forward and rearward on the top of the seatback.

► Center passenger seat

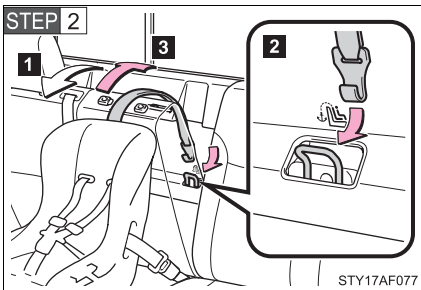

- 1 Swing the seatback forward slightly. (→P. 51)
- 2 Latch the hook onto the anchor bracket.
- 3 Return the seatback to its original position.

Make sure the seatback is securely locked by pushing forward and rearward on the top of the seatback.

**STEP 3** Secure the child restraint using a seat belt or lower anchors, and tighten the top strap.

Make sure the top strap is securely latched.

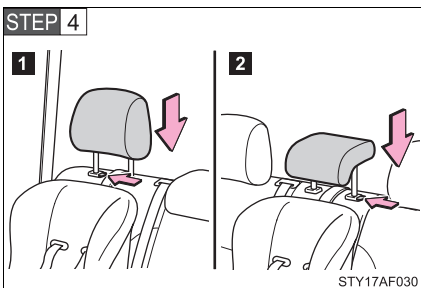

Replace the head restraint.

Installing position:

- 1 Outside passenger seat
- 2 Center passenger seat

## n Laws and regulations pertaining to anchorages

Anchorage conform to FMVSS225 or CMVSS210.2.

Child restraint systems conforming to FMVSS213 or CMVSS213 specifications can be used.

This vehicle is designed to conform to the SAE J1819.

### ⚠ CAUTION

#### n When installing a booster seat

Do not fully extend the shoulder belt to prevent the belt from going to ALR lock mode. (→P. 58)

! ALR mode causes the belt to tighten only which could cause injury or discomfort to the child.

! Do not allow the child to play with the seat belt or the child could be killed or seriously injured.

#### n When installing a child restraint system

Follow the directions given in the child restraint system installation manual and fix the child restraint system securely in place.

If the child restraint system is not correctly fixed in place, the child or other passengers may be seriously injured or even killed in the event of sudden braking or an accident.

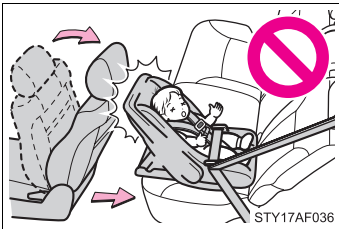

! Access Cab and Double Cab models: If the driver's seat interferes with the child restraint system and prevents it from being attached correctly, attach the child restraint system to the right-hand rear seat.

! Access Cab and Double Cab models: Adjust the front passenger seat so that it does not interfere with the child restraint system.

**! CAUTION**

**n When installing a child restraint system**

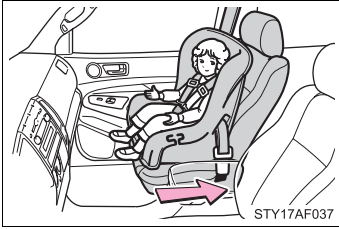

**I** Only put a forward-facing or booster child seat on the front seat when it is unavoidable. When installing a forward-facing or booster child seat on the front passenger seat, move the seat as far back as possible even if AIR BAG OFF indicator light is illuminated. Failing to do so may result in death or serious injury if the airbags deploy (inflate).

**I** When a booster seat is installed, always ensure that the shoulder belt is positioned across the center of the child's shoulder. The belt should be kept away from the child's neck, but not so that it could fall off the child's shoulder. Failing to do so may result in death or serious injury in the event of an accident or sudden braking.

**I** Ensure that the belt and tab are securely locked and the seat belt is not twisted.

**I** Push and pull the child restraint system in different directions to be sure it is secure.

**I** Follow all installation instructions provided by the child restraint system manufacturer.

**I** After securing the child restraint system, never slide or recline the seat.

**n Do not use a seat belt extender**

If a seat belt extender is used when installing a child restraint system, the seat belt will not securely hold the child restraint system, which could cause death or serious injury to the child or other passengers in the event of a collision.

**n To correctly attach a child restraint system to the anchorages**

When using the lower anchorages, be sure that there are no foreign objects around the anchorages and that the seat belt is not caught behind the child restraint. Make sure the child restraint system is securely attached, or it may cause death or serious injury to the child or other passengers in the event of a sudden stop or accident.

## 2-1. Driving procedures

# Driving the vehicle

The following procedures should be observed to ensure safe driving.

### n Starting the engine

→P. 138

### n Driving

#### ▶ Automatic transmission

**STEP 1** With the brake pedal depressed, shift the shift lever to D. (→P. 141)

**STEP 2** Release the parking brake. (→P. 148)

**STEP 3** Gradually release the brake pedal and gently depress the accelerator pedal to accelerate the vehicle.

#### ▶ Manual transmission

**STEP 1** With the clutch pedal fully depressed, shift the shift lever to 1. (→P. 144)

**STEP 2** Release the parking brake. (→P. 148)

**STEP 3** Gradually release the clutch pedal. At the same time, gently depress the accelerator pedal to accelerate the vehicle.

### n Stopping

#### ▶ Automatic transmission

**STEP 1** With the shift lever in D, depress the brake pedal.

**STEP 2** If necessary, set the parking brake.

When the vehicle is stopped for an extended period of time, shift the shift lever to P or N. (→P. 141)

#### ▶ Manual transmission

**STEP 1** With the clutch pedal fully depressed, depress the brake pedal.

**STEP 2** If necessary, set the parking brake.

When the vehicle is stopped for an extended period of time, shift the shift lever to N. (→P. 144)

## n Parking the vehicle

### ► Automatic transmission

**STEP 1** With the shift lever in D, depress the brake pedal.

**STEP 2** Set the parking brake. (→P. 148)

**STEP 3** Shift the shift lever to P. (→P. 141)

When parking on a hill, if necessary, block the wheels.

**STEP 4** Turn the engine switch off to stop the engine.

**STEP 5** Lock the door, making sure that you have the key on your person.

### ► Manual transmission

**STEP 1** With the clutch pedal fully depressed, depress the brake pedal.

**STEP 2** Set the parking brake. (→P. 148)

**STEP 3** Shift the shift lever to N. (→P. 144)

When parking on a hill, shift the shift lever to 1 or R. If necessary, block the wheels.

**STEP 4** Turn the engine switch off to stop the engine.

**STEP 5** Lock the door, making sure that you have the key on your person.

## Starting on a steep uphill

### ► Automatic transmission

**STEP 1** With the brake pedal depressed, firmly set the parking brake and shift the shift lever to D.

**STEP 2** Gently depress the accelerator pedal.

**STEP 3** Release the parking brake.

### ► Manual transmission

**STEP 1** With the parking brake firmly set and the clutch pedal fully depressed, shift the shift lever to 1.

**STEP 2** Lightly depress the accelerator pedal at the same time as gradually releasing the clutch pedal.

**STEP 3** Release the parking brake.

---

#### **n Driving in the rain**

- l Drive carefully when it is raining, because visibility will be reduced, the windows may become fogged-up, and the road will be slippery.
- l Drive carefully when it starts to rain, because the road surface will be especially slippery.
- l Refrain from high speeds when driving on an expressway in the rain, because there may be a layer of water between the tires and the road surface, preventing the steering and brakes from operating properly.

#### **n Breaking in your new Toyota**

To extend the life of the vehicle, the following precautions are recommended to observe:

- l For the first 200 miles (300 km):  
Avoid sudden stops.
- l For the first 500 miles (800 km):  
Do not tow a trailer.
- l For the first 1000 miles (1600 km):
  - Do not drive at extremely high speeds.
  - Avoid sudden acceleration.
  - Do not drive continuously in the low gears.
  - Do not drive slowly with the manual transmission in a high gear.
  - Do not drive at a constant speed for extended periods.

#### **n Operating your vehicle in a foreign country**

Comply with the relevant vehicle registration laws and confirm the availability of the correct fuel. (→P. 467)

#### **n Normal characteristics after turning off the engine**

Approximately five hours after the engine is turned off, you may hear sound coming from under the vehicle for several minutes. This is the sound of a fuel evaporation leakage check and, it does not indicate a malfunction.



 **CAUTION****n When starting the vehicle**

Vehicles with an automatic transmission, always keep your foot on the brake pedal while stopped with the engine running. This prevents the vehicle from creeping.

**n When driving the vehicle**

**I** Do not drive if you are unfamiliar with the location of the brake and accelerator pedals to avoid depressing the wrong pedal.

- Accidentally depressing the accelerator pedal instead of the brake pedal will result in sudden acceleration that may lead to an accident that could result in death or serious injury.
- When backing up, you may twist your body around, leading to a difficulty in operating the pedals. Make sure to operate the pedals properly.
- Make sure to keep a correct driving posture even when moving the vehicle only slightly, allowing you to depress the brake and accelerator pedals properly.
- Depress the brake pedal using your right foot. Depressing the brake pedal using your left foot may delay response in an emergency, resulting in an accident.

**I** Do not drive the vehicle over or stop the vehicle near flammable materials. The exhaust system and exhaust gases can be extremely hot. This may cause a fire if there is any flammable material nearby.

**I** Vehicles with an automatic transmission, do not let the vehicle roll backwards while the shift lever is in a driving position, or roll forward while the shift lever is in R.

Doing so may cause the engine to stall or lead to poor brake and steering performance, resulting in an accident or damage to the vehicle.

**I** If the smell of exhaust is noticed inside the vehicle, open the windows and check that the back window is closed. Large amounts of exhaust in the vehicle can cause driver drowsiness and an accident, resulting in death or a serious health hazard. Have the vehicle inspected by your Toyota dealer immediately.

**I** Do not under any circumstances shift the shift lever to P, R or N (automatic transmission) or R (manual transmission) while the vehicle is moving.

Doing so can cause significant damage to the transmission system and may result in a loss of vehicle control.

 **CAUTION**

**n When driving the vehicle**

- I** Do not shift the shift lever to N while the vehicle is moving.  
Doing so may cause the engine brake to not operate properly and lead to an accident.
- I** Do not turn the engine off while driving.  
The power steering and brake booster systems will not operate properly if the engine is not running.
- I** Use engine braking (downshift) to maintain a safe speed when driving down a steep hill.  
Using the brakes continuously may cause the brakes to overheat and lose effectiveness. (→P. 142, 145)
- I** When stopped on an inclined surface, use the brake pedal and parking brake to prevent the vehicle from rolling backward or forward and causing an accident.
- I** Do not adjust the position of the steering wheel, the seat, or the inside or outside rear view mirrors while driving.  
Doing so may result in a loss of vehicle control that can cause accidents that may result in death or serious injury.
- I** Always check that all passengers' arms, heads or other parts of their bodies are not outside the vehicle, as this may result in death or serious injury.
- I** Do not drive in excess of the speed limit. Even if the legal speed limit permits it, do not drive over 85 mph (140 km/h) unless your vehicle has high-speed capability tires. Driving over 85 mph (140 km/h) may result in tire failure, loss of control and possible injury. Be sure to consult a tire dealer to determine whether the tires on your vehicle are high-speed capability tires or not before driving at such speeds.

**n When driving on slippery road surfaces**

- I** Sudden braking, acceleration and steering may cause tire slippage and reduce your ability to control the vehicle, resulting in an accident.
- I** Sudden changes in engine speed, such as engine braking caused by up-shifting or down-shifting, may cause the vehicle to skid, resulting in an accident.

 **CAUTION**
**n When driving on slippery road surfaces**

- I After driving through a puddle, lightly depress the brake pedal to make sure that the brakes are functioning properly. Wet brake pads may prevent the brakes from functioning properly. If the brakes on only one side are wet and not functioning properly, steering control may be affected, resulting in an accident.

**n When shifting the shift lever**

- I Vehicles with an automatic transmission, be careful not to shift the shift lever with the accelerator pedal depressed.  
This may lead to unexpected rapid acceleration of the vehicle that may cause an accident and result in death or serious injury.

**n When the vehicle is stopped**

- I Do not race the engine.  
If the vehicle is in any gear other than P (automatic transmission only) or N, the vehicle may accelerate suddenly and unexpectedly, and may cause an accident.
- I Do not leave the vehicle with the engine running for a long time.  
If such a situation cannot be avoided, park the vehicle in an open space and check that exhaust fumes do not enter the vehicle interior.
- I Vehicles with an automatic transmission, always keep a foot on the brake pedal while the engine is running to prevent an accident caused by the vehicle moving.

**n When the vehicle is parked**

- I Do not leave glasses, cigarette lighters, spray cans, or soft drink cans in the vehicle when it is in the sun.  
Doing so may result in the following.
  - Gas may leak from a cigarette lighter or spray can, and may lead to a fire.
  - The temperature inside the vehicle may cause the plastic lenses and plastic material of eye glasses to deform or crack.
  - Soft drink cans may fracture, causing the contents to spray over the interior of the vehicle, and may also cause a short circuit in the vehicle's electrical components.

 **CAUTION**

**n When the vehicle is parked**

- I** Always apply the parking brake, shift the shift lever to P (automatic transmission only), stop the engine and lock the vehicle.  
Do not leave the vehicle unattended while the engine is running.
- I** Do not touch the exhaust pipe while the engine is running or immediately after turning the engine off.  
Doing so may cause burns.
- I** Do not leave the engine running in an area with snow build-up, or where it is snowing. If snowbanks build up around the vehicle while the engine is running, exhaust gases may collect and enter the vehicle. This may lead to death or a serious health hazard.

**n Exhaust gases**

Exhaust gases include harmful carbon monoxide (CO) that is colorless and odorless. Inhaling exhaust gases may lead to death or a serious health hazard.

- I** If the vehicle is in a poorly ventilated area, stop the engine. In a closed area, such as a garage, exhaust gases may collect and enter the vehicle. This may lead to death or a serious health hazard.
- I** The exhaust should be checked occasionally. If there is a hole or crack caused by corrosion, damage to a joint or abnormal exhaust noise, be sure to have the vehicle inspected and repaired by your Toyota dealer. Failure to do so may allow exhaust gases to enter the vehicle, resulting in death or a serious health hazard.
- I** Toyota does not recommend occupying the rear cargo area when it is fitted with a slide-in camper, camper shell or other type cover while the engine is running. This caution applies to both driving and stopped or parked situations with the engine running. Particular care should be taken to prevent exhaust gases from entering camper bodies, trailers or other enclosures on or around your vehicle. If exhaust fumes are detected, open all windows and thoroughly ventilate the area.

 **CAUTION****n When taking a nap in the vehicle**

Always turn the engine off. Otherwise, you may accidentally move the shift lever or depress the accelerator pedal, which could cause an accident or fire due to engine overheating. Additionally, if the vehicle is parked in a poorly ventilated area, exhaust gases may collect and enter the vehicle, leading to death or a serious health hazard.

**n When braking the vehicle**

**I** When the brakes are wet, drive more cautiously.

Braking distance increases when the brakes are wet, and may cause one side of the vehicle to brake differently than the other side. Also the parking brake may not securely hold the vehicle.

**I** If the power brake assist function does not operate, do not follow other vehicles closely and avoid downhills or sharp turns that require braking. In this case, braking is still possible, but it will require more force on the pedal than usual. Braking distance may also increase.

**I** Do not pump the brake pedal if the engine stalls.

Each push on the brake pedal uses up the reserve for the power-assisted brakes.

**I** The brake system consists of 2 individual hydraulic systems: If one of the systems fails, the other will still operate. In this case, the brake pedal should be depressed more firmly than usual and braking distance becomes longer.

Do not drive your vehicle with only a single brake system. Have your brakes fixed immediately.

 NOTICE

**n When driving the vehicle**

▶ Vehicles with a manual transmission

- ! Do not rest your foot on the clutch pedal while driving.  
Doing so may cause clutch trouble.
- ! Do not use any gears other than the first gear when starting off and moving forward.  
Doing so may damage the clutch.
- ! Do not use the clutch to hold the vehicle when stopping on an uphill grade.  
Doing so may damage the clutch.

▶ Vehicles with an automatic transmission

- ! Do not use the accelerator pedal or depress accelerator and brake pedals together to hold the vehicle on a hill.

**n When parking the vehicle**

Vehicles with an automatic transmission: Always put the shift lever in P. Failure to do so may cause the vehicle to move or the vehicle may accelerate suddenly if the accelerator pedal is accidentally depressed.

**n Avoiding damage to vehicle parts**

- ! Do not turn the steering wheel fully in either direction and hold it there for a long time.  
Doing so may damage the power steering pump.
- ! When driving over bumps in the road, drive as slowly as possible to avoid damaging the wheels, underside of the vehicle, etc.

**n If you hear a squealing or scraping noise while driving (brake pad wear limit indicators)**

Have the brake pads checked and replaced by your Toyota dealer as soon as possible.

The rotor damage can result if the pads are not replaced when needed.

It is dangerous to drive the vehicle when the wear limits of the brake pads and/or that of the brake discs are exceeded.

 NOTICE**n If you get a flat tire while driving**

A flat or damaged tire may cause the following situations. Hold the steering wheel firmly and gradually press the brake pedal to slow down the vehicle.

- | It may be difficult to control your vehicle.
- | The vehicle will make abnormal sounds.
- | The vehicle will behave abnormally.

Replace a flat tire with a new one. (→P. 439)

**n When encountering flooded roads**

Do not drive on a road that has flooded after heavy rain etc. Doing so may cause the following serious damage to the vehicle.

- | Engine stalling
- | Short in electrical components
- | Engine damage caused by water immersion

In the event that you drive on a flooded road and the vehicle is flooded, be sure to have your Toyota dealer check the following.

- | Brake function
- | Changes in quantity and quality of oil and fluid used for the engine, transmission, transfer (4WD vehicles), differentials, etc.
- | Lubricant condition for the propeller shaft, bearings and suspension joints (where possible) and the function of all joints, bearings, etc.

## Engine (ignition) switch

### n Engine switch

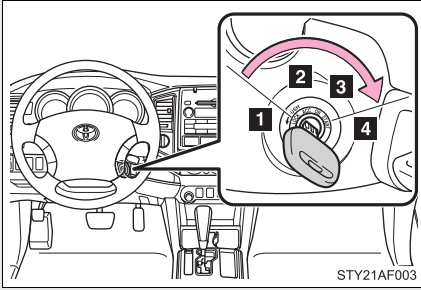

#### 1 LOCK

The steering wheel is locked and the key can be removed.

#### 2 ACC

Some electrical components such as the audio system can be used.

#### 3 ON

All electrical components can be used.

#### 4 START

For starting the engine.

### n Starting the engine

#### ► Automatic transmission

**STEP 1** Check that the parking brake is set.

**STEP 2** Check that the shift lever is set in P.

**STEP 3** Sit in the driver's seat and firmly depress the brake pedal.

**STEP 4** Turn the engine switch to the START position and start the engine.

#### ► Manual transmission

**STEP 1** Check that the parking brake is set.

**STEP 2** Check that the shift lever is set in N.

**STEP 3** Firmly depress the brake pedal and clutch pedal.

**STEP 4** Turn the engine switch to the START position and start the engine.



## n Turning the key from ACC to LOCK

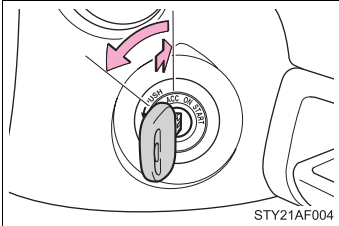

**STEP 1** Shift the shift lever to P (automatic transmission) or N (manual transmission). (→P. 141, 144)

**STEP 2** Push in the key and turn to the LOCK position.

## n Steering lock release

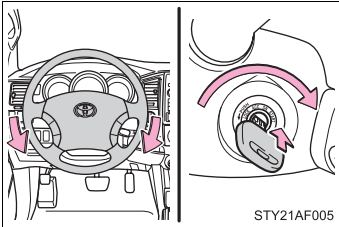

When starting the engine, the engine switch may seem stuck in the LOCK position. To free it, turn the key while turning the steering wheel slightly in either direction.

## n If the engine does not start (vehicles with engine immobilizer system)

The engine immobilizer system may not have been deactivated. (→P. 76)

## n Key reminder function

A buzzer sounds if the driver's door is opened, while the engine switch is in the ACC or LOCK position to remind you to remove the key.

## ⚠ CAUTION

### n When starting the engine

Always start the engine while sitting in the driver's seat. Do not depress the accelerator while starting the engine under any circumstances.

Doing so may cause an accident resulting in death or serious injury.

 **CAUTION**

**n Caution while driving**

Do not turn the engine switch to the LOCK position.

If in an emergency, you must turn the engine off while the vehicle is moving, turn the engine switch only to the ACC position.

 **NOTICE**

**n To prevent battery discharge**

Do not leave the engine switch in the ACC or ON position for long periods if the engine is not running.

**n When starting the engine**

**!** Do not crank for more than 30 seconds at a time. This may overheat the starter and wiring systems.

**!** Do not race a cold engine.

**!** If the engine becomes difficult to start or stalls frequently, have the engine checked immediately.

Select a shift position appropriate for the driving conditions.

n **Shifting the shift lever**

▶ **5-speed models**

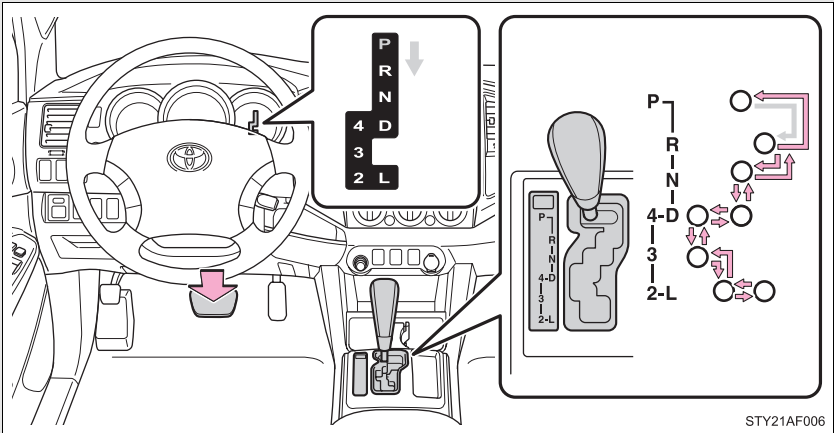

← While the engine switch is on, depress the brake pedal and move the shift lever.

▶ **4-speed models**

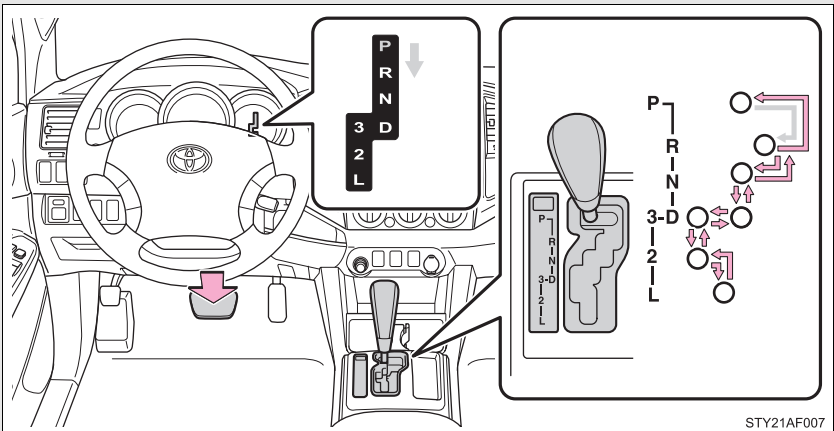

← While the engine switch is on, depress the brake pedal and move the shift lever.

## n Shift position uses

Shift position	Function	
	5-speed models	4-speed models
P	Parking the vehicle or starting the engine	
R	Reversing	
N	Neutral	
D	Normal driving*	
4	Position for engine braking	—
3	Position for more powerful engine braking	Position for engine braking
2	Position for more powerful engine braking	
L	Position for maximum engine braking	

\*: To improve fuel consumption and reduce noises, set the shift lever in D for normal driving.

## n Downshifting restrictions

The shift lever cannot be downshifted if the following speeds are exceeded.

### ► 2WD models

mph (km/h)

Downshifting	Maximum speed	
	5-speed models	4-speed models
4 → 3	82 (133)	—
3 → 2	54 (88)	74 (119)
2 → L	24 (39)	35 (57)

## ► 4WD models

mph (km/h)

Downshifting	Transfer position	Maximum speed
4 → 3	H2 and H4	82 (133)
	L4	31 (51)
3 → 2	H2 and H4	54 (88)
	L4	21 (34)
2 → L	H2 and H4	24 (39)
	L4	9 (15)

n **When driving with the cruise control system (if equipped)**

The engine brake will not operate when downshifting from D to 4 (5-speed models) or 3 (4-speed models). (→P. 163)

n **If the shift lever cannot be shifted from P**

→P. 450

# Manual Transmission (if equipped)

## n Shifting the shift lever

### ▶ 6-speed models

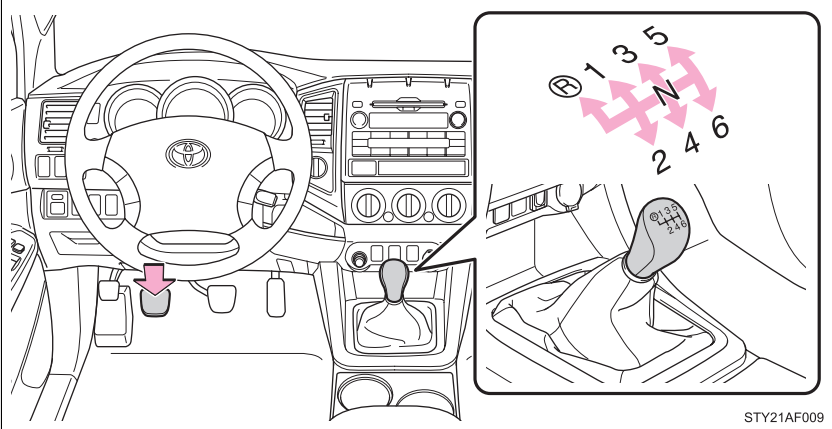

Fully depress the clutch pedal before operating the shift lever, and then release it slowly.

### ▶ 5-speed models

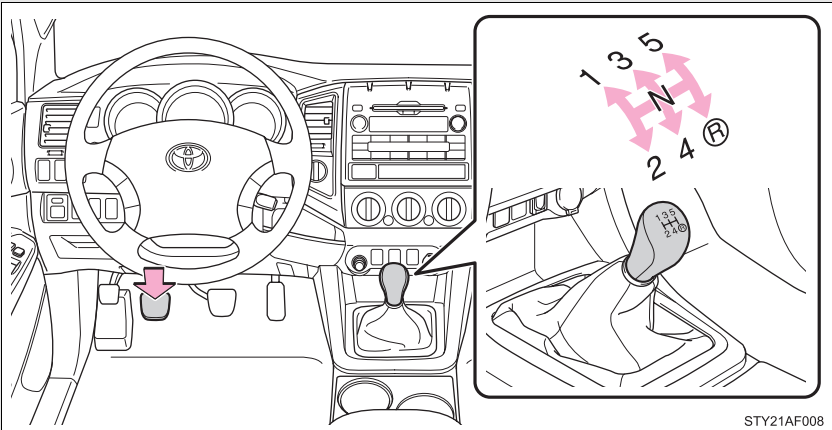

Fully depress the clutch pedal before operating the shift lever, and then release it slowly.

### n Maximum allowable speed

Observe the following maximum allowable speeds in each gear when maximum acceleration is necessary.

#### ► 2WD models except PreRunner

mph (km/h)

Shift position	Maximum speed	
	6-speed models	5-speed models
1	32 (52)	33 (53)
2	61 (99)	63 (101)
3	91 (146)	90 (146)
4	113 (182)	130 (209)

#### ► PreRunner

mph (km/h)

Shift position	Maximum speed	
	6-speed models	5-speed models
1	30 (49)	30 (48)
2	58 (93)	57 (92)
3	85 (137)	82 (133)
4	106 (171)	118 (190)
5	127 (204)	—

## ► 4WD models

mph (km/h)

Shift position	Transfer position	Maximum speed	
		6-speed models	5-speed models
1	H2 and H4	30 (49)	30 (48)
	L4	11 (19)	11 (18)
2	H2 and H4	58 (93)	57 (92)
	L4	22 (36)	22 (36)
3	H2 and H4	85 (137)	82 (133)
	L4	33 (53)	32 (51)
4	H2 and H4	106 (171)	118 (190)
	L4	41 (66)	46 (74)
5	H2 and H4	127 (204)	—
	L4	49 (79)	—

□ **Reverse warning buzzer (6-speed models only)**

When shifting into R, a buzzer will sound to inform the driver that the shift lever is in R.



## 2-1. Driving procedures

### Turn signal lever

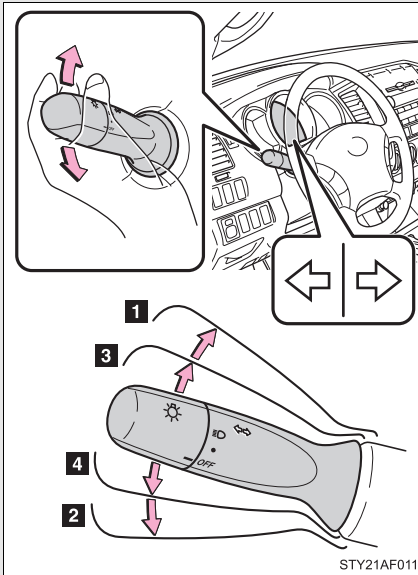

**1** Right turn

**2** Left turn

**3** Move and hold the lever partway to signal a lane change.

The right hand signal will flash until you release the lever.

**4** Move and hold the lever partway to signal a lane change.

The left hand signal will flash until you release the lever.

2

When driving

#### n Turn signals can be operated when

The engine switch is in the ON position.

#### n If the indicators flash faster than usual

Check that a light bulb in the front or rear turn signal lights has not burned out.

## 2-1. Driving procedures

### Parking brake

#### ▶ Lever type

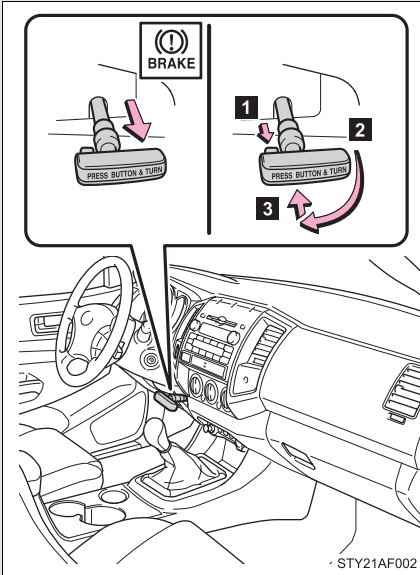

#### 1 Sets the parking brake

Fully set the parking brake while depressing the brake pedal.

At this time, the indicator will come on.

#### 1 Release the parking brake

**1** Press the button

**2** Turn the lever clockwise

**3** Press it in completely

#### ▶ Pedal type

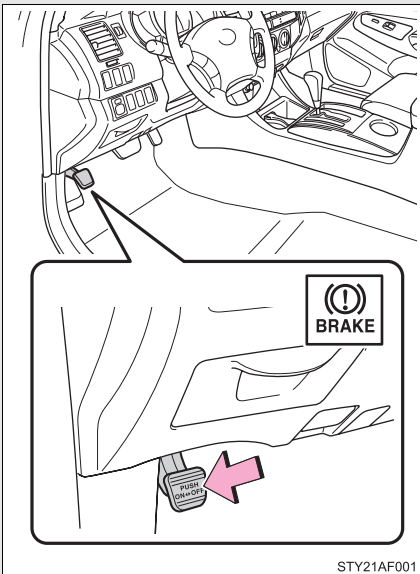

Sets the parking brake\*. (Depressing the pedal again releases the parking brake.)

At this time, the indicator will come on.

\*: Fully depress the parking brake pedal with your left foot while depressing the brake pedal with your right foot.

---

**n Parking brake engaged warning buzzer**

The buzzer sounds to indicate that parking brake is still engaged (with the vehicle having reach a speed of 3 mph [5 km/h]).

**NOTICE****n Before driving**

Fully release the parking brake.

Driving the vehicle with the parking brake set will lead to brake components overheating, which may affect braking performance and increase brake wear.

## 2-2. Gauges and meters

### Gauges and meters

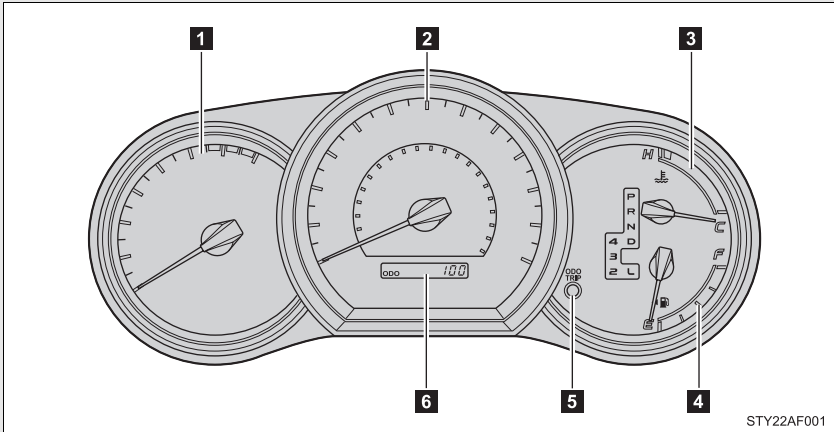

The following gauges, meters and displays illuminate when the engine switch is in the ON position.

**1** Tachometer

Displays the engine speed in revolutions per minute.

**2** Speedometer

Displays the vehicle speed.

**3** Engine coolant temperature gauge

Displays the engine coolant temperature.

**4** Fuel gauge

Displays the quantity of fuel remaining in the tank.

**5** ODO/TRIP button

Switches between odometer and trip meter displays. Pushing and holding the button will reset the trip meter when the trip meter is being displayed.

**6 Odometer/trip meter**

Odometer:

Displays the total distance the vehicle has been driven.

Trip meter:

Displays the distance the vehicle has been driven since the meter was last reset. Trip meters A and B can be used to record and display different distances independently.

**Odometer and trip meter display button**

Pressing this button switches between odometer and trip meter displays.

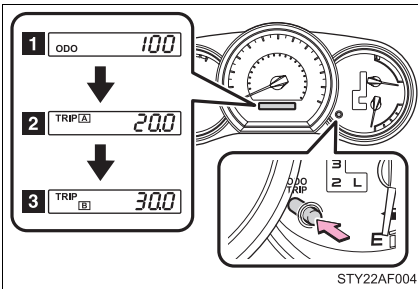

**1** Odometer

**2** Trip meter A \*

**3** Trip meter B \*

\*:Pushing and holding the button will reset the trip meter.

**Instrument panel light control**

The brightness of the instrument panel lights can be adjusted.

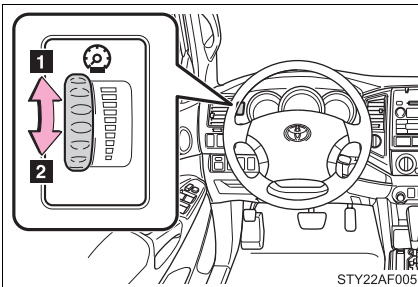

**1** Brighter

**2** Darker

 NOTICE

**n To prevent damage to the engine and its components**

- l** Do not let the indicator needle of the tachometer enter the red zone, which indicates the maximum engine speed.
- l** The engine may be overheating if the engine coolant temperature gauge is in the red zone (H). In this case, immediately stop the vehicle in a safe place, and check the engine after it has cooled completely. (→P. 456)

The indicator and warning lights on the instrument cluster and center panel inform the driver of the status of the vehicle's various systems.

► Instrument cluster

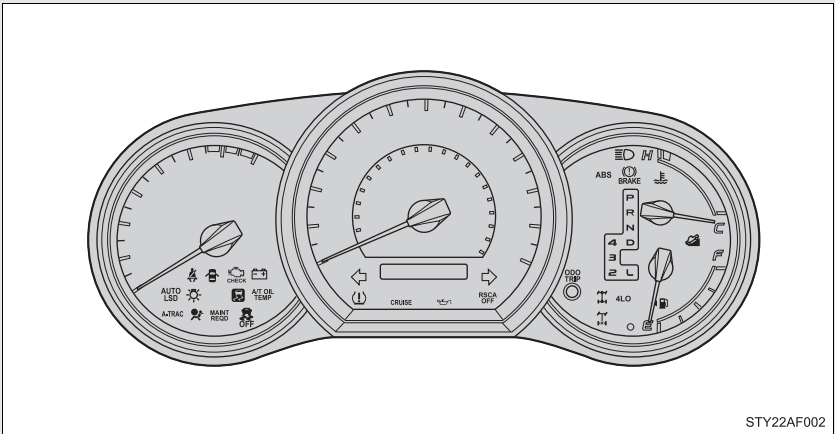

STY22AF002

► Center panel

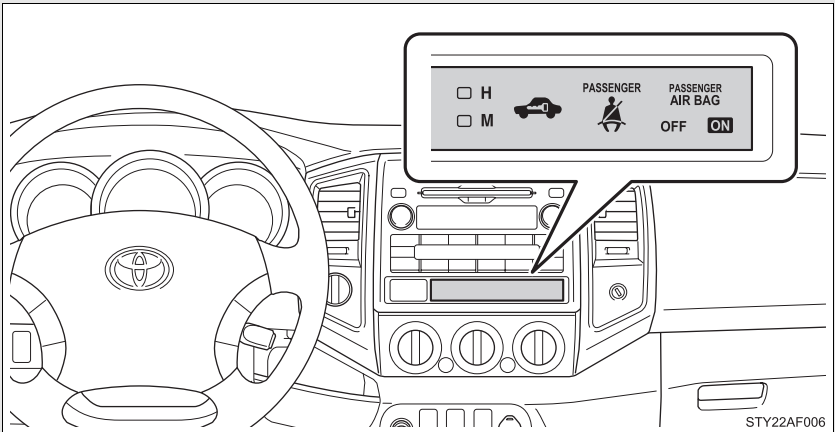

STY22AF006

## n Indicators

The indicators inform the driver of the operating state of the vehicle's various systems.



Turn signal indicator  
(→P. 147)



Headlight high beam indicator (→P. 157)



(U.S.A.)

Headlight indicator  
(→P. 157)



(Canada)

Tail light indicator  
(→P. 157)



(if equipped)

Security indicator  
(→P. 76)

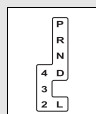

(5-speed automatic transmission vehicles)

Shift position and shift range indicators  
(→P. 141)

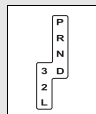

(4-speed automatic transmission vehicles)

Shift position and shift range indicators  
(→P. 141)



(if equipped)

Cruise control indicator  
(→P. 163)



\*1,2

Slip indicator  
(→P. 174, 176, 185)



\*1

VSC OFF indicator  
(→P. 176,185)



(if equipped)

\*1

Downhill assist control system indicator  
(→P. 181)



\*1

RSCA OFF indicator  
(→P. 95)



(if equipped)

Active traction control system indicator  
(→P. 174)



\*1

AUTO LSD indicator  
(→P. 176)



(4WD models)

Four-wheel drive indicator(→P. 170)



(4WD models)

4LO indicator (→P. 170)



(if equipped)

\*1

Rear differential lock indicator (→P. 178)



\*1

AIR BAG ON indicator  
(→P. 97)



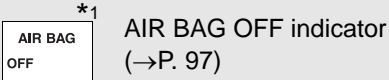

## n Warning lights

Warning lights inform the driver of malfunctions in any of the vehicle's systems. (→P. 424)

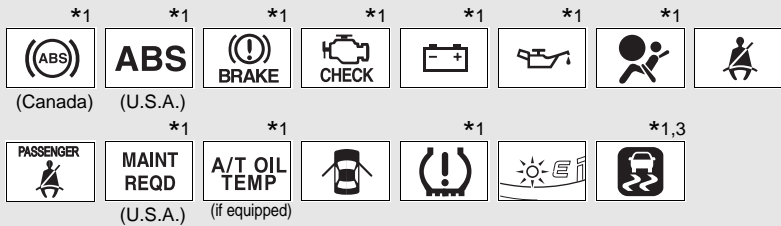

\*1: These lights turn on when the engine switch is turned to the ON position to indicate that a system check is being performed. They will turn off after the engine is started, or after a few seconds. There may be a malfunction in a system if a light does not come on, or if the lights do not turn off. Have the vehicle inspected by your Toyota dealer.

\*2: The indicator flashes to indicate that the system is operating.

\*3: The indicator light comes on to indicate a malfunction.

## ⚠ CAUTION

### n If a safety system warning light does not come on

Should a safety system light such as ABS and the SRS airbag warning light not come on when you start the engine, this could mean that these systems are not available to help protect you in an accident, which could result in death or serious injury. Have the vehicle inspected by your Toyota dealer immediately if this occurs.

## Accessory meter (if equipped)

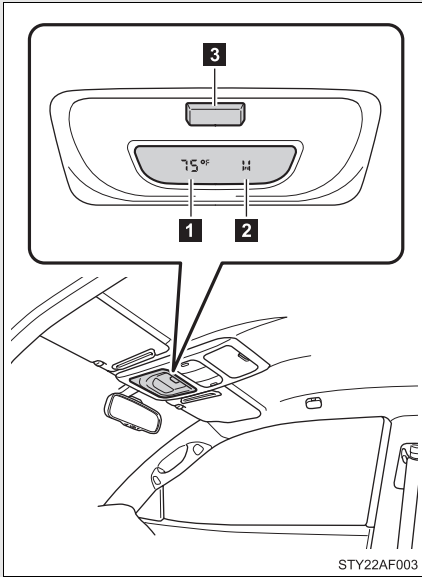

- 1** Outside temperature  
Displays the outside air temperature. (→P. 308)
- 2** Compass  
Displays the direction that the vehicle is heading. (→P. 332)
- 3** Display button  
Every time you press this button, the display toggles through the following information.

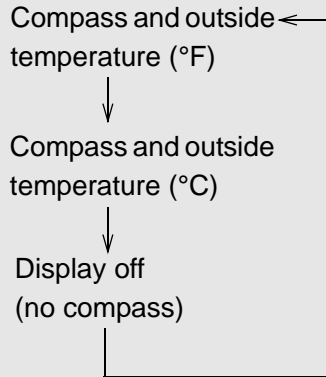

**n The accessory meter can be operated when**

The engine switch must be in the ON position.

## 2-3. Operating the lights and wipers

### Headlight switch

The headlights can be operated manually.

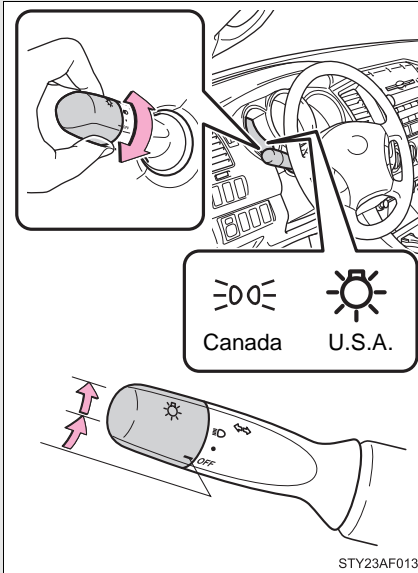

● The side marker, parking, tail, license plate and instrument panel lights turn on.

☰☉ The headlights and all lights listed above turn on.

2

When driving

### Turning on the high beam headlights

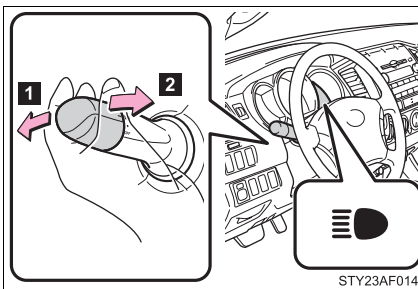

**1** With the headlights on, push the lever forward to turn on the high beams.

Pull the lever back to the center position to turn the high beams off.

**2** Pull the lever toward you to turn on the high beams.

Release the lever to turn them off. You can flash the high beams with the headlights on or off.

■ **Daytime running light system (if equipped)**

To make your vehicle more visible to other drivers, the front turn signal lights turn on automatically whenever the engine is started and the parking brake is released. Daytime running lights are not designed for use at night.

■ **Automatic light off system**

Opening the driver's door with the engine switch in the ACC or LOCK position will turn the headlights and tail lights off.

To turn the lights on again, turn the engine switch to the ON position, or turn the headlight switch off once and then back to the ● or ☰ position.



**NOTICE**

■ **To prevent battery discharge**

Do not leave the lights on longer than necessary when the engine is not running.

## 2-3. Operating the lights and wipers Fog light switch (if equipped)

The fog lights improve visibility in difficult driving conditions, such as in rain or fog.

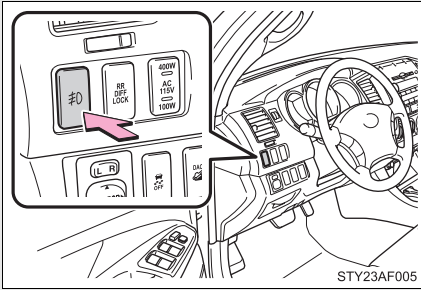

On/off

- n **The fog lights can be turned on only when**  
The headlights are on low beam.

## 2-3. Operating the lights and wipers Windshield wipers and washer

### n Without intermittent type

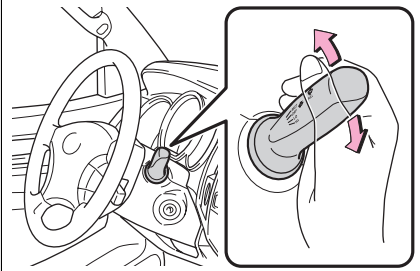

**1** Low speed windshield wiper operation

**2** High speed windshield wiper operation

**3** Temporary operation

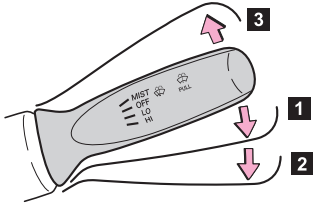

STY23AF011

**4** Washer operation

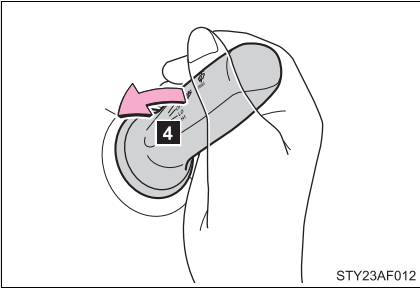

STY23AF012

**n Intermittent wiper with interval adjuster**

Wiper intervals can be adjusted for intermittent operation (when INT is selected).

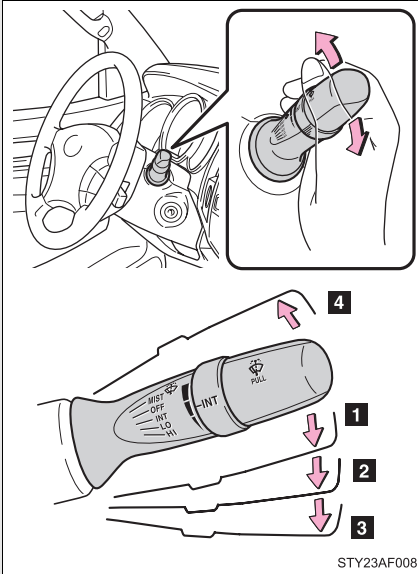

- 1** Intermittent windshield wiper operation
- 2** Low speed windshield wiper operation
- 3** High speed windshield wiper operation
- 4** Temporary operation

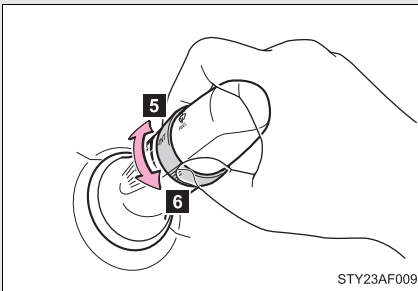

- 5** Intermittent wiper interval adjustment (increase)
- 6** Intermittent wiper interval adjustment (decrease)

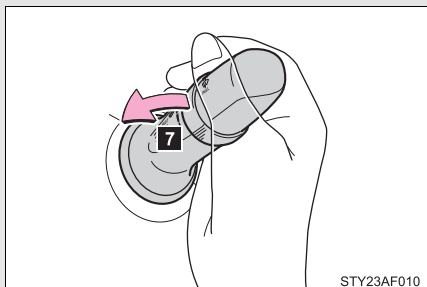

**7 Washer/wiper dual operation**

Wipers will automatically operate a couple of times after the washer squirts.

**n The windshield wiper and washer can be operated when**

The engine switch must be in the ON position.

**n If no windshield washer fluid sprays**

Check that the washer nozzles are not blocked and if there is washer fluid in the windshield washer fluid reservoir.

**! NOTICE**

**n When the windshield is dry**

Do not use the wipers, as they may damage the windshield.

**n When there is no washer fluid spray from the nozzle**

Damage to the washer fluid pump may be caused if the lever is pulled toward you and held continually.

**n When a nozzle becomes block**

Do not try to clear it with a pin or other object. The nozzle will be damaged.



## 2-4. Using other driving systems Cruise control (if equipped)

Use cruise control to maintain a set speed without using the accelerator.

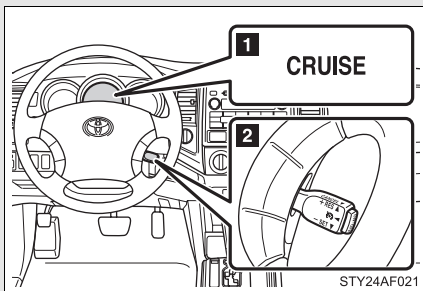

- 1 Indicator
- 2 Cruise control switch

### n Set the vehicle speed

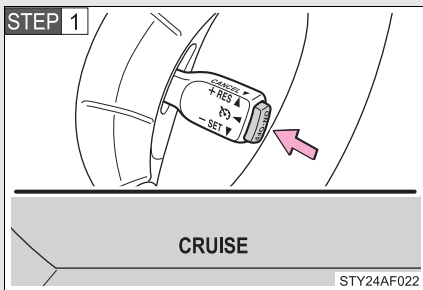

Press the ON-OFF button to turn the cruise control on.

At this time, the cruise control indicator will come on.

Press the button once more to deactivate the cruise control.

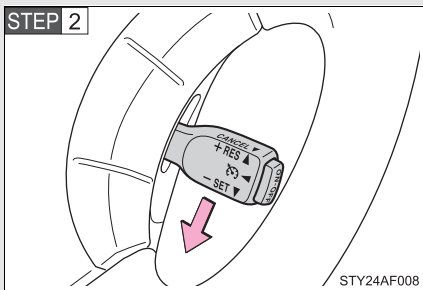

Accelerate or decelerate to the desired speed and push the lever down to set the cruise control speed.

**n Adjusting the speed setting**

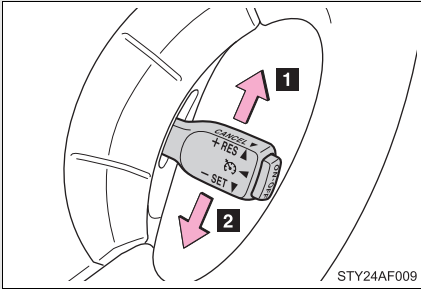

**1** Increase speed

**2** Decrease speed

Hold the lever until the desired speed setting is obtained.

Fine adjustment of the set speed (approximately 1.0 mph [1.6 km/h]) can be made by lightly pushing the lever up or down and releasing it.

**n Canceling and resuming regular acceleration**

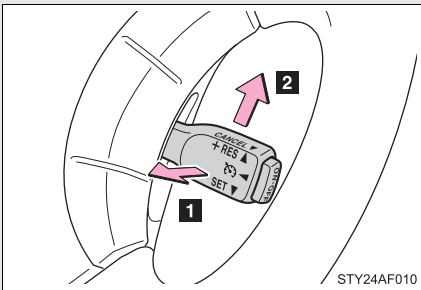

**1** Cancel

Pull the lever towards you to cancel cruise control.

The speed setting is also canceled when the brakes are applied or the clutch depressed (manual transmission).

**2** Resume

To resume cruise control and return to the set speed, push the lever up.

**n Cruise control can be set when**

- 1 The shift lever is in D, 4 (vehicles with 5-speed automatic transmission) or 3 (vehicles with 4-speed automatic transmission).
- 1 Vehicle speed is more than approximately 25 mph (40 km/h).

**n Accelerating**

The vehicle can be accelerated normally.

**n Automatic cruise control cancelation**

The set speed is automatically cancelled in any of the following situations.

- l Actual vehicle speed falls more than 10 mph (16 km/h) below the preset vehicle speed.  
At this time, the memorized set speed is not retained.
- l Actual vehicle speed is below 25 mph (40 km/h).
- l VSC is activated.

**n If the cruise control indicator light flashes**

Press the ON-OFF button to turn the cruise control off, and then reactivate the system.

If the cruise control speed cannot be set or if the cruise control cancels immediately after being activated, there may be a malfunction in the cruise control system. Have the vehicle inspected by your Toyota dealer.

**⚠ CAUTION****n To avoid operating the cruise control by mistake**

Keep the ON-OFF button off when not in use.

**n Situations unsuitable for cruise control**

Do not use cruise control in any of the following situations.

Doing so may result in control of the vehicle being lost and could cause serious or fatal accident.

- l In heavy traffic
- l On roads with sharp bends
- l On winding roads
- l On slippery roads, such as those covered with rain, ice or snow
- l On steep hills
- l When towing a trailer

## 2-4. Using other driving systems

### Rear view monitor system (vehicles with auto anti-glare inside rear view mirror)

The rear view monitor system assists the driver by displaying an image of the area behind the vehicle. The image is displayed in reverse on the screen. This reversed image is a similar image to the one on the inside rear view mirror.

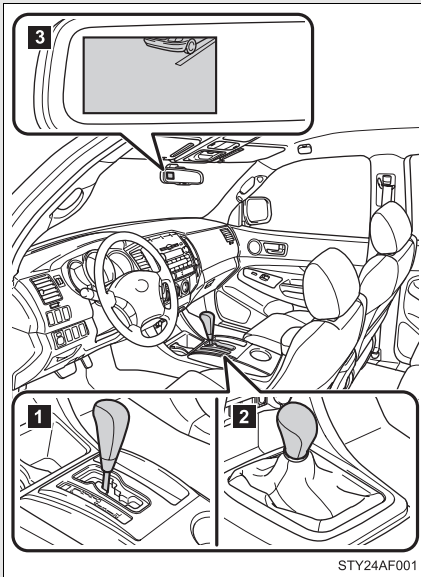

The rear view image is displayed on the inside rear view mirror.

If the shift lever is shifted out of R, the screen is turned off.

- 1** Automatic transmission
- 2** Manual transmission
- 3** Screen

#### n The rear view monitor system can be operated when

The shift lever is in R and engine switch is ON.

## 11 Switching the screen ON/OFF mode

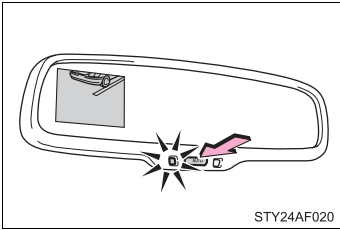

While displaying the screen, press the AUTO button on the inside the rear view mirror to switch the screen ON/OFF mode.

Screen ON mode: Green indicator comes on.

Screen OFF mode: Orange indicator comes on.

The auto anti-glare inside rear view mirror will revert to the automatic mode each time the engine switch is turned on.

## 11 Displayed area

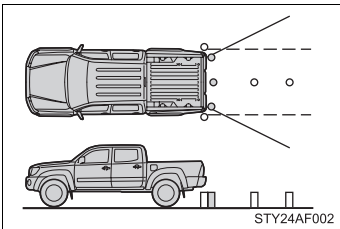

The area covered by the camera is limited. Objects that are close to either corner of the bumper or under the bumper cannot be seen on the screen.

The area displayed on the screen may vary according to vehicle orientation or road conditions.

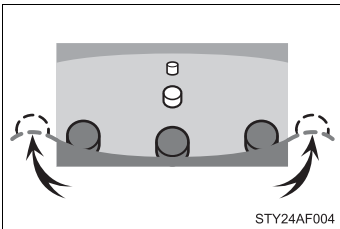

### ▮ Rear view monitor system camera

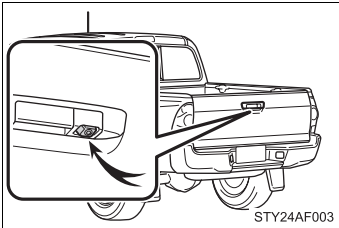

In the following cases, it may become difficult to see the images on the screen, even when the system is functioning correctly.

- ▮ The vehicle is in a dark area, such as at night.
- ▮ The temperature near the lens is extremely high or low.
- ▮ Water droplets are on the camera lens or humidity is high, such as when it rains.
- ▮ Foreign matter, such as snow or mud, adheres to the camera lens.
- ▮ The sun or headlights are shining directly into the camera lens.

### ▮ Smear effect

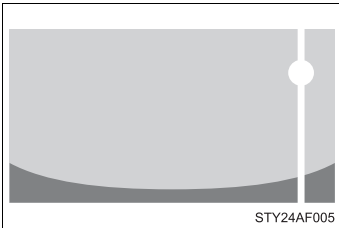

If a bright light, such as sunlight reflected off the vehicle body, is picked up by the camera, a smear effect\* characteristic to the camera may occur.

\*: Smear effect: A phenomenon that occurs when a bright light is picked up by the camera; when transmitted by the camera, the light source appears to have a vertical streak above and below it.

 CAUTION

**n When using the rear view monitor system, observe the following precautions to avoid an accident that could result in death or serious injuries.**

- l** Never depend solely on the monitor system when reversing.
- l** Always check visually and with the mirrors to confirm your intended path is clear.
- l** Depicted distances between objects and flat surfaces differ from actual distances.
- l** Do not use the system if the tailgate open.

**n Conditions which may affect the rear view monitor system**

- l** If the back of the vehicle has been hit, the camera's position and mounting angle may have changed. Have the vehicle inspected by your Toyota dealer.
- l** Rapid temperature changes, such as when hot water is poured on the vehicle in cold weather, may cause the system to function abnormally.
- l** If the camera lens is dirty, it cannot transmit a clear image. Rinse with water and wipe with a soft cloth. If extremely dirty, wash with a mild cleanser and rinse.
- l** The displayed image may be darker and moving images may be slightly distorted when the system is cold.

## 2-4. Using other driving systems

### Four-wheel drive system (if equipped)

Use the front-wheel drive control switch to select the following transfer modes.

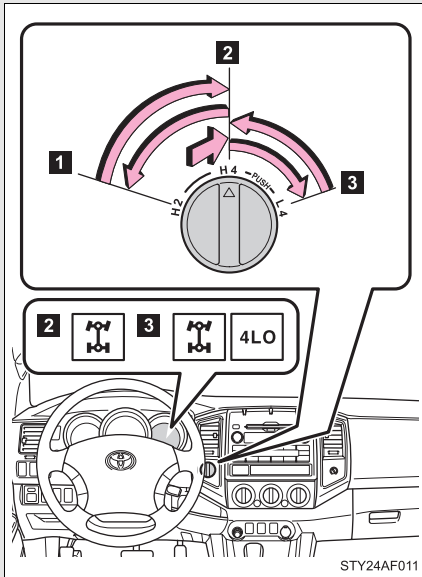

**1** H2 (high speed position, two-wheel drive)  
Normal driving

**2** H4 (high speed position, four-wheel drive)  
Greater traction than two wheel drive.  
When you experience a loss of power, such as wheel slipping.

The four-wheel drive indicator comes on.

**3** L4 (low speed position, four-wheel drive)  
Driving requiring maximum power and traction such as climbing or descending steep hills, off-road driving, and hard pulling in sand or mud, etc.

The four-wheel drive and 4LO indicators come on.



## Shifting between H4 and L4

### n Shifting from H4 to L4

#### ► Automatic transmission

**STEP 1** Stop the vehicle completely.

**STEP 2** Shift the shift lever to N.

**STEP 3** Push and turn the front-wheel drive control switch fully clockwise.

If the four-wheel drive indicator flashes and the buzzer sounds, try the above steps again.

#### ► Manual transmission

**STEP 1** Stop the vehicle or reduce your speed to less than 2 mph (3 km/h).

**STEP 2** Depress the clutch pedal all the way.

**STEP 3** Push and turn the front-wheel drive control switch fully clockwise.

If the four-wheel drive indicator flashes and the buzzer sounds, try the above steps again.

### n Shifting from L4 to H4

#### ► Automatic transmission

**STEP 1** Stop the vehicle completely.

**STEP 2** Shift the shift lever to N.

**STEP 3** Turn the front-wheel drive control switch counterclockwise.

If the four-wheel drive indicator flashes and the buzzer sounds, try the above steps again.

#### ► Manual transmission

**STEP 1** Stop the vehicle or reduce your speed to less than 2 mph (3 km/h).

**STEP 2** Depress the clutch pedal all the way.

**STEP 3** Turn the front-wheel drive control switch counterclockwise.

If the four-wheel drive indicator flashes and the buzzer sounds, try the above steps again.

**n Shifting between H2 and H4**

**l Shifting from H2 to H4**

Reduce the vehicle speed to less than 62 mph (100 km/h) and turn the front-wheel drive control switch fully clockwise.

**l Shifting from H4 to H2.**

Turn the front-wheel drive control switch fully counterclockwise.

This can be done at any speed. You need not depress the clutch pedal. (manual transmission)

**n If the four-wheel drive indicator light or the 4LO indicator light blinks**

**l Shifting from H2 to H4**

- If the four-wheel drive indicator continues to blink, drive straight ahead while accelerating or decelerating.
- If the four-wheel drive indicator continues to blink and the buzzer sounds, stop the vehicle or reduce the vehicle speed to less than 62 mph (100 km/h). Operate the switch again.

**l Shifting from H4 to H2**

- If the four-wheel drive indicator continues to blink, drive straight ahead while accelerating or decelerating, or drive forward or backward in a short distance.

**l Shifting to H4 or L4**

► Automatic transmission

If the 4LO indicator continues to blink when you operate the front-wheel drive control switch to the H4 or L4 position, drive forward or backward in a short distance, then stop the vehicle completely, shift the automatic transmission selector lever securely into N and operate the switch again.

► Manual transmission

If the 4LO indicator continues to blink when you operate the front-wheel drive control switch to the H4 or L4 position, drive forward or backward in a short distance, then stop the vehicle completely, depress the clutch pedal and operate the switch again.

If the indicator light continues to blink even if doing so, contact your Toyota dealer as soon as possible. There may be a trouble in the four-wheel drive system.

**n Shifting to L4.**

VSC is automatically turned off.

**n Four-wheel drive usage frequency**

You should drive in four-wheel drive for at least 10 miles (16 km) each month.

This will assure that the front-drive components are lubricated.

**⚠ CAUTION****n Caution while driving**

Never operate the front-wheel drive control switch if the wheels are slipping. Stop the slipping or spinning before operating.

## 2-4. Using other driving systems

### Active traction control system (if equipped)

The active traction control system automatically helps prevent the spinning of 4 wheels when the vehicle is started or accelerated on slippery road surfaces.

#### n System operation

**STEP 1** Vehicles with an automatic transmission:

Stop the vehicle, shift the shift lever to N and put the front-wheel drive control switch in the L4 position.

Vehicles with a manual transmission:

Stop the vehicle or reduce your speed to less than 2 mph (3 km/h). Depress the clutch pedal and put the front-wheel drive control switch in the L4 position.

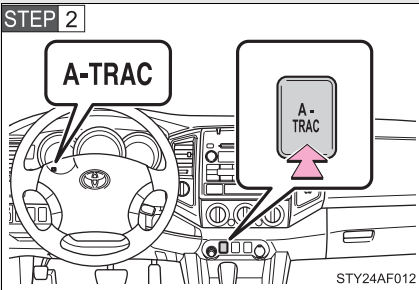

Press the A-TRAC switch to activate the system.

At this time, the active traction control system indicator will come on.

To cancel the system, push the switch again.

#### When the active traction control system is operating

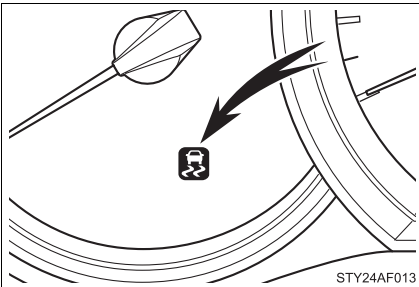

If four wheels spin, the slip indicator flashes to indicate that the active traction control system has been engaged.

---

n **When the rear differential is locked (vehicles with the rear differential lock system)**

The active traction control system is activated only when the vehicle speed is less than 3 mph (6 km/h).

n **Sounds and vibrations caused by the active traction control system**

- l A sound may be heard from the engine compartment when the engine is started or just after the vehicle begins to move. This sound does not indicate that a malfunction has occurred in the system.
- l Vibrations may be felt through the vehicle body and steering. It may occur when the system is operating.

n **If the brake system overheats**

The system will cease operation, a buzzer will sound and A-TRAC indicator blink to alert the driver. Stop the vehicle in a safe place. (There is no problem with continuing normal driving.)

The system will be automatically restored after a short time.

 **CAUTION**

n **The active traction control system may not operate effectively when**

Directional control and power may not be achievable while driving on slippery road surfaces, even if the active traction control system is operating. Do not drive the vehicle in conditions where stability and power may be lost.

## AUTO LSD system

The AUTO LSD system aids traction by using the traction control system to control engine performance and braking when one of the rear wheels begins to spin.

The system should be used only when one of the rear wheels spinning occurs in a ditch or rough surface.

### n System operation

The system can be used on 2WD models and in 2WD mode on 4WD models.

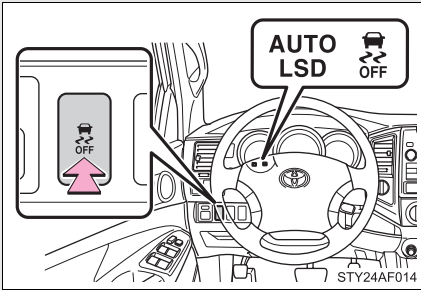

Press the VSC OFF switch to turn on the system.

At this time, the AUTO LSD and VSC OFF indicators will come on simultaneously.

To turn off the system, push the switch again.

If the engine is turned off while the AUTO LSD indicator is on and then restarted, the indicator will turn off automatically.

### When the AUTO LSD system is operating

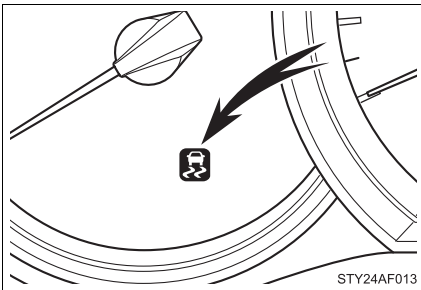

If the rear wheels spin, the slip indicator flashes to indicate that the AUTO LSD system has been controlled the spinning of the rear wheels.

---

n **Automatic VSC reactivation**

If the AUTO LSD system is turned on and the vehicle speed decreases, the VSC system will turn off and the VSC OFF indicator will turn on. or, if the vehicle speed increases the VSC system will turn on and the VSC OFF indicator will turn off.

n **If the brake system overheats**

The system will cease operation and a buzzer will sound to alert the driver. Stop the vehicle in a safe place. (There is no problem with continuing normal driving.)

The system will be automatically restored after a short time.

 **CAUTION**

n **To avoid an accident**

- I Do not use the AUTO LSD system in conditions other than the above. A much greater steering effort and more careful cornering control will be required.
- I Do not drive with the AUTO LSD system continuously turned on.

## 2-4. Using other driving systems

### Rear differential lock system (if equipped)

**The rear differential lock system is provided for use only when wheel spinning occurs in a ditch or on a slippery or rugged surface.**

The rear differential lock system is effective in case one of the rear wheels is spinning.

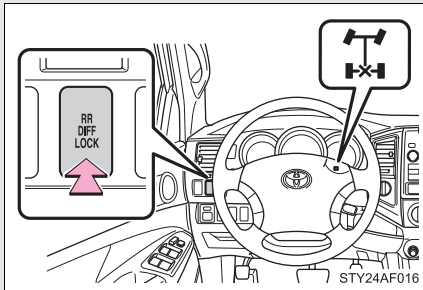

Press the RR DIFF LOCK switch to lock the rear differential.

At this time, the indicator will blink. Wait a few seconds for the system to complete operation. After the rear differential is locked, the rear differential lock indicator will stop blinking and remain on.

To unlock the rear differential, push the switch again.

#### Using the rear differential lock system

##### ► Automatic transmission

**STEP 1** 4WD models: Before using the rear differential lock system.

Stop the vehicle, shift the shift lever to N and put the front-wheel drive control switch in the L4 position to see if this is sufficient. If this has no effect, additionally use the rear differential lock system.

**STEP 2** Be sure to stop the wheels.

**STEP 3** Press the RR DIFF LOCK switch.

After the rear differential is locked, the indicator will come on.

**STEP 4** Gently depress the accelerator pedal.

Unlock the rear differential as soon as the vehicle moves.

To unlock the rear differential, push the switch again.



### ► Manual transmission

**STEP 1** 4WD models: Before using the rear differential lock system.

Stop the vehicle or reduce your speed to less than 2 mph (3 km/h). Depress the clutch pedal and put the front-wheel drive control switch in the L4 position to see if this is sufficient. If this has no effect, additionally use the rear differential lock system.

**STEP 2** Be sure to stop the wheels.

**STEP 3** Depress the clutch pedal.

**STEP 4** Press the RR DIFF LOCK switch.

After the rear differential is locked, the indicator will come on.

**STEP 5** Slowly release the clutch pedal.

Unlock the rear differential as soon as the vehicle moves.

To unlock the rear differential, push the switch again.

### n **Locking the rear differential**

l When the rear differential is locked, VSC is automatically turned off. (The rear differential lock and VSC OFF indicators come on.)

l The following systems do not operate when the rear differential is locked. It is normal operation for the ABS warning light and VSC OFF indicator to be on at this time. If the DAC switch turns on, the downhill assist control system indicator light flashes.

- ABS
- Brake assist system
- VSC
- TRAC
- Downhill assist control system
- Hill-start assist control system

### n **The rear differential lock is disengaged when**

l Shift the front-wheel drive control switch to H2 or H4 position. (4WD models)

Never forget to turn off the switch after using this feature.

■ **After unlocking the rear differential**

To check that the indicator goes off, turn the engine switch to the ON position, but do not start the engine.

 **CAUTION**

■ **To avoid an accident**

- I Do not use the rear differential lock system except when wheel spinning occurs in a ditch or on a slippery or ragged surface. Large steering effort and careful cornering control will be required.
- I Do not lock the rear differential until the wheels have stopped spinning. Otherwise, the vehicle may move in an unexpected direction when the differential lock is engaged, resulting in an accident. This may also lead to possible damage to differential lock component parts.
- I Do not drive over 5 mph (8 km/h) when the differential is locked.
- I Do not keep driving with the RR DIFF LOCK switch on.

## Downhill Assist Control system (if equipped)

**The downhill assist control system helps to prevent excessive speed on steep downhill descents.**

### n System operation

The system will operate when the vehicle is traveling under 15 mph (25 km/h) and the front-wheel drive control switch is in the L4 position.

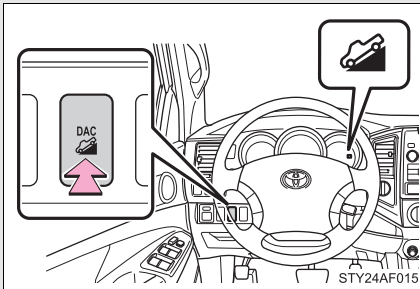

Press the DAC switch. The indicator will come on, and the system will operate.

With the vehicle traveling at a speed of 15 mph (25 km/h) or less, release your foot from the accelerator or brake pedal to activate the system.

When the system is in operation, the slip indicator light will flash, and the stop lights/high mounted stop light will come on. A sound may also occur during the operation. This does not indicate a malfunction.

### n Turning off the system

Press the DAC switch while the system is in operation. The indicator will flash as the system gradually ceases operation, and will turn off when the system is fully off.

Pressing the DAC switch while the indicator is flashing will start the system again.

---

**n Operating tips**

The system will operate when the shift lever is in a position other than P. However, to make effective use of the system it is recommended that the shift lever be shifted to 2 or L.

**n The system will not operate when**

- | The front-wheel drive control switch is in the H2 or H4 position.
- | The rear differential is locked.

**n The downhill assist control system indicator light flashes when**

- | The selector lever is in the N position.
- | The front-wheel drive control switch is in the H2 or H4 position.
- | The rear differential is locked.

**n If the brake system overheats**

The system will cease operation and a buzzer will sound to alert the driver. Stop the vehicle in a safe place. (There is no problem with continuing normal driving.)

**n System malfunction**

- | The downhill assist control system indicator does not come on when the engine switch is turned to the ON position.
- | The downhill assist control system indicator does not come on when the DAC switch is pressed.

In the above cases have your vehicle checked by your Toyota dealer.

 **CAUTION**

**n Do not rely excessively on the downhill assist control system.**

It may not be able to maintain a low speed over road surfaces on which sliding can easily occur, such as extremely steep slopes or icy or muddy roads.

## Clutch start cancel switch (if equipped)

**The switch allows the vehicle to be driven out of difficult situations by cranking the engine with the clutch engaged.**

Never use the switch for normal engine starting. Be sure to follow the starting procedure. (→P. 138)

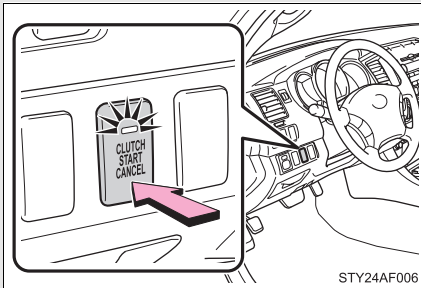

Press the CLUTCH START CANCEL switch to cancel the clutch start system when the engine switch is turned to the ON position.

The indicator comes on when the clutch start system is canceled.

The clutch start cancel switch is automatically turned off when the engine switch is turned off.

### n Clutch start system

The system is designed to keep the starter motor from operating if the clutch pedal is not depressed all the way down.

## Driving assist systems

**To help enhance driving safety and performance, the following systems operate automatically in response to various driving situations. Be aware, however, that these systems are supplementary and should not be relied upon too heavily when operating the vehicle.**

**n ABS (Anti-lock Brake System)**

Helps to prevent wheel lock when the brakes are applied suddenly, or if the brakes are applied while driving on a slippery road surface.

**n Brake Assist**

Generates an increased level of braking force after the brake pedal is depressed, while the system detects a panic stop situation.

**n VSC (Vehicle Stability Control)**

Helps the driver to control skidding when swerving suddenly or turning on slippery road surfaces.

**n TRAC (Traction Control)**

Maintains drive power and prevents the rear wheels (2WD models) or four wheels (4WD models) from spinning when starting the vehicle or accelerating on slippery roads.

**n Hill-start assist control (if equipped)**

Helps prevent the vehicle from rolling backwards when starting on an incline or slippery slope. It operates for approximately 5 seconds at maximum.

### When the VSC/TRAC/hill-start assist control systems are operating

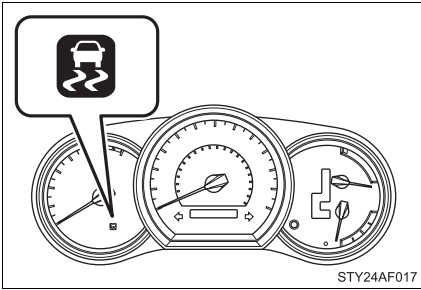

If the vehicle is in danger of slipping, the rear wheels (2WD models) or four wheels (4WD models) spin, the vehicle starts to roll backwards when starting on an incline, this indicator flashes to indicate that the VSC/TRAC/hill-start assist control systems have been engaged.

A buzzer (intermittent) sounds to indicate that VSC is operating.

The stop lights and high mounted stoplight turn on when the hill-start assist control system is operating.

2

When driving

### To disable TRAC and/or VSC

If the vehicle gets stuck in fresh snow or mud, TRAC and VSC may reduce power from the engine to the wheels. You may need to turn the system off to enable you to rock the vehicle in order to free it.

#### n Turning off TRAC (2WD models and 2WD mode on 4WD models)

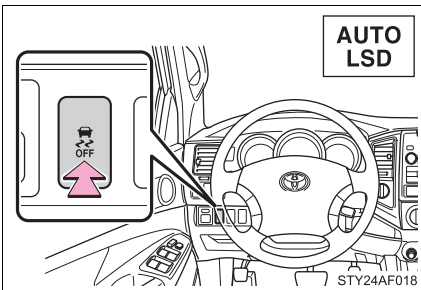

Quickly push and release the button to turn off TRAC.

The AUTO LSD indicator light should come on.

Push the button again to turn the system back on.

## n Turning off TRAC and VSC

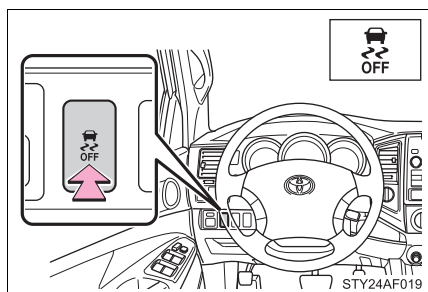

Push and hold the button for more than 3 seconds while the vehicle is stopped to turn off both TRAC and VSC.

The VSC OFF indicator light should come on.

Push the button again to turn both systems back on.

---

## n Automatic reactivation of TRAC and VSC

Turning the engine switch off after turning off the TRAC and VSC systems will automatically re-enable them.

## n Automatic TRAC reactivation (AUTO LSD mode)

With AUTO LSD mode, VSC OFF and AUTO LSD indicator lights turn on. The TRAC system will turn on when the vehicle speed increases.

## n Automatic TRAC and VSC reactivation

If the TRAC and VSC systems are turned off, the systems will not turn on even when vehicle speed increases.

## n Sounds and vibrations caused by the ABS, TRAC, VSC, brake assist and hill-start assist control system

l A sound may be heard from the engine compartment when the engine is started or just after the vehicle begins to move. This sound does not indicate that a malfunction has occurred in any of these systems.

l Any of the following conditions may occur when the above systems are operating. None of these indicates that a malfunction has occurred.

- Vibrations may be felt through the vehicle body and steering.
- A motor sound may be heard after the vehicle comes to a stop.
- The brake pedal may pulsate slightly when the ABS is activated.
- The brake pedal may move down slightly after the ABS is activated.



**n Hill-start assist control is operational when (if equipped)**

- l The shift lever is in the D, 4, 3, 2 (5-speed automatic transmission), D, 3, 2 (4-speed automatic transmission) or L positions.
- l The brake pedal is not depressed.

**n Hill-start assist control will not operate when (if equipped)**

- l The shift lever is in the P, R or N positions.
- l The rear differential is locked.

**n If the brake system overheats**

TRAC and hill-start control will cease operation and a buzzer will sound to alert the driver. Stop the vehicle in a safe place. (There is no problem with continuing normal driving.)

 CAUTION

**n The ABS does not operate effectively when**

- l The limits of the gripping performance have been exceeded.
- l The vehicle hydroplanes while driving at high speed on the wet or slick road.

**n Stopping distance when the ABS is operating will exceed that of normal conditions**

The ABS is not designed to shorten the vehicle's stopping distance. Always maintain a safe distance from the vehicle in front of you in the following situations.

- l When driving on dirt, gravel or snow-covered roads
- l When driving with tire chains
- l When driving over bumps in the road
- l When driving over roads with potholes or roads with uneven roads

**n When VSC is activated**

The slip indicator flashes and a warning buzzer sounds. Always drive carefully. Reckless driving may cause an accident. Exercise particular care when the indicator flashes and a buzzer sounds.

**n TRAC may not operate effectively when**

Directional control and power may not be achievable while driving on slippery road surfaces, even if TRAC is operating. Do not drive the vehicle in conditions where stability and power may be lost.

**n If the hill-start assist control does not operate effectively**

The hill start assist control may not operate effectively on steep inclines and roads covered in ice.

**n Replacing tires**

Make sure that all tires are of the same size, brand, tread pattern and total load capacity. In addition, make sure that the tires are inflated to the appropriate tire pressure level.

The ABS and VSC will not function correctly if different tires are fitted on the vehicle.

Contact your Toyota dealer for further information when replacing tires or wheels.

**⚠ CAUTION****n Handling of tires and suspension**

Using tires with any kind of problem or modifying the suspension will affect the driving assist systems, and may cause the system to malfunction.

**This vehicle has higher ground clearance and narrower tread in relation to the height of its center of gravity to make it capable of performing in a wide variety of off-road applications.**

### **Off-road vehicle feature**

- 1 Specific design characteristics give it a higher center of gravity than ordinary passenger cars. This vehicle design feature causes this type of vehicle to be more likely to rollover. And, it has a significantly higher rollover rate than other types of vehicles.
- 1 An advantage of the higher ground clearance is a better view of the road allowing you to anticipate problems.
- 1 It is not designed for cornering at the same speeds as ordinary passenger cars any more than low-slung sports cars are designed to perform satisfactorily under off-road conditions. Therefore, sharp turns at excessive speeds may cause rollover.

 **CAUTION****n Off-road vehicle precautions**

Always observe the following precautions to minimize the risk of serious personal injury or damage to your vehicle:

- I** In a rollover crash, an unbelted person is significantly more likely to die than a person wearing a seat belt. Therefore, the driver and all passengers should fasten their seat belts whenever the vehicle is moving.
- I** Avoid sharp turns or abrupt maneuvers, if at all possible.  
Failure to operate this vehicle correctly may result in loss of control or vehicle rollover causing death or serious injury.
- I** Avoid loading any items on the roof that will raise the vehicle's center of gravity.
- I** Always slow down in gusty crosswinds. Because of its profile and higher center of gravity, your vehicle is more sensitive to side winds than an ordinary passenger car. Slowing down will allow you to have much better control.
- I** When driving off-road or in rugged terrain, do not drive at excessive speeds, jump, make sharp turns, strike objects, etc. This may cause loss of control or vehicle rollover causing death or serious injury. You are also risking expensive damage to your vehicle's suspension and chassis.
- I** Do not drive horizontally across steep slopes. Driving straight up or straight down is preferred. Your vehicle (or any similar off-road vehicle) can tip over sideways much more easily than forward or backward.

## Off-road driving

When driving your vehicle off-road, please observe the following precautions to ensure your driving enjoyment and to help prevent the closure of areas to off-road vehicles.

- 1 Drive your vehicle only in areas where off-road vehicles are permitted to travel.
- 1 Respect private property. Get owner's permission before entering private property.
- 1 Do not enter areas that are closed. Honor gates, barriers and signs that restrict travel.
- 1 Stay on established roads. When conditions are wet, driving techniques should be changed or travel delayed to prevent damage to roads.

---

### n **Additional information for off-road driving**

► For owners in U.S. mainland, Hawaii and Puerto Rico:

To obtain additional information pertaining to driving your vehicle off-road, consult the following organizations.

- 1 State and Local Parks and Recreation Departments
- 1 State Motor Vehicle Bureau
- 1 Recreational Vehicle Clubs
- 1 U.S. Forest Service and Bureau of Land Management

 **CAUTION****n Off-road driving precautions**

Always observe the following precautions to minimize the risk of serious personal injury or damage to your vehicle:

- I** Drive carefully when off the road. Do not take unnecessary risks by driving in dangerous places.
- I** Do not grip the steering wheel spokes when driving off-road. A bad bump could jerk the wheel and injure your hands. Keep both hands and especially your thumbs on the outside of the rim.
- I** Always check your brakes for effectiveness immediately after driving in sand, mud, water or snow.
- I** After driving through tall grass, mud, rock, sand, rivers, etc., check that there is no grass, bush, paper, rags, stone, sand, etc. adhering or trapped on the underbody. Clear off any such matter from the underbody. If the vehicle is used with these materials trapped or adhering to the underbody, a breakdown or fire could occur.
- I** In a rollover crash, an unbelted person is significantly more likely to die than a person wearing a seat belt. Therefore, the driver and all passengers should fasten their seat belts whenever the vehicle is moving.
- I** When driving off-road or in rugged terrain, do not drive at excessive speeds, jump, make sharp turns, strike objects, etc. This may cause loss of control or vehicle rollover causing death or serious injury. You are also risking expensive damage to your vehicle's suspension and chassis.

 NOTICE

**n To prevent the water damage**

- I** Take all necessary safety measures to ensure that water damage to the engine or other components does not occur.
- I** Water entering the engine air intake will cause severe engine damage.
- I** Water entering the automatic transmission will cause deterioration in shift quality, locking up of your transmission accompanied by vibration, and ultimately damage.
- I** Water can wash the grease from wheel bearings, causing rusting and premature failure, and may also enter the differentials, transmission and transfer case, reducing the gear oil's lubricating qualities.

**n When you drive through water**

If driving through water, such as when crossing shallow streams, first check the depth of the water and the bottom of the river bed for firmness. Drive slowly and avoid deep water.

**n Inspection after off-road driving**

- I** Sand and mud that has accumulated in brake drums and around brake discs may affect braking efficiency and may damage brake system components.
- I** Always perform a maintenance inspection after each day of off-road driving that has taken you through rough terrain, sand, mud, or water. For scheduled maintenance information, refer to the "Scheduled Maintenance Guide" or "Owner's Manual Supplement".



## 2-5. Driving information

# Cargo and luggage

**Take notice of the following information about storage precautions, cargo capacity and load.**

- 1 Stow cargo and luggage in the rear deck whenever possible.
- 1 Be sure all items are secured in place.
- 1 Be careful to keep the vehicle level. Placing the weight as far forward as possible helps maintain vehicle balance.
- 1 For better fuel economy, do not carry unnecessary weight.

### n **Deck rails**

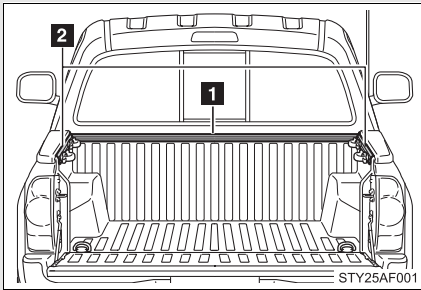

#### **1** Headboard rail

#### **2** Side rails

To use the deck rails, you must install genuine Toyota accessories or their equivalent for the deck rails.

Follow the manufacturer's instructions and precautions when installing a genuine Toyota accessory or equivalent.

### **⚠ CAUTION**

#### n **When you secure cargo with the deck rails**

Be sure to follow the instructions below in order to avoid the cargo coming loose.

- 1 Do not install accessories (tie-down cleats, storage boxes, etc.) at more than the following number of locations per deck rail.
  - Side rail:
    - Short deck—Max. 3 locations
    - Long deck—Max. 4 locations
  - Headboard rail:
    - Max 3 locations

 CAUTION

**n When you secure cargo with the deck rails**

- I** Spread out tie-down/support locations evenly along the length of the rails.
- I** Do not exceed a total tensile load of 440 lb. (200 kg) per deck rail.
- I** To prevent luggage or cargo from sliding forward during braking, make sure the deck rail accessories such as storage box are securely attached on the deck rails.

**Capacity and distribution**

Cargo capacity depends on the total weight of the occupants.

(Cargo capacity) = (Total load capacity) – (Total weight of occupants)

**Steps for Determining Correct Load Limit—**

- (1) Locate the statement “The combined weight of occupants and cargo should never exceed XXX kg or XXX lbs.” on your vehicle’s placard.
- (2) Determine the combined weight of the driver and passengers that will be riding in your vehicle.
- (3) Subtract the combined weight of the driver and passengers from XXX kg or XXX lbs.
- (4) The resulting figure equals the available amount of cargo and luggage load capacity.  
For example, if the “XXX” amount equals 1400 lbs. and there will be five 150 lb passengers in your vehicle, the amount of available cargo and luggage load capacity is 650 lbs. (1400 – 750 (5 × 150) = 650 lbs.)
- (5) Determine the combined weight of luggage and cargo being loaded on the vehicle. That weight may not safely exceed the available cargo and luggage load capacity calculated in Step 4.

- (6) If your vehicle will be towing a trailer, load from your trailer will be transferred to your vehicle. Consult this manual to determine how this reduces the available cargo and luggage load capacity of your vehicle.

### Example on your vehicle

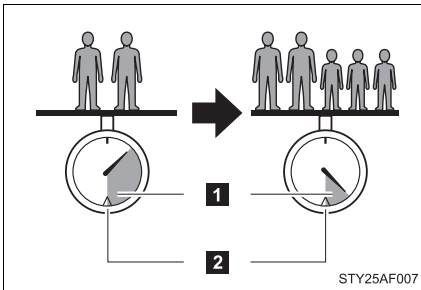

- 1 Cargo capacity
- 2 Total load capacity

When 2 people with the combined weight of A lb. (kg) are riding in your vehicle, which has a total load capacity of B lb. (kg), the available amount of cargo and luggage load capacity will be C lb. (kg) as follows:

$$B \text{ lb. (kg)} - A \text{ lb. (kg)} = C \text{ lb. (kg)}$$

In this condition, if 3 more passengers with the combined weight of D lb. (kg) get on, the available cargo and luggage load will be reduced E lb. (kg) as follows:

$$C \text{ lb. (kg)} - D \text{ lb. (kg)} = E \text{ lb. (kg)}$$

As shown in the above example, if the number of occupants increases, the cargo and luggage load will be reduced by an amount that equals the increased weight due to the additional occupants. In other words, if an increase in the number of occupants causes an excess of the total load capacity (combined weight of occupants plus cargo and luggage load), you must reduce the cargo and luggage on your vehicle.

 **CAUTION**

**n Things that must not be carried in the luggage compartment**

The following things may cause a fire if loaded in the luggage compartment.

- I Receptacles containing gasoline
- I Aerosol cans

**n Storage precautions**

I Do not stack anything in the luggage compartment higher than the seatbacks.

Such items may be thrown about and possibly injure people in the vehicle during sudden braking or in an accident.

I Do not drive with objects on top of the instrument panel.

They may interfere with the driver's field of view or move during sharp acceleration or turning, thus impairing the driver's control of the vehicle. In an accident they may injure the vehicle occupants.

I Secure all items in the occupant compartment, as they may shift and injure someone during an accident or sudden braking.

I Never allow anyone to ride in the rear deck. It is not designed for passengers. They should ride in their seats with their seat belts properly fastened. Otherwise, they are much more likely to suffer death or serious bodily injury, in the event of sudden braking or a collision.

**n Capacity and distribution**

I Do not exceed the maximum axle weight rating or the total vehicle weight rating.

I Even if the total load of occupant's weight and the cargo load is less than the total load capacity, do not apply the load unevenly. Improper loading may cause deterioration of steering or braking control which may cause death or serious injury.

**Vehicle load limits include total load capacity, seating capacity, towing capacity and cargo capacity.**

**n Total load capacity: (→P. 463)**

Total load capacity means the combined weight of occupants, cargo and luggage.

**n Seating capacity:**

▶ **Regular Cab models**

**3 occupants**

▶ **Access Cab models**

**4 occupants (Front 2, Rear 2)**

▶ **Double Cab models**

**5 occupants (Front 2, Rear 3)**

Seating capacity means the maximum number of occupants whose estimated average weight is 150 lb. (68 kg) per person.

Even if the number of occupants are within the seating capacity, do not exceed the total load capacity.

**n Towing capacity:**

▶ **Without towing package**

**3500 lb. (1587 kg)**

▶ **With towing package**

**6500 lb. (2948 kg)**

Towing capacity means the maximum gross trailer weight (trailer weight plus its cargo weight) that your vehicle is able to tow.

**n Cargo capacity**

Cargo capacity may increase or decrease depending on the weight and the number of occupants.

**n Total load capacity and seating capacity**

These details are also described on the tire and loading information label.(→P. 381)

 **CAUTION**

**n Overloading the vehicle**

Do not overload the vehicle.

It may not only cause damage to the tires, but also degrade steering and braking ability, resulting in an accident.

**Carry out the necessary preparations and inspections before driving the vehicle in winter. Always drive the vehicle in a manner appropriate to the prevailing weather conditions.**

**n Pre-winter preparations**

- 1 Use fluids that are appropriate to the prevailing outside temperatures.
  - Engine oil
  - Engine coolant
  - Washer fluid
- 1 Have a service technician inspect the level and specific gravity of battery electrolyte.
- 1 Have the vehicle fitted with four snow tires or purchase a set of tire chains for the rear tires.

Ensure that all tires are the same size and brand, and that chains match the size of the tires.

**n Before driving the vehicle**

Perform the following according to the driving conditions.

- 1 Do not try to forcibly open a window, scrape an outside rear view mirror surface or move a wiper or outside rear view mirror that is frozen. Pour warm water over the frozen area to melt the ice. Wipe away the water immediately to prevent it from freezing.
- 1 To ensure proper operation of the climate control system fan, remove any snow that has accumulated on the air inlet vents in front of the windshield.
- 1 Remove any ice that has accumulated on the vehicle chassis.
- 1 Periodically check for and remove any excess ice or snow that may have accumulated in the wheel well or on the brakes.

**n When driving the vehicle**

Accelerate the vehicle slowly and drive at a reduced speed suitable to road conditions.

**n When parking the vehicle**

If the parking brake is set, it may freeze up, preventing it from being released.

Stop the vehicle and move the shift lever to P if an automatic transmission, or move it to 1 when the vehicle is facing uphill or R when facing downhill if a manual transmission then place the wheel blocks without applying the parking brake.

### Selecting tire chains

Use the correct tire chain size when mounting the snow chains. Chain size is regulated for each tire size.

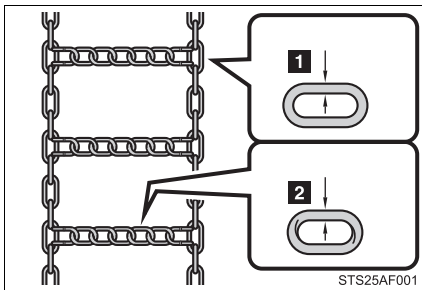

**1 Side chain**

0.2 in. (5 mm) in diameter

**2 Cross chain**

0.25 in. (6.3 mm) in diameter

### Regulations on the use of snow chains

1 Regulations regarding the use of tire chains vary according to location and type of road. Always check local regulations before installing chains.

1 Install the chains on the rear tires.

1 Retighten the chains after driving 1/4 - 1/2 mile (0.5 - 1.0 km).



**n Snow chain installation**

Observe the following precautions when installing and removing chains.

- I Install and remove tire chains in a safe location.
- I Install tire chains on the rear tires only. Do not install tire chains on the front tires.
- I Install tire chains following the instructions provided in the accompanying instructions.

**⚠ CAUTION****n Driving with snow tires**

Observe the following precautions to reduce the risk of accidents.

Failing to do so may result in a loss of vehicle control and cause death or serious injury.

- I Use tires of the size specified for your vehicle.
- I Maintain the recommended level of air pressure.
- I Do not drive in excess of 75 mph (120 km/h) regardless of the type of snow tires being used.
- I Snow tires should be installed on all wheels.
- I 4WD models:  
Do not mix tires of different makes, models, tread patterns or treadwear.

**n Driving with snow chains**

Observe the following precautions to reduce the risk of accidents.

Failing to do so may result in the vehicle being unable to be driven safely, and may cause death or serious injury.

- I Do not drive in excess of the speed limit specified for the tire chains being used or 30 mph (50 km/h), whichever is lower.
- I Avoid driving on bumpy road surfaces or over potholes.
- I Avoid sudden turns and braking.
- I Slow down sufficiently before entering a curve to ensure that vehicle control is maintained.

 **CAUTION**

**n When parking the vehicle**

Always use wheel blocks when parking without the parking brake. Failure to do so may allow the vehicle to move, resulting in an accident.

 **NOTICE**

**n Repairing or replacing snow tires**

Request repairs of and obtain replacement snow tires from Toyota dealers or legitimate tire retailers.

This is because the removal and attachment of snow tires affects the operation of the tire pressure warning valves and transmitters.

**n Fitting tire chains**

The tire pressure warning valves and transmitters may not function correctly when tire chains are fitted.

## Trailer towing

**Your vehicle is designed primarily as a passenger-and-load carrying vehicle, and thus towing a trailer will have an adverse effect on handling, performance, braking, durability, and fuel consumption. For your safety and the safety of others, do not overload the vehicle or trailer.**

**We recommend you use a weight distributing hitch when towing to keep your vehicle level with the ground.**

**n Weight limits**

Confirm that the total trailer weight, gross combination weight, gross vehicle weight, gross axle weight, and trailer tongue load are all within the limits.

**n Gross vehicle weight**

The gross vehicle weight must not exceed the Gross Vehicle Weight Rating (GVWR) indicated on the Certification Label. The gross vehicle weight is the sum of the weights of the unloaded vehicle, driver, passengers, luggage, hitch, and the trailer tongue load. It also includes the weight of any special equipment installed on your vehicle.

n **Gross axle weight**

The load on either the front or rear axle resulting from distribution of the gross vehicle weight on both axles must not exceed the Gross Axle Weight Rating (GAWR) listed on the Certification Label.

► Regular Cab models and Double Cab models

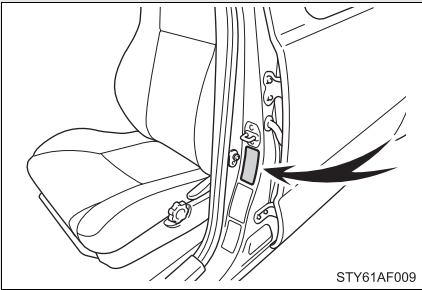

Certification label

► Access Cab models

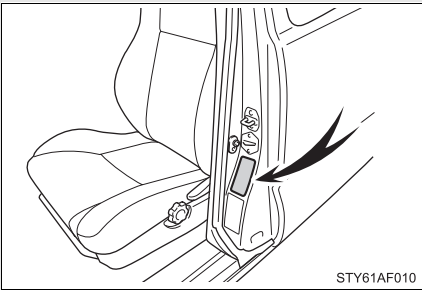

Certification label

### n Trailer tongue load

The trailer cargo load should be distributed so that the tongue load is 9 to 11% of the total trailer weight, not exceeding the maximum load of the following.

- ▶ Without towing package  
350 lb. (158 kg)
- ▶ With towing package  
650 lb. (294 kg)

However, if towing with a fifth wheel trailer, the cargo load must be distributed so that the tongue load is 19 to 21% of the total trailer weight.

The total trailer weight and tongue load can be measured with platform scales found at a highway weighing stations, building supply company, trucking company, junk yards, etc.

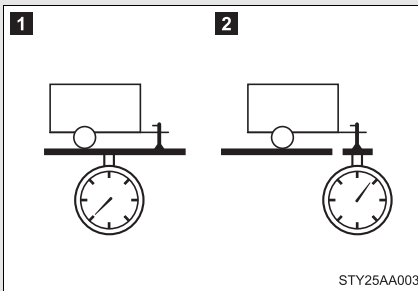

- 1 Total trailer weight
- 2 Tongue load

## **Towing a trailer**

Consult your Toyota dealer for further information about additional requirements such as a towing kits, etc.

## **Hitch and tow hitch receiver**

### **n Hitch**

Trailer hitch assemblies have different weight capacities established by the hitch manufacturer. Even though the vehicle may be rated for towing a higher weight, the operator must never exceed the maximum weight rating specified for the trailer hitch.

## Selecting trailer ball

Use the correct trailer ball for your application.

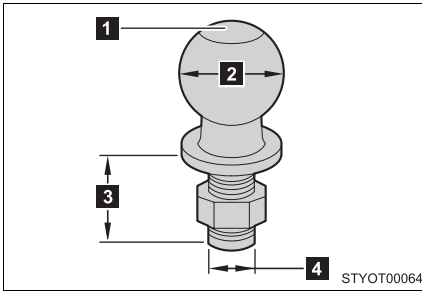

### 1 Trailer ball load rating

Matches or exceeds the gross trailer weight rating of the trailer.

### 2 Ball diameter

Matches the size of the trailer coupler. Most couplers are stamped with the required trailer ball size.

Trailer class	Typical trailer ball size
IV	2 5/16 in.
II and III	2 in.
I	1 7/8 in.

### 3 Shank length

Protrudes beyond the bottom of the lock washer and nut at least 2 threads.

### 4 Shank diameter

Matches the ball mount hole diameter size.

## Bumper towing

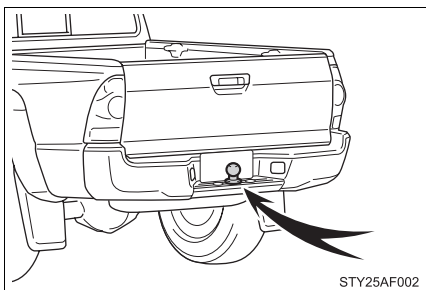

The rear bumper of your vehicle is equipped with a hole to install a trailer ball.

The maximum gross trailer weight: 3500 lb. (1587 kg)

The gross trailer weight (trailer weight plus the weight of cargo) when towing with the bumper must never exceed 3500 lb. (1587 kg).

## Fifth wheel trailer

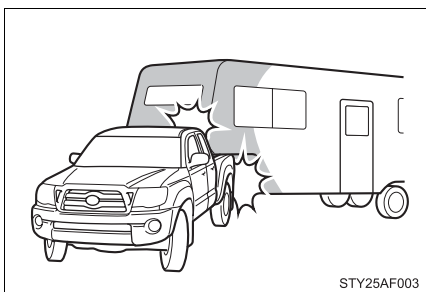

When towing a fifth wheel trailer, be careful not to hit the cabin or deck by the trailer while making a sharp turn.

## Service connector for towing brake controller

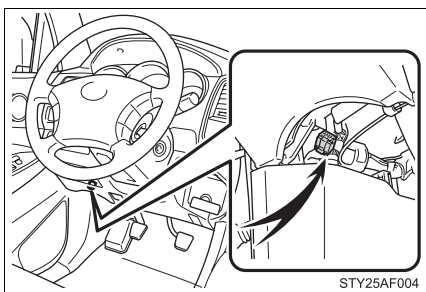

Your vehicle is equipped with a service connector for the trailer brake controller as shown.



## Connecting trailer lights

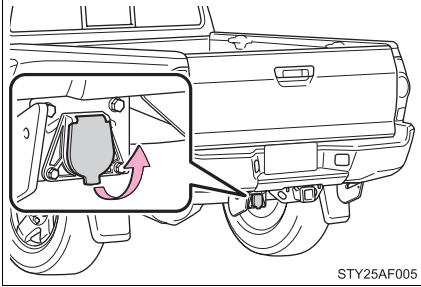

Use the wire harness stored in the rear end under body.

2

When driving

### n Before towing

Check that the following conditions are met:

- l Ensure that your vehicle's tires are properly inflated. (→P. 475)
- l Trailer tires should be inflated according to the trailer manufacturer's recommendation.
- l All trailer lights work to be legal.
- l Confirm all lights work each time you connect them.
- l The trailer ball is set up at the proper height for the coupler on the trailer.
- l Check that your vehicle remains level when a loaded or unloaded trailer is hitched. Do not drive if the vehicle is not level, and check for improper tongue load, overloading, worn suspension, or other possible causes.
- l Make sure the trailer cargo is securely loaded.
- l Check that your rear view mirrors conform to any federal, state/provincial or local regulations. If they do not, install rear view mirrors appropriate for towing purposes.

### n Break-in schedule

- l Toyota recommends that you do not use a new vehicle or a vehicle with any new power train components (engine, transmission, differential, wheel bearings, etc.) to tow a trailer for the first 500 miles (800 km) of driving.

**n Maintenance**

- I If you tow a trailer, your vehicle will require more frequent maintenance due to the additional load. (See “Scheduled Maintenance Guide” or “Owner’s Manual Supplement”.)
- I Retighten the fixing bolts of the towing ball and bracket after approximately 600 miles (1000 km).

**⚠ CAUTION**

**n To avoid accident or injury**

- I The gross trailer weight (trailer weight plus the weight of cargo) must not exceed the following.
  - ▶ Without towing package  
3500 lb. (1587 kg)
  - ▶ With towing package  
6500 lb. (2948 kg)
- I The gross trailer weight (trailer weight plus cargo weight) when towing with the bumper must not exceed 3500 lb. (1587 kg).
- I If the trailer and cargo weight is over 2000 lb. (907 kg), use a sway control device with sufficient capacity.
- I The combination of the gross trailer weight added to the total weight of the vehicle, occupants and vehicle cargo must not exceed a total of the following.
  - ▶ 2WD models except PreRunner  
7500 lb. (3402 kg)
  - ▶ 4WD models and PreRunner
    - 2.7 L 4-cylinder (2TR-FE) engine:  
8000 lb. (3628 kg)
    - 4.0 L V6 (1GR-FE) engine:
      - Without towing package  
8100 lb. (3674 kg)
      - With towing package  
11100 lb. (5034 kg)

 **CAUTION****n To avoid accident or injury**

- I Do not exceed the trailer hitch assembly weight, gross vehicle weight, gross axle weight and trailer tongue load capacities.
- I The tow hitch receiver installed on your vehicle must never be used on another vehicle.

**n Hitches**

- I If you wish to install a trailer hitch, your Toyota dealer should be consulted.
- I Use only a hitch that conforms to the total trailer weight requirement.
- I Follow the directions supplied by the hitch manufacturer.
- I Lubricate the hitch ball with a light coat of grease.
- I Remove the trailer hitch whenever you are not towing a trailer to reduce the possibility of additional damage caused by the hitch if your vehicle is struck from behind.

**n When towing a trailer**

- I If the total trailer weight exceeds 1000 lb. (453 kg), trailer brakes are required.
- I Never tap into your vehicle's hydraulic system, as this will lower the vehicle's braking effectiveness.
- I Never tow a trailer without using a safety chain securely attached to both the trailer and the vehicle. If damage occurs to the coupling unit or hitch ball, there is danger of the trailer wandering into another lane.

 NOTICE

**n When installing a trailer hitch**

Use only the position recommended by your Toyota dealer. Do not install the trailer hitch on the bumper; this may cause body damage.

**n Brakes**

Toyota recommends trailers with brakes that conform to any applicable federal and state/provincial regulations.

**n Safety chain**

A safety chain must always be used between the towing vehicle and the trailer. Leave sufficient slack in the chain for turns. The chain should cross under the trailer tongue to prevent the tongue from dropping to the ground in the case that it becomes damaged or separated. For the correct safety chain installation procedure, ask your Toyota dealer.

**n Do not directly splice trailer lights**

Directly splicing trailer lights may damage your vehicle's electrical system and cause a malfunction.

### Trailer towing tips

Your vehicle will handle differently when towing a trailer. The three main causes of vehicle-trailer accidents are driver error, excessive speed and improper trailer loading. Keep these in mind when towing.

- 1 Before starting out, check the trailer's light and the vehicle-trailer connections. Recheck after driving a short distance.
- 1 Practice turning, stopping and reversing with the trailer attached in an area away from traffic until you become accustomed to the feel of the vehicle.
- 1 Reversing with a trailer attached is difficult and requires practice. Grip the bottom of the steering wheel and move your hand to the left to move the trailer to the left. Move your hand to the right to move the trailer to the right. (This is generally opposite to reversing without a trailer attached.) Avoid sharp or prolonged turning. Have someone guide you when reversing to reduce the risk of an accident.
- 1 As stopping distance is increased when towing a trailer, vehicle-to-vehicle distance should be increased. For each 10 mph (16 km/h) of speed, allow at least one vehicle and trailer length.
- 1 Avoid sudden braking as you may skid, resulting in jackknifing and loss of control. This is especially true on wet or slippery surfaces.
- 1 Avoid jerky starts or sudden acceleration. For vehicles with a manual transmission, prevent excessive clutch slippage by keeping engine rpm low and not racing the engine. Always start out in first gear.
- 1 Avoid jerky steering and sharp turns, and slow down before making a turn.

- 1 Note that when making a turn, the trailer wheels will be closer than the vehicle wheels to the inside of the turn. Compensate by making a larger than normal turning radius.
- 1 Crosswinds and rough roads will adversely affect handling of your vehicle and trailer, causing sway. Periodically check the rear to prepare for being passed by large trucks or buses, which may cause your vehicle and trailer to sway. If swaying occurs, firmly grip the steering wheel, reduce speed immediately but gradually, and steer straight ahead. Never increase speed. If you make no extreme correction with the steering or brakes, your vehicle and trailer will stabilize.
- 1 Take care when passing other vehicles. Passing requires considerable distance. After passing a vehicle, do not forget the length of your trailer, and be sure you have plenty of room before changing lanes.
- 1 In order to maintain engine braking efficiency, do not use fifth gear (5-speed manual transmission) or sixth gear (6-speed manual transmission), or do not put the transmission in "D" (automatic transmission).
- 1 Due to the added load of the trailer, your vehicle's engine may overheat on hot days (at temperatures over 85°F [30°C]) when driving up a long or steep grade. If the engine coolant temperature gauge indicates overheating, immediately turn off the air conditioning (if in use), pull your vehicle off the road and stop in a safe spot. (→P. 456)
- 1 Always place wheel blocks under both the vehicle and the trailer wheels when parking. Apply the parking brake firmly, and put the transmission in P (automatic transmission) or in 1 or R (manual transmission). Avoid parking on a slope, but if unavoidable, do so only after performing the following:

**STEP 1** Apply the brakes and keep them applied.

**STEP 2** Have someone place wheel blocks under both the vehicle and trailer wheels.

**STEP 3** When the wheel blocks are in place, release the brakes slowly until the blocks absorb the load.

**STEP 4** Apply the parking brake firmly.

**STEP 5** Shift into 1 or R (manual transmission) or P (automatic transmission) and turn off the engine.

I When restarting after parking on a slope:

**STEP 1** With the transmission in P (automatic transmission) or the clutch pedal (manual transmission) depressed, start the engine. On vehicles with an automatic transmission, be sure to keep the brake pedal pressed.

**STEP 2** Shift into a forward gear. If reversing, shift into R.

**STEP 3** Release the parking brake (also brake pedal on vehicles with an automatic transmission), and slowly pull or back away from the wheel blocks. Stop and apply the brakes.

**STEP 4** Have someone retrieve the blocks.

## CAUTION

### n To avoid an accident

- I Do not exceed 45 mph (72 km/h) or posted towing speed limit, whichever is lower. As instability (swaying) of the towing vehicle-trailer combination increases as speed increases, exceeding 45 mph (72 km/h) may cause loss of control.
- I Slow down and downshift before descending steep or long downhill grades. Do not make sudden downshifts.
- I Avoid holding the brake pedal down too long or too frequently. This could cause the brakes to overheat and result in reduced braking efficiency.

## 2-5. Driving information

### Dinghy towing

Your vehicle is not designed to be dinghy towed (with 4 wheels on the ground) behind a motor home.

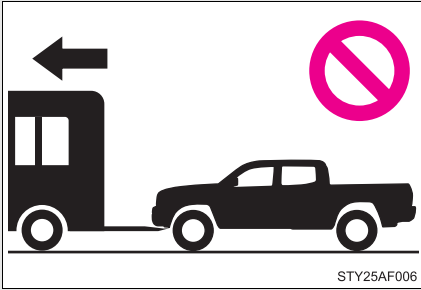

#### NOTICE

**n To avoid serious damage to your vehicle**

Do not tow your vehicle with four wheels on the ground.



# 3-1. Using the air conditioning system and defogger

## Air conditioning system

### ► Type A

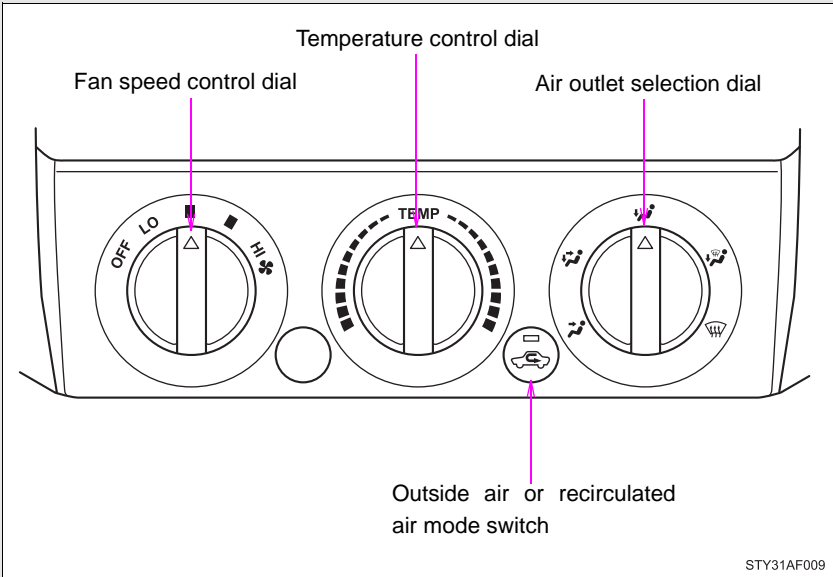

### ► Type B

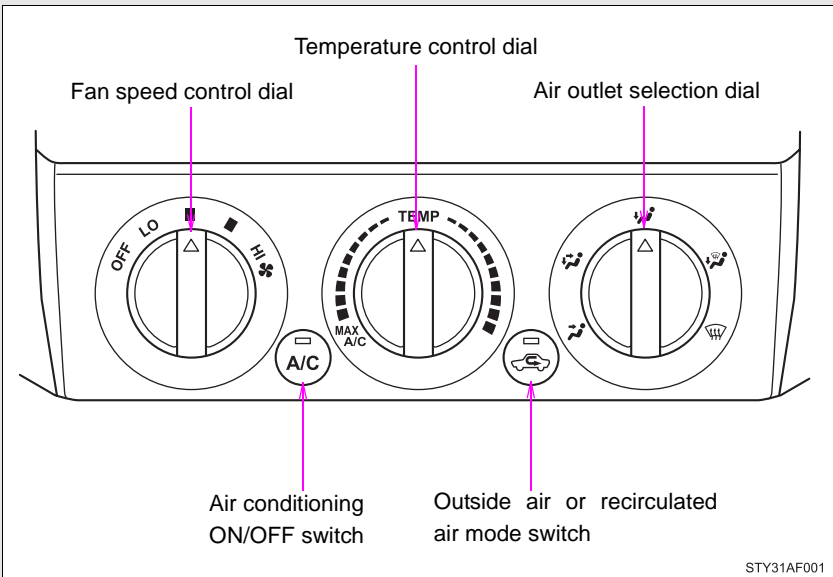

## Adjusting the settings

### n Adjusting the temperature setting (Type A)

Turn the temperature control dial clockwise to increase the temperature.

### n Adjusting the temperature setting (Type B)

Turn the temperature control dial clockwise (warm) or counterclockwise (cool).

If  is pressed, the system will blow ambient temperature air or heated air.

For quick cooling, turn the temperature control dial to the MAX A/C position. The air conditioning will automatically turn on and the air intake selector will be set to recirculated air mode.

### n Adjusting the fan speed

Turn the fan speed control dial clockwise (increase) or counterclockwise (decrease).

Set the dial to OFF to turn the fan off.

### n Selecting the air outlets

Set the air outlet selection dial to an appropriate position.

The positions between the air outlet selections shown below can also be selected for more detailed adjustment.

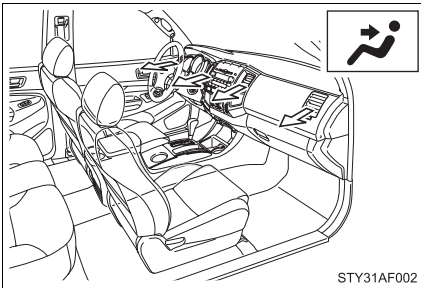

When the dial is set to , air flows to the upper body.

### 3-1. Using the air conditioning system and defogger

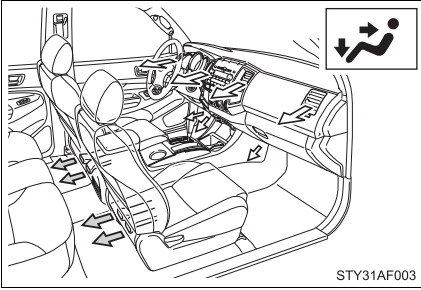

When the dial is set to , air flows to the upper body and feet.

←: Double Cab models only

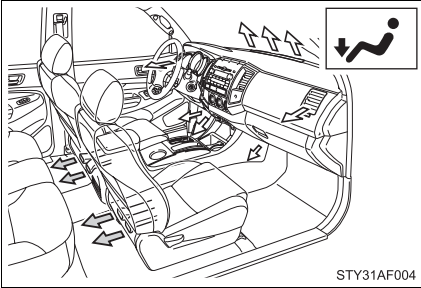

When the dial is set to , air flows to the feet.

←: Double Cab models only

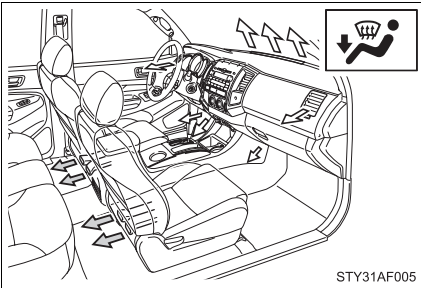



When the dial is set to , air flows to the feet and the windshield defogger operates.

The air intake selector is automatically set to outside air mode.

To return the recirculated air mode, press .

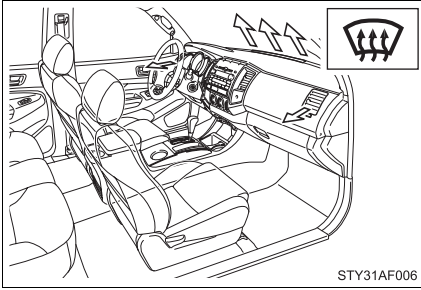
←: Double Cab models only





When the dial is set to , air flows to the windshield and side windows.

The air intake selector is automatically set to outside air mode.

In this position, the air intake selector cannot be changed to the recirculated air mode.

**n Switching between outside air and recirculated air modes**

Press .

The mode switches between  (outside air mode) and  (recirculated air mode) each time the switch is pressed.

**n If the ambient temperature drops while using the recirculated air mode**

The air intake mode automatically changes from recirculated air mode to outside air mode after a few minutes.

To cancel this function:

Press and hold  for longer than 2 seconds.

To reactivate this function:

Turn the engine switch to the LOCK or ACC position.

## Adjusting the position of the air outlets

### ► Center outlets

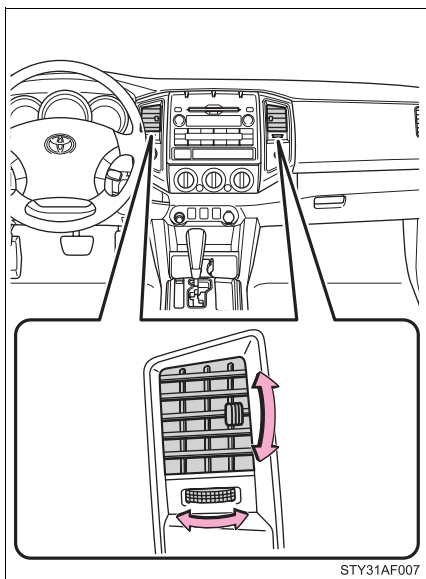

Direct air flow to the left or right, up or down.

► Right and left side outlets

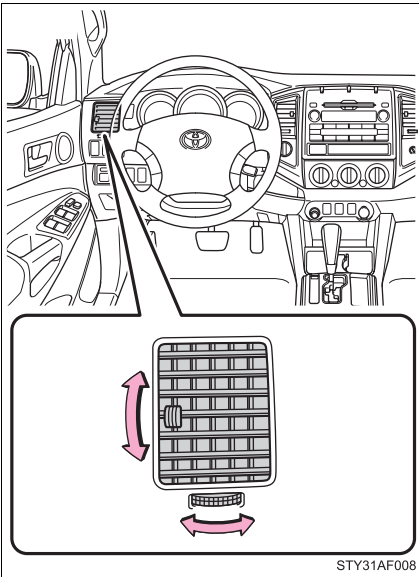

Direct air flow to the left or right, up or down.

**Opening and closing the air outlets**

► Center outlets

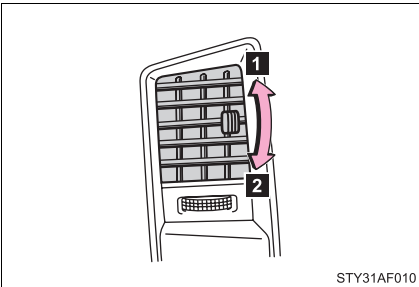

- 1** Open the vent.
- 2** Close the vent.

► Right and left side outlets

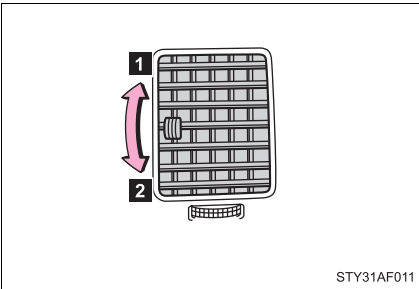

- 1 Open the vent.
- 2 Close the vent.

■ **For quick clearing of the windshield and side windows (type B only)**

Press  to turn the air conditioning on.

■ **Using the system in recirculated air mode**

The windows will fog up more easily if the recirculated air mode is used for an extended period.

■ **When outside air temperature approaches 32°F (0°C) (type B only)**

The air conditioning system may not operate even when  is pressed.

■ **When  is selected for the air outlets used**

For your driving comfort, air flowing to the feet may be warmer than air flowing to the upper body depending on the position of the temperature adjustment dial.

 CAUTION

**n To prevent the windshield from fogging up**

Do not set the air outlet selection dial to  during cool air operation in extremely humid weather. The difference between the temperature of the outside air and that of the windshield can cause the outer surface of the windshield to fog up, blocking your vision.

 NOTICE

**n To prevent battery discharge**

Do not leave the air conditioning system on longer than necessary when the engine is stopped.



## 3-2. Using the audio system

### Audio system types

- Type A: CD player with CD changer controller and AM/FM radio
- Type B: CD player with changer and AM/FM radio

#### ► Type A

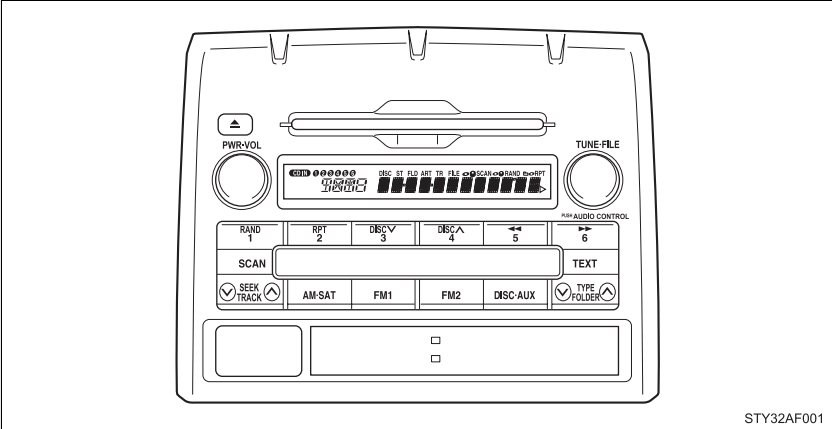

#### ► Type B

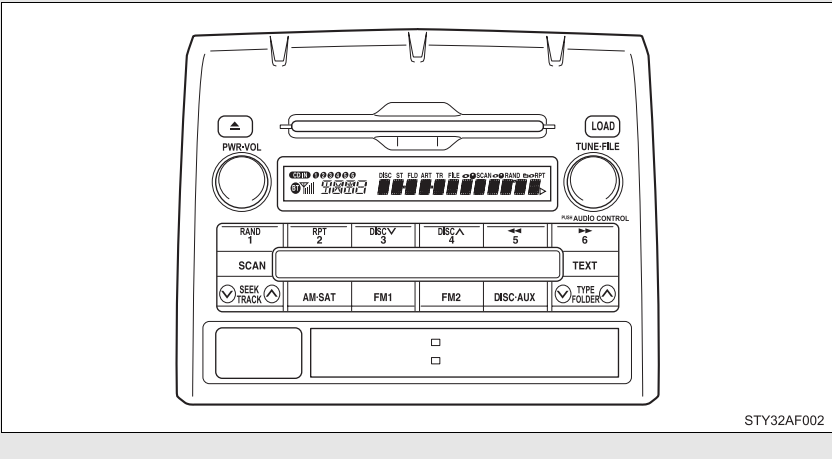

Title	Page
Using the radio	P. 231
Using the CD player	P. 237
Playing back MP3 and WMA discs	P. 244
Optimal use of the audio system	P. 253
Operating the sub woofer	P. 256
Using the AUX adapter	P. 257
Using the steering wheel audio switches	P. 259

### n **Using cellular phones**

Interference may be heard through the audio system's speakers if a cellular phone is being used inside or close to the vehicle while the audio system is operating.

 CAUTION

**n For vehicles sold in U.S.A. and Canada**

**l Part 15 of the FCC Rules**

FCC Warning:

Any unauthorized changes or modifications to this equipment will void the user's authority to operate this device.

**l Laser products**

- Do not take this unit apart or attempt to make any changes yourself. This is an intricate unit that uses a laser pickup to retrieve information from the surface of compact discs. The laser is carefully shielded so that its rays remain inside the cabinet. Therefore, never try to disassemble the player or alter any of its parts since you may be exposed to laser rays and dangerous voltages.
- This product utilizes a laser. Use of controls or adjustments or performance of procedures other than those specified herein may result in hazardous radiation exposure.

 NOTICE

**n To prevent battery discharge**

Do not leave the audio system on longer than necessary with the engine off.



**n To avoid damaging the audio system**

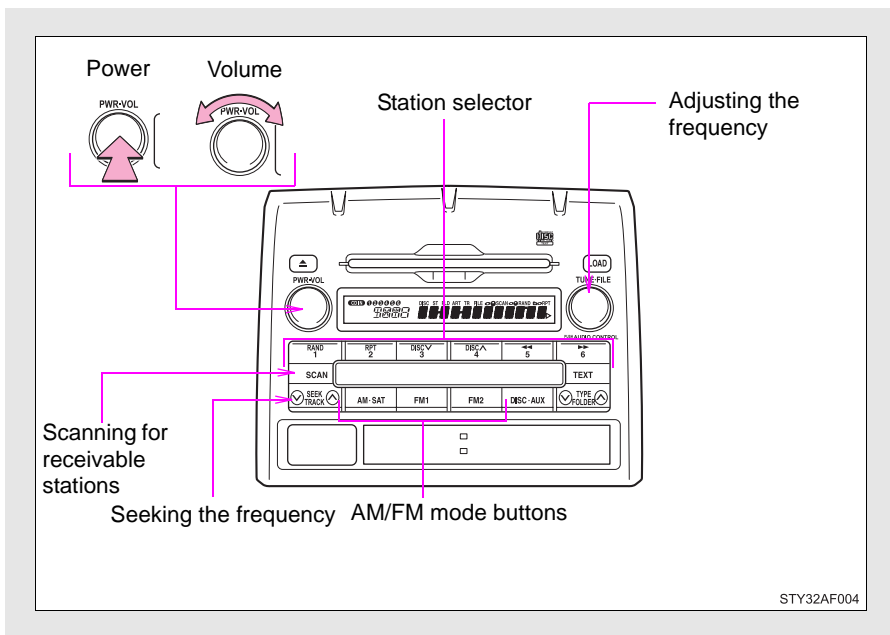

Take care not to spill drinks or other fluids over the audio system.

## 3-2. Using the audio system Using the radio



### Setting station presets (excluding XM<sup>®</sup> Satellite Radio)

**STEP 1** Search for desired stations by turning  or pressing “^” or “v” on .

**STEP 2** Press and hold the button (from  to ) that the station is to be set to until you hear a beep.

### Scanning radio stations (excluding XM<sup>®</sup> Satellite Radio)

#### n Scanning the preset radio stations

**STEP 1** Press and hold  until you hear a beep.

Preset stations will be played for 5 seconds each.

**STEP 2** When the desired station is reached, press the button once again to stop scanning.

**n Scanning all radio stations within range**

**STEP 1** Press  .

All stations with reception will be played for 5 seconds each.

**STEP 2** When the desired station is reached, press the button once again to stop scanning.

**XM<sup>®</sup> Satellite Radio\* (if equipped)**

**n Receiving XM<sup>®</sup> Satellite Radio**

**STEP 1** Press  and select the XM<sup>®</sup> band.

The display changes as follows each time  is pressed.



AM → SAT1 → SAT2 → SAT3



**STEP 2** Turn  to select the desired channel in the all categories

or press “^” or “v” on  to select the desired channel in the current category.

**n Setting XM<sup>®</sup> Satellite Radio channel presets**

Select the desired channel. Press and hold the button (from  to ) that the channel is to be set to until you hear a beep.

**n Changing the channel category**

Press “^” or “v” on the .

**n Scanning XM<sup>®</sup> Satellite Radio channels**

**1 Scanning channels in the current category**

**STEP 1** Press  .

**STEP 2** When the desired channel is reached, press  again.

**1 Scanning preset channels**

**STEP 1** Press and hold  until you hear a beep.

**STEP 2** When the desired channel is reached, press  again.

### n **Displaying text information**

Press  .

The display will show up to 10 characters.

The display changes as follows each time the button is pressed.

- l CH NAME
- l TITLE (SONG/PROGRAM TITLE)
- l NAME (ARTIST NAME/FEATURE)
- l CH NUMBER

\*:Except JBL brand audio system—

Use of XM<sup>®</sup> Satellite Radio requires XM<sup>®</sup> tuner and service.  
Contact your Toyota dealer.

### n **When the battery is disconnected**

Stations presets are erased.

### n **Reception sensitivity**

- l Objects, especially metal objects, such as cargo, a camper, or the retractable roof rack bar, may adversely affect the reception of XM<sup>®</sup> Satellite Radio.
- l Maintaining perfect radio reception at all times is difficult due to the continually changing position of the antenna, differences in signal strength and surrounding objects, such as trains, transmitters, etc.
- l The radio antenna is mounted on the right-side front fender. The antenna can be removed from the base by turning it.

### n **XM<sup>®</sup> Satellite Radio**

The Toyota genuine satellite radio tuner\*<sup>1</sup> and antenna\*<sup>1</sup> allows you to receive and play XM<sup>®</sup> Satellite Radio broadcasts. (Subscription is required. Not available in Hawaii and Alaska.)\*<sup>2</sup>

#### l XM<sup>®</sup> subscriptions

For detailed information about XM<sup>®</sup> Satellite Radio or to subscribe, visit XM<sup>®</sup> on the web at [www.xmradio.com](http://www.xmradio.com) or call 1-800-967-2346.

1 Radio ID

You will need the radio ID when activating XM<sup>®</sup> service or reporting a problem. Select “CH000” using  , and the receiver’s 8-character ID number will appear.

1 Satellite tuner

The tuner supports only Audio Services (Music and Talk) and the accompanying Text Information of XM<sup>®</sup> Satellite Radio.

\*1:Except JBL brand audio system—  
Use of XM<sup>®</sup> Satellite Radio requires XM<sup>®</sup> tuner and service.  
Contact your Toyota dealer.

\*2:Terms and services provided by XM<sup>®</sup> Satellite Radio are subject to change without notice.

■ **If the satellite radio does not operate normally**

If a problem occurs with the XM<sup>®</sup> tuner, a message will appear on the display. Refer to the table below to identify the problem, and take the suggested corrective action.

ANTENNA	The XM <sup>®</sup> antenna is not connected. Check whether the XM <sup>®</sup> antenna cable is attached securely.
	There is a short-circuit in the antenna or the surrounding antenna cable. See a Toyota certified dealer.
UPDATING	You have not subscribed to the XM <sup>®</sup> Satellite Radio. The radio is being updated with the latest encryption code. Contact the XM <sup>®</sup> Satellite Radio for subscription information. When a contract is canceled, you can choose the “CH000” and all free-to-air channels.
	The premium channel you selected is not authorized. Wait for about 2 seconds until the radio returns to the previous channel or “CH001”. If it does not change automatically, select another channel. If you want to listen to the premium channel, contact the XM <sup>®</sup> Satellite Radio.

NO SIGNAL	The XM <sup>®</sup> signal is too weak at the current location. Wait until your vehicle reaches a location with a stronger signal.
LOADING	The unit is acquiring audio or program information. Wait until the unit has received the information.
OFF AIR	The channel you selected is not broadcasting any programming. Select another channel.
----	There is no song/program title or artist name/feature associated with the channel at that time. No action needed.
---	The channel you selected is no longer available. Wait for about 2 seconds until the radio returns to the previous channel or "CH001". If it does not change automatically, select another channel.

Contact the XM<sup>®</sup> Listener Care Center at 1-800-967-2346 during the following hours\*.

Monday - Saturday: 6 a.m. - 2 a.m. Eastern Time

Sunday: 8 a.m. - 8 p.m. Eastern Time

\*: Subject to change without notice.

#### n **Certifications for the radio tuner**

This equipment has been tested and found to comply with the limits for a class B digital device, pursuant to Part 15 of the FCC Rules. These limits are designed to provide reasonable protection against harmful interference in a residential installation. This equipment generates, uses and can radiate radio frequency energy and, if not installed and used in accordance with the instructions, may cause harmful interference to radio communications. However, there is no guarantee that interference will not occur in a particular installation.

If this equipment does cause harmful interference to radio or television reception, which can be determined by turning the equipment off and on, the user is encouraged to try to correct the interference by trying one or more of the following:

- 1 Reorienting or relocate the receiving antenna.
- 1 Increasing the separation between the equipment and receiver.



- | Connecting the equipment into an outlet on a circuit different from that to which the receiver is connected.
- | Consulting the dealer or an experienced radio/TV technician for help.



**NOTICE**

**n To prevent damage, remove the antenna in the following cases.**

- | The antenna will touch the ceiling of a garage.
- | A cover will be put on the vehicle.

## 3-2. Using the audio system

### Using the CD player

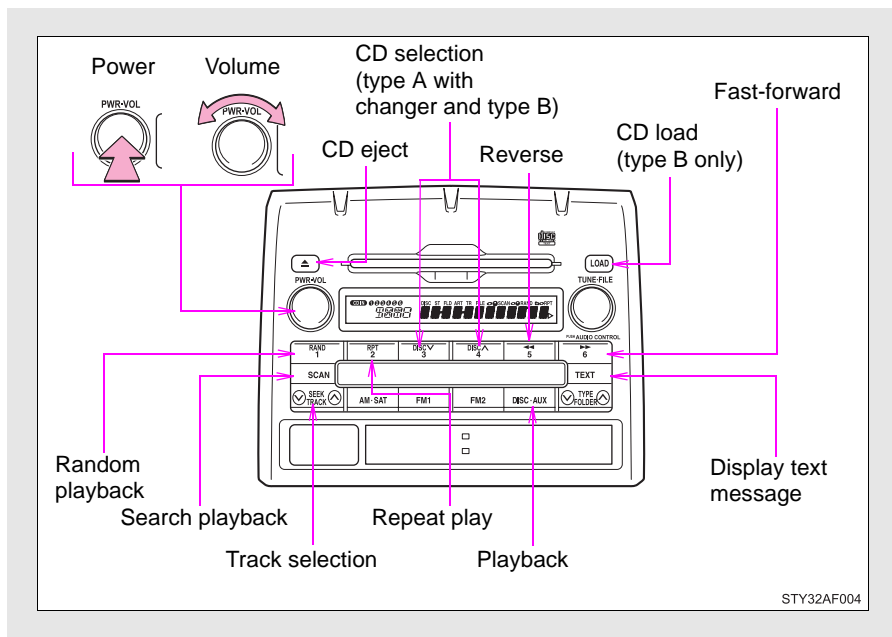

## Loading CDs

### n Loading a CD (type A)

Insert a CD.

### n Loading a CD (type B)

**STEP 1** Press **LOAD**.

"WAIT" is shown on the display.

**STEP 2** Insert a CD when the indicator on the slot turns from amber to green.

The display changes from "WAIT" to "LOAD".

### n Loading multiple CDs (type B only)

**STEP 1** Press and hold **LOAD** until you hear a beep.

"WAIT" is shown on the display.

**STEP 2** Insert a CD when the indicator on the slot turns from amber to green.

The display changes from “WAIT” to “LOAD”.

The indicator on the slot turns to amber when the CD is inserted.

**STEP 3** Insert the next CD when the indicator on the slot turns from amber to green again.

Repeat the procedure for the remaining CDs.

To stop the operation, press .

## Ejecting CDs

### n Ejecting a CD (type A)

Press  and remove the CD.

### n Ejecting a CD (type B)

**STEP 1** To select the CD to be ejected, press  or .

The number of the CD selected is shown on the display.

**STEP 2** Press  and remove the CD.

### n Ejecting all the CDs (type B only)

Press and hold  until you hear a beep, and then remove the CDs.

## Selecting and scanning a track

### n Selecting a track

Press “^” to move up or “v” to move down using  until the desired track number is displayed.

### n Scanning tracks

**STEP 1** Press .

The first 10 seconds of each track will be played.

**STEP 2** Press the switch again when the desired track is reached.

## Fast-forwarding and reversing tracks

To fast-forward or reverse.

Press and hold  or .

## Selecting a CD (type A with a CD changer and type B)

### n Selecting the desired CD

Press  or .

### n Selecting loaded CDs

**STEP 1** Press and hold  until you hear a beep.

The first 10 seconds of the first track on each CD will be played.

**STEP 2** Press the switch again when the desired CD is reached.

## Repeat play

### n Repeating a track

Press .

### n Repeating all of the tracks on a CD (type A with a CD changer and type B)

Press and hold  until you hear a beep.

## Random playback

### n Current CD

Press .

Tracks are played in a random order until the button is pressed once more.

### n All CDs (type A with a CD changer and type B)

Press and hold  until you hear a beep.

Tracks on all loaded CDs are played in a random order until the button is pressed once more.

## Switching the display

Press  .

Each time the switch is pressed, the display changes in the order of Track no./Elapsed time→CD title→Track name.

### Display

Up to 12 characters can be displayed at a time.

If there are 13 characters or more, pressing and holding  for 1 second or more will display the remaining characters.

A maximum of 24 characters can be displayed.

If  is pressed for 1 second or more again or has not been pressed for 6 seconds or more, the display will return to the first 12 characters.

Depending on the contents recorded, the characters may not be displayed properly or may not be displayed at all.

### Canceling random playback

Press  again.

### Canceling repeat play

Press  again.

### Error messages

Refer to the following table and take the appropriate measures. If the problem is not rectified, take the vehicle to your Toyota dealer.

Message	Cause	Correction Procedures
ERROR 1	<ul style="list-style-type: none"> <li>• The disc may be dirty or damaged</li> <li>• The disc may be inserted upside down</li> </ul>	<ul style="list-style-type: none"> <li>• Clean the disc</li> <li>• Insert the disc correctly</li> </ul>
ERROR 3	There is a problem within the system	Eject the disc or magazine
ERROR 4	Over-current	Ask your Toyota dealer

Message	Cause	Correction Procedures
WAIT	Operation is stopped due to a high temperature inside the player	Eject the disc and allow the player to cool down
CD OPEN	The external CD changer lid is open	Close the lid
NO DISC	There is no disc in the CD changer	Insert a disc

### Discs that can be used

Discs with the marks shown below can be used.

Playback may not be possible depending on recording format or disc features, or due to scratches, dirt or deterioration.



CDs with copy-protect features may not be used.

### CD player protection feature

To protect the internal components, playback is automatically stopped when a problem is detected while the CD player is being used.

### If CDs are left inside the CD player or in the ejected position for extended periods

CDs may be damaged and may not play properly.

### Lens cleaners

Do not use lens cleaners. Doing so may damage the CD player.

 NOTICE

**n CDs and adapters that cannot be used**

Do not use the following types of CDs or 3 in. (8 cm) CD adapters or Dual Disc.

Doing so may damage the CD player and/or the CD insert/eject function.

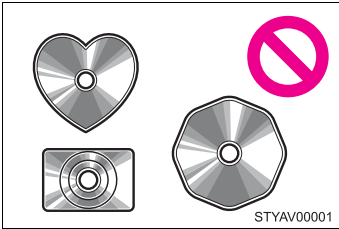

**I** CDs that have a diameter that is not 4.7 in. (12 cm)

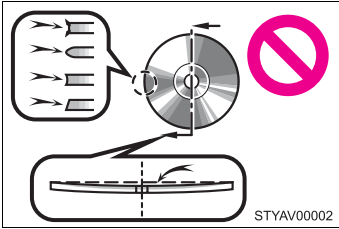

**I** Low-quality and deformed CDs

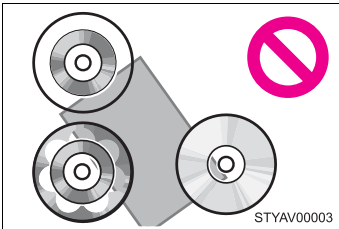

**I** CDs with a transparent or translucent recording area

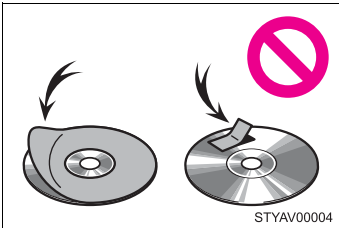

**I** CDs that have had tape, stickers or CD-R labels attached to them, or that have had the label peeled off

 NOTICE**n CD player precautions**

Failure to follow the precautions below may result in serious damage to the CDs or the player itself.

- I Do not insert anything other than CDs into the CD slot.
- I Do not apply oil to the CD player.
- I Store CDs away from direct sunlight.
- I Never try to disassemble any part of the CD player.

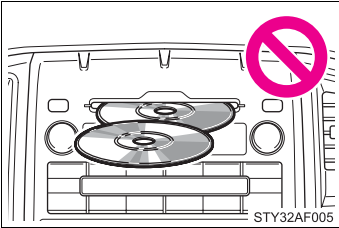

- I Type B: Do not insert more than one CD at a time



## 3-2. Using the audio system Playing back MP3 and WMA discs

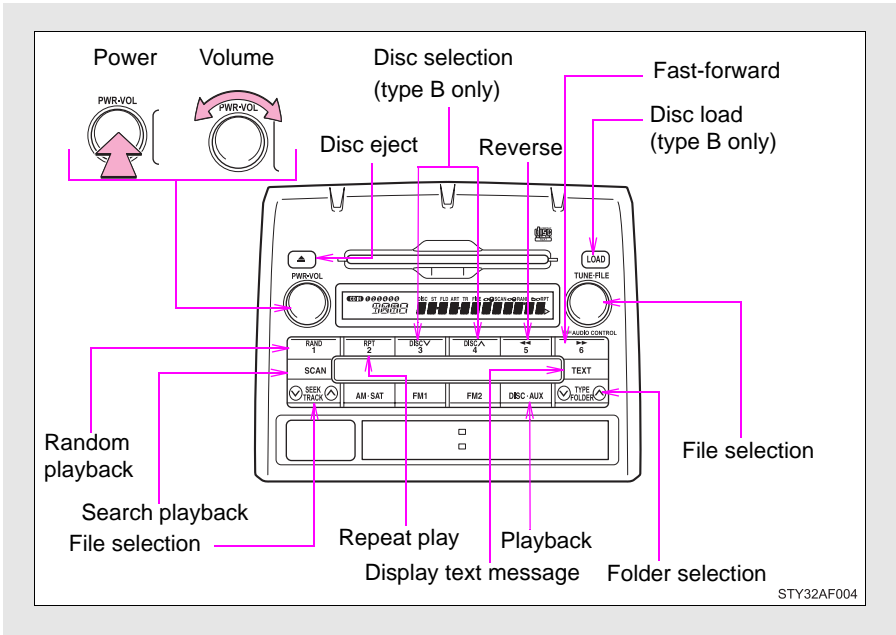

### Loading MP3 and WMA discs

#### n Loading a disc (type A)

Insert a disc.

#### n Loading a disc (type B)

**STEP 1** Press **LOAD**.

"WAIT" is shown on the display.

**STEP 2** Insert a disc when the indicator on the slot turns from amber to green.

The display changes from "WAIT" to "LOAD".

### n Loading multiple discs (type B only)

**STEP 1** Press and hold  until you hear a beep.

“WAIT” is shown on the display.

**STEP 2** Insert a disc when the indicator on the slot turns from amber to green.

The display changes from “WAIT” to “LOAD”.

The indicator on the slot turns to amber when the disc is inserted.

**STEP 3** Insert the next disc when the indicator on the slot turns from amber to green again.

Repeat the procedure for the remaining discs.



To stop the operation, press .

## Ejecting MP3 and WMA discs

### n Ejecting a disc (type A)

Press  and remove the disc.

### n Ejecting a disc (type B)

**STEP 1** To select the disc to be ejected, press  or .

The number of the disc selected is shown on the display.

**STEP 2** Press  and remove the disc.

### n Ejecting all the discs (type B only)

Press and hold  until you hear a beep, and then remove the discs.

## Selecting a disc (type B only)

### n Selecting the desired disc

Press  or .

## Selecting a folder

### n Selecting folders one at a time

To select the desired folder, press “^” or “v” on .

### n Selecting the desired folder by cueing the first file of each folder

Press and hold  until you hear a beep.

The first 10 seconds of the first file in the each folder will be played.

When the desired folder is reached, press the switch once again.

### n Returning to the first folder

Press and hold “v” on  until you hear a beep.

## Selecting and scanning files

### n Selecting one file at a time

To select the desired file, turn the  or press “^” or “v” on



### n Selecting the desired file by cueing the files in the folder

Press .

The first 10 seconds of all files in the folder will be played.

When the desired file is reached, press the switch once again.

## Fast-forwarding and reversing files

To fast-forward or reverse.

Press and hold  or .

## Repeat play

### n Repeating a file

Press .

### n Repeating all of the files in the folder

Press and hold  until you hear a beep.

## Random playback

### n Playing files from a particular folder in random order

Press .

### n Playing all of the files on a disc in random order

Press and hold  until you hear a beep.

## Switching the display

Press .

Each time the switch is pressed, the display changes in the order of Folder no./File no./Elapsed time→Folder name→File name→Album title (MP3 only)→Track title→Artist name.

□ **Display**

Up to 12 characters can be displayed at a time.

If there are 13 characters or more, pressing and holding  for 1 second or more will display the remaining characters.

A maximum of 24 characters can be displayed.

If  is pressed for 1 second or more again or has not been pressed for 6 seconds or more, the display will return to the first 12 characters.

Depending on the contents recorded, the characters may not be displayed properly or may not be displayed at all.

□ **Canceling random playback**

Press  again.

□ **Canceling repeat play**

Press  again.

□ **Error messages**

Refer to the following table and take the appropriate measures. If the problem is not rectified, take the vehicle to your Toyota dealer.

Message	Cause	Correction Procedures
ERROR 1	<ul style="list-style-type: none"> <li>• The disc may be dirty or damaged</li> <li>• The disc may be inserted upside down</li> </ul>	<ul style="list-style-type: none"> <li>• Clean the disc</li> <li>• Insert the disc correctly</li> </ul>
ERROR 3	There is a problem within the system	Eject the disc or magazine
ERROR 4	Over-current	Ask your Toyota dealer
WAIT	Operation is stopped due to a high temperature inside the player	Eject the disc and allow the player to cool down
NO MUSIC	This indicates that no playable data is included in the disc	Eject the disc

### ▮ Discs that can be used

Discs with the marks shown below can be used.

Playback may not be possible depending on recording format or disc features, or due to scratches, dirt or deterioration.



### ▮ MP3 and WMA player protection feature

To protect the internal components, playback is automatically stopped when a problem is detected while the MP3 and WMA player is being used.

### ▮ If discs are left inside the MP3 and WMA player or in the ejected position for extended periods

Discs may be damaged and may not play properly.

### ▮ Lens cleaners

Do not use lens cleaners. Doing so may damage the MP3 and WMA player.

### ▮ MP3 and WMA files

MP3 (MPEG Audio LAYER3) is a standard audio compression format.

Files can be compressed to approximately 1/10 of their original size by using MP3 compression.

WMA (Windows Media™ Audio) is a Microsoft audio compression format.

This format compresses audio data to a size smaller than that of the MP3 format.

There is a limit to the MP3 and WMA file standards and to the media/formats recorded by them that can be used.

#### ▮ MP3 file compatibility

- Compatible standards  
MP3 (MPEG1 LAYER3, MPEG2 LSF LAYER3)
- Compatible sampling frequencies  
MPEG1 LAYER3: 32, 44.1, 48 (kHz)  
MPEG2 LSF LAYER3: 16, 22.05, 24 (kHz)
- Compatible bit rates (compatible with VBR)  
MPEG1 LAYER3: 64, 80, 96, 112, 128, 160, 192, 224, 256, 320 (kbps)
- MPEG2 LSF LAYER3: 64, 80, 96, 112, 128, 144, 160 (kbps)
- Compatible channel modes: stereo, joint stereo, dual channel and monaural

### 1 WMA file compatibility

- Compatible standards  
WMA Ver. 7, 8, 9
- Compatible sampling frequencies  
32, 44.1, 48 (kHz)
- Compatible bit rates (only compatible with 2-channel playback)  
Ver. 7, 8: CBR 48, 64, 80, 96, 128, 160, 192 (kbps)  
Ver. 9: CBR 48, 64, 80, 96, 128, 160, 192, 256, 320 (kbps)

### 1 Compatible media

Media that can be used for MP3 and WMA playback are CD-Rs and CD-RWs.

Playback in some instances may not be possible, depending on the status of the CD-R or CD-RW. Playback may not be possible or the audio may jump if the disc is scratched or marked with fingerprints.

### 1 Compatible disc formats

The following disc formats can be used.

- Disc formats: CD-ROM Mode 1 and Mode 2  
CD-ROM XA Mode 2, Form 1 and Form 2
- File formats: ISO9660 Level 1, Level 2, (Romeo, Joliet)  
MP3 and WMA files written in any format other than those listed above may not play correctly, and their file names and folder names may not be displayed correctly.

Items related to standards and limitations are as follows.

- Maximum directory hierarchy: 8 levels
- Maximum length of folder names/file names: 32 characters
- Maximum number of folders: 192 (including the root)
- Maximum number of files per disc: 255

### 1 File names

The only files that can be recognized as MP3/WMA and played are those with the extension .mp3 or .wma.

### 1 Multi-sessions

As the audio system is compatible with multi-sessions, it is possible to play discs that contain MP3 and WMA files. However, only the first session can be played.

### 1 ID3 and WMA tags

ID3 tags can be added to MP3 files, making it possible to record the track title and artist name, etc.

The system is compatible with ID3 Ver. 1.0, 1.1, and Ver. 2.2, 2.3 ID3 tags. (The number of characters is based on ID3 Ver. 1.0 and 1.1.)

WMA tags can be added to WMA files, making it possible to record the track title and artist name in the same way as with ID3 tags.

### 1 MP3 and WMA playback

When a disc containing MP3 or WMA files is inserted, all files on the disc are first checked. Once the file check is finished, the first MP3 or WMA file is played. To make the file check finish more quickly, we recommend you do not write in any files other than MP3 or WMA files or create any unnecessary folders.

If the discs contain a mixture of music data and MP3 or WMA format data, only music data can be played.

### 1 Extensions

If the file extensions .mp3 and .wma are used for files other than MP3 and WMA files, they will be mistakenly recognized and played as MP3 and WMA files. This may result in large amounts of interference and damage to the speakers.

### 1 Playback

- To play MP3 file with steady sound quality, we recommend a fixed bit rate of 128 kbps and a sampling frequency of 44.1 kHz.
- CD-R or CD-RW playback may not be possible in some instances, depending on the characteristics of the disc.
- There is a wide variety of freeware and other encoding software for MP3 and WMA files on the market, and depending on the status of the encoding and the file format, poor sound quality or noise at the start of playback may result. In some cases, playback may not be possible at all.
- When files other than MP3 or WMA files are recorded on a disc, it may take more time to recognize the disc and in some cases, playback may not be possible at all.
- Microsoft, Windows, and Windows Media are the registered trademarks of Microsoft Corporation in the U.S. and other countries.





**NOTICE**

- n CDs and adapters that cannot be used (→P. 242)**
- n CD player precautions (→P. 243)**

## Optimal use of the audio system

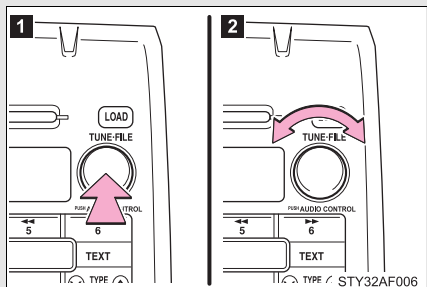

**1** Displays the current mode

**2** Changes the following setting

- Sound quality and volume balance (→P. 254)

The sound quality and balance setting can be changed to produce the best sound.

- Volume and tone quality level (Automatic Sound Levelizer) (→P. 254)

### Using the AUDIO CONTROL function

#### n Changing sound quality modes

Pressing  selects the mode to be changed in the following order.

BAS → MID\* → TRE → FAD → BAL → ASL



\*:JBL brand audio system

n **Adjusting sound quality**

Turning  adjusts the level.

Sound quality mode	Mode displayed	Level	Turn to the left	Turn to the right
Bass	BAS	-5 to 5	Low	High
Midrange	MID* <sup>1</sup>	-5 to 5		
Treble	TRE	-5 to 5		
Front/rear volume balance	FAD	F7 to R7	Shifts to roof* <sup>2</sup> /roof and sub-woofer* <sup>3</sup> , Shifts to rear* <sup>4</sup>	Shifts to front
Left/right volume balance	BAL	L7 to R7	Shifts to left	Shifts to right

\*1:JBL brand audio system

\*2:Access Cab models without sub woofer

\*3:Access Cab models with sub woofer

\*4:Double Cab models

n **Adjusting the Automatic Sound Levelizer (ASL)**

► Except JBL brand audio system

When “ASL” is selected, turning  to the right changes the “ASL” level in the order of “LOW”, “MID” and “HIGH”.

Turning  to the left turns “ASL” off.

ASL automatically adjusts the volume and tone quality according to vehicle speed.

► JBL brand audio system

When “ASL” is selected, turning  to the right turns “ASL” on , and turning  to the left turns “ASL” off.

ASL automatically adjusts the volume and tone quality according to vehicle speed.

n Trademark owned by SRS Labs, Inc.



The audio systems utilize SRS FOCUS<sup>®</sup> and SRS TruBass<sup>®</sup> audio enhancement technologies, under license from SRS Labs, Inc., in all modes except AM radio mode.

FOCUS, TruBass, SRS and  symbols are trademarks of SRS Labs, Inc.

FOCUS and TruBass technologies are incorporated under license from SRS Labs, Inc.

## 3-2. Using the audio system

### Operating the sub woofer (on some Access Cab models)

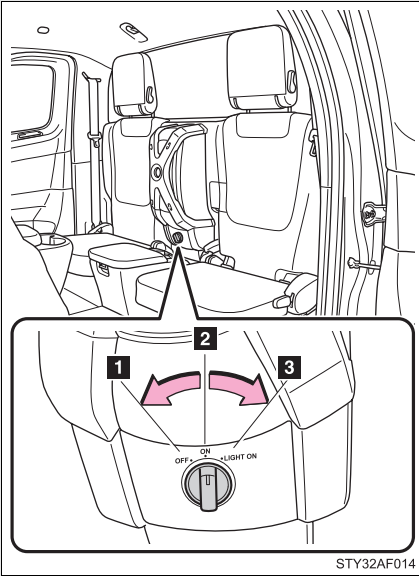

- 1** OFF
- 2** ON
- 3** LIGHT ON

The sub woofer illumination turns on. In this position, the sub woofer operates.

## 3-2. Using the audio system Using the AUX adapter

This adapter can be used to connect a portable audio device and listen to it through the vehicle's speakers.

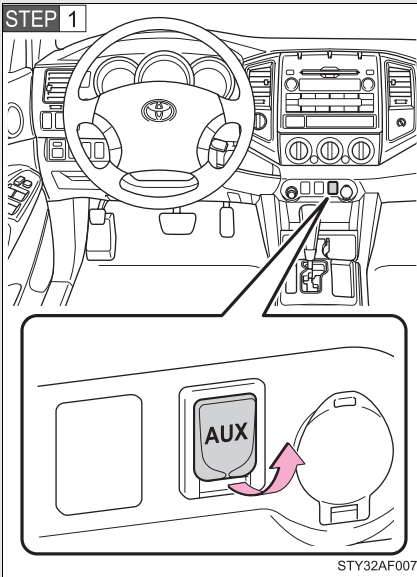

Connect the portable audio device.

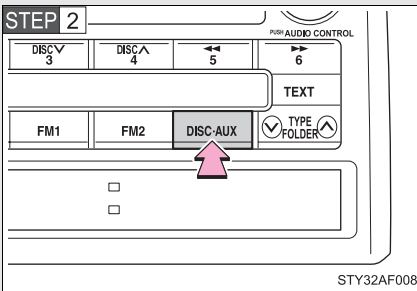

Press  .

▮ **Operating portable audio devices connected to the audio system**

The volume can be adjusted using the vehicle's audio controls. All other adjustments must be made on the portable audio device itself.

▮ **When using a portable audio device connected to the power outlet or cigarette lighter**

Noise may occur during playback. Use the power source of the portable audio device.

Some audio features can be controlled using the switches on the steering wheel.

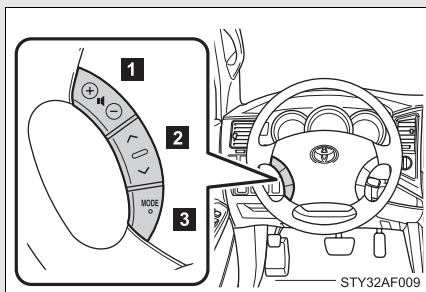

- 1** Volume
- 2** Radio: Select radio stations  
CD: Select tracks, files (MP3 and WMA) and discs
- 3** Power on/off, select audio source

### Turning on the power

Press  when the audio system is turned off.

The audio system can be turned off by holding the switch down until the system turns off.

### Changing the audio source

Press  when the audio system is turned on. The audio source

changes as follows each time  is pressed.

Type A:

FM1→FM2→CD→CD changer\*1→AUX→AM→SAT1\*2→SAT2\*2→SAT3\*2

↑



Type B:

FM1→FM2→CD changer→AUX→AM→SAT1\*2→SAT2\*2→SAT3\*2



\*1: If installed with a CD changer

\*2: Except JBL brand audio system—  
Use of XM® Satellite Radio requires XM® tuner and service.  
Contact your Toyota dealer.

## Adjusting the volume

Press “+” on  to increase the volume and “-” to decrease the volume.

Press and hold “+” or “-” on  to continue increasing or decreasing the volume.

## Selecting a radio station

**STEP 1** Press  to select the radio mode.

**STEP 2** Press “^” or “v” on  to select a preset station.

To scan for receivable stations, press and hold the switch until you hear a beep.

## Selecting a track/file

**STEP 1** Press  to select the CD mode.

**STEP 2** Press “^” or “v” on  to select the desired track/file.

### Selecting a folder (type A)

**STEP 1** Press  to select the CD mode.

**STEP 2** Press and hold “^” or “v” on  until you hear a beep.

### Selecting a disc in the CD player (type A with a CD changer and type B)

**STEP 1** Press  to select the CD mode.

**STEP 2** Press and hold “^” or “v” on  until you want to listen to is set.

#### CAUTION

##### n To reduce the risk of an accident

Exercise care when operating the audio switches on the steering wheel.

### 3-3. Using the hands-free phone system (for cellular phone) Hands-free phone system (for cellular phone) (if equipped)

**This system supports Bluetooth<sup>®</sup>, which allows you connect a cellular phone without using cables and to make or receive calls without operating the cellular phone buttons.**

Title	Page
Using the hands-free phone system	P. 266
Making a phone call	P. 274
Setting a cellular phone	P. 279
Security and system setup	P. 284
Using the phone book	P. 287

#### **n When using the hands-free system**

- l The audio system and voice guidance are muted when making a call.
- l If both parties speak at the same time it may be difficult to hear.
- l If the received call volume is overly loud, an echo may be heard.
- l Try to face toward the microphone as much as possible when speaking.
- l In the following circumstances it may be difficult to hear the other party:
  - If driving on unpaved roads
  - If driving at high speeds
  - If a window is open
  - If the air conditioning is blowing directly on the microphone
  - If the air conditioning fan speed is set to high

n **Conditions under which the system will not operate**

- l If using a cellular phone that does not support Bluetooth®
- l If the cellular phone is switched off
- l If you are outside service range
- l If the cellular phone is not connected
- l If the cellular phone's battery is low

n **Bluetooth® antenna**

The antenna is built into the display. If the cellular phone is behind the seat or in the console box, or touching or covered by metal objects, connection status may deteriorate.

n **Signal status**

This display may not correspond exactly with the cellular phone itself.

n **About Bluetooth®**



Bluetooth is a registered trademark of Bluetooth SIG, Inc.

n **Compatible models**

Compatible with HFP (Hands Free Profile) Ver. 1.0 and OPP (Object Push Profile) Ver. 1.1.

If your cellular phone does not support HFP, you cannot enter the Bluetooth® phone. If your cellular phone supports OPP alone, you cannot use the Bluetooth® phone.

□ **Certification for the hands-free phone system**

FCC ID: ACJ932C5ZZZ035 IC ID: 216J-C5ZZZ035 MADE IN U.S.A.
--

**NOTE:**

This device complies with Part 15 of the FCC Rules and RSS-210 of industry Canada. Operation is subject to the following two conditions: (1) This device may not cause harmful interference, and (2) this device must accept any interference received, including interference that may cause undesired operation.

**NOTICE:**

This equipment has been tested and found to comply with the limits for a Class B digital device, pursuant to part 15 of the FCC Rules. These limits are designed to provide reasonable protection against harmful interference in a residential installation. This equipment generates, uses and can radiate radio frequency energy and, if not installed and used in accordance with the instructions, may cause harmful interference to radio communications. However, there is no guarantee that interference will not occur in a particular installation. If this equipment does cause harmful interference to radio or television reception, which can be determined by turning the equipment off and on, the user is encouraged to try to correct the interference by one or more of the following measures:

- 1 Reorient or relocate the receiving antenna.
- 1 Increase the separation between the equipment and receiver.
- 1 Connect the equipment into an outlet on a circuit different from that to which the receiver is connected.
- 1 Consult the dealer or an experienced radio/TV technician for help.

**FCC WARNING:**

Changes or modifications not expressly approved by the party responsible for compliance could void the user's authority to operate the equipment.

**CAUTION:**

**Radio Frequency Radiation Exposure**

This equipment complies with FCC radiation exposure limits set forth for uncontrolled equipment and meets the FCC radio frequency (RF) Exposure Guidelines in Supplement C to OET65. This equipment has very low levels of RF energy that it deemed to comply without maximum permissive exposure evaluation (MPE). But it is desirable that it should be installed and operated with at least 20 cm and more between the radiator and person's body (excluding extremities: hands, wrists, feet and legs).

**Co-location:**

This transmitter must not be co-located or operated in conjunction with any other antenna or transmitter.

 **CAUTION**

**n Caution while driving**

Do not use a cellular phone or connect the Bluetooth® phone.

 **NOTICE**

**n When leaving the vehicle**

Do not leave a cellular phone in the vehicle. The inside of the vehicle may become hot, causing damage to the phone.

## 3-3. Using the hands-free phone system (for cellular phone) Using the hands-free phone system

### n Audio unit

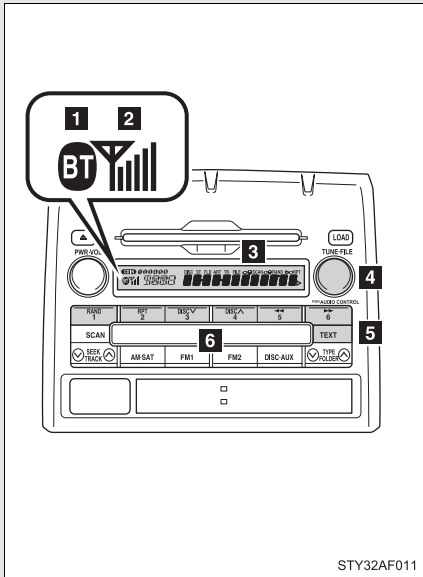

- 1 Displays Bluetooth® connection condition

If “BT” is not displayed, the hands-free phone system cannot be used.

- 2 Displays the reception level
- 3 Displays such items as numbers, names, messages and menu items

- 4 Selects items such as numbers or menu items  
Turn: Selects an item  
Press: Inputs the selected item

- 5 Press and hold: Displays information that is too long to be displayed at one time on the screen

- 6 Selects speed dials

**n Steering wheel telephone switches**

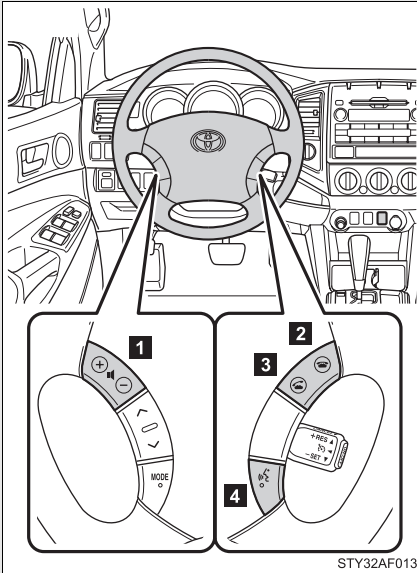

**1** Volume

The voice guidance volume cannot be adjusted by using this switch.

**2** Hands-free phone system off/ends a call/refuses a call

**3** Hands-free phone system on/starts a call

**4** Press: Voice command system on

Press and hold: Voice command system off

**n Microphone**

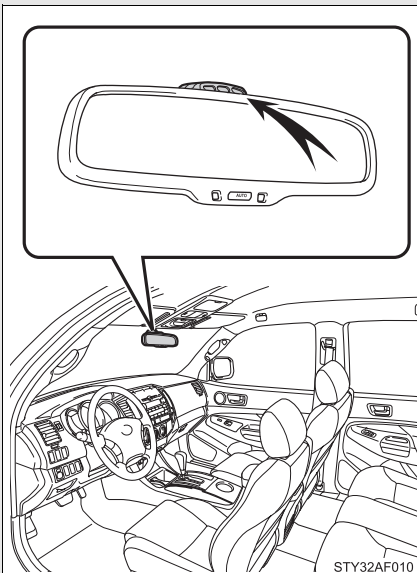



## Operating the system by using a voice command

By following voice guidance instructions output from the speaker, you can speak voice commands aloud to control the hands-free phone system without looking at the display or operating .

### n Operation procedure when using voice commands

Press  and say a voice command for a desired function. (→P. 269)

### n Auxiliary commands when using a voice command

The following auxiliary voice commands can be used at any time when operating the system using voice commands:

“Repeat”: Repeats the previous voice guidance instruction

“Go back”: Returns to the previous procedure

“Cancel”: Exits the hands-free phone system

“Help”: Reads aloud the function summary if a help comment is registered for the selected function



## Using the hands-free phone system for the first time

Before using the hands-free phone system, it is necessary to register a cellular phone in the system. The phone registration mode will be entered automatically when starting the system with no cellular phone registered. Follow the procedure below to register a cellular phone:

**STEP 1** Press  or .

The introductory guidance and phone name registration instructions are heard.

**STEP 2** Register a phone name by either of the following methods.

- a. Select “(RECORD NAME)” by using  , and say aloud the name you would like to register for the phone.
- b. Press  and say aloud the name you would like to register for the phone.

You will hear voice guidance instructing you to confirm the input.

**STEP 3** Select “Confirm” by using a voice command or .

A passkey is displayed and heard, and voice guidance instruction for inputting the passkey into the cellular phone is heard.

**STEP 4** Input the passkey into the cellular phone.

Refer to the manual that comes with the cellular phone for the operation of the phone.

Guidance for registration completion is heard.

### Menu list of the hands-free phone system

#### n Voice commands (MENU ITEMS)

First menu	Second menu	Third menu	Operation detail
Dial by name	-	-	Dialing by inputting a name registered in the phone book
Dial by number	-	-	Dialing by inputting a phone number
Redial (REDIAL)	-	-	Dialing a phone number stored in the outgoing history memory

### 3-3. Using the hands-free phone system (for cellular phone)

First menu	Second menu	Third menu	Operation detail
Callback (CALLBACK)	-	-	Dialing a phone number stored in the incoming history memory
Phone book (PHONE BOOK)	Add entry (ADD ENTRY)	By voice (BY VOICE)	Adding a new phone number
		By phone (BY PHONE)	
		Call history (CALL HISTORY)	
		(MANUAL INPUT)	
	Change name (CHANGE NAME)	-	Changing the name of a phone number in the phone book
	List names (LIST NAMES)	-	Listing the phone book data
	Set speed dial (SPEED DIAL)	-	Registering a speed dial
	Delete entry (DELETE ENTRY)	-	Deleting the phone book data
Delete speed dial (DEL SPD DIAL)	-	Deleting a registered speed dial	

First menu	Second menu	Third menu	Operation detail
Setup (SETUP)	Security (SECURITY)	Set PIN (SET PIN)	Setting a PIN
		Phone book lock (PHBK LOCK)	Locking the phone book
		Phone book unlock (PHBK UNLOCK)	Unlocking the phone book
	Phone setup (PHONE SETUP)	Pair phone (PAIR PHONE)	Registering a cellular phone to be used
		Select phone (SELECT PHONE)	Selecting a cellular phone to be used
		Change name (CHANGE NAME)	Changing a registered name of a cellular phone
		List phones (LIST PHONES)	Listing the registered cellular phones
		Set passkey (SET PASSKEY)	Changing the passkey
		Delete (DELETE)	Deleting a registered cellular phone
	(SYSTEM SETUP)	(GUIDANCE VOL)	Setting voice guidance volume
(INITIALIZE)		Initialization	

### n Using a short cut voice command

First menu	Second menu	Operation detail
Dial "XXX (name)"	-	Dialing a phone number registered in the phone book
Phone book add entry	-	Adding a new phone number
Phone book change name	-	Changing the name of a phone number in the phone book
Phone book list names	-	Listing the phone book data
Phone book set speed dial	-	Registering speed dial
Phone book delete entry	-	Deleting phone book data
Phone book delete speed dial	-	Deleting speed dial
Phone book	Phone book unlock	Unlocking the phone book
	Phone book lock	Locking the phone book

n **Automatic adjustment of volume**

When vehicle speed is 50 mph (80 km/h) or more, the volume automatically increases. The volume returns to the previous volume setting when vehicle speed drops to 43 mph (70 km/h) or less.

n **When using a voice command**

l For numbers, speak a combination of single digits from zero to nine, # (pound), \* (star), and + (plus).

l Speak the command correctly and clearly.

n **The system may not recognize your voice in the following situations:**

l When driving on a rough road

l When driving at high speeds

l When air is blowing out of the vents onto the microphone

l When the air conditioning fan emits a loud noise

n **The following cannot be performed while driving:**

l Operating the system with



l Registering a cellular phone to the system

n **Changing the passkey**

→P. 282

## Making a phone call

### n **Making a phone call**

- 1 Dialing by inputting a phone number  
“Dial by number”
- 1 Dialing by inputting a name  
“Dial by name”
- 1 Speed dialing
- 1 Dialing a phone number stored in the outgoing history memory  
“Redial”
- 1 Dialing a phone number stored in the incoming history memory  
“Callback”

### n **Receiving a phone call**

- 1 Answering the phone
- 1 Refusing the call

### n **Transferring a call**

### n **Using a call history memory**



- 1 Dialing
- 1 Storing data in the phone book
- 1 Deleting

## Dialing by inputting a phone number

**STEP 1** Press  and say “Dial by number”.

**STEP 2** Press  and say the phone number.



**STEP 3** Dial by one of the following methods:

- a. Press .
- b. Press  and say "Dial".
- c. Select "Dial" by using .



### Dialing by inputting a name

**STEP 1** Press  and say "Dial by name".

**STEP 2** Select a registered name to be input by either of the following methods:

- a. Press  and say a registered name.
- b. Press  and say "List names". Press  while the desired name is being read aloud.

**STEP 3** Dial by one of the following methods:

- a. Press .
- b. Press  and say "Dial".
- c. Select "Dial" by using .

### Speed dialing

**STEP 1** Press .

**STEP 2** Press the preset button in which the desired phone number is registered.

**STEP 3** Press .



### When receiving a phone call

n **Answering the phone**

Press .

n **Refusing the call**

Press .

### Transferring a call

A call can be transferred between the cellular phone and system while dialing, receiving a call, or conversing a call. Use one of the following methods:

- a. Operate the cellular phone.

Refer to the manual that comes with the cellular phone for the operation of the phone.

- b. Press  \*1.

- c. Press  and say "Call Transfer" \*2.

\*1: This operation can be performed only when transferring a call from the cellular phone to the system during a call.

\*2: While the vehicle is in motion, a call cannot be transferred from the system to the cellular phone.

**Using a call history memory**

Follow the procedure below to use a phone number stored in call history memory:

**STEP 1** Press  and say “Redial” (when using a phone number stored in the outgoing history memory) or “Callback” (when using a phone number stored in the incoming history memory).

**STEP 2** Select the phone number by either of the following methods:  
 a. Say “Previous” or “Go back” until the desired phone number is displayed.

b. Select the desired phone number by using .

The following operations can be performed:

Dialing: Press  or select “Dial” by using a voice command or



Storing the phone number in the phone book: Select “Store” by using a voice command or .

Deleting: Select “Delete” by using a voice command or .

▮ **A shortcut to Redial is available**

Press the  twice.

▮ **Muting your voice**

Your voice can be muted so that the other party cannot hear your voice during a call.

To set or cancel: Press  and say “Mute”.

▮ **Call history**

Up to 5 phone numbers can be stored in each of the outgoing and incoming history memories.

▮ **When talking on the phone**

l Do not talk simultaneously with the other party.

l Keep the volume of the received voice down. Otherwise, voice echo will increase.

## 3-3. Using the hands-free phone system (for cellular phone) Setting a cellular phone

Registering a cellular phone in the hands-free phone system allows the system to function. The following function can be used for registered cellular phones:

### n Functions and operation procedures

To enter a menu for each function, follow the steps below by using

voice commands or  :

- 1 Registering a cellular phone
  1. "Setup" → 2. "Phone setup" → 3. "Pair phone"
- 1 Selecting a cellular phone to be used
  1. "Setup" → 2. "Phone setup" → 3. "Select phone"
- 1 Changing a registered name
  1. "Setup" → 2. "Phone setup" → 3. "Change name"
- 1 Listing the registered cellular phones
  1. "Setup" → 2. "Phone setup" → 3. "List phones"
- 1 Changing the passkey
  1. "Setup" → 2. "Phone setup" → 3. "Set passkey"
- 1 Deleting a cellular phone
  1. "Setup" → 2. "Phone setup" → 3. "Delete"

### Registering a cellular phone

Select "Pair phone" by using a voice command or  , and do the procedure for registering a cellular phone. (→P. 268)

## Selecting a cellular phone to be used



**STEP 1** Select “Select phone” by using a voice command or  .

### ► Pattern A

**STEP 2** Select a cellular phone to be used by either of the following methods, and select “Confirm” by using a voice command or



a. Press  and say the desired phone name.

b. Press  and say “List phones”. While the name of the desired cellular phone is being read aloud, press  .



### ► Pattern B



**STEP 2** Select a cellular phone to be used by using  .

## Changing a registered name



**STEP 1** Select “Change name” by using a voice command or  .

**STEP 2** Select a name of cellular phone to be changed by either of the following methods:

a. Press  and say the desired phone name, and select “Confirm” by using a voice command or  .

b. Press  and say “List phones”. While the desired phone name is being read aloud, press .

c. Select the desired phone name by using .

**STEP 3** Press  or select “(RECORD NAME)” by using , and say a new name.

**STEP 4** Select “Confirm” by using a voice command or .

**Listing the registered cellular phones**

Select “List phones” by using a voice command or  and the system begins reading aloud the list of the registered cellular phones. When listing is complete, the system returns to “Phone setup”.

Pressing  while a name of cellular phone is being read selects the cellular phone, and the following functions will be available:

- Selecting a cellular phone: “Select phone”
- Changing a registered name: “Change name”
- Deleting a cellular phone: “Delete”

## Changing the passkey

**STEP 1** Select “Set passkey” by using a voice command or  .

► Pattern A

**STEP 2** Press  , say a four to eight-digit number, and select

“Confirm” by using a voice command or  .

► Pattern B

**STEP 2** Select a four to eight-digit number by using  .

The number should be input one digit at a time.

**STEP 3** When the entire number to be registered as a passkey has been input, press  once again.

## Deleting a cellular phone



**STEP 1** Select “Delete” by using a voice command or  .

► Pattern A

**STEP 2** Select a cellular phone to be deleted by either of the following methods and select “Confirm” by using a voice command or



a. Press  and say the name of the desired cellular phone.

b. Press  and say “List phones”. While the name of the desired cellular phone is being read aloud, press  .

► Pattern B

**STEP 2** Select a cellular phone to be deleted by using  .

**n The number of cellular phones that can be registered**

Up to 6 cellular phones can be registered in the system.



## 3-3. Using the hands-free phone system (for cellular phone) Security and system setup

To enter the menu of each setting, follow the steps below:

### n **Security setting items and operation procedure**

#### 1 Setting or changing the PIN (Personal Identification Number)

1. "Setup" → 2. "Security" → 3. "Set PIN"

#### 1 Locking the phone book

1. "Setup" → 2. "Security" → 3. "Phone book lock"

#### 1 Unlocking the phone book

1. "Setup" → 2. "Security" → 3. "Phone book unlock"

### n **System setup items and operation procedure**

#### 1 Setting voice guidance volume

1. "Setup" → 2. "(SYSTEM SETUP)" → 3. "(GUIDANCE VOL)"

#### 1 Initialization

1. "Setup" → 2. "(SYSTEM SETUP)" → 3. "(INITIALIZE)"





can only be used for system setup operation.

## Setting or changing the PIN

### n **Setting a PIN**

**STEP 1** Select "Set PIN" by using a voice command or .

**STEP 2** Enter a PIN by using a voice command or .

When using , input the number one digit at a time.

**n Changing the PIN**

**STEP 1** Select “Set PIN” by using a voice command or  .

**STEP 2** Enter the registered PIN by using a voice command or  .

**STEP 3** Enter a new PIN by using a voice command or  .

When using  , input the number one digit at a time.

**Locking or unlocking the phone book**

**STEP 1** Select “Phone book lock (PHBK LOCK)” or “Phone book unlock (PHBK UNLOCK)” by using a voice command or  .

**STEP 2** Input the PIN by either of the following methods and select “Confirm” by using a voice command or  :

a. Press  and say the registered PIN.

b. Input a new PIN by using  .

**n When the phone book is locked**

The following functions cannot be used:

- 1 Dialing by inputting a name
- 1 Speed dialing
- 1 Dialing a phone number stored in the call history memory
- 1 Using the phone book

## Setting voice guidance volume

**STEP 1** Select “(GUIDANCE VOL)” by using  .

**STEP 2** Change the voice guidance volume.

To decrease the volume: Turn  counterclockwise.

To increase the volume: Turn  clockwise.

## Initialization

**STEP 1** Select “(INITIALIZE)” and then “(CONFIRM)” by using  .

**STEP 2** Select “(CONFIRM)” by using  again.

### n Initialization

- 1 The following data in the system can be initialized:
  - Phone book
  - Outgoing and incoming history memory
  - Speed dial data
  - Registered cellular phone data
  - PIN
- 1 Once the initialization has been completed, the data cannot be restored.

### 3-3. Using the hands-free phone system (for cellular phone)

## Using the phone book

To enter the menu of each setting, follow the steps below:

- 1 Adding a new phone number
  - 1. "Phone book" → 2. "Add entry"
- 1 Changing a registered name
  - 1. "Phone book" → 2. "Change name"
- 1 Listing the registered data
  - 1. "Phone book" → 2. "List names"
- 1 Setting speed dial
  - 1. "Phone book" → 2. "Set speed dial (SPEED DIAL)"
- 1 Deleting registered data
  - 1. "Phone book" → 2. "Delete entry"
- 1 Deleting speed dial
  - 1. "Phone book" → 2. "Delete speed dial (DEL SPD DIAL)"

#### Adding a new phone number

The following methods can be used to add a new phone number:

- 1 Inputting a phone number by using a voice command
- 1 Transferring data from the cellular phone
- 1 Selecting a phone number from outgoing or incoming history memory

- 1 Inputting a phone number by using



#### n Adding procedure

- STEP 1** Select "Add entry" by using a voice command or



**STEP 2** Use one of the following methods to input a phone number:

► Inputting a phone number by using voice commands

STEP2-1 Select “By voice” by using a voice command or



STEP2-2 Press  , say the desired phone number, and select “Confirm” by using a voice command.

► Transferring data from the cellular phone

STEP2-1 Select “By phone” and then “Confirm” by using a

voice command or  .

STEP2-2 Transfer the data from the cellular phone.

Refer to the manual that comes with the cellular phone for the details of transferring data.

STEP2-3 Select the data to be registered by either of the following methods:

a. Say “Previous” or “Next” until the desired data is displayed, and select “Confirm” by using a voice

command or  .

b. Select the desired data by using  .

- ▶ Selecting a phone number from outgoing or incoming history memory

STEP2-1 Select “Call history” by using a voice command or



STEP2-2 Select “Outgoing” or “Incoming” by using a voice

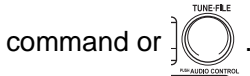

STEP2-3 Select the data to be registered by either of the following methods:

- a. Say “Previous” or “Go back” until the desired data is displayed, and select “Confirm” by using

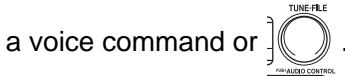

- b. Select the desired data by using .

- ▶ Inputting a phone number by using

STEP2-1 Select “(MANUAL INPUT)” by using .

STEP2-2 Input a phone number by using , and press

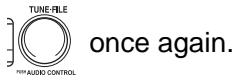



Input the phone number one digit at a time.

### 3-3. Using the hands-free phone system (for cellular phone)

**STEP 3** Select the name to be registered by either of the following methods, and select “Confirm” by using a voice command or



a. Press  and say the desired name.

b. Select “(RECORD NAME)” by using , and say the desired name.



**STEP 4** Select “Confirm” by using a voice command or  again.



In **STEP 3**, selecting “Set speed dial (SPEED DIAL)” instead of “Confirm” registers the newly added phone number as speed dial.

## Setting speed dial

**STEP 1** Select “Set speed dial (SPEED DIAL)” by using a voice command or .

**STEP 2** Select the data to be registered as speed dial by either of the following methods:

a. Press , say the desired phone number, and select “Confirm” by using a voice command or .

b. Press , and say “List names”. While the desired name is being read aloud, press , and select “Confirm” by using a voice command or .

c. Select the desired data by using  .

**STEP 3** Select the desired preset button, and register the data into speed dial by either of the following methods:

a. Press the desired preset button, and select “Confirm” by using a voice command or  .



b. Press and hold the desired preset button.

### Changing a registered name

**STEP 1** Select “Change name” by using a voice command or  .

**STEP 2** Select a name to be changed by either of the following methods.

a. Press  , say the desired name, and select “Confirm” by using a voice command or  .

b. Press  , and say “List names”. While the desired name is read aloud, press  .

c. Select the desired name by using  .

Select “(RECORD NAME)” by using  .

**STEP 3** Say a new name, and select “Confirm” by using a voice command or  .





## Deleting registered data

**STEP 1** Select “Delete entry” by using a voice command or  .



### ► Pattern A

**STEP 2** Select data to be deleted by either of the following methods, and select “Confirm” by using a voice command or  :

a. Press  , and say the name of the desired phone number to be deleted.

b. Press  , say “List phones”. While the name of the desired phone number is being read aloud, press  .

### ► Pattern B

**STEP 2** Select data to be deleted by using  , and select “(CONFIRM)” by using  .

## Deleting speed dial

**STEP 1** Select “Delete speed dial (DEL SPD DIAL)” by using a voice command or  .

**STEP 2** Press the preset button for which the desired speed dial is registered, and select “Confirm” by using a voice command or



### Listing the registered data

Select “List names” by using a voice command and the system begins reading aloud the list of the registered data.

When listing is complete, the system returns to “Phone book”.

Pressing  while an entry is being read aloud selects the entry, and the following functions will be available.

- Dialing: “Dial”
- Changing a registered name: “Change name”
- Deleting an entry: “Delete entry”
- Setting speed dial: “Set speed dial (SPEED DIAL)”

---

#### n Limitation of number of digits

A phone number that exceeds 24 digits cannot be registered.

## 3-4. Using the interior lights

### Interior lights list

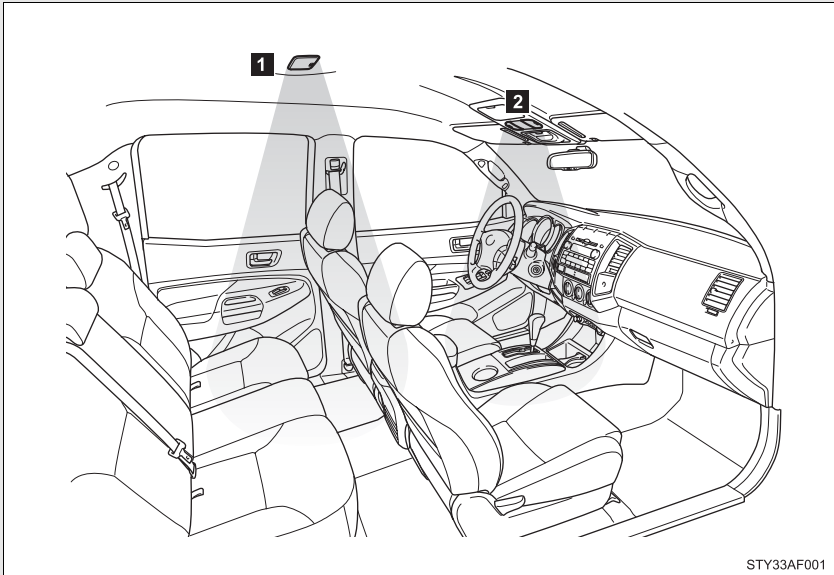

**1** Interior light (→P. 295)

**2** Personal lights (if equipped) (→P. 295)

#### ■ Illuminated entry system

When the interior light switch is in the DOOR position, the interior light automatically turns on/off according to whether the doors are locked/unlocked and whether the doors are open/closed.

#### ■ To prevent the battery from being discharged

If the interior light remains on when the door is not fully closed and the interior light switch is in the DOOR position, the light will go off automatically after 20 minutes.

## Interior light

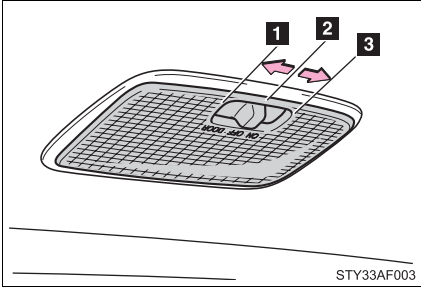

- 1** DOOR position
- 2** OFF
- 3** ON

## Personal lights (if equipped)

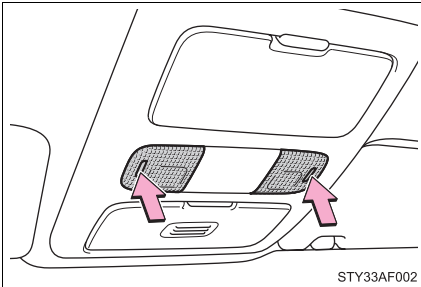

On/off

## 3-5. Using the storage features

### List of storage features

Glove box

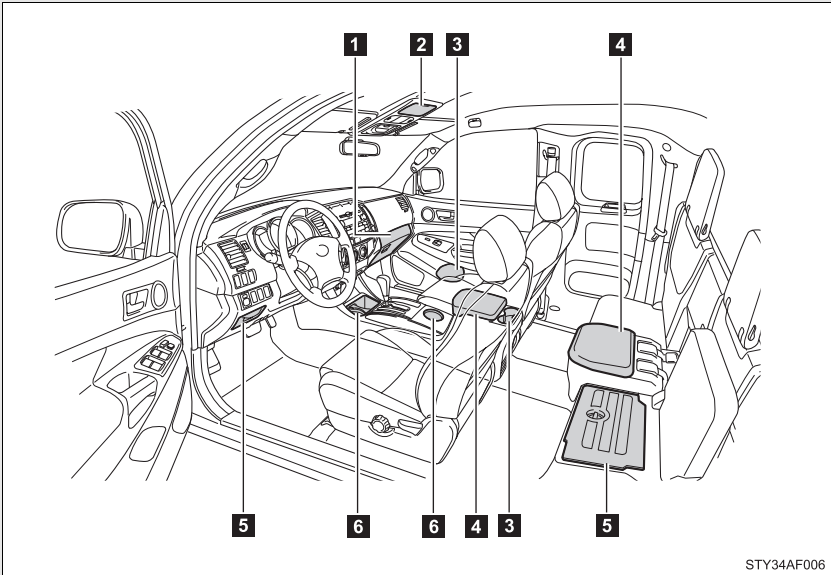

- 1** Glove box
- 2** Overhead console (if equipped)
- 3** Bottle holders
- 4** Console boxes (Access Cab and Double Cab models)
- 5** Auxiliary boxes
- 6** Cup holders

### Glove box

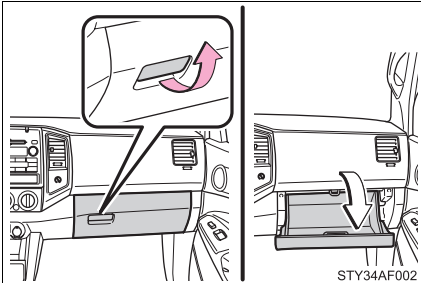

Pull up the lever.

**⚠ CAUTION**

**n Caution while driving**

Keep the glove box closed.

Injuries may result in the event of an accident or sudden braking.

**Console boxes (Access Cab and Double Cab models only)**

► Front (Access Cab and Double Cab models)

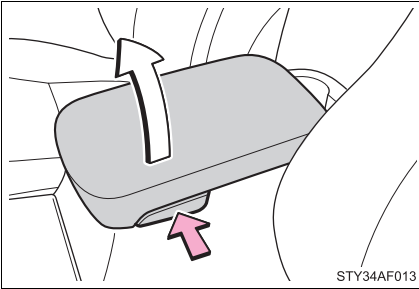

Push the button.

► Rear (Access Cab models)

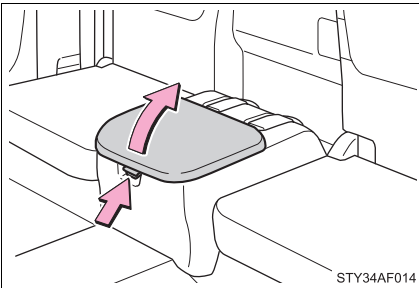

Lift the lid while pulling the knob.

**■ Removing the cargo net (front console box)**

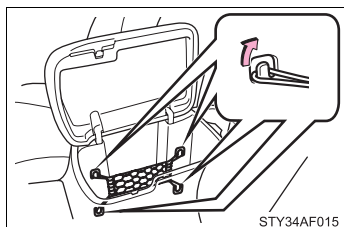

Unhook the net.

**▲ CAUTION**

**■ Caution while driving**

Keep the console box closed.

Injuries may result in the event of an accident or sudden braking.

**Cup holders**

**▶ Type A (Bench type front seat)**

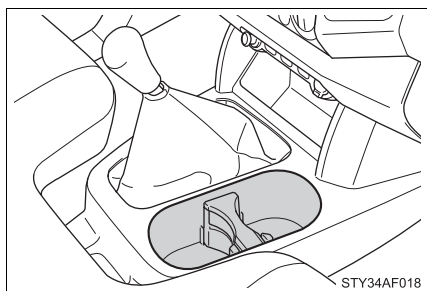

- ▶ Type B (Separated type front seats with an automatic transmission)

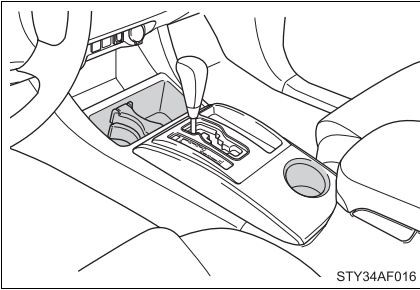

- ▶ Type C (Separated type front seats with a manual transmission)

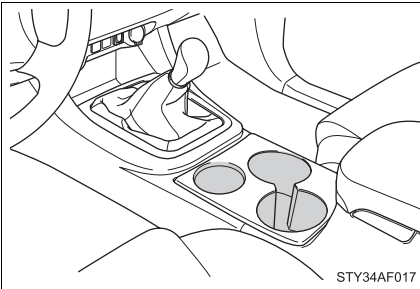

**n Adjusting the cup holder to the size of the cups or drink-cans (type A and type B)**

- ▶ Pattern A

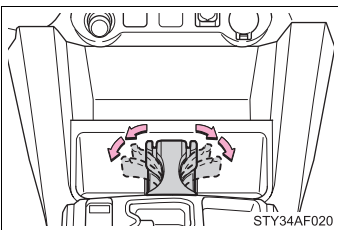

Adjust the holder.



► Pattern B

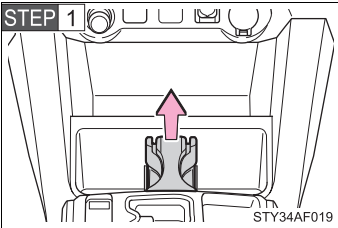

Remove the holder.

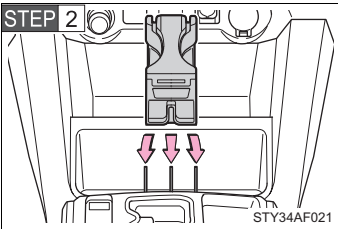

Change the holder position.

**! CAUTION**

**n Items unsuitable for the cup holder**

Do not place anything other than cups or aluminum cans in the cup holders. Other items may be thrown out of the holders in the event of an accident or sudden braking and cause injury. If possible, cover hot drinks to prevent burns.

**Bottle holders**

► Front

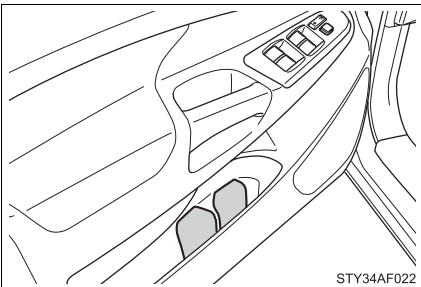

► Front console box (Access Cab and Double Cab models)

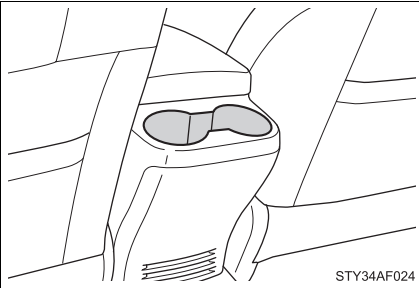

► Rear (Double Cab models)

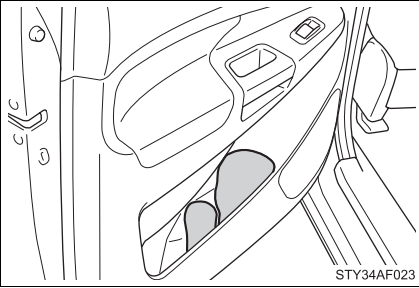

n **Bottle holders**

Depending on their size or shape, some bottles may not fit in the holders.

 **NOTICE**

n **Items that should not be stowed in the bottle holders**

Put the cap on before stowing a bottle. Do not place open bottles in the bottle holders, or glasses and paper cups containing liquid. The contents may spill and glasses may break.

**Auxiliary boxes**

► Front

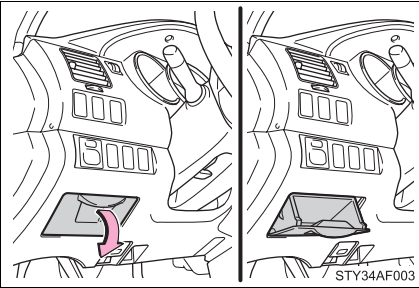

Pull the lid down.

► Under the rear seats (Access Cab models)

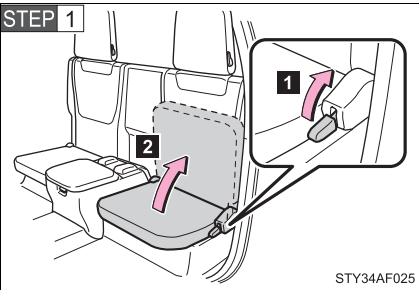

1 Pull up the lever.

2 Raise the bottom cushion up.

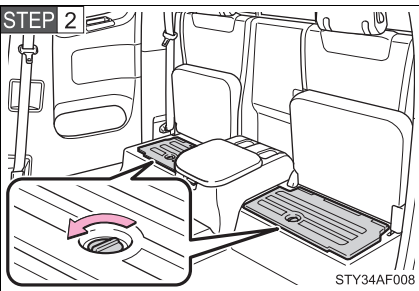

Turn the knob counterclockwise.

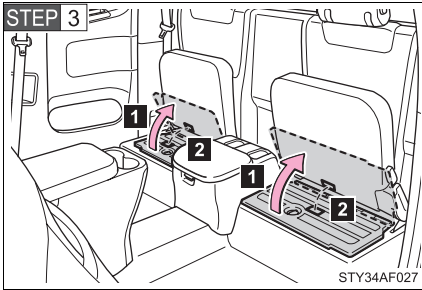

**1** Open the lid.

**2** Press the lid against the bottom of the lower cushion until it is supported by the hook-and-loop fastener.

Make sure that the lid is supported to prevent it from closing unexpectedly.

► Under the rear seats (Double Cab models)

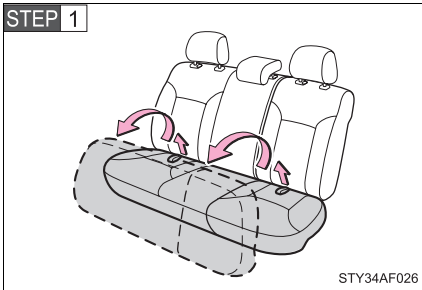

Swing the bottom cushion up by pulling the lock release strap.

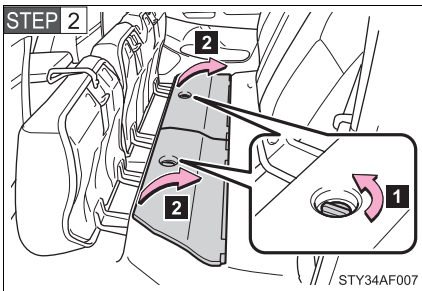

**1** Turn the knob counterclockwise.

**2** Open the lid.

**⚠ CAUTION**

**n Caution while driving**

Keep the auxiliary boxes closed and locked.

Injuries may result in the event of an accident or sudden braking.

## Overhead console

The overhead console is useful for temporarily storing sunglasses and similar small items.

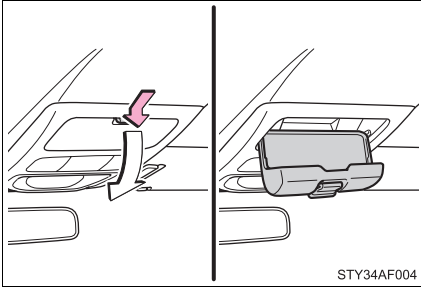

Pull the lid down while pushing the knob.

### ⚠ CAUTION

#### ■ Items that should not be left in the overhead console

Do not leave glasses or lighters in the console.

If the interior of the vehicle become hot, lighters may explode and glasses may warp or becomes cracked.

#### ■ Caution while driving

Keep the overhead console closed.

Injuries may result in the event of an accident or sudden braking.

#### ■ Items unsuitable for storing

Do not store items heavier than 0.4 lb. (0.2 kg).

Doing so may cause the overhead console to open and the items inside may fall out, resulting in an accident.

## 3-6. Other interior features

### Sun visors

#### ► Type A

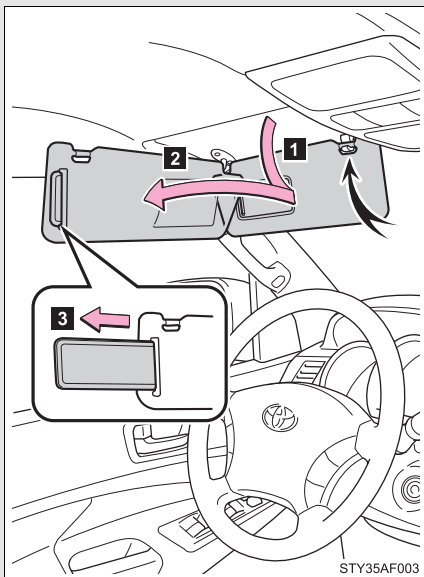

- 1** Forward position:  
Flip down.
- 2** Side position:  
Flip down, unhook, and swing to the side.
- 3** Side extender:  
Place in side position, then slide backwards.

#### ► Type B

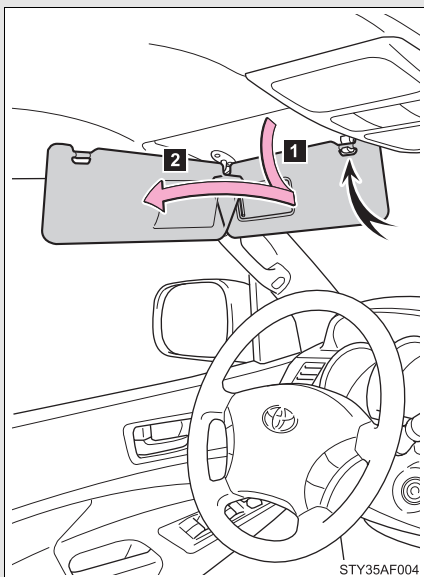

- 1** Forward position:  
Flip down.
- 2** Side position:  
Flip down, unhook, and swing to the side.

### 3-6. Other interior features

## Vanity mirrors

#### ► Type A

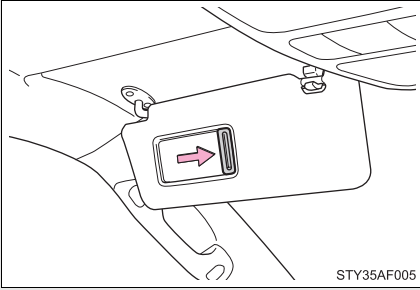

Slide the cover.

#### ► Type B

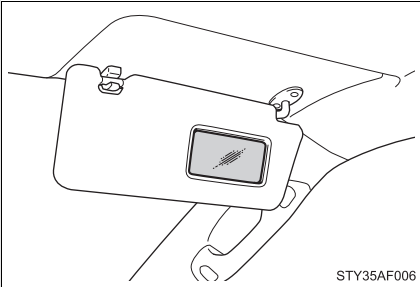

## Clock

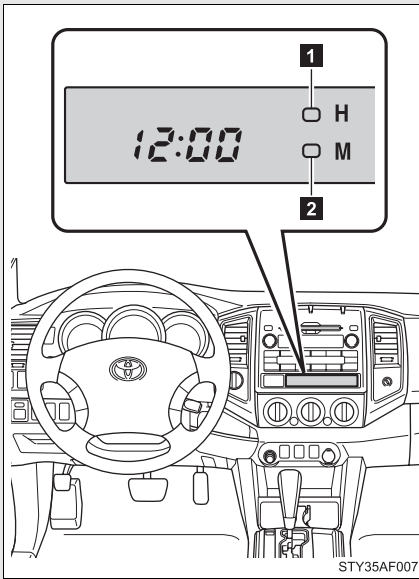

- 1** Adjusts the hours
- 2** Adjusts the minutes

**n The clock is displayed when**

The engine switch is in the ACC or ON position.

**n When disconnecting and reconnecting battery terminals**

The time display will automatically be set to 1:00.



### 3-6. Other interior features

## Outside temperature display (vehicles with accessory meter)

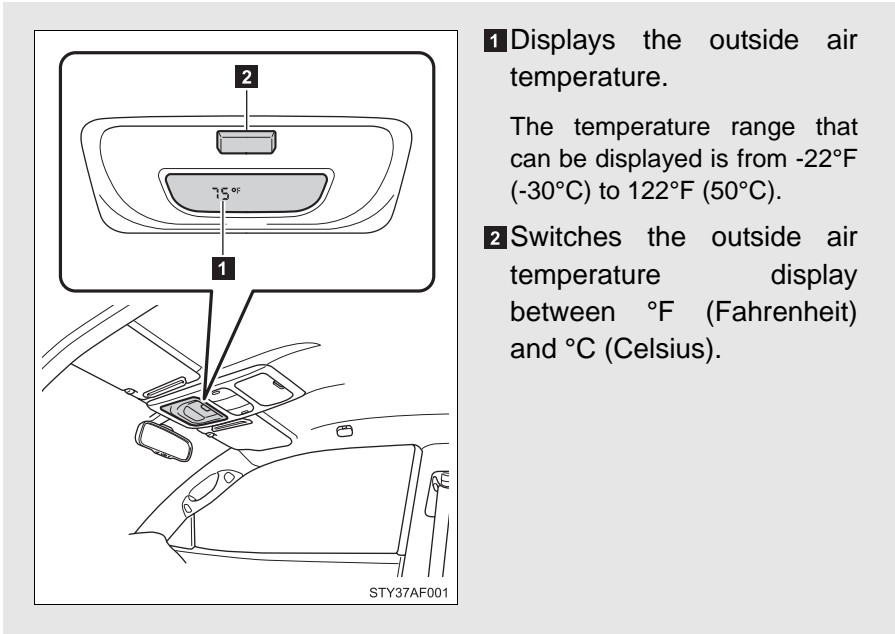

#### ■ When --°F or --°C is displayed

The system may be malfunctioning. Take your vehicle to your Toyota dealer.

#### ■ The outside air temperature is displayed when

The engine switch is in the ON position.

#### ■ When disconnecting and reconnecting battery terminals

The display will automatically be set to the initial mode.

#### ■ Display

In the following situations, the correct outside temperature may not be displayed, or the display may take longer than normal to change.

1 When stopped, or driving at low speeds (less than 12 mph [20 km/h])

1 When the outside temperature has changed suddenly (at the entrance/exit of a garage or tunnel, etc.)

## Cigarette lighter

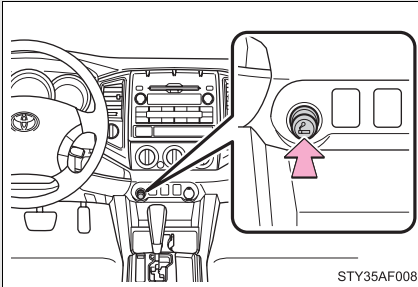

Push the cigarette lighter.

The cigarette lighter will pop up when it is ready for use.

- n **The cigarette lighter can be used when**  
The engine switch is in the ACC or ON position.

### CAUTION

- n **To avoid burns or fires**
  - I Do not touch the metal parts of the cigarette lighter.
  - I Do not hold the cigarette lighter down. It could overheat and cause a fire.
  - I Do not insert anything other than the cigarette lighter into the outlet.

## Power outlet (12V DC)

**The power outlet can be used for 12 V accessories that run on less than 10A.**

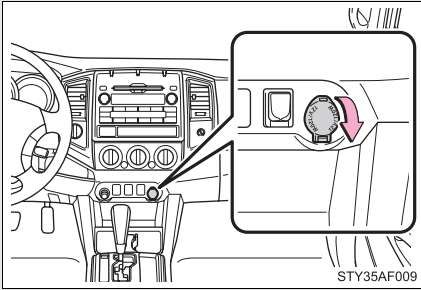

- **The power outlet can be used when**  
The engine switch is in the ACC or ON position.

### NOTICE

- **To avoid damaging the power outlet**

Close the power outlet lid when not in use.

Foreign objects or liquids that enter the power outlet may cause a short circuit.

- **To prevent the fuse from being blown**

Do not use an accessory that uses more than 12V/10A.

- **To prevent the battery from being discharged**

Do not use the power outlet longer than necessary when the engine is not running.

## Power outlet (if 115V AC equipped)

The power outlet can be used for electrical appliances.

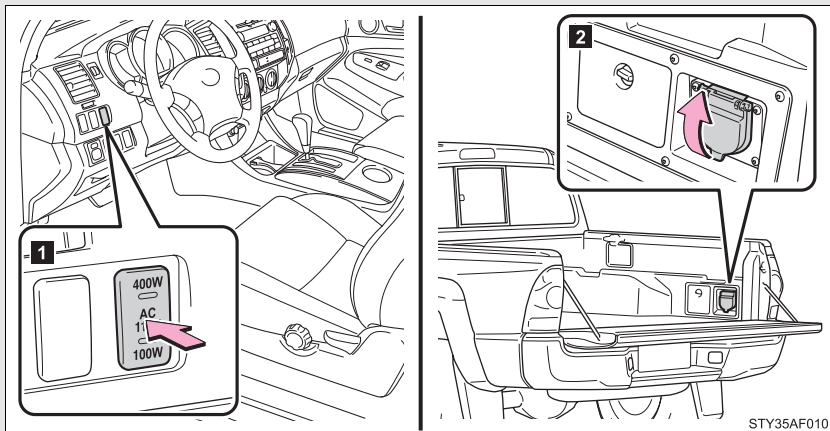

### 1 Main switch

To use the power outlet, turn on the main switch.

The power supply starts a few seconds after the main switch is pressed.

### 2 Power outlet socket

## Maximum available capacity of the power outlet

### n While the vehicle is being driven

The maximum capacity of the power outlet is always 115V AC/100W.

### n When the vehicle is stationary

The maximum capacity of the power outlet varies depending on the following conditions.

### 1 The maximum capacity is 115V AC/400W when the following condition applies:

- The shift lever is in P or N. (automatic transmission)

- The shift lever is in N and the clutch pedal is not depressed.  
(manual transmission)

A maximum capacity of 400W can only be restored by turning the power outlet main switch off and then on again under condition described above.

- 1 The maximum capacity is 115V AC/100W when the following condition applies:
- The shift lever is moved to any positions other than P and N.  
(automatic transmission)
  - The clutch pedal is depressed. (manual transmission)

---

□ **The power outlet can be used when**

The engine is started.

□ **The indicator light changes according the maximum available capacity, as follows:**

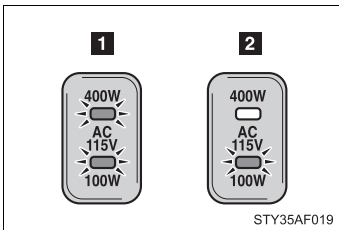

**1** Indicates 115V AC/400W

**2** Indicates 115V AC/100W

□ **When the power outlet is in operation**

The sound of the cooling fan may be heard from the front console box. This is normal and does not indicate a malfunction.

**n If the engine is started with the power outlet main switch on**

The maximum capacity of the power supply may decrease to below the standard, or may be cut off completely, even when the vehicle is stationary.

**n The protection circuit may be activated to cut the power supply if any of the following conditions apply:**

- l The engine is started with the power outlet main switch on.
- l Use of electrical appliances exceeding the maximum capacity is attempted.

A sound may be heard when the protection circuit is activated.  
This is normal and does not indicate a malfunction.

- l Electrical appliances, which consume power exceeding 100W, have been used continuously for a long time period.
- l The total power usage by all electrical features (headlights, air conditioning, etc.) has exceeded the total vehicle maximum for an extended period of time.

**n If the protection circuit is activated and the power supply is cut, conduct the following procedure:**

**STEP 1** Park the vehicle in a safe place, and then securely apply the parking brake.

**STEP 2** Check and ensure the following conditions:

- The shift lever is in P or N. (automatic transmission)
- The shift lever is in N and the clutch pedal is not depressed. (manual transmission)

**STEP 3** Make sure that the power consumption of the electric appliance is within the maximum capacity of the power outlet and the appliance is not broken.

**STEP 4** Press the power outlet main switch again.

When the cabin temperature is high, open the windows to cool the temperature down. Once it reaches the normal temperature, turn the power outlet main switch on again.

If the power supply is not resumed even after performing the above procedure, have the vehicle inspected by a Toyota dealer.

 CAUTION

**n Using a power outlet**

Observe the following precautions to reduce the risk of injury.

- ! Use of the power outlet when it is wet with rain, drinking water or snow may result in electrical shocks and is extremely dangerous. The power outlet must be thoroughly dried before use.
- ! Do not allow children to use or play with the power outlet.
- ! Be careful not to get any part of your body caught in the power outlet lid.
- ! When using electrical appliances, strictly follow any cautions and notices written on their labels and in the manufacturers' instruction manuals.
- ! Do not modify, disassemble or repair the power outlet or its inverter, in any way. Doing so may result in unexpected malfunctions or accidents, which could cause serious damage or injuries. Contact a Toyota dealer for any necessary repairs.

**n To prevent injuries and accidents, securely fix all electric appliances before use and do not use any appliances that may do any of the following:**

- ! Distract the driver while driving, or hamper safe driving.
- ! Result in a fire or burn injuries due to the appliance rolling, falling or overheating while driving.
- ! Emit steam, while the windows of the cabin are closed.

**n To prevent unexpected accidents, such as electric shocks, do not perform any of the following.**

- ! Using the power outlet for electric heaters while sleeping.
- ! Contaminating the power outlet with liquid substances or mud.
- ! Handling electrical appliance plugs at the power outlet with wet hands or feet.
- ! Inserting foreign objects into the power outlet.
- ! Using malfunctioning electric appliances.
- ! Inserting inappropriate or badly fitting plugs into the power outlet.

 NOTICE**n To avoid damaging the power outlet and the plug**

- l Close the power outlet lid when not in use.
- l Foreign objects or liquids that enter the power outlet may cause a short circuit.
- l Do not use plug adaptors to connect too many plugs to the power outlet.
- l After inserting a plug, gently close the power outlet lid.

**n To prevent the fuse from being blown**

Do not use a 115V AC appliance that requires more than maximum capacity. If a 115V AC appliance that consumes more than maximum capacity is used, the protection circuit will cut the power supply.

**n Appliances that may not operate properly (115V AC)**

The following 115V AC appliances may not operate even if their power consumption is under maximum capacity.

- l Appliances with high initial peak wattage
- l Measuring devices that process precise data.
- l Other appliances that require an extremely stable power supply

**n To prevent the battery from being discharged**

Turn off all the vehicle's electronic equipment and accessories, such as the headlights and air conditioning, when electrical appliances that consume in excess of 100W are used continuously for long periods of time.

**n To prevent any damage caused by heat**

Do not use any electrical appliances that give off intense heat such as toasters, in any locations including the internal or external trim, seats and deck.

- l Do not use any electrical appliances, which are easily affected by vibration or heat, inside the vehicle.  
Vibration while driving, or the heat of the sun while parking, may result in damage to those electrical appliances.





**NOTICE**

**n If any electrical appliances are to be used while driving**

Securely fasten both the appliances and their cables to prevent them from falling or getting caught any of the power train components.

**n If the power outlet is loose when an electrical appliance plug is connected**

Replace the outlet.

Contact a Toyota dealer for any necessary replacements.

**n If the power outlet gets dirty**

Turn the main switch off and use a soft, clean cloth to wipe it gently.

Do not use any cleansing materials, such as organic solvents, wax, or compound cleaners, as these may damage the power outlet or cause it to malfunction.

## Seatback table (if equipped)

**Front passenger's seatback can be used as a temporary table only when the vehicle is stopped.**

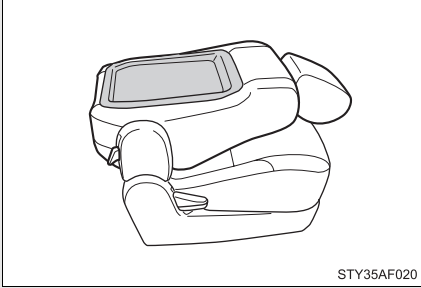

Fold down the front passenger's seat to use the seatback table. (→P. 47)

### CAUTION

#### **n Caution while driving**

Observe the following precautions to avoid death or serious injury.

- I** Do not set up the seatback table.
- I** Do not sit on or place anything on the seatback table.

### NOTICE

#### **n To prevent damage to the seatback table**

Do not put heavy loads on the table.

## Floor mat

**Securely place a mat that matches the size of the space on the carpet.**

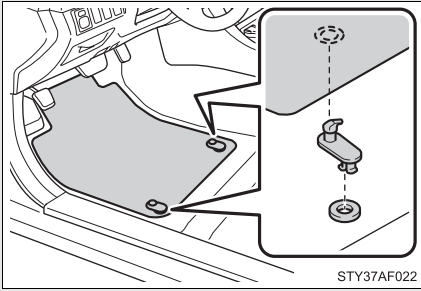

Secure the front floor mat using the hooks provided.

### **⚠ CAUTION**

#### **n When inserting the floor mat**

Observe the following precautions.

Failure to do so may result in the floor mat slipping and interfering with the movement of the pedals during driving, resulting in an accident.

- I** Make sure the floor mat is properly placed on the vehicle carpet and the correct side faces upward.
- I** Do not place floor mats on top of existing mats.

## Luggage compartment features

### ► Behind the rear seat (Double Cab models only)

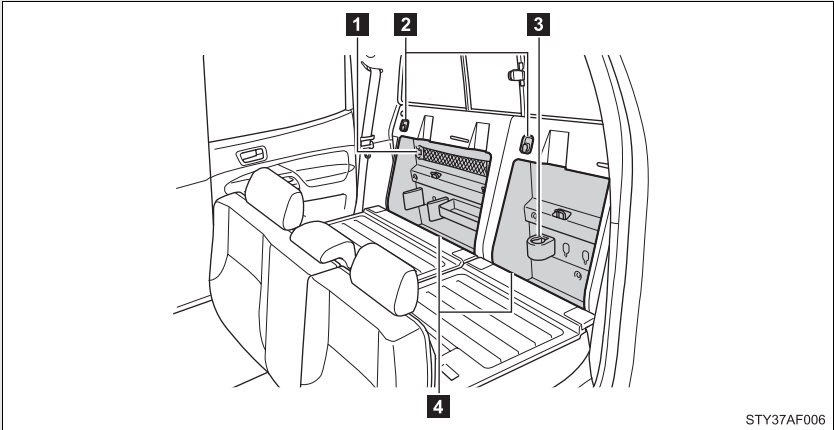

STY37AF006

**1** Cargo net hooks (vehicles with sub woofer)

**2** Grocery bag hooks

**3** Flashlight holder

**4** Storage boxes

► Deck

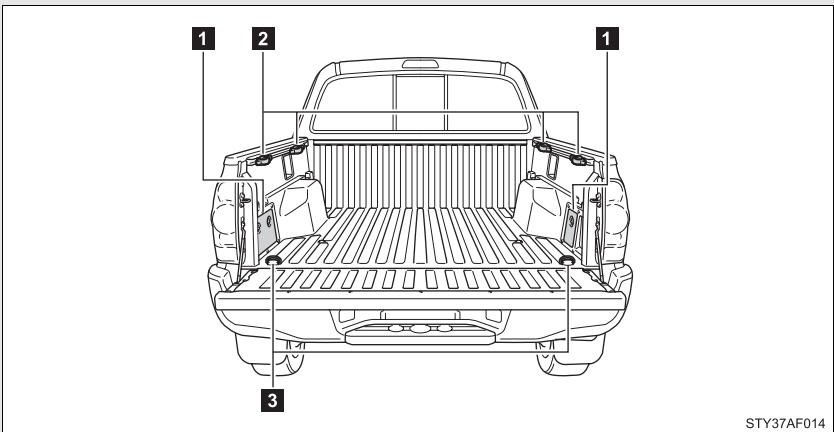

STY37AF014

**1** Auxiliary boxes

**2** Tie-down cleats

**3** Deck hooks

## Auxiliary boxes

### ► Left side

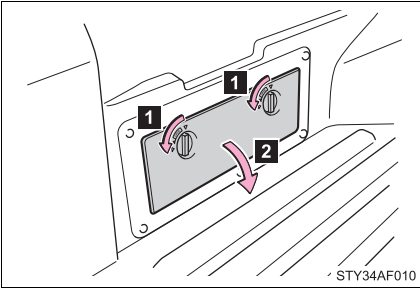

- 1 Turn the knob counterclockwise.
- 2 Open the lid.

### ► Right side (vehicles without 115V power outlet)

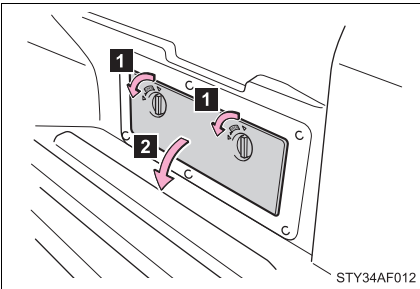

- 1 Turn the knob counterclockwise.
- 2 Open the lid.

### ► Right side (vehicles with 115V power outlet)

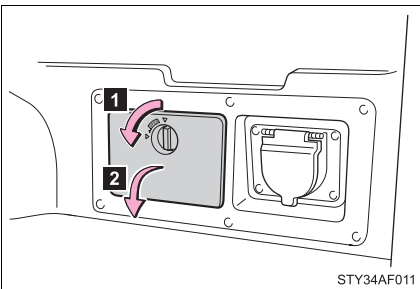

- 1 Turn the knob counterclockwise.
- 2 Open the lid.

**⚠ CAUTION****n Caution while driving**

Keep the auxiliary boxes closed and locked.  
Injuries may result in the event of an accident or sudden braking.

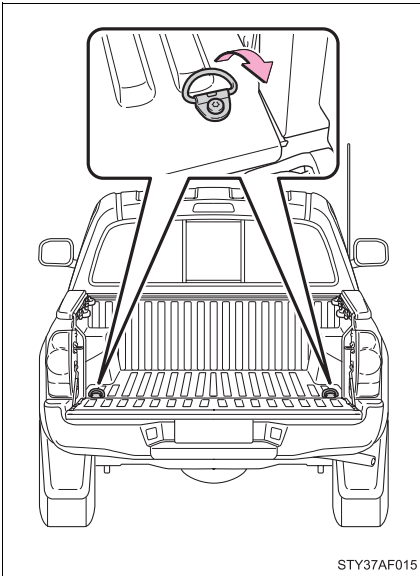
**Deck hooks**

Deck hooks are provided for securing loose items.

**⚠ CAUTION****n When not in use**

Keep the deck hooks folded.

## Tie-down cleats

The deck rail system enables you to insert and move tie-down cleats to their best location along deck rails to secure a load.

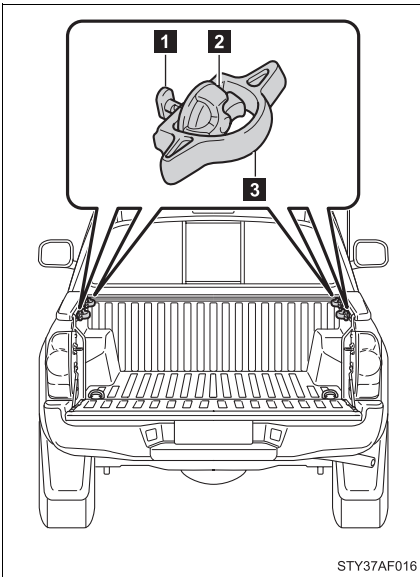

- 1** Locking plate
- 2** Thumb wheel
- 3** Tie-down cleat

### n Installing the tie-down cleat

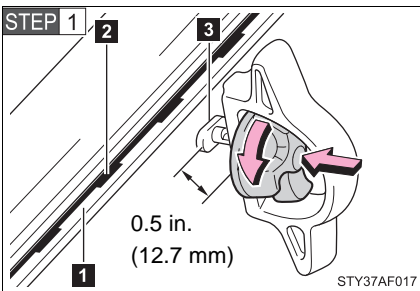

Loosen the thumb wheel in a counterclockwise motion, and depress the wheel so that the locking plate maintains 0.5 in. (12.7 mm) gap.

- 1** Deck rail
- 2** Detent
- 3** Locking plate

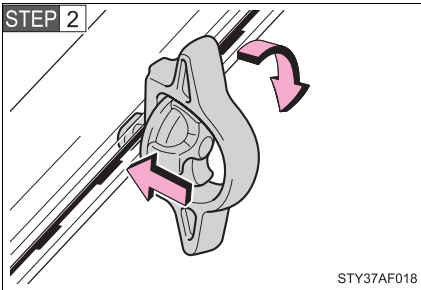

Insert the locking plate into the deck rail, rotate the tie-down cleat 90°, and release the thumb wheel.

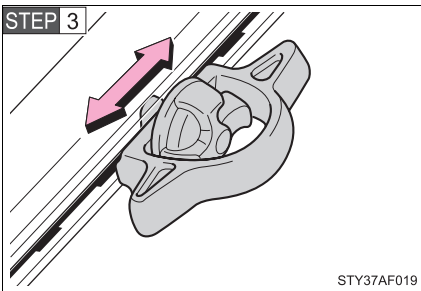

Slide the cleat to the closest detent in the rail system. You will feel that the locking plate snaps into a detent.

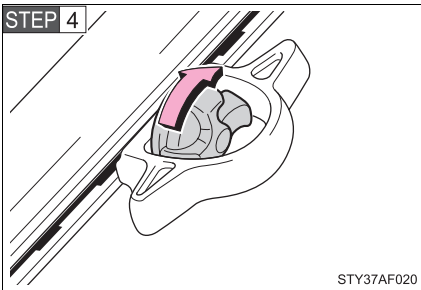

Tighten the thumb wheel in a clockwise motion until the clutch mechanism ratchets.

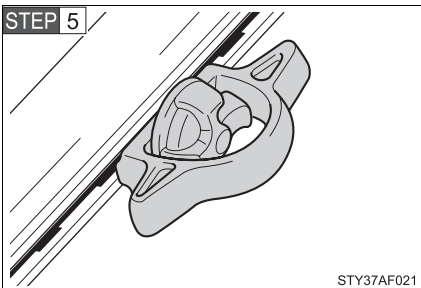

Check the tie-down cleat to confirm that it is locked into a detent and securely mounted to the deck rail system.



**⚠ CAUTION**

**n Tie-down cleat precautions**

- I** Properly install and tighten the tie-down cleats into the deck rail system. Failure to properly install and tighten the tie-down cleats can cause cargo to become unsecured. Unsecured cargo can cause injury when the vehicle is in motion.
- I** Properly secure all cargo to prevent shifting or sliding during driving. Failure to properly secure cargo can cause injury when the vehicle is in motion.
- I** Applying loads at an angle to the tie-down cleat greater than 45° or loads greater than 220 lb. (100 kg) may cause damage to the deck, deck rail system, tie-down cleat and/or the cargo.
- I** Do not exceed a total tensile load of 440 lb. (200 kg) per deck rail.
- I** Do not install more than the following number of tie-down cleats per deck rail:
  - Side rail:
    - Short deck—Max. 3 locations
    - Long deck—Max. 4 locations
  - Headboard rail: Max. 3 locations

**Storage boxes (Double Cab models only)**

Storage box is designed to place things like bottles.

► Right side (vehicles without sub woofer)

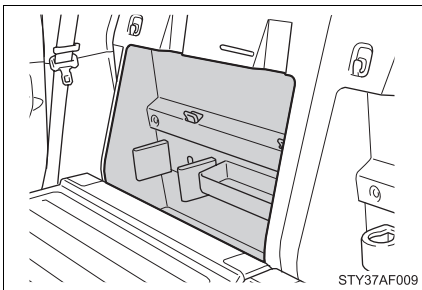

► Left side

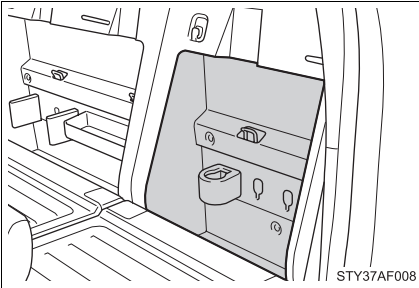

▢ Removing the separator

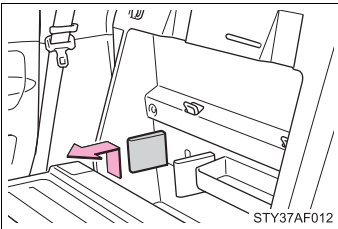

Remove the separator.  
It can be installed in various positions as required.

**Flashlight holder (Double Cab models only)**

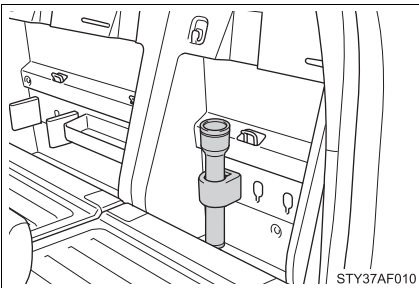

Flashlight holder is designed to hold the flashlight securely.

■ **Removing the flashlight holder**

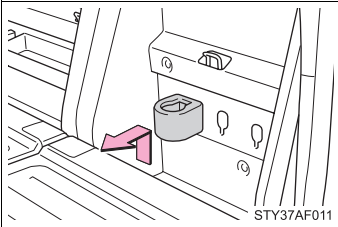

Remove the flashlight holder. It can be installed in various positions as required.

**Grocery bag hooks (Double Cab models only)**

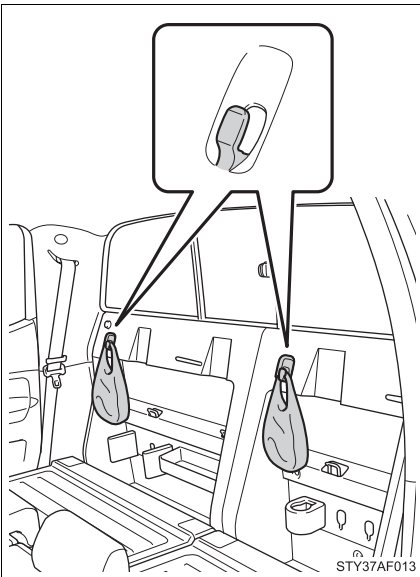

Grocery bag hook is designed to hang things like grocery bag.

**NOTICE**

■ **Grocery bag hook weight capacity**

Do not hang any object heavier than 7 lb. (3 kg) on the grocery bag hooks.

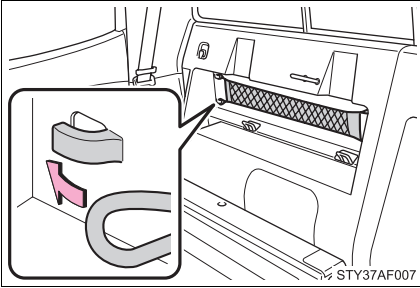
**Cargo net hooks (Double Cab models with sub woofer)**

Cargo net hooks are designed to hang the factory-supplied cargo net.

**⚠ NOTICE**

- n To prevent damage to the cargo net hook**  
Do not hang items other than the cargo net.

### 3-6. Other interior features

## Garage door opener box (if equipped)

The garage door opener box is designed to store a garage door opener transmitter.

#### n Storing the transmitter in the box

STEP 1

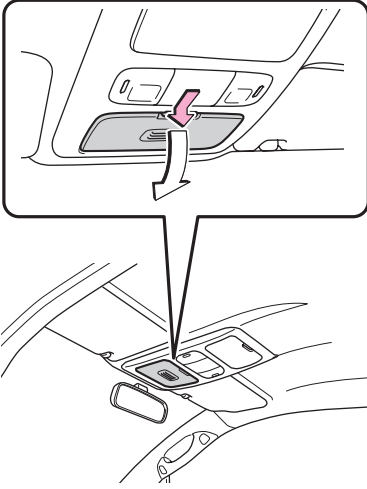

STY35AF011

Pull the lid down while pushing the knob.

STEP 2

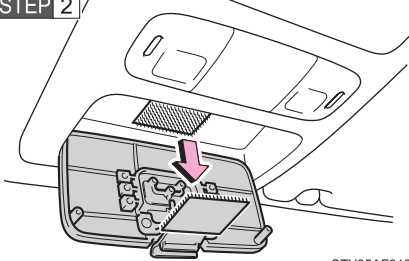

STY35AF012

Remove the hook-and-loop fastener square.

## STEP 3

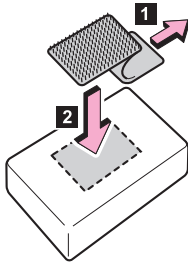

STY35AF013

- 1** Remove the paper strip covering the adhesive on back side of square.
- 2** Adhere the square to back side of the transmitter near the center.

## STEP 4

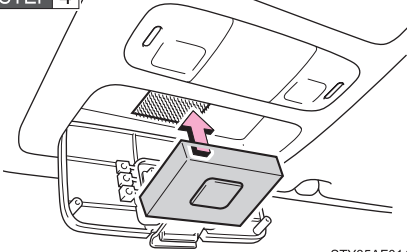

STY35AF014

- Place the transmitter with fastener square facing inside of box into the box.

Make sure the transmitter button is located above button pins.

## STEP 5

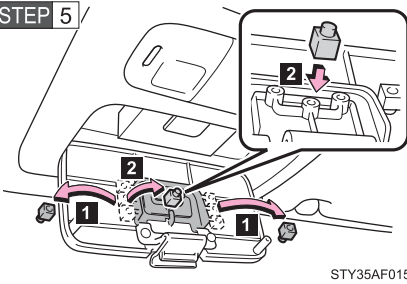

STY35AF015

- 1** Remove spacers from the center panel.
- 2** Place one spacer on the pin that would be below transmitter button when the cover is closed. Close the cover.

**n Operating the garage door opener transmitter**

When the garage door opener transmitter is properly installed, you can operate the transmitter by pushing the button of the cover.

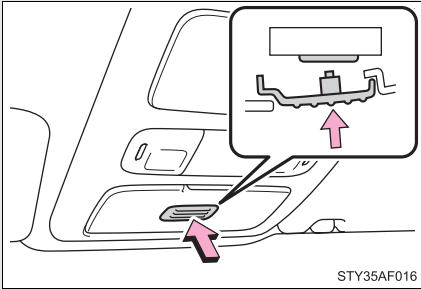

Push the button.

**n If a garage door opener transmitter has wire clip for sun visor**

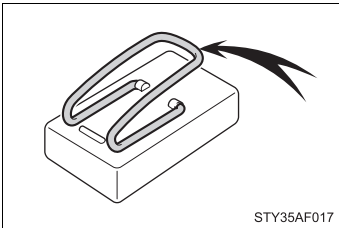

This clip must be removed prior to adhesion of the fastener.

**n If the center panel does not touch your garage door opener transmitter**

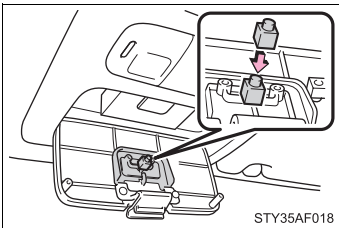

- 1 Check to see if the spacer is on the correct pin.
- 1 Attach another spacer to the top of original spacer. Check operation. If required, continue to add spacers until contact is achieved.

**n To prevent the transmitter from clattering during driving**

If the transmitter is clattering during driving, fill in a piece of felt or pad.

 **CAUTION****n Caution while driving**

Keep the garage door opener box closed.

Injuries may result in the event of an accident or sudden braking.

**n To prevent an accident**

Keep the remaining spacers away from the children.



### 3-6. Other interior features

## Compass (vehicles with accessory meter)

The compass on the accessory meter indicates the direction in which the vehicle is heading.

#### n Operation

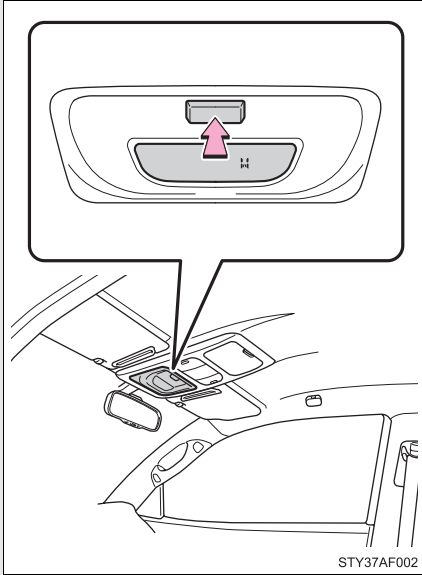

To turn the compass on or off, press the switch.

#### n Displays and directions

Display	Direction
N	North
NE	Northeast
E	East
SE	Southeast
S	South
SW	Southwest
W	West
NW	Northwest

## Calibrating the compass

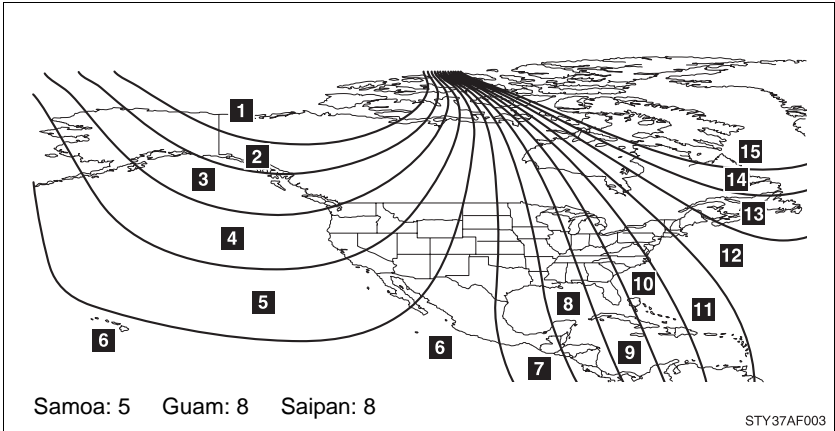

The direction display deviates from the true direction determined by the earth's magnetic field. The amount of deviation varies according to the geographic position of the vehicle.

If you cross over a map boundary shown in illustration, the compass will deviate.

To obtain higher precision or perfect calibration, refer to the following.

### 1 Deviation calibration

**STEP 1** Stop the vehicle where it is safe to drive in a circle.

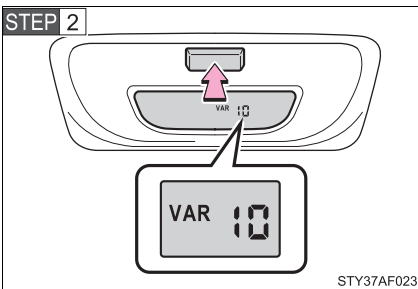

Press the switch until VAR appears on the display.

**STEP 3** Press the switch, and referring to the map above, select the number of the zone where you are.

If the direction is displayed several seconds after adjustment, the calibration is complete.

## n Circling calibration

**STEP 1** Stop the vehicle where it is safe to drive in a circle.

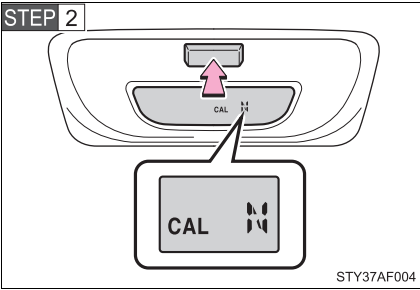

Press the switch until CAL appears on the display.

At this time, the compass display is locked in N.

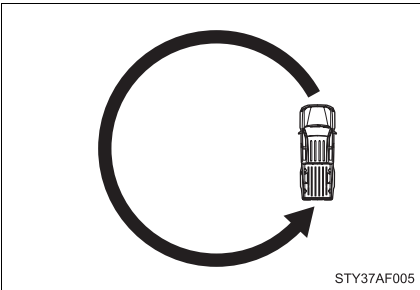

**STEP 3** Drive the vehicle at 5 mph (8 km/h) or less in a circle until the direction is displayed.

If there is not enough space to drive in a circle, drive around the block until the direction is displayed.

When CAL goes off and the compass display returns to the normal mode, calibration is complete.

### n **Conditions unfavorable to correct operation**

The compass may not show the correct direction in the following conditions:

- l The vehicle is stopped immediately after turning.  
The compass does not adjust while the vehicle is stopped.
- l The engine switch is turned off immediately after turning.
- l The vehicle is on an inclined surface.
- l The vehicle is in a place where the earth's magnetic field is subject to interference by artificial magnetic fields (underground car park/parking lot, under a steel tower, between buildings, roof car park/parking lot, near an intersection, near a large vehicle, etc.).
- l The vehicle has become magnetized.  
(There is a magnet or metal object on or near the roof.)
- l The battery has been disconnected.

### CAUTION

#### n **While driving the vehicle**

Do not adjust the display. Be sure to adjust the display only when the vehicle is stopped.

#### n **When doing the circling calibration**

Be sure to secure a wide space, and watch out for people and vehicles in the neighborhood. Do not violate any local traffic rules while performing circling calibration.



## NOTICE

### **n To avoid the compass malfunctions**

Do not place magnets or any metal objects on or near the roof. Doing this may cause a malfunction of the compass sensor.

### **n To ensure normal operation of the compass**

- l** Do not perform circling calibration of the compass in a place where the earth's magnetic field is subject to interference by artificial magnetic fields.
- l** During calibration, do not operate electric systems (power windows, etc.) as they may interfere with the calibration.

## Cleaning and protecting the vehicle exterior

**Perform the following to protect the vehicle and maintain it in prime condition.**

- 1 Working from top to bottom, liberally apply water to the vehicle body, wheel wells and underside of the vehicle to remove any dirt and dust.

Wash the vehicle body using a sponge or soft cloth, such as a chamois.

- 1 For hard-to-remove marks, use car wash soap and rinse thoroughly with water.

- 1 Wipe away any water.

- 1 Wax the vehicle when the waterproof coating deteriorates.

If water does not bead on a clean surface, apply wax when the vehicle body is cool.

---

### n **Automatic car washes**

- 1 Before washing the vehicle, do the following.

- Fold the mirrors back.
- Remove the antenna.

- 1 Brushes used in automatic car washes may scratch the vehicle surface and harm your vehicle's paint.

### n **High pressure car washes**

Do not allow the nozzles of the car wash to come within close proximity of the windows. Before entering an automatic car wash, check that the fuel filler door on your vehicle is closed properly.

### n **Aluminum wheels (if equipped)**

Remove any dirt immediately by using a neutral detergent. Do not use hard brushes or abrasive cleaners. Do not use strong or harsh chemical cleaners. Use the same mild detergent and wax as used on the paint.

### n **Bumpers and side moldings**

Do not scrub with abrasive cleaners.

## n To prevent deterioration and body corrosion

- l Wash the vehicle immediately in the following cases:
  - After driving near the sea coast
  - After driving on salted roads
  - If you see coal tar or tree sap on the paint surface
  - If you see dead insects or insect droppings on the paint
  - After driving in an area contaminated with soot, oily smoke, mine dust, iron powder or chemical substances
  - If the vehicle becomes heavily soiled in dust or mud
  - If liquids such as benzene and gasoline are spilled on the paint surface
- l If the paint is chipped or scratched, have it repaired immediately.

### CAUTION

#### n Caution about the exhaust pipe

Exhaust gasses cause the exhaust pipe to become quite hot.

When washing the vehicle, be careful not to touch the pipe until it has cooled sufficiently, as touching a hot exhaust pipe can cause burns.

### NOTICE

#### n To protect your vehicle's painted surfaces

Do not use organic cleaners such as benzene or gasoline.

#### n Cleaning the exterior lights

- l Wash carefully. Do not use organic substances or scrub with a hard brush. This may damage the surfaces of the lights.
- l Do not apply wax on the surfaces of the lights. Wax may cause damage to the lenses.

## Cleaning and protecting the vehicle interior

**The following procedures will help protect your vehicle's interior and keep it in top condition:**

n **Protecting the vehicle interior**

Remove dirt and dust using a vacuum cleaner. Wipe dirty surfaces with a cloth dampened with lukewarm water.

n **Cleaning the leather areas**

1 Remove dirt and dust using a vacuum cleaner.

1 Wipe any excess dirt and dust with a soft cloth dampened with diluted detergent.

Use a diluted water solution of approximately 5% neutral wool detergent.

1 Wring out any excess water from the cloth and thoroughly wipe off all remaining traces of detergent.

1 Wipe the surface with a dry, soft cloth to remove any remaining moisture. Allow the leather to dry in a shaded and ventilated area.

n **Synthetic leather areas**

1 Remove loose dirt using a vacuum cleaner.

1 Apply a mild soap solution to the synthetic leather using a sponge or soft cloth.

1 Allow the solution to soak in for a few minutes. Remove the dirt and wipe off the solution with a clean, damp cloth.

---

n **Caring for leather areas**

Toyota recommends cleaning the interior of the vehicle at least twice a year to maintain the quality of the vehicle's interior.



**n Shampooing the carpets**

There are several commercial foaming-type cleaners available. Use a sponge or brush to apply the foam. Rub in overlapping circles. Do not apply water. The excellent results are obtained when keeping the carpet as dry as possible.

**n Seat belts**

Clean with mild soap and lukewarm water using a cloth or sponge. Also check the belts periodically for excessive wear, fraying or cuts.

**⚠ CAUTION****n Water in the vehicle**

- I** Be careful not to splash or spill liquid on the floor.
- I** Do not get any of the SRS components or wiring in the vehicle interior wet. (→P. 81)

Electrical malfunction may cause the airbags to deploy or not function properly, resulting in death or severe injury.

 NOTICE

**n Cleaning detergents**

Do not use organic substances such as benzene or gasoline, acidic or alkaline solutions, dye, bleach or other detergent. Doing so may discolor the vehicle interior or cause streaks or damage to painted surfaces.

**n Preventing damage to leather surfaces**

Observe the following precautions to avoid damage to and deterioration of leather surfaces.

**I** Remove any dust or dirt on leather surfaces immediately.

**I** Do not expose the vehicle to direct sunlight for extended periods of time. Park the vehicle in the shade, especially during summer.

**I** Do not place items made of vinyl, plastic, or that contain wax on the upholstery, as they may stick to the leather surface if the vehicle interior heats up significantly.

**n Water on the floor**

Do not wash the vehicle floor with water.

Vehicle systems such as the audio system may be damaged if water comes into contact with electrical components under the floor of the vehicle, and may also cause the body to rust.

## Maintenance requirements

**To ensure safe and economical driving, day-to-day care and regular maintenance is essential. It is the owner's responsibility to perform regular checks. Toyota recommends the following maintenance.**

**n General maintenance**

Should be performed on a daily basis. This can be done by yourself or by a Toyota dealer.

**n Scheduled maintenance**

Should be performed at specified intervals according to the maintenance schedule.

For details about maintenance items and schedules, refer to the "Scheduled Maintenance Guide" or "Owner's Manual Supplement".

**n Do-it-yourself maintenance**

You can perform some maintenance procedures yourself. Please be aware that do-it-yourself maintenance may affect warranty coverage.

The use of Toyota Repair Manuals is recommended.

For details about warranty coverage, see the separate "Owner's Warranty Information Booklet", "Owner's Manual Supplement".

---

**n Repair and replacement**

It is recommended that genuine Toyota parts be used for repair to ensure performance of each system. If non-Toyota parts are used in replacement or if a repair shop other than Toyota dealer performs repairs, confirm the warranty coverage.

**n Allow inspection and repairs to be performed by a Toyota dealer**

- I Toyota technicians are well-trained specialists and are kept up to date with the latest service information. They are well informed about the operations of all systems on your vehicle.
- I Keep a copy of the repair order. It proves that the maintenance that has been performed is under warranty coverage. If any problem should arise while your vehicle is under warranty, your Toyota dealer will promptly take care of it.

**⚠ CAUTION**

**n Warning in handling of battery**

- I Engine exhaust, some of its constituents, and a wide variety of automobile components contain or emit chemicals known to the State of California to cause cancer and birth defects and other reproductive harm. Work in a well ventilated area.
- I Oils, fuels and fluids contained in vehicles as well as waste produced by component wear contain or emit chemicals known to the State of California to cause cancer and birth defects or other reproductive harm. Avoid exposure and wash any affected area immediately.
- I Battery posts, terminals and related accessories contain lead and lead compounds which are known to cause brain damage. Wash your hands after handling. (→P. 368)

## General maintenance

Listed below are the general maintenance items that should be performed at the intervals specified in the “Scheduled Maintenance Guide” or “Owner’s Manual Supplement”. It is recommended that any problem you notice should be brought to the attention of your Toyota dealer or qualified service shop for advice.

### Engine compartment

Items	Check points
Battery	Maintenance-free. (→P. 368)
Brake fluid	At the correct level? (→P. 364)
Engine coolant	At the correct level? (→P. 363)
Engine oil	At the correct level? (→P. 357)
Exhaust system	No fumes or strange sounds?
Power steering fluid	At the correct level? (→P. 366)
Radiator/condenser/hoses	Not blocked with foreign matter? (→P. 364)
Washer fluid	At the correct level? (→P. 371)

<b>Vehicle interior</b>
-------------------------

Items	Check points
Accelerator pedal	<ul style="list-style-type: none"> <li>• Moves smoothly (without uneven pedal effort or catching)?</li> </ul>
Automatic transmission “Park” mechanism	<ul style="list-style-type: none"> <li>• Can the vehicle be hold securely on an incline with the shift lever in P?</li> </ul>
Brake pedal	<ul style="list-style-type: none"> <li>• Moves smoothly?</li> <li>• Does it have appropriate clearance and correct amount of free play?</li> </ul>
Brakes	<ul style="list-style-type: none"> <li>• Not pull to one side when applied?</li> <li>• Loss of brake effectiveness?</li> <li>• Spongy feeling brake pedal?</li> <li>• Pedal almost touches floor?</li> </ul>
Clutch pedal	<ul style="list-style-type: none"> <li>• Moves smoothly?</li> <li>• Does it have correct amount of free play?</li> </ul>
Head restraints	<ul style="list-style-type: none"> <li>• Move smoothly and lock securely?</li> </ul>
Indicators/buzzers	<ul style="list-style-type: none"> <li>• Function properly?</li> </ul>
Lights	<ul style="list-style-type: none"> <li>• Do all the lights come on?</li> <li>• Headlights aimed correctly?</li> </ul>
Parking brake	<ul style="list-style-type: none"> <li>• Moves smoothly?</li> <li>• Can hold the vehicle securely on an incline?</li> </ul>
Seat belts	<ul style="list-style-type: none"> <li>• Does the seat belt system operate smoothly?</li> <li>• Are the belts undamaged?</li> </ul>
Seats	<ul style="list-style-type: none"> <li>• Do the seat controls operate properly?</li> </ul>

Items	Check points
Steering wheel	<ul style="list-style-type: none"> <li>• Moves smoothly?</li> <li>• Has correct free play?</li> <li>• No strange noises?</li> </ul>

### Vehicle exterior

Items	Check points
Doors	<ul style="list-style-type: none"> <li>• Operate smoothly?</li> </ul>
Engine hood	<ul style="list-style-type: none"> <li>• The lock system works properly?</li> </ul>
Fluid leaks	<ul style="list-style-type: none"> <li>• Is there any leakage after parking?</li> </ul>
Tire	<ul style="list-style-type: none"> <li>• Inflation pressure is correct?</li> <li>• Tire surfaces not worn or damaged?</li> <li>• Tires rotated according to the maintenance schedule?</li> <li>• Wheel nuts are not loose?</li> </ul>

### CAUTION

#### n If the engine is running

Turn the engine off and ensure that there is adequate ventilation before performing maintenance checks.

**Some states have vehicle emission inspection programs which include OBD (On Board Diagnostics) checks. The OBD system monitors the operation of the emission control system.**

**n If the malfunction indicator lamp comes on**

The OBD system determines that a problem exists somewhere in the emission control system. Your vehicle may not pass the I/M test and may need to be repaired. Contact your Toyota dealer to service the vehicle.

**n Your vehicle may not pass the I/M test:**

**l When the battery is disconnected or discharged**

Readiness codes that are set during ordinary driving are erased.

Also, depending on your driving habits, the readiness codes may not be completely set.

**l When the fuel tank cap is loose**

The malfunction indicator lamp comes on as a temporary malfunction and your vehicle may not pass the I/M test.

**n When the malfunction indicator lamp goes off after several driving trips**

The error code in the OBD system will not be cleared unless the vehicle is driven 40 or more times.

**n If your vehicle does not pass the I/M test**

Contact your Toyota dealer to prepare the vehicle for re-testing.



## Do-it-yourself service precautions

**If you perform maintenance yourself, be sure to follow the correct procedures as given in these sections.**

Items	Parts and tools
Battery condition (→P. 368)	<ul style="list-style-type: none"> <li>• Warm water</li> <li>• Baking soda</li> <li>• Grease</li> <li>• Conventional wrench (for terminal clamp bolts)</li> </ul>
Brake fluid level (→P. 364)	<ul style="list-style-type: none"> <li>• FMVSS No.116 DOT 3 or SAE J1703 brake fluid</li> <li>• Rag or paper towel</li> </ul>
Engine coolant level (→P. 363)	<ul style="list-style-type: none"> <li>• “Toyota Super Long Life Coolant” or similar high quality ethylene glycol based non-silicate, non-amine, non-nitrite and non-borate coolant with long-life hybrid organic acid technology.</li> </ul> <p>U.S.A.:</p> <p>“Toyota Super Long Life Coolant” is pre-mixed with 50% coolant and 50% deionized water.</p> <p>Canada:</p> <p>“Toyota Super Long Life Coolant” is pre-mixed with 55% coolant and 45% deionized water.</p>
Engine oil level (→P. 357)	<ul style="list-style-type: none"> <li>• Toyota Genuine Motor Oil or equivalent</li> <li>• Rag or paper towel</li> <li>• Funnel (used only for adding oil)</li> </ul>
Fuses (→P. 393)	<ul style="list-style-type: none"> <li>• Fuse with same amperage rating as original</li> </ul>

Items	Parts and tools
Light bulbs (→P. 403)	<ul style="list-style-type: none"> <li>• Bulb with same number and wattage rating as original</li> <li>• Phillips-head screwdriver</li> <li>• Conventional wrench</li> </ul>
Power steering fluid level (→P. 366)	<ul style="list-style-type: none"> <li>• Automatic transmission fluid DEXRON® II or III</li> <li>• Rag or paper towel</li> </ul>
Radiator and condenser (→P. 364)	—
Tire inflation pressure (→P. 381)	<ul style="list-style-type: none"> <li>• Tire pressure gauge</li> <li>• Compressed air source</li> </ul>
Washer fluid (→P. 371)	<ul style="list-style-type: none"> <li>• Water</li> <li>• Washer fluid containing antifreeze (for winter use)</li> </ul>

 **CAUTION**

The engine compartment contains many mechanisms and fluids that may move suddenly, become hot, or become electrically energized. To avoid death or serious injury observe the following precautions.

**n When working on the engine compartment**

- I Keep hands, clothing, and tools away from the moving fan and engine drive belt.
- I Be careful not to touch the engine, radiator, exhaust manifold, etc. right after driving as they may be hot. Oil and other fluids may also be hot.
- I Do not leave anything that may burn easily, such as paper or rags, in the engine compartment.
- I Do not smoke, cause sparks or expose an open flame to fuel or the battery. Fuel and battery fumes are flammable.
- I Be extremely cautious when working on the battery. It contains poisonous and corrosive sulfuric acid.
- I Take care because brake fluid can harm your hands or eyes and damage painted surfaces.  
If fluid gets on your hands or in your eyes, flush the affected area with clean water immediately.  
If you still experience discomfort, see a doctor.

**n When working near the cooling fan or radiator grille**

Be sure the engine switch is off.

With the engine switch on, the cooling fan may automatically start to run if the air conditioning is on and/or the coolant temperature is high.

**n Safety glasses**

Wear safety glasses to prevent flying or falling material, fluid spray, etc. from getting in the eyes.

 NOTICE

**n If you remove the air cleaner**

Driving with the air cleaner removed may cause excessive engine wear due to dirt in the air. Also a backfire could cause a fire in the engine compartment.

**n If the fluid level is low or high**

It is normal for the brake fluid level to go down slightly as the brake pads wear or when the fluid level in the accumulator is high.

If the reservoir needs frequent refilling, it may indicate a serious problem.

## 4-3. Do-it-yourself maintenance

### Hood

**Release the lock from the inside of the vehicle to open the hood.**

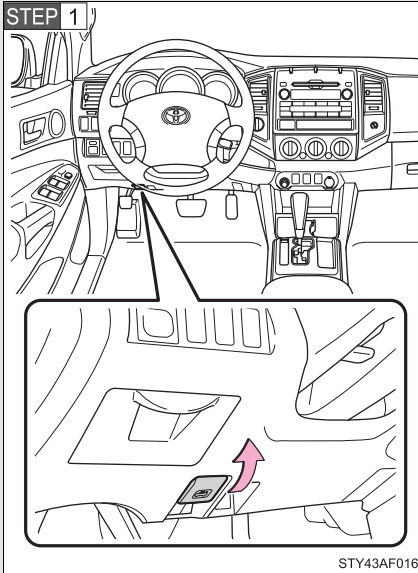

Pull the hood release lever.

The hood will pop up slightly.

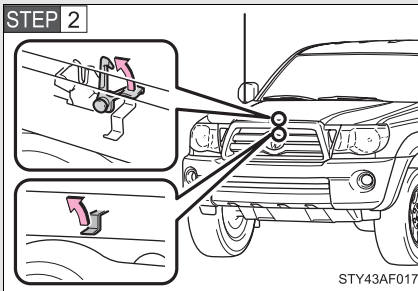

Pull up the hood catch lever and lift the hood.

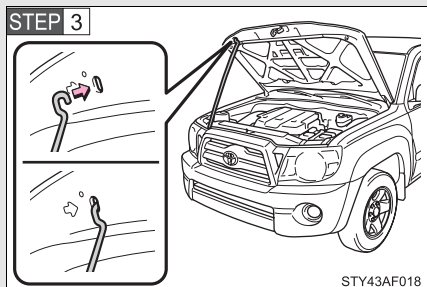

Hold the hood open by inserting the supporting rod into the slot.

**⚠ CAUTION**

**n Pre-driving check**

Check that the hood is fully closed and locked.

If the hood is not locked properly, it may open while the vehicle is in motion and cause an accident, which may result in death or serious injury.

**n After installing the support rod into the slot**

Make sure the rod supports the hood securely from falling down on to your head or body.

**⚠ NOTICE**

**n When closing the hood**

Be sure to return the support rod to its clip before closing the hood. Closing the hood with the support rod up could cause the hood to bend.

## 4-3. Do-it-yourself maintenance

### Engine compartment

#### ► 2.7 L 4-cylinder (2TR-FE) engine

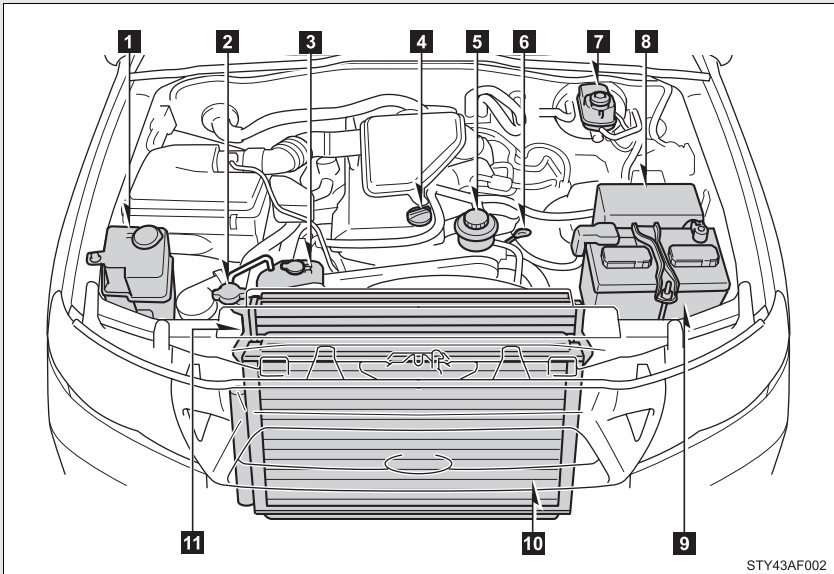

STY43AF002

- |   |  |
|---|--|
| <b>1</b> Washer fluid tank (→P. 371)              | <b>6</b> Engine oil level dipstick (→P. 357) |
| <b>2</b> Radiator cap (→P. 363)                   | <b>7</b> Brake fluid reservoir (→P. 364)     |
| <b>3</b> Engine coolant reservoir (→P. 357)       | <b>8</b> Fuse box (→P. 393)                  |
| <b>4</b> Engine oil filler cap (→P. 366)          | <b>9</b> Battery (→P. 368)                   |
| <b>5</b> Power steering fluid reservoir (→P. 364) | <b>10</b> Condenser (→P. 364)                |
| <b>11</b> Radiator (→P. 364)                      |  |

► 4.0 L V6 (1GR-FE) engine

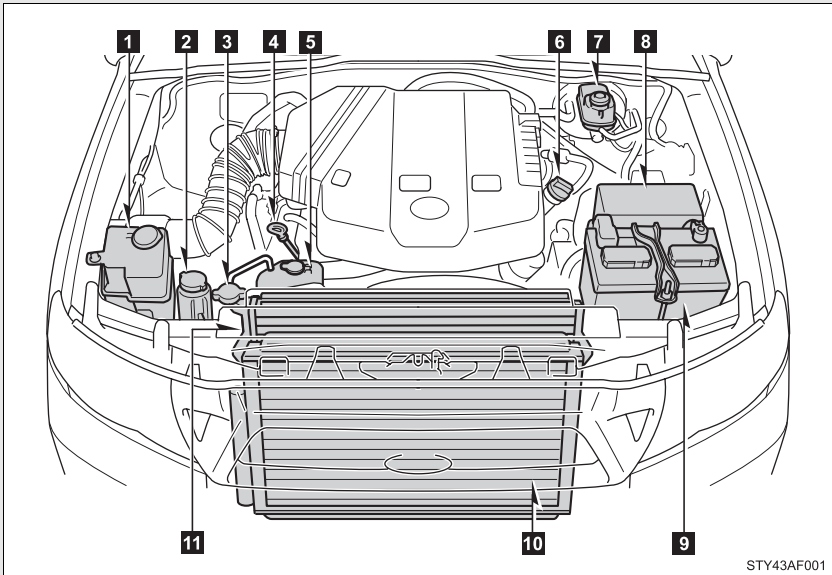

STY43AF001

- |   |  |
|---|--|
| <b>1</b> Washer fluid tank (→P. 371)              | <b>6</b> Engine oil filler cap (→P. 357) |
| <b>2</b> Power steering fluid reservoir (→P. 366) | <b>7</b> Brake fluid reservoir (→P. 364) |
| <b>3</b> Radiator cap                             | <b>8</b> Fuse box (→P. 393)              |
| <b>4</b> Engine oil level dipstick (→P. 357)      | <b>9</b> Battery (→P. 368)               |
| <b>5</b> Engine coolant reservoir (→P. 363)       | <b>10</b> Condenser (→P. 364)            |
|   | <b>11</b> Radiator (→P. 364)             |



## Engine oil

With the engine at operating temperature and turned off, check the oil level on the dipstick.

### n Checking the engine oil

**STEP 1** Park the vehicle on level ground. After turning off the engine, wait a few minutes for the oil to drain back into the bottom of the engine.

**STEP 2** Hold a rag under the end and pull the dipstick out.

▶ 2.7 L 4-cylinder (2TR-FE) engine

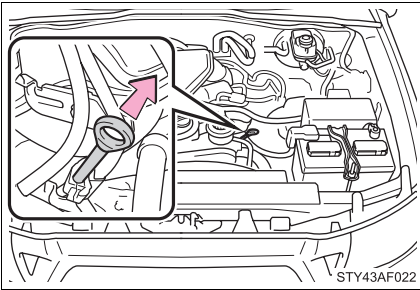

▶ 4.0 L V6 (1GR-FE) engine

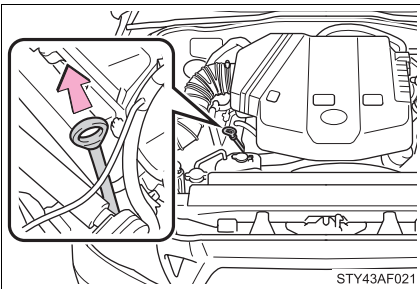

**STEP 3** Wipe the dipstick clean.

**STEP 4** Reinsert the dipstick fully.

**STEP 5** Holding a rag under the end, pull the dipstick out and check the oil level.

**STEP 6** Wipe the dipstick and reinsert it fully.

► 2.7 L 4-cylinder (2TR-FE) engine

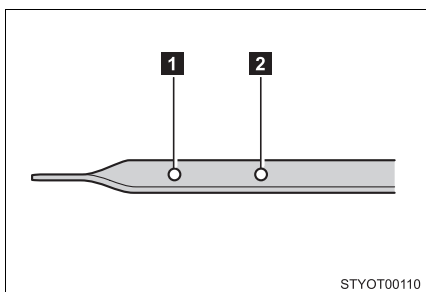

**1** Low

**2** Full

► 4.0 L V6 (1GR-FE) engine

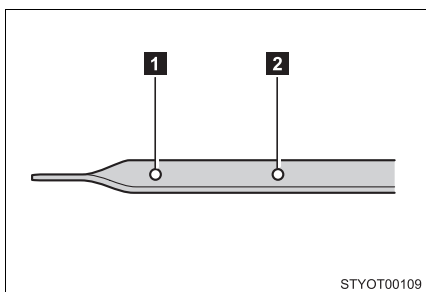

**1** Low

**2** Full

**n Adding engine oil**

► 2.7 L 4-cylinder (2TR-FE) engine

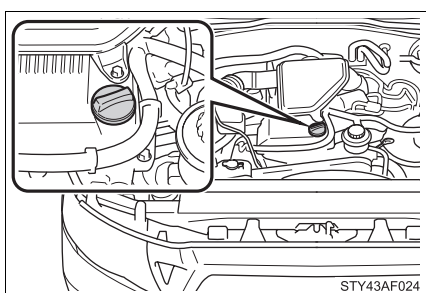

If the oil level is below or near the low level mark, add engine oil of the same type as already in the engine.

## ▶ 4.0 L V6 (1GR-FE) engine

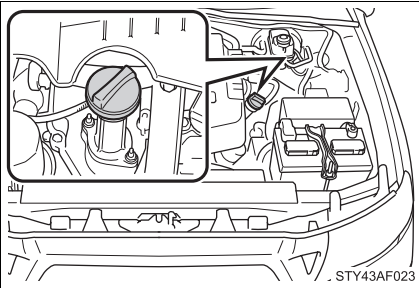

Make sure to check the oil type and prepare the items needed before adding oil.

Oil grade	ILSAC multigrade engine oil
Items	Clean funnel

**STEP 1** Remove the oil filler cap, turning it counterclockwise.

**STEP 2** Add engine oil slowly.

**STEP 3** Checking the dipstick.

**STEP 4** Reinstall the filler cap, turning it clockwise.

The approximate quantity of oil needed to raise the level between low and full on the dipstick is indicated as follows:

▶ 2.7 L 4-cylinder (2TR-FE) engine

1.4 qt. (1.3 L, 1.1 Imp. qt.)

▶ 4.0 L V6 (1GR-FE) engine

1.6 qt. (1.5 L, 1.3 Imp. qt.)

**n Recommended viscosity**

► 2.7 L 4-cylinder (2TR-FE) engine

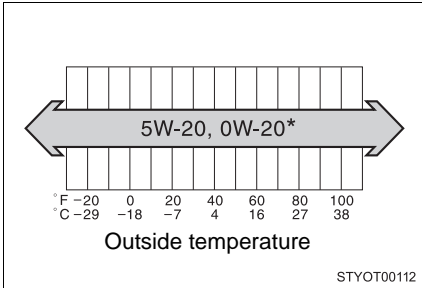

SAE 5W-20 or 0W-20

\*: SAE 5W-20 or 0W-20 engine oil may be used. However, SAE 0W-20 is the best choice for good fuel economy and good starting in cold weather.

► 4.0 L V6 (1GR-FE) engine

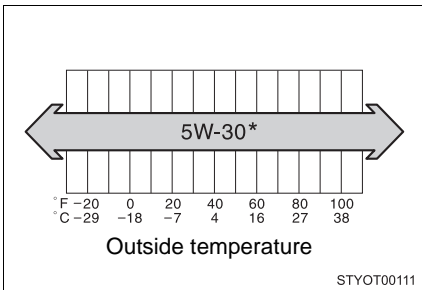

SAE 5W-30 is the best choice for good fuel economy, and good starting in cold weather.

\*: If SAE 5W-30 oil is not available, SAE 10W-30 oil may be used. However, it should be replaced with SAE 5W-30 at the next oil change.

**n How to read oil container labels**

Some oil containers are labeled with ILSAC certification marks that help you to select the proper oil.



### n Engine oil consumption

- | The amount of engine oil consumed depends on the oil viscosity, the quality of the oil and the way the vehicle is driven.
- | More oil is consumed under driving conditions such as high speeds and frequent acceleration and deceleration.
- | A new engine consumes more oil.
- | When judging the amount of oil consumption, keep in mind that the oil may have become diluted, making it difficult to judge the true level accurately.
- | Oil consumption: Max. 1.1 qt./600 miles, 0.9 Imp.qt./600 miles (1.0 L per 1000 km)
- | If you consume more than 1.1 qt. (1.0 L, 0.9 Imp.qt.) every 600 miles (1000 km), contact your Toyota dealer.

### n After changing the engine oil (U.S.A. only)

The oil change system should be reset. Perform the following procedures:

- STEP 1** Turn the engine switch off with the odometer reading shown.(→P. 150)
- STEP 2** Turn the engine switch to the ON position while holding down the trip meter reset button.
- STEP 3** Continue to press and hold the button until the odometer displays 000000.

If the system fails to reset, the light will continue flashing.

 **CAUTION**

**n Used engine oil**

- I** Used engine oil contains potentially harmful contaminants which may cause skin disorders such as inflammation or skin cancer, so care should be taken to avoid prolonged and repeated contact. To remove used engine oil from your skin, wash thoroughly with soap and water.
- I** Dispose of used oil and filters only in a safe and acceptable manner. Do not dispose of used oil and filters in household trash, in sewers or onto the ground. Call your Toyota dealer, service station or auto parts store for information concerning recycling or disposal.
- I** Do not leave used engine oil within the reach of children.

 **NOTICE**

**n To prevent serious engine damage**

Check the oil level on regular basis.

**n When replacing the engine oil**

- I** Be careful not to spill engine oil on the vehicle components.
- I** Avoid overfilling, as the engine could be damaged.
- I** Check the oil level on the dipstick every time you refill the vehicle.
- I** Be sure the engine oil filler cap is properly tightened.

## Engine coolant

The coolant level is satisfactory if it is between the FULL and LOW lines on the reservoir when the engine is cold.

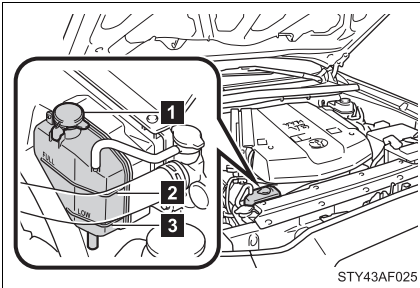

**1** Reservoir cap

**2** FULL

**3** LOW

If the level is on or below the LOW line, add coolant up to the FULL line.

### n If the coolant level drops within a short time after replenishing

Visually check the radiator, hoses, reservoir cap, radiator cap, drain cock and water pump.

If you cannot find a leak, have your Toyota dealer pressure test the cap and check for leaks in the cooling system.

### n Coolant selection

Only use “Toyota Super Long Life Coolant” or similar high quality ethylene glycol based non-silicate, non-amine, non-nitrite and non-borate coolant with long-life hybrid organic acid technology.

U.S.A.: “Toyota Super Long Life Coolant” is a mixture of 50% coolant and 50% deionized water. (Enabled: -31°F [-35°C])

Canada: “Toyota Super Long Life Coolant” is a mixture of 55% coolant and 45% deionized water. (Enabled: -44°F [-42°C])

For more details about engine coolant, contact your Toyota dealer.

## ⚠ CAUTION

### n When the engine is hot

Do not remove the radiator cap.

The cooling system may be under pressure and may spray hot coolant if the cap is removed, causing burns or other injuries.

**⚠ NOTICE**

**n When adding engine coolant**

Coolant is neither plain water nor straight antifreeze. The correct mixture of water and antifreeze must be used to provide proper lubrication, corrosion protection and cooling. Be sure to read the antifreeze or coolant label.

**n If you spill coolant**

Be sure to wash it off with water to prevent damage to parts or paint.

**Radiator and condenser**

Check the radiator and condenser and clear any foreign objects. If either of the above parts are extremely dirty or you are not sure of their condition, have your vehicle checked by your Toyota dealer.

**⚠ CAUTION**

**n When the engine is hot**

Do not touch the radiator or condenser as they may be hot and may cause burns.

**Brake fluid**

**n Checking fluid level**

▶ Type A

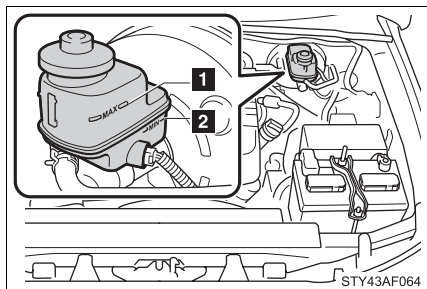

The brake fluid level should be between the MAX and MIN lines on the reservoir.

**1** MAX

**2** MIN



## ► Type B

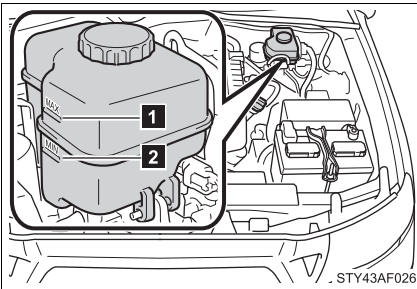

1 MAX

2 MIN

n **Adding fluid**

Make sure to check the fluid type and prepare the necessary items.

Fluid type	FMVSS No.116 DOT 3 or SAE J1703 brake fluid
Items	Rag or paper towel

## ► Type B only

**STEP 1** Turn the engine switch off.

**STEP 2** Depress the brake pedal 20 times or more.

**STEP 3** Remove the reservoir cap.

**STEP 4** Add newly opened brake fluid up to the MAX line.

n **Brake fluid can absorb moisture from the air**

Excess moisture in the fluid can cause a dangerous loss of braking efficiency. Use only newly opened brake fluid.

**! CAUTION**

**n When filling the reservoir**

Take care because brake fluid can harm your hands or eyes and damage painted surfaces.

If fluid gets on your hands or in your eyes, flush the affected area with clean water immediately.

If you still experience discomfort, see a doctor.

**! NOTICE**

**n If the fluid level is low or high**

It is normal for the brake fluid level to go down slightly as the brake pads wear or when the fluid level in the accumulator is high.

If the reservoir needs frequent refilling, it may indicate a serious problem.

**n If you spill fluid**

Be sure to wash it off with water to prevent damage to parts or paint.

**Power steering fluid**

**n Fluid level**

The fluid level should be within the appropriate range.

► 2.7 L 4-cylinder (2TR-FE) engine

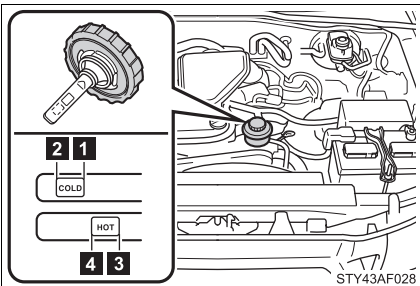

- 1** Full (when cold)
- 2** Add fluid (when cold)
- 3** Full (when hot)
- 4** Add fluid (when hot)

**Hot:** Vehicle has been driven around 50 mph (80 km/h) for 20 minutes, or slightly longer in frigid temperatures. (Fluid temperature, 104°F - 175°F [40°C - 80°C])

**Cold:** Engine has not been run for about 5 hours. (Room temperature, 32°F - 104°F [0°C - 40°C])

► 4.0 L V6 (1GR-FE) engine

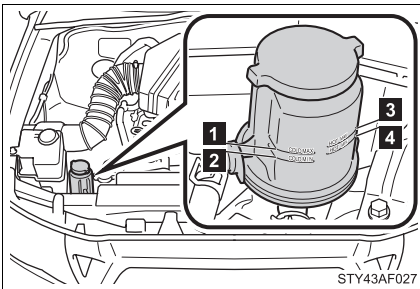

- 1 Full (when cold)
- 2 Add fluid (when cold)
- 3 Full (when hot)
- 4 Add fluid (when hot)

**Hot:** Vehicle has been driven around 50 mph (80 km/h) for 20 minutes, or slightly longer in frigid temperatures. (Fluid temperature, 140°F - 175°F [60°C - 80°C])

**Cold:** Engine has not been run for about 5 hours. (Room temperature, 50°F - 85°F [10°C - 30°C])

n **Checking the fluid level**

Make sure to check the fluid type and prepare the necessary items.

Fluid type	Automatic transmission fluid DEXRON® II or III
Items	Rag or paper towel

**STEP 1** Clean all dirt off the reservoir.

**STEP 2** Remove the cap by turning it counterclockwise.

**STEP 3** Wipe the dipstick clean.

**STEP 4** Reinstall and remove the reservoir cap again.

**STEP 5** Check the fluid level.

**⚠ CAUTION**

**n Checking the fluid level**

Take care, as the reservoir may be hot.

**⚠ NOTICE**

**n When adding fluid**

Avoid overfilling, or the power steering may be damaged.

**n After replacing the reservoir cap**

Check the steering box case, vane pump and hose connections for leaks or damage.

**Battery**

**n Battery exterior**

Make sure that the battery terminals are not corroded and that there are no loose connections, cracks, or loose clamps.

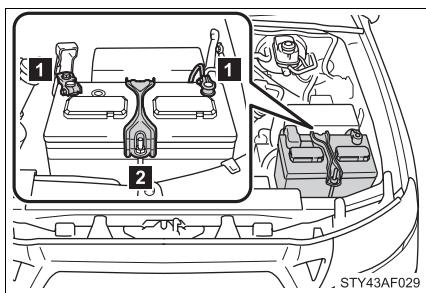

**1** Terminals

**2** Hold-down clamp

## n Checking battery condition

Check the battery condition using the indicator color.

### ► Type A

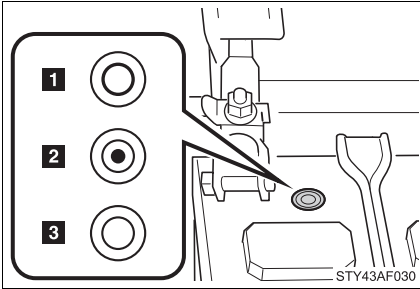

- 1** Green: Good condition
- 2** Dark: Charging is necessary. Have the vehicle inspected by your Toyota dealer.
- 3** Clear or light yellow: Not working properly, have the battery checked by your Toyota dealer.

### ► Type B

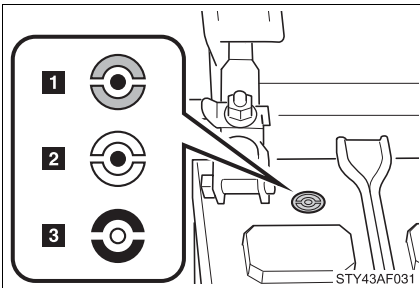

- 1** Blue: Good condition
- 2** White: Charging is necessary. Have the vehicle inspected by your Toyota dealer.
- 3** Red: Not working properly, have the battery checked by your Toyota dealer.

## n Before recharging

When recharging, the battery produces hydrogen gas which is flammable and explosive. Therefore, before recharging:

- 1 If recharging with the battery installed on the vehicle, be sure to disconnect the ground cable.
- 1 Make sure the power switch on the charger is off when connecting and disconnecting the charger cables to the battery.

 **CAUTION**

**n Chemicals in the battery**

A battery contains poisonous and corrosive sulfuric acid and may produce hydrogen gas which is flammable and explosive. To reduce the risk of death or serious injury, take the following precautions while working on or near battery:

- I Do not cause sparks by touching the battery terminals with tools.
- I Do not smoke or light a match near the battery.
- I Avoid contact with eyes, skin and clothes.
- I Never inhale or swallow electrolyte.
- I Wear protective safety glasses when working near the battery.
- I Keep children away from the battery.

**n Where to safety charge the battery**

Always charge the battery in an open area. Do not charge the battery in a garage or closed room where there is not sufficient ventilation.

**n How to recharge the battery**

Only perform a slow charge (5A or less).

The battery may explode if charged at a quicker rate.

**n Emergency measures regarding electrolyte**

- I If electrolyte gets in your eyes

Flush your eyes with clean water for at least 15 minutes and get immediate medical attention. If possible, continue to apply water with a sponge or cloth while traveling to the nearest medical facility.

- I If electrolyte gets on your skin

Wash the affected area thoroughly. If you feel pain or burning, get medical attention immediately.

- I If electrolyte gets on your clothes

It can soak through clothing on to your skin. Immediately take off the clothing and follow the procedure above if necessary.

- I If you accidentally swallow electrolyte

Drink a large quantity of water or milk. Follow with milk of magnesia, beaten raw egg or vegetable oil. Get emergency medical attention immediately.

 NOTICE

**n When recharging the battery**

Never recharge the battery while the engine is running. Also, be sure all accessories are turned off.

## Washer fluid

If any washer does not work, the washer tank may be empty.

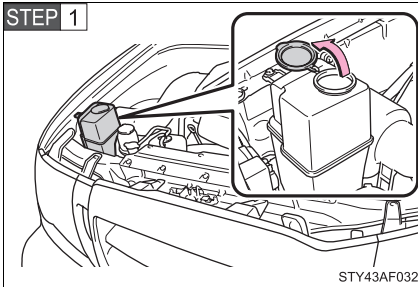

Open the lid.

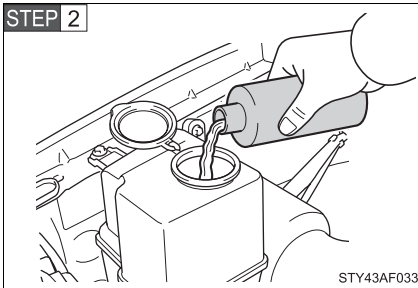

Add washer fluid.

 CAUTION

**n When refilling the washer fluid**

Do not refill the washer fluid when the engine is hot or running, as the washer fluid contains alcohol and may catch fire if spilled on the engine etc.

 NOTICE

**n Do not use any fluid other than washer fluid**

Do not use soapy water or engine antifreeze instead of washer fluid. Doing so may cause streaking on the vehicle's painted surfaces.

**n Diluting washer fluid**

Dilute washer fluid with water as necessary. Refer to the freezing temperatures listed on the washer fluid tank.



# Tires

**Replace or rotate tires in accordance with maintenance schedules and treadwear.**

## n Checking tires

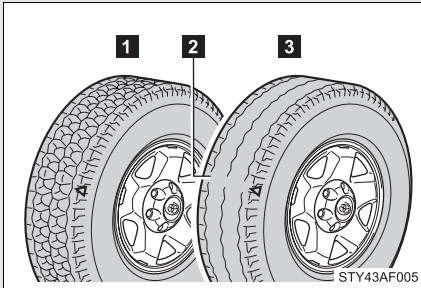

- 1** New tread
- 2** Treadwear indicator
- 3** Worn tread

The location of treadwear indicators is shown by the “TWI” or “△” marks, etc., molded on the sidewall of each tire.

Check spare tire condition and inflation pressure if not rotated.

## n Tire rotation

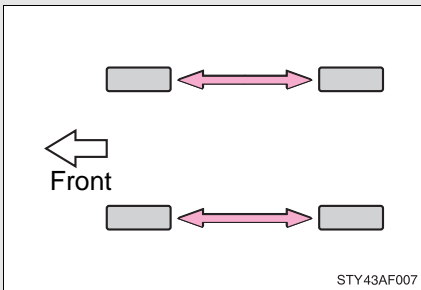

Rotate the tires in the order shown.

To equalize tire wear and extend tire life, Toyota recommends that tire rotation is carried out at the same interval as tire inspection.

Do not fail to initialize the tire pressure warning system after tire rotation.

## n The tire pressure warning system

Your Toyota is equipped with a tire pressure warning system that uses tire pressure warning valves and transmitters to detect low tire inflation pressure before serious problems arise. (→P. 427)

### **Installing tire pressure warning valves and transmitters**

When replacing tires or wheels, tire pressure warning valves and transmitters must also be installed.

When new tire pressure warning valves and transmitters are installed, new tire pressure warning valve and transmitter ID codes must be registered in the tire pressure warning computer and tire pressure warning system must be initialized. Have tire pressure warning valve and transmitter ID codes registered by your Toyota dealer. (→P. 375)

### **Initializing the tire pressure warning system**

**n The tire pressure warning system must be initialized in the following circumstances:**

- 1 When rotating the tires on vehicles differing with front and rear tire inflation pressures.
- 1 When changing the tire inflation pressure by changing traveling speed or load weight, etc.
- 1 When changing the tire size.

When the tire pressure warning system is initialized, the current tire inflation pressure is set as the pressure benchmark.

**n How to initialize the tire pressure warning system**

**STEP 1** Park the vehicle in safe place and turn the engine switch off.

While the vehicle is moving, initialization is not performed.

**STEP 2** Adjust the tire inflation pressure to the specified cold tire inflation pressure level. (→P. 475)

Make sure to adjust the tire pressure to the specified cold tire inflation pressure level. The tire pressure warning system will operate based on this pressure level.

**STEP 3** Turn the engine switch to the ON position.

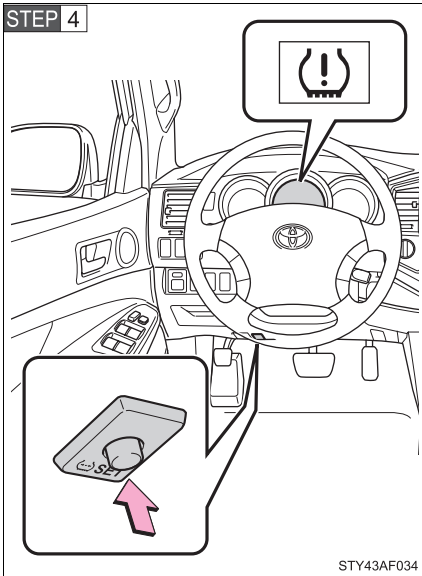

Push and hold the tire pressure warning reset switch about 3 seconds, and after releasing the switch the tire pressure warning light blinks slowly three times.

**STEP 5** Wait for a few minutes with the engine switch on, and then turn the engine switch to the ACC or LOCK position.

## Registering ID codes

The tire pressure warning valve and transmitter is equipped with a unique ID code. When replacing a tire pressure warning valve and transmitter, it is necessary to register the ID code of tire pressure warning valve and transmitter. Have the ID code registered by your Toyota dealer.

■ **When to replace your vehicle's tires**

Tires should be replaced if:

- 1 You have tire damage such as cuts, splits, cracks deep enough to expose the fabric or bulges indicating internal damage
- 1 A tire goes flat repeatedly or cannot be properly repaired due to the size or location of a cut or other damage

If you are not sure, consult with your Toyota dealer.

■ **Replacing tires and wheels**

If the ID code of the tire pressure warning valve and transmitter is not registered, the tire pressure warning system will not work properly. After driving for about 20 minutes, the tire pressure warning light comes on after blinking for 1 minute to indicate a system malfunction.

■ **Tire life**

Any tire over 6 years old must be checked by a qualified technician even if they have seldom or never been used or damage is not obvious.

■ **If the tread wears down below 0.16 in. (4 mm) on snow tires**

The effectiveness of snow tires is lost.

■ **Maximum load of tire**

Check that the maximum load of the replaced tire is greater than 1/2 of the Gross Axle Weight Ratings (GAWR) of either the front axle or the rear axle, whichever is greater.

As for the maximum load of the tire, see the load limit at maximum cold tire inflation pressure mentioned on the sidewall of the tire, and as for the Gross Axle Weight Ratings (GAWR), see the Certification Label.

(→P. 381, 465, 482).

## n Tire types

### 1 Summer tires

Summer tires are high-speed performance tires best suited to highway driving under dry conditions. Since summer tires do not have the same traction performance as snow tires, summer tires are inadequate for driving on snow-covered or icy roads. For driving on snow-covered roads or icy roads, the use of snow tires is recommended. When installing snow tires, be sure to replace all four tires.

### 2 All season tires

All season tires are designed to provide better traction in snow and to be adequate for driving in most winter conditions, as well as for use year round. All season tires, however, do not have adequate traction performance compared with snow tires in heavy or loose snow. Also, all season tires fall short in acceleration and handling performance compared with summer tires in highway driving.

### 3 Snow tires

For driving on snow-covered roads or icy roads, we recommend using snow tires. If you need snow tires, select tires of the same size, construction and load capacity as the originally installed tires. Since your vehicle has radial tires as original equipment, make sure your snow tires also have radial construction. Do not install studded tires without first checking local regulations for possible restriction. Snow tires should be installed on all wheels. (→P. 201)

■ **Initializing the tire pressure warning system**

Initialize the tires with the tire inflation pressure adjusted to the specified level.

■ **If you push the tire pressure warning reset switch accidentally**

If initialization is performed, adjust the tire inflation pressure to the specified level and initialize the tire pressure warning system again.

■ **When the initialization of the tire pressure warning system has failed**

Initialization can be completed in a few minutes. However, in the following cases, the settings have not been recorded and the system will not operate properly. If repeated attempts to record tire inflation pressure settings are unsuccessful, have the vehicle inspected by your Toyota dealer.

1 When operating the tire pressure warning reset switch, the tire pressure warning light does not flash 3 times.

1 After carrying out the initialization procedure, the tire pressure warning light blinks for 1 minute then stays on after driving for about 20 minutes.

■ **Routine tire inflation pressure checks**

The tire pressure warning system does not replace routine tire inflation pressure checks. Make sure to check tire inflation pressure as part of your routine of daily vehicle checks.

## n Tire pressure warning system certification

► For vehicles sold in U.S.A.

### NOTE:

This device complies with Part 15 of the FCC Rules. Operation is subject to the following two conditions: (1) This device may not cause harmful interference, and (2) this device must accept any interference received, including interference that may cause undesired operation.

### NOTICE:

This equipment has been tested and found to comply with the limits for a Class B digital device, pursuant to Part 15 of the FCC Rules. These limits are designed to provide reasonable protection against harmful interference in a residential installation. This equipment generates, uses and can radiate radio frequency energy and, if not installed and used in accordance with the instructions, may cause harmful interference to radio communications. However, there is no guarantee that interference will not occur in a particular installation. If this equipment does cause harmful interference to radio or television reception, which can be determined by turning the equipment off and on, the user is encouraged to try to correct the interference by one or more of the following measures:

- 1 Reorient or relocate the receiving antenna.
- 1 Increase the separation between the equipment and receiver.
- 1 Connect the equipment into an outlet on a circuit different from that to which the receiver is connected.
- 1 Consult the dealer or an experienced radio/TV technician for help.

### FCC WARNING:

Changes or modifications not expressly approved by the party responsible for compliance could void the user's authority to operate the equipment.

► For vehicles sold in Canada

### NOTE:

Operation is subject to the following two conditions: (1) this device may not cause interference, and (2) this device must accept any interference, including interference that may cause undesired operation of the device.

 CAUTION

**n When inspecting or replacing tires**

Observe the following precautions to prevent accidents. Failure to do so may cause damage to parts of the drive train, as well as dangerous handling characteristics, which may lead to fatal or injury accidents.

**I** Do not mix tires of different makes, models, tread patterns or tread-wear.

**I** Do not use tire sizes other than those recommended by Toyota.

**I** Do not mix radial, bias-belted, or bias-ply tires.

**I** Do not mix summer, all season and winter tires.

**n When initializing the tire pressure warning system**

Do not push the tire pressure warning reset switch without first adjusting the tire inflation pressure to the specified level. Otherwise, the tire pressure warning light may not come on even if the tire inflation pressure is low, or it may come on when the tire inflation pressure is actually normal.

 NOTICE

**n Repairing or replacing tires, wheels and tire pressure warning valves and transmitters**

When removing or fitting the wheels, tires or the tire pressure warning valve and transmitter, contact your Toyota dealer as the tire pressure warning valve and transmitter may be damaged if not handled correctly.

**n To avoid damaging the tire pressure warning valves and transmitters**

Do not use liquid sealants on flat tires.



## 4-3. Do-it-yourself maintenance

### Tire inflation pressure

#### n Tire inflation pressure

The recommended cold tire inflation pressure and tire size is displayed on the tire and loading information label. (→P. 475)

#### ► Regular Cab and Double Cab models

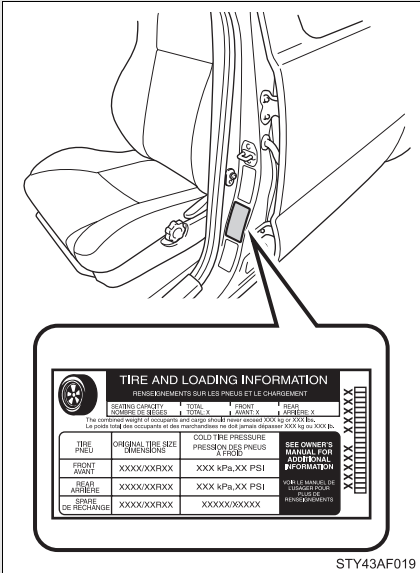

► Access Cab models

**TIRE AND LOADING INFORMATION**  
 renseignements sur les pneus et le chargement

LOADING CAPACITY: 1 total, 4 front, 4 rear  
 Capacité de charge: 1 total, 4 avant, 4 arrière

The combined weight of occupants and cargo should never exceed XXX kg or XXX lbs.  
 Le poids total des occupants et de la cargaison ne doit jamais dépasser XXX kg ou XXX lb.

TIRE PNEU	ORIGINAL TIRE SIZE DIMENSIONS	COLD TIRE PRESSURE PRESSION DES PNEUS À FROID
FRONT AVANT	XXXX/XXRXX	XXX kPa/XX PSI
REAR ARRIÈRE	XXXX/XXRXX	XXX kPa/XX PSI
SPARE DE RÉCHANGE	XXXX/XXRXX	XXXXX/XXXX

SEE OWNER'S MANUAL FOR TIRE BALL INFORMATION  
 VOIR LE MANUEL DE CHARGES POUR PLUS DE RENSEIGNEMENTS

STY43AF020

## n Inspection and adjustment procedure

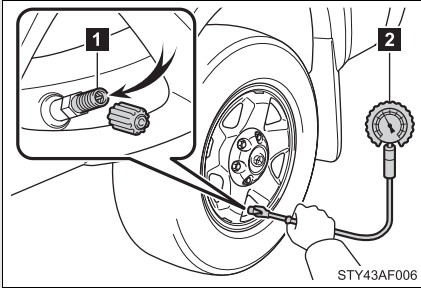

- 1 Tire valve
- 2 Tire pressure gauge

**STEP 1** Remove the tire valve cap.

**STEP 2** Press the tip of the tire pressure gauge onto the tire valve.

**STEP 3** Read the pressure using the graduations of the gauge.

**STEP 4** If the tire inflation pressure is not within the recommended levels, adjust inflate the tire.

If you add too much air, press the center of the valve to lower.

**STEP 5** After completing the tire inflation pressure measurement and adjustment, apply soapy water to the valve and check for leakage.

**STEP 6** Reinstall the tire valve cap.

**n Tire inflation pressure check interval**

You should check tire pressure every two weeks, or at least once a month.

Do not forget to check the spare.

**n Effects of incorrect tire inflation pressure**

Driving with incorrect tire inflation pressure may result in the following:

- l Reduced fuel efficiency
- l Reduced driving comfort and tire life
- l Reduced safety
- l Damage to the drive train

If a tire needs frequent refilling, have it checked by your Toyota dealer.

**n Instructions for checking tire inflation pressure**

When checking tire inflation pressure, observe the following:

- l Check only when the tires are cold.

If your vehicle has been parked for at least 3 hours and has not been driven for more than 1 mile or 1.5 km, you will get an accurate cold tire inflation pressure reading.

- l Always use a tire pressure gauge.

The appearance of the tire can be misleading. In addition, tire inflation pressures that are even just a few pounds off can degrade ride and handling.

- l Do not bleed or reduce tire inflation pressure after driving. It is normal for the tire inflation pressure to be higher after driving.

- l Never exceed the vehicle capacity weight.

Passengers and luggage weight should be placed so that the vehicle is balanced.

 CAUTION**n Proper inflation is critical to save tire performance**

Keep your tires properly inflated.

Otherwise, the following conditions may occur and result in an accident causing death or serious injury.

- I Excessive wear
- I Uneven wear
- I Poor handling
- I Possibility of blowouts resulting from overheated tires
- I Poor sealing of the tire bead
- I Wheel deformation and/or tire separation
- I A greater possibility of tire damage from road hazards

 NOTICE**n When inspecting and adjusting tire inflation pressure**

Be sure to reinstall the tire valve caps.

Without the valve caps, dirt or moisture could get into the valve and cause air leakage, which could result in an accident. If the caps have been lost, replace them as soon as possible.

## Wheels

**If a wheel is bent, cracked or heavily corroded, it should be replaced.**

**Otherwise, the tire may separate from the wheel or cause loss of handling control.**

### **n Wheel selection**

When replacing wheels, care should be taken to ensure that they are equivalent to those removed in load capacity, diameter, rim width, and offset.

Replacement wheels are available at your Toyota dealer.

Toyota does not recommend using:

- 1 Wheels of different sizes or types
- 1 Used wheels
- 1 Bent wheels that have been straightened

### **n Wheel precautions**

- 1 Use only Toyota wheel nuts and wrench designed for use with your aluminum wheels.
- 1 When rotating, repairing or changing your tires, check that the wheel nuts are still tight after driving 100 miles (160 km).
- 1 Be careful not to damage the aluminum wheels when using tire chains.
- 1 Use only Toyota genuine balance weights or equivalent and a plastic or rubber hammer when balancing your wheels.

---

### **n When replacing wheels**

The wheels of your Toyota are equipped with tire pressure warning valves and transmitters (except for spare tire) that allow the tire pressure warning system to provide advanced warning in the event of a loss in tire inflation pressure. Whenever wheels are replaced, the tire pressure warning valves and transmitters must be installed. (→P. 374)

 **CAUTION****n When replacing wheels**

- i** Do not use wheels that are a different size from those recommended in the Owner's Manual, as this may result in loss of handling control.
- i** Never use an inner tube in a leaking wheel which is designed for a tubeless tire. Doing so may result in an accident, causing death or serious injury.

 **NOTICE****n Replacing tire pressure warning valves and transmitters**

- i** Because tire repair or replacement may affect the tire pressure warning valves and transmitters, make sure to have tires serviced by your Toyota dealer or other qualified service shop. In addition, make sure to purchase your tire pressure warning valves and transmitters at your Toyota dealer.
- i** Ensure that only genuine Toyota wheels are used on your vehicle. Tire pressure warning valves and transmitters may not work properly with non-genuine wheels.

## 4-3. Do-it-yourself maintenance

### Air conditioning filter

The air conditioning filter must be changed regularly to maintain air conditioning efficiency.

#### n Removal method

**STEP 1** Turn the engine switch off.

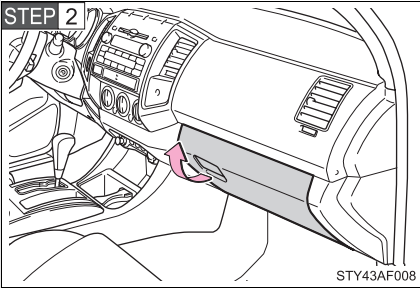

Open the glove box.

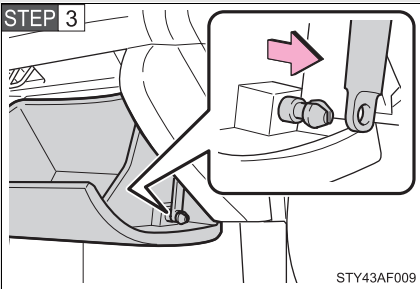

Slide off the damper.

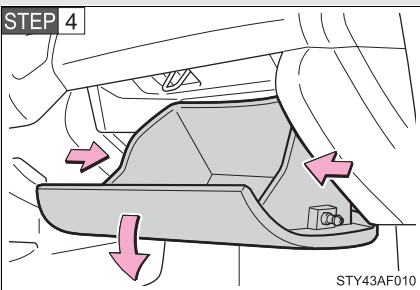

Push in each side of the glove box to disconnect the claws.



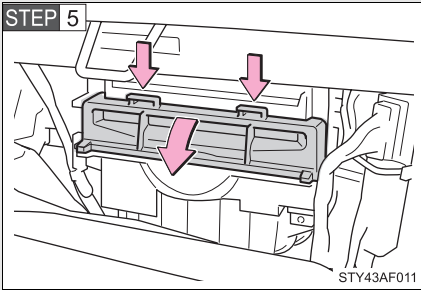

Open the filter door.

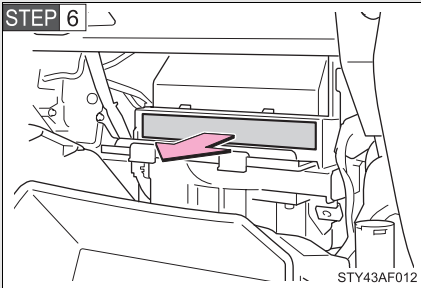

Remove the filter.

### 11 Replacement method

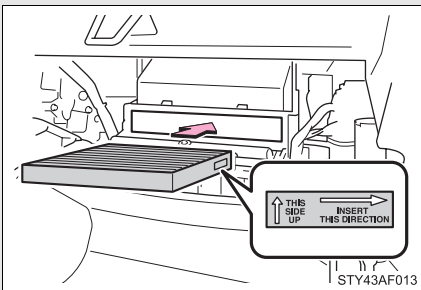

Remove the air conditioning filter and replace it with a new one.

When installing the filter, follow the instructions indicated on the label.

■ **Checking interval**

Inspect and replace the air conditioning filter according to the maintenance schedule. In dusty areas or areas with heavy traffic flow, early replacement may be required. (For scheduled maintenance information, please refer to the “Scheduled Maintenance Guide” or “Owner’s Manual Supplement”.)

■ **If air flow from the vents decreases dramatically**

The filter may be clogged. Check the filter and replace if necessary.



**NOTICE**

■ **When using the air conditioning system**

Make sure that a filter is always installed.

Using the air conditioning system without a filter may cause damage to the system.

## Wireless remote control battery (if equipped)

**Replace the battery with a new one if it is discharged.**

n **You will need the following items:**

Lithium battery CR2032

n **Replacing the battery**

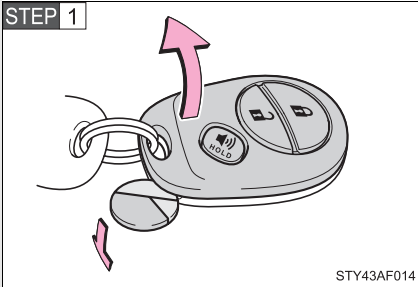

Remove the cover using a coin protected with tape etc.

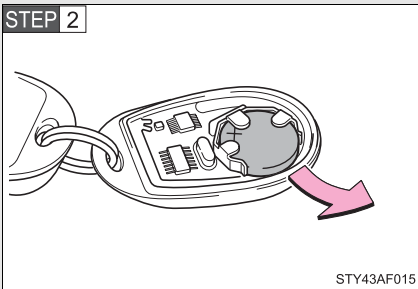

Remove the discharged transmitter battery.

Insert a new battery with the “+” terminal facing up.

**n If the wireless remote control battery is discharged**

The following symptoms may occur.

- l The wireless remote control will not function properly.
- l The operational range is reduced.

**n Use a CR2032 lithium battery**

- l Batteries can be purchased at your Toyota dealer, jewelers, or camera stores.
- l Replace only with the same or equivalent type recommended by your Toyota dealer.
- l Dispose of used batteries according to the local laws.



**CAUTION**

**n Removed battery and other parts**

Keep away from children.

These parts are small and if swallowed by a child they can cause choking.



**NOTICE**

**n For normal operation after replacing the battery**

Observe the following precautions to prevent accidents.

- l Always work with dry hands.  
Moisture may cause the battery to rust.
- l Do not touch or move any other components inside the remote control.
- l Do not bend either of the battery terminals.

## 4-3. Do-it-yourself maintenance

### Checking and replacing fuses

**If any of the electrical components do not operate, a fuse may have blown. If this happens, check and replace the fuses as necessary.**

**STEP 1** Turn the engine switch off.

**STEP 2** The fuses are located in the following places. To check the fuses, follow the instructions below.

#### ► Engine compartment

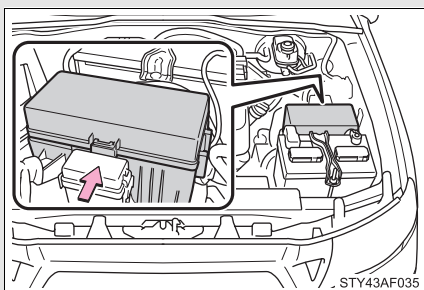

Push the tab in and lift the lid off.

#### ► Under the instrument panel

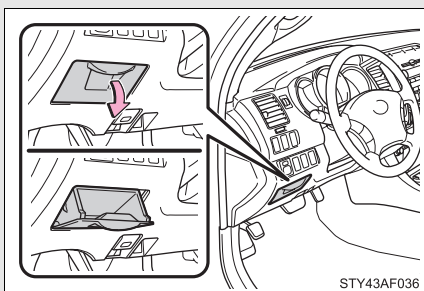

1. Open the auxiliary box.

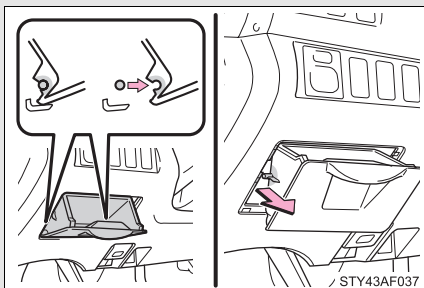

2. Pull up the box and disengage the claws. Remove the stoppers from the cutouts and remove the box.

**STEP 3** After a system failure, see “Fuse layout and amperage ratings” (→P. 396) for details about which fuse to check.

**STEP 4**

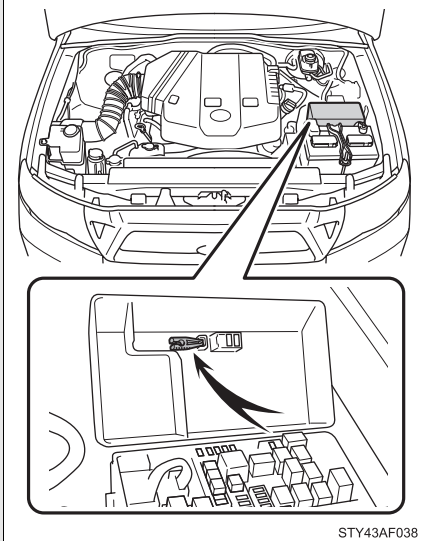

Remove the fuse with the pull-out tool.

**STEP 5** Check if the fuse has blown.

► Type A

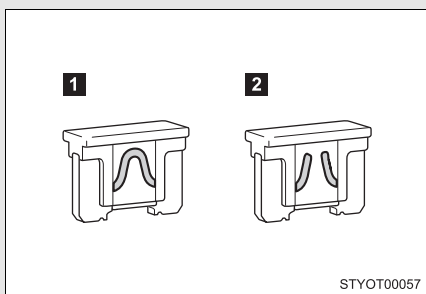

**1** Normal fuse

**2** Blown fuse

Replace it with one of an appropriate amperage rating. The amperage rating can be found on the fuse box lid.

## ► Type B

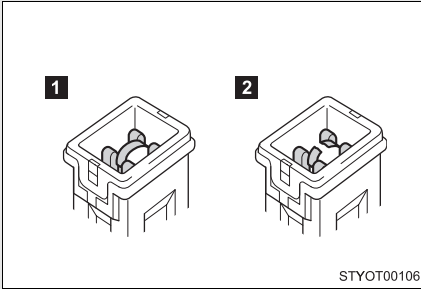
**1** Normal fuse**2** Blown fuse

Replace it with one of an appropriate amperage rating. The amperage rating can be found on the fuse box lid.

## ► Type C

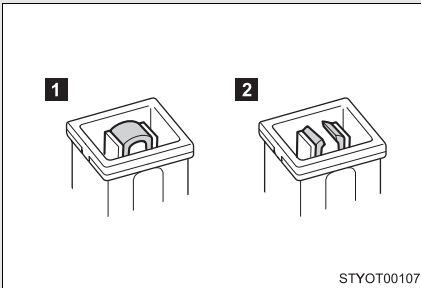
**1** Normal fuse**2** Blown fuse

Replace it with one of an appropriate amperage rating. The amperage rating can be found on the fuse box lid

## ► Type D

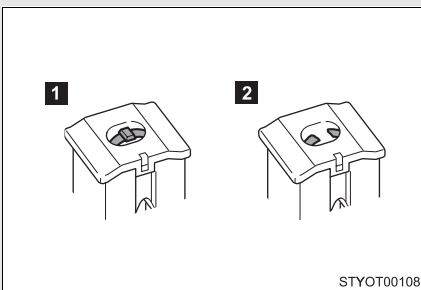
**1** Normal fuse**2** Blown fuse

Replace it with one of an appropriate amperage rating. The amperage rating can be found on the fuse box lid

## Fuse layout and amperage ratings

### n Engine compartment

#### ► Type A

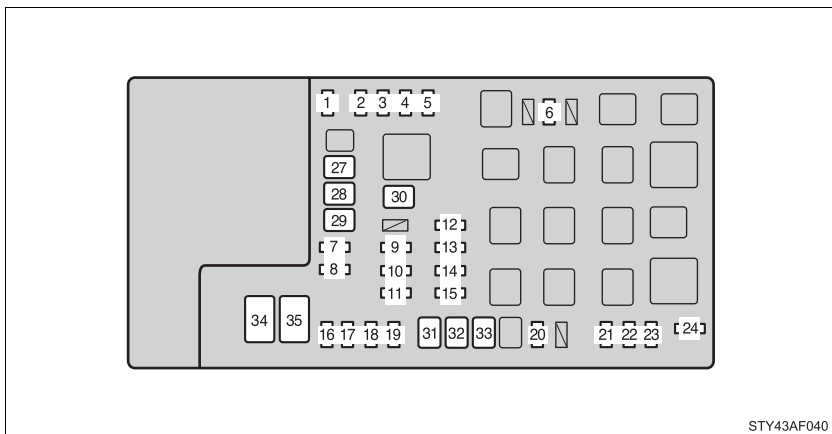

#### ► Type B

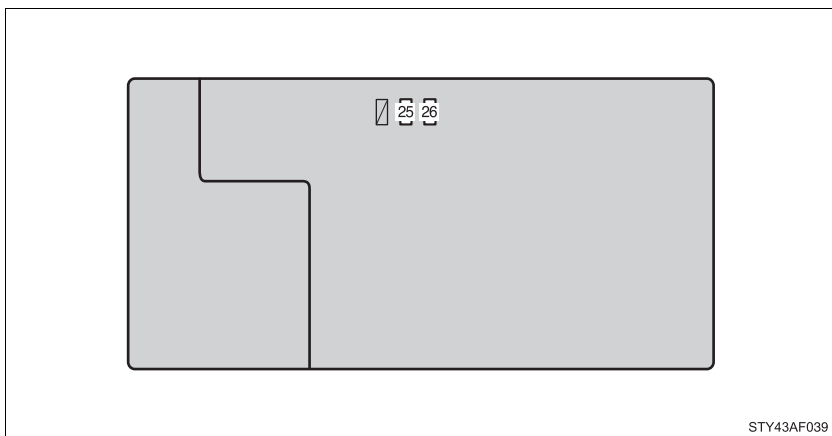



Fuse		Ampere	Circuit
1	A/C	10 A	Air conditioning system
2	FR FOG	15 A	Front fog lights
3	TOWING TAIL	30 A	Trailer lights (tail lights)
4	STOP	10 A	Stop lights, high mounted stop-light, vehicle stability control system, anti-lock brake system, shift lock system, multiport fuel injection system/sequential multiport fuel injection system, towing converter
5	OBD	7.5 A	On-board diagnosis system
6	EFI NO.2	10 A	Multiport fuel injection system/ sequential multiport fuel injection system
7	TOWING BRK	30 A	Trailer brake controller
8	BATT CHG	30 A	Trailer sub battery
9	TOWING	30 A	Towing converter
10	TRN-HAZ	15 A	Turn signal lights, emergency flashers, meter and gauge
11	RADIO NO.2	30 A	Audio system
12	HEAD (LO RH)	10 A	Right-hand headlight (low beam)
13	HEAD (LO LH)	10 A	Left-hand headlight (low beam), front fog lights
14	HEAD (HI RH)	10 A	Right-hand headlight (high beam)
15	HEAD (HI LH)	10 A	Left-hand headlight (high beam), meter and gauge
16	ETCS	10 A	Multiport fuel injection system/ sequential multiport fuel injection system, electronic throttle control system
17	ALT-S	7.5 A	Charging system

Fuse		Ampere	Circuit
18	EFI	20 A	Multiport fuel injection system/ sequential multiport fuel injection system
19	HORN	10 A	Horn
20	A/F HEATER	15 A	Multiport fuel injection system/ sequential multiport fuel injection system
21	ECU-B	7.5 A	Wireless remote control system, air conditioning system, multiplex communication system, meter and gauge, clock, front passenger occupant classification system
22	DOME	7.5 A	Interior light, personal lights
23	RADIO NO.1	10 A	Audio system
24	STA	7.5 A	Starting system, multiport fuel injection system/sequential multi- port fuel injection system, meter and gauge, clutch start cancel switch
25	Spare	10 A	Spare fuse
26	Spare	15 A	Spare fuse
27	J/B	50 A	TAIL, AC SKT, DR LCK, D FR P/W, D RR P/W, P FR P/W and P RR P/ W fuses
28	AM1	50 A	ACC, IG1, IG1 NO.2, WIP, WSH, 4WD and STA fuses
29	HEATER	50 A	A/C fuse, air conditioning system
30	ABS NO.1	50 A	Anti-lock brake system, vehicle sta- bility control system
31	AM2	30 A	IGN and GAUGE fuses, multiport fuel injection system/sequential multiport fuel injection system

Fuse		Ampere	Circuit
32	A/PUMP	50 A	Multiport fuel injection system/ sequential multiport fuel injection system
33	ABS NO.2	30 A	Anti-lock brake system, vehicle sta- bility control system
34	AC SKT	100 A	Cigarette lighter, power outlets
35	ALT	120 A*	AM1, AC SKT, HEATER, FR FOG, STOP, OBD, J/B, TOWING TAIL, TOWING BRK and BATT CHG fuses
		140 A*	

\*: Replace the fuse with one of the same ampere rating as the original

## n Under the instrument panel

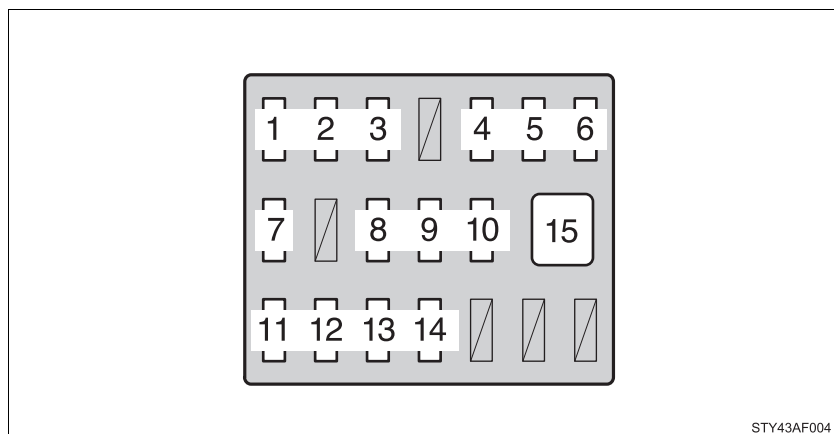

Fuse		Ampere	Circuit
1	IGN	15 A	Multiport fuel injection system/ sequential multiport fuel injection system, anti-lock brake system, traction control system, vehicle stability control system, SRS airbag system, front passenger occupant classification system
2	GAUGE	7.5 A	Meter and gauge, emergency flashers
3	TAIL	10 A	Tail lights, license plate lights, parking lights, multiport fuel injection system/sequential multiport fuel injection system, front fog lights, instrument panel light control, illuminations
4	ACC	7.5 A	Shift lock system, outside rear view mirrors, audio system, power outlets
5	PWR OUTLET	15 A	Power outlets
6	DR LCK	20 A	Door lock system

Fuse		Ampere	Circuit
7	IG1 NO.2	10 A	Anti-lock brake system, vehicle stability control system, stop lights, charging system, multiport fuel injection system/sequential multiport fuel injection system, air conditioning system, instrument panel light control, anti-glare inside rear view mirror, back monitor, clutch start cancel switch, rear differential lock system, power outlets, tire pressure warning system
8	IG1	10 A	Back-up lights, air conditioning system, passenger airbag off switch, shift lock system
9	P RR P/W	20 A	Rear passenger's power window (right side)
10	P FR P/W	20 A	Front passenger's power window
11	WSH	10 A	Wipers and washer
12	D RR P/W	20 A	Rear passenger's power window (left side)
13	4WD	20 A	Four-wheel drive system, rear differential lock system
14	WIP	30 A	Wipers and washer
15	D FR P/W	30 A	Power windows

#### n After a fuse is replaced

- l If the lights do not turn on even after the fuse has been replaced, a bulb may need replacement. (→P. 403)
- l If the replaced fuse blows again, have the vehicle inspected by your Toyota dealer.

#### n If there is an overload in the circuits

The fuses are designed to blow before the entire wiring harness is damaged.

 **CAUTION**

**n To prevent system breakdowns and vehicle fire**

Observe the following precautions.

Failing to do so may cause damage, and possibly a fire or injury.

- l** Never use a fuse of a higher amperage rating than indicated, or use any other object in place of a fuse.
- l** Always use a genuine Toyota fuse or equivalent.  
Never replace a fuse with a wire, even as a temporary fix.  
This can cause extensive damage or even fire.
- l** Do not modify the fuse or the fuse box.

 **NOTICE**

**n Before replacing fuses**

Have the cause of electrical overload determined and repaired by your Toyota dealer as soon as possible.

## Light bulbs

You may replace the following bulbs yourself. The difficulty level of replacement varies depending on the bulb. If necessary bulb replacement seems difficult to perform, contact your Toyota dealer.

For more information about replacing other light bulbs, contact your Toyota dealer.

1 **Prepare a replacement light bulb.**

Check the wattage of the light bulb being replaced. (→P. 478)

1 **Front bulb locations**

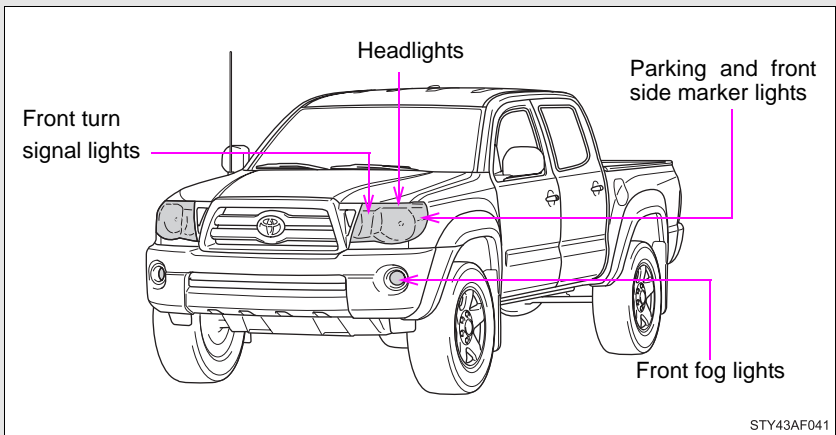

### n Rear bulb locations

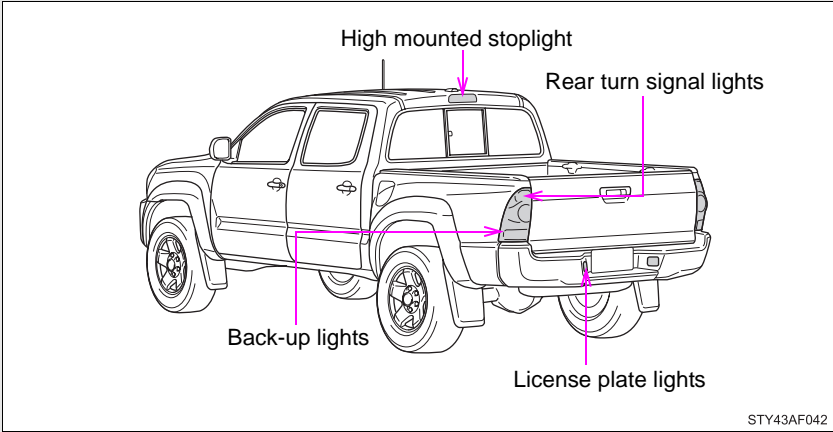

## Replacing light bulbs

### n Headlights

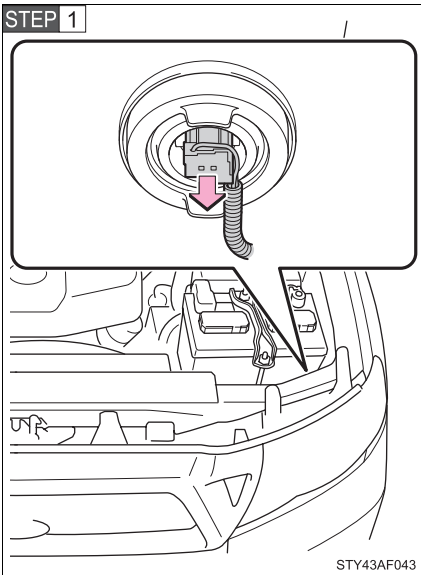

Unplug the connector.



**STEP 2**

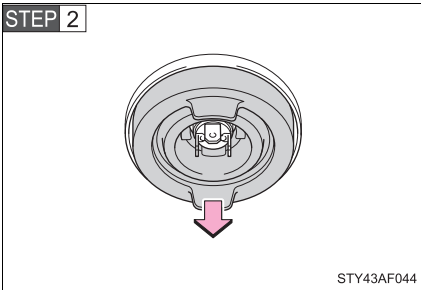

Remove the rubber cover.

**STEP 3**

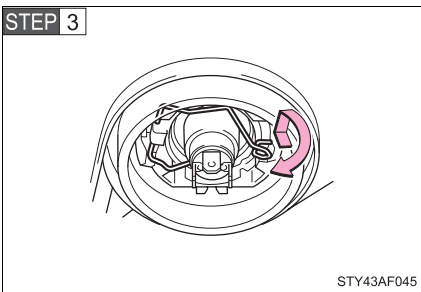

Release the bulb retaining spring.

**STEP 4**

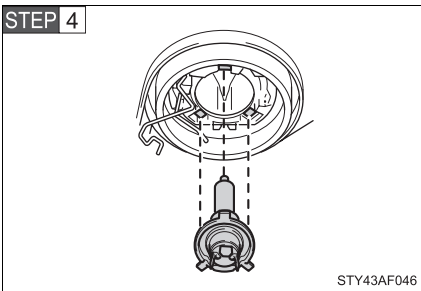

Remove the bulb.

To install a new bulb, align the tabs of the bulb with the cutouts of the mounting hole.

n **Front fog lights (if equipped)**

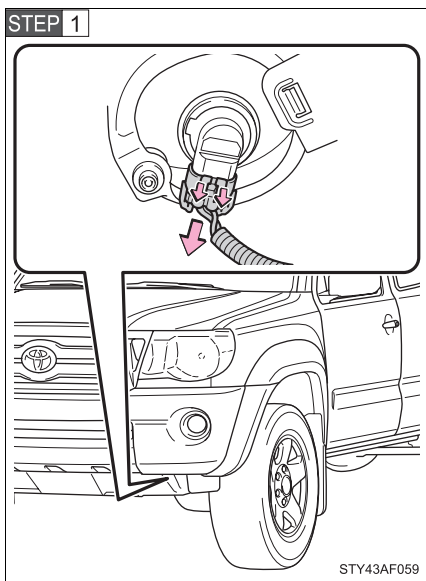

Unplug the connector while pulling the lock release.

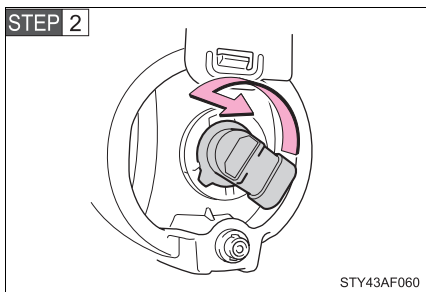

Turn the bulb counterclockwise.

## n Parking and front side marker lights

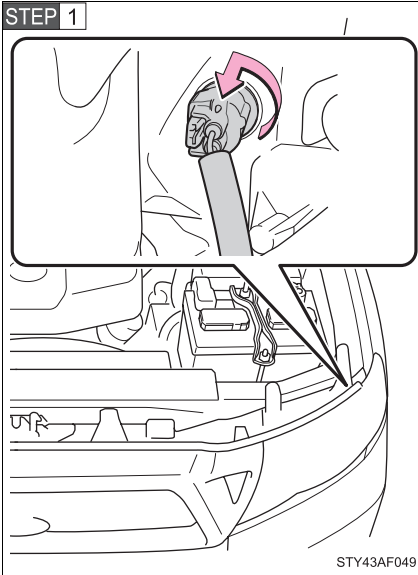

Turn the bulb base counterclockwise.

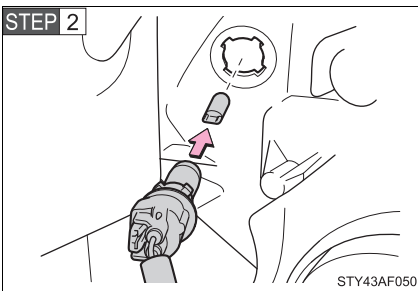

Remove the light bulb.

## n Front turn signal lights

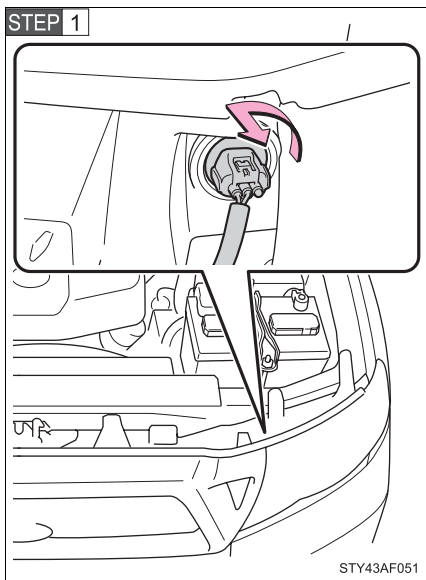

Turn the bulb base counterclockwise.

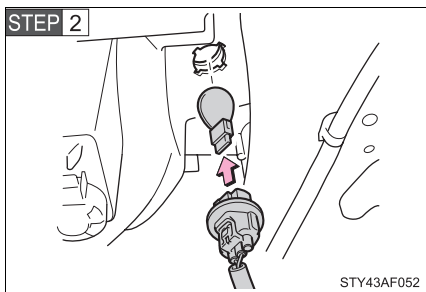

Remove the light bulb.

n **Back-up lights and rear turn signal lights**

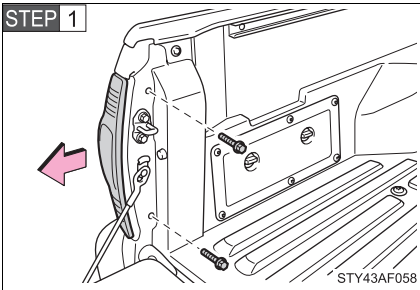

Remove the bolts and rear combination assembly.

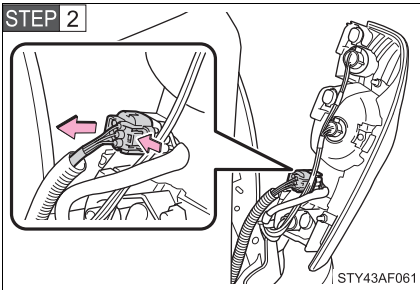

Unplug the connector while depressing the lock release.

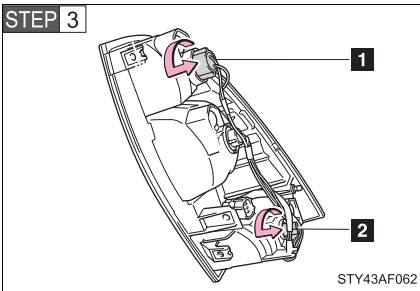

Turn the bulb bases counter-clockwise.

**1** Rear turn signal light

**2** Back-up light

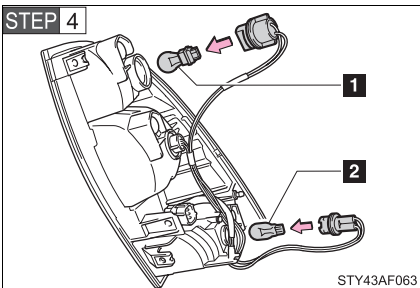

Remove the light bulb.

**1** Rear turn signal light

**2** Back-up light

### n High mounted stoplight

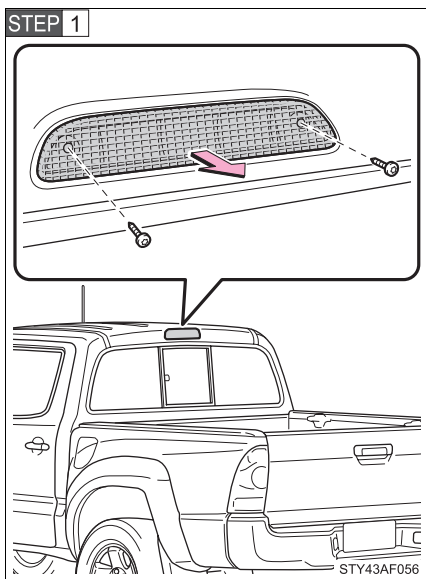

Remove the screws and cover.

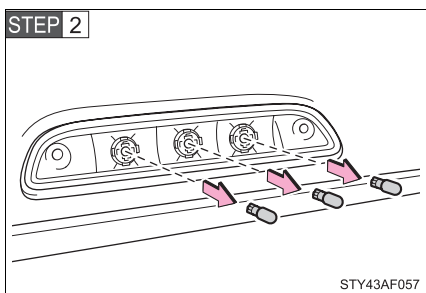

Remove the light bulbs.

## n License plate lights

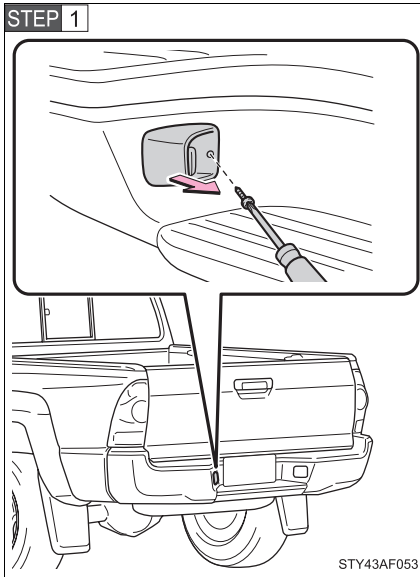

Remove the screw and light unit.

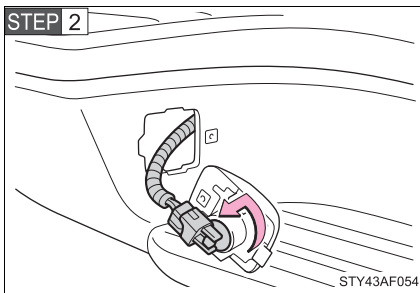

Turn the bulb base counterclockwise.

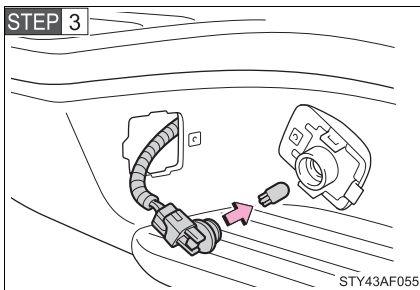

Remove the light bulb.

**n Lights other than the above**

If any of the lights listed below has burnt out, have it replaced by your Toyota dealer.

- Stop/tail lights
- Rear side marker lights

---

**n Condensation build-up on the inside of the lens**

Contact your Toyota dealer for more information in the following situations. Temporary condensation build-up on the inside of the headlight lens does not indicate a malfunction.

- l Large drops of water are built up on the inside of the lens.
- l Water has built up inside the headlight.

**n LED light bulbs**

The stop/tail and rear side marker lights consist of a number of LEDs. If any of the LEDs burn out, take your vehicle to your Toyota dealer to have the light replaced.

If two or more LEDs in a stop light burn out, your vehicle may not conform to local laws (SAE).

**⚠ CAUTION**

**n Replacing light bulbs**

- l Turn off the headlights. Do not attempt to replace the bulb immediately after turning off the headlights.  
The bulbs become very hot and may cause burns.
- l Do not touch the glass portion of the light bulb with bare hands. Hold the bulb by the plastic or metal portion.  
If the bulb is scratched or dropped it may blow out or crack.
- l Fully install light bulbs and any parts used to secure them. Failing to do so may result in heat damage, fire, or water entering the headlight unit. This may damage the headlights or cause condensation to build up on the lens.

**n To prevent damage or fire**

Make sure bulbs are fully seated and locked.



## 5-1. Essential information

### If your vehicle needs to be towed

If towing is necessary, we recommend having your vehicle towed by your Toyota dealer or a commercial towing service, using a lift-type truck or a flat bed truck.

Use a safety chain system for all towing, and abide by all state/provincial and local laws.

The wheels and axle on the ground must be in good condition.

If they are damaged, use a towing dolly or flat bed truck.

#### Before towing

The following may indicate a problem with your transmission. Contact your Toyota dealer before towing.

- 1 The engine is running, but the vehicle will not move.
- 1 The vehicle makes an abnormal sound.

#### Emergency towing (4WD models and PreRunner only)

If a tow truck is not available, in an emergency your vehicle may be temporarily towed using a cable or chain secured to the emergency towing eyelet/hook. This should only be attempted on hard, surfaced roads for short distances at low speeds.

A driver must be in the vehicle to steer and operate the brakes. The vehicle's wheels, drive train, axles, steering and brakes must be in good condition.

##### ► Vehicles without off-road package

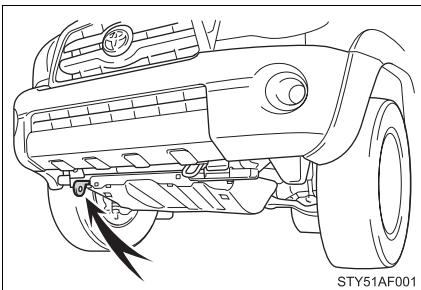

Towing eyelet

► Vehicles with off-road package

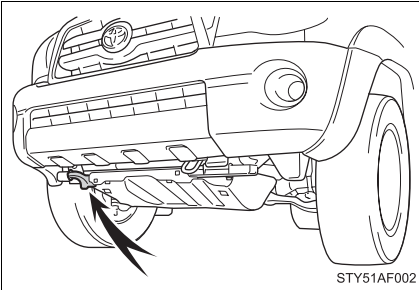

Towing hook

n **Emergency towing procedure**

- STEP 1** The engine switch must be in the ACC (engine off) or the ON (engine running) position.
- STEP 2** 4WD models: Put the front-wheel drive control switch in H2.
- STEP 3** Put the shift lever in N.
- STEP 4** Release the parking brake.

**⚠ CAUTION**

n **Caution while towing**

- l Use extreme caution when towing the vehicle. Avoid sudden starts or erratic driving maneuvers which place excessive stress on the emergency towing eyelet/hook and the cables or chains.
- l If the engine is not running, the power assist for the brakes and steering will not function, making steering and braking more difficult.

 NOTICE

**n Emergency towing eyelet/hook precautions**

- l Before emergency towing, check that the eyelet/hook is not broken or damaged.
- l Fasten the towing cable or chain securely to the eyelet/hook.
- l Do not jerk the eyelet/hook. Apply steady and even force.
- l To avoid damaging the eyelet/hook, do not pull from the side or at a vertical angle. Always pull straight ahead.

**Towing with a sling-type truck**

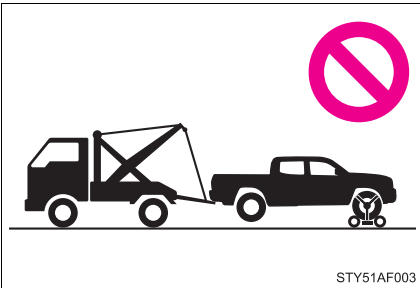

 NOTICE

**n To prevent body damage**

Do not tow with a sling-type truck, either from the front or rear.

## Towing with a wheel lift-type truck from the front

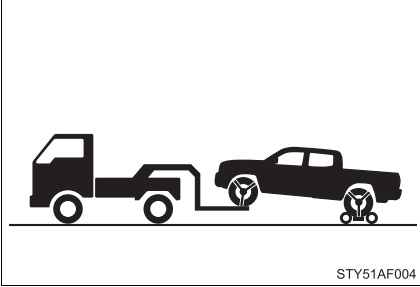

Vehicles with an automatic transmission: Use a towing dolly under the rear wheels.

2WD models with a manual transmission: We recommend to use a towing dolly under the rear wheels.

When not using a towing dolly, release the parking brake and shift the shift lever to N.

4WD models with a manual transmission: We recommend to use a towing dolly under the rear wheel.

When not using a towing dolly, release the parking brake, shift the shift lever to N and put the front-wheel drive control switch in H2.

### NOTICE

**n To prevent causing serious damage to the transmission (vehicles with an automatic transmission)**

Never tow this vehicle wheels on the ground.

## Towing with a wheel lift-type truck from the rear

### ▶ 2WD models

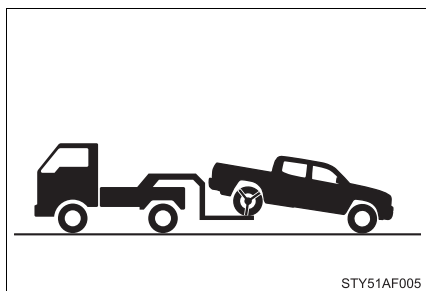

Turn the engine switch to the ACC position.

### ▶ 4WD models

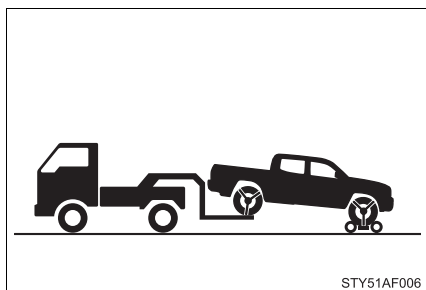

We recommend to use a towing dolly under the front wheels.

When not using a towing dolly, turn the engine switch to the ACC position, shift the shift lever to N and put the front-wheel drive control switch in H2.

### NOTICE

#### **n To prevent damaging the vehicle**

- I** Do not tow the vehicle with the key removed or in the LOCK position. The steering lock mechanism is not strong enough to hold the front wheel straight.
- I** When raising the vehicle, ensure adequate ground clearance for towing at the opposite end of the raised vehicle. Without adequate clearance, the vehicle could be damaged while being towed.

## Using a flat bed truck

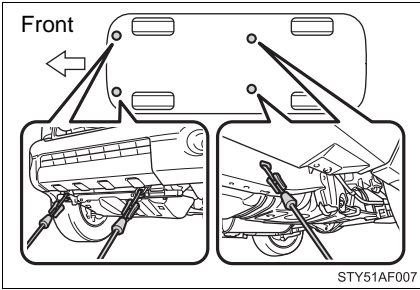

If your Toyota is transported by a flat bed truck, it should be tied down at the locations shown in the illustration.

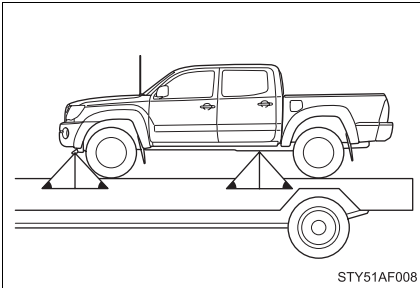

If you use chains or cables to tie down your vehicle, the angles shaded in black must be  $45^\circ$ .

Do not overly tighten the tie downs or the vehicle may be damaged.

Apply the parking brake firmly.

## If you think something is wrong

**If you notice any of the following symptoms, your vehicle probably needs adjustment or repair. Contact your Toyota dealer as soon as possible.**

### **n Visible symptoms**

- 1 Fluid leaks under the vehicle  
(Water dripping from the air conditioning after use is normal.)
- 1 Flat-looking tires or uneven tire wear
- 1 Engine coolant temperature gauge needle continually points higher than normal

### **n Audible symptoms**

- 1 Changes in exhaust sound
- 1 Excessive tire squeal when cornering
- 1 Strange noises related to the suspension system
- 1 Pinging or other noises related to the engine

### **n Operational symptoms**

- 1 Engine missing, stumbling or running rough
- 1 Appreciable loss of power
- 1 Vehicle pulls heavily to one side when braking
- 1 Vehicle pulls heavily to one side when driving on a level road
- 1 Loss of brake effectiveness, spongy feeling, pedal almost touches the floor

## Fuel pump shut off system

**To minimize the risk of fuel leakage when the engine stalls or an air-bag inflates upon collision, the fuel pump shut off system stops supplying fuel to the engine.**

Follow the procedure below to restart the engine after the system is activated.

**STEP 1** Turn the engine switch to the ACC or LOCK position.

**STEP 2** Restart the engine.



### NOTICE

**n Before starting the engine**

Inspect the ground under the vehicle.

If you find that fuel has leaked onto the ground, the fuel system has been damaged and is in need of repair. Do not restart the engine.



## 5-1. Essential information

### Event data recorder

**Your vehicle has computers that monitor and control certain aspects of your vehicle. These computers assist in driving and maintaining optimal vehicle performance.**

Besides storing data useful for troubleshooting, there is an event data recorder (EDR) that records data in a crash or a near car crash event.

#### **In a crash or a near car crash event**

The SRS airbag sensor assembly contains the EDR. In a crash or a near car crash event, this device may record some or all of the following information:

- 1 Engine speed
- 1 Whether the brake pedal was applied or not
- 1 Vehicle speed
- 1 To what extent the accelerator pedal was depressed
- 1 Position of the transmission shift lever
- 1 Whether the driver and front passenger wore seat belts or not
- 1 Driver's seat position
- 1 SRS airbag deployment data
- 1 SRS airbag system diagnostic data
- 1 Front passenger's occupant classification

The information above is intended to be used for the purpose of improving vehicle safety performance. Unlike general data recorders, the EDR does not record sound data such as conversation between passengers.

**Disclosure of the data**

Toyota will not disclose the data recorded in an EDR to a third party except when:

- 1 An agreement from the vehicle's owner (or the leasing company for a leased vehicle) is obtained
- 1 Officially requested by the police or other authorities
- 1 Used as a defense for Toyota in a law suit
- 1 Ordered by a court of law

However, if necessary Toyota will:

- 1 Use the data for research on Toyota vehicle safety performance
- 1 Disclose the data to a third party for research purposes without disclosing details of the vehicle owner, and only when it is deemed necessary
- 1 Disclose summarized data cleared of vehicle identification information to a non-Toyota organization for research purposes

## 5-2. Steps to take in an emergency

### If a warning light turns on or a warning buzzer sounds...

**Calmly perform the following actions if any of the warning lights turn on or flash. If a light turns on or flashes, but then turns off, this does not necessarily indicate a malfunction in the system.**

**Stop the vehicle immediately. Continuing to drive the vehicle may be dangerous.**

The following warning indicates a possible problem in the brake system. Immediately stop the vehicle in a safe place and contact your Toyota dealer.



Warning light	Warning light/Details
	<p><b>Brake system warning light (warning buzzer)*</b></p> <ul style="list-style-type: none"><li>• Low brake fluid</li><li>• Malfunction in the brake system</li></ul> <p>This light also comes on when the parking brake is not released. If the light turns off after the parking brake is fully released, the system is operating normally.</p>

\*: Parking brake engaged warning buzzer:

The buzzer sounds to indicate that parking brake is still engaged (with the vehicle having reached a speed of 3 mph [5 km/h])

### Stop the vehicle immediately.

The following warnings indicate the possibility of damage to the vehicle that may lead to an accident. Immediately stop the vehicle in a safe place and contact your Toyota dealer.



Warning light	Warning light/Details
	<p><b>Charging system warning light</b> Indicates a malfunction in the vehicle's charging system.</p>
	<p><b>Low engine oil pressure warning light</b> Indicates that the engine oil pressure is too low*.</p>

\*: The light may come on when the oil level is extremely low. It is not designed to indicate low oil level, and the oil level must be checked using the engine oil level dipstick.

### Have the vehicle inspected immediately.





Failing to investigate the cause of the following warnings may lead to the system operating abnormally and possibly cause an accident. Have the vehicle inspected by your Toyota dealer immediately.

Warning light	Warning light/Details
	<p><b>Malfunction indicator lamp</b> Indicates a malfunction in:</p> <ul style="list-style-type: none"> <li>• The electronic engine control system;</li> <li>• The electronic throttle control system;</li> <li>• The electronic automatic transmission control system; or</li> <li>• Emission control system.</li> </ul>

Warning light	Warning light/Details
	<p><b>SRS warning light</b></p> <p>Indicates a malfunction in:</p> <ul style="list-style-type: none"> <li>• The SRS airbag system;</li> <li>• The front passenger occupant classification system;</li> <li>• The passenger airbag off switch (Access Cab models); or</li> <li>• The seat belt pretensioner system.</li> </ul>
<p><b>ABS</b> (U.S.A.)</p>  <p>(Canada)</p>	<p><b>ABS warning light</b></p> <p>Indicates a malfunction in:</p> <ul style="list-style-type: none"> <li>• The ABS; or</li> <li>• The brake assist system.</li> </ul>
	<p><b>Slip indicator light</b></p> <p>The indicator light comes on to indicate a malfunction in:</p> <ul style="list-style-type: none"> <li>• The VSC;</li> <li>• The TRAC;</li> <li>• The active traction control system (if equipped);</li> <li>• The AUTO LSD;</li> <li>• The downhill assist control system (if equipped); or</li> <li>• The hill-start assist control system (if equipped).</li> </ul>
<p><b>A/T OIL TEMP</b> (if equipped)</p>	<p><b>Automatic transmission fluid temperature warning light</b></p> <p>Indicates that the automatic transmission fluid temperature is too high.</p>

**Follow the correction procedures.**

After taking the specified steps to correct the suspected problem, check that the warning light turns off.

Warning light	Warning light/Details	Correction procedure
	<p><b>Open door warning light</b> Indicates that a door is not fully closed.</p>	<p>Check that all doors are closed.</p>
 (On the instrument cluster)	<p><b>Driver's seat belt reminder light (warning buzzer)<sup>*1</sup></b> Warns the driver to fasten his/her seat belt.</p>	<p>Fasten the seat belt.</p>
 (On the center panel)	<p><b>Front passenger's seat belt reminder light (warning buzzer)<sup>*2</sup></b> Warns the front passenger to fasten his/her seat belt.</p>	<p>Fasten the seat belt.</p>
	<p><b>Tire pressure warning light</b></p> <ul style="list-style-type: none"> <li>• When the light comes on: Low tire inflation pressure.</li> <li>• When the light stays on after blinking for 1 minute: Malfunction in the tire pressure warning system.</li> </ul>	<p>Adjust the tire inflation pressure.</p> <p>Have the system checked by your Toyota dealer.</p>
	<p><b>Low fuel level warning light</b> Low level of fuel.</p>	<p>Refuel the vehicle.</p>

Warning light	Warning light/Details	Correction procedure
 <p>MAINT REQD (U.S.A.)</p>	<p><b>Engine oil replacement reminder light</b></p> <ul style="list-style-type: none"> <li>• Illuminates for about 3 seconds and then flashes for about 12 seconds: Indicates that the engine oil is scheduled to be changed.</li> <li>• Comes on and remains: Indicates that the engine oil should be changed.</li> </ul>	<p>Check the engine oil, and change if necessary.</p> <p>Check and change the engine oil.</p>

\*1: Driver’s seat belt reminder:

The driver’s seat belt reminder sounds to alert the driver that his or her seat belt is not fastened. Once the engine switch is turned to the ON or START position, the buzzer sounds for 6 seconds. If the vehicle has reached a speed of at least 12 mph (20 km/h), the buzzer sounds intermittently for 10 seconds. Then, if the seat belt is still unfastened, the buzzer will sound in a different tone for 20 more seconds.

\*2: Front passenger’s seat belt reminder:

The front passenger’s seat belt reminder sounds to alert the front passenger that his or her seat belt is not fastened. The buzzer sounds intermittently for 10 seconds after the vehicle has reached a speed of at least 12 mph (20 km/h). Then, if the seat belt is still unfastened, the buzzer will sound in a different tone for 20 more seconds.

---

**n Key reminder buzzer**

The buzzer indicates that the key has not been removed (with the engine switch in the ACC or LOCK position and the driver's door opened).

**n If the malfunction indicator lamp comes on while driving**

First check the following:

- l Is your vehicle low on gas?  
If it is, refuel the vehicle immediately.
- l Is the fuel tank cap loose?  
If it is, tighten it securely.

The light will go off after taking several driving trips.

If the light does not go off even after several trips, contact your Toyota dealer as soon as possible.

**n Front passenger detection sensor and passenger seat belt reminder**

If luggage or other load is placed on the front passenger seat, depending on its weight, the reminder light to flash and buzzer to sound.

**n When the tire pressure warning light comes on**

Check the tire inflation pressure and adjust to the appropriate level. Pushing the tire pressure warning reset switch does not turn off the tire pressure warning light.

**n The tire pressure warning light may turn on due to natural causes**

The tire pressure warning light may turn on due to natural causes such as natural air leaks or tire inflation pressure changes caused by temperature. In this case, adjusting the tire inflation pressure will turn off the warning light (after a few minutes).

**n When a tire is replaced with a spare tire**

The temporary spare tire is not equipped with the tire pressure warning valve and transmitter. If a tire goes flat, the tire pressure warning light will not turn off even though the flat tire is replaced with the temporary spare tire. Replace the temporary spare tire with the repaired tire and adjust the proper tire inflation pressure. The tire pressure warning light will turn off after a few minutes.



### n **If the tire pressure warning system is inoperative**

The tire pressure warning system will be disabled in the following conditions:

(When the condition becomes normal, the system will work properly.)

- l If tires not equipped with tire pressure warning valves and transmitters are used.
- l If the ID code on the tire pressure warning valves and transmitters is not registered in the tire pressure warning computer.
- l If the tire inflation pressure is 73 psi (500 kPa, 5.1 kgf/cm<sup>2</sup> or bar) or higher.

The tire pressure warning system may be disabled in the following conditions:

(When the condition becomes normal, the system will work properly.)

- l If electronic devices or facilities using similar radio wave frequencies are nearby.
  - l If a radio set at similar frequencies is in use in the vehicle.
  - l If a window tint that affects the radio wave signals is installed.
  - l If there is a lot of snow or ice on the vehicle, in particular around the wheels or wheel housings.
  - l If non-genuine Toyota wheels are used. (Even if you use Toyota wheels, the tire pressure warning system may not work properly with some types of tires.)
  - l If tire chains are used.
- ### n **If the tire pressure warning light comes on after blinking for 1 minute frequently**

If the tire pressure warning light comes on after blinking for 1 minute frequently when the engine switch is turned to the ON position, have it checked by your Toyota dealer.

### n **After changing the engine oil (U.S.A. only)**

Make sure to reset the oil maintenance data. (→P. 361)

### n **Customization that can be configured at Toyota dealer**

The vehicle speed linked seat belt reminder buzzer can be disabled. (Customizable features →P. 493)

 **CAUTION**
**n If the tire pressure warning light comes on**

Be sure to observe the following precautions. Failure to do so could cause loss of vehicle control and result in death or serious injury.

- i** Stop your vehicle in a safe place as soon as possible. Adjust the tire inflation pressure immediately.
- i** If the tire pressure warning light comes on even after tire inflation pressure adjustment, it is probable that you have a flat tire. Check the tires. If the tire is flat, change to the spare tire and have the flat tire repaired by the nearest Toyota dealer.
- i** Avoid abrupt maneuvering and braking. If the vehicle tires deteriorate, you could lose control of the steering wheel or the brakes.

**n If a blowout or sudden air leakage should occur**

The tire pressure warning system may not activate immediately.

**n Maintenance of the tire**

Each tire, including the spare (if provided), should be checked monthly when cold and inflated to the inflation pressure recommended by the vehicle manufacturer on the vehicle placard or tire inflation pressure label (tire and load information label). (If your vehicle has tires of a different size than the size indicated on the vehicle placard or tire inflation pressure label [tire and load information label], you should determine the proper tire inflation pressure for those tires.)

As an added safety feature, your vehicle has been equipped with a tire pressure monitoring system (TPMS-tire pressure warning system) that illuminates a low tire pressure telltale (tire pressure warning light) when one or more of your tires is significantly under-inflated. Accordingly, when the low tire pressure telltale (tire pressure warning light) illuminates, you should stop and check your tires as soon as possible, and inflate them to the proper pressure. Driving on a significantly under-inflated tire causes the tire to overheat and can lead to tire failure. Under-inflation also reduces fuel efficiency and tire tread life, and may affect the vehicle's handling and stopping ability.

 CAUTION

Please note that the TPMS (tire pressure warning system) is not a substitute for proper tire maintenance, and it is the driver's responsibility to maintain correct tire pressure, even if under-inflation has not reached the level to trigger illumination of the TPMS low tire pressure telltale (tire pressure warning light).

Your vehicle has also been equipped with a TPMS (tire pressure warning system) malfunction indicator to indicate when the system is not operating properly. The TPMS (tire pressure warning system) malfunction indicator is combined with the low tire pressure telltale (tire pressure warning light). When the system detects a malfunction, the telltale will flash for approximately one minute and then remain continuously illuminated. This sequence will continue upon subsequent vehicle start-ups as long as the malfunction exists. When the malfunction indicator is illuminated, the system may not be able to detect or signal low tire pressure as intended.

TPMS (tire pressure warning system) malfunctions may occur for a variety of reasons, including the installation of replacement or alternate tires or wheels on the vehicle that prevent the TPMS (tire pressure warning system) from functioning properly. Always check the TPMS (tire pressure warning system) malfunction telltale after replacing one or more tires or wheels on your vehicle to ensure that the replacement or alternate tires and wheels allow the TPMS (tire pressure warning system) to continue to function properly.

 NOTICE

**n Precaution when installing a different tire**

When a tire of a different specification or maker is installed, the tire pressure warning system may not operate properly.

## 5-2. Steps to take in an emergency If you have a flat tire

**Remove the flat tire and replace it with the spare provided.**

**n Before jacking up the vehicle**

- 1 Stop the vehicle on a hard, flat surface.
- 1 Set the parking brake.
- 1 Shift the shift lever to P (automatic transmission) or R (manual transmission).
- 1 Stop the engine.
- 1 Turn on the emergency flashers.

**n Location of the spare tire**

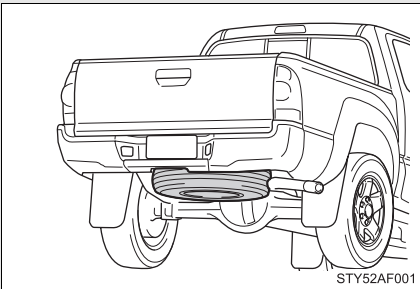

**n Location of the jack and tools**

► Regular Cab models

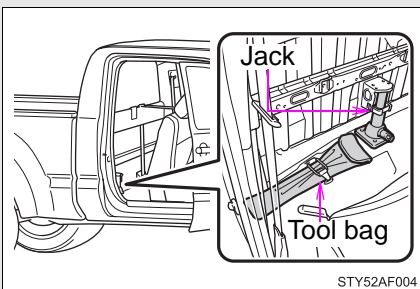

► Access Cab models

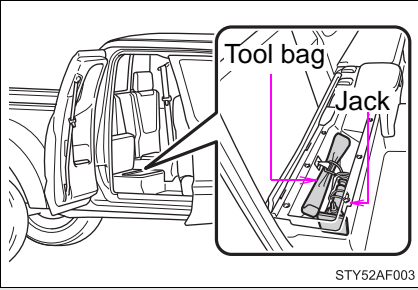

► Double Cab models

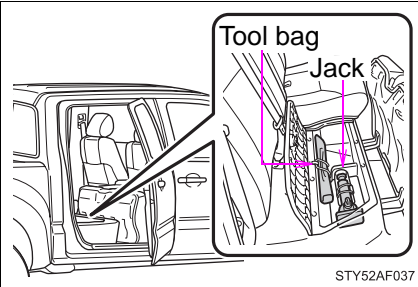

**Taking out the jack and tool bag**

► Regular Cab models

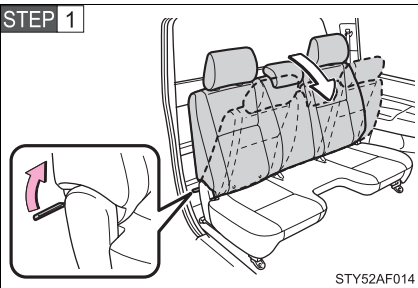

Pull the lever and fold down the seatback.

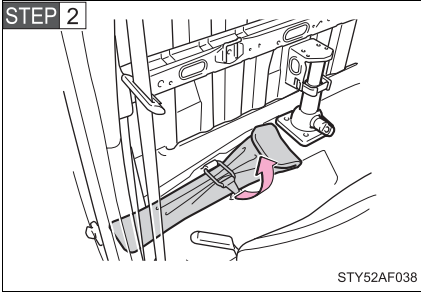

Unhook the strap and remove the tool bag.

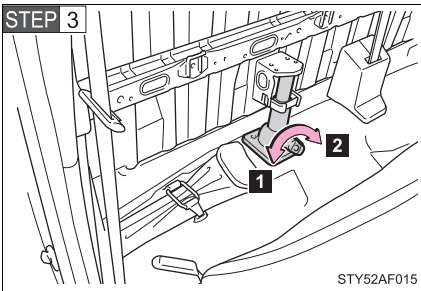

Loosen and remove the jack.

- 1 Loosen
- 2 Tighten

► Access Cab models

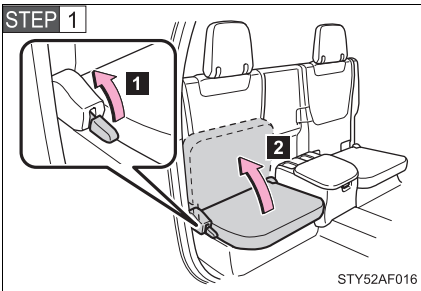

- 1 Pull up the lever
- 2 Raise the bottom cushion up.

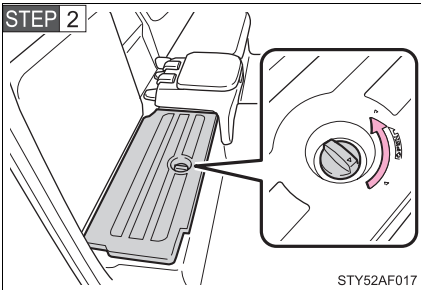

Turn the knob counterclockwise.

## 5-2. Steps to take in an emergency

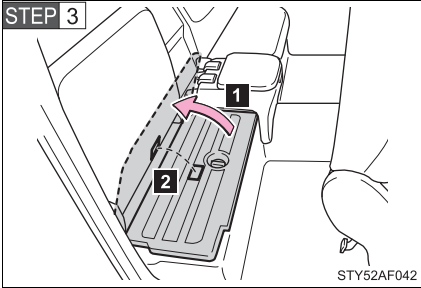

**1** Open the lid.

**2** Press the lid against the bottom of the lower cushion until it is supported by the hook-and-loop fastener.

Make sure that the lid is supported to prevent it from closing unexpectedly.

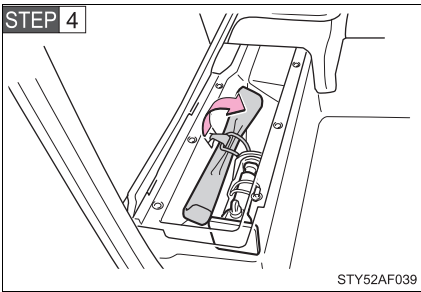

Unhook the strap and remove the tool bag.

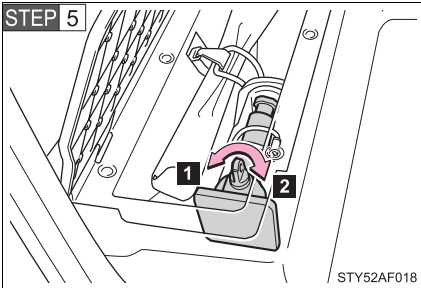

Loosen and remove the jack.

**1** Loosen

**2** Tighten

### ► Double Cab models

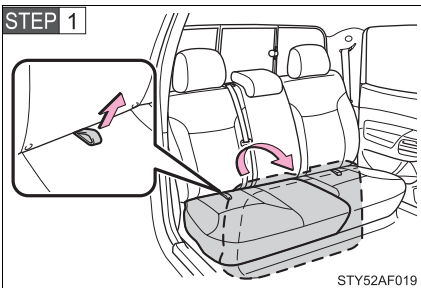

Swing the bottom cushion up by pulling the lock release strap.

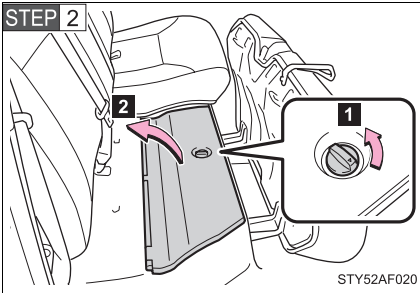

- 1 Turn the knob counterclockwise.
- 2 Open the lid.

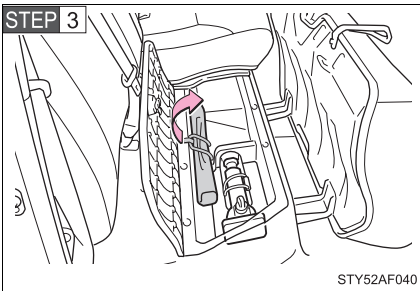

Unhook the strap and remove the tool bag.

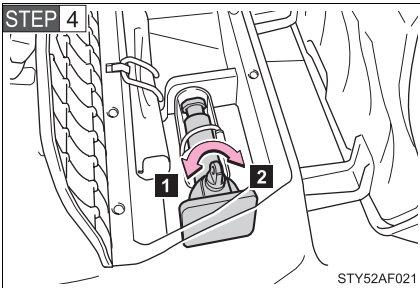

Loosen and remove the jack.

- 1 Loosen
- 2 Tighten



### Assemble the jack handle (in the tool bag)

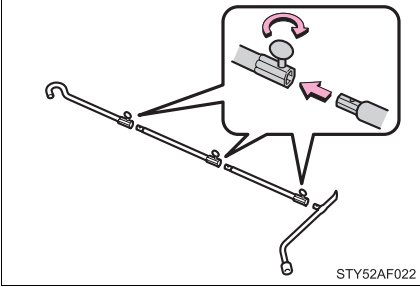

Assemble the jack handle extension as shown. Be sure to tighten each screw securely.

### Taking out the spare tire

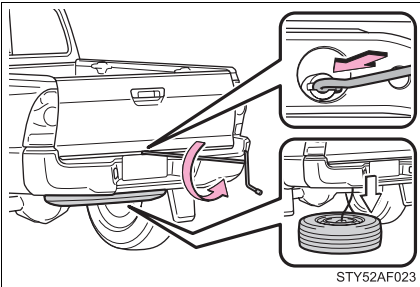

Insert the end of the jack handle extension into the lowering screw and turn it counterclockwise.

After the tire is lowered completely to the ground, remove the holding bracket.

**Replacing a flat tire**

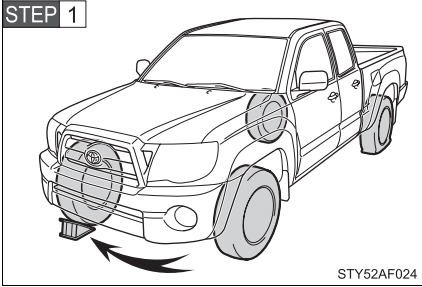

Chock the tires.

Flat tire		Wheel chock positions
Front	Left-hand side	Behind the rear right-hand side tire
	Right-hand side	Behind the rear left-hand side tire
Rear	Left-hand side	In front of the front right-hand side tire
	Right-hand side	In front of the front left-hand side tire

**STEP 2** Remove the wheel ornament using the wheel nut wrench as shown.

To protect the wheel and wheel ornament, place a rag between the wrench and the wheel ornament, as shown in the illustration.

► Type A

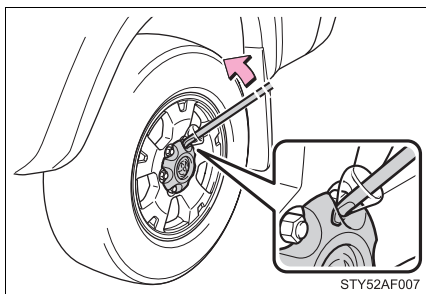

► Type B

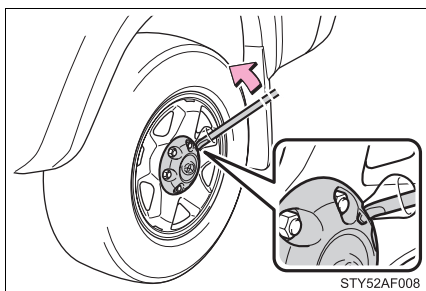

► Type C

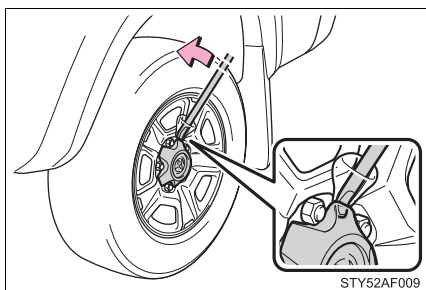

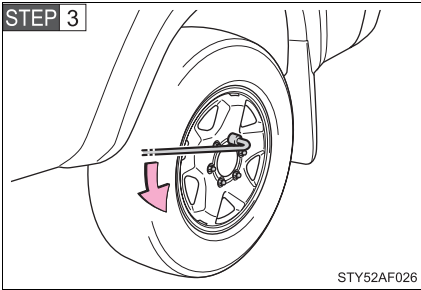

Slightly loosen the wheel nuts (one turn).

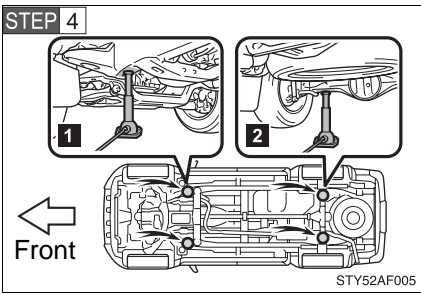

Position the jack at the correct jack point as shown.

- 1 Front
- 2 Rear

Make sure the jack is positioned on a level and solid place.

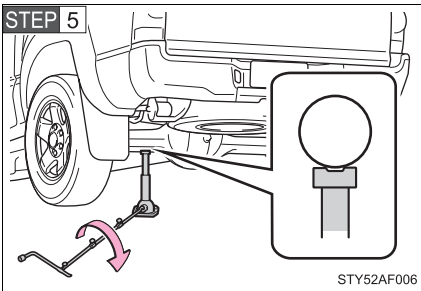

Raise the vehicle until the tire is slightly raised off the ground.

When positioning the jack under the rear axle housing, make sure the groove on the top of the jack fits with the rear axle housing.

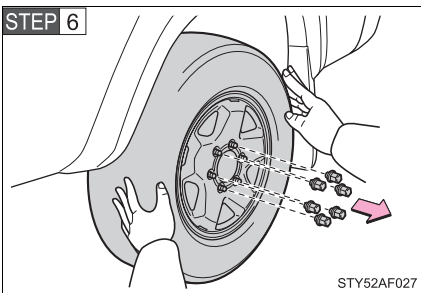

Remove all the wheel nuts and the tire.

When resting the tire on the ground, place the tire so that the wheel design faces up to avoid scratching the wheel surface.

## Installing the tire

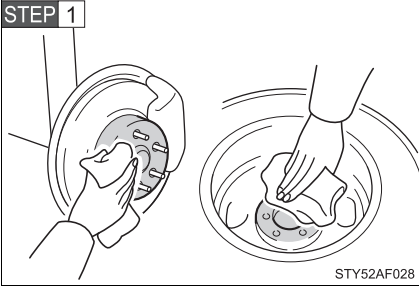

Remove any dirt or foreign matter from the wheel contact surface.

If foreign matter is on the wheel contact surface, the wheel nuts may loosen while the vehicle is in motion, and the tire may come off the vehicle.

**STEP 2** Install the tire and loosely tighten each wheel nut by hand by approximately the same amount.

► Replacing a steel wheel with a steel wheel

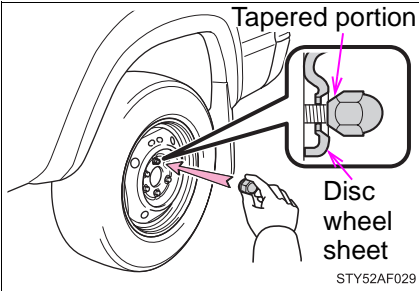

Tighten the nuts until the tapered portion comes into loose contact with the disc wheel sheet.

► Replacing an aluminum wheel with a steel wheel

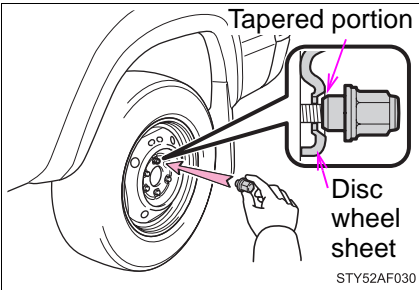

Tighten the nuts until the tapered portion comes into loose contact with the disc wheel sheet.

► Replacing an aluminum wheel with an aluminum wheel

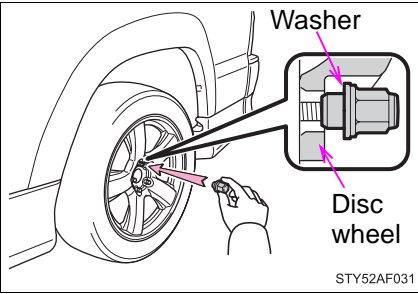

Tighten the nuts until the washer of the nut comes into loose contact with the disc wheel.

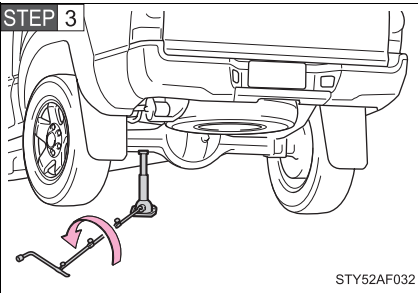

Lower the vehicle.

**STEP 4** Firmly tighten each nut two or three times in the order shown in the illustration.

**Tightening torque:**  
85 ft·lbf (113 N·m, 11.5 kgf·m)

► 2WD models except PreRunner

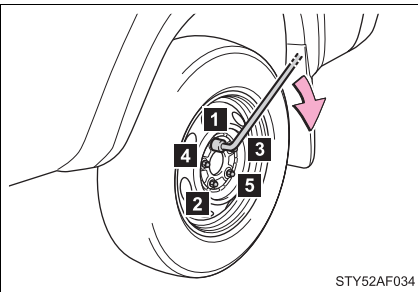

► 4WD models and PreRunner

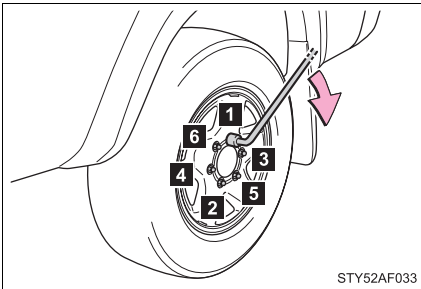

**Stowing the flat tire, jack and all tools**

**STEP 1** Lay down the tire with the outer side facing up, and install the holding bracket.

Then secure the tire, taking care that the tire goes straight up without catching on any other part, to prevent it from flying forward during a collision or sudden braking.  
Keep winding until three clicks are heard.

**STEP 2** Stow the tools and jack securely.

■ **After completing the tire change**

The tire pressure warning system must be reset. (→P. 374)

■ **When using the temporary spare tire**

As the temporary spare tire is not equipped with the tire pressure warning valve and transmitter, low inflation pressure of the spare tire will not be warned. Also, if you replace the temporary spare tire after the tire pressure warning light comes on, the light remains on.

 **CAUTION****n Using the jack**

Improper use of the jack may lead to death or injuries due to the vehicle suddenly falling off the jack.

- I Do not use the jack for any purpose other than replacing tires or installing and removing tire chains.
- I Only use the jack that comes with this vehicle for replacing a flat tire. Do not use it on other vehicles, and do not use other jacks for replacing tires on this vehicle.
- I Always check that the jack is securely set to the jack point.
- I Do not put any part of your body under the vehicle supported by a jack.
- I Do not start or run the engine while your vehicle is supported by the jack.
- I Do not raise the vehicle while someone is in it.
- I When raising the vehicle, do not put an object on or under the jack.
- I Do not raise the vehicle to a height greater than that required to replace the tire.
- I Use a jack stand if it is necessary to get under the vehicle.

Take particular care when lowering the vehicle to ensure that no one working on or near the vehicle will be injured.

**n Using the jack handle**

Tighten all the screws securely to prevent the extension parts from coming apart unexpectedly.

**n Replacing a flat tire**

Observe the following precautions to reduce the risk of death or serious injury.

- I Lower the spare tire completely to the ground before removing it from under the vehicle.
- I Do not try to remove the wheel ornament by hand. Take due care in handling the ornament to avoid unexpected personal injury.



 **CAUTION**

**n Replacing a flat tire**

- i** Never use oil or grease on the wheel bolts or wheel nuts.  
The oil or grease can cause the wheel nuts to loosen, causing a serious accident. Remove any oil or grease on the wheel bolts or wheel nuts.
- i** Have the wheel nuts tightened with a torque wrench to 85 ft·lbf (113 N·m, 11.5 kgf·m) as soon as possible after changing wheels.  
Failure to follow these precautions could cause the nuts to loosen and the wheels may fall off, which could lead to an accident causing death or serious injury.
- i** Do not attach a heavily damaged wheel ornament, as it may fly off the wheel while the vehicle is moving.

**n When using the temporary spare tire**

- i** Remember that your temporary spare tire is specifically designed for use with your vehicle. Do not use your temporary spare tire on another vehicle.
- i** Do not use two temporary spare tires simultaneously.
- i** Replace the temporary spare tire with a standard tire as soon as possible.
- i** Avoid sudden acceleration, deceleration and braking, as well as sharp cornering.

**n Speed limit when using the temporary spare tire**

Do not drive at speeds in excess of 50 mph (80 km/h) when a temporary spare tire is installed on the vehicle.

The temporary spare tire is not designed for driving at high speeds. Failing to observe this precaution may lead to an accident causing death or serious injury.

**n Driving with tire chains and the temporary spare tire**

Do not fit tire chains to the temporary spare tire.

Tire chains may damage the vehicle body and adversely affect driving performance.

 CAUTION**n When the spare tire is attached**

The vehicle speed may not be correctly detected, and the following systems may not operate correctly:

- | ABS & Brake assist
- | VSC
- | TRAC
- | Active traction control system (if equipped)
- | Hill-start assist control system (if equipped)
- | Downhill assist control system (if equipped)
- | AUTO LSD
- | Cruise control

Also, not only can the following system not be utilized fully, it may actually negatively effect the drive-train components:

- | 4WD system

 NOTICE

**n Do not drive the vehicle with a flat tire.**

Do not continue driving with a flat tire.

Driving even a short distance with a flat tire can damage the tire and the wheel beyond repair.

**n When stowing the flat tire**

Ensure that there is no object caught between the tire and the vehicle underbody.

**n When replacing the tires**

**I** When removing or fitting the wheels, tires or the tire pressure warning valve and transmitter, contact your Toyota dealer as the tire pressure warning valve and transmitter may be damaged if not handled correctly.

**I** Replace the grommets for the tire pressure warning valves and transmitters as well.

**n To avoid damaging the tire pressure warning valves and transmitters**

Do not use liquid sealants on flat tires.

## 5-2. Steps to take in an emergency If the engine will not start

**If the engine still does not start after following the correct starting procedure (→P. 138) or releasing the steering lock (→P. 139), confirm the following points.**

**n The engine will not start even when the starter motor operates normally.**

One of the following may be the cause of the problem.

- 1 There may not be sufficient fuel in the vehicle's tank.  
Refuel the vehicle.
- 1 The engine may be flooded.  
Try to restart the engine once more following correct starting procedures.
- 1 There may be a malfunction in the engine immobilizer system.  
(→P. 76)

**n The starter motor turns over slowly, the interior lights and headlights are dim, or the horn does not sound or sounds at a low volume.**

One of the following may be the cause of the problem.

- 1 The battery may be discharged. (→P. 452)
- 1 The battery terminal connections may be loose or corroded.

**n The starter motor does not turn over, the interior lights and headlights do not turn on, or the horn does not sound.**

One of the following may be the cause of the problem.

- 1 One or both of the battery terminals may be disconnected.
- 1 The battery may be discharged. (→P. 452)

Contact your Toyota dealer if the problem cannot be repaired, or if repair procedures are unknown.

## 5-2. Steps to take in an emergency

### If the shift lever cannot be shifted from P (if equipped)

If the shift lever cannot be shifted with your foot on the brake, there may be a problem with the shift lock system (a system to prevent accidental operation of the shift lever). Have the vehicle inspected by your Toyota dealer immediately.

The following steps may be used as an emergency measure to ensure that the shift lever can be shifted.

**STEP 1** Set the parking brake.

**STEP 2** Turn the engine switch to the ACC or ON position.

**STEP 3** Depress the brake pedal.

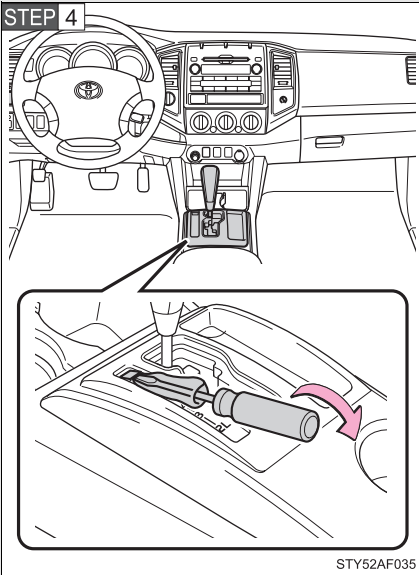

Pry the cover up with a flat-head screwdriver or equivalent.

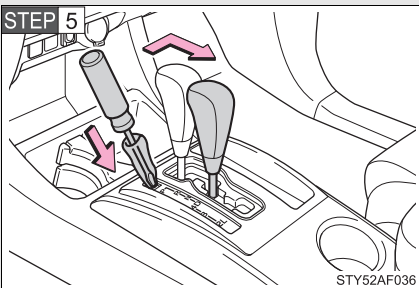

Press the shift lock override button.

The shift lever can be shifted while the button is pressed.

## If you lose your keys

**New genuine Toyota keys can be made by your Toyota dealer using the key number stamped on your key number plate. Vehicles with engine immobilizer system, the dealer will also need the master key. (→P. 30)**

---

**n If you lose all your master keys. (vehicles with engine immobilizer system)**

You cannot make new keys; the whole engine immobilizer system must be replaced.

## 5-2. Steps to take in an emergency

### If the vehicle battery is discharged

The following procedures may be used to start the engine if the vehicle's battery is discharged.

You can call your Toyota dealer or qualified repair shop.

If you have a set of jumper (or booster) cables and a second vehicle with a 12-volt battery, you can jump start your Toyota following the steps below.

**STEP 1** Connect the jumper cables.

► 2.7 L 4-cylinder (2TR-FE) engine

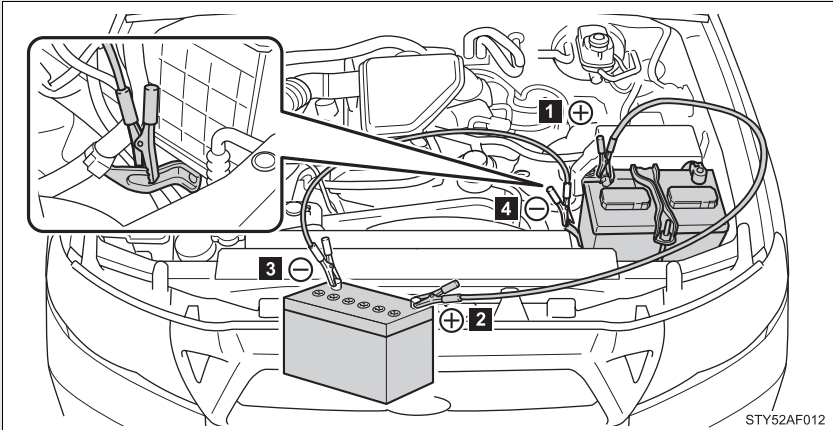

## ► 4.0 L V6 (1GR-FE) engine

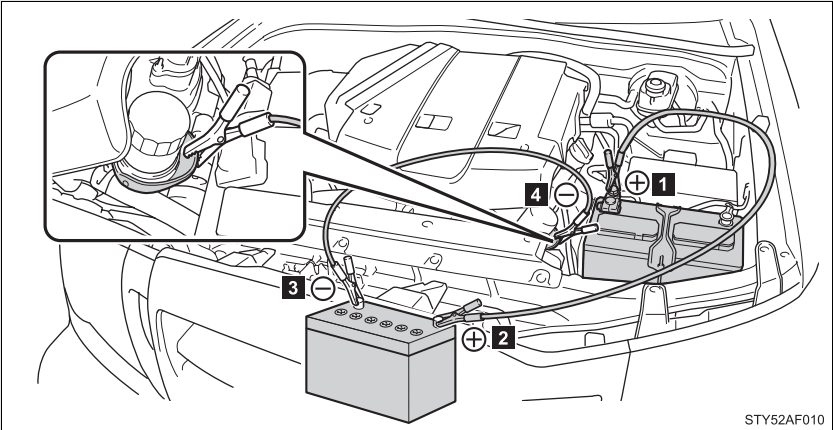

- 1** Positive (+) battery terminal on your vehicle
  - 2** Positive (+) battery terminal on the second vehicle
  - 3** Negative (-) battery terminal on the second vehicle
  - 4** Connect the jumper cable to ground on your vehicle as shown in the illustration.
- STEP 2** Start the engine of the second vehicle. Increase the engine speed slightly and maintain at that level for approximately 5 minutes to recharge the battery of your vehicle.
- STEP 3** Maintain the engine speed of the second vehicle and start the vehicle's engine.
- STEP 4** Once the vehicle's engine has started, remove the jumper cables in the exact reverse order in which they were connected.

Once the engine starts, have the vehicle checked at your Toyota dealer as soon as possible.



### n **Starting the engine when the battery is discharged (vehicles with an automatic transmission)**

The engine cannot be started by push-starting.

### n **Avoiding a discharged battery**

- I Turn off the headlights and the audio system while the engine is turned off.
- I Turn off any unnecessary electrical components when the vehicle is running at a low speed for an extended period, such as in heavy traffic, etc.

## CAUTION

### n **Avoiding battery fires or explosions**

Observe the following precautions to prevent accidentally igniting the flammable gas that may be emitted from the battery.

- I Make sure the jumper cable is connected to the correct terminal and that it is not unintentionally in contact with any part other than the intended terminal.
- I Do not allow the jumper cables to come into contact with the “+” and “-” terminals.
- I Do not smoke, use matches, cigarette lighters or allow open flame near the battery.

### n **Battery precautions**

The battery contains poisonous and corrosive acidic electrolyte, while related parts contain lead and lead compounds. Observe the following precautions when handling the battery.

- I When working with the battery, always wear safety glasses and take care not to allow any battery fluids (acid) to come into contact with skin, clothing or the vehicle body.
- I Do not lean over the battery.
- I In the event that battery fluid comes into contact with the skin or eyes, immediately wash the affected area with water and seek medical attention. Place a wet sponge or cloth over the affected area until medical attention can be received.

 **CAUTION****n Battery precautions**

- I** Always wash your hands after handling the battery support, terminals, and other battery-related parts.
- I** Do not allow children near the battery.

 **NOTICE****n To prevent damaging the vehicle (vehicles with a manual transmission)**

Do not pull- or push-start the vehicle, because the three-way catalytic converter may overheat and become a fire hazard.

**n When handling jumper cables**

Be careful that the jumper cables do not become tangled in the cooling fan or any of the belts when connecting or disconnecting them.

## 5-2. Steps to take in an emergency If your vehicle overheats

### **If your engine overheats:**

**STEP 1** Stop the vehicle in a safe place and turn off the air conditioning system.

**STEP 2** Check to see if steam is coming out from under the hood.

If you see steam:

Stop the engine. Carefully lift the hood after the steam subsides and then restart the engine.

If you do not see steam:

Leave the engine running and carefully lift the hood.

**STEP 3** Check to see if the cooling fan is operating.

If the fan is operating:

Wait until the temperature of the engine (shown on the instrument cluster) begins to fall and then stop the engine.

If the fan is not operating:

Stop the engine immediately and call your local Toyota dealer.

## STEP 4

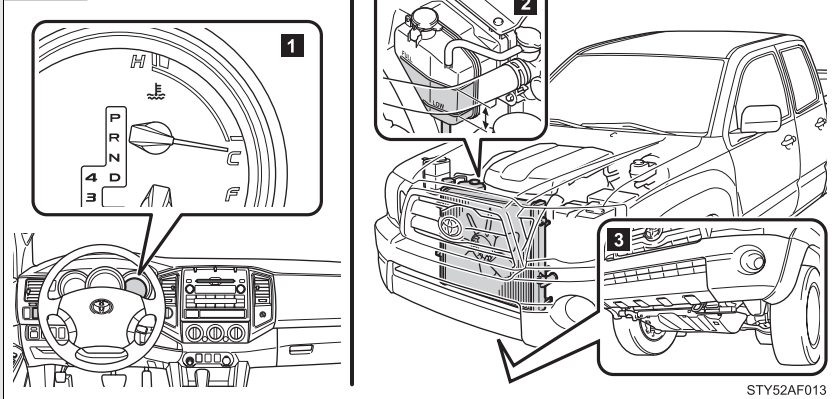

STY52AF013

- 1** The engine has cooled down sufficiently.

The engine coolant temperature gauge indicates C.

- 2** Check the engine coolant level.

- 3** Look for obvious coolant leaks from the radiator, hoses and under the vehicle.

Note that water draining from the air conditioning is normal if it has been used.

## STEP 5

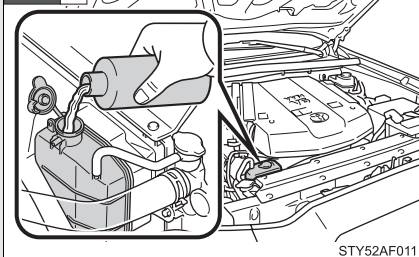

STY52AF011

Add engine coolant if required.

Water can be used in an emergency if engine coolant is unavailable. (→P. 470)

Have the vehicle checked at your nearest Toyota dealer as soon as possible.

---

**n Overheating**

If you observe the following, your vehicle may be overheating.

- 1 The engine coolant temperature gauge enters the red zone or a loss of power is experienced.
- 1 Steam is coming from under the hood.

 **CAUTION**

**n To prevent an accident or injury when inspecting under the hood of your vehicle**

- 1 If steam is seen coming from under the hood, do not open the hood until the steam has subsided. The engine compartment may be very hot, causing serious injury such as burns.
- 1 Keep hands and clothing away from the fan and other belts while the engine is running.
- 1 Do not loosen the radiator cap while the engine and radiator are hot. Serious injury, such as burns, may result from hot coolant and steam released under pressure.

 **NOTICE**

**n When adding engine coolant**

Wait until the engine has cooled down before adding engine coolant. When adding coolant, do so slowly. Adding cool coolant to a hot engine too quickly can cause damage to the engine.

## 5-2. Steps to take in an emergency If the vehicle becomes stuck

**Carry out the following procedures if the tires spin or the vehicle becomes stuck in mud, dirt, or snow.**

- STEP 1** Stop the engine. Set the parking brake and put the shift lever in P (vehicles with an automatic transmission) or N (vehicles with a manual transmission).
- STEP 2** Remove the mud, snow, or sand from around the stuck tire.
- STEP 3** Place wood, stones or some other material to help provide traction under the tires.
- STEP 4** Restart the engine.
- STEP 5** Turn off the VSC (→P. 186)
- STEP 6** Shift the shift lever to D or R (automatic transmission) or 1 or R (manual transmission) and carefully apply the accelerator to free the vehicle.

### CAUTION

#### **n When attempting to free a stuck vehicle**

If you choose to rock the vehicle back and forth to free it, make sure the surrounding area is clear, to avoid striking other vehicles, objects or persons. The vehicle may also lunge forward or lunge back suddenly as it becomes free. Use extreme caution.

#### **n When shifting the shift lever**

Vehicles with an automatic transmission: Be careful not to shift the shift lever with the accelerator pedal depressed.

This may lead to unexpected rapid acceleration of the vehicle that may cause an accident and result in death or serious injury.



## NOTICE

### **n To avoid damaging the transmission and other components**

- l** Avoid spinning the wheels and do not rev the engine.
- l** If the vehicle remains stuck after trying these procedures, the vehicle may require towing to be freed.

## 6-1. Specifications

### Maintenance data (fuel, oil level, etc.)

#### Dimensions

##### ► 2WD models except PreRunner

Cab type	Regular Cab	Access Cab	
		Except X-Runner	X-Runner
Overall length	190.4 in. (4835 mm)	208.1 in. (5285 mm)	
Overall width	72.2 in. (1835 mm)		74.0 in. (1880 mm)
Overall height*	65.8 in. (1670 mm)	66.1 in. (1680 mm)	65.6 in. (1665 mm)
Wheelbase	109.6 in. (2785 mm)	127.4 in. (3235 mm)	
Front tread	61.0 in. (1550 mm)		62.2 in. (1580 mm)
Rear tread	61.0 in. (1550 mm)		62.2 in. (1580 mm)

\*: Unladen vehicle

##### ► 4WD models and PreRunner

Cab type	Regular Cab	Access Cab
Overall length	190.4 in. (4835 mm)	208.1 in. (5285 mm)
Overall width	74.6 in. (1895 mm)	
Overall height*	69.9 in. (1775 mm)	70.3 in. (1785 mm)
Wheelbase	109.6 in. (2785 mm)	127.4 in. (3235 mm)
Front tread	63.0 in. (1600 mm)	
Rear tread	63.4 in. (1610 mm)	

\*: Unladen vehicle



Cab type	Double Cab	
	With short deck	With long deck
Overall length	208.1 in. (5285 mm)	221.3 in. (5620 mm)
Overall width	74.6 in. (1895 mm)	
Overall height*	70.1 in. (1780 mm)	
Wheelbase	127.4 in. (3235 mm)	140.6 in. (3570 mm)
Front tread	63.0 in. (1600 mm)	
Rear tread	63.4 in. (1610 mm)	

\*: Unladen vehicle

### Vehicle capacity weight

► 2WD models except PreRunner

Cab type	Engine	Deck type	Vehicle capacity weight (Occupant + luggage)*
Regular Cab	2.7 L 4-cylinder (2TR-FE) engine	Long deck	1250 lb. (567 kg)
Access Cab	2.7 L 4-cylinder (2TR-FE) engine		1200 lb. (544 kg)
	4.0 L V6 (1GR-FE) engine		850 lb. (386 kg)

\*: Installing accessories in addition to those installed at the factory increases vehicle weight, thereby reducing vehicle capacity weight. Contact your Toyota dealer about the weight of accessory parts.

## ► PreRunner

Cab type	Engine	Deck type	Vehicle capacity weight (Occupant + luggage)*
Regular Cab	2.7 L 4-cylinder (2TR-FE) engine	Long deck	1300 lb. (590 kg)
Access Cab	2.7 L 4-cylinder (2TR-FE) engine		
	4.0 L V6 (1GR-FE) engine		
Double Cab	4.0 L V6 (1GR-FE) engine	Short deck	
		Long deck	

\*: Installing accessories in addition to those installed at the factory increases vehicle weight, thereby reducing vehicle capacity weight. Contact your Toyota dealer about the weight of accessory parts.

## ► 4WD models

Cab type	Engine	Deck type	Vehicle capacity weight (Occupant + luggage)*
Regular Cab	2.7 L 4-cylinder (2TR-FE) engine	Long deck	1300 lb. (590 kg)
Access Cab	2.7 L 4-cylinder (2TR-FE) engine		
	4.0 L V6 (1GR-FE) engine		1205 lb. (547 kg)
Double Cab	4.0 L V6 (1GR-FE) engine	Short deck	1200 lb. (544 kg)
		Long deck	1100 lb. (498 kg)

\*: Installing accessories in addition to those installed at the factory increases vehicle weight, thereby reducing vehicle capacity weight. Contact your Toyota dealer about the weight of accessory parts.

## Towing capacity

Towing capacity  
(Trailer weight + cargo)

- ▶ Without towing package  
3500 lb. (1587 kg)
- ▶ With towing package  
6500 lb. (2948 kg)

## Vehicle identification

### n Vehicle identification number

The vehicle identification number (VIN) is the legal identifier for your vehicle. This is the primary identification number for your Toyota. It is used in registering the ownership of your vehicle.

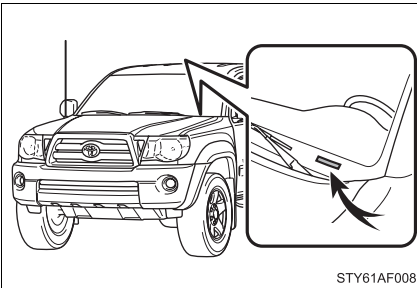

This number is stamped on the top left of the instrument panel.

### ▶ Regular Cab and Double Cab models

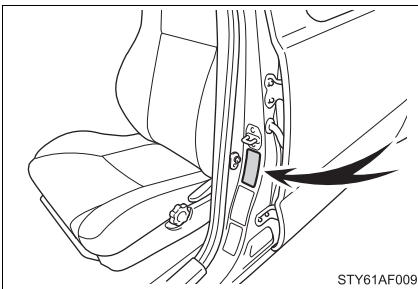

This number is also on the Certification Label.

► Access Cab models

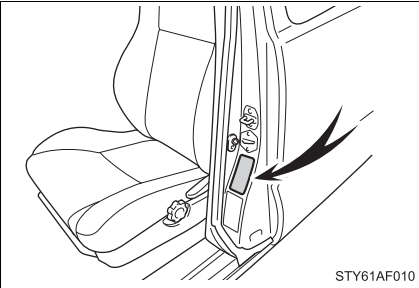

This number is also on the Certification Label.

n **Engine number**

The engine number is stamped on the engine block as shown.

► 2.7 L 4-cylinder (2TR-FE) engine

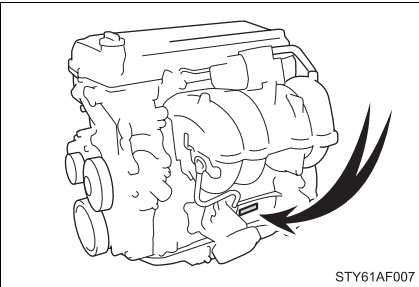

► 4.0 L V6 (1GR-FE) engine

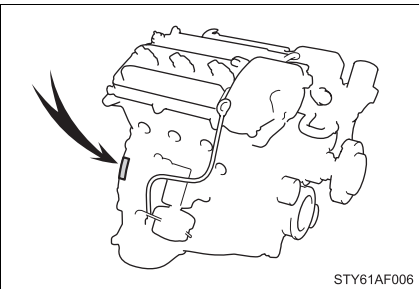

**Engine**

## ▶ 2.7 L 4-cylinder (2TR-FE) engine

Model	2TR-FE
Type	4-cylinder in line, 4-cycle, gasoline
Bore and stroke	3.74 × 3.74 in. (95.0 × 95.0 mm)
Displacement	164.3 cu.in. (2694 cm <sup>3</sup> )
Drive belt tension	Automatic adjustment
Valve clearance (engine cold) Intake Exhaust	Automatic adjustment

## ▶ 4.0 L V6 (1GR-FE) engine

Model	1GR-FE
Type	6-cylinder V type, 4-cycle, gasoline
Bore and stroke	3.70 × 3.74 in. (94.0 × 95.0 mm)
Displacement	241.4 cu.in. (3956 cm <sup>3</sup> )
Drive belt tension	Automatic adjustment
Valve clearance (engine cold) Intake Exhaust	0.006 — 0.010 in. (0.15 — 0.25 mm) 0.011 — 0.015 in. (0.29 — 0.39 mm)

**Fuel**

Fuel type	Unleaded gasoline only
Octane rating	87 (Research octane number 91) or higher
Fuel tank capacity (Reference)	21.1 gal. (80.0 L, 17.6 Imp.gal.)

**Lubrication system**

▶ 2.7 L 4-cylinder (2TR-FE) engine

<p>Oil capacity drain and refill (Reference)</p> <p>▶ With filter</p> <p>▶ Without filter</p>	<p>6.1 qt. (5.8 L, 5.1 Imp.qt.)</p> <p>5.4 qt. (5.1 L, 4.5 Imp.qt.)</p>
<p>Oil grade</p>	<p>ILSAC multigrade engine oil</p>
<p>Recommended oil viscosity</p>	<p>Use Toyota approved "Toyota Genuine Motor Oil" or equivalent to satisfy the grade and viscosity shown below.</p> <div data-bbox="469 699 896 987" style="border: 1px solid black; padding: 10px; text-align: center;"> <p>°F -20 0 20 40 60 80 100</p> <p>°C -29 -18 -7 4 16 27 38</p> <p>Outside temperature</p> <p>STYOT00113</p> </div>

Oil viscosity

- 1 The 0W portion of the oil viscosity rating indicates the characteristic of the oil which allows cold startability. Oils with a lower value before the W allow for easier starting of the engine in cold weather.
- 1 The 20 in 0W-20 indicates the oil viscosity when the oil is at its operating temperature. An oil with a higher viscosity may be better suited if the vehicle is operated at high speeds, or under extreme load condition.

## ▶ 4.0 L V6 (1GR-FE) engine

<p>Oil capacity drain and refill (Reference)</p> <p>▶ 2WD models except PreRunner</p> <p>▶ 4WD models and PreRunner</p>	<p>▶ With filter 4.8 qt. (4.5 L, 4.0 Imp.qt.)</p> <p>▶ Without filter 4.4 qt. (4.2 L, 3.7 Imp.qt.)</p> <p>▶ With filter 5.5 qt. (5.2 L, 4.6 Imp.qt.)</p> <p>▶ Without filter 5.2 qt. (4.9 L, 4.3 Imp.qt.)</p>
<p>Oil grade</p>	<p>ILSAC multigrade engine oil</p>
<p>Recommended oil viscosity</p>	<p>Use Toyota approved "Toyota Genuine Motor Oil" or equivalent to satisfy the grade and viscosity shown below.</p> <div data-bbox="501 781 928 1068" style="text-align: center;"> <p style="text-align: center;">Outside temperature</p> <p style="text-align: right; font-size: small;">STYOT00111</p> </div>

\*: 5W-30 is an oil that provides optimal levels of fuel efficiency.

### Oil viscosity

- 1 The 5W portion of the oil viscosity rating indicates the characteristic of the oil which allows cold startability. Oils with a lower value before the W allow for easier starting of the engine in cold weather.
- 1 The 30 in 5W-30 indicates the oil viscosity when the oil is at its operating temperature. An oil with a higher viscosity may be better suited if the vehicle is operated at high speeds, or under extreme load condition.

### Cooling system

<p>Capacity</p> <ul style="list-style-type: none"> <li>▶ 2.7 L 4-cylinder (2TR-FE) engine</li> <li>▶ 4.0 L V6 (1GR-FE) engine</li> </ul>	<ul style="list-style-type: none"> <li>▶ Vehicles with an automatic transmission 9.1 qt. (8.6 L, 7.6 Imp.qt.)</li> <li>▶ Vehicles with a manual transmission 9.1 qt. (8.7 L, 7.6 Imp.qt.)</li> <li>▶ Vehicles with an automatic transmission 10.1 qt. (9.6 L, 8.5 Imp.qt.)</li> <li>▶ Vehicles with a manual transmission 10.3 qt. (9.7 L, 8.5 Imp.qt.)</li> </ul>
<p>Coolant type</p>	<p>Use either of the following.</p> <ul style="list-style-type: none"> <li>• “Toyota Super Long Life Coolant”</li> <li>• Similar high-quality ethylene glycol-based non-silicate, non-amine, non-nitrite, and non-borate coolant with long-life hybrid organic acid technology</li> </ul> <p>Do not use plain water alone.</p>

### Ignition system

<p>Spark plug</p> <ul style="list-style-type: none"> <li>▶ 2.7 L 4-cylinder (2TR-FE) engine</li> </ul> <p>Make       DENSO</p> <p>              NGK</p> <p>Gap</p> <ul style="list-style-type: none"> <li>▶ 4.0 L V6 (1GR-FE) engine</li> </ul> <p>Make       DENSO</p> <p>              NGK</p> <p>Gap</p>	<p>SK20HR11</p> <p>ILFR6C11</p> <p>0.043 in. (1.1 mm)</p> <p>K20HR-U11</p> <p>LFR6C11</p> <p>0.043 in. (1.1 mm)</p>
---	---

 NOTICE

**n Iridium-tipped spark plugs (2.7 L 4-cylinder [2TR-FE] engine only)**

Use only iridium-tipped spark plugs. Do not adjust gap when tuning engine.



## Electrical system

Battery	
Open voltage at 68°F (20°C):	12.6 — 12.8 V Fully charged 12.2 — 12.4 V Half charged 11.8 — 12.0 V Discharged (Voltage checked 20 minutes after the key is removed with all the lights turned off)
Charging rates	5 A max.

## Differential

Oil capacity	Front (4WD models)	1.59 qt. (1.50 L, 1.32 Imp.qt.)
	Rear	<ul style="list-style-type: none"> <li>▶ 2WD models except PreRunner 3.66 qt. (3.46 L, 3.04 Imp.qt.)</li> <li>▶ 4WD models and PreRunner 3.12 qt. (2.95 L, 2.60 Imp.qt.)</li> </ul>
Oil type and viscosity		<p>Toyota Genuine Differential Gear Oil LT 75W-85 GL-5 or equivalent</p> <p>“Toyota Genuine Differential Gear Oil” is filled in your Toyota vehicle at factory fill. Use Toyota approved “Toyota Genuine Differential Gear Oil” or an equivalent of matching quality to satisfy the above specification. Please contact your Toyota dealer for further details.</p>

## Automatic transmission

### ▶ 4-speed models

Fluid capacity (Drain and refill)	2.9 qt. (2.7 L, 2.4 Imp.qt.)
Fluid type	Toyota Genuine ATF Type T-IV

### ▶ 5-speed models

Fluid capacity *	11.5 qt. (10.9 L, 9.6 Imp.qt.)
Fluid type	Toyota Genuine ATF WS

\*: The fluid capacity is the quantity of reference. If replacement is necessary, contact your Toyota dealer.

### NOTICE

#### **n Automatic transmission fluid type (4-speed models)**

Using automatic transmission fluid other than “Toyota Genuine ATF Type T-IV” may cause deterioration in shift quality, locking up of your transmission accompanied by vibration, and ultimately damage the automatic transmission of your vehicle.

#### **n Automatic transmission fluid type (5-speed models)**

Using automatic transmission fluid other than “Toyota Genuine ATF WS” may cause deterioration in shift quality, locking up of your transmission accompanied by vibration, and ultimately damage the automatic transmission of your vehicle.

**Manual transmission**

Gear oil capacity (Reference) ▶ 2.7 L 4-cylinder (2TR-FE) engine	▶ 2WD models 2.7 qt. (2.6 L, 2.3 Imp.qt.)
▶ 4.0 L V6 (1GR-FE) engine	▶ 4WD models 2.3 qt. (2.2 L, 1.9 Imp.qt.) 1.9 qt. (1.8 L, 1.6 Imp.qt.)
Gear oil type	Gear oil API GL-4 or GL-5
Recommended gear oil viscosity	SAE 75W-90

**Clutch**

Clutch free play	0.2 — 0.6 in. (5 — 15 mm)
Fluid type	FMVSS No. 116 DOT 3 or SAE J1703

**Transfer (4WD models)**

Oil capacity	1.1 qt. (1.0 L, 0.9 Imp.qt.)
Oil type	Gear oil API GL-4 or GL-5
Recommended oil viscosity	SAE 75W-90

## Brakes

Pedal clearance <sup>*1</sup> ▶ 2WD models except PreRunner ▶ PreRunner ▶ 4WD models	4.3 in. (110 mm)  4.2 in. (106 mm) ▶ Without off-road package 4.2 in. (106 mm) ▶ With off-road package 3.4 in. (88 mm)
Pedal free play	0.04 — 0.24 in. (1 — 6 mm)
Brake pad wear limit	0.04 in. (1.0 mm)
Brake lining wear limit	0.04 in. (1.0 mm)
Parking brake pedal travel <sup>*2</sup> (pedal type)	7 — 10 clicks
Parking brake lever travel <sup>*3</sup> (lever type)	7 — 10 clicks
Fluid type	FMVSS No. 116 DOT 3 or SAE J1703

\*1: Minimum pedal clearance when depressed with a force of 110 lbf (490 N, 50 kgf) with the engine running.

\*2: Parking brake pedal travel when depressed with a force of 67.4 lbf (300 N, 30.6 kgf).

\*3: Parking brake lever travel when pulled with a force of 44.9 lbf (200 N, 20.4 kgf).

### Chassis lubrication

Propeller shafts Spider	Lithium base chassis grease, NLGI No.2
Slide yoke	Molybdenum — disulfide lithium base chassis grease, NLGI No.2 or lithium base chassis grease, NLGI No.2

### Steering

Free play	Less than 1.2 in. (30 mm)
Power steering fluid type	Automatic transmission fluid DEXRON® II or III

### Tires and wheels

#### ► Type A

Tire size	P215/70R15 97S
Tire inflation pressure (Recommended cold tire inflation pressure)	<p>Front tires: 30 psi (210 kPa, 2.1 kgf/cm<sup>2</sup> or bar)</p> <p>Rear tires: 33 psi (230 kPa, 2.3 kgf/cm<sup>2</sup> or bar)</p> <p>Spare tire*: 33 psi (230 kPa, 2.3 kgf/cm<sup>2</sup> or bar)</p> <p>Driving at high speeds above 100 mph (160 km/h) (in countries where such speeds are permitted by law) Add 3 psi (20 kPa, 0.2 kgf/cm<sup>2</sup> or bar) to the front tires and rear tires. Never exceed the maximum cold tire inflation pressure indicated on the tire sidewall.</p>
Wheel size	15 × 6 J, 15 × 6 JJ
Wheel nut torque	85 ft·lbf (113 N·m, 11.5 kgf·m)

\*: If you affix the spare tire to a front position, please make sure to adjust the tire to the correct inflation pressure as soon as possible.

## ► Type B

Tire size	P245/75R16 109S
Tire inflation pressure (Recommended cold tire inflation pressure)	<p>Front tires: 30 psi (210 kPa, 2.1 kgf/cm<sup>2</sup> or bar)</p> <p>Rear tires: 30 psi (210 kPa, 2.1 kgf/cm<sup>2</sup> or bar)</p> <p>Spare tire: 30 psi (210 kPa, 2.1 kgf/cm<sup>2</sup> or bar)</p> <p>Driving at high speeds above 100 mph (160 km/h) (in countries where such speeds are permitted by law) Add 3 psi (20 kPa, 0.2 kgf/cm<sup>2</sup> or bar) to the front tires and rear tires. Never exceed the maximum cold tire inflation pressure indicated on the tire sidewall.</p>
Wheel size	16 × 7 J, 16 × 7 JJ
Wheel nut torque	85 ft·lbf (113 N·m, 11.5 kgf·m)

## ► Type C

Tire size	P265/70R16 111T
Tire inflation pressure (Recommended cold tire inflation pressure)	<p>Front tires: 29 psi (200 kPa, 2.0 kgf/cm<sup>2</sup> or bar)</p> <p>Rear tires: 32 psi (220 kPa, 2.2 kgf/cm<sup>2</sup> or bar)</p> <p>Spare tire*: 32 psi (220 kPa, 2.2 kgf/cm<sup>2</sup> or bar)</p> <p>Driving at high speeds above 100 mph (160 km/h) (in countries where such speeds are permitted by law) Add 3 psi (20 kPa, 0.2 kgf/cm<sup>2</sup> or bar) to the front tires and rear tires. Never exceed the maximum cold tire inflation pressure indicated on the tire sidewall.</p>
Wheel size	16 × 7 JJ
Wheel nut torque	85 ft·lbf (113 N·m, 11.5 kgf·m)

\*: If you affix the spare tire to a front position, please make sure to adjust the tire to the correct inflation pressure as soon as possible.

## ► Type D

Tire size	P265/65R17 110S
Tire inflation pressure (Recommended cold tire inflation pressure)	<p>Front tires: 29 psi (200 kPa, 2.0 kgf/cm<sup>2</sup> or bar)</p> <p>Rear tires: 29 psi (200 kPa, 2.0 kgf/cm<sup>2</sup> or bar)</p> <p>Spare tire: 29 psi (200 kPa, 2.0 kgf/cm<sup>2</sup> or bar)</p> <p>Driving at high speeds above 100 mph (160 km/h) (in countries where such speeds are permitted by law) Add 3 psi (20 kPa, 0.2 kgf/cm<sup>2</sup> or bar) to the front tires and rear tires. Never exceed the maximum cold tire inflation pressure indicated on the tire sidewall.</p>
Wheel size	17 × 7 1/2 JJ
Wheel nut torque	85 ft-lbf (113 N·m, 11.5 kgf·m)

## ► Type E

Tire size	P255/45R18 99V
Tire inflation pressure (Recommended cold tire inflation pressure)	<p>Front tires: 35 psi (240 kPa, 2.4 kgf/cm<sup>2</sup> or bar)</p> <p>Rear tires: 35 psi (240 kPa, 2.4 kgf/cm<sup>2</sup> or bar)</p> <p>Spare tire: 35 psi (240 kPa, 2.4 kgf/cm<sup>2</sup> or bar)</p> <p>Driving at high speeds above 100 mph (160 km/h) (in countries where such speeds are permitted by law) Add 4 psi (30 kPa, 0.3 kgf/cm<sup>2</sup> or bar) to the front tires and rear tires. Never exceed the maximum cold tire inflation pressure indicated on the tire sidewall.</p>
Wheel size	18 × 8 JJ
Wheel nut torque	85 ft-lbf (113 N·m, 11.5 kgf·m)

<b>Light bulbs</b>
--------------------

	Light Bulbs	Bulb No.	W	Type
Exterior	Headlights	—	60/55	A
	Front fog lights	9145	42	B
	Parking and front side marker lights	—	5	D
	Front turn signal lights	4157 NAK	27/8	D
	Rear turn signal lights	3157A	27/8	D
	Back-up lights	921	18	C
	License plate lights	168	5	C
Interior	High mounted stoplight	168	5	C
	Interior light	—	5	E
	Personal lights	168	5	C

A: HB2 halogen bulbs

B: H10 halogen bulbs

C: Wedge base bulbs (clear)

D: Wedge base bulbs (amber)

E: Double end bulbs



**Your vehicle must use only unleaded gasoline.**

**Unleaded gasoline with an Octane Rating of 87 (Research Octane Number 91) or higher required for optimum engine performance.**

At minimum, the gasoline you use should meet the specifications of ASTM D4814 in the U.S.A. and CGSB3.5-M93 in Canada.

---

n **Fuel tank opening for unleaded gasoline**

To help prevent incorrect fueling, your Toyota has a fuel tank opening that only accommodates the special nozzle on unleaded fuel pumps.

n **If your engine knocks**

l Consult your Toyota dealer.

l You may occasionally notice light knocking for a short time while accelerating or driving uphill. This is normal and there is no need for concern.

n **Gasoline quality**

In very few cases, driveability problems may be caused by the brand of gasoline you are using. If driveability problems persist, try changing the brand of gasoline. If this does not correct the problem, consult your Toyota dealer.

n **Gasoline quality standards**

l Automotive manufacturers in the US, Europe and Japan have developed a specification for fuel quality called World-Wide Fuel Charter (WWFC) that is expected to be applied worldwide.

l The WWFC consists of four categories that are based on required emission levels. In the US, category 4 has been adopted.

l The WWFC improves air quality by lowering emissions in vehicle fleets, and customer satisfaction through better performance.

▮ **Toyota recommends the use of gasoline containing detergent additives**

- ▮ Toyota recommends the use of gasoline that contains detergent additives to avoid build-up of engine deposits.
- ▮ All gasoline sold in the US contains detergent additives to clean and/or keep clean intake systems.

▮ **Toyota recommends the use of cleaner burning gasoline**

Cleaner burning gasoline, including reformulated gasoline that contains oxygenates such as ethanol or MTBE (Methyl Tertiary Butyl Ether) is available in many areas.

Toyota recommends the use of cleaner burning gasoline and appropriately blended reformulated gasoline. These types of gasoline provide excellent vehicle performance, reduce vehicle emissions and improve air quality.

▮ **Toyota does not recommend blended gasoline**

- ▮ Toyota allows the use of oxygenate blended gasoline where the oxygenate content is up to 10% ethanol or 15% MTBE.
- ▮ If you use gasohol in your Toyota, be sure that it has an octane rating no lower than 87.
- ▮ Toyota does not recommend the use of gasoline containing methanol.

▮ **Toyota does not recommend gasoline containing MMT**

Some gasoline contains octane enhancing additive called MMT (Methylcyclopentadienyl Manganese Tricarbonyl).

Toyota does not recommend the use of gasoline that contains MMT. If fuel containing MMT is used, your emission control system may be adversely affected.

The malfunction indicator lamp on the instrument cluster may come on. If this happens, contact your Toyota dealer for service.

 NOTICE**n Notice on gasoline quality**

**I** Do not use leaded gasoline.

Leaded gasoline can cause damage to your vehicle's three-way catalytic converters causing the emission control system to malfunction.

**I** Do not use gasohol other than that stated here.

Other gasohol may cause fuel system damage or vehicle performance problems.

**I** Use of unleaded gasoline with an Octane rating lower than 87 may result in engine knocking. Persistent knocking can lead to engine damage.

**n Fuel-related poor driveability**

If after using a different type of fuel, poor driveability is encountered (poor hot starting, vaporization, engine knocking, etc.), discontinue the use of that type of fuel.

**n When refueling with gasohol**

Take care not to spill gasohol.

It can damage your vehicle's paint.

## 6-1. Specifications

### Tire information

#### Typical tire symbols

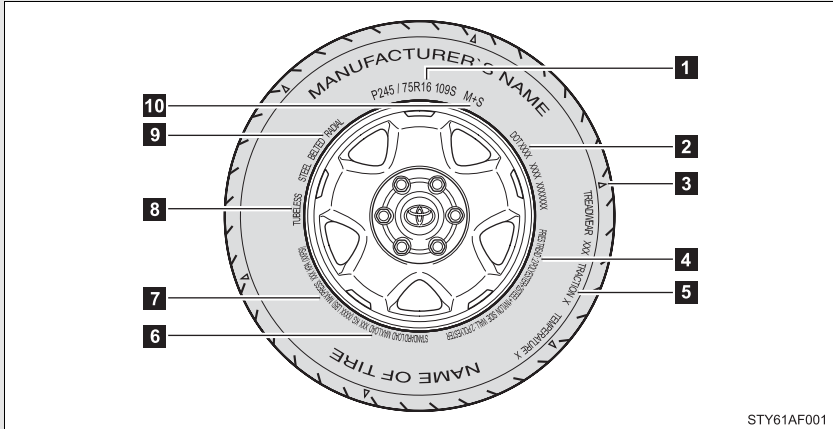

STY61AF001

**1** Tire size (→P. 484)

**2** DOT and Tire Identification Number (TIN) (→P. 483)

**3** Location of treadwear indicators (→P. 373)

**4** Tire ply composition and materials

Ply is layers of rubber-coated parallel cords. Cords are the strands which form the plies in a tire.

**5** Uniform tire quality grading

For details, see “Uniform tire quality grading” that follows.

**6** Load limit at maximum cold tire inflation pressure (→P. 487)

**7** Maximum cold tire inflation pressure (→P. 487)

This means the pressure to which a tire may be inflated.

**8** TUBELESS or TUBE TYPE

A tubeless tire does not have a tube and air is directly filled in the tire. A tube type tire has a tube inside the tire and the tube maintains the air pressure.

**9** Radial tires or bias-ply tires

A radial tire has RADIAL on the sidewall. A tire not marked RADIAL is a bias-ply tire.

**10** Summer tire or all season tire (→P. 377)

An all season tire has M+S on the sidewall. A tire not marked M+S is a summer tire.

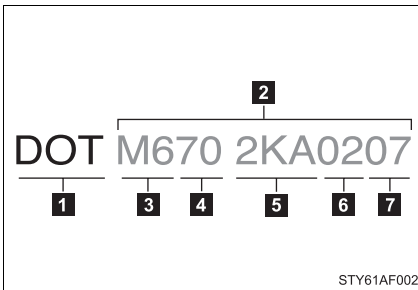
**Typical DOT and tire identification number (TIN)****1** DOT symbol\***2** Tire Identification Number (TIN)**3** Tire manufacturer's identification mark**4** Tire size code**5** Manufacturer's optional tire type code (3 or 4 letters)**6** Manufacturing week**7** Manufacturing year

\*:The DOT symbol certifies that the tire conforms to applicable Federal Motor Vehicle Safety Standards.

## Tire size

### n Typical tire size information

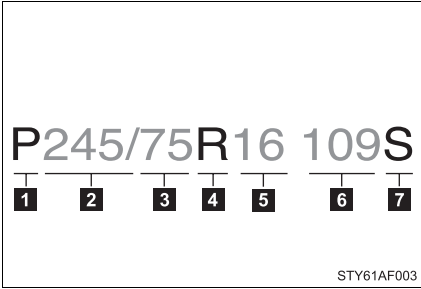

The illustration indicates typical tire size.

- 1** Tire use  
(P = Passenger car,  
T = Temporary use)
- 2** Section width (millimeters)
- 3** Aspect ratio  
(tire height to section width)
- 4** Tire construction code  
(R = Radial, D = Diagonal)
- 5** Wheel diameter (inches)
- 6** Load index (2 digits or 3 digits)
- 7** Speed symbol  
(alphabet with one letter)

### n Tire dimensions

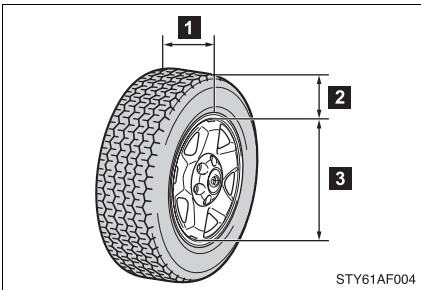

- 1** Section width
- 2** Tire height
- 3** Wheel diameter

## Tire section names

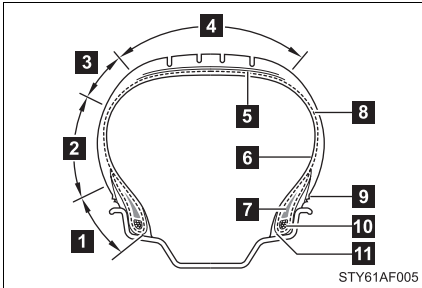

- 1** Bead
- 2** Sidewall
- 3** Shoulder
- 4** Tread
- 5** Belt
- 6** Inner liner
- 7** Reinforcing rubber
- 8** Carcass
- 9** Rim lines
- 10** Bead wires
- 11** Chafer

## Uniform tire quality grading

This information has been prepared in accordance with regulations issued by the National Highway Traffic Safety Administration of the U.S.A. Department of Transportation.

It provides the purchasers and/or prospective purchasers of Toyota vehicles with information on uniform tire quality grading.

Your Toyota dealer will help answer any questions you may have as you read this information.

### n DOT quality grades

All passenger vehicle tires must conform to Federal Safety Requirements in addition to these grades. Quality grades can be found where applicable on the tire sidewall between tread shoulder and maximum section width.

For example: Treadwear 200 Traction AA Temperature A

n **Treadwear**

The treadwear grade is a comparative rating based on the wear rate of the tire when tested under controlled conditions on a specified government test course.

For example, a tire graded 150 would wear one and a half (1 - 1/2) times as well on the government course as a tire graded 100.

The relative performance of tires depends upon the actual conditions of their use, however, and may depart significantly from the norm due to variations in driving habits, service practices and differences in road characteristics and climate.

n **Traction AA, A, B, C**

The traction grades, from highest to lowest, are AA, A, B and C, and they represent the tire's ability to stop on wet pavement as measured under controlled conditions on specified government test surfaces of asphalt and concrete.

A tire marked C may have poor traction performance.

Warning: The traction grade assigned to this tire is based on braking (straight ahead) traction tests and does not include cornering (turning) traction.

n **Temperature A, B, C**

The temperature grades are A (the highest), B, and C, representing the tire's resistance to the generation of heat and its ability to dissipate heat when tested under controlled conditions on a specified indoor laboratory test wheel.

Sustained high temperature can cause the material of the tire to degenerate and reduce tire life, and excessive temperature can lead to sudden tire failure.

The grade C corresponds to a level of performance which all passenger car tires must meet under the Federal Motor Vehicle Safety Standard No. 109.

Grades B and A represent higher levels of performance on the laboratory test wheel than the minimum required by law.



Warning: The temperature grades for this tire are established for a tire that is properly inflated and not overloaded.

Excessive speed, underinflation, or excessive loading, either separately or in combination, can cause heat buildup and possible tire failure.

### Glossary of tire terminology

Tire related term	Meaning
Cold tire inflation pressure	Tire pressure when the vehicle has been parked for three hours or more, or has not been driven more than 1 mile or 1.5 km under that condition
Maximum inflation pressure	The maximum cold inflated pressure to which a tire may be inflated, shown on the sidewall of the tire
Recommended inflation pressure	Cold tire inflation pressure recommended by a manufacturer
Accessory weight	The combined weight (in excess of those standard items which may be replaced) of transmission, power steering, power brakes, power windows, power seats, radio and heater, to the extent that these items are available as factory-installed equipment (whether installed or not)
Curb weight	The weight of a motor vehicle with standard equipment, including the maximum capacity of fuel, oil and coolant, and if so equipped, air conditioning and additional weight optional engine
Maximum loaded vehicle weight	The sum of: (a) Curb weight (b) Accessory weight (c) Vehicle capacity weight (d) Production options weight

Tire related term	Meaning
Normal occupant weight	150 lb. (68 kg) times the number of occupants specified in the second column of Table 1* that follows
Occupant distribution	Distribution of occupants in a vehicle as specified in the third column of Table 1* below
Production options weight	The combined weight of installed regular production options weighing over 5 lb. (2.3 kg) in excess of the standard items which they replace, not previously considered in curb weight or accessory weight, including heavy duty brakes, ride levelers, roof rack, heavy duty battery, and special trim
Rim	A metal support for a tire or a tire and tube assembly upon which the tire beads are seated
Rim diameter (Wheel diameter)	Nominal diameter of the bead seat
Rim size designation	Rim diameter and width
Rim type designation	The industry manufacturer's designation for a rim by style or code
Rim width	Nominal distance between rim flanges
Vehicle capacity weight (Total load capacity)	The rated cargo and luggage load plus 150 lb. (68 kg) times the vehicle's designated seating capacity
Vehicle maximum load on the tire	The load on an individual tire that is determined by distributing to each axle its share of the maximum loaded vehicle weight, and dividing by two
Vehicle normal load on the tire	The load on an individual tire that is determined by distributing to each axle its share of curb weight, accessory weight, and normal occupant weight (distributed in accordance with Table 1* below), and dividing it by two

Tire related term	Meaning
Weather side	The surface area of the rim not covered by the inflated tire
Bead	The part of the tire that is made of steel wires, wrapped or reinforced by ply cords and that is shaped to fit the rim
Bead separation	A breakdown of the bond between components in the bead
Bias ply tire	A pneumatic tire in which the ply cords that extend to the beads are laid at alternate angles substantially less than 90 degrees to the centerline of the tread
Carcass	The tire structure, except tread and sidewall rubber which, when inflated, bears the load
Chunking	The breaking away of pieces of the tread or sidewall
Cord	The strands forming the plies in the tire
Cord separation	The parting of cords from adjacent rubber compounds
Cracking	Any parting within the tread, sidewall, or innerliner of the tire extending to cord material
CT	A pneumatic tire with an inverted flange tire and rim system in which the rim is designed with rim flanges pointed radially inward and the tire is designed to fit on the underside of the rim in a manner that encloses the rim flanges inside the air cavity of the tire
Extra load tire	A tire designed to operate at higher loads and at higher inflation pressures than the corresponding standard tire
Groove	The space between two adjacent tread ribs
Innerliner	The layer(s) forming the inside surface of a tubeless tire that contains the inflating medium within the tire

Tire related term	Meaning
Innerliner separation	The parting of the innerliner from cord material in the carcass
Intended outboard sidewall	(a)The sidewall that contains a whitewall, bears white lettering, or bears manufacturer, brand, and/or model name molding that is higher or deeper than the same molding on the other sidewall of the tire, or (b)The outward facing sidewall of asymmetrical tire that has a particular side that must always face outward when mounted on a vehicle
Light truck (LT) tire	A tire designated by its manufacturer as primarily intended for use on lightweight trucks or multipurpose passenger vehicles
Load rating	The maximum load that a tire is rated to carry for a given inflation pressure
Maximum load rating	The load rating for a tire at the maximum permissible inflation pressure for that tire
Maximum permissible inflation pressure	The maximum cold inflation pressure to which a tire may be inflated
Measuring rim	The rim on which a tire is fitted for physical dimension requirements
Open splice	Any parting at any junction of tread, sidewall, or innerliner that extends to cord material
Outer diameter	The overall diameter of an inflated new tire
Overall width	The linear distance between the exteriors of the sidewalls of an inflated tire, including elevations due to labeling, decorations, or protective bands or ribs
Passenger car tire	A tire intended for use on passenger cars, multipurpose passenger vehicles, and trucks, that have a gross vehicle weight rating (GVWR) of 10,000 lb. or less

Tire related term	Meaning
Ply	A layer of rubber-coated parallel cords
Ply separation	A parting of rubber compound between adjacent plies
Pneumatic tire	A mechanical device made of rubber, chemicals, fabric and steel or other materials, that, when mounted on an automotive wheel, provides the traction and contains the gas or fluid that sustains the load
Radial ply tire	A pneumatic tire in which the ply cords that extend to the beads are laid at substantially 90 degrees to the centerline of the tread
Reinforced tire	A tire designed to operate at higher loads and at higher inflation pressures than the corresponding standard tire
Section width	The linear distance between the exteriors of the sidewalls of an inflated tire, excluding elevations due to labeling, decoration, or protective bands
Sidewall	That portion of a tire between the tread and bead
Sidewall separation	The parting of the rubber compound from the cord material in the sidewall
Snow tire	A tire that attains a traction index equal to or greater than 110, compared to the ASTM E-1136 Standard Reference Test Tire, when using the snow traction test as described in ASTM F-1805-00, Standard Test Method for Single Wheel Driving Traction in a Straight Line on Snow-and Ice-Covered Surfaces, and which is marked with an Alpine Symbol (  ) on at least one sidewall
Test rim	The rim on which a tire is fitted for testing, and may be any rim listed as appropriate for use with that tire

Tire related term	Meaning
Tread	That portion of a tire that comes into contact with the road
Tread rib	A tread section running circumferentially around a tire
Tread separation	Pulling away of the tread from the tire carcass
Treadwear indicators(TWI)	The projections within the principal grooves designed to give a visual indication of the degrees of wear of the tread
Wheel-holding fixture	The fixture used to hold the wheel and tire assembly securely during testing

\*:Table 1 — Occupant loading and distribution for vehicle normal load for various designated seating capacities

Designated seating capacity, Number of occupants	Vehicle normal load, Number of occupants	Occupant distribution in a normally loaded vehicle
2 through 4	2	2 in front
5 through 10	3	2 in front, 1 in second seat
11 through 15	5	2 in front, 1 in second seat, 1 in third seat, 1 in fourth seat
16 through 20	7	2 in front, 2 in second seat, 2 in third seat, 1 in fourth seat

## Customizable features

**Your vehicle includes a variety of electronic features that can be personalized to your preferences. Programming these preferences requires specialized equipment and may be performed by an authorized Toyota dealership.**

Some function settings are changed simultaneously with other functions being customized. Contact your Toyota dealer for further details.

Item	Function	Default setting	Customized setting
Wireless remote control (→P. 32)	Operation signal (Buzzer)	ON	OFF
Seat Belt Reminder Buzzer (→P. 427)	Vehicle speed linked seat belt reminder buzzer	ON	OFF

## Items to initialize

**The following items must be initialized for normal system operation in cases such as after the battery is reconnected, or maintenance is performed on the vehicle.**

Item	When to initialize	Reference
Engine oil maintenance data	After changing engine oil	P. 361
Tire pressure warning system	<ul style="list-style-type: none"> <li>• When rotating the tires on vehicles differing with front and rear tire inflation pressures.</li> <li>• When changing the tire inflation pressure by changing traveling speed or load weight, etc.</li> <li>• When changing the tire size.</li> </ul>	P. 374



## Reporting safety defects for U.S. owners

If you believe that your vehicle has a defect which could cause a crash or could cause injury or death, you should immediately inform the National Highway Traffic Safety Administration (NHTSA) in addition to notifying Toyota Motor Sales, U.S.A., Inc. (Toll-free: 1-800-331-4331).

If NHTSA receives similar complaints, it may open an investigation, and if it finds that a safety defect exists in a group of vehicles, it may order a recall and remedy campaign. However, NHTSA cannot become involved in individual problems between you, your dealer, or Toyota Motor Sales, U.S.A., Inc.

To contact NHTSA, you may call the Vehicle Safety Hotline toll-free at 1-888-327-4236 (TTY: 1-800-424-9153); go to <http://www.safercar.gov>; or write to: Administrator, NHTSA, 1200 New Jersey Ave, S.E., Washington, DC 20590. You can also obtain other information about motor vehicle safety from <http://www.safercar.gov>.

## Seat belt instructions for Canadian owners (in French)

The following is a French explanation of seat belt instructions extracted from the seat belt section in this manual.

See the seat belt section for more detailed seat belt instructions in English.

### Utilisation correcte des ceintures de sécurité

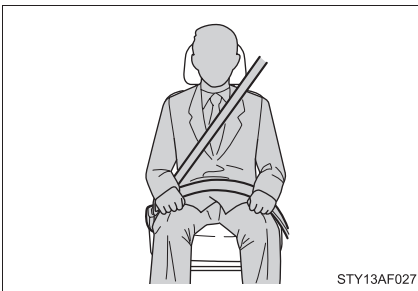

- Tirez sur la ceinture épaulière jusqu'à ce qu'elle recouvre entièrement l'épaule; elle ne doit cependant pas toucher le cou ni glisser de l'épaule.
- Placez la sangle abdominale de la ceinture de sécurité le plus bas possible sur les hanches.
- Réglez la position du dossier du siège. Tenez-vous assis dans le fond du siège, le dos droit.
- Ne tournez pas la ceinture de sécurité.

## Entretien et soins

### ■ Ceintures de sécurité

Avec un tissu ou une éponge, nettoyez à l'aide d'un savon doux et de l'eau tiède. Vérifiez aussi les ceintures régulièrement pour vous assurer qu'elles ne présentent pas d'usure excessive, d'effilochage ou de coupures.

### ATTENTION

#### ■ Dommages et usure de la ceinture de sécurité

Vérifiez périodiquement le système de ceintures de sécurité. Assurez-vous qu'il n'y a pas de coupures, d'effilochures ni de pièces desserrées. N'utilisez pas une ceinture de sécurité endommagée avant qu'elle soit remplacée. Des ceintures de sécurité endommagées ne peuvent pas protéger les occupants contre les blessures.

# Camper information

This information has been prepared in accordance with regulation issued by the National Highway Traffic Safety Administration of the U.S. Department of Transportation. It provides the purchasers and/or prospective purchasers of Toyota vehicles with information on truck-camper loading. Your Toyota dealer will help answer any questions you may have as you read this information.

## Center of gravity location

The figures given in the illustration indicate the recommended center of gravity zone.

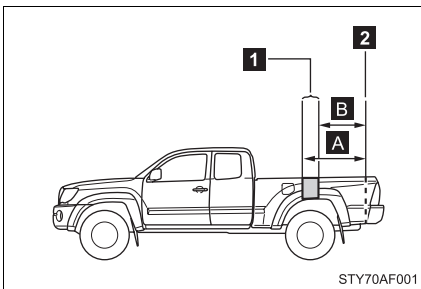

**1** Recommended location for cargo center of gravity for cargo weight rating

**2** Rear end of truck bed

	<b>A</b>	<b>B</b>
Regular Cab models	49.9 in. (1267 mm)	36.1 in. (917 mm)
Access Cab models ▶ Except X-Runner ▶ X-Runner*	49.9 in. (1267 mm) —	36.1 in. (917 mm) —
Double Cab models ▶ With short deck ▶ With long deck	45.6 in. (1157 mm) 35.9 in. (911 mm)	31.8 in. (807 mm) 27.8 in. (706 mm)

\*: Truck-campers cannot be used with the X-Runner since it is not designed for them.

## ⚠ CAUTION

### n Loading precaution

If a load is too far back, it can cause dangerous handling. If it is too far forward, the front axle may be overloaded.

## Cargo weight rating and proper matching

When the truck is used to carry a slide-in camper, the total cargo load of the truck consists of the manufacturer's camper weight figure, the weight of installed additional camper equipment not included in the manufacturer's camper weight figure, the weight of camper cargo, and the weight of passengers in the camper.

The total cargo load should not exceed the truck's cargo weight rating and the camper's center of gravity should fall within the truck's recommended center of gravity zone when installed.

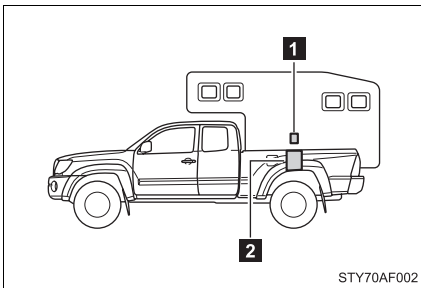

- 1 Camper center of gravity
- 2 Recommended center of gravity location zone

### n Cargo weight rating

#### ► Regular Cab models

2 people, 2TR-FE engine, 2WD except PreRunner: 950 lb. (430 kg)

3 people, 2TR-FE engine, 2WD except PreRunner: 800 lb. (362 kg)

2 people, 2TR-FE engine, PreRunner: 1000 lb. (453 kg)

3 people, 2TR-FE engine, PreRunner: 850 lb. (385 kg)

2 people, 2TR-FE engine, 4WD:	1000 lb. (453 kg)
3 people, 2TR-FE engine, 4WD:	850 lb. (385 kg)

► Access Cab models

2 people, 2TR-FE engine, 2WD except PreRunner:	900 lb. (408 kg)
4 people, 2TR-FE engine, 2WD except PreRunner:	600 lb. (272 kg)
2 people, 2TR-FE engine, PreRunner:	1000 lb. (453 kg)
4 people, 2TR-FE engine, PreRunner:	700 lb. (317 kg)
2 people, 1GR-FE engine, PreRunner:	1000 lb. (453 kg)
4 people, 1GR-FE engine, PreRunner:	700 lb. (317 kg)
2 people, 2TR-FE engine, 4WD:	1000 lb. (453 kg)
4 people, 2TR-FE engine, 4WD:	700 lb. (317 kg)
2 people, 1GR-FE engine, 4WD:	905 lb. (410 kg)
4 people, 1GR-FE engine, 4WD:	605 lb. (274 kg)

► Double Cab models with short deck

2 people, 1GR-FE engine, PreRunner:	1000 lb. (453 kg)
5 people, 1GR-FE engine, PreRunner:	550 lb. (249 kg)
2 people, 1GR-FE engine, 4WD:	900 lb. (408 kg)
5 people, 1GR-FE engine, 4WD:	450 lb. (204 kg)

► Double Cab models with long deck

2 people, 1GR-FE engine, PreRunner:	1000 lb. (453 kg)
5 people, 1GR-FE engine, PreRunner:	550 lb. (249 kg)
2 people, 1GR-FE engine, 4WD:	800 lb. (363 kg)
5 people, 1GR-FE engine, 4WD:	350 lb. (159 kg)

 CAUTION

**n Overloading**

Be careful — overloading can cause dangerous braking and handling problems, and can damage your vehicle and its tires.

## Gross axle and vehicle weight ratings

Secure loose items to prevent weight shifts that could affect the balance of your vehicle. When the truck camper is loaded, drive to a scale and weigh on the front and on the rear wheels separately to determine axle loads. Individual axle loads should not exceed either of the Gross Axle Weight Ratings (GAWR). The total of the axle loads should not exceed the Gross Vehicle Weight Rating (GVWR). These ratings are given on the vehicle certification label which is located on the door latch post on the left side of the vehicle. (→P. 465) If weight ratings are exceeded, move or remove items to bring all weights below the ratings.

### ► Gross axle weight rating

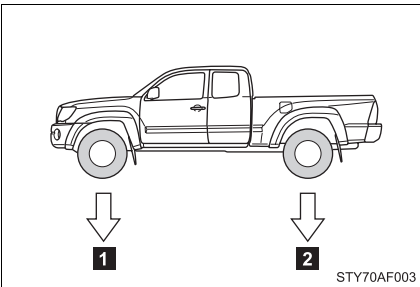

**1** Front GAWR

**2** Rear GAWR

### ► Gross vehicle weight rating

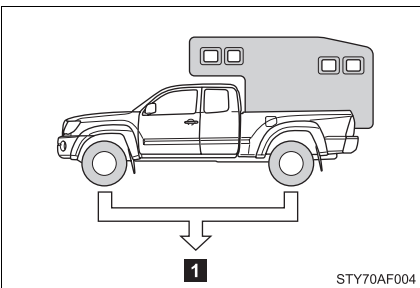

**1** Not exceed GVWR

n **GAWR**

	GAWR	
	Front	Rear
2WD models except PreRunner	2380 lb. (1079 kg)	2685 lb. (1217 kg)
4WD models and PreRunner	2755 lb. (1249 kg)	<ul style="list-style-type: none"> <li>▶ Regular Cab models 3000 lb. (1360 kg)</li> <li>▶ Access Cab and Double Cab models 3110 lb. (1410 kg)</li> </ul>

n **GVWR**

▶ 2WD models except PreRunner

Cab type	GVWR
Regular Cab	<ul style="list-style-type: none"> <li>▶ Vehicles with an automatic transmission 4650 lb. (2109 kg)</li> <li>▶ Vehicles with a manual transmission 4600 lb. (2086 kg)</li> </ul>
Access Cab	<ul style="list-style-type: none"> <li>▶ Vehicles with 2.7 L 4-cylinder (2TR-FE) engine 4900 lb. (2222 kg)</li> <li>▶ Vehicles with 4.0 L V6 (1GR-FE) engine 4700 lb. (2131 kg)</li> </ul>

▶ PreRunner

Cab type	GVWR
Regular Cab	5000 lb. (2268 kg)
Access Cab	5250 lb. (2381 kg)
Double Cab	5350 lb. (2426 kg)



► 4WD models

Cab type	GVWR
Regular Cab	5100 lb. (2313 kg)
Access Cab	5350 lb. (2426 kg)
Double Cab	5450 lb. (2472 kg)

<b>A</b>	<b>A/C</b> .....	<b>220</b>
	<b>ABS</b> .....	<b>184</b>
	<b>Access doors</b> .....	<b>39</b>
	<b>Accessory meter</b> .....	<b>156</b>
	<b>Active traction control system</b> .....	<b>174</b>
	<b>Air conditioning filter</b> .....	<b>388</b>
	<b>Air conditioning system</b>	
	Air conditioning filter.....	388
	Manual air conditioning system.....	220
	<b>Airbags</b>	
	Airbag operating conditions.....	84
	Airbag precautions for your child.....	89
	Airbag warning light.....	426
	Curtain shield airbag operating conditions.....	85
	Curtain shield airbag precautions.....	91
	Front passenger occupant classification system.....	97
	General airbag precautions.....	88
	Locations of airbags.....	81
	Modification and disposal of airbags.....	92
	Passenger airbag off switch.....	93
	Proper driving posture.....	79, 88
	Roll sensing of curtain shield airbag off switch.....	95
	Side airbag operating conditions.....	85
	Side airbag precautions.....	90
	SRS airbags.....	81
	<b>Antenna</b> .....	<b>233</b>
	<b>Anti-lock brake system</b>	
	ABS warning light.....	426
	Anti-lock brake system.....	184
	<b>Audio input</b> .....	<b>257</b>
	<b>Audio remote controls</b> .....	<b>259</b>
	<b>Audio system</b>	
	Antenna.....	233

Audio input.....	257
AUX adapter.....	257
CD player.....	237
MP3/WMA disc.....	244
Optimal use.....	253
Portable music player.....	257
Radio.....	231
Steering wheel audio switch.....	259
Sub woofer.....	256
Type.....	228
<b>AUTO LSD system</b> .....	<b>176</b>
<b>Automatic light off system</b> .....	<b>158</b>
<b>Automatic limited slip differential</b> .....	<b>176</b>
<b>Automatic transmission</b>	
Automatic transmission.....	141
If the shift lever cannot be shifted from P.....	450
<b>AUX adapter</b> .....	<b>257</b>
<b>Auxiliary box</b> ....	<b>296, 302, 319, 320</b>

<b>B</b>	<b>Back-up lights</b>	
	Replacing light bulbs.....	409
	Wattage.....	478
	<b>Back window</b> .....	<b>71</b>
	<b>Battery</b>	
	Charging system warning light.....	425
	Checking.....	369
	If the vehicle battery is discharged.....	452
	Preparing and checking before winter.....	201
	<b>Bluetooth®</b> .....	<b>266</b>
	<b>Bottle holders</b> .....	<b>296, 300</b>
	<b>Brake assist</b> .....	<b>184</b>
	<b>Brakes</b>	
	Brake system warning buzzer.....	175, 177, 182, 187
	Brake system warning light... ..	424
	Fluid.....	364
	Parking brake.....	148

**Break-in tips** ..... 130

**C** **Camper information** ..... 499

**Care**

- Exterior ..... 338
- Interior ..... 340
- Seat belts ..... 341

**Cargo capacity** ..... 195

**Cargo net hook**..... 319, 327

**CD player** ..... 237

**Certification label** ..... 206, 465

**Chains** ..... 202

**Child restraint system**

- Booster seats, definition ..... 104
- Booster seats, installation .... 113
- Convertible seats,
  - definition..... 104
- Convertible seats,
  - installation ..... 112
- Front passenger occupant
  - classification system ..... 97
- Infant seat, definition ..... 104
- Infant seats, installation..... 111
- Installing CRS with lower
  - anchorage ..... 114, 118
- Installing CRS with seat
  - belts ..... 109
- Installing CRS with top
  - straps ..... 119, 122, 123
- Passenger airbag off
  - switch ..... 93

**Child safety**

- Airbag precautions ..... 88
- Battery precautions ..... 370, 454
- Child restraint system..... 104
- Child-protectors ..... 37
- How your child should wear
  - the seat belt ..... 58
- Installing child restraints ..... 109
- Power window lock switch..... 69
- Power window precautions..... 70

- Removed wireless remote
  - control battery
    - precautions .....392

- Seat belt extender
  - precautions .....60
- Seat belt precautions .....59

**Child-protectors** .....37

**Cigarette lighter** .....309

**Cleaning**

- Exterior .....338
- Interior .....340
- Seat belts .....341

**Clock** ..... 307

**Clutch start cancel switch**.....183

**Compass**.....156, 332

**Condenser** .....364

**Console boxes** .....296, 297

**Cooling system**

- Engine overheating .....456

**CRS** .....104

**Cruise control**.....163

**Cup holders** .....296, 298

**Curtain shield airbags** .....81

**Customizable features**.....493

**D** **Daytime running light**

**system** ..... 158

**Deck**

- Auxiliary boxes .....320
- Deck hooks .....321
- Deck rails .....195
- Deck .....319
- Tie-down cleats .....322

**Deck rails** .....195

**Dimension**.....462

**Dinghy towing** .....218

**Do-it-yourself maintenance**.....349

**Doors**

- Access doors.....39
- Door glasses .....69
- Door lock .....32, 35
- Open door warning light.....427
- Side doors .....35

Side mirrors.....66

**Downhill Assist Control System**.....181

**Driver's seat belt reminder buzzer** .....427, 428

**Driver's seat belt reminder light**.....427, 428

**Driving**

Break-in tips ..... 130

Correct posture .....79

Driving assist systems..... 184

Procedures.....128

Winter driving tips.....201

**E**

**Emergency, in case of**

Blown fuse.....393

If the engine will not start .....449

If the shift lever cannot be shifted from P.....450

If the vehicle battery is discharged .....452

If the warning buzzer sounds .....424

If the warning light turns on...424

If you have a flat tire .....433

If you lose your keys .....451

If you think something is wrong .....420

If the vehicle becomes stuck .....459

If your vehicle needs to be towed .....414

If your vehicle overheats .....456

**Engine**

Compartment .....355

Engine switch .....138

Exhaust gas .....134

Hood.....353

How to start the engine .....138

Identification number.....465

If the engine will not start .....449

Ignition switch.....138

Immobilizer system .....76

Overheating .....456

Warning light.....424

**Engine coolant**

Capacity .....470

Checking .....363

Preparing and checking before winter.....201

Temperature gauge .....150

**Engine coolant temperature gauge**.....150

**Engine immobilizer system** .....76

**Engine oil**

Capacity .....468

Checking .....357

Preparing and checking before winter.....201

Warning light.....425, 428

**Engine oil maintenance data** .....361

**Engine switch**.....138

**Event data recorder** .....422

**F**

**Floor mat** .....318

**Fluid**

Brake.....364

Washer.....371

**Fog lights**

Replacing light bulbs.....406

Switch .....159

Wattage.....478

**Four-wheel drive system**

Front-wheel drive control switch.....170

**Front fog lights**

Replacing light bulbs.....406

Switch .....159

Wattage.....478

**Front passenger occupant classification system** .....97

**Front passenger's seat belt reminder light** .....427, 428

**Front passenger's seat belt warning buzzer** .....427, 428

**Front seats**  
 Adjustment ..... 45

**Front side marker lights**  
 Replacing light bulbs ..... 407  
 Switch ..... 157  
 Wattage ..... 478

**Front turn signal lights**  
 Lever ..... 147  
 Replacing light bulbs ..... 408  
 Switch ..... 147  
 Wattage ..... 478

**Fuel**  
 Capacity ..... 467  
 Fuel gauge ..... 150  
 Fuel pump shut off system ... 421  
 Gas station information ..... 520  
 Information ..... 479  
 Refueling ..... 72  
 Type ..... 467  
 Warning light ..... 427

**Fuel door ..... 72**

**Fuel filler door ..... 72**

**Fuel pump shut off system .... 421**

**Fuses**  
 Fuses ..... 393  
 Locations ..... 396, 400

**G** **Garage door opener box ..... 328**

**Gas station information ..... 520**

**Gauges ..... 150**

**Glove box ..... 296**

**H** **Hands-free system**  
 (for cellular phone) ..... 262

**Head restraints**  
 Adjusting ..... 54

**Headlights**  
 Replacing light bulbs ..... 404  
 Switch ..... 157  
 Wattage ..... 478

**High mounted spotlight**  
 Replacing ..... 410

Wattage ..... 478

**Hill-start assist control ..... 184**

**Hood ..... 353**

**Hooks**  
 Cargo net ..... 327  
 Deck hooks ..... 321  
 Shopping bag ..... 326  
 Tie-down cleats ..... 322

**I** **I/M test ..... 348**

**Identification**  
 Engine ..... 466  
 Tire ..... 483  
 Vehicle ..... 465

**Ignition switch ..... 138**

**Illuminated entry system ..... 294**

**Immobilizer system ..... 76**

**Indicator lights ..... 153**

**Initialization**  
 Items to initialize ..... 494

**Inside rear view mirror ..... 63**

**Interior lights**  
 Interior lights ..... 294  
 Personal lights ..... 295  
 Switch ..... 295  
 Wattage ..... 478

**Instrument panel light control ..... 151**

**J** **Jack**  
 Positioning the jack ..... 441  
 Replacing the wheel ..... 433

**Jack handle ..... 438**

**K** **Keyless entry ..... 32**

**Keys**  
 Engine switch ..... 138  
 If you lose your keys ..... 451  
 Ignition switch ..... 138  
 Wireless remote control  
 battery ..... 391  
 Keyless entry ..... 32

Key number.....30  
 Keys .....30  
 Reminder buzzer.....429  
 Wireless remote control .....32

**L**

**License plate lights**

Replacing light bulbs .....411  
 Switch.....157  
 Wattage.....478

**Light bulbs**

Replacing .....403  
 Wattage.....478

**Lights**

Automatic light off system .....158  
 Fog light switch .....159  
 Headlights switch .....157  
 Instrument panel light control  
 dial .....151  
 Interior light switch .....295  
 Replacing light bulbs .....403  
 Turn signal lights switch .....147  
 Wattage.....478

**Limited slip differential.....176**

**Load capacity .....195, 199, 463**

**Lock steering column.....62**

**Luggage storage box.....324**

**Luggage compartment  
 features.....319**

**M**

**Maintenance**

Do-it-yourself maintenance ...349  
 General maintenance.....345  
 Maintenance data.....462  
 Maintenance requirements...343  
 Vehicle exterior .....338  
 Vehicle interior .....340

**Malfunction indicator lamp .....425**

**Manual air conditioning  
 system .....220**

**Manual transmission .....144**

**Meter**

Accessory meter .....156

Instrument panel light  
 control.....151  
 Meters .....150

**Mirrors**

Inside rear view mirror .....63  
 Side mirrors.....66  
 Vanity mirrors.....306

**MP3 disc .....244**

**O**

**Odometer .....151**

**Off-road precautions**

Driving.....192  
 Vehicle .....190

**Oil**

Engine oil .....357  
 Warning light.....425,428

**Opener**

Fuel door.....72  
 Hood .....353

**Outside rear view mirrors**

Adjusting and folding.....66

**Outside temperature**

display .....308

**Overhead console.....304**

**Overheating, Engine.....456**

**P**

**Parking brake .....148**

**Passenger airbag off switch**

Installing the child  
 restraint system .....110  
 Passenger airbag off switch  
 precautions .....106  
 Passenger airbag off  
 switch.....93  
 Passenger risk group .....94

**Personal lights .....295**

**Parking lights**

Replacing light bulbs .....407  
 Switch .....157  
 Wattage.....478

**Power outlet .....310, 311**

**R**

**Power steering**  
 Fluid..... 366

**Power windows ..... 69**

**Radiator..... 355, 364**

**Radio ..... 231**

**Rear seat**  
 Adjustment ..... 50  
 Folding down..... 51  
 Raising the bottom  
 cushion..... 50

**Rear side marker lights**  
 Replacing light bulbs ..... 412  
 Switch..... 157

**Rear turn signal lights**  
 Lever ..... 147  
 Replacing light bulbs ..... 409  
 Switch..... 147  
 Wattage..... 478

**Rear view monitor system**  
 Before removing the  
 tailgate ..... 40  
 Rear view monitor  
 system..... 166

**Rear window ..... 71**

**Replacing**  
 Wireless remote control  
 battery..... 391  
 Fuses..... 393  
 Light bulbs ..... 403  
 Tires ..... 373, 433  
 Wheels ..... 386

**Rear differential lock  
 system ..... 178**

**Rear step bumper..... 43**

**Reporting safety defects for  
 U.S. owners ..... 496**

**Roll sensing of curtain shield  
 airbags off switch ..... 95**

**S**

**Seat belts**  
 Adjustment .....56  
 ALR .....58  
 Automatic Locking  
 Retractor .....58  
 Child restraint system  
 installation..... 109  
 Cleaning and maintaining.....341  
 ELR .....58  
 Emergency Locking  
 Retractor .....58  
 How to wear your seat belt.....56  
 How your child should wear  
 the seat belt .....58  
 Pregnant women, proper  
 seat belt use .....58  
 Reminder buzzer.....427, 428  
 Reminder light.....427  
 Seat belt extenders .....59  
 Seat belt pretensioners .....57

**Seating capacity..... 199**

**Seats**  
 Adjustment .....45  
 Adjustment precautions.....49  
 Child seats/child restraint  
 system installation ..... 109  
 Cleaning..... 340  
 Folding down the rear seat.....51  
 Folding down the rear seat  
 precautions .....52  
 Folding passenger's seat .....47  
 Folding seatback.....46  
 Front seat adjustment .....45  
 Front seat adjustment  
 precautions .....49  
 Head restraint.....54  
 Moving passenger's seat for  
 rear seat entry.....46  
 Properly sitting in the seat.....79  
 Raising the bottom cushion.....50

**Seatback table.....317**

**Service reminder  
 indicators .....154**

**Shift lever**  
 Automatic transmission ..... 141  
 Four-wheel drive ..... 170  
 If the shift lever cannot be shifted from P ..... 450  
 Manual transmission ..... 144  
**Shift lock system ..... 450**  
**Side airbags ..... 81**  
**Side doors ..... 35**  
**Side marker lights**  
 Replacing light bulbs ..... 407, 412  
 Switch ..... 157  
 Wattage ..... 478  
**Side mirror**  
 Adjusting and folding ..... 66  
**Spare tire**  
 Inflation pressure ..... 475  
 Replacing ..... 433  
 Spare tire ..... 433  
**Spare plug ..... 470**  
**Specifications ..... 462**  
**Speedometer ..... 150**  
**SRS airbags**  
 Curtain shield airbags ..... 81  
 Front airbags ..... 81  
 Passenger airbag off switch ..... 93  
 Precautions ..... 88  
 Roll sensing of curtain shield airbag off switch ..... 95  
 Side airbags ..... 81  
**Steering wheel**  
 Adjustment ..... 62  
 Audio switch ..... 259  
**Stop lights**  
 Replacing light bulbs ..... 409  
 Wattage ..... 478  
**Storage feature ..... 296**  
**Storage precautions ..... 198**  
**Stuck**  
 If the vehicle becomes stuck ..... 459  
**Sun visors ..... 305**

**Switch**  
 A-TRAC switch ..... 174  
 AUTO LSD switch ..... 176  
 Clutch start cancel switch ..... 183  
 Cruise control switch ..... 163  
 DAC switch ..... 181  
 Engine switch ..... 138  
 Fog light switch ..... 159  
 Front-wheel drive control switch ..... 170  
 Ignition switch ..... 138  
 Headlights switch ..... 157  
 Light switch ..... 157  
 Passenger airbag off switch ..... 93  
 Power door lock switch ..... 36  
 Power window switch ..... 69  
 Rear differential lock switch ..... 178  
 Roll sensing of curtain shield airbag off switch ..... 95  
 Tire pressure warning reset switch ..... 375  
 Turn signal lights ..... 147  
 VSC OFF switch ..... 176, 185  
 Window lock switch ..... 69  
 Wiper and washer ..... 160

**T**  
**Tachometer ..... 150**  
**Tailgate**  
 Removing the tailgate ..... 40  
 Tailgate ..... 40  
**Tail lights**  
 Replacing light bulbs ..... 412  
 Switch ..... 157  
**Talk switch ..... 267**  
**Telephone switch ..... 267**  
**Theft deterrent system**  
 Engine immobilizer system ..... 76  
 Theft prevention labels ..... 78  
**Theft prevention labels ..... 78**  
**Tire inflation pressure ..... 475**



**Tire information**

- Glossary ..... 487
- Size ..... 484
- Tire identification number ..... 483
- Uniform tire quality grading .. 485

**Tires**

- Chains ..... 202
- Checking ..... 373
- If you have a flat tire ..... 433
- Identification number ..... 483
- Inflation pressure ..... 475
- Inflation pressure sensor ..... 374
- Information ..... 482
- Replacing ..... 373, 433
- Rotating tires ..... 373
- Size ..... 475
- Snow tires..... 203
- Spare tire ..... 438
- Tire pressure warning  
reset switch..... 375
- Tire pressure warning  
system..... 373, 430
- Warning light ..... 427

**Tools..... 433, 434**

**Total load capacity ..... 199**

**Towing**

- Bumper towing ..... 210
- Dinghy towing..... 218
- Emergency towing..... 414
- Fifth wheel trailer ..... 210
- Trailer towing..... 205

**Traction control system ..... 184**

**TRAC ..... 184**

**Trip meter..... 151**

**Turn signal lights**

- Lever ..... 147
- Replacing light bulbs ..... 408
- Switch..... 147
- Wattage..... 478

**V**

**Valet key .....30**

**Vanity mirrors.....306**

**Vehicle identification**

**number .....465**

**Vehicle stability control.....184**

**VSC.....184**

**W**

**Warning buzzers**

- Key reminder .....429
- Brake system .....424
- Seat belt reminder.....427, 428

**Warning lights**

- ABS .....426
- Airbag system .....426
- Anti-lock brake system .....426
- Automatic transmission fluid  
temperature .....426
- Brake system .....424
- Charging system .....425
- Driver's seat belt .....427
- Electronic engine control  
system .....425
- Engine oil replacement.....428
- Front passenger occupant  
classification system .....426
- Front passenger's seat belt...427
- Low brake fluid .....424
- Low engine oil pressure .....425
- Low fuel level .....427
- Low tire inflation pressure .....427
- Malfunction indicator lamp ....425
- Open door .....427
- Seat belt.....427
- Seat belt pretensioner  
system .....426
- SRS.....426
- SRS airbag system .....426
- Tire pressure .....427
- Tire pressure warning  
system .....427
- VSC/TRAC .....426

<b>Washer</b>	
Checking .....	371
Preparing and checking	
before winter .....	201
Switch.....	160
<b>Washing and waxing .....</b>	<b>338</b>
<b>Weight</b>	
Cargo capacity .....	195
Cargo weight rating.....	500
Gross axle weight rating.....	502
Gross vehicle weight	
rating.....	502
Load limits .....	199
Weight.....	463
<b>Wheels .....</b>	<b>386</b>
<b>Window glasses .....</b>	<b>69, 71</b>
<b>Window lock switch.....</b>	<b>69</b>
<b>Windows</b>	
Power windows .....	69
Washer.....	160
<b>Windshield wipers .....</b>	<b>160</b>
<b>Wireless remote control</b>	
Replacing the battery .....	391
Wireless remote control .....	32
<b>Winter driving tips .....</b>	<b>201</b>
<b>WMA disc.....</b>	<b>244</b>

What to do if...

## What to do if...

A tire punctures

P. 433 If you have a flat tire

The engine does not start

P. 449 If the engine will not start

P. 76 Engine immobilizer system

P. 452 If the vehicle battery is discharged

The shift lever cannot be moved out

P. 450 If the shift lever cannot be shifted from P

The engine coolant temperature gauge enters the red zone

P. 456 If your vehicle overheats

Steam can be seen coming from under the hood

The key is lost

P. 451 If you lose your keys

The battery runs out

P. 452 If the vehicle battery is discharged

The doors cannot be locked

P. 35 Side doors

P. 39 Access doors

The vehicle is stuck in mud or sand

P. 459 If the vehicle becomes stuck

The warning light or indicator light comes on

P. 424 If a warning light turns on



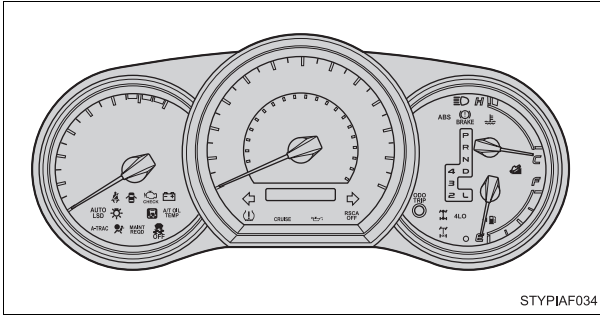



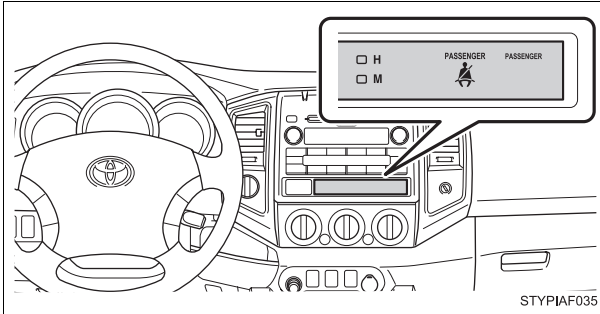







## n Instrument cluster



## n Center panel



## nWarning lights

	Brake system warning light	P. 424		Automatic transmission fluid temperature warning light	P. 426
	Charging system warning light	P. 425		Slip indicator*	P. 426
	Low engine oil pressure warning light	P. 425		Tire pressure warning light	P. 427
	Malfunction indicator lamp	P. 425		Open door warning light	P. 427
	ABS warning light			Low fuel level warning light	P. 427
or				Driver's seat belt reminder light	P. 427
		P. 426		Front passenger's seat belt reminder light	P. 427
	Engine oil replacement reminder light	P. 428			
	SRS warning light	P. 426			

\*: Slip indicator comes on.

## GAS STATION INFORMATION

**Auxiliary catch lever**  
P. 353

**Fuel filler door**  
P. 72

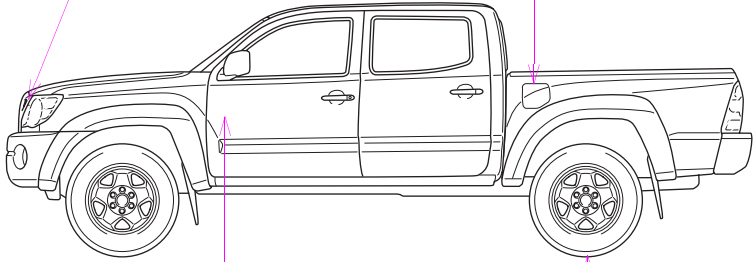

**Hood lock release lever**  
P. 353

**Tire inflation pressure** STYPIAF008  
P. 475

Fuel tank capacity	21.1 gal. (80.0 L, 17.6 Imp.gal.)
Fuel type	Unleaded gasoline, Octane Rating 87 (Research Octane Number 91) or higher
Cold tire inflation pressure	P. 475
Engine oil capacity (Drain and refill)	P. 468
Engine oil type	Toyota Genuine Motor Oil or equivalent Oil grade: P. 468 ILSAC multigrade engine oil Recommended oil viscosity: SAE 5W-20 or 0W-20 (2.7 L 4-cylinder [2TR-FE] engine) SAE 5W-30 (4.0 L V6 [1GR-FE] engine)

**1 Before driving**

**1-1. Key information ..... 30**  
 Keys ..... 30

**1-2. Opening, closing and locking the doors ..... 32**  
 Wireless remote control ..... 32  
 Side doors ..... 35  
 Access doors (Access Cab models only)..... 39  
 Tailgate ..... 40

**1-3. Adjustable components (seats, mirrors, steering wheel)..... 45**  
 Front seats ..... 45  
 Rear seats (Access Cab and Double Cab models) ..... 50  
 Head restraints ..... 54  
 Seat belts ..... 56  
 Steering wheel ..... 62  
 Anti-glare inside rear view mirror..... 63  
 Outside rear view mirrors ..... 66

**1-4. Opening and closing the windows ..... 69**  
 Power windows ..... 69  
 Back window (vehicles with sliding type) ..... 71

**1-5. Refueling ..... 72**  
 Opening the fuel tank cap .... 72

**1-6. Theft deterrent system ..... 76**  
 Engine immobilizer system... 76  
 Theft prevention labels (U.S.A.)..... 78

**1-7. Safety information ..... 79**  
 Correct driving posture ..... 79  
 SRS airbags ..... 81  
 Front passenger occupant classification system..... 97  
 Child restraint systems ..... 104  
 Installing child restraints ..... 109

**2 When driving**

**2-1. Driving procedures..... 128**  
 Driving the vehicle ..... 128  
 Engine (ignition) switch..... 138  
 Automatic Transmission ..... 141  
 Manual Transmission ..... 144  
 Turn signal lever ..... 147  
 Parking brake ..... 148

**2-2. Gauges and meters ..... 150**  
 Gauges and meters ..... 150  
 Indicators and warning lights ..... 153  
 Accessory meter..... 156

**2-3. Operating the lights and wipers ..... 157**  
 Headlight switch ..... 157  
 Fog light switch..... 159  
 Windshield wipers and washer ..... 160

<b>2-4. Using other driving systems .....</b>	<b>163</b>
Cruise control.....	163
Rear view monitor system (vehicles with auto anti-glare inside rear view mirror) .....	166
Four-wheel drive system.....	170
Active traction control system .....	174
AUTO LSD system.....	176
Rear differential lock system .....	178
Downhill Assist Control system .....	181
Clutch start cancel switch ...	183
Driving assist systems .....	184
<b>2-5. Driving information.....</b>	<b>190</b>
Off-road precautions (4WD models and PreRunner) .....	190
Cargo and luggage .....	195
Vehicle load limits .....	199
Winter driving tips .....	201
Trailer towing .....	205
Dinghy towing .....	218

## Interior and exterior features

<b>3-1. Using the air conditioning system and defogger.....</b>	<b>220</b>
Air conditioning system .....	220

<b>3-2. Using the audio system.....</b>	<b>228</b>
Audio system types .....	228
Using the radio .....	231
Using the CD player .....	237
Playing back MP3 and WMA discs .....	244
Optimal use of the audio system.....	253
Operating the sub woofer (on some Access Cab models) .....	256
Using the AUX adapter.....	257
Using the steering wheel audio switches.....	259
<b>3-3. Using the hands-free phone system (for cellular phone).....</b>	<b>262</b>
Hands-free phone system (for cellular phone) .....	262
Using the hands-free phone system.....	266
Making a phone call .....	274
Setting a cellular phone.....	279
Security and system setup .....	284
Using the phone book .....	287
<b>3-4. Using the interior lights ...</b>	<b>294</b>
Interior lights list .....	294
• Interior light .....	295
• Personal lights.....	295



**3-5. Using the storage features ..... 296**  
 List of storage features..... 296  
 • Glove box ..... 296  
 • Console boxes ..... 297  
 • Cup holders..... 298  
 • Bottle holders ..... 300  
 • Auxiliary boxes ..... 302  
 • Overhead console ..... 304

**3-6. Other interior features ..... 305**  
 Sun visors ..... 305  
 Vanity mirrors ..... 306  
 Clock ..... 307  
 Outside temperature display (vehicles with accessory meter)..... 308  
 Cigarette lighter ..... 309  
 Power outlet (12V DC) ..... 310  
 Power outlet (if 115V AC equipped) ..... 311  
 Seatback table ..... 317  
 Floor mat ..... 318  
 Luggage compartment features ..... 319  
 Garage door opener box .... 328  
 Compass (vehicles with accessory meter)..... 332

**4-2. Maintenance ..... 343**  
 Maintenance requirements ..... 343  
 General maintenance ..... 345  
 Emission inspection and maintenance (I/M) programs ..... 348

**4-3. Do-it-yourself maintenance ..... 349**  
 Do-it-yourself service precautions ..... 349  
 Hood ..... 353  
 Engine compartment ..... 355  
 Tires..... 373  
 Tire inflation pressure ..... 381  
 Wheels..... 386  
 Air conditioning filter ..... 388  
 Wireless remote control battery ..... 391  
 Checking and replacing fuses ..... 393  
 Light bulbs ..... 403

**4 Maintenance and care**

**4-1. Maintenance and care..... 338**  
 Cleaning and protecting the vehicle exterior ..... 338  
 Cleaning and protecting the vehicle interior ..... 340

**5 When trouble arises**

**5-1. Essential information ..... 414**  
 If your vehicle needs to be towed..... 414  
 If you think something is wrong..... 420  
 Fuel pump shut off system ..... 421  
 Event data recorder ..... 422

<b>5-2. Steps to take in an emergency .....</b>	<b>424</b>
If a warning light turns on or a warning buzzer sounds... ..	424
If you have a flat tire.....	433
If the engine will not start ....	449
If the shift lever cannot be shifted from P.....	450
If you lose your keys .....	451
If the vehicle battery is discharged .....	452
If your vehicle overheats .....	456
If the vehicle becomes stuck .....	459

---

## 6 Vehicle specifications

---

<b>6-1. Specifications.....</b>	<b>462</b>
Maintenance data (fuel, oil level, etc.) .....	462
Fuel information .....	479
Tire information.....	482
<b>6-2. Customization .....</b>	<b>493</b>
Customizable features .....	493
Items to initialize .....	494

---

## 7 For owners

---

Reporting safety defects for U.S. owners .....	496
Seat belt instructions for Canadian owners (in French) .....	497
Camper information .....	499

---

## Index

---

<b>Abbreviation list.....</b>	<b>506</b>
<b>Alphabetical index .....</b>	<b>508</b>
<b>What to do if... ..</b>	<b>517</b>

1

2

3

4

5

6

7