

PRIUS

POWERED
BY



2009 Quick Reference Guide

2009 Prius

This *Quick Reference Guide* is a summary of basic vehicle operations. It contains brief descriptions of fundamental operations so you can locate and use the vehicle's main equipment quickly and easily.

The *Quick Reference Guide* is not intended as a substitute for the *Owner's Manual* located in the vehicle's glove box. We strongly encourage you to review the *Owner's Manual* and supplementary manuals so you will have a better understanding of the vehicle's capabilities and limitations.

Your dealership and the entire staff of Toyota Motor Sales, U.S.A., Inc. wish you many years of satisfied driving in your new Prius.

! A word about safe vehicle operations

This *Quick Reference Guide* is not a full description of Prius operations. Every Prius owner should review the *Owner's Manual* that accompanies this vehicle.

Pay special attention to the boxed information highlighted in color throughout the *Owner's Manual*. Each box contains safe operating instructions to help you avoid injury or equipment malfunction.

All information in this *Quick Reference Guide* is current at the time of printing. Toyota reserves the right to make changes at any time without notice.

INDEX

BASIC HYBRID VEHICLE OPERATION

Hybrid Synergy Drive System	2
Keyless entry¹	6
Key fob	3
Parking & turning OFF the Hybrid System	9
Shifting	8
Smart Key system	4-5
Smart Key unlock functions¹	5
Turning the Hybrid System ON	7

OVERVIEW

Engine maintenance	15
Fuel tank door opener and cap	14
Hood release	15
Indicator symbols	12-13
Instrument cluster	12
Instrument panel	10-11
Light control-Instrument panel	14
Rear hatch	14

FEATURES/OPERATIONS

Air Conditioning/Heating	20-21
Audio	22-23
Clock	25
Cruise control	21
Cup and bottle holders	25
Garage door opener (HomeLink [®]) ²	17
Lights & turn signals	16
Luggage storage box	24
Parking brake	25
Power outlets	25
Seat adjustments-Front	18
Seat adjustments-Rear	18
Seats-Head restraints	18
Telephone controls (Bluetooth [®])	24
Tilt steering wheel	19
Windows	19
Windshield wipers & washers	17

SAFETY AND EMERGENCY FEATURES

Door locks	26
Doors-Child safety locks	26
Emergency flashers	27
Jump starting	28
Rear air vent	27
Seat belts	26
Seat belts-Shoulder belt anchor	26
Spare tire & tools	29
Tire Pressure Monitoring (warning) System	27

¹ Programmable by customer. For dealer-programmable features, please visit your Toyota dealer.

² HomeLink[®] is a registered trademark of Johnson Controls, Inc.

BASIC HYBRID VEHICLE OPERATION

Hybrid Synergy Drive System

The Hybrid Synergy Drive System utilizes a computer controlled gasoline engine and electric motor to provide the most efficient combination of power for the vehicle. To conserve energy, when the brakes are applied, braking force generates electricity which is then sent to the traction battery. In addition, the engine shuts off when the vehicle is stopped. The benefits are better fuel economy, reduced vehicle emissions and improved performance.

Note: Fuel consumption and energy information of the Hybrid System are shown on the multi-information display. Refer to this screen for important driving information and feedback to maximize energy use/creation and conserve fuel.

Tips for improved fuel economy

- Ensure tire pressures are maintained at levels specified in the *Owner's Manual*.
- If possible, link trips to reduce engine cold starts.
- Avoid driving at speeds that are higher than necessary, especially on the highway.
- When possible, avoid sudden stops to maximize regenerative braking energy.
- Minimize use of the Air Conditioning.

Refer to the *Owner's Manual* for more details.

Key fob

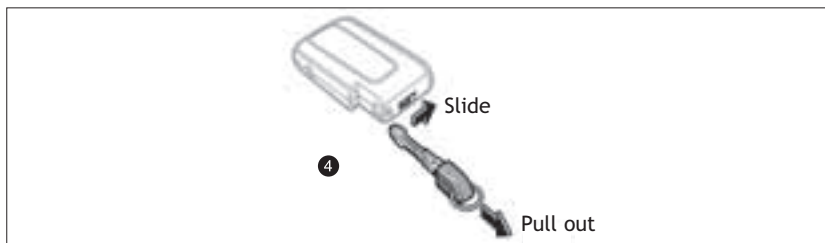
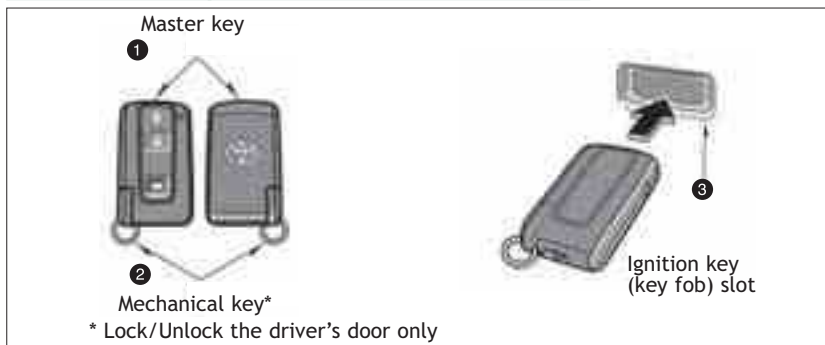

- 1 **Master key** Ignition key & wireless remote.
- 2 **Mechanical key** Fits into master key and can be removed to manually lock/unlock driver door only.
- 3 **Ignition key slot** When inserting, push completely in. When removing, gently pull; key will be pushed out by a spring. **DO NOT FORCE THE KEY.** If it cannot be removed, push it all the way in again, then pull it out.
- 4 **To remove or replace mechanical key** Slide the lock knob in the direction of the arrow.

Smart Key system (if equipped)

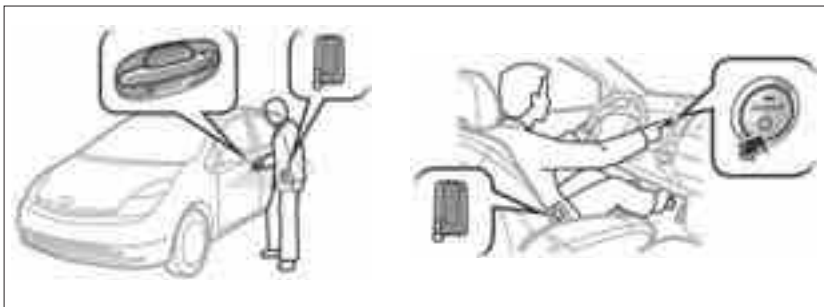

Carrying a Smart Key allows the vehicle to be locked, unlocked and the Hybrid System engaged without handling the key.

Locking operation

Front door

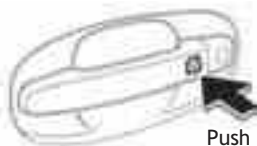

Rear hatch

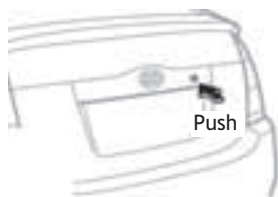

Unlocking operation

Front door

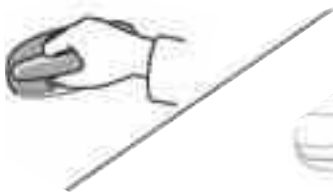

Rear hatch

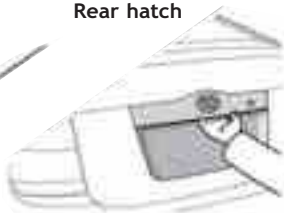

NOTE: After unlocking, if a door is not opened within 60 seconds, all doors will relock for safety. Refer to your *Owner's Manual* and the following section of this guide for Smart Key unlocking programmable options.

Smart Key system cancel switch

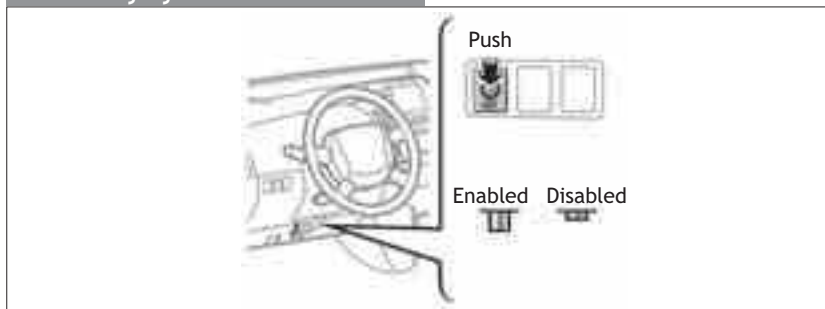

NOTE: To conserve battery power, turn the Smart Key system "OFF" when not using the vehicle for prolonged periods of time. For more battery saving information, refer to the *Owner's Manual* for more details.

Smart Key unlock functions (if equipped)

The Smart Key unlocking function can be programmed to operate in three different modes when Smart Key is activated. In all modes, grasping the front passenger's door handle will unlock all doors.

- To unlock driver's door only, grasp driver's door handle.
- To unlock all doors, grasp any door handle except rear doors.
- To unlock driver's door or hatch independently, grasp the handle.

Refer to the *Owner's Manual* for more information on this feature, and how to change modes.

BASIC HYBRID VEHICLE OPERATION

Keyless entry

Locking operation



Push 

Unlocking operation



Push ONCE: Driver door
TWICE: All doors 

NOTE: After unlocking, if a door is not opened within 60 seconds, all doors will relock for safety.

Panic button



Push and hold 

Turning the Hybrid System ON

Start function

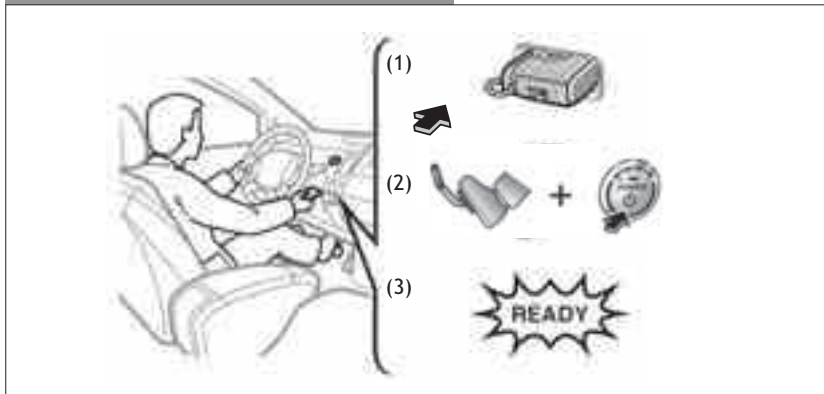

- (1) Insert key.*
- (2) Depress the brake pedal and push the "POWER" button briefly and firmly.
- (3) The "READY" light will blink. After a few seconds, when the light remains ON and a beep sounds, you may begin driving.

Note: The brake pedal must be depressed to turn the Hybrid System on.

* It is not necessary to insert the ignition key (key fob) if Smart Key system is installed and activated.



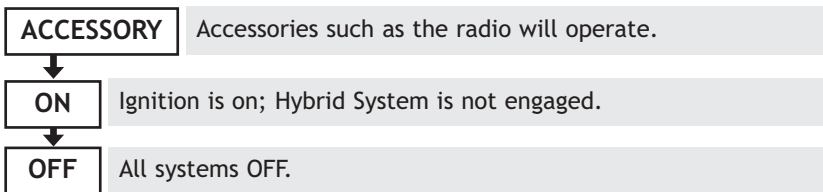

Changing operation modes

Pressing "POWER" without depressing the brake pedal while the Hybrid System is OFF will change the operation mode in succession from:

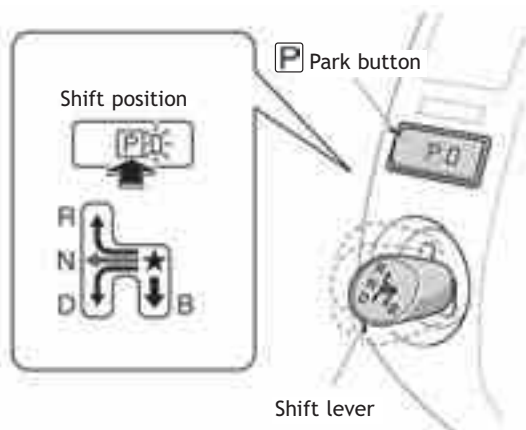

Shifting



	Park button
	Reverse (buzzer sounds)
	Neutral
	Drive
	Engine brake *

Brake pedal must be depressed when shifting to or from the  Park position. If brake is not applied, a beep will sound and the vehicle cannot be shifted.

NOTE: The shift lever will always return to its original position after shifting. **ALWAYS CONFIRM SHIFT POSITION BY CHECKING INDICATOR SYMBOLS ON THE INSTRUMENT CLUSTER.**

* The engine brake is the equivalent of downshifting. Shift to "B" when engine braking is desired (i.e. downhill driving, coasting to a stop, etc.).

Parking & turning OFF the Hybrid System

(1)



(2)



(3)



(4)



- (1) When the vehicle is at a complete stop, keep brake pedal depressed and push  Park button above the shift lever.
- (2) Push the "POWER" button to turn off the system.
- (3) Fully depress the parking brake.
- (4) Remove the key fob if inserted.*

WARNING: If the "POWER" button is held for longer than three seconds while the vehicle is moving, the Hybrid System will shut off.

* It is not necessary to insert the ignition key (key fob) if Smart Key system is installed and activated.

Information

In some instances when the engine starts, and/or on a short trip after the engine is stopped, the engine water pump may continue operating for a short time. This is a standard operation of the vehicle to ensure optimum performance and shouldn't be a concern.

OVERVIEW

Instrument panel

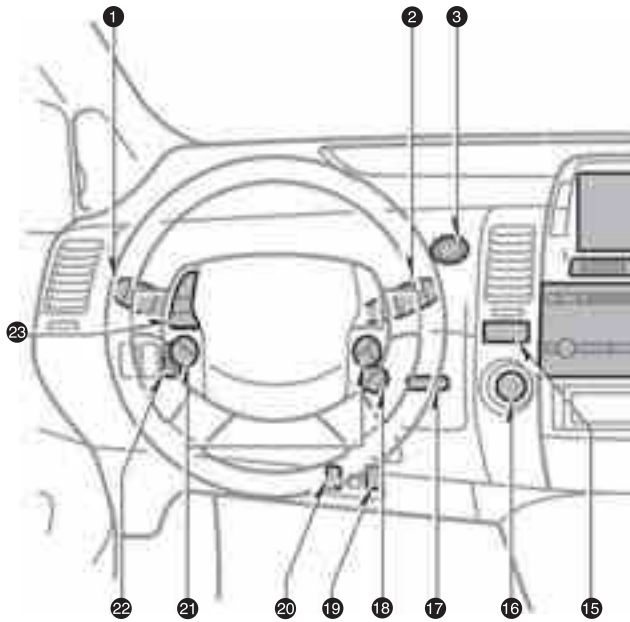

- ① Headlight, turn signal and front fog light¹ controls
- ② Wiper and washer controls
- ③ "POWER" button
- ④ Clock
- ⑤ "AUDIO" switch (multi-information display control)
- ⑥ "CLIMATE" switch (multi-information display control)
- ⑦ Multi-information display
- ⑧ "DISPLAY" switch (multi-information display control)
- ⑨ "INFO" switch (multi-information display control)
- ⑩ Mph or km/h button
- ⑪ Trip meter reset
- ⑫ Emergency flasher button

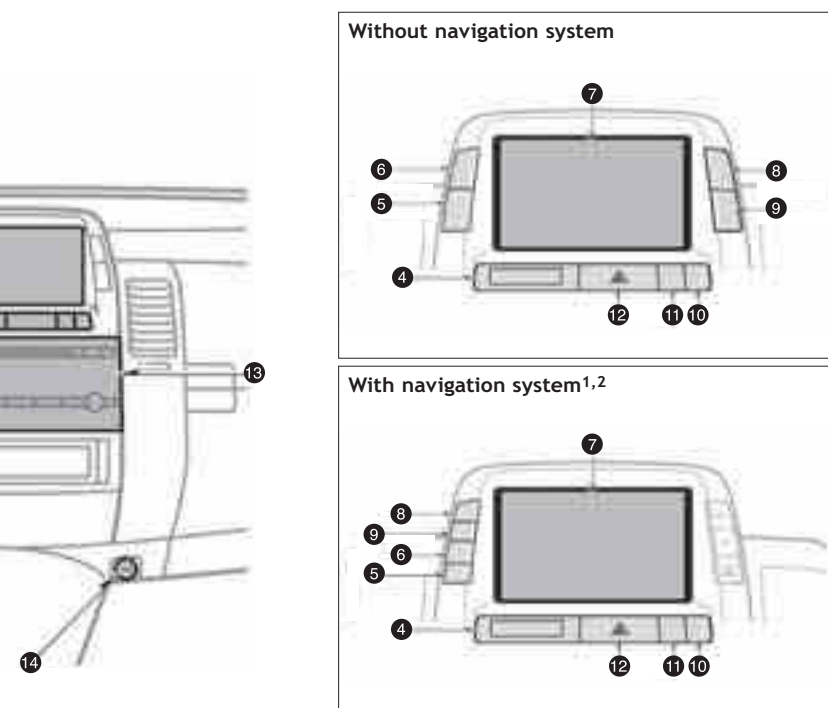

- 13 Audio system
- 14 12V DC Power outlet
- 15  Park button
- 16 Electronic shift lever
- 17 Ignition key (key fob) slot
- 18 Cruise control¹
- 19 Tire Pressure Monitoring (warning) System
- 20 Smart Key system cancel¹
- 21 Steering wheel climate control
- 22 Instrument panel light control
- 23 Steering wheel audio control

¹ If equipped

² For details, refer to the *Navigation System Owner's Manual*.

Instrument cluster

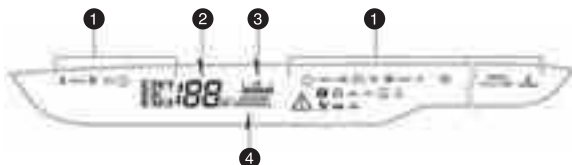















- ① Service indicators and reminder
- ② Speedometer
- ③ Fuel gauge
- ④ Odometer and two trip meters

Indicator symbols

BRAKE	Brake system warning ¹
	Driver seat belt reminder ¹ (alarm will sound if speed is over 12 mph)
 PASSENGER	Front passenger seat belt reminder ¹ (alarm will sound if speed is over 12 mph)
	Charging system warning ¹
 CHECK	Malfunction/Check Engine indicator ¹
	Low engine oil pressure warning ¹
	Low fuel level indicator ¹
	Master warning ¹
	High coolant temperature warning ¹
	Open door warning ¹
	Airbag SRS warning ¹
	Low Tire Pressure Warning ¹
VSC	Vehicle Stability Control warning ¹
MAINT REQD	Engine oil replacement reminder ¹
 MAIN	Traction battery warning ¹

¹ For details, refer to Section 5-2, 2009 Owner's Manual.

² If this light flashes, see "Cruise control" Section 2-4, 2009 Owner's Manual.

P/S	PS	Electric power steering system warning ¹
		Smart Key system warning ¹
		Turn signal indicator
		Headlight high beam indicator
		Headlight indicator
		Slip indicator
		Automatic headlight leveling system warning ¹
CRUISE		Cruise control indicator ²
		Hybrid System warning ¹
		Running mode position indicator ³
READY		Driving ready light
A/C AUTO		Automatic Air Conditioner indicator
		Recirculate mode indicator
		Windshield airflow indicator
		Rear window and outside rearview mirror defogger indicator
		Hybrid vehicle immobilizer/Theft deterrent system indicator
PASSENGER AIR BAG OFF 		Front passenger occupant classification indicator
ABS		Anti-lock Brake System warning ¹
		Yellow: Brake System warning ¹

³ For details, refer to "Transmission" Section 2-1, 2009 Owner's Manual.

Fuel tank door opener and cap

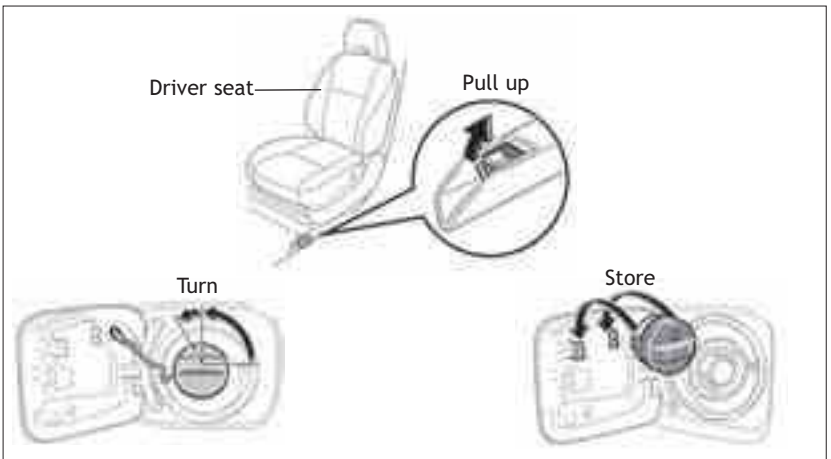

NOTE: Tighten until one click is heard. If the cap is not tightened enough, Check Engine “” indicator may illuminate.

NOTE: MAINTAIN GASOLINE IN THE TANK AT ALL TIMES. SERIOUS DAMAGE TO THE HYBRID SYSTEM CAN OCCUR IF THE VEHICLE RUNS OUT OF GASOLINE.

Rear hatch

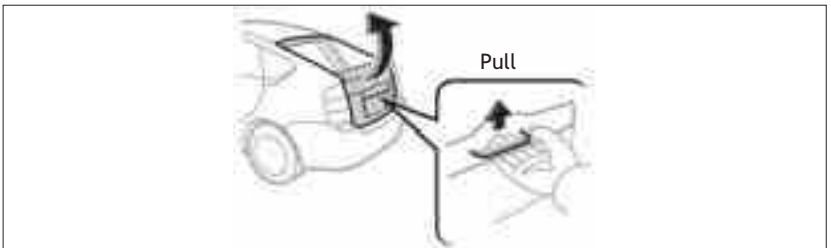

To open the rear hatch, grasp the handle and pull up.

Light control-Instrument panel

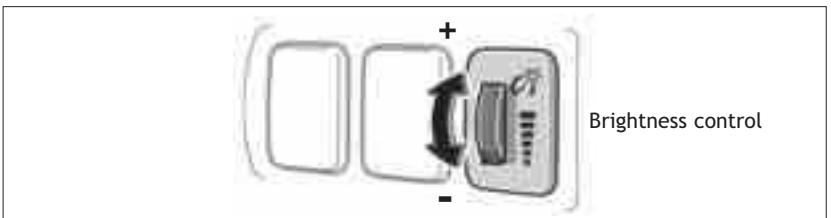

Hood release

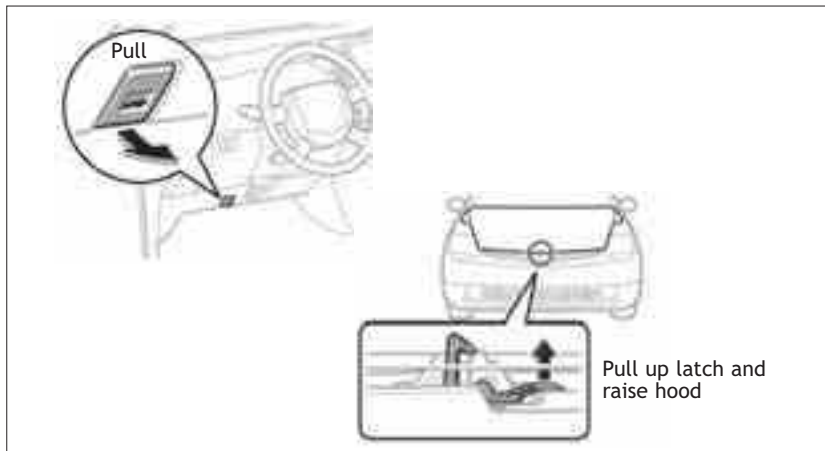

Engine maintenance

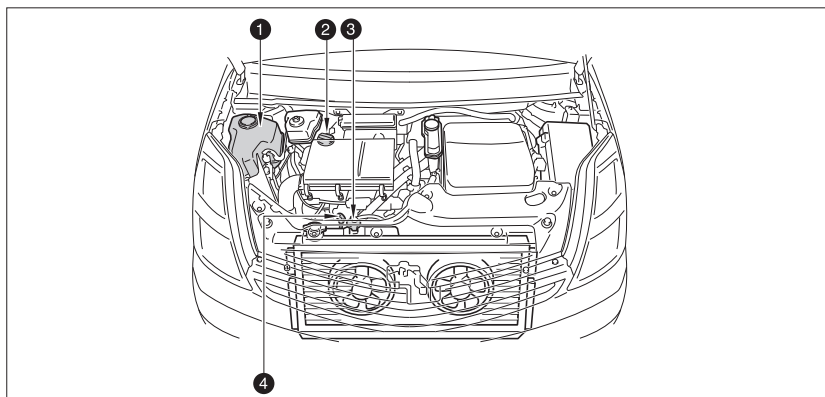

- ① Windshield washer fluid tank
- ② Engine oil filler cap
- ③ Engine coolant reservoir
- ④ Engine oil level dipstick

Note: Regularly scheduled maintenance, including oil changes, will help extend the life of your vehicle and maintain performance. Please refer to the "Owner's Warranty Information Booklet," "Scheduled Maintenance Guide" or "Owner's Manual Supplement."

FEATURES/OPERATIONS

Lights & turn signals

Headlights

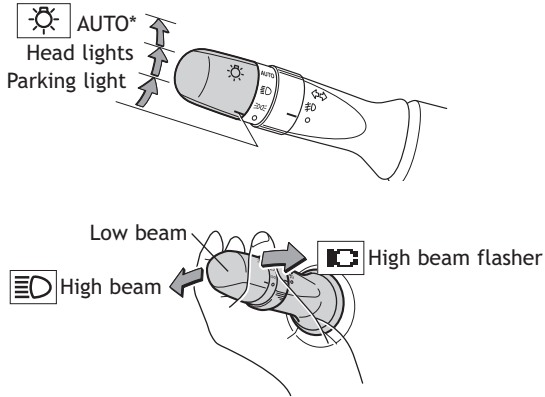

Automatic light cutoff system Automatically turns off lights when the driver's door is opened with the Hybrid System "OFF."

Front fog lights (if equipped)

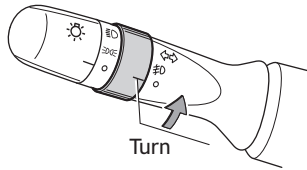

Front fog lights come on only when the headlights are on low beam.

Turn signals

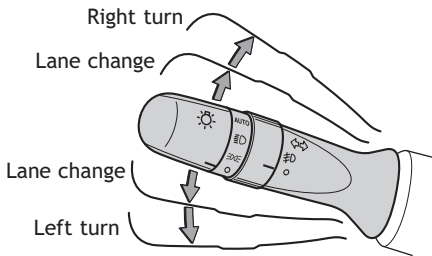

Windshield wipers & washers

Front

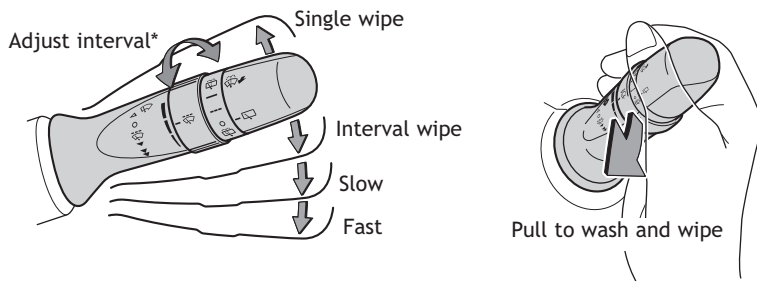

*** Intermittent windshield wiper interval adjustment**
Rotate to increase/decrease wipe frequency.

Rear

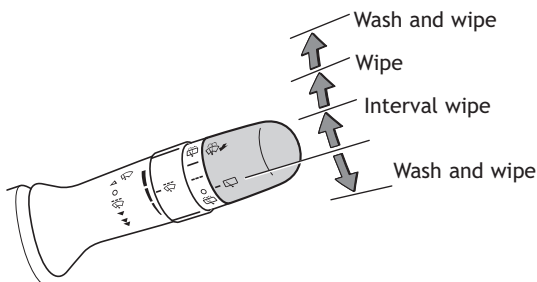

Garage door opener (HomeLink®) (if equipped)

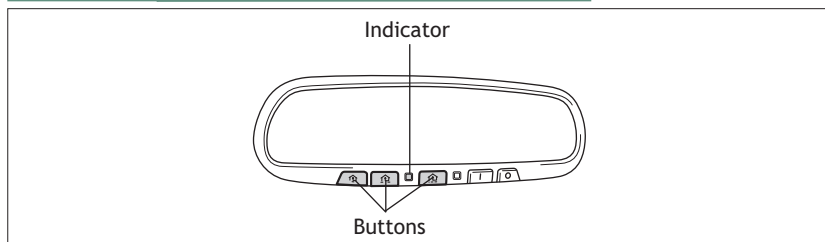

Garage door openers manufactured under license from HomeLink®* can be programmed to operate garage doors, estate gates, security lighting, etc.

Refer to the *Owner's Manual* for more details.

For programming assistance, contact the Toyota Customer Experience Center at 1-800-331-4331, or visit <http://www.homelink.com>.

* HomeLink® is a registered trademark of Johnson Controls, Inc.

Seat adjustments-Front



Seat adjustments-Rear

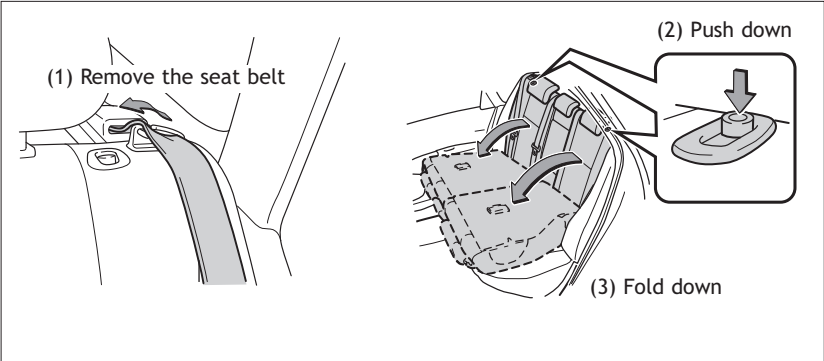

Seats-Head restraints

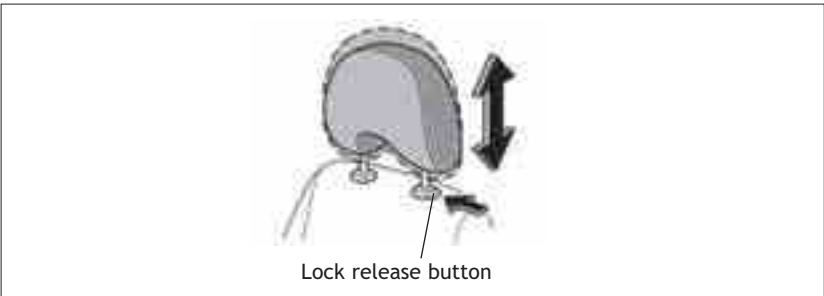

Tilt steering wheel

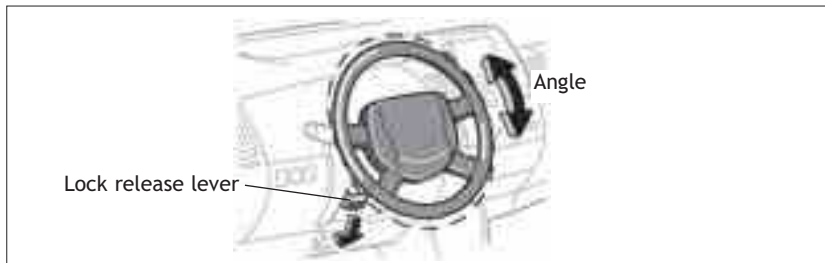

Hold wheel, push lever down, set angle and return lever.

Note: Do not attempt to adjust while the vehicle is in motion.

Windows

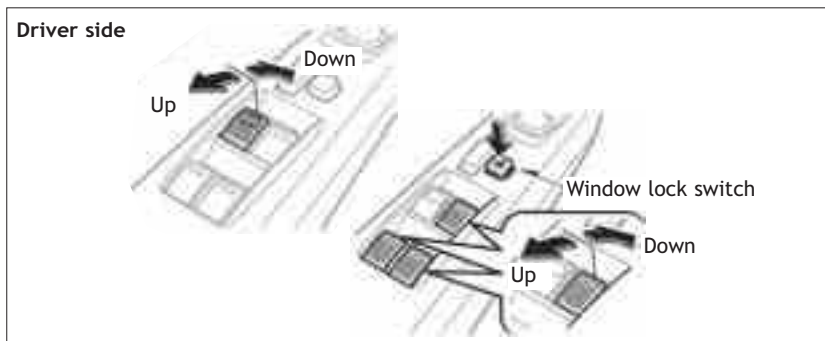

Window operation

Automatic operation (driver side only) Push the switch completely down or pull it completely up and release to fully open or close. To stop window midway, lightly push the switch in the opposite direction.

Window lock switch Deactivates all passenger windows. Driver's window remains operable.

NOTE: If 12V battery is disconnected, the driver's window will need to be reinitialized. Refer to the *Owner's Manual* for more details.

Air Conditioning/Heating

Type 1 functions

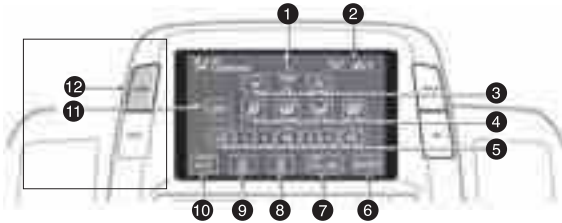

Type 2 functions

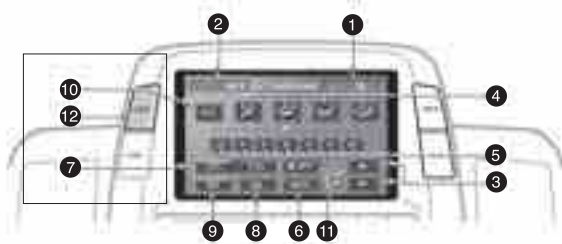

With navigation system*



- ① Passenger compartment temperature
- ② Outside temperature
- ③ Temperature selector
- ④ Airflow vent
- ⑤ Fan speed
- ⑥ Automatic climate control ON
- ⑦ Fresh or recirculated cabin air
- ⑧ Rear window and outside rearview mirror defogger
- ⑨ Windshield airflow
- ⑩ Air Conditioning ON/OFF
- ⑪ Climate control OFF
- ⑫ Display the operation screen

* For details, refer to the "Navigation System Owner's Manual."

Steering wheel switches

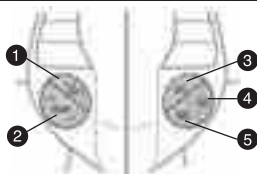

- ❶ Auto A/C ON/OFF
- ❷ Temperature selector
- ❸ Air intake selector
- ❹ Windshield vent
- ❺ Rear window and outside rearview mirror defogger

Cruise control (if equipped)

Turning system ON/OFF

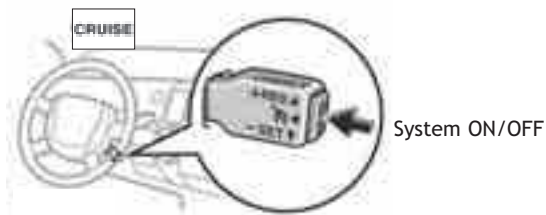

Setting a speed

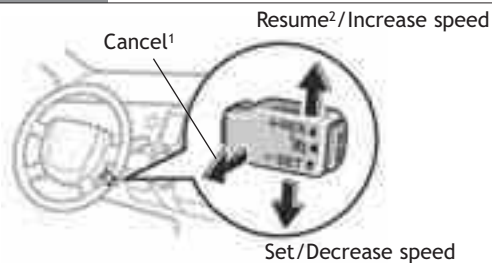

¹ The set speed may also be cancelled by depressing the brake pedal.

² If vehicle speed falls below 25 mph, the set speed will not be resumed.

Audio

Type 1

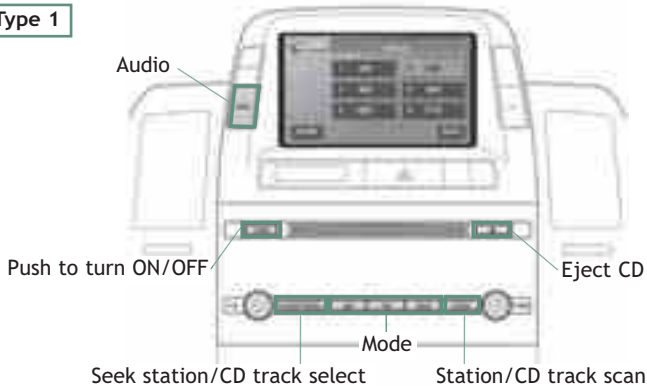

Type 2 additional functions

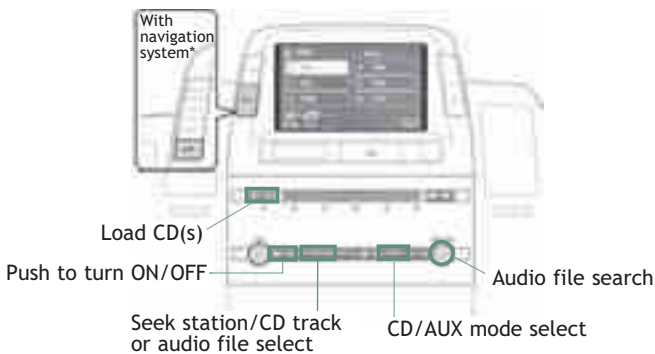

* For details, refer to the "Navigation System Owner's Manual."

Audio operation screen



RADIO

To preset a station Tune in the desired station and touch a station selector icon (1-6) until you hear a beep.

To scan for stations Push "SCAN." Push again to hold selection.

CD PLAYER

To scan tracks on a disc Touch "SCAN" icon on the display. Push again to hold selection.

CD changer (Type 2 only)

-To load one disc Push "LOAD" and insert one disc.

-To load multiple discs Push and hold "LOAD" until you hear a beep. Insert one disc. Shutter will close and then re-open for next disc.

To select a file (MP3/WMA only) Turn "TUNE•FILE."

Steering wheel switches

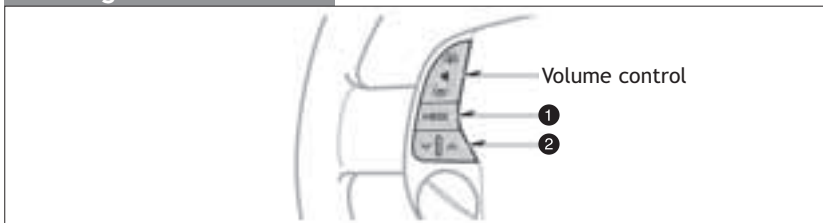

① "MODE"

Push to turn audio ON and select an audio mode.

Push and hold to turn the audio system OFF.

② "V ^ " switch

In radio mode Push to select a preset station; push and hold to seek the next strong station.

In CD mode Push to skip up or down to next/previous track.

AUX audio jack (if equipped)



By inserting a mini plug into the AUX audio jack, you can listen to music from a portable audio device through the vehicle's speaker system while in AUX mode.

Luggage storage box

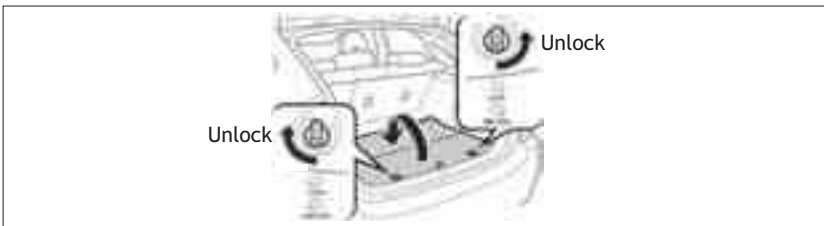

Telephone controls (Bluetooth®) (if equipped)

Display

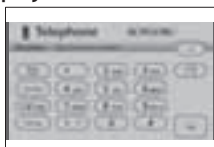

Microphone



Steering wheel telephone switches

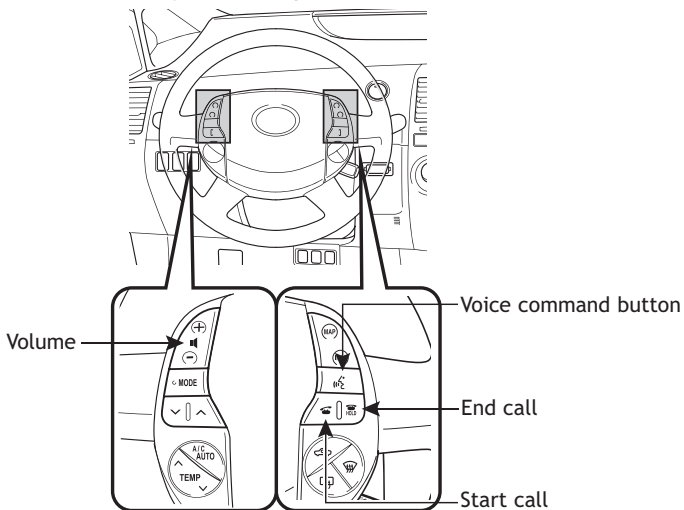

Bluetooth® technology allows dialing or receipt of calls without taking hands from the steering wheel or using a cable to connect the telephone and the system.

Refer to "Hands-free system (for cellular phone)," Section 3-4 in the *Owner's Manual* for more details.

Cup and bottle holders

Cup holder-Front



Cup holder-Rear

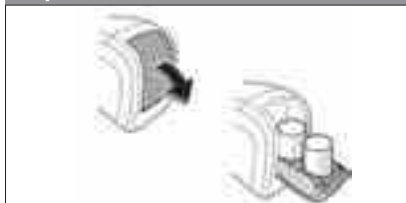

Bottle holder

Front door

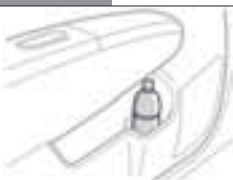

Power outlets

Instrument panel (12V)

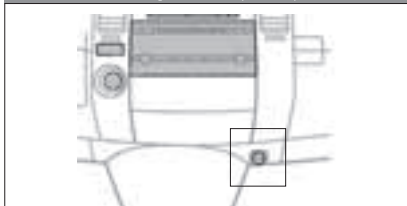

Center console box (12V)



The Hybrid System must be in "ACC" or "IG-ON."

Parking brake



Clock



SAFETY AND EMERGENCY FEATURES

Door locks

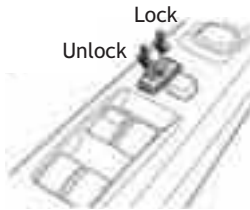

Doors-Child safety locks

Rear door

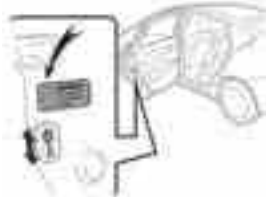

Moving the lever to "LOCK" will allow the door to be opened only from the outside.

Seat belts

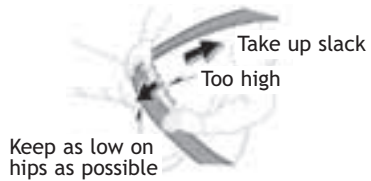

Keep as low on hips as possible

If belt is fully extended, then retracted even slightly, it cannot be re-extended beyond that point, unless fully retracted again. This feature is used to help hold child restraint systems securely.

To find more information about seat belts, and how to install a child restraint system, refer to the *Owner's Manual*.

Seat belts-Shoulder belt anchor



Push up, or squeeze lock release to lower

Emergency flashers



Rear air vent



Note: The air vent on the right side of the rear seatback is designed to assist in cooling the Hybrid vehicle battery. **DO NOT BLOCK OR COVER THIS VENT**, as it may cause overheating, resulting in reduced vehicle performance.

Tire Pressure Monitoring (warning) System

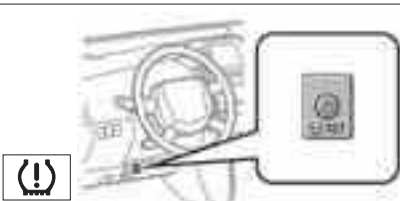

System reset initialization

1. Push and hold "SET" button until the indicator blinks three times.
2. Wait a few minutes to allow initialization to complete.

After adjusting tire pressures, or after tires have been rotated or replaced, turn the ignition switch to "ON" and press and hold the "SET" button until indicator blinks three times. Let the vehicle sit for a few minutes to allow initialization to complete.

Refer to the load label on the door jamb or the *Owner's Manual* for tire inflation specifications.

If the tire pressure indicator flashes for more than 60 seconds and then remains on, take the vehicle to your local Toyota dealer.

Note: The warning light may come on due to temperature changes or changes in tire pressure from natural air leakage. If the system has not been initialized recently, setting the tire pressures to factory specifications should turn off the light.

Jump starting

Jump start terminal

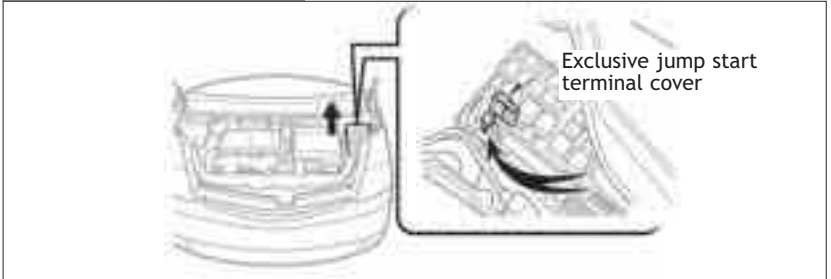

The jump start terminal is in the fuse box. To access the terminal, open the fuse block cover and the jump start terminal cover.

Connecting jumper cables

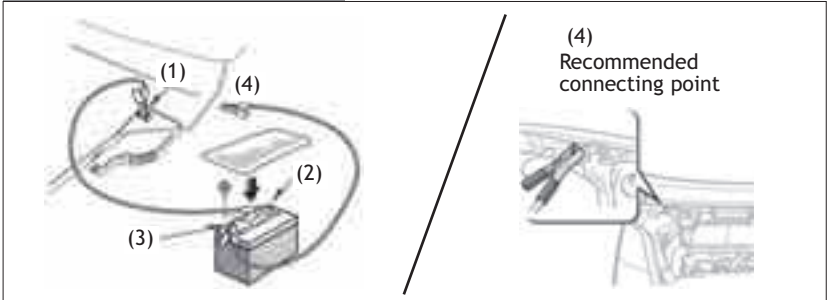

- (1) Connect positive (red) jumper cable to the jump start terminal.
- (2) Connect positive (red) jumper cable to the positive (+) terminal on the booster battery.
- (3) Connect negative (black) jumper cable to the negative (-) terminal on the booster battery.
- (4) Connect negative (black) jumper cable to the recommended connecting point of the vehicle with the discharged battery.
- (5) Depress brake pedal, and press "POWER" button to start the vehicle.

Refer to the "Owner's Manual" for more details.

Spare tire & tools

Tool location

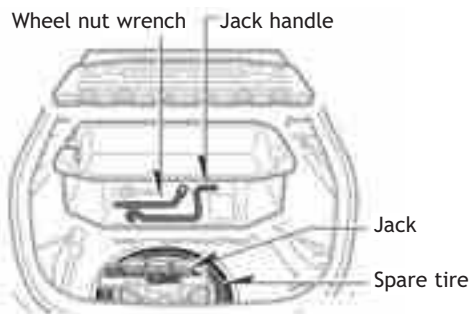

Removing the spare tire

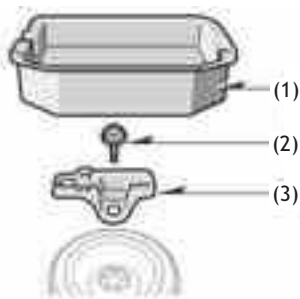

- (1) Remove the luggage storage box.
- (2) Loosen the bolt and remove it.
- (3) Remove the jack box.

Refer to the *"Owner's Manual"* for tire changing and jack positioning procedures.



Customer Experience Center
1-800-331-4331

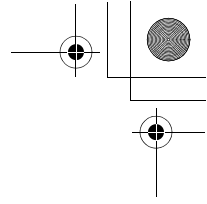
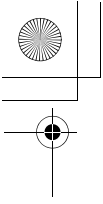

For your information

Main Owner's Manual

Please note that this manual applies to all models and explains all equipment, including options. Therefore, you may find some explanations for equipment not installed on your vehicle.

All specifications provided in this manual are current at the time of printing. However, because of the Toyota policy of continual product improvement, we reserve the right to make changes at any time without notice.

Depending on specifications, the vehicle shown in the illustration may differ from your vehicle in terms of equipment.

Accessories, spare parts and modification of your Toyota

A wide variety of non-genuine spare parts and accessories for Toyota vehicles are currently available in the market. You should know that Toyota does not warrant these products and is not responsible for their performance, repair, or replacement, or for any damage they may cause to, or adverse effect they may have on, your Toyota vehicle.

This vehicle should not be modified with non-genuine Toyota products. Modification with non-genuine Toyota products could affect its performance, safety or durability, and may even violate governmental regulations. In addition, damage or performance problems resulting from the modification may not be covered under warranty.

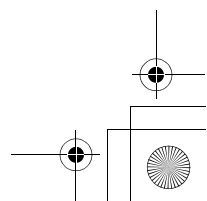
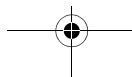
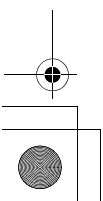

Installation of a mobile two-way radio system

As the installation of a mobile two-way radio system in your vehicle could affect electronic systems such as the multiport fuel injection system/sequential multiport fuel injection system, cruise control system, anti-lock brake system, vehicle stability control system, SRS airbag system and seat belt pretensioner system and Toyota hybrid system, be sure to check with your Toyota dealer for precautionary measures or special instructions regarding installation.

High voltage parts and cables on the hybrid vehicles emit approximately the same amount of electromagnetic waves as the conventional gasoline powered vehicles or home electronic appliances despite of their electromagnetic shielding.

Unwanted noise may occur in the reception of the mobile two-way radio.

Scraping of your Toyota

The SRS airbag and seat belt pretensioner devices in your Toyota contain explosive chemicals. If the vehicle is scrapped with the airbags and seat belt pretensioners left as they are, this may cause an accident such as fire. Be sure to have the systems of the SRS airbag and seat belt pretensioner removed and disposed of by a qualified service shop or by your Toyota dealer before you scrap your vehicle.

Perchlorate Material

Special handling may apply,
See www.dtsc.ca.gov/hazardouswaste/perchlorate.

Your vehicle has components that may contain perchlorate. These components may include airbag, seat belt pretensioners, and wireless remote control batteries.

 **CAUTION****n General precautions while driving**

Driving under the influence: Never drive your vehicle when under the influence of alcohol or drugs that have impaired your ability to operate your vehicle. Alcohol and certain drugs delay reaction time, impair judgment and reduce coordination, which could lead to an accident that will result in death or serious injury to you, your occupants or others.

Defensive driving: Always drive defensively. Anticipate mistakes that other drivers or pedestrians might make and be ready to avoid accidents.

Driver distraction: Always give your full attention to driving. Anything that distracts the driver, such as adjusting controls, talking on a cellular phone or reading can result in a collision with resulting death or serious injury to you, your occupants or others.

n When children are in the vehicle

Never leave children unattended in the vehicle, and never allow children to have or use the key.

When left unattended, children may be able to start the vehicle or shift the vehicle into neutral. There is also a danger that children may injure themselves by playing with the cigarette lighter, the windows, the moon roof, or other features of the vehicle. In addition, heat build-up or extremely cold temperatures inside the vehicle can be fatal to children.

n Dispose of the hybrid battery (traction battery)

If your vehicle is disposed of without the hybrid battery having been removed, there is a danger of serious electric shock if high voltage parts, cables and their connectors are touched. In the event of that your vehicle must be disposed of, the hybrid battery must be disposed of your Toyota dealer or a qualified service shop. If the hybrid battery is not disposed of properly, they may cause electric shock that can result in death or serious injury.

Symbols used throughout this manual

Cautions & Notices

CAUTION

This is a warning against anything which may cause injury to people if the warning is ignored. You are informed about what you must or must not do in order to reduce the risk of injury to yourself and others.

NOTICE

This is a warning against anything which may cause damage to the vehicle or its equipment if the warning is ignored. You are informed about what you must or must not do in order to avoid or reduce the risk of damage to your Toyota and its equipment.

Symbols used in illustrations



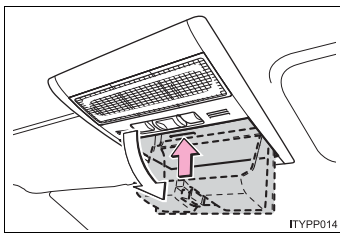

Safety symbol

The symbol of a circle with a slash through it means “Do not”, “Do not do this”, or “Do not let this happen”.



Arrows indicating operations

-  Indicates the action (pushing, turning, etc.) used to operate switches and other devices.
-  Indicates the outcome of an operation (e.g. a lid opens).

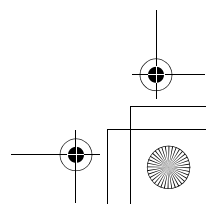
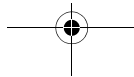
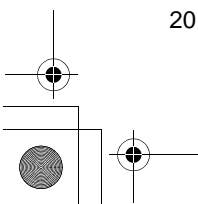
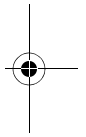
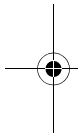
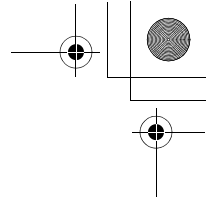
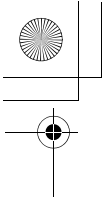
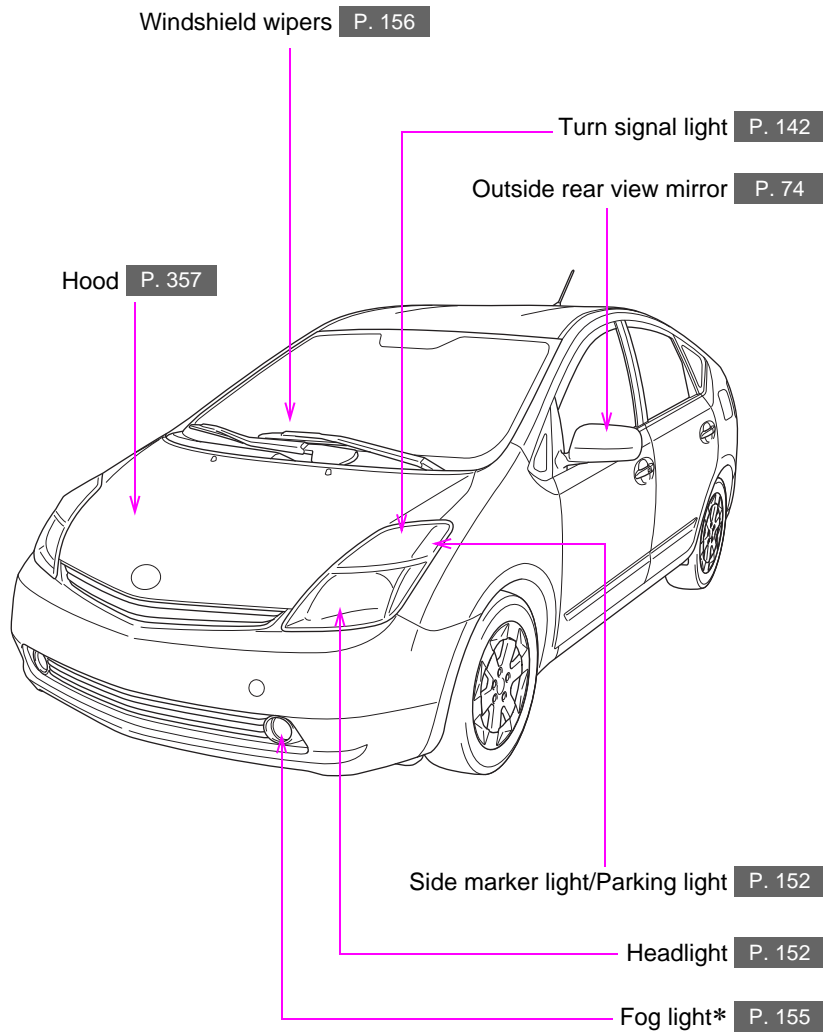

TABLE OF CONTENTS

1	Before driving	Adjusting and operating features such as door locks, mirrors, and steering column.
2	When driving	Driving, stopping and safe-driving information.
3	Interior features	Air conditioning and audio systems, as well as other interior features for a comfortable driving experience.
4	Maintenance and care	Cleaning and protecting your vehicle, performing do-it-yourself maintenance, and maintenance information.
5	When trouble arises	What to do if the vehicle needs to be towed, gets a flat tire, or is involved in an accident.
6	Vehicle specifications	Detailed vehicle information.
7	For owners	Reporting safety defects for U.S. owners and seat belt instructions for Canadian owners.
	Index	Alphabetical listing of information contained in this manual.

Pictorial index

Exterior



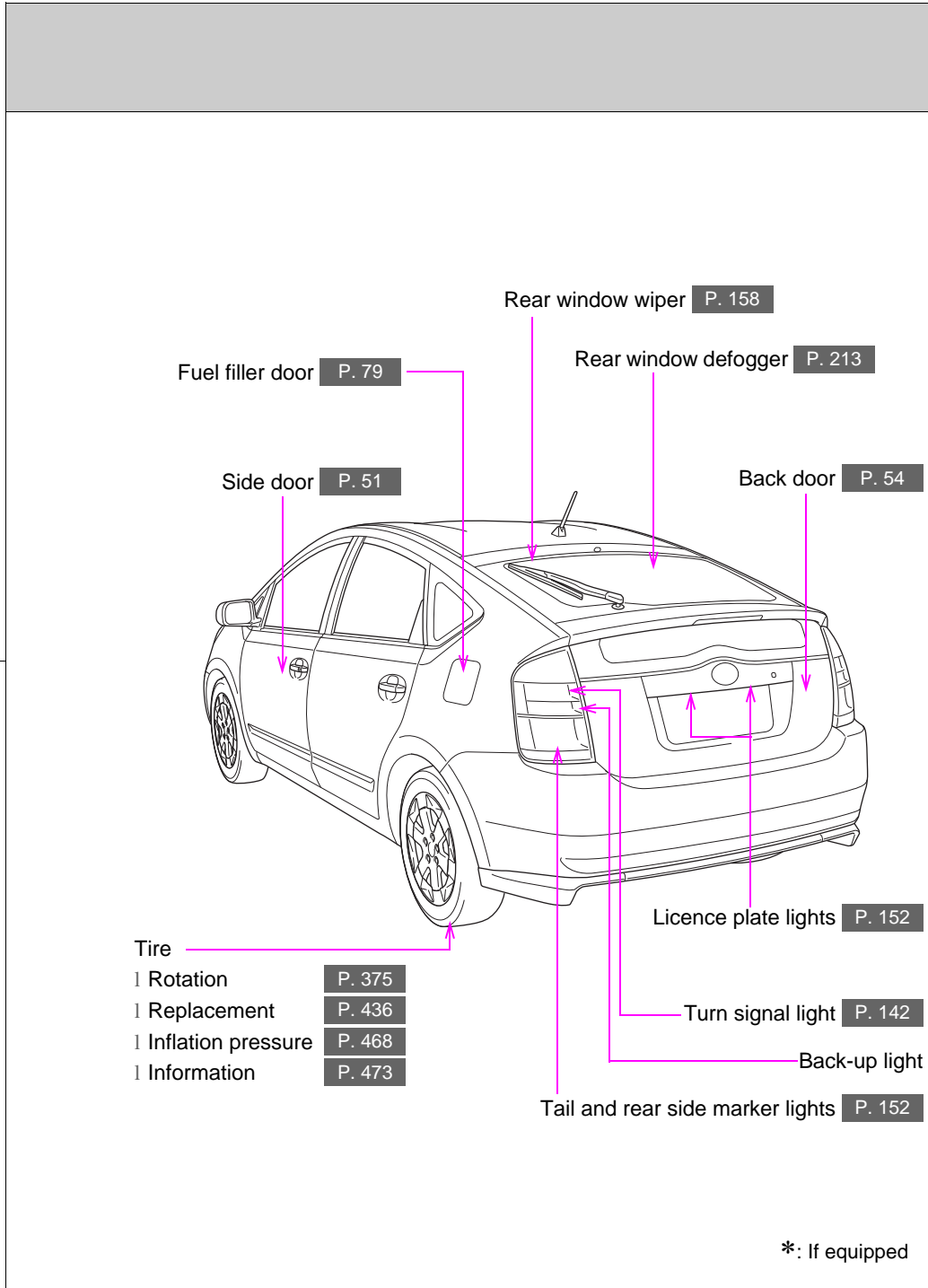

Pictorial index

Interior

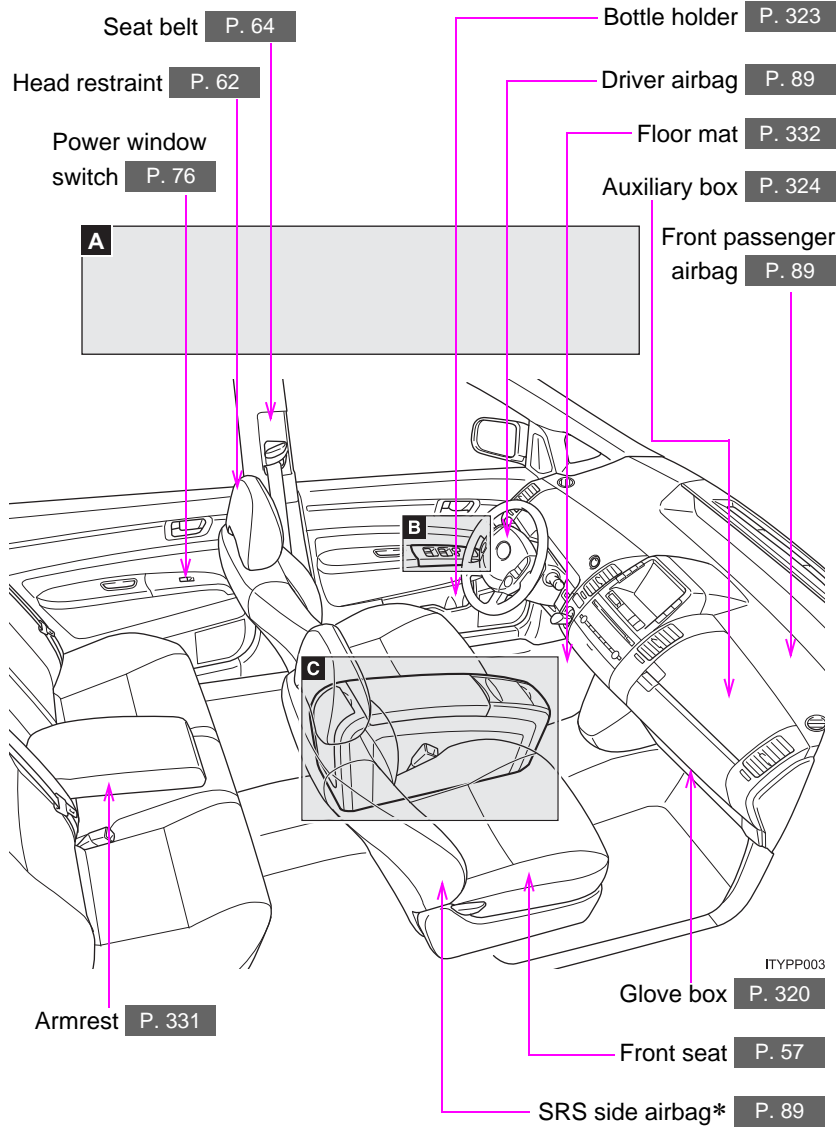

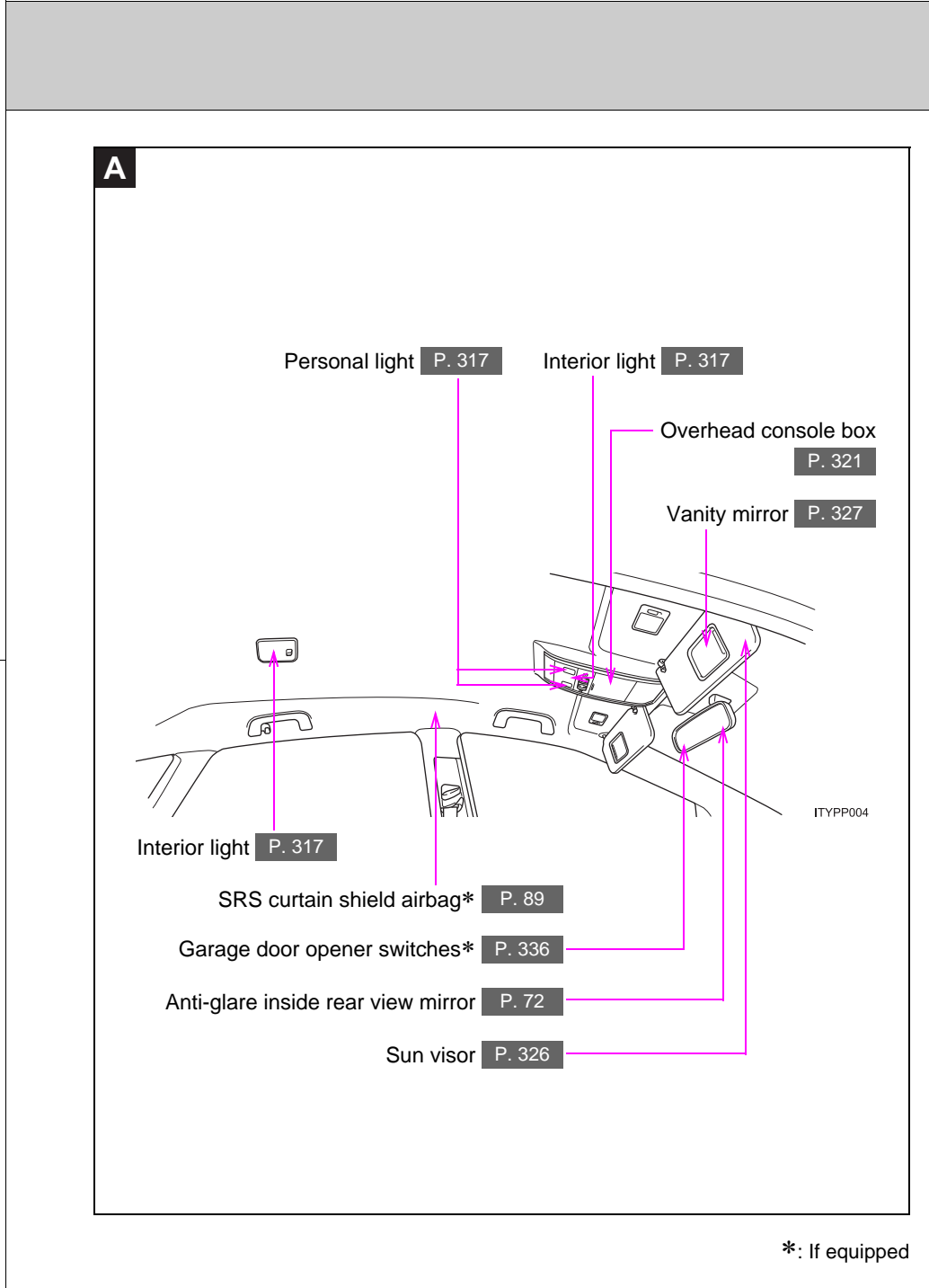

Pictorial index

Interior

B

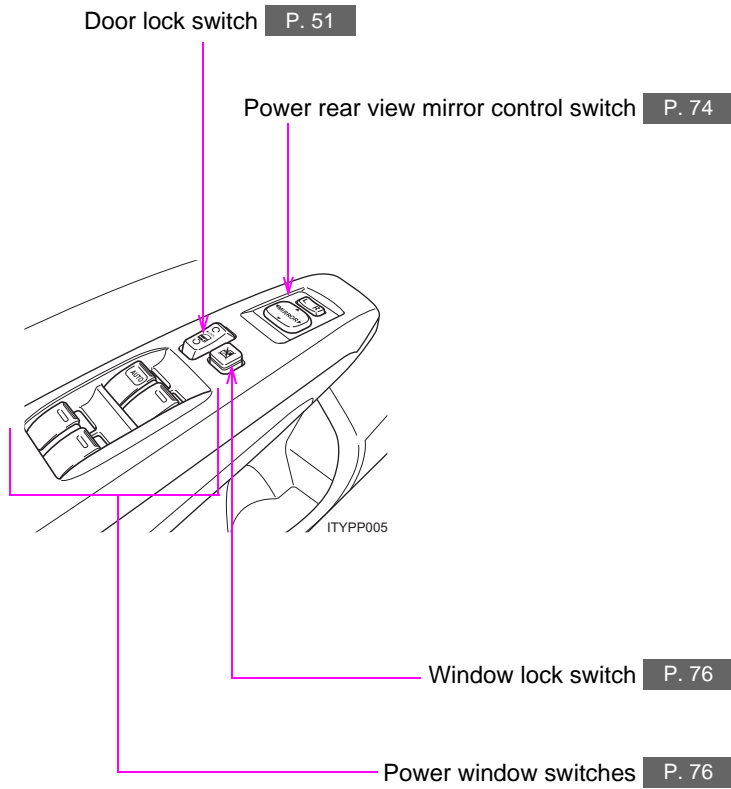

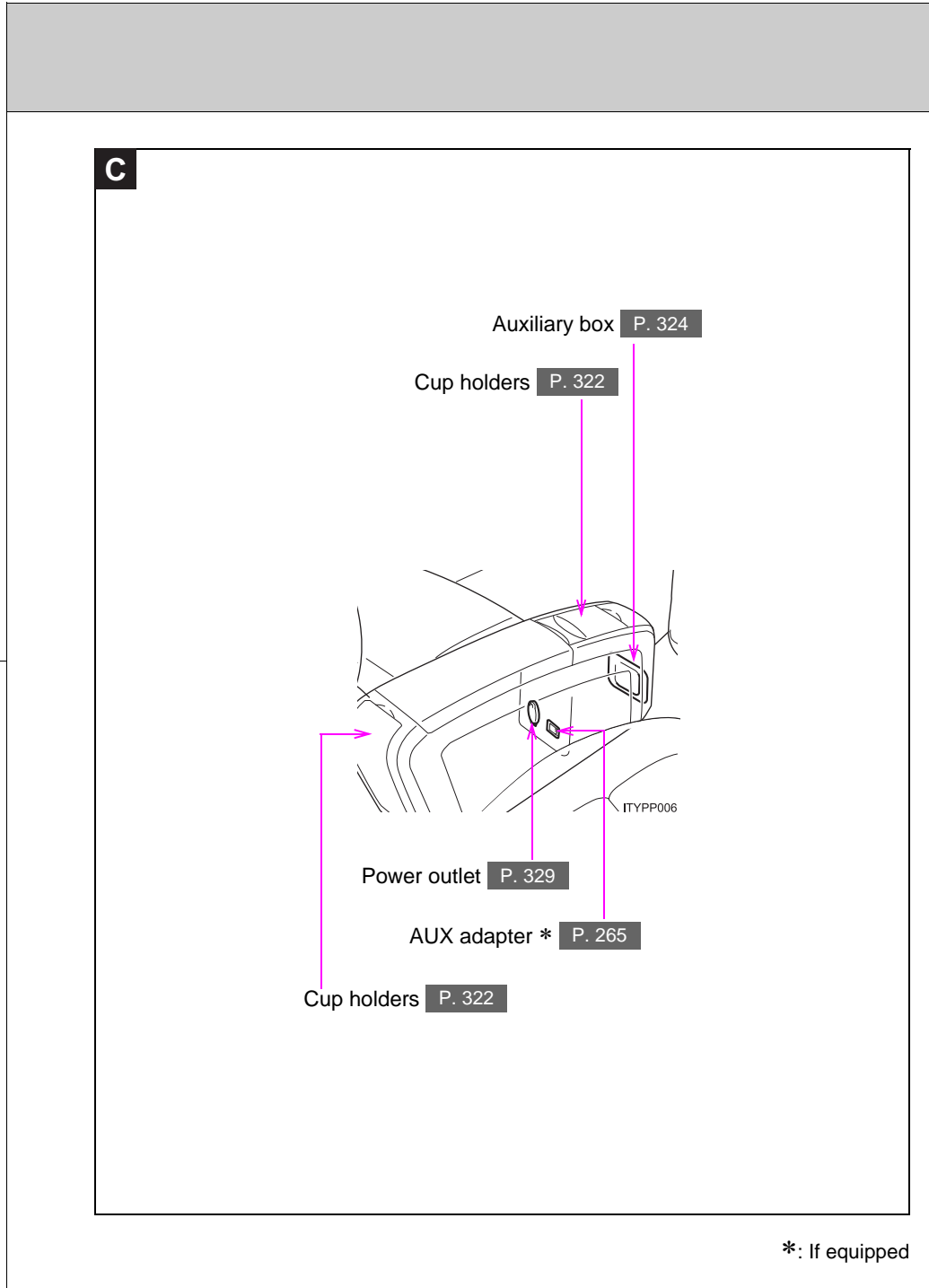

Pictorial index

Instrument panel

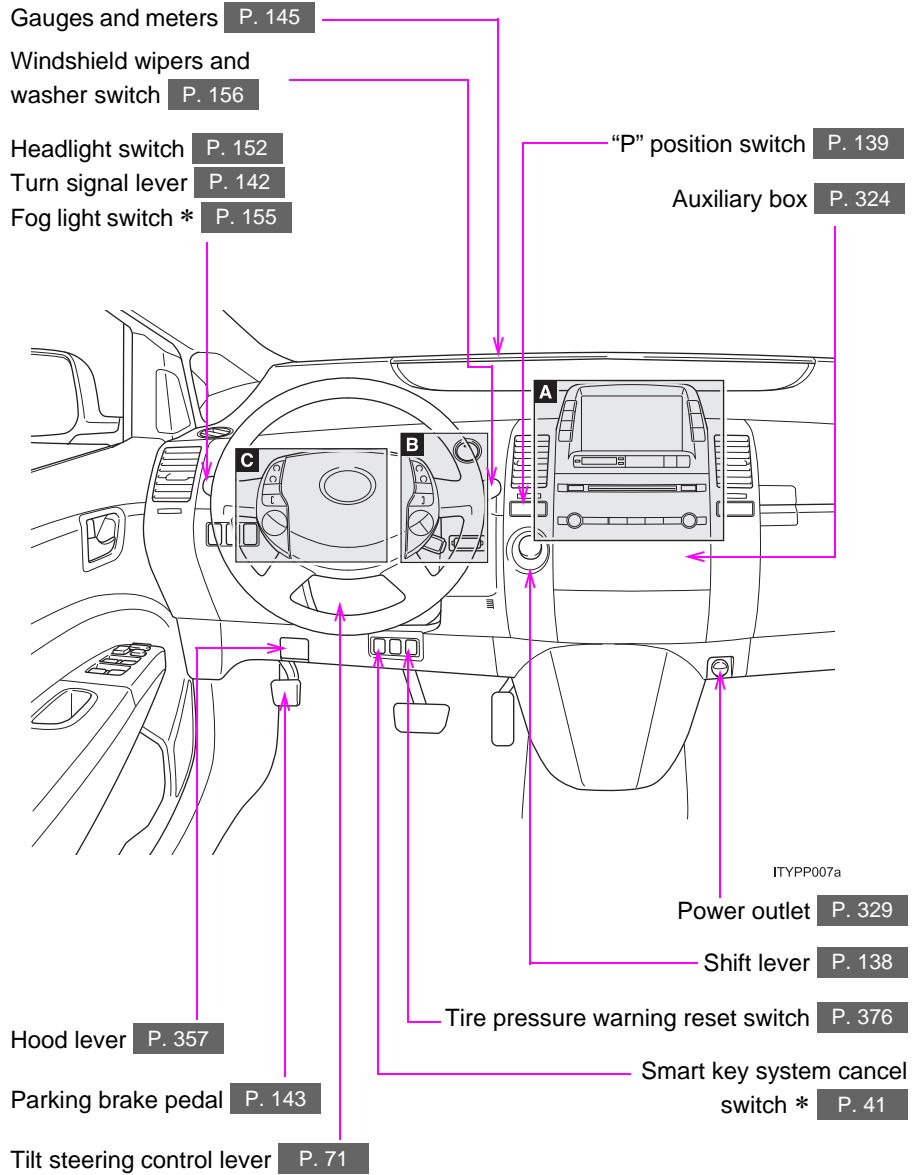

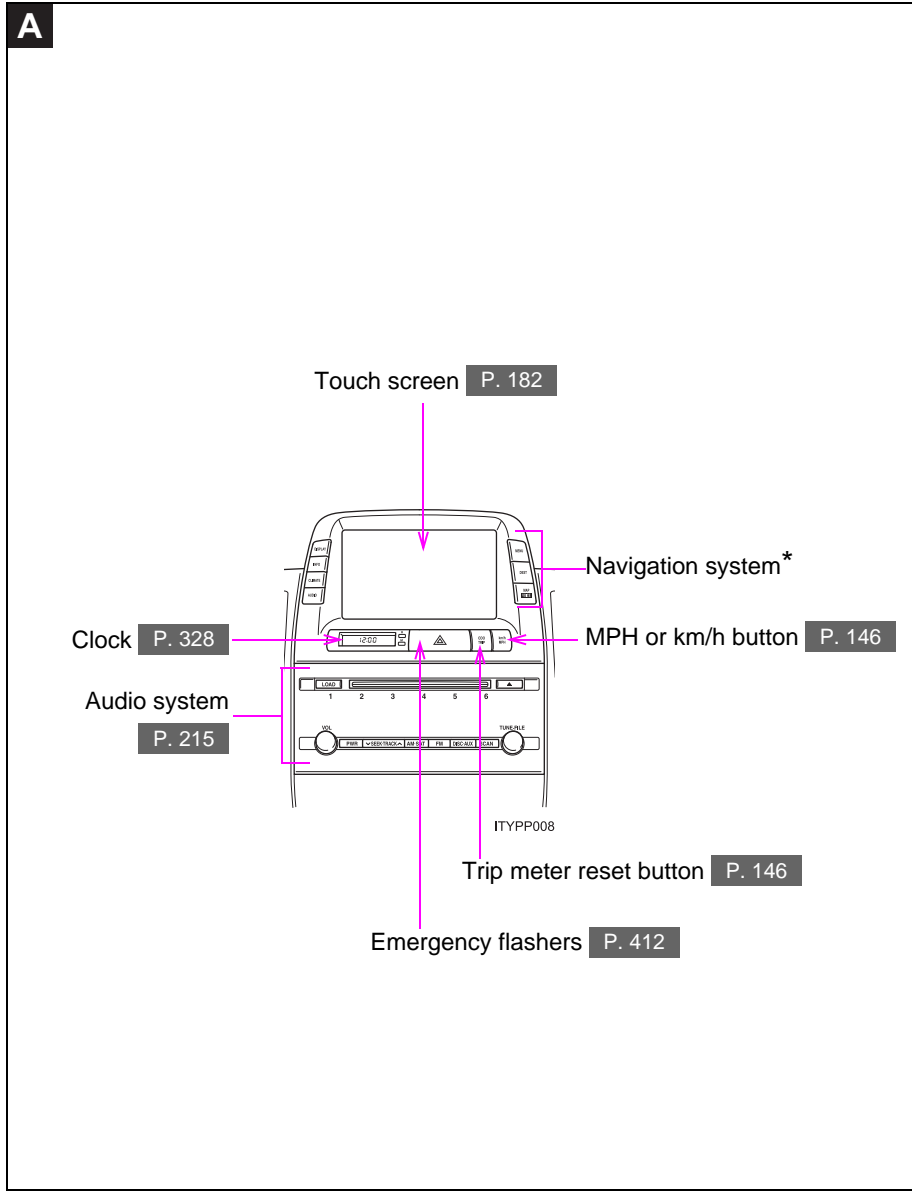

*: If equipped
*: Refer to "Navigation System Owner's Manual".

Pictorial index

Instrument panel

B

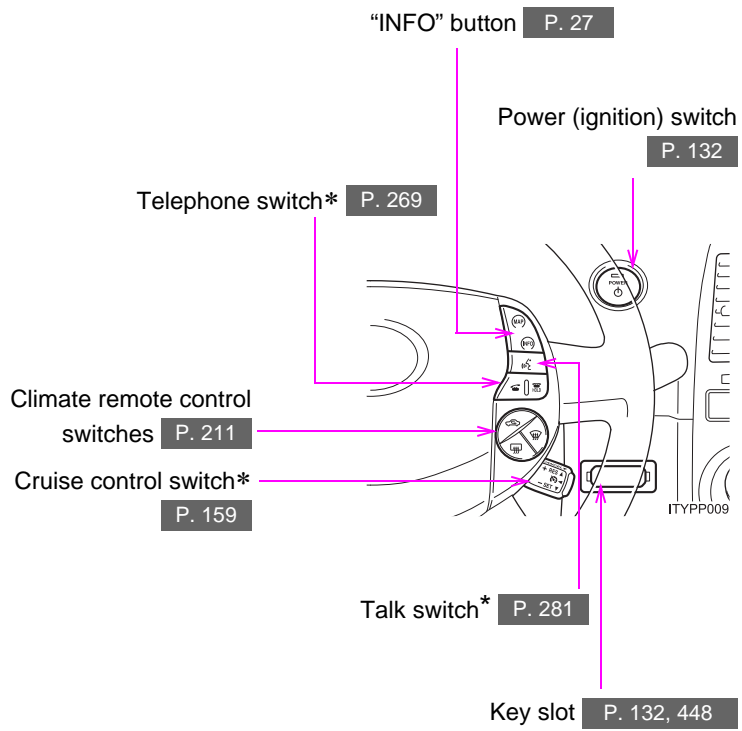

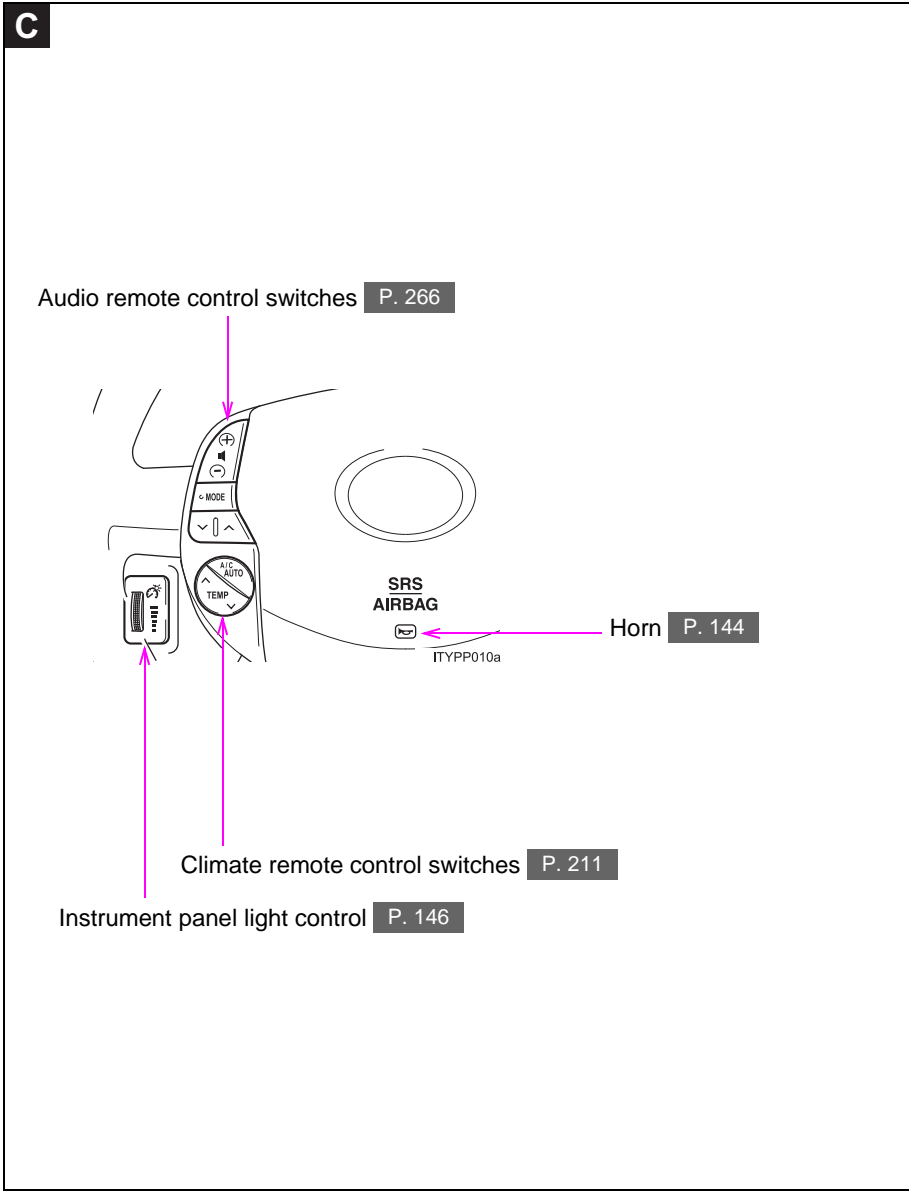

*: If equipped
*: Refer to "Navigation System Owner's Manual".

TABLE OF CONTENTS | Index

1 Before driving

1-1. Hybrid system
Hybrid system 22

1-2. Key information
Keys 34

1-3. Opening, closing and locking the doors and back door
Smart key system..... 36
Wireless remote control 49
Side doors 51
Back door 54

1-4. Adjustable components (seats, mirrors, steering wheel)
Front seats 57
Rear seats..... 59
Head restraints..... 62
Seat belts 64
Steering wheel 71
Anti-glare inside rear view mirror..... 72
Outside rear view mirrors 74

1-5. Opening and closing the windows and moon roof
Power windows 76

1-6. Refueling
Opening the fuel tank cap..... 79

1-7. Theft deterrent system
Immobilizer system..... 82
Alarm 84
Theft prevention labels (U.S.A.)..... 86

1-8. Safety information
Correct driving posture 87
SRS airbags 89
Front passenger occupant classification system..... 101
Child restraint systems 107
Installing child restraints 111

2 When driving

2-1. Driving procedures
Driving the vehicle 122
Power (ignition) switch..... 132
Transmission 138
Turn signal lever 142
Parking brake 143
Horn..... 144

2-2. Instrument cluster
Gauges and meters 145
Indicators and warning lights 148

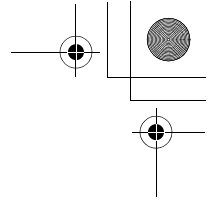
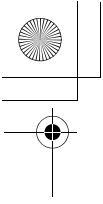

2-3. Operating the lights and windshield wipers

Headlight switch.....	152
Fog light switch	155
Windshield wipers and washer	156
Rear window wiper and washer	158

2-4. Using other driving systems

Cruise control.....	159
Rear view monitor system...	163
Driving assist systems	166

2-5. Driving information

Cargo and luggage	169
Vehicle load limits	172
Winter driving tips	173
Trailer towing	177
Dinghy towing	178

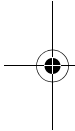

3 Interior features

3-1. Using the touch screen

Touch screen	182
Setting the touch screen (Vehicles with AUX adapter)	187
Setting the touch screen (Vehicles without AUX adapter)	192

3-2. Using the air conditioning system and defogger

Automatic air conditioning system (Vehicles with AUX adapter)	197
Automatic air conditioning system (Vehicles without AUX adapter)	204
Using the steering wheel climate remote control switches	211
Rear window and outside rear view mirror defoggers	213



3-3. Using the audio system

Audio system type (Vehicle with AUX adapter)	215
Audio system type (Vehicle without AUX adapter)	218
Using the radio (Vehicle with AUX adapter)	221
Using the radio (Vehicle without AUX adapter)	230
Using the CD player (Vehicle with AUX adapter)	235
Using the CD player (Vehicle without AUX adapter)	243
Playing MP3 and WMA discs	250
Optimal use of the audio (Vehicle with AUX adapter)	259

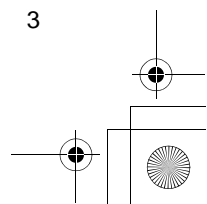
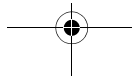
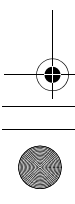

TABLE OF CONTENTS | Index

Optimal use of the audio system (Vehicle without AUX adapter) 263

Using the AUX adapter 265

Using the steering switches 266

3-4. Using the hands-free system (for cellular phone)

Hands-free system (for cellular phone) 269

Using the Bluetooth® phone 274

Setting the hands-free system (for cellular phone) 288

3-5. Using the interior lights

Interior lights list 315

3-6. Using the storage features

List of storage features 319

3-7. Other interior features

Sun visors 326

Vanity mirror 327

Clock 328

Power outlet 329

Armrest 331

Floor mats 332

Luggage compartment features 333

Garage door opener 336

4 Maintenance and care

4-1. Maintenance and care

Cleaning and protecting the vehicle's exterior 342

Cleaning and protecting the vehicle's interior 344

4-2. Maintenance

Maintenance requirements 347

General maintenance 349

Emission inspection and maintenance (I/M) programs 352

4-3. Do-it-yourself maintenance

Do-it-yourself service precautions 353

Hood 357

Positioning a floor jack 358

Engine compartment 360

Tires 375

Tire inflation pressure 384

Wheels 388

Air conditioning filter 390

Electronic key battery 392

Checking and replacing fuses 394

Light bulbs 403

5 When trouble arises

5-1. Essential information

Emergency flashers	412
If your vehicle needs to be towed	413
If you think something is wrong	420
Event data recorder	421

5-2. Steps to take in an emergency

If a warning light turns on or a warning buzzer sounds.....	423
If you have a flat tire.....	436
If the hybrid system will not start.....	446
If you lose your keys	447
If the electronic key does not operate properly.....	448
If the 12 volt battery is discharged	449
If your vehicle overheats	454
If the vehicle becomes stuck	457

6 Vehicle specifications

6-1. Specifications

Maintenance data (fuel, oil level, etc.)	460
Fuel information.....	470
Tire information	473

6-2. Customization

Customizable features.....	486
----------------------------	-----

6-3. Initialization

Items to initialize.....	489
--------------------------	-----

7 For owners

Reporting safety defects for U.S. owners.....	492
Seat belt instructions for Canadian owners (in French).....	493

Index

Abbreviation list	496
Alphabetical index.....	498
What to do if... ..	504

1-1. Hybrid system Hybrid system

Your vehicle is a hybrid vehicle. It has characteristics different from conventional vehicles. Be sure you are closely familiar with the characteristics of your vehicle, and operate with care.

The hybrid system combines a gasoline engine and an electric motor (traction motor) according to driving conditions, improving fuel efficiency and reducing exhaust emissions.

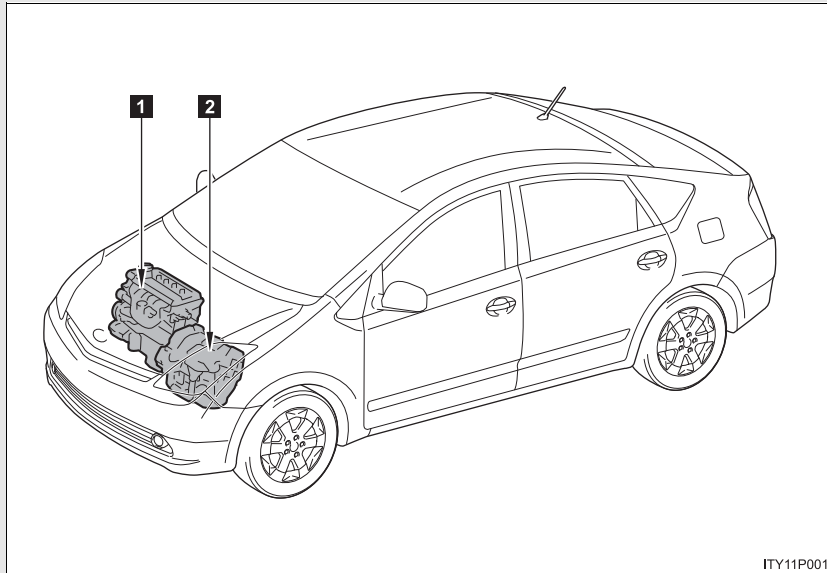

- 1** Gasoline engine
- 2** Electric motor (Traction motor)

ITY11P001

1-1. Hybrid system

n **When stopped/during take-off**

The gasoline engine stops when the vehicle is stopped. During take-off, the electric motor (traction motor) drives the vehicle. At slow speeds or when traveling down a gentle slope, the engine is stopped and the motor is used.

n **During normal driving**

The gasoline engine is predominantly used. The electric motor (traction motor) charges the hybrid battery (traction battery) as necessary.

n **When accelerating sharply**

The power of the hybrid battery (traction battery) is added via electric motor (traction motor) to that of the gasoline engine.

n **When braking (Regenerative brake)**

The electric motor (traction motor) charges the hybrid battery (traction battery).

1

Before driving

n **Regenerative braking**

The motor generator converts kinetic energy to electric energy when:

- l The accelerator pedal is released.
- l The brake pedal is depressed with the shift lever in "D" or "B".

n **Conditions in which the gasoline engine may not stop**

The gasoline engine starts and stops automatically. However, it may not stop automatically in the following conditions:

- l The gasoline engine is warming up.
- l The hybrid battery (traction battery) is being charged.
- l The hybrid battery (traction battery) temperature is low or high.

1-1. Hybrid system

n **Charging the battery**

- l As the gasoline engine charges the hybrid battery (traction battery), the battery does not need to be charged from an outside source. However, if the vehicle is left parked for a long time the hybrid battery will slowly discharge. For this reason, be sure to drive the vehicle at least once every several months for at least 30 minutes or 10 miles (16 km). If the hybrid battery becomes fully discharged and you are unable to jump-start the vehicle with the 12 volt battery, contact your Toyota dealer.
- l If the shift lever is in "N", the hybrid battery (traction battery) will not be charged. When driving in heavy traffic, operate the vehicle with the shift lever in "D" to avoid discharging the battery.

n **After the 12 volt battery has discharged or has been changed or removed**

The gasoline engine may not stop even if the vehicle is running on the hybrid battery (traction battery). If this continues for a few days, contact your Toyota dealer.

1-1. Hybrid system

n **Sounds and vibrations specific to a hybrid vehicle**

There may be no engine sounds or vibration even though the vehicle is able to move. Always put the shift lever in "P" when parked.

The following sounds or vibrations may occur when the hybrid system is operating, and are not a malfunction.

- l Motor sounds may be heard from the engine compartment.
- l Sounds may be heard from the hybrid battery (traction battery) behind the rear seat when the hybrid system starts or stops.
- l Sounds from the hybrid system may be heard when the back door lid is open.
- l Sounds may be heard from the transmission when the hybrid system starts or stops.
- l Engine sounds may be heard when accelerating sharply.
- l Sounds may be heard from the regenerative brake when you press the brake pedal.
- l Vibration may be felt when the gasoline engine starts or stops.
- l You may hear cooling fan sounds coming from the air intake vents behind the rear seat.

n **Maintenance, repair, recycling, and disposal**

Contact your Toyota dealer regarding maintenance, repair, recycling and disposal. Do not dispose of the vehicle yourself.

1

Before driving

1-1. Hybrid system

High voltage components

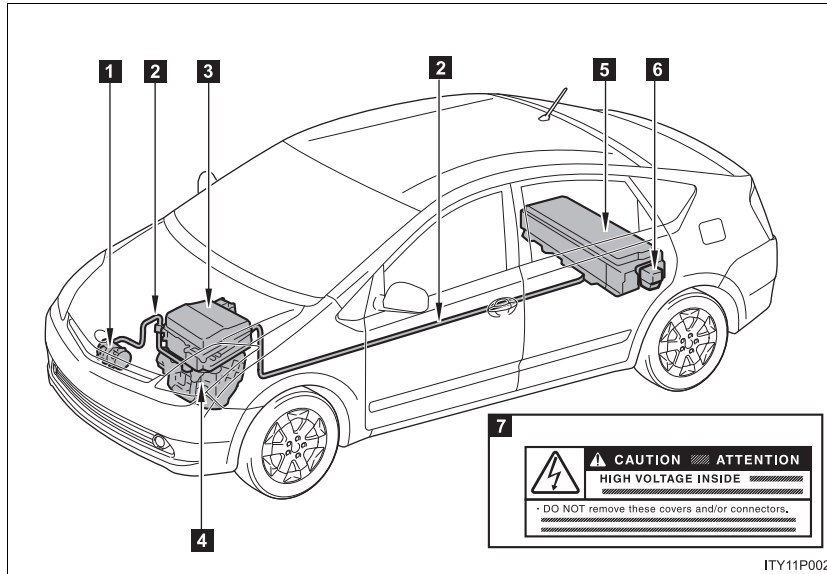

- 1** Air conditioning compressor
- 2** High voltage cables (orange color)
- 3** Power control unit
- 4** Electric motor (Traction motor)
- 5** Hybrid battery (Traction battery)
- 6** Service plug
- 7** Caution label

Take care when handling the hybrid system, as it contains a high voltage system (about 500V at maximum) as well as parts that become extremely hot when the hybrid system is operating. Obey the caution labels attached to the vehicle.

n Hybrid battery air vent

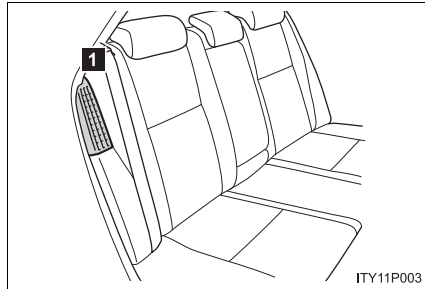

1 Hybrid battery air vent

There is an air intake vent on the side of the rear right seatback for the purpose of cooling the hybrid battery (traction battery). If the vent becomes blocked, the hybrid battery may overheat, leading to a reduction in hybrid battery output.

1
Before driving

Emergency shut off system

The emergency shut off system blocks off the high voltage current and stops the fuel pump to minimize the risk of electrocution and fuel leakage when a certain level of impact is detected by the impact sensor. If the emergency shut off system activates, your vehicle will not restart. To restart the hybrid system, contact your Toyota dealer.

Energy monitor/consumption screen

You can view the status of your hybrid system on the touch screen (→P. 182). The following images are examples only, and may vary slightly from actual conditions.



1-1. Hybrid system

n Energy monitor

How to display on the touch screen:

STEP 1 Press  .





STEP 2 Touch  or  on the “Information” screen.

If the “Consumption” screen is displayed, touch  or  .

How to display with steering switch:

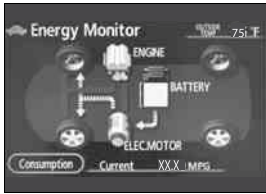
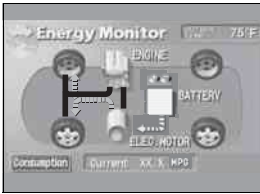
STEP 1 Press  .

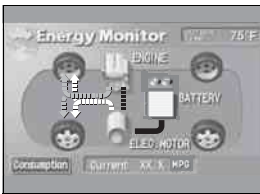
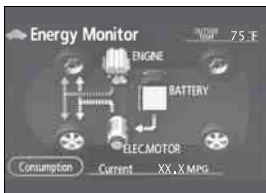
If the “Consumption” screen is displayed, press  .

	Touch screen	
	Type A	Type B
When the vehicle is powered by the electric motor (traction motor)		
When the vehicle is powered by both the gasoline engine and the electric motor (traction motor)		
		

1-1. Hybrid system

	Touch screen	
	Type A	Type B
When the vehicle is charging the hybrid battery (traction battery)		
When there is no energy flow		
Hybrid battery (traction battery) status	Low ↔ Full	Low ↔ Full

1

Before driving



1-1. Hybrid system

n Consumption

How to display on the touch screen:

STEP 1 Press .

STEP 2 Touch  or  on the "Information" screen.

If the "Energy Monitor" screen is displayed, touch  or .

How to display with steering switch:

STEP 1 Press .

If the "Consumption" screen is displayed, press .

► Type A

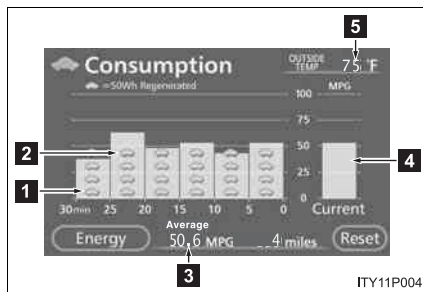

1 Fuel consumption in the past 30 minutes

2 Regenerated energy in the past 30 minutes

One symbol indicates 50 Wh. Up to 4 symbols are shown.

3 Average fuel consumption

4 Instantaneous fuel consumption

5 Outside temperature

► Type B

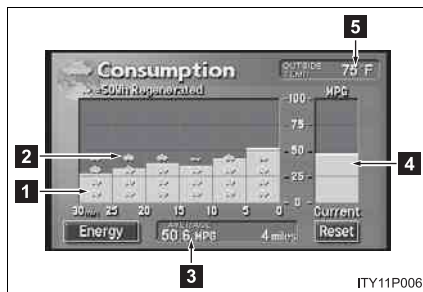

n Resetting the consumption data

Touching **Reset** or **Reset** will reset the “Average fuel consumption”.

Hybrid warning message

A message is automatically displayed when a malfunction occurs in the hybrid system or an improper operation is attempted.

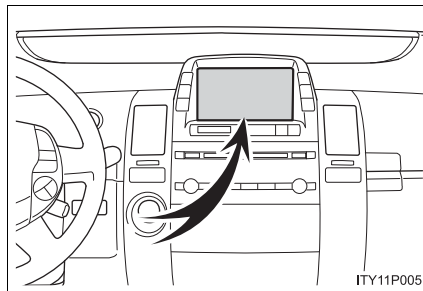

If a warning message is shown on the touch screen, read the message and follow the instructions.

1

Before driving

n If a warning light comes on or a warning message is displayed, or the 12 volt battery is disconnected

The hybrid system may not start. In that case, try to start the system again. If the “READY” light does not come on, contact your Toyota dealer.

1-1. Hybrid system

 **CAUTION****n High voltage precautions**

The vehicle has high voltage DC and AC systems as well as a 12 volt system. DC and AC high voltage is very dangerous and can cause severe burns and electric shock that may result in death or serious injury.

- I** Never touch, disassemble, remove or replace the high voltage parts, cables and their connectors.
- I** The hybrid system will become hot after starting as the system uses high voltage. Be careful of both the high voltage and the high temperature, and always obey the caution labels attached to the vehicle.
- I** Never try to open the service plug access hole located in the luggage compartment. The service plug is used only when the vehicle is serviced and is subject to high voltage.

n Nickel-metal hydride battery

Your vehicle contains a sealed nickel-metal hydride battery. If disposed of improperly, it is hazardous to the environment and there is a risk of severe burns and electrical shock that may result in death or serious injury.

n Emergency shut off system

- I** Carefully check to see if there are exposed high voltage parts or cables. Never touch the parts or cables. (→P. 26)
- I** Carefully inspect the ground under the vehicle. If you find that liquid has leaked onto the ground, the fuel system may have been damaged. Leave the vehicle as soon as possible.

⚠ CAUTION

n Road accident cautions

Observe the following precautions to reduce the risk of injury.

- I** Pull your vehicle off the road, put the shift lever in "P", apply the parking brake, turn the hybrid system off.
- I** Do not touch the high voltage parts, cables and connectors.
- I** If electric wires are exposed inside or outside your vehicle, an electric shock may occur. Never touch exposed electric wires.
- I** If a fluid leak occurs, do not touch it as it may be strong alkaline electrolyte from the hybrid battery (traction battery). If it comes into contact with your skin or eyes, wash it off immediately with a large amount of water or if possible, boric acid solution. Seek immediate medical attention.
- I** If a fire occurs in the hybrid vehicle, leave the vehicle as soon as possible. Never use a fire extinguisher that is not meant for electric fires. Using even a small amount of water may be dangerous.
- I** If your vehicle needs to be towed, do so with the front wheels raised. If the wheels with the electric motor (traction motor) are on the ground when towing, the motor may continue to generate electricity. This may cause an electricity leakage leading to a fire. (→P. 413)

1

Before driving

⚠ NOTICE

n Hybrid battery air vent

- I** Do not put foreign objects over the air vent. The hybrid battery (traction battery) may overheat and be damaged.
- I** Clean the air vent regularly to prevent the hybrid battery (traction battery) from overheating.
- I** Do not wet the air vent. It may cause a short circuit and damage the hybrid battery (traction battery).
- I** Do not load a large amount of water such as an aquarium into the vehicle. If water spills over the hybrid battery (traction battery), the battery may be damaged.

1-2. Key information Keys

The following keys are provided with the vehicle.

► Vehicles with smart key system

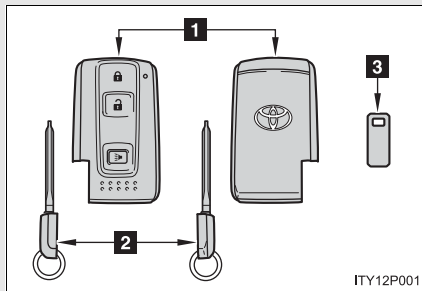

1 Electronic keys

- Operating the smart key system (→P. 36)
- Operating the wireless remote control function (→P. 49)

2 Mechanical keys

3 Key number plate

► Vehicle without smart key system

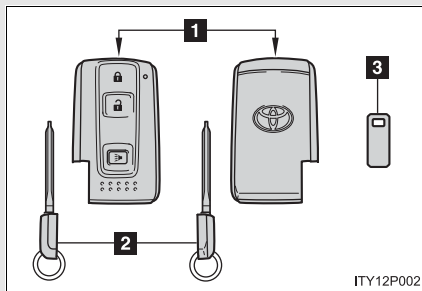

1 Electronic keys

Operating the wireless remote control function (→P. 49)

2 Mechanical keys

3 Key number plate

Using the mechanical key

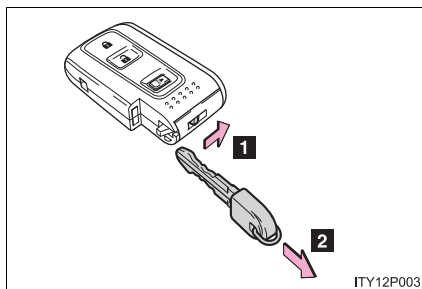

Take out the mechanical key.

After using the mechanical key, store it in the electronic key. Carry the mechanical key together with the electronic key. If the electronic key battery is depleted or the smart key system does not operate properly, you will need the mechanical key.

1-2. Key information

n Key number plate

Keep the plate in a safe place such as your wallet, not in the vehicle. In the event that a mechanical key is lost, a new key can be made at your Toyota dealer using the key number plate. (→P. 447)

n When riding in an aircraft

When bringing an electronic key onto an aircraft, make sure you do not press any buttons on the electronic key while inside the aircraft cabin. If you are carrying an electronic key in your bag etc, ensure that the buttons are not likely to be pressed accidentally. Pressing a button may cause the electronic key to emit radio waves that could interfere with the operation of the aircraft.

1

Before driving

 NOTICE

n To prevent key damage

- l** Do not bend the keys, subject them to storing impact, expose them to high temperatures by placing them in direct sunlight, or get them wet.
- l** Do not expose the keys to electromagnetic materials or attach any material that blocks electromagnetic waves to the key surface.
- l** Do not disassemble the electronic key.

1-3. Opening, closing and locking the doors and back door Smart key system*

The following operations can be performed simply by carrying the electronic key, for example in your pocket.
(The driver should always carry the electronic key.)

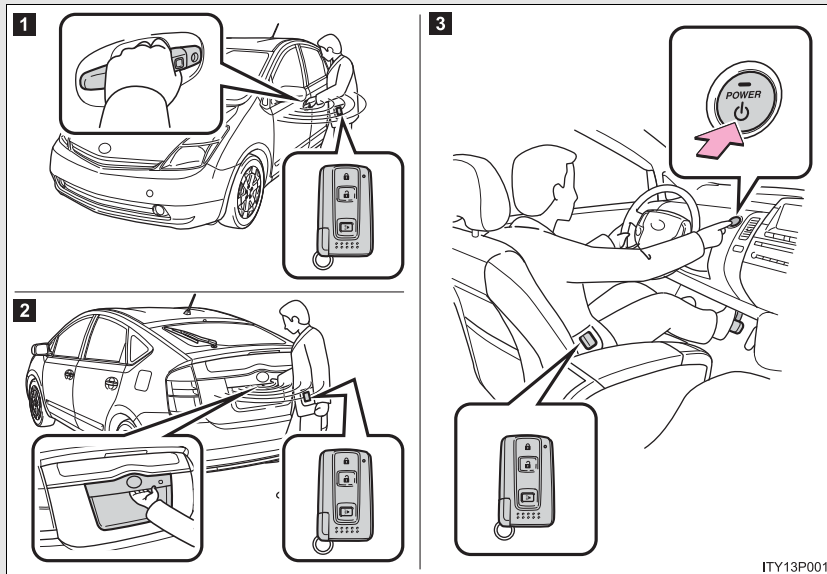

- 1** Locks and unlocks the side doors (→P. 37)
- 2** Locks and unlocks the back door (→P. 38)
- 3** Starts and stops the hybrid system (→P. 133)

*: If equipped

1-3. Opening, closing and locking the doors and back door

Unlocking and locking the doors (front door handles only)

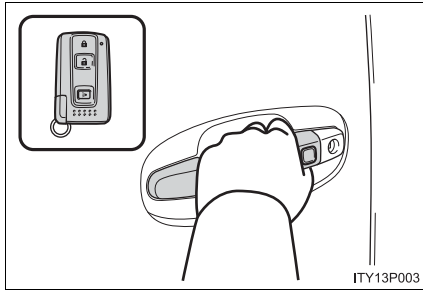

Grip the handle to unlock the door.

Make sure to touch the sensor on the back of the handle.

The door cannot be unlocked for 3 seconds after the door is locked.

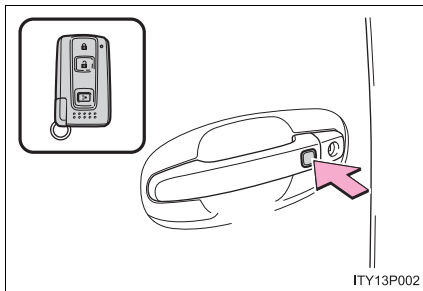

Press the lock button to lock the door.

1

Before driving

1-3. Opening, closing and locking the doors and back door

Locking and unlocking the back door

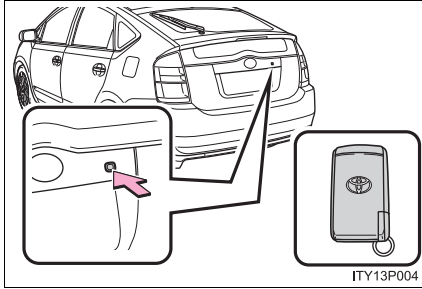

Press the lock button to lock the door.

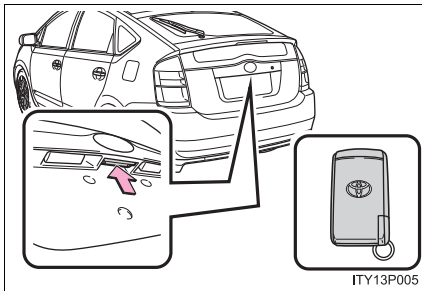

Press the open switch to unlock the door.

The door cannot be unlocked for 3 seconds after the door is locked.

1-3. Opening, closing and locking the doors and back door

Antenna location and effective range

Antenna location

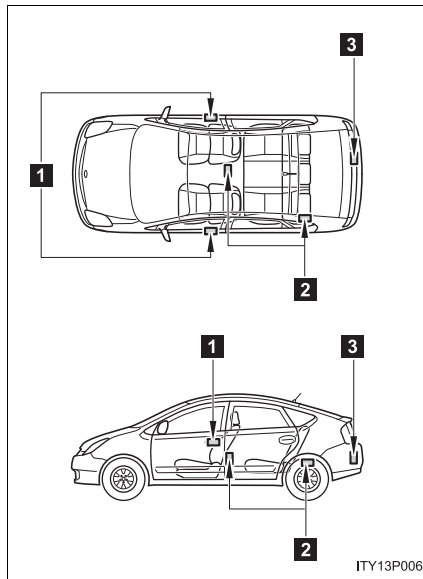

- 1** Antennas outside cabin
- 2** Antennas inside cabin
- 3** Antenna outside back door

1

Before driving

1-3. Opening, closing and locking the doors and back door

n Effective range (areas within which the electronic key is detected)

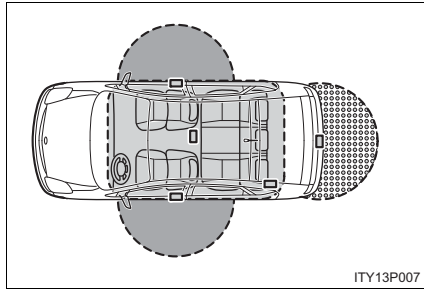

● When locking or unlocking the doors

The system can be operated when the electronic key is within about 3ft. (1 m) of an outside front door handles. (Only the doors detecting the key can be operated.)

○ When starting the hybrid system or changing "POWER" switch modes

The system can be operated when the electronic key is inside the vehicle.

● When unlocking the back door

The system can be operated when the electronic key is within about 3 ft. (1 m) of the back door release button.

1-3. Opening, closing and locking the doors and back door

To disable smart key system

If you do not intend to drive your vehicle for a long time, push the cancel switch to deactivate the smart key system.

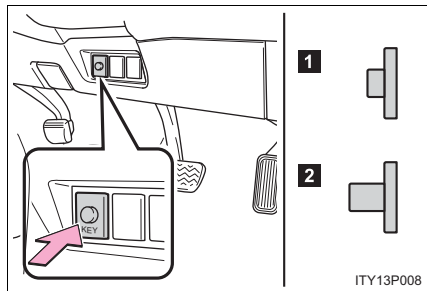

- 1** Disabled
- 2** Enabled

1

Before driving

1-3. Opening, closing and locking the doors and back door

n **Operation signals**

A buzzer sounds and the emergency flashers flash to indicate that the doors have been locked/unlocked. (Locked: Once; Unlocked: Twice)

n **Conditions affecting operation**

The smart key system uses weak radio waves. In the following situations, the communication between the electronic key and the vehicle may be affected, preventing the smart key system and wireless remote control from operating properly. (Way of coping: P. 448)



- l When the electronic key battery is depleted
- l Near a TV tower, electric power plant, gas station, radio station, large display, airport or other facility that generates strong radio waves or electrical noise
- l When carrying a portable radio, cellular phone, cordless phone or other wireless communication devices
- l When the electronic key has come into contact with, or is covered by a metallic object
- l When multiple electronic keys are in the vicinity
- l When carrying or using the electronic key together with the following devices that emit radio waves
 - Another vehicle's electronic key
 - A wireless key that emits radio waves
 - Personal computer
- l If window tint with a metallic content or metallic objects are attached to the rear window

1-3. Opening, closing and locking the doors and back door

n Switching the door unlock function

It is possible to set which doors the entry function unlocks.

STEP 1 Turn the "POWER" switch OFF.

STEP 2 When the indicator on the key surface is turned off, push and hold  for approximately 5 seconds while pushing the  button on the key.

The setting changes each time an operation is performed, as shown below. (Wait for at least 5 seconds after each operation to continue an operation.)

Mode	Unlocking doors	Beep
Driver's door unlocking mode	Hold the driver's door handle to unlock only the driver's	Exterior: one beep Interior: two beeps sound three times
	Hold the passenger's door handle or back door opener to unlock all the doors	
All doors unlocking mode	Hold the front door handle or back door opener to unlock all the doors	Exterior: one beep Interior: two beeps sound twice
Single door unlocking mode	Hold the driver's door or back door opener to unlock the door.	Exterior: one beeps Interior: two beeps sound once
	Hold the passenger's door handle to unlock all the doors	

STEP 3 Unlock the doors using the wireless remote control and open one of the doors.

If a door is not opened within 60 seconds after  is pressed, the doors will be locked again and the alarm will automatically be set.

In case that the alarm is triggered, immediately stop the alarm. (→P. 84)

1

Before driving

1-3. Opening, closing and locking the doors and back door

n **Battery-saving function**

In the following circumstances, the entry function is disabled in order to prevent the vehicle and electronic key batteries from discharging.

- l When the entry function has not been used for 2 weeks or more
- l When the electronic key has been left within approximately 3 ft. (1 m) of the vehicle for 10 minutes or more

The system will resume operation when...

- l The vehicle is locked using the door handle lock switch
- l The vehicle is locked/unlocked using the wireless remote control function (→P. 49) or the mechanical key (→P. 448)

n **Electronic key battery depletion**

- l The standard battery life is 1 to 3 years. (The battery becomes depleted even if the electronic key is not used.) If the smart key system or the wireless remote control function does not operate, or the detection area becomes smaller, the battery may be depleted. Replace the battery when necessary. (→ P. 392)

- l To avoid serious deterioration, do not leave the electronic key within 3 ft. (1 m) of the following electrical appliance that produce a magnetic field.

- TVs
- Personal computers
- Recharging cellular phones or cordless phones
- Table lamps

n **To operate the system properly**

Make sure to carry the electronic key when operating the system. Do not get the electronic key too close to the vehicle when operating the system from the outside of the vehicle.

Depending on the position and holding condition of the electronic key, the key may not be detected correctly and the system may not operate properly. (The alarm may go off accidentally, or the door lock prevention may not function.)

1-3. Opening, closing and locking the doors and back door

n **Note for the smart key system**

l Even when the electronic key is within the effective range (detection areas), the system may not operate properly in the following cases.

- The electronic key is too close to the window or outside door handle, near the ground, or in a high place when the doors are locked or unlocked.
- The electronic key is on the instrument panel, luggage cover, floor or in the glove box when the engine is started or engine switch modes are changed.

l The doors may unlock if a large amount of water splashes on the door handle, such as in the rain or in a car wash. (The doors will automatically be locked after approximately 60 seconds if the doors are not opened and closed.)

l Gripping the door handle when wearing a glove may not unlock the door.

l If the wireless remote control is used to lock the doors when the electronic key is near the vehicle, there is a possibility that the door may not be unlocked by the entry function. (Use the wireless remote control to unlock the doors.)

n **When the vehicle is not driven for extended periods**

To prevent theft of the vehicle, do not leave the electronic key within 6 ft. (2 m) of the vehicle.

n **Security feature**

If a door is not opened within approximately 60 seconds after the vehicle is unlocked, the theft deterrent system automatically locks the vehicle again.

1

Before driving

1-3. Opening, closing and locking the doors and back door

n Alarms and warning indicators

A combination of exterior and interior alarms are used to prevent theft of the vehicle and unforeseeable accidents resulting from erroneous operation. Take appropriate measures according to which warning light comes on. (→P. 423)

l When any warning lights come on.

Take appropriate measures according to which warning light comes on. (→P. 423)

The following table describes circumstances and correction procedures when only alarms are sounded.

Alarm	Situation	Correction procedure
Interior alarm: One beep (sounds continuously) Touch screen: Warning message*	The hybrid system was not turned off and the transmission was in a position other than "P", and the driver's door is open.	Pressing the "P" position switch.
Interior alarm: Beeps (sound intermittently)	The driver's door is opened while the hybrid system is in ACCESSORY mode and the shift lever is in the "P" position.	Turn the hybrid system OFF and close the driver's door.
Exterior alarm: One beep (sounds for 2 seconds)	The lock button has been pressed while the hybrid system is OFF and the smart key is still in the vehicle.	Take the smart key from the vehicle and lock the vehicle again.
Interior alarm: One beep	The battery charge of the smart key is low.	Replace the battery of the smart key.
Exterior alarm: One beep (sound for 10 seconds)	The lock button is pressed when the hybrid system is OFF and one of the doors is half open.	Close all the doors then lock the vehicle again.

*: Follow the warning message displayed on the touch screen.

1-3. Opening, closing and locking the doors and back door

- n **If the smart key system does not operate properly**
 - l Locking and unlocking the doors: Use the mechanical key. (→P. 448)
 - l Starting the hybrid system: →P. 134
- n **When the electronic key battery is fully depleted**
→P. 392
- n **Customization that can be configured at Toyota dealer**
Settings (e.g. smart key system) can be changed.
(Customizable features →P. 486)
- n **Certification for the smart key system**
 - ▶ For vehicles sold in the U.S.A.

FCC ID: MOZB31EG
MADE IN JAPAN

FCC ID: MOZB31UG
MADE IN JAPAN

FCC ID: MOZRO-2TY-1
MADE IN JAPAN

FCC ID: PENASAT2
MADE IN JAPAN

NOTE:

This device complies with Part 15 of the FCC Rules. Operation is subject to the following two conditions: (1) this device may not cause harmful interference, and (2) this device must accept any interference received, including interference that may cause undesired operation.

FCC WARNING:

Changes or modifications not expressly approved by the party responsible for compliance could void the user's authority to operate the equipment.

1

Before driving

1-3. Opening, closing and locking the doors and back door

► For vehicles sold in Canada

NOTE:

This device complies with RSS-210 of Industry Canada.

Operation is subject to the following two conditions: (1) this device may not cause interference, and (2) this device must accept any interference, including interference that may cause undesired operation of the device.

⚠ CAUTION

n Caution regarding interference with electronic devices

I People with implanted pacemakers or cardiac defibrillators should keep away from the smart key system antennas. (→P. 39)

The radio waves may affect the operation of such devices. If necessary, the entry function can be disabled. Ask your Toyota dealer for details, such as the frequency of radio waves and timing of emitting the radio waves.

Then, consult your doctor to see if you should disable the entry function.

I Users of any electrical medical device other than implanted pacemakers and implanted cardiac defibrillators should consult the manufacturer of the device for information about its operation under the influence of radio waves. Radio waves could have unexpected effects on the operation of such medical devices.

Ask your Toyota dealer for details for disabling the entry function.

1-3. Opening, closing and locking the doors and back door Wireless remote control

The wireless remote control can be used to lock and unlock the vehicle and the back door from outside the vehicle.

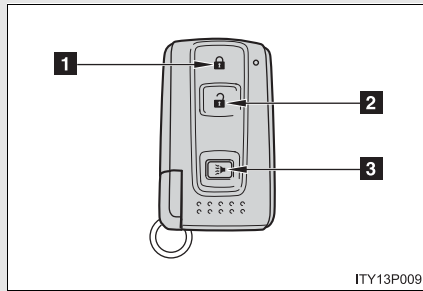

1 Locks all doors

2 Unlocks all doors

Pressing the button unlocks the driver's door. Pressing the button again within 3 seconds unlocks the other doors.

3 Sounds alarm
(push and hold) (→P. 85)

1

Before driving

n **Operation indicator**

A buzzer sounds and the emergency flashers flash to indicate that the doors have been locked/unlocked. (Locked: Once; Unlocked: Twice)

n **Door lock buzzer**

If a door is not fully closed, a buzzer sounds continuously if an attempt to lock the door is made. Fully close the door to stop the buzzer, and lock the vehicle once more.

n **Security feature**

→P. 45

n **When the electronic key battery is fully depleted**

→P. 392

1-3. Opening, closing and locking the doors and back door

n **Conditions affecting operation**

→P. 42

n **Low battery**

If the wireless remote control does not function or if it only operates very close to the vehicle, the battery may be low. (→P. 392)

n **Customization that can be configured at Toyota dealer**

Settings (e.g. 2-step unlocking function) can be changed.
(Customizable features →P. 486)

n **Certification for wireless remote control**

► For vehicles sold in the U.S.A.

FCC ID: MOZB21TG
MADE IN JAPAN

FCC ID: MOZB21RG
MADE IN JAPAN

NOTE:

This device complies with Part 15 of the FCC Rules. Operation is subject to the following two conditions: (1) this device may not cause harmful interference, and (2) this device must accept any interference received, including interference that may cause undesired operation.

FCC WARNING:

Changes or modifications not expressly approved by the party responsible for compliance could void the user's authority to operate the equipment.

► For vehicles sold in the Canada

NOTE:

This device complies with RSS-210 of Industry Canada.
Operation is subject to the following two conditions: (1) this device may not cause interference, and (2) this device must accept any interference, including interference that may cause undesired operation of the device.

1-3. Opening, closing and locking the doors and back door Side doors

The vehicle can be locked and unlocked using the entry function, wireless remote control or door lock switch.

n **Smart key system**

→P. 37

n **Wireless remote control**

→P. 49

n **Door lock switch**

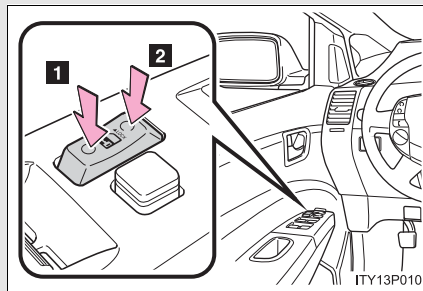

1 Unlocks all doors

2 Locks all doors

n **Inside lock button**

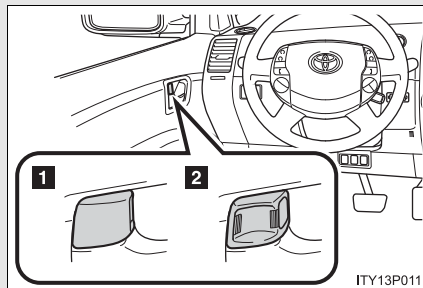

1 Locks the door

2 Unlocks the door

The driver's door can be opened by pulling the inside handles even if the lock buttons are in the lock position.

1

Before driving

1-3. Opening, closing and locking the doors and back door

Locking the front doors from the outside without a key

STEP 1 Move the inside lock button to the lock position.

STEP 2 Close the door.

► Vehicles with smart key system

The door cannot be locked if the "POWER" switch is in ACCESSORY or ON mode, or the electronic key is left inside the vehicle.

Depending on the position of the electronic key, the key may not be detected correctly and the door may be locked.

► Vehicles without smart key system

The door cannot be locked if the electronic key is in the key slot.

Rear door child-protector lock

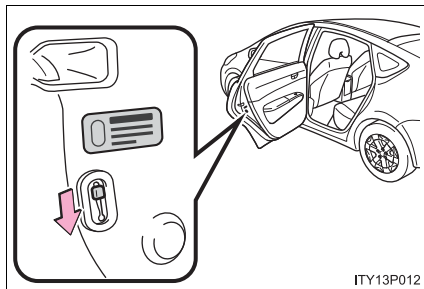

The door cannot be opened from inside the vehicle when the locks are set.

These locks can be set to prevent children from opening the rear doors. Push down rear door switches to lock the rear doors.

1-3. Opening, closing and locking the doors and back door

n Closing the front doors from outside with the inside lock button set in the locked position (Vehicles with smart key system)

The door cannot be locked if the "POWER" switch is in ACCESSORY or ON mode, or the electronic key is left in the vehicle. (However, depending on the key's location, the system may not be able to detect it. In these instances the door lock protection function will not operate properly.)

n Using the mechanical key

The doors can also be locked and unlocked with the mechanical key. (→P. 448)

n Customization that can be configured at Toyota dealer

Settings (e.g. unlocking function using a key) can be changed. (Customizable features →P. 486)

1

Before driving

⚠ CAUTION**n To prevent an accident**

Observe the following precautions while driving the vehicle. Failing to do so may result in a door opening and an occupant falling out, resulting in death or serious injury.

- ! Always use a seat belt.
- ! Always lock all doors.
- ! Ensure that all doors are properly closed.
- ! Do not pull the inside handle of the doors while driving.
The doors may be opened and the passengers are thrown out of the vehicle and it may result in serious injury or death. Be especially careful for the driver's door, the door may be opened even if the inside lock button is in locked position.
- ! Set the rear door child protector locks when children are seated in the rear seat.

1-3. Opening, closing and locking the doors and back door Back door

The back door can be opened using the back door opener.

n Back door opener

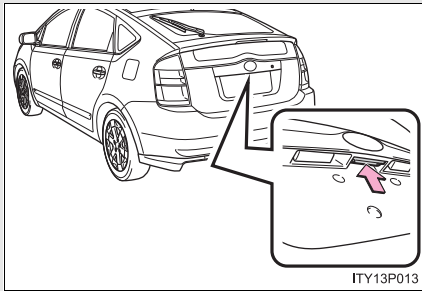

Press the open switch to unlock the door.

n Smart key system

→P. 38

1-3. Opening, closing and locking the doors and back door

n Luggage compartment light

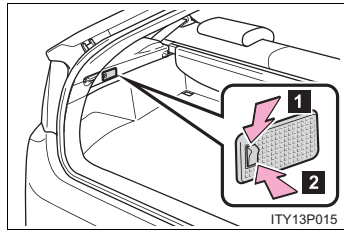

- 1 ON
- 2 OFF



Before driving

n When closing the back door

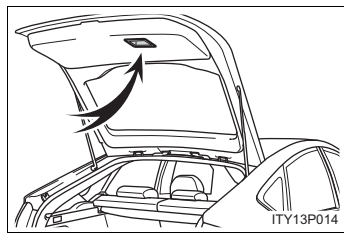

Lower the back door using the back door handle, and make sure to push the back door down from the outside to close it.

n If the back door opener is inoperative

The back door can be operated from the inside.

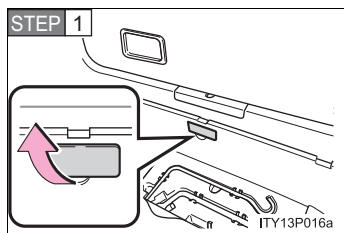

Remove the cover.

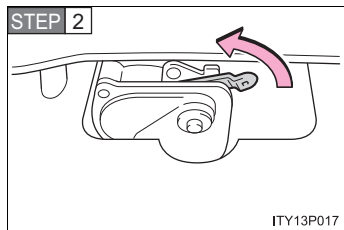

Move the lever.

1-3. Opening, closing and locking the doors and back door

CAUTION

n Caution while driving

Keep the back door closed.

This not only keeps personal belongings from being thrown out, but also prevents exhaust gases from entering the vehicle.

n When children are in the vehicle

I Never leave children unattended in the vehicle as they may lock themselves in the vehicle or back door, which could cause the child to overheat or suffocate, resulting in death or serious injury.

I Do not allow a child open or close the back door. Doing so may cause the back door to operate unexpectedly and part of the child's body may become caught.

1-4. Adjustable components (seats, mirrors, steering wheel) Front seats

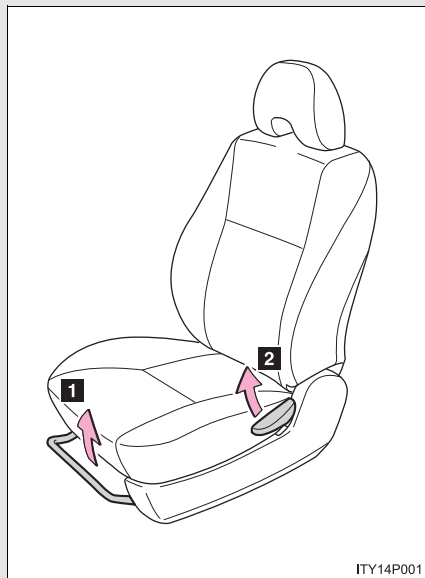

ITY14P001

- 1** Seat position adjustment lever
- 2** Seatback angle adjustment lever

1

Before driving

n Flattening seatbacks

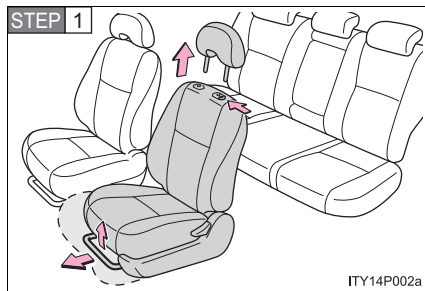

ITY14P002a

Move the seat forward and remove the head restraint.

After returning seat to its original position, be certain to replace the head restraint.

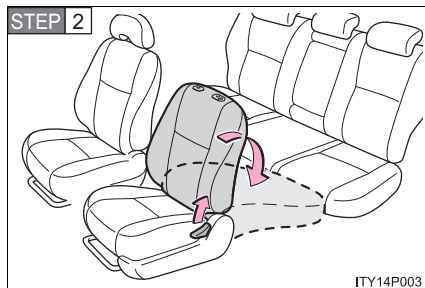

ITY14P003

Pull the seatback angle adjustment lever to unlock and push down the seatback.

1-4. Adjustable components (seats, mirrors, steering wheel)

 CAUTION

n Reclining adjustment

Do not recline the seat more than necessary when the vehicle is in motion, to reduce the risk of sliding under the lap belt.

If the seat is too reclined, during an accident the lap belt may slide past the hips and apply restraint forces directly to the abdomen or your neck may contact the shoulder belt, increasing the risk of death or serious injury.

n While driving

I Do not allow passengers to ride on the flattened seat.

I Do not drive with the head restraints removed.

1-4. Adjustable components (seats, mirrors, steering wheel) Rear seats

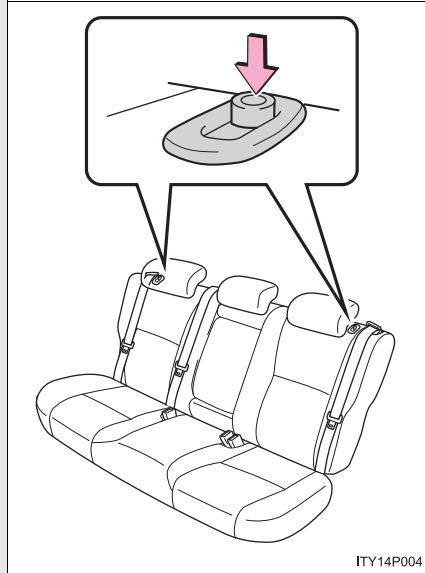

ITY14P004

Seatback angle adjustment button

Press the button down until the lock is completely released.

1

Before driving

Folding down rear seatbacks

n Before folding down rear seatbacks

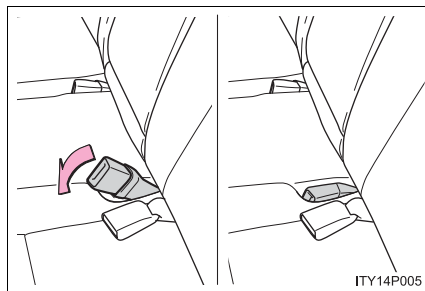

ITY14P005

Stow the rear center seat belt buckle.

1-4. Adjustable components (seats, mirrors, steering wheel)

n Folding down rear seatbacks

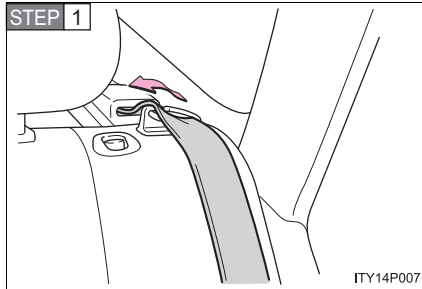

Remove the seat belt from the guide.

In case you do not remove the seat belt from the guide, the seat belt might be locked when you fold down the rear seatbacks.

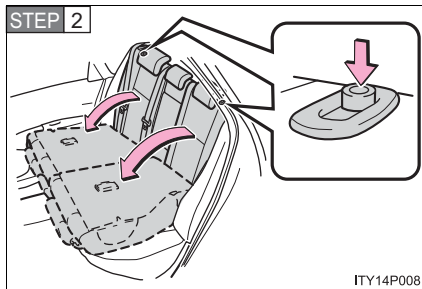

Fold the seatback down while pushing the seatback angle adjustment button.

Press the button until the lock is completely released.

n Returning rear seatbacks

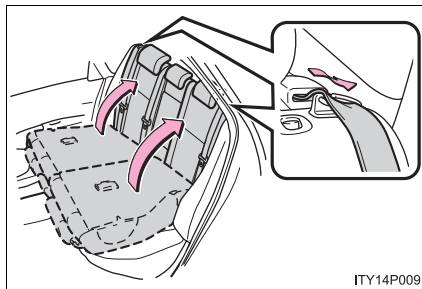

Tilt the rear seatback up until it locks, making sure that you hold the seat belt to prevent it from getting caught between the seatback and the inner side of the vehicle.

Make sure the shoulder belt pass through the guide.

1-4. Adjustable components (seats, mirrors, steering wheel)

CAUTION

n Seat adjustment

Do not recline the seat more than necessary when the vehicle is in motion to reduce the risk of sliding under the lap belt. If the seat is too reclined, the lap belt may slide past the hips and apply restraint forces directly to the abdomen or your neck may contact the shoulder belt, increasing the risk of death or serious injury in the event of an accident.

n After returning the seatback to the upright position

Observe the following precaution. Failure to do so may result in death or serious injury.

Check that the seat belts are not twisted or caught under the seat.

1

Before driving

1-4. Adjustable components (seats, mirrors, steering wheel) Head restraints

n Vertical adjustment

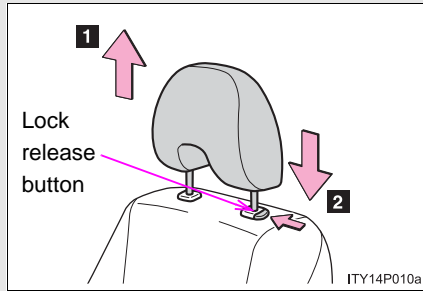

Vertical adjustment

- 1** Up
- 2** Down

Push and hold the lock release button when lowering the head restraint.

n Removing the head restraints

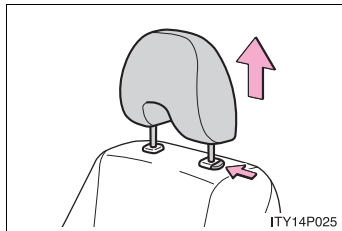

Grip head restraint and remove while holding the lock release button.

n Adjusting the height of the head restraints

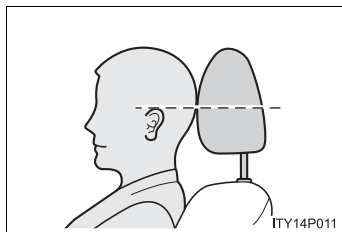

Make sure that the head restraints are adjusted so that the center of the head restraint is closest to the top of your ears.

n Adjusting the center rear seat head restraint

Always raise the head restraint one level from the stowed position when using.

1-4. Adjustable components (seats, mirrors, steering wheel)

CAUTION

n Head restraint precautions

Observe the following precautions regarding the head restraints. Failure to do so may result in death or serious injury.

- I** Use the head restraints designed for each respective seat.
- I** Adjust the head restraints to the correct position at all times.
- I** Do not drive with the head restraints removed.

1

Before driving

1-4. Adjustable components (seats, mirrors, steering wheel) Seat belts

Make sure that all occupants are wearing their seat belts before driving the vehicle.

n Correct use of the seat belts

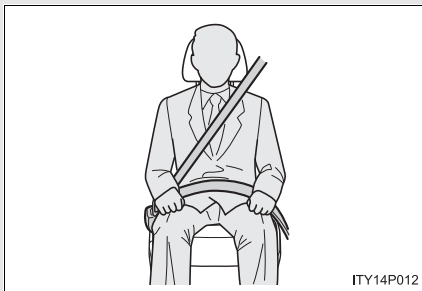

- 1 Extend the shoulder belt so that it comes fully over the shoulder, but does not come into contact with the neck or slide off the shoulder.
- 1 Position the lap belt as low as possible over the hips.
- 1 Adjust the position of the seatback. Sit up straight and well back in the seat.
- 1 Do not twist the seat belt.

n Fastening and releasing the seat belt

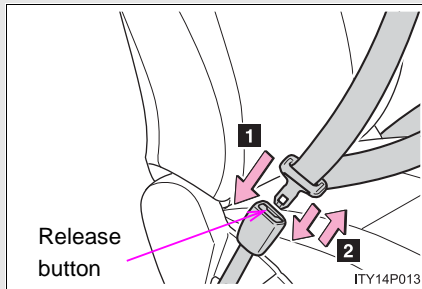

1 Fastening the belt

Push the tab into the buckle until a clicking sound is heard.

2 Releasing the belt

Press the release button.

1-4. Adjustable components (seats, mirrors, steering wheel)

n Adjusting the height of the belt (front seats)

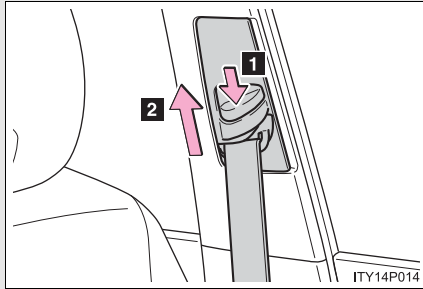

1 Down

2 Up

Move the height adjuster up and down as needed until you hear a click.

1

Before driving

Seat belt pretensioners (front seats)

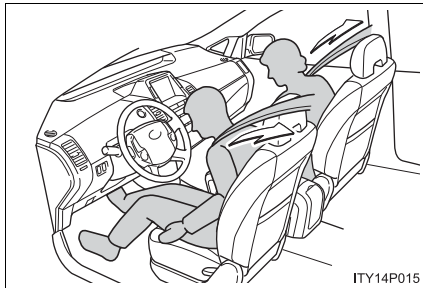

The pretensioner helps the seat belt to quickly restrain the occupant by retracting the seat belt when the vehicle is subjected to certain types of severe frontal collision.

The pretensioner may not activate in the event of a minor frontal impact, a side impact or a rear impact.

1-4. Adjustable components (seats, mirrors, steering wheel)

n **Emergency locking retractor (ELR)**

The retractor will lock the belt during a sudden stop or on impact. It may also lock if you lean forward too quickly. A slow, easy motion will allow the belt to extend, and you can move around fully.

n **Automatic locking retractor (ALR)**

When a passenger's shoulder belt is completely extended and then retracted even slightly, the belt is locked in that position and cannot be extended. This feature is used to hold the child restraint system (CRS) firmly. To free the belt again, fully retract the belt and then pull the belt out once more. (→P. 111)

n **Pregnant women**

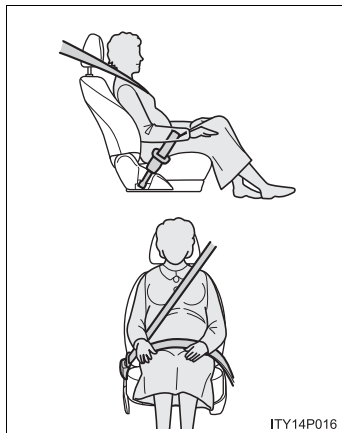

Obtain medical advice and wear the seat belt in the proper way. (→P. 64)

Women who are pregnant should position the lap belt as low as possible over the hips in the same manner as other occupants. Extend the shoulder belt completely over the shoulder and position the belt across the chest. Avoid belt contact over the rounding of the abdominal area.

If the seat belt is not worn properly, not only a pregnant woman, but also the fetus could suffer death or serious injury as a result of sudden braking or a collision.

1-4. Adjustable components (seats, mirrors, steering wheel)

n **People suffering illness**

Obtain medical advice and wear the seat belt in the proper way. (→P. 64)

n **Child seat belt usage**

The seat belts of your vehicle were principally designed for persons of adult size.

l Use a child restraint system appropriately for the child, until the child become large enough to properly wear the vehicle's seat belt. (→P. 107)

l When the child becomes large enough to properly wear the vehicle's seat belt, follow the instructions on P. 64 regarding seat belt usage.

n **Replacing the belt after the pretensioner has been activated**

If the vehicle is involved in multiple collisions, the pretensioner will active for the first collision, but will not active for the second or subsequent collisions.

n **Seat belt extender**

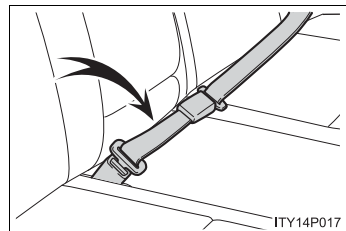

If your seat belts cannot be fastened securely because they are not long enough, a personalized seat belt extender is available from your Toyota dealer free of charge.

1

Before driving

1-4. Adjustable components (seats, mirrors, steering wheel)

! CAUTION

Observe the following precautions to reduce the risk of injury in the event of sudden braking or an accident. Failing to do so may cause death or serious injury.

n Wearing a seat belt

- ! Ensure that all passengers wear a seat belt.
- ! Always wear a seat belt properly.
- ! Each seat belt should be used by one person only. Do not use a seat belt for more than one person at the same time, including children.
- ! Children should be seated in the rear seat and always use a seat belt and/or an appropriate child restraint system.
- ! Do not recline the seat any more than necessary to achieve a proper seating position. The seat belt is most effective when the occupants are sitting up straight and well back in the seats.
- ! Do not wear the shoulder belt under your arm.
- ! Always wear your seat belt low and snug across your hips.

n Child restraint lock function belt precaution

Do not allow children to play with the child restraint lock function belt. If the belt becomes twisted around a child's neck, it will not be possible to pull the belt out leading to choking or other serious injuries that could result in death. If this occurs and the buckle cannot be unfastened, scissors should be used to cut the belt.

n Seat belt damage and wear

- ! Do not damage the seat belts by allowing the belt, plate or buckle to be jammed in the door.
- ! Inspect the seat belt system periodically. Check for cuts, fraying, and loose parts. Do not use a damaged seat belt until it is replaced. Damaged seat belts cannot protect an occupant from death or serious injury.
- ! Ensure that the belt and tab are locked and the belt is not twisted. If the seat belt does not function correctly, immediately contact your Toyota dealer.
- ! Replace the seat assembly, including the belts, if your vehicle has been involved in a serious accident, even if there is no obvious damage.

1-4. Adjustable components (seats, mirrors, steering wheel)

CAUTION

n Seat belt damage and wear

I Do not attempt to install, remove, modify, disassemble or dispose of a seat belt. Have any necessary repairs carried out by your Toyota dealer. Inappropriate handling of the pretensioner may cause it to activate or operate improperly and may cause death or serious injury.

n Adjustable shoulder anchor

Always make sure the shoulder belt is positioned across the center of your shoulder. The belt should be kept away from your neck, but not falling off your shoulder. Failure to do so could reduce the amount of protection in an accident and cause death or serious injuries in a collision. (→P. 65)

n Seat belt pretensioners

I Do not place anything, such as a cushion, on the front passenger's seat. Doing so will disperse the passenger's weight, which prevents the sensor from detecting the passenger's weight properly. As a result, the seat belt pretensioner for the front passenger's seat may not activate in the event of a collision.

I If the pretensioner has activated, the seat belt becomes locked: it cannot be further extended, nor will it return to the stowed position. The seat belt cannot be used again and must be replaced at your Toyota dealer.

n Using a seat belt extender

I Do not wear the seat belt extender, if you can fasten the seat belt without the extender.

I Do not use the seat belt extender when installing a child restraint system, because the belt will not securely hold the child restraint system, increasing the risk of death or serious injury in the event of a collision.

I The personalized extender may not be safe on another vehicle, when used by another person, or at a different seating position other than the one originally intended.

1

Before driving

1-4. Adjustable components (seats, mirrors, steering wheel)

 NOTICE

n When using a seat belt extender

When releasing the seat belt, press on the buckle release button on the extender, not on the seat belt.
This helps prevent damage to the vehicle interior and the extender itself.

1-4. Adjustable components (seats, mirrors, steering wheel) Steering wheel

The steering wheel can be adjusted to a comfortable position.

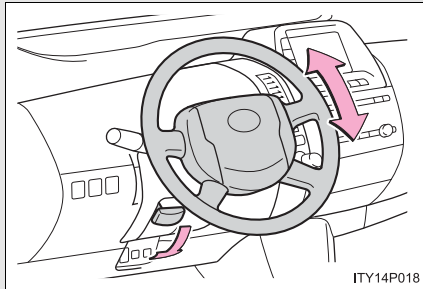

STEP 1 Hold the steering wheel and press the lever down.

STEP 2 Adjust to the ideal position by moving the steering wheel vertically.

1

Before driving

CAUTION

n While driving

Do not adjust the steering wheel while driving. Doing so may cause the driver to mishandle the vehicle and an accident, resulting in death or serious injury.

n After adjusting the steering wheel

Make sure that the steering wheel is securely locked. Otherwise, the steering wheel may move suddenly, possibly causing an accident and resulting in death or serious injury.

1-4. Adjustable components (seats, mirrors, steering wheel) Anti-glare inside rear view mirror

► Manual anti-glare inside rear view mirror

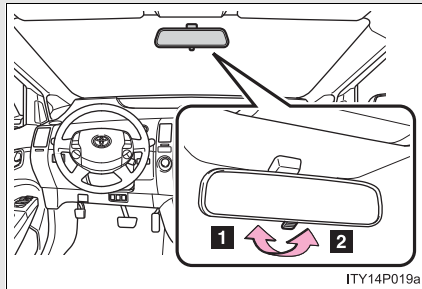

- 1 Normal position
- 2 Anti-glare position

► Auto anti-glare inside rear view mirror

In the “AUTO” mode, sensors are used to detect the headlights of vehicles behind and automatically reduces the reflected light.

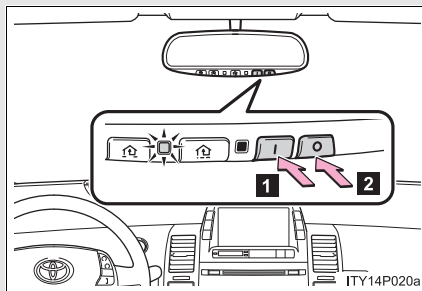

- 1 ON
- 2 OFF

The indicator comes on when automatic mode is turned ON.

The anti-glare mirror default mode is automatic mode. The anti-glare mirror is automatically set to automatic mode whenever the “POWER” switch is turned ON.

1-4. Adjustable components (seats, mirrors, steering wheel)

n To prevent sensor error (vehicles with auto anti-glare inside rear view mirror)

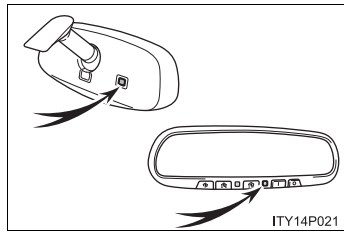

To ensure correct functioning of the sensors, do not touch or cover the sensors.

1

Before driving

⚠ CAUTION

n While driving

Do not adjust the position of the mirror while driving. Doing so may lead to mishandling of the vehicle and an accident, or resulting in death or serious injury.

1-4. Adjustable components (seats, mirrors, steering wheel) Outside rear view mirrors

Mirror angle can be adjusted using the switch when the “POWER” switch is in ACCESSORY or ON mode.

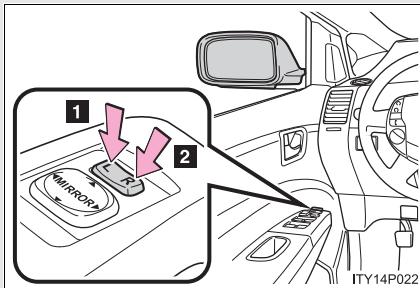

Select a mirror to adjust

- 1 Left
- 2 Right

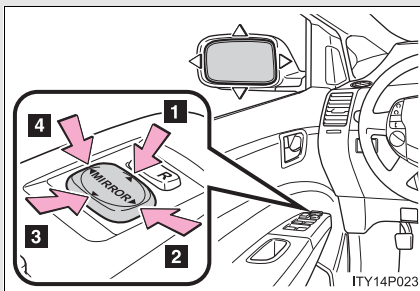

Adjust the mirror

- 1 Up
- 2 Right
- 3 Down
- 4 Left

Folding the mirrors

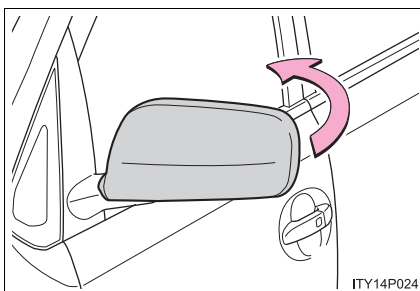

Push backward to fold the mirrors.

1-4. Adjustable components (seats, mirrors, steering wheel)

n **When the mirrors are fogged up (vehicle with mirror defoggers)**

Turn on the mirror heaters to defog the mirrors. (→P. 213)

CAUTION

n **While driving**

Observe the following precautions.

Failing to do so may result in losing control of the vehicle and cause an accident, resulting in death or serious injury.

- ! Do not adjust the mirrors.
- ! Do not drive with the mirrors folded back.
- ! Before driving, be sure to extend mirrors and make an adjustment properly.

n **When the mirror defoggers are operating**

Do not touch the mirror surface as the mirror surface becomes hot.

NOTICE

n **If ice should jam the mirror**

Do not operate the control or scrape the mirror face. Use a spray de-icer to free the mirror.

1

Before driving

1-5. Opening and closing the windows and moon roof Power windows

The power windows can be opened and closed using the following switches.

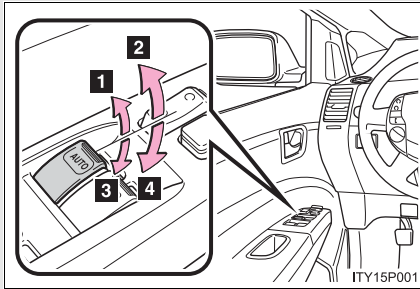

- 1** Closing
- 2** One-touch closing*
(driver's window only)
- 3** Opening
- 4** One-touch opening*
(driver's window only)

*:Pushing the switch in the opposite direction will stop window travel partway.

Lock switch

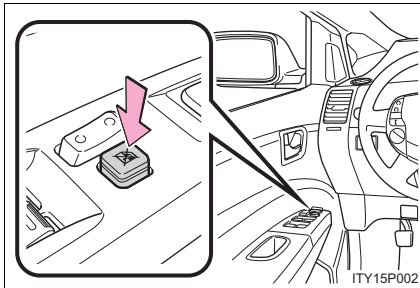

Press the switch down to lock passenger window switches.

Use this switch to prevent children from accidentally opening or closing a passenger window.

1-5. Opening and closing the windows and moon roof

n **The power windows can be operated when**

The "POWER" switch is in ON mode.

n **Operating the power windows after turning the "POWER" switch OFF**

The power windows can be operated for approximately 45 seconds even after the "POWER" switch is switched to ACCESSORY mode or turned OFF. They cannot, however, be operated once the driver's or front passenger's door is opened.

n **Jam protection function (driver's window only)**

If an object becomes caught between the window and the window frame, window travel is stopped and the window is opened slightly.

n **When the 12 volt battery is disconnected**

The power windows must be initialized in order to ensure proper operation. (driver's window only)

STEP 1 Open the window halfway.

STEP 2 Fully close the window by pulling the switch up and continue holding the switch for 1 second.

The indicator on the switch changes from a flashing pattern to being on when initial settings are complete.

n **Customization that can be configured at Toyota dealer**

Settings (e.g. linked door lock operation) can be changed. (Customizable features →P. 486)

1

Before driving

1-5. Opening and closing the windows and moon roof

CAUTION

n When closing the windows

Observe the following precautions.

Failing to do so may result in death or serious injury.

- I** Check to make sure that all passengers do not have any part of their body in a position where it could be caught when a window is being operated.
- I** Do not allow children to operate the power windows.
Closing a power window on someone can cause death or serious injury.

n Jam protection function driver's window only

- I** Never try jamming any part of your body to activate the jam protection function intentionally.
- I** The jam protection function may not work if something gets caught just before the window fully closes.

1-6. Refueling Opening the fuel tank cap

Perform the following steps to open the fuel tank cap.

1 **Before refueling the vehicle**

Turn the "POWER" switch OFF and ensure that all the doors and windows are closed.

2 **Opening the fuel tank cap**

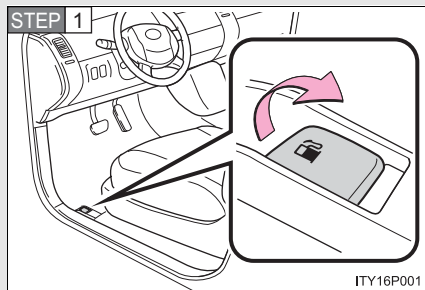

Open the fuel filler door.

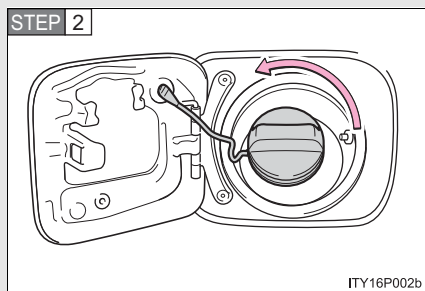

To remove the fuel tank cap, turn the cap slowly counter-clockwise, then pause slightly before removing it.

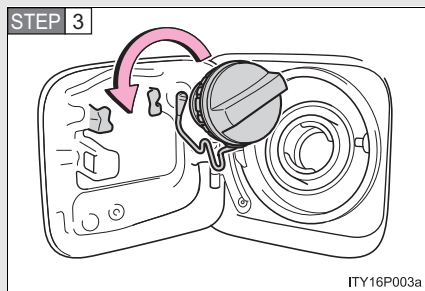

Hang the fuel tank cap on the back of the fuel filler door.

1

Before driving

1-6. Refueling

Closing the fuel tank cap

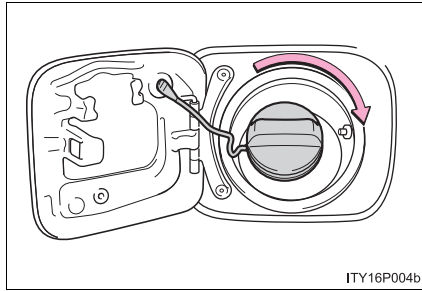

After refueling, turn the fuel tank cap clockwise until you hear a click. The cap will revolve slightly in the opposite direction once released.

n Fuel types

Use unleaded gasoline. (Octane Rating 87 [Research Octane Number 91] or higher)

n Fuel tank capacity

Approximately 11.9 gal. (45 L, 9.9 Imp. gal.)

⚠ CAUTION

n When refueling the vehicle

Observe the following precautions while refueling the vehicle. Failure to do so, may result in death or serious injury.

- I** Touch the vehicle or some other metal surface to discharge any static electricity.
Sparks resulting from discharging static electricity may cause the fuel vapors to ignite.
- I** Always hold the grips on the fuel tank cap and turn it slowly to remove it.
A whooshing sound may be heard when the fuel tank cap is loosened. Wait until the sound cannot be heard before fully removing the cap. In hot weather, pressurized fuel may spray out the filler neck and cause injury.
- I** Do not allow anyone that has not discharged static electricity from their bodies to come close to an open fuel tank.
- I** Do not inhale vaporized fuel.
Fuel contains substances that are harmful if inhaled.
- I** Do not smoke while refueling the vehicle.
Doing so may cause the fuel to ignite and cause a fire.
- I** Do not return to the vehicle or touch any person or object that is statically charged.
This may cause static electricity to build up, resulting in a possible ignition hazard.

n When replacing the fuel tank cap

Do not use anything but a genuine Toyota fuel tank cap designed for your vehicle. Failure to do so may cause a fire or other incident which may result in death or serious injury.

⚠ NOTICE

n Refueling

Do not spill fuel during refueling.
Failing to do so may damage the vehicle, such as causing the exhaust systems to operate abnormally or damaging fuel system components or the vehicle's painted surface.

1

Before driving

1-7. Theft deterrent system Immobilizer system

The vehicle's keys have built-in transponder chips that prevent the hybrid system from starting if the key has not been previously registered in the vehicle's on-board computer.

Never leave the keys inside the vehicle when you leave the vehicle.

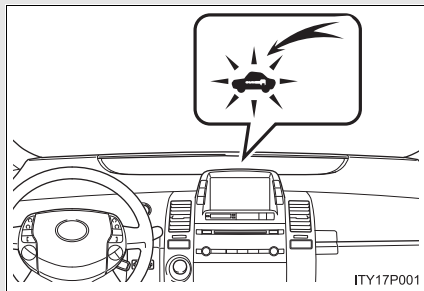

Vehicle with smart key system:

The indicator light flashes after the "POWER" switch has been turned OFF mode to indicate that the system is operating.

Vehicles without smart key system:

The indicator light flashes after the key has been removed from the key slot to indicate that the system is operating.

1-7. Theft deterrent system

n **System maintenance**

The vehicle has a maintenance-free type of immobilizer system.

n **Conditions that may cause the system to malfunction**

- l If the grip portion of the key is in contact with a metallic object.
- l If the key is in close proximity to or touching a key to the security system (key with a built-in transponder chip) of another vehicle.

n **Certifications for the immobilizer system**

- ▶ For vehicles sold in the U.S.A.

FCC ID: MOZRI-24KTY
MADE IN JAPAN

This device complies with Part 15 of the FCC Rules. Operation is subject to the following two conditions: (1) this device may not cause harmful interference, and (2) this device must accept any interference received, including interference that may cause undesired operation.

FCC WARNING:

Changes or modifications not expressly approved by the party responsible for compliance could void the user's authority to operate the equipment.

- ▶ For vehicles sold in Canada

This device complies with RSS-210 of Industry Canada.

Operation is subject to the following two conditions: (1) this device may not cause interference, and (2) this device must accept any interference, including interference that may cause undesired operation of the device.

NOTICE

n **For proper system operation**

Do not modify, remove or disable the immobilizer system. If any unauthorized changes or modifications are made, the proper operation of the system cannot be guaranteed.

1

Before driving

1-7. Theft deterrent system Alarm*

The system sounds the alarm and flashes the vehicle lights when an attempt to steal the vehicle is detected.

n **Triggering the alarm**

The alarm is triggered in the following situations.

- 1 A locked door or back door is unlocked or opened in any way other than using the entry function, wireless remote door lock function or using the mechanical key. (The doors will lock again automatically)
- 1 The hood is opened while the vehicle is locked.

n **Setting the alarm system**

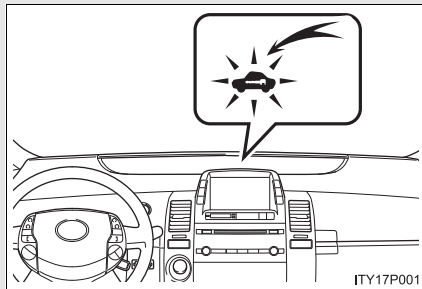

Close the doors, hood and lock all doors. The system will be set automatically after 30 seconds.

The indicator light changes from being on to flashing when the system is set.

n **Deactivating or stopping the alarm**

Do one of the following to deactivate or stop the alarm.

- 1 Unlock the doors.
- 1 Start the hybrid system. (the alarm will be deactivated or stopped after a few seconds.)

*: If equipped

1-7. Theft deterrent system

n **Items to check before locking the vehicle**

To prevent unexpected triggering of the alarm and vehicle theft, make sure of the following

- l Nobody is in the vehicle.
- l The windows are closed before the alarm is set.
- l No valuables or other personal items are left in the vehicle.

n **Triggering of the alarm**

The alarm may be triggered in the following situations.

(Stopping the alarm deactivates the alarm system.)

- l A person inside the vehicle opens a door, the back door or hood.
- l The 12 volt battery is recharged or replaced when the vehicle is locked.

n **Panic mode**



When (⏏) is pushed for longer than about one second, an alarm will sound for about 60 seconds and the vehicle lights will flash to deter any person from trying to break into or damage your vehicle.

To stop the alarm, push any button on the wireless remote control.

1

Before driving

1-7. Theft deterrent system Theft prevention labels (U.S.A.)

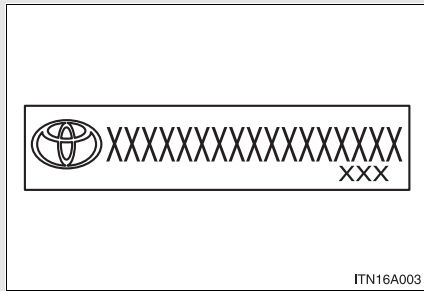

These labels are attached to the vehicle to reduce vehicle theft by facilitating the tracing and recovery of parts from stolen vehicles. Do not remove under penalty of law.

1-8. Safety information

Correct driving posture

Drive with a good posture as follows:

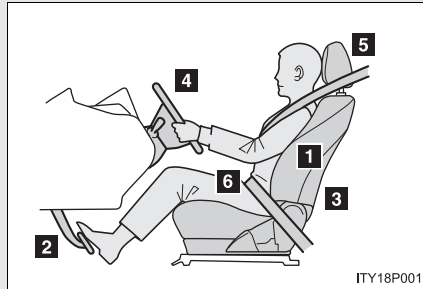

- 1** Sit upright and well back in the seat.
- 2** Adjust the position of the seat forward or backward to ensure the pedals can be reached and easily depressed to the extent required. (→P. 57)
- 3** Adjust the seatback so that the controls are easily operable.
- 4** Adjust the tilt position of the steering wheel downward so the airbag is facing your chest. (→P. 71)
- 5** Lock the head restraint in place with the center of the head restraint closest to the top of your ears. (→P. 62)
- 6** Wear the seat belt correctly. (→P. 64)

1

Before driving

1-8. Safety information

CAUTION

n While driving

- I** Do not adjust the position of the driver's seat.
Doing so could cause the driver to lose control of the vehicle.
- I** Do not place a cushion between the driver or passenger and the seatback.
A cushion may prevent correct posture from being achieved, and reduce the effectiveness of the seat belt and head restraint, increasing the risk of death or serious injury to the driver or passenger.
- I** Do not place anything under the front seats.
Objects placed under the front seats may become jammed in the seat tracks and stop the seat from locking in place. This may lead to an accident. The adjustment mechanism may also be damaged.

n Adjusting the seat position

- I** Do not recline the seat more than necessary when the vehicle is in motion, to reduce the risk of sliding under the lap belt.
If the seat is too reclined during an accident, the lap belt may slide past the hips and apply restraint forces directly to the abdomen or your neck may contact the shoulder belt, increasing the risk of death or serious injury.
- I** Take care when adjusting the seat position to ensure that other passengers are not injured by the moving seat.
- I** Do not put your hands under the seat or near the moving parts to avoid injury.
Fingers or hands may become jammed in the seat mechanism.

1-8. Safety information SRS airbags

The SRS airbags inflate when the vehicle is subjected to certain types of severe impacts that may cause significant injury to the occupants. They work together with the seat belts to help reduce the risk of death or serious injury.

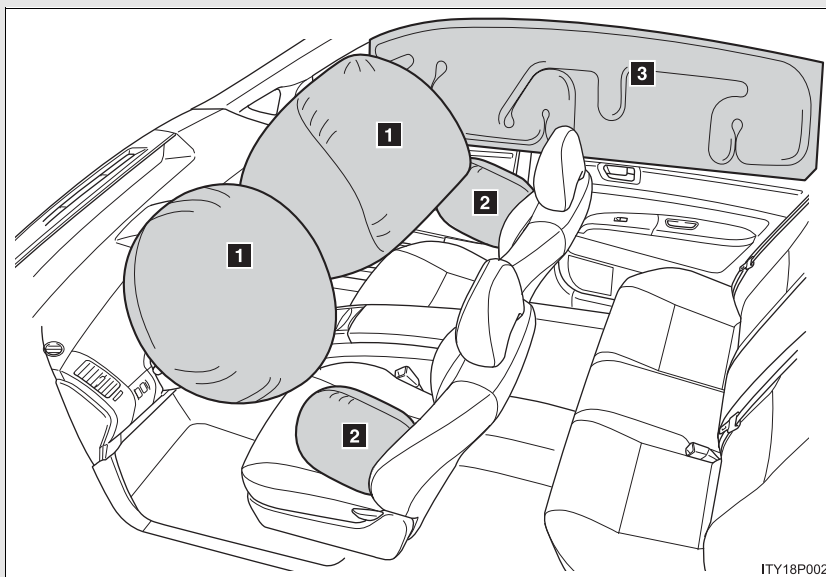

► Front airbags

1 Driver airbag/front passenger airbag

Can help protect the head and chest of the driver and front passenger from impact with interior components.

► Side and curtain shield airbags

2 Side airbag (if equipped)

Can help protect the torso of the front occupants and rear outboard occupants.

3 Curtain shield airbag (if equipped)

Can help protect primarily the head of front occupants and rear outboard occupants.

1

Before driving

1-8. Safety information

Airbag system components

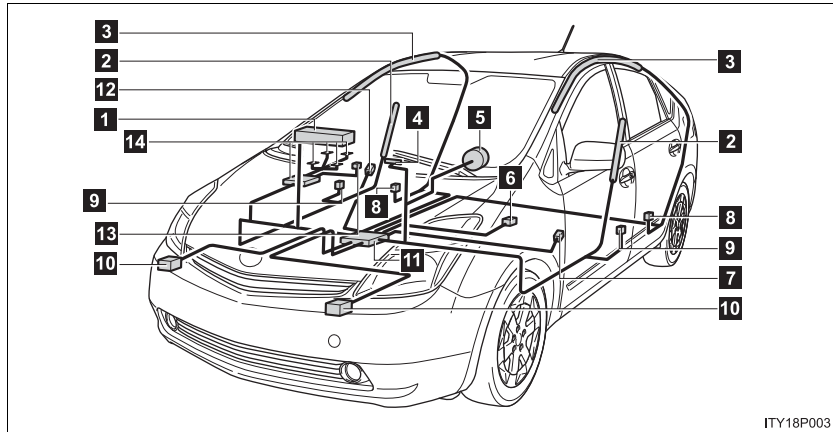

- | | |
|---|--|
| 1 Front passenger airbag | 9 Side and curtain shield airbag sensor (if equipped) |
| 2 Side airbag (if equipped) | 10 Front airbag sensor |
| 3 Curtain shield airbag (if equipped) | 11 Airbag sensor assembly |
| 4 SRS warning light | 12 "AIR BAG ON" and "AIR BAG OFF" indicator lights |
| 5 Driver airbag | 13 Front passenger's seat belt buckle switch |
| 6 Driver's seat belt buckle switch | 14 Occupant detection system (ECU and sensors) |
| 7 Driver's seat position sensor | |
| 8 Curtain shield airbag sensor (if equipped) | |

Your vehicle is equipped with “ADVANCED AIRBAGS” designed based on US motor vehicle safety standards (FMVSS208). The airbag system controls airbag deployment power for the driver and front passenger. The driver airbag system consists of the driver seat’s position sensor etc. The front passenger’s airbag system consists of the front passenger occupant classification sensor etc.

The main SRS airbag system components are shown above. The SRS airbag system is controlled by the airbag sensor assembly. The airbag sensor assembly consists of a safing sensor and an airbag sensor.

In certain types of severe frontal or side impacts, the SRS airbag system triggers the airbag inflators. A chemical reaction in the inflators quickly fills the airbags with non-toxic gas to help restrain the motion of the occupants.

1

Before driving

n If the SRS airbags deploy (inflate)

- 1 Bruising and slight abrasions may result from contact with a deploying (inflating) SRS airbag.
- 1 A loud noise and white powder will be emitted.
- 1 Parts of the airbag module (steering wheel hub, airbag cover and inflator) as well as the seats, and parts of the front and rear pillars and roof side rail, may be hot for several minutes. The airbag itself may also be hot.
- 1 The windshield may crack.

1-8. Safety information

n **Operating conditions (front airbags)**

- l The SRS front airbags will deploy if the severity of the frontal impact is above the designed threshold level, comparable to an approximate 15 mph (25 km/h) collision, when the vehicle impacts straight into a fixed barrier that does not move or deform.

However, this threshold velocity will be considerably higher if the vehicle strikes an object, such as a parked vehicle or sign pole, which can move or deform on impact, or if the vehicle is involved in an underride collision (e.g. a collision in which the front of the vehicle “underrides”, or goes under, the bed of a truck, etc.).

- l It is possible that in some collisions where the forward deceleration of the vehicle is very close to the designed threshold level, the SRS front airbags and the seat belt pretensioners may not activate together.
- l The SRS front passenger airbags will not activate, if there is no passenger sitting in the front passenger seat. However, the front passenger airbag may deploy, if heavy luggage is put, even if the seat is unoccupied. (→P. 101)

n **Operating conditions (side and curtain shield airbags [if equipped])**

- l The SRS side airbags and curtain shield airbags are designed to inflate when the passenger compartment is subjected to a severe impact from the side.
- l The SRS front side airbag on the passenger seat will not activate, if there is no passenger sitting in the front passenger seat. However, the front side airbag on the passenger seat may deploy, if heavy luggage is put, even if the seat is unoccupied. (→P. 101)

n Conditions under which the SRS airbags may deploy (inflate), other than a collision

The SRS front airbags may also deploy if a serious impact occurs to the underside of your vehicle. Some examples are shown in the illustration.

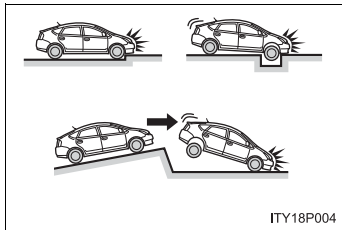

- 1 Hitting a curb, edge of pavement or hard surface
- 1 Falling into or jumping over a deep hole
- 1 Landing hard or vehicle falling

1

Before driving

n Types of collisions that may not deploy the SRS airbag (front airbags)

The SRS front airbags are generally not designed to inflate if the vehicle is involved in a side or rear collision, if it rolls over, or if it is involved in a low-speed frontal collision. But, whenever a collision of any type causes sufficient forward deceleration of the vehicle, deployment of the SRS front airbags may occur.

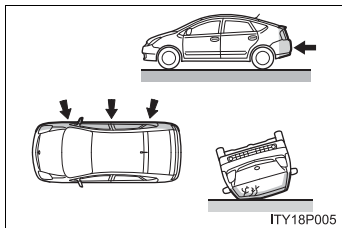

- 1 Collision from the side
- 1 Collision from the rear
- 1 Vehicle rollover

1-8. Safety information

n Types of collisions that may not deploy the SRS airbag (side and curtain shield airbags [if equipped])

The SRS side airbag and curtain shield airbag system may not activate if the vehicle is subjected to a collision from the side at certain angles, or a collision to the side of the vehicle body other than the passenger compartment.

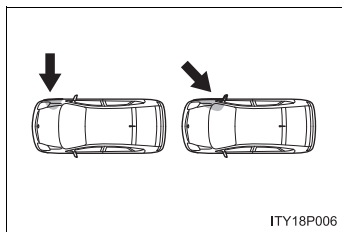

- | Collision from the side to the vehicle body other than the passenger compartment
- | Collision from the side at an angle

The SRS side airbags and curtain shield airbags are generally not designed to inflate if the vehicle is involved in a frontal or rear collision, if it rolls over, or if it is involved in a low-speed side collision.

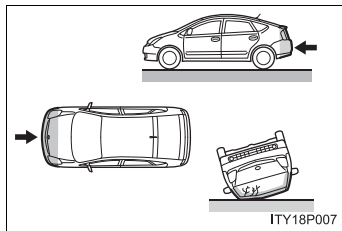

- | Collision from the front
- | Collision from the rear
- | Vehicle rollover

n When to contact your Toyota dealer

In the following cases, contact your Toyota dealer as soon as possible. Do not disconnect the 12 volt battery cables before contacting your Toyota dealer.

- 1 Any of the SRS airbags have been inflated.

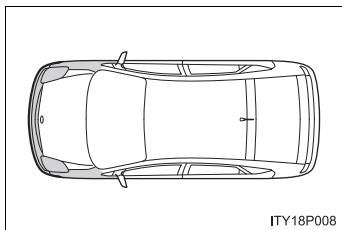

- 1 The front of the vehicle is damaged or deformed, or was involved in an accident that was not severe enough to cause the SRS airbags to inflate.

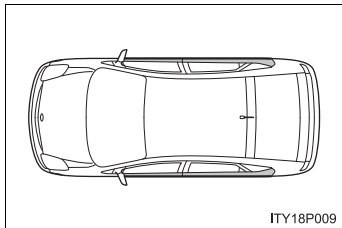

- 1 A portion of the doors is damaged or deformed, or the vehicle was involved in an accident that was not severe enough to cause the SRS side airbags and curtain shield airbags to inflate.

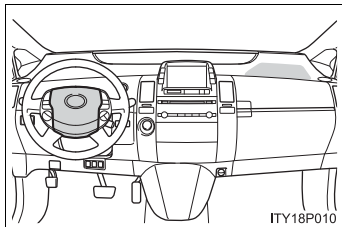

- 1 The pad section of the steering wheel, front passenger airbag cover is scratched, cracked, or otherwise damaged.

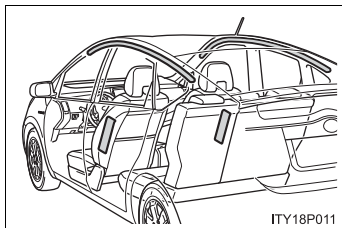

- 1 The surface of the seats with the side airbag is scratched, cracked, or otherwise damaged.
- 1 The portion of the front pillars, rear pillars or roof side rail garnishes (padding) containing the curtain shield airbags inside is scratched, cracked, or otherwise damaged.

1

Before driving

1-8. Safety information

CAUTION

n SRS airbag precautions

Observe the following precautions regarding the airbags. Failure to do so may cause death or serious injury.

I The driver and all passengers in the vehicle must wear their seat belts properly.

The SRS airbags are supplemental devices to be used with the seat belts.

I The SRS driver airbag deploys with considerable force, and can cause death or serious injury especially if the driver is very close to the airbag. The National Highway Traffic Safety Administration (“NHTSA”) advises:

Since the risk zone for driver airbag is the first 2 - 3 in. (50 - 75 mm) of inflation, placing yourself 10 in. (250 mm) from your driver airbag provides you with a clear margin of safety. This distance is measured from the center of the steering wheel to your breastbone. If you sit less than 10 in. (250 mm) away now, you can change your driving position in several ways:

- Move your seat to the rear as far as you can while still reaching the pedals comfortably.
- Slightly recline the back of the seat. Although vehicle designs vary, many drivers can achieve the 10 in. (250 mm) distance, even with the driver seat all the way forward, simply by reclining the back of the seat somewhat. If reclining the back of your seat makes it hard to see the road, raise yourself by using a firm, non-slippery cushion, or raise the seat if your vehicle has that feature.
- If your steering wheel is adjustable, tilt it downward. This points the airbag toward your chest instead of your head and neck.

The seat should be adjusted as recommended by NHTSA above, while still maintaining control of the foot pedals, steering wheel, and your view of the instrument panel controls.

⚠ CAUTION

n SRS airbag precautions

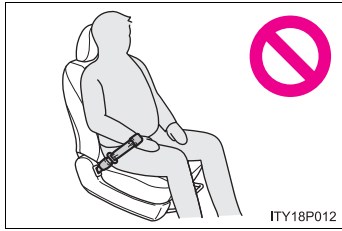

I If the seat belt extender has been connected to the driver's seat belt buckle but the seat belt extender has not also been fastened to the latch plate of the driver's seat belt, the SRS driver's airbag system will judge that the driver is wearing the seat belt even though the seat belt has not been connected. In this case, the driver's airbag may not activate correctly in a collision, resulting in death or serious injury in the event of collision. Be sure to wear the seat belt with the seat belt extender.

I The SRS front passenger airbag also deploys with considerable force, and can cause death or serious injury especially if the front passenger is very close to the airbag. The front passenger seat should be as far from the airbag as possible with the seatback adjusted, so the front passenger sits upright.

I Improperly seated and/or restrained infants and children can be killed or seriously injured by a deploying airbag. An infant or child who is too small to use a seat belt should be properly secured using a child restraint system. Toyota strongly recommends that all infants and children be placed in the rear seats of the vehicle and properly restrained. The rear seats are the safest for infants and children. (→P. 107)

1

Before driving

1-8. Safety information

CAUTION

n SRS airbag precautions

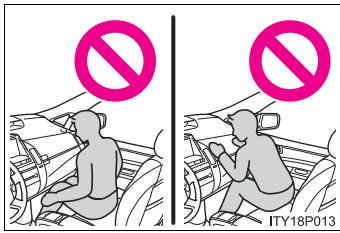

I Do not sit on the edge of the seat or lean against the dashboard.

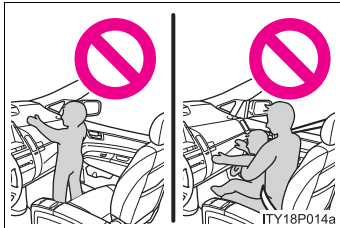

I Do not allow a child to stand in front of the SRS front passenger airbag unit or sit on the knees of a front passenger.

I Do not drive the vehicle while the driver or passenger have items resting on their knees.

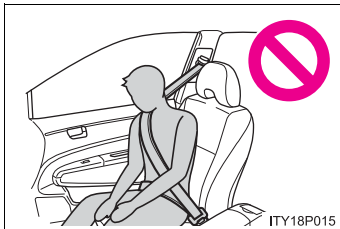

I Do not lean against the door, the roof side rail or the front, side and rear pillars.

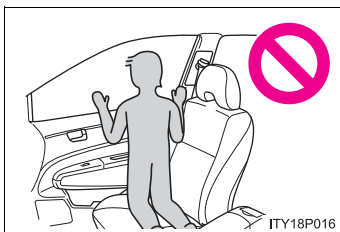

I Do not allow anyone to kneel on the front passenger seat toward the door or put their head or hands outside the vehicle.

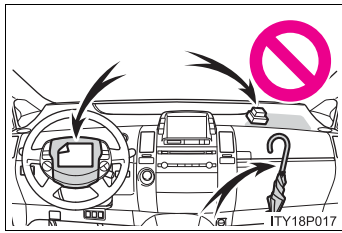
CAUTION**n SRS airbag precautions**

I Do not attach anything to or lean anything against areas such as the dashboard, steering wheel pad. These items can become projectiles when SRS driver and front passenger airbags deploy.

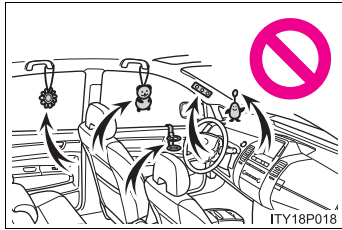

I Do not attach anything to areas such as the door, windshield glass, side door glass, front and rear pillars, roof side rail or assist grip.

I Do not hang coat hangers or other hard objects on the coat hooks. All of these items could become projectiles and cause death or serious injury should the SRS curtain shield airbag deploy.

I Do not use seat accessories which cover the parts where the SRS side airbags inflate as they may interfere with inflation of the airbags.

I Do not strike or apply significant levels of force to the area of the SRS airbag components shown on P. 90. Doing so can cause the SRS airbags to malfunction.

I Do not touch any of the component parts immediately after the SRS airbags have deployed (inflated) as they may be hot.

I If breathing becomes difficult after the SRS airbag has deployed, open a door or window to allow fresh air in, or leave the vehicle if it is safe to do so. Wash off any residue as soon as possible to prevent skin irritation.

I If the areas where the SRS airbags are stored, such as the steering wheel pad and front pillar garnish, are damaged or cracked, have them replaced by your Toyota dealer.

I Do not place anything, such as a cushion, on the front passenger's seat. Doing so will disperse the passenger's weight, which prevents the sensor from detecting the passenger's weight properly. As a result, the SRS front passenger airbag may not deploy in the event of a collision.

1

Before driving

1-8. Safety information

CAUTION

n Modification and disposal of SRS airbag system components

Do not dispose of your vehicle or perform any of the following modifications without consulting your Toyota dealer. The SRS airbag may malfunction or deploy (inflate) accidentally, causing death or serious injury.

- I** Installation, removal, disassembly and repair of the SRS airbags
- I** Repairs, modifications, removal or replacement of the steering wheel, instrument panel, dashboard, seats or seat upholstery, front, side and rear pillars or roof side rail
- I** Repairs or modifications of the front fender, front bumper, or side of the occupant compartment
- I** Installation of snow plows, winches, etc. to the front grille (bull bars, kangaroo bar etc.)
- I** Modifications to the vehicle's suspension system
- I** Installation of electronic devices such as mobile two-way radios or CD players
- I** Modifications to your vehicle for a person with a physical disability.

1-8. Safety information

Front passenger occupant classification system

Your vehicle is equipped with a front passenger occupant classification system. This system detects the conditions of the front passenger seat and activates or deactivates the devices for front passenger.

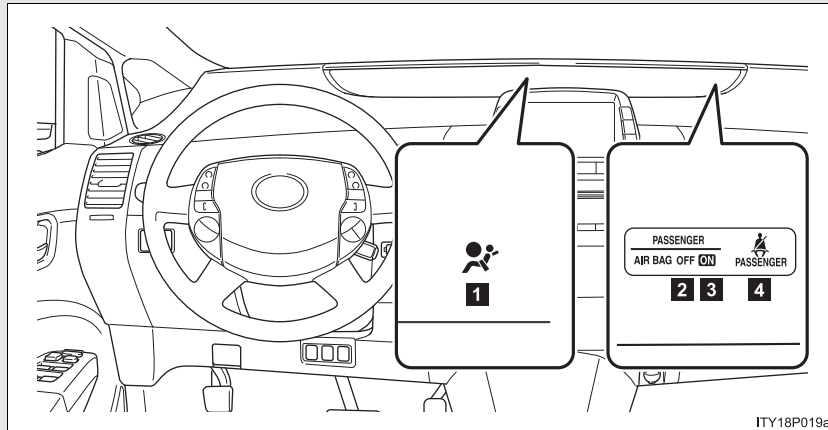

- 1 SRS warning light
- 2 "AIR BAG OFF" indicator light
- 3 "AIR BAG ON" indicator light
- 4 Front passenger's seat belt reminder light

1-8. Safety information

Condition and operation in the front passenger occupant classification system

n Adult*1

Indicator/ warning light	“AIR BAG ON” and “AIR BAG OFF” indicator lights	“AIR BAG ON”
	SRS warning light	Off
	Front passenger’s seat belt reminder light	Flashing*2
Devices	Front passenger airbag	Activated
	Side airbag on the right side passenger seats	
	Curtain shield airbag in the front passenger side	
	Front passenger’s seat belt pretensioner	

n Child*3 or child restraint system*4

Indicator/ warning light	“AIR BAG ON” and “AIR BAG OFF” indicator lights	“AIR BAG OFF”*5
	SRS warning light	Off
	Front passenger’s seat belt reminder light	Flashing*2
Devices	Front passenger airbag	Deactivated
	Side airbag on the right side passenger seats	
	Curtain shield airbag in the front passenger side	Activated
	Front passenger’s seat belt pretensioner	Activated

1-8. Safety information

Unoccupied

Indicator/ warning light	"AIR BAG ON" and "AIR BAG OFF" indicator lights	Not illumi- nated
	SRS warning light	Off
	Front passenger's seat belt reminder light	
Devices	Front passenger airbag	Deactivated
	Side airbag on the right side passenger seats	
	Curtain shield airbag in the front passenger side	Activated
	Front passenger's seat belt pretensioner	Deactivated

1

Before driving

1-8. Safety information

n There is a malfunction in the system

Indicator/ warning light	"AIR BAG ON" and "AIR BAG OFF" indicator lights	"AIR BAG OFF"
	SRS warning light	On
	Front passenger's seat belt reminder light	Off
Devices	Front passenger airbag	Deactivated
	Side airbag on the right side passenger seats	
	Curtain shield airbag in the front passenger side	Activated
	Front passenger's seat belt pretensioner	Activated

*1: The system judges a person of adult size as an adult. When a smaller adult sits in the front passenger seat, the system may recognize him/her as a child depending on his/her physique and posture.

*2: In the event the front passenger does not wear a seat belt.

*3: When a large child who has outgrown a child restraint system sits in the front passenger seat, the system may recognize him/her as an adult depending on his/her physique or posture.

*4: Never install a rear-facing child restraint system on the front passenger seat. A forward-facing child restraint system should only be installed on the front passenger seat when it is unavoidable. (→P. 107)

*5: In case the indicator is not illuminated, consult this manual as for installing the child restraint system properly. (→P. 111)

⚠ CAUTION**n Front passenger occupant classification system precautions**

Observe the following precautions regarding front passenger occupant classification system.

Failure to do so may cause death or serious injury.

- ! Wear the seat belt properly.
- ! Make sure the front passenger's seat belt tab has not been left inserted into the buckle before someone sits in the front passenger seat.
- ! Make sure the "AIR BAG OFF" indicator lights is not illuminated when using the seat belt extender for the front passenger seat. If the "AIR BAG OFF" indicator light is illuminated, disconnect the extender tongue from the seat belt buckle, then reconnect the seat belt. Reconnect the seat belt extender after making sure the "AIR BAG ON" indicator light is illuminated. If you use the seat belt extender while the "AIR BAG OFF" indicator light is illuminated, the front passenger airbag and side airbag on the front passenger side may not activate correctly, which could cause death or serious injury in the event of collision.
- ! Do not apply a heavy load to the front passenger seat.
- ! Do not put weight on the front passenger seat by putting your hands or feet on the front passenger seatback from the rear passenger seat.
- ! Do not let a rear passenger lift the front passenger seat with their feet or press on the seatback with their legs.
- ! Do not put objects under the front passenger seat.
- ! Do not recline the front passenger seatback so far that it touches a rear seat. This may cause the "AIR BAG OFF" indicator light to be illuminated, which indicates that the passenger's airbags will not deploy in the event of a severe accident. If the seatback touches the rear seat, return the seatback to a position where it does not touch the rear seat. Keep the front passenger seatback as upright as possible when the vehicle is moving. Reclining the seatback excessively may lessen the effectiveness of the seat belt system.

1

Before driving

1-8. Safety information

CAUTION

n Front passenger occupant classification system precautions

- I** If an adult sits in the front passenger seat, the “AIR BAG ON” indicator light is illuminated. If the “AIR BAG OFF” indicator light is illuminated, ask the passenger to sit up straight, well back in the seat, feet on the floor, and with the seat belt worn correctly. If the “AIR BAG OFF” indicator light still remain illuminated, either ask the passenger to move to the rear seat, or if that is not possible, move the front passenger seat fully rearward.
- I** When it is unavoidable to install the forward-facing child restraint system on the front passenger seat, install the child restraint system on the front passenger seat in the proper order. (→P. 111)
- I** Do not modify or remove the front seats.
- I** Do not kick the front passenger seat or subject it to severe impact. Otherwise, the SRS warning light may come on to indicate a malfunction on the detection system. In this case, contact your Toyota dealer immediately.
- I** Child restraint systems installed on the rear seat should not contact the front seatbacks.
- I** Do not use a seat accessory, such as a cushion or seat cover, that covers the seat cushion surface.
- I** Do not modify or replace the upholstery of the front seat.

1-8. Safety information

Child restraint systems

A child restraint system for a small child or baby must itself be properly restrained on the seat with the lap portion of the lap/shoulder belt.

The laws of all 50 states of the U.S.A. and Canada now require the use of child restraint systems.

1

Before driving

Points to remember

Studies have shown that installing a child restraint on a rear seat is much safer than installing one to the front passenger seat.

- 1 Choose a child restraint system that suits your vehicle and is appropriate to the age and size of the child.
- 1 For installation details, follow the instructions provided with the child restraint system.
General installation instructions are provided in this manual.
(→P. 111)

Types of child restraints

Child restraint systems are classified into the following 3 types according to the age and size of the child.

- ▶ Rear facing — Infant seat/convertible seat

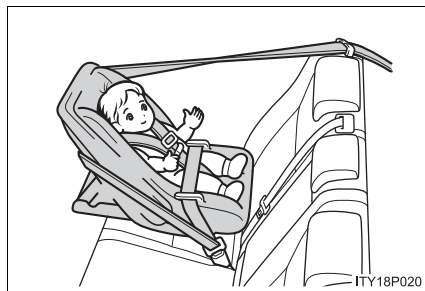

1-8. Safety information

► Forward facing — Convertible seat

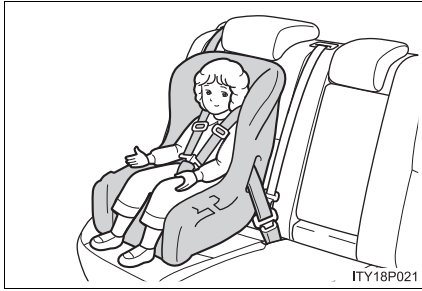

► Booster seat

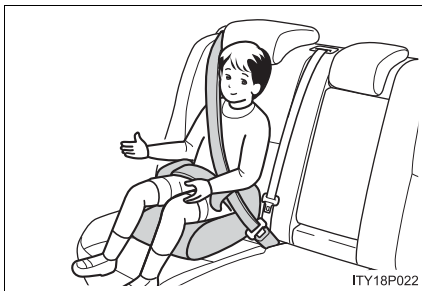

n **Selecting an appropriate child restraint system**

- 1 Use a child restraint system appropriate for the child until the child becomes large enough to properly wear the vehicle's seat belt.
- 1 If a child is too large for a child restraint system, sit the child on a rear seat and use the vehicle's seat belt. (→P. 64)

! CAUTION

n Child restraint precautions

- I** For effective protection in automobile accidents and sudden stops, a child must be properly restrained, using a seat belt or child restraint system depending on the age and size of the child. Holding a child in your arms is not a substitute for a child restraint system. In an accident, the child can be crushed against the windshield, or between you and the vehicle's interior.
- I** Toyota strongly urges the use of a proper child restraint system that conforms to the size of the child, installed on the rear seat. According to accident statistics, the child is safer when properly restrained in the rear seat than in the front seat.
- I** Never install a rear-facing child restraint system on the front passenger seat even if "AIR BAG OFF" indicator light is illuminated. In the event of an accident, the force of the rapid inflation of the front passenger airbag can cause death or serious injury to the child if the rear-facing child restraint system is installed on the front passenger seat.
- I** A forward-facing child restraint system may be installed on the front passenger seat only when it is unavoidable. A child restraint system that requires a top tether strap should not be used in the front passenger seat since there is no top tether strap anchor for the front passenger seat. Adjust the seatback as upright as possible and always move the seat as far back as possible even if "AIR BAG OFF" indicator light is illuminated, because the front passenger airbag could inflate with considerable speed and force. Failing to do so may cause death or serious injury to the child.
- I** Do not use the seat belt extender when installing a child restraint system on the front or rear passenger seat. If installing a child restraint system with the seat belt extender connected to the seat belt, the seat belt will not securely hold the child restraint system, which could cause death or serious injury to the child or other passengers in the event of collision.

1

Before driving

1-8. Safety information

CAUTION

n Child restraint precautions

- I** Do not allow the child to lean his/her head or any part of his/her body against the door or the area of the seat, front and rear pillars or roof side rail from which the side airbags or curtain shield airbags deploy even if the child is seated in the child restraint system. It is dangerous if the side airbags and curtain shield airbags inflate, and the impact could cause death or serious injury to the child.
- I** Make sure you have complied with all installation instructions provided by the child restraint manufacturer and that the system is properly secured. If it is not secured properly, it may cause death or serious injury to the child in the event of a sudden stop or accident.

n Child restraint lock function belt precaution

Do not allow children to play with the child restraint lock function belt. If the belt becomes twisted around a child's neck, it will not be possible to pull the belt out leading to choking or other serious injuries that could result in death. If this occurs and the buckle cannot be unfastened, scissors should be used to cut the belt.

n When the child restraint system is not in use

- I** Keep the child restraint system properly secured on the seat even if it is not in use. Do not store the restraint unsecured in the passenger compartment.
- I** If it is necessary to detach the child restraint system, remove it from the vehicle or store it securely in the luggage compartment. This will prevent it from injuring passengers in the event of a sudden stop or accident.

1-8. Safety information

Installing child restraints

Follow the child restraint system manufacturer's instructions. Firmly secure child restraints to the outboard rear seats using the LATCH anchors or a seat belt. Attach the top tether strap when installing a child restraint.

The lap/shoulder belt can be used if your child restraint system is not compatible with the LATCH (Lower Anchors and Tethers for Children) system.

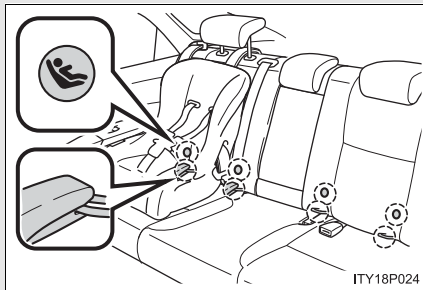

Child restraint LATCH anchors

LATCH anchors are provided for the outboard rear seats. (Buttons displaying the location of the anchors are attached to the seats.)

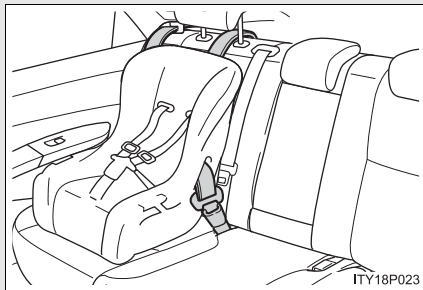

Seat belts equipped with a child restraint locking mechanism (ALR/ELR belts except driver's seat belt) (→P. 66)

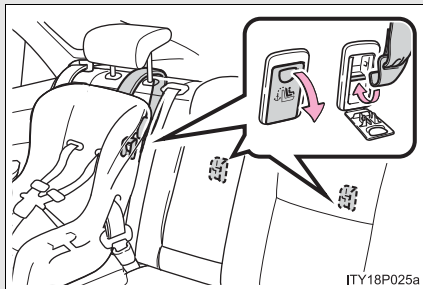

Anchor bracket (for top tether strap)

Anchor brackets are provided for all rear seats.

1

Before driving

1-8. Safety information

Installation with LATCH system

► Type A

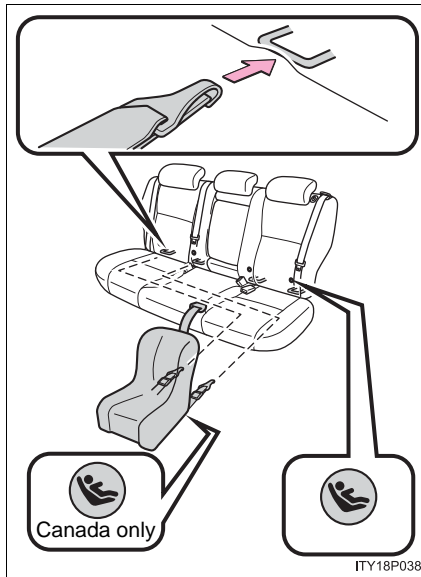

STEP 1 Widen the gap between the seat cushion and seatback slightly.

STEP 2 Latch the hooks of the lower straps onto the LATCH anchors.

STEP 3 If the child restraint has a top tether strap, the top tether strap should be latched onto the top tether strap anchor.

For owners in Canada:
A symbol on a child restraint system indicates the presence of a lower connector system.

► Type B

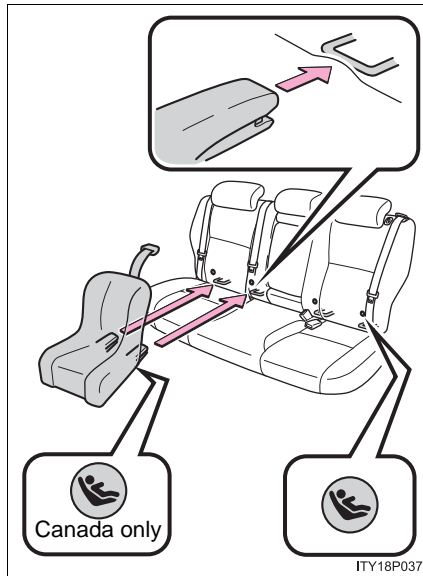

STEP 1 Widen the gap between the seat cushion and seatback slightly.

STEP 2 Latch the buckles onto the LATCH anchors.

STEP 3 If the child restraint has a top tether strap, the top tether strap should be latched onto the top tether strap anchor.

For owners in Canada:
A symbol on a child restraint system indicates the presence of a lower connector system.

1

Before driving

1-8. Safety information

Installing child restraints using a seat belt (child restraint lock function belt)

n Rear facing — Infant seat/convertible seat

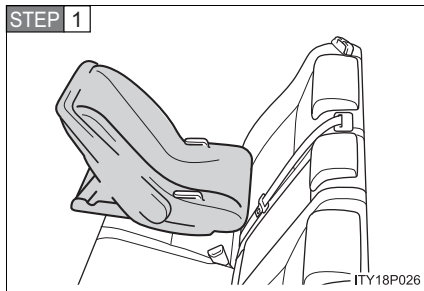

Place the child seat on the rear seat facing the rear of the vehicle.

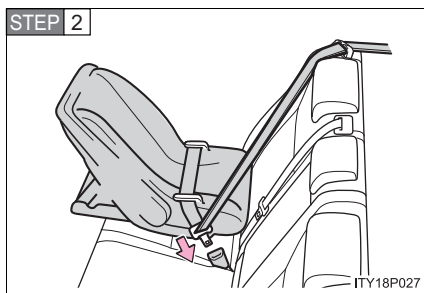

Run the seat belt through the child seat and insert the plate into the buckle. Make sure that the belt is not twisted.

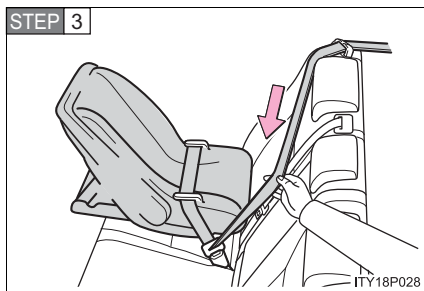

Fully extend the shoulder belt and then allow it to retract slightly in order to activate the ALR lock mode.

Lock mode allows the seat belt to retract only.

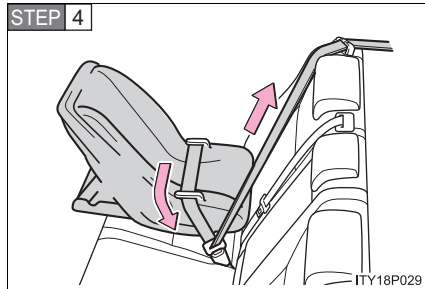

While pushing the child seat down into the rear seat, allow the shoulder belt to retract until the child seat is securely in place.

After the shoulder belt has retracted to a point where there is no slack in the belt, pull the belt to check that it cannot be extended.

n Forward facing — Convertible seat

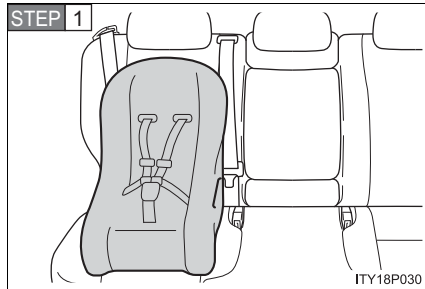

Place the child seat on the seat facing the front of the vehicle.

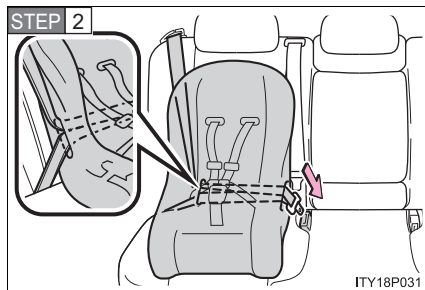

Run the seat belt through the child seat and insert the plate into the buckle. Make sure that the belt is not twisted.

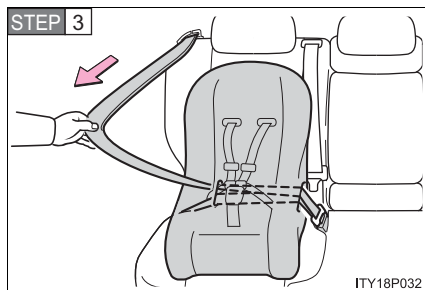

Fully extend the shoulder strap and then allow it to retract slightly into the ALR lock mode.

Lock mode allows the seat belt to retract only.

1

Before driving

1-8. Safety information

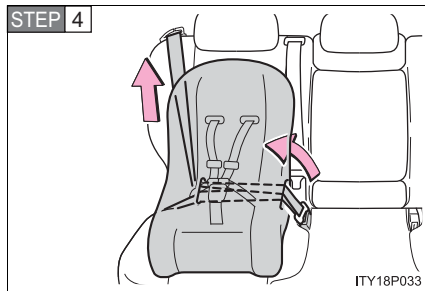

While pushing the child seat into the rear seat, allow the shoulder belt to retract until the child seat is securely in place.

After the shoulder belt has retracted to a point where there is no slack in the belt, pull the belt to check that it cannot be extended.

STEP 5 If the child restraint has a top tether strap, the top tether strap should be latched onto the top tether strap anchor. (→P. 117)

n Booster seat

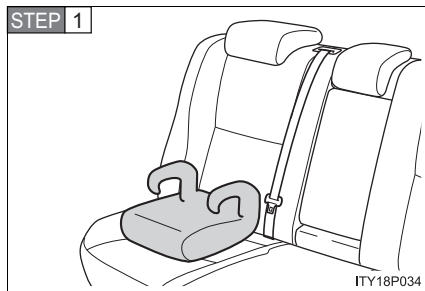

Place the booster seat on the seat facing the front of the vehicle.

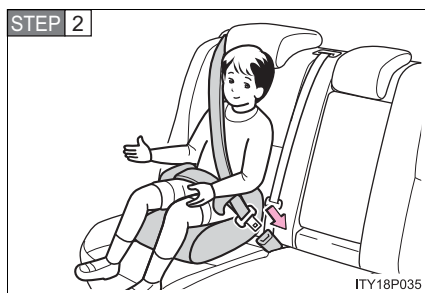

Sit the booster in the child seat. Fit the seat belt to the booster seat according to the manufacturer's instructions and insert the plate into the buckle. Make sure that the belt is not twisted.

Check that the shoulder belt is correctly positioned over the child's shoulder, and that the lap belt is as low as possible. (→P. 64)

Removing a child restraint installed with a seat belt

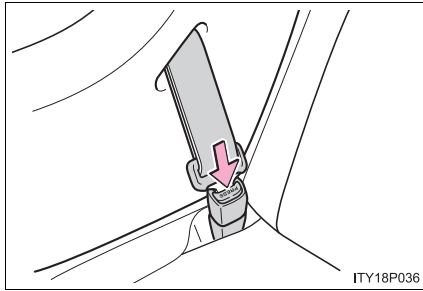

Push the buckle release button and fully retract the seat belt.

1

Before driving

Child restraint systems with a top tether strap

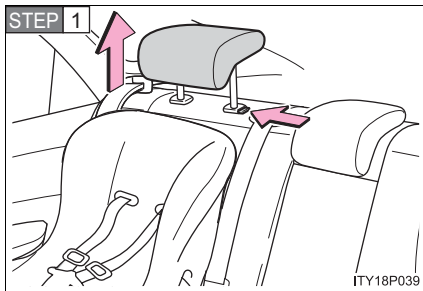

Secure the child restraint using a seat belt or lower anchors, and lock the head restraint in place at the highest position.

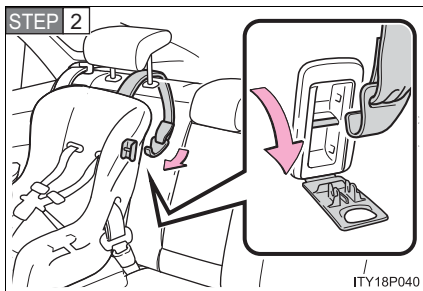

Open the anchor bracket cover, latch the hook onto the anchor bracket and tighten the top tether strap.

Make sure the top tether strap is securely latched.

1-8. Safety information

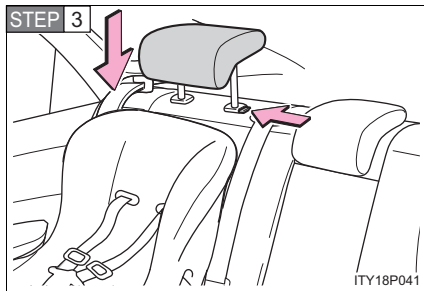

Reinstall the head restraint.

n **Laws and regulations pertaining to anchorages**

The LATCH system conform to FMVSS225 or CMVSS210.2.
Child restraint systems conforming to FMVSS213 or CMVSS213 specifications can be used.
This vehicle is designed to conform to the SAE J1819.

! CAUTION

n **When installing a booster seat**

Do not fully extend the shoulder belt to prevent the belt from going to ALR lock mode: (→P. 66)
ALR mode causes the belt to tighten only which could cause injury or discomfort to the child.

⚠ CAUTION**n When installing a child restraint system**

Follow the directions given in the child restraint system installation manual and fix the child restraint system securely in place.

If the child restraint system is not correctly fixed in place, the child or other passengers may be injured or even killed in the event of sudden braking or an accident.

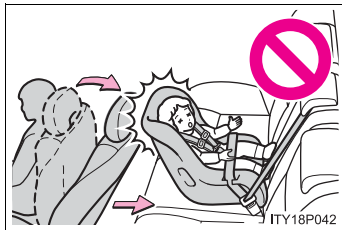

I If the driver's seat interferes with the child restraint system and prevents it from being attached correctly, attach the child restraint system to the right-hand rear seat.

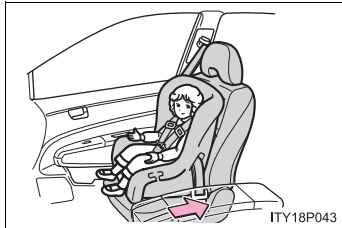

I Only put a forward facing or booster child seat on the front seat when unavoidable. When installing a forward facing or booster child seat on the front passenger seat, move the seat as far back as possible even if "AIR BAG OFF" indicator light is illuminated. Failing to do so may result in death or serious injury if the airbags deploy (inflate).

I When a booster seat is installed, always ensure that the shoulder belt is positioned across the center of the child's shoulder. The belt should be kept away from the child's neck, but not so that it could fall off the child's shoulder. Failing to do so may result in death or serious injury in the event of an accident or sudden braking.

I Ensure the belt and tab are securely locked and that the seat belt is not twisted.

I Push and pull the child seat from side to side and forward to be sure it is secure.

1

Before driving

1-8. Safety information

CAUTION

n When installing a child restraint system

- I** After securing a child restraint system, never adjust the seat.
- I** Follow all installation instructions provided by the child restraint system manufacturer.

n Do not use a seat belt extender

If a seat belt extender is used when installing a child restraint system, the seat belt will not securely hold the child restraint system, which could cause death or serious injury to the child or other passengers in the event of a collision.

n To correctly attach a child restraint system to the anchors

When using the LATCH anchors, be sure that there are no foreign objects around the anchors and that the seat belt is not caught behind the child restraint. Make sure the child restraint system is securely attached, or it may cause death or serious injury to the child or other passengers in the event of a sudden stop or accident.

2-1. Driving procedures

Driving the vehicle

The following procedures should be observed to ensure safe driving.

n Starting the hybrid system (→P. 133)

n Driving

STEP 1 With the brake pedal depressed, shift the shift lever to “D”.
(→P. 138)

STEP 2 Release the parking brake.
(→P. 143)

STEP 3 Gradually release the brake pedal and gently depress the accelerator pedal to accelerate the vehicle.

n Stopping

STEP 1 With the shift lever in “D”, depress the brake pedal.

STEP 2 If necessary, set the parking brake.

When the vehicle is stopped for an extended period of time, push the “P” position switch.
(→P. 139)

n Parking the vehicle

STEP 1 With the shift lever in “D”, depress the brake pedal.

STEP 2 Set the parking brake.
(→P. 143)

STEP 3 Push the “P” position switch.
(→P. 139)

When parking on hill, if necessary, block the wheels.

STEP 4 Press the “POWER” switch and stop the hybrid system.

STEP 5 Lock the door, making sure that you have the electronic key on your person.

Starting on a steep incline

STEP 1 Firmly set the parking brake and shift the shift lever to “D”.

STEP 2 Gently depress the accelerator pedal.

STEP 3 Release the parking brake.

n Driving in the rain

- l Drive carefully when it is raining, because visibility will be reduced, the windows may become fogged-up, and the road will be slippery.
- l Drive carefully when it starts to rain, because the road surface will be especially slippery.
- l Refrain from high speeds when driving on an expressway in the rain, because there may be a layer of water between the tires and the road surface, preventing the steering and brakes from operating properly.

n Breaking in your new Toyota

To extend the life of the vehicle, the following precautions are recommended to observe:

- l For the first 180 miles (300 km):
Avoid sudden stops.
- l For the first 621 miles (1000 km):
 - Do not drive at extremely high speeds.
 - Avoid sudden acceleration.
 - Do not drive continuously in the low gears.
 - Do not drive at a constant speed for extended periods.

n Operating your vehicle in a foreign country

Comply with the relevant vehicle registration laws and confirm the availability of the correct fuel. (→P. 462)

n For efficient use

- l Put the shift lever into "D" when driving
In the "N" position, the gasoline engine operates but electricity cannot be generated.
The hybrid battery (traction battery) will be discharged requiring unnecessary engine power to recharge.
- l Drive your vehicle smoothly
Avoid abrupt acceleration and deceleration. Gradual acceleration and deceleration will make more effective use of the traction motor without having to use gasoline engine power.

2

When driving

2-1. Driving procedures

1 Avoid repeated acceleration

Repeated acceleration consumes hybrid battery (traction battery) power, resulting in poor acceleration. Battery power can be restored by driving with the accelerator pedal slightly released.

1 Push the "P" position switch when parking

In the "N" position, the hybrid battery (traction battery) does not recharge. Leaving the shift lever in the "N" position for an extended period of the time may discharge the hybrid battery. The vehicle cannot run if the hybrid battery is discharged.

n **Normal characteristics after turning off the hybrid system**

Approximately five hours after the hybrid system is turned off, you may hear sound coming from under the vehicle for several minutes. This is because the fuel evaporation leakage check is performed. It does not indicate a malfunction.

⚠ CAUTION**n When starting the vehicle**

Always keep your foot on the brake pedal while stopped with the hybrid system operating. This prevents the vehicle from creeping.

n When driving the vehicle

I Do not drive if you are unfamiliar with the location of the brake and accelerator pedals to avoid depressing the wrong pedal.

- Accidentally depressing the accelerator pedal instead of the brake pedal will result in sudden acceleration that may lead to an accident that could result in death or serious injury.
- When backing up, you may twist your body around, leading to a difficulty in operating the pedals. Make sure to operate the pedals properly.
- Make sure to keep a correct driving posture even when moving the vehicle only slightly, allowing you to depress the brake and accelerator pedals properly.
- Depress the brake pedal using your right foot. Depressing the brake pedal using your left foot may delay response in an emergency, resulting in an accident.

I The driver should pay attention to pedestrians when the vehicle is powered only by the electric motor (traction motor). Because there is no hybrid system sounds, the pedestrians may misjudge the vehicle's movement.

I Do not drive the vehicle over or stop the vehicle near flammable materials. The exhaust system and exhaust gases can be extremely hot. this may cause a fire if there is any flammable material nearby.

I Do not let the vehicle roll backwards while the shift lever is in a driving position, or roll forward while the shift lever is in "R". Doing so may cause the hybrid system not to operate or lead to poor brake and steering performance, resulting in an accident or damage to the vehicle.

I If the smell of exhaust is noticed inside the vehicle, open the windows and check that the back door is closed. Large amounts of exhaust in the vehicle can cause driver drowsiness and an accident, resulting in death or a serious health hazard. Have the vehicle inspected by your Toyota dealer immediately.

2

When driving

2-1. Driving procedures

 **CAUTION****n When driving the vehicle**

- I** Do not under any circumstances shift the shift lever to “R”, “N” or push the “P” position switch while the vehicle is moving.
Doing so can cause significant damage to the transmission and may result in a loss of vehicle control.
- I** Do not shift the shift lever to “N” while the vehicle is moving.
Doing so may cause the engine brake not to operate properly and lead to an accident.
- I** Do not turn the hybrid system off while driving.
The power steering and brake actuator will not operate properly if the hybrid system is not operating.
- I** Use engine braking (“B”) to maintain a safe speed when driving down a steep hill.
Using the brakes continuously may cause the brakes to overheat and lose effectiveness. (→P. 138)
- I** When stopped on an inclined surface, use the brake pedal and parking brake to prevent the vehicle from rolling backward or forward and causing an accident.
- I** Do not adjust the position of the steering wheel, the seat, or the inside or outside rear view mirrors while driving.
Doing so may result in a loss of vehicle control that can cause accidents that may result in death or serious injury.
- I** Always check that all passengers’ arms, heads or other parts of their bodies are not outside the vehicle, as this may result in death or serious injury.
- I** Do not drive in excess of the speed limit. Even if the legal speed limit permits it, do not drive over 85 mph (140 km/h) unless your vehicle has high speed capability tires. Driving over 85 mph (140 km/h) may result in tire failure, loss of control and possible injury. Be sure to consult a tire dealer to determine whether the tires on your vehicle are high-speed capability tires or not before driving at such speeds.

⚠ CAUTION

n When driving on slippery road surfaces

- !** Sudden braking, acceleration and steering may cause tire slippage and reduce your ability to control the vehicle, resulting in an accident.
- !** Sudden changes in engine speed, such as engine braking caused by up-shifting or down-shifting, may cause the vehicle to skid, resulting in an accident.
- !** After driving through a puddle, lightly depress the brake pedal to make sure that the brakes are functioning properly. Wet brake pads may prevent the brakes from functioning properly. If the brakes on only one side are wet and not functioning properly, steering control may be affected, resulting in an accident.

n When shifting the shift lever

Be careful not to shift the shift lever with the accelerator pedal depressed. This may lead to unexpected rapid acceleration of the vehicle that may cause an accident and result in death or serious injury.

n When the vehicle is stopped

- !** Do not race the hybrid system.
If the vehicle is in any gear other than "P" or "N" the vehicle may accelerate suddenly and unexpectedly, and may cause an accident.
- !** Do not leave the vehicle with the hybrid system on for a long time.
If such a situation cannot be avoided, park the vehicle in an open space and check that exhaust fumes do not enter the vehicle interior.
- !** Always keep a foot on the brake pedal while the hybrid system is operating to prevent an accident caused by the vehicle moving.

2

When driving

2-1. Driving procedures

CAUTION

n When the vehicle is parked

I Do not leave glasses, cigarette lighters, spray cans, or soft drink cans in the vehicle when it is in the sun.

Failure to do so may result in the following:

- Gas may leak from a cigarette lighter or spray can, and may lead to a fire.
- The temperature inside the vehicle may cause the plastic lenses and plastic material of eye glasses to deform or crack.
- Soft drink cans may fracture, causing the contents to spray over the interior of the vehicle, and may also cause a short circuit in the vehicle's electrical components.

I Always apply the parking brake, push the "P" position switch, stop the hybrid system and lock the vehicle.

Do not leave the vehicle unattended while the hybrid system is operating.

I Do not touch the exhaust pipe while the hybrid system is operating or immediately after turning the hybrid system off.

Doing so may cause burns.

I Do not leave the hybrid system operating in an area with snow build up, or where it is snowing. If snowbanks build up around the vehicle while the hybrid system is operating, exhaust gases may collect and enter the vehicle. This may lead to death or a serious health hazard.

n Exhaust gases

Exhaust gases include harmful carbon monoxide (CO) that is colorless and odorless. Inhaling exhaust gases may lead to death or a serious health hazard.

I If the vehicle is in a poorly ventilated area, stop the hybrid system. In a closed area, such as a garage, exhaust gases may collect and enter the vehicle. This may lead to death or a serious health hazard.

I The exhaust should be checked occasionally. If there is a hole or crack cause by corrosion, damage to a joint or abnormal exhaust noise, be sure to have the vehicle inspected and repaired by your Toyota dealer. Failure to do so may allow exhaust gases to enter the vehicle, resulting in death or a serious health hazard.

⚠ CAUTION**n When taking a nap in the vehicle**

Always turn the hybrid system off. Otherwise, you may accidentally move the shift lever or depress the accelerator pedal, which could cause an accident or fire due to hybrid system overheating. Additionally, if the vehicle is parked in a poorly ventilated area, exhaust gases may collect and enter the vehicle, leading to death or a serious health hazard.

n When braking the vehicle

I When the brakes are wet, drive more cautiously. Braking distance increases when the brakes are wet, and may cause one side of the vehicle to brake differently than the other side. Also the parking brake may not securely hold the vehicle.

I If the power brake assist function does not operate, do not follow other vehicles closely and avoid downhill or sharp turns that require braking. In this case, braking is still possible, but it will require more force on the pedal than usual. Braking distance may also increase.

I Do not pump the brake pedal if the hybrid system stalls. Each push on the pedal uses up your reserved brake fluid pressure.

I The brake system consists of 3 individual hydraulic systems: if one of the systems fails, the other will still operate. In this case, the brake pedal should be depressed more firmly than usual and braking distance becomes longer.

Do not drive your vehicle with only a single brake system. Have your brakes fixed immediately.

2

When driving

2-1. Driving procedures

NOTICE

n While driving the vehicle

Do not use the accelerator pedal or depress accelerator and brake pedals together to hold the vehicle on a hill.

n When parking the vehicle

Always push the “P” position switch. Failure to do so may cause the vehicle to move or the vehicle may accelerate suddenly if the accelerator pedal is accidentally depressed.

n Avoiding damage to vehicle parts

I Do not turn the steering wheel fully in either direction and hold it there for a long time.
Doing so may damage the power steering motor.

I When driving over bumps in the road, drive as slowly as possible to avoid damaging the wheels, underside of the vehicle, etc.

n If you hear a squealing or scraping noise (brake pad wear limit indicators)

Have your Toyota dealer check and replace the brake pads as soon as possible.

The rotor damage can result if the pads are not replaced when needed.

Front brake only: Moderate levels of the brake pad and disc wear allow enhanced front braking power. As a result, the discs may wear more quickly than conventional brake discs. Therefore, when replacing the brake pads, Toyota recommends that you also have the thickness of the discs measured. It is dangerous to drive the vehicle when the wear limits of the brake pads and/or that of the brake discs are exceeded.

 NOTICE

n If you get a flat tire while driving

A flat or damaged tire may cause the following situations. Hold the steering wheel firmly and gradually press the brake pedal to slow down the vehicle.

- | It may be difficult to control your vehicle.
- | The vehicle will make abnormal sounds.
- | The vehicle will behave abnormally.

Replace a flat tire with a new one. (→P. 439)

n When encountering flooded roads

Do not drive on a road that has flooded after heavy rain etc. Doing so may cause the following serious damage to the vehicle.

- | Engine stalling
- | Short in electrical components
- | Engine damage caused by water immersion

In the event that you drive on a flooded road and the vehicle is flooded, be sure to have your Toyota dealer check the following.

- | Brake function
- | Changes in quantity and quality of engine oil, transmission fluid for the hybrid system, etc.
- | Lubricant condition for the bearings and suspension joints (where possible) and the function of all joints, bearings, etc.

2

When driving

2-1. Driving procedures

Power (ignition) switch

Performing the following operations when carrying the electronic key on your person starts the hybrid system or changes “POWER” switch modes.

1 Changing “POWER” switch mode

Modes can be changed by pressing the “POWER” switch with the brake pedal released. (The mode changes each time the switch is pressed.)

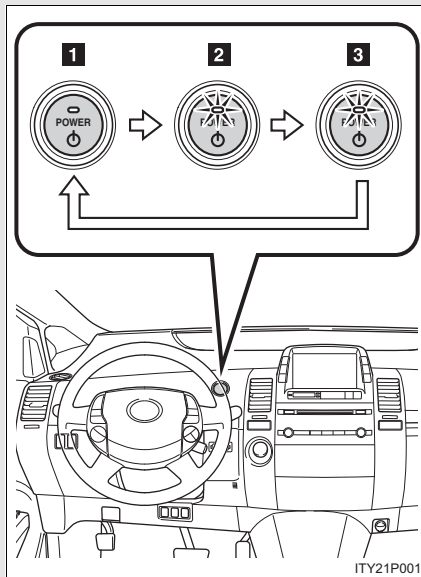

1 OFF mode*

2 ACCESSORY mode

Some electrical components such as the audio system can be used.

3 ON mode

All electrical components can be used.

*:The power cannot be switched to OFF unless the shift lever is in “P”.

n Starting the hybrid system (vehicle with smart key system)

STEP 1 Check that the parking brake is set.

STEP 2 Turn off unnecessary lights and accessories.

STEP 3 Check that the shift position is set in "P".

STEP 4 Sit in the driver's seat and firmly depress the brake pedal.

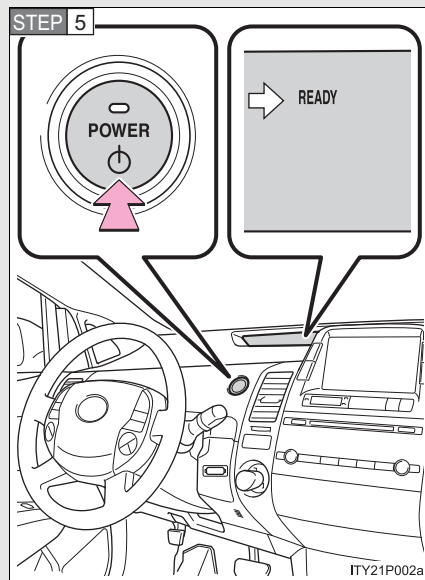

Press the "POWER" switch.

The hybrid system can be started from any mode.

After a few seconds, the "READY" light will flash and come on with a beep sound.

The vehicle can move when the "READY" light is on, even if the hybrid system is stopped.

2

When driving

2-1. Driving procedures

n Starting the hybrid system (vehicle without smart key system)

STEP 1 Check that the parking brake is set.

STEP 2 Turn off unnecessary lights and accessories.

STEP 3 Check that the shift position is set in "P".

STEP 4

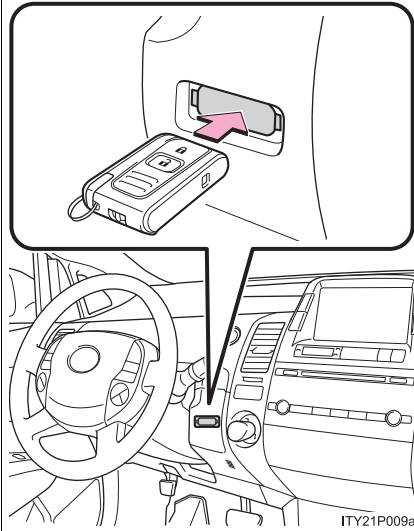

Insert the key into the key slot and firmly with the brake pedal depressed.

2-1. Driving procedures

STEP 5

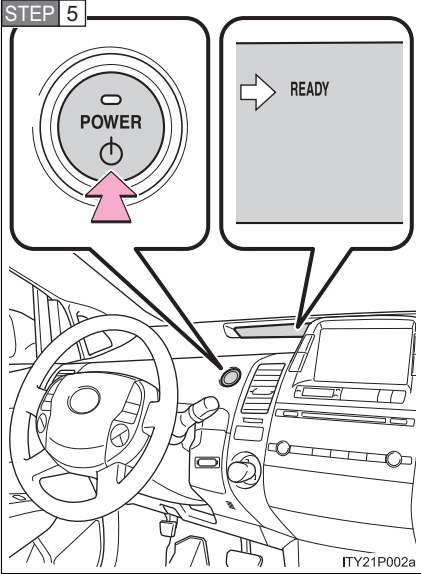

Press the "POWER" switch.

After a few seconds, the "READY" light will flash and come on with a beep sound.

The vehicle can move when the "READY" light is on, even if the hybrid system is stopped.

2

When driving

ITY21P002a

2-1. Driving procedures

n **If the hybrid system does not start**

The hybrid system immobilizer system may not have been deactivated.
(→P. 82)

n **If the “READY” light does not come on**

If the “READY” light does not come on when you press the power switch with the shift lever in “P” and the brake pedal pressed, contact your Toyota dealer immediately.

n **When the “POWER” switch indicator flashes in amber**

The system may be malfunctioning. Have the vehicle inspected by your Toyota dealer immediately.

n **Auto power OFF function**

The “POWER” switch will automatically turn OFF when left in ACCESSORY mode for 1 hour or more.

n **Electronic key battery depletion**

→P. 44

n **When the electronic key battery is discharged**

→P. 392

n **Conditions affecting operation**

→P. 42

n **Leak detection pump**

Several hours after the engine is turned off, you may hear a sound coming from underneath the luggage compartment for several minutes.
This is normal operation and does not indicate a malfunction.

 CAUTION

n When starting the hybrid system

Always start the hybrid system while sitting in the driver's seat. Do not press the accelerator pedal while starting the hybrid system under any circumstances.

Doing so may cause an accident resulting in death or serious injury.

n Stopping the hybrid system in an emergency

If you want to stop the hybrid system in an emergency while driving the vehicle, push and hold the "POWER" switch for more than 3 seconds.

However, do not touch the "POWER" switch while driving except in an emergency. If the hybrid system stops while the vehicle is being driven, this could lead to an unexpected accident.

2

When driving

 NOTICE

n To prevent 12 volt battery discharge

Do not leave the "POWER" switch in ACCESSORY or ON mode for long periods if the hybrid system is not operating.

n When starting the hybrid system

! Do not race the hybrid system.

! If the hybrid system becomes difficult to start or stalls frequently, have the hybrid system checked immediately.

2-1. Driving procedures Transmission

Select a shift position appropriate for the driving conditions.

n Shifting the shift lever

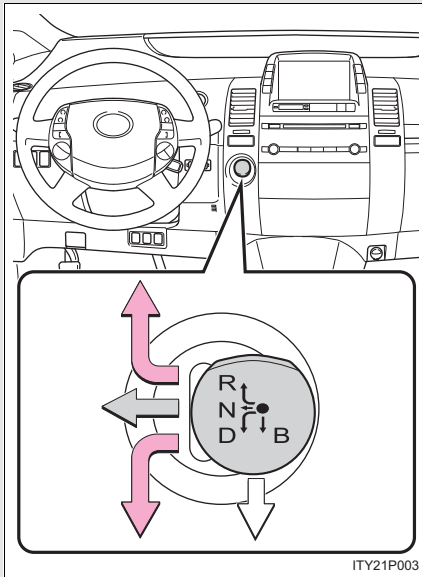

← You can operate the shift lever only in "D".

← Keep the shift lever in "N" for a while after you shift it to that position.

● The shift lever always returns to this original position after shifting operation.

Shift position uses

Shift position	Function
P	Parking the vehicle or starting the hybrid system
R	Reversing
N	Neutral
D	Normal driving
B	Engine braking position*

*: Shown only while in "D" position.

2

When driving

Changing shift ranges in "P" position

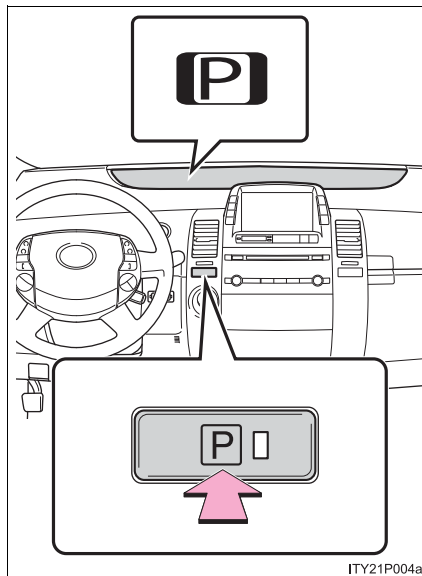

With the brake pedal pressed down, push the "P" position switch.

The "P" position is displayed on the instrument cluster, and the indicator on the "P" position switch comes on.

You can only shift to other position from "P" when the brake pedal is depressed.

When parking, check the shift position is "P" on the instrument cluster, and release the brake pedal gently after applying the parking brake.

2-1. Driving procedures

n **Using engine brake**

To use the engine braking, shift the shift lever to “B” position.

- l During high speed driving, you may feel that deceleration by engine braking is less than that of a typical vehicle.
- l Do not continue normal driving with the transmission in “B” for a long time.
This may cause decreased fuel economy. To prevent this, use “D” for normal driving.

n **Reverse warning buzzer**

When shifting into “R”, a buzzer will sound to inform the driver that the shift lever is in “R”.

n **If the system malfunctions**

The following conditions, there is some problem in the system. Immediately stop the vehicle in a safe place and contact your Toyota dealer.

- l The indicator on the “P” position switch flashes. However, this does not indicate a malfunction unless a warning message appears in the touch screen.
- l All frames of shift position indicators in the instrument cluster flash.
- l The parking system error message appears on the touch screen.
- l The instrument cluster and touch screen does not come on when the “POWER” switch is in ON mode.

n Alarms

The following table describes circumstances and correction procedures when only alarms are sound.

Alarm	Situation	Correction procedure
Interior alarm sounds once	The driver attempts to shift out of the "P" position without pressing the brake pedal.	The transmission will not move out of the "P" position, so press the brake pedal before attempting to shift again.
	The "P" position switch is pressed while the vehicle is moving.	The transmission will automatically be set to the "N" position, so select the appropriate position.
	The driver attempts to shift to the "R" position while the vehicle is in forward motion.	
	The driver attempts to shift to the "D" position while the vehicle is in rearward motion.	
	The driver attempts to select the "B" position while in a shift position other than "D" and "P".	
	The driver attempts to select the "B" position while in the "P" position.	
Interior alarm beep sounds and warning message*	If the driver's door is opened when the transmission is in "N", "D" or "B".	Push the "P" position switch.

*: Follow the warning message displayed.

2

When driving

2-1. Driving procedures

Turn signal lever

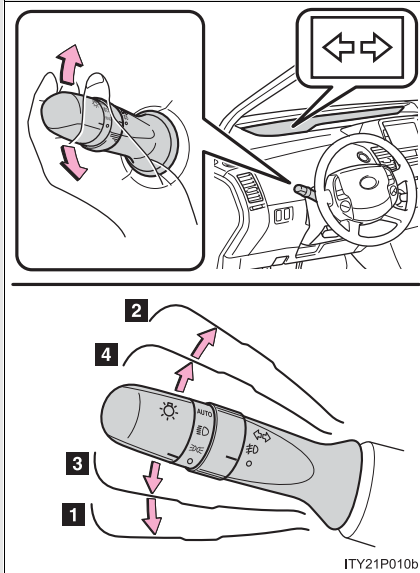

- 1** Left turn
- 2** Right turn
- 3** Move and hold the lever partway to signal a lane change
The left hand signal will flash until you release the lever.
- 4** Move and hold the lever partway to signal a lane change
The right hand signal will flash until you release the lever.

n Turn signals can be operated when

The "POWER" switch is in ON mode.

n If the indicators flash faster than usual

Check that a light bulb in the front or rear turn signal lights has not burned out.

2-1. Driving procedures

Parking brake

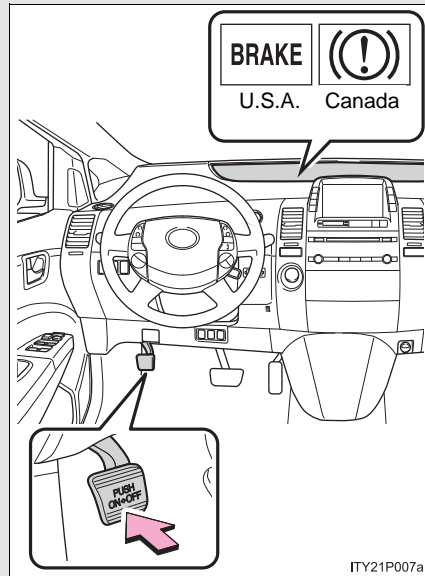

Sets the parking brake*
(Depressing the pedal again releases the parking brake.)

*:Fully depress the parking brake pedal with your left foot while depressing the brake pedal with your right foot.

2

When driving

NOTICE

n Before driving

Fully release the parking brake.

Driving the vehicle with the parking brake set will lead to brake components overheating, which may affect braking performance and increase brake wear.

n When parking the vehicle

Before you leave the vehicle, set the parking brake, push the "P" position switch and make sure that the vehicle does not move.

2-1. Driving procedures

Horn

n To sound the horn

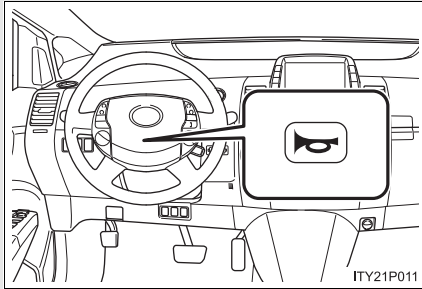

Press on or close to the  mark.

n After adjusting the steering wheel

Mark sure that the steering wheel is securely locked.
The horn may not sound if the steering wheel is not securely locked.
(→P. 71)

2-2. Instrument cluster Gauges and meters

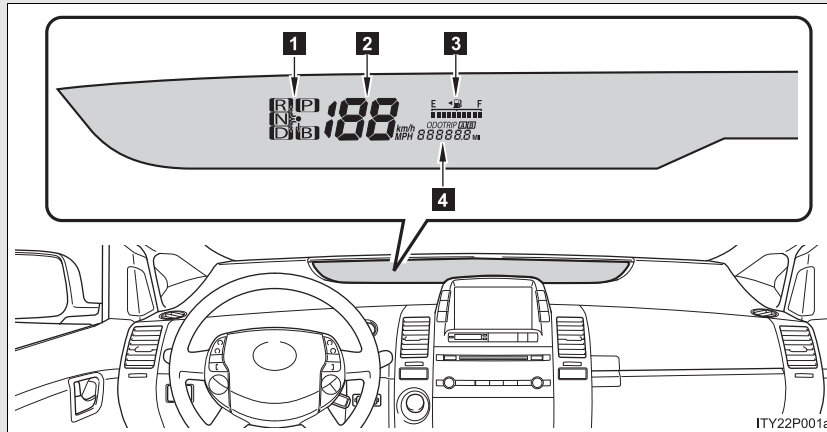

The following gauges and meters illuminate when the “POWER” switch is in ON mode.

- 1** Shift position indicator
Displays the shift position
- 2** Speedometer
Displays the vehicle speed.
- 3** Fuel gauge
Displays the quantity of fuel remaining in the tank.
- 4** Odometer
Displays the total distance the vehicle has been driven.
Trip meter
Displays the distance the vehicle has been driven since the meter was last reset. Trip meters A and B can be used to record and display different distances independently.

2

When driving

2-2. Instrument cluster

Odometer/trip meter and trip meter reset button

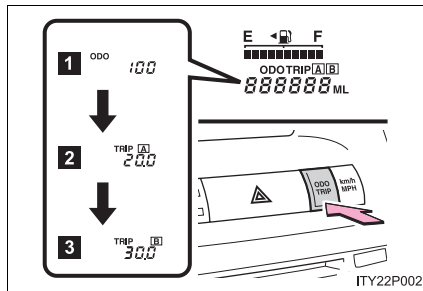

- 1 Odometer
- 2 Trip meter A*
- 3 Trip meter B*

*: Pushing and holding the button will reset the trip meter.

MPH or km/h button

The speed units can be selected MPH or km/h.

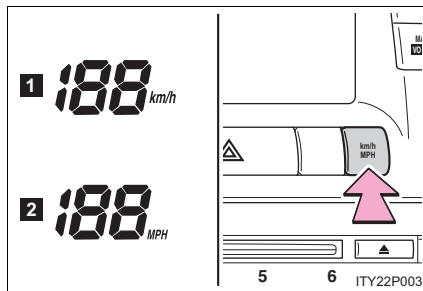

- 1 km/h
- 2 MPH

Instrument panel light control

The brightness of the instrument panel lights can be adjusted.

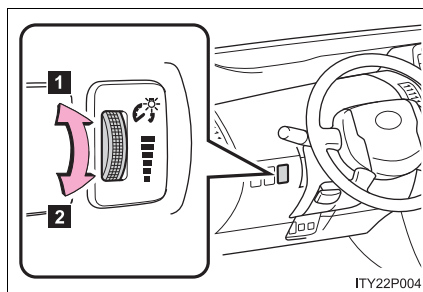

- 1 Brighter
- 2 Darker

2-2. Instrument cluster

 NOTICE

n To prevent damage to the hybrid system and its components

The hybrid system may be overheating if the high coolant temperature warning light is displayed on the touch screen. In this case, immediately stop the vehicle in a safe place. Check the hybrid system after it has cooled completely. (→P. 454)

2

When driving

2-2. Instrument cluster Indicators and warning lights

The indicator and warning lights on the instrument cluster and center panel inform the driver of the status of the vehicle's various systems.

► Instrument cluster

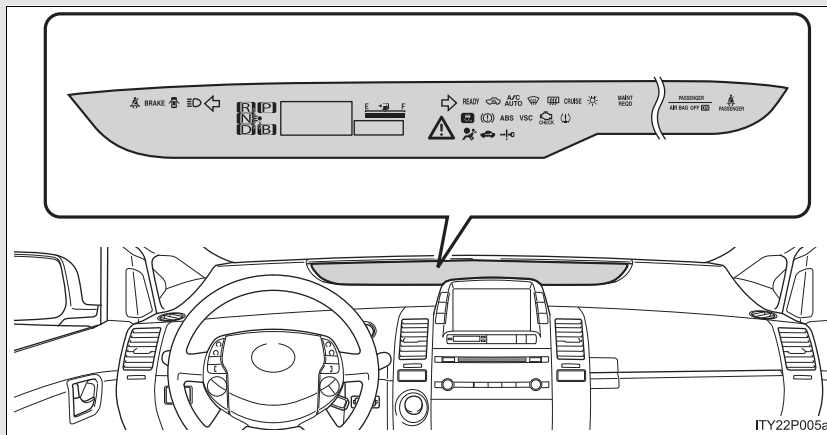

► Touch screen (Type A)



2-2. Instrument cluster

► Touch screen (Type B)

















2

When driving

2-2. Instrument cluster

n Indicators

The indicators inform the driver of the operating state of the vehicle's various systems.

	Turn signal indicator (→P. 142)		SRS airbag on-off indicator (→P. 101)
	Headlight high beam indicator (→P. 152)		Recirculate mode indicator (→P. 201, 208)
	Headlight indicator (→P. 152) (U.S.A.)		Automatic air conditioner indicator (→P. 198, 205)
	Tail light indicator (→P. 152) (Canada)		Windshield air flow indicator (→P. 201, 208)
	Shift position and shift range indicators (→P. 138)		Rear window and outside rear view mirror defoggers indicator (→P. 213)
	Cruise control indicator (→P. 159)		Driving ready indicator (→P. 132)
	Slip indicator (→P. 166)		Immobilizer / Theft deterrent system indicator (→P. 82, 84)

n Warning lights

Warning lights inform the driver of malfunctions in the indicated vehicle's systems. (→P. 423)

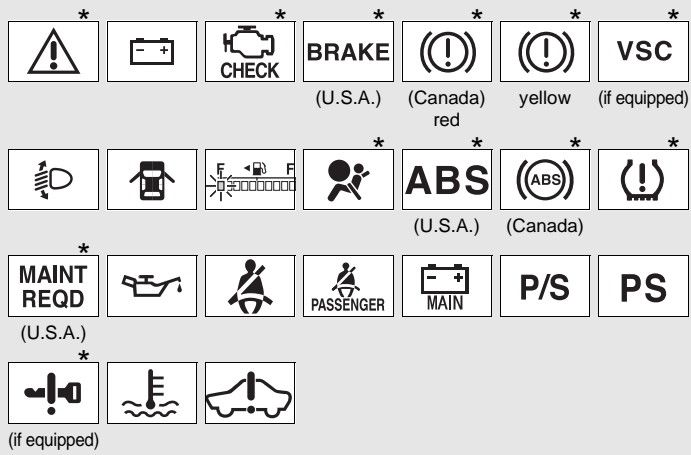

*: These lights turn on when the "POWER" switch is turned to ON mode to indicate that a system check is being performed. They will turn off after the hybrid system is started is on, or after a few seconds. There may be a malfunction in a system if the lights do not come on, or turn off. Have the vehicle inspected by your Toyota dealer.

! CAUTION

n If a safety system warning light does not come on

Should a safety system light such as ABS and the SRS airbag warning light not come on when you start the hybrid system, this could mean that these systems are not available to help protect you in an accident, which could result in death or serious injury. Have the vehicle inspected by your Toyota dealer immediately if this occurs.

2-3. Operating the lights and windshield wipers Headlight switch

The headlights can be operated manually or automatically.

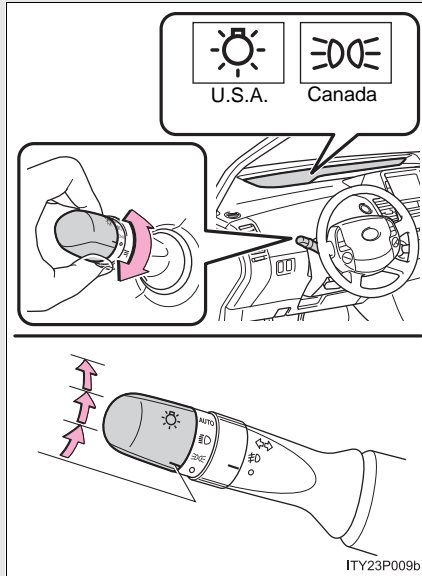

 The side marker, parking, tail, license plate and instrument panel lights turn on.

 The headlights and all lights listed above turn on.

AUTO The headlights and all (if equipped) the lights listed above turn on and off automatically. (When the "POWER" switch is in ON mode.)

Turning on the high beam headlights

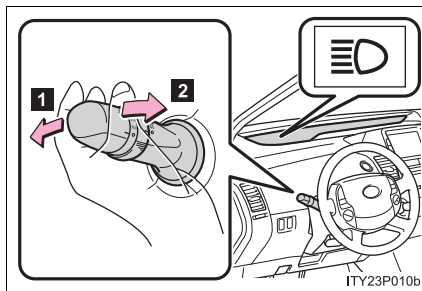

1 With the headlights on, push the lever forward to turn on the high beams.

Pull the lever back to the center position to turn the high beams off.

2 Pull the lever toward you to turn on the high beams.

Release to turn them off. You can flash the high beams with the headlights on or off.

2-3. Operating the lights and windshield wipers

n Daytime running light system (if equipped)

To make your vehicle more visible to other drivers, the headlights turn on automatically (at a reduced intensity) whenever the hybrid system is started and the parking brake is released. Daytime running lights are not designed for use at night.

n Headlight control sensor (if equipped)

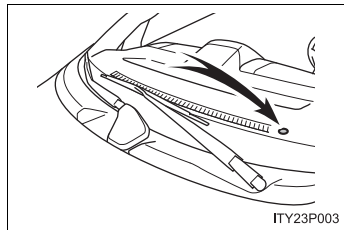

The sensor may not function properly if an object is placed on the sensor, or anything that blocks the sensor is affixed to the windshield.



Doing so interferes with the sensor detecting the level of ambient light and may cause the automatic headlight control system to malfunction.

2

When driving

n Automatic light off system

Opening the driver's door with the "POWER" switch in ACCESSORY mode or OFF will turn the headlights and tail lights off.

To turn the lights on again, switch to ON mode, or turn the light switch "OFF" once and then back to the  or  position.

n Automatic headlight leveling system (Vehicle with discharge headlights)

The level of the headlights is automatically adjusted according to the number of passengers and the loading condition of the vehicle to ensure that the headlights do not interfere with other road users.

n If the indicator flashes...

It may indicate a malfunction in the system. Contact your Toyota dealer.

n Customization that can be configured at Toyota dealer

Settings (e.g. light sensor sensitivity) can be changed.
(Customizable features →P. 486)

2-3. Operating the lights and windshield wipers

 **NOTICE**

n To prevent 12 volt battery discharge

Do not leave the lights on longer than necessary if the hybrid system is not operating.

2-3. Operating the lights and windshield wipers Fog light switch*

The fog lights improve visibility in difficult driving conditions, such as in rain or fog. They can be turned on only when the headlights are on low beam.

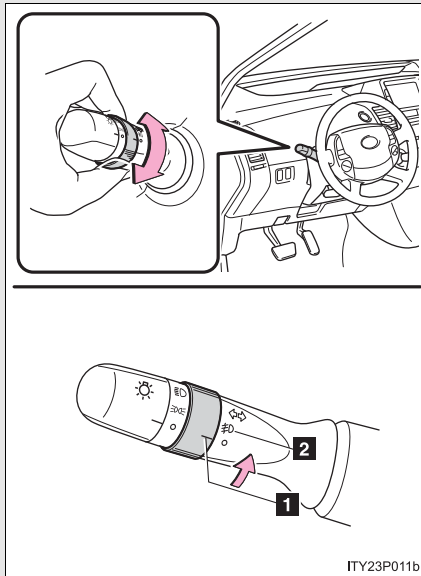

- 1** OFF
- 2** ON

2

When driving

*: If equipped

2-3. Operating the lights and windshield wipers Windshield wipers and washer

Wiper intervals can be adjusted for intermittent operation (when  is selected).

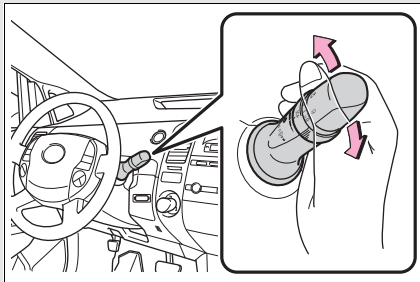

- 1** Intermittent windshield wiper operation
- 2** Low speed windshield wiper operation
- 3** High speed windshield wiper operation
- 4** Temporary operation

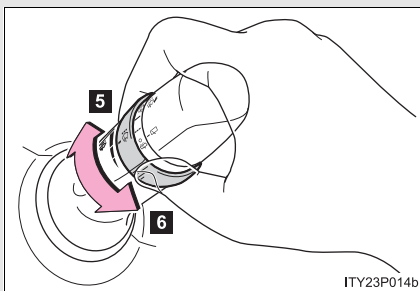
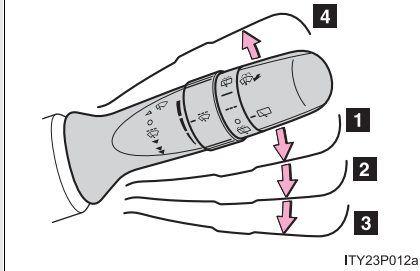

- 5** Increases the intermittent windshield wiper frequency
- 6** Decreases the intermittent windshield wiper frequency

2-3. Operating the lights and windshield wipers

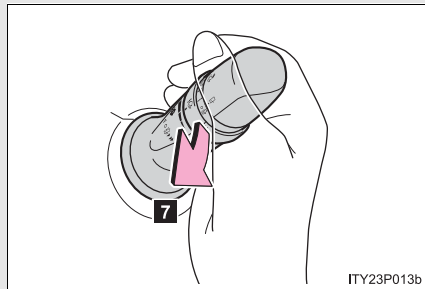

7 Wash/wipe operation

Wipers operate automatically.

2

When driving

n The windshield wiper and washer can be operated when

The "POWER" switch is in ON mode.

n If no windshield washer fluid sprays

Check that the washer nozzles are not blocked and if there is washer fluid in the windshield washer fluid reservoir.

⚠ NOTICE

n When the windshield is dry

Do not use the wipers, as they may damage the windshield.

n When there is no washer fluid spray from the nozzle

Damage to the washer fluid pump may be caused if the lever is pulled toward you and held continually.

n When a nozzle becomes block

Do not try to clear it with a pin or other object. The nozzle will be damaged.

2-3. Operating the lights and windshield wipers

Rear window wiper and washer

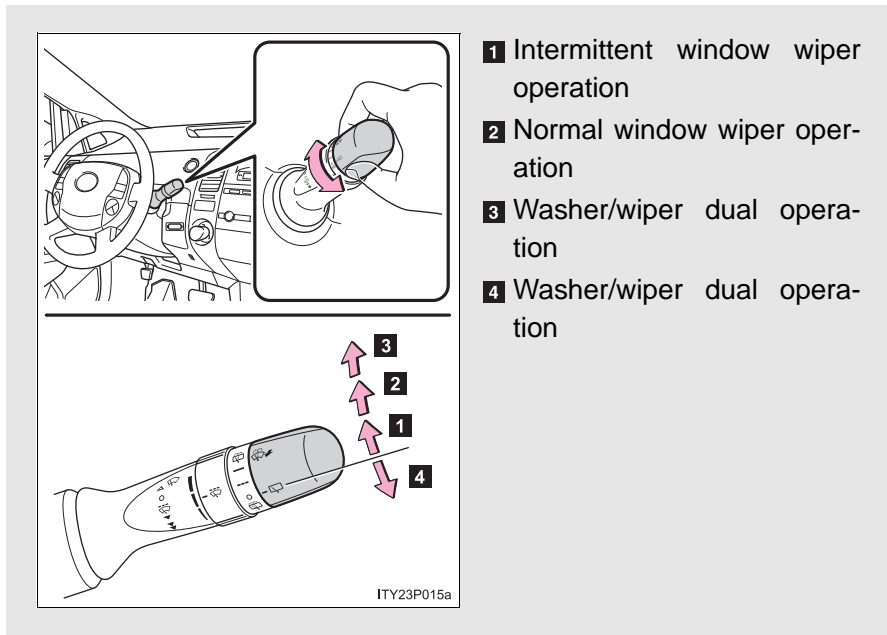

- n **The rear window wiper and washer can be operated when**
The “POWER” switch is in ON mode.

 **NOTICE**

- n **When the rear window is dry**
Do not use the wipers, as they may damage the rear window.

2-4. Using other driving systems Cruise control*

Use the cruise control to maintain a set speed without using the accelerator.

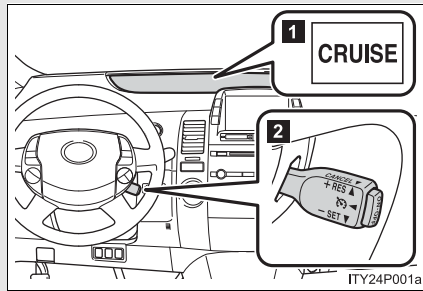

- 1 Indicator
- 2 Cruise control switch

1 Set the vehicle speed

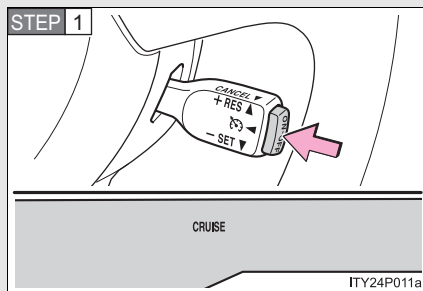

Turn the "ON-OFF" button ON.

Push the button once more to deactivate the cruise control.

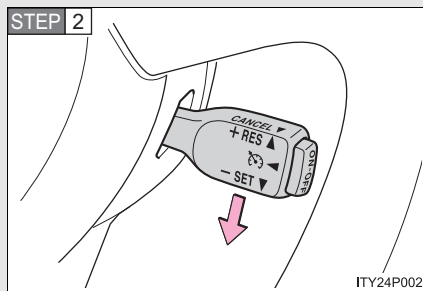

Accelerate or decelerate to the desired speed and press the lever down to set the cruise control speed.

2

When driving

*: If equipped

2-4. Using other driving systems

n Adjusting the speed setting

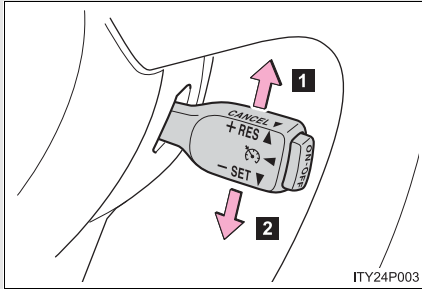

- 1** Increase speed
- 2** Decrease speed

Hold the lever until the desired speed setting is obtained.

Fine adjustment of the set speed (approximately 1.0 mph [1.6 km/h]) can be made by lightly pressing the lever up or down and releasing it.

n Canceling and resuming regular acceleration

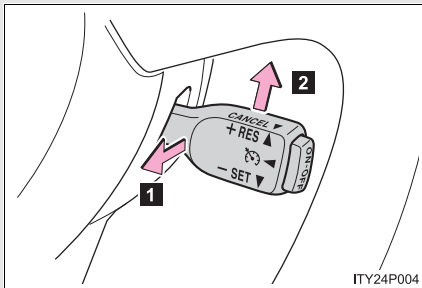

- 1** Cancel

Push the lever towards you to cancel cruise control.

The setting is also canceled when the brake pedal is depressed.

- 2** Resume

To resume cruise control and return to the set speed, push the lever up.

2-4. Using other driving systems

n **Cruise control can be set when**

- l The shift lever is in the "D" range.
- l Vehicle speed is between approximately 25 mph (40 km/h) and 125 mph (200 km/h).

n **Accelerating**

The vehicle can be accelerated normally. After acceleration, the set speed resumes.

n **Automatic cruise control cancelation**

The set speed is automatically canceled in any of the following situations.

- l Actual vehicle speed falls more than 10 mph (16 km/h) below the preset vehicle speed
- l Actual vehicle speed is below 25 mph (40 km/h)
- l Enhanced VSC is activated

n **If the cruise control indicator light flashes**

Turn the "ON-OFF" button off once, and then reactivate the system. If the cruise control speed cannot be set or if the cruise control cancels immediately after being activated, there may be a malfunction in the cruise control system. Have the vehicle inspected by your Toyota dealer.

2

When driving

2-4. Using other driving systems

CAUTION

n To avoid operating the cruise control by mistake

Keep the "ON-OFF" button off when not in use.

n Situations unsuitable for cruise control

Do not use cruise control in any of the following situations. Doing so may result in control of the vehicle being lost and could cause serious or fatal accident.

- l** In heavy traffic
- l** On roads with sharp bends
- l** On slippery roads, such as those covered with rain, ice or snow
- l** On winding roads
- l** On steep hills
Vehicle speed may exceed the set speed when driving down a steep hill.

2-4. Using other driving systems Rear view monitor system*

The rear view monitor system assists the driver by displaying an image of the view behind the vehicle while reversing. The image is displayed in reverse on the screen. This allows the image to appear in the same manner as that of the rear view mirror.

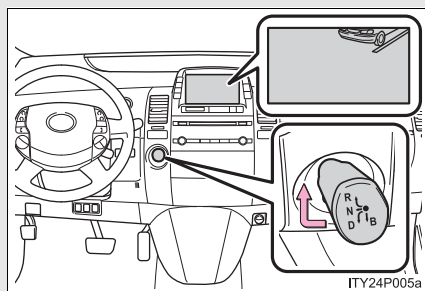

Rear view image is displayed when the shift lever is in "R".

If you move the lever out of "R", the screen returns to the previous one.

2

When driving

n Displayed area

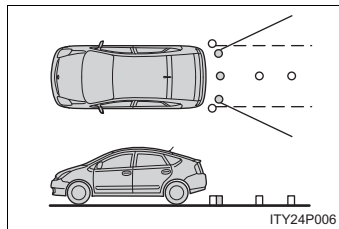

The area covered by the camera is limited. Objects which are close to either corner of the bumper or under the bumper cannot be seen on the screen.

The area displayed on the screen may vary according to vehicle orientation or road conditions.

► Corner of bumper

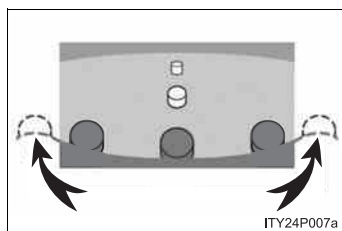

*: If equipped

2-4. Using other driving systems

n Rear view monitor system camera

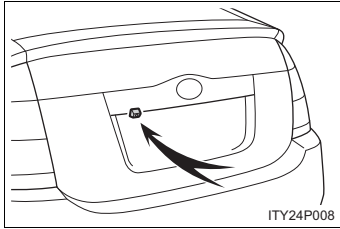

In the following cases, it may be difficult to see the images on the screen, even when the system is functioning correctly.

- In the dark (e.g. at night).
- If the temperature near the lens is extremely high or low.
- If water droplets get on the camera, or when humidity is high (e.g. when it rains).
- If foreign matter (e.g. snow or mud) get on the camera lens.
- If the sun or headlights are shining directly into the camera lens.

n Smear effect

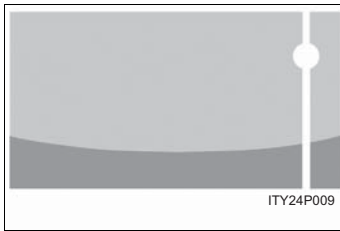

If a bright light (for example, sunlight reflected off the vehicle body) is picked up by the camera, a smear effect* peculiar to the camera may occur.

*:Smear effect—A phenomenon that occurs when a bright light (for example, sunlight reflected off the vehicle body) is picked up by the camera; when transmitted by the camera, the light source appears to have a vertical streak above and below it.

2-4. Using other driving systems

CAUTION

n When using the rear view monitor system, observe these precautions to avoid an accident that could result in death or serious injuries.

- |** Never depend solely on the monitor system when reversing.
- |** Always check visually and with the mirrors to confirm your intended path is clear.
- |** Depicted distances between objects and flat surfaces differ from actual distances.
- |** Do not use the system if the back door is open.

n Conditions which may affect the rear view monitor system

- |** If the back of the vehicle is hit, the camera's position and mounting angle may change. Contact your Toyota dealer.
- |** Rapid temperature changes, such as when hot water is poured on the vehicle in cold weather, may cause the system to function abnormally.
- |** If the camera lens is dirty, it cannot transmit a clear image. Rinse with water and wipe with a soft cloth. If extremely dirty, wash with a mild cleanser and rinse.
- |** The displayed image may be darker and moving images may be slightly distorted when the system is cold.

2

When driving

2-4. Using other driving systems

Driving assist systems

To help enhance driving safety and performance, the following systems operate automatically in response to various driving situations. Be aware, however, that these systems are supplementary and should not be relied upon too heavily when operating the vehicle.

■ **ABS (Anti-lock Brake System)**

Helps to prevent wheel lock when the brakes are applied suddenly, or if the brakes are applied while driving on a slippery road surface.

■ **Brake Assist**

Generates an increased level of braking force after the brake pedal is depressed, when the system detects a panic stop situation.

■ **Enhanced VSC (Vehicle Stability Control) (If equipped)**

Helps the driver to control skidding when swerving suddenly or turning on slippery road surfaces.

■ **EPS (Electric Power Steering)**

Employs an electric motor to reduce the amount of effort needed to turn the steering wheel.

When the Enhanced VSC is operating

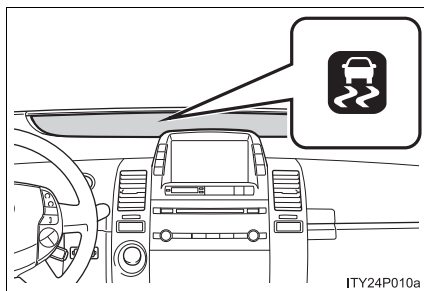

If the vehicle is in danger of slipping or the front wheels spin, the indicator flashes to indicate that the Enhanced VSC have been engaged.

A buzzer (intermittent) sounds to indicate that Enhanced VSC is operating.

The slip indicator light flashes as well when ABS is operating.

2-4. Using other driving systems

n Sounds and vibrations caused by the ABS, brake assist and Enhanced VSC

- 1 A sound may be heard from the hybrid system compartment when the hybrid system is started or just after the vehicle begins to move. This sound does not indicate that a malfunction has occurred in any of these systems.
- 1 Any of the following conditions may occur when the above systems are operating. None of these indicates that a malfunction has occurred.
 - Vibrations may be felt through the vehicle body and steering.
 - A motor sound may be heard after the vehicle comes to a stop.
 - The brake pedal may pulsate slightly after the ABS is activated.
 - The brake pedal may move down slightly after the ABS is activated.

n Reduced effectiveness of EPS

The effectiveness of EPS is reduced to prevent the system from overheating when there is frequent steering input over an extended period of time. The steering wheel may feel heavy as a result. Should this occur, refrain from excessive steering input or stop the vehicle and turn the hybrid system OFF. The system should return to normal within 10 minutes.

2

When driving

2-4. Using other driving systems

CAUTION

n The ABS does not operate effectively when

- l** The limits of tire gripping performance have been exceeded.
- l** The vehicle hydroplanes while driving at high speed on the wet or slick road.

n Stopping distance when the ABS is operating on the wet or slick roads

The ABS is not designed to shorten the vehicle's stopping distance. Always maintain a sufficient distance from the vehicle in front of you in the following situations.

- l** When driving on dirt, gravel or snow-covered roads
- l** When driving with tire chains
- l** When driving over bumps in the road
- l** When driving over roads with potholes or roads with uneven pavement

n When the Enhanced VSC is activated

The slip indicator light flashes and a warning buzzer sounds. Always drive carefully.

Reckless driving may cause an accident. Exercise particular care when the indicator light flashes and a buzzer sounds.

n Replacing tires

Make sure that all tires are of the same size, brand, tread pattern and total load capacity. In addition, make sure that the tires are inflated to the specified tire pressure level.

The ABS and Enhanced VSC will not function correctly if different tires are fitted on the vehicle.

Contact your Toyota dealer for further information when replacing tires or wheels.

2-5. Driving information

Cargo and luggage

Take notice of the following information about storage precautions, cargo capacity and load.

- 1 Stow cargo and luggage in the luggage compartment whenever possible. Be sure all items are secured in place.
- 1 Be careful to keep the vehicle level. Placing the weight as far forward as possible helps maintain vehicle balance.
- 1 For better fuel economy, do not carry unnecessary weight.

2

Capacity and distribution

Cargo capacity depends on the total weight of the occupants.

(Cargo capacity) = (Total load capacity) — (Total weight of occupants)

Steps for Determining Correct Load Limit—

- (1) Locate the statement “The combined weight of occupants and cargo should never exceed XXX kg or XXX lbs.” on your vehicle’s placard.
- (2) Determine the combined weight of the driver and passengers that will be riding in your vehicle.
- (3) Subtract the combined weight of the driver and passengers from XXX kg or XXX lbs.
- (4) The resulting figure equals the available amount of cargo and luggage load capacity.

For example, if the “XXX” amount equals 1400 lbs. and there will be five 150 lb passengers in your vehicle, the amount of available cargo and luggage load capacity is 650 lbs. (1400 - 750 (5 × 150) = 650 lbs.)

- (5) Determine the combined weight of luggage and cargo being loaded on the vehicle.

That weight may not safely exceed the available cargo and luggage load capacity calculated in Step 4.

When driving

2-5. Driving information

- (6) If your vehicle will be towing a trailer, load from your trailer will be transferred to your vehicle. Consult this manual to determine how this reduces the available cargo and luggage load capacity of your vehicle. (→P. 172)

Toyota does not recommend towing a trailer with your vehicle. Your vehicle is not designed for trailer towing.

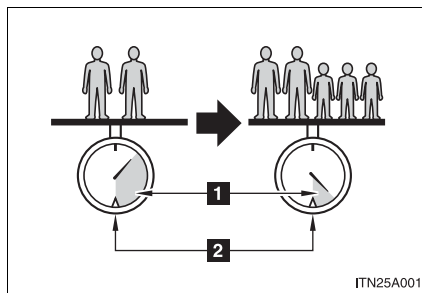
Example on your vehicle

- 1** Cargo capacity
2 Total load capacity

When 2 people with the combined weight of 366 lb. (166 kg) are riding in your vehicle, which has a total load capacity of 810 lb. (365 kg), the available amount of cargo and luggage load capacity will be as follows:

$$810 \text{ lb.} - 366 \text{ lb.} = 444 \text{ lb.} \quad (365 \text{ kg} - 166 \text{ kg} = 199 \text{ kg})$$

In this condition, if 3 more passengers with the combined weight of 388 lb. (176 kg) get on, the available cargo and luggage load will be reduced as follows:

$$444 \text{ lb.} - 388 \text{ lb.} = 56 \text{ lb.} \quad (199 \text{ kg} - 176 \text{ kg} = 23 \text{ kg})$$

As shown in the above example, if the number of occupants increases, the cargo and luggage load equaling the combined weight of the occupants who got on later, by an amount. In other words, if an increase in the number of occupants causes an excess of the total load capacity (combined weight of occupants plus cargo and luggage load), you must reduce the cargo and luggage on your vehicle.

⚠ CAUTION**n Storage precautions**

- I** Do not stack anything in the luggage compartment higher than the seatbacks.
Such items may be thrown about and possibly injure people in the vehicle during sudden braking or in an accident.
- I** Do not place anything on the luggage cover.
Such items may be thrown about and possibly injure people in the vehicle during sudden braking or in an accident.
- I** Do not drive with objects on top of the instrument panel.
They may interfere with the driver's field of view or move during sharp acceleration or turning, thus impairing the driver's control of the vehicle. In an accident they may injure the vehicle occupants.
- I** Secure all items in the occupant compartment, as they may shift and injure someone during an accident or sudden braking.
- I** Never allow anyone to ride in the luggage compartment. It is not designed for passengers. They should ride in their seats with their seat belts properly fastened. Otherwise, they are much more likely to suffer death or serious injury, in the event of sudden braking or a collision.

n Weight of the load

- I** Improper loading may cause deterioration of steering or braking control resulting in an accident which may cause death or serious injury.
- I** Do not exceed the maximum axle weight rating or the total vehicle weight rating.
- I** Even if the total load of occupant's weight and the cargo load is less than the total load capacity, do not apply the load unevenly. Improper loading may cause deterioration of steering or braking control which may cause death or serious injury.

2

When driving

2-5. Driving information

Vehicle load limits

Vehicle load limits include total load capacity, seating capacity, towing capacity and cargo capacity.

n Total load capacity: 810 lb. (365 kg)

Total load capacity means the combined weight of occupants, cargo and luggage.

n Seating capacity: 5 occupants (Front 2, Rear 3)

Seating capacity means the maximum number of occupants whose estimated average weight is 150 lb. (68 kg) per person.

Even if the number of occupants are within the seating capacity, do not exceed the total load capacity.

n Towing capacity

Toyota does not recommend towing a trailer with your vehicle.

n Cargo capacity

Cargo capacity may increase or decrease depending on the weight and the number of occupants.

n Total load capacity and seating capacity

These details are also described on the tire and loading information label. (→P. 384)

⚠ CAUTION

n Overloading the vehicle

Do not overload the vehicle.

It may not only cause damage to the tires, but also degrade steering and braking ability, resulting in an accident.

2-5. Driving information

Winter driving tips

Carry out the necessary preparations and inspections before driving the vehicle in winter. Always drive the vehicle in a manner appropriate to the prevailing weather conditions.

n Pre-winter preparations

- 1 Use fluids that are appropriate to the prevailing outside temperatures.
 - Engine oil
 - Engine coolant
 - Washer fluid
- 1 Have a service technician inspect the level and specific gravity of 12 volt battery electrolyte.
- 1 Have the vehicle fitted with four snow tires or purchase a set of tire chains for the front tires.

Ensure that all tires are the same size and brand, and that chains match the size of the tires.

2

When driving

2-5. Driving information

n Before driving the vehicle

Perform the following according to the driving conditions.

- 1 Do not try to forcibly open a window or move a wiper that is frozen. Pour warm water over the frozen area to melt the ice. Wipe away the water immediately to prevent it from freezing.
- 1 To ensure proper operation of the climate control system fan, remove any snow that has accumulated on the air inlet vents in front of the windshield.
- 1 Remove any ice that has accumulated on the vehicle chassis.
- 1 Periodically check for and remove any excess ice or snow that may have accumulated in the wheel well or on the brakes.

n When driving the vehicle

Accelerate the vehicle slowly and drive at a reduced speed suitable to road conditions.

n When parking the vehicle

Park the vehicle and push the "P" position switch without setting the parking brake. The parking brake may freeze up, preventing it from being released.

Regulations on the use of snow chains

- 1 Regulations regarding the use of tire chains vary according to location and type of road. Always check local regulations before installing chains.
- 1 Use SAE Class "S" type radial tire chains, with the exception of radial cable chains or V-bar type chains.
 - Install the chains on the front tires.
 - Refer to the explanation that comes with the tire chains for installation instructions.
- 1 Retighten the chains after driving 1/4 - 1/2 mile (0.5 - 1.0 km).

2

When driving

n Snow chain installation

Observe the following precautions when installing and removing chains.

- 1 Install and remove tire chains in a safe location.
- 1 Install tire chains on the front tires.
- 1 Install tire chains following the instructions provided in the accompanying instructions.

CAUTION

n Driving with snow tires

Observe the following precautions to reduce the risk of accidents. Failing to do so may result in a loss of vehicle control and cause death or serious injury.

- 1 Use tires of the size specified for your vehicle.
- 1 Maintain the specified level of tire inflation pressure.
- 1 Do not drive in excess of 75 mph (120 km/h), regardless of the type of snow tires being used.
- 1 Snow tires should be installed on all wheels.

2-5. Driving information

CAUTION

n Driving with snow chains

Observe the following precautions to reduce the risk of accidents. Failing to do so may result in the vehicle being unable to be driven safely, and may cause death or serious injury.

- I** Do not drive in excess of the speed limit specified for the tire chains being used, or 30 mph (50 km/h), whichever is lower.
- I** Avoid driving on bumpy road surfaces or over potholes.
- I** Avoid sudden turns and braking, as use of chains may adversely affect vehicle handling.
- I** Slow down sufficiently before entering a curve to ensure that vehicle control is maintained.

NOTICE

n Repairing or replacing snow tires

Request repairs of and obtain replacement snow tires from Toyota dealers. This is because the removal and attachment of snow tires affects the operation of the tire pressure warning valves and transmitters.

n Fitting tire chains

The tire pressure warning valves and transmitters may not function correctly when tire chains are fitted.

2-5. Driving information

Trailer towing

Toyota does not recommend towing a trailer with your vehicle. Toyota also does not recommend the installation of a tow hitch or the use of a tow hitch carrier for a wheelchair, scooter, bicycle, etc. Your Toyota is not designed for trailer towing or for the use of tow hitch mounted carriers.



2

When driving

2-5. Driving information

Dinghy towing

Your vehicle is not designed to be dinghy towed (with 4 wheels on the ground) behind a motor home.

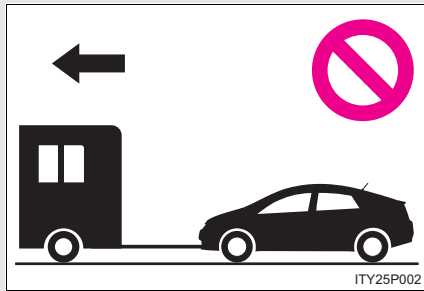

 **NOTICE**

- n To avoid serious damage to your vehicle**
Do not tow your vehicle with four wheels on the ground.

2-5. Driving information

2

When driving

3-1. Using the touch screen Touch screen

By touching the screen with your finger, you can control the audio system and air-conditioning, adjust the screen display etc.

▶ Vehicles with navigation system

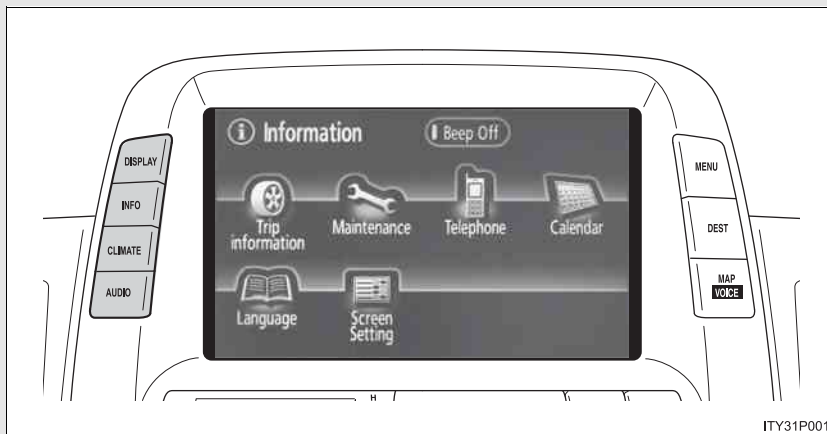

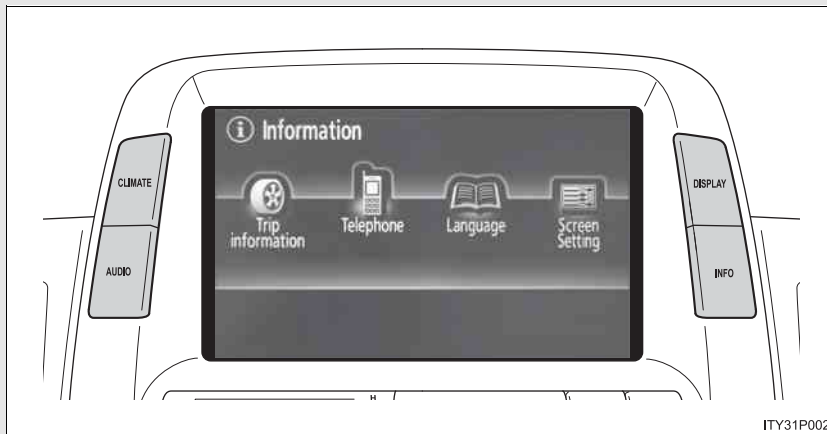

▶ Vehicles without navigation system (Type A)

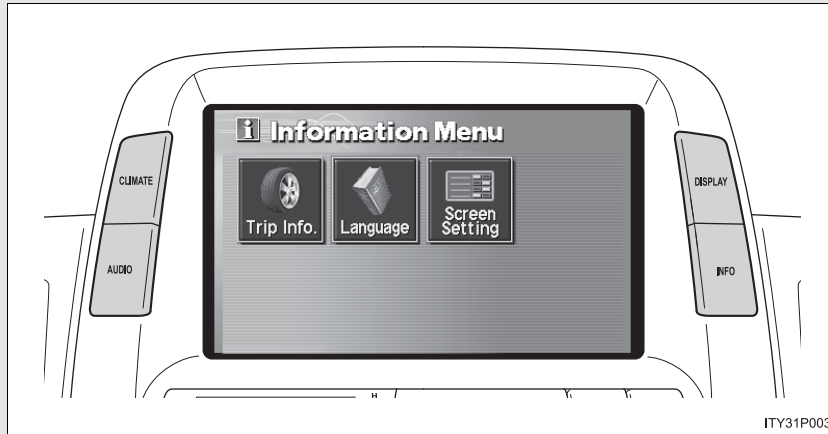

3-1. Using the touch screen

► Vehicles without navigation system (Type B)



The "Information" screen shown in the above illustration is displayed when the  is pressed.

Switches	Page
"CLIMATE"	P. 197, 204
"AUDIO"	P. 215, 218
"INFO" (Displaying the "Information" screen)	P. 182
"DISP" (Adjusting the display)	P. 188, 193
Trip Information. (Displaying the "Trip Information" screen)	P. 27
Maintenance	Navigation System Owner's Manual
Telephone	P. 274
Calendar	Navigation System Owner's Manual
Language	P. 187, 192
Screen Setting	P. 190, 195

3-1. Using the touch screen

The initial screen

- ▶ Vehicles with navigation system and vehicles without navigation system (Type A)



If the "POWER" switch is set to ACCESSORY or ON mode, the initializing screen will be displayed for a few seconds as the system starts up.

- ▶ Vehicles without navigation system (Type B)

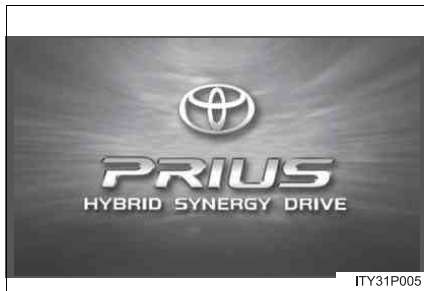

3-1. Using the touch screen

Outside temperature display

The outside temperature is shown ranging from -22 °F (-30 °C) up to 122 °F (50 °C) at the upper right of the energy consumption or energy monitor screen or the upper left/right of the air conditioner screen.

- ▶ Vehicles with navigation system and vehicles without navigation system (Type A)

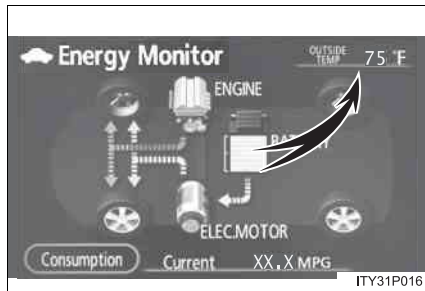

- ▶ Vehicles without navigation system (Type B)

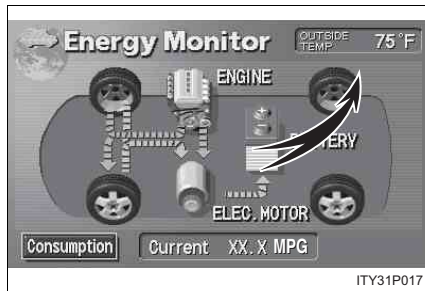

3

Interior features

3-1. Using the touch screen

n To avoid damaging the touch screen

- l Touch the screen lightly with your finger. If there is no response, remove your finger from the screen and try again.
- l Remove any dirt on the screen by wiping with a soft cloth. Do not use detergent.

n When using the touch screen

- l If the screen is cold, the display may be dark, or the system may seem to be operating slightly slower than normal.
- l The screen may seem dark and hard to see when viewed through sunglasses. Change your angle of viewing, adjust the display on the "Display" screen or remove your sunglasses.

n When the outside temperature drops below 37 °F (3 °C).

Also except the screen where outside temperature is displayed, outside temperature and  * are displayed in the upper portion of the screen for a few seconds.

*:  may not be displayed depending on the display type.

3-1. Using the touch screen Setting the touch screen (Vehicles with AUX adapter)

You can change the touch screen to your desired settings.

Language settings

The language used for all voice guidance, messages and touch screen switches may be changed.

STEP 1 Press  .

STEP 2 Touch  on the "Information" screen.



Select the desired language.

STEP 4 Touch  .

Turning off the beep sound (if equipped)

The beep that sounds when a touch screen button is touched can be turned off.

STEP 1 Press  .

3

Interior features

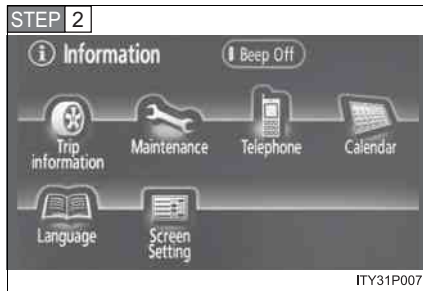

3-1. Using the touch screen



Touch  .



Adjusting the display

STEP 1 Press  .

STEP 2 Adjust the display as desired using  and  .

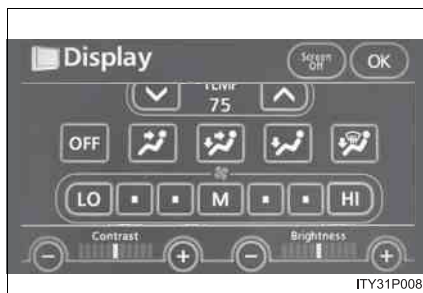
If you do not touch the screen for 20 seconds, the system will return to the previous screen.



		
Contrast	Weaker	Stronger
Brightness	Darker	Brighter

3-1. Using the touch screen

n “Day Mode”

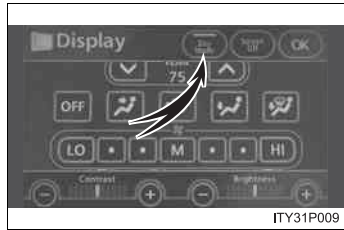

When the headlights are turned on, the screen dims. However the screen can be switched to day mode.

The screen will stay in day mode when the headlights are turned on until

 is touched again.

If the instrument panel light control is set to “MAX”, “DAY MODE” is not displayed.

n To turn off the picture display

If  is touched, the screen display is turned off, and guidance is by voice only.

3-1. Using the touch screen

Screen settings

STEP 1 Press  .

STEP 2 Touch  on the “Information” screen.

The following screen settings can be changed.

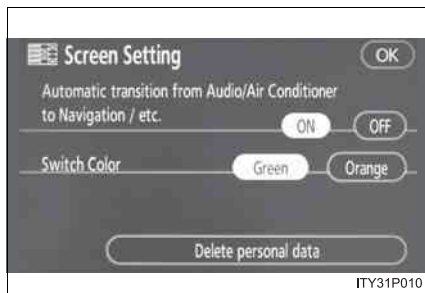

1 Automatic transition

20 seconds after air-conditioning or audio system use, the system will return the display to the previous screen.

2 Switch color

You can select the switch color.

3 Personal data deletion

The following personal data is deleted:

- User selection settings
- Phone book data
- Dialed numbers and received calls
- Speed dial
- Bluetooth® phone data
- Security code
- Maintenance conditions*
- Maintenance information “off” setting*
- Memory points*
- Areas to avoid*
- Previous points*
- Route trace*

*:If the navigation system is equipped

3-1. Using the touch screen

n **Setting automatic transition**

STEP 1 Touch **ON** or **OFF** on the “Screen Setting” screen.

STEP 2 Press **OK**.

n **Setting the switch color**

STEP 1 Touch **Green** or **Orange** on the “Screen Setting” screen.

STEP 2 Press **OK**.

n **To delete personal data**

STEP 1 Touch the **Delete personal data** on the “Screen Setting” screen.

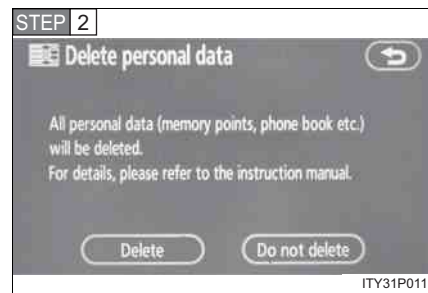

STEP 2 Touch **Delete**.

Check carefully beforehand, as data cannot be retrieved once initialized.

3

Interior features

n **When deleting personal data**

Data can only be deleted when the vehicle is stopped.

n **When selling the vehicle**

Be sure to initialize both the call history and personal data. (→P. 190)

n **If you touch the**

The display returns to the previous screen.

3-1. Using the touch screen Setting the touch screen (Vehicles without AUX adapter)

You can change the touch screen to your desired settings.

Language settings

The language used for all voice guidance, messages and touch screen switches may be changed.

STEP 1 Press  .

STEP 2 Touch  on the "Information" screen.





Select the desired language.

STEP 4 Touch  .

3-1. Using the touch screen



Adjusting the display

STEP 1 Press  .

STEP 2 Adjust the display as desired using  and  .

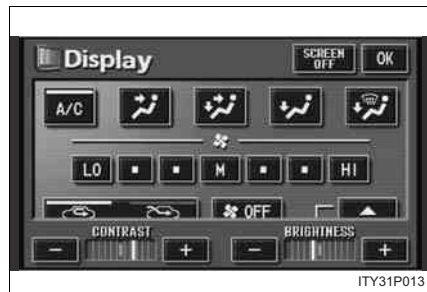
If you do not touch the screen for 20 seconds, the system will return to the previous screen.



		
Contrast	Weaker	Stronger
Brightness	Darker	Brighter

3
Interior features

3-1. Using the touch screen

n “Day Mode”

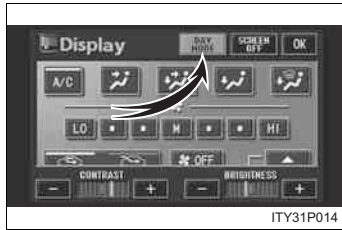

When the headlights are turned on, the screen dims. However the screen can be switched to day mode.

The screen will stay in day mode when the headlights are turned on until

DAY MODE is touched again.

If the instrument panel light control is set to “MAX”, “DAY MODE” is not displayed.

n To turn off the picture display

If **SCREEN OFF** is touched, the screen display is turned off, and guidance is by voice only.

3-1. Using the touch screen

Screen settings

STEP 1 Press  .

STEP 2 Touch  on the "Information" screen.

The following screen settings can be changed.

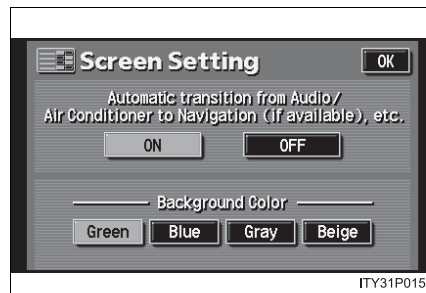

1 Automatic transition

20 seconds after air-conditioning or audio system use, the system will return the display to the previous screen.

2 Background color

You can select the background color.

3

Interior features

3-1. Using the touch screen

n **Setting automatic transition**

STEP 1 Touch **ON** or **OFF** on the “Screen Setting” screen.

STEP 2 Press **OK**.

n **Setting the background color**

STEP 1 Touch **Green**, **Blue**, **Gray** or **Beige** on the “Screen Setting” screen.

STEP 2 Press **OK**.

3-2. Using the air conditioning system and defogger Automatic air conditioning system (Vehicles with AUX adapter)

Airflow and outlets are automatically adjusted according to the temperature setting.

Press  to display the air conditioning operation screen.

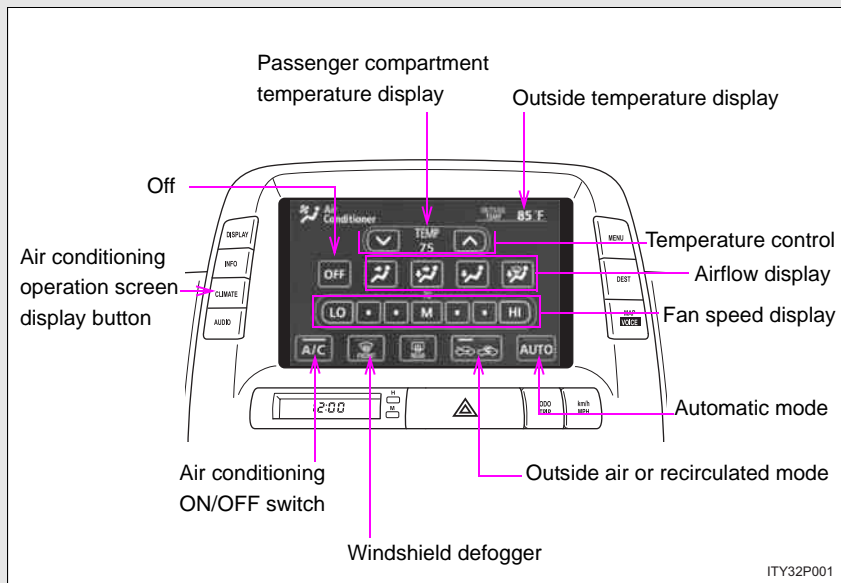

The above illustration is for a vehicle equipped with the navigation system. The position of  may differ slightly for vehicles not equipped with the navigation system.

3-2. Using the air conditioning system and defogger

Using the automatic mode

STEP 1 Press **AUTO**.

A/C
AUTO indicator located in the instrument panel.

The air conditioning system will begin to operate. Air outlets and fan, and automatically switches between outside air and recirculated air modes are automatically adjusted according to the temperature setting.

STEP 2 Press \wedge to increase the temperature and \vee to decrease the temperature.

Adjusting the settings

n Adjusting the temperature setting

Press \wedge to increase the temperature and \vee to decrease the temperature.

3-2. Using the air conditioning system and defogger

n Adjusting the fan speed

Touch any switch of  (decrease ↔ increase) on the operating screen.

Press  to turn the fan off.

n Changing the air outlets

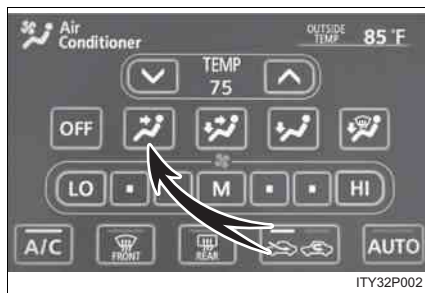

Touch any mode on the operating screen.

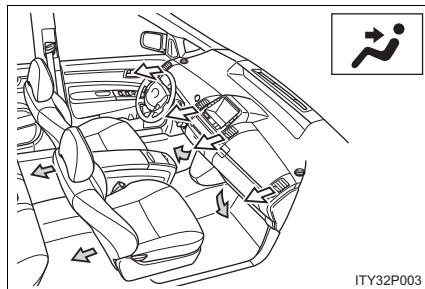

Air flows to the upper body.

← : In the beginning of the automatic mode, air might be delivered.

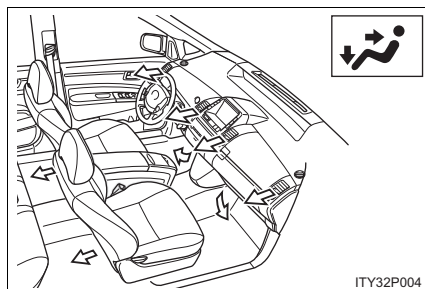

Air flows to the upper body and feet.

3-2. Using the air conditioning system and defogger

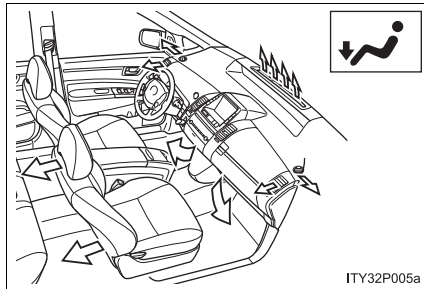

Air flows to the feet.

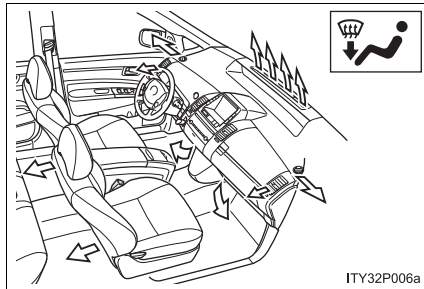



Air flows to the feet and the windshield defogger operates.

3-2. Using the air conditioning system and defogger

n Switching between outside air and recirculated air modes

Press  .

The mode switches between  (recycles air inside the vehicle) and  (introduces air from outside the vehicle) modes each time the button is pressed.

1 When the system is switched to automatic mode, the air conditioning system operates automatically. However, recirculated air mode will be activated if it is selected manually.

1 If the hybrid system is turned off in the outside air mode, the automatic control of the air intake is activated when the hybrid system is turned on again.

 indicator will come on in the instrument cluster while the recirculated air mode is selected.

3

Interior features

Defogging the windshield

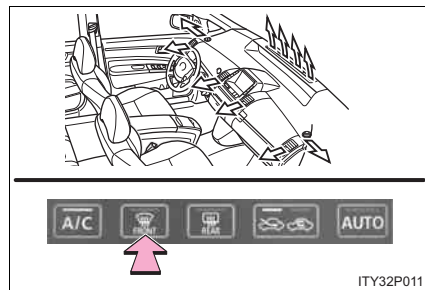

Press  .

The air conditioning system control operates automatically.

 indicator will come on in the instrument cluster while the windshield air flow mode is on.

3-2. Using the air conditioning system and defogger

Adjusting the position of and opening and closing the air outlets

► Front outlets

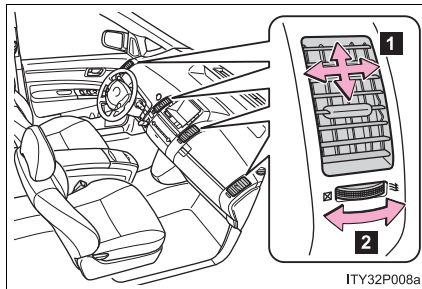

- 1** Direct air flow to the left or right, up or down
- 2** Turn the knob to open or close the vent

n Using the automatic mode

Fan speed is adjusted automatically in accordance with the temperature setting and ambient conditions. As a result, the following may occur.

- l The system may switch automatically to recirculated mode when the coolest temperature setting is selected in summer.
- l Immediately after the switch is pressed, the fan may stop for a while until warm or cool air is ready to flow.

n Using the system in recirculated air mode

The windows will fog up more easily if the recirculated air mode is used for an extended period.

n Window defogger feature

Recirculated air mode may automatically switch to  (outside air) mode in situations where the windows need to be defogged.

n Outside temperature approaches 32°F (0°C).

The air conditioning system may not operate even when  is touched.

n 2-way air intake control

To improve fuel economy, OUTSIDE AIR mode control changes when the air intake selector is set in OUTSIDE AIR on the following conditions:

- l When the maximum heating is needed with the air flow in “Floor” or “Floor/Windshield”, fresh air flows in the upper compartment, while air is recirculated in the lower compartment.
- l When cooling is needed, both fresh and recirculate modes turn on.

3-2. Using the air conditioning system and defogger

CAUTION

n To prevent the windshield from fogging up

Do not use  during cool air operation in extremely humid weather. The difference between the temperature of the outside air and that of the windshield can cause the outer surface of the windshield to fog up, blocking your vision.

NOTICE

n To prevent 12 volt battery discharge

Do not leave the automatic air conditioning system on longer than necessary when the hybrid system is not operating.

3

Interior features

3-2. Using the air conditioning system and defogger Automatic air conditioning system (Vehicles without AUX adapter)

Airflow and outlets are automatically adjusted according to the temperature setting.

Press  to display the air conditioning operation screen.

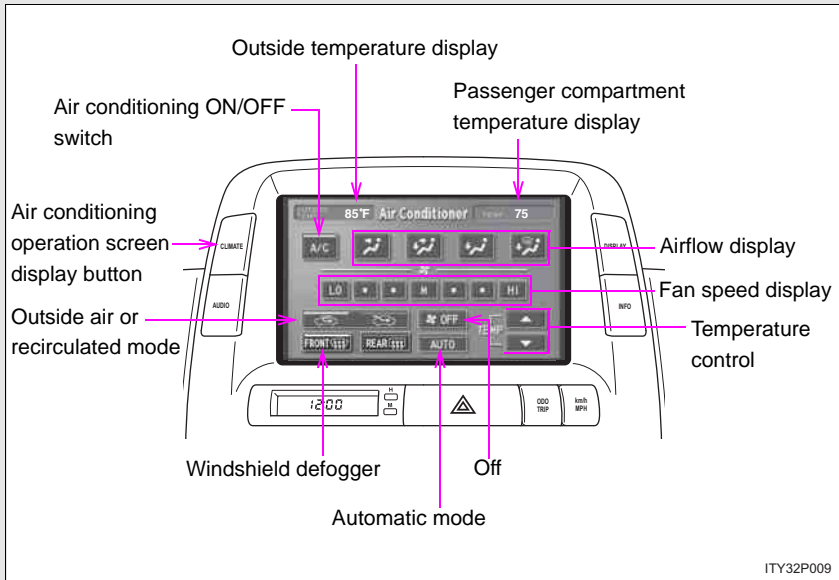

3-2. Using the air conditioning system and defogger

Using the automatic mode

STEP 1 Press **AUTO**.

A/C
AUTO indicator located in the instrument panel.

The air conditioning system will begin to operate. Air outlets and fan, and automatically switches between outside air and recirculated air modes are automatically adjusted according to the temperature setting.

STEP 2 Press \wedge to increase the temperature and \vee to decrease the temperature.

Adjusting the settings

n Adjusting the temperature setting

Press \wedge to increase the temperature and \vee to decrease the temperature.

3

Interior features

3-2. Using the air conditioning system and defogger

n Adjusting the fan speed

Touch any switch of  (decrease ↔ increase) on the operating screen.

Press  to turn the fan off.

n Changing the air outlets

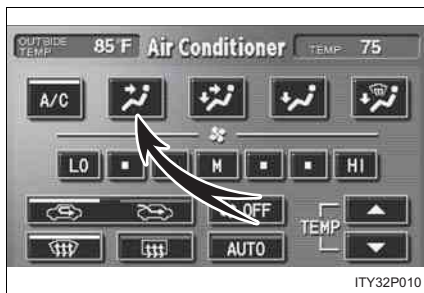

Touch any mode on the operating screen.

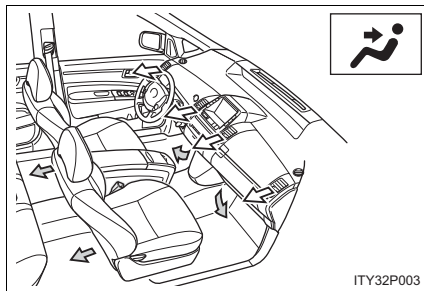

Air flows to the upper body.

← : In the beginning of the automatic mode, air might be delivered.

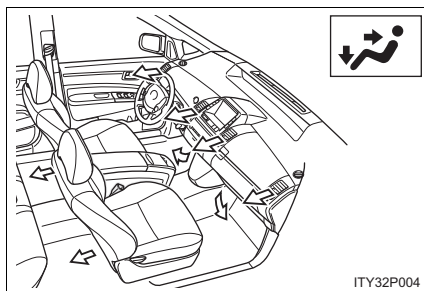

Air flows to the upper body and feet.

3-2. Using the air conditioning system and defogger

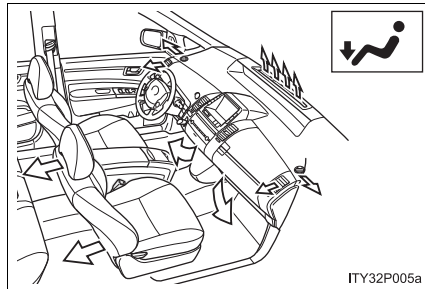

Air flows to the feet.

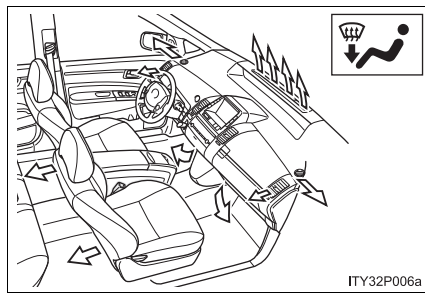

Air flows to the feet and the windshield defogger operates.



3

Interior features

3-2. Using the air conditioning system and defogger

n Switching between outside air and recirculated air modes

Press .

The mode switches between  (recycles air inside the vehicle) and  (introduces air from outside the vehicle) modes each time the button is pressed.

! When the system is switched to automatic mode, the air conditioning system operates automatically. However, recirculated air mode will be activated if it is selected manually.

! If the hybrid system is turned off in the outside air mode, the automatic control of the air intake is activated when the hybrid system is turned on again.

 indicator will come on in the instrument cluster while the recirculated air mode is selected.

Defogging the windshield

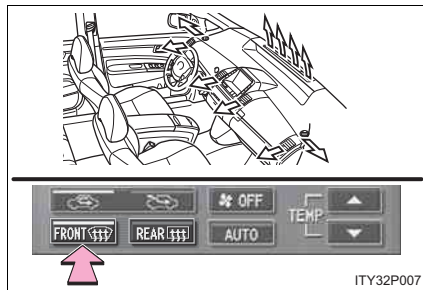

Press .

The air conditioning system control operates automatically.

 indicator will come on in the instrument cluster while the windshield air flow mode is on.

3-2. Using the air conditioning system and defogger

Adjusting the position of and opening and closing the air outlets

► Front outlets

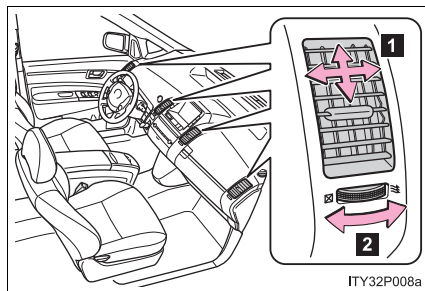

- 1 Direct air flow to the left or right, up or down
- 2 Turn the knob to open or close the vent

n **Using the automatic mode**

Fan speed is adjusted automatically in accordance with the temperature setting and ambient conditions. As a result, the following may occur.

- l The system may switch automatically to recirculated mode when the coolest temperature setting is selected in summer.
- l Immediately after the switch is pressed, the fan may stop for a while until warm or cool air is ready to flow.

n **Using the system in recirculated air mode**

The windows will fog up more easily if the recirculated air mode is used for an extended period.

n **Window defogger feature**

Recirculated air mode may automatically switch to  (outside air) mode in situations where the windows need to be defogged.

n **Outside temperature approaches 32°F (0°C).**

The air conditioning system may not operate even when  is touched.

n **2-way air intake control**

To improve fuel economy, OUTSIDE AIR mode control changes when the air intake selector is set in OUTSIDE AIR on the following conditions:

- l When the maximum heating is needed with the air flow in “Floor” or “Floor/Windshield”, fresh air flows in the upper compartment, while air is recirculated in the lower compartment.
- l When cooling is needed, both fresh and recirculate modes turn on.

3-2. Using the air conditioning system and defogger

CAUTION

n To prevent the windshield from fogging up

Do not use  during cool air operation in extremely humid weather. The difference between the temperature of the outside air and that of the windshield can cause the outer surface of the windshield to fog up, blocking your vision.

NOTICE

n To prevent 12 volt battery discharge

Do not leave the automatic air conditioning system on longer than necessary when the hybrid system is not operating.

3-2. Using the air conditioning system and defogger Using the steering wheel climate remote control switches

Some air conditioning features can be controlled using the switches on the steering wheel.

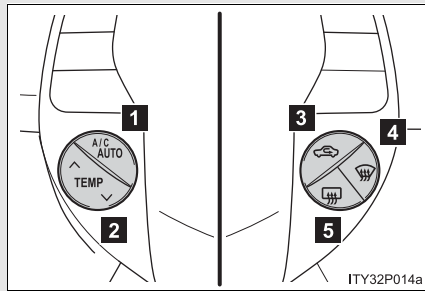

- 1** Automatic mode
- 2** Temperature control
- 3** Recirculated air mode
- 4** Windshield defogger mode
- 5** Rear window and outside rear view mirror defogger mode

Using the automatic mode

STEP 1 Press .

The air conditioning system will operate, and air outlets and fan speed will be set automatically.

“AUTO” will be displayed on the multi-information display. (if equipped)

STEP 2 Press “^” on  to increase the temperature and “v” to decrease the temperature.

Adjusting the temperature setting

Press “^” on  to increase the temperature and “v” to decrease the temperature.

3

Interior features

3-2. Using the air conditioning system and defogger

Changing the recirculated air mode

Press  . (→P. 201, 208)

Using the windshield defogger mode

Press  . (→P. 201, 208)

Using the rear window and outside rear view mirror defogger mode

Press  . (→213)

CAUTION

n To reduce the risk of an accident

Exercise care when operating the audio switches on the steering wheel.

3-2. Using the air conditioning system and defogger Rear window and outside rear view mirror defoggers

These features are used to defog the rear window, and to remove raindrops, dew and frost from the outside rear view mirrors. (vehicles with mirror defoggers)

Press  to display the air conditioning operation screen.

► Type A

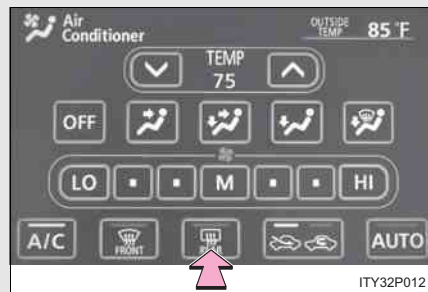

Press the button.

Press the button to turn on the rear window and outside rear view mirror defoggers. The defoggers will automatically turn off after approximately 15 minutes. Pressing the button again also turns the defoggers off.

► Type B

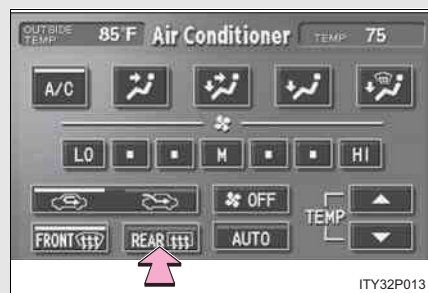

 indicator located in the instrument panel.

3

Interior features

3-2. Using the air conditioning system and defogger

n **Operating conditions**

The "POWER" switch must be in the ON mode.

CAUTION

n **When the outside rear view mirror defoggers are on (vehicles with mirror defoggers)**

Do not touch the rear view mirror surfaces, as they can become very hot and burn you.

NOTICE

n **To prevent 12 volt battery discharge**

Turn the defoggers off when the hybrid system is not operating.

3-3. Using the audio system Audio system type (Vehicle with AUX adapter)

CD and CD changer and AM/FM radio

Press  to display the audio operation screen.

This illustration below is for a vehicle equipped with the CD changer player.

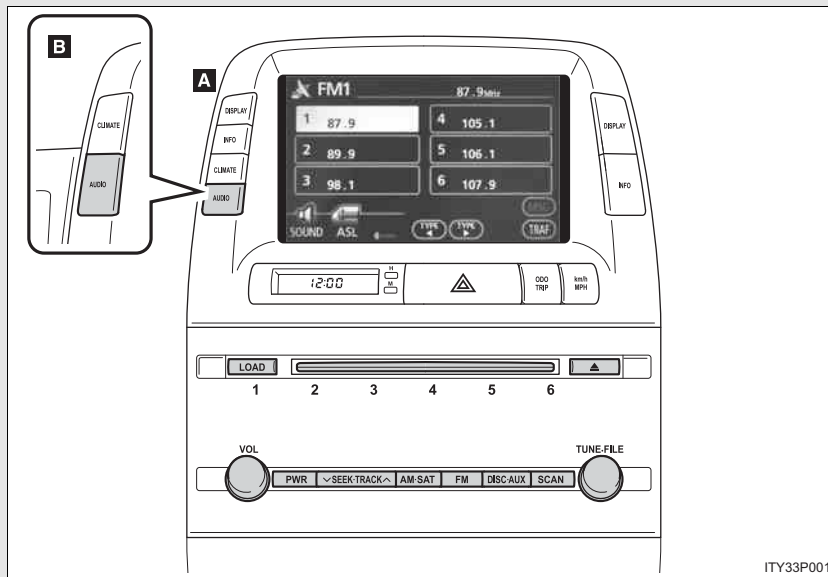

A Vehicles with navigation system

B Vehicles without navigation system

The audio system appearance and screen may differ slightly for vehicles equipped with the CD changer.

3

Interior features

3-3. Using the audio system

CD player: Plays audio CDs, CD text, MP3 discs and WMA discs.

Title	Page
Using the radio	P. 221
Using the CD player	P. 235
Playing MP3 and WMA discs	P. 250
Optimal use of the audio system	P. 259
Using the AUX adapter	P. 265
Using the steering wheel switches	P. 266

n Using cellular phones

Interference may be heard through the audio system's speakers if a cellular phone is being used inside or close to the vehicle while the audio system is operating.

3-3. Using the audio system

CAUTION

n For vehicles sold in the U.S.A. and Canada

l Part 15 of the FCC Rules

FCC Warning:

Any unauthorized changes or modifications to this equipment will void the user's authority to operate this device.

l Laser products

- Do not take this unit apart or attempt to make any changes yourself. This is an intricate unit that uses a laser pickup to retrieve information from the surface of compact discs. The laser is carefully shielded so that its rays remain inside the cabinet. Therefore, never try to disassemble the player or alter any of its parts since you may be exposed to laser rays and dangerous voltages.

- This product utilizes a laser.

Use of controls or adjustments or performance of procedures other than those specified herein may result in hazardous radiation exposure.

3

Interior features

NOTICE

n To prevent 12 volt battery discharge

Do not leave the audio system on longer than necessary when the hybrid system is not operating.

n To avoid damaging the audio system

Take care not to spill drinks or other fluids over the audio system.

3-3. Using the audio system Audio system type (Vehicle without AUX adapter)

CD and AM/FM radio

Press  to display the audio operation screen.

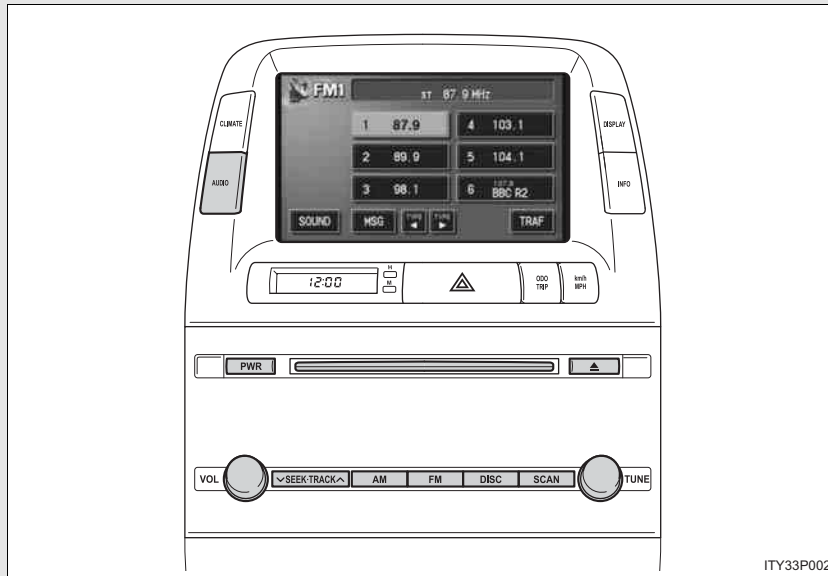

3-3. Using the audio system

CD player:Plays audio CDs and CD text.

Title	Page
Using the radio	P. 230
Using the CD player	P. 243
Optimal use of the audio system	P. 263
Using the steering wheel switches	P. 266

n Using cellular phones

Interference may be heard through the audio system's speakers if a cellular phone is being used inside or close to the vehicle while the audio system is operating.

! CAUTION

n For vehicles sold in the U.S.A. and Canada

I Part 15 of the FCC Rules

FCC Warning:

Any unauthorized changes or modifications to this equipment will void the user's authority to operate this device.

I Laser products

- Do not take this unit apart or attempt to make any changes yourself. This is an intricate unit that uses a laser pickup to retrieve information from the surface of compact discs. The laser is carefully shielded so that its rays remain inside the cabinet. Therefore, never try to disassemble the player or alter any of its parts since you may be exposed to laser rays and dangerous voltages.
- This product utilizes a laser. Use of controls or adjustments or performance of procedures other than those specified herein may result in hazardous radiation exposure.

3-3. Using the audio system

 **NOTICE**

n To prevent 12 volt battery discharge

Do not leave the audio system on longer than necessary when the hybrid system is not operating.

n To avoid damaging the audio system

Take care not to spill drinks or other fluids over the audio system.

3-3. Using the audio system

Using the radio (Vehicle with AUX adapter)

Press **AM-SAT** or **FM** to choose either an AM or FM band.

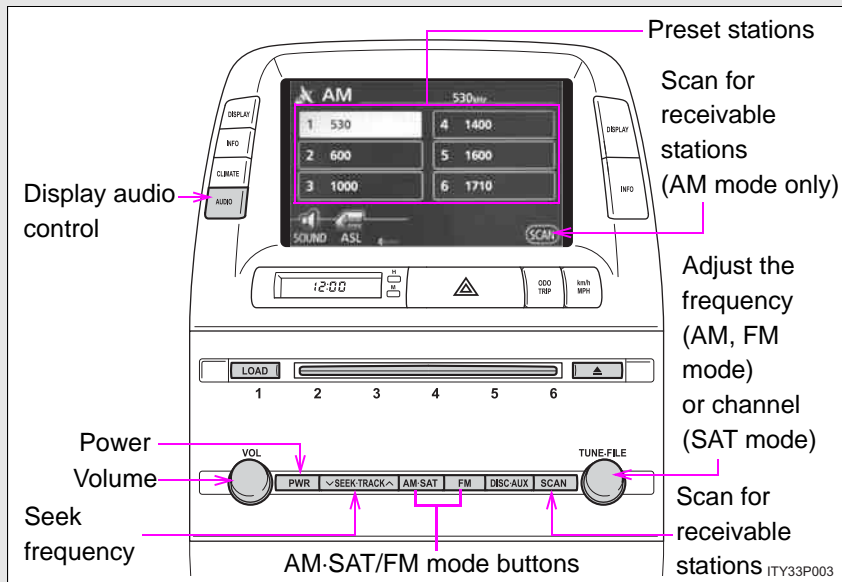

When you press **AUDIO** while listening to the radio, the following audio control screen appears.



This illustration is a vehicle equipped with the CD changer

3-3. Using the audio system

Setting station presets (excluding XM[®] satellite radio)



STEP 1 Search for desired stations by turning the  dial or pressing  .

STEP 2 Touch and hold one of the preset stations (1 - 6) until you hear a beep.



Scanning radio stations (excluding XM[®] satellite radio)

n Scanning the preset radio stations

▶ AM station

STEP 1 Touch  on the screen or press  until "P-SCAN" appears.

Preset stations will be played for a few seconds each.

STEP 2 When the desired station is reached, touch  or press  once again.

▶ FM station



STEP 1 Press  until "P-SCAN" appears.

STEP 2 When the desired station is reached, press the button once again.



3-3. Using the audio system

▮ Scanning all radio stations within range

▶ AM station

STEP 1 Touch  on the screen or press .

“SCAN” appears on the screen and all stations with reception will be played for a few seconds each.

STEP 2 When the desired station is reached, touch  or press  once again.

▶ FM station

STEP 1 Press .

“SCAN” appears on the screen and all stations with reception will be played for a few seconds each.

STEP 2 When the desired station is reached, press  once again.

3



Interior features

RDS (Radio Data System)

This feature allows your radio to receive station identification information and program information (classical, jazz, etc.) from radio stations which broadcast this information.

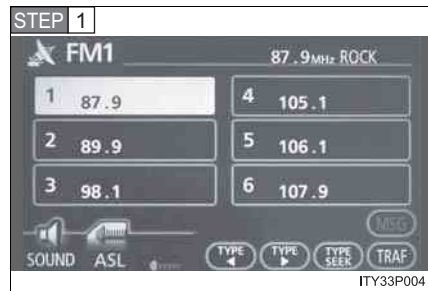
▮ Receiving RDS broadcasts



Touch  or  on the screen.

3-3. Using the audio system

The type of program changes each time the button is pressed.

- 1 ROCK
- 1 EASYLIS (Easy listening)
- 1 CLS/JAZZ (Classical music and Jazz)
- 1 R & B (Rhythm and Blues)
- 1 INFORM (Information)
- 1 RELIGION
- 1 MISC (Miscellaneous)
- 1 ALARM (Emergency messages)

If the system receives no RDS stations, "NO PTY" appears on the display.

When a program is set, "TYPE SEEK" appears.

STEP 2 Touch  on the screen or press \wedge or \vee on .

The radio seeks or scans the station by the relevant program type.

If no radio station of that type is found, "NOTHING" appears on the screen.

n Displaying radio text messages

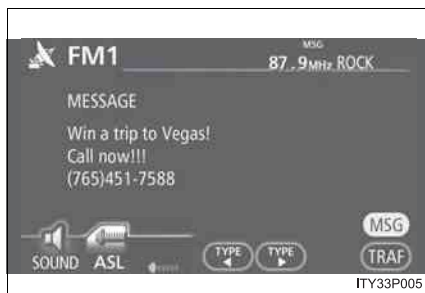

Touch  on the screen.

If "MSG" appears on the screen, a text message may be displayed.

3-3. Using the audio system

n Traffic announcement

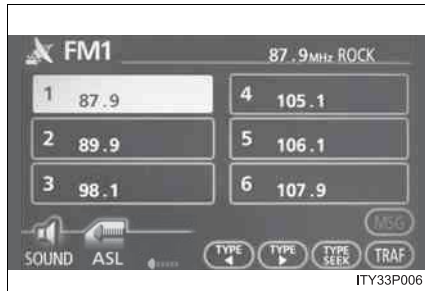

Touch **TRAF** on the screen.

“TRAF SEEK” appears on the screen, and the radio will start seeking any station broadcasting traffic program information.

If no traffic program station is found, “NOTHING” appears on the screen.

XM[®] satellite radio (if equipped)

n Receiving XM[®] satellite radio



Press **AM-SAT** until “SAT” appears on the screen.

The display changes as follows each time the switch is pressed.

AM → SAT1 → SAT2 → SAT3

3

Interior features

STEP 2 Turn the **TUNE-FILE** dial to select a desired channel from all the categories or press **^** or **v** on **SEEK-TRACK** to select a desired channel in the current category.

n Presetting XM[®] satellite radio channels

Select the desired channel. Touch one of the preset stations (1 - 6) and hold it until you hear a beep.



n Changing the channel category

Touch **TYPE** or **TYPE** on the screen.

3-3. Using the audio system

n Scanning XM[®] satellite radio channels



1 Scanning channels in the current category

STEP 1 Touch  on the screen or press  .

“SCAN” appears on the screen.

STEP 2 When the desired channel is reached, touch  or press the button once again.

1 Scanning preset channels

STEP 1 Touch  on the screen or press  and hold it until you hear a beep.

“P-SCAN” appears on the screen.

STEP 2 When the desired channel is reached, touch  or press the button once again.

n Displaying the title and artist name



Touch  on the screen.

The screen will display up to 10 characters.

Touch the button once again to return to the previous screen.

3-3. Using the audio system

n **When the 12 volt battery is disconnected**

All preset stations are erased.

n **Reception sensitivity**

1 Maintaining perfect radio reception at all times is difficult due to the continually changing position of the antenna, differences in signal strength and surrounding objects, such as trains, transmitters, etc.

1 The radio antenna is mounted on the roof. To maintain clear radio reception, do not attach metallic window tinting or other metallic objects to the antenna wire mounted inside the rear window.

n **XM[®] satellite radio**

An XM[®] Satellite Radio is a tuner designed exclusively to receive broadcasts provided under a separate subscription.

Availability is limited to the 48 contiguous states and 10 Canadian provinces.

1 XM[®] subscriptions

For detailed information about XM[®] Satellite Radio or to subscribe:

U.S.A. –

Visit on the web at www.xmradio.com or call 1-800-967-2346.

Canada –

Visit on the web at www.xmradio.ca or call 1-877-438-9677.

1 Radio ID

You will need the radio ID when activating XM[®] service or reporting a problem. Select “CH000” using the  dial, and the receiver’s 8-character ID number will appear.

1 Satellite tuner

The tuner supports only Audio Services (Music and Talk) and the accompanying Text Information of XM[®] satellite radio.

*: Terms and services provided by XM[®] Radio are subject to change without notice.

3-3. Using the audio system

n If the satellite radio does not operate normally

If a problem occurs with the XM[®] tuner, a message will appear on the screen. Refer to the table below to identify the problem, and take the suggested corrective action.

ANTENNA	The XM [®] antenna is not connected. Check whether the XM [®] antenna cable is attached securely.
	There is a short-circuit in the antenna or the surrounding antenna cable. See a Toyota certified dealer.
UPDATING	You have not subscribed to XM [®] satellite radio. The radio is being updated with the latest encryption code. Contact XM [®] satellite radio for subscription information. When a contract is canceled, you can choose "CH000" and all free-to-air channels.
	The premium channel you selected is not authorized. Wait for about 2 seconds until the radio returns to the previous channel or "CH001". If it does not change automatically, select another channel. If you want to listen to the premium channel, contact XM [®] satellite radio.
NO SIGNAL	The XM [®] signal is too weak at the current location. Wait until your vehicle reaches a location with a stronger signal.
LOADING	The unit is acquiring audio or program information. Wait until the unit has received the information.
OFF AIR	The channel you selected is not broadcasting any programming. Select another channel.
----	There is no song/program title or artist name/feature associated with the channel at that time. No action needed.

3-3. Using the audio system

The channel you selected is no longer available. Wait for about 2 seconds until the radio returns to the previous channel or "CH001". If it does not change automatically, select another channel.

Contact the XM[®] Listener Care Center at 1-800-967-2346 (U.S.A.) or 1-877-438-9677 (Canada).

n Certifications for the radio tuner

This equipment has been tested and found to comply with the limits for a class B digital device, pursuant to Part 15 of the FCC Rules. These limits are designed to provide reasonable protection against harmful interference in a residential installation. This equipment generates, uses and can radiate radio frequency energy and, if not installed and used in accordance with the instructions, may cause harmful interference to radio communications. However, there is no guarantee that interference will not occur in a particular installation.

If this equipment does cause harmful interference to radio or television reception, which can be determined by turning the equipment off and on, the user is encouraged to try to correct the interference by trying one or more of the following:

- 1 Reorienting or relocating the receiving antenna.
- 1 Increasing the separation between the equipment and receiver.
- 1 Connecting the equipment into an outlet on a circuit different from that to which the receiver is connected.
- 1 Consulting the dealer or an experienced radio/TV technician for help.

3

Interior features

3-3. Using the audio system

Using the radio (Vehicle without AUX adapter)

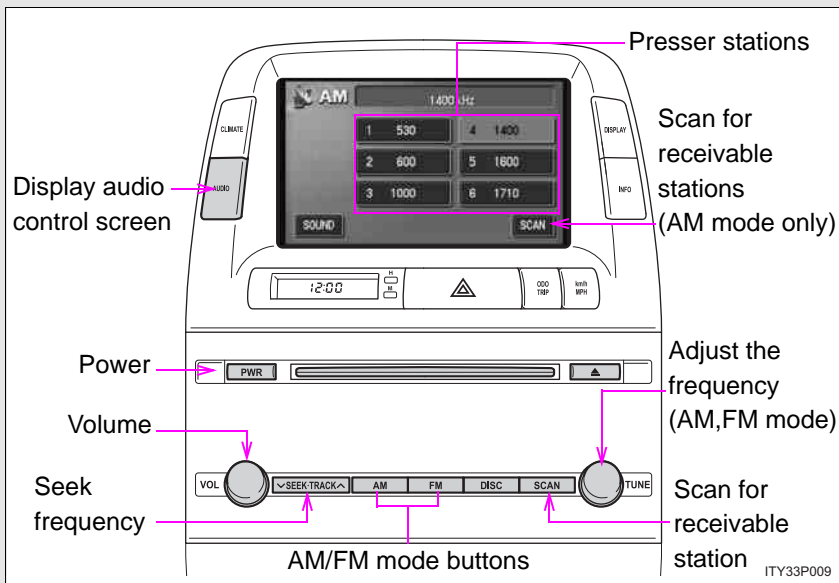

Press **AM** or **FM** to choose either an AM or FM band.

When you press **AUDIO** while listening to the radio, the following audio control screen appears.



3-3. Using the audio system

Setting station presets



STEP 1 Search for desired stations by turning the  dial or pressing \wedge or \vee on .

STEP 2 Touch and hold one of the preset stations (1 - 6) until you hear a beep.



Scanning radio stations

n Scanning the preset radio stations

► AM station

STEP 1 Touch  on the screen or press  until "P-SCAN" appears.

Preset stations will be played for a few seconds each.

STEP 2 When the desired station is reached, touch  or press  once again.

► FM station

STEP 1 Press  until "P-SCAN" appears.

STEP 2 When the desired station is reached, press the button once again.



3

Interior features



3-3. Using the audio system

n Scanning all radio stations within range

► AM station

STEP 1 Touch  on the screen or press  .

“SCAN” appears on the screen and all stations with reception will be played for a few seconds each.

STEP 2 When the desired station is reached, touch  or press  once again.

► FM station

STEP 1 Press  .

“SCAN” appears on the screen and all stations with reception will be played for a few seconds each.

STEP 2 When the desired station is reached, press the button once again.

RDS (Radio Data System)

This feature allows your radio to receive station identification information and program information (classical, jazz, etc.) from radio stations which broadcast this information.

n Receiving RDS broadcasts

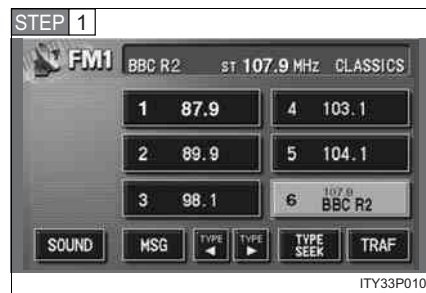

Touch  or  on the screen.

3-3. Using the audio system

The type of program changes each time the button is pressed.

- 1 ROCK
- 1 EASYLIS (Easy listening)
- 1 CLS/JAZZ (Classical music and Jazz)
- 1 R & B (Rhythm and Blues)
- 1 INFORM (Information)
- 1 RELIGION
- 1 MISC (Miscellaneous)
- 1 ALARM (Emergency messages)

If the system receives no RDS stations, "NO PTY" appears on the screen.

When a program is set, "TYPE SEEK" appears.

STEP 2 Touch **TYPE SEEK** on the screen or press \wedge or \vee on **SEEKTRACK**.

The radio seeks or scans the station by the relevant program type.

If no radio station of that type is found, "NOTHING" appears on the screen.

n Displaying radio text messages



Touch **MSG** on the screen.

If "MSG" appears on the screen, a text message may be displayed.

3-3. Using the audio system

n Traffic announcement

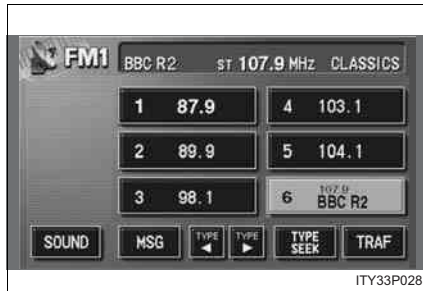

Touch **TRAF** on the screen.

“TRAF SEEK” appears on the screen, and the radio will start seeking any station broadcasting traffic program information.

If no traffic program station is found, “NOTHING” appears on the screen.

n When the 12 volt battery is disconnected

All preset stations are erased.

n Reception sensitivity

- l Maintaining perfect radio reception at all times is difficult due to the continually changing position of the antenna, differences in signal strength and surrounding objects, such as trains, transmitters, etc.
- l The radio antenna is mounted on the roof. To maintain clear radio reception, do not attach metallic window tinting or other metallic objects to the antenna wire mounted inside the rear window.

3-3. Using the audio system Using the CD player (Vehicle with AUX adapter)

Insert a CD or press **DISC-AUX** with a CD inserted.

When you press **AUDIO** while listening to a CD, the following audio control screen appears.

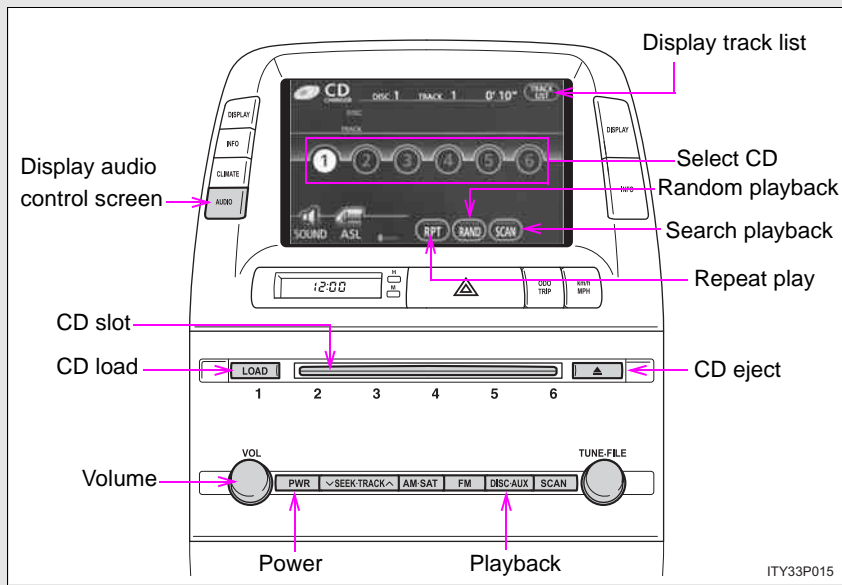

3

Interior features

3-3. Using the audio system

Loading CDs

n Loading a CD (CD player without changer)

Insert a CD.

n Loading a single CD (CD player with changer)

STEP 1 Press **LOAD**.

STEP 2 When the indicator changes from flashing amber to green, insert a CD after the CD player door opens.

n Loading multiple CDs

STEP 1 Press and hold **LOAD** until you hear a beep.

STEP 2 When the indicator changes from flashing amber to green, insert a CD after the CD player door opens.

STEP 3 After inserting a CD, wait until the indicator changes from flashing amber to green, then insert the next CD after the CD door has opened.

Repeat steps 2 and 3 until you have inserted all CDs.

To cancel the operation, press the **LOAD** or **DISC-AUX**. If you do not insert a CD within 15 seconds, loading will be canceled automatically.

Ejecting CDs

n Ejecting a CD (CD player without changer)

Press **▲** and remove the CD.

n Ejecting a CD (CD player with changer)

STEP 1 To select the CD to be ejected, touch the desired disc number (1 - 6) on the screen.

STEP 2 Press **▲** and remove the CD.

3-3. Using the audio system

n Ejecting all CDs (CD player with changer)

Press and hold  until you hear a beep, then remove the CDs.

Selecting, fast forwarding and scanning tracks

n Selecting a track

Press \wedge to move up and \vee to move down using  until the desired track number appears on the screen.



To fast forward or rewind, press and hold \wedge or \vee on .

n Selecting a track from the track list

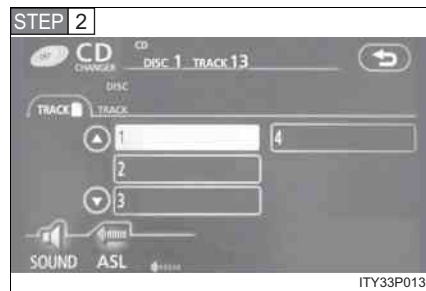
STEP 1 Touch  on the screen.



Touch the desired track number.

 or  : changes the list by 6 track groups.

This function is available only when the vehicle is not moving.

3

Interior features

n Scanning a CD

STEP 1 Touch  on the screen.

“SCAN” appears on the screen.

The first 10 seconds of each track will be played.

STEP 2 Touch  once again when the desired track is reached.

3-3. Using the audio system

Selecting a CD (CD player with changer only)

n To select a CD to play

Touch the desired disc number (1 - 6) on the screen.

n To scan loaded CDs

STEP 1 Touch and hold **SCAN** on the screen until you hear a beep.

The first 10 seconds of the first track on each CD will be played.

STEP 2 Touch **SCAN** once again when the desired CD is reached.

Random playback

n Current CD

Touch **RAND** on the screen.

Songs are played in random order until random playback is canceled.

n All CDs (CD player with changer only)

Touch and hold **RAND** on the screen until you hear a beep.

Tracks on all loaded CDs are played in random order until **RAND** is touched once again.

Repeating a track or a disc

n Repeating a track

Touch **RPT** on the screen.

n Repeating a disc (CD player with changer only)

Touch **RPT** on the screen and hold until you hear a beep.

3-3. Using the audio system

n Canceling random, repeat and scan playback

Touch **RAND** , **RPT** , or **SCAN** on the screen once again.

n Displaying the title and artist name

If a CD-TEXT disc is inserted, the title of the disc and track will be displayed. Up to 13 letters can be displayed.

n Error messages

Refer to the following table and take the appropriate measures. If the problem is not rectified, take the vehicle to your Toyota dealer.

Message	Cause	Correction Procedures
CD X CHECK	<ul style="list-style-type: none"> • The disc X is dirty or damaged • The disc X is inserted upside down • The disc X is not playable with the player 	<ul style="list-style-type: none"> • Clean the disc • Insert the disc correctly • Confirm the disc is playable with the player
CD ERROR	<ul style="list-style-type: none"> • There is a malfunction within the system • Operation is stopped due to a high temperature inside the player 	<ul style="list-style-type: none"> • Eject the disc • Eject the disc and allow the player to cool down
NO DATA DISC	This indicates that no playable data is included in the disc	Eject the disc

3-3. Using the audio system

n Discs that can be used

Discs with the marks shown below can be used.
Playback may be possible depending on recording format or disc features,
or due to scratches, dirt or deterioration.



CDs with copy-protect features may not be used.

n CD player protection feature

To protect the internal components, playback is automatically stopped when
a problem is detected.

n If CDs are left inside the CD player or in the ejected position for extended periods

CDs may be damaged and may not play properly.

n Lens cleaners

Do not use lens cleaners. Doing so may damage the CD player.

 NOTICE

n Discs and adapters that cannot be used

Do not use the following types of discs, 3 in. (8 cm) disc adapters or Dual Discs.

Doing so may damage the player and render the disc insert/eject function unusable.

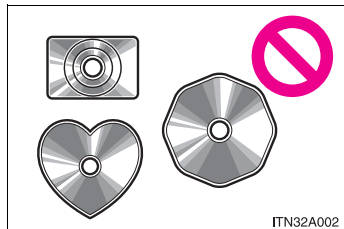

! Discs that have a diameter that is not 4.7 in. (12 cm).

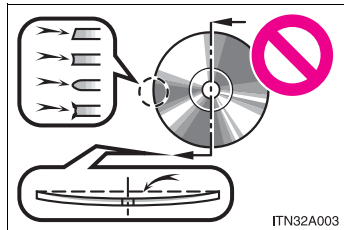

! Low-quality and deformed discs.

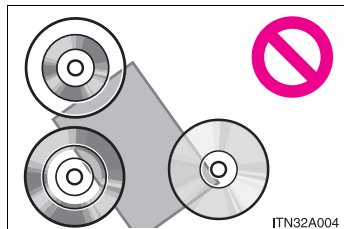

! Discs with a transparent or translucent recording area.

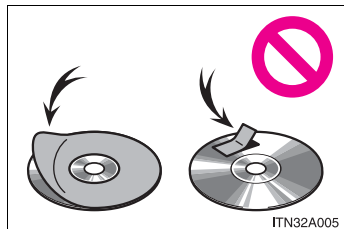

! Discs that have tape, stickers or CD-R labels attached to them, or that have the label peeled off.

3-3. Using the audio system

NOTICE

n Player precautions

Failure to follow the precautions below may result in damage to the discs or the player itself.

- I** Do not insert anything other than discs into the disc slot.
- I** Do not apply oil to the player.
- I** Store discs away from direct sunlight.
- I** Never try to disassemble any part of the player.

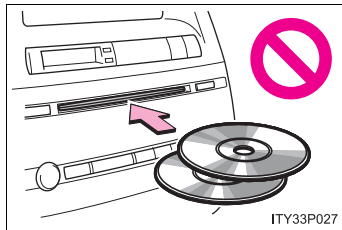

- I** Do not insert more than one disc at a time.

3-3. Using the audio system Using the CD player (Vehicle without AUX adapter)

Insert a CD or press  with a CD inserted.

When you press  while listening to a CD, the following audio control screen appears.

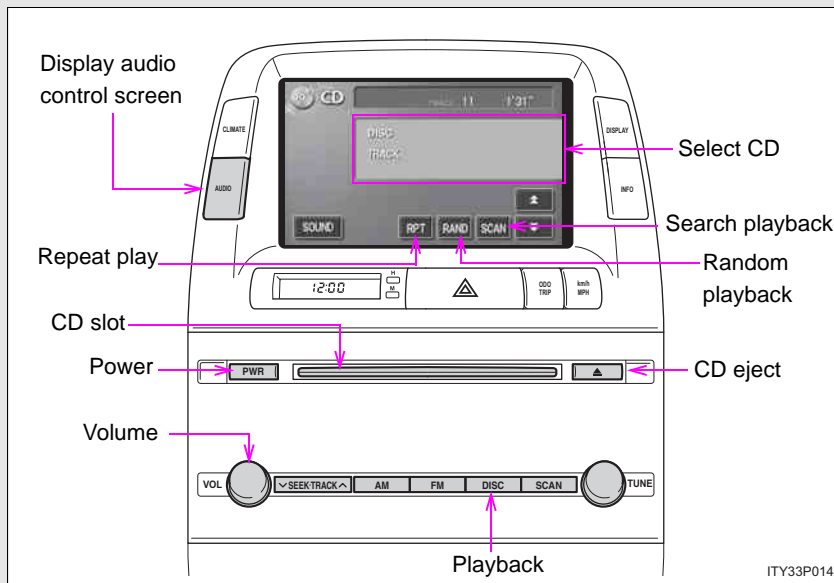

3

Interior features

3-3. Using the audio system

Loading a CD

n Loading a single CD

Insert a CD.

Ejecting a CD

n Ejecting a CD

Press  and remove the CD.

Selecting, fast forwarding and scanning tracks

n Selecting a track

Press \wedge to move up and \vee to move down using  until the desired track number appears on the screen.

To fast forward or rewind, press and hold \wedge or \vee on .

n Scanning a CD

STEP 1 Touch  on the screen.

“SCAN” appears on the screen.

The first 10 seconds of each track will be played.

STEP 2 Touch  once again when the desired track is reached.

3-3. Using the audio system

Displaying the disc and track title

Touch **TITLE** on the screen.

Random playback

n Current CD

Touch **RAND** on the screen.

Songs are played in random order until random playback is canceled.

Repeating a track

n Repeating a track

Touch **RPT** on the screen.

3

Interior features

3-3. Using the audio system

n **Canceling random, repeat and scan playback**

Touch **RAND** , **RPT** , **SCAN** or **TITLE** on the screen once again.

n **Displaying the title and artist name**

If a CD-TEXT disc is inserted, the title of the disc and track will be displayed. Up to 29 letters can be displayed.

n **Error messages**

Refer to the following table and take the appropriate measures. If the problem is not rectified, take the vehicle to your Toyota dealer.

Message	Cause	Correction Procedures
CD X CHECK	<ul style="list-style-type: none"> • The disc X is dirty or damaged • The disc X is inserted upside down • The disc X is not playable with the player 	<ul style="list-style-type: none"> • Clean the disc • Insert the disc correctly • Confirm the disc is playable with the player
CD ERROR	<ul style="list-style-type: none"> • There is a malfunction within the system • Operation is stopped due to a high temperature inside the player 	<ul style="list-style-type: none"> • Eject the disc • Eject the disc and allow the player to cool down
NO DATA DISC	This indicates that no playable data is included in the disc	Eject the disc

3-3. Using the audio system

n Discs that can be used

Discs with the marks shown below can be used.
Playback may be possible depending on recording format or disc features,
or due to scratches, dirt or deterioration.



CDs with copy-protect features may not be used.

n CD player protection feature

To protect the internal components, playback is automatically stopped when
a problem is detected.

n If CDs are left inside the CD player or in the ejected position for extended periods

CDs may be damaged and may not play properly.

n Lens cleaners

Do not use lens cleaners. Doing so may damage the CD player.

3

Interior features

3-3. Using the audio system

NOTICE

n Discs and adapters that cannot be used

Do not use the following types of discs, 3 in. (8 cm) disc adapters or Dual Discs.

Doing so may damage the player and render the disc insert/eject function unusable.

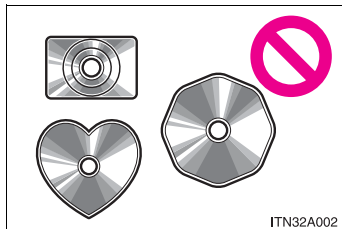

I Discs that have a diameter that is not 4.7 in. (12 cm).

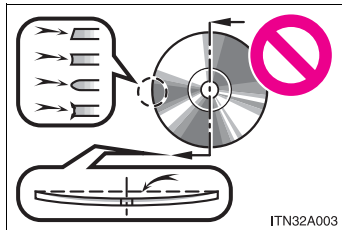

I Low-quality and deformed discs.

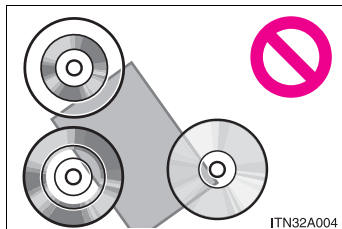

I Discs with a transparent or translucent recording area.

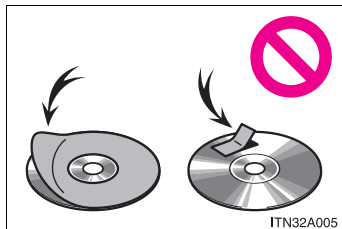

I Discs that have tape, stickers or CD-R labels attached to them, or that have the label peeled off.

3-3. Using the audio system

NOTICE

n Player precautions

Failure to follow the precautions below may result in damage to the discs or the player itself.

- I** Do not insert anything other than discs into the disc slot.
- I** Do not apply oil to the player.
- I** Store discs away from direct sunlight.
- I** Never try to disassemble any part of the player.

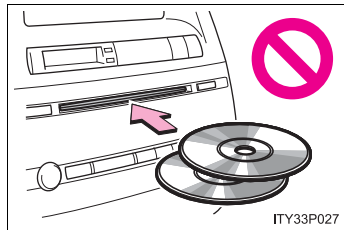

- I** Do not insert more than one disc at a time.

3

Interior features

3-3. Using the audio system Playing MP3 and WMA discs*

Insert an MP3 or WMA disc or press **DISC/AUX** with a disc inserted.

When you press **AUDIO** during playback of the disc, the following audio control screen appears.

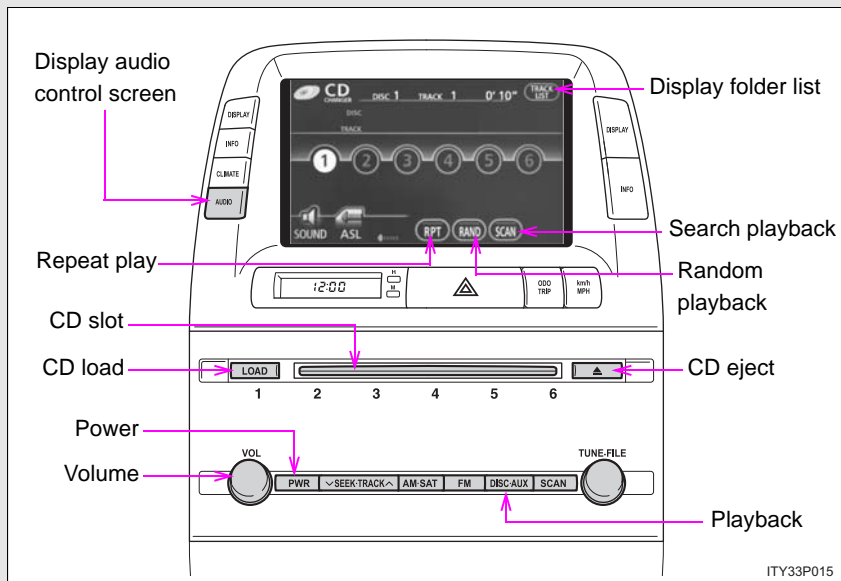

This illustration is a vehicle equipped with the CD changer.

*: If equipped

3-3. Using the audio system

Loading, ejecting and selecting MP3 and WMA discs

Refer to the section entitled "Using the CD player" for details.
(→P. 235)

Selecting a folder

n Selecting a folder

Touch "FOLDER ▲" or "▼" on the screen to select the previous/next folder.

n Selecting a folder from the folder list

STEP 1 Touch **FOLDER LIST** on the screen.

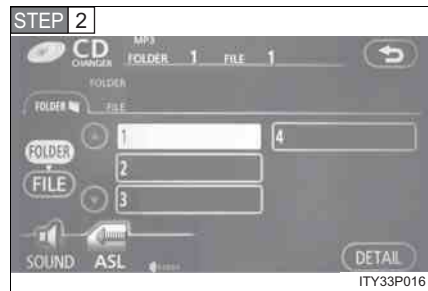

STEP 2 Touch the desired folder number.

▲ or ▼ : changes the list by 6 folder groups.

DETAIL : displays the details of the file currently playing.

FILE : displays the file list.

This function is available only when the vehicle is not moving.

n Selecting the desired folder by cueing the first file of each folder

Touch and hold **SCAN** on the screen until you hear a beep. When the desired folder is reached, touch **SCAN** once again.



3

Interior features

3-3. Using the audio system

Selecting and scanning files

n Selecting one file at a time

Turn the  dial or press \wedge or \vee on  to select the desired file.

n Selecting a file from the file list

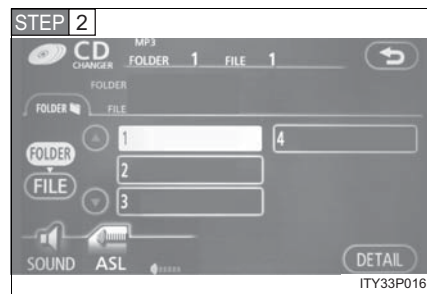

STEP 1 Touch  on the screen to turn the folder list on.



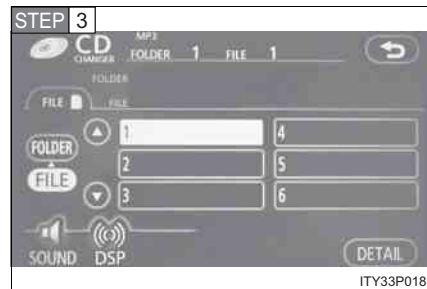

Touch  on the folder list screen.



Touch the desired file number.

 or  :changes the list by 6 groups.

 : displays the folder list.

 :displays the details of the file currently playing.

This function is available only when the vehicle is not moving.

3-3. Using the audio system

n **Selecting a desired file by cueing the files in the folder**

Touch  on the screen.

When the desired file is reached, touch  once again.

File repeat

Touch  on the screen.

Folder repeat

Touch and hold  on the screen until you hear a beep.

Random playback

n **To play files from a particular folder in random order**

Touch  on the screen.

n **To play all the files on a disc in random order**

Touch and hold  on the screen until you hear a beep.

n **Canceling random, repeat and scan playback**

Touch ,  or  on the screen once again.

n **Error messages**

→P. 239

n **Discs that can be used**

Discs with the marks shown below can be used.

Playback may not be possible depending on recording format or disc features, or due to scratches, dirt or deterioration.



3-3. Using the audio system

n **CD player protection feature**

To protect the internal components, playback is automatically stopped when a problem is detected while the CD player is being used.

n **If CDs are left inside the CD player or in the ejected position for extended periods**

CDs may be damaged and may not play properly.

n **Lens cleaners**

Do not use lens cleaners. Doing so may damage the CD player.

n **MP3 and WMA files**

MP3 (MPEG Audio LAYER 3) is a standard audio compression format.

Files can be compressed to approximately 1/10 of their original size by using MP3 compression.

WMA (Windows Media TMAudio) is a Microsoft audio compression format.

This format compresses audio data to a size smaller than that of the MP3 format.

There is a limit to the MP3 and WMA file standards and to the media/formats recorded by them that can be used.

l **MP3 file compatibility**

- Compatible standards
MP3 (MPEG1 LAYER3, MPEG2 LSF LAYER3)
- Compatible sampling frequencies
MPEG1 LAYER3: 32, 44.1, 48 (kHz)
MPEG2 LSF LAYER3: 16, 22.05, 24 (kHz)
- Compatible bit rates
MPEG1 LAYER3: 64, 80, 96, 112, 128, 160, 192, 224, 256, 320 (kbps)
- MPEG2 LSF LAYER3: 64, 80, 96, 112, 128, 144, 160 (kbps)
*: Compatible with VBR
- Compatible channel modes: stereo, joint stereo, dual channel and monaural

3-3. Using the audio system

1 WMA file compatibility

- Compatible standards
WMA Ver. 7, 8, 9
- Compatible sampling frequencies
32, 44.1, 48 (kHz)
- Compatible bit rates
Ver. 7, 8: CBR 48, 64, 80, 96, 128, 160, 192 (kbps)
Ver. 9: CBR 48, 64, 80, 96, 128, 160, 192, 256, 320 (kbps)
*: Only compatible with 2-channel playback

1 Compatible media

Media that can be used for MP3 and WMA playback are CD-Rs and CD-RWs.

Playback in some instances may not be possible, depending on the status of the CD-R or CD-RW. Playback may not be possible or the audio may jump if the disc is scratched or marked with fingerprints.

1 Compatible disc formats

The following disc formats can be used.

- Disc formats: CD-ROM Mode 1 and Mode 2
CD-ROM XA Mode 2, Form 1 and Form 2
- File formats: ISO9660 level 1, level 2, (Romeo, Joliet)
MP3 and WMA files written in any format other than those listed above may not play correctly, and their file names and folder names may not be displayed correctly.

Items related to standards and limitations are as follows:

- Maximum directory hierarchy: 8 levels
- Maximum length of folder names/file names: 32 characters
- Maximum number of folders: 192 (including the root)
- Maximum number of files per disc: 255

3-3. Using the audio system

1 File names

The only files that can be recognized as MP3/WMA and played are those with the extension .mp3 or .wma.

1 Multi-sessions

As the audio system is compatible with multi-sessions, it is possible to play discs that contain MP3 and WMA files. However, only the first session can be played.

1 ID3 and WMA tags

ID3 tags can be added to MP3 files, making it possible to record the track title and artist name, etc.

The system is compatible with ID3 Ver. 1.0, 1.1, and Ver. 2.2, 2.3 ID3 tags. (The number of characters is based on ID3 Ver. 1.0 and 1.1.)

WMA tags can be added to WMA files, making it possible to record the track title and artist name in the same way as with ID3 tags.

1 MP3 and WMA playback

When a disc containing MP3 or WMA files is inserted, all files on the disc are first checked. Once the file check is finished, the first MP3 or WMA file is played. To make the file check finish more quickly, we recommend you do not write in any files other than MP3 or WMA files or create any unnecessary folders.

Discs that contain a mixture of music data and MP3 or WMA format data cannot be played.

3-3. Using the audio system

1 Extensions

If the file extensions .mp3 and .wma are used for files other than MP3 and WMA files, they will be mistakenly recognized and played as MP3 and WMA files. This may result in large amounts of interference and damage to the speakers.

1 Playback

- To play MP3 files with steady sound quality, we recommend a fixed bit rate of 128 kbps and a sampling frequency of 44.1 kHz.
- CD-R or CD-RW playback may not be possible in some instances, depending on the characteristics of the disc.
- There is a wide variety of freeware and other encoding software for MP3 and WMA files on the market, and depending on the status of the encoding and the file format, poor sound quality or noise at the start of playback may result. In some cases, playback may not be possible at all.
- When files other than MP3 or WMA files are recorded on a disc, it may take more time to recognize the disc and in some cases, playback may not be possible at all.
- Microsoft, Windows, and Windows Media are the registered trademarks of Microsoft Corporation in the U.S. and other countries.

n CD-R and CD-RW discs

- 1 CD-R/CD-RW discs that have not been subject to the “finalizing process” (a process that allows discs to be played on a conventional CD player) cannot be played.
- 1 It may not be possible to play CD-R/CD-RW discs recorded on a music CD recorder or a personal computer because of disc characteristics, scratches or dirt on the disc, or dirt, condensation, etc. on the lens of the unit.
- 1 It may not be possible to play discs recorded on a personal computer depending on the application settings and the environment. Record with the correct format. (For details, contact the appropriate application manufacturers of the applications.)

3-3. Using the audio system

- l CD-R/CD-RW discs may be damaged by direct exposure to sunlight, high temperatures or other storage conditions. The unit may be unable to play damaged discs.
- l If you insert a CD-RW disc into the MP3/WMA player, playback will begin more slowly than with a conventional CD or CD-R disc.
- l Recordings on CD-R/CD-RW cannot be played using the DDCD (Double Density CD) system.

n **Unsuitable discs, and player precautions**

→P. 241

3-3. Using the audio system Optimal use of the audio (Vehicle with AUX adapter)

Press  on the panel to display the audio/video control screen.

▶ Operating the radio and CD player (type A)

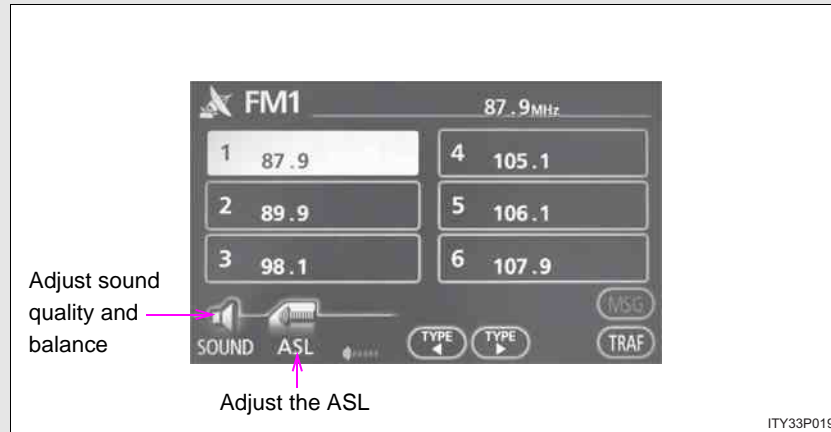

▶ Operating the radio and CD player (type B)

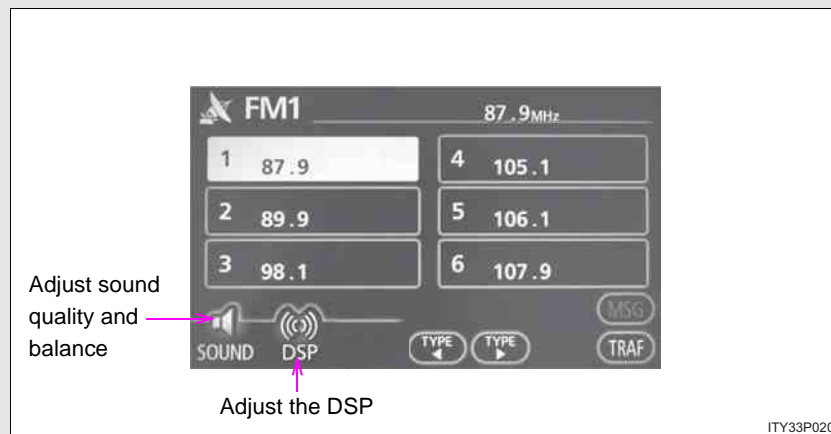

3

Interior features

3-3. Using the audio system





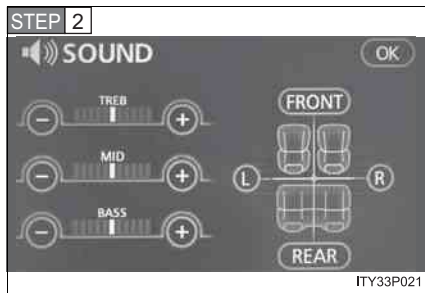



Adjusting sound quality and balance

STEP 1 Touch  on the screen.

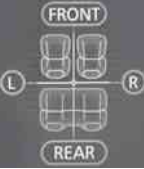

Adjust the settings, referring to the following table.

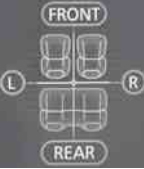
Once you have finished, touch .

Sound quality mode	Display	Level	Touch
High-pitched tones*		-5 to 5	
Mid-pitched tones* (Type A only)		-5 to 5	 or 
Low-pitched tones*		-5 to 5	
Front/rear volume balance		F7 to R7	 or 
Left/right volume balance		L7 to R7	 or 

*: The sound quality level is adjusted individually in each radio or CD mode.

3-3. Using the audio system

Setting DSP

The following features can be set as desired by touching  on the screen.

▶ Type B only

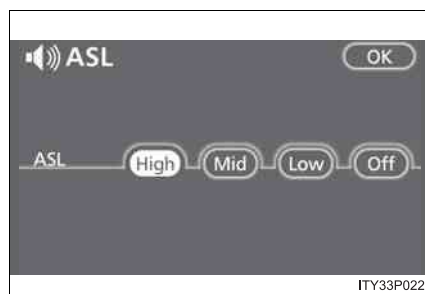

Turning Automatic Sound Levelizer (ASL)

▶ Type A

Touch .

ASL automatically adjusts the volume and tone quality according to the noise level as you drive your vehicle.

▶ Type B

Touch ,  or .

ASL adjusts the volume and tone quality according to the noise level as you drive your vehicle.

3

Interior features

3-3. Using the audio system

n Trademark owned by SRS Labs, Inc.



The audio systems utilize SRS FOCUS[®] and SRS TruBass[®] audio enhancement technologies, under license from SRS Labs, Inc., in all mode except AM radio mode.

FOCUS, TruBass, SRS and [®] symbols are trademarks of SRS Labs, Inc.

FOCUS and TruBass technologies are incorporated under license from SRS Labs, Inc.

3-3. Using the audio system Optimal use of the audio system (Vehicle without AUX adapter)

Press  on the panel to display the audio/video control screen.

► Operating the radio and CD player



3

Interior features

Adjusting sound quality and balance



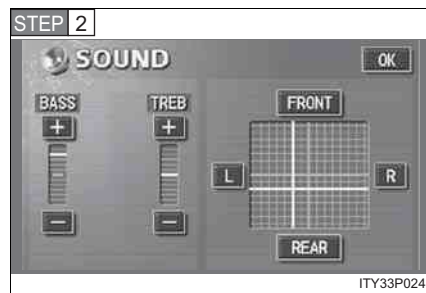

STEP 1 Touch  on the screen.



Adjust the settings, referring to the following table.

Once you have finished, touch .

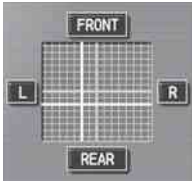
3-3. Using the audio system

Sound quality mode	Display	Level	Touch
High-pitched tones*		-5 to 5	- or +
Low-pitched tones*		-5 to 5	
Front/rear volume balance		F7 to R7	FRONT or REAR
Left/right volume balance		L7 to R7	L or R

*: The sound quality level is adjusted individually in each radio or CD mode.

n Trademark owned by SRS Labs, Inc.



The audio systems utilize SRS FOCUS® and SRS TruBass® audio enhancement technologies, under license from SRS Labs, Inc., in all mode except AM radio mode.

FOCUS, TruBass, SRS and ® symbols are trademarks of SRS Labs, Inc.

FOCUS and TruBass technologies are incorporated under license from SRS Labs, Inc.

3-3. Using the audio system Using the AUX adapter*

This adapter can be used to connect a portable audio device and listen to it through the vehicle's speakers.

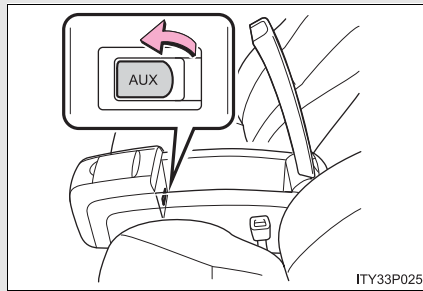

STEP 1 Connect the portable audio device.

STEP 2 Press **DISC/AUX**.

3

n **Operating portable audio devices connected to the audio system**

The volume can be adjusted using the vehicle's audio controls. All other adjustments must be made on the portable audio device itself.

n **When using a portable audio device connected to the power outlet**

Noise may occur during playback. Use the power source of the portable audio device.

Interior features

*: If equipped

265

3-3. Using the audio system

Using the steering switches

Some audio features can be controlled using the switches on the steering wheel.

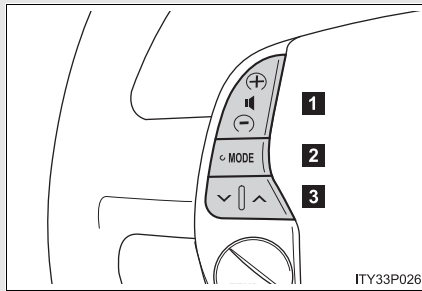

- 1** Volume
- 2** Power on, select audio source
- 3** Radio: Select radio stations
CD: Select tracks, discs and folder

Turning on the power

Press  when the audio system is turned OFF.

The audio system can be turned OFF by holding the switch down for 1 second or more.

Changing the audio source

Press  when the audio system is turned ON. The audio source changes as follows each time the button is pressed. If a CD is not inserted, that mode will be skipped.

FM (1, 2)→CD player→AM→SAT (1, 2, 3)

3-3. Using the audio system

Adjusting the volume

Press “+” on  to increase the volume and “-” to decrease the volume.

Hold down the button to continue increasing or decreasing the volume.

Selecting a radio station

STEP 1 Press  to select the radio mode.

STEP 2 Press \wedge or \vee on  to select a radio station.

To scan for receivable stations, press and hold the switch until you hear a beep.

Selecting a track

STEP 1 Press  to select the CD mode.

STEP 2 Press \wedge or \vee on  to select the desired track.

Selecting a disc or folder in the CD player (Folder selection is available only when MP3/WMA disc is in use.)

STEP 1 Press  to select the CD player.

STEP 2 Press and hold \wedge or \vee on  until you hear a beep.

3

Interior features

3-3. Using the audio system

n **Canceling automatic selection of a radio station**

Push the same switch.

CAUTION

n **To reduce the risk of an accident**

Exercise care when operating the audio switches on the steering wheel.

3-4. Using the hands-free system (for cellular phone) Hands-free system (for cellular phone)

The hands-free system is a function that allows you to use your mobile phone without touching it.

This system supports Bluetooth® mobile phones. Bluetooth® is a wireless data system that allows the mobile phone to wirelessly connect to the hands-free system and make/receive calls.

► Telephone switch

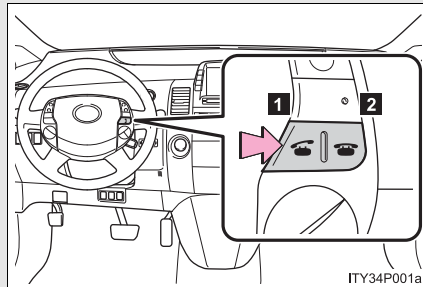

- 1 Sending/Receiving/"Telephone" screen display (when stopped)
- 2 End call

► Microphone

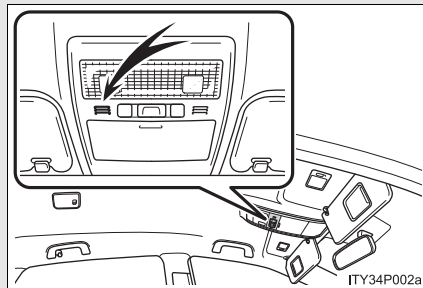

The person you are speaking to can be heard from the driver's side speaker.

To use the hands-free system you must register your Bluetooth® phone in the system. (→P. 274)

3

Interior features

3-4. Using the hands-free system (for cellular phone)

Status display

You can check such indicators as signal strength and battery charge on the “Telephone” screen.



- 1** Connection status
- 2** Battery charge
- 3** Call area
- 4** Signal strength

Indicators	Conditions
Connection status	Blue: Good Yellow: Bad BT: Not connected
Battery charge	Full: Full Low: Low
Call area	“Rm”: Roaming area “Hm”: Home area
Signal strength	Good: Good Bad: Bad Not connected: Not connected

3-4. Using the hands-free system (for cellular phone)

n **When using the hands-free system**

- l The audio system and voice guidance are muted when making a call.
- l If both parties speak at the same time it may be difficult to hear.
- l If the received call volume is overly loud, an echo may be heard.
- l Try to face the microphone as much as possible when speaking.
- l In the following circumstances it may be difficult to hear the other party.
 - When driving on unsealed roads
 - When driving at high speeds
 - If the window is open
 - If the air-conditioning is blowing directly on the microphone
 - If the air-conditioning is set to high

n **Conditions under which the system will not operate**

- l If using a mobile phone that does not support Bluetooth®.
- l If the mobile phone is switched off.
- l If you are outside service range.
- l If the mobile phone is not connected.
- l If the mobile phone's battery is low.

n **Bluetooth® antenna**

The antenna is built into the display. If the mobile phone is behind the seat or in the console box, or touching or covered by metal objects, connection status may deteriorate.

n **Battery charge/Signal status**

This display may not correspond exactly with the mobile phone itself.

3

Interior features

3-4. Using the hands-free system (for cellular phone)

n About Bluetooth®



Bluetooth is a registered trademark of Bluetooth SIG, Inc.

n Compatible models

Compatible with HFP (Hands Free Profile) Ver. 1.0 and OPP (Object Push Profile) Ver. 1.1.

If your cellular phone does not support HFP, you cannot enter the Bluetooth® phone. If your cellular phone supports OPP alone, you cannot use the Bluetooth® phone.

n Certification for the hands-free system

FCC ID: BABBT003A
IC ID: 2024B-BT003A

This device complies with Part 15 of the FCC Rules and RSS-210. Operation is subject to the following two conditions: (1) This device may not cause harmful interference, and (2) This device must accept any interference received, including interference that may cause undesired operation.

3-4. Using the hands-free system (for cellular phone)

FCC WARNING:

Changes or modifications not expressly approved by the party responsible for compliance could void the user's authority to operate the equipment.

CAUTION:

Radio Frequency Radiation Exposure

This equipment complies with FCC radiation exposure limits set forth, for uncontrolled equipment and meets the FCC radio frequency (RF) Exposure Guidelines in Supplement C to OET65. This equipment has very low levels of RF energy that it is deemed to comply without maximum permissive exposure evaluation (MPE). But it is desirable that it should be installed and operated with at least 7.9 in (20 cm) and more between the radiator and person's body (excluding extremities: hands, wrists, feet and legs).

Co-location:

This transmitter must not be co-located or operated in conjunction with any other antenna or transmitter.



Interior features



 CAUTION
n Caution while driving Do not use a cellular phone or connect the Bluetooth® phone.

 NOTICE
n When leaving the vehicle Do not leave your mobile phone in the vehicle. The inside of the vehicle may become hot, causing damage to the phone.

3-4. Using the hands-free system (for cellular phone) Using the Bluetooth® phone

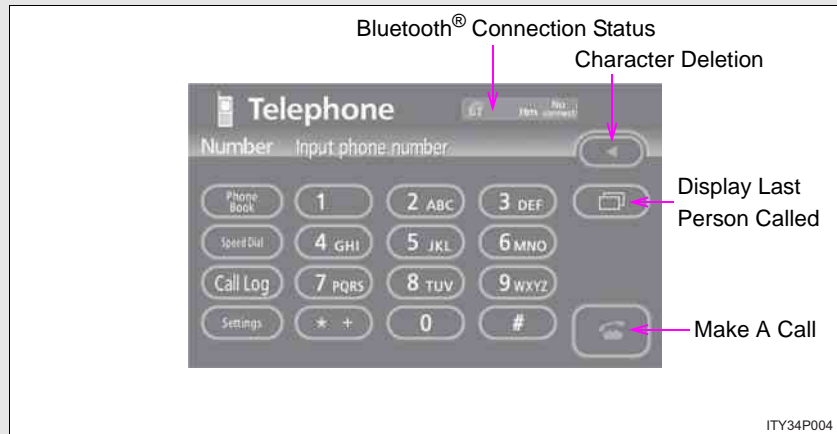
► Telephone screen





To display the screen shown above, press , then touch  on the "Information" screen.

Registering a Bluetooth® phone

You can register up to 6 phones in the system.

STEP 1 Press  .

STEP 2 Touch  on the "Information" screen.

STEP 3 Touch  on the "Telephone" screen.

3-4. Using the hands-free system (for cellular phone)

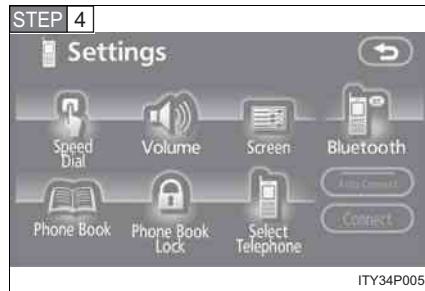

Touch .

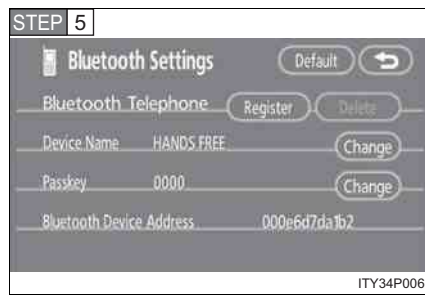

Touch .

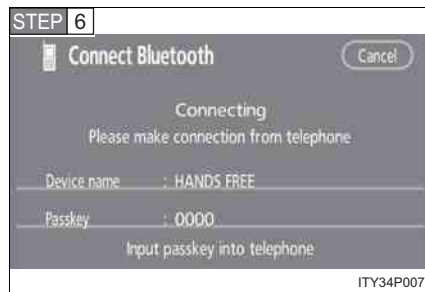

Input the passkey displayed on screen into your phone.

If the message "Bluetooth* connection successful" is displayed, registration is complete.

If the message "Bluetooth* connection failed. Please check the "Passkey" and the settings of the telephone" is displayed, start again from the beginning.

*:Bluetooth is a registered trademark of Bluetooth SIG, Inc.

3

Interior features

3-4. Using the hands-free system (for cellular phone)

Bluetooth® phone connection

There are two connection methods available—automatic and manual.

STEP 1 Press  .

STEP 2 Touch  on the “Information” screen.

STEP 3 Touch  on the “Telephone” screen.

STEP 4 Choose one of the following methods.

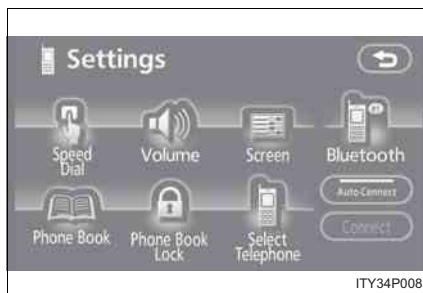

1 Automatic connection

If the “POWER” switch is in the ACCESSORY or ON mode, the system will automatically connect to the Bluetooth* phone. Touching automatic connection will turn it ON/OFF.

2 Manual connection

If automatic connection fails or is turned OFF, connection must be made manually.

If the message “Bluetooth* connection successful” is displayed, connection is complete.

*.Bluetooth is a registered trademark of Bluetooth SIG. Inc.

ii Reconnecting to the Bluetooth® phone

If the system cannot connect due to poor signal strength with the “POWER” switch in the ACCESSORY or ON mode, the system will automatically attempt to reconnect.

If the phone is turned off, the system will not attempt to reconnect. In this case, connection must be made manually, or the phone must be re-selected.

3-4. Using the hands-free system (for cellular phone)

Making a call

Once the Bluetooth® phone is registered, you can make a call using the following procedure.

Dialing

STEP 1 Press  .



STEP 2 Touch  on the “Information” screen.



Inputting the phone number.

To delete the input phone number, touch  .

To dial the last input phone number, touch  .

STEP 4 Touch  or press the  on the steering wheel.

3

Interior features

3-4. Using the hands-free system (for cellular phone)

nDialing from the phone book

You can dial a number from the phone book data imported from your mobile phone. Up to 1000 entries may be stored in the phone book. (→P. 298)

STEP 1 Press .

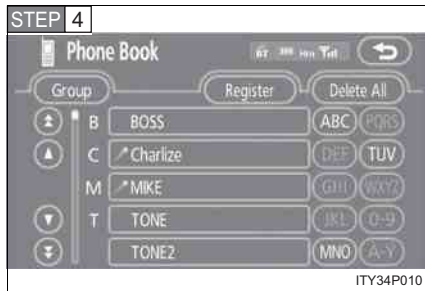

STEP 2 Touch  on the “Information” screen.

STEP 3 Touch  on the “Telephone” screen.

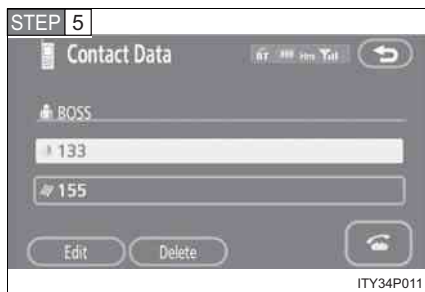

Choose the data to call from the list.



Choose the number and then touch  or press the  on the steering wheel.

3-4. Using the hands-free system (for cellular phone)

Dialing from history

You can make a call from past dialed numbers or received calls. Up to 5 numbers are stored, with the last recent number being deleted to make room for a new number.

STEP 1 Press .

STEP 2 Touch  on the "Information" screen.



STEP 3 Touch  on the "Telephone" screen.

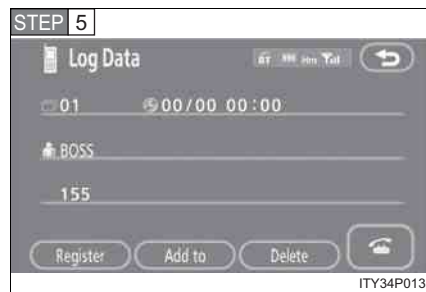

Choose the number to call from the list.

To choose a number from the incoming calls history, touch  and choose a number to call.



Touch  or press the  on the steering wheel.

3

Interior features

3-4. Using the hands-free system (for cellular phone)

Calling using speed dial

You can make a call using numbers registered from the phone book and call history. (→P. 289)

STEP 1 Press .

STEP 2 Touch  on the “Information” screen.

STEP 3 Touch  on the “Telephone” screen.



Choose the desired number to make a call.

To change the page, touch  or .

3-4. Using the hands-free system (for cellular phone)

Calling using voice recognition

Using voice recognition, you can call by name from the “Phone Book” screen, call by number from the “Telephone” screen, and send tones from the “Call” screen. (→P. 285)

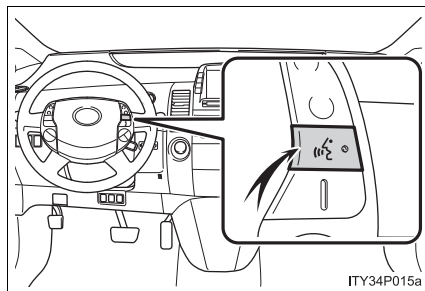

Talk switch

Calling by name from the “Phone Book” screen

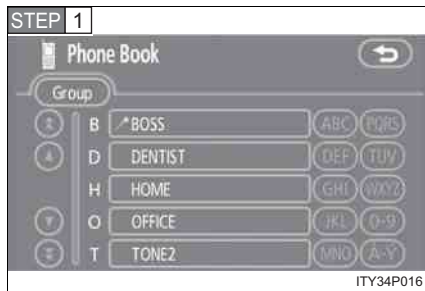

Press the talk switch.

STEP 2 Following the system guidance, wait until the beep and then say the desired name.

If there are multiple entries for the same name, “Next” will be displayed.

To select the next candidate, touch **Next** or say “Next candidate”.

STEP 3 Following the system guidance, press the talk switch.

STEP 4 Following the system guidance, wait until the beep and then say “Dial”.

3-4. Using the hands-free system (for cellular phone)

Calling by number from the “Telephone” screen

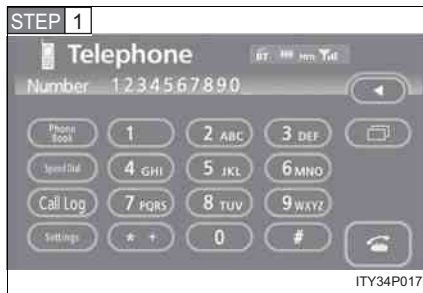

Press the talk switch.

STEP 2 Following the system guidance, wait until the beep and then say the desired number.

STEP 3 Following the system guidance, press the talk switch.

STEP 4 Following the system guidance, wait until the beep and then say “Dial”.

Sending tones from the “Call” screen



Press the talk switch.

STEP 2 Following the system guidance, wait until the beep and then say the desired number.

STEP 3 Following the system guidance, press the talk switch.

STEP 4 Following the system guidance, wait until the beep and then say “Yes”.

Calling using POI

You can make a call using a Point Of Interest. (→“Navigation System Owner’s Manual”)

3-4. Using the hands-free system (for cellular phone)

n **Made/Received call history list**

- 1 If you make a call to or receive a call from a number registered in the phone book, the name is displayed in the call history.
- 1 If you make multiple calls to the same number, only the last call made is displayed in the made calls history.
- 1  is displayed to the left of phone number for unanswered calls.
- 1 Calls where the number is unavailable, such as public telephones, are not stored in the call history.

n **When driving**



- 1 The functions “Dialing”, “Dialing from the phone book”, and “Dialing from history” are unavailable.
- 1 If you press the  on the steering wheel, the “Speed Dial” screen is displayed. At this time phone numbers will not be displayed. Choose from the names displayed to make a call.

n **International calls**

You may not be able to make international calls, depending on the mobile phone in use.

n **To display the voice recognition command list**



STEP 1 After pressing the talk switch, touch . If the “Operating Guide” screen is displaying, touch .

STEP 2 Touch .

3

Interior features

3-4. Using the hands-free system (for cellular phone)

n To display the voice recognition operating guide

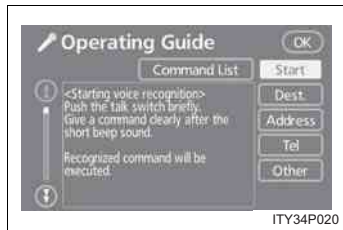

STEP 1 After pressing the talk switch, touch **Help**. If the "Command List" screen is displaying, touch **Operating Guide**.

STEP 2 Touch **Tel**.

n To cancel voice recognition

- 1 Press and hold the talk switch.
- 1 Press  on the steering wheel.
- 1 Say "Cancel".
- 1 Touch **Cancel**. (excluding command verification)



n When using voice recognition

Use correct commands and speak clearly, otherwise the system may not correctly recognize the command. Wind or other noises may also cause the system not to recognize the desired command.

Receiving a call

When a call is received, the following screen is displayed together with a sound.





Touch  or press the  on the steering wheel.

3-4. Using the hands-free system (for cellular phone)

n To refuse a call

Touch and hold .

n To adjust the received call volume

Touch the  or . You can also adjust the volume using the steering switches.

n International calls



Received international calls may not be displayed correctly, depending on the mobile phone in use.

Speaking on the phone

The following screen is displayed when speaking on the phone.



n To adjust the received call volume

Touch the  or . You can also adjust the volume using the steering switches.

n To prevent the other party from hearing your voice

Touch the .

3-4. Using the hands-free system (for cellular phone)



n Inputting a key

When using phone services such as an answering service or a bank, you can store phone numbers and code numbers in the phone book.

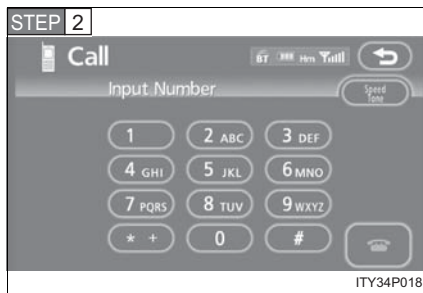
STEP 1 Touch  .



Input the number.

If repeated tone symbols* are stored in the phone book,  and  are displayed on the right side of the screen.

*:Repeated tone symbols are symbols or numbers displayed as p or w, that come after the phone number.
(e.g. 056133p0123w#1)

STEP 3 Confirm the number displayed on screen, and touch  .

If you touch  , operation is completed without making a call.

n To transfer a call

Touch  .

n To hang up

Touch  or press the  on the steering wheel.

3-4. Using the hands-free system (for cellular phone)

n **Transferring calls**

- l It is not possible to transfer from hands-free to the mobile phone while driving.
- l If you transfer from the mobile phone to hands-free, the hands-free screen will be displayed, and you can operate the system using the screen.
- l Transfer method and operation may vary according to the mobile phone used.
- l For operation of the mobile phone in use, see the phone's manual.

n **To send a tone by speed tone**

Touch  then touch . Choose the desired number from the speed tone list displayed.

n **While driving**

Key input is unavailable.

3



Interior features

3-4. Using the hands-free system (for cellular phone) Setting the hands-free system (for cellular phone)

You can speed dial, register in and edit the phone book, and set the Bluetooth® phone.

► Settings screen



To display the screen shown above, press , touch  on the "Information" screen, then touch  on the "Telephone" screen.

3-4. Using the hands-free system (for cellular phone)

Registering/Deleting a speed dial item

Registering a speed dial item

You can register a number from the phone book or the call history. Up to 17 entries may be stored.

STEP 1 Press .

STEP 2 Touch  on the "Information" screen.

STEP 3 Touch the  switch on the "Telephone" screen.

STEP 4 Touch  on the "Settings" screen.

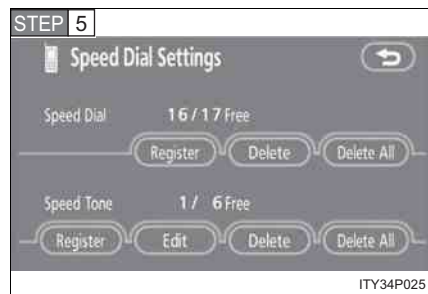

Touch  in the "Speed Dial" section of the "Speed Dial Settings" screen.

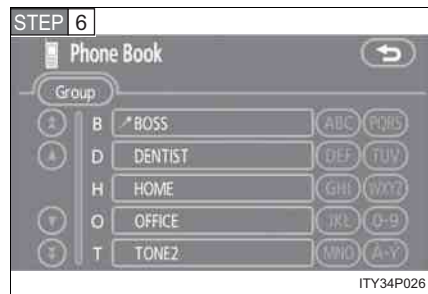

Select the data to be registered.

3

Interior features

3-4. Using the hands-free system (for cellular phone)

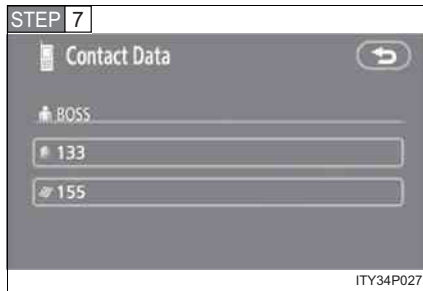

Select the number to be registered.

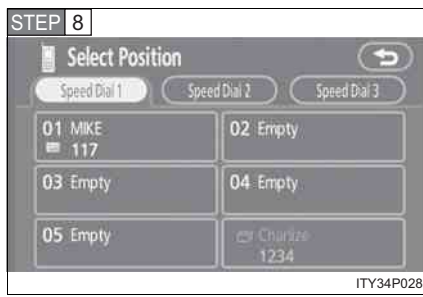

Press the desired switch.

The last dialed number will be registered in position 6.

n Deleting a speed dial item

STEP 1 Press  .

STEP 2 Touch  on the "Information" screen.

STEP 3 Touch the  switch on the "Telephone" screen.

STEP 4 Touch  on the "Settings" screen.

STEP 5 Touch  in the "Speed Dial" section of the "Speed Dial Settings" screen.

STEP 6 Select the data to be deleted.

STEP 7 A confirmation message will be displayed. If everything is correct, touch  .

3-4. Using the hands-free system (for cellular phone)

n To delete all speed dial items

Follow the steps for “Deleting a speed dial item” to “STEP 5”. In the “Speed Dial” section of the “Speed Dial Settings” screen, touch the **Delete All** . A confirmation message will be displayed. If everything is correct, touch **Yes** .

Registering/Editing/Deleting a Speed Tone

n Registering a speed tone

You can register up to 6 items.

STEP 1 Press  .

STEP 2 Touch  on the “Information” screen.

STEP 3 Touch **Settings** on the “Telephone” screen.

STEP 4 Touch  on the “Settings” screen.

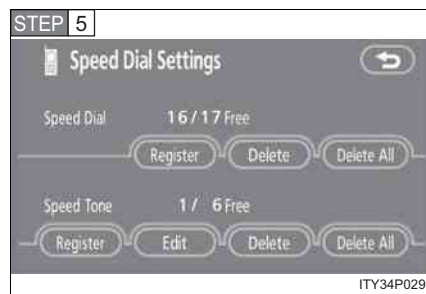

Touch **Register** in the “Speed Tone” section.

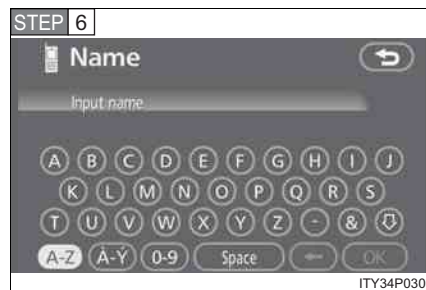

Input the desired name and touch **OK** .

A-Z , **A-Y** : Letter input

0-9 : Number/Symbol input

Space : Space

← : Backspace

3-4. Using the hands-free system (for cellular phone)

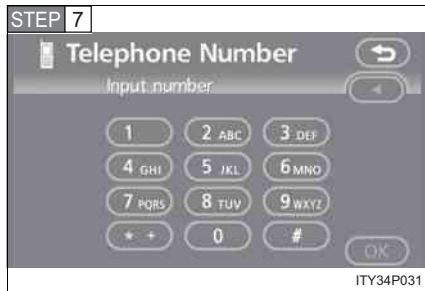

Input the number and touch

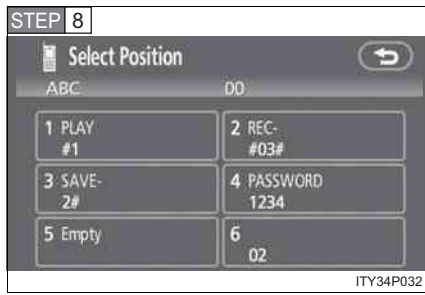



Touch the desired switch.

Editing a speed tone

STEP 1 Press  .

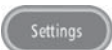
STEP 2 Touch  on the “Information” screen.

STEP 3 Touch  on the “Telephone” screen.

STEP 4 Touch  on the “Settings” screen.

STEP 5 Touch  in the “Speed Tone” section of the “Speed Dial Settings” screen.

3-4. Using the hands-free system (for cellular phone)

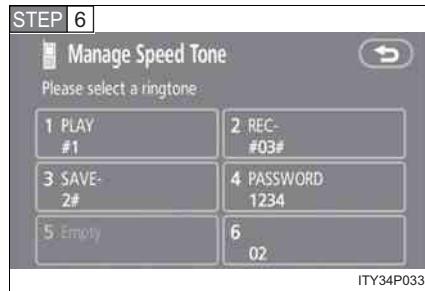

Touch the switch to be edited.

STEP 7 Input the name and touch  .

STEP 8 Input the number and touch  .

n Deleting a speed tone

STEP 1 Press  .

STEP 2 Touch  on the “Information” screen.

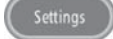
STEP 3 Touch  on the “Telephone” screen.



STEP 4 Touch  on the “Settings” screen.

STEP 5 Touch  in the “Speed Tone” section of the “Speed Dial Settings” screen.

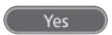
STEP 6 Choose the data to delete.

STEP 7 A confirmation message will be displayed. If everything is correct, touch  .

n To delete all speed tone data

Follow the steps “Deleting a speed tone” to “STEP 5”. In the “Speed Tone” section, touch  . A confirmation message will be displayed. If everything is correct, touch  .

3-4. Using the hands-free system (for cellular phone)

Setting the volume



STEP 1 Press  .

STEP 2 Touch  on the "Information" screen.

STEP 3 Touch  on the "Telephone" screen.

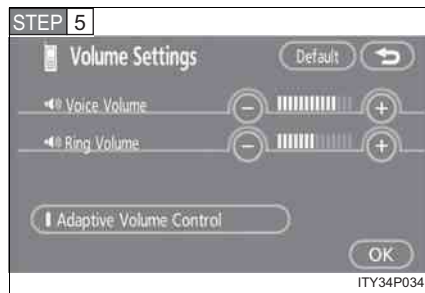
STEP 4 Touch  on the "Settings" screen.



Touch  or  to lower or raise the volume.

Voice Volume: Change the speaker volume

Ring Volume: Change the ring volume



n Adaptive Volume Control

When traveling at 50 mph (80 km/h) or over, the system automatically raises the volume one level.

If the vehicle's speed drops to 43 mph (70 km/h), the volume will return to its original level.

You can turn this function ON/OFF by touching  .

n To return to the default volume settings

Touch  , then  .

3-4. Using the hands-free system (for cellular phone)

Changing the screen settings

The following settings can be changed.

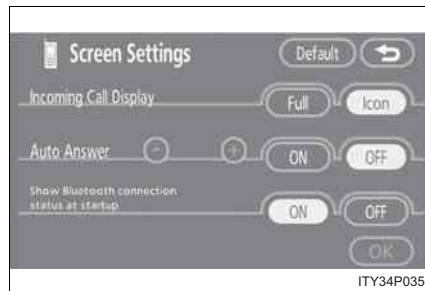

“Incoming Call Display”

The incoming call screen settings can be changed.

“Auto Answer”

When a call is received, the system automatically switches to the talking screen after the set period of time, meaning you can speak without pressing anything.

“Show Bluetooth* connection status at startup”

You can set the system to show the status confirmation display when connecting.

*:Bluetooth is a registered trademark of Bluetooth SIG, Inc.

3

Interior features

3-4. Using the hands-free system (for cellular phone)

n“Incoming Call Display” settings

STEP 1 Press  .

STEP 2 Touch  on the “Information” screen.

STEP 3 Touch  on the “Telephone” screen.

STEP 4 Touch  on the “Settings” screen.

STEP 5 Select the desired switch.

 :The hands-free screen is displayed when a call is received, and you can operate the system from that screen.

 :A message is displayed at the top of the screen, and you can only operate the system with the steering switches.

n“Auto Answer” settings

STEP 1 Press  .

STEP 2 Touch  on the “Information” screen.

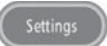
STEP 3 Touch  on the “Telephone” screen.

STEP 4 Touch  on the “Settings” screen.

STEP 5 Touch  in the “Auto Answer” section of the “Screen Settings” screen.

STEP 6 Set the wait time using  and  . (1 - 60 seconds)

3-4. Using the hands-free system (for cellular phone)



n “Show Bluetooth* connection status at startup” settings

STEP 1 Press  .

STEP 2 Touch  on the “Information” screen.

STEP 3 Touch  on the “Telephone” screen.



STEP 4 Touch  on the “Settings” screen.

STEP 5 Touch  /  in the “Show Bluetooth* connection status at startup” section of the “Screen Settings” screen.

*:Bluetooth is a registered trademark of Bluetooth SIG. Inc.

3

n To set the screen settings to default

Touch  , then touch  .

Interior features

3-4. Using the hands-free system (for cellular phone)

Phone book settings

Up to 1000 names, 2 items per name, can be registered.

nTransferring mobile phone data

STEP 1 Press  .

STEP 2 Touch  on the “Information” screen.

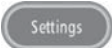
STEP 3 Touch  on the “Telephone” screen.

STEP 4 Touch  on the “Settings” screen.

STEP 5 Touch  .

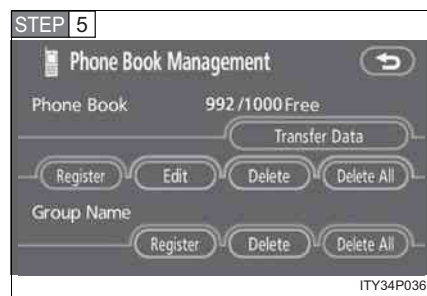

Touch  .



Select the group to transfer to.

3-4. Using the hands-free system (for cellular phone)

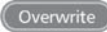

To overwrite data, touch .

To add to existing data, touch .



Transfer will begin. If you wish to cancel the transfer before finished, touch .

Transfer is complete when "Transfer completed" is displayed.

If "Transfer failed" is displayed, restart the process from the beginning.

3

Interior features

■ Registering by input

STEP 1 Press .

STEP 2 Touch  on the "Information" screen.

STEP 3 Touch  on the "Telephone" screen.

STEP 4 Touch  on the "Settings" screen.

3-4. Using the hands-free system (for cellular phone)

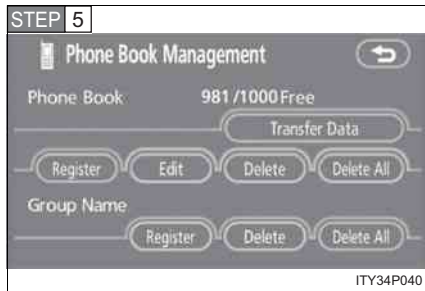

Touch the **Register** in the “Phone Book” section.

3-4. Using the hands-free system (for cellular phone)

STEP 6 Choose the switch to register.

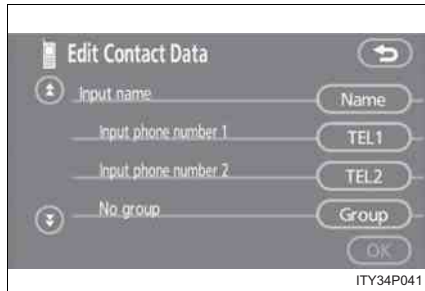

Name : Input the name on the "Name" screen.

TEL1 , **TEL2** : Input the number(s) on the "Telephone Number" screen. When you touch **OK** , the "Select Icon" screen will appear.

Choose the desired icon.

- **Mobile phone1**
- **Home**
- **Other**
- **Mobile phone2**
- **Work**



Interior features

Group : Select the desired group from the "Select Group" screen. (No Group, 01 - 09)

Voice Rec : Select the desired phone number and touch **REC** to record a voice tag.

To play the voice tag, touch **PLAY** . To delete the voice tag, touch

Delete .

STEP 7 Once input is complete, touch **OK** .

3-4. Using the hands-free system (for cellular phone)

n Add history data to a registered entry

STEP 1 Press .

STEP 2 Touch  on the “Information” screen.

STEP 3 Touch  on the “Telephone” screen.

STEP 4 Choose the desired number from the list.

To choose from the received call history, touch  then select the desired number.

STEP 5 Touch .



STEP 6 Choose the phone book entry to be added to.

STEP 7 Check the data to be added, then touch .

3-4. Using the hands-free system (for cellular phone)

n Editing phone book data

STEP 1 Press  .

STEP 2 Touch  on the “Information” screen.

STEP 3 Touch  on the “Telephone” screen.

STEP 4 Touch  on the “Settings” screen.

STEP 5 Touch  in the “Phone Book” section of the “Phone Book Management” screen.

STEP 6 Choose the data to edit.

STEP 7 Choose the switch to edit.

STEP 8 After editing, press  .

n Deleting phone book data

STEP 1 Press  .

STEP 2 Touch  on the “Information” screen.

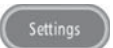
STEP 3 Touch  on the “Telephone” screen.

STEP 4 Touch  on the “Settings” screen.



STEP 5 Touch  in the “Phone Book” section of the “Phone Book Management” screen.

STEP 6 Select the data to delete.

STEP 7 A confirmation message will be displayed. If everything is correct, touch  .

3-4. Using the hands-free system (for cellular phone)

n To delete all data

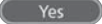
Follow the steps “Deleting phone book data” to “STEP 5”. In the “Phone Book” section of the “Phone Book Management” screen, touch . To delete all data within a group, touch , then select the group to delete. To delete all contact data, touch . Check that everything is correct, then touch .

n Registering/Editing/Deleting from the phone book

You can register data in the phone book, edit registered data, and delete items.



STEP 1 Press .

STEP 2 Touch  on the “Information” screen.

STEP 3 Touch  on the “Telephone” screen.

STEP 4 To register data, touch  on the “Phone Book” screen.

To delete all data, touch .

To delete or edit specific data, select the data to delete/edit, then touch  to delete, or  to edit.

n The phone book

The method for transferring phone book data from the phone to the system varies with phone model. See the phone’s manual.

3-4. Using the hands-free system (for cellular phone)

Changing the phone book group name settings

■ Registering a group name

STEP 1 Press .

STEP 2 Touch  on the "Information" screen.

STEP 3 Touch  on the "Telephone" screen.

STEP 4 Touch  on the "Settings" screen.

STEP 5 Touch the  switch in the "Group Name" section of the "Phone Book Management" screen.

STEP 6 Select the group to register ("01" - "19").

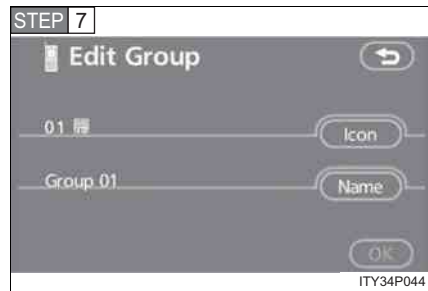

Select the switch to be edited.

Icon :The below screen will be displayed. Select the desired icon.

Name :Input the name on the "Name" screen.

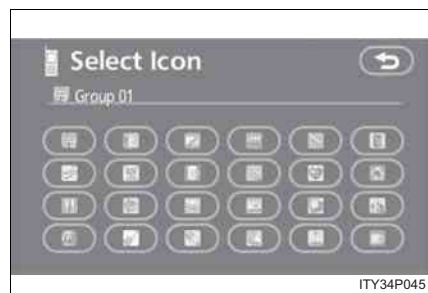

STEP 8 Once editing is complete, touch .

3

Interior features

3-4. Using the hands-free system (for cellular phone)

n Deleting a group name

STEP 1 Press  .

STEP 2 Touch  on the “Information” screen.

STEP 3 Touch  on the “Telephone” screen.

STEP 4 Touch  on the “Settings” screen.



STEP 5 Touch the  switch in the “Group Name” section of the “Phone Book Management” screen.

STEP 6 Select the group name to delete.

STEP 7 A confirmation message will be displayed. If everything is correct, touch  .

n To delete all data

Follow the steps “Deleting phone book data” procedure to “STEP 5”. In the “Phone Book” section of the “Phone Book Management” screen, touch

 . A confirmation message will be displayed. If everything is correct, touch  .

3-4. Using the hands-free system (for cellular phone)

Deleting the history

STEP 1 Press  .

STEP 2 Touch  on the “Information” screen.

STEP 3 Touch  on the “Telephone” screen.

STEP 4 Select the data to delete from the list.

To delete data from the received calls history, touch  , then select the data to delete.



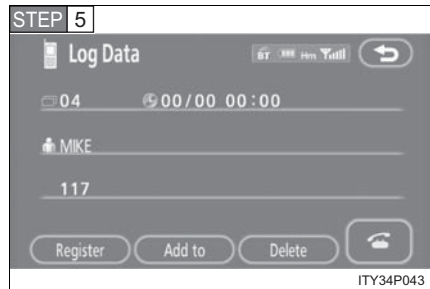

STEP 5 Touch  .



The screenshot shows a 'Log Data' screen with a list of call records. The first record shows '04' and '00/00 00:00'. Below it, the name 'MIKE' is listed with the number '117'. At the bottom of the screen, there are buttons for 'Register', 'Add to', 'Delete', and a telephone icon. The text 'ITY34P043' is visible at the bottom right of the screen.

STEP 6 Check that everything is correct, then touch  .

n To delete all data

Follow the steps “Deleting a group name” to “STEP 4”. Touch  on the “Outgoing Calls” screen. To delete all received call history data, touch  , then touch  . Check that everything is correct, then touch  .

3-4. Using the hands-free system (for cellular phone)

Changing the security settings

You can disable certain hands-free system functions. Use the security settings when you do not wish other people to see the registered data, for example when having the vehicle valet parked at a hotel.

To enable or disable security, the security code (4 digits) is required. The default code is "0000". Be sure to change the security code before use.

Changing the security code

STEP 1 Press .

STEP 2 Touch  on the "Information" screen.

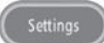
STEP 3 Touch  on the "Telephone" screen.

STEP 4 Touch  on the "Settings" screen.

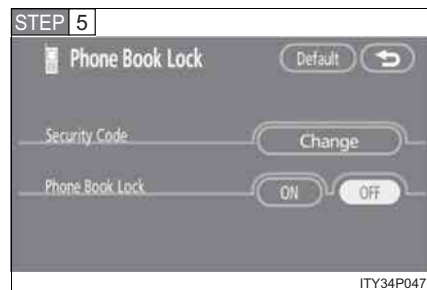

Touch  in the "Security Code" section.

3-4. Using the hands-free system (for cellular phone)

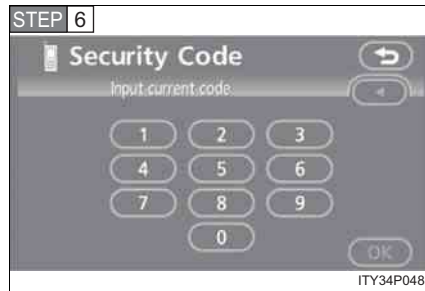

Input the current security code, and touch **OK** .

STEP 7 Input the new security code, and touch **OK** .

STEP 8 A confirmation message will appear. If everything is correct, touch **Yes** .

Enabling security

STEP 1 Press  .

STEP 2 Touch  on the “Information” screen.

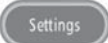
STEP 3 Touch  on the “Telephone” screen.

STEP 4 Touch  on the “Settings” screen.

STEP 5 Touch  in the “Phone Book Lock” section of the “Phone Book Lock” screen.

STEP 6 Input the security code, and touch  .

3

Interior features

3-4. Using the hands-free system (for cellular phone)

n Setting the security code to default

STEP 1 Press  .

STEP 2 Touch  on the “Information” screen.

STEP 3 Touch  ; on the “Telephone” screen.

STEP 4 Touch  on the “Settings” screen.

STEP 5 Touch  on the “Phone Book Lock” screen.

STEP 6 Input the security code on the “Security Code” screen, then touch  .

STEP 7 A confirmation message will appear. If everything is correct, touch  .

n If the “Phone Book Lock” is set

If the security code is input and the “Phone Book Lock” set, the following functions are locked.

- l Display of the phone book screen and transferring, registering, editing, deleting the phone book data.
- l Display of speed dial screen, registering, deleting the speed dial and speed dialing.
- l Display of the other party’s name for calls being received or made.
- l Displayed of dialed numbers screen and received calls screen, deleting dialed numbers and received numbers.
- l Display of phone information screen.
- l Changing the security code.

The speed dial screen is not displayed while driving.

3-4. Using the hands-free system (for cellular phone)

n When changing the security code

- l Be sure to choose a number difficult for strangers to guess.
- l Do not forget the security code. Even your Toyota dealer will be unable to disable the security. If you do forget the code, initialize all personal data. (→P. 190)

Setting a Bluetooth® phone

n Selecting a Bluetooth® phone

If multiple Bluetooth® phones are registered, follow the below procedure to select the Bluetooth® phone to be used. You may only use one phone at a time.

STEP 1 Press .

STEP 2 Touch  on the "Information" screen.

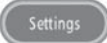
STEP 3 Touch  on the "Telephone" screen.

STEP 4 Touch .

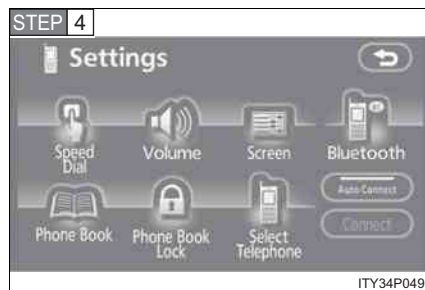

3

Interior features

3-4. Using the hands-free system (for cellular phone)

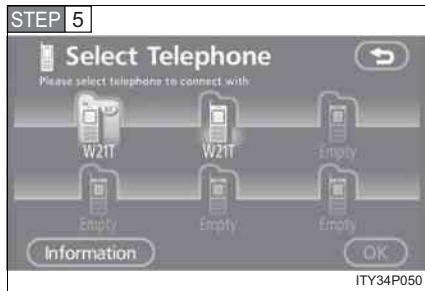

Select the phone to be use, then touch **OK** .

If no phones are registered, "Empty" will be displayed.

If "Bluetooth*" connection successful" is displayed, registration was successful.

If another Bluetooth® phone is already connected, a confirmation message is displayed. Touch **Yes** or **No** .

*.Bluetooth is a registered trademark of Bluetooth SIG. Inc.

nDisplaying Bluetooth® information

You can check the device address and device name.

STEP 1 Press  .

STEP 2 Touch  on the "Information" screen.

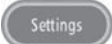
STEP 3 Touch  on the "Telephone" screen.

STEP 4 Touch  on the "Settings" screen.

STEP 5 On the "Select Telephone" screen, select the desired phone and touch  .

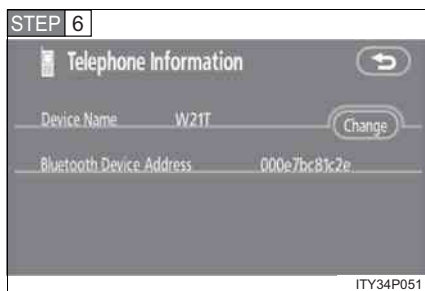

To change the device name, touch  in the "Device Name" section, and input the name on the "Name" screen (max. 20 characters).

3-4. Using the hands-free system (for cellular phone)

To change the Bluetooth® settings

You can change the device name and passkey.

STEP 1 Press  .

STEP 2 Touch  on the “Information” screen.

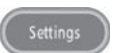
STEP 3 Touch  on the “Telephone” screen.

STEP 4 Touch  on the “Settings” screen.

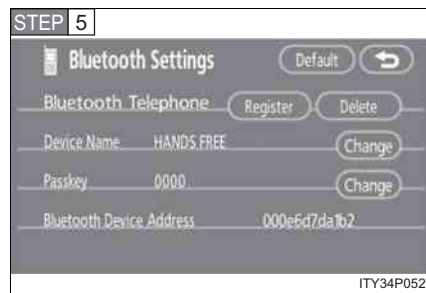

To change the device name, touch  in the “Device Name” section, and input the name on the “Name” screen (max. 20 characters).

To change the passkey, touch  in the “Passkey” section, and input 4 - 8 digits on the “Passkey” screen.

3

Interior features

To setting the Bluetooth® settings to default

STEP 1 Press  .

STEP 2 Touch  on the “Information” screen.

STEP 3 Touch  on the “Telephone” screen.

STEP 4 Touch  on the “Settings” screen.

STEP 5 Touch  on the “Bluetooth* Settings” screen.

STEP 6 A confirmation message is displayed. If everything is correct, touch  .

*:Bluetooth is a registered trademark of Bluetooth SIG. Inc.

3-4. Using the hands-free system (for cellular phone)

To delete the Bluetooth® settings

STEP 1 Press  .

STEP 2 Touch  on the “Information” screen.



STEP 3 Touch  on the “Telephone” screen.

STEP 4 Touch  on the “Settings” screen.

STEP 5 Touch  in the “Bluetooth* Telephone” section of the “Bluetooth* Settings” screen.

STEP 6 On the “Delete Telephone” screen, select the phone to delete.

To check the device address, touch  .

STEP 7 If you touch  , a confirmation message is displayed. If everything is correct, touch  .

*:Bluetooth is a registered trademark of Bluetooth SIG. Inc.

3-5. Using the interior lights

Interior lights list

Illuminated entry system: The various lights automatically turn on/off according to the presence of the electronic key, whether the doors are locked/unlocked, whether the doors are open/closed, and the “POWER” switch mode.

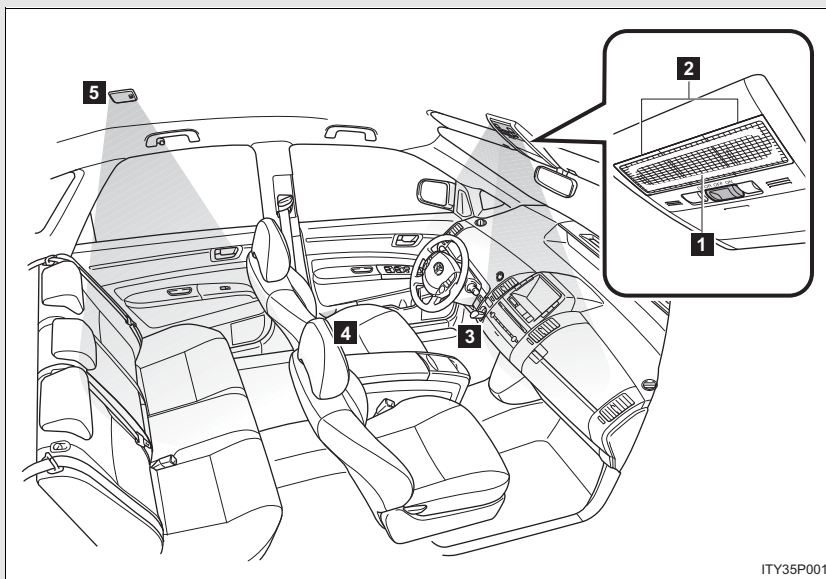

- 1** Front interior light (→P. 317)
- 2** Front personal lights (→P. 317)
- 3** Key slot lights
- 4** Front door courtesy lights
- 5** Rear interior light (→P. 317)

3

Interior features

3-5. Using the interior lights

■ **To prevent 12 volt battery discharge**

If the interior lights and personal lights ON when the door is not fully closed or the interior light switch in "DOOR" position, the lights will go off automatically after 20 minutes.

■ **Customization that can be configured at Toyota dealer**

Setting (e.g. The time elapsed before lights turn off) can be changed.
(Customizable features →P. 486)

3-5. Using the interior lights

Interior lights

► Front

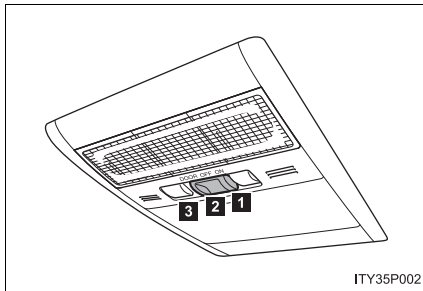

- 1 "ON"
- 2 "OFF"
- 3 "DOOR"

The interior lights are turned on/off by the illuminated entry system.

► Rear

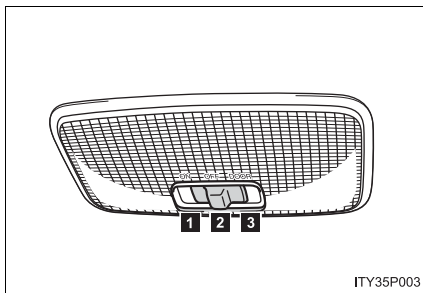

- 1 "ON"
- 2 "OFF"
- 3 "DOOR"

The interior lights are turned on/off by the illuminated entry system.

3

Interior features

Personal light

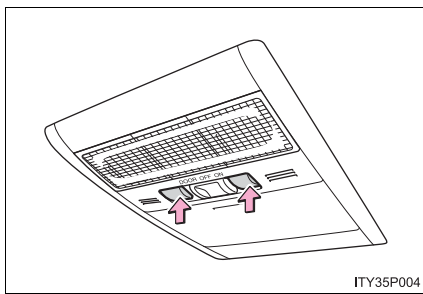

ON/OFF

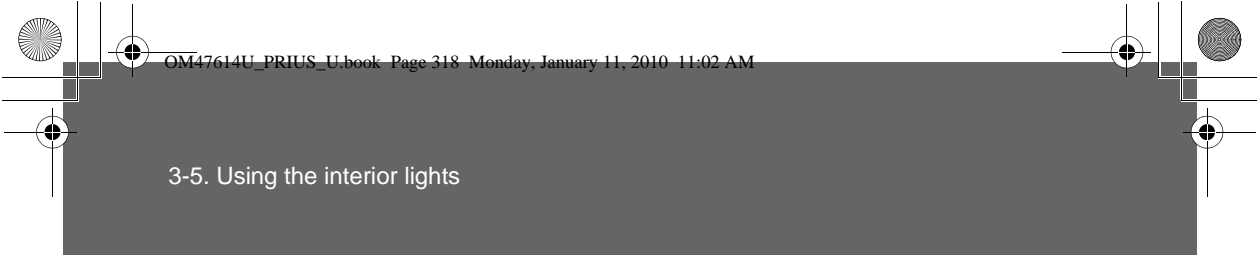

3-5. Using the interior lights

n **Customization that can be configured at Toyota dealer.**
Settings can be changed. (Customizable features →P. 486)

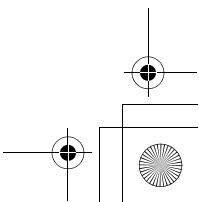
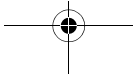
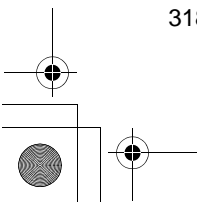
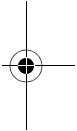
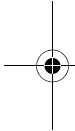

3-6. Using the storage features

List of storage features

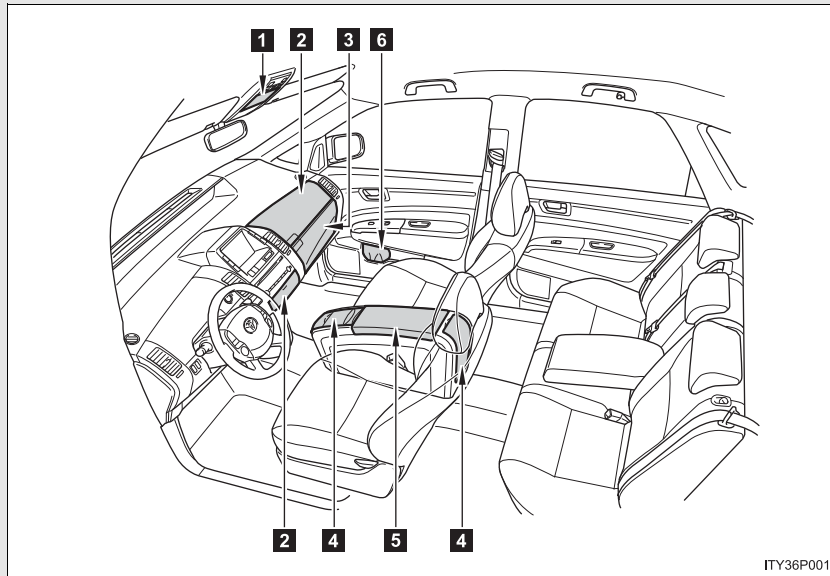

- 1** Overhead console
- 2** Auxiliary box
- 3** Glove box
- 4** Cup holders
- 5** Console box
- 6** Bottle holder

3

Interior features

3-6. Using the storage features

Glove box

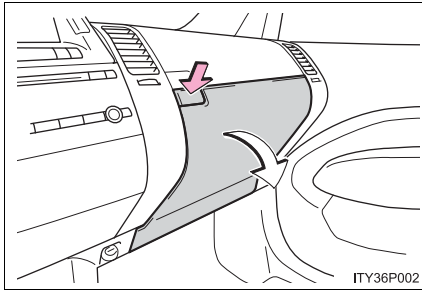

Push the button.

n Glove box light

The glove box light turns on when the headlight switch is on.

⚠ CAUTION

n While driving

Keep the glove box closed.
Injuries may result in the event of an accident or sudden braking.

Console box

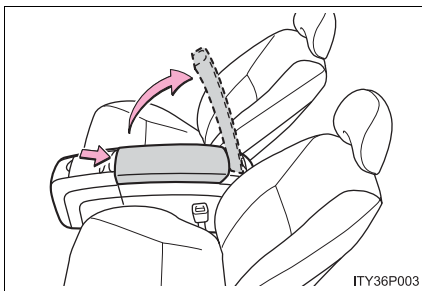

Lift the lid while pulling the lever.

3-6. Using the storage features

⚠ CAUTION

n While driving

Keep the console box closed.
Injuries may result in the event of an accident or sudden braking.

Overhead console

The overhead console is useful for temporarily storing sunglasses and similar small items.

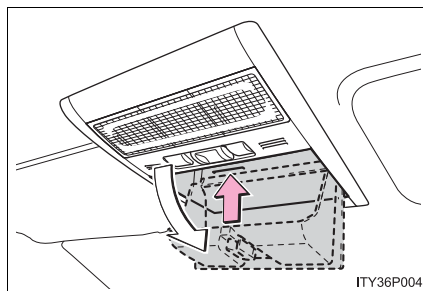

Push the lid.

3

Interior features

⚠ CAUTION

n Items that should not be left in the overhead console

Do not leave glasses or lighters in the console.
If the interior of the vehicle becomes hot, lighters may explode and glasses may warp or become cracked.

n While driving

Do not leave the overhead console open. Items may fall out and cause injury.

3-6. Using the storage features

Cup holders

► Front

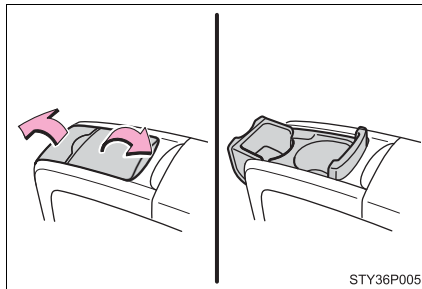

To open, press down and release the front cup holder lid.

► Rear

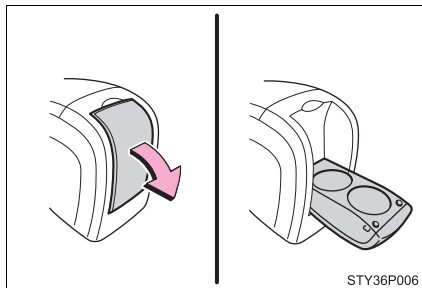

To open, press in and release the rear cup holder on the armrest.

⚠ CAUTION

n Items unsuitable for the cup holder

Do not place anything other than cups or aluminum cans in the cup holders. Other items may be thrown out of the holders in the event of an accident or sudden braking and cause injury. If possible, cover hot drinks to prevent burns.

n When not in use

Keep the cup holders closed. Injuries may result in the event of an accident or sudden braking.

3-6. Using the storage features

Bottle holders

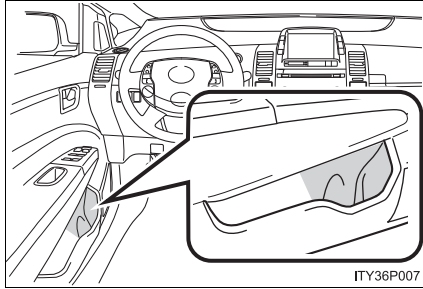

⚠ CAUTION

n Items unsuitable for the bottle holder

Do not place anything other than pet bottles in the bottle holders. Other items may be thrown out of the holders in the event of an accident or sudden braking and cause injury.

3

Interior features

3-6. Using the storage features

Auxiliary box

► Type A

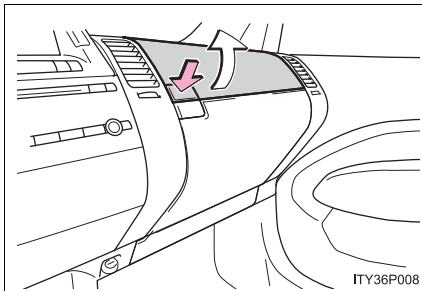

Push the button.

► Type B

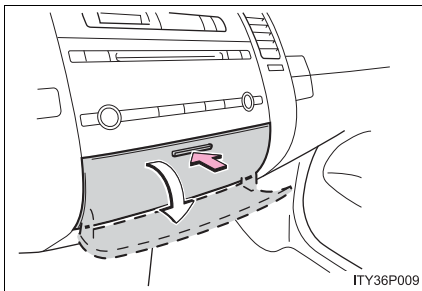

Push the lid.

► Type C

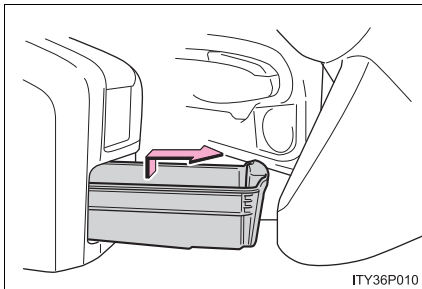

Lift the tray and pull it forward.

3-6. Using the storage features

n Removing the separate tray (type A)

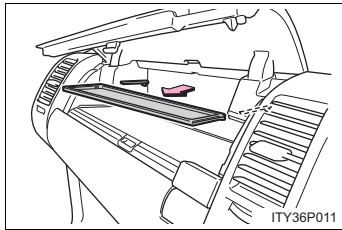

Pull up.

! CAUTION

n While driving

Keep the auxiliary boxes closed. Injuries may result in the event of an accident or sudden braking.

3

Interior features

3-7. Other interior features

Sun visors

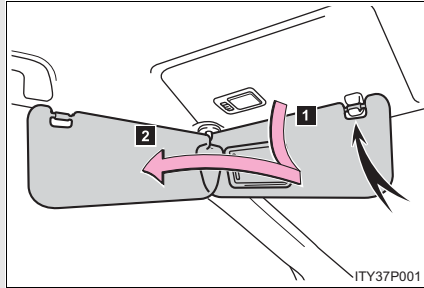

- 1** Forward position: Flip down.
- 2** Side position: Flip down, unhook, and swing to the side.

3-7. Other interior features

Vanity mirror

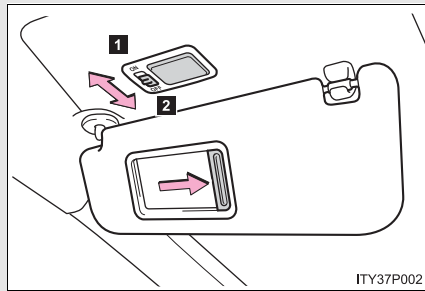

Slide the cover.

- 1** ON: The light turns on when the cover is opened.
- 2** OFF: Turns the light off.

3

Interior features

3-7. Other interior features

Clock

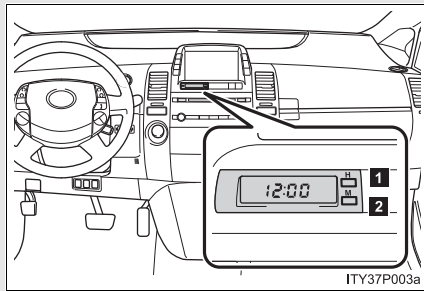

- 1** Adjusts the hour
- 2** Adjusts the minutes.

n The clock is displayed when

The "POWER" switch is in ACCESSORY or ON mode.

n When the 12 volt battery is disconnected

The time display will automatically be set to 1:00.

n When the instrument panel lights are turned on the brightness of the time indicator will be reduced.

3-7. Other interior features

Power outlet

The power outlet can be used for 12V accessories that run on less than 10A.

► Instrument panel

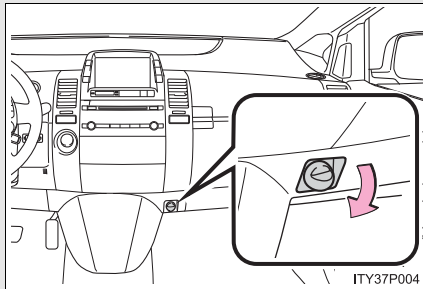

► Rear console box

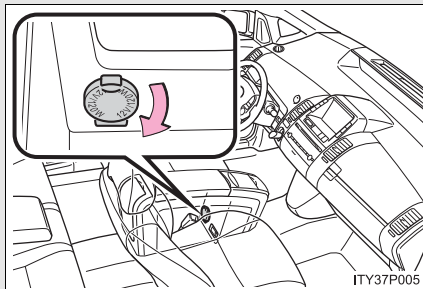

3

Interior features

- n The power outlet can be used when
The "POWER" switch is in ACCESSORY or ON mode.

3-7. Other interior features

 **NOTICE**

n To avoid damaging the power outlet

Close the power outlet lid when not in use.
Foreign objects or liquids that enter the power outlet may cause a short circuit.

n To prevent the fuse from being blown

Do not use an accessory that uses more than 12V/10A.

n To prevent 12 volt battery discharge

Do not use the power outlet longer than necessary when the hybrid system is not operating.

3-7. Other interior features

Armrest

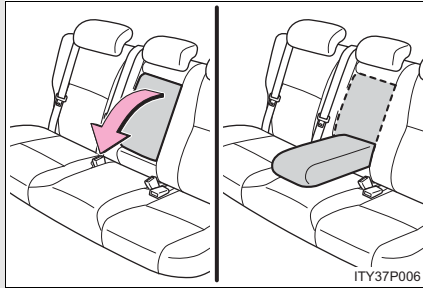

Pull the armrest down for use.

 **NOTICE**

- n To prevent damage to the armrest**
Do not place too much strain on the armrest.

3

Interior features

3-7. Other interior features

Floor mats

Securely place a mat that matches the size of the space on the carpet.

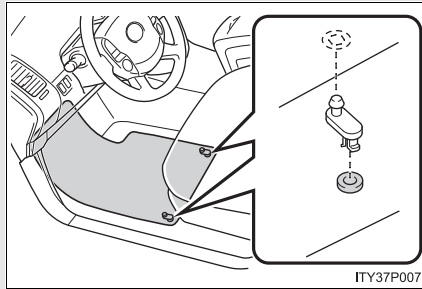

Secure the floor mat using the hooks provided.

⚠ CAUTION

n When inserting the floor mat

Observe the following precautions.

Failure to do so may result in the floor mat slipping and interfering with the movement of the pedals during driving, resulting in an accident.

- I** Make sure the floor mat is properly placed on the vehicle carpet and the correct side faces upward.
- I** Do not place floor mats on top of existing mats.

3-7. Other interior features

Luggage compartment features

n Cargo hooks

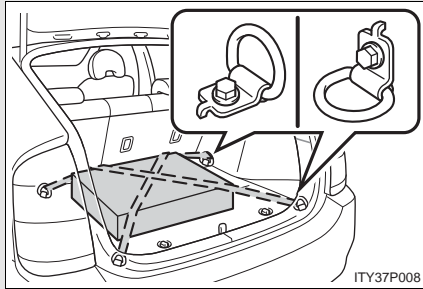

Cargo hooks are provided for securing loose items.

n Auxiliary box

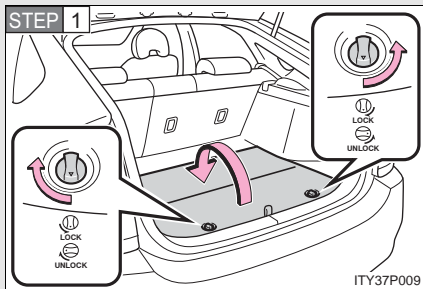

Turn the knob to the "UNLOCK" position and open the lid.

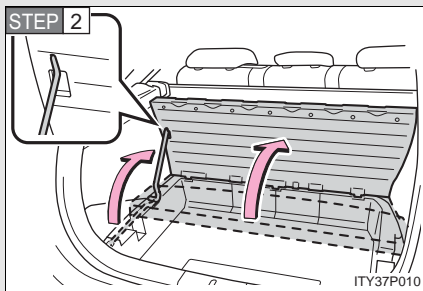

Hold the lid open by inserting the support rod into the slot.

3-7. Other interior features

n Luggage cover (If equipped)

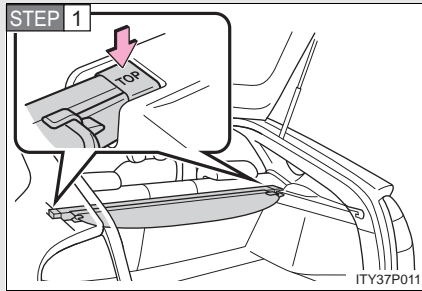

Adjust the cover so that "TOP" is facing upwards.

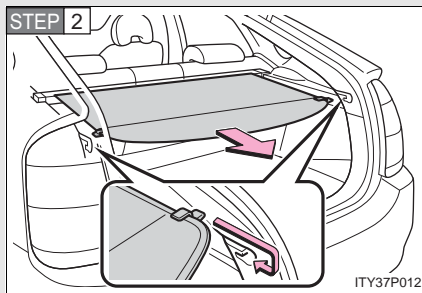

Pull out the luggage cover and secure it to the hook brackets.

n Removing the luggage cover

The luggage cover can be removed by following the procedure below.

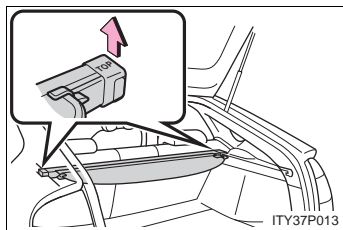

Lift it up.

3-7. Other interior features

n Stowing the luggage cover

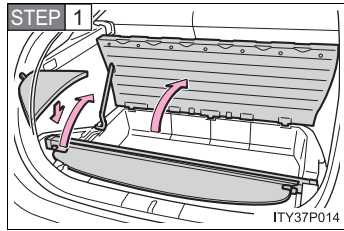

Remove the side deck boards and open the auxiliary box.

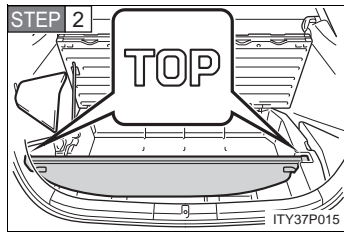

Adjust the cover so that "TOP" is facing up.

3

Interior features

CAUTION

n While driving

To avoid injury, always return the cargo hooks to their positions when they are not in use.

3-7. Other interior features

Garage door opener

The garage door opener can be programmed to operate garage doors, gates, entry doors, door locks, home lighting systems, and security systems, and other devices.

The garage door opener (HomeLink® Universal Transceiver) is manufactured under license from HomeLink®.

Programming the HomeLink® (for U.S.A. owners)

The HomeLink® compatible transceiver in your vehicle has 3 buttons which can be programmed to operate 3 different devices. Refer to the programming method below appropriate for the device.

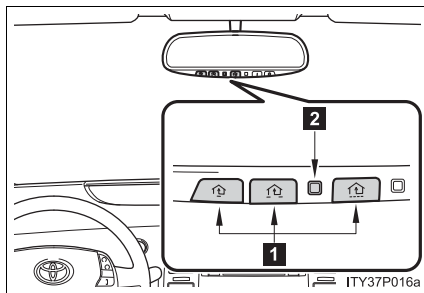

- 1 Buttons
- 2 Indicator

1 Programming the HomeLink®

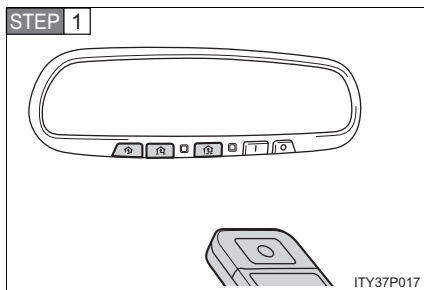

Point the remote control for the device 1 to 3 in. (25 to 75 mm) from the HomeLink® control buttons.

Keep the indicator light on the HomeLink® in view while programming.

3-7. Other interior features

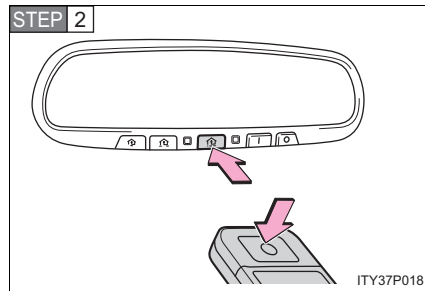

Press and hold down one of the buttons on the HomeLink[®] and the button on the transmitter. When the indicator light on the HomeLink[®] changes from a slow to a rapid flash after 20 seconds, you can release both buttons.

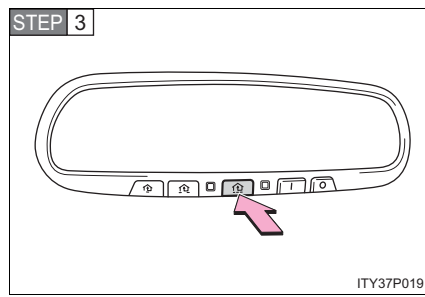

Test the operation of the HomeLink[®] by pressing the newly programmed button.

If programming a garage door opener, check to see if the garage door opens and closes. If the garage door does not operate, see if your garage transmitter is of the Rolling Code type. Press and hold the programmed HomeLink[®] button. The garage door has the rolling code feature if the indicator light (on the HomeLink[®]) flashes rapidly for 2 seconds and then remains lit. If your transmitter is the Rolling Code type, proceed to the heading "Programming a rolling code system".

STEP 4 Repeat the steps above to program another device for each of the remaining HomeLink[®] buttons.

3

Interior features

3-7. Other interior features

n Programming a Rolling Code system (for U.S.A. owners)

If your device is Rolling Code equipped, follow the steps under the heading “Programming the HomeLink®” before proceeding with the steps listed below.

STEP 1 Locate the training button on the ceiling mounted garage door opener motor. The exact location and color of the button may vary by brand of garage door opener.

Refer to the operation manual supplied with the garage door opener for the location of the training button.

STEP 2 Press the training button.

STEP 3 Press and release the vehicle’s programmed HomeLink® button twice. The garage door may open.

If the garage door opens, the programming process is complete. If the door does not open, press and release the button a third time. This third press and release will complete the programming process by opening the garage door.

The ceiling mounted garage door opener motor should now recognize the HomeLink® transceiver and operate the garage door.

STEP 4 Repeat the steps above to program another rolling code system for any of the remaining HomeLink® buttons.

n Programming an entry gate (for U.S.A. owners)/Programming all devices in the Canadian market

STEP 1 Place your transmitter 1 to 3 in. (25 to 75 mm) away from the surface of the HomeLink®.

Keep the indicator light on the HomeLink® in view while programming.

STEP 2 Press and hold the selected HomeLink® button.

STEP 3 Repeatedly press and release (cycle) the device’s remote control button for two seconds each until step 4 is complete.

STEP 4 When the indicator light on the HomeLink® compatible transceiver start to flashing rapidly, release the buttons.

STEP 5 Test the operation of the HomeLink[®] by pressing the newly programmed button. Check to see if the gate/device operates correctly.

STEP 6 Repeat the steps above to program another device for each of the remaining HomeLink[®] buttons.

n Programming other devices

To program other devices such as home security systems, home door locks or lighting, contact your authorized Toyota dealer for assistance.

n Reprogramming a button

The individual HomeLink[®] buttons cannot be erased but can be reprogrammed. To reprogram a button, follow the “Basic programming” instructions.

3

Interior features

Operating the HomeLink[®]

Press the appropriate HomeLink[®] button. The HomeLink[®] indicator light on the HomeLink[®] transceiver should turn on.

The HomeLink[®] continues to send a signal for up to 20 seconds as long as the button is pressed.

Erasing the entire HomeLink[®] memory (all three programs)

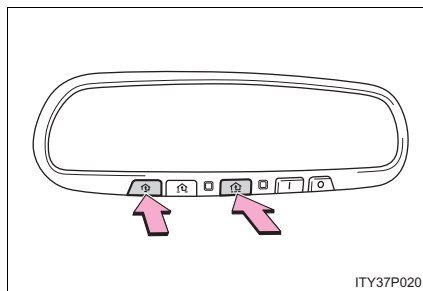

Press and hold down the 2 outside buttons for 20 seconds until the indicator light flashes.

If you sell your vehicle, be sure to erase the programs stored in the HomeLink[®] memory.

3-7. Other interior features

n **Before programming**

- l Install a new battery in the transmitter.
- l The battery side of the transmitter must be pointed away from the HomeLink®.

n **Certification for the garage door opener**

This device complies with Part 15 of the FCC Rules and with RSS-210 of the IC Rules.

Operation is subject to the following two conditions: (1) this device may not cause harmful interference, and (2) this device must accept any interference received, including interference that may cause undesired operation.

WARNING: This transmitter has been tested and complies with FCC and IC rules. Changes or modifications not expressly approved by the party responsible for compliance could void the user's authority to operate the device.

CAUTION

n **When programming a garage door or other remote control device**

The garage door or other devices may operate, so ensure people and objects are out of danger to prevent potential harm.

n **Conforming to federal safety standards**

Do not use the HomeLink® Compatible Transceiver with any garage door opener or device that lacks safety stop and reverse features as required by federal safety standards.

This includes any garage door that cannot detect an obstruction object. A door or device without these features increases the risk of death or serious injury.

4-1. Maintenance and care

Cleaning and protecting the vehicle's exterior

Perform the following to protect the vehicle and maintain it in prime condition.

- 1 Working from top to bottom, liberally apply water to the vehicle body, wheel wells and underside of the vehicle to remove any dirt and dust.

Wash the vehicle body using a sponge or soft cloth, such as a cham-ois.

- 1 For hard-to-remove marks, use car wash soap and rinse thoroughly with water.
- 1 Wipe away any water.
- 1 Wax the vehicle when the waterproof coating deteriorates.

If water does not bead on a clean surface, apply wax when the vehicle body is cool.

n Automatic car washes

- 1 Fold the mirrors back before washing the vehicle.
- 1 Brushes used in automatic car washes may scratch the vehicle surface and harm your vehicle's paint.

n High pressure automatic car washes

Do not allow the nozzles of the car wash to come within close proximity of the windows. Before entering an automatic car wash, check that the fuel filler door is closed.

n Aluminum wheels

Remove any dirt immediately by using a neutral detergent. Do not use hard brushes or abrasive cleaners. Do not use strong or harsh chemical cleaners. Use the same mild detergent and wax as used on the paint.

n Bumpers and side moldings

Do not scrub with abrasive cleaners.

4-1. Maintenance and care

n To prevent paint deterioration and corrosion on the body

l Wash the vehicle immediately in the following cases:

- After driving near the sea coast
- After driving on salted roads
- If you see coal tar or tree sap on the paint surface
- If you see dead insects or insect droppings on the paint
- After driving in an area contaminated with soot, oily smoke, mine dust, iron powder or chemical substances
- If the vehicle becomes heavily soiled in dust or mud
- If liquids such as benzine and gasoline are spilled on the paint surface

l If the paint is chipped or scratched, have it repaired immediately.

CAUTION

n Caution about the exhaust pipe

Exhaust gasses cause the exhaust pipe to become quite hot. When washing the vehicle, be careful not to touch the pipe until it has cooled sufficiently, as touching a hot exhaust pipe can cause burns.

NOTICE

n To protect your vehicle's painted surfaces

Do not use organic cleaners such as benzine or gasoline.

n Cleaning the exterior lights

- l Wash carefully. Do not use organic substances or scrub with a hard brush. This may damage the surfaces of the lights.
- l Do not apply wax on the surface of the lights. Wax may cause damage to the lenses.

4-1. Maintenance and care

Cleaning and protecting the vehicle's interior

The following procedures will help protect your vehicle's interior and keep it in top condition:

n Protecting the vehicle interior

Remove dirt and dust using a vacuum cleaner. Wipe dirty surfaces with a cloth dampened with lukewarm water.

n Cleaning the leather areas

1 Remove dirt and dust using a vacuum cleaner.

1 Wipe any excess dirt and dust with a soft cloth dampened with diluted detergent.

Use a diluted water solution of approximately 5% neutral wool detergent.

1 Wring out any excess water from the cloth and thoroughly wipe off all remaining traces of detergent.

1 Wipe the surface with a dry, soft cloth to remove any remaining moisture. Allow the leather to dry in shaded and ventilated area.

n Synthetic leather areas

1 Remove loose dirt using a vacuum cleaner.

1 Apply a mild soap solution to the synthetic leather using a sponge or soft cloth.

1 Allow the solution to soak in for a few minutes. Remove the dirt and wipe off the solution with a clean, damp cloth.

4-1. Maintenance and care

n Caring for leather areas

Toyota recommends cleaning the interior of the vehicle at least twice a year to maintain the quality of the vehicle's interior.

n Shampooing the carpets

There are several commercial foaming-type cleaners available. Use a sponge or brush to apply the foam. Rub in overlapping circles. Do not apply water. The excellent results are obtained by keeping the carpet as dry as possible.

n Seat belts

Clean with mild soap and lukewarm water using a cloth or sponge. Also check the belts periodically for excessive wear, fraying or cuts.

⚠ CAUTION

n Water in the vehicle

I Do not splash or spill liquid in the vehicle, such as on the floor, in the hybrid battery (traction battery) air vents, or in the luggage compartment. Doing so may cause the hybrid battery, electrical components etc. to malfunction or catch fire.

I Do not get any of the SRS components or wiring in the vehicle interior wet. (→P. 90)
Electrical malfunction may cause the airbags to deploy or not function properly, resulting in death or serious injury.

4

Maintenance and care

4-1. Maintenance and care

NOTICE

n Cleaning detergents

Do not use the following types of detergent, as they may discolor the vehicle interior or cause streaks or damage to painted surfaces.

- I** Non-seat portions: Organic substances such as benzine or gasoline, alkaline or acidic solutions, dye, or bleach.
- I** Seats: Acidic solutions, such as thinner, benzine, or alcohol.

n Preventing damage to leather surfaces

Observe the following precautions to avoid damage to and deterioration of leather surfaces.

- I** Remove any dust or dirt on leather surfaces immediately.
- I** Do not expose the vehicle to direct sunlight for extended periods of time. Park the vehicle in the shade, especially during summer.
- I** Do not place items made of vinyl, plastic, or that contain wax on the upholstery, as they may stick to the leather surface if the vehicle interior heats up significantly.

n Water on the floor

Do not wash the vehicle floor with water.

Vehicle systems such as the audio system may be damaged if water comes into contact with electrical components under the floor of the vehicle, and may also cause the body to rust.

n Cleaning the inside of the rear window

- I** Do not use glass cleaner to clean the rear window, as this may cause damage to the rear window defogger heater wires. Use a cloth dampened with lukewarm water to gently wipe the window clean. Wipe the window in strokes running parallel to the heater wires.
- I** Be careful not to scratch or damage the heater wires or antenna.

4-2. Maintenance

Maintenance requirements

To ensure safe and economical driving, day-to-day care and regular maintenance is essential. It is the owner's responsibility to perform regular checks. Toyota recommends the following maintenance.

■ **General maintenance**

Should be performed on a daily basis. This can be done by yourself or by a Toyota dealer.

■ **Scheduled maintenance**

Should be performed at specified intervals according to the maintenance schedule.

For details about maintenance items and schedules, refer to the "Scheduled Maintenance Guide" or "Owner's Manual Supplement".

■ **Do-it-yourself maintenance**

You can perform some maintenance procedures yourself. Please be aware that do-it-yourself maintenance may affect warranty coverage.

The use of Toyota Repair Manuals are recommended.

For details about warranty coverage, see the separate "Owner's Warranty Information Booklet" or "Owner's Manual Supplement".

■ **Repair and replacement**

It is recommended that genuine Toyota parts be used for repair to ensure performance of each system. If non-Toyota parts are used in replacement or if a repair shop other than a Toyota dealer performs repairs, confirm the warranty coverage.

4-2. Maintenance

n Allow inspection and repairs to be performed by a Toyota dealer

- l Toyota technicians are well-trained specialists and are kept up to date with the latest service information. They are well informed about the operations of all systems on your vehicle.
- l Keep a copy of the repair order. It proves that the maintenance that has been performed is under warranty coverage. If any problem should arise while your vehicle is under warranty, your Toyota dealer will promptly take care of it.

! CAUTION

n Hazardous materials

- l Engine exhaust, some of its constituents, and a wide variety of automobile components contain or emit chemicals known to the State of California to cause cancer and birth defects and other reproductive harm. Work in a well ventilated area.
- l Oils, fuels and fluids contained in vehicles as well as waste produced by component wear contain or emit chemicals known to the State of California to cause cancer and birth defects or other reproductive harm. Avoid exposure and wash any affected area immediately.
- l 12 volt battery posts, terminals and related accessories contain lead and lead compounds which are known to cause brain damage. Wash your hands after handling. (→P. 371)
- l Used engine oil contains chemicals that have been shown to cause cancer in laboratory animals. Avoid prolonged and repeated contact. Always protect your skin by washing thoroughly with soap and water.

4-2. Maintenance General maintenance

Listed below are the general maintenance items that should be performed at the intervals specified in the “Scheduled Maintenance Guide” or “Owner’s Manual Supplement”. It is recommended that any problem you notice should be brought to the attention of your Toyota dealer or qualified service shop for advice.

Engine compartment

Items	Check points
Brake fluid	• At the correct level? (→P. 369)
Engine/inverter coolant	• At the correct level? (→P. 367)
Engine oil	• At the correct level? (→P. 361)
Exhaust system	• No fumes or strange sounds?
Radiator/condenser/hoses	• Not blocked with foreign matter? (→P. 369)
Washer fluid	• At the correct level? (→P. 374)

Luggage compartment

Items	Check points
12 volt battery	• Maintenance-free (→P. 371)

4-2. Maintenance

Vehicle interior

Items	Check points
Accelerator pedal	<ul style="list-style-type: none"> • Moves smoothly (without uneven pedal effort or catching)?
Automatic transmission "Park" mechanism	<ul style="list-style-type: none"> • Can the vehicle be hold securely on an incline with the shift lever in "P"?
Brake pedal	<ul style="list-style-type: none"> • Moves smoothly? • Does it have appropriate clearance and correct amount of free play?
Brakes	<ul style="list-style-type: none"> • Pulls to one side when applied? • Loss of brake effectiveness? • Spongy feeling brake pedal? • Pedal almost touches floor?
Head restraints	<ul style="list-style-type: none"> • Move smoothly and lock securely?
Indicators/buzzers	<ul style="list-style-type: none"> • Function properly?
Lights	<ul style="list-style-type: none"> • Do all the lights come on?
Parking brake	<ul style="list-style-type: none"> • Moves smoothly? • Can hold the vehicle securely on an incline?
Seat belts	<ul style="list-style-type: none"> • Does the seat belt system operate smoothly? • Are the belts undamaged?
Seats	<ul style="list-style-type: none"> • Do the seat controls operate properly?
Steering wheel	<ul style="list-style-type: none"> • Moves smoothly? • Has correct free play? • No strange noises?

Vehicle exterior

Items	Check points
Doors	<ul style="list-style-type: none"> • Operate smoothly?
Engine hood	<ul style="list-style-type: none"> • The lock system works properly?
Fluid leaks	<ul style="list-style-type: none"> • Is there any leakage after parking?
Tire	<ul style="list-style-type: none"> • Inflation pressure is correct? • Tire surfaces not worn or damaged? • Tires rotated according to the maintenance schedule? • Wheel nuts are not loose?

⚠ CAUTION

n If the hybrid system is operating

Turn off the hybrid system and ensure that there is adequate ventilation before performing maintenance checks.

4

Maintenance and care

4-2. Maintenance

Emission inspection and maintenance (I/M) programs

Some states have vehicle emission inspection programs which include OBD (On Board Diagnostics) checks. The OBD system monitors the operation of the emission control system.

n If the malfunction indicator lamp comes on

The OBD system determines that a problem exists somewhere in the emission control system. Your vehicle may not pass the I/M test and may need to be repaired. Contact your Toyota dealer to service the vehicle.

n Your vehicle may not pass the I/M test:

- 1 When the 12 volt battery is disconnected or discharged

Readiness codes that are set during ordinary driving are erased.

Also, depending on your driving habits, the readiness codes may not be completely set.

- 1 When the fuel tank cap is loose

The malfunction indicator lamp comes on as a temporary malfunction and your vehicle may not pass the I/M test.

n When the malfunction indicator lamp goes off after several driving trips

The error code in the OBD system will not be cleared unless the vehicle is driven 40 or more times.

n If your vehicle does not pass the I/M test

Contact your Toyota dealer to prepare the vehicle for re-testing.

4-3. Do-it-yourself maintenance Do-it-yourself service precautions

If you perform maintenance yourself, be sure to follow the correct procedure given in these sections.

Items	Parts and tools
12 volt battery condition (→P. 371)	<ul style="list-style-type: none"> • Warm water • Baking soda • Grease • Conventional wrench (for terminal clamp bolts)
Brake fluid level (→P. 369)	<ul style="list-style-type: none"> • FMVSS No.116 DOT 3 or SAE J1703 brake fluid • Rag or paper towel • Funnel (used only for adding brake fluid)
Engine/inverter coolant level (→P. 367)	<ul style="list-style-type: none"> • “Toyota Super Long Life Coolant” or similar high quality ethylene glycol based non-silicate, non-amine, non-nitrite and non-borate coolant with long-life hybrid organic acid technology. For the U.S.A.: “Toyota Super Long Life Coolant” is pre-mixed with 50% coolant and 50% deionized water. For Canada: “Toyota Super Long Life Coolant” is pre-mixed with 55% coolant and 45% deionized water. • Funnel (used only for adding coolant)

4-3. Do-it-yourself maintenance

Items	Parts and tools
Engine oil level (→P. 361)	<ul style="list-style-type: none">• "Toyota Genuine Motor Oil" or equivalent• Rag or paper towel, funnel (used only for adding engine oil)
Fuses (→P. 394)	<ul style="list-style-type: none">• Fuse with same amperage rating as original
Radiator and condenser (→P. 369)	—
Tire inflation pressure (→P. 384)	<ul style="list-style-type: none">• Tire pressure gauge• Compressed air source
Washer fluid (→P. 374)	<ul style="list-style-type: none">• Water washer fluid containing anti-freeze (for winter use)• Funnel

⚠ CAUTION

The engine compartment contains many mechanisms and fluids that may move suddenly, become hot, or become electrically energized. To avoid death or serious injury observe the following precautions.

n When working on the engine compartment:

- I** Keep hands, clothing, and tools away from the moving fan and engine drive belt.
- I** Be careful not to touch the engine, inverter, radiator, exhaust manifold, etc. right after driving as they may be hot. Oil and other fluids may also be hot.
- I** Do not leave anything that may burn easily, such as paper or rags, in the engine compartment.
- I** Do not smoke, cause sparks or expose an open flame to fuel or the 12 volt battery. Fuel and 12 volt battery fumes are flammable.
- I** Be extremely cautious when working on the 12 volt battery. It contains poisonous and corrosive sulfuric acid.
- I** Never touch, disassemble, remove or replace the high voltage parts, cables and their connectors. It can cause severe burns or electric shock that may result in death or serious injury.
- I** When the hybrid system is operating with the "READY" light on, the engine may suddenly start in some cases. When you inspect the engine compartment, be sure to turn off the hybrid system.

n When working near the electric cooling fan or radiator grille

Be sure the "POWER" switch is OFF.

With the "POWER" switch in ON mode, the electric cooling fan may automatically start to run if the air conditioning is on and/or the coolant temperature is high. (→P. 369)

n Safety glasses

Wear safety glasses to prevent flying or falling material, fluid spray, etc. from getting in the eyes.

4-3. Do-it-yourself maintenance

 NOTICE

n If you remove the air cleaner filter

Driving with the air cleaner filter removed may cause excessive engine wear due to dirt in the air. Also a backfire could cause a fire in the engine compartment.

4-3. Do-it-yourself maintenance

Hood

Release the lock from the inside of the vehicle to open the hood.

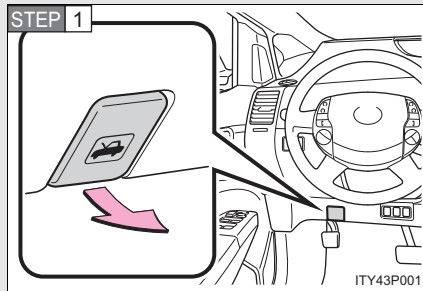

Pull the hood lock release lever.

The hood will pop up slightly.

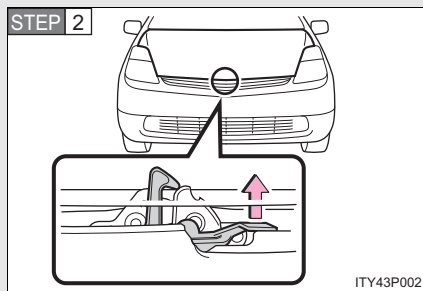

Lift the hood catch and lift the hood.

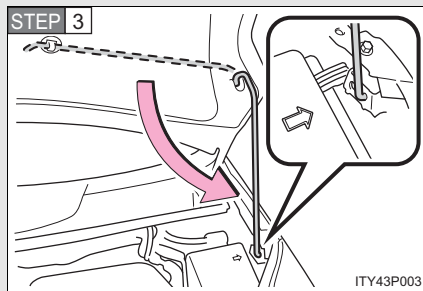

Hold the hood open by inserting the supporting rod into the slot.

4

Maintenance and care

CAUTION

n Pre-driving check

Check that the hood is fully closed and locked.
If the hood is not locked properly it may open while the vehicle is in motion and cause an accident, which may result in death or serious injury.

4-3. Do-it-yourself maintenance Positioning a floor jack

When raising your vehicle with a floor jack, position the jack correctly. Improper placement may damage your vehicle or cause injury.

► Front

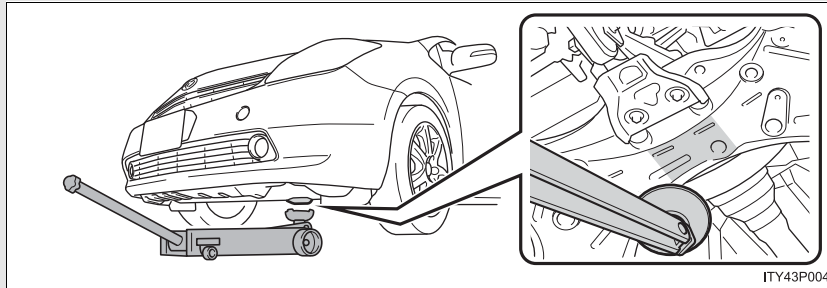

► Rear

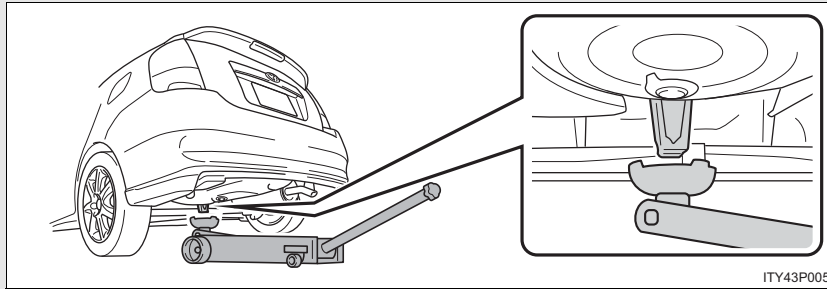

⚠ CAUTION

n When raising your vehicle

Make sure to observe the following to reduce the possibility of death or serious injury.

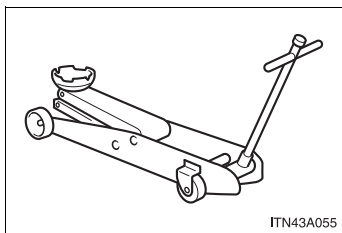

I Lift up the vehicle using a floor jack such as the one shown in the illustration.

- I** Do not use the floor jack that was supplied with your vehicle.
- I** Do not put any part of your body or get underneath the vehicle supported only by the floor jack.
Always use automotive jack stands or a solid, level, surface.
- I** Do not start the hybrid system while the vehicle is supported by the floor jack.
- I** Stop the vehicle on level firm ground, firmly set the parking brake and push the "P" position switch.
- I** Make sure to set the floor jack properly at the jack point.
Raising the vehicle with an improperly positioned floor jack will damage the vehicle and may cause the vehicle to fall off the floor jack.
- I** Do not raise the vehicle while someone is in the vehicle.
- I** When raising the vehicle, do not place any objects on top of or underneath the floor jack.

4-3. Do-it-yourself maintenance Engine compartment

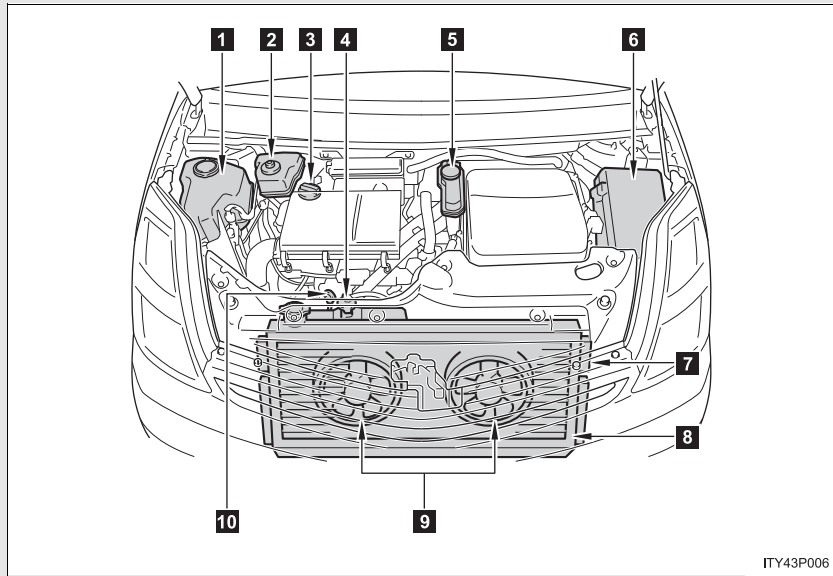

- | | |
|--|--|
| 1 Washer fluid tank
(→P. 374) | 5 Inverter coolant reservoir
(→P. 367) |
| 2 Brake fluid reservoir
(→P. 369) | 6 Fuse box
(→P. 394) |
| 3 Engine oil filler cap
(→P. 363) | 7 Radiator
(→P. 369) |
| 4 Engine coolant reservoir
(→P. 367) | 8 Condenser
(→P. 369) |
| | 9 Electric cooling fans |
| | 10 Engine oil level dipstick
(→P. 361) |

n 12 volt battery

→P. 371

4-3. Do-it-yourself maintenance

Engine compartment cover

■ Removing the cover

► Front

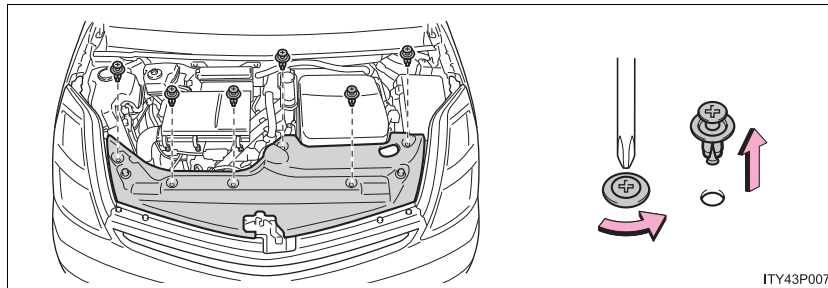

■ Installing the clips

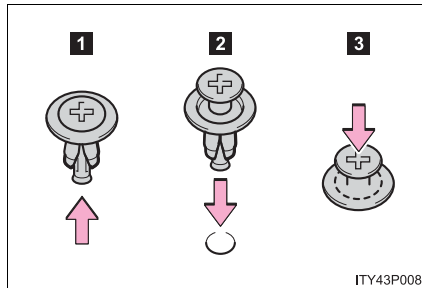

1 Push up center portion

2 Insert

3 Press

4

Maintenance and care

Engine oil

With the engine at operating temperature and turned off, check the oil level on the dipstick.

■ Checking the engine oil

STEP 1 Park the vehicle on level ground. After turning off the hybrid system, wait more than five minutes for the oil to drain back into the bottom of the engine.

4-3. Do-it-yourself maintenance

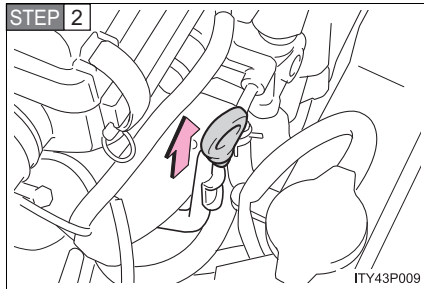

Hold a rag under the end and pull the dipstick out.

STEP 3 Wipe the dipstick clean.

STEP 4 Reinsert the dipstick fully.

STEP 5 Holding a rag under the end, pull the dipstick out and check the oil level.

STEP 6 Wipe the dipstick and reinsert it fully.

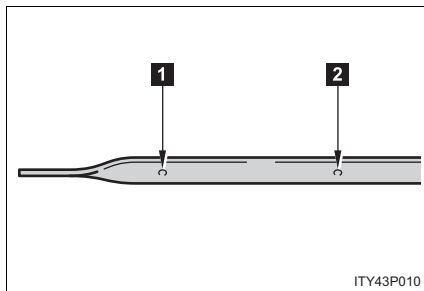

1 Low

2 Full

4-3. Do-it-yourself maintenance

n Adding engine oil

If the oil level is below or near the low level mark, add engine oil of the same type as already in the engine.

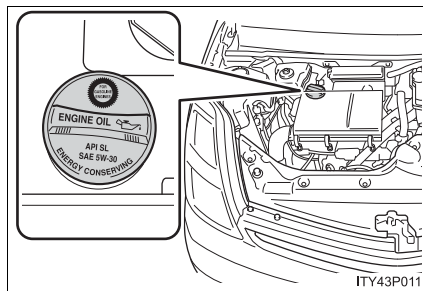

Make sure to check the oil type and prepare the items needed before adding oil.

Oil grade	ILSAC multigrade engine oil
Oil quantity (Low → Full)	1.6 qt. (1.5 L, 1.3 Imp. qt.)
Items	Clean funnel

- STEP 1** Remove the oil filler cap.
- STEP 2** Add engine oil slowly, checking the dipstick.
- STEP 3** Install the filler cap, turning it clockwise until you hear a click.

4-3. Do-it-yourself maintenance

n Recommended viscosity

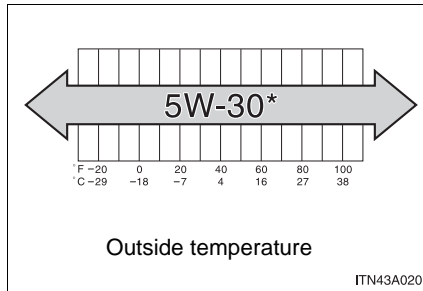

SAE 5W-30 is the best choice for good fuel economy, and good starting in cold weather.

*: If SAE 5W-30 oil is not available, SAE 10W-30 oil may be used. However, it should be replaced with SAE 5W-30 at the next oil change.

n How to read oil container labels

The ILSAC (International Lubricant Standardization and Approval Committee) Certification Mark is added to some oil containers to help you select the oil you should use.

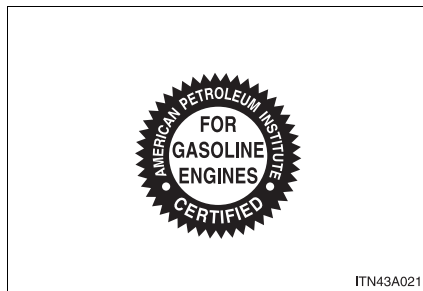

n Engine oil consumption

- l The amount of engine oil consumed depends on the oil viscosity, the quality of the oil and the way the vehicle is driven.
- l More oil is consumed under driving conditions such as high speeds, frequent acceleration and deceleration.
- l A new engine consumes more oil.
- l When judging the amount of oil consumption, keep in mind that the oil may have become diluted, making it difficult to judge the true level accurately.
- l Oil consumption: Max. 1.1 qt./600 miles, 0.9 Imp. qt./600 miles (1.0 L per 1000 km). If the vehicle consumes more than this amount, contact your Toyota dealer.

n Resetting the engine oil maintenance data (U.S.A. only)

Perform the following steps:

- STEP 1** Turn the "POWER" switch to OFF mode with the odometer shown.
- STEP 2** Turn the "POWER" switch to ON mode with the trip meter reset button (→P. 146) held down.
- STEP 3** Keep pressing the button for longer than 5 seconds after the "POWER" switch is in ON mode.

When the odometer indicates "000000" and the light goes off, the system reset is completed.

4-3. Do-it-yourself maintenance

CAUTION

n Used engine oil

- I** Used engine oil contains potentially harmful contaminants which may cause skin disorders such as inflammation or skin cancer, so care should be taken to avoid prolonged and repeated contact. To remove used engine oil from your skin, wash thoroughly with soap and water.
- I** Dispose of used oil and filters only in a safe and acceptable manner. Do not dispose of used oil and filters in household trash, in sewers or onto the ground.
Call your Toyota dealer, service station or auto parts store for information concerning recycling or disposal.
- I** Do not leave used engine oil within the reach of children.

NOTICE

n To prevent serious engine damage

Check the oil level on regular basis.

n When replacing the engine oil

- I** Be careful not to spill engine oil on the vehicle components.
- I** Avoid overfilling, or the engine could be damaged.
- I** Check the oil level on the dipstick every time you refill the vehicle.
- I** Be sure the engine oil filler cap is properly retightened.

Engine/inverter coolant

The coolant level is satisfactory if it is between the “FULL” and “LOW” lines on the reservoir when the engine is cold.

► Engine coolant reservoir

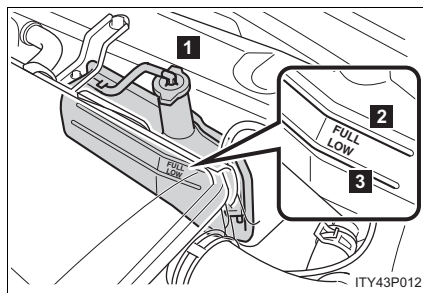

- 1 Reservoir cap
- 2 FULL
- 3 LOW

If the level is on or below the “LOW” line, add coolant up to the “FULL” line.

► Inverter coolant reservoir

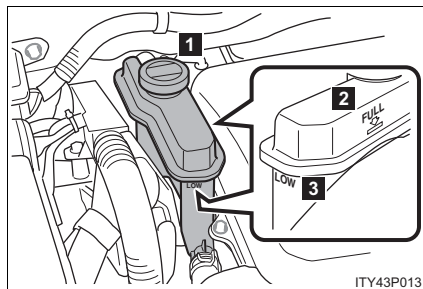

- 1 Reservoir cap
- 2 FULL
- 3 LOW

If the level is on or below the “LOW” line, add coolant up to the “FULL” line.

4-3. Do-it-yourself maintenance

n If the coolant level drops within a short time after replenishing

Visually check the radiator, hoses, engine coolant filler cap, radiator cap, drain cock and water pump.

If you cannot find a leak, have your Toyota dealer pressure test the cap and check for leaks in the cooling system.

n Coolant selection

Only use "Toyota Super Long Life Coolant" or similar high quality ethylene glycol based non-silicate, non-amine, non-nitrite, and non-borate coolant with long-life hybrid organic acid technology.

U.S.A.: "Toyota Super Long Life Coolant" is a mixture of 50% coolant and 50% deionized water. (Enabled: -31°F [-35°C])

Canada: "Toyota Super Long Life Coolant" is a mixture of 55% coolant and 45% deionized water. (Enabled: -44°F [-42°C])

For more details about engine coolant, contact your Toyota dealer.

⚠ CAUTION

n When the coolant is hot

Do not remove the coolant reservoir cap.

The cooling system may be under pressure and may spray hot coolant if the cap is removed, causing burns or other injuries.

⚠ NOTICE

n When adding the coolant

Coolant is neither plain water nor straight antifreeze. The correct mixture of water and anti freeze must be used to provide proper lubrication, corrosion protection and cooling. Be sure to read the antifreeze or coolant label.

n If you spill coolant

Be sure to wash it off with water to prevent it damage to parts or paint.

Radiator and condenser

Check the radiator and condenser and clear any foreign objects. If either of the above parts are extremely dirty or you are not sure of their condition, have your vehicle checked by your Toyota dealer.

⚠ CAUTION

n When the engine is hot

Do not touch the radiator or condenser, as they may be hot and you may be burned.

Brake fluid

n Checking fluid level

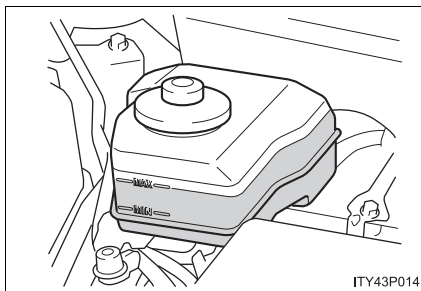

The brake fluid level should be between the "MAX" and "MIN" lines on the tank.

Make sure to check the fluid type and prepare the necessary items.

n Adding fluid

Fluid type	FMVSS No.116 DOT 3 or SAE J1703 brake fluid
Items	Clean funnel

4-3. Do-it-yourself maintenance

n Brake fluid can absorb moisture from the air

Excess moisture in the fluid can cause a dangerous loss of braking efficiency. Use only newly opened brake fluid.

⚠ CAUTION

n When filling the reservoir

Take care because brake fluid can harm your hands or eyes and damage painted surfaces.

If fluid gets in your eyes, flush your eyes with clean water immediately.

If you still experience discomfort, see a doctor.

⚠ NOTICE

n If the fluid level is low

It is normal for the brake fluid level to go down slightly as the brake pads wear or when the fluid level in the accumulator is high.

If the reservoir needs frequent refilling, it may indicate a serious problem.

12 volt battery

Location

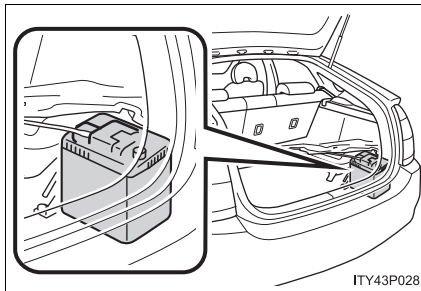

The 12 volt battery is located in the right-hand side of luggage compartment.

12 volt battery exterior

Make sure that the 12 volt battery terminals are not corroded and that there are no loose connections, cracks, or loose clamps.

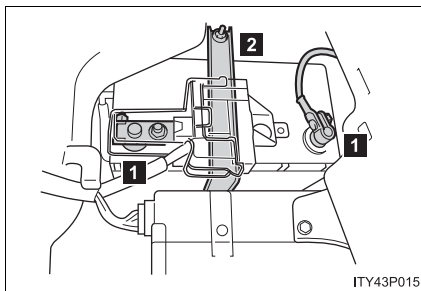

- 1 Terminals
- 2 Hold-down clamp

4-3. Do-it-yourself maintenance

n **Before recharging**

When recharging, the 12 volt battery produces hydrogen gas which is flammable and explosive. Therefore, before recharging:

- l If recharging with the 12 volt battery installed on the vehicle, be sure to disconnect the ground cable.
- l Make sure the power switch on the charger is off when connecting and disconnecting the charger cables to the 12 volt battery.

n **After recharging/reconnecting the 12 volt battery**

In some cases, the hybrid system may not start. Follow one or both of the following procedures:

- l After opening and closing the driver's door, wait 10 seconds then attempt to start the engine. (If the system does not start first time, repeat the procedure.)
- l With the shift lever in "P" and the "POWER" switch in the OFF mode, open and close any door, then attempt to start the hybrid system.

If the system will not start even after multiple attempts at both methods, contact your Toyota dealer.

⚠ CAUTION**n Chemicals in the 12 volt battery**

The 12 volt battery contains poisonous and corrosive sulfuric acid and may produce hydrogen gas which is flammable and explosive. To reduce the risk of death or serious injury, take the following precautions while working on or near the 12 volt battery:

- ! Do not cause sparks by touching the 12 volt battery terminals with tools.
- ! Do not smoke or light a match near the 12 volt battery.
- ! Avoid contact with eyes, skin and clothes.
- ! Never inhale or swallow electrolyte.
- ! Wear protective safety glasses when working near the 12 volt battery.
- ! Keep children away from the 12 volt battery.

n Where to safety charge the 12 volt battery

Always charge the 12 volt battery in an open area. Do not charge the 12 volt battery in a garage or closed room where there is not sufficient ventilation.

n How to recharge the 12 volt battery

Only perform a slow charge (3.5 A or less). The 12 volt battery may explode if charged at a quicker rate.

n Emergency measures regarding electrolyte

- ! If electrolyte gets in your eyes
Flush your eyes with clean water for at least 15 minutes and get immediate medical attention. If possible, continue to apply water with a sponge or cloth while traveling to the nearest medical facility.
- ! If electrolyte gets on your skin
Wash the affected area thoroughly. If you feel pain or a burning sensation, seek medical attention immediately.
- ! If electrolyte gets on your clothes
It can soak through clothing on to your skin. Immediately take off the clothing and follow the procedure above if necessary.
- ! If you accidentally swallow electrolyte
Drink a large quantity of water or milk. Follow with milk of magnesia, beaten raw egg or vegetable oil. Get emergency medical attention immediately.

4-3. Do-it-yourself maintenance

NOTICE

n When recharging the 12 volt battery

Never recharge the 12 volt battery while the hybrid system is operating. Also, be sure all accessories are turned off.

Washer fluid

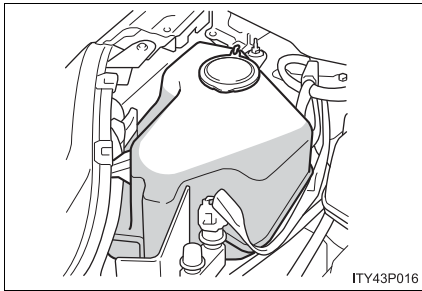

If any washer does not work, the washer tank may be empty. Add washer fluid.

CAUTION

n When refilling the washer fluid

Do not refill the washer fluid when the hybrid system is hot or operating, as the washer fluid contains alcohol and may catch fire if spilled on the hybrid system etc.

NOTICE

n Do not use any fluid other than washer fluid

Do not use soapy water or engine antifreeze instead of washer fluid. Doing so may cause streaking on the vehicle's painted surfaces.

n Diluting washer fluid

Dilute washer fluid with water as necessary. Refer to the freezing temperatures listed on the washer fluid tank.

4-3. Do-it-yourself maintenance Tires

Replace or rotate tires in accordance with maintenance schedules and treadwear.

n Checking tires

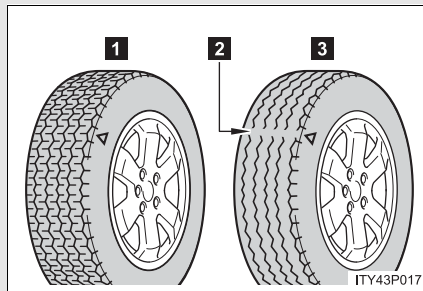

- 1** New tread
- 2** Treadwear indicator
- 3** Worn tread

The location of treadwear indicators is shown by the "TWI" or "Δ" marks, etc., molded on the sidewall of each tire.

Check spare tire condition and inflation pressure if not rotated.

n Tire rotation

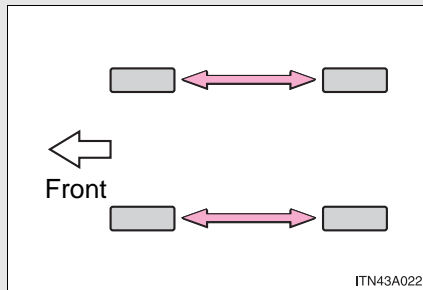

Rotate the tires in the order shown.

To equalize tire wear and extend tire life, Toyota recommends that tire rotation is carried out at the same interval as tire inspection.

Do not fail to initialize the tire pressure warning system after tire rotation.

n The tire pressure warning system

Your Toyota is equipped with a tire pressure warning system that uses tire pressure warning valves and transmitters to detect low tire inflation pressure before serious problems arise. (→P. 426)

The compact spare tire is not equipped with a tire pressure warning valve and transmitter.

4-3. Do-it-yourself maintenance

Installing tire pressure warning valves and transmitters

When replacing tires or wheels, tire pressure warning valves and transmitters must also be installed.

When new tire pressure warning valves and transmitters are installed, new tire pressure warning valve and transmitter ID codes must be registered in the tire pressure warning computer and tire pressure warning system must be initialized. Have tire pressure warning valve and transmitter ID codes registered by Toyota dealer. (→P. 378)

Initializing the tire pressure warning system

n The tire pressure warning system must be initialized in the following circumstances:

- 1 When rotating the tires on vehicles differing with front and rear tire inflation pressures.
- 1 When changing the tire inflation pressure by changing traveling speed or load weight, etc.
- 1 When changing the tire size.

When the tire pressure warning system is initialized, the current tire inflation pressure is set as the pressure benchmark.

n How to initialize the tire pressure warning system

STEP 1 Park the vehicle in safe place and turn the “POWER” switch to OFF mode.

While the vehicle is moving, initialization is not performed.

STEP 2 Adjust the tire inflation pressure to the specified cold tire inflation pressure level. (→P. 468)

Make sure to adjust the tire pressure to the specified cold tire inflation pressure level. The tire pressure warning system will operate based on this pressure level.

STEP 3 Turn the “POWER” switch to ON mode.

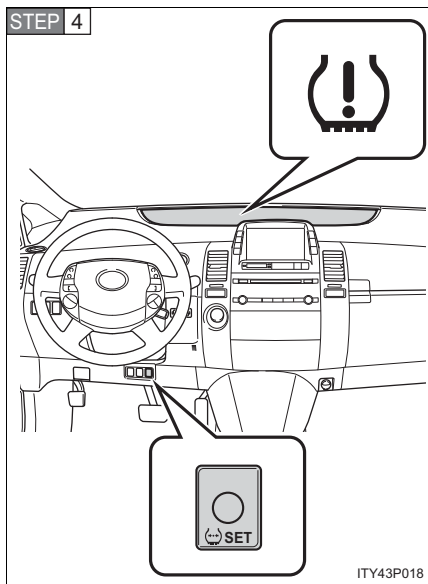

Push and hold the tire pressure warning reset switch until the tire pressure warning light blinks slowly 3 times.

STEP 5 Wait for a few minutes with the ON mode, and then turn “POWER” switch to OFF mode.

4-3. Do-it-yourself maintenance

Registering ID codes

The tire pressure warning valve and transmitter is equipped with a unique ID code. When replacing a tire pressure warning valve and transmitter, it is necessary to register the ID code of tire pressure warning valve and transmitter. Have the ID code registered by your Toyota dealer.

n When to replace your vehicle's tires

Tires should be replaced if:

- l You have tire damage such as cuts, splits, cracks deep enough to expose the fabric or bulges indicating internal damage
- l A tire goes flat repeatedly or cannot be properly repaired due to the size or location of a cut or other damage

If you are not sure, consult with your Toyota dealer.

n Replacing tires and wheels

If the ID code of the tire pressure warning valve and transmitter is not registered, the tire pressure warning system will not work properly. After driving for about 20 minutes, the tire pressure warning light comes on after blinking for 1 minute to indicate a system malfunction.

n Tire life

Any tire over 6 years old must be checked by a qualified technician even if they have seldom or never been used or damage is not obvious.

n If the tread wears down below 0.16 in. (4 mm) on snow tires

The effectiveness of snow tires is lost.

n Maximum load of tire

Check that the maximum load of the replaced tire is greater than 1/2 of the Gross Axle Weight Ratings (GAWR) of either the front axle or the rear axle, whichever is greater.

As for the maximum load of the tire, see the load limit at maximum cold tire inflation pressure mentioned on the sidewall of the tire, and as for the Gross Axle Weight Ratings (GAWR), see the Certification Label.

(→P. 384, 473).

4-3. Do-it-yourself maintenance

n Tire types

1 Summer tires

Summer tires are high-speed performance tires best suited to highway driving under dry conditions. Since summer tires do not have the same traction performance as snow tires, summer tires are inadequate for driving on snow-covered or icy roads. For driving on snow-covered roads or icy roads, the use of snow tires is recommended. When installing snow tires, be sure to replace all four tires.

2 All season tires

All season tires are designed to provide better traction in snow and to be adequate for driving in most winter conditions, as well as for use year round. All season tires, however, do not have adequate traction performance compared with snow tires in heavy or loose snow. Also, all season tires fall short in acceleration and handling performance compared with summer tires in highway driving.

3 Snow tires

For driving on snow-covered roads or icy roads, we recommend using snow tires. If you need snow tires, select tires of the same size, construction and load capacity as the originally installed tires. Since your vehicle has radial tires as original equipment, make sure your snow tires also have radial construction. Do not install studded tires without first checking local regulations for possible restriction. Snow tires should be installed on all wheels. (→P. 173)

n Initializing the tire pressure warning system

Initialize the tires with the tire inflation pressure adjusted to the specified level.

4

Maintenance and care

4-3. Do-it-yourself maintenance

n If you push the tire pressure warning reset switch accidentally

If initialization is performed, adjust the tire inflation pressure to the specified level and initialize the tire pressure warning system again.

n When the initialization of the tire pressure warning system has failed

Initialization can be completed in a few minutes. However, in the following cases, the settings have not been recorded and the system will not operate properly. If repeated attempts to record tire inflation pressure settings are unsuccessful, have the vehicle inspected by your Toyota dealer.

l When operating the tire pressure warning reset switch, the tire pressure warning light does not flash 3 times.

l After carrying out the initialization procedure, the tire pressure warning light blinks for 1 minute then stays on after driving 20 minutes.

n Routine tire inflation pressure checks

The tire pressure warning system does not replace routine tire inflation pressure checks. Make sure to check tire inflation pressure as part of your routine of daily vehicle checks.

4-3. Do-it-yourself maintenance

n Tire pressure warning system certification

FCC ID: PAXPMV107J

FCC ID: HYQ13BCG

IC ID: 3729A-PMV107J

IC ID: 1551A-13BCG

- ▶ For vehicles sold in the U.S.A.

NOTE:

This device complies with Part 15 of the FCC Rules. Operation is subject to the following two conditions: (1) this device may not cause harmful interference, and (2) this device must accept any interference received, including interference that may cause undesired operation.

FCC WARNING:

Changes or modifications not expressly approved by the party responsible for compliance could void the user's authority to operate the equipment.

- ▶ For vehicles sold in Canada

NOTE:

Operation is subject to the following two conditions: (1) this device may not cause interference, and (2) this device must accept any interference, including interference that may cause undesired operation of the device.

4

Maintenance and care

4-3. Do-it-yourself maintenance

CAUTION

n Tire pressure warning system operation

The tire pressure warning system may not provide warning immediately if a tire bursts or if sudden air leakage occurs.

n When inspecting or replacing tires

Observe the following precautions to prevent accidents. Failure to do so may cause damage to parts of the drive train, as well as dangerous handling characteristics, which may lead to fatal or injury accidents.

- I** Do not mix tires of different makes, models, tread patterns or tread-wear.
- I** Do not use tire sizes other than those recommended by Toyota.
- I** Do not mix radial, bias-belted, or bias-ply tires.
- I** Do not mix summer, all season and winter tires.
- I** Do not use tires that have been used on another vehicle.
- I** Do not use tires if you do not know how they were used previously.

n When initializing the tire pressure warning system

Do not push the tire pressure warning reset switch without first adjusting the tire inflation pressure to the specified level. Otherwise, the tire pressure warning light may not come on even if the tire inflation pressure is low, or it may come on when the tire inflation pressure is actually normal.

 NOTICE

n Repairing or replacing tires, wheels and tire pressure warning valves and transmitters

I When removing or fitting the wheels, tires or the tire pressure warning valve and transmitter, contact your Toyota dealer as the tire pressure warning valve and transmitter may be damaged if not handled correctly.

I When replacing tires, make sure also to replace the tire pressure warning valve and transmitter grommets.

n To avoid damaging the tire pressure warning valves and transmitters

Do not use liquid sealants on flat tires.

n Driving on rough roads

Take particular care when driving on roads with loose surfaces or pot-holes.

These conditions may cause losses in tire inflation pressure, reducing the cushioning ability of the tires. In addition driving on rough roads may cause damage to the tires themselves, as well as the vehicle's wheels and body.

n If tire inflation pressures become low while driving

Do not continue driving, or your tires and/or wheels may be ruined.

4-3. Do-it-yourself maintenance Tire inflation pressure

n Tire inflation pressure

The recommended cold tire inflation pressure and tire size is displayed on the tire and loading information label. (→P. 468)

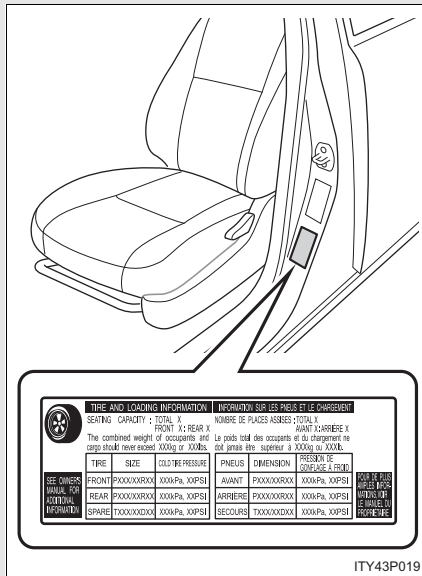

n Inspection and adjustment procedure

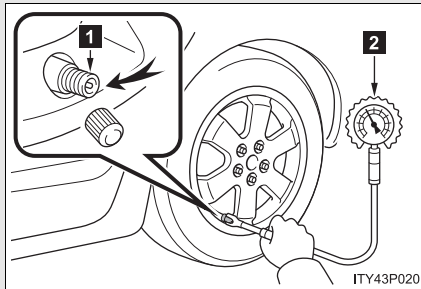

- 1 Tire valve
- 2 Tire pressure gauge

- STEP 1** Remove the tire valve cap.
- STEP 2** Press the tip of the tire pressure gauge onto the tire valve.
- STEP 3** Read the pressure using the graduations of the gauge.
- STEP 4** If the tire inflation pressure is not within the recommended levels, adjust tire pressure.
If you add too much air, press the center of the valve to lower.
- STEP 5** After completing the tire inflation pressure measurement and adjustment, apply soapy water to the valve and check for leakage.
- STEP 6** Reinstall the tire valve cap.

n Tire inflation pressure check interval

You should check tire inflation pressure every two weeks, or at least once a month.
Do not forget to check the spare.

4-3. Do-it-yourself maintenance

n **Effects of incorrect tire inflation pressure**

Driving with incorrect tire inflation pressure may result in the following:

- l Reduced fuel efficiency
- l Reduced driving comfort and tire life
- l Reduced safety
- l Damage to the drive train

If a tire needs frequent refilling, have it checked by your Toyota dealer.

n **Instructions for checking tire inflation pressure**

When checking tire inflation pressure, observe the following:

- l Check only when the tires are cold.
If your vehicle has been parked for at least 3 hours and has not been driven for more than 1 mile or 1.5 km, you will get an accurate cold tire inflation pressure reading.
- l Always use a tire pressure gauge.
The appearance of the tire can be misleading. In addition, tire inflation pressures that are even just a few pounds off can degrade ride and handling.
- l Do not bleed or reduce tire inflation pressure after driving. It is normal for the tire inflation pressure to be higher after driving.
- l Never exceed the vehicle capacity weight.
Passengers and luggage weight should be placed so that the vehicle is balanced.

4-3. Do-it-yourself maintenance

CAUTION

n Proper inflation is critical to save tire performance

Keep your tires properly inflated. Otherwise, the following conditions may occur and result in an accident causing death or serious injury.

- | Excessive wear**
- | Uneven wear**
- | Poor handling**
- | Possibility of blowouts resulting from overheated tires**
- | Poor sealing of the tire bead**
- | Wheel deformation and/or tire separation**
- | A greater possibility of tire damage from road hazards**

NOTICE

n When inspecting and adjusting tire inflation pressure

Be sure to reinstall the tire valve caps.

Without the valve caps, dirt or moisture could get into the valve and cause air leakage, which could result in an accident. If the caps have been lost, replace them as soon as possible.

4

Maintenance and care

4-3. Do-it-yourself maintenance Wheels

If a wheel is bent, cracked or heavily corroded, it should be replaced.

Otherwise, the tire may separate from the wheel or cause loss of handling control.

n **Wheel selection**

When replacing wheels, care should be taken to ensure that they are equivalent to those removed in load capacity, diameter, rim width, and offset.

Replacement wheels are available at your Toyota dealer.

Toyota does not recommend using:

- 1 Wheels of different sizes or types
- 1 Used wheels
- 1 Bent wheels that have been straightened

n **Aluminum wheel precautions**

- 1 Use only Toyota wheel nuts and wrenches designed for use with your aluminum wheels.
- 1 When rotating, repairing or changing your tires, check that the wheel nuts are still tight after driving 1000 miles (1600 km).
- 1 Be careful not to damage the aluminum wheels when using tire chains.
- 1 Use only Toyota genuine balance weights or equivalent and a plastic or rubber hammer when balancing your wheels.

n When replacing wheels

The wheels of your Toyota are equipped with tire pressure warning valves and transmitters that allow the tire pressure warning system to provide advanced warning in the event of a loss in tire inflation pressure. Whenever wheels are replaced, the tire pressure warning valves and transmitters must be installed. (→P. 376)

⚠ CAUTION

n When replacing wheels

- I** Do not use wheels that are a different size from those recommended in the Owner's Manual, as this may result in loss of handling control.
- I** Never use an inner tube in a leaking wheel which is designed for a tubeless tire. Doing so may result in an accident, causing death or serious injury.

⚠ NOTICE

n Replacing tire pressure warning valves and transmitters

- I** Because tire repair or replacement may affect the tire pressure warning valves and transmitters, make sure to have tires serviced by your Toyota dealer. In addition, make sure to purchase your tire pressure warning valves and transmitters at your Toyota dealer.
- I** Ensure that only genuine Toyota wheels are used on your vehicle. Tire pressure warning valves and transmitters may not work properly with non-genuine wheels.

4-3. Do-it-yourself maintenance Air conditioning filter

The air conditioning filter must be changed regularly to maintain air conditioning efficiency.

n Removal method

STEP 1 Turn the "POWER" switch to OFF mode.

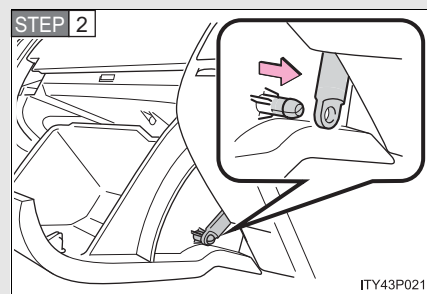

Open the glove box slide off the damper.

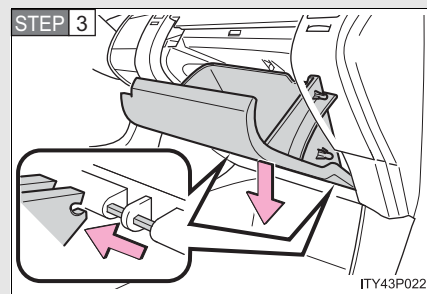

Lift the glove box to disconnect the claws at the bottom and remove it.

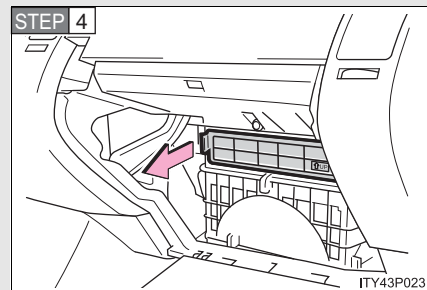

Remove the filter case.

4-3. Do-it-yourself maintenance

n Replacement method

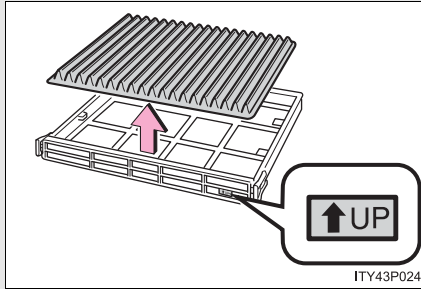

Remove the air conditioning filter from the filter case and replace it with a new one.

The “↑UP” marks shown on the filter and the filter case should be pointing up.

n Checking interval

Inspect and replace the air conditioning filter according to the maintenance schedule. In dusty areas or areas with heavy traffic flow, early replacement may be required. (For scheduled maintenance information, refer to the Owner's Manual Supplement/Scheduled Maintenance Guide".)

n If air flow from the vents decreases dramatically

The filter may be clogged. Check the filter and replace if necessary.

⚠ NOTICE

n To prevent damage to the system

When using the air conditioning system, make sure that a filter is always installed.

4-3. Do-it-yourself maintenance Electronic key battery

Replace the battery with a new one if it is discharged.

n You will need the following items:

- 1 Small Phillips-head screwdriver
- 1 Lithium battery (CR2032)

n Replacing the battery

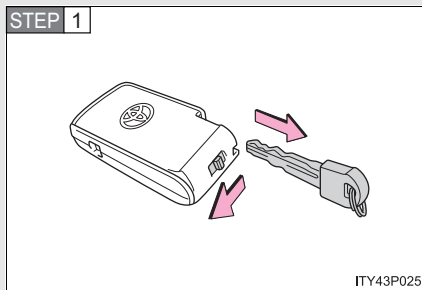

Take out the mechanical key.

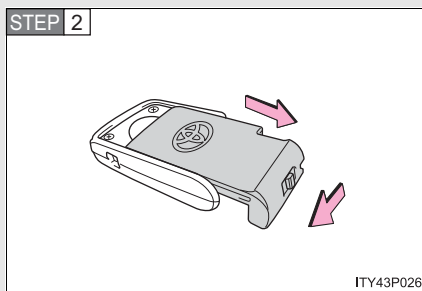

Remove the cover.

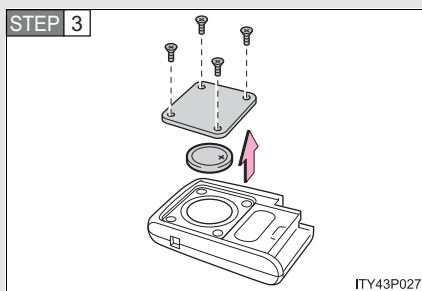

Remove the battery cover bolts, the battery cover and depleted battery.

Insert a new battery with the "+" terminal facing up.

4-3. Do-it-yourself maintenance

n If the electronic key battery is discharged

The following symptoms may occur.

- l The smart key system and wireless remote control will not function properly.
- l The operational range is reduced.

n Use a CR2032 lithium battery

- l Batteries can be purchased at your Toyota dealer, jewelers, or camera stores.
- l Replace only with the same or equivalent type recommended by a Toyota dealer.
- l Dispose of used batteries according to the local laws.

⚠ CAUTION

n Removed battery and other parts

Keep away from children.
These parts are small and if swallowed by a child they can cause choking.

⚠ NOTICE

n For normal operation after replacing the battery

Observe the following precautions to prevent accidents.

- l Always work with dry hands.
Moisture may cause the battery to rust.
- l Do not touch or move any other components inside the electronic key.
- l Do not bend the battery terminals.

4-3. Do-it-yourself maintenance Checking and replacing fuses

If any of the electrical components do not operate, a fuse may have blown. If this happens, check and replace the fuses as necessary.

STEP 1 Turn the "POWER" switch to OFF mode.

STEP 2 Remove the engine compartment cover if necessary.

→P. 361

STEP 3 Open the fuse box cover.

▶ Engine compartment

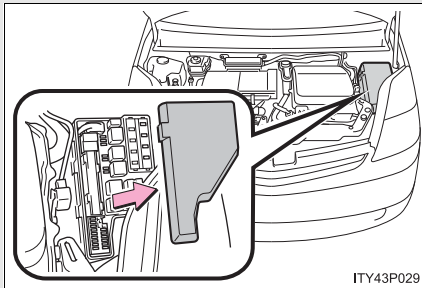

Push the tabs in and lift the lid off.

▶ Driver's side instrument panel

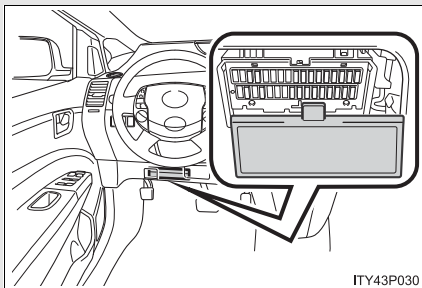

Remove the lid.

4-3. Do-it-yourself maintenance

► Luggage compartment

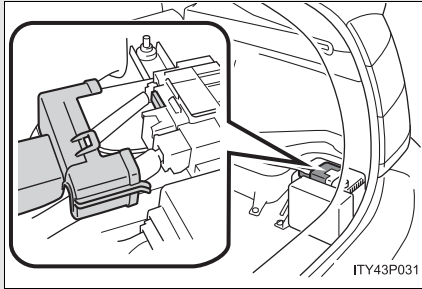

Remove the cover.

STEP 4 After a system failure, see “Fuse layout and amperage ratings” (→P. 397) for details about which fuse to check.

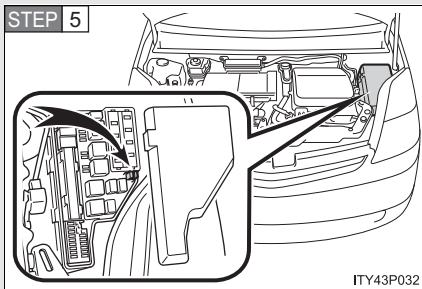

STEP 5 Remove the fuse with the pull-out tool.

4

Maintenance and care

4-3. Do-it-yourself maintenance

STEP 6 Check if the fuse has blown.

► Type A

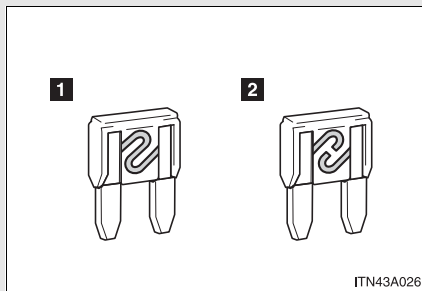

1 Normal fuse

2 Blown fuse

Replace it with one of an appropriate amperage rating. The amperage rating can be found on the fuse box lid.

► Type B

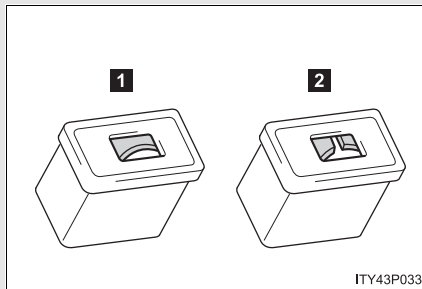

1 Normal fuse

2 Blown fuse

Replace it with one of an appropriate amperage rating. The amperage rating can be found on the fuse box lid.

► Type C

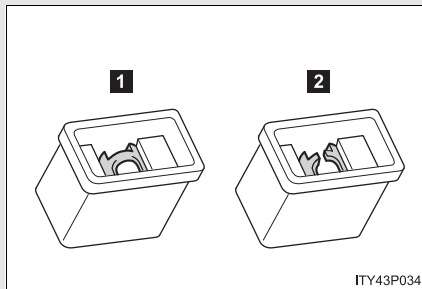

1 Normal fuse

2 Blown fuse

Contact your Toyota dealer.

4-3. Do-it-yourself maintenance

Fuse layout and amperage ratings

n Driver's side instrument panel

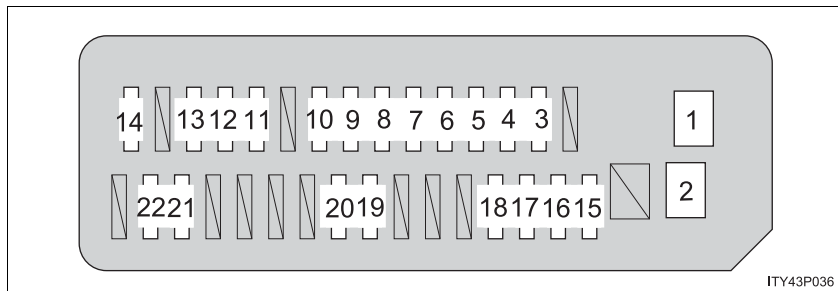

	Fuse	Ampere	Circuit
1	PWR	30 A	Power windows
2	DEF	40 A	Rear window defogger
3	M/HTR	15 A	Outside rear view mirror heater
4	WIP	30 A	Windshield wiper
5	RR WIP	15 A	Rear wiper
6	WSH	20 A	Washer
7	ECU-IG	7.5 A	Smart key system, power windows, touch screen, electric power steering, theft deterrent system
8	GAUGE	10 A	Gauge and meter, backup lights, emergency flasher, power windows
9	OBD	7.5 A	On-board diagnosis system
10	STOP	7.5 A	Stop lights
11	DOOR	25 A	Power door lock system
12	ACC-B	25 A	"POWER OUTLET", "ACC" fuses

4-3. Do-it-yourself maintenance

Fuse		Ampere	Circuit
13	ECU-B	15 A	Touch screen, power windows, air conditioning system
14	AM1	7.5 A	Hybrid system
15	TAIL	10 A	Tail lights, license plates light, parking lights
16	PANEL	7.5 A	Touch screen, clock, audio system, instrument panel lights
17	A/C (HTR)	10 A	Air conditioning system
18	FR DOOR	20 A	Power windows
19	PWR OUTLET	15 A	Power outlet
20	ACC	7.5 A	Audio system, touch screen, clock
21	PWR OUTLET FR	15 A	Power outlet
22	IGN	7.5 A	Hybrid system, hybrid vehicle immobilizer system, SRS airbags

4-3. Do-it-yourself maintenance

n Engine compartment

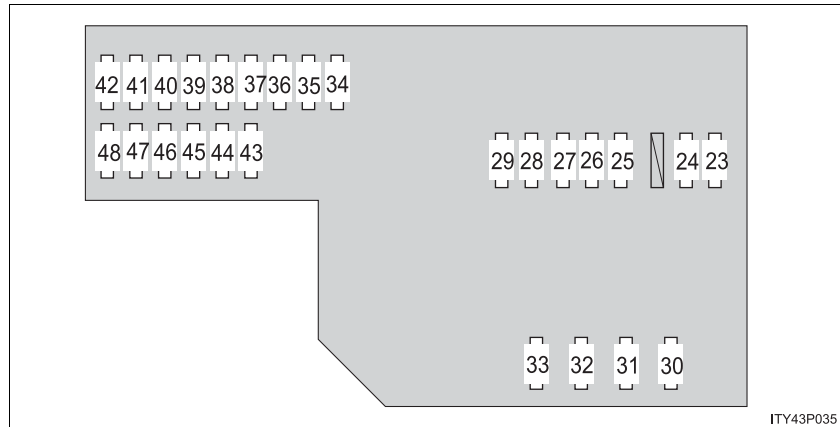

ITY43P035

Fuse	Ampere	Circuit
23	30 A	Spare
24	15 A	Spare
25	7.5 A	Daytime running light system
26	10 A ^{*1}	Right-hand headlight (low beam)
	15 A ^{*2}	
27	10 A ^{*1}	Left-hand headlight (low beam)
	15 A ^{*2}	
28	10 A	Right-hand headlight (high beam)
29	10 A	Left-hand headlight (high beam)
30	15 A	Multipoint fuel injection system/ sequential multipoint fuel injection system
31	15 A	"IGN" fuse, ignition system
32	10 A	Horn
33	20 A	Hybrid system
34	7.5 A	Parking control system, hybrid vehicle immobilizer system

4-3. Do-it-yourself maintenance

	Fuse	Ampere	Circuit
35	ABS-1	25 A	Anti-lock brake system
36	ETCS	10 A	Electronic throttle control system
37	BATT FAN	10 A	Battery cooling fan
38	HAZ	10 A	Turn signal lights, emergency flasher
39	DOME	15 A	Audio system, interior lights, smart key system, gauge and meter, turn signal lights, luggage room light, clock
40	ABS MAIN3	15 A	Anti-lock brake system
41	ABS MAIN2	10 A	Anti-lock brake system
42	ABS MAIN1	10 A	Anti-lock brake system
43	FR FOG	15 A	Fog lights
44	CHS W/P	10 A	CHS W/P
45	AMP	30 A	Audio system
46	PTC HTR2	30 A	PTC heater
47	PTC HTR1	30 A	PTC heater
48	CDS FAN	30 A	Electric cooling fan

*1: Vehicles with halogen headlights (low beam)

*2: Vehicles with discharge headlights (low beam)

4-3. Do-it-yourself maintenance

n Luggage compartment

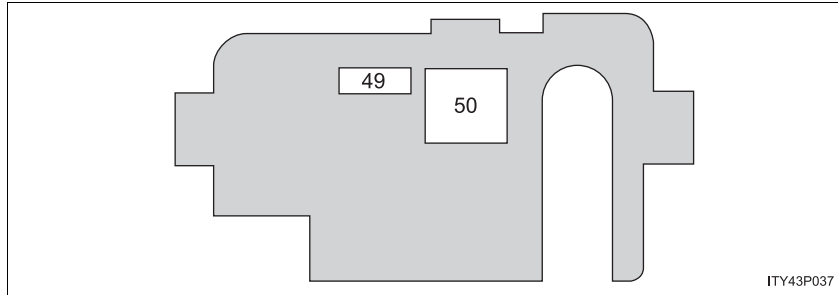

	Fuse	Ampere	Circuit
49	DC/DS-S	5 A	Inverter and converter
50	MAIN	120 A	Hybrid system

4-3. Do-it-yourself maintenance

CAUTION

n To prevent system breakdowns and vehicle fire

Observe the following precautions.

Failing to do so may cause damage, and possibly a fire or injury.

- I** Never use a fuse of a higher amperage rating than indicated, or use any other object in place of a fuse.
- I** Always use a genuine Toyota fuse or equivalent.
Never replace a fuse with a wire, even as a temporary fix.
This can cause extensive damage or even fire.
- I** Do not modify fuses or the fuse box.

NOTICE

n Before replacing fuses

Have the cause of electrical overload determined and repaired by your Toyota dealer.

4-3. Do-it-yourself maintenance Light bulbs

You may replace the following bulbs yourself. For more information about replacing other light bulbs, contact your Toyota dealer.

■ **Prepare a replacement light bulb.**

Check the wattage of the light bulb being replaced. (→P. 469)

■ **Remove the engine compartment cover if necessary.**

→P. 361

■ **Front bulb locations**

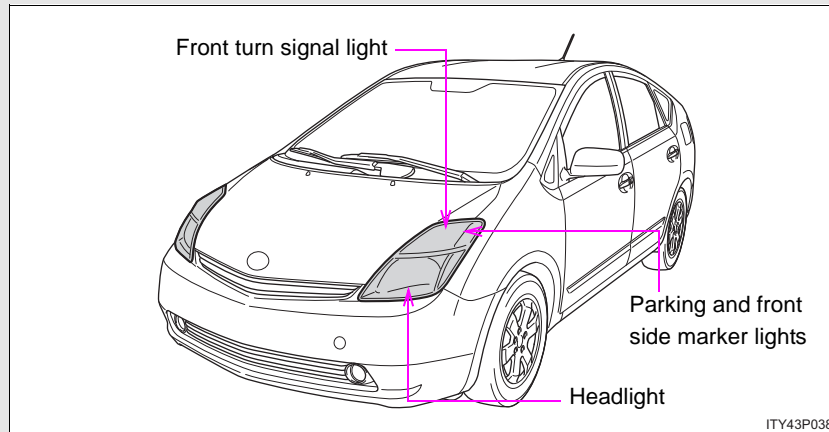

■ **Rear bulb locations**

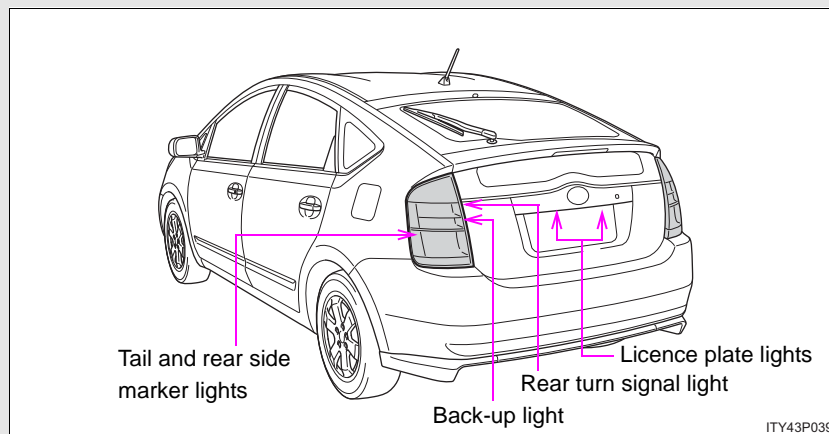

4-3. Do-it-yourself maintenance

Replacing light bulbs

n Headlights (vehicles with halogen bulbs)

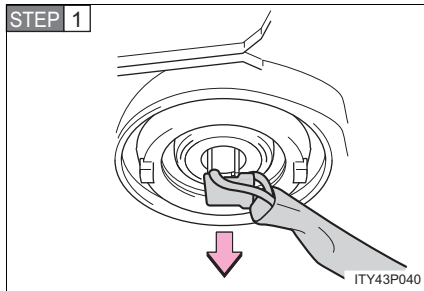

Unplug the connector.

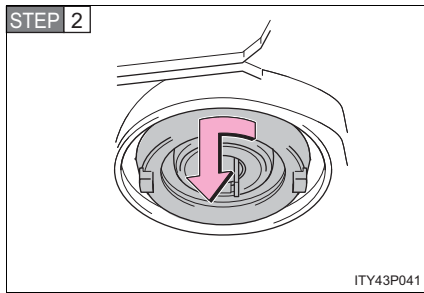

Remove the rubber cover.

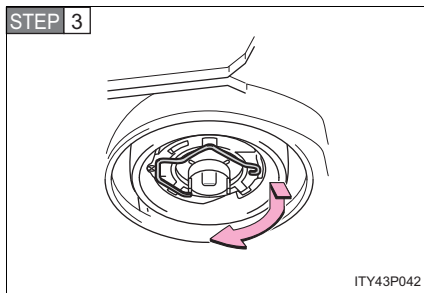

Release the bulb retaining spring.

4-3. Do-it-yourself maintenance

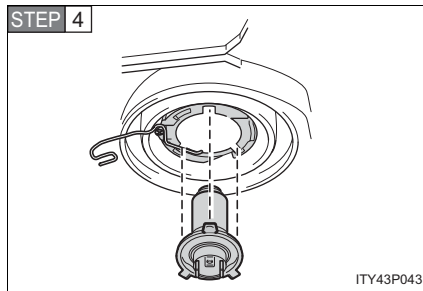

Remove the bulb.

n Parking and front side marker lights

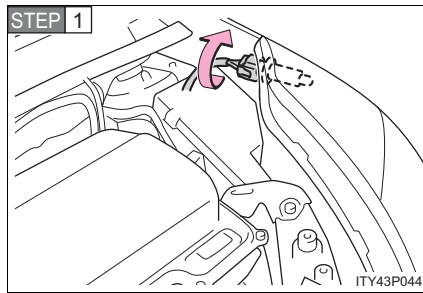

Turn the bulb base counterclockwise.

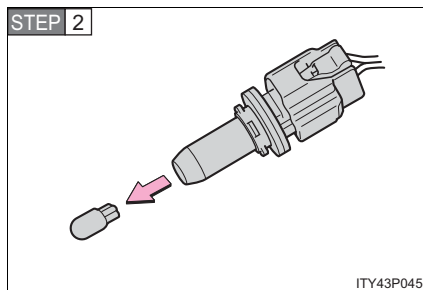

Remove the light bulb.

4

Maintenance and care

4-3. Do-it-yourself maintenance

n Front turn signal lights

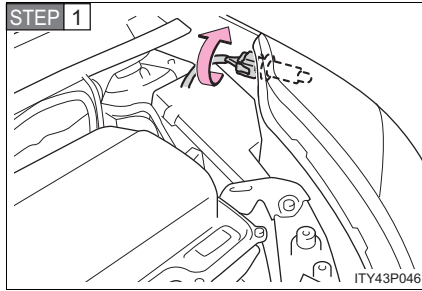

Turn the bulb base counterclockwise.

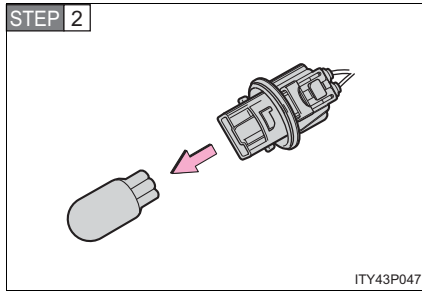

Remove the light bulb.

4-3. Do-it-yourself maintenance

n Back-up lights, tail and rear side maker lights, rear turn signal light

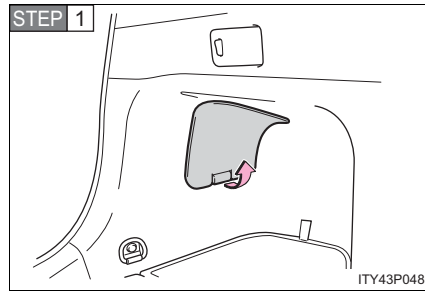

Open the back door and remove the cover.

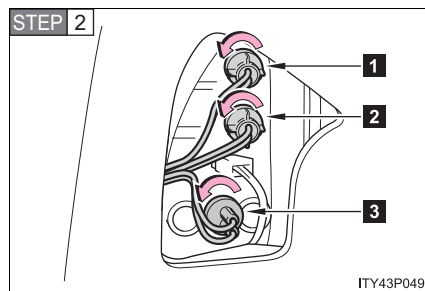

Turn the bulb base counterclockwise.

- 1** Rear turn signal light
- 2** Back-up light
- 3** Tail and rear side marker light

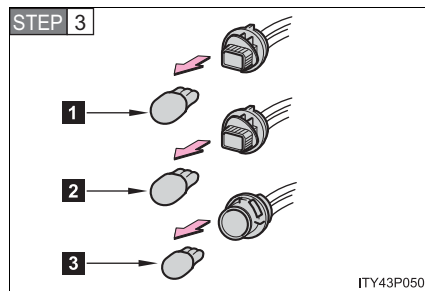

Remove the light bulb.

- 1** Rear turn signal light
- 2** Back-up light
- 3** Tail and rear side marker light

4

Maintenance and care

4-3. Do-it-yourself maintenance

n License plate lights

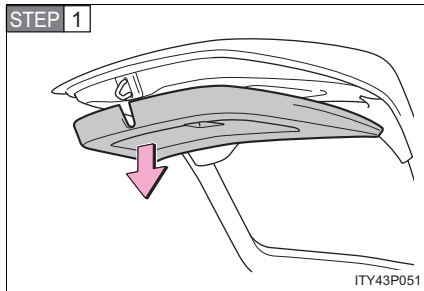

Remove the upper trim board.

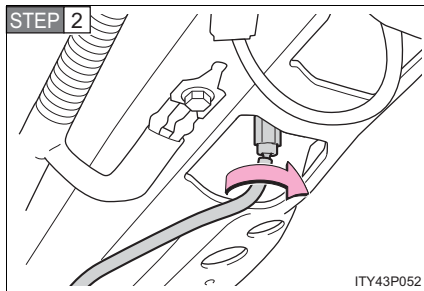

Turn the bulb base counterclockwise.

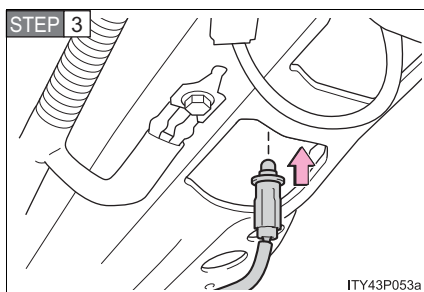

Remove the light bulb.

n Front fog lights

If the high mounted stoplight has burnt out, have it replaced by your Toyota dealer.

4-3. Do-it-yourself maintenance

n **Condensation build-up on the inside of the lens**

Contact your Toyota dealer for more information in the following situations. Temporary condensation build-up on the inside of the headlight lens does not indicate a malfunction.

- l Large drops of water are built up on the inside of the lens.
- l Water has built up inside the headlight.

n **LED light bulbs**

The stop and high mounted stoplights consist of a number of LEDs. If any of the LEDs burn out, take your vehicle to your Toyota dealer to have the light replaced.

If two or more LEDs in a stoplight burn out, your vehicle may not conform to local laws (SAE).

n **High-intensity discharge (HID) headlights**

If voltage to the high-intensity discharge bulbs is insufficient, the light may not come on, or may go out temporarily. The high-intensity discharge bulbs will come on when normal power is restored.

4-3. Do-it-yourself maintenance

CAUTION

n Replacing light bulbs

- I** Turn off the headlights. Do not attempt to replace the bulb immediately after turning off the headlights.
The bulbs become very hot and may cause burns.
- I** Do not touch the glass portion of the light bulb with bare hands. Hold the bulb by the plastic or metal portion.
If the bulb is scratched or dropped it may blow out or crack.
- I** Fully install light bulbs and any parts used to secure them. Failing to do so may result in heat damage, fire, or water entering the headlight unit. This may damage the headlights or cause condensation to build up on the lens.
- I** Do not take apart or repair the low beam discharge headlight bulbs, connectors, power supply circuits, or related components.
Doing so could result in electric shock and death or serious injury.

n High-intensity discharge (HID) headlights

- I** Contact your Toyota dealer before replacing high-intensity discharge headlights (including light bulbs).
- I** Do not touch the high-intensity discharge headlight's high voltage socket when the headlights are turned on. An extremely high voltage of 20000V will be discharged and could result in death or serious injury by electric shock.

n To prevent damage or fire

- Make sure bulbs are fully seated and locked.

5-1. Essential information

Emergency flashers

Use the emergency flashers if the vehicle malfunctions or is involved in an accident.

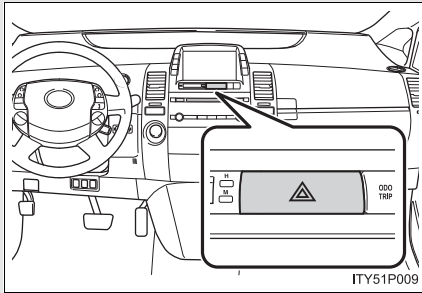

Press the switch to flash all the turn signal lights. To turn them off, push the switch once again.

NOTICE

n To prevent 12 volt battery discharge

Do not leave the emergency flashers on longer than necessary when the hybrid system is not operating.

5-1. Essential information If your vehicle needs to be towed

If towing is necessary, we recommend having your vehicle towed by your Toyota dealer or a commercial towing service, using a lift-type truck or a flat bed truck.

Use a safety chain system for all towing, and abide by all state/provincial and local laws.

If towing from the front, the vehicle's rear wheel and axles must be in good condition. (→P. 417)

If they are damaged, use a towing dolly or flat bed truck.

Before towing

The following may indicate a problem with your transmission. Contact your Toyota dealer before towing.

- 1 The hybrid system is operating, but the vehicle will not move.
- 1 The vehicle makes an abnormal sound.

Emergency towing

If a tow truck is not available, in an emergency your vehicle may be temporarily towed using a cable or chain secured to the emergency towing eyelet. This should only be attempted on hard, surfaced roads for short distances below 18 mph (30km/h).

A driver must be in the vehicle to steer and operate the brakes. The vehicle's wheels, drive train, axles, steering and brakes must be in good condition.

5

When trouble arises

5-1. Essential information

► Towing eyelet

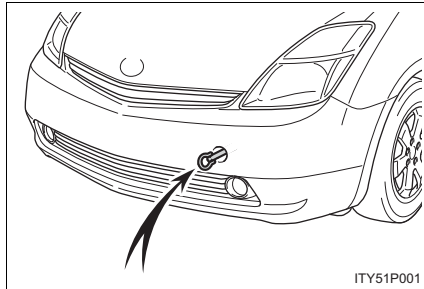

n **Emergency towing procedure**

- STEP 1** Release the parking brake.
- STEP 2** Put the shift lever in "N".
- STEP 3** Turn the "POWER" switch to ACCESSORY (hybrid system off) or ON mode (hybrid system on).

⚠ CAUTION

n **While towing**

- I** Use extreme caution when towing the vehicle. Avoid sudden starts or erratic driving maneuvers which place excessive stress on the emergency towing eyelet and the cable or chain.
- I** If the hybrid system is not operating, the power assist for the brakes and steering will not function, making steering and braking more difficult.

⚠ NOTICE

n **To prevent causing serious damage to the transmission**

- Never tow this vehicle from the rear with the four wheels on the ground. This may cause serious damage to the transmission.

Installing towing eyelet

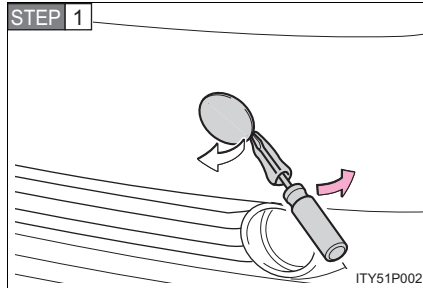

Remove the eyelet cover using a flathead screwdriver.

To protect the bodywork, place a rag between the screwdriver and the vehicle body, as shown in the illustration.

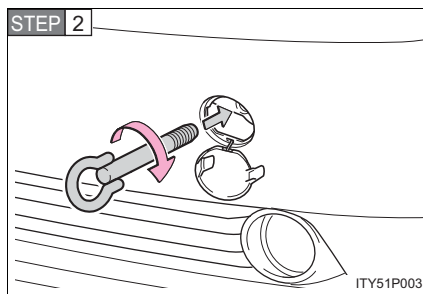

Insert the towing eyelet into the hole and tighten partially by hand.

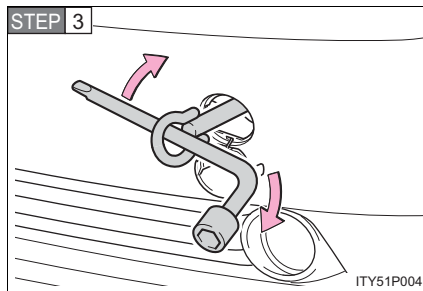

Tighten down the towing eyelet securely using a wheel nut wrench.

n Location of the emergency towing eyelet

→P. 436

5

When trouble arises

5-1. Essential information

CAUTION

n Installing towing eyelet to the vehicle

Make sure that towing eyelet is installed securely.
If not securely installed, towing eyelet may come loose during towing. This may lead to accidents that cause serious injury or even death.

Towing with a sling-type truck

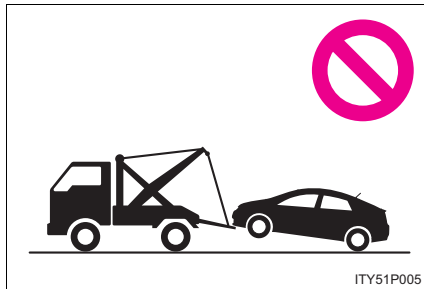

NOTICE

n To prevent body damage

Do not tow with a sling-type truck, either from the front or rear.

5-1. Essential information

Towing with a wheel lift-type truck

► From front

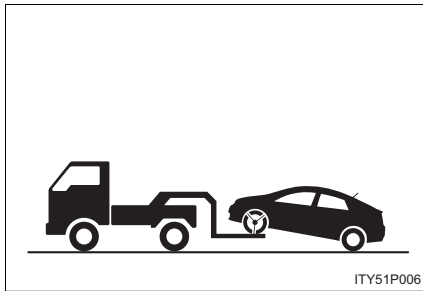

Release the parking brake.

► From rear

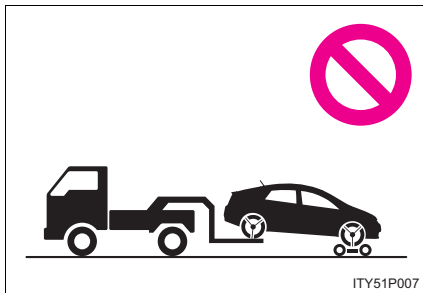

Use a towing dolly under the front wheel.

5

When trouble arises

5-1. Essential information

NOTICE

n To prevent causing serious damage to the transmission

Never tow this vehicle from the rear with the front wheels on the ground.

n To prevent damaging the vehicle

l Do not tow the vehicle with the “POWER” switch OFF.

The steering lock mechanism is not strong enough to hold the front wheel straight.

l When raising the vehicle, ensure adequate ground clearance for towing at the opposite end of the raised vehicle. Without adequate clearance, the vehicle could be damaged while being towed.

5-1. Essential information

Using a flat bed truck

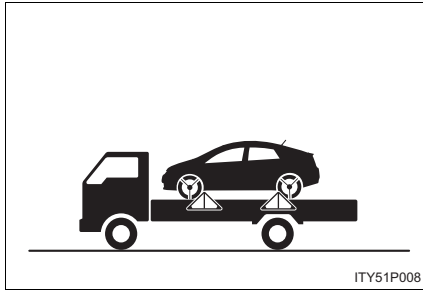

If you use chains or cables to tie down your vehicle, the angles shaded in black must be 45°.

Do not overly tighten the tie downs or the vehicle may be damaged.

5-1. Essential information If you think something is wrong

If you notice any of the following symptoms, your vehicle probably needs adjustment or repair. Contact your Toyota dealer as soon as possible.

n Visible symptoms

- 1 Fluid leaks under the vehicle
(Water dripping from the air conditioning after use is normal.)
- 1 Flat-looking tires or uneven tire wear

n Audible symptoms

- 1 Changes in exhaust sound
- 1 Excessive tire squeal when cornering
- 1 Strange noises related to the suspension system
- 1 Pinging or other noises related to the hybrid system

n Operational symptoms

- 1 Engine missing, stumbling or running rough
- 1 Appreciable loss of power
- 1 Vehicle pulls heavily to one side when braking
- 1 Vehicle pulls heavily to one side when driving on a level road
- 1 Loss of brake effectiveness, spongy feeling, pedal almost touches the floor

5-1. Essential information Event data recorder

Your vehicle has computers that monitor and control certain aspects of your vehicle. These computers assist in driving and maintaining optimal vehicle performance.

Besides storing data useful for troubleshooting, there is a system to record data in a crash or a near car crash event. This is called an Event Data Recorder (EDR).

In a crash or a near car crash event

The SRS airbag sensor assembly contains the EDR. In a crash or a near car crash event, this device may record some or all of the following information:

- 1 Gasoline engine speed
- 1 Whether the brake pedal was applied or not
- 1 Vehicle speed
- 1 To what extent the accelerator pedal was depressed
- 1 Position of the transmission shift lever
- 1 Whether the driver and front passenger wore seat belts or not
- 1 Driver's seat position
- 1 SRS airbag deployment data
- 1 SRS airbag system diagnostic data
- 1 Front passenger's occupant classification

The information above is intended to be used for the purpose of improving vehicle safety performance. Unlike general data recorders, the EDR does not record sound data such as conversation between passengers.

5

When trouble arises

5-1. Essential information

Disclosure of the data

Toyota will not disclose the data recorded in an EDR to a third party except when:

- 1 An agreement from the vehicle's owner (or the leasing company for a leased vehicle) is obtained
- 1 Officially requested by the police or other authorities
- 1 Used as a defense for Toyota in a law suit
- 1 Ordered by a court

However, if necessary Toyota will:



- 1 Use the data for research on Toyota vehicle safety performance
- 1 Disclose the data to a third party for research purposes without disclosing details of the vehicle owner, and only when it is deemed necessary
- 1 Disclose summarized data cleared of vehicle identification information to a non-Toyota organization for research purposes

5-2. Steps to take in an emergency If a warning light turns on or a warning buzzer sounds...

Calmly perform the following actions if any of the warning lights turn on or flash. If a light turns on or flashes, but then turns off, this does not necessarily indicate a malfunction in the system.

Stop the vehicle immediately. Continuing to drive the vehicle may be dangerous.

The following warning indicates a possible problem in the brake system. Immediately stop the vehicle in a safe place and contact your Toyota dealer.

Warning light	Warning light/Details
 BRAKE (U.S.A.)	<p>Brake system warning light and warning buzzer* (red indicator)</p> <ul style="list-style-type: none"> • Low brake fluid • Malfunction in the brake system <p>This light also comes on when the parking brake is not released. If the light turns off after the parking brake is fully released, the system is operating normally.</p>
 (Canada)	



*:Parking brake engaged warning buzzer:

A buzzer will sound if the vehicle is driven at a speed of approximately 3 mph (5 km/h) or more.

5-2. Steps to take in an emergency

Stop the vehicle immediately.



The following warning indicates the possibility of damage to the vehicle that may lead to an accident. Immediately stop the vehicle in a safe place and contact your Toyota dealer.

Warning light	Warning light/Details
 *1	Charging system warning light Indicates a malfunction in the vehicle's charging system.
 *1	Low engine oil pressure warning light Indicates that the engine oil pressure is too low.
 *1	Hybrid system warning light Indicates a malfunction in the hybrid system.







*1: This warning light is displayed on the touch screen.

Have the vehicle inspected by your Toyota dealer immediately.

Failing to investigate the cause of the following warnings may lead to the system operating abnormally and possibly cause an accident. Have the vehicle inspected by your Toyota dealer immediately.

Warning light	Warning light/Details
	Malfunction indicator lamp Malfunction in: <ul style="list-style-type: none"> • The electronic hybrid system control system; • The electronic throttle control system; or • The transmission control system.
	SRS warning light Malfunction in: <ul style="list-style-type: none"> • The SRS airbag system; • Front passenger occupant classification system; or • The seat belt pretensioner system.

5-2. Steps to take in an emergency

Warning light	Warning light/Details
	Vehicle stability control system warning light (if equipped) Indicates a malfunction in the Enhanced VSC system.
 *1	Automatic headlight leveling system warning light (if equipped) Indicates a malfunction in the automatic headlight leveling system.
 (U.S.A.)  (Canada)	ABS warning light Malfunction in: <ul style="list-style-type: none"> • The ABS; or • The brake assist system.
	Brake system warning light (yellow indicator) Malfunction in the electronically controlled brake system.
 *1 or  *1	Electric power steering system warning light Malfunction in the EPS (Electric Power Steering).





*1: This warning light is displayed on the touch screen.

5
When trouble arises





5-2. Steps to take in an emergency

Have the malfunction repaired immediately.

After taking the specified steps to correct the suspected problem, check that the warning light turns off.

Warning light	Warning light/Details	Correction procedure
	Open door warning light (warning buzzer)*² A door or a back door is not fully closed.	Check that all doors and the back door are closed.
	Low fuel level warning light Remaining fuel (Approximately 3.0 gal. [11.4 L, 2.5 Imp.gal.] or less)	Refuel the vehicle.
	Driver's seat belt reminder light (warning buzzer)*³ Warns the driver to fasten his/her seat belt.	Fasten the seat belt.
	Front passenger's seat belt reminder light (warning buzzer)*³ Warns the front passenger to fasten his/her seat belt.	Fasten the seat belt.
	Tire pressure warning light	
	When the light comes on: Low tire inflation pressure.	Adjust the tire inflation pressure.
	When the light stays on after blinking for 1 minute: Malfunction in the tire pressure warning system.	Have the system checked by your Toyota dealer.

5-2. Steps to take in an emergency

Warning light	Warning light/Details	Correction procedure
	Engine oil replacement reminder light Illuminates for about 3 seconds and then flashes for about 15 seconds: Engine oil is scheduled to be changed.	Check and the engine oil, and change if necessary.
	Comes on and remains: Engine oil should be changed.	Check and change the engine oil.
 *1	Hybrid battery warning light The hybrid battery voltage drops when the transmission is left in "N" position.	Push the "P" position switch.
	The hybrid battery is discharged.	If this light comes on with the "READY" light on in this case, have the system checked by your Toyota dealer.
 *1	High coolant temperature warning light Indicates high engine coolant temperature	→P. 454
	Master warning light A buzzer sounds and the warning light comes on and flashes to indicate that the master warning system has detected a malfunction.	Take appropriate action in accordance with the message displayed on the touch screen.

*1: This warning light is displayed on the touch screen.

*2: Open door warning buzzer:



5-2. Steps to take in an emergency

*3:Driver's and front passenger's seat belt reminder buzzer:



The driver's and front passenger's seat belts reminder sounds to alert the driver and front passenger that his or her seat belt is not fastened. The buzzer sounds intermittently for 10 seconds after the vehicle has reached a speed of at least 12 mph (20 km/h). Then, if the seat belt is still unfastened, the buzzer will sound in a different tone for 20 more seconds.

Have the malfunction repaired immediately. (vehicles with smart key system)

After taking the specified steps to correct the suspected problem, check that the warning light turn off.

Alarm	Warning light	Details	Correction procedure
Interior and exterior alarm: One beep (sounds continuously)		The driver has removed the smart key from the vehicle while the hybrid system is not OFF and the shift lever is in a position other than "P".	Pressing the "P" position switch before removing the smart key from the vehicle and turning the hybrid system OFF.
Interior alarm: One beep Exterior alarm: 3 beeps		The driver has removed the smart key from the vehicle while the hybrid system is not OFF and the shift lever is in the "P" position.	Turn the hybrid system OFF and remove the key from the vehicle.
		A passenger has removed the smart key from the vehicle while the hybrid system is not OFF.	Check whether the passenger leaving the vehicle is carrying the smart key.

5-2. Steps to take in an emergency

Alarm	Warning light	Details	Correction procedure
Exterior alarm: One beep (sounds for 2 seconds)		The lock button has been pressed while the hybrid system is not OFF and the shift position is in "P".	Turn the hybrid system OFF.
Interior alarm: One beep	 (for 5 seconds)	The vehicle's ID code detection system has judged that the smart key is not present when the "POWER" switch is pressed.	Check that the smart key is in the vehicle and within the detection area.

5-2. Steps to take in an emergency

n **If the malfunction indicator lamp comes on while driving**

First check the following:

- 1 Is your vehicle low on gas?
If it is, refuel the vehicle immediately.
- 1 Is the fuel tank cap loose?
If it is, tighten it securely.

The light will go off after taking several driving trips.

If the light does not go off even after several trips, contact your Toyota dealer as soon as possible.

n **Power steering warning light**

When the voltage is low or drops, the power steering warning light may come on.

n **SRS warning light**

This warning light system monitors the following:

- 1 The airbag sensor assembly
- 1 Front airbag sensors
- 1 The curtain shield airbag sensors
- 1 The side and curtain shield airbag sensor assemblies
- 1 The driver's seat position sensor
- 1 Driver's seat belt buckle switch
- 1 The front passenger occupant classification ECU
- 1 The pressure sensor
- 1 The belt tension sensor
- 1 "AIR BAG ON" and "AIR BAG OFF" indicator lights
- 1 Front passenger's seat belt buckle switch
- 1 The inflators
- 1 The warning light
- 1 The interconnecting wiring and power sources

5-2. Steps to take in an emergency

n Front passenger detection sensor and passenger seat belt reminder

If luggage is placed on the front passenger seat, the front passenger detection sensor may cause the warning light to flash, even if a passenger is not sitting in the seat.

n When the tire pressure warning light comes on

Check the tire inflation pressure and adjust to the appropriate level. Pushing the tire pressure warning reset switch does not turn off the tire pressure warning light.

n The tire pressure warning light may turn on due to natural causes

The tire pressure warning light may turn on due to natural causes such as natural air leaks or tire inflation pressure changes caused by temperature. In this case, adjusting the tire inflation pressure will turn off the warning light (after a few minutes).

n When a tire is replaced with a spare tire

The compact spare tire is not equipped with the tire pressure warning valve and transmitter. If a tire goes flat, the tire pressure warning light will not turn off even though the flat tire is replaced with the spare tire. Replace the spare tire with the repaired tire and adjust the proper tire inflation pressure. The tire pressure warning light will turn off after a few minutes.

n If the tire pressure warning system is inoperative

The tire pressure warning system will be disabled in the following conditions:

(When the condition becomes normal, the system will work properly.)

- 1 If tires not equipped with tire pressure warning valves and transmitters are used.
- 1 If the ID code on the tire pressure warning valves and transmitters is not registered in the tire pressure warning computer.
- 1 If the tire inflation pressure is 73 psi (500 kPa, 5.1 kgf/cm² or bar) or higher.

5-2. Steps to take in an emergency

The tire pressure warning system may be disabled in the following conditions:

(When the condition becomes normal, the system will work properly.)

- 1 If electronic devices or facilities using similar radio wave frequencies are nearby.
- 1 If a radio set at similar frequencies is in use in the vehicle.
- 1 If a window tint that affects the radio wave signals is installed.
- 1 If there is a lot of snow or ice on the vehicle, in particular around the wheels or wheel housings.
- 1 If non-genuine Toyota wheels are used (Even if you use Toyota wheels, the tire pressure warning system may not work properly with some types of tires.).
- 1 If tire chains are used.
- n **If the tire pressure warning light comes on after blinking for 1 minute frequently**

If the tire pressure warning light comes on after blinking for 1 minute frequently when the "POWER" switch is turned to ON mode, have it checked by your Toyota dealer.

5-2. Steps to take in an emergency

CAUTION

n When the power steering warning light comes on

The steering wheel may become extremely heavy.
If the steering wheel becomes heavier than usual when operating, firmly hold and operate it using more force than usual.

n If the tire pressure warning light comes on

Be sure to observe the following precautions. Failure to do so could cause loss of vehicle control and result in death or serious injury.

- l** Stop your vehicle in a safe place as soon as possible. Adjust the tire inflation pressure immediately.
- l** If the tire pressure warning light comes on even after tire inflation pressure adjustment, it is probable that you have a flat tire. Check the tires. If the tire is flat, change to the spare tire and have the flat tire repaired by the nearest Toyota dealer.
- l** Avoid abrupt maneuvering and braking. If the vehicle tires deteriorate, you could lose control of the steering wheel or the brakes.

n If a blowout or sudden air loss should occur

The tire pressure warning system may not activate immediately.

5

When trouble arises

433

5-2. Steps to take in an emergency

CAUTION

n Maintenance of the tires

Each tire, including the spare (if provided), should be checked monthly when cold and inflated to the inflation pressure recommended by the vehicle manufacturer on the vehicle placard or tire inflation pressure label (tire and load information label). (If your vehicle has tires of a different size than the size indicated on the vehicle placard or tire inflation pressure label [tire and load information label], you should determine the proper tire inflation pressure for those tires.)

As an added safety feature, your vehicle has been equipped with a tire pressure monitoring system (TPMS-tire pressure warning system) that illuminates a low tire pressure telltale (tire pressure warning light) when one or more of your tires is significantly under-inflated. Accordingly, when the low tire pressure telltale (tire pressure warning light) illuminates, you should stop and check your tires as soon as possible, and inflate them to the proper pressure. Driving on a significantly under-inflated tire causes the tire to overheat and can lead to tire failure. Under-inflation also reduces fuel efficiency and tire tread life, and may affect the vehicle's handling and stopping ability.

Please note that the TPMS (tire pressure warning system) is not a substitute for proper tire maintenance, and it is the driver's responsibility to maintain correct tire pressure, even if under-inflation has not reached the level to trigger illumination of the TPMS low tire pressure telltale (tire pressure warning light).

5-2. Steps to take in an emergency

CAUTION

Your vehicle has also been equipped with a TPMS (tire pressure warning system) malfunction indicator to indicate when the system is not operating properly. The TPMS (tire pressure warning system) malfunction indicator is combined with the low tire pressure telltale (tire pressure warning light). When the system detects a malfunction, the telltale will flash for approximately one minute and then remain continuously illuminated. This sequence will continue upon subsequent vehicle start-ups as long as the malfunction exists. When the malfunction indicator is illuminated, the system may not be able to detect or signal low tire pressure as intended.

TPMS (tire pressure warning system) malfunctions may occur for a variety of reasons, including the installation of replacement or alternate tires or wheels on the vehicle that prevent the TPMS (tire pressure warning system) from functioning properly. Always check the TPMS (tire pressure warning system) malfunction telltale after replacing one or more tires or wheels on your vehicle to ensure that the replacement or alternate tires and wheels allow the TPMS (tire pressure warning system) to continue to function properly.

NOTICE

n Precaution when installing a different tire

When a tire of a different specification or maker is installed, the tire pressure warning system may not operate properly.

5

When trouble arises

435

5-2. Steps to take in an emergency If you have a flat tire

Remove the flat tire and replace it with the spare provided.

n Before jacking up the vehicle

- 1 Stop the vehicle on a hard, flat surface.
- 1 Set the parking brake.
- 1 Push the “P” position switch
- 1 Stop the hybrid system.
- 1 Turn on the emergency flashers.

n Location of the spare tire, jack and tools

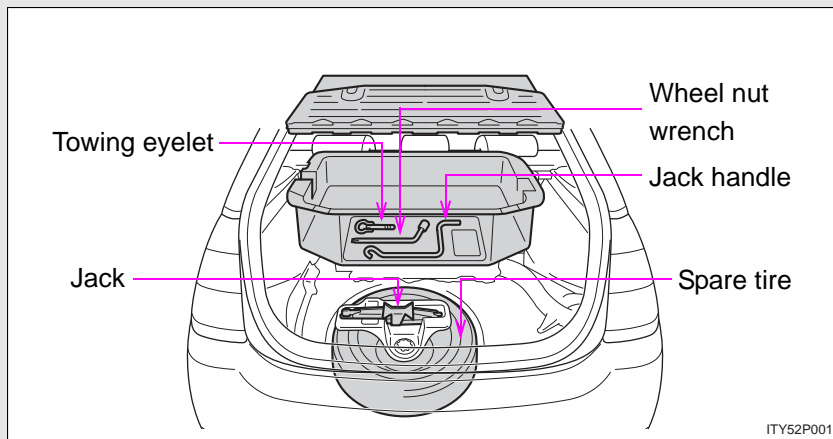

5-2. Steps to take in an emergency

n Compact spare tire

The compact spare tire saves space in your luggage compartment, and its lighter weight helps to enhance fuel economy and permits easier installation in case of a flat tire.

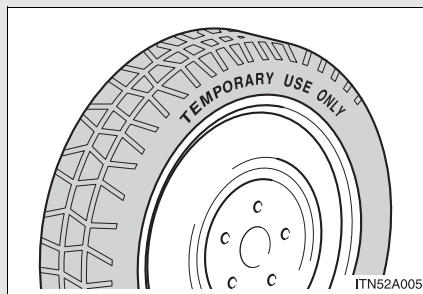

The compact spare tire is designed for temporary emergency use only.

n The compact spare tire

- 1 The compact spare tire is identified by the label "TEMPORARY USE ONLY" on the tire sidewall.
Use the compact spare tire temporarily only in an emergency.
- 1 Make sure to check the tire inflation pressure of the compact spare tire. (→P. 468)

n Tread life

The compact spare tire can be used many times, if necessary. It has tread life of up to 3000 miles (4800 km) depending on road conditions and your driving habits. When treadwear indicators appear on the tire, replace the tire. (→P. 375)

n When using the compact spare tire

As the compact spare tire is not equipped with the tire pressure warning valve and transmitter, low inflation pressure of the spare tire will not be warned. Also, if you replace the compact spare tire after the tire pressure warning light comes on, the light remains on.

5

When trouble arises

5-2. Steps to take in an emergency

Taking out the jack.

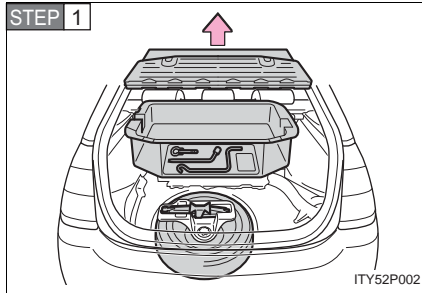

Open the auxiliary box.
(→P. 333)

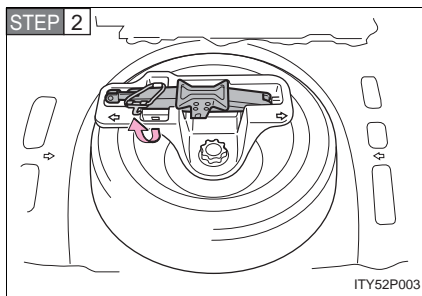

Unlock the tightening strap.

After storing the jack, make sure it is securely held by the tightening strap.

5-2. Steps to take in an emergency

Taking out the spare tire

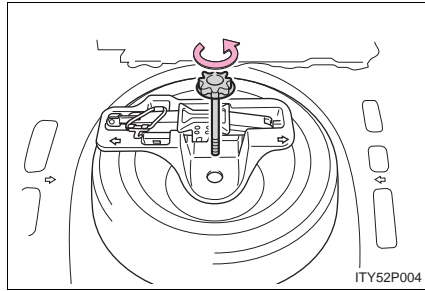

Loosen the center fastener that secures the spare tire.

Replacing a flat tire

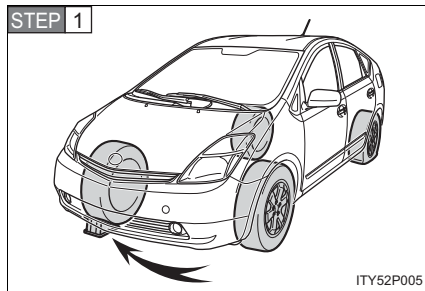

Chock the tires.

Flat tire		Wheel chock positions
Front	Left-hand side	Behind the rear right-hand side tire
	Right-hand side	Behind the rear left-hand side tire
Rear	Left-hand side	In front of the front right-hand side tire
	Right-hand side	In front of the front left-hand side tire

5

When trouble arises

5-2. Steps to take in an emergency

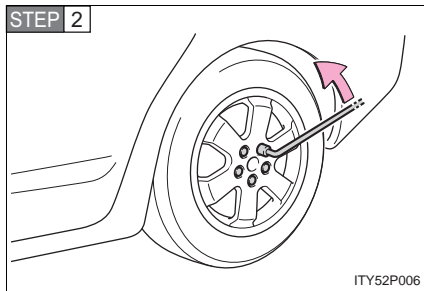

Slightly loosen the wheel nuts (one turn).

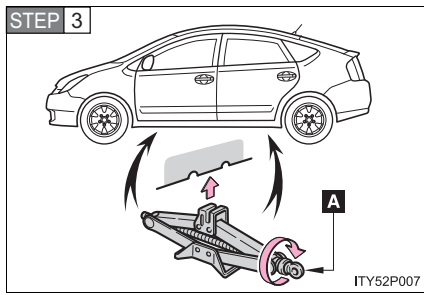

Turn the tire jack portion "A" by hand until the notch of the jack is in contact with the jack point.

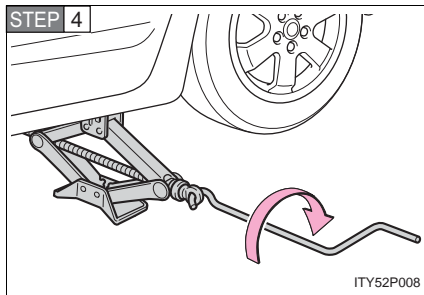

Raise the vehicle until the tire is slightly raised off the ground.

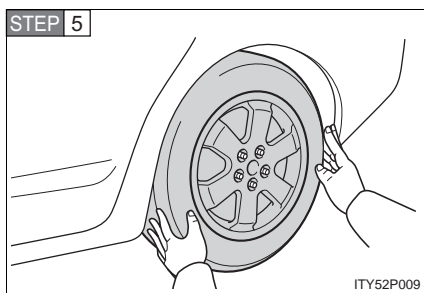

Remove all the wheel nuts and the tire.

When resting the tire on the ground, place the tire so that the wheel design faces up to avoid scratching the wheel surface.

5-2. Steps to take in an emergency

Installing the spare tire

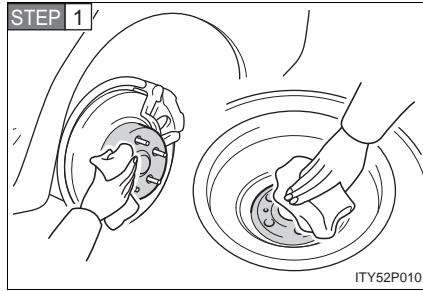

Remove any dirt or foreign matter from the wheel contact surface.

If foreign matter is on the wheel contact surface, the wheel nuts may loosen while the vehicle is in motion, and the tire may come off the vehicle.

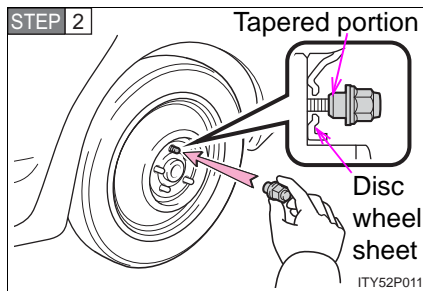

Install the spare tire and loosely tighten each nut by hand to approximately the same amount.

Tighten the wheel nuts until the tapered portion comes into loose contact with the disc wheel sheet.

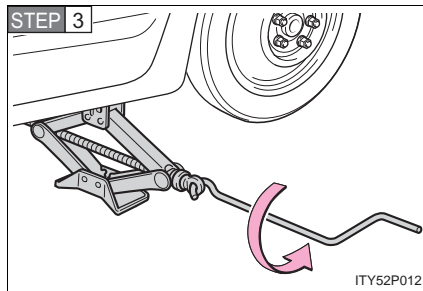

Lower the vehicle.

5

When trouble arises

5-2. Steps to take in an emergency

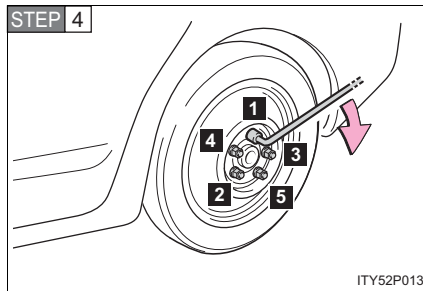

Firmly tighten each nut two or three times in the order shown in the illustration.

Tightening torque:
76 ft•lb (103 N•m, 10.5 kgf•m)

STEP 5 Stow the flat tire, the tire jack and all tools.

n **If you have a flat front tire on a road covered with snow or ice**

Install the compact spare tire on the rear of the vehicle. Perform the following steps and fit tire chains to the front tires.

STEP 1 Replace a rear tire with the compact spare tire.

STEP 2 Replace the flat front tire with the tire removed from the rear of the vehicle.

STEP 3 Fit tire chains to the front tires.

n **After completing the tire change**

The tire pressure warning system must be reset. (→P. 376)

5-2. Steps to take in an emergency

CAUTION

n Using the tire jack

Improper use of the tire jack may lead to death or injuries due to the vehicle suddenly falling off the jack.

- I** Do not use the tire jack for any purpose other than replacing tires or installing and removing tire chains.
- I** Only use the tire jack that comes with this vehicle for replacing a flat tire.
Do not use it on other vehicles, and do not use other tire jacks for replacing tires on this vehicle.
- I** Always check that the tire jack is securely set to the jack point.
- I** Do not raise the vehicle while someone is in it.
- I** When raising the vehicle, do not put an object on or under the jack.
- I** Do not raise the vehicle to a height greater than that required to replace the tire.
- I** Use a jack stand if it is necessary to get under the vehicle.
- I** Do not put any part of your body under the vehicle supported by a jack.
- I** Do not start or operate the hybrid system while your vehicle is supported by the jack.

Take particular care when lowering the vehicle to ensure that no one working on or near the vehicle may be injured.

n Replacing a flat tire

Observe the following precautions to reduce the risk of death or serious injury.

- I** Never use oil or grease on the wheel bolts or wheel nuts.
The oil or grease can cause the wheel nuts to loosen, causing a serious accident. Remove any oil or grease on the wheel bolts or wheel nuts.
- I** Have the wheel nuts tightened with a torque wrench to 76 ft•lbf (103 N•m, 10.5 kgf•m) as soon as possible after changing wheels.
Failure to follow these precautions could cause the nuts to loosen and the wheels may fall off, which could lead to an accident causing death or serious injury.

5

When trouble arises

5-2. Steps to take in an emergency

CAUTION

n When using the compact spare tire

- I** Remember that your spare tire is specifically designed for use with your vehicle. Do not use your spare tire on another vehicle.
- I** Do not use two spare tires simultaneously.
- I** Replace the compact spare tire with a standard tire as soon as possible.
- I** Avoid sudden acceleration, deceleration and braking, as well as sharp cornering.

n Speed limit when using the compact spare tire

Do not drive at speeds in excess of 50 mph (80 km/h) when a compact spare tire is installed on the vehicle.

The compact spare tire is not designed for driving at high speeds. Failing to observe this precaution may lead to an accident causing death or serious injury.

n When the spare tire is attached

The vehicle speed may not be correctly detected, and the following systems may not operate correctly:

- I** ABS & Brake assist
- I** Enhanced VSC
- I** Navigation system

5-2. Steps to take in an emergency

NOTICE

n Do not drive the vehicle with a flat tire

Do not continue driving with a flat tire. Driving even a short distance with a flat tire can damage the tire and the wheel beyond repair.

n Be careful when driving over bumps with the compact spare tire installed on the vehicle

The vehicle becomes lower when driving with the compact spare tire compared to when driving with standard tires. Be careful when driving over uneven road surfaces.

n Driving with tire chains and the compact spare tire

Do not fit tire chains to the compact spare tire. Tire chains may damage the vehicle body and adversely affect driving performance.

n When replacing the tires

When removing or fitting the wheels, tires or the tire pressure warning valve and transmitter, contact your Toyota dealer as the tire pressure warning valve and transmitter may be damaged if not handled correctly.

n To avoid damaging the tire pressure warning valves and transmitters

Do not use liquid sealants on flat tires.

5

When trouble arises

445

5-2. Steps to take in an emergency If the hybrid system will not start

If the hybrid system will not start even though correct starting procedures are being followed (→P. 132), consider each of the following points.

n The hybrid system will not start even when the starter motor operates normally.

One of the following may be the cause of the problem.

- 1 The electronic key battery may be discharged. (→P. 448)
- 1 The hybrid system may be flooded.
Try to restart the hybrid system once more following correct starting procedures. (P. 132)
- 1 There may be a malfunction in the immobilizer system.
(→P. 82)

n The interior lights and headlights are dim, or the horn does not sound or sounds at a low volume

One of the following may be the cause of the problem.

- 1 The 12 volt battery may be discharged. (→P. 449)
- 1 The 12 volt battery terminal connections may be loose or corroded.

n The interior lights and headlights do not turn on, or the horn does not sound

One of the following may be the cause of the problem.

- 1 One or both of the 12 volt battery terminals may be disconnected.
- 1 The 12 volt battery may be discharged. (→P. 449)

Contact your Toyota dealer if the problem cannot be repaired, or if repair procedures are unknown.

5-2. Steps to take in an emergency If you lose your keys

New genuine Toyota keys can be made by your Toyota dealer using master key and the key number stamped on your key number plate.

5

When trouble arises

447

5-2. Steps to take in an emergency If the electronic key does not operate properly

If the electronic key battery is discharged, the doors can be opened by the mechanical key. The hybrid system can be still started by following the procedure.

Locking and unlocking the doors

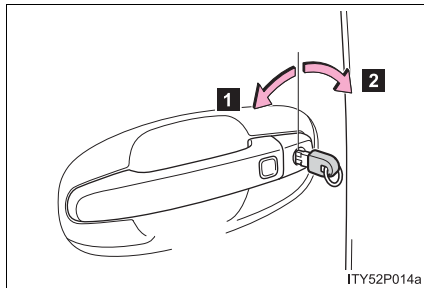

Using the mechanical key (→P. 34) in order to perform the following operations:

- 1** Locks all doors
- 2** Unlocks the door

Turning the key rearward unlocks the driver's door. Turning the key once again unlocks the other doors.

Starting the hybrid system

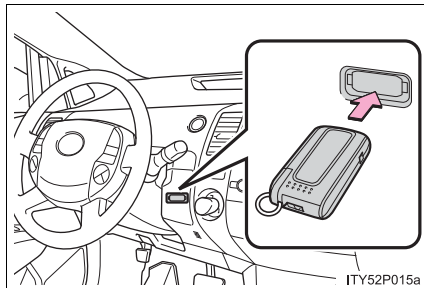

To start the hybrid system, insert the key into the key slot. (→P. 134)

n Replacing the key battery

As this procedure is the temporary measure, it is recommended that the electronic key battery be replaced immediately. (→P. 392)

5-2. Steps to take in an emergency If the 12 volt battery is discharged

The following procedures may be used to start the hybrid system if the vehicle's 12 volt battery is discharged.

You can call your Toyota dealer, or qualified repair shop.

If you have a set of jumper (or booster) cables and a second vehicle with a 12 volt battery, you can jump start your Toyota following the steps below.

STEP 1 Open the hood and fuse block cover.

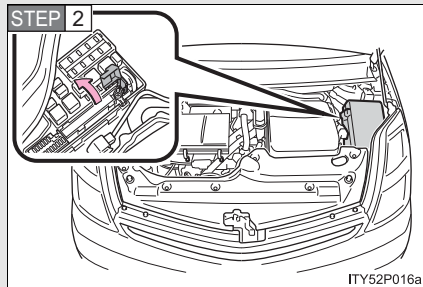

Open the exclusive jump starting terminal cover.

5-2. Steps to take in an emergency

STEP 3 Connecting the jumper cables.

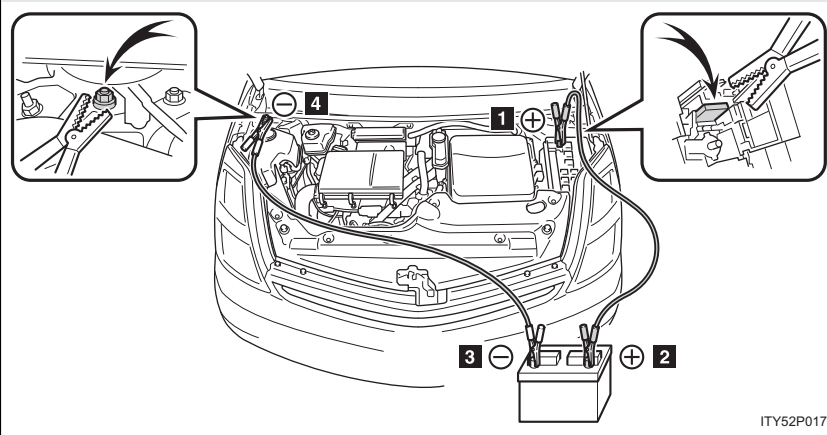

- 1** Exclusive jump starting terminal on your vehicle.
- 2** Positive (+) battery terminal on the second vehicle.
- 3** Negative (-) battery terminal on the second vehicle.
- 4** Connect the jumper cable to ground on your vehicle as shown in the illustration.

5-2. Steps to take in an emergency

- STEP 4** Start the engine of the second vehicle. Increase the engine speed slightly and maintain at that level for approximately five minutes to recharge the 12 volt battery of your vehicle.
- STEP 5** Open and close any of the doors with the “POWER” switch OFF.
- STEP 6** Maintain the engine speed on the second vehicle and turn the “POWER” switch to the ON mode, then start the vehicle’s hybrid system.
- STEP 7** Make sure the “READY” light comes on. If the “READY” light will not come on and the hybrid system will not start after you recharge the battery, do the following procedure. Turn the hybrid system off. Open and close the driver’s door. Then push the “POWER” switch briefly and firmly. If the light does not come on, contact your Toyota dealer.
- STEP 8** Once the vehicle’s hybrid system has started, remove the jumper cables in the exact reverse order in which they were connected.

Once the hybrid system starts, have the vehicle checked at your Toyota dealer as soon as possible.

n **Starting the hybrid system when the battery is discharged**

The hybrid system cannot be started by push-starting.

n **Avoiding a discharged 12 volt battery**

- 1 Turn off the headlights and the audio system while the hybrid system is turned off.
- 1 Turn off any unnecessary electrical components when the vehicle is running at a low speed for an extended period, such as in heavy traffic, etc.

5

When trouble arises

5-2. Steps to take in an emergency

n **When the 12 volt battery is removed or discharged**

The following systems must be initialized.

- l Power windows (→P. 76)
- l The hybrid system may not start. (→P. 446)

CAUTION

n **Avoiding 12 volt battery fires or explosions**

Observe the following precautions to prevent accidentally igniting the flammable gas that may be emitted from the 12 volt battery.

- l Make sure the jumper cable is connected to the correct terminal and that it is not unintentionally in contact with any part other than the intended terminal.
- l Do not allow the jumper cables to come into contact with the “+” and “-” terminals.
- l Do not allow open flame or use matches, cigarette lighters or smoke near the 12 volt battery.

n **12 volt battery precautions**

The 12 volt battery contains poisonous and corrosive acidic electrolyte, while related parts contain lead and lead compounds. Observe the following precautions when handling the 12 volt battery:

- l When working with the 12 volt battery, always wear safety glasses and take care not to allow any battery fluids (acid) to come into contact with skin, clothing or the vehicle body.
- l Do not lean over the 12 volt battery.
- l In the event that battery fluid comes into contact with the skin or eyes, immediately wash the affected area with water and seek medical attention. Place a wet sponge or cloth over the affected area until medical attention can be received.
- l Always wash your hands after handling the battery support, terminals, and other battery-related parts.
- l Do not allow children near the 12 volt battery.

5-2. Steps to take in an emergency

NOTICE

n To prevent damaging the vehicle

The exclusive jump starting terminal is to be used when charging the 12 volt battery from another vehicle in an emergency. It cannot be used to jump start another vehicle.

n When handling jumper cables

Be careful that the jumper cables do not become tangled in the cooling fan or any of the belts when connecting or disconnecting them.

5-2. Steps to take in an emergency If your vehicle overheats

The following may indicate that your vehicle is overheating:

The high engine coolant temperature warning light comes on:
The hybrid system may be overheating.

Follow the correction procedure as described below.

Correction procedures

STEP 1 Stop the vehicle in a safe place and turn off the automatic air conditioning system.

STEP 2 Check to see if steam is coming out from under the hood.

If you see steam:

Stop the hybrid system. Carefully lift the hood after the steam subsides and then restart the hybrid system.

If you do not see steam:

Leave the hybrid system operating and carefully lift the hood.

STEP 3 Remove the engine compartment cover. (→P. 361)

STEP 4 Check to see if the cooling fan is operating.

If the fan is operating:

Wait until the engine coolant temperature gauge begins to fall and then stop the hybrid system.

If the fan is not operating:

Stop the hybrid system immediately and call your local Toyota dealer.

5-2. Steps to take in an emergency

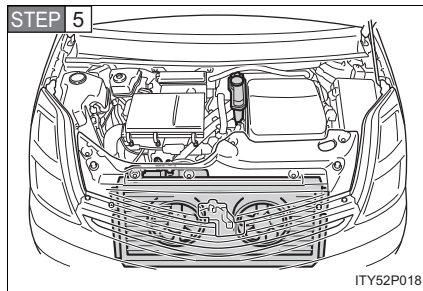

After the hybrid system has cooled down sufficiently, check the coolant level and inspect the radiator core (radiator) for any leaks.

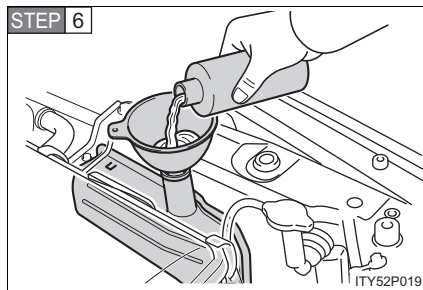

Add coolant if required.

Water can be used in an emergency measure if coolant is unavailable. (→P. 465)

Have the vehicle checked at your nearest Toyota dealer as soon as possible.

n Overheating

In the following situations, your vehicle may be overheating.

- 1 High coolant temperature warning light is displayed on the touch screen.
- 1 Steam is coming from under the hood.

5

When trouble arises

5-2. Steps to take in an emergency

CAUTION

n To prevent an accident or injury when inspecting under the hood of your vehicle

- I** If steam is seen coming from under the hood, do not open the hood until the steam has subsided. The engine compartment may be very hot, causing serious injury such as burns.
- I** Keep hands and clothing away from the fan and engine drive belt while the hybrid system is operating.
- I** Do not loosen the radiator cap while the hybrid system and radiator are hot.
Serious injury, such as burns, may result from hot coolant and steam released under pressure.

NOTICE

n When adding engine coolant

- Wait until the hybrid system has cooled down before adding engine/inverter coolant.
- When adding coolant, do so slowly. Adding cool coolant to a hot hybrid system too quickly can cause damage to the hybrid system.

5-2. Steps to take in an emergency If the vehicle becomes stuck

Carry out the following procedures if the tires spin or the vehicle becomes stuck in mud, dirt, or snow.

STEP 1 Stop the hybrid system. Set the parking brake and push the “P” position switch.

STEP 2 Remove the mud, snow, or sand from around the stuck tire.

STEP 3 Place wood, stones or some other material to help provide traction under the tires.

STEP 4 Restart the hybrid system.

STEP 5 Carefully apply the accelerator to free the vehicle.

CAUTION

n When attempting to free a stuck vehicle

If you choose to rock the vehicle back and forth to free it, make sure the surrounding area is clear, to avoid striking other vehicles, objects or persons. The vehicle may also lunge forward or lunge back suddenly as it becomes free. Use extreme caution.

n When shifting the shift lever

Be careful not to shift the shift lever with the accelerator pedal depressed. This may lead to unexpected rapid acceleration of the vehicle that may cause an accident and result in death or serious injury.

NOTICE

n To avoid damaging the transmission and other components

l Avoid spinning the wheels.

l If the vehicle remains stuck after trying these procedures, the vehicle may require towing to be freed.

5

When trouble arises

5-2. Steps to take in an emergency

6-1. Specifications Maintenance data (fuel, oil level, etc.)

Dimensions and weight

Overall length	175.0 in. (4445 mm)	
Overall width	67.9 in. (1725 mm)	
Overall height *	58.7 in. (1490 mm)	
Wheelbase	106.3 in. (2700 mm)	
Tread	Front	59.3 in. (1505 mm)
	Rear	58.3 in. (1480 mm)
Vehicle capacity weight (Occupants + luggage)	810 lb. (365 kg)	

*:Unladen vehicle

Vehicle identification

The vehicle identification number (VIN) is the legal identifier for your vehicle. This is the primary identification number for your Toyota. It is used in registering the ownership of your vehicle.

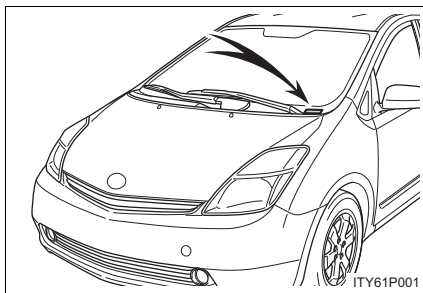

This number is stamped on the top left of the instrument panel.

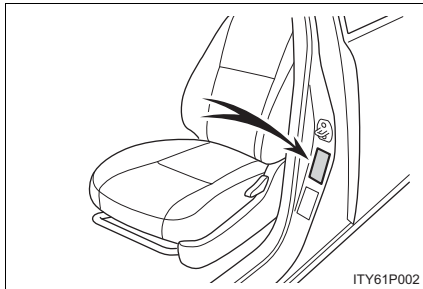

This number is also on the Certification Label.

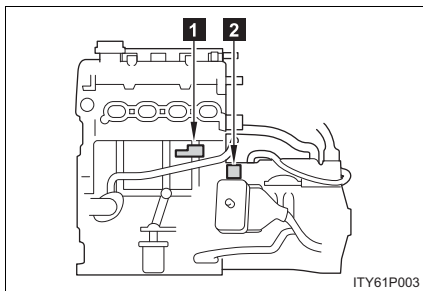

The gasoline engine number and electric motor (traction motor) number are stamped on the engine block as shown.

- 1** Gasoline engine number
- 2** Electric motor (traction motor) number

6

Vehicle specifications

6-1. Specifications

Engine

Model	1NZ-FXE
Type	4-cylinder in line, 4-cycle, gasoline
Bore and stroke	2.95 × 3.33 in. (75.0 × 84.7 mm)
Displacement	91.4 cu. in. (1497 cm ³)
Drive belt tension	<p>44 - 88 lbf(196 - 392 N, 20 - 40 kgf)*</p> <div data-bbox="715 824 1145 1115" data-label="Diagram"> <p>The diagram shows a belt loop around three pulleys. The top pulley is labeled 'Idler assembly', the bottom-left pulley is 'Crankshaft', and the bottom-right pulley is 'Water pump'. A pink arrow points to the top of the idler pulley where the belt is tensioned. The diagram is labeled 'ITY61P012'.</p> </div> <p>*: Drive belt tension measured with Boroughs drive belt tension gauge No. BT-33-73F (used belt)</p>
Valve clearance (engine cold)	
Intake	0.007 - 0.009 in. (0.17 - 0.23 mm)
Exhaust	0.011 - 0.013 in. (0.27 - 0.33 mm)

Fuel

Fuel type	Unleaded gasoline only
Octane Rating	87 (Research Octane Number 91) or higher
Fuel tank capacity	11.9 gal. (45 L, 9.9 Imp.gal.)

6-1. Specifications

Electric motor (Traction motor)

Type	Permanent magnet synchronous motor
Maximum output	50 kW
Maximum torque	400 N•m (40.8 kgf•m, 295 ft•lbf)

Hybrid battery (Traction battery)

Type	Nickel-Metal hydride battery
Voltage	7.2 V/module
Capacity	6.5 Ah (3HR)
Quantity	28 modules
Overall voltage	201.6 V

6-1. Specifications

Lubrication system

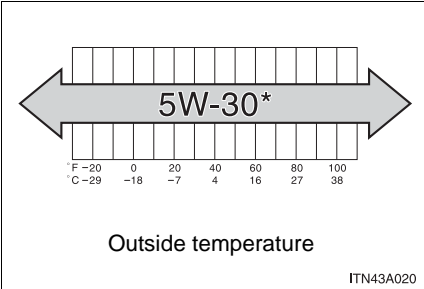
Oil capacity drain and refill with filter without filter	3.9 qt. (3.7 L, 3.3 Imp.qt.) 3.6 qt. (3.4 L, 3.0 Imp.qt.)
Oil grade	ILSAC multigrade engine oil
Recommended oil viscosity	<p>Use Toyota approved "Toyota Genuine Motor Oil" or equivalent to satisfy the grade and viscosity shown below.</p>  <p style="text-align: right;">ITN43A020</p>

*:5W-30 is an oil that provides optimal levels of fuel efficiency.

Oil viscosity:

- 1 The 5W portion of the oil viscosity rating indicates the characteristic of the oil which allows cold startability. Oils with a lower value before the W allow for easier starting of the engine in cold weather.
- 1 The 30 in 5W-30 indicates the oil viscosity when the oil is as its operating temperature. An oil with a higher viscosity may be better suited if the vehicle is operated at high speeds, or under extreme load condition.

6-1. Specifications

Cooling system

Capacity	
Gasoline engine	9.0 qt. (8.6 L, 7.5 Imp.qt.)
Power control unit	2.9 qt. (2.7 L, 2.4 Imp.qt.)
Coolant type	Use either of the following: <ul style="list-style-type: none"> • “Toyota Super Long Life Coolant” • Similar high-quality ethylene glycol-based non-silicate, non-amine, non-nitrite, and non-borate coolant with long-life hybrid organic acid technology Do not use plain water alone.

Ignition system

Spark plug	
Make	DENSO NGK
	SK16R11 IFR5A11
Gap	0.043 in. (1.1 mm)

 **NOTICE**

n Iridium-tipped spark plugs

Use only iridium-tipped spark plugs. Do not adjust gap when tuning engine.

6

Vehicle specifications

6-1. Specifications

Electrical system

12 volt battery	
Open voltage at 68°F (20°C):	12.6 — 12.8 V Fully charged 12.2 — 12.4 V Half charged 11.5 — 11.9 V Discharged (Voltage is checked 20 minutes after the hybrid system and all lights are turned off.)
Charging rates	3.5 A max.

Transmission

Fluid capacity Drain and refill	3.8 qt. (3.6 L, 3.2 Imp.qt.)
Fluid type	Toyota Genuine ATF WS

 **NOTICE**

n Transmission fluid type

Using transmission fluid other than “Toyota Genuine ATF WS” may cause deterioration in shift quality, locking up of your transmission accompanied by vibration, and ultimately damage the transmission of your vehicle.

6-1. Specifications

Brakes

Pedal clearance *1	3.98 in. (101.0 mm) Min.
Pedal free play	Less than 0.04 - 0.24 in. (1.0 - 6.0 mm)
Brake pad wear limit	0.04 in. (1.0 mm)
Parking brake pedal travel *2	6 — 9 clicks
Parking brake lining wear limit	0.04 in. (1.0 mm)
Fluid type	SAE J1703 or FMVSS No. 116 DOT 3

*1: Minimum pedal clearance when depressed with a force of 44 lbf (196 N, 20.0 kgf) while the hybrid system is operating.

*2: Parking brake pedal travel when depressed with a force of 66.0 lbf (294 N, 33.0 kgf).

6-1. Specifications

Steering

Free play	Less than 1.2 in. (30 mm)
-----------	---------------------------

Tires and wheels

Tire size	P195/55R16 86V, P185/65R15 86S, T125/70D16 96M (spare)
Front and rear tire inflation pressure (Recommended cold tire inflation pressure)	Front tire: 35 psi (240 kPa, 2.4 kgf/cm ² or bar) Rear tire: 33 psi (230 kPa, 2.3 kgf/cm ² or bar)
Spare tire inflation pressure (Recommended cold tire inflation pressure)	60 psi (420 kPa, 4.2 kgf/cm ² or bar)
Wheel size	16 × 6 JJ, 15 × 6 JJ, 16 × 4T (spare)
Wheel nut torque	76 ft•lbf (103 N•m, 10.5 kgf•m)

Light bulbs

	Light Bulbs	Bulb No.	W	Type
Exterior	Headlights Discharge bulbs	—	35	A
	Halogen bulbs	—	60/55	B
	Front fog lights	9006	51	C
	Parking/front side marker lights	—	5	D
	Front turn signal lights	—	21	D
	Rear turn signal lights	—	21	D
	Back-up lights	7440	21	D
	Tail lights/rear side marker lights	—	5	D
Interior	License plate lights	—	5	D
	Interior lights	—	8	E
	Personal lights	—	5	D
	Door courtesy lights	—	5	D
	Vanity lights	—	5	E
Luggage compartment light	—	5	E	

- A: D4R discharge bulbs
- B: HB2 halogen bulbs
- C: HB4 halogen bulbs
- D: Wedge base bulbs
- E: Double end bulbs

6-1. Specifications

Fuel information

Select octane rating 87 (Research Octane Number 91) or higher. Use of unleaded gasoline with an octane rating lower than 87 may result in engine knocking. Persistent knocking can lead to engine damage.

At minimum, the gasoline you use should meet the specifications of ASTM D4814 in the U.S.A. and CGSB3.5-M93 in Canada.

n Fuel tank opening for unleaded gasoline

To help prevent incorrect fueling, your Toyota has a fuel tank opening that only accommodates the special nozzle on unleaded fuel pumps.

n If your engine knocks

l Consult your Toyota dealer.

l You may occasionally notice light knocking for a short time while accelerating or driving uphill. This is normal and there is no need for concern.

n Gasoline quality

In very few cases, driveability problems may be caused by the brand of gasoline you are using. If driveability problems persist, try changing the brand of gasoline. If this does not correct the problem, consult your Toyota dealer.

n Gasoline quality standards

l Automotive manufacturers in the US, Europe and Japan have developed a specification for fuel quality called World-Wide Fuel Charter (WWFC) that is expected to be applied worldwide.

l The WWFC consists of four categories that are based on required emission levels. In the US, category 4 has been adopted.

l The WWFC improves air quality by lowering emissions in vehicle fleets, and customer satisfaction through better performance.

n Toyota recommends the use of gasoline containing detergent additives

l Toyota recommends the use of gasoline that contains detergent additives to avoid build-up of engine deposits.

l All gasoline sold in the US contains detergent additives to clean and/or keep clean intake systems.

6-1. Specifications

n **Toyota recommends the use of cleaner burning gasoline**

Cleaner burning gasoline, including reformulated gasoline that contains oxygenates such as ethanol or MTBE (Methyl Tertiary Butyl Ether) is available in many areas.

Toyota recommends the use of cleaner burning gasoline and appropriately blended reformulated gasoline. These types of gasoline provide excellent vehicle performance, reduce vehicle emissions and improve air quality.

n **Toyota does not recommend blended gasoline**

l Toyota allows the use of oxygenate blended gasoline where the oxygenate content is up to 10% ethanol or 15% MTBE.

l If you use gasohol in your Toyota, be sure that it has an octane rating no lower than 87.

l Toyota DOES NOT recommend the use of gasoline containing methanol.

n **Toyota does not recommend gasoline containing MMT**

Some gasoline contains octane enhancing additive called MMT (Methylcyclopentadienyl Manganese Tricarbonyl).

Toyota DOES NOT recommend the use of gasoline that contains MMT. If fuel containing MMT is used, your emission control system may be adversely affected.

The malfunction indicator lamp on the instrument cluster may come on. If this happens, contact your Toyota dealer for service.

6-1. Specifications

NOTICE

n Notice on fuel quality

- I** Do not use improper fuels. If improper fuels are used the engine will be damaged.
- I** Do not use leaded gasoline.
Leaded gasoline can cause damage to your vehicle's three-way catalytic converters causing the emission control system to malfunction.
- I** Do not use gasohol other than that stated here.
Other gasohol may cause fuel system damage or vehicle performance problems.
- I** Using unleaded gasoline with an octane number or rating lower than that stated here will cause persistent heavy knocking.
At worst, this will lead to engine damage.

n Fuel-related poor driveability

If after using a different type of fuel, poor driveability is encountered (poor hot starting, vaporization, engine knocking, etc.), discontinue the use of that type of fuel.

n When refueling with gasohole

Take care not to spill gasohol. It can damage your vehicle's paint.

6-1. Specifications Tire information

Typical tire symbols

► Standard tire

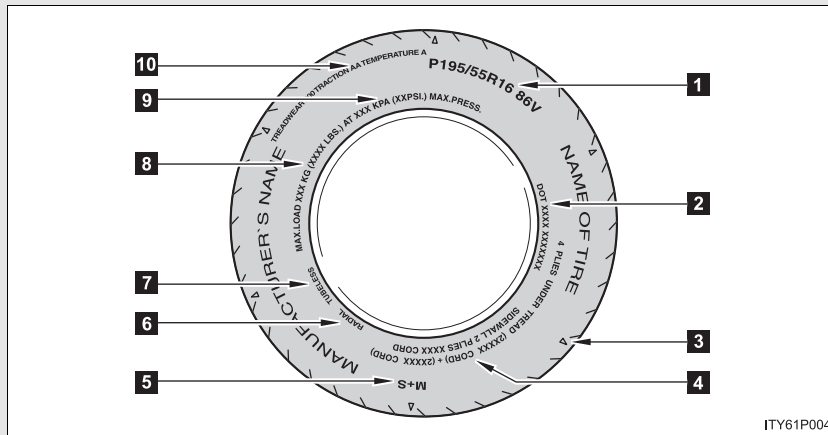

► Compact spare tire

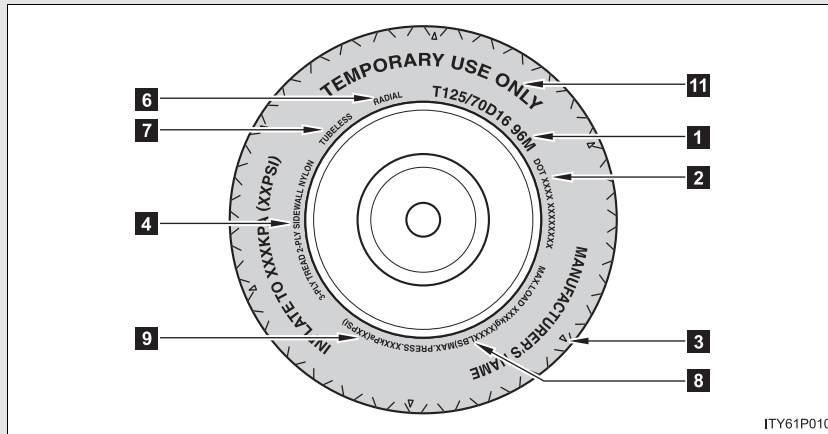

- | | |
|---|-----------|
| 1 Tire size | (→P. 476) |
| 2 DOT and Tire Identification Number (TIN) | (→P. 475) |
| 3 Location of treadwear indicators | (→P. 375) |

6

Vehicle specifications

6-1. Specifications

4 Tire ply composition and materials

Ply is a layer of rubber-coated parallel cords. Cords are the strands which form the ply in a tire.

5 Summer tire or all season tire (→P. 379)

An all season tire has "M+S" on the sidewall. A tire not marked "M+S" is a summer tire.

6 Radial tires or bias-ply tires

A radial tire has RADIAL on the sidewall. A tire not marked RADIAL is a bias-ply tire.

7 TUBELESS or TUBE TYPE

A tubeless tire does not have a tube and air is directly filled in the tire. A tube type tire has a tube inside the tire and the tube maintains the air pressure.

8 Load limit at maximum cold tire inflation pressure (→P. 479)

9 Maximum cold tire inflation pressure (→P. 479)

This means the pressure to which a tire may be inflated.

10 Uniform tire quality grading

For details, see "Uniform tire quality grading" that follows.

11 "TEMPORARY USE ONLY" (→P. 437)

A compact spare tire is identified by the phrase "TEMPORARY USE ONLY" molded into its sidewall. This tire is designed for temporary emergency use only.

Typical DOT and tire identification number (TIN)

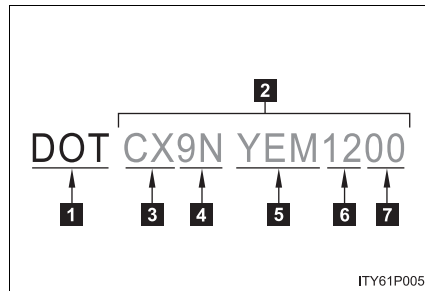

- 1** DOT symbol*
- 2** Tire Identification Number (TIN)
- 3** Tire manufacturer's identification mark
- 4** Tire size code
- 5** Manufacturer's optional tire type code (3 or 4 letters)
- 6** Manufacturing week
- 7** Manufacturing year

*:The DOT symbol certifies that the tire conforms to applicable Federal Motor Vehicle Safety Standards.

6-1. Specifications

Tire size

n Typical tire size information

► Standard tire

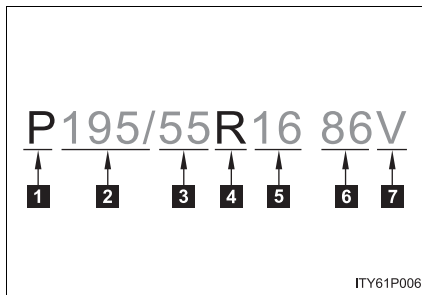

The illustration indicates typical tire size.

- 1** Tire use
(P = Passenger car,
T = Temporary use)
- 2** Section width (millimeters)
- 3** Aspect ratio
(tire height to section width)
- 4** Tire construction code
(R = Radial, D = Diagonal)
- 5** Wheel diameter (inches)
- 6** Load index (2 or 3 digits)
- 7** Speed symbol
(alphabet with one letter)

► Spare tire

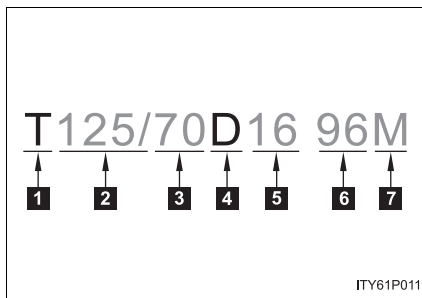

n Tire dimensions

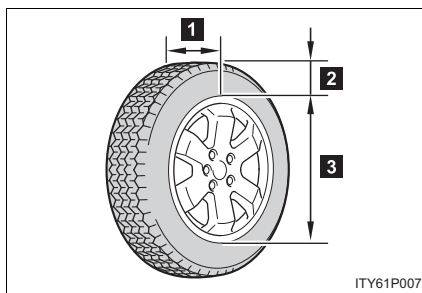

- 1** Section width
- 2** Tire height
- 3** Wheel diameter

Tire section names

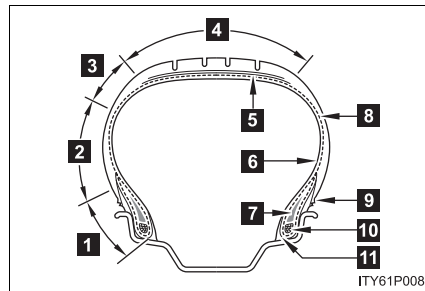

- 1** Bead
- 2** Sidewall
- 3** Shoulder
- 4** Tread
- 5** Belt
- 6** Inner liner
- 7** Reinforcing rubber
- 8** Carcass
- 9** Rim lines
- 10** Bead wires
- 11** Chafer

Uniform Tire Quality Grading

This information has been prepared in accordance with regulations issued by the National Highway Traffic Safety Administration of the U.S. Department of Transportation.

It provides the purchasers and/or prospective purchasers of Toyota vehicles with information on uniform tire quality grading.

Your Toyota dealer will help answer any questions you may have as you read this information.

1 DOT quality grades

All passenger vehicle tires must conform to Federal Safety Requirements in addition to these grades. Quality grades can be found where applicable on the tire sidewall between tread shoulder and maximum section width.

For example: Treadwear 200 Traction AA Temperature A

6-1. Specifications

n **Treadwear**

The treadwear grade is a comparative rating based on the wear rate of the tire when tested under controlled conditions on a specified government test course.

For example, a tire graded 150 would wear one and a half (1 - 1/2) times as well on the government course as a tire graded 100.

The relative performance of tires depends upon the actual conditions of their use, however, and may depart significantly from the norm due to variations in driving habits, service practices and differences in road characteristics and climate.

n **Traction AA, A, B, C**

The traction grades, from highest to lowest, are AA, A, B and C, and they represent the tire's ability to stop on wet pavement as measured under controlled conditions on specified government test surfaces of asphalt and concrete.

A tire marked C may have poor traction performance.

Warning: The traction grade assigned to this tire is based on braking (straight ahead) traction tests and does not include cornering (turning) traction.

n **Temperature A, B, C**

The temperature grades are A (the highest), B, and C, representing the tire's resistance to the generation of heat and its ability to dissipate heat when tested under controlled conditions on a specified indoor laboratory test wheel.

Sustained high temperature can cause the material of the tire to degenerate and reduce tire life, and excessive temperature can lead to sudden tire failure.

The grade C corresponds to a level of performance which all passenger car tires must meet under the Federal Motor Vehicle Safety Standard No. 109.

Grades B and A represent higher levels of performance on the laboratory test wheel than the minimum required by law.

Warning: The temperature grades for this tire are established for a tire that is properly inflated and not overloaded. Excessive speed, underinflation, or excessive loading, either separately or in combination, can cause heat buildup and possible tire failure.

Glossary of tire terminology

Tire related term	Meaning
Cold tire inflation pressure	Tire pressure when the vehicle has been parked for three hours or more, or has not been driven more than 1 mile or 1.5 km under that condition
Maximum inflation pressure	The maximum cold inflated pressure to which a tire may be inflated, shown on the sidewall of the tire
Recommended inflation pressure	Cold tire inflation pressure recommended by a manufacturer.
Accessory weight	The combined weight (in excess of those standard items which may be replaced) of transmission, power steering, power brakes, power windows, power seats, radio and heater, to the extent that these items are available as factory-installed equipment (whether installed or not)
Curb weight	The weight of a motor vehicle with standard equipment, including the maximum capacity of fuel, oil and coolant, and if so equipped, air conditioning and additional weight optional engine
Maximum loaded vehicle weight	The sum of: (a) Curb weight (b) Accessory weight (c) Vehicle capacity weight (d) Production options weight
Normal occupant weight	150 lb. (68 kg) times the number of occupants specified in the second column of Table 1* that follows

6

Vehicle specifications

6-1. Specifications

Tire related term	Meaning
Occupant distribution	Distribution of occupants in a vehicle as specified in the third column of Table 1* below
Production options weight	The combined weight of installed regular production options weighing over 5 lb. (2.3 kg) in excess of the standard items which they replace, not previously considered in curb weight or accessory weight, including heavy duty brakes, ride levelers, roof rack, heavy duty battery, and special trim
Rim	A metal support for a tire or a tire and tube assembly upon which the tire beads are seated
Rim diameter (Wheel diameter)	Nominal diameter of the bead seat
Rim size designation	Rim diameter and width
Rim type designation	The industry manufacturer's designation for a rim by style or code
Rim width	Nominal distance between rim flanges
Vehicle capacity weight (Total load capacity)	The rated cargo and luggage load plus 150 lb. (68 kg) times the vehicle's designated seating capacity
Vehicle maximum load on the tire	The load on an individual tire that is determined by distributing to each axle its share of the maximum loaded vehicle weight, and dividing by two
Vehicle normal load on the tire	The load on an individual tire that is determined by distributing to each axle its share of curb weight, accessory weight, and normal occupant weight (distributed in accordance with Table 1* below), and dividing it by two
Weather side	The surface area of the rim not covered by the inflated tire

6-1. Specifications

Tire related term	Meaning
Bead	The part of the tire that is made of steel wires, wrapped or reinforced by ply cords and that is shaped to fit the rim
Bead separation	A breakdown of the bond between components in the bead
Bias ply tire	A pneumatic tire in which the ply cords that extend to the beads are laid at alternate angles substantially less than 90 degrees to the centerline of the tread
Carcass	The tire structure, except tread and sidewall rubber which, when inflated, bears the load
Chunking	The breaking away of pieces of the tread or sidewall
Cord	The strands forming the plies in the tire
Cord separation	The parting of cords from adjacent rubber compounds
Cracking	Any parting within the tread, sidewall, or inner-liner of the tire extending to cord material
CT	A pneumatic tire with an inverted flange tire and rim system in which the rim is designed with rim flanges pointed radially inward and the tire is designed to fit on the underside of the rim in a manner that encloses the rim flanges inside the air cavity of the tire
Extra load tire	A tire designed to operate at higher loads and at higher inflation pressures than the corresponding standard tire
Groove	The space between two adjacent tread ribs

6-1. Specifications

Tire related term	Meaning
Innerliner	The layer(s) forming the inside surface of a tubeless tire that contains the inflating medium within the tire
Innerliner separation	The parting of the innerliner from cord material in the carcass
Intended outboard sidewall	(a)The sidewall that contains a whitewall, bears white lettering, or bears manufacturer, brand, and/or model name molding that is higher or deeper than the same molding on the other sidewall of the tire, or (b)The outward facing sidewall of asymmetrical tire that has a particular side that must always face outward when mounted on a vehicle
Light truck (LT) tire	A tire designated by its manufacturer as primarily intended for use on lightweight trucks or multipurpose passenger vehicles
Load rating	The maximum load that a tire is rated to carry for a given inflation pressure
Maximum load rating	The load rating for a tire at the maximum permissible inflation pressure for that tire
Maximum permissible inflation pressure	The maximum cold inflation pressure to which a tire may be inflated
Measuring rim	The rim on which a tire is fitted for physical dimension requirements
Open splice	Any parting at any junction of tread, sidewall, or innerliner that extends to cord material
Outer diameter	The overall diameter of an inflated new tire

6-1. Specifications

Tire related term	Meaning
Overall width	The linear distance between the exteriors of the sidewalls of an inflated tire, including elevations due to labeling, decorations, or protective bands or ribs
Passenger car tire	A tire intended for use on passenger cars, multipurpose passenger vehicles, and trucks, that have a gross vehicle weight rating (GVWR) of 10,000 lb. or less
Ply	A layer of rubber-coated parallel cords
Ply separation	A parting of rubber compound between adjacent plies
Pneumatic tire	A mechanical device made of rubber, chemicals, fabric and steel or other materials, that, when mounted on an automotive wheel, provides the traction and contains the gas or fluid that sustains the load
Radial ply tire	A pneumatic tire in which the ply cords that extend to the beads are laid at substantially 90 degrees to the centerline of the tread
Reinforced tire	A tire designed to operate at higher loads and at higher inflation pressures than the corresponding standard tire
Section width	The linear distance between the exteriors of the sidewalls of an inflated tire, excluding elevations due to labeling, decoration, or protective bands
Sidewall	That portion of a tire between the tread and bead
Sidewall separation	The parting of the rubber compound from the cord material in the sidewall

6-1. Specifications

Tire related term	Meaning
Snow tire	A tire that attains a traction index equal to or greater than 110, compared to the ASTM E-1136 Standard Reference Test Tire, when using the snow traction test as described in ASTM F-1805-00, Standard Test Method for Single Wheel Driving Traction in a Straight Line on Snow-and Ice-Covered Surfaces, and which is marked with an Alpine Symbol () on at least one sidewall
Test rim	The rim on which a tire is fitted for testing, and may be any rim listed as appropriate for use with that tire
Tread	That portion of a tire that comes into contact with the road
Tread rib	A tread section running circumferentially around a tire
Tread separation	Pulling away of the tread from the tire carcass
Treadwear indicators (TWI)	The projections within the principal grooves designed to give a visual indication of the degrees of wear of the tread
Wheel-holding fixture	The fixture used to hold the wheel and tire assembly securely during testing

*:Table 1 — Occupant loading and distribution for vehicle normal load for various designated seating capacities

6-1. Specifications

Designated seating capacity, Number of occupants	Vehicle normal load, Number of occupants	Occupant distribution in a normally loaded vehicle
2 through 4	2	2 in front
5 through 10	3	2 in front, 1 in second seat
11 through 15	5	2 in front, 1 in second seat, 1 in third seat, 1 in fourth seat
16 through 20	7	2 in front, 2 in second seat, 2 in third seat, 1 in fourth seat

6-2. Customization Customizable features

Your vehicle includes a variety of electronic features that can be personalized to your preferences. Programming these preferences requires specialized equipment and may be performed by an authorized Toyota dealership.

Some function settings are changed simultaneously with other functions being customized. Contact your Toyota dealer for further details.

Item	Function	Default setting	Customized setting
Smart key system (→P. 36)	Smart key system	ON	OFF
	Operation signal (Emergency flashers)	ON	OFF
	Operation signal (Buzzer)	ON	OFF
Wireless remote control (→P. 49)	Unlocking operation	Driver's door unlocked in 1-step, all doors unlocked in 2-step	All doors unlocked in 1-step
		60 seconds	OFF
	Time elapsed before automatic door lock function is activated if door is not opened after being unlocked		30 seconds

Item	Function	Default setting	Customized setting
Wireless remote control (→P. 49)	Operation indicator (Emergency flashers)	ON	OFF
	Operation indicator (Buzzer)	ON	OFF
	Panic function	ON	OFF
	Buzzer sounds when pushing  with any door not closed	ON	OFF
Door lock (→P. 448)	Unlocking using a key	Driver's door unlocked in 1-step, all doors unlocked in 2-step	All doors unlocked in 1-step
Automatic light control system (→P. 152)	Light sensor sensitivity	Level 3	Levels 1 to 5
	Time elapsed before headlights automatically turn off after doors are closed	60 seconds	0 seconds
			30 seconds
			90 seconds
Daytime running light	ON	OFF*	

6-2. Customization

Item	Function	Default setting	Customized setting
Illumination (→P. 315)	Time elapsed before lights turn off	15 seconds	7.5 seconds
			30 seconds
	Operation when the doors are unlocked	ON	OFF
	Operation after the "POWER" switch turned OFF	ON	OFF
Front/rear personal lights turned on when a door is opened		Corresponding light only	All lights
			OFF

*:Vehicles sold outside Canada

6-3. Initialization Items to initialize

After reconnecting or performing maintenance on the 12 volt battery, the following items must be initialized for normal system operation.

Item	When to initialize	Reference
Power window	<ul style="list-style-type: none"> • After reconnecting or changing the 12 volt battery • After changing a fuse 	P. 76
Engine oil maintenance data	<ul style="list-style-type: none"> • After changing engine oil 	P. 365
Tire pressure warning system	<ul style="list-style-type: none"> • When rotating the tires on vehicles differing with front and rear tire inflation pressures. • When changing the tire inflation pressure by changing traveling speed or load weight, etc. • When changing the tire size. 	P. 377

6-3. Initialization

Reporting safety defects for U.S. owners

If you believe that your vehicle has a defect which could cause a crash or could cause injury or death, you should immediately inform the National Highway Traffic Safety Administration (NHTSA) in addition to notifying Toyota Motor Sales, U.S.A., Inc. (Toll-free: 1-800-331-4331).

If NHTSA receives similar complaints, it may open an investigation, and if it finds that a safety defect exists in a group of vehicles, it may order a recall and remedy campaign. However, NHTSA cannot become involved in individual problems between you, your dealer, or Toyota Motor Sales, U.S.A., Inc.

To contact NHTSA, you may call the Vehicle Safety Hotline toll-free at 1-888-327-4236 (TTY: 1-800-424-9153); go to <http://www.safercar.gov>; or write to: Administrator, NHTSA, 1200 New Jersey Ave, S.E., Washington, DC 20590. You can also obtain other information about motor vehicle safety from <http://www.safercar.gov>.

Seat belt instructions for Canadian owners (in French)

The following is a French explanation of seat belt instructions extracted from the seat belt section in this manual.

See the seat belt section for more detailed seat belt instructions in English.

Utilisation adéquate des ceintures de sécurité

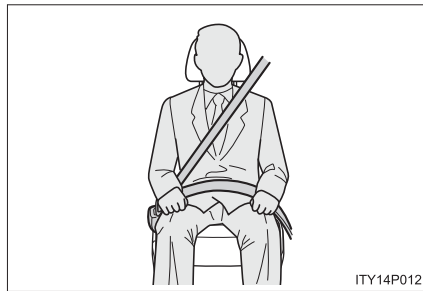

- Tirez sur la ceinture épaulière jusqu'à ce qu'elle recouvre entièrement l'épaule; elle ne doit cependant pas toucher le cou ni glisser de l'épaule.
- Placez la sangle abdominale le plus bas possible sur les hanches.
- Réglez la position du dossier du siège. Tenez-vous assis dans le fond du siège, le dos droit.
- Ne vrillez pas la ceinture de sécurité.

7

For owners

Utilisation adéquate des ceintures de sécurité

■ Ceintures de sécurité

Avec un tissu ou une éponge, nettoyez à l'aide d'un savon doux et de l'eau tiède. Vérifiez aussi les ceintures régulièrement pour vous assurer qu'elles ne présentent pas d'usure excessive, d'effilochage ou de coupures.

⚠ ATTENTION

■ Dommages et usure de la ceinture de sécurité

Vérifiez périodiquement le système de ceintures de sécurité. Assurez-vous qu'il n'y a pas de coupures, d'effilochures ni de pièces desserrées. N'utilisez pas une ceinture de sécurité endommagée avant qu'elle soit remplacée. Les ceintures de sécurité endommagées ne peuvent pas protéger les occupants contre les blessures.

Abbreviation list
Abbreviation/Acronym list

ABBREVIATIONS	MEANING
A/C	Air Conditioning
ABS	Anti-lock Brake System
ACC	Accessory
ALR	Automatic Locking Retractor
CRS	Child Restraint System
ECU	Electronic Control Unit
EDR	Event Data Recorder
ELR	Emergency Locking Retractor
EPS	Electronic Power Steering
GAWR	Gross Axle Weight Ratings
I/M	Emission inspection and maintenance
LATCH	Lower Anchors and Tethers for Children
LED	Light Emitting Diode
MMT	Methylcy clopentadienyl Manganese Tricarbonyl
M + S	Mud and Snow
MTBE	Methyl Tertiary Butyl Ether
OBD	On Board Diagnostics
SRS	Supplemental Restraint System
TIN	Tire Identification Number
TPMS	Tire Pressure Monitoring (Warning) System
VIN	Vehicle Identification Number
VSC	Vehicle Stability Control

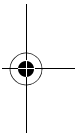
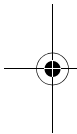

497

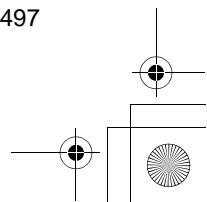
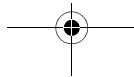
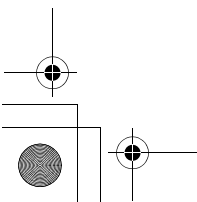

PRIUS_U_(OM47614U)

Alphabetical index Alphabetical index

- | | | | | | |
|----------|---|----------|--|----------|---|
| A | <p>A/C.....197</p> <p>ABS166</p> <p>Air conditioning system</p> <p style="padding-left: 20px;">Air conditioning filter.....390</p> <p style="padding-left: 20px;">Automatic air conditioning system197</p> <p style="padding-left: 20px;">Steering wheel climate remote control switches.....211</p> <p>Airbags</p> <p style="padding-left: 20px;">Airbag operating conditions.....92</p> <p style="padding-left: 20px;">Airbag precautions for your child96</p> <p style="padding-left: 20px;">Airbag warning light.....424</p> <p style="padding-left: 20px;">Curtain shield airbag precautions96</p> <p style="padding-left: 20px;">Front passenger occupant classification system101</p> <p style="padding-left: 20px;">General airbag precautions.....96</p> <p style="padding-left: 20px;">Locations of airbags89</p> <p style="padding-left: 20px;">Modification and disposal of airbags100</p> <p style="padding-left: 20px;">Side airbag precautions96</p> <p style="padding-left: 20px;">Side and curtain shield airbags operating conditions.....92</p> <p style="padding-left: 20px;">SRS airbags89</p> <p>Alarm.....84</p> <p>Antenna.....227</p> <p>Armrest.....331</p> <p>Audio input.....265</p> <p>Audio system</p> <p style="padding-left: 20px;">Antenna.....227</p> <p style="padding-left: 20px;">CD player/changer235</p> <p style="padding-left: 20px;">MP3/WMA disc.....250</p> <p style="padding-left: 20px;">Optimal use259</p> <p style="padding-left: 20px;">Portable music player.....265</p> <p style="padding-left: 20px;">Radio.....221</p> <p style="padding-left: 20px;">Steering switches266</p> <p>Automatic headlight leveling system152</p> <p>Automatic light control system152</p> <p>AUX adapter265</p> <p>Auxiliary boxes324</p> | B | <p>Back-up lights</p> <p style="padding-left: 20px;">Wattage.....469</p> <p>Back door</p> <p style="padding-left: 20px;">Back door.....54</p> <p style="padding-left: 20px;">Wireless remote control49</p> <p style="padding-left: 20px;">Smart key system36</p> <p>Battery</p> <p style="padding-left: 20px;">Checking371</p> <p style="padding-left: 20px;">Hybrid battery (traction battery)26</p> <p style="padding-left: 20px;">If the vehicle 12 volt battery is discharged449</p> <p style="padding-left: 20px;">Preparing and checking before winter.....173</p> <p>Bluetooth®269</p> <p>Brake</p> <p style="padding-left: 20px;">Fluid369</p> <p style="padding-left: 20px;">Parking brake143</p> <p>Brake assist.....166</p> <p>Break-in tips.....123</p> | C | <p>Care</p> <p style="padding-left: 20px;">Exterior.....342</p> <p style="padding-left: 20px;">Interior.....344</p> <p style="padding-left: 20px;">Seat belts345</p> <p>Cargo capacity.....169</p> <p>Cargo hooks.....333</p> <p>CD player/changer235</p> <p>Chains.....175</p> <p>Child-protectors.....52</p> <p>Child restraint system</p> <p style="padding-left: 20px;">Definition107</p> <p style="padding-left: 20px;">Installation.....111</p> <p style="padding-left: 20px;">Installing CRS with lower anchorages.....112</p> <p style="padding-left: 20px;">Installing CRS with seatbelts114</p> <p style="padding-left: 20px;">Installing CRS with top straps.....117</p> <p>Child safety</p> <p style="padding-left: 20px;">Airbag precautions96</p> <p style="padding-left: 20px;">Child restraint system107</p> <p style="padding-left: 20px;">Child-protectors.....52</p> |
|----------|---|----------|--|----------|---|

How your child should wear
the seatbelt 67
Installing child restraints 111
Power window lock switch 76
Power window precautions 78
Removed electronic key battery
precautions 393
Seat belt precautions 68
Back door 56

Cleaning
Exterior 342
Interior 344
Seat belts 345

Clock **328**

Condenser **369**

Console box **320**

Cooling system
Hybrid system overheating... 454

Cruise control
Cruise control 159

Cup holders **322**

Curtain shield airbags **89**

Customizable features **486**

D **Daytime running light
system** **153**

Defogger
Rear window 213
Side mirror 213

Dimension **460**

Dinghy towing **178**

Display
Touch screen 182
Trip information 27

Do-it-yourself maintenance **353**

Door courtesy lights **315**

Door pocket **323**

Doors
Door lock 36, 49, 51
Rear door child protector 52

**Driver's seat belt reminder
light** **426**

Driving
break-in tips 123
Correct posture 87
Procedures 122
Winter driving tips 173

E **Electronic key**
Replacing battery 392
When the electronic key
battery is discharged 448

Electric Power Steering 166

Emergency flashers
Switch 412

Emergency, in case of
If a warning light turns on 423
If the electronic key does not
operate properly 448
If the hybrid system will not
start 446
If the 12 volt battery is
discharged 449
If you have a flat tire 436
If you lose your keys 447
If you think something is
wrong 420
If your vehicle becomes
stuck 457
If your vehicle needs to be
towed 413
If your vehicle overheats 454

Engine
Compartment 360
Hood 357
How to start the hybrid
system 132
If the hybrid system will
not start 446
Overheating 454
"POWER" switch 132

Alphabetical index

Engine compartment cover.....361

Engine/inverter coolant

- Capacity465
- Checking367
- Preparing and checking before winter 173

Engine oil

- Capacity464
- Checking361
- Preparing and checking before winter 173

Engine oil maintenance data365

Enhanced VSC (Vehicle Stability Control)..... 166

Event data recorder421

F

Floor mats.....332

Fluid

- Brake369
- Washer374

Fog lights

- Switch155
- Wattage469

Front passenger occupant classification system 101

Front passenger's seat belt reminder light..... 426

Front seats

- Adjustment57

Front turn signal lights

- Wattage469

Fuel

- Capacity462
- Fuel gauge145
- Gas station information508
- Information470
- Refueling79
- Type470

Fuel door.....79

Fuel filler door79

Fuses.....394

G

Garage door opener336

Gas station information508

Gauges..... 145

Glove box320

H

Hands-free system (for cellular phone)..... 269

Hazard lights

- Switch412

Head restraints.....62

Headlights

- Discharge headlights precautions410
- Replacing light bulbs403
- Switch152
- Wattage469

Heaters

- Side mirror213

Hood.....357

Hooks

- Cargo333

Horn144

Hybrid system

- Emergency shut off system27
- Energy monitor / consumption screen27
- High-voltage components26
- Power switch132

I

Illuminated entry system.....315

Immobilizer system82

I/M test352

Identification

- Engine461
- Vehicle461

Ignition switch..... 132

Indicator lights..... 148

Initialization

- Items to initialize489

Inside rear view mirror72

Instrument panel light control 146

Interior lights

- Interior lights 317
- Switch 317
- Wattage 469

J

Jack

- Positioning a floor jack 358
- Vehicle-equipped jack 436

Jack handle..... 436

K

Keys

- Electronic key 49
- If you lose your keys 447
- If your electronic key 448
- Key number plate 35
- Keyless entry 36
- Keys 34
- "POWER" switch 132
- Mechanical key 34
- Wireless remote control key ... 49

L

Light bulbs

- Replacing 403
- Wattage 469

Lights

- Emergency flasher switch 412
- Fog light switch 155
- Hazard light switch 412
- Headlights switch 152
- Interior lights list 315
- Replacing light bulbs 403
- Turn signal lever 142
- Vanity lights 327
- Wattage 469

Load capacity 172

M

Maintenance

- Do-it-yourself maintenance 353
- General maintenance 349

Maintenance data 460

- Maintenance requirements 347

Meter

- Instrument panel light control 146
- Meters 145

Mirrors

- Inside rear view mirror 72
- Side mirror heater 213
- Side mirrors 74
- Vanity mirrors 327

MP3 disc 250

O

Odometer 145

Oil

- Engine oil 361

Opener

- Fuel filler door 79
- Hood 357
- Back door 54

Outside rear view mirrors

- Adjusting and folding 74

Outside temperature display 185

Overheating, Hybrid system 454

P

Parking brake 143

Parking lights

- Replacing light bulbs 403
- Switch 152
- Wattage 469

Personal lights 317

Power outlet 329

Power windows 76

R

Radiator 369

Radio 221

RDS (Radio Data System) 223

Alphabetical index

Rear turn signal lights
 Replacing light bulbs 403
 Wattage 469

Rear view monitor system 163

Rear window defogger 213

Replacing
 Electronic key battery 392
 Fuses 394
 Light bulbs 403

Reporting safety defects for U.S. owners 492

S **Seat belts**
 Adjusting the seat belt 64
 Automatic Locking Retractor (ALR) 66
 Child restraint system installation 111
 Cleaning and maintaining the seat belts 345
 Emergency Locking Retractor (ELR) 66
 How to wear your seat belt 64
 How your child should wear the seat belt 67
 Pregnant women, proper seat belt use 66
 Reminder light 426
 Seat belt extenders 67
 Seat belt pretensioners 65

Seating capacity 172

Seats
 Adjustment 57
 Adjustment precautions 58
 Child seats/child restraint system installation 111
 Cleaning 344
 Head restraint 62
 Properly sitting in the seat 87

Service reminder indicators 148

Shift lever
 Transmission 138

Side airbags 89

Side marker lights
 Switch 152

Side mirror
 Adjusting and folding 74

Smart key system
 Antenna location 39
 Entry function 36
 Starting the hybrid system 132

Spare tire
 Inflation pressure 468
 Storage location 437

Spark plug 465

Specifications 460

Speedometer 145

Steering wheel
 Adjustment 71
 Audio switches 266

Storage compartment 319

Storage feature 319

Stuck
 If your vehicle becomes stuck 457

Sun visors 326

Switch
 Emergency flasher switch 412
 Fog light switch 155
 Hazard light switch 412
 Light switches 152
 Power door lock switch 51
 "POWER" switch 132
 Power window switch 76
 Window lock switch 76
 Wipers and washer switch 156

T **Tail lights**
 Switch 152

Theft deterrent system
 Alarm 84
 Immobilizer system 82

Theft prevention labels 86

Tire inflation pressure 468

Tire information

- Glossary 479
- Size 476
- Tire identification number 475
- Uniform tire quality grading .. 477

Tires

- Chains 175
- Checking 375
- Compact spare tire 437
- If you have a flat tire 436
- Inflation pressure 468
- Information 473
- Pressure warning system 375
- Replacing 436
- Rotating tires 375
- Size 468
- Snow tires 175
- Spare tire 437

Tools..... 436

Total load capacity..... 172

Touch screen..... 182

Towing

- Dinghy towing 178
- Emergency towing 413
- Trailer towing 177

Transmission

- “P” position switch 139
- Transmission 138

Trip information..... 27

Trip meter..... 146

Turn signal lights

- Replacing light bulbs 403
- Switch 142
- Wattage 469

V

Vanity lights

- Vanity lights 327
- Wattage 469

Vanity mirrors..... 327

Vehicle identification

- number 461

Vehicle load limits..... 172

W

Warning buzzers

- Brake system 423
- Open door 426
- Seat belt reminder 426

Warning lights

- Anti-lock brake system (ABS) 425
- Brake system 423
- Charging system 424
- Electric power steering warning light 425
- Low fuel level 426
- Malfunction indicator lamp 424
- Master warning light 427
- Open door 426
- Seat belt reminder light 426
- SRS airbags 424
- Tire pressure warning light 426

Washer

- Checking 374
- Preparing and checking before winter 173
- Switch 156

Washing and waxing 342

Weight

- Cargo capacity 169
- Load limits 172
- Weight 460

Wheels 388

Window glasses 76

Window lock switch..... 76

Windows

- Power windows 76
- Rear window defogger 213
- Washer 156

Windshield wipers

- Windshield wipers 156

Winter driving tips 173

Wireless remote control key

- Locking/Unlocking 49
- Replacing the battery 392

WMA disc..... 250

What to do if... What to do if...

A tire punctures

P. 436 If you have a flat tire

The hybrid system does not start

P. 82 Immobilizer system

P. 446 If the hybrid system will not start

P. 449 If the 12 volt battery is discharged

The high coolant temperature warning light comes on.

P. 454 If your vehicle overheats

Steam can be seen coming from under the hood

The key is lost

P. 447 If you lose your keys

The 12 volt battery runs out

P. 449 If the 12 volt battery is discharged

The doors cannot be locked

P. 51 Doors

The horn begins to sound

P. 84 Alarm

The vehicle is stuck in mud or sand

P. 457 If the vehicle becomes stuck

The warning light or indicator light comes on

P. 423 If a warning light turns on or a warning buzzer sounds...

What to do if...

► Instrument cluster

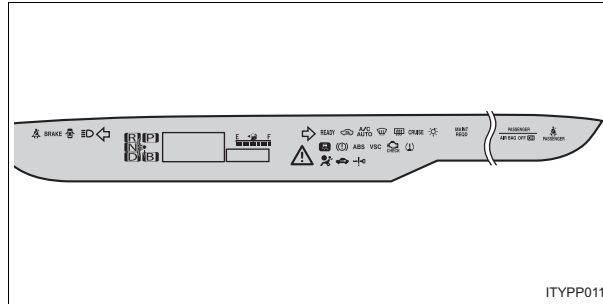

ITYPP011



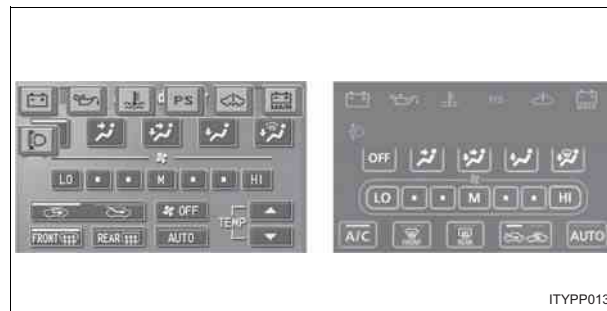













► Touch screen



ITYPP013

What to do if...

n Warning lights

<p>BRAKE Brake system warning light (red indicator)</p> <p>or</p> <p> P. 423</p>	<p> Charging system warning light P. 424</p>
<p>ABS ABS warning light ECB*/VSC warning light</p> <p>or</p> <p> P. 425</p> <p>Brake system warning light (yellow indicator)</p> <p> P. 425</p>	<p> Malfunction indicator lamp P. 424</p> <p> Driver's seat belt reminder light P. 426</p> <p> Front passenger's seat belt reminder light P. 426</p> <p> Tire pressure warning light P. 426</p>
<p> Low fuel level warning light P. 426</p>	<p>P/S</p> <p>or</p> <p>PS Electric power steering warning light P. 425</p>
<p> SRS warning light P. 424</p>	<p> Master warning light P. 427</p> <p>Automatic headlight leveling system warning light</p> <p> P. 425</p>
<p> Open door warning light P. 426</p>	<p> Low engine oil pressure warning light P. 424</p>
<p> High coolant temperature warning light P. 427</p>	<p>VSC VSC warning light P. 425</p>
<p> Hybrid battery warning light P. 427</p>	<p>MAINT REQD Engine oil replacement reminder light P. 427</p>
<p> Hybrid system warning light P. 424</p>	

What to do if...

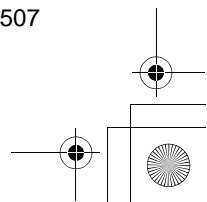
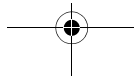
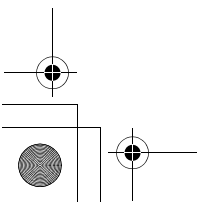
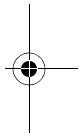
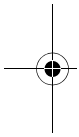

GAS STATION INFORMATION

Auxiliary catch lever
P. 357

Fuel filler door
P. 79

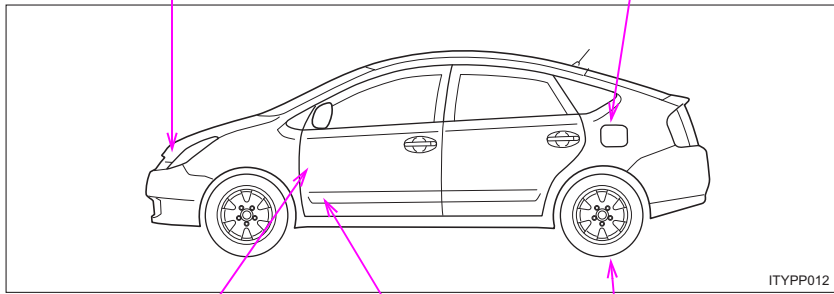

Hood lock release lever
P. 357

Fuel filler door opener
P. 79

Tire inflation pressure
P. 468

Fuel tank capacity	11.9 gal. (45 L, 9.9 Imp.gal.)	
Fuel type	Unleaded gasoline only	P. 80, 462
Cold tire inflation pressure		P. 468
Engine oil capacity (Drain and refill)	With filter	qt. (L, Imp.qt.) 3.9 (3.7, 3.3)
	Without filter	3.6 (3.4, 3.0)
Engine oil type	"Toyota Genuine Motor Oil" or equivalent Oil grade: ILSAC multigrade engine oil Recommended oil viscosity: SAE 5W-30	P. 464