

Foreword

Welcome to the growing group of value-conscious people who drive Toyotas. We are proud of the advanced engineering and quality construction of each vehicle we build.

This Owner's Manual explains the operation of your new Toyota. Please read it thoroughly and have all the occupants follow the instructions carefully. Doing so will help you enjoy many years of safe and trouble-free motoring. For important information about this manual and your Toyota, read the following pages carefully.

When it comes to service, remember that your Toyota dealer knows your vehicle very well and is interested in your complete satisfaction. Your Toyota dealer will provide quality maintenance and any other assistance you may require.

If there is not a Toyota dealer near you, please call the following number:

U.S. OWNERS:

- When traveling in the U.S. mainland or Canada:
Toyota Customer Experience Center **Toll-free:1- 800- 331- 4331**
- Hawaii:
Servco Automotive Customer Services **Toll-free:1- 888- 272- 5515**

CANADIAN OWNERS:

- When traveling in Canada or the U.S. mainland:
Toyota Canada Customer Interaction Centre **Toll-free:1- 888- TOYOTA- 8 or 1- 888- 869- 6828**

Please leave this Owner's Manual in this vehicle at the time of resale. The next owner will need this information also.

All information and specifications in this manual are current at the time of printing. However, because of Toyota's policy of continual product improvement, we reserve the right to make changes at any time without notice.

Please note that this manual applies to all models and explains all equipment, including options. Therefore, you may find some explanations for equipment not installed on your vehicle.

Please access our websites for further information.

- The U.S. mainland www.toyota.com
- Hawaii www.toyotahawaii.com
- Canada www.toyota.ca

TOYOTA MOTOR CORPORATION

© 2006 TOYOTA MOTOR CORPORATION

All rights reserved. This material may not be reproduced or copied, in whole or in part, without the written permission of Toyota Motor Corporation.

Important information about this manual

Safety and vehicle damage warnings

Throughout this manual, you will see safety and vehicle damage warnings. You must follow these warnings carefully to avoid possible injury or damage.

The types of warnings, what they look like, and how they are used in this manual are explained as follows:

 CAUTION
This is a warning against anything which may cause injury to people if the warning is ignored. You are informed about what you must or must not do in order to reduce the risk of injury to yourself and others.

NOTICE
<i>This is a warning against anything which may cause damage to the vehicle or its equipment if the warning is ignored. You are informed about what you must or must not do in order to avoid or reduce the risk of damage to your vehicle and its equipment.</i>

Safety symbol

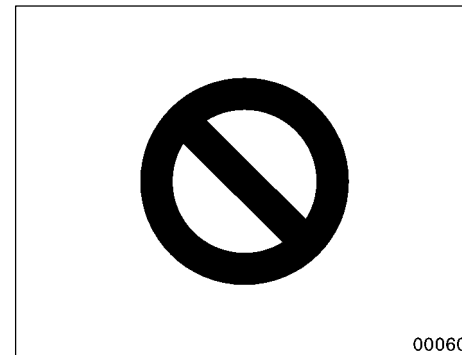

When you see the safety symbol shown above, it means: “Do not...”; “Do not do this”; or “Do not let this happen”.

Important information about your Toyota

Occupant restraint systems

Toyota encourages you and your family to take the time to read Section 1-3 of this Owner's Manual carefully. In terms of helping you understand how you can receive the maximum benefit of the occupant restraint systems this vehicle provides, Section 1-3 of this Owner's Manual is the most important Section for you and your family to read.

Section 1-3 describes the function and operation concerning seats, seat belts, SRS airbags and child restraint systems of this vehicle and some potential hazards you should be aware of. These systems work together along with the overall structure of this vehicle in order to provide occupant restraint in the event of a crash. The effect of each system is enhanced when it is used properly and together with other systems. No single occupant restraint system can, by itself, provide you or your family with the equal level of restraint which these systems can provide when used together. That is why it is important for you and your family to understand the purpose and proper use of each of these systems and how they relate to each other.

The purpose of all occupant restraint systems is to help reduce the possibility of death or serious injury in the event of a collision. None of these systems, either individually or together, can ensure that there is no injury in the event of collision. However, the more you know about these systems and how to use them properly, the greater your chances become of surviving an accident without death or serious injury.

Seat belts provide the primary restraint to all occupants of the vehicle, and every occupant of the vehicle should wear seat belts properly at all times. Children should always be secured in child restraint systems that are appropriate for their age and size. SRS (Supplemental Restraint System) airbags are, as their names imply, designed to work with, and be supplemental to, seat belts and are not substitutes for them. SRS airbags can be very effective in reducing the risk of head and chest injuries by preventing contact of the head and chest with interior portions of the vehicle.

06 SIENNA_U (L/O 0603)

In order to be effective, the SRS airbags must deploy with tremendous speed. The rapid deployment of the SRS airbags makes the SRS airbags themselves potential sources of serious injury if an occupant is too close to an airbag, or if an object or some part of his or her body has been placed between the occupant and the airbag at the time of deployment. This is just one example of how the instructions in Section 1-3 of this Owner's Manual will help ensure proper use of the occupant restraint systems, and increase the safety they can provide to you and your family in the event of an accident.

Toyota recommends you to read the provisions in Section 1-3 carefully and refer to them as needed during your time of ownership of this vehicle.

Event data recorder

Your vehicle has computers that monitor and control certain aspects of your vehicle. These computers assist in driving and maintaining optimal vehicle performance. Besides storing data useful for troubleshooting, there is a system to record data in a crash or a near car crash event. This is called an Event Data Recorder (EDR).

The SRS airbag sensor assembly contains the EDR. In a crash or a near car crash event, this device may record some or all of the following information:

- Engine speed
- Whether the brake pedal was applied or not
- Vehicle speed
- To what extent the accelerator pedal was depressed
- Position of the transmission selector lever
- Whether the driver and front passenger wore the seat belts or not
- Driver's seat position
- Front passenger's occupant classification
- SRS airbag deployment data

06 SIENNA_U (L/O 0603)

- SRS airbag system diagnostic data

If your vehicle is equipped with a vehicle stability control (VSC) system, its Electronic Control Unit (ECU) may contain another EDR. There are a variety of driving situations which include activating the VSC under which the VSC EDR will record certain information. The VSC EDR may record some or all of the following information:

- Behavior of the vehicle
- Steering wheel angle
- Vehicle speed
- To what extent the accelerator pedal was depressed
- To what extent the brake pedal was applied
- To what extent the ECU controlled the condition of the 4 wheels
- Vehicle stability control system diagnostic data

The information above is intended to be used for the purpose of improving vehicle safety performance. Unlike general data recorders, the EDR does not record sound data such as conversation between passengers.

Toyota will not disclose the data recorded in an EDR to a third party except when:

- An agreement from the vehicle's owner (or the leasing company for a leased vehicle) is obtained
- Officially requested by the police or other authorities
- Used as a defense for Toyota in a law suit
- Ordered by the court

However, if necessary Toyota will:

- Use the data for research on Toyota vehicle safety performance
- Disclose the data to a third party for research purposes without disclosing details of the vehicle owner, and only when it is deemed necessary
- Disclose summarized data cleared of vehicle identification information to a non-Toyota organization for research purposes

New vehicle warranty

Your new vehicle is covered by the following Toyota limited warranties:

- New vehicle warranty
- Emission control systems warranty
- Others

For further information, please refer to the "Owner's Warranty Information Booklet" or "Owner's Manual Supplement".

Your responsibility for maintenance

It is the owner's responsibility to make sure that the specified maintenance is performed. Section 6 gives details of these maintenance requirements. Also included in Section 6 is general maintenance. For scheduled maintenance information, please refer to the "Scheduled Maintenance Guide" or "Owner's Manual Supplement".

Important health and safety information about your Toyota



- **WARNING:** Engine exhaust, some of its constituents, and a wide variety of automobile components contain or emit chemicals known to the State of California to cause cancer and birth defects and other reproductive harm. In addition, oils, fuels and fluids contained in vehicles as well as waste produced by component wear contain or emit chemicals known to the State of California to cause cancer and birth defects or other reproductive harm.
- **Battery posts, terminals and related accessories contain lead and lead compounds. Wash your hands after handling. Used engine oil contains chemicals that have caused cancer in laboratory animals. Always protect your skin by washing thoroughly with soap and water.**

Accessories, spare parts and modification of your Toyota

A wide variety of non-genuine spare parts and accessories for Toyota vehicles are currently available in the market. You should know that Toyota does not warrant these products and is not responsible for their performance, repair, or replacement, or for any damage they may cause to, or adverse effect they may have on, your Toyota vehicle.

This vehicle should not be modified with non-genuine Toyota products. Modification with non-genuine Toyota products could affect its performance, safety or durability, and may even violate governmental regulations. In addition, damage or performance problems resulting from the modification may not be covered under warranty.

Spark ignition system of your Toyota

The spark ignition system in your Toyota meets all requirements of the Canadian Interference-Causing Equipment Standard.

Installation of a mobile two-way radio system

As the installation of a mobile two-way radio system in your vehicle could affect electronic systems such as multiport fuel injection system/sequential multiport fuel injection system, electronic throttle control system, cruise control system, dynamic laser cruise control system, anti-lock brake system, traction control system, vehicle stability control system, SRS airbag system and seat belt pretensioner system, be sure to check with your Toyota dealer for precautionary measures or special instructions regarding installation.

Tires and loading on your Toyota

Underinflated or overinflated tire pressure and the excess load may result in the deterioration of steering ability and braking ability, leading to an accident. Check the tire inflation pressure periodically and be sure to keep the load limits given in this Owner's Manual. For details about tire inflation pressure and load limits, see pages 398 and 471.

Scrapping of your Toyota

The SRS airbag and seat belt pretensioner devices in your Toyota contain explosive chemicals. If the vehicle is scrapped with the airbags and pretensioners left as they are, this may cause an accident such as fire. Be sure to have the systems of the SRS airbag and seat belt pretensioner removed and disposed of by the qualified service shop or by your Toyota dealer before you dispose of your vehicle.

— Quick reference

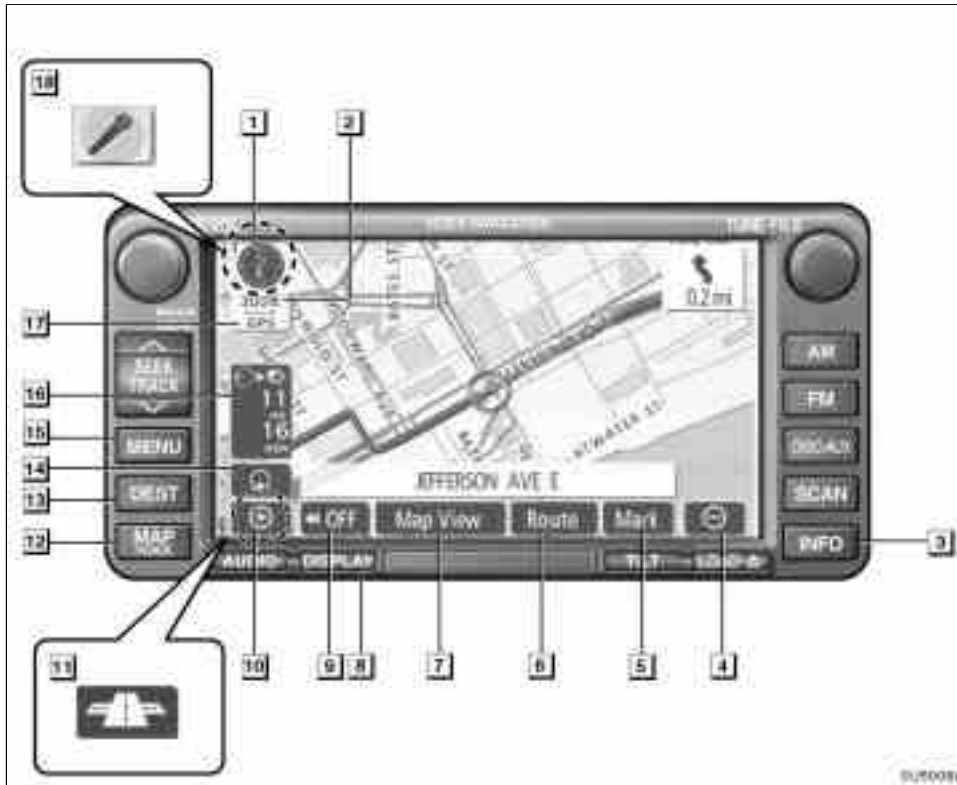

1 North-up or heading-up symbol

This symbol indicates a map view with north-up or heading-up. Touching this symbol changes the map orientation. 18

2 Scale indicator

This figure indicates the map scale. . . . 15

3 “INFO” button

Push this button to display the “Information” screen. 3, 92, 95, 103, 146

4 Zoom out touch-screen button

Touch this touch-screen button to reduce the map scale. 15

5 “Mark”

Touch this touch-screen button to register the current position or the cursor position as a memory point. 10

6 “Route”

Touch this touch-screen button to change the route. 53, 55

7 “Map View”

Touch this touch-screen button to browse information about guidance route, to set the Points of Interest to be displayed on the screen, or to record the route. 58, 61, 62, 63

- 8 “DISPLAY” button**
Push this button to display the “Display” screen. 145
- 9 “◀◀OFF”**
Touch this touch-screen button to obtain a broader view. Some of the buttons on the screen are not displayed. They are displayed again by touching “ON▶▶”. 84
- 10 Zoom in touch-screen button**
Touch this touch-screen button to magnify the map scale. 15
- 11 Foot print map touch-screen button**
Touch this touch-screen button to display the foot print map and the building information. 16
- 12 “MAP/VOICE” button**
Push this button to repeat a voice guidance, cancel one touch scroll, start guidance, and display the current position. . . . 9, 10, 52
- 13 “DEST” button**
Push this button to display the “Destination” screen. vi, 24
- 14 Screen configuration touch-screen button**
Touch this touch-screen button to change the screen mode. 13

- 15 “MENU” button**
Push this button to display the “Menu” screen. viii, 65, 209
- 16 Distance and time to destination**
Displays the distance, the estimated travel time to the destination, and the estimated arrival time at the destination. 52
- 17 “GPS” mark (Global Positioning System)**
Whenever your vehicle is receiving signals from the GPS, this mark is displayed. 198
- 18 Speech command system indicator**
This indicator is shown by pushing the speech command switch. The speech command system can be operated while this indicator is shown. 142



— “Destination” screen

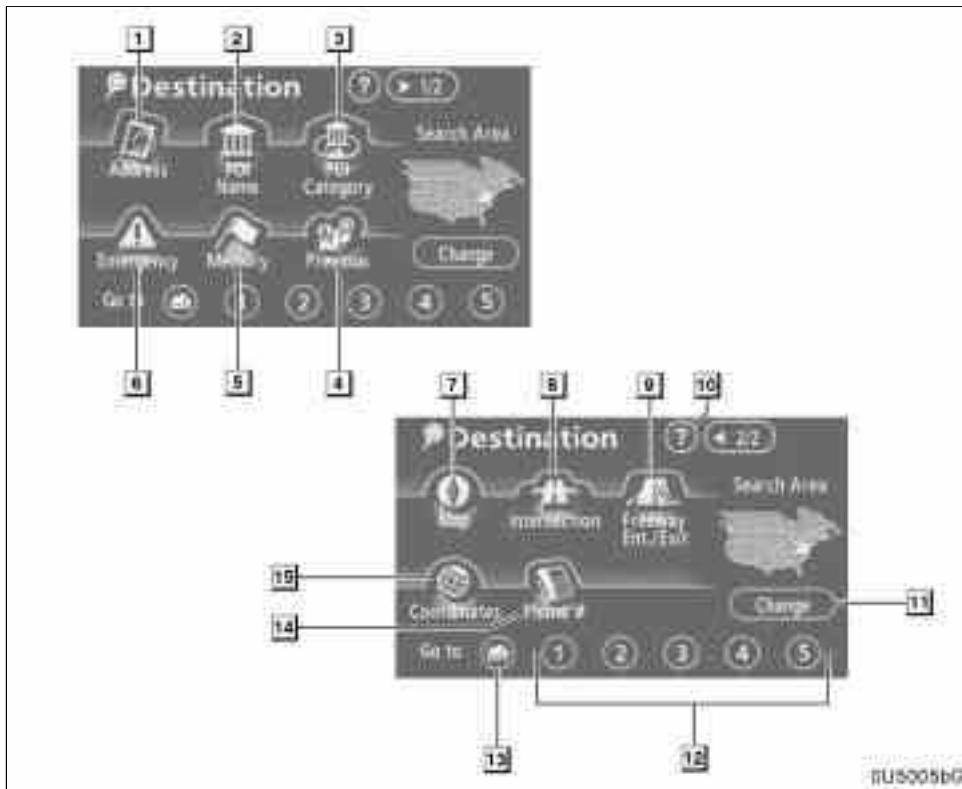

- 1 “Address”**
A house number and the street address can be input by using the input keys. 27
- 2 “POI Name”**
Select one of the many POIs (Points of Interest) that have already been stored in the system’s database. 31
- 3 “POI Category”**
A destination can be selected from the POI category. 35
- 4 “Previous”**
A destination can be selected from any of the last 100 previously set destinations and from the previous starting point. 39
- 5 “Memory”**
The location can be selected from the registered “Memory points”. (To register memory points, see “ — Registering memory points” on page 70.) 39
- 6 “Emergency”**
One of the four categories of emergency service points that are already stored in the system’s database can be selected. 38

7	“Map”	A destination can be selected simply by touching the location on the displayed map. 40
8	“Intersection”	The names of two intersecting streets can be entered. This is helpful if only the general vicinity, not the specific address, is known. 40
9	“Freeway Ent./Exit”	The name of a freeway (interstate) entrance or exit can be entered. 41
10	“?”	Function help for the “Destination” screen can be viewed on this screen. 8
11	“Change”	To change the search area, touch this touch-screen button. 24
12	Quick access touch-screen buttons	One of 5 preset destinations can be selected by touching the screen directly. To use this function, it is necessary to set the “Quick access” for each memory point. (To register a “Quick Access”, see “ — Editing memory points” on page 71.) 27

13	Home touch-screen button	A personal home address can be selected without entering the address each time. To use this function, it is necessary to set “Home” for the memory point. (To register “Home”, see “ — Registering home” on page 75.) 26
14	“Phone #”	A destination can be entered by the telephone number. 42
15	“Coordinates”	A destination can be set by using latitude and longitude as coordinates. 42



— “Menu” screen

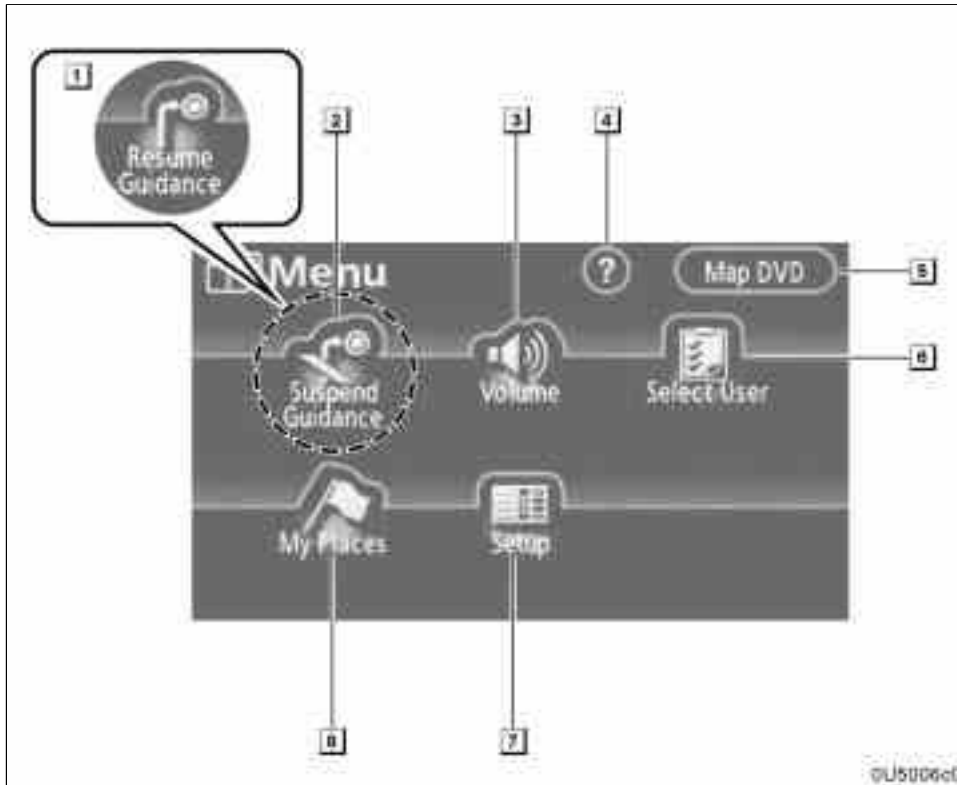

- 1 “Resume Guidance”**
Resumes guidance 66
- 2 “Suspend Guidance”**
Suspends guidance. 66
- 3 “Volume”**
Sets the volume for voice guidance.
..... 67
- 4 “?”**
Function help for the “Menu” screen can be viewed on this screen. 8
- 5 “Map DVD”**
Displays information regarding the disc version or covered area. 200
- 6 “Select User”**
Up to 3 different settings for different users can be memorized. 67
- 7 “Setup”**
Enables various settings for the navigation system. ix, 80
- 8 “My Places”**
Enables changes to “Memory points”, “Home” and “Areas to avoid”. Enables deletion of the previous point. 69

— “Setup” screen

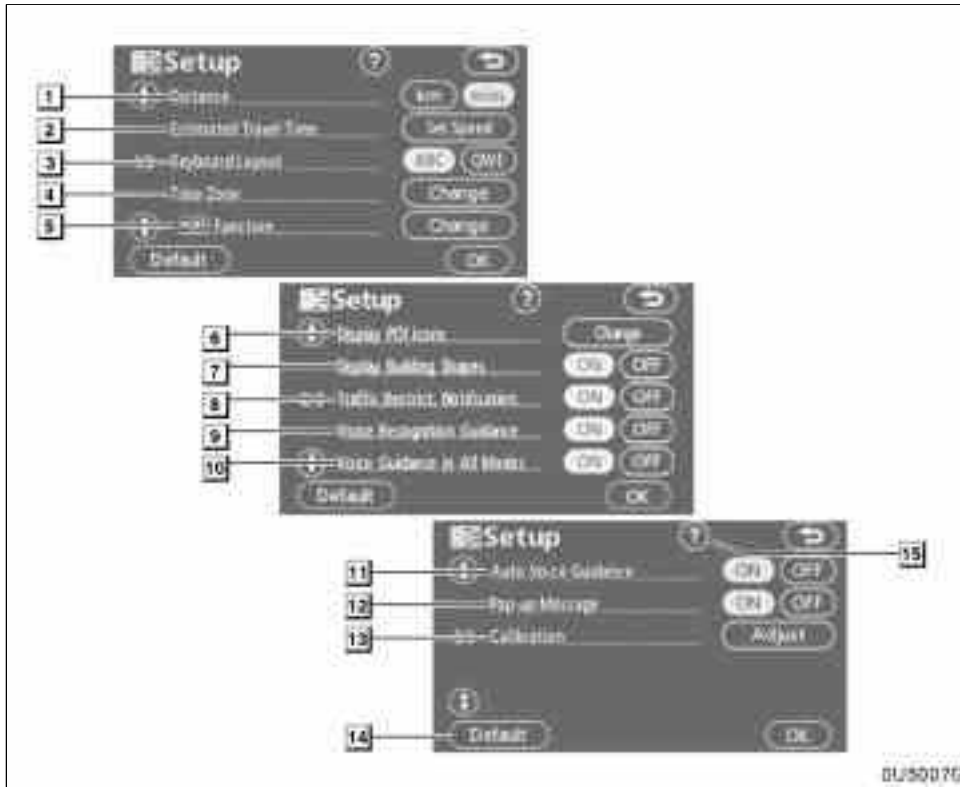

- 1 “Distance”**
The distance units “km” or “miles” can be selected. 81
- 2 “Estimated Travel Time”**
The system to display the travel time and the arrival time to the destination on the route guidance screen can be set. 81
- 3 “Keyboard Layout”**
Key layout can be changed. 82
- 4 “Time Zone”**
The desired time zone can be selected. 83
- 5 “Function”**
The choice whether to display each touch-screen button and current street name on the map screen can be set. 84
- 6 “Display POI Icons”**
A selection of 6 icons displayed on the “Display POI Icons” top screen is possible. 84
- 7 “Display Building Shapes”**
Selection of either ON or OFF to display the building shape on the map screen is possible. 85



8	“Traffic Restrict. Notification”	
	Notification of seasonal restrictions can be selected.	85
9	“Voice Recognition Guidance”	
	Voice recognition guidance can be set.	86
10	“Voice Guidance in All Modes”	
	Voice guidance can be set in all modes.	86
11	“Auto Voice Guidance”	
	Automatic voice guidance can be set.	86
12	“Pop-up Message”	
	Selection of either ON or OFF to display the pop-up message is possible.	87
13	“Calibration”	
	Adjustment of the current vehicle position mark can be done manually, or mis-calculation by changing tire will be adjusted.	87
14	“Default”	
	This touch-screen button initializes all of the settings.	80
15	“?”	
	Function help for the “Setup” screen can be viewed.	8

SECTION 1-1

OPERATION OF INSTRUMENTS AND CONTROLS

Overview of instruments and controls

Instrument panel overview	2
Instrument cluster overview	5
Indicator symbols on the instrument panel	7

06 SIENNA_U (L/O 0603)

Instrument panel overview

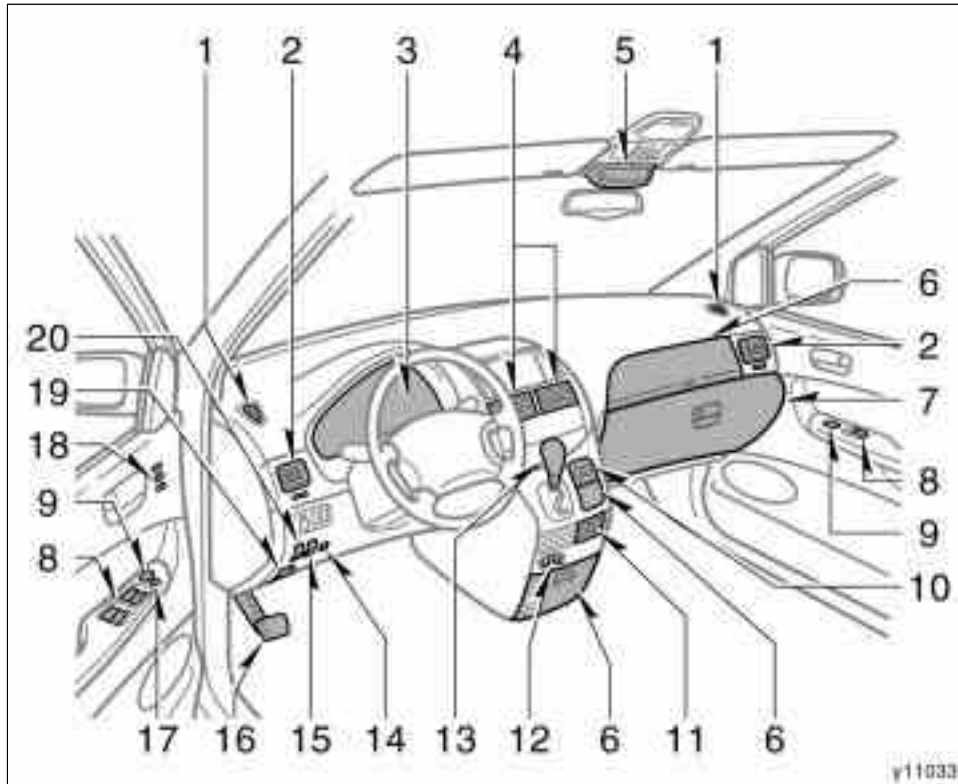

1. Side defroster outlets
2. Side vents
3. Instrument cluster
4. Center vents
5. Multi- information display or garage door opener box
6. Auxiliary boxes
7. Glove box
8. Power window switches
9. Power door lock switches
10. Seat heater dials or auxiliary box
11. Cup holder and coin holder
12. Power outlets
13. Automatic transmission selector lever
14. Tire pressure warning system reset switch
15. Power sliding door main switch ("SLIDE DOOR OFF" switch)
16. Parking brake pedal
17. Window lock switch
18. Driving position memory buttons
19. Hood lock release lever
20. Power back door main switch ("BACK DOOR OFF" switch)

06 SIENNA_U (L/O 0603)

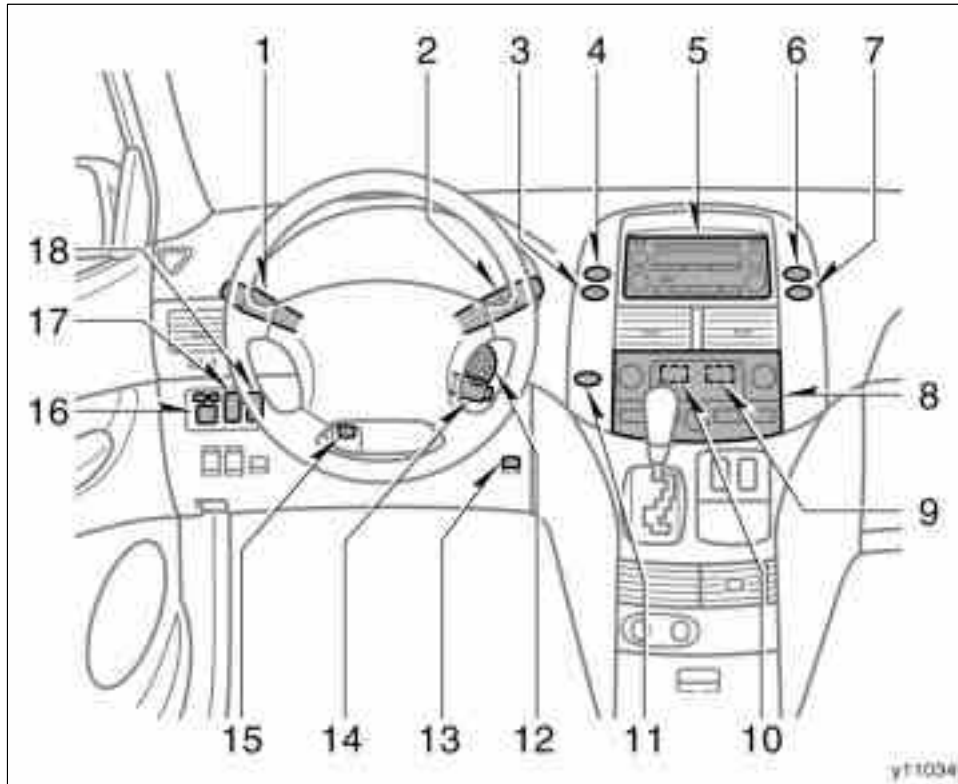

1. Headlight, turn signal and front fog light switches
2. Wiper and washer switches
3. Rear window and outside rear view mirror defogger and windshield wiper de-icer switch
4. Emergency flasher switch
5. Audio system or rear view monitor system/navigation system including audio system (For the navigation system, see the separate "Navigation System Owner's Manual".)
6. Power outlet main switch
7. AUX adapter
8. Air conditioning controls
9. "AIRBAG ON" and "AIRBAG OFF" indicator lights
10. Toyota park assist system switch and indicator light
11. Personal light main switch
12. Ignition switch
13. "TRAC OFF" switch
14. Cruise control switch or dynamic laser cruise control switch

06 SIENNA_U (L/O 0603)

15. Tilt and telescopic steering lock release lever
16. Power rear view mirror control switches
17. "REAR VENT" switch
18. Headlight beam level control dial

►Overhead console

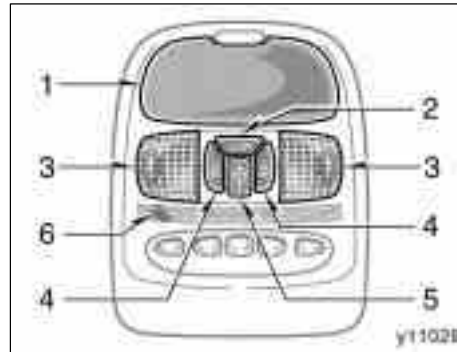

1. Conversation mirror
2. Power back door switch
3. Front personal lights
4. Power sliding door switches
5. Electric moon roof switch
6. Microphone (See the separate "Navigation System Owner's Manual".)

►Steering switches

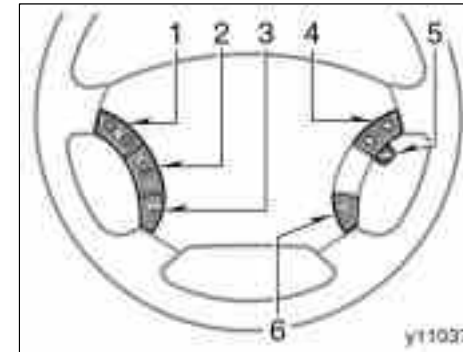

1. Volume control switches for audio system/hands-free system (For the hands-free system, see the separate "Navigation System Owner's Manual".)
2. "∧∨" switch
3. "MODE" switch
4. Telephone switches (See the separate "Navigation System Owner's Manual".)
5. Distance switch
6. Speech command switch (See the separate "Navigation System Owner's Manual".)

06 SIENNA_U (L/O 0603)

Instrument cluster overview

►Type A

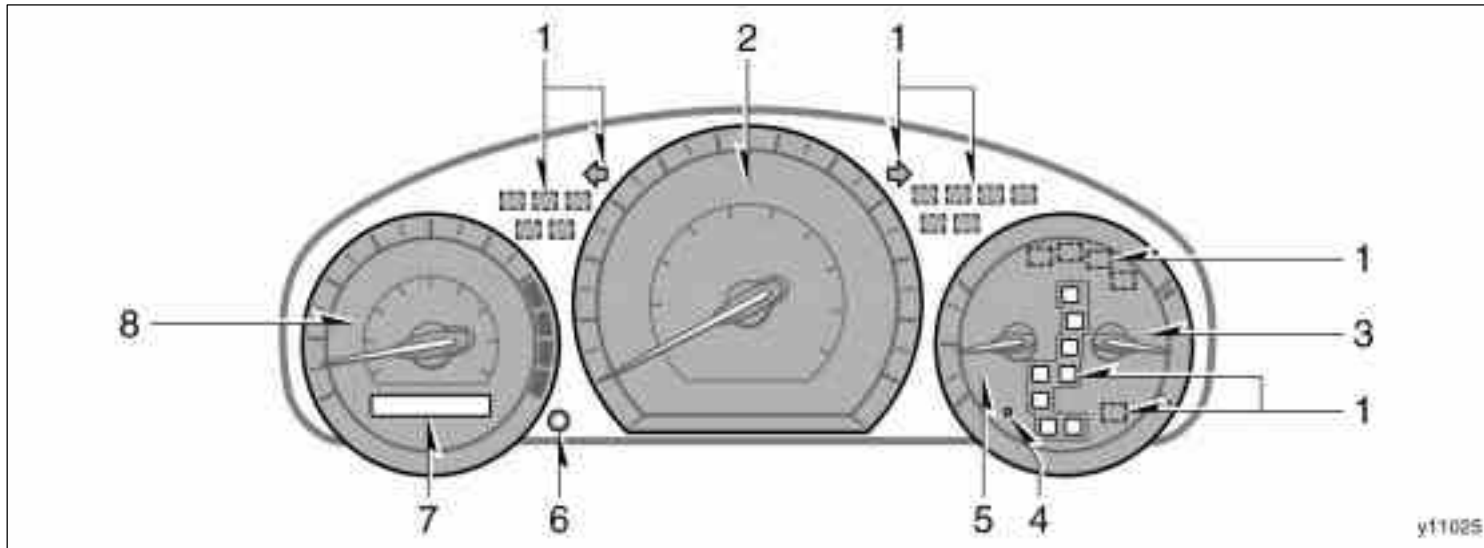

1. Service reminder indicators and indicator lights
2. Speedometer
3. Engine coolant temperature gauge

4. Low fuel level warning light
5. Fuel gauge
6. Trip meter reset knob/instrument panel light control knob

7. Odometer and two trip meters
8. Tachometer

06 SIENNA_U (L/O 0603)



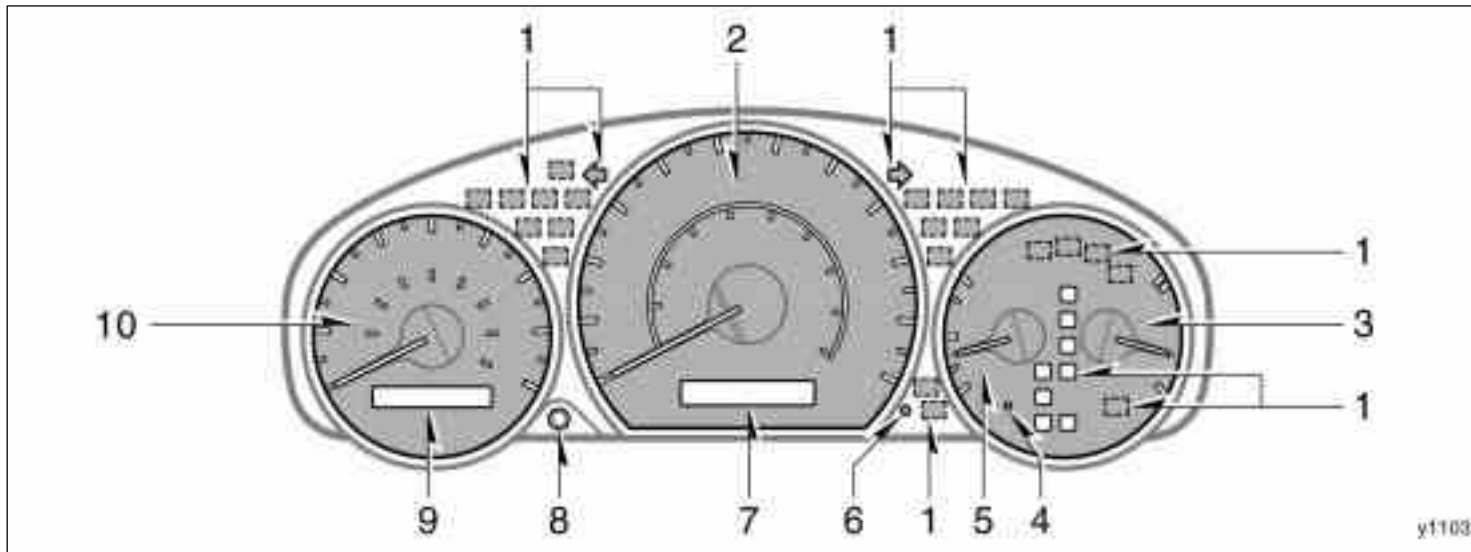









►Type B









- | | | |
|---|--|--|
| 1. Service reminder indicators and indicator lights | 5. Fuel gauge | 8. Trip meter reset knob/instrument panel light control knob |
| 2. Speedometer | 6. Dynamic laser cruise control master warning light | 9. Odometer and two trip meters |
| 3. Engine coolant temperature gauge | 7. Dynamic laser cruise control display | 10. Tachometer |
| 4. Low fuel level warning light | | |

06 SIENNA_U (L/O 0603)

Indicator symbols on the instrument panel

BRAKE or 	Brake system warning light* ¹	ABS or 	Anti-lock brake system warning light* ¹
	Driver's seat belt reminder light* ¹		Open door warning light* ¹
PASSENGER 	Front passenger's seat belt reminder light* ¹		SRS warning light* ¹
	Charging system warning light* ¹	VSC 	Vehicle stability control system/traction control system warning light* ¹
CHECK or 	Malfunction indicator lamp* ¹		Low tire pressure warning light* ¹
	Low engine oil pressure warning light* ¹		Low windshield washer fluid level warning light* ¹
		MAINT REQD	Engine oil replacement reminder light* ¹ (for vehicles sold in U.S.A.)

06 SIENNA_U (L/O 0603)

3RD SEAT	Third seat warning light*1
	Engine immobilizer/theft deterrent system indicator light
	"AIRBAG ON" indicator light
	"AIRBAG OFF" indicator light
	Headlight indicator light
	Tail light indicator light
	Headlight high beam indicator light
	Turn signal indicator lights
PRND 4 3 2 L	Automatic transmission indicator lights

	Slip indicator light
TRAC OFF	Traction control system off indicator light (two-wheel drive models)
CRUISE	Cruise control indicator light*2 or dynamic laser cruise control indicator light*3
READY	Dynamic laser cruise control ready mode indicator light
NORM.	Conventional cruise control mode indicator light

*1: For details, see "Service reminder indicators and warning buzzers" on page 187 in Section 1-6.

*2: If this light flashes, see "Cruise control" on page 213 in Section 1-7.

*3: If this light flashes, see "Dynamic laser cruise control" on page 216 in Section 1-7.

SECTION 1-2

OPERATION OF INSTRUMENTS AND CONTROLS

Keys and Doors

Keys	10
Engine immobilizer system	13
Wireless remote control	14
Front doors	22
Sliding doors	25
Power sliding doors	28
Back door	36
Power back door	37
Power windows	42
Manual quarter windows	46
Power quarter windows	46
Hood	47
Theft deterrent system	48
Fuel tank cap	50
Electric moon roof	52

06 SIENNA_U (L/O 0603)

Keys (without engine immobilizer system)

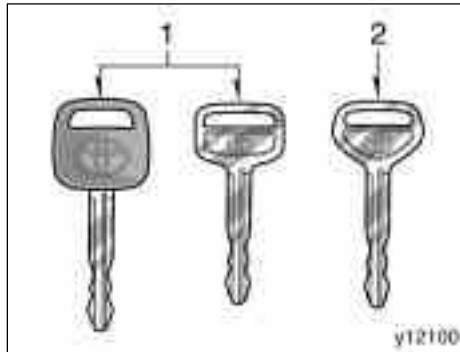

Your vehicle is supplied with two kinds of keys.

1. Master keys—These keys work in every lock.
2. Sub key—This key will not work in the glove box.

To protect items locked in the glove box when using valet parking, leave the sub key with the attendant.

Since the front doors and sliding doors can be locked without a key, you should always carry a spare master key in case you accidentally lock your keys inside the vehicle.

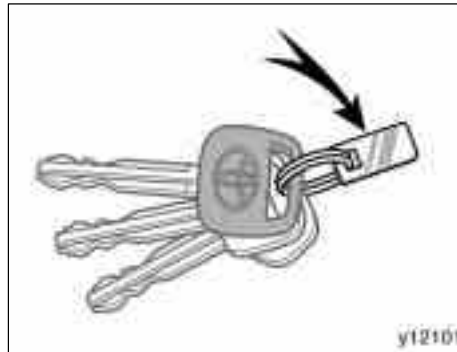

KEY NUMBER PLATE

Your key number is shown on the plate. Keep the plate in a safe place such as your wallet, not in the vehicle.

If you should lose your keys or if you need additional keys, duplicates can be made by a Toyota dealer using the key number.

We recommend writing down the key number and storing it in a safe place.

Keys (with engine immobilizer system)

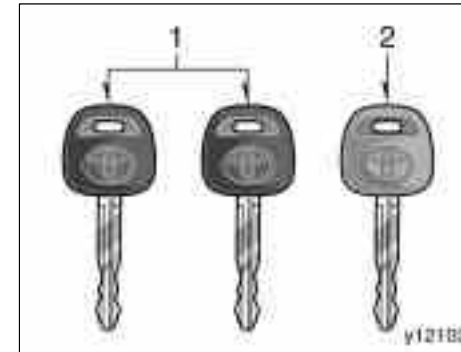

Your vehicle is supplied with two kinds of keys.

1. Master keys (black)—These keys work in every lock. Your Toyota dealer will need one of them to make a new key with a built-in transponder chip.
2. Sub key (gray)—This key will not work in the glove box.

A transponder chip for engine immobilizer system has been placed in the head of the master and sub keys. These chips are needed to enable the system to function correctly, so be careful not to lose these keys. If you make your own duplicate key, you will not be able to cancel the system or start the engine.

06 SIENNA_U (L/O 0603)

To protect items locked in the glove box when using valet parking, leave the sub key with the attendant.

Since the front doors and sliding doors can be locked without a key, you should always carry a spare master key in case you accidentally lock your keys inside the vehicle.



NOTICE

When using a key containing a transponder chip, observe the following precautions:

◆ *When starting the engine, do not use the key with a key ring resting on the key grip and do not press the key ring against the key grip. Otherwise the engine may not start, or may stop soon after it starts.*

◆ *When starting the engine, do not use the key with other transponder keys around (including keys of other vehicles) and do not press other key plates against the key grip. Otherwise the engine may not start, or may stop soon after it starts. If this happens, remove the key once and then insert it again after removing other transponder keys (including keys of other vehicles) from the ring or while gripping or covering them with your hand to start the engine.*

06 SIENNA_U (L/O 0603)



◆ Do not bend the key grip.

- ◆ Do not cover the key grip with any material that cuts off electromagnetic waves.
- ◆ Do not knock the key hard against other objects.
- ◆ Do not leave the key exposed to high temperatures for a long period, such as on the dashboard and hood under direct sunlight.
- ◆ Do not put the key in water or wash it in an ultrasonic washer.
- ◆ Do not use the key with electromagnetic materials.

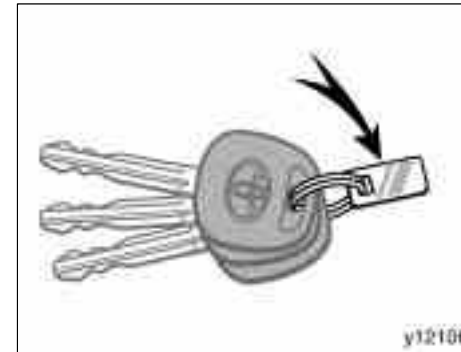

KEY NUMBER PLATE

Your key number is shown on the plate. Keep the plate in a safe place such as your wallet, not in the vehicle.

If you should lose your keys or if you need additional keys, duplicates can be made by a Toyota dealer using the key number.

We recommend writing down the key number and storing it in a safe place.

Engine immobilizer system



The engine immobilizer system is a theft prevention system. When you insert the key in the ignition switch, the transponder chip in the key's head transmits an electronic code to the vehicle. The engine will start only when the electronic code in the chip corresponds to the registered ID code for the vehicle.

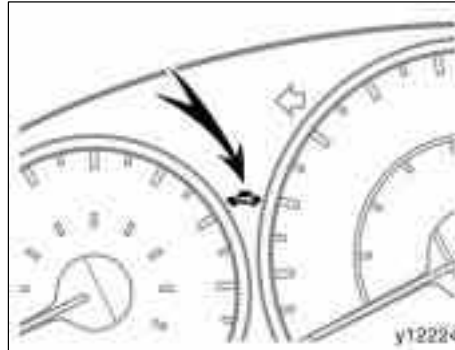

The system is automatically set when the key is removed from the ignition switch.

On some models—

The indicator light will start flashing to show the system is set.

If any of the following indicator conditions occurs, contact your Toyota dealer.

- The indicator light stays on except when the theft deterrent system is setting or activating. (See "Theft deterrent system" on page 48 in this Section.)
- The indicator light does not start flashing when the key is removed from the ignition switch.
- The indicator light flashes inconsistently.

Inserting the registered key in the ignition switch automatically cancels the system, which enables the engine to start. The indicator light will go off.

For your Toyota dealer to make you a new key with built-in transponder chip, your dealer will need your key number and master key. However, there is a limit to the number of additional keys your Toyota dealer can make for you.

If you make your own duplicate key, you will not be able to cancel the system or start the engine.

NOTICE

Do not modify, remove or disassemble the engine immobilizer system. If any unauthorized changes or modifications are made, proper operation of the system cannot be guaranteed.

06 SIENNA_U (L/O 0603)

For vehicles sold in U.S.A.

FCC ID: MOZ RI-21BTY

This device complies with Part 15 of the FCC Rules. Operation is subject to the following two conditions:

(1) This device may not cause harmful interference, and (2) this device must accept any interference received, including interference that may cause undesired operation.



CAUTION

Changes or modifications not expressly approved by the party responsible for compliance could void the user's authority to operate the equipment.

For vehicles sold in Canada

This device complies with RSS-210 of Industry Canada. Operation is subject to the following two conditions:

(1) This device may not cause interference, and (2) this device must accept any interference, including interference that may cause undesired operation of the device.

Wireless remote control—

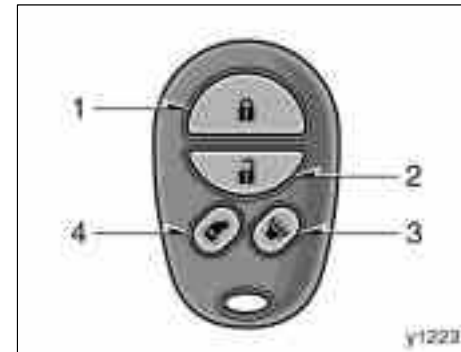

Type A

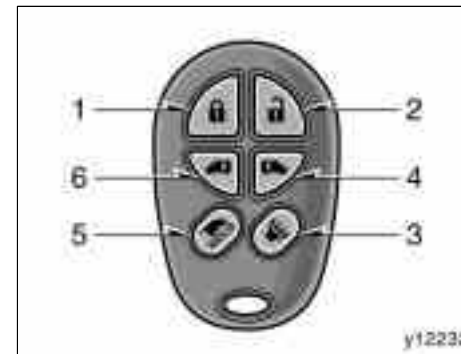

Type B

06 SIENNA_U (L/O 0603)

1. Lock switch
2. Unlock switch
3. Alarm switch
4. Sliding door open switch (right side)
5. Back door open switch
6. Sliding door open switch (left side)

The wireless remote control system is designed to lock or unlock all the side doors and back door, or activate the panic mode from a distance within approximately 1 m (3 ft.) of the vehicle. On some models, the system also allows you to activate the theft deterrent system from the same distance.

When you operate any switch, push it slowly and securely.

The wireless remote control transmitter is an electronic component. Observe the following instructions in order not to cause damage to the wireless remote control transmitter.

- Do not leave the transmitter in places where the temperature becomes high such as on the dashboard.
- Do not disassemble it.
- Avoid knocking it hard against other objects or dropping it.
- Avoid putting it in water.

You can use up to 4 wireless remote control transmitters for the same vehicle. Contact your Toyota dealer for detailed information.

If the wireless remote control transmitter does not actuate the doors or alarm, or operate from a normal distance:

- Check for closeness to a radio transmitter such as a radio station or an airport which can interfere with normal operation of the transmitter.
- The battery may have been consumed. Check the battery in the transmitter. To replace the battery, see “—Replacing battery” on page 20.

If you lose your wireless remote control transmitter, contact your Toyota dealer as soon as possible to avoid the possibility of theft, or an accident. (See “If you lose your wireless remote control transmitter” on page 439 in Section 4.)

MADE IN U.S.A.

This complies with Part 15 of the FCC rules. Operation is subject to the following two conditions:

(1) This device may not cause harmful interference, and (2) this device must accept any interference received, including interference that may cause undesired operation.

06 SIENNA_U (L/O 0603)

—Locking and unlocking doors



Locking operation (type A)



Locking operation (type B)



Unlocking operation (type A)



Unlocking operation (type B)

To lock and unlock all the doors, push the switches of the transmitter slowly and securely.

To lock: Push the lock switch. All the side doors and back door are locked simultaneously. At this time one beep will be heard, turn signal lights will flash once.

Check to see that the doors are securely locked.

If any of the side doors or back door is not securely closed, or if the key is in the ignition switch, locking cannot be performed by the lock switch and a beep will sound continuously for 10 seconds. However, if the key is in the ignition switch, a beep will not sound.

To stop the beep, close all the side doors and back door securely or push the unlock switch.

The buzzer can be disabled. For details, contact your Toyota dealer.

To unlock: Push the unlock switch once to unlock only the driver's door. Pushing the switch twice within 3 seconds unlocks all the side doors and back door simultaneously. Each time the unlock switch is pushed, two beeps will be heard, turn signal lights will flash twice.

06 SIENNA_U (L/O 0603)

This double switch operation to unlock all the side doors and back door can be changed to a single switch operation. For details, contact your Toyota dealer.

When the unlock switch is pressed, the front personal lights and ignition switch light come on. The lights remain on for about 15 seconds unless any of the side doors or back door are opened then and closed. (For further information, see "Front personal lights" on page 176 and/or "Ignition switch light" on page 179 in Section 1-5.)

You have 60 seconds to open a door after using the wireless remote unlock feature. If a door is not opened by then, all the side doors and back door will automatically lock again.

The timing for the automatic door lock function can be changed. For details, contact your Toyota dealer.

If the lock or unlock switch is kept pressed in, the locking or unlocking operation is not repeated. Release the switch and then push again.

The following adjustments can be made in this system. For details, contact your Toyota dealer.

- Cancelling the wireless door locking or unlocking function
- Cancelling the flash of the turn signal lights
- Cancelling the beep sound

—Opening and closing sliding doors



Right side power sliding door (type A)



Right side power sliding door (type B)

06 SIENNA_U (L/O 0603)



Left side power sliding door (type B only)

Push and hold the switch of the wireless remote control transmitter about one second. The power sliding door opens and closes completely.

Right side power sliding door—

To open: Push the sliding door open switch (right side).

To close: Push the sliding door open switch (right side) again.

Left side power sliding door—

To open: Push the sliding door open switch (left side).

To close: Push the sliding door open switch (left side) again.

Opening operation can be performed by the switches under the following conditions only:

- The sliding door is unlocked.
- The power sliding door system is on. (The “SLIDE DOOR OFF” switch on the instrument panel is pushed out.)
- The key is not in the ignition switch.
- The sliding door is between the fully-closed position and half-opened position.

The sliding door stops at the half-opened position when the window is opened more than about 15 cm (6 in.).

The left side power sliding door does not operate when the fuel filler door is opened.

Closing operation can be performed by the wireless remote control switches under the following conditions only:

- The power sliding door system is on. (The “SLIDE DOOR OFF” switch on the instrument panel is pushed out.)
- The key is not in the ignition switch.
- The sliding door is between the fully-opened position and half-opened position.

The sliding door operation by the wireless remote control can be changed or disabled. For details, contact your Toyota dealer.

06 SIENNA_U (L/O 0603)

—Opening and closing back door (type B only)



Push and hold the back door open switch on the wireless remote control transmitter for about one second. The power back door opens and closes completely.

When closing or opening the back door, two beeps will be heard and the turn signal lights will flash twice.

Opening operation can be performed by the switch under the following conditions only:

- The back door is unlocked.
- The power back door system is on. (The "BACK DOOR OFF" switch on the instrument panel is pushed out.)
- The key is not in the ignition switch.
- The back door is between the fully-closed position and half-opened position.

Closing operation can be performed by the switch under the following conditions only:

- The power back door system is on. (The "BACK DOOR OFF" switch on the instrument panel is pushed out.)
- The key is not in the ignition switch.
- The back door is between the fully-opened position and half-opened position.

The back door operation by the wireless remote control can be changed or disabled. For details, contact your Toyota dealer.

—Activating alarm



Pushing and holding the alarm switch blows the horn intermittently and flashes the headlights, tail lights and turns on the front personal lights.

The alarm switch is used to deter vehicle theft when you witness anyone attempting to break into or damage your vehicle.

The alarm will last for one minute. To stop alarm midway, do the following:

- Push any of the switch on the wireless remote control transmitter.
- Lock or unlock either front doors or back door with the key.
- Turn the ignition key from the "LOCK" to "ON" position.

06 SIENNA_U (L/O 0603)

—Replacing battery

The alarm does not work when the ignition key is in the "ON" position.

This alarm function can be disabled. For details, contact your Toyota dealer.

For replacement, use a CR2032 lithium battery or equivalent.



CAUTION

Special care should be taken to prevent small children from swallowing the removed transmitter battery or components.

NOTICE

- ◆ *When replacing the transmitter battery, be careful not to lose the components.*
- ◆ *Replace only with the same or equivalent type recommended by a Toyota dealer.*
- ◆ *Dispose of used batteries according to the local laws.*

Replace the transmitter battery by following these procedures:



1. Using a coin or equivalent, open the transmitter case.

06 SIENNA_U (L/O 0603)

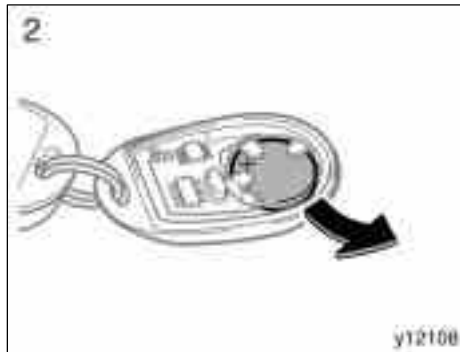

2. Remove the discharged transmitter battery.

NOTICE

Do not bend the terminals.

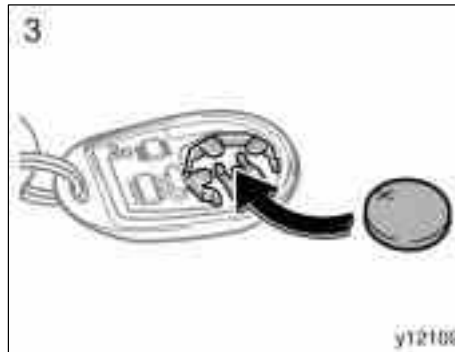

3. Put in a new transmitter battery with positive (+) side up.

Close the transmitter case securely.

NOTICE

- ◆ *Make sure the positive side and negative side of the transmitter battery are faced correctly.*
- ◆ *Do not replace the battery with wet hands. Water may cause unexpected rust.*
- ◆ *Do not touch or move any components inside the transmitter, or it may interfere with proper operation.*

◆ *Be careful not to bend the electrode when inserting the transmitter battery and that dust or oils do not adhere to the transmitter case.*

◆ *Close the transmitter case securely.*

After replacing battery, check that the transmitter operates properly. If the transmitter still does not operate properly, contact your Toyota dealer.

06 SIENNA_U (L/O 0603)

Front doors

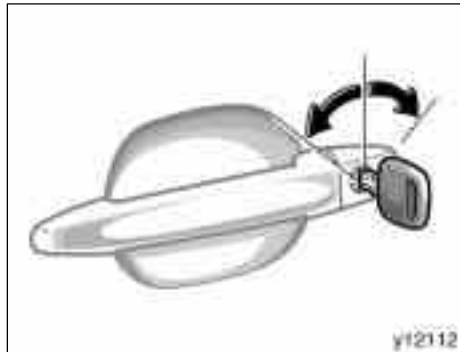

LOCKING AND UNLOCKING WITH KEY Insert the key into the keyhole and turn it.

To lock: Turn the key forward.

To unlock: Turn the key backward.

All the side doors and back door lock and unlock simultaneously with either front door. In the driver's door lock, turning the key once will unlock the driver's door and twice in succession will unlock all the doors simultaneously.

This double key turning operation to unlock all the side doors and back door can be changed to a single key turning operation. For details, contact your Toyota dealer.

22

When either front door is unlocked with a key, the front personal lights and ignition switch light will come on and remain on for about 15 seconds before fading out. (For details, see "Front personal lights" on page 176 and "Ignition switch light" on page 179 in Section 1-5.)



LOCKING AND UNLOCKING WITH INSIDE LOCK KNOB

Move the lock knob.

To lock: Push the knob forward.

To unlock: Pull the knob backward.

The front doors can be opened by pulling the inside handles even if the lock knobs are in the locked position.

06 SIENNA_U (L/O 0603)

CAUTION

Do not pull the inside handle of the front doors while driving. The doors will open and an accident may occur. Toyota strongly recommends that all children be placed in the rear seat of the vehicle.

Closing the door with the lock knob in the lock position will also lock the door. Be careful not to lock your keys in the vehicle.

The front doors cannot be locked if you leave the key in the ignition switch.

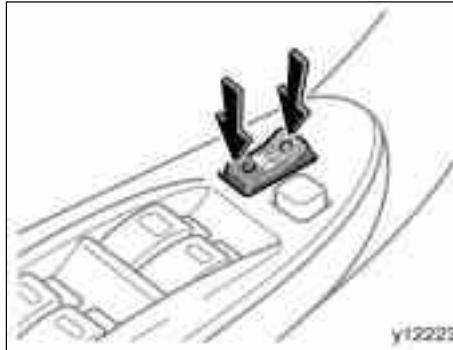

Driver's side

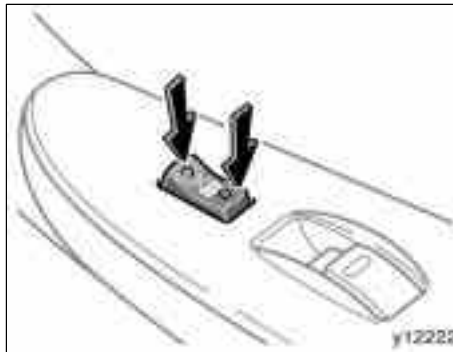

Front passenger's side

LOCKING AND UNLOCKING WITH POWER DOOR LOCK SWITCH

Push the switch.

To lock: Push the switch down on the front side.

To unlock: Push the switch down on the rear side.

Operating the switch simultaneously locks or unlocks all the side doors and back door.

If you do either of the following, no side door or back door can be unlocked with the power door lock switch.

- Lock all the side doors and back door with the key or wireless remote control transmitter when all the side doors and back door are closed.
- Open the driver's door or front passenger's door and move the inside lock knobs of both front doors to the lock position, then close the front doors.

The power door lock switch can be reset in the following ways.

- Turn the ignition key to "ON".
- Unlock all the side doors and back door with the key or wireless remote control transmitter.
- Unlock the driver's door or front passenger's door with the inside lock knob, and then unlock all the doors and back door with the power door lock switch.

 CAUTION
<p>Before driving, be sure that the doors are closed and locked, especially when small children are in the vehicle. Along with the proper use of seat belts, locking the doors helps prevent the driver and passengers from being thrown out from the vehicle in an accident. It also helps prevent the doors from being opened unintentionally.</p>

—Automatic door locking and unlocking functions

AUTOMATIC DOOR LOCKING

You can select the following functions:

- **Locking linked with the shift position**

All doors are automatically locked when the selector lever is moved out of "P" position.

- **Locking linked with vehicle speed**

All doors are automatically locked when the vehicle speed goes above about 20 km/h (12 mph).

You can set or cancel the automatic door locking functions:

Be sure to apply the parking brake when performing the following operations.

To select the locking linked with the shift position:

1. Close all doors and turn the ignition key to the "ON" position.
2. Shift the selector lever to the "P" position.

3. Within 10 seconds of turning the ignition key to the "ON" position, press and hold the driver's side power door lock switch in the lock position for 5 seconds and then release.

The doors will be locked and unlocked to indicate that the function is set.

To cancel the function, do the above operation again.

To select the locking linked with the vehicle speed:

1. Close all doors and turn the ignition key to the "ON" position.
2. Shift the selector lever from "P" to the "N" position.
3. Within 10 seconds of turning the ignition key to the "ON" position, press and hold the driver's side power door lock switch in the lock position for 5 seconds and then release.

The doors will be locked and unlocked to indicate that the function is set.

To cancel the function, do the above operation again.

06 SIENNA_U (L/O 0603)

AUTOMATIC DOOR UNLOCKING

You can select the following functions:

- **Unlocking linked with the shift position**

All doors are automatically unlocked when the selector lever is moved to "P" position.

- **Unlocking linked with the ignition switch**

All doors are automatically unlocked when the driver's door is opened within 10 seconds after the ignition key is turned to the "ACC" or "LOCK" position, or the key is removed.

You can set or cancel the automatic door unlocking functions:

Be sure to apply the parking brake when performing the following operations.

To select the unlocking linked with the shift position:

1. Close all doors and turn the ignition key to the "ON" position.
2. Shift the selector lever to the "P" position.

3. Within 10 seconds of turning the ignition key to the "ON" position, press and hold the driver's side power door lock switch in the unlock position for 5 seconds and then release.

The doors will be locked and unlocked to indicate that the function is set.

To cancel the function, do the above operation again.

To select the unlocking linked with the ignition switch:

1. Close all doors and turn the ignition key to the "ON" position.
2. Shift the selector lever from "P" to the "N" position.
3. Within 10 seconds of turning the ignition key to the "ON" position, press and hold the driver's side power door lock switch in the unlock position for 5 seconds and then release.

The doors will be locked and unlocked to indicate that the function is set.

To cancel the function, do the above operation again.

Sliding doors (non-powered)

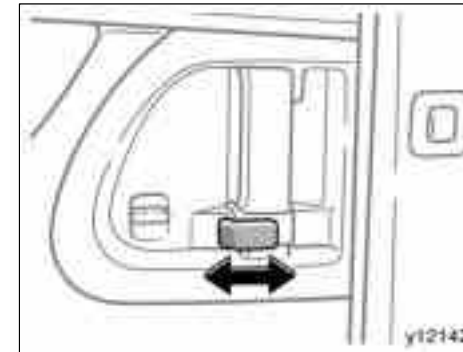

LOCKING AND UNLOCKING WITH INSIDE LOCK KNOB

Move the lock knob.

To lock: Move the knob forward.

To unlock: Move the knob backward.

Closing the sliding door with the lock knob in the lock position will also lock the sliding door. Be careful not to lock your keys in the vehicle.

06 SIENNA_U (L/O 0603)

CLOSING THE FULLY-OPENED SLIDING DOOR

To close the fully-opened sliding door, pull the inside or outside handle and then close the door.

CAUTION

Before driving, be sure that the doors are closed and locked, especially when small children are in the vehicle. Along with the proper use of seat belts, locking the doors helps prevent the passengers from being thrown out from the vehicle in an accident. It also helps prevent the doors from being opened unintentionally.



CAUTION

- When closing the sliding door, confirm safety of the area around. Keep the heads, hands and other parts of the bodies of all occupants away from the sliding door. Otherwise, the closing door may cause an unexpected serious injury.
- When the vehicle is stopped on a slope, the door will slide faster when opening or closing, so be especially careful that the passengers do not get hit or pinched by the door.

- When stopping on a downward slope, open the door fully while passengers are getting on or off. Do not pull the outside handle or inside handle while the door is open as the door could suddenly close by itself causing injury.

NOTICE

Do not close the sliding door by applying the brakes. Doing so could cause the door to be damaged.

06 SIENNA_U (L/O 0603)

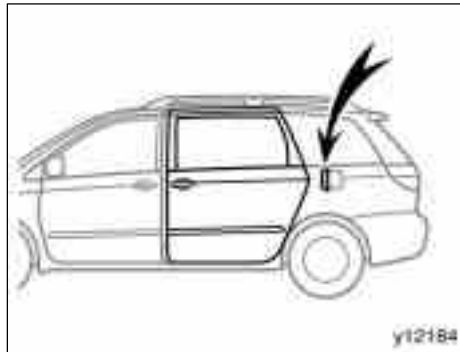

When the fuel filler door is opened, the left side sliding door will not open. Close the fuel filler door securely and then operate the sliding door.

NOTICE

Avoid forcibly opening the left side sliding door fully when the fuel filler door is opened. Otherwise, the fuel filler door may be damaged.

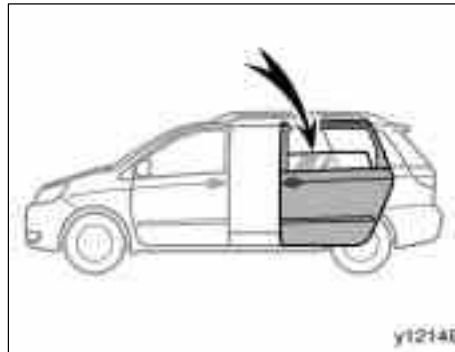

When the sliding door window is opened more than about 15 cm (6 in.), the sliding door will stop at half-opened position for safety reasons. Close the window and then operate the sliding door.

CAUTION

Do not leave the sliding door at half-opened position because the door is not latched at this position. If the vehicle is stopped on a downward slope, it may move and cause an unexpected injury.

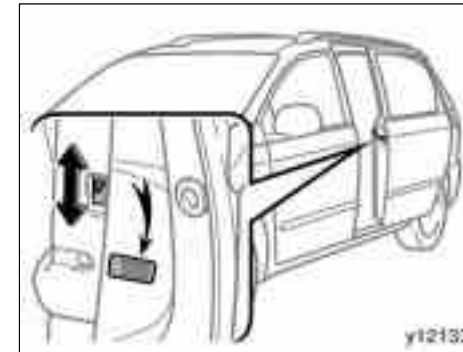

SLIDING DOOR CHILD-PROTECTORS

Open the sliding door fully and move the lock lever to the "LOCK" position as shown on the label. Then close the sliding door.

If the child-protector is locked, you cannot open the sliding door from the inside. We recommend using this feature whenever small children are in the vehicle.

Power sliding doors—

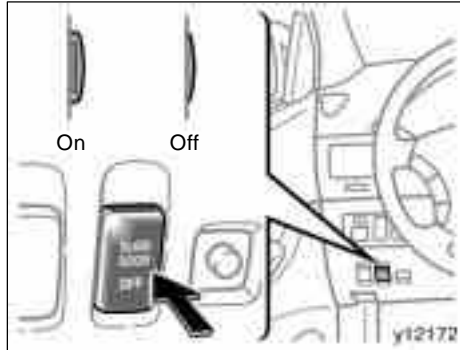

**POWER SLIDING DOOR MAIN SWITCH
("SLIDE DOOR OFF" switch)**

This switch is used to turn on and off the power sliding door system. In order to operate the power sliding door, the "SLIDE DOOR OFF" switch on the instrument panel must be pushed out. (The orange line on top of the switch indicates that the power sliding door system is on.) To disable the power sliding door feature, push in the switch.

When the power sliding door system is on, you can open and close the sliding door with the power sliding door switches on the overhead console or wireless remote control transmitter even if the sliding door child-protector is locked.

When the power sliding door system is off, you can open and close the sliding door by the same operations as non-powered sliding door.

The sliding door closer is operative even if the power sliding door system is off. See page 32 about sliding door closer.

NOTICE

When your vehicle goes through an automatic car wash, make sure the power sliding door system is off.

CAUTION

- Do not leave small children or pets unattended in your vehicle. They could operate the power sliding door and injure themselves or others. Turn off the power sliding door system when the power sliding door is not in use.
- When jacking up the vehicle, turn off the power sliding door system and close the sliding door completely.

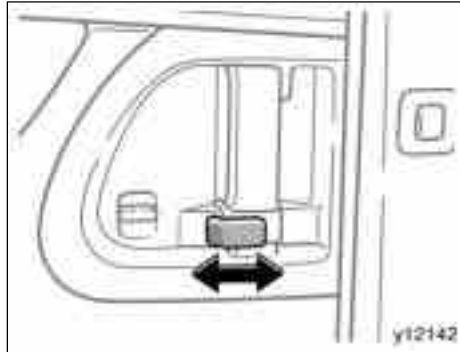

LOCKING AND UNLOCKING WITH INSIDE LOCK KNOB

Move the lock knob.

To lock: Move the knob forward.

To unlock: Move the knob backward.

Closing the sliding door with the lock knob in the lock position will also lock the sliding door. Be careful not to lock your keys in the vehicle.

CAUTION

Before driving, be sure that the doors are closed and locked, especially when small children are in the vehicle. Along with the proper use of seat belts, locking the doors helps prevent the passengers from being thrown out from the vehicle in an accident. It also helps prevent the doors from being opened unintentionally.

—Operation of power sliding door

The power sliding door can be operated automatically in the following ways:

- Operates with the power sliding door switches inside the vehicle
- Operates with the wireless remote control transmitter
- Assists operation with the outside or inside handle by hand

The power sliding door system can be canceled by the "SLIDE DOOR OFF" switch.

When the power sliding door system is on, if you put the transmission out of "P" with the ignition key in the "ON" position and the sliding door is not completely closed, a buzzer will sound.

CAUTION

- Careful attention is needed so as not to get your fingers trapped as the sliding door automatically opens or closes.
- Never allow a child to operate the sliding door.

NOTICE

Do not apply excessive force when the sliding door is operated automatically. Otherwise, the power sliding door system may be damaged.

You can cause a beep to sound when the power sliding door is opened or closed. For details, contact your Toyota dealer.

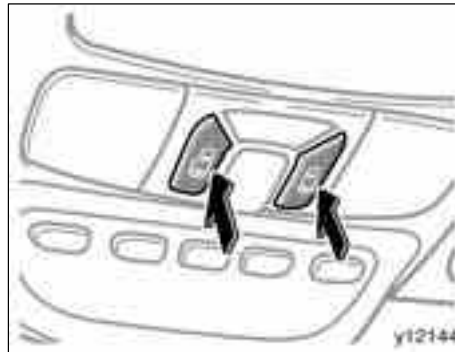

Front overhead console





Center pillar

OPERATING WITH THE POWER SLIDING DOOR SWITCHES

To open the door, push the switch. To close the door, push the switch once again. The door opens and closes completely.

Switches on the front overhead console:

“” switch—To operate the left side door

“” switch—To operate the right side door

Switches on the center pillar:

“PWR DOOR” switch—To operate each side door

Opening operation can be performed by the switches under the following conditions:

- The sliding door is unlocked.
- The power sliding door system is on. (The “SLIDE DOOR OFF” switch is pushed out.)
- The sliding door is between the fully-closed position and half-opened position.

06 SIENNA_U (L/O 0603)

- When the ignition key is in the “ON” position, the transmission selector lever must be in “P”.
- The child-protector is unlocked. (switches on the center pillar only)

Closing operation can be performed by the switches under the following conditions:



- The power sliding door system is on. (The “SLIDE DOOR OFF” switch is pushed out.)
- The sliding door is between the fully-opened position and half-opened position.

Left and right side power sliding door models—The left side power sliding door does not operate when the fuel filler door is opened.

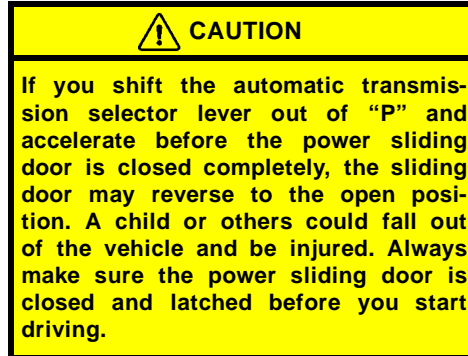
The length of time required to push the switches for operating the sliding door can be changed. For details, contact your Toyota dealer.



OPERATING WITH THE WIRELESS REMOTE CONTROL TRANSMITTER

To open or close the door, push the “” or “” switch on the wireless remote control transmitter about one second. (Only when the power sliding door system is on.) For details, see “Wireless remote control” on page 14 in this Section.

ASSISTS OPERATION WITH THE OUTSIDE OR INSIDE HANDLE BY HAND

When the power sliding door system is on (the “SLIDE DOOR OFF” switch is pushed out), if you pull the outside handle or slide the inside handle, the sliding door will automatically and completely open or close.

When the power sliding door system is off, the sliding door can be operated manually by the outside or inside handle.

06 SIENNA_U (L/O 0603)

CLOSING THE FULLY-OPENED SLIDING DOOR

To close the fully-opened sliding door, pull the inside or outside handle and then close the door.

Sliding door closer: When the sliding door has not been fully closed, it is automatically closed completely even if the power sliding door system is off.

CAUTION

- Careful attention is needed so as not to get your fingers trapped as the sliding door automatically closes when it has not been fully closed.
- Never allow a child to operate the sliding door.

NOTICE

Do not apply excessive force when the sliding door closer is operating. Otherwise, the sliding door closer may be damaged.



JAM PROTECTION FUNCTION

If anything with sufficient resistance obstructs the power sliding door while it is closing or opening, the sliding door will automatically reverse to the opposite direction. However, if the power sliding door is between the half-opened and fully-opened positions while it is opening, the door will stop at that position.

If the jam protection function operates continuously at the closing operation more than 2 times, the sliding door will be stopped at that position and the power sliding door system will be canceled.

Before operating the power sliding door, make sure there is nobody near the sliding door. Make sure the sliding door stops at the fully-opened position, and then allow the passengers to get in and out of the vehicle.

The resistance must be as strong as the force of the moving door, or stronger. As the sliding door approaches the fully-closed or fully-opened position, its moving force increases significantly.

The jam protection function may not work if something gets caught just before the sliding door is fully closed.

If the sliding door receives a strong impact, this function may operate even if nothing is caught.

CAUTION

The power sliding door could injure people if they are caught in the door path. When using the power sliding door, observe the following:

- Never try jamming any part of your body to activate the jam protection function intentionally, as it could result in a serious injury.

- The jam protection function may not work if something gets caught just before the sliding door is fully closed.
- Before you close the power sliding door, always make sure there is nobody around it. Also make sure the heads, hands and other parts of the bodies of all occupants are kept completely inside the vehicle. If someone's neck, head or hands get caught in a closing door, it could result in death or serious injury. When anyone closes the power sliding door, make sure he or she operates the door safely.

NOTICE

Objects caught in the path of the sliding door may be damaged. Make sure there is nothing in the doorway before closing the sliding door.

If the battery is disconnected or run down, the power sliding door system may not work after you reconnect, replace or recharge the battery. In any of these cases, close the sliding doors completely by hand to normalize the power sliding door system.

If the power sliding door system does not operate properly after the above procedure, there may be a problem in the system. Contact your Toyota dealer.

—Power sliding door cautions



⚠ CAUTION

- When closing the sliding door, confirm safety of the area around. Keep the heads, hands and other parts of the bodies of all occupants away from the sliding door. Otherwise, the closing door may cause an unexpected serious injury.
- When the vehicle is stopped on a slope, the door will slide faster when opening or closing, so be especially careful that the passengers do not get hit or pinched by the door.

06 SIENNA_U (L/O 0603)

- When stopping on a downward slope, open the door fully while passengers are getting on or off. Do not pull the outside handle or inside handle while the door is open as the door could suddenly close by itself causing injury.

NOTICE

Do not close the sliding door by applying the brakes. Doing so could cause the door to be damaged.

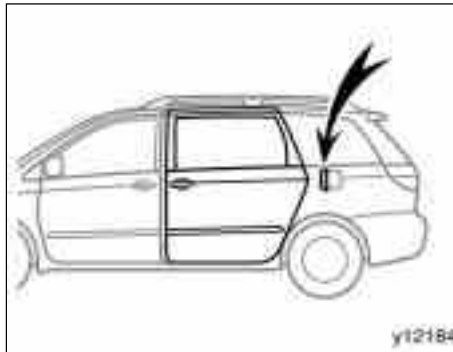

When the fuel filler door is opened, the left side sliding door will not open. Close the fuel filler door securely and then operate the sliding door.

NOTICE

Avoid forcibly opening the left side sliding door fully when the fuel filler door is opened. Otherwise, the fuel filler door may be damaged.

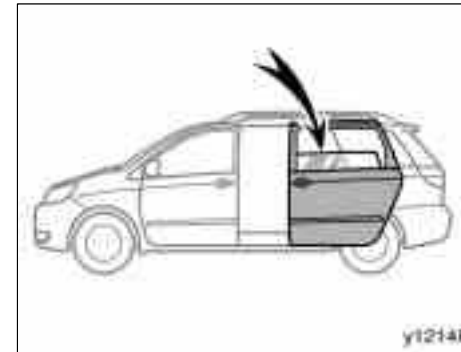

When the sliding door window is opened more than about 15 cm (6 in.), the sliding door will stop at half-opened position for safety reasons. Close the window and then operate the sliding door.

—Sliding door
child-protectors

CAUTION

When the power sliding door is ON—Do not leave the sliding door at half-opened position because the door will unlock after 30 minutes. If the vehicle is stopped on a downward slope, it may move and cause an unexpected injury.

When the power sliding door is OFF—Do not leave the sliding door at half-opened position because the door is not latched at this position. If the vehicle is stopped on a downward slope, it may move and cause an unexpected injury.

NOTICE

When the power sliding door is ON—To prevent the battery from being discharged, do not leave the sliding door at half-opened position.

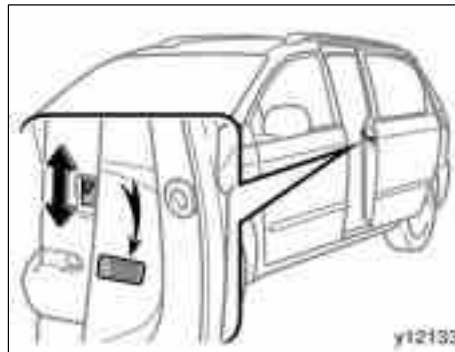

Open the sliding door fully and move the lock lever to the “LOCK” position as shown on the label. Then close the sliding door.

When the child-protector is locked, you cannot open the sliding door by the inside door handle. We recommend using this feature whenever small children are in the vehicle.

CAUTION

Make sure to turn off the power sliding door system after locking the child-protectors.

06 SIENNA_U (L/O 0603)

Back door (non- powered)

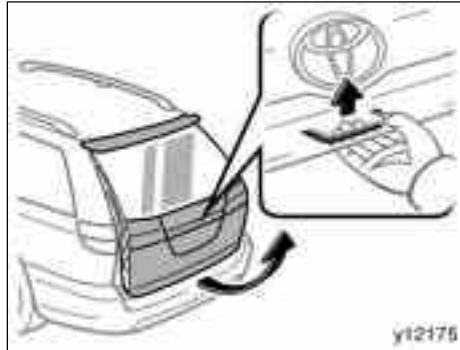

To open the back door, push up the back door opener and raise the door.

The back door can be opened when the vehicle is stopped.

The back door can be locked or unlocked in the following ways.

- Operate the power door lock switch. (See “Front doors” on page 22 in this Section.)
- Operate the wireless remote control. (See “Wireless remote control” on page 14 in this Section.)
- All the side doors and back door are locked and unlocked simultaneously with the driver’s door. (See “Front doors” on page 22 in this Section.)

When all the side doors and back door are unlocked simultaneously with a key, the front personal lights and ignition switch light will come on and remain on for about 15 seconds before fading out. (For details, see “Front personal lights” on page 176 and “Ignition switch light” on page 179 in Section 1-5.)

If the back door opener does not operate, see “If you cannot operate back door opener” on page 440 in Section 4.

If the battery is disconnected or run down, the back door will be automatically locked after you reconnect, replace or recharge the battery. Be careful not to lock your keys in the vehicle.

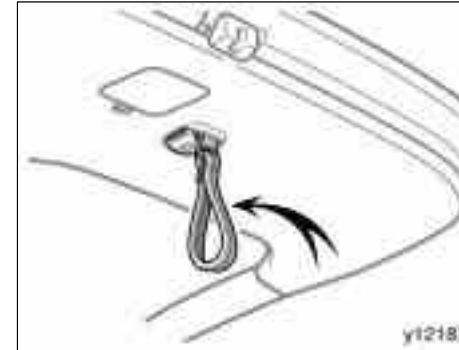

When closing the back door, the inside strap can be used to make the reach easier.

To close the back door, lower it and press down on it. After closing the back door, try pulling it up to make sure it is securely closed.

See “—Stowage precautions” on page 399 in Section 2 for precautions when loading luggage.

**Power back door—
—“BACK DOOR OFF” switch**

CAUTION

Keep the back door closed while driving. This not only keeps the luggage from being thrown out but also prevents exhaust gases from entering the vehicle.

NOTICE

To avoid damage to the back door dampers, do not apply any force, paint or let any other foreign matter on them.

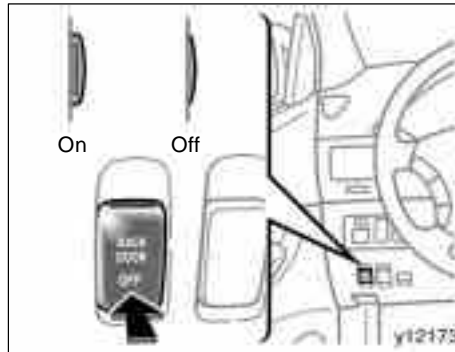

This switch is used to turn on and off the power back door system. In order to operate the power back door, the “BACK DOOR OFF” switch on the instrument panel must be pushed out. (The orange line on top of the switch indicates that the power back door system is on.) To disable the power back door feature, push in the switch.

CAUTION

- Do not leave small children or pets unattended in your vehicle. They could operate the power back door, and anyone around the back door could be injured. Turn off the power back door system when the power back door is not in use.
- When jacking up the vehicle, turn off the power back door system and close the back door completely.

NOTICE

When your vehicle goes through an automatic car wash, make sure the power back door system is off.

—Automatic operation (power back door—ON)

The power back door can be operated automatically in the following ways:

- Operates with the power back door switch on the overhead console
- Operates with the wireless remote control transmitter
- Assists closing by hand

The power back door system can be canceled by the "BACK DOOR OFF" switch.

When the system is canceled, see "—Manual operation" on page 41 in this Section.

When closing or opening the back door automatically, two beeps will be heard and the turn signal lights will flash twice.

The beep sound can be changed. For details, contact your Toyota dealer.

! CAUTION

- Careful attention is needed so as not to get your fingers trapped as the back door automatically closes.
- Never allow a child to operate the back door.

NOTICE

Do not apply excessive force when the back door is operated automatically. Otherwise, the power back door system may be damaged.

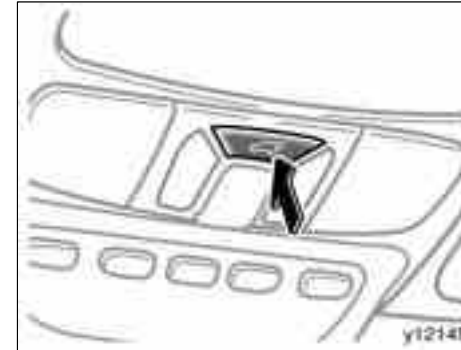

OPERATING WITH THE POWER BACK DOOR SWITCH

To open the door, push and hold the "🚗" switch on the overhead console about one second. To close the door, push this switch once again. The door opens and closes completely.

06 SIENNA_U (L/O 0603)

Opening operation can be performed by the switch under the following conditions:

- The back door is unlocked.
- The power back door system is on. (The "BACK DOOR OFF" switch is pushed out.)
- The back door is between in the fully-closed position and half-opened position.
- When the ignition key is in the "ON" position, the transmission selector lever must be in "P".

Closing operation can be performed by the switch under the following conditions:

- The power back door system is on. (The "BACK DOOR OFF" switch is pushed out.)
- The back door is between in the fully-opened position and half-opened position.

The time of pushing the switches for operating the back door can be changed. For details, contact your Toyota dealer.

OPERATING WITH THE WIRELESS REMOTE CONTROL TRANSMITTER

To open or close the door, push and hold the "🔑" switch on the wireless remote control transmitter about one second. (Only when the power back door system is on.) For details, see "Wireless remote control" on page 14 in this Section.

ASSISTS CLOSING BY HAND

When the power back door system is on (the "BACK DOOR OFF" switch is pushed out), if you move the back door about 10—15 cm (4—6 in.) from its fully-opened position, the back door will automatically and completely close.

When the power back door system is off, the back door can be closed manually.

The assisting function when closing the back door can be disabled and the assisting function when opening the back door can be added. For details, contact your Toyota dealer.

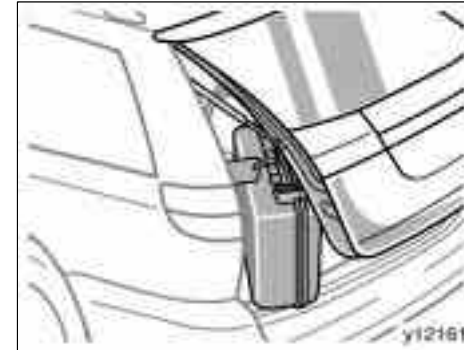

JAM PROTECTION FUNCTION

If anything with sufficient resistance obstructs the power back door while it is closing or opening, the back door will automatically reverse to the opposite direction.

If the jam protection function operates continuously at the closing operation more than 2 times, the back door will be stopped at that position.

06 SIENNA_U (L/O 0603)

Before operating the power back door, make sure there is nobody near the back door.

The resistance must be as strong as the force of the moving door, or stronger. As the back door approaches the fully-closed or fully-opened position, its moving force increases significantly.

The jam protection function may not work if something gets caught just before the back door is fully closed.

If the back door receives a strong impact, this function may operate even if nothing is caught.

CAUTION

The power back door could injure people if they are caught in the door path. When using the power back door, observe the following:

- **Never try jamming any part of your body to activate the jam protection function intentionally, as it could result in a serious injury.**
- **The jam protection function may not work if something gets caught just before the sliding door is fully closed.**
- **Before you close the power back door, always make sure there is nobody around it. If someone's neck, head or hands get caught in a closing door, it could result in death or serious injury. When anyone closes the power back door, make sure he or she operates the door safely.**

If the battery is disconnected or run down, the back door will be automatically locked and the power back door system may not work after you reconnect, replace or recharge the battery. In any of these cases, normalize the power back door system by following procedure.

1. Unlock the back door with the key, wireless remote control transmitter or power door lock switch.
2. Close the back door completely by hand.

If the power back door system does not operate properly after the above procedure, there may be a problem in the system. Contact your Toyota dealer.

NOTICE

Objects caught in the path of the back door may be damaged. Make sure there is nothing in the doorway before closing the back door.

06 SIENNA_U (L/O 0603)

—Manual operation (power back door—OFF)

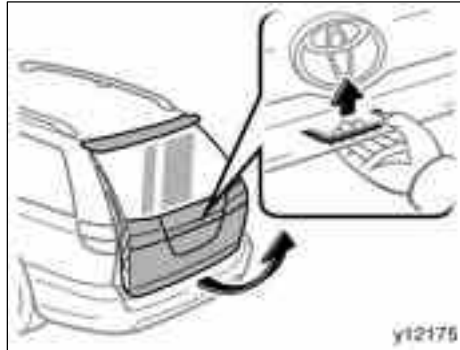

To open the back door, push up the back door opener and raise the door.

The back door can be opened when the vehicle is stopped.

The back door can be locked or unlocked in the following ways.

- Operate the power door lock switch. (See “Front doors” on page 22 in this Section.)
- Operate the wireless remote control. (See “Wireless remote control” on page 14 in this Section.)
- All the side doors and back door are locked and unlocked simultaneously with the driver’s door. (See “Front doors” on page 22 in this Section.)

When all the side doors and back door are unlocked simultaneously with a key, the front personal lights and ignition switch light will come on and remain on for about 15 seconds before fading out. (For details, see “Front personal lights” on page 176 and “Ignition switch light” on page 179 in Section 1-5.)

If the back door opener does not operate, see “If you cannot operate back door opener” on page 440 in Section 4.

If the battery is disconnected or run down, the back door will be automatically locked after you reconnect, replace or recharge the battery. Be careful not to lock your keys in the vehicle.

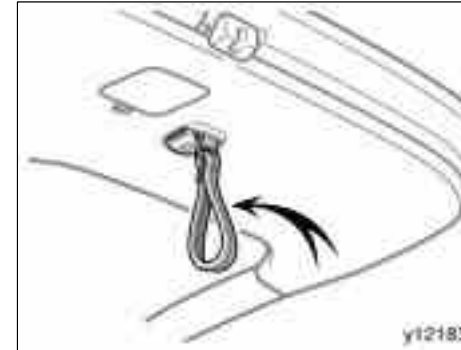

When closing the back door, the inside strap can be used to make the reach easier.

To close the back door, lower it and press down on it. After closing the back door, try pulling it up to make sure it is securely closed.

See “—Stowage precautions” on page 399 in Section 2 for precautions when loading luggage.

CAUTION

Keep the back door closed while driving. This not only keeps the luggage from being thrown out but also prevents exhaust gases from entering the vehicle.

NOTICE

To avoid damage to the back door dampers, do not apply any force, paint or let any other foreign matter on them.

Back door closer: When the back door has not been fully closed, it is automatically closed completely even if the power back door system is off.

CAUTION

- Careful attention is needed so as not to get your fingers trapped as the back door automatically closes when it has not been fully closed.
- Never allow a child to operate the back door.

NOTICE

Do not apply excessive force when the back door closer is operating. Otherwise, the back door closer may be damaged.

Power windows

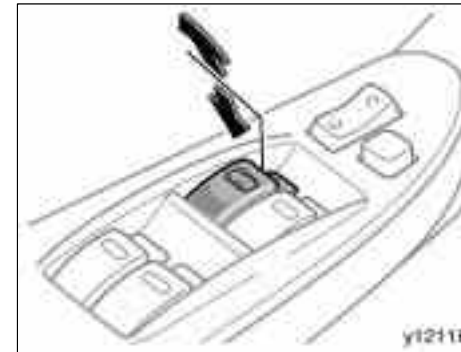

The windows can be operated with the switch on each front door.

The power windows work when the ignition key is in the "ON" position.

Key off operation: If both front doors are closed, the front door windows and sliding door windows work for 43 seconds even after the ignition switch is turned off. It stops working when either front door is opened.

06 SIENNA_U (L/O 0603)

OPERATING THE DRIVER'S WINDOW

Use the switch on the driver's door.

Normal operation: The window moves as long as you hold the switch.

To open: Lightly push down the switch.

To close: Lightly pull up the switch.

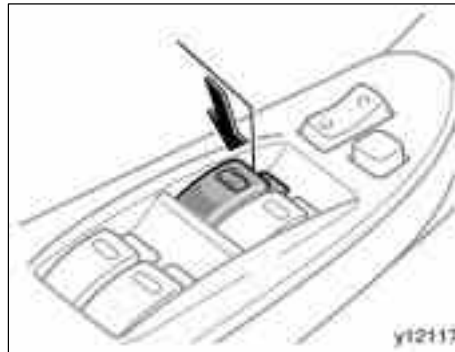

Type A (to open only)

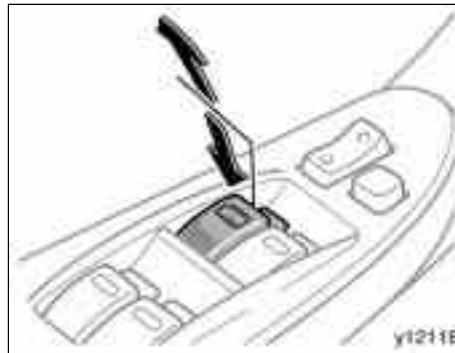

Type B (to open and close)

Automatic operation:

Type A—Push the switch completely down and then release it. The window will fully open. To stop the window partway, lightly pull the switch up and then release it.

Type B—Push the switch completely down or pull it completely up, and then release it. The window will fully open or close. To stop the window partway, lightly move the switch in the opposite direction and then release it.

Jam protection function (type B only):

During automatic closing operation, the window stops and opens half way if something gets caught between the window and window frame.

If the window receives a strong impact, this function may work even if nothing is caught.

06 SIENNA_U (L/O 0603)

If the battery is disconnected or run down, the power window may not operate automatically and the jam protection function will not function correctly after you reconnect, replace or recharge the battery. In any of these cases, you should normalize the power window.

To normalize the power window:

1. Push down the power window switch and lower the window halfway.
2. Pull up the switch until the window closes and hold the switch for a second.

Make sure that the window opens and closes automatically. If the power window cannot be operated properly, have it checked by your Toyota dealer.

CAUTION

- Never try jamming any part of your body to activate the jam protection function intentionally, as it could result in a serious injury.
- The jam protection function may not work if something gets caught just before the window is fully closed.

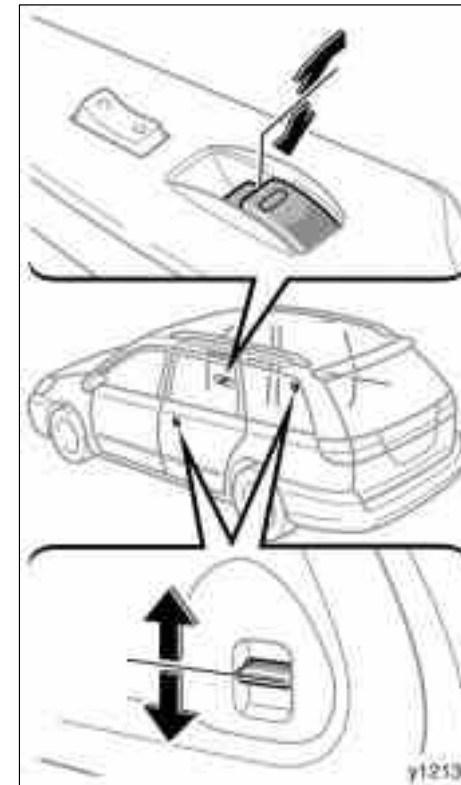
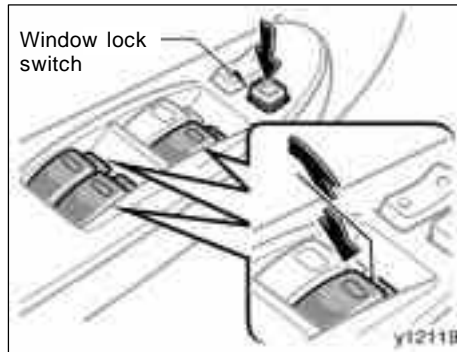

OPERATING THE PASSENGERS' WINDOWS

Use the switch on each passenger's door or the switches on the driver's door that control each passenger's window.

The window moves as long as you hold the switch.

To open: Push down the switch.

To close: Pull up the switch.

If you push in the window lock switch on the driver's door, the passengers' windows cannot be operated.

The sliding door window cannot be operated when the sliding door is opened.

 **CAUTION**

To avoid serious personal injury, you must do the following.

- Before you close the power windows, always make sure there is nobody around the power windows. You must also make sure the heads, hands and other parts of the bodies of all occupants are kept completely inside the vehicle. If someone's neck, head or hands get caught in a closing window, it could result in death or serious injury. When anyone closes the power windows, make sure he or she operates the windows safely.
- When small children are in the vehicle, never let them use the power window switches without supervision. Use the window lock switch to prevent them from making unexpected use of the switches.

- Be sure to remove the ignition key when you leave your vehicle.
- Never leave anyone (particularly a small child) alone in your vehicle, especially with the ignition key still inserted. Otherwise, he/she could use the power window switches and get trapped in a window. Unattended person (particularly a small child) can be involved in a serious accident.

Manual quarter windows



To open the quarter window, pull the latch handle toward you and swing it fully out.

When closing the window, make sure it is completely closed.

Power quarter windows

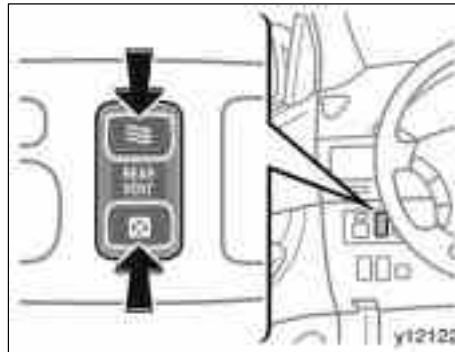

The quarter windows can be operated with the "REAR VENT" switch on the instrument panel.

The power quarter windows work when the ignition key is in the "ON" position.

To open: Push the switch on the upper side.

To close: Push the switch on the lower side.

Both the left and right rear quarter windows move as long as you hold the switch.

Key off operation: If both front doors are closed, they work for 43 seconds even after the ignition switch is turned off. They stop working when either front door is opened.

CAUTION

To avoid serious personal injury, you must do the following.

- Before you close the power quarter windows, always make sure there is nobody around the power quarter windows. You must also make sure the heads, hands and other parts of the bodies of all occupants are kept completely inside the vehicle. If someone's neck, head or hands get caught in a closing window, it could result in death or serious injury. When anyone closes the power windows, make sure he or she operates the windows safely.
- When small children are in the vehicle, never let them use the power quarter window switches without supervision.

06 SIENNA_U (L/O 0603)

- Be sure to remove the ignition key when you leave your vehicle.
- Never leave anyone (particularly a small child) alone in your vehicle, especially with the ignition key still inserted. Otherwise, he/she could use the power quarter window switch and get trapped in a window. Unattended person (particularly a small child) can be involved in a serious accident.

Hood

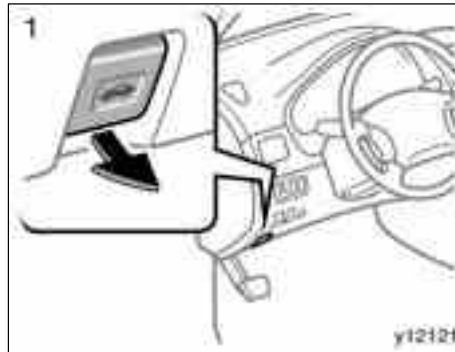

To open the hood:

1. Pull the hood lock release lever. The hood will spring up slightly.

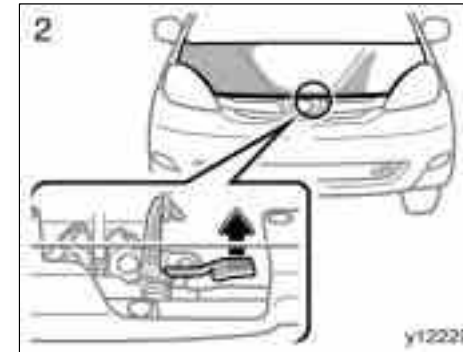

2. In front of the vehicle, pull up the auxiliary catch lever and lift the hood.

CAUTION

Before driving, be sure that the hood is closed and securely locked. Otherwise, the hood may open unexpectedly while driving and an accident may occur.

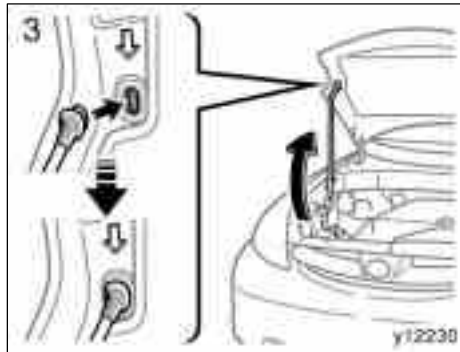

3. Hold the hood open by inserting the support rod into the slot.

To insert the support rod into the slot, move it straight up. If it is moved to the side or toward the inside of the vehicle, it may become detached.

Before closing the hood, check to see that you have not forgotten any tools, rags, etc. and return the support rod to its clip—this prevents rattles. Then lower the hood and make sure it locks into place. If necessary, press down gently on the front edge to lock it.

CAUTION
After inserting the support rod into the slot, make sure the rod supports the hood securely from falling down on to your head or body.

NOTICE
Be sure to return the support rod to its clip before closing the hood. Closing the hood with the support rod up could cause the hood to bend.

Theft deterrent system



To deter the vehicle theft, the system is designed to sound an alarm if any of the side doors, back door or hood is forcibly unlocked or opened or the battery terminal is disconnected and then reconnected when the vehicle is locked.

The alarm blows the horn intermittently and flashes the headlights, tail lights and turn signal lights, and turns on the front personal lights.

06 SIENNA_U (L/O 0603)

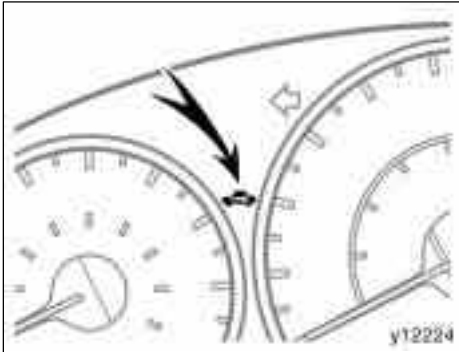

SETTING THE SYSTEM

1. Turn the ignition key to the "LOCK" position and remove it.

On some models, the indicator light will start flashing when the key is removed from the ignition switch. (See "Engine immobilizer system" on page 13 in this Section for details.)

2. Have all passengers get out of the vehicle.
3. Close and lock all the side doors, back door and hood.

The indicator light will remain on when all the side doors, back door and hood are closed and locked.

The system will automatically be set after 30 seconds. When the system is set, the indicator light will start flashing again.

4. After making sure the indicator light starts flashing, you may leave the vehicle.

Never leave anyone in the vehicle when you set the system, because unlocking from the inside will activate the system.

CANCELING THE SYSTEM

The system can be canceled by the following ways:

- Any of the side doors or the back door is unlocked with the key or wireless remote control transmitter.
- Turn the ignition key to "ON" position.

If the parking lights and tail lights come on for 2 seconds when the system is canceled, the system has been alarmed. Check to see if there is any abnormality with your vehicle.

WHEN THE SYSTEM IS SET

Activating the system

The system will sound the alarm under the following conditions:

- If any of the side doors or back door is unlocked or opened without the key or wireless remote control transmitter, or if the hood is forcibly opened.
- If the battery terminal is disconnected and then reconnected.
- If the ignition is hotwired.

The indicator light will come on when the system is activated.

If the alarm has been activated and any of the side doors or back door is unlocked, all the side doors and back door will re-lock automatically.

After one minute, the alarm will automatically stop and the indicator light will start flashing again.

Reactivating the system

Once set, the system is automatically reset after the alarm stopped automatically after one minute.

The alarm will activate again under the same circumstances described in "Activating the system".

06 SIENNA_U (L/O 0603)

Stopping the alarm

The alarm will be stopped by the following these ways:

- Unlock any of the side doors or the back door with the key or wireless remote control transmitter.
- Turn the ignition key from the "LOCK" to "ON" position.

These ways cancel the system at the same time.

If the battery becomes discharged due to the vehicle being unused for a long time, etc., when the battery is recharged or replaced, the system will give the alarm. If this happens, immediately unlock any of the side doors or the back door with the key or the wireless remote control transmitter, and the alarm will stop.

TESTING THE SYSTEM

1. Open all the windows.
2. Set the system as described above. All the side doors and back door should be locked with the key or wireless remote control transmitter. Be sure to wait until the indicator light starts flashing.
3. Unlock any side door from the inside. The system should activate the alarm.
4. Stop the alarm as described above.
5. Repeat this operation for the other doors and hood. When testing the hood, also check that the system is activated when the battery terminal is disconnected and then reconnected.

If the system does not work properly, have it checked by your Toyota dealer.

Fuel tank cap

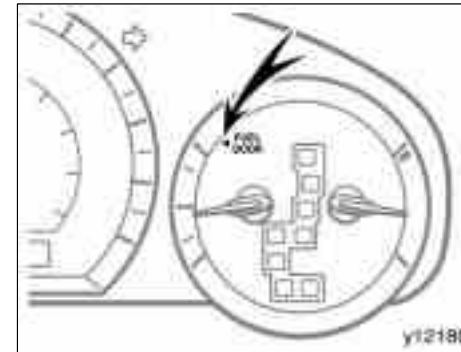

This indicates that the fuel filler door is on the left side of your vehicle.

06 SIENNA_U (L/O 0603)



1. To open the fuel filler door, pull the lever up.

When refueling, turn off the engine.

CAUTION

- Do not smoke, cause sparks or allow open flames when refueling. The fumes are flammable.
- When opening the cap, do not remove the cap quickly. In hot weather, fuel under pressure could cause injury by spraying out of the filler neck if the cap is suddenly removed.

NOTICE

Avoid opening the fuel filler door when the left side sliding door is fully opened. Otherwise, the fuel filler door may be damaged.

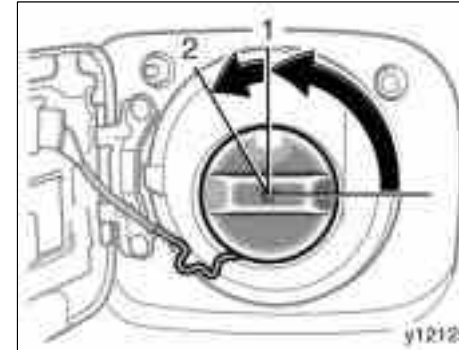

2. To remove the fuel tank cap, turn the cap counterclockwise by 90 degrees (to the pressure point 1), and then turn it an additional 30 degrees (to point 2). Pause slightly before removing it.

It is not unusual to hear a slight swoosh when the cap is opened.

06 SIENNA_U (L/O 0603)

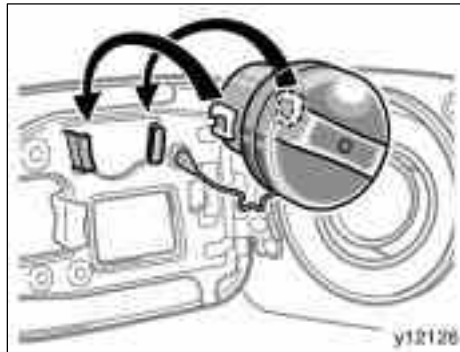

3. The removed cap can be stored on the back side of the fuel filler door.

Position the cap so that the hooks point to the left and right, and set it in the receptacle on the back side of the door.

When installing the cap, turn the cap clockwise until you hear one click. When you hear the click, the cap is fully closed.

If the cap is not installed securely, the malfunction indicator lamp comes on. Make sure the cap is tightened securely.

The indicator lamp goes off after driving several times. If the indicator lamp does not go off, contact your Toyota dealer as soon as possible.

CAUTION

- Make sure the cap is installed securely to prevent fuel spillage in the event of an accident.
- Use only a genuine Toyota fuel tank cap for replacement. It is designed to regulate fuel tank pressure.

NOTICE

To prevent damage to the cap, apply force only in the turning direction to the cap. Do not pull or pry it.

Electric moon roof



Sliding operation

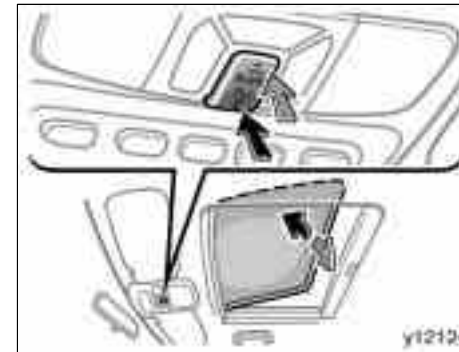

Tilting operation

06 SIENNA_U (L/O 0603)

To operate the moon roof, use the switch on the overhead console.

The moon roof works when the ignition key is in the "ON" position.

The sun shade can be opened or closed by hand.

Sliding operation—

To open: Push the switch on the "SLIDE OPEN" side.

The roof will fully open automatically. To stop the roof partway, push the switch on either the "SLIDE OPEN" or "TILT UP" side quickly.

When you quickly push and release the switch, the moon roof will open while the switch is being pushed and stop when released.

The sun shade will be opened together with the roof.

When the moon roof is opened fully, the deflector will raise to reduce the entering of the strong wind. The angle of the deflector will be adjusted according to the vehicle speed.

To close: Push the switch on the "TILT UP" side.

The roof will fully close automatically. To stop the roof partway, push the switch on either the "SLIDE OPEN" or "TILT UP" side quickly.

When you quickly push and release the switch, the moon roof will close while the switch is being pushed and stop when released.

Tilting operation—

To tilt up: Push the switch on the "TILT UP" side.

The roof will fully tilt up automatically. To stop the roof partway, push the switch on either the "SLIDE OPEN" or "TILT UP" side quickly.

When you quickly push and release the switch, the moon roof will tilt up while the switch is being pushed and stop when released.

To tilt down: Push the switch on the "SLIDE OPEN" side.

The roof will fully tilt down automatically. To stop the roof partway, push the switch on either the "SLIDE OPEN" or "TILT UP" side quickly.

When you quickly push and release the switch, the moon roof will tilt down while the switch is being pushed and stop when released.

Key off operation: If both front doors are closed, it works for 43 seconds even after the ignition switch is turned off. It stops working when either front door is opened.

Jam protection function:

- If something gets caught between the moon roof and frame during slide closing operation, the moon roof stops and opens half way, and the deflector stops and raises fully.
- If something gets caught between the moon roof and frame during tilting down operation, the moon roof stops and opens fully.

If the moon roof receives a strong impact, this function may work even if nothing is caught.

If the moon roof does not operate automatically or the jam protection function does not operate correctly, you should normalize the moon roof.

To normalize the moon roof, push and hold the switch on the "TILT UP" side until the moon roof tilts all the way up and then tilts down a little automatically.

06 SIENNA_U (L/O 0603)

Make sure that the moon roof opens and closes automatically. If the moon roof cannot be operated properly, have it checked by your Toyota dealer.

CAUTION

To avoid serious personal injury, you must do the following.

- While the vehicle is moving, always keep the heads, hands and other parts of the bodies of all occupants away from the roof opening. Otherwise, they could be seriously injured if the vehicle stops suddenly or if the vehicle is involved in an accident.
- Before you close the moon roof, always make sure there is nobody around the moon roof. You must also make sure nobody places his or her head, hands and other parts of the body in the roof opening. If someone's neck, head or hands get caught in the closing roof, it could result in death or serious injury. When anyone closes the moon roof, first make sure it is safe to do so.

- Be sure to remove the ignition key when you leave your vehicle.
- Never leave anyone (particularly a small child) alone in your vehicle, especially with the ignition key still inserted. Otherwise, he/she could use the power window switches and get trapped in a window. Unattended person (particularly a small child) can be involved in a serious accident.
- Never sit on top of the vehicle around the roof opening.
- Never try jamming any part of your body to activate the jam protection function intentionally, as it could result in a serious injury.
- The jam protection function may not work if something gets caught just before the moon roof is fully closed.

SECTION 1-3

OPERATION OF INSTRUMENTS AND CONTROLS

Occupant restraint systems

Seats	56
Front seats	56
Driving position memory system	63
Rear seats	65
Head restraints	104
Armrests	104
Seat heaters	105
Seat belts	106
SRS airbags	118
Child restraint	137

Seats

While the vehicle is being driven, all vehicle occupants should have the seatback upright, sit well back in the seat and properly wear the seat belts provided.

CAUTION

- Do not drive the vehicle unless the occupants are properly seated. Do not allow any passengers to sit on top of a folded-down seatback, or in the luggage compartment or cargo area. Persons not properly seated and/or not properly restrained by seat belts can be severely injured in the event of emergency braking or a collision.
- During driving, do not allow any passengers to stand up or move around between seats. Otherwise, severe injuries can occur in the event of emergency braking or a collision.

Front seats— —Front seat precautions

Driver seat

CAUTION

The SRS driver airbag deploys with considerable force, and can cause death or serious injury especially if the driver is very close to the airbag. The National Highway Traffic Safety Administration (“NHTSA”) advises:

Since the risk zone for driver airbag is the first 50—75 mm (2—3 in.) of inflation, placing yourself 250 mm (10 in.) from your driver airbag provides you with a clear margin of safety. This distance is measured from the center of the steering wheel to your breastbone. If you sit less than 250 mm (10 in.) away now, you can change your driving position in several ways:

- Move your seat to the rear as far as you can while still reaching the pedals comfortably.

- Slightly recline the back of the seat. Although vehicle designs vary, many drivers can achieve the 250 mm (10 in.) distance, even with the driver seat all the way forward, simply by reclining the back of the seat somewhat. If reclining the back of your seat makes it hard to see the road, raise yourself by using a firm, non-slippery cushion, or raise the seat if your vehicle has that feature.

- If your steering wheel is adjustable, tilt it downward. This points the airbag toward your chest instead of your head and neck.

The seat should be adjusted as recommended by NHTSA above, while still maintaining control of the foot pedals, steering wheel, and your view of the instrument panel controls.

06 SIENNA_U (L/O 0603)

Front passenger seat

CAUTION

The SRS front passenger airbag also deploys with considerable force, and can cause death or serious injury especially if the front passenger is very close to the airbag. The front passenger seat should be as far from the airbag as possible with the seatback adjusted, so the front passenger sits upright.

Front seats (with SRS side airbags)

CAUTION

The SRS side airbags are installed in the driver and front passenger seats. Observe the following precautions.

- Do not lean against the front door when the vehicle is in use, since the side airbag inflates with considerable speed and force. Otherwise, you may be killed or seriously injured.
- Do not use seat accessories which cover the area where the side airbags inflate. Such accessories may prevent the side airbags from activating correctly, causing death or serious injury.
- Do not modify or replace the seats or upholstery of the seats with side airbags. Such change may prevent the side airbag system from activating correctly, disable the system or cause the side airbags to inflate accidentally, resulting in death or serious injury.

—Seat adjustment precautions

CAUTION

- Do not adjust the seat while the vehicle is moving as the seat may unexpectedly move and cause the driver to lose control of the vehicle.
- Be careful that the seat does not hit a passenger or luggage.
- After adjusting the seat position, release the lever and try sliding the seat forward and backward to make sure it is locked in position.
- After adjusting the seatback, push your body back against the seat to make sure the seat is locked in position.
- Do not put objects under the seats except for putting them in the auxiliary box. Otherwise, the objects may interfere with the seat-lock mechanism or unexpectedly push up the seat position adjusting lever and the seat may suddenly move, causing the driver to lose control of the vehicle.

06 SIENNA_U (L/O 0603)

—Adjusting driver's seat (manual seat)

- While adjusting the seat, do not put your hands under the seat or near the moving parts. Otherwise, your hands or fingers may be caught and injured.



1. SEAT POSITION ADJUSTING LEVER

Hold the center of the lever and pull it up. Then slide the seat to the desired position with slight body pressure and release the lever.

2. SEAT HEIGHT ADJUSTING KNOB

To change the seat height, turn the knob either way.

3. SEATBACK ANGLE ADJUSTING LEVER

Lean forward and pull the lever up. Then lean back to the desired angle and release the lever.

—Adjusting driver's seat
(power seat)

CAUTION

Avoid reclining the seatback any more than needed. The seat belts provide maximum protection in a frontal or rear collision when the driver and the front passenger are sitting up straight and well back in the seats. If you are reclined, the lap belt may slide past your hips and apply restraint forces directly to the abdomen or your neck may contact the shoulder belt. In the event of a frontal collision, the more the seat is reclined, the greater the risk of death or personal injury.

4. SEAT LUMBAR SUPPORT ADJUSTING KNOB

To change the amount of lumbar support, turn the knob either way.



1. SEAT POSITION, SEAT CUSHION ANGLE AND SEAT HEIGHT ADJUSTING SWITCH

Move the control switch in the desired direction.

Releasing the switch will stop the seat at that position.

Do not place anything under the front seats, as this might interfere with the seat movement.

2. SEATBACK ANGLE ADJUSTING SWITCH

Move the control switch in the desired direction.

Releasing the switch will stop the seatback at that position.

—Adjusting front passenger's seat (manual seat)

CAUTION

Avoid reclining the seatback any more than needed. The seat belts provide maximum protection in a frontal or rear collision when the driver and the front passenger are sitting up straight and well back in the seats. If you are reclined, the lap belt may slide past your hips and apply restraint forces directly to the abdomen or your neck may contact the shoulder belt. In the event of a frontal collision, the more the seat is reclined, the greater the risk of death or personal injury.

3. SEAT LUMBAR SUPPORT ADJUSTING SWITCH

Press either side of the switch.

The amount of lumbar support will change while the switch is pressed.



1. SEAT POSITION ADJUSTING LEVER

Hold the center of the lever and pull it up. Then slide the seat to the desired position with slight body pressure and release the lever.

2. SEATBACK ANGLE ADJUSTING LEVER

Lean forward and pull the lever up. Then lean back to the desired angle and release the lever.

CAUTION

Avoid reclining the seatback any more than needed. The seat belts provide maximum protection in a frontal or rear collision when the driver and the front passenger are sitting up straight and well back in the seats. If you are reclined, the lap belt may slide past your hips and apply restraint forces directly to the abdomen or your neck may contact the shoulder belt. In the event of a frontal collision, the more the seat is reclined, the greater the risk of death or personal injury.

06 SIENNA_U (L/O 0603)

—Adjusting front passenger's seat (power seat)

3. SEATBACK FOLDING LEVER (on some models)

The front passenger's seat can be folded down using this lever.



1. SEAT POSITION ADJUSTING SWITCH

Move the control switch in the desired direction.

Releasing the switch will stop the seat at that position.

Do not place anything under the front seats, as this might interfere with the seat movement.

2. SEATBACK ANGLE ADJUSTING SWITCH

Move the control switch in the desired direction.

Releasing the switch will stop the seat-back at that position.

06 SIENNA_U (L/O 0603)

—Folding front passenger's seat

CAUTION

Avoid reclining the seatback any more than needed. The seat belts provide maximum protection in a frontal or rear collision when the driver and the front passenger are sitting up straight and well back in the seats. If you are reclined, the lap belt may slide past your hips and apply restraint forces directly to the abdomen or your neck may contact the shoulder belt. In the event of a frontal collision, the more the seat is reclined, the greater the risk of death or personal injury.



1. Pull the seatback angle adjusting lever and raise the seatback to its upright position.



2. Pull the seatback folding lever and fold the seatback down.

06 SIENNA_U (L/O 0603)



You can use the seatback as a temporary table only when the vehicle is stopped.

CAUTION

To avoid serious injury:

- Do not set up the seatback table while the vehicle is moving.
- Do not sit on the folded seatback.
- Make sure the front passenger's seat is securely locked in sliding position when you set the seat as a temporary table.

NOTICE

To prevent damage to the seat, avoid putting heavy loads on the temporary table.

Driving position memory system

This system can memorize the position of the driver's seat and outside rear view mirrors, and recall them at the touch of a button.

Buttons "1" and "2" can memorize two separate positions.

06 SIENNA_U (L/O 0603)

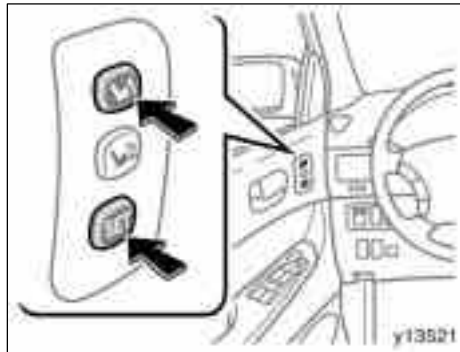

SETTING THE DRIVING POSITION

The key must be in the "ON" position and the automatic transmission selector lever is in the "P" position.

1. **Adjust the driver's seat and outside rear view mirrors to the desired position.**
2. **While pushing the "SET" button, push button "1" or "2" until a beep is heard.**

The system can memorize up to 2 positions by repeating the above steps. If step 2 is performed when both buttons "1" and "2" are memorized, the previous position will be erased and a new position will be set.

64

To make only slight changes to an already memorized position, the easiest way is to first activate the memorized position, then make the desired changes and perform step 2 above.



RECALLING THE MEMORIZED POSITION

When you push button "1" or "2", a beep will sound and the driving position will be automatically adjusted to the position recorded for that button.

The memorized position can be recalled under the following conditions:

- The ignition key is in the "ON" position and the automatic transmission selector lever is in the "P" position.
- The key is not in the ignition switch and less than 30 seconds have passed since opening the driver's door.

To stop the operation, push any driving position memory button.

To reactivate the system, push the button "1" or "2" again.

If the vehicle's battery is disconnected, the memory will be erased and the positions will have to be set again.

! CAUTION

- Do not start the vehicle while the adjustment are being made.
- Take care not to select the wrong button, or the seat could strike the rear passenger or hit your body against the steering wheel. If this happens, you can stop the movement by pressing another driving position memory switch, or depressing the brake pedal.

**Rear seats—
—Rear seat precautions**

! CAUTION

- Adjustment should not be made while the vehicle is moving.
- Be careful that the seat does not hit a passenger or luggage.
- After adjusting the seat position, try sliding it forward and backward to make sure it is lock in position.
- After adjusting the seatback, push back your body to make sure it is locked in position.

- When returning seats to their original position, observe the following precautions in order to prevent personal injury in a collision or sudden stop:
Be careful not to get your hands or feet pinched in the seat.
Make sure the seat is securely locked by pushing forward and rearward on the top of the seatback or by trying to pull up the edge of the bottom cushion. Failure to do so will prevent the seat belt from operating properly.
Make sure the seat belts are not twisted or caught under the seat and are arranged in their proper position and are ready to use.

Folding the seats up will enlarge the luggage compartment. See "—Stowage precautions" on page 399 in Section 2 for precautions when loading luggage.

06 SIENNA_U (L/O 0603)

—Adjusting second seats



Outer seat



Center seat

1. SEAT POSITION ADJUSTING LEVER

Hold the center of the lever and pull it up. Then slide the seat to the desired position with slight body pressure and release the lever.

2. SEATBACK ANGLE ADJUSTING LEVER/STRAP (from front)

Lean forward and pull the lever or strap toward you. Then lean back to the desired angle and release the lever or strap.

3. SEATBACK ANGLE ADJUSTING STRAP (from rear)

Pull the strap and push the seatback forward or pull it backward to the desired angle and release the strap.

06 SIENNA_U (L/O 0603)

—Tumbling second seat for third seat entry

CAUTION

Avoid reclining the seatback any more than needed. The seat belts provide maximum protection in a frontal or rear collision when the passengers are sitting up straight and well back in the seats. If you are reclined, the lap belt may slide past your hips and apply restraint forces directly to the abdomen or your neck may contact the shoulder belt. In the event of a frontal collision, the more the seat is reclined, the greater the risk of death or personal injury.



For access to the third seat, perform the following procedure.

Fold down the seatback while pulling the seatback angle adjusting lever or strap and swing up the seat.

After passengers are in, return the seat until it locks securely, and lift up the seat back by pulling the lever or strap.

CAUTION

After returning the seat, make sure the seat is securely locked by pushing forward and rearward on the top of the seatback or by trying to pull up the edge of the bottom cushion. Failure to do so will prevent seat belt from operating properly.

06 SIENNA_U (L/O 0603)

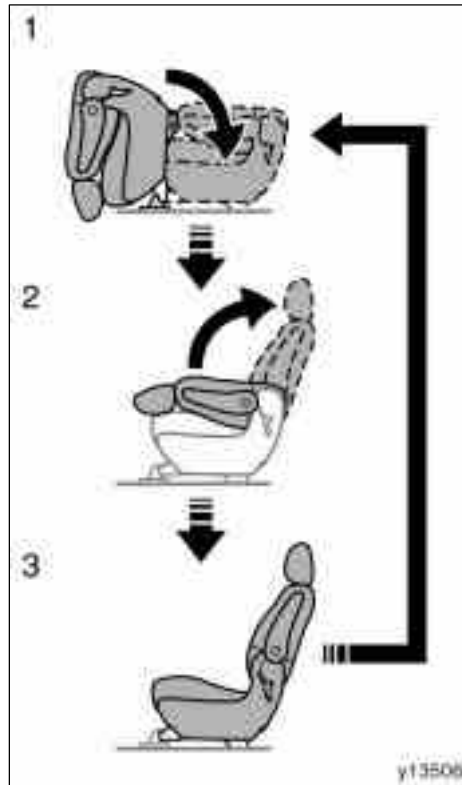

When returning the tumbled second seat to its original position:

Once the seat is moved from the tumbled position to the folded-down position, it cannot be directly returned to the tumbled position again. (It is impossible to operate the seat in the order 1→2→1.) When you return the folded-down seat (position 2) to its tumbled position (position 1), you must return the folded-down seat (position 2) to its original position (position 3) once. (It is possible to operate the seat in the order 1→2→3→1.)

—Tumbling second seats (outer seats)

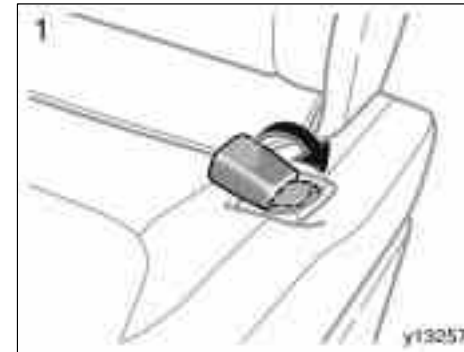

BEFORE TUMBLING SECOND SEATS (7-passenger models only)

1. Stow the second seat belt buckles as shown in the illustration.

This prevents the buckles from sticking out when you tumble the second seats.

NOTICE

To prevent damage to the seat belt buckles, the buckles must be stowed before you fold the seatback.

06 SIENNA_U (L/O 0603)



2. Make sure the shoulder belt passes through the hanger when folding the second seat.

This prevents the shoulder belt from being damaged.



CAUTION

The seat belt must be removed from the hanger when the seat belt is in use.



TUMBLING SECOND SEATS

1. Lower the head restraint to the lowest position. Hold the center of the lever and pull it up. Then slide the seat to the rear-most lock position.

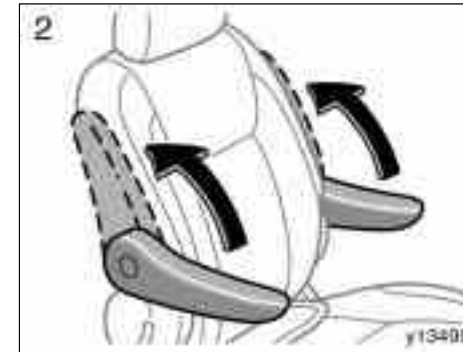

2. 7-passenger models only: Pull the armrests up.

06 SIENNA_U (L/O 0603)



3. Fold down the seatback while pulling the seatback angle adjusting lever or strap and swing up the seat.

If the front seat is in the way, adjust it so it will not interfere.

CAUTION

- Make sure the seat is free of people or luggage. Then, hold the seat and slowly move it. Otherwise, people may be injured or luggage may be damaged if the seat hits them.
- To avoid serious injury, do not sit on the folded seatback.

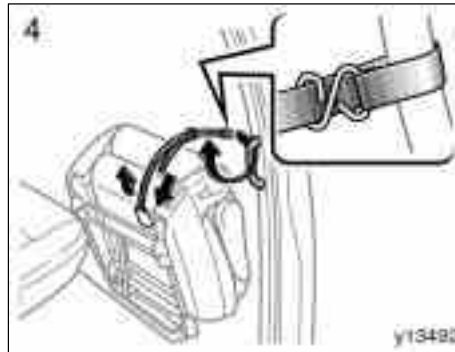

4. Take the holding strap out of the pocket. Pass the strap through the assist grip, and hook it as shown in the illustration.

When returning the second seat to its original position, put the holding strap into the pocket.

NOTICE

- ◆ Do not use anything other than the assist grip to hold the second seat.
- ◆ The holding strap must be stowed into the pocket when it is not in use.

CAUTION

- When tumbling the second seats, fix the seats securely by adjusting the length of the holding strap. Failure to do so may cause an unexpected accident or severe injury in the event of emergency braking or a collision.
- Do not sit on the third seats when the second seat is tumbled in order to prevent personal injury in a collision or sudden stop.

06 SIENNA_U (L/O 0603)



You can use the seatback as a temporary table only when the vehicle is stopped.

When you fold down the seatback from its upright position, the rear leg locks will disengage. In this case, lift up the seat and fold down again to engage the rear leg locks.

CAUTION

To avoid serious injury:

- Do not set up the seatback table while the vehicle is moving.
- Do not sit on the folded seatback.
- Make sure the second seat is securely locked in position when you set the second seat as a temporary table.

NOTICE

To prevent damage to the seat, avoid putting heavy loads on the temporary table.



06 SIENNA_U (L/O 0603)

When returning the tumbled second seat to its original position:

Once the seat is moved from the tumbled position to the folded-down position, it cannot be directly returned to the tumbled position again. (It is impossible to operate the seat in the order 1→2→1.) When you return the folded-down seat (position 2) to its tumbled position (position 1), you must return the folded-down seat (position 2) to its original position (position 3) once. (It is possible to operate the seat in the order 1→2→3→1.)

CAUTION

When folding or returning the seat, observe the following precautions in order to prevent personal injury:

- Do not fold or remove the seat while the vehicle is moving.
- Be careful not to get your hands or feet pinched in the seat.

When returning seats to their original position, observe the following precautions in order to prevent personal injury in a collision or sudden stop:

- Make sure the seat is securely locked by pushing forward and rearward on the top of the seatback or by trying to pull up the edge of the bottom cushion. Failure to do so will prevent the seat belt from operating properly.
- Make sure the seat belts are not twisted or caught in the seatback and are arranged in their proper position and are ready to use.

—Tumbling second seat (center seat)



TUMBLING SECOND SEAT

1. Lower the head restraint to the lowest position. Hold the center of the lever and pull it up. Then slide the seat to the rear-most lock position.

06 SIENNA_U (L/O 0603)



2. Fold down the seatback while pulling the seatback angle adjusting strap.



3. Pull the seat lock release lever (red) and swing up the seat.

If the front seats are in the way, adjust it so it will not interfere.

If the seat is not in the rear-most lock position, the rear leg will not unlock. In this case, slide the seat to the rear-most lock position and then do the above operation again.

CAUTION

- Make sure the seat is free of people or luggage. Then, hold the seat and slowly move it. Otherwise, people may be injured or luggage may be damaged if the seat hits them.
- To avoid serious injury, do not sit on the folded seatback.

06 SIENNA_U (L/O 0603)

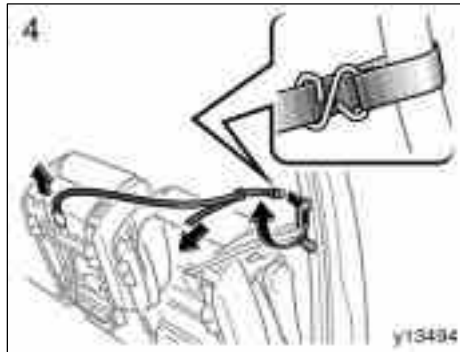

4. Take the holding strap out of the pocket. Pass the strap through the assist grip, and hook it as shown in the illustration.

When returning the second seat to its original position, put the holding strap into the pocket.

NOTICE

- ◆ Do not use anything other than the assist grip to hold the second seat.
- ◆ The holding strap must be stowed into the pocket when it is not in use.

CAUTION

- When tumbling the second seats, fix the seats securely by adjusting the length of the holding strap. Failure to do so may cause an unexpected accident or severe injury in the event of emergency braking or a collision.
- Do not sit on the third seats when the second seat is tumbled in order to prevent personal injury in a collision or sudden stop.



You can use the seatback as a temporary table only when the vehicle is stopped.

CAUTION

To avoid serious injury:

- Do not set up the seatback table while the vehicle is moving.
- Do not sit on the folded seatback.
- Make sure the second seat is securely locked in position when you set the second seat as a temporary table.

NOTICE

To prevent damage to the seat, avoid putting heavy loads on the temporary table.

⚠ CAUTION

When folding or returning the seat, observe the following precautions in order to prevent personal injury:

- Do not fold or remove the seat while the vehicle is moving.
- Be careful not to get your hands or feet pinched in the seat.

When returning seats to their original position, observe the following precautions in order to prevent personal injury in a collision or sudden stop:

- Make sure the seat is securely locked by pushing forward and rearward on the top of the seatback or by trying to pull up the edge of the bottom cushion. Failure to do so will prevent the seat belt from operating properly.
- Make sure the seat belts are not twisted or caught in the seatback and are arranged in their proper position and are ready to use.

—Removing second seats (outer seats)



BEFORE REMOVING SECOND SEATS (7-passenger models only)

1. Stow the second seat belt buckles as shown in the illustration.

This prevents the buckles from sticking out when you fold up the second seats.

NOTICE

To prevent damage to the seat belt buckles, the buckles must be stowed before you fold the seatback.

06 SIENNA_U (L/O 0603)



2. Make sure the shoulder belts pass through the hangers when folding the second seat.

This prevents the shoulder belt from being damaged.



CAUTION

The seat belt must be removed from the hanger when the seat belt is in use.



REMOVING SECOND SEATS

1. Lower the head restraint to the lowest position. Hold the center of the lever and pull it up. Then slide the seat to the rear-most lock position.

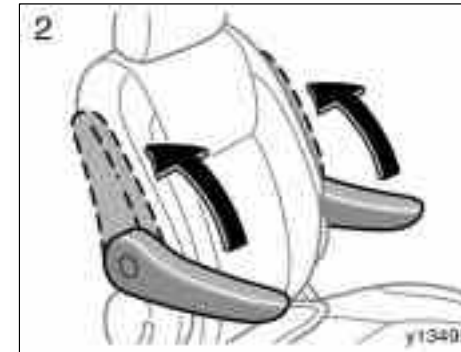

2. 7-passenger models only: Pull the armrests up.

06 SIENNA_U (L/O 0603)



3. Fold down the seatback while pulling the seatback angle adjusting lever or strap and swing up the seat.

CAUTION

- Make sure the seat is free of people or luggage. Then, hold the seat and slowly move it. Otherwise, people may be injured or luggage may be damaged if the seat hits them.
- To avoid serious injury, do not sit on the folded seatback.

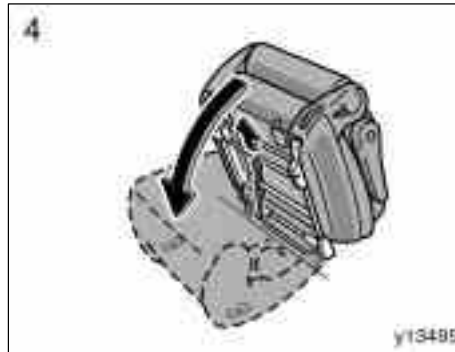

4. Pull and hold the front leg release strap and fold down the seat. Then the front leg locks will disengage and you can remove the seat.

CAUTION

When removing the seat, observe the following to prevent personal injury:

- Do not fold or remove the seat while the vehicle is moving.
- Be careful not to get your hands or feet pinched in the seat.
- Be careful not to hit the removed seat against a person or drop it on yourself.

To prevent personal injury in a collision or sudden stop:

- Do not sit on or place anything on the folded seatback while driving.
- Do not leave the removed seat loose in the vehicle.
- Do not try to sit on or place anything on the removed seat.

NOTICE

- ◆ *Avoid putting heavy loads on the removed seat. The metallic tips of the seat leg may be damaged and the seat cannot be reinstalled.*
- ◆ *Do not carry the removed seat with holding the seat position adjusting lever. Otherwise, the seat may slide and not installed properly. If you slide the removed seat, return the seat to the rear-most position before it is installed.*

06 SIENNA_U (L/O 0603)

—Installing second seats (outer seats)

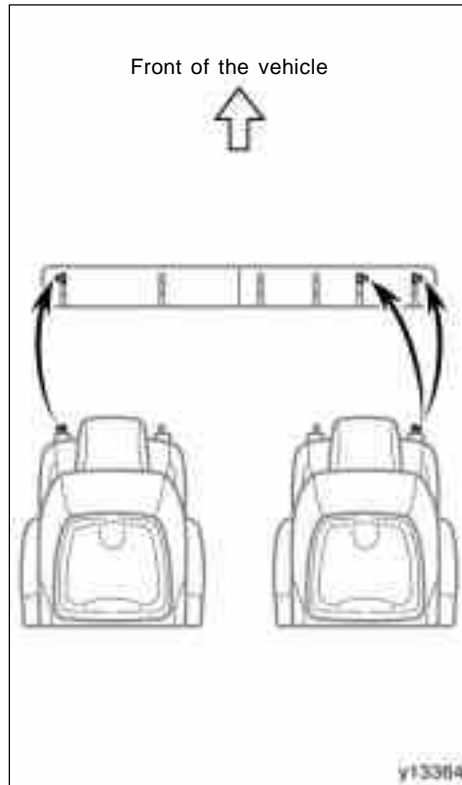

7-passenger models

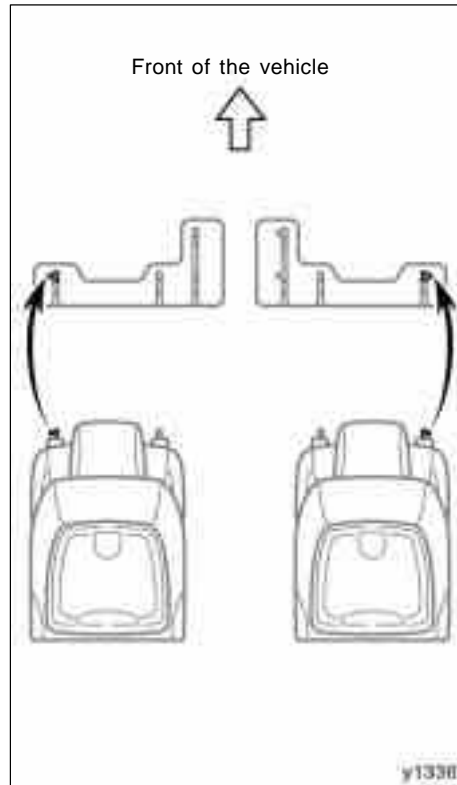

8-passenger models

When you install the second seats, be sure to place it where the seat is originally positioned because each second seat is not interchangeable. You can distinguish the original seat position by the position of the front seat leg pin and the shape of the seat striker bezel in the floor.

The right side second seat has a pin in the outside of the right front leg and the left side second seat has a pin in the outside of the left front leg as shown in the illustration.

CAUTION

You must install the seat in proper position to wear the seat belt properly. Failure to be properly restrained with the seat belt in an accident can cause death or serious injury. Refer to the label on the side of the seat for additional installation instructions.

NOTICE

You must install the seat in its original position. If it is installed in the wrong position, the seat lock or bezel will be damaged.

06 SIENNA_U (L/O 0603)



1. Align the front leg hooks with the rear strikers in the floor. Then swing up the seat.



2. Make sure the front leg is locked securely, fold down the seat and engage the rear leg lock.

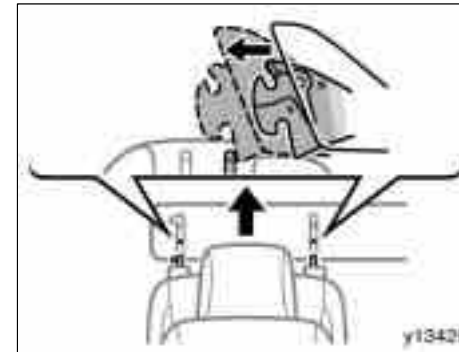

You can easily align the front leg hooks with the rear strikers by using the floor bezel. Put the front legs of the seat short of the rear strikers as shown in the illustration. Then slide the seat forward along the groove of the bezel until the front legs will reach the striker. Make sure the front legs align with the striker, swing up the seat.

06 SIENNA_U (L/O 0603)

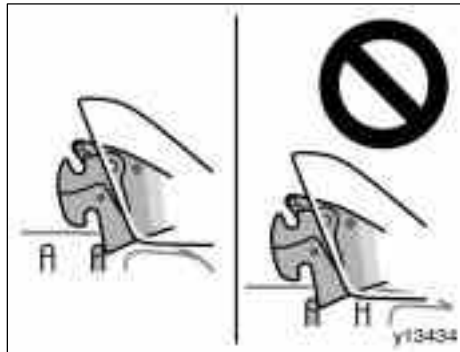

NOTICE

When installing the seat, make sure to align the front leg hooks with both of the rearmost strikers in the floor. If you align the legs with the front strikers, the bezel in the floor will be damaged.

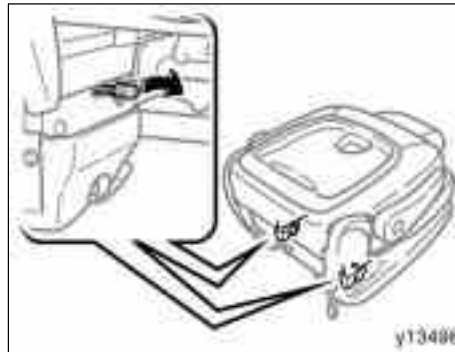

If you lock the rear legs before the front legs are locked securely, disengage the rear leg lock by pushing the red pin inside each rear leg. Then reinstall the seat following the correct procedure.



06 SIENNA_U (L/O 0603)

When returning the tumbled second seat to its original position:

Once the seat is moved from the tumbled position to the folded-down position, it cannot be directly returned to the tumbled position again. (It is impossible to operate the seat in the order 1→2→1.) When you return the folded-down seat (position 2) to its tumbled position (position 1), you must return the folded-down seat (position 2) to its original position (position 3) once. (It is possible to operate the seat in the order 1→2→3→1.)

CAUTION

When reinstalling the seat, observe the following to prevent personal injury:

- Do not reinstall the seat while the vehicle is moving.
- Be careful not to get your hands or feet pinched in the seat.
- Be careful not to hit the removed seat against a person or drop it on yourself.
- After folding or installing the seat, push it forward and backward to make sure it is locked in position.

When reinstalling seats to their original position, observe the following precautions in order to prevent personal injury in a collision or sudden stop:

- Make sure the seat is securely locked by pushing forward and rearward on the top of the seatback or by trying to pull up the edge of the bottom cushion. Failure to do so will prevent the seat belt from operating properly.

- Make sure the seat belts are not twisted or caught under the seat and are arranged in their proper position and are ready to use.

- Install each seat in the same position from which it was removed. Failure to do so will prevent the occupants from using seat belts properly.

- Do not reinstall the seat with its back facing forward.

- Make sure the seat is securely locked in the proper position.

NOTICE

Do not carry the removed seat by holding the seat position adjusting lever. Otherwise, the seat may slide and not be installed properly. If you slide the removed seat, return the seat to the rear-most position before it is installed.

06 SIENNA_U (L/O 0603)



7-passenger models only: The right side seat can be moved to the inside when the console box is not installed between the second seats.

—Removing second seat (center seat)



REMOVING CENTER SECOND SEAT

1. Lower the head restraint to the lowest position. Hold the center of the lever and pull it up. Then slide the seat to the rear-most lock position.

06 SIENNA_U (L/O 0603)



2. Fold down the seatback while pulling the seatback angle adjusting strap.



3. Pull the rear leg release lever (red) and swing up the seat.

If the seat is not in the rear-most lock position, the rear leg will not unlock. In this case, slide the seat to the rear-most lock position and then do the above operation again.

CAUTION

- Make sure the seat is free of people or luggage. Then, hold the seat and slowly move it. Otherwise, people may be injured or luggage may be damaged if the seat hits them.
- To avoid serious injury, do not sit on the folded seatback.



4. Pull and hold the front leg release strap and fold down the seat. Then the front leg locks will disengage and you can remove the seat.

CAUTION

When removing the seat, observe the following to prevent personal injury:

- Do not fold or remove the seat while the vehicle is moving.
- Be careful not to get your hands or feet pinched in the seat.
- Be careful not to hit the removed seat against a person or drop it on yourself.

To prevent personal injury in a collision or sudden stop:

- Do not sit on or place anything on the folded seatback while driving.
- Do not leave the removed seat loose in the vehicle.
- Do not try to sit on or place anything on the removed seat.

NOTICE

- ◆ *Avoid putting heavy loads on the removed seat. The metallic tips of the seat leg may be damaged and the seat cannot be reinstalled.*
- ◆ *Do not carry the removed seat with holding the seat position adjusting lever.*

**—Installing second seat
(center seat)**

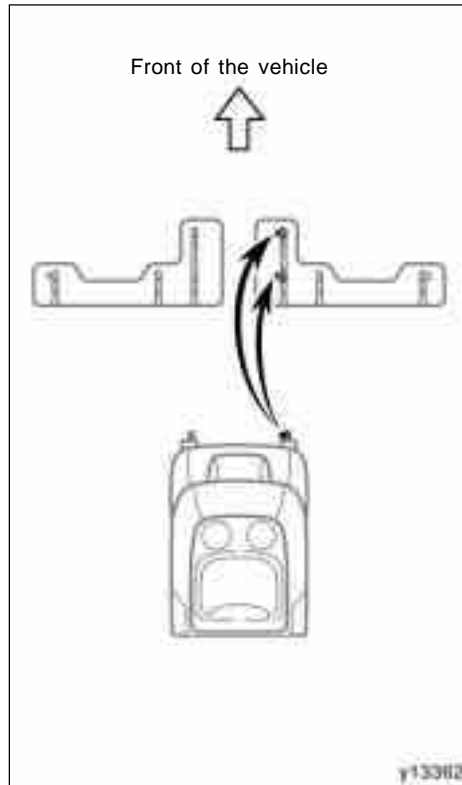

When you install the second seats, be sure to place it where the seat is originally positioned because each second seat is not interchangeable. You can distinguish the original seat position by the position of the front seat leg pin and the shape of the seat striker bezel in the floor.

The second center seat has a pin in the inside of the right front leg as shown in the illustration.

CAUTION

You must install the seat in proper position to wear the seat belt properly. Failure to be properly restrained with the seat belt in an accident can cause death or serious injury. Refer to the label on the side of the seat for additional installation instructions.

NOTICE

You must install the seat in its original position. If it is installed in the wrong position, the seat lock or bezel will be damaged.

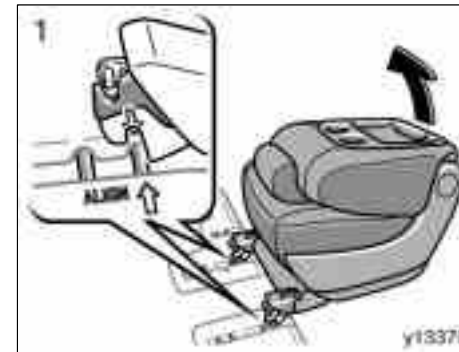

1. Align the front leg hooks with the rear strikers in the floor. Then swing up the seat.

06 SIENNA_U (L/O 0603)



2. Make sure the front leg is locked securely, fold down the seat and engage the rear leg lock.

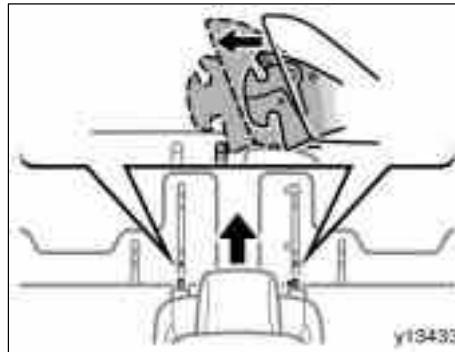

You can easily align the front leg hooks with the rear strikers by using the floor bezel. Put the front legs of the seat short of the rear strikers as shown in the illustration. Then slide the seat forward along the groove of the bezel until the front legs will reach the striker. Make sure the front legs align with the striker, swing up the seat.



NOTICE

When installing the seat, make sure to align the front leg hooks with the rearmost strikers of each pair in the floor. If you align the legs with the front strikers, the bezel in the floor will be damaged.

06 SIENNA_U (L/O 0603)



If you lock the rear legs before the front legs are not lock securely, disengage the rear leg lock by pulling the rear leg release lever. Then reinstall the seat following the correct procedure.



INSTALLING THE SECOND CENTER SEAT IN THE FRONT AND CENTER POSITION

The second center seat can be used in the forward position.

To use the center second seat in the forward position, install according to the following procedure.

06 SIENNA_U (L/O 0603)



BEFORE INSTALLING THE SECOND CENTER SEAT IN FRONT AND CENTER POSITION

1. Slide the front seats forward from the rear-most position, stand the seatbacks to the upright position.



2. For vehicles equipped with the front seat side table, pull up the lock release lever and fold the table down.

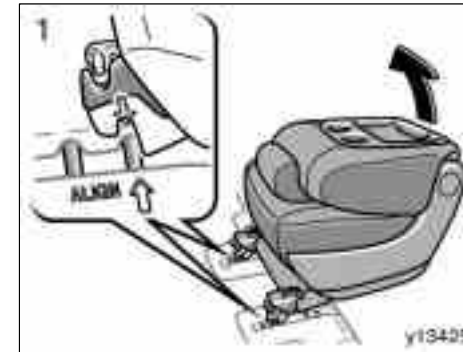

INSTALLING THE SECOND CENTER SEAT IN THE FRONT AND CENTER POSITION

1. Remove the second center seat from the normal position. (For details, see “—Removing second seat (center seat)” on page 82 in this Section.)

Align the front leg hook with the rear striker of the forward pair. Then swing the seat until it reaches the folded seat side table.

06 SIENNA_U (L/O 0603)

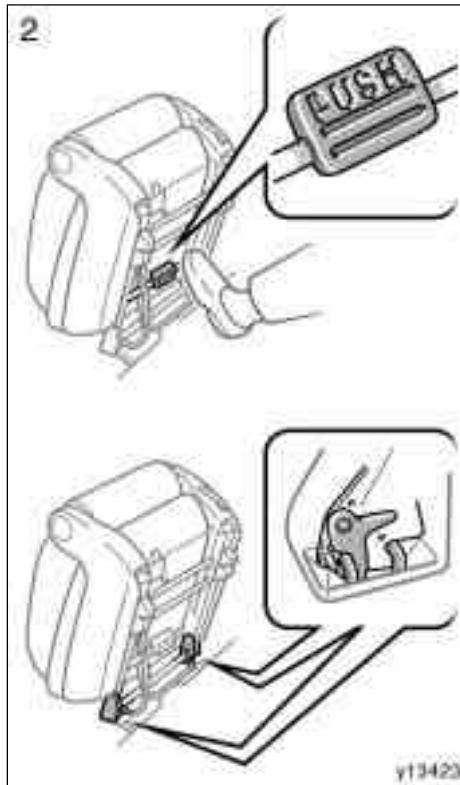

2. Push the foot pedal forward to securely latch the front leg locks. Make sure the front leg is locked securely, fold down the seat and engage the rear leg lock.

CAUTION

When reinstalling the seat, observe the following to prevent personal injury:

- Do not reinstall the seat while the vehicle is moving.
- Be careful not to get your hands or feet pinched in the seat.
- Be careful not to hit the removed seat against a person or drop it on yourself.
- After folding or installing the seat, push it forward and backward to make sure it is locked in position.

When reinstalling seats to their original position, observe the following precautions in order to prevent personal injury in a collision or sudden stop:

- Make sure the seat is securely locked by pushing forward and rearward on the top of the seatback or by trying to pull up the edge of the bottom cushion. Failure to do so will prevent the seat belt from operating properly.

—Adjusting third seats
(manual seat)

- Make sure the seat belts are not twisted or caught under the seat and are arranged in their proper position and are ready to use.
- Install each seat in the same position from which it was removed. Failure to do so will prevent the occupants from using seat belts properly.
- Do not reinstall the seat with its back facing forward.
- Make sure the seat is securely locked in the proper position.

NOTICE

Do not carry the removed seat by holding the seat position adjusting lever.



Lean forward and pull the strap forward. Then lean back to the desired angle and release the strap.

- CAUTION**
- Align both seatbacks at the same angle when a person sits in the third seat center position. Otherwise, the person cannot wear the seat belt properly and this may cause serious injuries in a collision.
 - Avoid reclining the seatback any more than needed. The seat belts provide maximum protection in a frontal or rear collision when the passengers are sitting up straight and well back in the seats. If you are reclined, the lap belt may slide past your hips and apply restraint forces directly to the abdomen or your neck may contact the shoulder belt. In the event of a frontal collision, the more the seat is reclined, the greater the risk of death or personal injury.

—Adjusting third seats (power seat)



To adjust the seatback angle, push either side of the switch.

Releasing the switch will stop the seatback at that position.

⚠ CAUTION

- Align both seatbacks at the same angle when a person sits in the third seat center position. Otherwise, the person cannot wear the seat belt properly and this may cause serious injuries in a collision.
- Avoid reclining the seatback any more than needed. The seat belts provide maximum protection in a frontal or rear collision when the passengers are sitting up straight and well back in the seats. If you are reclined, the lap belt may slide past your hips and apply restraint forces directly to the abdomen or your neck may contact the shoulder belt. In the event of a frontal collision, the more the seat is reclined, the greater the risk of death or personal injury.

—Stowing third seats (manual seat)

Before stowing the third seats:

- Stow the seat belt buckles and center seat belt. (See “—Stowing seat belt buckles of the second and third seats” on page 111 and “—Stowing the center seat belt of the third seats” on page 112 in this Section.)
- Lower the head restraint to the lowest position. See “Head restraints” on page 104 in this Section.

06 SIENNA_U (L/O 0603)



STOWING THIRD SEATS

1. Pull the seatback angle adjusting strap ("TO FOLD/LIFT SEATBACK" printed on its surface), then fold down the seatback.

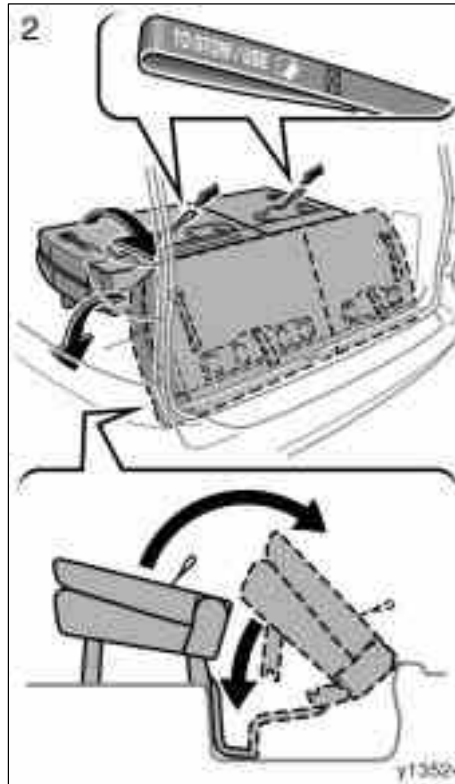

2. Pull and hold the seat lock release strap ("TO STOW/USE" printed on its surface) and lift up the seat rearward. Then push the seat down.

If the seat does not lift up when the seat lock release strap ("TO STOW/USE" printed on its surface) is pulled, reset as following procedure.

Lift the seatback by pulling on the seatback angle adjusting strap ("TO FOLD/LIFT SEATBACK" printed on its surface). Then push the seatback down again.

06 SIENNA_U (L/O 0603)

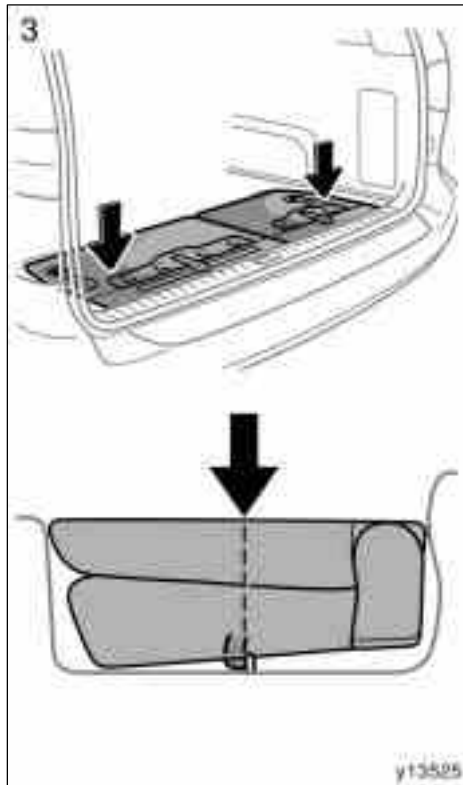

3. Push the seat against the floor and make sure it is locked securely.

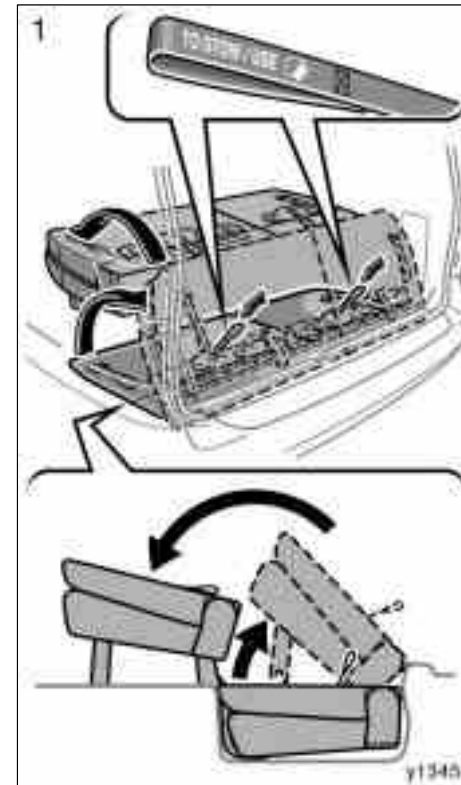

06 SIENNA_U (L/O 0603)

To return the third seats, perform the following procedure.

1. Pull and hold the seat lock release strap ("TO STOW/USE" printed on its surface), then lift up the seat rearward. Push the seat forward and then engage the front leg locks. Make sure the front legs are locked securely.

If the seat does not lift up when the seat lock release strap ("TO STOW/USE" printed on its surface) is pulled, reset as following procedure.

Lift the seatback by pulling on the seatback angle adjusting strap ("TO FOLD/LIFT SEATBACK" printed on its surface). Then push the seatback down again.



2. Pull the seatback angle adjusting strap ("TO FOLD/LIFT SEATBACK" printed on its surface) and raise the seatback.



CAUTION

Do not sit on the third seat when it is in the stowed position as shown in the illustration. It may cause an accident or severe injury in the event of emergency braking or collision.

 CAUTION

When stowing or returning the seat, observe the following precautions in order to prevent personal injury:

- Make sure the seat is free of people or luggage. Then, hold the seat and slowly move it. Otherwise, people may be injured or luggage may be damaged if the seat hits them.
- Be careful not to get your hands or feet pinched in the seat.
- Do not stow and return the seats when you are inside the vehicle in order to prevent pinching your hands or feet in the seat. Be sure to stow and return the seats from outside the vehicle.

When returning seats to their original position, observe the following precautions in order to prevent personal injury in a collision or sudden stop:

- Make sure the seat is securely locked by pushing forward and rearward on the top of the seatback or by trying to pull up the edge of the bottom cushion. Failure to do so will prevent the seat belt from operating properly.
- Make sure the seat belts are not twisted or caught in the seatback and are arranged in their proper position and are ready to use.

**—Folding third seats
(power seat only)**

The third seats can be folded down automatically by operating the folding/returning switch that is inside the back door opening on the outer edge of the ceiling.

Before folding the third seats:

- Stow the seat belt buckles and center seat belt. (See “—Stowing seat belt buckles of the second and third seats” on page 111 and “—Stowing the center seat belt of the third seats” on page 112 in this Section.)
- Lower the head restraint to the lowest position. (See “Head restraints” on page 104 in this Section.)
- Make sure that there is no object on the seat cushion. If an object is caught between the seat cushion and seatback during the operation, seat operation will stop.

06 SIENNA_U (L/O 0603)

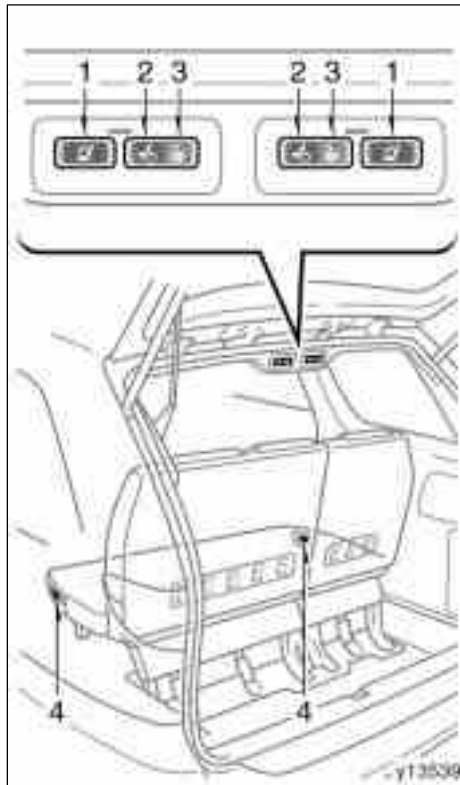

1. FOLDING/RETURNING SWITCH

The seatback will be folded by pushing this switch.

The seatback will be returned by pushing this switch again.

2. RETURNING SWITCH

The seatback will be returned by pushing this switch.

3. STOWING SWITCH

The seats will be stow. (See “—Stowing third seats” on page 99)

4. SEATBACK ADJUSTING SWITCH

The seatback will be returned by pushing this switch.

The seatback will be adjusted. (See “Adjusting third seats” on page 91)

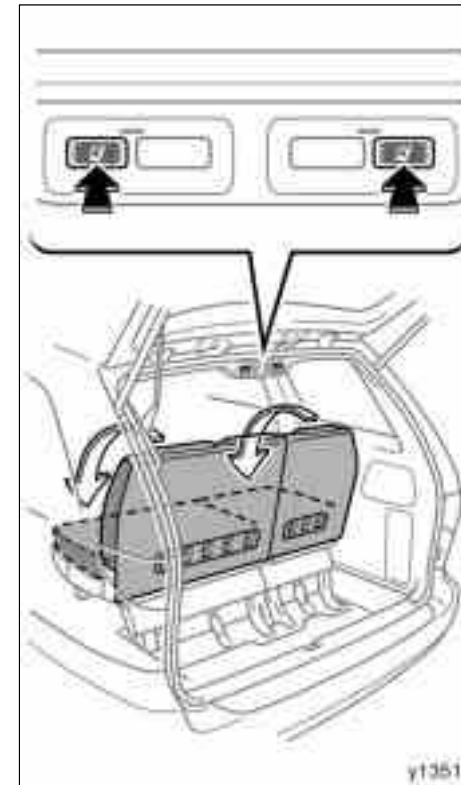

06 SIENNA_U (L/O 0603)

FOLDING THIRD SEATS

Push the folding/returning switch. The seatback will fold down.

If the indicator light above the switches flashes three times when the folding/returning switch is pushed, the folding operation will not start.

To continue the operation, do the following:

1. Open the back door when the ignition key is in "LOCK" or "ACC" and/or the automatic transmission selector lever is in "P".
2. Push the folding/returning switch.

Seat operation will stop if any one of the switches shown in the illustrations is pushed. At this time the indicator light above the switches comes on and a beep sounds for about 10 seconds.

If the engine is started during operating, the seat operation may also be stopped.

To continue the folding operation, the seatback must be back to its original position first.

If an object is caught between the seatback and seat cushion, the indicator light above the switches flashes and a beep sounds for about 10 seconds. Remove the object before operating the seat again.

If the indicator light above the switches flashes even though there is no object between the seatback and seat cushion, contact your Toyota dealer.

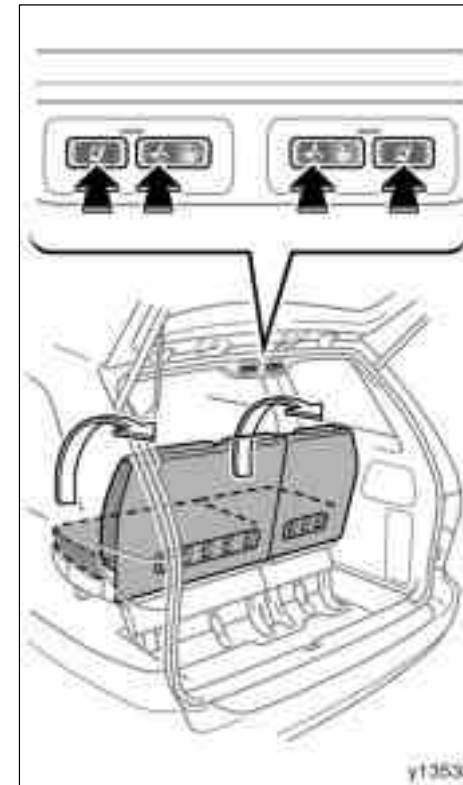

Operation from outside

06 SIENNA_U (L/O 0603)

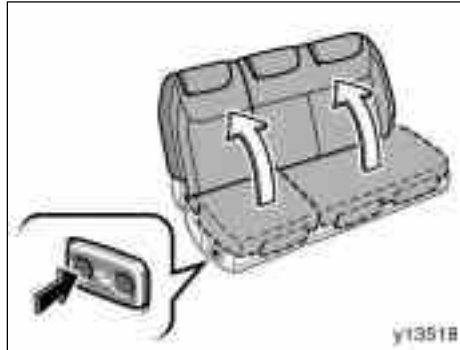

Operation from inside

RETURNING THIRD SEATS

Push one of the switches shown in the illustrations. The seatback returns to its original position.

If the indicator light above the switches flashes three times when the switch is pushed, the returning operation will not start.

To continue the operation, do the following:

1. Operation from outside only—Open the back door when the ignition key is in “LOCK” or “ACC” and/or the automatic transmission selector lever is in “P”.

2. Lock the seat legs and push any switch other than the stowing switch.

Seat operation will stop if any one of the switches shown in the illustrations is pushed. At this time the indicator light above the switches comes on and a beep sounds for about 10 seconds.

If the engine is started during operating, the seat operation may also be stopped.

To continue the returning operation, the seatback must be back to the folded position first.

CAUTION

When folding or returning the seats, observe the following precautions in order to prevent personal injury:

- Make sure that the seat path is clear before moving the seat. Otherwise, injury may result from contact with the seat.
- Be careful not to allow hands or feet to get caught or pinched in the seat.

When returning the seats to their original position, make sure the seat belts are not twisted or caught in the seatback. It could result in serious injuries in a sudden braking or a collision.

Do not shift the automatic transmission selector lever out of “P” with the ignition key in “ON” during the operation. Doing so may cause the vehicle to move and result in serious personal injury.

**—Stowing third seat
(power seat)**

The third seats can be stowed by pushing and holding the stowing switch that is inside the back door opening on the outer edge of the ceiling.

Before stowing the third seats:

- Stow the seat belt buckles and center seat belt. (See “—Stowing seat belt buckles of the second and third seats” on page 111 and “—Stowing the center seat belt of the third seats” on page 112 in this Section.)
- Lower the head restraint to the lowest position. (See “Head restraints” on page 104 in this Section.)
- Make sure that there is no object on the seat cushion, floor around the seats and floor of the luggage compartment. If an object is caught during the operation, seat operation will stop.

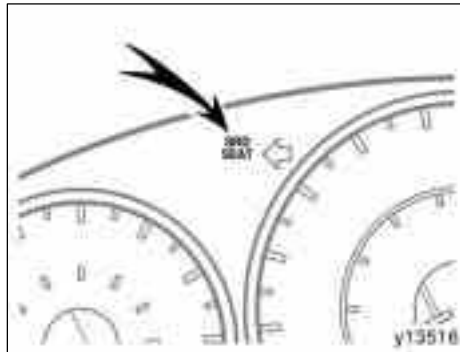

This “3RD SEAT” warning light warns the third seat operation is not yet complete when the ignition key is turned to the “ON” position.

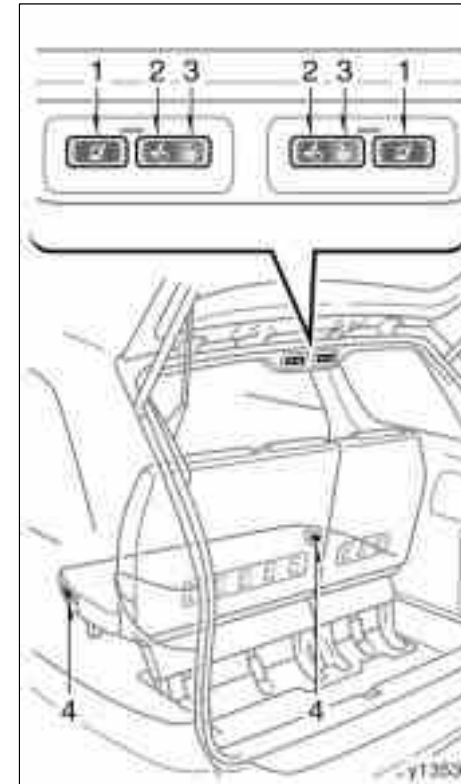

06 SIENNA_U (L/O 0603)

1. FOLDING/RETURNING SWITCH

The seatback will be folded/returned. (See "Folding third seats" on page 95)

2. RETURNING SWITCH

The seat will be returned from the stowed position by pushing and holding this switch.

3. STOWING SWITCH

The seat will be stowed by pushing and holding this switch.

4. SEATBACK ADJUSTING SWITCH

The seatback will be returned. (See "Folding third seats" on page 95)

The seatback will be adjusted. (See "Adjusting third seats" on page 91)

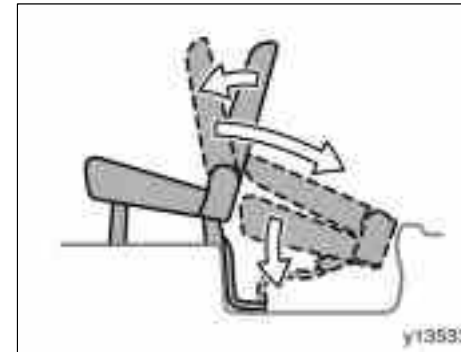
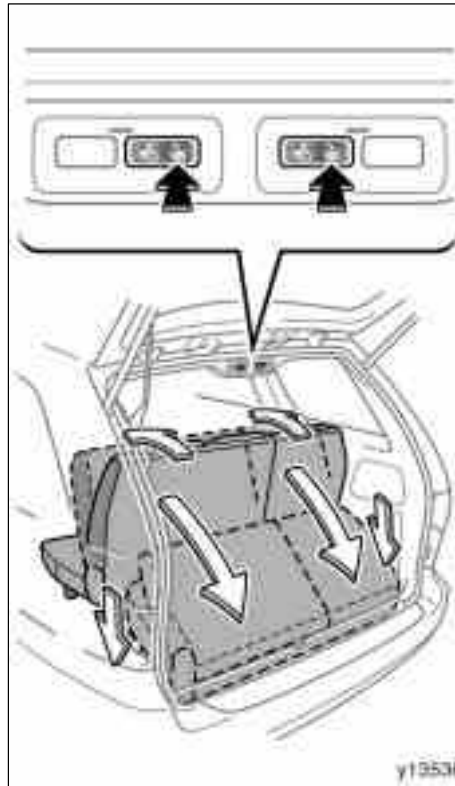

STOWING THIRD SEATS

Push and hold the stowing switch. A beep sounds twice to indicate the start of the operation. The beep sounds again twice when the operation is completed.

If the indicator light above the switches flashes while the stowing switch is being pushed, the stowing operation will not start.

06 SIENNA_U (L/O 0603)

To continue the operation, do the following:

1. Open the back door when the ignition key is in "LOCK" or "ACC" and/or the automatic transmission selector lever is in "P".
2. Push and hold the stowing switch.

To operation stops, the indicator light above the switches comes on and a beep sounds for about 10 seconds if any of the following condition occur during the operation:

- When the stowing switch is released.
- When the folding/returning switch, returning switch or seatback adjusting switch is pushed while the stowing switch is being pushed.
- When the ignition key is turned to the "ON" position and the automatic transmission selector lever is moved from the "P" position.
- When the automatic transmission selector lever is in the "N" position and the ignition key is turned to the "ON" position.

If the engine is started during operating, the seat operation may also be stopped.

If an object is caught between the seatback and seat cushion, the indicator light above the switches flashes and a beep sounds for about 10 seconds. Remove the object before operating the seat again.

If the indicator light above the switches flashes even though there is no object between the seatback and seat cushion, contact your Toyota dealer.

If an object is caught between the seat and floor, the object prevents the seat from moving. Do not continue the operation. Remove the object before operating the seat again.

When the seat is already folded, the seat can be stowed using the same procedure. If an object is caught between the seatback and seat cushion, the stowing operation will not start.

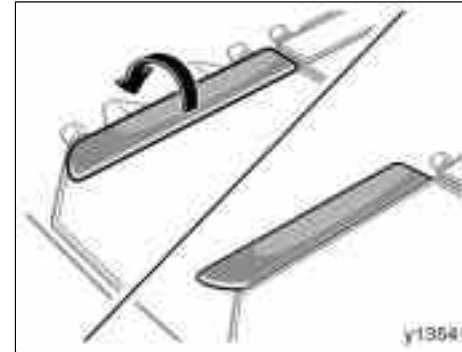

After stowing the seats, open the flaps as shown in the illustration.

06 SIENNA_U (L/O 0603)

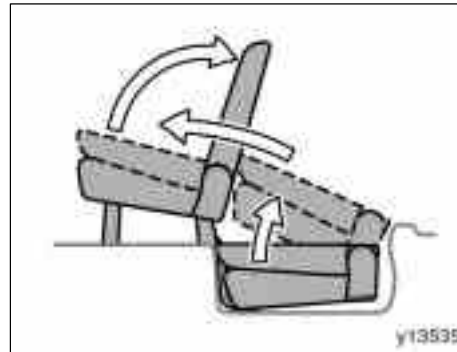
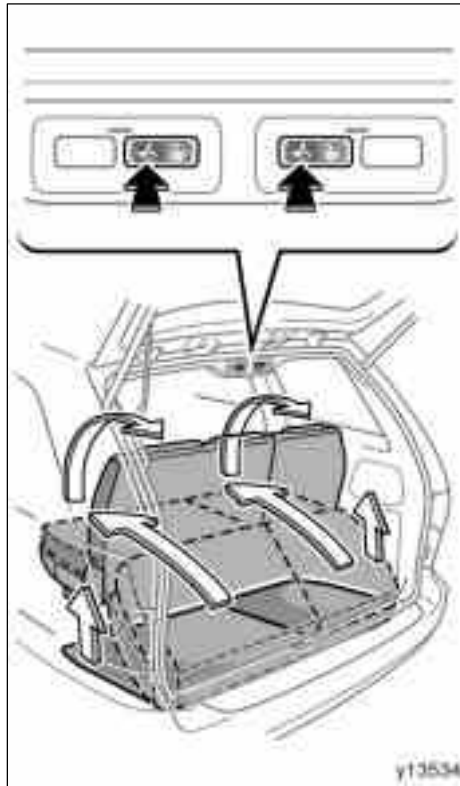

RETURNING THIRD SEATS

Push and hold the returning switch until the seat cushion is locked. A beep sounds twice to indicate the start of the operation. Releasing the switch when the beep sounds again completes the operation automatically.

If the indicator light above the switches flashes while the returning switch is being pushed, the returning operation will not start.

To continue the operation, do the following:

1. Open the back door when the ignition key is in "LOCK" or "ACC" and/or the automatic transmission selector lever is in "P".

2. Push and hold the returning switch.

To operation stops, the indicator light above the switches comes on and a beep sounds for about 10 seconds if any of the following condition occur during the operation:

- When the returning switch is released before the seat legs are securely locked.
- When the folding/returning switch, stowing switch or seatback adjusting switch is pushed while the returning switch is being pushed.
- When the ignition key is turned to the "ON" position and the automatic transmission selector lever is moved from the "P" position.
- When the automatic transmission selector lever is in the "N" position and the ignition key is turned to the "ON" position.

06 SIENNA_U (L/O 0603)

If the engine is started during operating, the seat operation may also be stopped.

If an object is caught between the seat and floor, the object prevents the seat from moving. Do not continue the operation. Remove the object before operating the seat again.

If the indicator light above the switches flashes even though there is no object between the seatback and seat cushion, contact your Toyota dealer.



CAUTION

When stowing or returning the seats, observe the following precautions in order to prevent personal injury:

- **Make sure that the seat path is clear before moving the seat. Otherwise, injury may result from contact with the seat.**
- **Be careful not to allow hands or feet to get caught or pinched in the seat. Be sure to operate the seats from outside the vehicle.**

When the indicator above the stowing switch and returning switch come on or flash, do not continue the operation. An object or a person may be caught in the seat. If a person is caught, serious injury may result.

When returning the seats to their original position, make sure the seat belts are not twisted or caught in the seatback. It could result in serious injuries in a sudden braking or a collision.

Do not shift the automatic transmission selector lever out of "P" with the ignition key in "ON" during the operation. Doing so may cause the vehicle to move and result in serious personal injury.

NOTICE

Make sure that the seat path is clear before stowing or returning the seat. Otherwise, the seat cushion and seat legs may be damaged if the seat comes into contact with the luggage.

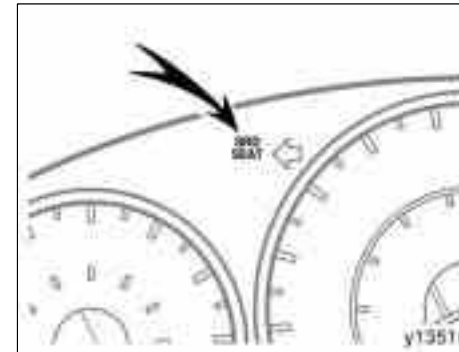

This "3RD SEAT" warning light warns the third seat operation is not yet complete when the ignition key is turned to the "ON" position.

Head restraints

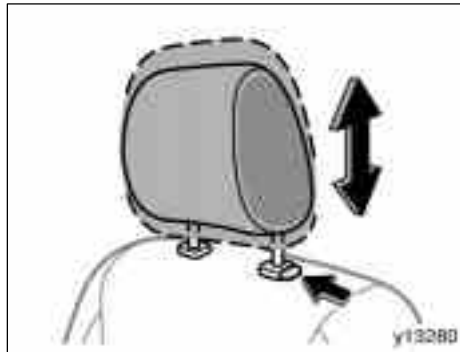

Front and second seats

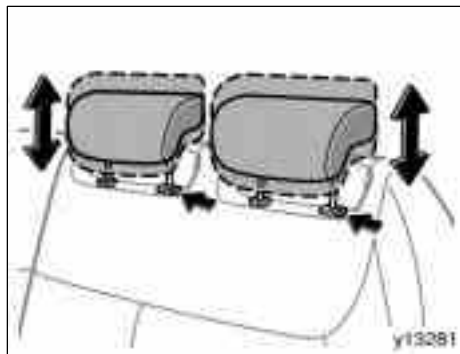

Third seats

For your safety and comfort, adjust the head restraint before driving.

To raise: Pull it up.
To lower: Push it down while pressing the lock release button.

Third seats—When an occupant sits on the seat, always pull up the head restraint to the lock position.

The head restraint is most effective when it is close to your head. Therefore, using a cushion on the seatback is not recommended.

CAUTION

- Adjust the center of the head restraint so that it is closest to the top of your ears.
- After adjusting the head restraint, make sure it is locked in position.
- Do not drive with the head restraints removed.

Armrests

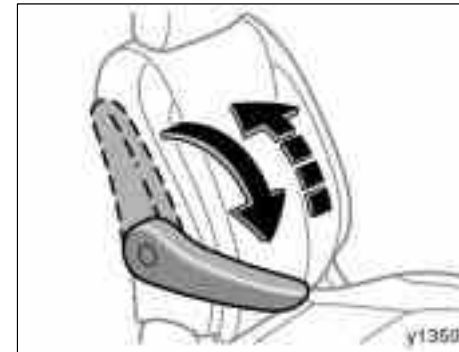

To adjust the armrest, lower the armrest to the lowest position and raise it to the desired angle. Raising the armrest to the highest position unlocks the armrest to let you return it to the lowest position.

NOTICE

To prevent damage to the armrest, avoid putting heavy loads on it.

Seat heaters

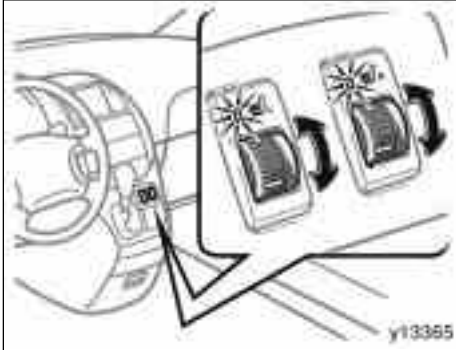

To turn on the seat heater, move the dial upward (“L” dial for the left front seat or “R” dial for the right front seat). At this time, the indicator light will illuminate to indicate the seat heater is operating.

Move the dial upward or downward to adjust to the desired temperature.

To turn it off, move the dial downward until it stops.

When the seat heater is not in use, move the dial fully downward.

The key must be in the “ON” position to operate seat heaters.

CAUTION

Occupants must use caution when operating the seat heater because it may make them feel too hot or cause burns at low temperatures (erythema, varicella). Use extra caution for;

- Babies, small children, elderly persons, sick persons or persons with physical disabilities
- Persons who have sensitive skin
- Persons who are exhausted
- Persons who have taken alcohol or drugs which induce sleep (sleeping drug, cold remedy, etc.)

To prevent the seat from overheating, do not use the seat heater with a blanket, cushion, or other insulating objects which cover the seat.

NOTICE

- ◆ *Do not put unevenly weighed objects on the seat and do not stick sharp objects (needles, nails, etc.) into the seat.*
- ◆ *When cleaning the seats, do not use organic substances (paint thinner, benzine, alcohol, gasoline, etc.). They may damage the heater and seat surface.*
- ◆ *To prevent the battery from being discharged, turn the switch off when the engine is not running.*

**Seat belts—
—Seat belt precautions**

Toyota strongly urges that the driver and passengers in the vehicle be properly restrained at all times with the seat belts provided. Failure to do so could increase the chance of injury and/or the severity of injury in accidents.

The seat belts provided for your vehicle are designed for people of adult size, large enough to properly wear them.

Child. Use a child restraint system appropriate for the child until the child becomes large enough to properly wear the vehicle's seat belts. See "Child restraint" on page 137 in this Section for details.

If a child is too large for a child restraint system, the child should sit in the rear seat and must be restrained using the vehicle's seat belt. According to accident statistics, the child is safer when properly restrained in the rear seat than in the front seat.

If a child must sit in the front seat, the seat belts should be worn properly. If an accident occurs and the seat belts are not worn properly, the force of the rapid inflation of the airbag may cause death or serious injury to the child.

Do not allow any children to stand up or kneel on either rear or front seats. An unrestrained child could suffer serious injury or death during emergency braking or a collision. Also, do not let the child sit on your lap. Holding a child in your arms does not provide sufficient restraint.

Pregnant woman. Toyota recommends the use of a seat belt. Ask your doctor for specific recommendations. The lap belt should be worn securely and as low as possible over the hips and not on the waist.

Injured person. Toyota recommends the use of a seat belt. Depending on the injury, first check with your doctor for specific recommendations.

 **CAUTION**

Persons should ride in their seats properly wearing their seat belts whenever the vehicle is moving. Otherwise, they are much more likely to suffer serious bodily injury or death in the event of sudden braking or a collision.

When using the seat belts, observe the following:

- **Use the belt for only one person at a time. Do not use a single belt for two or more people—even children.**
- **Avoid reclining the seatback any more than needed. The seat belts provide maximum protection in a frontal or rear collision when the driver and the front passenger are sitting up straight and well back in the seats. If you are reclined, the lap belt may slide past your hips and apply restraint forces directly to the abdomen or your neck may contact the shoulder belt. In the event of a frontal collision, the more the seat is reclined, the greater the risk of death or personal injury.**

—Fastening front and rear seat belts

- Be careful not to damage the belt webbing or hardware. Take care that they do not get caught or pinched in the seat or doors.
- Inspect the belt system periodically. Check for cuts, fraying, and loose parts. Damaged parts should be replaced. Do not disassemble or modify the system.
- Keep the belts clean and dry. If they need cleaning, use a mild soap solution or lukewarm water. Never use bleach, dye, or abrasive cleaners, or allow them to come into contact with the belts—they may severely weaken the belts. (See “Cleaning the interior” on page 447 in Section 5.)
- Replace the belt assembly (including bolts) if it has been used in a severe impact. The entire assembly should be replaced even if damage is not obvious.

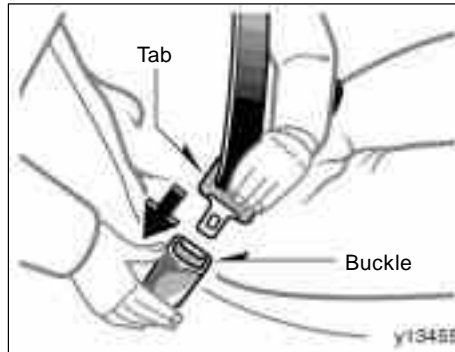

Adjust the seat as needed and sit up straight and well back in the seat. To fasten your belt, pull it out of the retractor and insert the tab into the buckle.

You will hear a click when the tab locks into the buckle.

The seat belt length automatically adjusts to your size and the seat position.

The retractor will lock the belt during a sudden stop or on impact. It also may lock if you lean forward too quickly. A slow, easy motion will allow the belt to extend, and you can move around freely.

When a passenger's shoulder belt is completely extended and is then retracted even slightly, the belt is locked in that position and cannot be extended. This feature is used to hold the child restraint system securely. (For details, see “Child restraint” on page 137 in this Section.) To free the belt again, fully retract the belt and then pull the belt out once more.

If the seat belt cannot be pulled out of the retractor, firmly pull the belt and release it. You will then be able to smoothly pull the belt out of the retractor.

 CAUTION

- After inserting the tab, make sure the tab and buckle are locked and that the belt is not twisted.
- Do not insert coins, clips, etc. in the buckle as this may prevent you from properly latching the tab and buckle.
- If the seat belt does not function normally, immediately contact your Toyota dealer. Do not use the seat until the seat belt is fixed, because it cannot protect an adult occupant or your child from death or serious injury.

06 SIENNA_U (L/O 0603)



Adjust the position of the lap and shoulder belts.

Position the lap belt as low as possible on your hips—not on your waist, then adjust it to a snug fit by pulling the shoulder portion upward through the latch plate.

CAUTION

- Both high-positioned lap belts and loose-fitting belts could cause serious injuries due to sliding under the lap belt during a collision or other unintended event. Keep the lap belt positioned as low on hips as possible.
- Do not place the shoulder belt under your arm.



Seat belts for seats with outside armrests—

Fasten your belt, ensuring that the shoulder portion of the belt passes over the top of the outside armrest and that the lap portion of the belt passes under the outside armrest as shown.

CAUTION

Always wear the belt with the shoulder portion over the outside armrest and the lap portion under the outside armrest. Failure to do so may increase the chance of injury in an accident.

06 SIENNA_U (L/O 0603)



Seat belts with an adjustable shoulder anchor—

Adjust the shoulder anchor position to your size.

To raise: Slide the anchor up.

To lower: Push in the lock release button and slide the anchor down.

After adjustment make sure the anchor is locked in position.

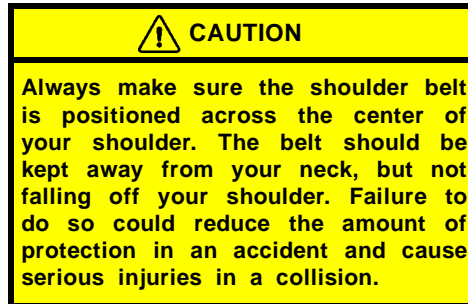

To release the belt, press the buckle release button and allow the belt to retract.

If the belt does not retract smoothly, pull it out and check for kinks or twists. Then make sure it remains untwisted as it retracts.

06 SIENNA_U (L/O 0603)



CENTER SEAT BELT OF THE THIRD SEATS

The center seat belt of the third seats is a 3-point type restraint with 2 buckles. Both seat belt buckles must be correctly located and securely latched for proper operation.

Make sure buckle 1 is securely latched for ready use of the center seat belt of the third seats.



Two buckles and tabs for center seat belt of the third seats

The two tabs have different shapes to prevent the belt from being buckled in the wrong place.

Buckle 1—Matches the tab with the hooked end

Buckle 2—Matches the tab with the concave end

CAUTION

Make sure the both buckles are correctly located and securely latched. Failure to properly match the buckle and tab may cause serious injury in case of an accident or a collision.

06 SIENNA_U (L/O 0603)

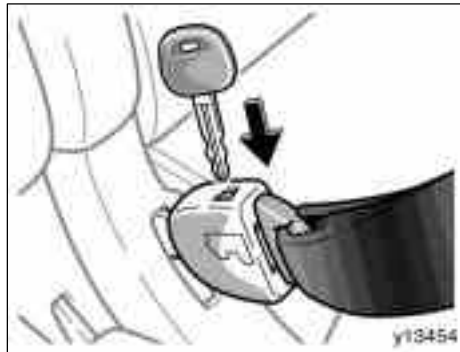

To release the hooked end tab, insert the key into the hole on buckle 1 and allow the belt to retract.



CAUTION

Do not use the center seat belt of the third seats with either buckle released. Fastening only the shoulder belt or lap belt may cause serious personal injury in case of a sudden braking or a collision.

—Stowing seat belt buckles of the second and third seats



Second (7-passenger models)

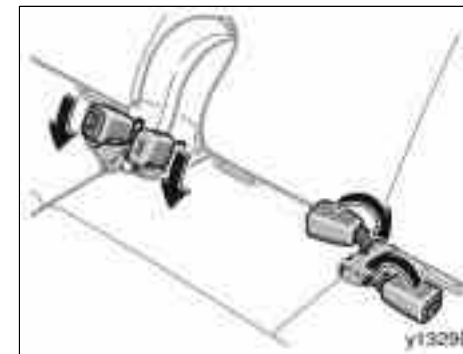

Third

06 SIENNA_U (L/O 0603)

—Stowing the center seat belt of the third seats

The seat belt buckles of the second seats (7-passenger models) and third seats can be stowed when not in use.

Seat belt buckles must be stowed before you fold the seat back.

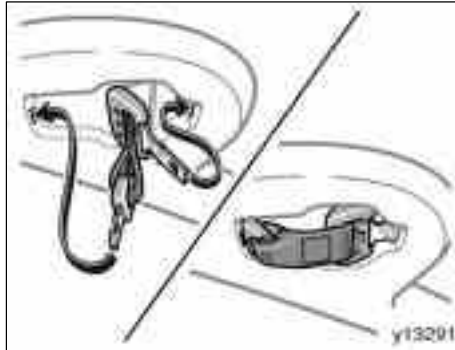

STOWING THE CENTER SEAT BELT OF THE THIRD SEATS

To stow the center seat belt of the third seats, pull the seat belt out of its cover. It will automatically roll back part-way. Roll the seat belt backward and insert it into the slot of its cover as shown above. Make sure the tabs are securely locked in the cover.

Seat belt must be stowed before you fold the seatback.

NOTICE

Stow the center seat belt of the third seats when not in use.

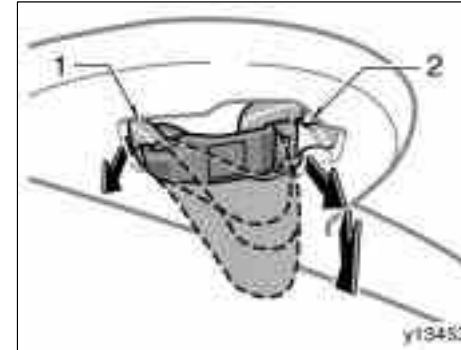

PULLING OUT THE CENTER SEAT BELT OF THE THIRD SEATS

To use the center seat belt of the third seats, pull the tab (1) out, then pull the belt out a little and pull the tab (2) out from the cover.

If the seat belt cannot be pulled out of the retractor, firmly pull the belt and release it. You will then be able to smoothly pull the belt out of the retractor.

—Seat belt comfort guides



The shoulder belt comfort guide for the outside third seats will provide added seat belt comfort for children who have outgrown child restraints and for small adults. When the shoulder belt is inserted through the guide, the comfort guide pulls the belt away from the neck and head of an occupant.

For wearing the seat belt, see “—Fastening front and rear seat belts” on page 107 in this Section.

⚠ CAUTION

- Make sure the belt is not twisted and that it lies flat.
- Always make sure the shoulder belt is positioned across the center of the shoulder. The belt should be kept away from the neck, and should not fall off the shoulder. Failure to observe these precautions could reduce the effectiveness of the seat belt in an accident, causing death or serious injury.

—Seat belt extender

If your seat belts cannot be fastened securely because they are not long enough, a personalized seat belt extender is available from your Toyota dealer free of charge.

Please contact your local Toyota dealer so that the dealer can order the proper required length for the extender. Bring the heaviest coat you expect to wear for proper measurement and selection of length. Additional ordering information is available at your Toyota dealer.

⚠ CAUTION

When using the seat belt extender, observe the following precautions. Failure to follow these instructions could reduce the effectiveness of the seat belt restraint system in case of an accident, increasing the chance of personal injury.

- Remember that the extender provided for you may not be safe when used on a different vehicle, for another person, or at a different seating position than the one originally intended.

06 SIENNA_U (L/O 0603)



- If the seat belt extender had been connected to the driver's seat belt buckle without the driver actually wearing the seat belt, the SRS driver's airbag system will judge that the driver is wearing it. In this case, the driver's airbag may not activate correctly, causing death or serious injury in the event of collision. Be sure to wear the seat belt with the seat belt extender.

- Make sure the "AIRBAG ON" indicator light is illuminated when using the seat belt extender for the front passenger seat. If the "AIRBAG OFF" indicator light is illuminated, disconnect the extender tongue from the seat belt buckle, then reconnect the seat belt. Reconnect the seat belt extender after making sure the "AIRBAG ON" indicator light is illuminated. If you use the seat belt extender while the "AIRBAG OFF" indicator light is illuminated, the front passenger airbag and side airbag on the front passenger side may not activate correctly, causing death or serious injury in the event of collision.
- Be sure to wear the seat belt without the seat belt extender if you can fasten the seat belt without the extender.

- Do not use the seat belt extender when installing a child restraint system on the front or rear passenger seat. If installing a child restraint system with the seat belt extender connected to the seat belt, the seat belt will not securely hold the child restraint system, which could cause death or serious injury to the child or other passengers in the event of collision.

06 SIENNA_U (L/O 0603)



To connect the extender to the seat belt, insert the tab into the seat belt buckle so that the “PRESS” signs on the buckle release buttons of the extender and the seat belt are both facing outward as shown.

You will hear a click when the tab locks into the buckle.

When releasing the seat belt, press on the buckle release button on the extender, not on the seat belt. This helps prevent damage to the vehicle interior and extender itself.

As far as the seat belt extender on the front passenger side is concerned, do not fail to disconnect the extender from the seat belt after the above operation in order to activate the front passenger airbag correctly when getting into the vehicle next time.

When not in use, remove the extender and store in the vehicle for future use.

CAUTION

- After inserting the tab, make sure the tab and buckle are locked and that the lap and shoulder portions of the belt and the seat belt extender are not twisted.
- Do not insert coins, clips, etc. in the buckle as this may prevent you from properly latching the tab and buckle.
- If the seat belt does not function normally, immediately contact your Toyota dealer. Do not use the seat until the seat belt is fixed, because it cannot protect an adult occupant or your child from injury.

—Seat belt pretensioners



The driver and front passenger seat belt pretensioners are designed to be activated in response to a severe frontal impact.

When the sensor detects a severe frontal impact, the front seat belts are quickly drawn back by the retractors so that the belts snugly restrain the occupants.

06 SIENNA_U (L/O 0603)

The front passenger's seat belt pretensioner will not activate if no passenger is detected in the front passenger seat by the front passenger occupant classification system. However, the front passenger's seat belt pretensioner may activate if luggage is put on the seat, or the seat belt is buckled up regardless of the presence of an occupant in the seat. (As for the front passenger occupant classification system, see "—Front passenger occupant classification system" on page 133 in this Section.)

The seat belt pretensioners and SRS airbags may not operate together in all collisions.

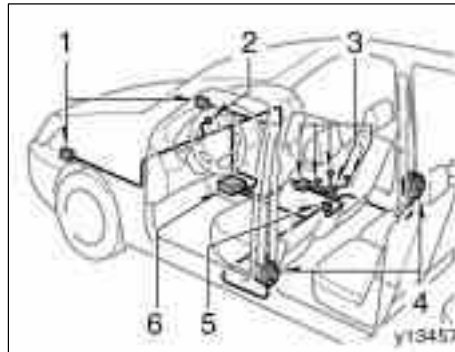

The seat belt pretensioner system consists mainly of the following components and their locations are shown in the illustration.

1. Front airbag sensors
2. SRS warning light
3. Front passenger occupant classification system (ECU and sensors)
4. Seat belt pretensioner assemblies
5. Front passenger's seat belt buckle switch
6. Airbag sensor assembly

The seat belt pretensioners are controlled by the airbag sensor assembly. The airbag sensor assembly consists of a safing sensor and airbag sensor.

When the seat belt pretensioners are activated, an operating noise may be heard and a small amount of non-toxic gas may be released. This does not indicate that a fire is occurring. This gas is normally harmless.

Once the seat belt pretensioners have been activated, the seat belt retractors remain locked.

CAUTION

Do not modify, remove, strike or open the seat belt pretensioner assemblies, airbag sensor or surrounding area or wiring. Failure to follow these instructions may prevent the seat belt pretensioners from activating correctly, cause sudden operation of the system or disable the system, which could result in death or serious injury. Consult your Toyota dealer about any repair and modification.

NOTICE

Do not perform any of the following changes without consulting your Toyota dealer. Such changes can interfere with proper operation of the seat belt pretensioners in some cases.

- ◆ *Installation of electronic devices such as a mobile two-way radio, cassette tape player or compact disc player*
- ◆ *Repairs on or near the front seat belt pretensioner assemblies*
- ◆ *Modification of the suspension system*
- ◆ *Modification of the front end structure*
- ◆ *Attachment of a grille guard (bull bar, kangaroo bar, etc.), snowplow, winches or any other equipment to the front end*
- ◆ *Repairs made on or near the front fenders, front end structure or console*

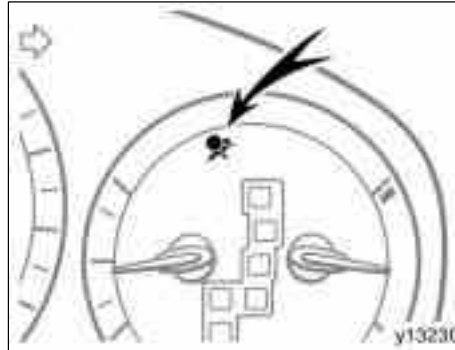

This indicator comes on when the ignition switch is turned to the "ON" position. It goes off after about 6 seconds. This means the seat belt pretensioners are operating properly.

This warning light system monitors the airbag sensor assembly, front airbag sensors, side and curtain shield airbag sensor assemblies, curtain shield airbag sensor assemblies, driver's seat position sensor, driver's seat belt buckle switch, front passenger occupant classification system, "AIRBAG ON" indicator light, "AIRBAG OFF" indicator light, front passenger's seat belt buckle switch, seat belt pretensioner assemblies, inflators, interconnecting wiring and power sources. (For details, see "Service reminder indicators and warning buzzers" on page 187 in Section 1-6.)

If any of the following conditions occurs, this indicates a malfunction of the airbags or seat belt pretensioners. Contact your Toyota dealer as soon as possible.

- When the ignition key is turned to the "ON" position, the light does not come on, remains on for more than 6 seconds or flashes.
- The light comes on or starts flashing while driving.
- If any seat belt does not retract or cannot be pulled out due to a malfunction or activation of the relevant seat belt pretensioner.
- The seat belt pretensioner assembly or surrounding area has been damaged.

**SRS airbags—
—SRS driver airbag and front
passenger airbag**

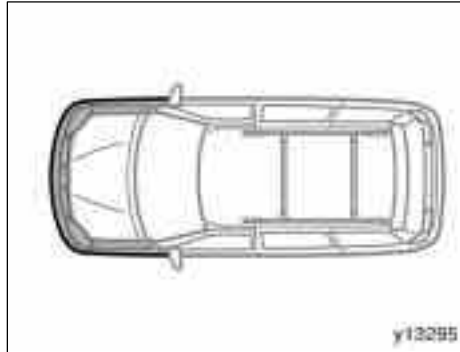

In the following cases, contact your Toyota dealer as soon as possible:

- The front of the vehicle (shaded in the illustration) was involved in an accident that was not severe enough to cause the seat belt pretensioners to operate.
- Either seat belt pretensioner assembly or surrounding area is scratched, cracked, or otherwise damaged.

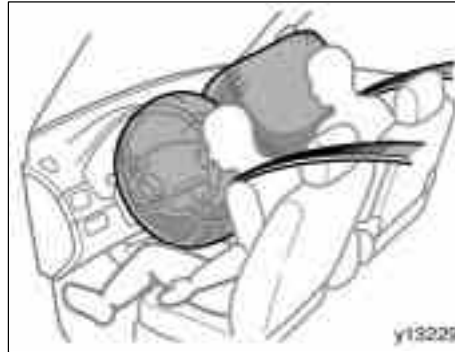

The SRS (Supplemental Restraint System) front airbags are designed to provide further protection for the driver and front passenger in addition to the primary safety protection provided by the seat belts.

Your vehicle is equipped with "ADVANCED AIRBAGS" designed based on US motor vehicle safety standards (FMVSS208). The airbag system controls airbag deployment power for the driver and front passenger. The driver airbag system consists of the driver seat's position sensor etc. The front passenger's airbag system consists of the front passenger occupant classification sensor etc.

In response to a severe frontal impact, the SRS front airbags work with the seat belts to help reduce injury by inflating. The SRS front airbags help reduce injuries mainly to the driver's or front passenger's head or chest caused by hitting the vehicle interior.

The SRS front passenger airbag will not activate if there is no passenger sitting in the front passenger seat. However, the front passenger airbag may deploy if luggage is put on the seat, or the seat belt is buckled up, regardless of the presence of an occupant in the seat. (As for the front passenger occupant classification system, see "—Front passenger occupant classification system" on page 133 in this Section.)

Always wear your seat belt properly.

06 SIENNA_U (L/O 0603)

CAUTION

- The SRS front airbag system is designed only as a supplement to the primary protection of the driver and front passenger seat belt systems. The driver and front passenger can be killed or seriously injured by the inflating airbags if they do not wear the available seat belts properly. During sudden braking just before a collision, an unrestrained driver or front passenger can move forward into direct contact with or close proximity to the airbag which may then deploy during the collision. To ensure maximum protection in an accident, the driver and all passengers in the vehicle must wear their seat belts properly. Wearing a seat belt properly during an accident reduces the chances of death or serious injury or being thrown out of the vehicle. For instructions and precautions concerning the seat belt system, see "Seat belts" on page 106 in this Section.

- Improperly seated and/or restrained infants and children can be killed or seriously injured by the deploying airbags. An infant or child who is too small to use a seat belt should be properly secured using a child restraint system. Toyota strongly recommends that all infants and children be placed in the rear seat of the vehicle and properly restrained. The rear seat is the safest for infants and children. For instructions concerning the installation of a child restraint system, see "Child restraint" on page 137 in this Section.

The SRS front airbags are designed to deploy in severe (usually frontal) collisions where the magnitude and duration of the forward deceleration of the vehicle exceeds the designed threshold level.

The SRS front airbags will deploy if the severity of the impact is above the designed threshold level, comparable to an approximate 25 km/h (15 mph) collision when the vehicle has the impact straight into a fixed barrier that does not move or deform.

However, this threshold velocity will be considerably higher if the vehicle strikes an object, such as a parked vehicle or sign pole, which can move or deform on impact, or if the vehicle is involved in an underride collision (e.g. a collision in which the front of the vehicle "underrides", or goes under, the bed of a truck, etc.).

It is possible that in some collisions where the forward deceleration of the vehicle is very close to the designed threshold level, the SRS front airbags and the seat belt pretensioners may not activate together.

Always wear your seat belts properly.

06 SIENNA_U (L/O 0603)

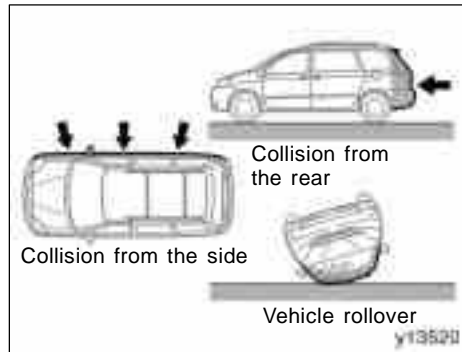

The SRS front airbags are not generally designed to inflate if the vehicle is involved in a side or rear collision, if it rolls over, or if it is involved in a low-speed frontal collision. But, whenever a collision of any type causes sufficient forward deceleration of the vehicle, deployment of the SRS front airbags may occur.

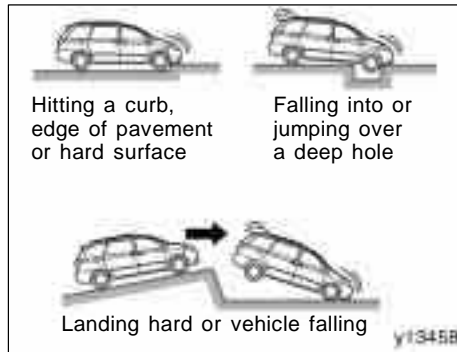

The SRS front airbags may also deploy if a serious impact occurs to the underside of your vehicle. Some examples are shown in the illustration.

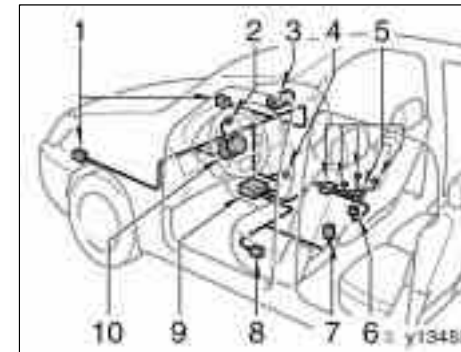

The SRS front airbag system consists mainly of the following components, and their locations are shown in the illustration.

1. Front airbag sensors
2. SRS warning light
3. Airbag module for front passenger (airbag and inflator)
4. "AIRBAG ON" and "AIRBAG OFF" indicator lights
5. Front passenger occupant classification system (ECU and sensors)
6. Front passenger's seat belt buckle switch
7. Driver's seat belt buckle switch

06 SIENNA_U (L/O 0603)

8. Driver's seat position sensor
9. Airbag sensor assembly
10. Airbag module for driver (airbag and inflator)

The airbag sensor assembly consists of a safing sensor and airbag sensor.

The front airbag sensors constantly monitor the forward deceleration of the vehicle. If an impact results in a forward deceleration beyond the designed threshold level, the system triggers the airbag inflators. At this time a chemical reaction in the inflators very quickly fills the airbags with non-toxic gas to help restrain the forward motion of the occupants. The front airbags then quickly deflate, so that there is no obstruction of the driver's vision should it be necessary to continue driving.

When the airbags inflate, they produce a loud noise and release some smoke and residue along with non-toxic gas. This does not indicate a fire. This smoke may remain inside the vehicle for some time, and may cause some minor irritation to the eyes, skin or breathing. Be sure to wash off any residue as soon as possible to prevent any potential skin irritation with soap and water. If you can safely exit from the vehicle, you should do so immediately.

Deployment of the airbags happens in a fraction of a second, so the airbags must inflate with considerable force. While the system is designed to reduce serious injuries, primarily to the head and chest, it may also cause other, less severe injuries to the face, chest, arms and hands. These are usually in the nature of minor burns or abrasions and swelling, but the force of a deploying airbag can cause more serious injuries, especially if an occupant's hands, arms, chest or head is in close proximity to the airbag module at the time of deployment. This is why it is important for the occupant to; avoid placing any object or part of the body between the occupant and the airbag module; sit straight and well back into the seat; wear the available seat belt properly; and sit as far as possible from the airbag module, while still maintaining control of the vehicle.

Parts of the airbag module (steering wheel hub, airbag cover and inflator) may be hot for several minutes after deployment, so do not touch! The airbags inflate only once. The windshield may be damaged by absorbing some of the force of the inflating airbag.

CAUTION

The driver or front passenger who is too close to the steering wheel or dashboard during airbag deployment can be killed or seriously injured. Toyota strongly recommends that:

- **The driver sit as far back as possible from the steering wheel while still maintaining control of the vehicle.**
- **The front passenger sit as far back as possible from the dashboard.**
- **All vehicle occupants be properly restrained using the available seat belts.**

For instructions and precautions concerning the seating position, see "—Front seat precautions" on page 56 in this Section.

06 SIENNA_U (L/O 0603)



- Do not sit on the edge of the seat or lean against the dashboard when the vehicle is in use, since the front passenger airbag could inflate with considerable speed and force. Anyone who is up against, or very close to, an airbag when it inflates, can be killed or seriously injured. Sit up straight and well back in the seat, and always use your seat belt properly.



- Toyota strongly recommends that all infants and children be placed in the rear seat of the vehicle and be properly restrained.
- Do not hold a child on your lap or in your arms. Use a child restraint system in the rear seat. For instructions concerning the installation of a child restraint system, see "Child restraint" on page 137 in this Section.

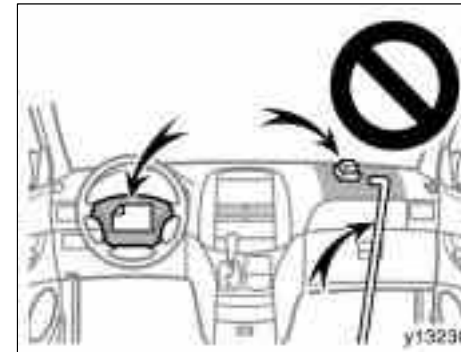

- Do not put anything or any part of your body on or in front of the dashboard or steering wheel pad that houses the front airbag system. They might restrict inflation or cause death or serious injury as they are projected rearward by the force of the deploying airbags. Likewise, the driver and front passenger should not hold objects in their arms or on their knees.

06 SIENNA_U (L/O 0603)

- Do not modify or remove any wiring. Do not modify, remove, strike or open any components such as the steering wheel pad, steering wheel, column cover, dashboard near the front passenger airbag, front passenger airbag cover, front passenger airbag or airbag sensor assembly. Doing so may prevent the front airbag system from activating correctly, cause sudden activation of the system or disable the system, which could result in death or serious injury.

Failure to follow these instructions can result in death or serious injury. Consult your Toyota dealer about any repair and modification.

If you wish to modify your vehicle for a person with a physical disability, consult your Toyota dealer. It may dangerously interfere with the SRS front airbags operation.

NOTICE

Do not perform any of the following changes without consulting your Toyota dealer. Such changes can interfere with proper operation of the SRS front airbag system in some cases.

- ◆ *Installation of electronic devices such as a mobile two-way radio, cassette tape player or compact disc player*
- ◆ *Modification of the suspension system*
- ◆ *Modification of the front end structure*
- ◆ *Attachment of a grille guard (bull bar, kangaroo bar, etc.), snowplow, winches or any other equipment to the front end*
- ◆ *Repairs made on or near the front fenders, front end structure, console, steering column, steering wheel or dashboard near the front passenger airbag*

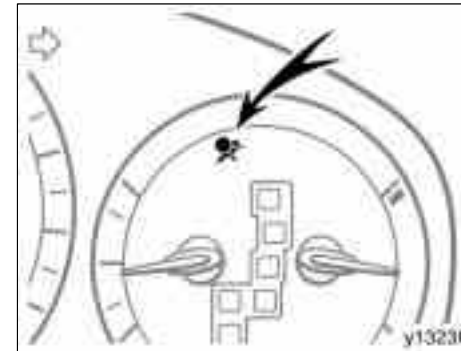

This indicator comes on when the ignition switch is turned to the "ON" position. It goes off after about 6 seconds. This means the SRS front airbags are operating properly.

06 SIENNA_U (L/O 0603)

This warning light system monitors the airbag sensor assembly, front airbag sensors, side and curtain shield airbag sensor assemblies, curtain shield airbag sensor assemblies, driver's seat position sensor, driver's seat belt buckle switch, front passenger occupant classification system, "AIRBAG ON" indicator light, "AIRBAG OFF" indicator light, front passenger's seat belt buckle switch, seat belt pretensioner assemblies, inflators, interconnecting wiring and power sources. (For details, see "Service reminder indicators and warning buzzers" on page 187 in Section 1-6.)

If any of the following conditions occurs, this indicates a malfunction of the airbags or seat belt pretensioners. Contact your Toyota dealer as soon as possible.

- When the ignition key is turned to the "ON" position, the light does not come on, remains on for more than 6 seconds or flashes.
- The light comes on or starts flashing while driving.

If the light stays on, it indicates that the SRS driver and front passenger airbag system and/or front passenger occupant classification system and "AIRBAG ON" and "AIRBAG OFF" indicator lights have a problem. If the light flashes, the SRS side airbag system and/or curtain shield airbag system have a problem.

The SRS warning light and "AIRBAG OFF" indicator light will come on if there is a malfunction in the front passenger occupant classification system.

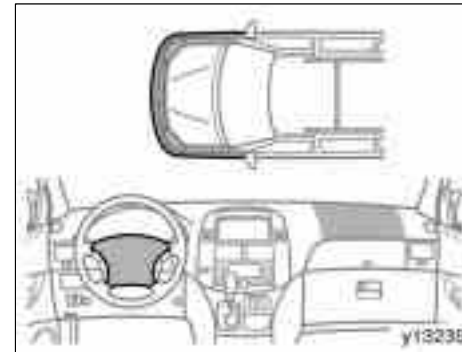

In the following cases, contact your Toyota dealer as soon as possible:

- The SRS front airbags have been inflated.
- The front of the vehicle (shaded in the illustration) was involved in an accident that was not severe enough to cause the SRS front airbags to inflate.
- The pad section of the steering wheel or dashboard (shaded in the illustration) is scratched, cracked, or otherwise damaged.

—SRS side airbags and curtain shield airbags

NOTICE

Do not disconnect the battery cables before contacting your Toyota dealer.

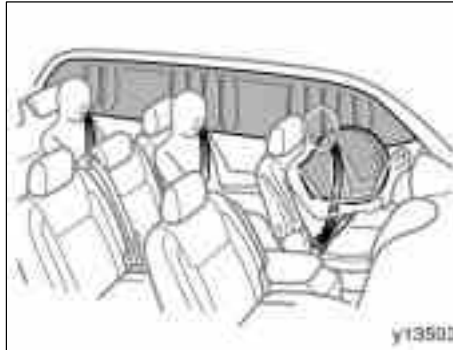

The SRS (Supplemental Restraint System) side airbags and curtain shield airbags are designed to provide further protection for the driver and all window-side passengers in addition to the primary safety protection provided by the seat belts.

In response to a severe side impact, the SRS side airbags and curtain shield airbags work with the seat belts to help reduce injury by inflating. The SRS side airbags help reduce injuries mainly to the driver's or front passenger's chest and the SRS curtain shield airbags help reduce injuries mainly to the driver's and all window-side passengers' heads.

The SRS side airbag on the passenger seat will not activate if there is no passenger sitting in the front passenger seat. However, the side airbag on the passenger seat may deploy if luggage is put on the seat, or the seat belt is buckled up regardless of the presence of the occupant in the seat. (As for the front passenger occupant classification system, see “—Front passenger occupant classification system” on page 133 in this Section.)

The SRS curtain shield airbags on the passenger side are activated even with no passenger in the front seat or all window-side seat.

The SRS curtain shield airbags may activate even when the side airbags are not activated.

Always wear your seat belt properly.

06 SIENNA_U (L/O 0603)

CAUTION

- The SRS side airbag and curtain shield airbag system is designed only as a supplement to the primary protection of the driver and all window-side passenger seat belt systems. To ensure maximum protection in an accident, the driver and all passengers in the vehicle must wear their seat belts properly. Wearing a seat belt properly during an accident reduces the chances of death or serious injury or being thrown out of the vehicle. For instructions and precautions concerning the seat belt system, see "Seat belts" on page 106 in this Section.

- Do not allow anyone to lean his/her head or any part of his/her body against the side window or the area of the seat, front or side pillars or roof side rail from which the SRS side airbag and curtain shield airbag deploy even if he/she is a child seated in the child restraint system. It is dangerous if the SRS side airbag and curtain shield airbag inflate, and the impact of the deploying airbag could cause death or serious injury to the occupant.
- Improperly seated and/or restrained infants and children can be killed or seriously injured by the deploying airbags. An infant or child who is too small to use a seat belt should be properly secured using a child restraint system. Toyota strongly recommends that all infants and children be placed in the rear seats of the vehicle and properly restrained. The rear seats are the safest for infants and children. For instructions concerning the installation of a child restraint system, see "Child restraint" on page 137 in this Section.

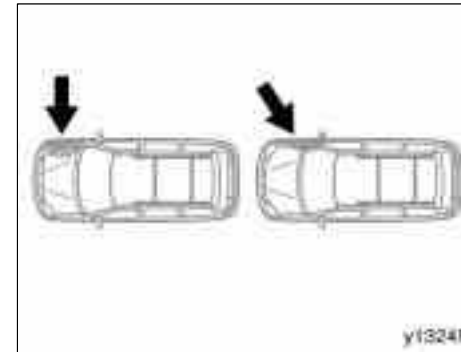

The SRS side airbag and curtain shield airbag system may not activate if the vehicle is subjected to a collision from the side at certain angles, or a collision to the side of the vehicle body other than the passenger compartment as shown in the illustration.

The SRS side airbags and curtain shield airbags are designed to inflate when the passenger compartment area suffers a severe impact from the side.

Always wear your seat belts properly.

06 SIENNA_U (L/O 0603)

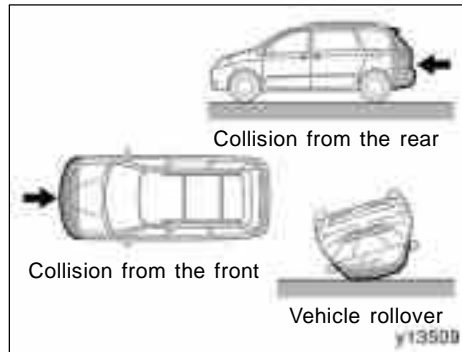

The SRS side airbags and curtain shield airbags are not generally designed to inflate if the vehicle is involved in a front or rear collision, if it rolls over, or if it is involved in a low-speed side collision.

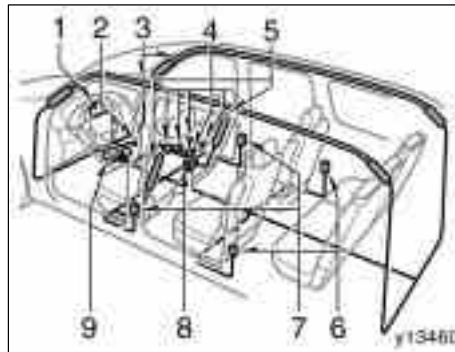

The SRS side airbag and curtain shield airbag system consists mainly of the following components, and their locations are shown in the illustration.

1. SRS warning light
2. "AIRBAG ON" and "AIRBAG OFF" indicator lights
3. Curtain shield airbag modules (airbag and inflator)
4. Front passenger occupant classification system (ECU and sensors)
5. Side airbag modules (airbag and inflator)
6. Curtain shield airbag sensors
7. Side and curtain shield airbag sensors

8. Front passenger's seat belt buckle switch

9. Airbag sensor assembly

The SRS side airbag and curtain shield airbag system is controlled by the airbag sensor assembly. The airbag sensor assembly consists of a safing sensor and airbag sensor.

In a severe side impact, the side and curtain shield airbag sensor and/or the curtain shield airbag sensor trigger(s) the side airbag inflators and/or the curtain shield airbag inflators. At this time a chemical reaction in the inflators quickly fills the airbags with non-toxic gas to help restrain the lateral motion of the occupants.

When the airbags inflate, they produce a fairly loud noise and release some smoke and residue along with non-toxic gas. This does not indicate a fire. This smoke may remain inside the vehicle for some time, and may cause some minor irritation to the eyes, skin or breathing. Be sure to wash off any residue as soon as possible to prevent any potential skin irritation with soap and water. If you can safely exit from the vehicle, you should do so immediately.

06 SIENNA_U (L/O 0603)

Deployment of the airbags happens in a fraction of a second, so the airbags must inflate with considerable force. While the system is designed to reduce serious injuries, it may also cause minor burns or abrasions and swelling.

Front seats as well as parts of front and side pillars, and roof side rails may be hot for several minutes, but the airbags themselves will not be hot. The airbags are designed to inflate only once.

CAUTION

SRS side airbags and curtain shield airbags inflate with considerable force. To reduce the possibility of death or serious injury when they inflate, the driver and all window-side passengers must:

- Wear their seat belts properly.
- Remain properly seated with their backs upright and against the seats at all times.



- Do not allow anyone to lean against the door when the vehicle is in use, since the side airbag and curtain shield airbag could inflate with considerable speed and force. Otherwise, he/she may be killed or seriously injured. Special care should be taken especially when you have a small child in the vehicle.
- Sit up straight and well back in the seat, distributing your weight evenly in the seat. Do not apply excessive weight to the outer side of the seats with a side airbag, and to the front and side pillars and roof side rail with a curtain shield airbag.



- Do not allow anyone to get his/her head closer to the area where the side airbag and curtain shield airbag inflate, since these airbags could inflate with considerable speed and force. Otherwise, he/she may be killed or seriously injured. Special care should be taken especially when you have a small child in the vehicle.

06 SIENNA_U (L/O 0603)



- Do not allow anyone to kneel on the seat facing the side window, since the side airbag and curtain shield airbag could inflate with considerable speed and force. Otherwise, he/she may be killed or seriously injured. Special care should be taken especially when you have a small child in the vehicle.



- Do not allow anyone to get his/her head or hands out of windows since the curtain shield airbags could inflate with considerable speed and force. Otherwise, he/she may be killed or seriously injured. Special care should be taken especially when you have a small child in the vehicle.

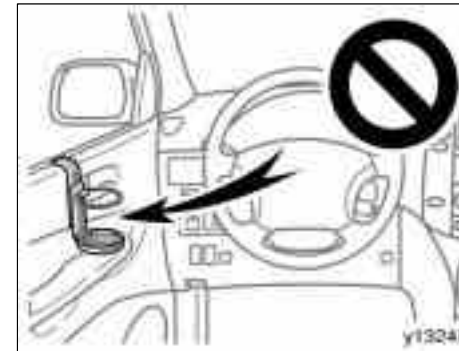

- Do not attach a cup holder or any other device or object on or around the door. When the side airbag inflates, the cup holder or any other device or object will be thrown with great force or the side airbag may not activate correctly, resulting in death or serious injury. Likewise, the driver and front passenger should not hold objects in their arms or on their knees.

06 SIENNA_U (L/O 0603)



- Do not attach a microphone or any other device or object around the area where the curtain shield airbag activates such as on the windshield glass, side door glass, front or side pillars, roof side rails and assist grips. When the curtain shield airbag inflates, the microphone or other device or object will be thrown away with great force or the curtain shield airbag may not activate correctly, resulting in death or serious injury.

- Do not hook a hanger, heavy or sharp pointed objects on the coat hook. If the curtain shield airbag inflates, those items will be thrown away with great force or the curtain shield airbag may not activate correctly, resulting in death or serious injury. When you hang clothes, hang them on the coat hook directly.
- Do not use seat accessories which cover the parts where the side airbags inflate. Such accessories may prevent the side airbags from activating correctly, causing death or serious injury.
- Do not modify or replace the seats or upholstery of the seats with side airbags. Such changes may prevent the side airbag system from activating correctly, disable the system or cause the side airbags to inflate accidentally, resulting in death or serious injury.

- Do not disassemble or repair the front or side pillars and roof side rail containing the curtain shield airbags. Such changes may disable the system or cause the curtain shield airbags to inflate accidentally, resulting in death or serious injury.

Failure to follow these instructions can result in death or serious injury. Consult your Toyota dealer about any repair and modification.

If you wish to modify your vehicle for a person with a physical disability, consult your Toyota dealer. It may dangerously interfere with the SRS side airbags and curtain shield airbags operation.

06 SIENNA_U (L/O 0603)

NOTICE

Do not perform any of the following changes without consulting your Toyota dealer. Such changes can interfere with proper operation of the SRS side airbag and curtain shield airbag system in some cases.

- ◆ *Installation of electronic devices such as a mobile two-way radio, cassette tape player or compact disc player*
- ◆ *Modification of the suspension system*
- ◆ *Modification of the side structure of the passenger compartment*
- ◆ *Repairs made on or near the console or front seat*

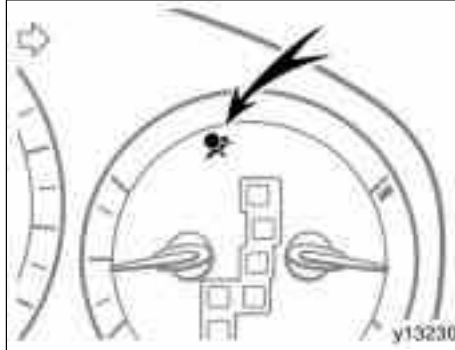

This indicator comes on when the ignition switch is turned to the "ON" position. It goes off after about 6 seconds. This means the SRS side airbags and curtain shield airbags are operating properly.

This warning light system monitors the airbag sensor assembly, front airbag sensors, side and curtain shield airbag sensor assemblies, curtain shield airbag sensor assemblies, driver's seat position sensor, driver's seat belt buckle switch, front passenger occupant classification system, "AIRBAG ON" indicator light, "AIRBAG OFF" indicator light, front passenger's seat belt buckle switch, seat belt pretensioner assemblies, inflators, interconnecting wiring and power sources. (For details, see "Service reminder indicators and warning buzzers" on page 187 in Section 1-6.)

If any of the following conditions occurs, this indicates a malfunction of the airbags or seat belt pretensioners. Contact your Toyota dealer as soon as possible.

- When the ignition key is turned to the "ON" position, the light does not come on, remains on for more than 6 seconds or flashes.
- The light comes on or starts flashing while driving.

06 SIENNA_U (L/O 0603)

If the light stays on, it indicates that the SRS driver and front passenger airbag system and/or front passenger occupant classification system and "AIRBAG ON" and "AIRBAG OFF" indicator lights have a problem. If the light flashes, the SRS side airbag system and/or curtain shield airbag system have a problem.

The SRS warning light and "AIRBAG OFF" indicator light will come on if there is a malfunction in the front passenger occupant classification system.

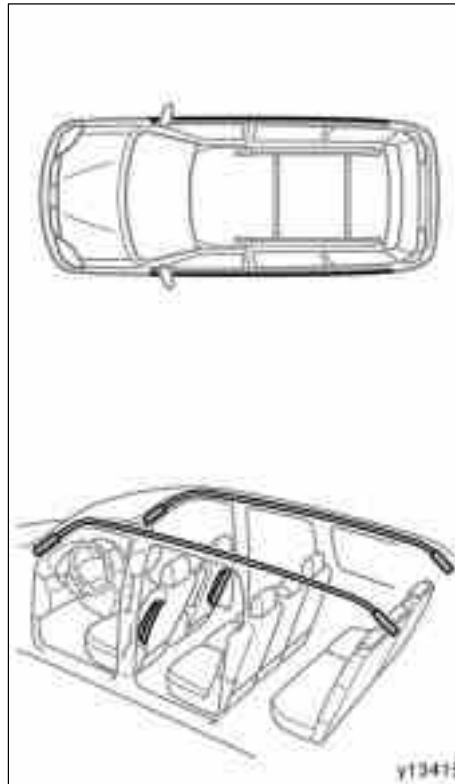

In the following cases, contact your Toyota dealer as soon as possible:

- Any of the SRS side airbags and curtain shield airbags have been inflated.
- The portion of the doors (shaded in the illustration) was involved in an accident that was not severe enough to cause the SRS side airbags and curtain shield airbags to inflate.
- The surface of the seats with the side airbag (shaded in the illustration) is scratched, cracked, or otherwise damaged.
- The portion of the front pillars, side pillars or roof side rail garnishes (padding) containing the curtain shield airbags inside (shaded in the illustration) is scratched, cracked, or otherwise damaged.

NOTICE

Do not disconnect the battery cables before contacting your Toyota dealer.

—Front passenger occupant classification system

Your vehicle is equipped with a front passenger occupant classification system. This system detects the conditions 1—4 in the table on page 135 and based on these conditions activates or deactivates the following systems;

- Front passenger airbag
- Side airbag on the front passenger seat
- Front passenger's seat belt pretensioner

The system monitors the weight and load on the front passenger seat, and the seat belt buckle switch to determine conditions 1—4.

In order for the system to detect the conditions correctly, do not do any of the following:

- Apply a heavy load to the front passenger seat or equipment (e.g. seatback table, grocery bag hooks, armrest or auxiliary box).
- Attach a commercial seatback table, etc. to the front passenger seat seatback.
- Put weight on the front passenger seat by putting your hands or feet on the seatback from the rear passenger seat.

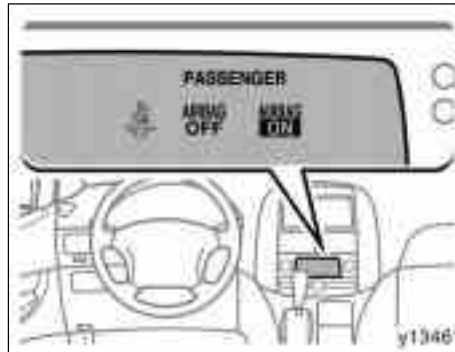

The “AIRBAG ON” and “AIRBAG OFF” indicator lights indicate the actuation of the front passenger airbag, side airbag on the front passenger seat and front passenger’s seat belt pretensioner.

The “AIRBAG OFF” indicator light will be illuminated when the ignition switch is in the “ON” position with the condition 2 in the table shown below.

If the front passenger occupant classification system determines that a person of adult size sits in the front passenger seat but the “AIRBAG OFF” indicator light is illuminated, one of the following is likely to have occurred:

- A rear passenger lifts the front passenger seat cushion with their legs.
- Objects are placed under the front passenger seat.
- The front passenger seatback is in contact with the second seat.

To ensure the system correctly detects an adult sitting in the front passenger seat, make sure the above do not occur.

Make sure that the “AIRBAG ON” indicator light is illuminated when an adult is seated in the front passenger seat. If the “AIRBAG OFF” indicator light is illuminated, ask the passenger to sit up straight, well back in the seat, and with the seat belt worn correctly. If the “AIRBAG OFF” indicator light still remains illuminated, either ask the passenger to move to the rear seat, or if that is not possible, move the front passenger seat fully rearward.

06 SIENNA_U (L/O 0603)

The "AIRBAG ON" and "AIRBAG OFF" indicator lights will be illuminated initially when the ignition key is turned to the "ON" position. After about 4 seconds, they will go off. After that, the front passenger occupant classification system operates and judges which indicator light be illuminated.



The SRS warning light and "AIRBAG OFF" indicator light will come on if there is a malfunction in the front passenger occupant classification system.

06 SIENNA_U (L/O 0603)

Condition and operation in the front passenger occupant classification system

Condition detected by the front passenger occupant classification system	Indicator/warning light			Devices			
	"AIRBAG ON" and "AIRBAG OFF" indicator lights	SRS warning light	Front passenger's seat belt reminder light	Front passenger airbag	Side airbag on the front passenger seat	Curtain shield airbag in the front passenger side	Front passenger's seat belt pretensioner
1. Adult*1	"AIRBAG ON"	Off	Flashing*4	Activated			
2. Child*2 or child restraint system*3	"AIRBAG OFF"	Off	Flashing*4	Deactivated		Activated	Activated
3. Unoccupied	Not illuminated	Off	Off	Deactivated			Deactivated
4. There is a malfunction in the system	"AIRBAG OFF"	On	Off	Deactivated			Activated

*1: The system judges a person of adult size as an adult. When a smaller adult sits in the front passenger seat, the system may recognize him/her as a child depending on his/her physique and posture.

*2: When a larger child who has outgrown a child restraint system sits in the front passenger seat, the system may recognize him/her as an adult depending on his/her physique or posture.

*3: Never install a rear-facing child restraint system on the front passenger seat. A forward-facing child restraint system should only be installed on the front passenger seat when it is unavoidable. (See "Child restraint" on page 137 in this Section as for installing the child restraint system.)

*4:

In the event that the front passenger does not wear a seat belt.



CAUTION

To avoid potential death or serious injury when the front passenger occupant classification system does not detect the conditions correctly, observe the following.

- Do not recline the front passenger seat seatback so that it interferes with a second seat as it may cause the "AIRBAG OFF" indicator light be illuminated. If the seatback interferes with the second seat, return the seatback to a position where it does not interfere with the second seat.

Keep the front passenger seatback as upright as possible when the vehicle is moving. Reclining the seatback excessively may lessen the effectiveness of the seat belt system.

- Make sure the "AIRBAG ON" indicator light is illuminated when using the seat belt extender for the front passenger seat. If the "AIRBAG OFF" indicator light is illuminated, disconnect the extender tongue from the seat belt buckle, then reconnect the seat belt. Reconnect the seat belt extender after making sure the "AIRBAG ON" indicator light is illuminated. If you use the seat belt extender while the "AIRBAG OFF" indicator light is illuminated, the front passenger airbag and side airbag on the front passenger side may not activate correctly, which could cause death or serious injury in the event of collision.

- If an adult sits in the front passenger seat, the "AIRBAG ON" indicator light should be illuminated. If the "AIRBAG OFF" indicator light is illuminated, ask the passenger to sit up straight, well back in the seat, feet on the floor, and with the seat belt worn correctly. If the "AIRBAG OFF" indicator light still remains illuminated, either ask the passenger to move to the rear seat, or if that is not possible, move the front passenger seat fully rearward.
- Wear the seat belt properly.
- Make sure the front passenger's seat belt tab has not been left inserted into the buckle before someone sits in the front passenger seat.
- Do not apply a heavy load to the front passenger seat or equipment (e.g. seatback table, grocery bag hooks, armrest or auxiliary box).
- Do not put weight on the front passenger seat by putting your hands or feet on the front passenger seat seatback from the rear passenger seat.

- Do not let a rear passenger lift the front passenger seat with their feet or press on the seatback with their legs.
- Do not put objects under the front passenger seat.
- Child restraint systems installed on the second seat should not contact the front seatbacks.
- When it is unavoidable to install the forward-facing child restraint system on the front passenger seat, install the child restraint system on the front passenger seat in the proper order. (As for the installation order, see “—Installation with seat belt” on page 140 in this Section.)
- Do not remove the front seats.
- Do not kick the front passenger seat or subject it to severe impact. Otherwise, the SRS warning light may come on to indicate a malfunction of the detection system. In this case, contact your Toyota dealer immediately.

The “AIRBAG ON” indicator light may be illuminated (the front passenger airbag and side airbag on the front passenger seat may deploy) even if observing the above cautions, when a child sits in, or a forward-facing child restraint system is installed on the front passenger seat. Refer to all the cautions in “SRS airbags” on page 118 and “Child restraint” on page 137 in this Section.

Child restraint— —Child restraint precautions

Toyota strongly urges the use of appropriate child restraint systems for children.

The laws of all 50 states in the U.S.A. and Canada now require the use of a child restraint system.

Your vehicle conforms to SAEJ1819.

If a child is too large for a child restraint system, the child should sit in the rear seat and must be restrained using the vehicle's seat belt. See “Seat belts” on page 106 in this Section for details.

CAUTION

- For effective protection in automobile accidents and sudden stops, a child must be properly restrained, using a seat belt or child restraint system depending on the age and size of the child. Holding a child in your arms is not a substitute for a child restraint system. In an accident, the child can be crushed against the windshield, or between you and the vehicle's interior.

06 SIENNA_U (L/O 0603)

- Toyota strongly urges use of a proper child restraint system which conforms to the size of the child, installed on the rear seat. According to accident statistics, the child is safer when properly restrained in the rear seat than in the front seat.
- Never install a rear-facing child restraint system on the front passenger seat even if the "AIRBAG OFF" indicator light is illuminated. In the event of an accident, the force of the rapid inflation of the front passenger airbag can cause death or serious injury to the child if the rear-facing child restraint system is installed on the front passenger seat.

- A forward-facing child restraint system should be allowed to be installed on the front passenger seat only when it is unavoidable. Always move the seat as far back as possible even if the "AIRBAG OFF" indicator light is illuminated, because the front passenger airbag could inflate with considerable speed and force. Otherwise, the child may be killed or seriously injured.
- On vehicles with side airbags and curtain shield airbags, do not allow the child to lean his/her head or any part of his/her body against the side window or the area of the seat, front or side pillars or roof side rails from which the side airbags or curtain shield airbags deploy even if the child is seated in the child restraint system. It is dangerous if the side airbag and/or curtain shield airbag inflate, and the impact could cause death or serious injury to the child.

- Do not use the seat belt extender when installing a child restraint system on the front or rear passenger seat. If installing a child restraint system with the seat belt extender connected to the seat belt, the seat belt will not securely hold the child restraint system, which could cause death or serious injury to the child or other passengers in the event of collision.
- Make sure that you have complied with all installation instructions provided by the child restraint manufacturer and that the system is properly secured. If it is not secured properly, it may cause death or serious injury to the child in the event of a sudden stop or accident.

—Child restraint system

A child restraint system for a small child or baby must itself be properly restrained on the seat with the lap portion of the lap/shoulder belt. You must carefully consult the manufacturer's instructions which accompany the child restraint system.

To provide proper restraint, use a child restraint system following the manufacturer's instructions about the appropriate age and size of the child for the child restraint system.

Install the child restraint system correctly following the instructions provided by its manufacturer. General directions are also provided under the following illustrations.

The child restraint system should be installed on the rear seat. According to accident statistics, the child is safer when properly restrained in the rear seat than in the front seat.

When not using the child restraint system, keep it secured with the seat belt or place it somewhere other than the passenger compartment. This will prevent it from injuring passengers in the event of a sudden stop or accident.

—Types of child restraint system

Child restraint systems are classified into the following 3 types depending on the child's age and size.

- (A) Infant seat
- (B) Convertible seat
- (C) Booster seat

Install the child restraint system following the instructions provided by its manufacturer.

Your vehicle has anchor brackets for securing the top strap of a child restraint system.

For instructions about how to use the anchor bracket, see “—Using a top strap” on page 151 in this Section.

The child restraint lower anchorages approved for your vehicle may also be used. See “—Installation with child restraint lower anchorages” on page 155 in this Section.



(A) Infant seat



(B) Convertible seat

—Installation with seat belt



(C) Booster seat



(A) INFANT SEAT INSTALLATION

An infant seat must be used in rear-facing position only.



 CAUTION

- Never install a rear-facing child restraint system on the front passenger seat even if the "AIRBAG OFF" indicator light is illuminated. In the event of an accident, the force of the rapid inflation of the front passenger airbag could cause death or serious injury to the child if the rear-facing child restraint system is installed on the front passenger seat.

06 SIENNA_U (L/O 0603)



- Do not install a child restraint system on the second (or third) seat if it interferes with the lock mechanism of the front (or second) seats. Otherwise, the child or front (or second) seat occupant(s) may be killed or seriously injured in case of sudden braking or a collision.
- If the driver's seat position does not allow sufficient space for safe installation, install the child restraint system on the second right seat.

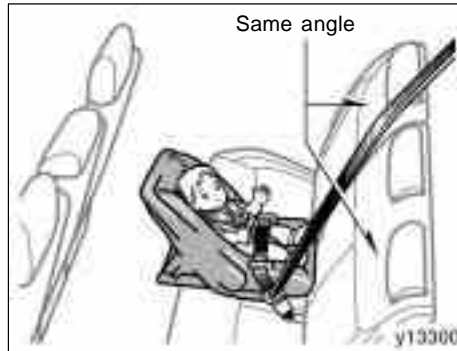

- When installing a child restraint system in the third seat center position, adjust both seatbacks to the same angle. Otherwise, the child restraint system cannot be securely restrained and this may cause death or serious injuries in a collision.

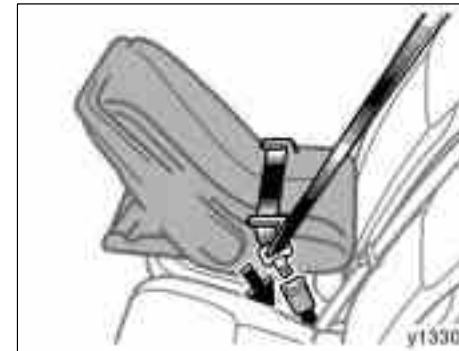

1. Run the lap and shoulder belt through or around the infant seat following the instructions provided by its manufacturer and insert the tab into the buckle taking care not to twist the belt. Keep the lap portion of the belt tight.

06 SIENNA_U (L/O 0603)

CAUTION

- After inserting the tab, make sure the tab and buckle are locked and that the lap and shoulder portions of the belt are not twisted.
- Do not insert coins, clips, etc. in the buckle as this may prevent your child from properly latching the tab and buckle.
- If the seat belt does not function normally, it cannot protect your child from death or serious injury. Contact your Toyota dealer immediately. Do not install the child restraint system on the seat until the seat belt is fixed.



2. Fully extend the shoulder belt to put it in the lock mode. When the belt is then retracted even slightly, it cannot be extended.

To hold the infant seat securely, make sure the belt is in the lock mode before letting the belt retract.



3. While pressing the infant seat firmly against the seat cushion and seatback, let the shoulder belt retract as far as it will go to hold the infant seat securely.

06 SIENNA_U (L/O 0603)

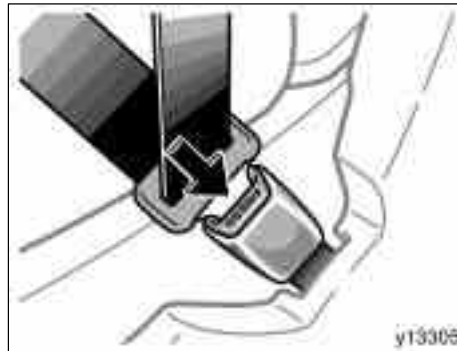
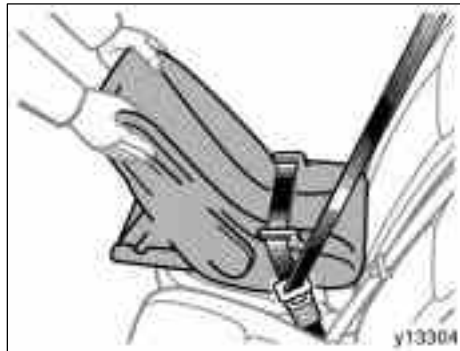

⚠ CAUTION
Push and pull the child restraint system in different directions to be sure it is secure. Follow all the installation instructions provided by its manufacturer.

4. To remove the infant seat, press the buckle release button and allow the belt to retract completely. The belt will move freely again and be ready to work for an adult or older child passenger.

(B) CONVERTIBLE SEAT INSTALLATION
A convertible seat must be used in forward-facing or rear-facing position depending on the age and size of the child. When installing, follow the manufacturer's instructions about the applicable age and size of the child as well as directions for installing the child restraint system.

06 SIENNA_U (L/O 0603)

Install the child restraint system on the front passenger seat only when it is unavoidable. Your vehicle is equipped with a front passenger occupant classification system. In order to activate the occupant classification system correctly, install the forward-facing child restraint system on the front passenger seat in the following order:

1. Turn the ignition key to the "ON" position.
2. Move the front passenger seat to the rearward position.
3. Put the child restraint system on the front passenger seat without putting your weight on the front passenger seat.
4. Insert the seat belt tab into the seat belt buckle.
5. Fully extend the shoulder belt to put it in the lock mode. When the belt is then retracted even slightly, it cannot be extended. To hold the seat securely, make sure the belt is in the lock mode before letting the belt retract.

6. While pressing the convertible seat firmly against the seat cushion and seatback, let the shoulder belt retract as far as it will go to hold the convertible seat securely.

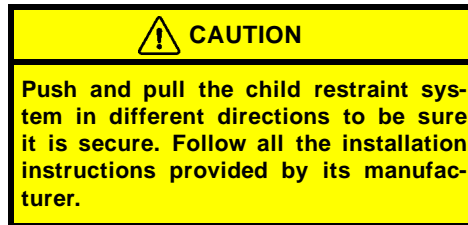

7. Put a child on the child restraint system and secure the child, complying with the instructions provided by the child restraint system manufacturer.

The "AIRBAG OFF" indicator light should be illuminated when the ignition key is "ON" and the child is in the child restraint system after following these procedures. The "AIRBAG OFF" indicator light indicates the SRS front passenger airbag and side airbag on the passenger side will not deploy. If the "AIRBAG ON" indicator light is illuminated, remove the child restraint system and reinstall it with the ignition key in the "ACC" or "LOCK" position. If the "AIRBAG ON" indicator light is illuminated when the ignition key is turned to the "ON" position, then the SRS front passenger airbag and side airbag on the passenger side may deploy in an accident. Do not drive the vehicle in this condition. Remove the child restraint system and contact your Toyota dealer.

 CAUTION

- Never install a rear-facing child restraint system on the front passenger seat. A forward-facing child restraint system should only be installed on the front passenger seat when unavoidable. If you must install the child restraint system on the front passenger seat, put the seat in its most rearward position, and install the forward-facing child restraint system in the proper order. Otherwise, the front passenger occupant classification system can not detect the presence of the child restraint system and the front passenger airbag and side airbag on the front passenger seat could deploy.



- Never install a rear-facing child restraint system on the front passenger seat even if the "AIRBAG OFF" indicator light is illuminated. In the event of an accident, the force of the rapid inflation of the front passenger airbag could cause death or serious injury to the child if the rear-facing child restraint system is installed on the front passenger seat.



- A forward-facing child restraint system should be allowed to be installed on the front passenger seat only when it is unavoidable. Always move the seat as far back as possible even if the "AIRBAG OFF" indicator light is illuminated, because the front passenger airbag could inflate with considerable speed and force. Otherwise, the child may be killed or seriously injured.

06 SIENNA_U (L/O 0603)

- On vehicles with side airbags and curtain shield airbags, do not allow the child to lean his/her head or any part of his/her body against the side window or the area of the seat, front or side pillars or roof side rails from which the side airbags or curtain shield airbags deploy even if the child is seated in the child restraint system. It is dangerous if the side airbag and/or curtain shield airbag inflate, and the impact could cause death or serious injury to the child.

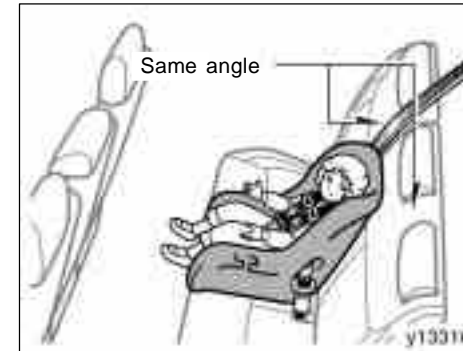

- Do not install a child restraint system on the second (or third) seat if it interferes with the lock mechanism of the front (or second) seats. Otherwise, the child or front (or second) seat occupant(s) may be killed or seriously injured in case of sudden braking or a collision.
- If the driver's seat position does not allow sufficient space for safe installation, install the child restraint system on the second right seat.

- When installing a child restraint system in the third seat center position, adjust both seatbacks to the same angle. Otherwise, the child restraint system cannot be securely restrained and this may cause death or serious injuries in a collision.

06 SIENNA_U (L/O 0603)



1. Run the lap and shoulder belt through or around the convertible seat following the instructions provided by its manufacturer and insert the tab into the buckle taking care not to twist the belt. Keep the lap portion of the belt tight.

CAUTION

- After inserting the tab, make sure the tab and buckle are locked and that the lap and shoulder portions of the belt are not twisted.
- Do not insert coins, clips, etc. in the buckle as this may prevent your child from properly latching the tab and buckle.
- If the seat belt does not function normally, it cannot protect your child from death or serious injury. **Contact your Toyota dealer immediately. Do not install the child restraint system on the seat until the seat belt is fixed.**



2. Fully extend the shoulder belt to put it in the lock mode. When the belt is then retracted even slightly, it cannot be extended.

To hold the convertible seat securely, make sure the belt is in the lock mode before letting the belt to retract.

06 SIENNA_U (L/O 0603)



3. While pressing the convertible seat firmly against the seat cushion and seatback, let the shoulder belt retract as far as it will go to hold the convertible seat securely.



CAUTION

Push and pull the child restraint system in different directions to be sure it is secure. Follow all the installation instructions provided by its manufacturer.

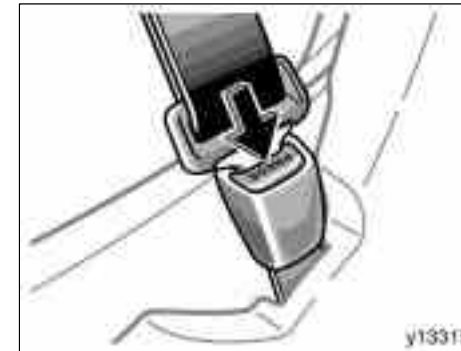

4. To remove the convertible seat, press the buckle release button and allow the belt to retract completely. The belt will move freely again and be ready to work for an adult or older child passenger.

06 SIENNA_U (L/O 0603)



(C) BOOSTER SEAT INSTALLATION

A booster seat must be used in forward-facing position only.



⚠ CAUTION

- A forward-facing child restraint system should be allowed to be installed on the front passenger seat only when it is unavoidable. Always move the seat as far back as possible even if the "AIRBAG OFF" indicator light is illuminated, because the front passenger airbag could inflate with considerable speed and force. Otherwise, the child may be killed or seriously injured.
- On vehicles with side airbags and curtain shield airbags, do not allow the child to lean his/her head or any part of his/her body against the side window or the area of the seat, front or side pillars or roof side rails from which the side airbags or curtain shield airbags deploy even if the child is seated in the child restraint system. It is dangerous if the side airbag and/or curtain shield airbag inflate, and the impact could cause death or serious injury to the child.

06 SIENNA_U (L/O 0603)

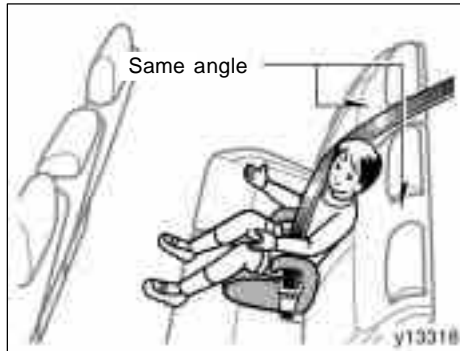

- When installing a child restraint system in the third seat center position, adjust both seatbacks to the same angle. Otherwise, the child restraint system cannot be securely restrained and this may cause death or serious injuries in a collision.



1. Sit the child on a booster seat. Run the lap and shoulder belt through or around the booster seat and across the child following the instructions provided by its manufacturer and insert the tab into the buckle taking care not to twist the belt.

Make sure the shoulder belt is correctly across the child's shoulder and that the lap belt is positioned as low as possible on the child's hips. See "Seat belts" on page 106 in this Section for details.

CAUTION

- Always make sure the shoulder belt is positioned across the center of child's shoulder. The belt should be kept away from child's neck, but not falling off child's shoulder. Otherwise, the child may be killed or seriously injured in case of sudden braking or a collision.
- Both high-positioned lap belts and loose-fitting belts could cause death or serious injuries due to sliding under the lap belt during a collision or other unintended event. Keep the lap belt positioned as low on a child's hips as possible.
- For child's safety, do not place the shoulder belt under child's arm.
- After inserting the tab, make sure the tab and buckle are locked and that the lap and shoulder portions of the belt are not twisted.
- Do not insert coins, clips, etc. in the buckle as this may prevent your child from properly latching the tab and buckle.

06 SIENNA_U (L/O 0603)

- If the seat belt does not function normally, it cannot protect your child from death or serious injury. Contact your Toyota dealer immediately. Do not install the child restraint system on the seat until the seat belt is fixed.



2. To remove the booster seat, press the buckle release button and allow the belt to retract.

—Using a top strap (for second seats)



Follow the procedure below for a child restraint system that requires the use of a top strap.

06 SIENNA_U (L/O 0603)

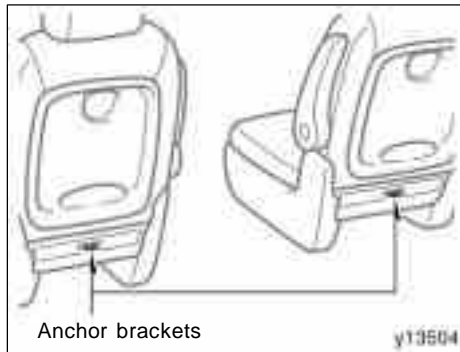

7-passenger models

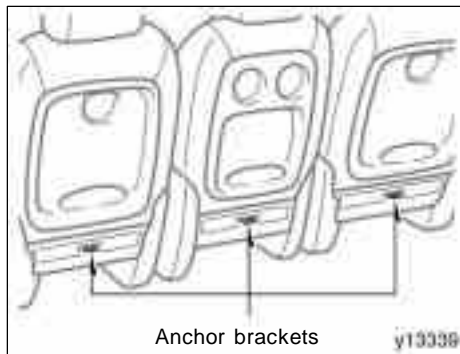

8-passenger models

Use the anchor brackets on the back of the second seats to attach the top strap. Anchor brackets are installed for each second seating position.

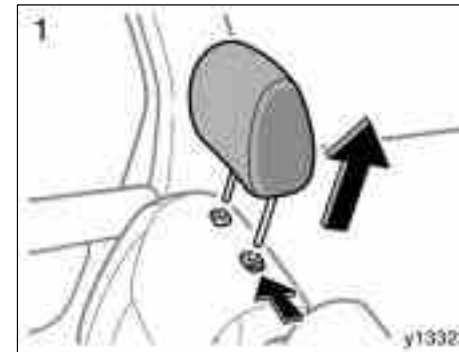

TO USE THE ANCHOR BRACKET:

- 1. Remove the head restraint.**

06 SIENNA_U (L/O 0603)



2. Fix the child restraint system with the seat belt.

Latch the hook onto the anchor bracket and tighten the top strap.

For instructions to install the child restraint system, see "Child restraint" on page 137 in this Section.

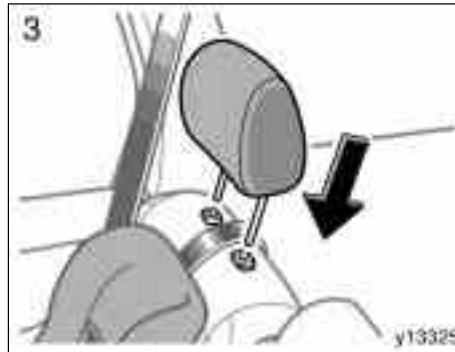

3. Replace the head restraint.

—Using a top strap
(for third seats)



Follow the procedure below for a child restraint system that requires the use of a top strap.

CAUTION

Make sure the top strap is securely latched, and check that the child restraint system is secure by pushing and pulling it in different directions. Follow all the installation instructions provided by its manufacturer.

06 SIENNA_U (L/O 0603)

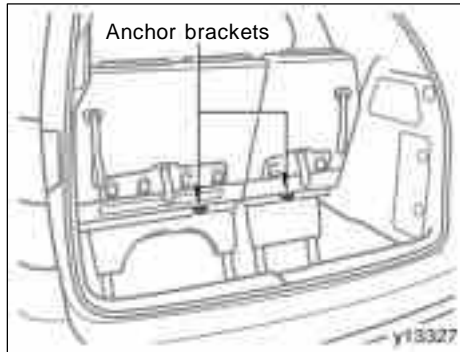

Use the anchor brackets on the back of the third seats to attach the top strap.

Anchor brackets are installed for right and center seating position.

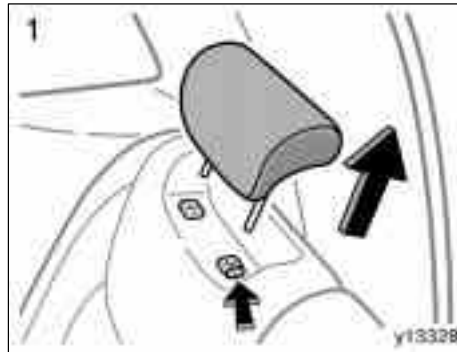

TO USE THE ANCHORAGES:

1. Remove the head restraint.



2. Fix the child restraint system with the seat belt.

Latch the hook onto the anchor bracket and tighten the top strap.

For instructions to install the child restraint system, see "Child restraint" on page 137 in this Section.

06 SIENNA_U (L/O 0603)

—Installation with child restraint lower anchorages (for second seats)

CAUTION

- Do not replace the head restraint when the child restraint system is installed. The head restraint may interfere with the top strap and the child restraint system can not be securely restrained. This may cause death or serious injuries in a collision.
- Make sure the top strap is securely latched, and check that the child restraint system is secure by pushing and pulling it in different directions. Follow all the installation instructions provided by its manufacturer.

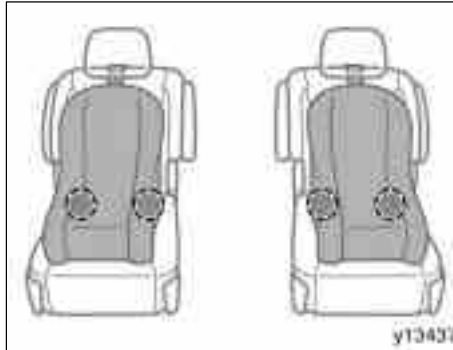

7- passenger models

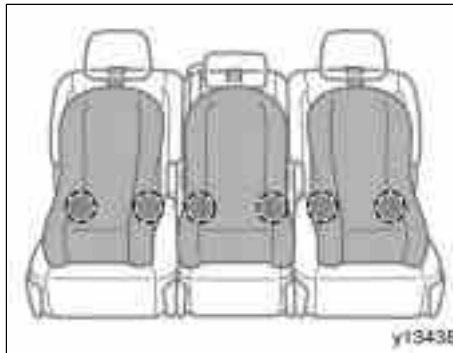

8- passenger models

The lower anchorages for the child restraint systems complying with the FMVSS225 or CMVSS210.2 specifications are installed in the rear seat.

The anchorages are installed in the seat cushion of each second seat.

Child restraint systems complying with the FMVSS213 or CMVSS213 specification can be fixed to these anchorages. In this case, it is not necessary to fix the child restraint system with a seat belt on the vehicle.

06 SIENNA_U (L/O 0603)

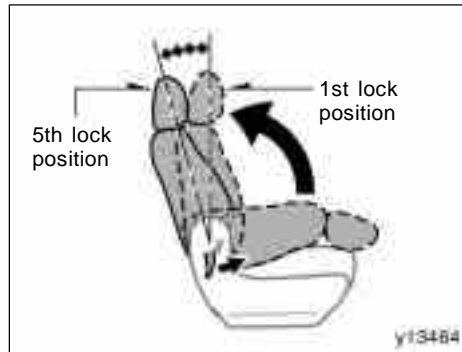

CHILD RESTRAINT SYSTEM INSTALLATION

1. Fold down the seatback. The rear seat legs will disengage. Pushing downward on the back of the seat, make sure the rear seat legs are re-locked into place. Next pull back the seatback to the 1st lock position (the most upright position). Then adjust the seatback to the 5th lock position.

Make sure the seat and seatback are locked securely.



Type A



Type B

2. Turn up the covers for the lower anchorages. Confirm the position of the lower anchorages near the button in the seat cushion.
3. **Type A**—Latch the hooks of lower straps onto the anchorages and tighten the lower straps.
Type B—Latch the buckles onto the anchorages.

For owners in Canada—The symbol on a child restraint system indicates the presence of a lower connector system.

If your child restraint system has a top strap, it should be anchored. (For the installation of the top strap, see “—Using a top strap (for second seats)” on page 151 in this Section.)

For installation details, refer to the instruction manual equipped with each product.

 **CAUTION**

- When using the lower anchorages for the child restraint system, be sure that there are no irregular objects around the anchorages or that the seat belt is not caught.
- Push and pull the child restraint system in different directions to be sure it is secure. Follow all the installation instructions provided by its manufacturer.
- When using the lower anchorages for the child restraint system, ensure that the seat is moved to the rear-most position, with the seat-back close to the child restraint system.
- After securing the child restraint system, never slide or recline the seat.
- Do not install a child restraint system on the second seat if it interferes with the lock mechanism of the front seats. Otherwise, the child or front seat occupant(s) may be killed or seriously injured in case of sudden braking or a collision.

—Installation with child restraint lower anchorages (for third seats)

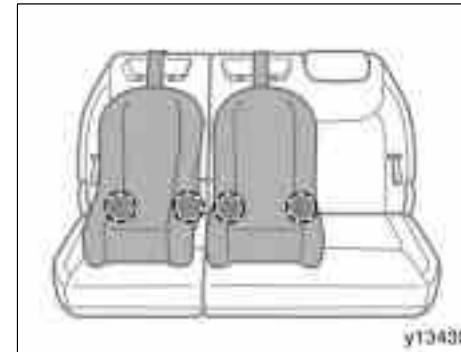

The lower anchorages for the child restraint systems complying with the FMVSS225 or CMVSS210.2 specifications are installed in the rear seat.

The anchorages are installed in the clearance between the seat cushion and seat-back of the right and center seats.

Child restraint systems complying with the FMVSS213 or CMVSS213 specification can be fixed to these anchorages. In this case, it is not necessary to fix the child restraint system with a seat belt on the vehicle.

06 SIENNA_U (L/O 0603)

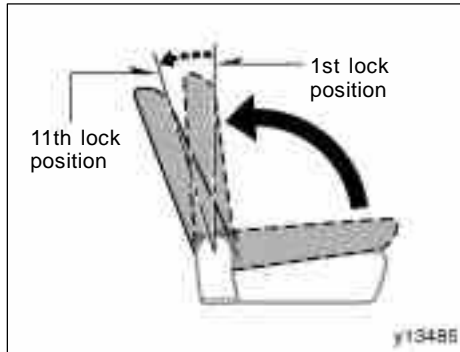

Manual seat

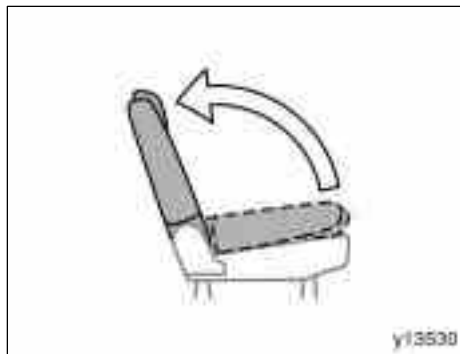

Power seat

CHILD RESTRAINT SYSTEM INSTALLATION

1. **Manual seat**—Fold down the seatback and pull back to the 1st lock position (the most upright position) until it locks into place. Adjust the seatback to the 11th lock position.

Make sure the seatback is locked securely.

Power seat—Fold down the seatback by pressing the folding/returning switch. Raise the seatback by pressing the same switch, the returning switch or the seatback adjusting switch. (The seat back will automatically stop.) For details of these switch operations, see page 95.

Do not touch the switch while the seatback is moving, because the operation will stop.



Type A

06 SIENNA_U (L/O 0603)



Type B

2. Widen the gap between the seat cushion and seatback slightly and confirm the position of the lower anchorages near the button on the seatback.

3. Type A—Latch the hooks of lower straps onto the anchorages and tighten the lower straps.

Type B—Latch the buckles onto the anchorages.

For owners in Canada—The symbol on a child restraint system indicates the presence of a lower connector system.

If your child restraint system has a top strap, it should be anchored. (For the installation of the top strap, see “Using a top strap (for third seats)” on page 153 in this Section.)

For installation details, refer to the instruction manual equipped with each product.

CAUTION

- When using the lower anchorages for the child restraint system, be sure that there are no irregular objects around the anchorages or that the seat belt is not caught.
- Push and pull the child restraint system in different directions to be sure it is secure. Follow all the installation instructions provided by its manufacturer.
- After securing the child restraint system, never recline the seat.
- Do not put a child restraint system on the third seat if it interferes with the lock mechanism of the second seats. Otherwise, the child or front (or second) seat occupant(s) may be killed or seriously injured in case of sudden braking or a collision.

06 SIENNA_U (L/O 0603)

SECTION 1-4

OPERATION OF INSTRUMENTS AND CONTROLS

Steering wheel and Mirrors

Tilt and telescopic steering wheel	162
Outside rear view mirrors	162
Anti- glare inside rear view mirror	165
Auto anti- glare inside rear view mirror	165
Vanity mirrors	166

Tilt and telescopic steering wheel

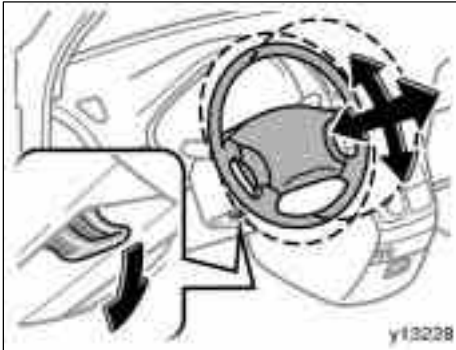

To adjust the steering wheel position, push down the lock release lever. Then tilt the steering wheel to the desired angle, push or pull it to the desired steering column length and pull up the lock release lever.

CAUTION

- Do not adjust the steering wheel while the vehicle is moving. Doing so may cause the driver to mishandle the vehicle and an accident may occur resulting in death or serious injuries.
- After adjusting the steering wheel, try moving it up and down or forward and rearward to make sure it is locked in position.

Outside rear view mirrors—



Adjust the mirror so that you can just see the side of your vehicle in the mirror.

Be careful when judging the size or distance of any object seen in the outside rear view mirror on the passenger's side because it is a convex mirror. Any object seen in a convex mirror will look smaller and farther away than when seen in a flat mirror.

—Power rear view mirror control

Vehicles with the auto anti-glare inside rear view mirror—On some models, when the inside rear view mirror surface darkens in “AUTO” mode, the outside rear view mirror surface also darkens to reduce the reflection of the headlights of the vehicle behind you. (For details, see “Auto anti-glare inside rear view mirror” on page 165 in this Section.)

On some models, when you push the rear window defogger switch, the heater panels in the outside rear view mirrors will quickly clear the mirror surface. (See “Rear window and outside rear view mirror defoggers and windshield wiper de-icer” on page 182 in Section 1-5.)

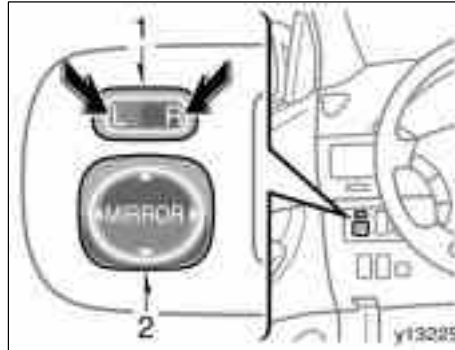

Type A

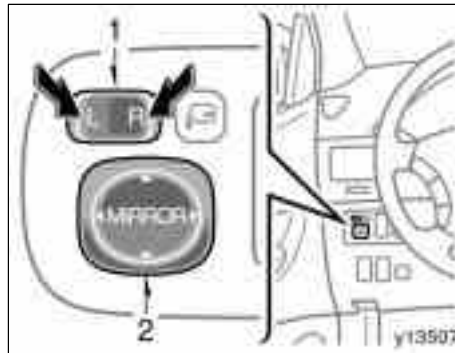

Type B

To adjust a mirror, use the switches.

1. Master switch—To select the mirror to be adjusted
Push the switch to “L” (left) or “R” (right).
2. Control switch—To move the mirror
Push the switch in the desired direction.

Mirrors can be adjusted when the key is in the “ACC” or “ON” position.

Vehicles with the driving position memory system—The position of the outside rear view mirrors and driver’s seat can be memorized. For details, see “Driving position memory system” on page 63 in Section 1-3.

⚠ CAUTION

- Do not adjust the mirror while the vehicle is moving. Doing so may cause the driver to mishandle the vehicle and an accident may occur resulting in death or serious injuries.
- On some models, since the mirror surfaces can get hot, do not touch them when the defogger switch is on.

NOTICE

If ice should jam the mirror, do not operate the control or scrape the mirror face. Use a spray de-icer to free the mirror.

—Folding rear view mirrors

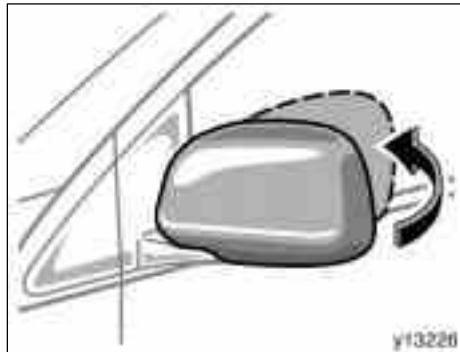

Type A

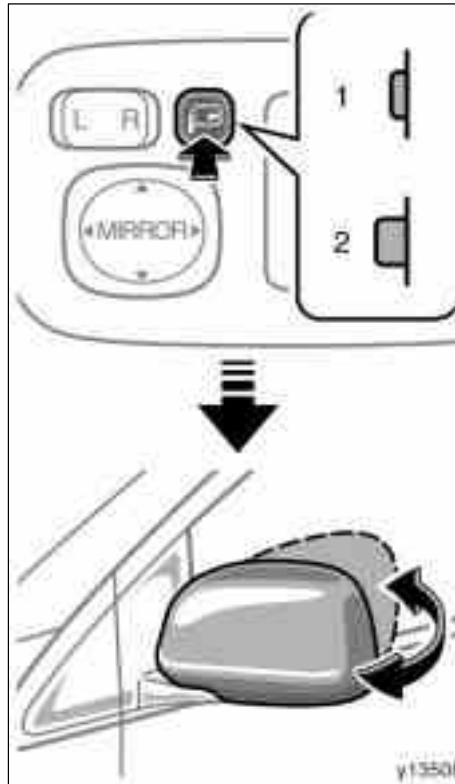

Type B

The rear view mirrors can be folded backward for parking in compact areas.

Type B only—Mirror can be folded when key is in the “ACC” or “ON” position.

Position 1—To fold the mirrors.

Position 2—To return the mirrors back to their original positions.

The rear view mirrors can be also folded by pushing backward.

CAUTION

- To avoid personal injury and any mirror malfunction, do not touch the mirror while it is moving.
- Do not drive with the mirrors folded backward. Both the driver and passenger side rear view mirrors must be extended and properly adjusted before driving.

Anti-glare inside rear view mirror

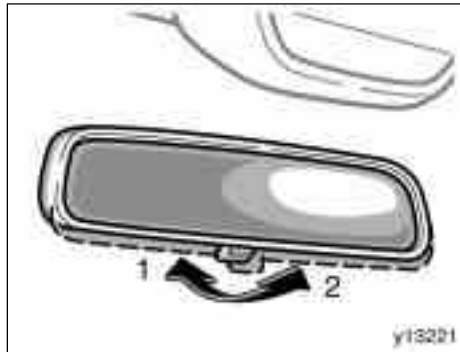

Adjust the mirror so that you can just see the rear of your vehicle in the mirror.

To reduce glare from the headlights of the vehicle behind you during night driving, operate the lever on the lower edge of the mirror.

Daylight driving—Lever at position 1

The reflection in the mirror has greater clarity at this position.

Night driving—Lever at position 2

Remember that by reducing glare you also lose some rear view clarity.

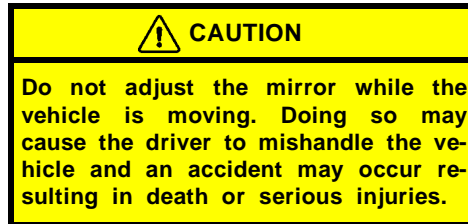

Auto anti-glare inside rear view mirror

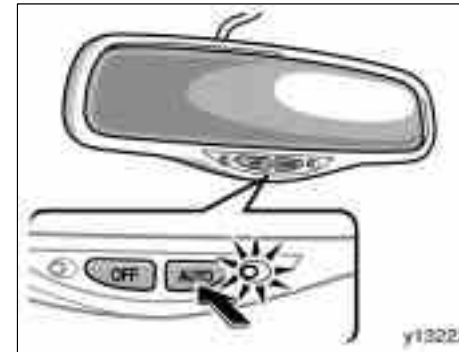

Adjust the mirror so that you can just see the rear of your vehicle in the mirror.

This mirror is equipped with auto anti-glare function. The function is designed to reduce glare from the headlights of the vehicle behind you during night driving.

When the ignition key is inserted and turned on, the inside rear view mirror always turns on in the automatic function mode.

The indicator illuminates to show you that the function is on.

06 SIENNA_U (L/O 0603)

In automatic function mode, if the mirror detects light from the headlights of the vehicle behind you, the mirror surface darkens slightly to reduce the reflected light.

To turn off the automatic function, push the "OFF" switch.

To turn on the automatic function again, push the "AUTO" switch.

Adjust it before driving so that the rear view is in the best condition.

When the inside air temperature is low, it may take a little longer for the mirror to darken in response to the detection of headlights.

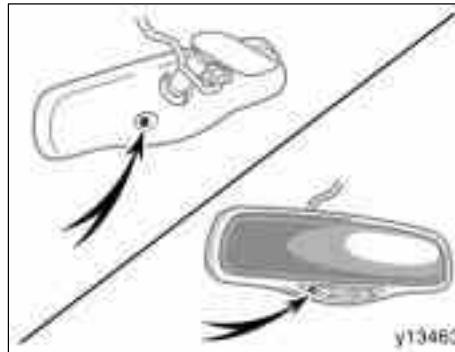

To ensure correct functioning of anti-glare mirror sensors located on both sides of the mirror, do not touch or cover the sensors with your finger or a piece of cloth, etc.

Vanity mirrors

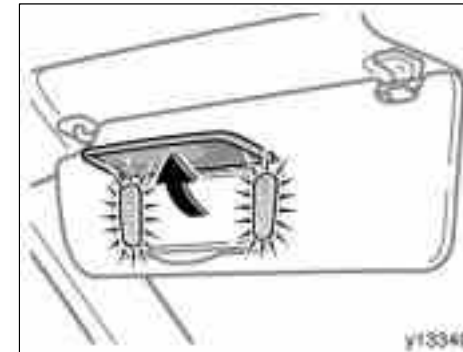

To use the vanity mirrors, swing down the sun visor and open the cover.

On vehicles with the vanity lights, the light will come on when you open the cover.

VANITY LIGHTS CUT OFF OPERATION

When the ignition switch is turned off and vanity light stays lighting on, the light will cut off automatically after 20 minutes.



CAUTION

Do not adjust the mirror while the vehicle is moving. Doing so may cause the driver to mishandle the vehicle and an accident may occur resulting in death or serious injuries.

06 SIENNA_U (L/O 0603)

You can cancel the cut off operation by:

- Turning the key to the "ACC" position.
- Opening or closing any of front and sliding doors.
- Turning off all the "ON" lights.

All the lights are cut off when all the side doors and back door are locked by key or wireless remote control transmitter.

The ignition switch must be turned off.

06 SIENNA_U (L/O 0603)

SECTION 1-5

OPERATION OF INSTRUMENTS AND CONTROLS

Lights, Wipers and Defogger

Headlights and turn signals	170
Headlight beam level control	174
Emergency flashers	175
Instrument panel light control	175
Front fog lights	176
Front personal lights	176
Rear personal lights	177
Luggage compartment light	178
Ignition switch light	179
Exterior foot lights	179
Windshield wipers and washer	180
Rear window wiper and washer	181
Rear window and outside rear view mirror defoggers and windshield wiper de-icer	182

**Headlights and turn signals
(without automatic light
control system)**

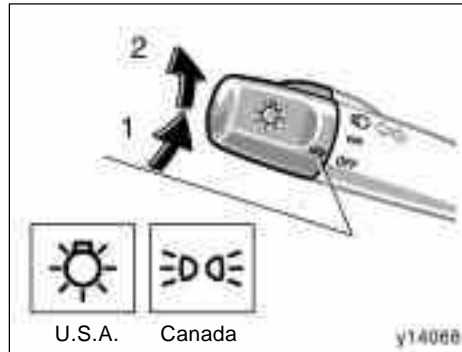

HEADLIGHTS

To turn on the following lights: Twist the headlight/turn signal lever knob.

Position 1—Parking, tail, license plate, side marker and instrument panel lights

On some models—

For Canada—The tail light indicator lights up in the instrument cluster.

Position 2—Headlights and all of the above

On some models—

For the U.S.A.—The headlight indicator lights up in the instrument cluster.

Automatic light cut off system

Position 1—

The lights automatically turn off when the driver's door is opened with the ignition key in the "ACC" or "LOCK" position.

Position 2—

The lights automatically turn off after 30 seconds when all the side doors and back door are closed with the ignition key in the "ACC" or "LOCK" position.

If the lock switch of the wireless remote control transmitter is pushed when all the side doors and back door are already locked, the lights automatically turn off immediately.

The time before the headlights turn off can be changed. For details, contact your Toyota dealer.

To turn them on again, turn the key to the "ON" position or actuate the headlight switch.

If you are going to park for over one week, make sure the headlight switch is off.

NOTICE

To prevent the battery from being discharged, do not leave the lights on for a long period when the engine is not running.

**Daytime Running Light (DRL) system
(all models sold in Canada and some
models sold in U.S.A.)**

The Daytime Running Light (DRL) system can make it easier for others to see the front of your vehicle during the day. The DRL system can be helpful in many different driving conditions, but they can be especially helpful in the short periods after dawn and before sunset.

The DRL system will make the headlights come on when:

- The ignition is on with the engine running.
- The knob is in the "OFF" position or position 1.
- The parking brake is released.

To turn off the DRL system, twist the knob to position 2 or turn the ignition switch off.

06 SIENNA_U (L/O 0603)

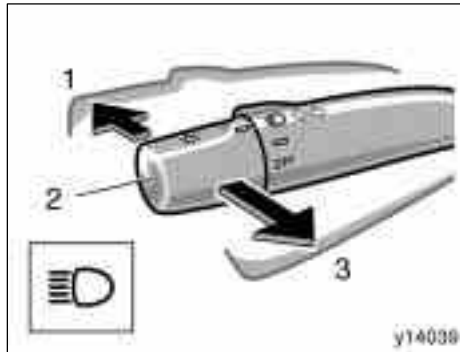

High-Low beams—For high beams, turn the headlights on and push the lever away from you (position 1). Pull the lever toward you (position 2) for low beams.

The headlight high beam indicator light (blue light) on the instrument panel will tell you that the high beams are on.

Flashing the high beam headlights (position 3)—Pull the lever all the way back. The high beam headlights turn off when you release the lever.

You can flash the high beam headlights with the knob turned to “OFF”.

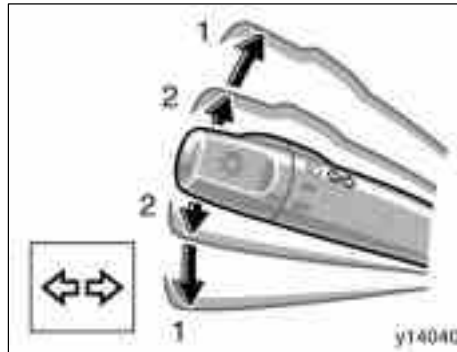

TURN SIGNALS

To signal a turn, push the headlight/turn signal lever up or down to position 1.

The key must be in the “ON” position.

The lever automatically returns after you make a turn, but you may have to return it by hand after you change lanes.

To signal a lane change, move the lever up or down to the pressure point (position 2) and hold it.

If the turn signal indicator lights (green lights) on the instrument panel flash faster than normal, a front or rear turn signal bulb is burned out.

Headlights and turn signals (with automatic light control system)

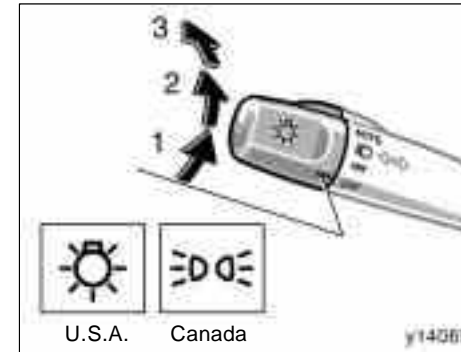

HEADLIGHTS

To turn on the following lights: Twist the headlight/turn signal lever knob.

Position 1—Parking, tail, license plate, side marker and instrument panel lights

On some models—

For Canada—The tail light indicator lights up in the instrument cluster.

Position 2—Headlights and all of the above

On some models—

For the U.S.A.—The headlight indicator lights up in the instrument cluster.

Position 3 (“AUTO”)—Headlights and/or all of the lights in position 1

06 SIENNA_U (L/O 0603)

They automatically turn on or off depending on the darkness of the surroundings. Manually twist the knob to the position 2 to turn on the headlights if they are needed immediately when entering a dark tunnel, parking structure, etc.

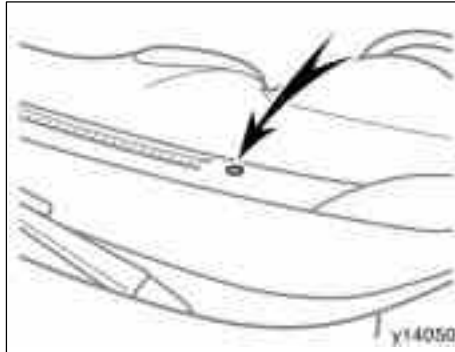

The automatic light control sensor is on the top of the driver's side instrument panel.

Do not place anything on the instrument panel, and/or do not affix anything on the windshield to block this sensor.

If you feel that the automatic light control comes into operation too early or too late, have the sensor adjusted by your Toyota dealer.

Automatic light cut off system

Position 1 or position 3 with the tail lights on—

The lights automatically turn off when the driver's door is opened with the ignition key in the "ACC" or "LOCK" position.

Position 2 or 3 with the headlights on—

The lights automatically turn off after 30 seconds when all the side doors and back door are closed with the ignition key in the "ACC" or "LOCK" position.

If the lock switch of the wireless remote control transmitter is pushed when all the side doors and back door are already locked, the lights automatically turn off immediately.

The time before the headlights turn off can be changed. For details, contact your Toyota dealer.

To turn them on again, turn the key to the "ON" position or actuate the headlight switch.

If you are going to park for over one week, make sure the headlight switch is off.

NOTICE

To prevent the battery from being discharged, do not leave the lights on for a long period when the engine is not running.

06 SIENNA_U (L/O 0603)

Daytime Running Light (DRL) system (all models sold in Canada and some models sold in U.S.A.)

The Daytime Running Light (DRL) system can make it easier for others to see the front of your vehicle during the day. The DRL system can be helpful in many different driving conditions, but they can be especially helpful in the short periods after dawn and before sunset.

The DRL system will make the headlights come on when:

- The ignition is on with the engine running.
- The knob is in the "OFF" position, position 1 or position 3 with the tail lights on.
- The parking brake is released.

To turn off the DRL system, twist the knob to position 2 or position 3 with the headlights on, or turn the ignition switch off.

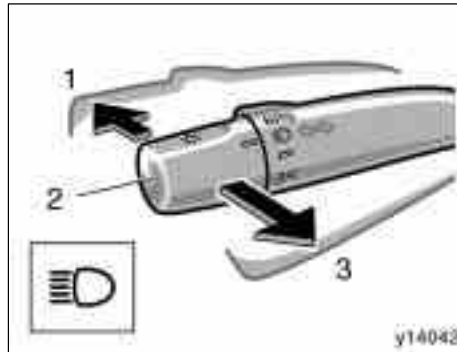

High-Low beams—For high beams, turn the headlights on and push the lever away from you (position 1). Pull the lever toward you (position 2) for low beams.

The headlight high beam indicator light (blue light) on the instrument panel will tell you that the high beams are on.

Flashing the high beam headlights (position 3)—Pull the lever all the way back. The high beam headlights turn off when you release the lever.

You can flash the high beam headlights with the knob turned to "OFF".



TURN SIGNALS

To signal a turn, push the headlight/turn signal lever up or down to position 1.

The key must be in the "ON" position.

The lever automatically returns after you make a turn, but you may have to return it by hand after you change lanes.

To signal a lane change, move the lever up or down to the pressure point (position 2) and hold it.

If the turn signal indicator lights (green lights) on the instrument panel flash faster than normal, a front or rear turn signal bulb is burned out.

06 SIENNA_U (L/O 0603)

Headlight beam level control

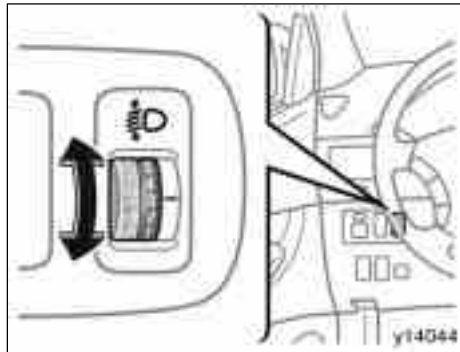

To adjust the headlight beam level, turn the dial.

The following list shows examples of proper dial settings. For loading conditions other than those listed, adjust the dial position so that the beam level is the same as the one obtained according to the list when only the driver is in the vehicle. The higher the number of the dial position, the lower the headlight beam level.

Always keep the headlight beam at the proper level, or your headlights may dazzle other road users.

Loading condition and dial position

Loadings conditions	Variations	7- passenger models	8- passenger models
Driver only, or Driver + one passenger in the front seat		0	0
Driver + one passenger in the front seat and all passengers in the second seat		1	0
All passengers		1	1
All passengers + full luggage loading to the luggage compartment		1	2
Driver + full luggage loading to the luggage compartment		1	2

Emergency flashers

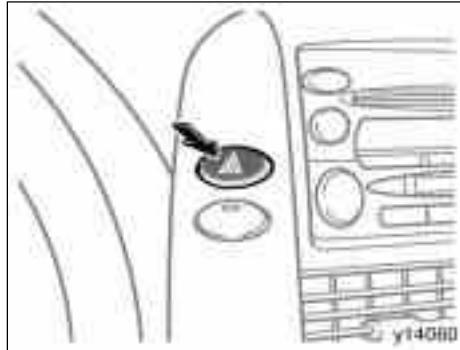

To turn on the emergency flashers, push the switch.

All the turn signal lights will flash. To turn them off, push the switch once again.

Turn on the emergency flashers to warn other drivers if your vehicle must be stopped where it might be a traffic hazard.

Always pull as far off the road as possible.

The turn signal light switch will not work when the emergency flashers are operating.

NOTICE

To prevent the battery from being discharged, do not leave the switch on longer than necessary when the engine is not running.

Instrument panel light control

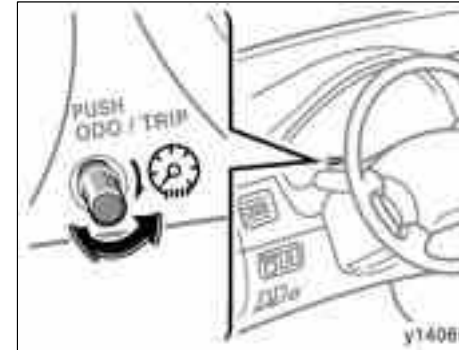

To adjust the brightness of the instrument panel lights, turn the knob.

On some models, with the knob turned fully clockwise, the intensity of the instrument panel lights will not be reduced even when the tail lights/headlights are turned on.

06 SIENNA_U (L/O 0603)

Front fog lights



To turn on the front fog lights, twist the band of the headlight and turn signal switch lever. They will come on only when the headlights are on low beam.

Front personal lights

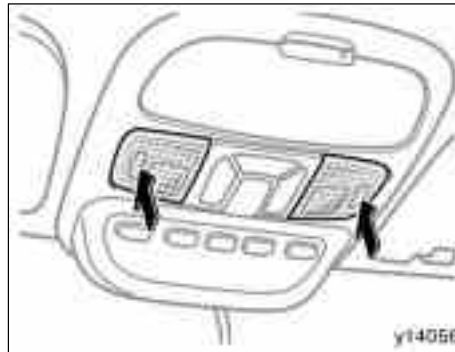

To turn on the front personal lights, operate the personal light main switch. The lights can be turned on or off by pushing each lens when the personal light main switch is in the “DOOR” or “OFF” position.

The personal light main switch has the following positions:

“ON”—Keeps the light on all the time.

“OFF”—The lights can be turned on or off by pushing each lens.

“DOOR”—Turns the light on when any of the side doors or back door is opened.

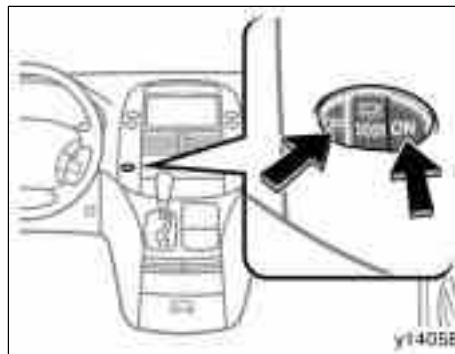

Personal light main switch

06 SIENNA_U (L/O 0603)

ILLUMINATED ENTRY SYSTEM

Door linked operation—When the switch is in the “DOOR” position and any of the side doors or back door is opened, the light will come on. After all the side doors and back door are closed, the light remains on for about 15 seconds before fading out.

Ignition switch linked operation—When the switch is in the “DOOR” position, and the ignition switch is turned to “LOCK”, the light will come on. The light remains on for about 15 seconds before fading out.

When any of the side doors and back door is unlocked using either the key or the wireless remote control transmitter, the light will come on and remain on for about 15 seconds before fading out.

However, in the following cases, the light goes off immediately.

- All the side doors and back door are closed when the ignition key is in the “ACC” or “ON” position.
- All the side doors and back door are closed and locked.

The following adjustments can be made in this system. For details, contact your Toyota dealer.

- Cancelling the door key or the wireless remote control transmitter linked operation
- Cancelling the ignition switch linked operation.
- Changing the duration of lighting

To prevent the battery being discharged, the lights will automatically turn off when the key is removed and the door is left opened with the switch at the “DOOR” position for 20 minutes or more.

Rear personal lights

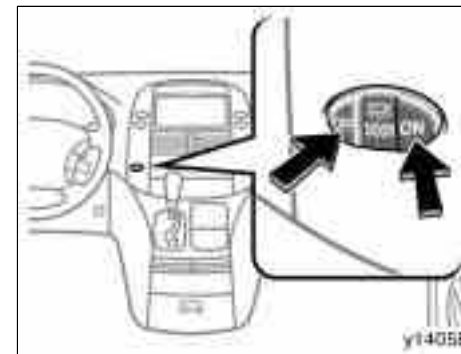
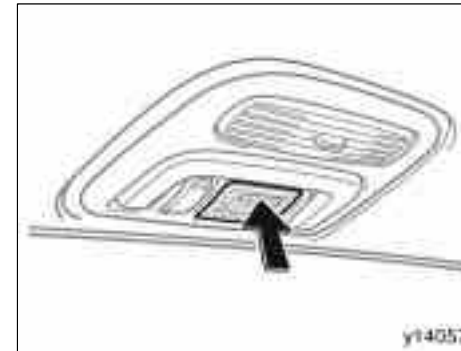

Personal light main switch

06 SIENNA_U (L/O 0603)

To turn on the rear personal lights, operate the personal light main switch. The lights can be turned on or off by pushing each lens when the personal light main switch is in the “DOOR” position.

The personal light main switch has the following positions:

“ON”—Keeps the light on all the time.

“OFF”—Turns the light off.

“DOOR”—Turns the light on when any of the sliding doors or back door is opened.

To prevent the battery being discharged, the lights will automatically turn off when the key is removed and the door is left opened with the switch at the “DOOR” position for 20 minutes or more.

Luggage compartment light



To turn on the luggage compartment light, push the luggage compartment light switch upwards. The light turns on when the personal light main switch is in the “ON” or “DOOR” position.

The personal light main switch has the following positions:

“ON”—The light turns on when the luggage compartment switch is pushed upwards.

“OFF”—Turns the light off.

“DOOR”—Turns the light on when the luggage compartment switch is pushed upwards and any of the sliding door or back door is opened. The light goes off when both the sliding doors and back door are closed.

To prevent the battery being discharged, the lights will automatically turn off when the key is removed and the door is left opened with the switch at the “DOOR” position for 20 minutes or more.

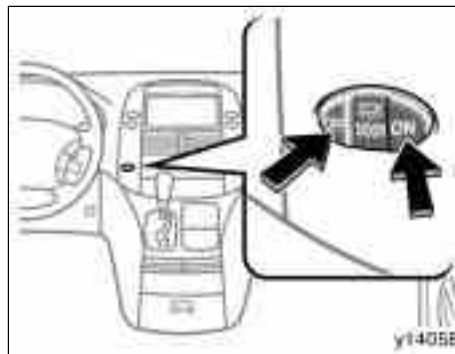

Personal light main switch

06 SIENNA_U (L/O 0603)

Ignition switch light

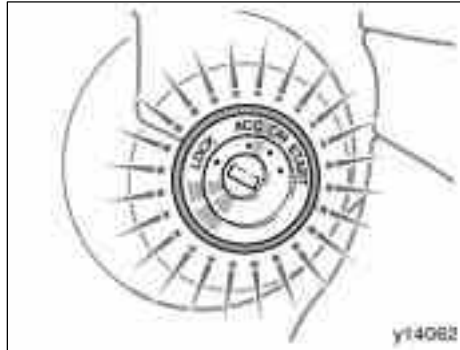

For easy access to the ignition switch, the ignition switch light comes on when any of the side doors and back door is opened or when the ignition switch is turned to the “LOCK” position.

The light remains on for about 15 seconds after all the side doors and back door are closed.

However, in the following cases, the light goes off immediately.

- All the side doors and back door are closed when the ignition key is in the “ACC” or “ON” position.
- All the side doors and back door are closed and locked.

When any of the side doors or back door is unlocked using either the key or the wireless remote control transmitter, the light will come on and remain on for about 15 seconds before fading out.

The following adjustments can be made in this system. For details, contact your Toyota dealer.

- Cancelling the door key or the wireless remote control transmitter linked operation
- Changing the duration of lighting

To prevent the battery being discharged, the light will automatically turn off when the key is removed and the door is left opened for 20 minutes or more.

Exterior foot lights



The light will come on when the side doors and back door are unlocked simultaneously using either the key or the wireless remote control. This light remains on for 15 seconds before fading out when any door is opened, and additional 15 seconds after all the side doors and back door are closed.

However, in the following cases, the light goes off immediately.

- Doors are locked with wireless remote control.
- The selector lever is put in a position other than “P” with the ignition switch on.

- The doors are locked via the driver's door key cylinder.
- The doors are locked via the switches either inside the driver's or front passenger's door.

Windshield wipers and washer

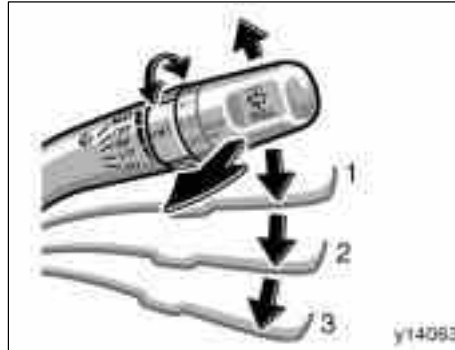

To turn on the windshield wipers, move the lever to the desired setting.

The key must be in the "ON" position.

Lever position	Speed setting
Position 1	Intermittent
Position 2	Slow
Position 3	Fast

For a single sweep of the windshield, push the lever up and release it.

With interval adjuster: The "INT" band lets you adjust the wiping time interval when the wiper lever is in the intermittent position (position 1). Twist the band upward to increase the time between sweeps, and downward to decrease it.

To squirt washer fluid, pull the lever toward you.

If the windshield wipers are off, they will operate a couple of times after the washer squirts.

For instructions on adding washer fluid, see "Adding washer fluid" on page 487 in Section 7-3.

In freezing weather, warm the windshield with the defroster before using the washer. This will help prevent the washer fluid from freezing on your windshield, which can block your vision.

NOTICE
<i>Do not operate the wipers if the windshield is dry. It may scratch the glass.</i>

When waxing your vehicle, make sure that the washer nozzles do not become blocked. If a nozzle becomes blocked, contact your Toyota dealer to have the vehicle serviced.

NOTICE
 If a nozzle becomes blocked, do not try to clear it with a pin or other object. The nozzle will be damaged.

Rear window wiper and washer

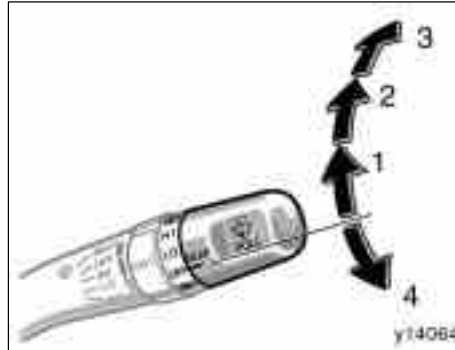

NOTICE

- ◆ Do not operate the rear wiper if the rear window is dry. It may scratch the glass.
- ◆ Do not lift the rear wiper arm away from the window, as it may break.

To turn on the rear window wiper, twist the lever knob upward.

The key must be in the "ON" position.

Lever position	Speed setting
Position 1	Intermittent
Position 2	Normal

To squirt washer fluid on the rear window, twist the knob upward or downward as far as it will go (position 3 or 4). The knob automatically returns from these positions after you release it. The rear window wiper operates while the washer squirts.

For instructions on adding washer fluid, see "Adding washer fluid" on page 487 in Section 7-3.

Rear window and outside rear view mirror defoggers and windshield wiper de-icer



To defog or defrost the rear window, push the switch.

The key must be in the "ON" position.

The thin heater wires on the inside of the rear window will quickly clear the window surfaces. An indicator light will illuminate to indicate the defogger is operating.

On some models, the rear view mirror defoggers and/or the windshield wiper de-icer is also operating simultaneously by this switch. Vehicles with the outside rear view mirror defoggers, the heater panel in the outside rear view mirrors will quickly clear the surfaces. Vehicles with the windshield wiper de-icer, the windshield wiper blades will be de-iced.

Push the switch once again to turn the defoggers off.

The system will automatically shut off after the defoggers have operated about 15 minutes.

CAUTION

Vehicles with outside rear view mirror defoggers, since the mirror surfaces can get hot, do not touch them when the defogger switch is on.

NOTICE

When cleaning the inside of the rear window, be careful not to scratch or damage the heater wires or connectors.

Make sure you turn the defoggers off when the surfaces are clear or the wiper blades have de-iced. Leaving the defoggers on for a long time could cause the battery to discharge, especially during stop-and-go driving. The defoggers are not designed for drying rain water or for melting snow.

If the outside rear view mirrors are heavily coated with ice, use a spray de-icer before operating the switch.

SECTION 1-6

OPERATION OF INSTRUMENTS AND CONTROLS

Gauges, Meters and Service reminder indicators

Fuel gauge	184
Engine coolant temperature gauge	184
Tachometer	185
Odometer and two trip meters	186
Service reminder indicators and warning buzzers	187

06 SIENNA_U (L/O 0603)

Fuel gauge

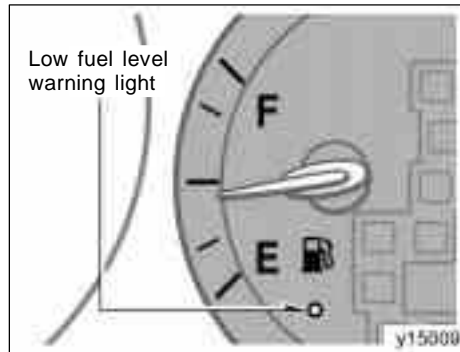

Type A

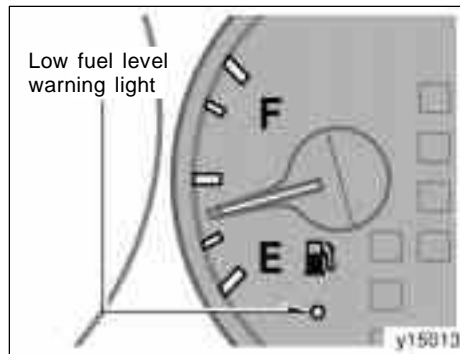

Type B

The gauge indicates the approximate quantity of fuel remaining in the tank when the ignition switch is on.

Nearly full—Needle at “F”
Nearly empty—Needle at “E”

It is a good idea to keep the tank over 1/4 full.

The needle moves when braking, accelerating or making turns. This is caused by the movement of the fuel in the tank.

If the fuel level approaches “E” or the low fuel level warning light comes on, fill the fuel tank as soon as possible.

On inclines or curves, due to the movement of fuel in the tank, the fuel gauge needle may fluctuate or the low fuel level warning light may come on earlier than usual.

If the fuel tank is completely empty, the malfunction indicator lamp comes on. Fill the fuel tank immediately.

The indicator lamp goes off after driving several times. If the indicator lamp does not go off, contact your Toyota dealer as soon as possible.

Engine coolant temperature gauge

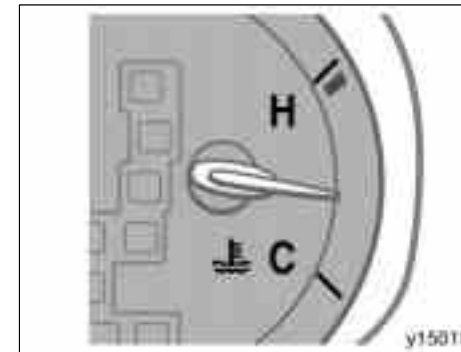

Type A

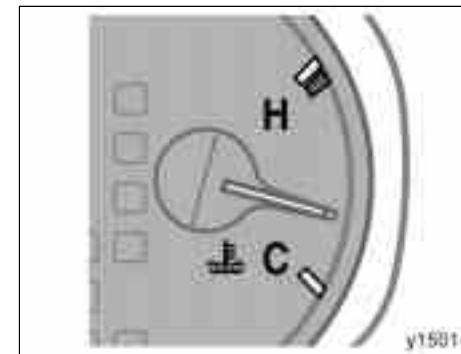

Type B

06 SIENNA_U (L/O 0603)

The gauge indicates the engine coolant temperature when the ignition switch is on. The engine operating temperature will vary with changes in weather and engine load.

If the needle moves into the red zone, your engine is too hot. If your vehicle overheats, stop your vehicle and allow the engine to cool.

Your vehicle may overheat during severe operating conditions, such as:

- Driving up a long hill on a hot day.
- Reducing speed or stopping after high speed driving.
- Idling for a long period with the air conditioning on in stop-and-go traffic.
- Towing a trailer.

NOTICE

- ◆ *Do not remove the thermostat in the engine cooling system as this may cause the engine to overheat. The thermostat is designed to control the flow of coolant to keep the temperature of the engine within the specified operating range.*
- ◆ *Do not continue driving with an overheated engine. See "If your vehicle overheats" on page 420 in Section 4.*

Tachometer

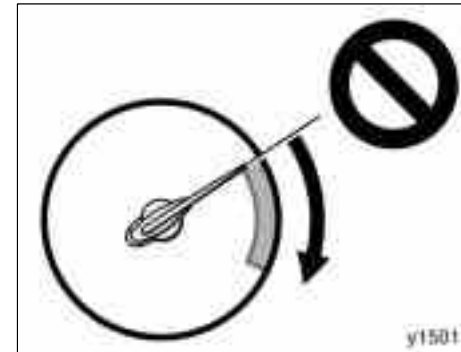

The tachometer indicates engine speed in thousands of rpm (revolutions per minute). Use it while driving to select correct shift points and to prevent engine lugging and over-revving.

Driving with the engine running too fast causes excessive engine wear and poor fuel economy. Remember, in most cases the slower the engine speed, the greater the fuel economy.

NOTICE

Do not let the indicator needle get into the red zone. This may cause severe engine damage.

Odometer and two trip meters

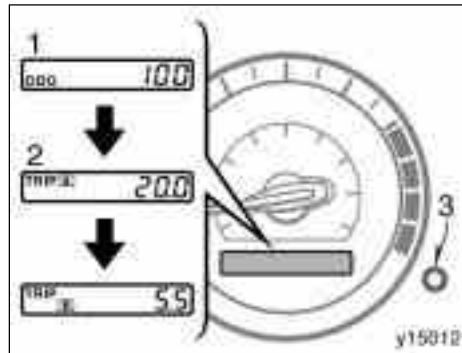

This meter displays the odometer and two trip meters.

1. Odometer—It shows the total distance the vehicle has been driven.
2. Two trip meters—Show two different distances independently driven since the last time each trip meter was set to zero.

You can use one trip meter to calculate the fuel economy and the other to measure the distance on each trip. All trip meter data is cancelled if the electrical power source is disconnected.







3. Trip meter reset knob—Resets the two trip meters to zero, and also change the meter display.

To change the meter display, quickly push and release the knob. The meter display changes in the order from the odometer to trip meter A to trip meter B, then back to the odometer each time you push.





To reset the trip meter A to zero, display the meter A reading, then push and hold the knob until the meter is set to zero. The same process can be applied for resetting the trip meter B.

06 SIENNA_U (L/O 0603)

Service reminder indicators and warning buzzers

If the indicator or buzzer comes on...		Do this.
(a)	BRAKE or 	If parking brake is off, stop immediately and contact Toyota dealer.
(b)	 (indicator and buzzer)	Fasten driver's seat belt.
(c)	PASSENGER 	Fasten front passenger's seat belt.
(d)		Stop immediately and contact Toyota dealer.
(e)	 CHECK or 	Take vehicle to Toyota dealer.
(f)	Low fuel level warning light	Fill up tank.
(g)		Stop and check.

06 SIENNA_U (L/O 0603)

If the indicator or buzzer comes on...		Do this.
(h)	ABS or 	Take vehicle to Toyota dealer. If brake system warning light is also on, stop immediately and contact Toyota dealer.
(i)		Close all doors.
(j)		Take vehicle to Toyota dealer immediately.
(k)	VSC	Take vehicle to Toyota dealer.
(l)		Vehicles without vehicle stability control system—Adjust tire inflation pressure. If warning light remains, contact Toyota dealer. Vehicles with vehicle stability control system—Adjust tire inflation pressure and turn off warning light by pushing reset switch for a few seconds. If warning light remains, contact Toyota dealer.
(m)		Add washer fluid.
(n)	MAINT REQD	Replace engine oil.

06 SIENNA_U (L/O 0603)

If the indicator or buzzer comes on...		Do this.
(o)	3RD SEAT	Check if third seat operation is completed.
	Third seats warning light and buzzer	Check if an object is caught between third seat and seatback and/or between third seat and floor. If nothing is caught, contact Toyota dealer.
(p)	Dynamic laser cruise control master warning light	Check condition according to warning code. If system malfunctions, contact Toyota dealer.
(q)	Key reminder buzzer	Remove key.

(a) Brake System Warning Light

This light comes on in the following cases when the ignition key is in the "ON" position.

● **When the parking brake is applied...**

This light comes on for a few seconds when the ignition key is turned to the "ON" position even after the parking brake is released.

● **When the brake fluid level is low...**

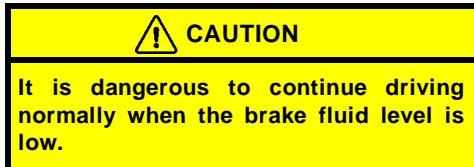

Have your vehicle checked at your Toyota dealer in the following case:

- The light does not come on even if the parking brake is applied when the ignition key is in the "ON" position.
- The light does not come on even if the ignition key is turned on with the parking brake released.

A warning light turning on briefly during operation does not indicate a problem.

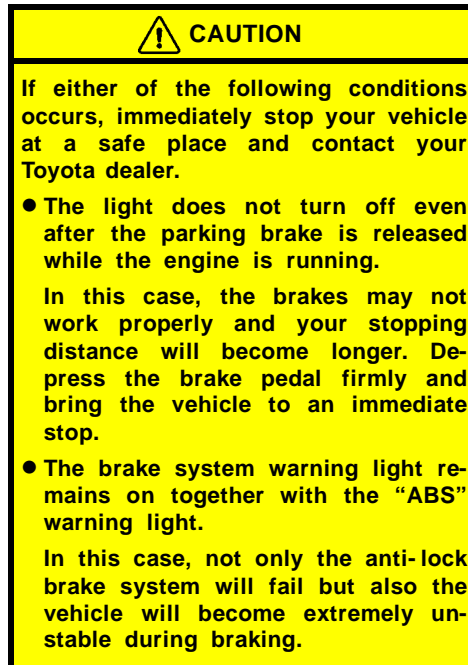

(b) Driver's Seat Belt Reminder Light and Buzzer

The light and buzzer act as a reminder to buckle up the driver's seat belt.

Once the ignition key is turned to "ON", the reminder light flashes and buzzer sounds if the driver's seat belt is not fastened. Unless the driver fastens the belt, the light continues flashing and the buzzer stops after about 4 to 8 seconds.

(c) Front Passenger's Seat Belt Reminder Light

The light acts as a reminder to have the front passenger buckle up the seat belt.

Once the ignition key is turned to "ON", the reminder light flashes if a passenger sits in the front passenger seat and does not fastened. However, if a front passenger uses an additional seat cushion, the light may not flash even when the seat belt is not buckled up.

If luggage or other load is placed on the front passenger seat, depending on its weight and how it is placed on the seat, built-in sensors in the seat cushion may detect the pressure, causing the reminder light to flash.

06 SIENNA_U (L/O 0603)

(d) Charging System Warning Light

This warning light comes on when the ignition switch is turned to the "ON" position, and goes off when the engine is started.

When there are problems in the charging system while the engine is running, the warning light comes on.

NOTICE

When the charging system warning light comes on while the engine is running, malfunctions such as the engine drive belt being broken may have occurred. If the warning light comes on, immediately stop the vehicle in a safe place and contact your Toyota dealer.

(e) Malfunction Indicator Lamp

This lamp comes on when the ignition key is turned to the "ON" position and goes off after the engine starts. This means that the warning light system is operating properly.

If the lamp remains on, or the lamp comes on while driving, first check the followings.

- Empty fuel tank
If the fuel tank is empty, refuel immediately.
- Loose fuel tank cap
If the fuel tank cap is loose, securely tighten it.

These cases are temporary malfunctions. The malfunction indicator lamp will go off after taking several driving trips.

If the lamp does not go off even after several trips, contact your Toyota dealer as soon as possible.

If the fuel tank is not empty or the fuel tank cap is not loose...

- There is a problem somewhere in the engine, emission control system, electronic throttle control system, automatic transmission electrical system or warning light system itself.

Contact your Toyota dealer as soon as possible to service the vehicle.

If engine speed does not increase when the accelerator pedal is depressed, there may be a problem somewhere in the electronic throttle control system.

At this time, vibration may occur. However, if you depress the accelerator pedal more firmly and slowly, you can drive your vehicle at low speeds. Have your vehicle checked by your Toyota dealer as soon as possible.

Even if the abnormality of the electronic throttle control system is corrected during low speed driving, the system may not be recovered until the engine is stopped and the ignition key is turned to "ACC" or "LOCK" position.



Emissions Inspection and Maintenance (I/M) programs

Your vehicle may not pass a state emission inspection if the malfunction indicator lamp remains on. Contact your Toyota dealer to check your vehicle's emission control system and OBD (On-Board Diagnostics) system before taking your vehicle for the inspection.

For details, see "Emissions Inspection and Maintenance (I/M) programs" on page 456 in Section 6.

(f) Low Fuel Level Warning Light

This light comes on when the fuel level in the tank becomes nearly empty. Fill up the tank as soon as possible.

On inclines or curves, due to the movement of fuel in the tank, the low fuel level warning light may come on earlier than usual.

(g) Low Engine Oil Pressure Warning Light

This light warns that the engine oil pressure is too low.

If it flickers or stays on while you are driving, pull off the road to a safe place and stop the engine immediately. Call a Toyota dealer or qualified repair shop for assistance.

The light may occasionally flicker when the engine is idling or it may come on briefly after a hard stop. There is no cause for concern if it then goes out when the engine is accelerated slightly.

The light may come on when the oil level is extremely low. It is not designed to indicate low oil level, and the oil level must be checked using the level dipstick.

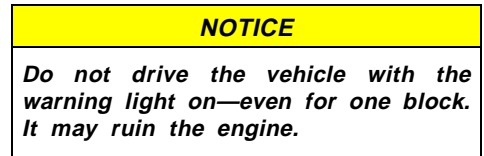

(h) "ABS" Warning Light

Vehicles without the vehicle stability control system—

The light comes on when the ignition key is turned to the "ON" position. If the anti-lock brake system works properly, the light turns off after a few seconds. Thereafter, if the system malfunctions, the light comes on again.

When the "ABS" warning light is on (and the brake system warning light is off), the anti-lock brake system does not operate, but the brake system still operates conventionally.

When the "ABS" warning light is on (and the brake system warning light is off), the anti-lock brake system does not operate but the brake assist system still operates. In this case, the wheels could lock up during a sudden braking or braking on slippery road surfaces.

06 SIENNA_U (L/O 0603)

If either of the following conditions occurs, this indicates a malfunction somewhere in the components monitored by the warning light system. Contact your Toyota dealer as soon as possible to service the vehicle.

- The light does not come on when the ignition key is turned to the "ON" position, or remains on.
- The light comes on while you are driving.

A warning light turning on briefly during operation does not indicate a problem.

CAUTION

If the "ABS" warning light remains on together with the brake system warning light, immediately stop your vehicle at a safe place and contact your Toyota dealer.

In this case, not only the anti-lock brake system will fail but also the vehicle will become extremely unstable during braking.

Vehicles with the vehicle stability control system—

The light comes on when the ignition key is turned to the "ON" position. If the anti-lock brake system and the brake assist system works properly, the light turns off after a few seconds. Thereafter, if the system malfunctions, the light comes on again.

When the "ABS" warning light is on (and the brake system warning light is off), the anti-lock brake system, the brake assist system, the traction control system and the vehicle stability control system do not operate, but the brake system still operates conventionally.

When the "ABS" warning light is on (and the brake system warning light is off), the anti-lock brake system does not operate so that the wheels could lock up during a sudden braking or braking on slippery road surfaces.

If either of the following conditions occurs, this indicates a malfunction somewhere in the components monitored by the warning light system. Contact your Toyota dealer as soon as possible to service the vehicle.

- The light does not come on when the ignition key is turned to the "ON" position, or remains on.
- The light comes on while you are driving.

A warning light turning on briefly during operation does not indicate a problem.

CAUTION

If the "ABS" warning light remains on together with the brake system warning light, immediately stop your vehicle at a safe place and contact your Toyota dealer.

In this case, not only the anti-lock brake system will fail but also the vehicle will become extremely unstable during braking.

06 SIENNA_U (L/O 0603)

(i) Open Door Warning Light

This light remains on until all the doors are completely closed.

(j) SRS Warning Light

This indicator comes on when the ignition key is turned to the “ON” position. It goes off after about 6 seconds. This means the SRS airbags and seat belt pretensioners are operating properly.

The warning light system monitors the airbag sensor assembly, front airbag sensors, side and curtain shield airbag sensor assemblies, curtain shield airbag sensor assemblies, driver's seat position sensor, driver's seat belt buckle switch, front passenger occupant classification system, “AIRBAG ON” indicator light, “AIRBAG OFF” indicator light, front passenger's seat belt buckle switch, seat belt pretensioner assemblies, inflators, interconnecting wiring and power sources.

If any of the following conditions occurs, this indicates a malfunction of the airbags or seat belt pretensioners. Contact your Toyota dealer as soon as possible.

- The light does not come on when the ignition key is turned to the “ON” position or remains on for more than 6 seconds or flashes.
- The light comes on or starts flashing while driving.

If the light stays on, it indicates that the SRS driver and front passenger airbag system and/or front passenger occupant classification system and “AIRBAG ON” and “AIRBAG OFF” indicator lights have a problem. If the light flashes, the SRS side airbag system and/or curtain shield airbag system have a problem.

The SRS warning light and “AIRBAG OFF” indicator light will come on if there is a malfunction in the front passenger occupant classification system.

(k) “VSC” Warning Light

This light warns that there is a problem somewhere in the vehicle stability control system or traction control system.

The light will come on when the ignition key is turned to “ON” and will go off after a few seconds.

If the light comes on while driving, the system does not work. However, as conventional braking operates when applied, there is no problem to continue your driving.

In the following cases, contact your Toyota dealer:

- The warning light does not come on after the ignition key is turned to “ON”.
- The warning light remains on after the ignition key is turned to “ON”.
- The warning light comes on while driving.

Two-wheel drive models only—The “TRAC OFF” indicator light will come on when the “VSC” warning light comes on even if the “TRAC OFF” switch is not pushed.

(l) Low Tire Pressure Warning Light

This light warns that the tire inflation pressure of any one of the tires is critically low. The light comes on when the ignition key is turned to the “ON” position. It goes off after a few seconds. This indicates that the low tire pressure warning system is functioning properly.

06 SIENNA_U (L/O 0603)

Vehicles without vehicle stability control system—If the light comes on while driving, adjust tire inflation pressure to the specified level. (See “Tires” on page 501 in Section 8.) After the tire inflation pressure is adjusted, the light should go off after driving at least 30 km/h (19 mph) for some time. If the light still remains or blinks once every second, have the low tire pressure warning system checked at your Toyota dealer.

Vehicles with vehicle stability control system—If the light comes on while driving, adjust tire inflation pressure to the specified level. (See “Tires” on page 501 in Section 8.) After the tire inflation pressure is adjusted, push the tire pressure warning system reset switch for a few seconds and make sure the warning light goes off. If the light still remains or blinks once every second, have the low tire pressure warning system checked at your Toyota dealer.

If the light blinks twice every second, the low tire pressure warning system needs to be initialized.

For details, see “Tire pressure warning system” on page 208 in Section 1-7.

(m) Low Windshield Washer Fluid Level Warning Light

The light warns that the windshield washer fluid level is too low. Add washer fluid at your earliest opportunity. (For instructions, see “Adding washer fluid” on page 487 in Section 7-3.)

(n) Engine Oil Replacement Reminder Light (for vehicles sold in U.S.A.)

This light acts as a reminder to replace the engine oil.

This light will come on when the ignition key is turned to “ON” and will go off after about a few seconds.

When you drive for about 7200 km (4500 miles) after the engine oil replacement, this light illuminates for about 3 seconds and then flashes for about 12 seconds with the ignition key turned to the “ON” position. If you continue driving without replacing the engine oil, and if the distance driven exceeds 8000 km (5000 miles), the light will come on after the ignition key is turned to “ON” position. The light will remain on thereafter.

If the light is flashing, we recommend that you replace the engine oil at an early opportunity depending on the driving and road conditions. If the light comes on, replace it as soon as possible.

The system must be reset after the engine oil replacement. Reset the system by the following procedure:

1. Turn the ignition key to the “ACC” or “LOCK” position with the odometer reading shown. (For details, see “Odometer and two trip meters” on page 186 in this Section.)
2. Turn the ignition key to the “ON” position while holding down the trip meter reset button.

Hold down the button for at least 5 seconds. The odometer indicates “000000” and the light goes off.

If the system fails to reset, the light will continue flashing.

06 SIENNA_U (L/O 0603)

(o) Third Seats Warning Light and Buzzer

“3RD SEAT” Warning light (instrument cluster)—

This light warns that the third seat operation is not yet complete. Complete the third seat operation. For details, see “—Folding third seats” on page 95 or “—Stowing third seats” on page 99 in Section 1-3.

Third seats warning light and buzzer (switch)—

This light warns that the third seat operation is not yet completed.

When flashing—An object may be caught between the seat and seatback.

When illuminated—An object may be caught between the seat and floor or switch is released during the operation.

Remove the object and then operate again. If nothing is caught when flashing, contact your Toyota dealer.

(p) Dynamic Laser Cruise Control Master Warning Light

This light warns that there is a problem somewhere in the dynamic laser cruise control system.

The light will come on when the ignition key is turned to “ON” and go off after a few seconds.

When the light comes on, the alarm sounds and the warning code will appear on the display. At this time, dynamic laser cruise control is cancelled. For details, see “Dynamic laser cruise control” on page 216 in Section 1-7.

(q) Key Reminder Buzzer

This buzzer acts as a reminder to remove the key when you open the driver’s door with the ignition key in the “ACC” or “LOCK” position.

CHECKING SERVICE REMINDER INDICATORS (except the low fuel level warning light and low windshield washer fluid level warning light)

1. Apply the parking brake.
2. Open one of the doors.
The open door warning light should come on.
3. Close the door.
The open door warning light should go off.
4. Turn the ignition key to “ON”, but do not start the engine.

All the service reminder indicators except the open door warning light should come on. The “ABS” and “VSC” warning lights, low tire pressure warning light, dynamic laser cruise master warning light and engine oil replacement reminder light go off after a few seconds. The SRS warning light goes off after about 6 seconds. (“TRAC OFF”, “READY” (dynamic laser cruise ready mode) indicator lights and slip indicator light also comes on and go off after a few seconds.)

If any service reminder indicator or warning buzzer does not function as described above, have it checked by your Toyota dealer as soon as possible.

SECTION 1-7

OPERATION OF INSTRUMENTS AND CONTROLS

Ignition switch, Transmission and Parking brake

Ignition switch	198
Automatic transmission	199
Traction control system	203
Vehicle stability control system	207
Tire pressure warning system	208
Parking brake	213
Cruise control	213
Dynamic laser cruise control	216

Ignition switch

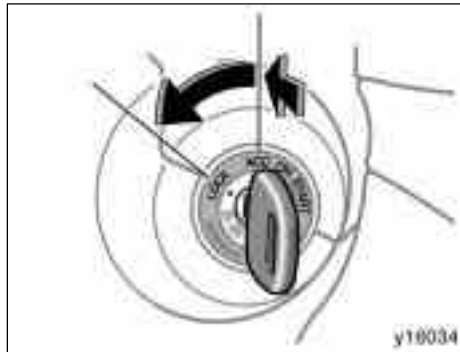

“START”—Starter motor on. The key will return to the “ON” position when released.

For starting tips, see page 403 in Section 3.

“ON”—Engine on and all accessories on.

This is the normal driving position.

“ACC”—Accessories such as the radio operate, but the engine is off.

If you leave the key in the “ACC” or “LOCK” position and open the driver’s door, a buzzer will remind you to remove the key.

“LOCK”—Engine is off and the steering wheel is locked. The key can be removed only at this position.

You must push in the key to turn the key from “ACC” to the “LOCK” position. The selector lever must be put in the “P” position before pushing the key.

Vehicles with engine immobilizer system—Once you remove the key, the engine immobilizer system is automatically set. (See “Engine immobilizer system” on page 13 in Section 1-2.)

When starting the engine, the key may seem stuck at the “LOCK” position. To free it, first be sure the key is pushed all the way in, and then rock the steering wheel slightly while turning the key gently.

It is not a malfunction if the needle on all meters and gauges move slightly when the key is turned to the “ACC”, “ON” or “START” position.

NOTICE

Do not leave the key in the “ON” position if the engine is not running. The battery will discharge and the ignition could be damaged.

06 SIENNA_U (L/O 0603)

Automatic transmission

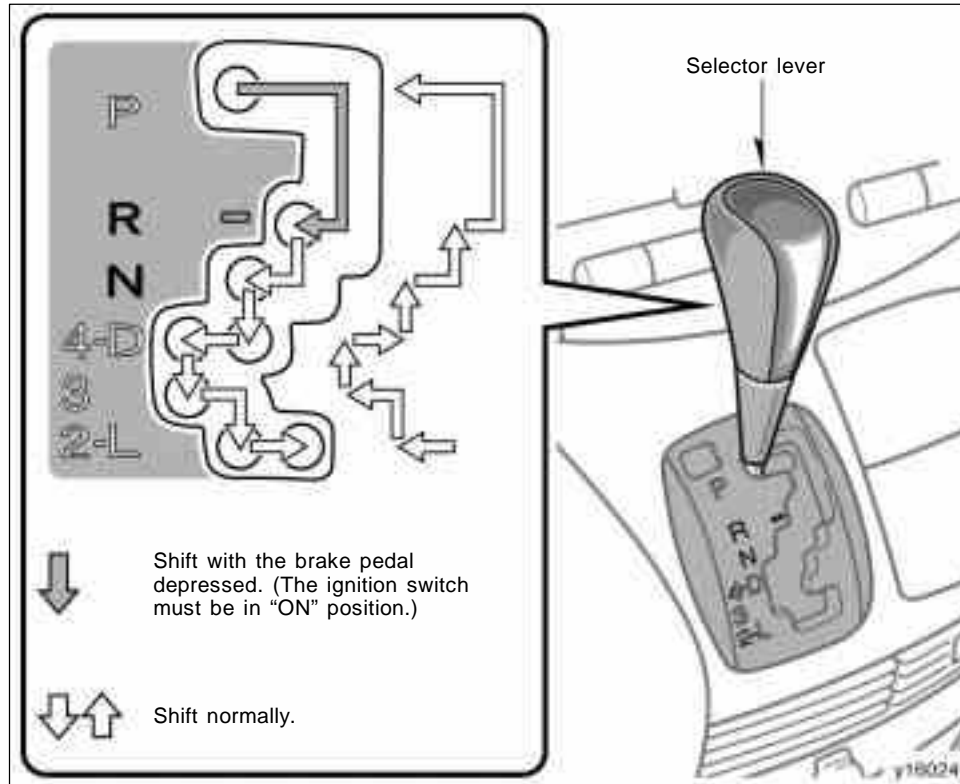

Your automatic transmission has a shift lock system to minimize the possibility of incorrect operation. This means you can only shift out of "P" position when the brake pedal is depressed (with the ignition switch in the "ON" position).

(a) Selector lever

The shift position is also displayed on the instrument cluster.

- P:** Parking, engine starting and key removal
- R:** Reverse
- N:** Neutral
- D:** Normal driving
(shifting into overdrive possible)
- 4:** Engine braking
(shifting into overdrive not possible)
- 3, 2:** Stronger engine braking
- L:** Maximum engine braking

06 SIENNA_U (L/O 0603)

(b) Normal driving

1. Start the engine as instructed in "How to start the engine" on page 404 in Section 3. The transmission must be in "P" or "N".
2. With your foot holding down the brake pedal, shift the selector lever to "D".

When the lever is in the "D" position, the automatic transmission system will select the most suitable gear for running conditions such as normal cruising, hill climbing, hard towing, etc.

Always use the "D" position for better fuel economy and quieter driving. If the engine coolant temperature is low, the transmission will not shift into the overdrive gear even in the "D" position.



3. Release the parking brake and brake pedal. Depress the accelerator pedal slowly for smooth starting.

(c) Using engine braking

To use engine braking, you can downshift the transmission as follows:

- Shift into the "4" position. The transmission will downshift to fourth gear and engine braking will be enabled.
- Shift into the "3" position. The transmission will downshift to third gear when the vehicle speed drops down to or lower than the following speed, and stronger engine braking will be enabled.

Two-wheel drive models	
215/65R16 tires 141 km/h (87 mph)
225/60R17 tires 147 km/h (91 mph)
All-wheel drive models	
 137 km/h (85 mph)

- Shift into the "2" position. The transmission will downshift to second gear when the vehicle speed drops down to or lower than the following speed, and stronger engine braking will be enabled.

Two-wheel drive models	
215/65R16 tires 91 km/h (56 mph)
225/60R17 tires 95 km/h (59 mph)
All-wheel drive models	
 88 km/h (54 mph)

- Shift into the "L" position. The transmission will downshift to first gear when the vehicle speed drops down to or lower than the following speed, and maximum engine braking will be enabled.

Two-wheel drive models	
215/65R16 tires 43 km/h (26 mph)
225/60R17 tires 44 km/h (27 mph)
All-wheel drive models	
 42 km/h (26 mph)

06 SIENNA_U (L/O 0603)

Vehicles with cruise control or dynamic laser cruise control—When the cruise control is being used, even if you downshift from “D” to “4”, engine braking will not be enabled because the cruise control is not cancelled.

For ways to decrease the vehicle speed, see “Cruise control” on page 213 or “Dynamic laser cruise control” on page 216 in this Section.

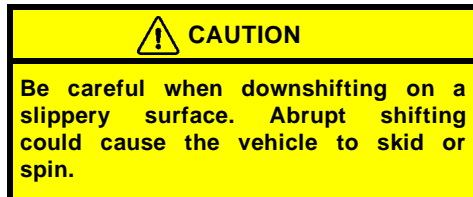

(d) Using “3”, “2” and “L” positions

The “3”, “2” and “L” positions are used for strong engine braking as described previously.

With the selector lever in “3”, “2” or “L”, you can start the vehicle in motion as with the lever in “D”.

With the selector lever in “3” or “2”, the vehicle will start in first gear and automatically shift to third gear or second gear.

With the selector lever in “L”, the transmission is engaged in first gear.

NOTICE	
◆ Be careful not to over-rev the engine. Watch the tachometer to keep engine rpm from going into the red zone. The approximate maximum allowable speed for each position is given below for your reference:	
Two-wheel drive models	
“3”	90 km/h (56 mph)
“2”	58 km/h (36 mph)
“L”	32 km/h (20 mph)
All-wheel drive models	
“3”	87 km/h (54 mph)
“2”	56 km/h (35 mph)
“L”	30 km/h (19 mph)
◆ Do not continue hill climbing or hard towing for a long time in the “3”, “2” or “L” position. This may cause severe automatic transmission damage from overheating. To prevent such damage, “4” position should be used in hill climbing or hard towing.	

(e) Backing up

1. Bring the vehicle to a complete stop.
2. With the brake pedal held down with your foot, shift the selector lever to the "R" position.

NOTICE

Never shift into reverse while the vehicle is moving.

Vehicles with rear view monitor system—
When the selector lever is shifted into "R" position with the ignition switch in the "ON" position, rear view monitor system will activate. For instructions, see "Rear view monitor system" on page 348 in Section 1-10.

(f) Parking

1. Bring the vehicle to a complete stop.
2. With the brake pedal pressed down, fully depress the parking brake pedal to apply the parking brake securely.
3. With the brake pedal pressed down, shift the selector lever to the "P" position.

 **CAUTION**

Never attempt to move the selector lever into "P" position under any circumstances while the vehicle is moving. Serious mechanical damage and loss of vehicle control may result.

(g) Good driving practice

- If the transmission repeatedly shifts up and down between fourth gear and overdrive when climbing a gentle slope, shift the selector lever to the "4" position. Be sure to shift the selector lever to the "D" position immediately afterward.
- When towing a trailer, in order to maintain engine braking efficiency, do not use "D" position.

 **CAUTION**

Always keep your foot on the brake pedal while stopped with the engine running. This prevents the vehicle from creeping.

NOTICE

Always use the brake pedal or the parking brake to hold the vehicle on an upgrade. Do not attempt to hold the vehicle using the accelerator pedal, as this can cause the transmission to overheat.

(h) If you cannot shift the selector lever out of "P" position

If you cannot shift the selector lever from the "P" position even though the brake pedal is depressed, use the shift lock override button. For instructions, see "If you cannot shift automatic transmission selector lever" on page 439 in Section 4.

Traction control system (two-wheel drive models)

The traction control system automatically helps prevent the spinning of front wheels when the vehicle is started or accelerated on slippery road surfaces.

When the ignition key is turned to "ON", the system automatically turns on.

CAUTION

Under certain slippery road conditions, full traction of the vehicle and power against front wheels cannot be maintained, even though the traction control system is in operation. Do not drive the vehicle under any speed or maneuvering conditions which may cause the vehicle to lose traction control. In situations where the road surface is covered with ice or snow, your vehicle should be fitted with snow tires or tire chains. Always drive at an appropriate and cautious speed for the present road conditions.

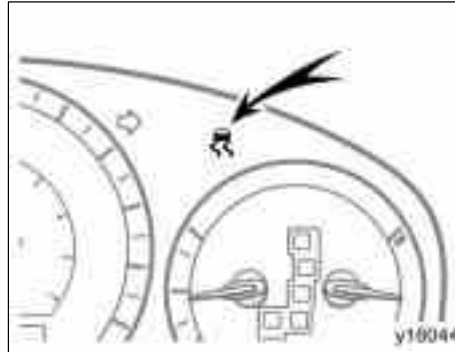

NORMAL DRIVING MODE

Leave the system on during the ordinary driving so that it can operate when needed.

You may hear a sound in the engine compartment for a few seconds just after the vehicle begins to move. This means that the traction control system is in the self-check mode, but does not indicate a malfunction.

When the traction control system is operating, the following conditions occur:

- The system controls the spinning of the front wheels. At this time, the slip indicator light blinks.
- You may feel vibration or noise in your vehicle, caused by operation of the brakes. This indicates the system is functioning properly.

The slip indicator light comes on for a few seconds when the ignition key is turned to "ON". If the indicator light does not come on when the ignition is turned on, contact your Toyota dealer.

06 SIENNA_U (L/O 0603)

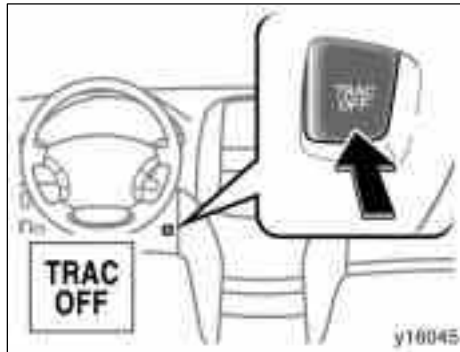

TRACTION CONTROL OFF MODE

If your wheels get stuck in a ditch when you are driving on a severe off road and sand, turn off the traction control system. This system that controls engine performance interferes with the process of freeing your wheels.

To turn off: Push "TRAC OFF" switch.

The "TRAC OFF" indicator light will come on.

The vehicle stability control system is always activated, even if the traction control system is turned off.

To turn on: Push "TRAC OFF" switch once again.

The "TRAC OFF" indicator light will go off.

204

"TRAC OFF" indicator light comes on for a few seconds when the ignition key is turned to "ON". It will come on again when you push the "TRAC OFF" switch to turn off the system.

In the following cases, contact your Toyota dealer:

- The indicator light does not come on when the ignition key is turned "ON".
- The indicator light remains on after the ignition is turned on.
- The indicator light comes on with the normal driving mode while driving.

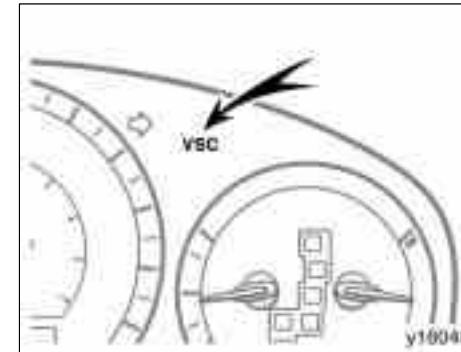

"VSC" warning light

This light warns that there is a problem somewhere in the traction control system or the vehicle stability control system.

The light will come on when the ignition key is turned to "ON" and will go off after a few seconds.

If the light comes on while driving, the system does not work. However, as conventional braking operates when applied, there is no problem to continue your driving.

In the following cases, contact your Toyota dealer:

- The warning light does not come on after the ignition key is turned to "ON".
- The warning light remains on after the ignition key is turned to "ON".
- The warning light comes on while driving.

The "TRAC OFF" indicator light will come on when the "VSC" warning light comes on even if the "TRAC OFF" switch is not pushed.

Traction control system (all-wheel drive models)

The traction control system automatically helps prevent the spinning of 4 wheels when the vehicle is started or accelerated on slippery road surfaces.

When the ignition key is turned to "ON", the system automatically turns on.

CAUTION

Under certain slippery road conditions, full traction of the vehicle and power against 4 wheels cannot be maintained, even though the traction control system is in operation. Do not drive the vehicle under any speed or maneuvering conditions which may cause the vehicle to lose traction control. In situations where the road surface is covered with ice or snow, your vehicle should be fitted with snow tires or tire chains. Always drive at an appropriate and cautious speed for the present road conditions.

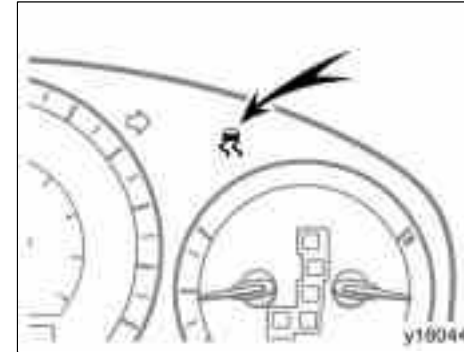

NORMAL DRIVING MODE

Leave the system on during the ordinary driving so that it can operate when needed.

You may hear a sound in the engine compartment for a few seconds just after the vehicle begins to move. This means that the traction control system is in the self-check mode, but does not indicate a malfunction.

06 SIENNA_U (L/O 0603)

When the traction control system is operating, the following conditions occur:

- The system controls the spinning of the 4 wheels. At this time, the slip indicator light blinks.
- You may feel vibration or noise in your vehicle, caused by operation of the brakes. This indicates the system is functioning properly.

The slip indicator light comes on for a few seconds when the ignition key is turned to "ON". If the indicator light does not come on when the ignition is turned on, contact your Toyota dealer.

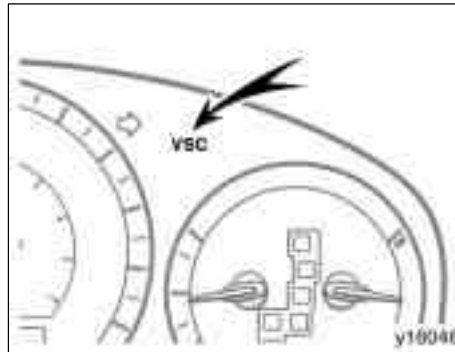

"VSC" warning light

This light warns that there is a problem somewhere in the traction control system or the vehicle stability control system.

The light will come on when the ignition key is turned to "ON" and will go off after a few seconds.

If the light comes on while driving, the system does not work. However, as conventional braking operates when applied, there is no problem to continue your driving.

In the following cases, contact your Toyota dealer:

- The warning light does not come on after the ignition key is turned to "ON".
- The warning light remains on after the ignition key is turned to "ON".
- The warning light comes on while driving.

Vehicle stability control system

The vehicle stability control system helps provide integrated control of the systems such as an anti-lock brake system, brake assist system, traction control, engine control, etc. This system automatically controls the brakes and engine to help prevent the vehicle from skidding when cornering on a slippery road surface or operating steering wheel abruptly.

This system activates when the vehicle speed is about more than 15 km/h (9 mph).

You may hear a sound in the engine compartment for a few seconds just after the vehicle begins to move. This means that the system is in the self-check mode, but does not indicate a malfunction.

 **CAUTION**

- Do not rely excessively on the vehicle stability control system. Even if the vehicle stability control system is operating, you must always drive carefully and attentively to avoid serious injury. Reckless driving will result in an unexpected accident. If the slip indicator light flashes, an alarm sounds, special care should be taken while driving.
- Only use tires of specified size. The size, manufacturer, brand and tread pattern for all 4 tires should be the same. If you use the tires other than specified, or different type or size, the vehicle stability control system may not function correctly. When replacing the tires or wheels, contact your Toyota dealer. (See “Checking and replacing tires” on page 474 in Section 7-2.)

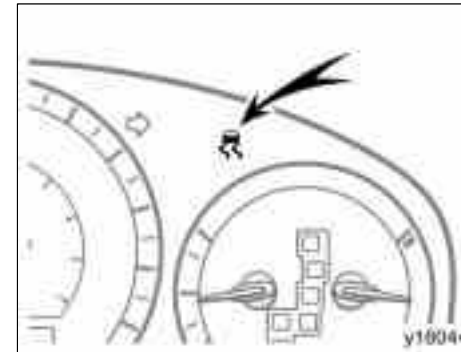

If the vehicle is going to skid during driving, the slip indicator light blinks and an alarm sounds intermittently. Special care should be taken while driving.

The slip indicator light comes on for a few seconds when the ignition key is turned to “ON”. If the indicator light does not come on when the ignition is turned on, contact your Toyota dealer.

06 SIENNA_U (L/O 0603)

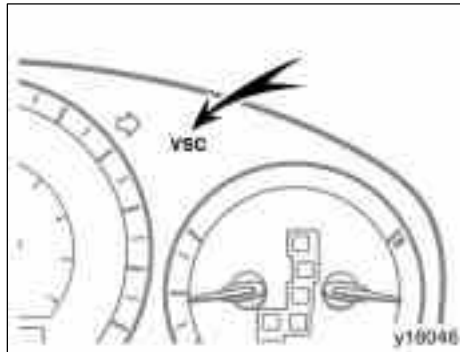

“VSC” warning light

This light warns that there is a problem somewhere in the vehicle stability control system or the traction control system.

The light will come on when the ignition key is turned to “ON” and will go off after a few seconds.

If the light comes on while driving, the system does not work. However, as conventional braking operates when applied, there is no problem to continue your driving.

In the following cases, contact your Toyota dealer:

- The warning light does not come on after the ignition key is turned to “ON”.
- The warning light remains on after the ignition key is turned to “ON”.
- The warning light comes on while driving.

Two-wheel drive models only—The “TRAC OFF” indicator light will come on when the “VSC” warning light comes on even if the “TRAC OFF” switch is not pushed.

Tire pressure warning system

The tire pressure warning system is designed to provide warning when tire inflation pressure of any one of the tires is critically low while the vehicle is moving. The low tire pressure warning light comes on to inform you that such low tire pressure may hamper driving.

This system is not designed to operate when the vehicle is stopped. Therefore, check the tire inflation pressure regularly. The recommended cold tire inflation pressure, tire size and the vehicle capacity weight are on the tire and loading information label. (For instructions, see “Checking tire inflation pressure” on page 471 in Section 7-2.)

Installed tires should be of the specified size. They should be of the same size and construction. If tires other than the specified size are used, or if tires of different sizes or constructions are mixed, the tire pressure warning system will not function properly.

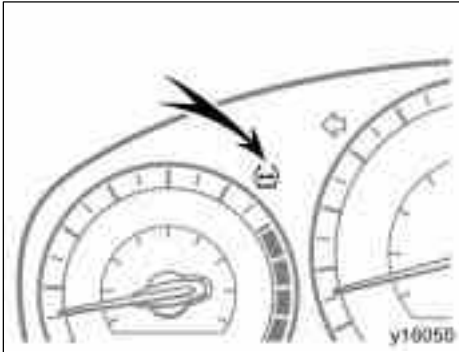

LOW TIRE PRESSURE WARNING LIGHT

This light comes on when the ignition key is turned to the "ON" position. It goes off after a few seconds. This indicates that the tire pressure warning system is functioning properly.

If the low tire pressure warning light comes on or blinks while driving, do the following.

If the warning light comes on:

Vehicles with standard tires—

1. **Adjust the tire inflation pressure to the specified level as soon as possible. (See "Tires" on page 501 in Section 8.)**

2. **Vehicles with vehicle stability control system—Push the tire pressure warning system reset switch for a few seconds and make sure the warning light goes off.**

Vehicles without vehicle stability control system—Once the ignition switch is turned off, the warning light also goes off. If the light comes on again when the vehicle is started after adjusting the tire inflation pressure to the specified level, have the tire pressure warning system checked at your Toyota dealer.

Vehicles with vehicle stability control system—If the light remains on after the reset switch has been pushed, have the tire pressure warning system checked at your Toyota dealer.

If you have a flat tire, replace it with the spare tire. For details, see "If you have a flat tire" on page 421 in Section 4.

Vehicles with run-flat tires—

1. **Decelerate at a speed below 90 km/h (55 mph), then adjust the tire pressure to the specified level as soon as possible. Do not drive more than 160 km (100 miles).**

2. **Vehicles with vehicle stability control system—Push the tire pressure warning system reset switch for a few seconds and make sure the warning light goes off.**

- When the tire inflation pressure is below 140 kPa (1.4 kgf/cm² or bar, 20 psi), consult your Toyota dealer. If the tire is flat or the tire inflation pressure is below 100 kPa (1.0 kgf/cm² or bar, 15 psi), the tire must be replaced. Do not use the repaired tire.

- When the tire inflation pressure is 140 kPa (1.4 kgf/cm² or bar, 20 psi) or more, adjust it to specified level. (See "Tires" on page 501 in Section 8.)

Vehicles without vehicle stability control system—Once the ignition switch is turned off, the warning light also goes off. If the light comes on again when the vehicle is started after adjusting the tire pressure to the specified level, have the tire pressure warning system checked at your Toyota dealer.

Vehicles with vehicle stability control system—If the light remains on after the reset switch has been pushed, have the tire pressure warning system checked at your Toyota dealer.

06 SIENNA_U (L/O 0603)

For details about the run-flat tires, see “Run-flat tires” on page 476 in Section 7-2.

If the warning light blinks once every second:

The low tire pressure warning system may be malfunctioning. Contact your Toyota dealer.

If the warning light blinks twice every second:

The low tire pressure warning system needs to be initialized. Reset the system with the tire pressure warning system reset switch. (To reset the system, see “TIRE PRESSURE WARNING SYSTEM RESET SWITCH”.)

The tire pressure warning system does not function properly under certain circumstances. In the following cases, the low tire pressure warning light may not come on even if the tire inflation pressure is low, or it may come on when the tire inflation pressure is actually normal.

- The tread wear is uneven among the tires.
- A compact spare tire, snow tires, or tire chains are used.

- The tire inflation pressure is excessively higher than specified, or tire inflation pressure suddenly drops due to bursting or other causes.
- The vehicle is driven on a slippery road surface such as rough or frozen roads.
- The vehicle speed is less than 30 km/h (19 mph) or more than 100 km/h (62 mph), and the driving duration is less than 5 minutes.
- The tires differ in tread pattern or manufacturer.
- The tires are not the specified size.
- The tread wear is very different among the installed tires.
- The pressure of two or more tires drops at the same time.
- Rapid acceleration/deceleration or sharp turns is continue.
- Towing a trailer.
- The loading is over the limit or imbalanced.
- Initialization was not performed correctly after replacing or rotating tires or wheels.

- Vehicles with vehicle stability control system—The outside temperature is below 0°C (32°F) or above 40°C (104°F).

CAUTION

When the tire pressure warning light comes on, observe the following instructions:

- **Vehicles with the standard tires—**
Adjust the tire inflation pressure to the specified level as soon as possible.
- **Vehicles with the run-flat tires—**
Decelerate as soon as possible to the lowest appropriate speed that conditions permit. Do not drive for longer than 160 km (100 miles) or over 90 km/h (55 mph).
- **Avoid abrupt steering wheel maneuvering and braking. If the vehicle tires deteriorate, you could lose control of the steering wheel or the brakes, causing death or serious injury.**

06 SIENNA_U (L/O 0603)

Note: The tire pressure warning system on your vehicle will warn you when one of your tires is significantly under-inflated and when some combinations of your tires are significantly under-inflated. However, there are other combinations of significantly under-inflated tires for which your tire pressure warning system may not warn you. These other combinations are relatively common, accounting for approximately half the instances in which vehicles have significantly under-inflated tires. For example, your system may not warn you when both tires on the same side or on the same axle of your vehicle are significantly under-inflated. It is particularly important, therefore, for you to check the tire pressure in all of your tires regularly and maintain proper pressure.



TIRE PRESSURE WARNING SYSTEM RESET SWITCH

The tire pressure warning system need to be initialized in the following conditions:

- When the low tire pressure warning light blinks twice every second
- After replacing or rotating tires or wheels

When initializing the system, the present tire condition is stored as a standard.

To initialize the system, perform the following:

1. Park the vehicle at a safe place and apply the parking brake. Stop the engine.
2. Adjust the pressure of all the installed tires to the specified level. (See "Tires" on page 501 in Section 8.)
3. Turn the ignition key to "ON".

Vehicles with vehicle stability control system only—If the low tire pressure warning light comes on, push the reset switch for a few seconds and make sure the warning light goes off.

4. Push and hold the reset switch until the low tire pressure warning light blinks three times.

Vehicles without vehicle stability control system—Initialization is completed after driving at the speeds of 30 km/h (19 mph) or over for about 8 hours total, when the tire pressure warning system detects the normal tire pressure.

06 SIENNA_U (L/O 0603)

Vehicles with vehicle stability control system—Initialization is completed after driving at the speeds of 30 km/h (19 mph) or over for more than one hour. If the following driving conditions are satisfied, initialization will be completed in about one hour.

- The vehicle speed is between 50 km/h (31 mph) and 100 km/h (62 mph).
- The roads are dry, smooth and straight.
- The number of passengers is 1 or 2 (including driver).

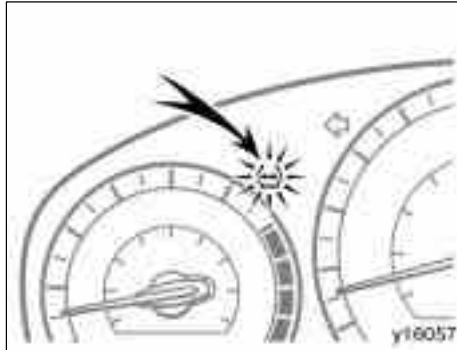

When initializing the system, make sure the low tire pressure warning light blinks three times. If the warning light does not blink three times, initializing will be failed and the tire pressure warning system will not function properly.

Do not push the reset switch without adjusting the tire inflation pressure to the specified level. Otherwise, the low tire pressure warning light may not come on even if the tire inflation pressure is low, or it may come on when the tire inflation pressure is actually normal.

If you push the reset switch while the vehicle is moving, initialization is not performed.

If the low tire pressure warning light does not blink when you push and hold the reset switch, have the low pressure warning system checked at your Toyota dealer.

When the warning light blinks twice every second while driving, you may be unable to reset the system. In this case, set the system again according to the above procedure.

Parking brake

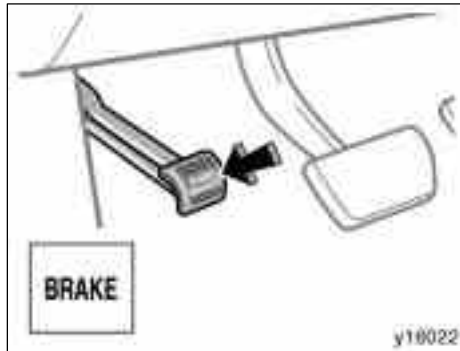

Type A

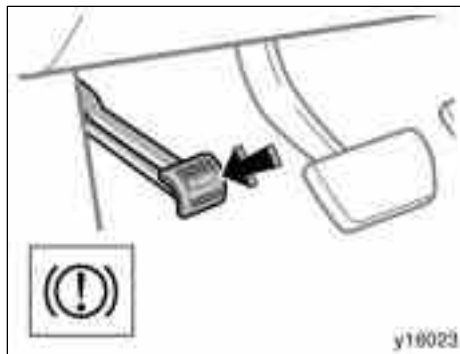

Type B

When parking, firmly apply the parking brake to avoid inadvertent creeping.

To set: Fully depress the parking brake pedal. For better holding power, first depress the brake pedal and hold it while setting the parking brake.

To release: Depress the parking brake pedal once again.

To remind you that the parking brake is set, the parking brake reminder light in the instrument panel remains on until you release the parking brake.

CAUTION

Before driving, be sure the parking brake is fully released and the parking brake reminder light is off.

Cruise control

The cruise control is designed to maintain a set cruising speed without requiring the driver to operate the accelerator. Cruising speed can be set to any speed above 40 km/h (25 mph).

Within the limits of the engine's capabilities, cruising speed can be maintained up or down grades. However, changes in vehicle speed may occur on steeper grades.

CAUTION

- To help maintain maximum control of your vehicle, do not use the cruise control when driving in heavy or varying traffic, or on slippery (rainy, icy or snow-covered) or winding roads.
- Avoid vehicle speed increases when driving downhill. If the vehicle speed is too fast in relation to the cruise control set speed, cancel the cruise control then downshift the transmission to use engine braking to slow down.

06 SIENNA_U (L/O 0603)

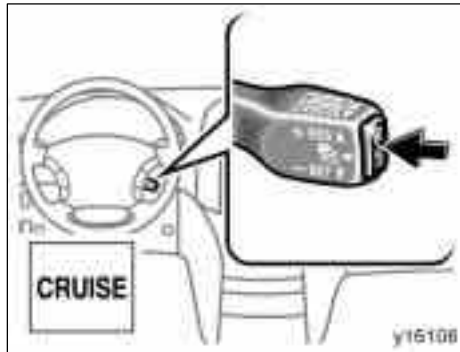

TURNING THE SYSTEM ON AND OFF

To turn the cruise control on, press the "ON-OFF" button. The "CRUISE" indicator light on the instrument panel will come on to indicate that the cruise control is operational. Pressing the "ON-OFF" button again turns the system off.

When the system is turned off, cruising speed must be reset when the cruise control is turned on again.

When the ignition is turned off, the system is also automatically turned off. To use cruise control again, press the "ON-OFF" button again to turn it on.

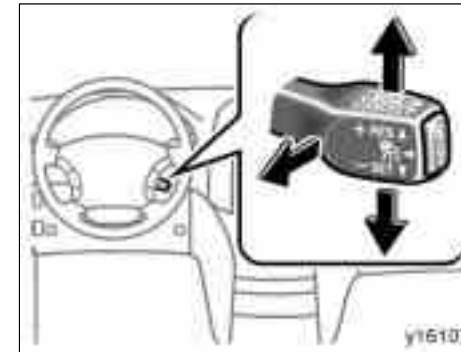
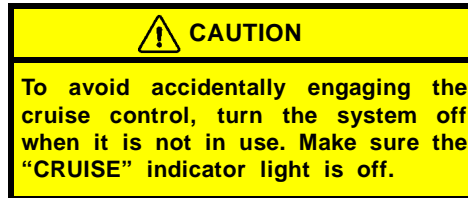

SETTING THE CRUISING SPEED

The transmission must be in "D" or "4" before you set the cruising speed.

Bring your vehicle to the desired speed, push the lever down in the "- SET" direction and release it. This sets the vehicle at that speed. If the speed is not satisfactory, tap the lever up for a faster speed, or tap it down for a slower speed. Each tap changes the set speed by 1.6 km/h (1.0 mph). You can now take your foot off the accelerator pedal.

06 SIENNA_U (L/O 0603)

If you need acceleration—for example, when passing—depress the accelerator pedal enough for the vehicle to exceed the set speed. When you release it, the vehicle will return to the speed set prior to the acceleration.

CANCELLING THE CRUISE CONTROL

The cruise control may be temporarily cancelled by the driver or by the system itself under certain circumstances. Temporary cancellation allows the set cruising speed to remain in memory.

The cruise control can be temporarily cancelled by doing the following:

- Pulling the lever in the “CANCEL” direction and releasing it
- Depressing the brake pedal

Under certain circumstances, the cruise control is temporarily cancelled:

- When vehicle speed falls below 40 km/h (25 mph)
- When vehicle stability control is activated

When vehicle speed drops 16 km/h (10 mph) below the set speed, the cruise control is cancelled and the set speed is erased from memory.

The “CRUISE” indicator light remains on to indicate that the system is still in operation.

To turn the cruise control off, press the “ON-OFF” button. Make sure the “CRUISE” indicator light is off.

If the cruise control automatically cancels out other than for the above cases, have your vehicle checked by your Toyota dealer at the earliest opportunity.

RESUMING THE CRUISE CONTROL

If the cruise control is temporarily cancelled, the cruising speed can be resumed by pushing the lever up in the “+ RES” direction.

Vehicle speed must be above 40 km/h (25 mph).

RESETTING TO A FASTER SPEED

Push the lever up in the “+ RES” direction and hold it. Release the lever when the desired speed is attained. While the lever is held up, the vehicle will gradually gain speed.

However, a faster way to reset is to accelerate the vehicle and then push the lever down in the “- SET” direction.

RESETTING TO A SLOWER SPEED

Push the lever down in the “- SET” direction and hold it. Release the lever when the desired speed is attained. While the lever is held down, the vehicle speed will gradually decrease.

However, a faster way to reset is to depress the brake pedal and then push the lever down in the “- SET” direction.

Even if you downshift from “D” to “4”, with the cruise control on, engine braking will not be enabled because the cruise control is not cancelled. To decrease the vehicle speed, reset to a slower speed with the cruise control lever or depress the brake pedal. If you use the brake pedal, cruise control is cancelled.

CRUISE CONTROL FAILURE WARNING

If the "CRUISE" indicator light flashes when using the cruise control, press the "ON-OFF" button to turn the system off and then press it again to turn it on.

If any of the following conditions then occurs, there is some trouble in the cruise control system.

- The indicator light does not come on.
- The indicator light flashes again.
- The indicator light goes out after it comes on.

If this is the case, contact your Toyota dealer and have your vehicle inspected.

Dynamic laser cruise control—

Dynamic laser cruise control allows you to drive at a selected cruising speed over about 45 km/h (28 mph) with your foot off the accelerator pedal, maintaining an appropriate vehicle-to-vehicle distance.

CAUTION

Do not rely excessively on dynamic laser cruise control in order to avoid serious injury or death, or to prevent accidents or to control the vehicle's speed in emergency situations. Do not use cruise control except in appropriate road and traffic conditions. Always drive carefully and attentively. Before using dynamic laser cruise control, read and understand the following instructions.

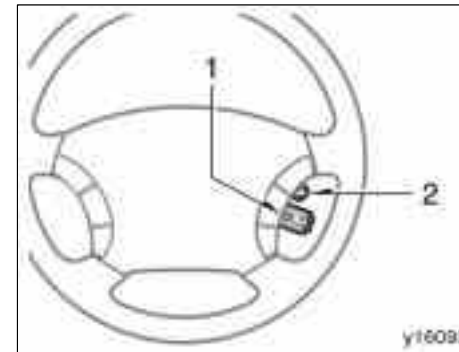

Steering wheel

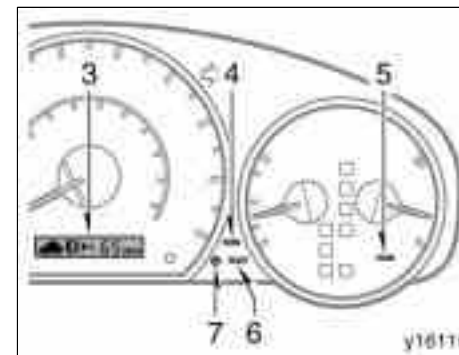

Instrument cluster

—Dynamic laser cruise control modes

1. Cruise control switch
2. Distance switch
3. Display
4. "NORM." indicator light
(conventional cruise control mode indicator light)
5. "CRUISE" indicator light
6. "READY" indicator light
(ready mode indicator light)
7. Master warning light



Vehicle-to-vehicle distance control mode

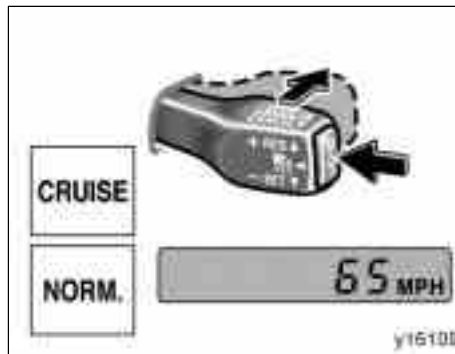

Conventional (fixed speed) cruise control mode

The dynamic laser cruise control function has two cruise control modes.

- Vehicle-to-vehicle distance control mode for maintaining an appropriate distance between vehicles
- Conventional (fixed speed) cruise control mode for cruising at preset speeds

You can change the mode by using the control lever.

The two cruise control modes function differently. If you use dynamic laser cruise control, always confirm which mode is selected.

For the vehicle-to-vehicle distance control mode, see "—Vehicle-to-vehicle distance control mode" on page 218. For the conventional (fixed speed) cruise control mode, see "—Conventional (fixed speed) cruise control mode" on page 228.

—Vehicle-to-vehicle distance control mode

The system's laser radar sensor detects the reflectors of vehicles and measures the vehicle-to-vehicle distance. The detection range of the sensor is about 120 m (400 ft.) ahead.

⚠ CAUTION

Dynamic laser cruise control is not a collision-avoidance system and will not prevent accidents. Dynamic laser cruise control is a vehicle speed control device that is intended for use only on freeways or roads where the traffic is light or moderate. To avoid serious injury, you must use caution and be attentive to road and traffic conditions while using dynamic laser cruise control.

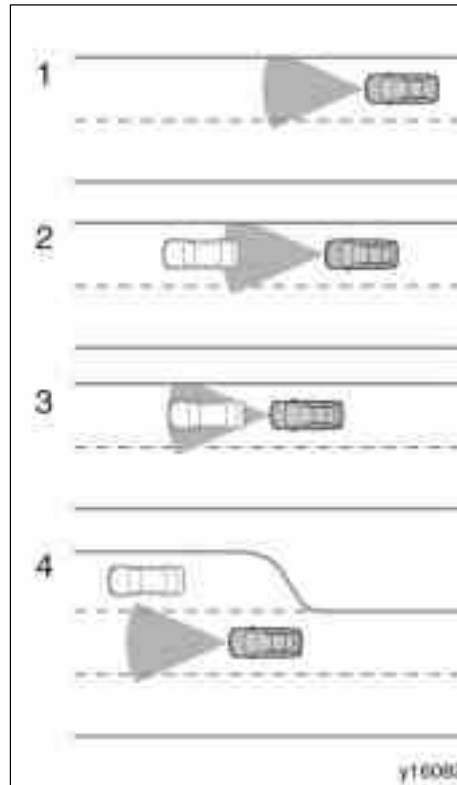

DYNAMIC LASER CRUISE CONTROL OPERATIONS

The dynamic laser cruise control function operates automatically and depending on whether a vehicle is detected ahead may change the speed of your vehicle as follows.

If no vehicle is running ahead of you—

1. **Cruising at a fixed speed:** If there is no vehicle detected ahead, your cruising speed is maintained at the preset speed from about 45 km/h (28 mph) to about 135 km/h (85 mph). The preset speed is displayed in the display. For the vehicle speed setting, see “SETTING THE CRUISING SPEED” on page 222.

If a vehicle is detected ahead of you—

2. **Deceleration cruising function:** If a slower moving vehicle is detected ahead of you, your vehicle cruising speed decreases within the range of about 40 km/h (25 mph) to about 135 km/h (85 mph). The display shows the preset speed, the detected vehicle ahead and selected vehicle-to-vehicle distance. If your vehicle gets closer to the vehicle ahead because of insufficient automatic deceleration, then the alarm warns you to also manually apply brakes.
3. **Follow-up cruising function:** After deceleration, your vehicle cruising speed changes in proportion to the speed of the vehicle ahead to maintain an appropriate distance from your vehicle to the vehicle ahead. The vehicle-to-vehicle distance can be changed. For details, see “CHANGING VEHICLE-TO-VEHICLE DISTANCE” on page 225.
4. **Acceleration cruising function:** If the vehicle ahead changes lanes, your vehicle cruising speed will be gradually increased up to the preset speed, and your vehicle resumes fixed-speed cruising.

This system operates by detecting primarily the reflectors of the vehicle ahead. The distance may not be accurately or absolutely detected in the following cases:

- The vehicle ahead has higher ground clearance, which means that the placement of the reflectors is in a higher position.
- The rear section of the vehicle ahead is extremely dirty.
- The vehicle ahead or other vehicles around you are flinging up water or snow.
- Excessive exhaust gas (black smoke) is coming from the vehicle ahead or other vehicles around you, obscuring your front view.
- There is an obstruction (protective film, sticker, etc.) on the reflectors on the vehicle ahead, or reflectors are not installed on the vehicle ahead or are damaged.
- Heavy luggage in the luggage compartment or rear seats is causing the nose of your vehicle to tilt up.



To avoid accidents, always keep the laser radar sensor glass clean and never allow it to be covered with icicle or any substance, so it can detect the vehicle in front. (See “LASER RADAR SENSOR” on page 226.)

06 SIENNA_U (L/O 0603)

CAUTION

Do not rely excessively on dynamic laser cruise control. Observe the following precautions in order to avoid serious injury or death:

- Under certain conditions where the vehicle in front slows drastically, or is stopped, the dynamic laser cruise control will neither warn you nor decelerate. You must depress the brake pedal to slow down, ensuring collision avoidance or that sufficient vehicle-to-vehicle distance is maintained.

- Do not use dynamic laser cruise control in the following conditions:

In bad weather (such as rain, fog, snow, sandstorms or direct sunlight, or when raindrops or snowflakes get on the laser radar sensor glass), the vehicle-to-vehicle distance will not be measured accurately.

When using the windshield wipers at high or low speeds the dynamic laser radar cruise control turns off.

On roads with heavy traffic or sharp bends, an appropriate speed cannot be maintained and an accident may occur.

On slippery road surfaces (icy or snow-covered road surfaces), the tires will race and you will be unable to control the vehicle.

When there is no vehicle detected ahead on steep downhill slopes, the preset speed will be easily exceeded because of inefficient engine braking. (In this case, automatic braking will not work.) If there is a vehicle detected ahead, the delay in deceleration timing could cause serious injury or death.

When the alarm sounds frequently (because acceleration or deceleration was repeated or sufficient vehicle-to-vehicle distance was not maintained), an appropriate vehicle speed cannot be attained and an accident may occur.

On roads with steep and short inclines and declines, failure to detect the vehicle ahead will shorten the distance between your vehicle and the vehicle ahead and an accident may occur.

- Deceleration cruising function and approach warning do not operate when the vehicle ahead is at a stop or driving very slowly.
- If the vehicle ahead of you decelerates abruptly or if another vehicle cuts in ahead of you, your vehicle may collide with the vehicle ahead unless you manually depress the brake pedal to slow down your vehicle.

06 SIENNA_U (L/O 0603)

- Depending on the road configuration (curved, left and right continuous curved, the start or end of a curve, or narrow driving lanes due to road construction) or your vehicle condition (steering wheel maneuvering, position in the lane, or unstable driving because of an accident or breakdown), vehicles in other lanes or surrounding objects may be detected, resulting in a control failure or the approach warning activation. This may also result in a very close distance between vehicles due to a failure to detect the vehicle ahead.

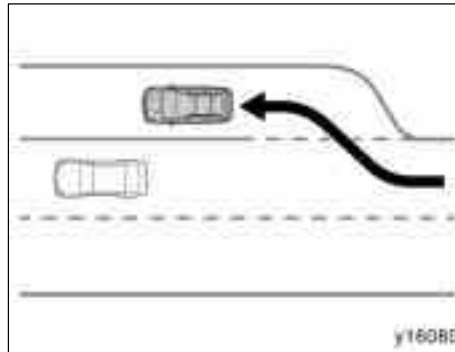

Dynamic laser cruise control should not be used in circumstances which are inappropriate for any cruise control, such as entering free way on-ramps or off-ramps.

CAUTION

- Do not use dynamic laser cruise control when exiting from or when entering or merging onto a freeway. When you are following a slower moving vehicle and exiting, the sensor does not detect the vehicle and will accelerate to the preset speed.

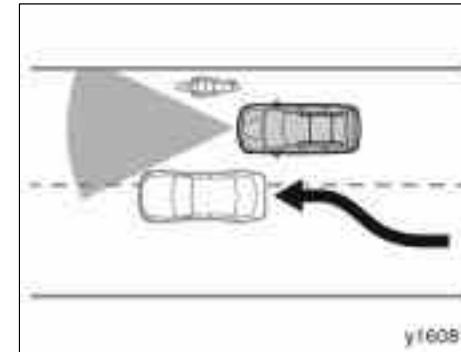

- If other vehicles are driving outside of the laser radar detection range, a delay in the detection of the vehicle cutting in at short range or failure to detect a motorcycle running on the side of the same lane will occur. In this case, the dynamic laser cruise control system will not function properly.
- When a slower vehicle in front of you leaves the lane, the dynamic laser cruise control will no longer detect a vehicle ahead and will attempt to accelerate the vehicle to the faster preset speed.

06 SIENNA_U (L/O 0603)



When the ignition is turned off, all the preset data is cleared. When you use the dynamic laser cruise control again, you need to reset the data.

CAUTION

To avoid accidentally engaging the cruise control, turn the system off when it is not in use. Make sure the "CRUISE" indicator light is off.

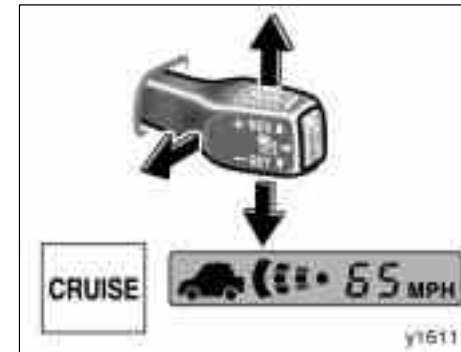

TURNING THE SYSTEM ON AND OFF

To turn the dynamic laser cruise control on, press the "ON-OFF" button. The "CRUISE" and "READY" indicator lights on the instrument panel will come on to indicate that the vehicle-to-vehicle distance control mode is operational. Pressing the "ON-OFF" button again turns the system off.

When the system is turned off, cruising speed and vehicle-to-vehicle distance must be reset when the vehicle-to-vehicle distance control mode is turned on again.

When the ignition is turned off, the system is also automatically turned off. To use dynamic laser cruise control again, press the "ON-OFF" button again to turn it on.

222

SETTING THE CRUISING SPEED

The transmission must be in "D" or "4" before you set the cruising speed.

Bring your vehicle to the desired speed, push the lever down in the "- SET" direction and release it. This sets the vehicle at that speed. At this time, the display indicates settings such as the preset vehicle speed, whether a vehicle is present ahead and selected vehicle-to-vehicle distance. If there is no vehicle detected ahead, the display does not indicate the vehicle ahead. You can now take your foot off the accelerator pedal.

06 SIENNA_U (L/O 0603)

If you need to accelerate—for example, when passing—depress the accelerator pedal enough for the vehicle to exceed the preset speed. When you release the accelerator pedal, the vehicle will return to the control prior to acceleration.

You cannot set a desired speed if the master warning light comes on, the alarm sounds and the display indicates one of the warning codes “E1”, “E2” or “E3”. If any of the above codes appears on the display, see “VEHICLE-TO-VEHICLE DISTANCE CONTROL MODE FAILURE WARNING” on page 227.

CANCELLING THE VEHICLE-TO-VEHICLE CONTROL MODE

The vehicle-to-vehicle distance control mode may be temporarily cancelled by the driver or by the system itself under certain circumstances. Temporary cancellation allows the set cruising speed and vehicle-to-vehicle distance to remain in memory.

The vehicle-to-vehicle distance control mode can be temporarily cancelled by doing the following:

- Pulling the lever in the “CANCEL” direction and releasing it
- Depressing the brake pedal

Under certain circumstances, the vehicle-to-vehicle distance control mode is temporarily cancelled:

- When vehicle speed falls below 40 km/h (25 mph)
- When vehicle stability control is activated

The “READY” indicator light comes on to indicate that the system is still in operation.

To turn the system off, press the “ON-OFF” button. Make sure the “CRUISE” indicator light is off.

If one of the warning codes “E1”, “E2” or “E3” appears on the display, the preset speed automatically cancels out. See “VEHICLE-TO-VEHICLE DISTANCE CONTROL MODE FAILURE WARNING” on page 227.

If the vehicle-to-vehicle distance control mode automatically cancels out other than for the above cases, have your vehicle checked by your Toyota dealer at the earliest opportunity.

RESUMING THE VEHICLE-TO-VEHICLE DISTANCE CONTROL MODE

If the vehicle-to-vehicle distance control mode is temporarily cancelled, the cruising speed and vehicle-to-vehicle distance can be resumed by pushing the lever up in the “+ RES” direction.

Vehicle speed must be above 40 km/h (25 mph).

During follow-up cruising, if there are no vehicles ahead because they have changed lanes, your vehicle will accelerate gradually up to the preset speed. At this time, pushing the lever up in the “+ RES” direction will quickly speed up your vehicle in vehicle-to-vehicle distance control mode.

06 SIENNA_U (L/O 0603)

RESETTING TO A FASTER SPEED

Push the lever up in the "+ RES" direction and hold it. The displayed speed will increase in increments of 5 mph (for the U.S.A.) or 5 km/h (for Canada). Release the lever when the desired speed is attained. The vehicle speed will gradually increase to the display speed.

However, a faster way to reset is to accelerate the vehicle and then push the lever down in the "- SET" direction.

CAUTION

When the vehicle-to-vehicle distance control is on, your cruising speed is regulated in proportion to the speed of the vehicle ahead, so increasing the preset speed using the control lever does not accelerate the vehicle. However, if the vehicle ahead leaves the lane, your cruising speed will increase to the preset speed because the preset speed has been set higher using the control display. Confirm the setting on the display.

RESETTING TO A SLOWER SPEED

Push the lever down in the "- SET" direction and hold it. The displayed speed will decrease in increments of 5 mph (for the U.S.A.) or 5 km/h (for Canada). Release the lever when the desired speed is attained. The vehicle speed will gradually decrease to the display speed.

However, a faster way to reset is to depress the brake pedal and then push the lever down in the "- SET" direction.

If the control lever is released when the vehicle speed exceeds the upper limit of the preset speed traveling downhill while you are pushing the lever down, the system will memorize the upper limit of the preset speed as a preset speed.

Even if you downshift from "D" to "4" in the vehicle-to-vehicle distance control mode, engine braking will not be enabled because this mode is not cancelled. To decrease the vehicle speed, reset to a slower speed with the cruise control lever or depress the brake pedal. If you use the brake pedal, cruise control is cancelled.

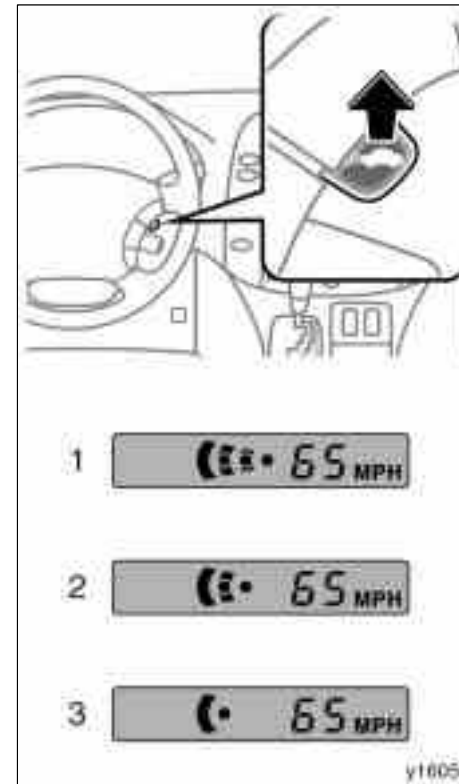

06 SIENNA_U (L/O 0603)

CHANGING VEHICLE-TO-VEHICLE DISTANCE

You can select one of the following vehicle-to-vehicle distances.

1. LONG
2. MIDDLE
3. SHORT

Each time you pull the distance switch briefly toward you, the setting changes from LONG to MIDDLE to SHORT and then back to LONG. You can confirm the setting on the display.

Your vehicle speed changes in proportion to the speed of the vehicle ahead, maintaining the selected distance. However, if the vehicle ahead is slower, the selected distance will be shorter than the designated distance.

When the vehicle-to-vehicle distance control mode is activated or the "READY" indicator comes on, the vehicle-to-vehicle distance setting can be changed.

The vehicle-to-vehicle distance is always set to LONG when the ignition switch is turned on.

Select the vehicle-to-vehicle distance considering traffic conditions. The approximate vehicle-to-vehicle distance based on time interval when driving at 88 km/h (55 mph) is shown below:

LONG about 75 m (245 ft.)
MIDDLE about 50 m (165 ft.)
SHORT about 30 m (100 ft.)

If the vehicle speed is slower than 88 km/h (55 mph), the distance will be shorter than the above.

During long downhill driving, the vehicle-to-vehicle distance will be shorter than the selected distance.



BRAKING CONTROL

Dynamic laser cruise control is not a collision avoidance system. If the approach warning is activated, depress the brake pedal to decelerate to ensure an appropriate vehicle-to-vehicle distance.

If you are getting closer to the vehicle ahead at a relatively higher speed than that of the vehicle ahead or if engine braking cannot be applied properly, braking control is automatically activated. At this time, the display flashes.

Braking control is operating only when the vehicle-to-vehicle distance control mode is selected and your vehicle speed exceeds about 40 km/h (25 mph). If the speed decreases below about 40 km/h (25 mph), braking control will cease, requiring the manual application of brakes.

CAUTION

Braking control will not ensure that your vehicle will reduce speed appropriately. You must depress the brake pedal to slow down, ensuring collision avoidance or that sufficient vehicle-to-vehicle distance is maintained.

APPROACH WARNING

While you are cruising in the vehicle-to-vehicle distance control mode, if the vehicle ahead decelerates abruptly or if another vehicle cuts in ahead of you, inadequate braking will make your vehicle become closer to the vehicle ahead of you and the display will flash and beep.

CAUTION

- If the display flashes and beeps, you must depress the brake pedal to slow down to avoid a collision or maintain sufficient vehicle-to-vehicle distance.
- In the following conditions, the approach warning may not turn on even if the vehicle drives closer to the vehicle ahead, and an accident may occur:
 - Your vehicle and the vehicle ahead are cruising at almost the same speed.
 - The vehicle ahead is cruising at a faster speed than yours. (The distance between the vehicles will become longer.)
 - The vehicle ahead is at a stop or driving very slowly. Pay special attention to a very slow vehicle at the end of the line in heavy traffic or at a tollgate.
 - The speed has just been set.
 - The accelerator pedal is depressed or has just been released.

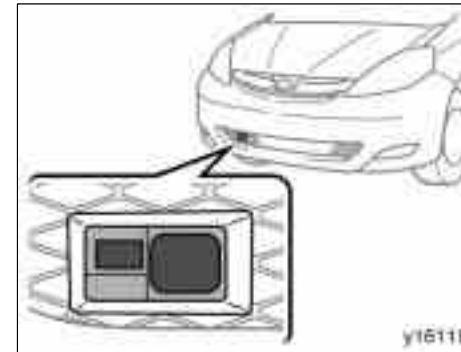

LASER RADAR SENSOR

The laser radar sensor is used for vehicle-to-vehicle distance control cruising.

If dirt is on the sensor glass, the dynamic laser cruise control function is automatically cancelled and a warning code appears on the display. (See “VEHICLE-TO-VEHICLE DISTANCE CONTROL MODE FAILURE WARNING” on page 227.)

However, if the glass sensor is covered with icicle or any substance, dirt may not be detected.

06 SIENNA_U (L/O 0603)

Before driving in the vehicle-to-vehicle distance control mode, make sure the radar sensor glass is clean.

This product is a class I laser product complied with 21 C.F.R part 1040.10 and 1040.11.

CAUTION

To ensure that dynamic laser cruise control will function properly while driving, observe the following:

- Always keep the laser radar sensor glass clean. When cleaning, use a soft cloth and be careful not to damage the sensor.
- Avoid strong impacts around the laser radar sensor. An incorrect laser radar sensor alignment will result in system malfunction. A special device is required to adjust the laser radar sensor alignment. Be sure to have the sensor adjusted by your Toyota dealer.
- Do not affix a sticker (including a transparent sticker) or attach an accessory around the laser radar sensor.

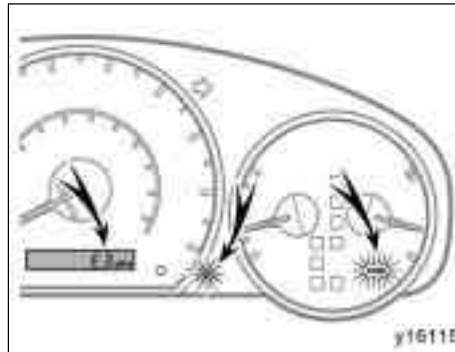

VEHICLE-TO-VEHICLE DISTANCE CONTROL MODE FAILURE WARNING

If there is trouble somewhere in the dynamic laser cruise control while the vehicle-to-vehicle distance control mode is on, the master warning light comes on and the alarm sounds, and one of the warning codes "E1", "E2" or "E3" will appear on the display. Dynamic laser cruise control is automatically cancelled.

If "E3" appears on the display, the "CRUISE" indicator light in the instrument cluster also flashes.

If "E1" appears on the display, the system cannot easily measure the vehicle-to-vehicle distance because of a dirty laser radar sensor glass while the dynamic laser cruise control is on.

If this code appears, clean the sensor glass with a soft cloth and try setting the preset speed again. If the dirt is removed without cleaning, the system will automatically enter the ready mode.

If the system does not enter the ready mode even after cleaning or the code remains on the display, the system might be malfunctioning. Although there is no problem to continue driving, please contact your Toyota dealer.

CAUTION

Always keep the sensor glass and never allow it to be covered with icicle or any substance, so it can detect the vehicle in front.

06 SIENNA_U (L/O 0603)

If “E2” appears on the display, the system cannot easily measure the vehicle-to-vehicle distance because of the following conditions:

- The wipers are operating at high or low speeds
- Direct sunlight from the front
- It is difficult to make a measurement because of bad weather (such as rainy, foggy, or snowy weather)

In the following cases, dynamic laser cruise control switches to the ready mode:

- The wipers are stopped or are switched to intermittent operation.
- No direct sunlight from the front

In the above conditions, push the lever up in the “+ RES” direction and release it. Dynamic laser cruise control will be restored. If the setting operation cannot be performed or if the warning code still appears even after the weather clears, the system might have malfunctioned. Although there is no problem to continue driving, contact your Toyota dealer.

If “E3” appears on the display, a system malfunction has been detected.

If this code appears, stop your vehicle in a safe place, turn the ignition off, and then restart it to reset the system. If the setting still cannot be made or the same code appears again, the system might have malfunctioned. Although there is no problem to continue driving, contact your Toyota dealer.

—Conventional (fixed speed) cruise control mode

The conventional cruise control mode is designed to maintain a set cruising speed without requiring the driver to operate the accelerator. Cruising speed can be set to any speed above 45 km/h (28 mph).

Within the limits of the engine's capabilities, cruising speed can be maintained up or down grades. However, changes in vehicle speed may occur on steeper grades.

CAUTION

- In the conventional cruise control mode, the approach warning does not activate and no alarm will sound even if you are too close to the vehicle ahead, as neither the presence of the vehicle ahead nor the vehicle-to-vehicle distance is detected. Pay special attention to the distance between your vehicle and the vehicle ahead. Always confirm the setting in the display.

06 SIENNA_U (L/O 0603)

- Do not use the conventional mode in the following conditions, or serious injury or death could result:

To help maintain maximum control of your vehicle, do not use conventional cruise control mode when using dynamic laser cruise control while driving in heavy or varying traffic, or on slippery (rainy, icy or snow-covered) or winding roads.

Avoid vehicle speed increasing when driving downhill. If the vehicle speed is too fast in relation to the preset speed in the conventional cruise control mode, cancel the conventional cruise control mode and then downshift the transmission to use engine braking to slow down.

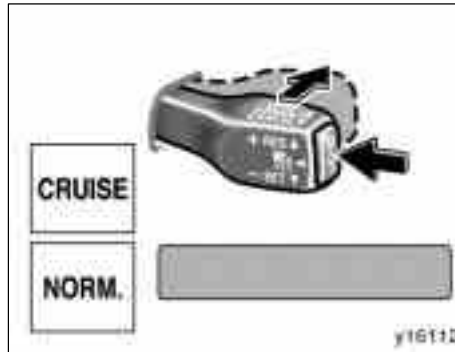

TURNING THE SYSTEM ON AND OFF

To turn the conventional cruise control mode on, press the "ON-OFF" button. The "CRUISE" and "READY" indicator lights on the instrument panel will come on. Push the lever in the "MODE" direction for longer than 1 second to change to conventional cruise control mode. The indicator on the instrument panel is as shown. You can now set the cruising speed. Pressing the "ON-OFF" button again turns the system off.

When the system is turned off, cruising speed must be reset when the conventional cruise control mode is turned on again.

However, once the vehicle-to-vehicle distance control mode activates and is used, it cannot be changed to the conventional cruise control mode using the above operation. To change the mode, press the "ON-OFF" button to turn the system off and then press it again to turn it on. Next push the lever in the "MODE" direction for longer than about 1 second.

To change to the vehicle-to-vehicle distance control mode from the conventional cruise control mode, push the lever in the "MODE" direction for longer than about 1 second.

⚠ CAUTION

To avoid accidentally engaging the cruise control, turn the system off when it is not in use. Make sure the "CRUISE" indicator light is off.

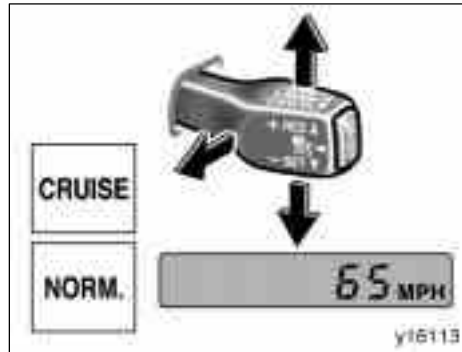

SETTING THE CRUISING SPEED

The transmission must be in "D" or "4" before you set the cruising speed.

Bring your vehicle to the desired speed, push the lever down in the "- SET" direction and release it. This sets the vehicle at that speed and the display shows the preset speed. You can now take your foot off the accelerator pedal.

If you need to accelerate—for example, when passing—depress the accelerator pedal enough for the vehicle to exceed the preset speed. When you release the accelerator pedal, the vehicle will return to the speed set prior to acceleration.

You cannot set a desired speed if the master warning light comes on, the alarm sounds and the display indicates the warning code "E3". If this code appears on the display, see "CONVENTIONAL CRUISE CONTROL MODE FAILURE WARNING" on page 231.

CANCELLING THE CONVENTIONAL CRUISE CONTROL MODE

The conventional cruise control mode may be temporarily cancelled by the driver or by the system itself under certain circumstances. Temporary cancellation allows the set cruising speed to remain in memory.

The conventional cruise control mode can be temporarily cancelled by doing the following:

- Pulling the lever in the "CANCEL" direction and releasing it
- Depressing the brake pedal

Under certain circumstances, the conventional cruise control mode is temporarily cancelled:

- When vehicle speed falls below 40 km/h (25 mph)
- When vehicle stability control is activated

When vehicle speed drops 16 km/h (10 mph) below the set speed, the conventional cruise control mode is cancelled and the set speed is erased from memory.

The "CRUISE" indicator light remains on to indicate that the system is still in operation.

To turn the system off, press the "ON-OFF" button. Make sure the "CRUISE" indicator light is off.

If the conventional cruise control mode automatically cancels out other than for the above cases, have your vehicle checked by your Toyota dealer at the earliest opportunity.

RESUMING THE CONVENTIONAL CRUISE CONTROL MODE

If the conventional cruise control mode is temporarily cancelled, the cruising speed can be resumed by pushing the lever up in the "+ RES" direction.

Vehicle speed must be above 40 km/h (25 mph).

06 SIENNA_U (L/O 0603)

RESETTING TO A FASTER SPEED

Push the lever up in the "+ RES" direction and hold it. Release the lever when the desired speed is attained. While the lever is held up, the vehicle will gradually gain speed.

When the difference between the actual vehicle speed and the set speed is less than 5 km/h (3 mph), the set speed can be increased 1.6 km/h (1 mph) each time by pushing the lever up in the "+ RES" direction quickly within 0.6 seconds.

However, a faster way to reset is to accelerate the vehicle and then push the lever down in the "- SET" direction.

RESETTING TO A SLOWER SPEED

Push the lever down in the "- SET" direction and hold it. Release the lever when the desired speed is attained. While the lever is held down, the vehicle speed will gradually decrease.

When the difference between the actual vehicle speed and the set speed is less than 5 km/h (3 mph), the set speed can be lowered 1.6 km/h (1 mph) each time by pushing the lever down in the "- SET" direction quickly within 0.6 seconds.

However, a faster way to reset is to accelerate the vehicle and then push the lever down in the "- SET" direction.

Even if you downshift from "D" to "4" in the conventional cruise control mode, engine braking will not be enabled because this mode is not cancelled. To decrease the vehicle's speed, reset to a slower speed with the cruise control lever or depress the brake pedal. If you use the brake pedal, cruise control is cancelled.

CONVENTIONAL CRUISE CONTROL MODE FAILURE WARNING

If there is trouble in the conventional cruise control mode, the "CRUISE" indicator light in the instrument cluster flashes, the master warning light comes on and the alarm sounds, the warning code "E3" will appear on the display.

If a system malfunction is detected when the conventional cruise control mode is in the ready mode or operating, the master warning light comes on, an alarm sounds and the above code appears.

If this code appears, press the "ON-OFF" button to turn the system off and then push it again to turn it on. If the setting still cannot be made or the same code appears again, the system might have malfunctioned. Although there is no problem to continue driving, please contact your Toyota dealer.

06 SIENNA_U (L/O 0603)

SECTION 1-8

OPERATION OF INSTRUMENTS AND CONTROLS

Audio system

Reference	234
Using your audio system	234
AUX adapter	252
Audio remote controls	253
Rear seat entertainment system	255
Audio/video system operating hints	297

For vehicle equipped with Navigation system, please refer to the separate "Navigation System Owner's Manual".

06 SIENNA_U (L/O 0603)

Reference



Type 1: AM-FM radio/compact disc player (with compact disc changer controller)



Type 2-1: AM-FM radio/compact disc player with changer



Type 2-2: AM-FM radio/compact disc player with changer

Using your audio system— —Some basics

This section describes some of the basic features on Toyota audio systems. Some information may not pertain to your system.

Your audio system works when the ignition key is in the “ACC” or “ON” position.

TURNING THE SYSTEM ON AND OFF

Push “PWR·VOL” to turn the audio system on and off.

Push “AM”, “FM1”, “FM2”, “DISC·AUX” or “LOAD” to turn on that function without pushing “PWR·VOL”.

You can turn on each player by inserting a compact disc.

You can turn off each player by ejecting the compact disc. If the audio system was previously off, then the entire audio system will be turned off when you eject the compact disc. If another function was previously playing, it will come on again.

SWITCHING BETWEEN FUNCTIONS

Push “AM”, “FM1”, “FM2”, “DISC·AUX” “LOAD” if the system is already on but you want to switch from one function to another.

06 SIENNA_U (L/O 0603)

TONE AND BALANCE

For details about your system's tone and balance controls, see the description of your own system.

Type 1 and type 2-1 audio systems utilize FOCUS® and TruBass® audio enhancement technologies, under license from SRS Labs, Inc., in all mode except AM radio mode.

Tone

How good an audio program sounds to you is largely determined by the mix of the treble, midrange (type 2-2) and bass levels. In fact, different kinds of music and vocal programs usually sound better with different mixes of treble, midrange and bass.

Balance

A good balance of the left and right stereo channels and of the front and rear sound levels is also important.

Keep in mind that if you are listening to a stereo recording or broadcast, changing the right/left balance will increase the volume of one group of sounds while decreasing the volume of another.

YOUR RADIO ANTENNA

Your vehicle has the mast type antenna or on-glass antenna printed on the inside of the rear quarter window.

Mast type antenna—To remove an antenna, carefully turn it counterclockwise.

NOTICE

- ◆ **Mast type antenna:**
To prevent damage to the antenna, make sure it is removed before driving your Toyota through an automatic car wash.
- ◆ **On-glass antenna:**
Putting a film (especially a conductive or metallic film) on the rear window will noticeably reduce the sensitivity of the radio.

YOUR COMPACT DISC PLAYER (type 1)

When you insert a disc, gently push it in with the label side up. The player will play from track 1 through to the end of the disc. Then it will play from track 1 again.

NOTICE

Never try to disassemble or oil any part of the compact disc player. Do not insert anything other than compact discs into the slot.

The player is intended for use with 12 cm (4.7 in.) discs only.

YOUR COMPACT DISC PLAYER WITH CHANGER (type 2-1 and 2-2)

When you insert a disc, push the "LOAD" button and gently push the disc in with the label side up. This compact disc player can store up to six discs. The player will play from track 1 through to the end of the disc. Then it will play from track 1 of the next disc.

NOTICE

Never try to disassemble or oil any part of the compact disc player. Do not insert anything other than compact discs into the slot.

The player is intended for use with 12 cm (4.7 in.) discs only.



NOTICE

- ◆ *Do not stack up two discs for insertion, or it will cause damage to the compact disc changer. Insert only one compact disc into slot at a time.*
- ◆ *Never try to disassemble or oil any part of the compact disc player. Do not insert anything except a compact disc into the slot.*

06 SIENNA_U (L/O 0603)

—Controls and features

►Type 1



Details of specific buttons, controls and features are described in the alphabetical list that follows.

06 SIENNA_U (L/O 0603)

1 2 3 4 5 6 (Preset buttons)

These buttons are used to preset and tune in radio stations.

To preset a station to a button: Tune in the desired station. (See "TUNE-FILE" or "SEEK/TRACK".) Push and hold down the button until you hear a beep—this will set the station to the button. The button number will appear on the display.



To recall a preset station: Push the button for the station you want. The button number and station frequency will appear on the display.

These systems can store one AM and two FM stations for each button. (The display will show "AM", "FM1" or "FM2" when you push "AM" or "FM1" or "FM2" button.)

(Eject button)

Push the compact disc eject button to eject a compact disc.

(Reverse/Fast-forward button)

Push and hold "" (preset button 6) or "" (preset button 5) to fast forward or reverse within a compact disc. When you release the button, the compact disc player will resume playing.

AM

Push the "AM" button to turn on the radio and select the AM band. "AM" will appear on the display.

AUDIO CONTROL (Tone and sound balance adjustment function)

Each time you push the "AUDIO CONTROL" knob, the mode changes. To adjust the tone and balance, turn the knob.

BAS: Adjusts low-pitched tones. The display ranges from -5 to 5.

TRE: Adjusts high-pitched tones. The display ranges from -5 to 5.

FAD: Adjusts the sound balance between the front and rear speakers. The display ranges from F7 to R7.

BAL: Adjusts the sound balance between the right and left speakers. The display ranges from L7 to R7.

ASL: The Automatic Sound Levelizer can be turned on by turning the knob. In addition, turning the knob allows you to select from LOW, MID, and HIGH volume and tone settings. The ASL system automatically adjusts volume and tone in accordance with ambient noise levels. This helps ensure an optimal listening experience even when road, wind or other ambient noise levels rise.

RSE: Vehicles with a rear seat entertainment system—The system can be locked. For details, see page 267 in this Section.

06 SIENNA_U (L/O 0603)

DISC-AUX (Compact disc)

Push the "DISC-AUX" button to play a compact disc.

When the audio system is set into compact disc operation, the display shows the track, or track and disc number currently being played.

Vehicles with rear seat entertainment system—

The "DISC-AUX" button may also be used to operate a DVD player when a disc is loaded in the DVD player. Pressing the "DISC-AUX" button changes between the CD player and DVD player. When the DVD player is in operation, "AUX" appears on the display.

Vehicles with AUX adapter—

To switch between CD, DVD, and AUX (external device) modes, press the "DISC-AUX" button. The AUX mode is only available when AUX adapter is connected to the system. When the AUX adapter is in use, "AUX" will appear on the display.

Error messages

If the player malfunctions, your audio system will display following error messages.

"WAIT": The compact disc player unit may be too hot. Allow the player to cool down.

"ERROR 1": The disc may be dirty, damaged or inserted incorrectly (up-side down). Clean the disc and re-insert it.

"NO DISC": The compact disc changer of separate unit is empty. Insert a disc.

"ERROR 3": There is a problem inside the system. Eject the disc or magazine. Set the disc or magazine again.

"ERROR 4": Over-current. Ask your Toyota dealer to inspect.

"CD OPEN": The compact disc changer lid of separate unit is open. Close the compact disc changer lid.

If "NO MUSIC" appears on the display, it indicates that a disc with no MP3/WMA data has been inserted. Remove the disc from the player and insert an MP3/WMA data disc.

If the malfunction still exists, take your vehicle to your Toyota dealer.

∨ DISC ^

With compact disc changer only—

Use these buttons to select the disc you want to listen to.

Push "∨" (preset button 3) or "^" (preset button 4) until the number of the disc you want to listen appears on the display.

FM1 FM2

Push the "FM1" or "FM2" button to turn on the radio and select the FM band. "FM1" or "FM2" will appear on the display. This system allows you to set twelve FM stations, two for each of the preset button.

MP3/FOLDER (Folder up/down)

To skip up or down to a different folder: Push either side of the "MP3/FOLDER" several times until the number of the folder you want to listen to appears on the display.

To jump to the first file in the current folder:

Push and hold the "∨" side of the button until you hear a beep.

When playing a disc featuring both audio data (CD-DA) and MP3/WMA files, audio data (CD-DA) is played.

06 SIENNA_U (L/O 0603)

PWR-VOL (Power and Volume)

Push “PWR·VOL” to turn the audio system on and off. Turn “PWR·VOL” to adjust the volume.

RAND (Random)

Compact disc player

There are two random features—you can either listen to the tracks on one compact disc in random order, or listen to the tracks on all the compact discs in the magazine in random order.

To play the tracks on one disc in random order:

Quickly push and release “RAND” (preset button 1). “ RAND₁” will appear on the display and the player will perform the tracks on the disc you are listening to in random order. To turn off the random feature, push this button again.

With compact disc changer only—

To play all the tracks in the magazine in random order:

Push and hold “RAND” (preset button 1) until you hear a beep. “ RAND₁” will appear on the display and the player will perform all the tracks on all the discs in the magazine in random order. To turn off the random feature, push this button again.

240

MP3/WMA player

There are two random playback features—you can either listen to all of the files on the compact discs in random order. You can also listen to the files in a single folder in random order.

To randomly play the files in a folder: Quickly push and release “RAND” (preset button 1). “ RAND₁” will appear on the display.

To randomly play all of the files on the compact disc:

Push and hold “RAND” (preset button 1) until you hear a beep. “ RAND₁” will appear on the display and the player will play all of the files on the disc in random order. To turn off the random playback feature, push this button again.

RPT (Repeat)

Compact disc player

There are two repeat features—you can either replay a disc track or a whole compact disc.

Repeating a track:

Quickly push and release “RPT” (preset button 2) while the track is playing. “ RPT” will appear on the display. When the track ends, it will automatically replay. To turn off the repeat feature, push this button again.

With compact disc changer only—

Repeating a disc:

Push and hold “RPT” (preset button 2) until you hear a beep. “ RPT” will appear on the display. The player will repeat all the tracks on the disc you are listening to. When the disc ends, the player will automatically go back to the first track on the disc and replay. To turn off the repeat feature, push this button again.

06 SIENNA_U (L/O 0603)

MP3/WMA player

There are two repeat features—you can repeat a signal file or an entire folder.

Repeating a file:

Quickly push and release “RPT” (preset button 2) while the file is playing. “RPT” will appear on the display. When the file ends, it will repeat automatically. This process will be continued until you push the button again to turn off the repeat feature.

Repeating a folder:

Push and hold “RPT” (preset button 2) until you hear a beep. “RPT” will appear on the display. The player will repeat all of the files in the folder. When the last file in the folder ends, the folder will repeat from the beginning. To turn off the repeat feature, push this button again.

SCAN

Radio

You can either scan all the frequencies on a band or scan only the preset stations for that band.

To scan the preset stations:

Push and hold the “SCAN” button until you hear a beep. The radio will tune in the next preset station up or down the band, stay there for 5 seconds, and then move to the next preset station. To stop scanning, push this button again.

To scan all the frequencies:

Quickly push and release the “SCAN” button. The radio will find the next station up or down the station band, stay there for 5 seconds, and then scan again to the next station. To stop scanning, push this button again.

Compact disc player

There are two scan features—you can either scan the tracks on a specific disc or scan the first tracks of all the discs in the magazine.

Scanning the tracks on a disc:

Quickly push and release the “SCAN” button. “SCAN” will appear on the display and the player will scan up or down all the tracks on the disc you are listening to. To stop scanning, push this button again. If the player scanned all the tracks on the disc, it will stop scanning.

The discs in the compact disc changer can be scanned up only.

With compact disc changer only—

Scanning the first tracks of all the discs in the magazine:

Push and hold the “SCAN” button until you hear a beep. “.SCAN” will appear on the display and the player will scan up the first track of the next disc. To stop scanning, push this button again. If the player has scanned all the discs, it will stop scanning.

06 SIENNA_U (L/O 0603)

MP3/WMA player

There are two scan features—you can either scan the files in a folder on a specific disc or scan the first file of all the folder.

Scanning the files on a folder:

Quickly push and release “SCAN”. “SCAN” will appear on the display and the player will scan all the files in the folder you are listening to. To select a file, push the “SCAN” again. After all the tracks on the disc have been scanned in one pass, normal play resumes.

Scanning the first file of all the folders: Push “SCAN” until you hear a beep. “SCAN” will appear on the display and the player will scan the first file of the next folder. To select a folder, push the “SCAN” again. After all the folders have been scanned in one pass, normal play resumes.

SEEK/TRACK (Seeking/Track up/down)

Radio

In the seek mode, the radio finds and plays the next station up or down the station band.

To seek the next station, quickly push and release “^” or “v” side of the “SEEK/TRACK” button. Do this again to find the station after that.

Compact disc player

Use this button to skip up or down to a different track.

Push “^” or “v” side of the “SEEK/TRACK” button until the number of the track you want to listen to appears on the display. If you want to return to the beginning of the current track, quickly push the down side of the button one time.

Vehicles with rear seat entertainment system—

While the DVD player is in operation, the chapter or track can be changed by pushing the “^” or “v” side of the “SEEK/TRACK” button.

MP3/WMA player

To file up or down to a different file:

Push either side of the “SEEK/TRACK” several times until the file you want to listen to appears on the display. If you want to return to the beginning of the current file, push the “v” side of the button one time, quickly.

To fast forward or reverse the disc:

If you want to fast forward or reverse the disc, push and hold it until you hear a beep. When you release the button, the player will resume playing.

Vehicles with rear seat entertainment system—

While the DVD player is in operation, the chapter or track can be changed by pushing the “^” or “v” side of the “SEEK/TRACK” button.

ST (Stereo reception) display

Your radio automatically changes to stereo reception when a stereo broadcast is received. “ST” appears on the display. If the signal becomes weak, the radio reduces the amount of channel separation to prevent the weak signal from creating noise. If the signal becomes extremely weak, the radio switches from stereo to mono reception.

06 SIENNA_U (L/O 0603)

TEXT

Compact disc player

This button is used to change the display for the compact disc that contains text data.

To change the display, quickly push and release the "TEXT" button while the compact disc is playing. The display changes in the order from the elapsed time to disc title to track title, then back to the elapsed time.

If this button is pushed while a compact disc that does not contain text data is playing, "NO TITLE" will appear on the display.

If the entire disc or track title does not appear on the display, push and hold the button until you hear a beep. The rest of the title will appear.

MP3/WMA player

This button is used to change the display for the MP3/WMA file that contains text data.

To change the display, quickly push and release the "TEXT" button while the MP3/WMA file is playing. The display changes in the order from the elapsed time to folder name to file name to album title to track title to artist name, then back to the elapsed time.

If this button is pushed while an MP3/WMA file that does not contain text data is playing, "NO TITLE" will appear on the display.

If the entire text data is not displayed, push and hold it until you hear a beep. The rest of the text data will appear.

TUNE-FILE (Tuning and File up/down)

Radio

Turn the "TUNE-FILE" knob clockwise to step up the frequency. Turn the knob counterclockwise to step down the frequency.

MP3/WMA player

Turn the knob clockwise to file up. Turn the knob counterclockwise to file down.

06 SIENNA_U (L/O 0603)

►Type 2-1



Details of specific buttons, controls and features are described in the alphabetical list that follows.

06 SIENNA_U (L/O 0603)

►Type 2-2



Details of specific buttons, controls and features are described in the alphabetical list that follows.

06 SIENNA_U (L/O 0603)

1 2 3 4 5 6 (Preset buttons)

These buttons are used to preset and tune in radio stations.

To preset a station to a button: Tune in the desired station. (See "TUNE-FILE" or "SEEK/TRACK".) Push and hold down the button until you hear a beep—this will set the station to the button. The preset button number will appear on the display.

To recall a preset station: Push the button for the station you want. The preset button number and station frequency will appear on the display.

This radio can store one AM and two FM stations for each button. (The display will show "AM", "FM1" or "FM2" when you push "AM", "FM1" or "FM2" button.)

(Eject button)

This button is used to eject one or all compact discs.

To eject the current compact disc, push and release the compact disc eject button.

To eject a specific disc, push "V" (preset button 3) or "^" (preset button 4) until the number of the disc you want to eject is displayed. Push and release the eject button.

To eject all discs at a time, press and hold the eject button until you hear a beep. The last compact disc played before pushing the button will be ejected first. If the ejected disc is not removed for a long time, the eject function will be cancelled.

(Reverse/Fast-forward button)

Push and hold "▶▶" (preset button 6) or "◀◀" (preset button 5) to fast forward or reverse within a compact disc. When you release the button, the compact disc player will resume playing.

AM

Push the "AM" button to turn on the radio and select the AM band. "AM" will appear on the display.

AUDIO CONTROL (Tone and sound balance adjustment function)

Each time you push the "AUDIO CONTROL" knob, the mode changes. To adjust the tone and balance, turn the knob.

Type 2-1—

BAS: Adjusts low-pitched tones. The display ranges from -5 to 5.

TRE: Adjusts high-pitched tones. The display ranges from -5 to 5.

FAD: Adjusts the sound balance between the front and rear speakers. The display ranges from F7 to R7.

BAL: Adjusts the sound balance between the right and left speakers. The display ranges from L7 to R7.

ASL: The Automatic Sound Levelizer can be turned on by turning the knob. The ASL system automatically adjusts volume and tone in accordance with ambient noise levels. This helps ensure an optimal listening experience even when road, wind or other ambient noise levels rise.

RSE: Vehicles with a rear seat entertainment system—The system can be locked. For details, see page 267 in this Section.

Type 2-2—

BAS: Adjusts low-pitched tones. The display ranges from -5 to 5.

MID: Adjusts mid-pitched tones. The display ranges from -5 to 5.

TRE: Adjusts high-pitched tones. The display ranges from -5 to 5.

FAD: Adjusts the sound balance between the front and rear speakers. The display ranges from F7 to R7.

BAL: Adjusts the sound balance between the right and left speakers. The display ranges from L7 to R7.

06 SIENNA_U (L/O 0603)

SURROUND: Turn on or off the surround function. “SURROUND ON” or “SURROUND OFF” will appear on the display.

ASL: The Automatic Sound Levelizer can be turned on by turning the knob. In addition, turning the knob allows you to select from LOW, MID, and HIGH volume and tone settings. The ASL system automatically adjusts volume and tone in accordance with ambient noise levels. This helps ensure an optimal listening experience even when road, wind or other ambient noise levels rise.

RSE: Vehicles with a rear seat entertainment system—The system can be locked. For details, see page 267 in this Section.

DISC-AUX (Compact disc)

Push the “DISC-AUX” button to play a compact disc.

When the audio system is set into compact disc operation, the display shows the track, or track and disc number currently being played.

Vehicles with rear seat entertainment system—

The “DISC-AUX” button may also be used to operate a DVD player when a disc is loaded in the DVD player. Pressing the “DISC-AUX” button changes between the CD player and DVD player. When the DVD player is in operation, “AUX” appears on the display.

Vehicles with AUX adapter—

To switch between CD, DVD, and AUX (external device) modes, press the “DISC-AUX” button. The AUX mode is only available when AUX adapter is connected to the system. When the AUX adapter is in use, “AUX” will appear on the display.

Error messages

If the player malfunctions, your audio system will display following error messages.

“WAIT”: The compact disc player unit may be too hot. Allow the player to cool down.

“ERROR 1”: The disc may be dirty, damaged or inserted incorrectly (up-side down). Clean the disc and re-insert it.

“NO DISC”: The compact disc changer of separate unit is empty. Insert a disc.

“ERROR 3”: There is a problem inside the system. Eject the disc or magazine. Set the disc or magazine again.

“ERROR 4”: Over-current. Ask your Toyota dealer to inspect.

“CD OPEN”: The compact disc changer lid of separate unit is open. Close the compact disc changer lid.

If “NO MUSIC” appears on the display, it indicates that a disc with no MP3/WMA data has been inserted. Remove the disc from the player and insert an MP3/WMA data disc.

If the malfunction still exists, take your vehicle to your Toyota dealer.

06 SIENNA_U (L/O 0603)

∨ DISC ^

Use these buttons to select a disc you want to listen to.

Push “∨” (preset button 3) or “^” (preset button 4) until the number of the disc you want to listen to appears on the display.

FM1 FM2

Push the “FM1” or “FM2” button to turn on the radio and select the FM band. “FM1” or “FM2” will appear on the display. This system allows you to set twelve FM stations, two for each of the preset button.

LOAD

This button is used to load the compact discs in the compact disc player. This player can store up to six discs.

To load one compact disc only, quickly push and release the button, then insert a compact disc. After the disc is loaded, the shutter of the slot will close.

If no compact disc is inserted, the shutter will close after 15 seconds.

To load multiple compact discs, push and hold the button (until you hear a beep when the audio system is on). When the indicators on both sides of the slot turn green, insert the first compact disc. After the disc is loaded, the shutter of the slot will close. After a few seconds, the shutter will automatically open again and the indicators will turn green so the next disc can be inserted. The same process can be applied for loading the rest of the discs. If the player is full of discs, “DISC FULL” will appear on the display.

If no compact disc is inserted, the shutter will close after 15 seconds.

MP3/FOLDER (Folder up/down)

To skip up or down to a different folder: Push either side of the “MP3/FOLDER” several times until the number of the folder you want to listen to appears on the display.

To jump to the first file in the current folder:

Push and hold the “∨” side of the button until you hear a beep.

When playing a disc featuring both audio data (CD-DA) and MP3/WMA files, audio data (CD-DA) is played.

PWR-VOL (Power and Volume)

Push “PWR-VOL” to turn the audio system on and off. Turn “PWR-VOL” to adjust the volume.

RAND (Random)

Compact disc player

There are two random features—you can either listen to the tracks on one compact disc in random order, or listen to the tracks on all the compact discs in the magazine in random order.

To play the tracks on one disc in random order:

Quickly push and release “RAND” (preset button 1). “RAND” will appear on the display and the player will perform the tracks on the disc you are listening to in random order. To turn off the random feature, push this button again.

To play all the tracks in the magazine in random order:

Push and hold “RAND” (preset button 1) until you hear a beep. “ RAND” will appear on the display and the player will perform all the tracks on all the discs in the magazine in random order. To turn off the random feature, push this button again.

06 SIENNA_U (L/O 0603)

MP3/WMA player

There are two random playback features—you can either listen to all of the files on the compact discs in random order. You can also listen to the files in a single folder in random order.

To randomly play the files in a folder: Quickly push and release “RAND” (preset button 1). “ RAND” will appear on the display.

To randomly play all of the files on the compact disc:

Push and hold “RAND” (preset button 1) until you hear a beep. “ RAND” will appear on the display and the player will play all of the files on the disc in random order. To turn off the random playback feature, push this button again.

RPT (Repeat)

Compact disc player

There are two repeat features—you can either replay a disc track or a whole compact disc.

Repeating a track:

Quickly push and release “RPT” (preset button 2) while the track is playing. “ RPT” will appear on the display. When the track ends, it will automatically replay. To turn off the repeat feature, push this button again.

Repeating a disc:

Push and hold “RPT” (preset button 2) until you hear a beep. “ RPT” will appear on the display. The player will repeat all the tracks on the disc you are listening to. When the disc ends, the player will automatically go back to the first track on the disc and replay. To turn off the repeat feature, push this button again.

MP3/WMA player

There are two repeat features—you can repeat a signal file or an entire folder.

Repeating a file:

Quickly push and release “RPT” (preset button 2) while the file is playing. “ RPT” will appear on the display. When the file ends, it will repeat automatically. This process will be continued until you push the button again to turn off the repeat feature.

Repeating a folder:

Push and hold “RPT” (preset button 2) until you hear a beep. “ RPT” will appear on the display. The player will repeat all of the files in the folder. When the last file in the folder ends, the folder will repeat from the beginning. To turn off the repeat feature, push this button again.

06 SIENNA_U (L/O 0603)

SCAN

Radio

You can either scan all the frequencies on a band or scan only the preset stations for that band.

To scan the preset stations:

Push and hold the "SCAN" button until you hear a beep. The radio will tune in the next preset station up or down the band, stay there for 5 seconds, and then move to the next preset station. To stop scanning, push this button again.

To scan all the frequencies:

Quickly push and release the "SCAN" button. The radio will find the next station up or down the station band, stay there for 5 seconds, and then scan again to the next station. To stop scanning, push this button again.

Compact disc player

There are two scan features—you can either scan the tracks on a specific disc or scan the first tracks of all the discs in the magazine.

Scanning the tracks on a disc:

Quickly push and release the "SCAN" button. "SCAN" will appear on the display and the player will scan up or down all the tracks on the disc you are listening to. To stop scanning, push this button again. If the player scanned all the tracks on the disc, it will stop scanning.

The discs in the compact disc changer of separate unit can be scanned up only.

Scanning the first tracks of all the discs in the magazine:

Push and hold the "SCAN" button until you hear a beep. "SCAN" will appear on the display and the player will scan up or down the first track of the next disc. To stop scanning, push this button again. If the auto changer has scanned all the discs, it will stop scanning.

The discs in the compact disc changer of separate unit can be scanned up only.

MP3/WMA player

There are two scan features—you can either scan the files in a folder on a specific disc or scan the first file of all the folder.

Scanning the files on a folder:

Quickly push and release "SCAN". "SCAN" will appear on the display and the player will scan all the files in the folder you are listening to. To select a file, push the "SCAN" again. After all the tracks on the disc have been scanned in one pass, normal play resumes.

Scanning the first file of all the folders:

Push "SCAN" until you hear a beep. "SCAN" will appear on the display and the player will scan the first file of the next folder. To select a folder, push the "SCAN" again. After all the folders have been scanned in one pass, normal play resumes.

06 SIENNA_U (L/O 0603)

SEEK/TRACK (Seeking/Track up/down)

Radio

In the seek mode, the radio finds and plays the next station up or down the station band.

To seek the next station, quickly push and release “^” or “v” side of the “SEEK/TRACK” button. Do this again to find the station after that.

Compact disc player

Use this button to skip up or down to a different track.

Push “^” or “v” side of the “SEEK/TRACK” button until the number of the track you want to listen to appears on the display. If you want to return to the beginning of the current track, quickly push the down side of the button one time.

Vehicles with rear seat entertainment system—

While the DVD player is in operation, the chapter or track can be changed by pushing the “^” or “v” side of the “SEEK/TRACK” button.

MP3/WMA player

To file up or down to a different file:

Push either side of the “SEEK/TRACK” several times until the file you want to listen to appears on the display. If you want to return to the beginning of the current file, push the “v” side of the button one time, quickly.

To fast forward or reverse the disc:

If you want to fast forward or reverse the disc, push and hold it until you hear a beep. When you release the button, the player will resume playing.

Vehicles with rear seat entertainment system—

While the DVD player is in operation, the chapter or track can be changed by pushing the “^” or “v” side of the “SEEK/TRACK” button.

ST (Stereo reception) display

Your radio automatically changes to stereo reception when a stereo broadcast is received. “ST” appears on the display. If the signal becomes weak, the radio reduces the amount of channel separation to prevent the weak signal from creating noise. If the signal becomes extremely weak, the radio switches from stereo to mono reception.

TEXT

Compact disc player

This button is used to change the display for the compact disc that contains text data.

To change the display, quickly push and release the “TEXT” button while the compact disc is playing. The display changes in the order from the elapsed time to disc title to track title, then back to the elapsed time.

If this button is pushed while a compact disc that does not contain text data is playing, “NO TITLE” will appear on the display.

If the entire disc or track title does not appear on the display, push and hold the button until you hear a beep. The rest of the title will appear.

MP3/WMA player

This button is used to change the display for the MP3/WMA file that contains text data.

To change the display, quickly push and release the "TEXT" button while the MP3/WMA file is playing. The display changes in the order from the elapsed time to folder name to file name to album title to track title to artist name, then back to the elapsed time.

If this button is pushed while an MP3/WMA file that does not contain text data is playing, "NO TITLE" will appear on the display.

If the entire text data is not displayed, push and hold it until you hear a beep. The rest of the text data will appear.

TUNE-FILE (Tuning and File up/down)

Radio

Turn the "TUNE-FILE" knob clockwise to step up the frequency. Turn the knob counterclockwise to step down the frequency.

MP3/WMA player

Turn the knob clockwise to file up. Turn the knob counterclockwise to file down.

AUX adapter

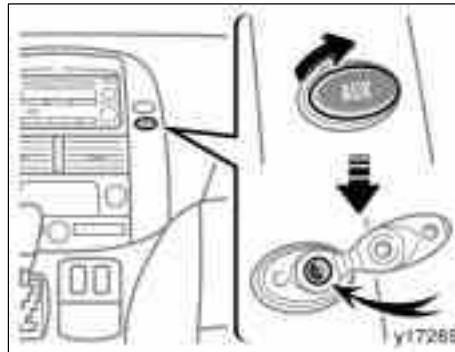

If you install an audio system other than a genuine audio system, you will not be able to use the AUX adapter.

By inserting a mini plug into the AUX adapter, you can listen to music from a portable audio device through the vehicle's speaker system.

To use the AUX adapter, switch to the AUX mode (external device mode) by pressing the "DISC-AUX" button. When the AUX adapter is in use, "AUX" will appear on the display. To adjust the volume, turn the "PWR-VOL" knob.

When using a portable audio device connected to the power outlet or cigarette lighter, noise may occur during playback. If this happens, use the power source of the portable audio device.

06 SIENNA_U (L/O 0603)

Audio remote controls (steering switches)

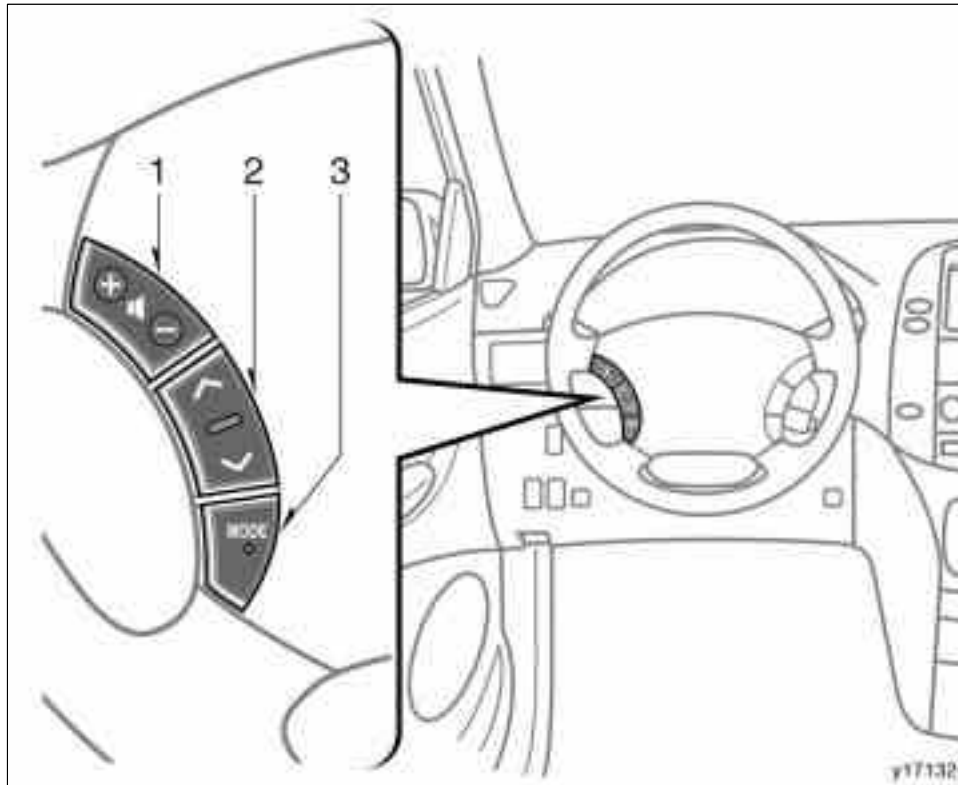

Some parts of the audio system can be adjusted using the switches on the steering wheel.

Details of the specific switches, controls, and features are described below.

1. Volume control switch
2. “^∨” switch
3. “MODE” switch

06 SIENNA_U (L/O 0603)

1. Volume control switch

Push “+” to increase the volume. The volume continues to increase while the switch is being pushed.

Push “-” to decrease the volume. The volume continues to decrease while the switch is being pushed.

2. “^v” switch

Radio

This switch has the following features—

To select a preset station:

Quickly push and release the “^” or “v” side of the switch. Do this again to select the next preset station.

To seek a station:

Push and hold the “^” or “v” side of the switch until you hear a beep. Do this again to find the next station. If you push the switch on either side during the seek mode, seeking will be cancelled.

To step up or down the frequency, push and hold the switch even after you hear a beep. When you release from the switch, the radio will begin seeking up or down for a station. Do this again to find the next station.

Compact disc player

Use this switch to skip up or down to a different track in either direction.

Quickly push and release the “^” or “v” side of the switch until the track you want to listen to is set. If you want to return to the beginning of the current track, push the “v” side of the switch once, quickly.

Vehicles with rear seat entertainment system—

While the DVD player is in operation, the chapter or track can be changed by pushing the “^” or “v” side of the switch.

With compact disc changer only—

Push and hold the “^” or “v” side of the switch until the disc you want to listen to is set.

MP3/WMA player

Use this switch to select a desired file or disc.

To select a desired file:

Quickly push and release the “^” or “v” side of the switch until the file you want to listen to is set. If you want to return to the beginning of the current file, push the “v” side of the switch once, quickly.

To select a desired disc:

Push and hold the “^” or “v” side of the switch until the disc you want to listen to is set.

Vehicles with rear seat entertainment system—

While the DVD player is in operation, the chapter or track can be changed by pushing the “^” or “v” side of the switch.

3. “MODE” switch

Push the “MODE” switch to select an audio mode. Each push changes the mode sequentially if the desired mode is ready to use. The DVD player will be selectable if a rear seat entertainment system is installed in your vehicle.

To turn the audio system on, push the “MODE” switch.

To turn the audio system off, push and hold the “MODE” switch until the system turns off.

06 SIENNA_U (L/O 0603)

Rear seat entertainment system—

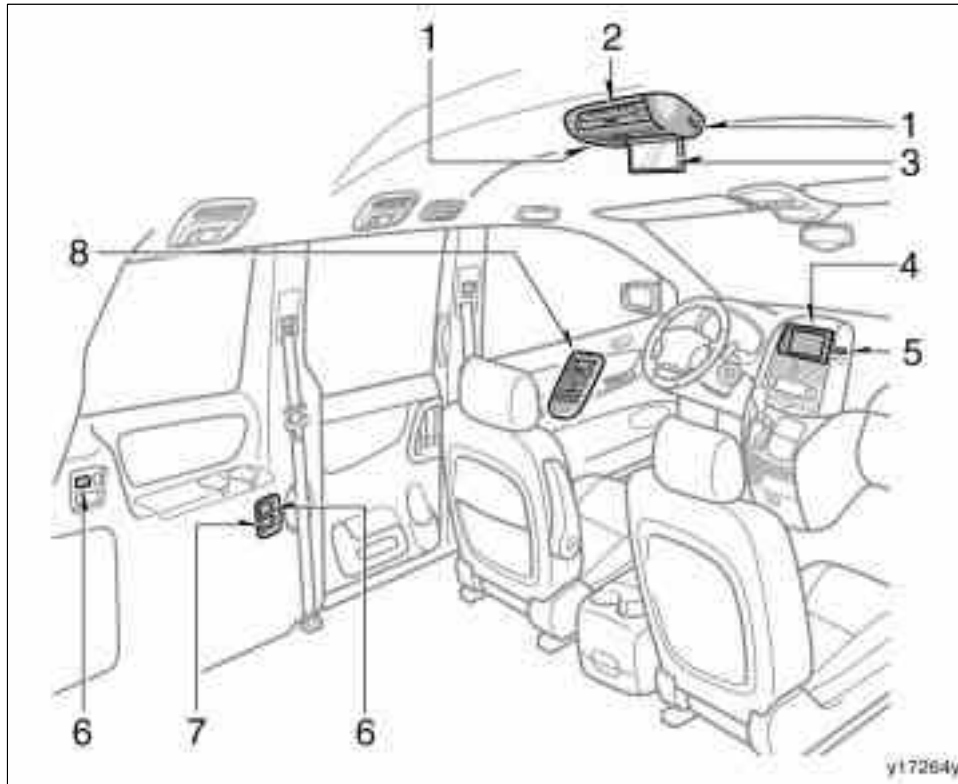

The rear seat entertainment system consists of the following components.

1. Headphone volume control dials and headphone jacks
2. DVD player
3. Rear seat entertainment system display
4. Front audio system
5. Power outlet main switch
6. Power outlets
7. A/V input adapter
8. Rear seat entertainment system controller

06 SIENNA_U (L/O 0603)

The rear seat entertainment system is designed for the rear passengers to enjoy audio and DVD video separately from the front audio system.

The rear seat entertainment system can be operated when the ignition key is in the "ACC" or "ON" position.

The rear passengers can enjoy DVD video, audio CD, video CD, CD text, dts-CD and MP3.

The rear seat entertainment system can play DVD video, audio CD, video CD, CD text, dts-CD or MP3 only when a disc is loaded in the DVD player.

You can enjoy videos and sound when your personal audio system is connected to the input terminal adapter. For details, refer to the manufacturer's instructions.

You can enjoy the rear seat entertainment system with commercial headphone. See "—Headphone jacks" on page 296 in this Section for details.

You can also enjoy the rear seat entertainment system with a wireless headphone. The wireless headphone can be used within rear seat. If the signal becomes weak, the headphone will mute. For details, refer to the manufacturer's instructions.

With some wireless headphone generally available in the market, it may be difficult to catch sound properly. Toyota recommends the use of Toyota genuine wireless headphone.

You can purchase a wireless headphone at a Toyota dealer.

CAUTION

- **Do not operate a motor vehicle while using headphones. Doing so may cause an accident, resulting in death or serious injury.**

- **With DVD player:**

Conversational speech on some DVDs is recorded at a low volume to emphasize the impact of sound effects. If you adjust the volume assuming that the conversations represent the maximum volume level that the DVD will play, you may be startled by louder sound effects or when you change to a different audio source. Be sure to adjust the volume with this in mind.

Make sure the volume is not increased, before you turn on the headphone.

06 SIENNA_U (L/O 0603)

—Display

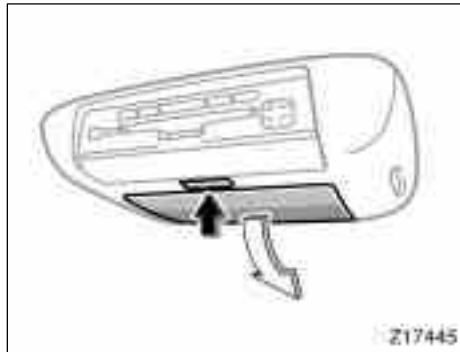

To open the display, push the lock release button.



Pull the display down to an easily viewable angle (between 90° and 125°)

NOTICE

The screen should be cleaned with a dry soft cloth. If the screen is pushed by hand or wiped with a hard cloth, the surface of the screen may be scratched.

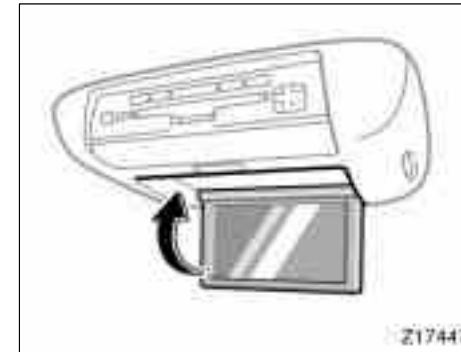

To close, push the display up until you hear a click.

The illumination of the screen is automatically turned off when the display is closed. However, the rear seat entertainment system is not turned off.

CAUTION

To reduce the chance of injury in case of an accident or sudden stop while driving, close the display when it is not in use.

NOTICE

- ◆ *Benzene or alkaline solutions may damage the coated surface of the screen.*
- ◆ *To prevent the battery from being discharged, do not turn on the rear seat entertainment system longer than necessary when the engine is not running.*

—Rear seat entertainment system controller

The rear seat entertainment system can be operated with the rear seat entertainment system controller and buttons on the DVD player unit. The system cannot be operated by touching the switches on the screen directly.

 **CAUTION**

Do not disassemble or modify the controller. It may cause an accident, fire or electric shock.

NOTICE

Keep the controller away from direct sunlight, high heat and high humidity. These conditions could cause the case to deform or the battery to explode or leak.

BEFORE USING THE CONTROLLER (for new vehicle owners)

A battery is already set in the controller with an insulating sheet, which prevents the battery from being discharged. Before using the controller, remove the insulating sheet according to the following procedure.

06 SIENNA_U (L/O 0603)

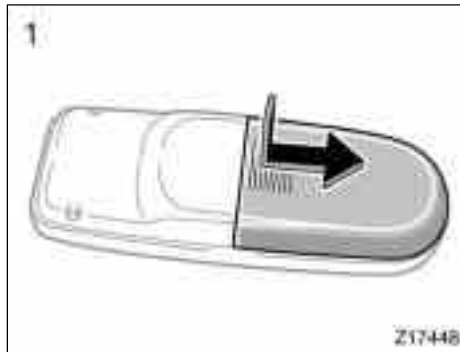

1. Remove the cover of the controller as shown.

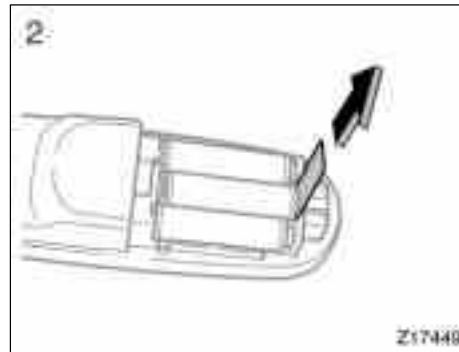

2. Remove the insulating sheet.



USING THE CONTROLLER

To use the rear seat entertainment system controller, direct the signal output portion of the controller to the signal reception portion of the rear seat entertainment system display.

The controller does not operate properly when the signal reception portion of the display is exposed to direct sunlight. Block the display from direct sunlight.

 CAUTION
<p>To reduce the chance of injury in case of an accident or a sudden stop while driving, stow the controller in the console box or front seat side table when it is not in use.</p>

NOTICE
<p><i>Observe the followings, otherwise the controller may be damaged.</i></p> <ul style="list-style-type: none">◆ <i>Do not drop or strongly knock the controller against hard objects.</i>◆ <i>Do not sit on or place heavy objects on the controller.</i>◆ <i>Do not leave the controller exposed to high temperatures (such as on the instrument panel) for a long time.</i>

06 SIENNA_U (L/O 0603)

—Control buttons

►Controller

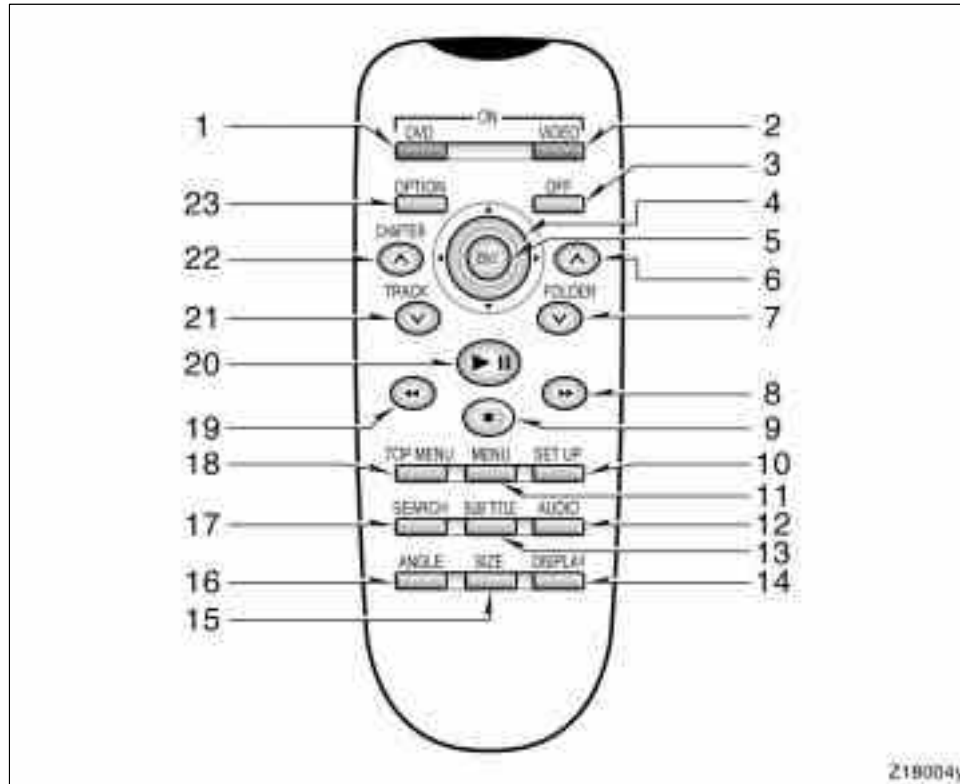

1. "DVD" button
This button turns on the DVD mode.
2. "VIDEO" button
This button causes the display to use the video signal from an external video device.
3. "OFF" button
This button turns off the rear seat entertainment system.
4. Joystick
This joystick selects a control switch, mode switch on the screen or the menu for the disc.
5. "ENT" button
This button inputs the selected switch or the selected menu for the disc.
6. "FOLDER ^" button
This button selects a desired folder.
7. "FOLDER v" button
This button selects a desired folder.
8. "▶▶" button
This button fast forwards a screen when the DVD player is operated.

06 SIENNA_U (L/O 0603)

9. "■" button
This button stops a screen when the DVD player is operated.
10. "SET UP" button
This button indicates the initial set up screen when the DVD player is operated.
11. "MENU" button
This button indicates the menu screen for DVD video when the DVD player is operated.
12. "AUDIO" button
This button indicates the changing audio screen when the DVD player is operated.
13. "SUB TITLE" button
This button indicates the changing subtitle screen when the DVD player is operated.
14. "DISPLAY" button
This button adjusts the color, tone, contrast and brightness of the screen.
15. "SIZE" button
This button changes the display mode when the DVD player is operated.
16. "ANGLE" button
This button selects the angle of the screen when the DVD player is operated.
17. "SEARCH" button
This button indicates the title search screen when the DVD player is operated.
18. "TOP MENU" button
This button indicates the title selection screen for DVD video when the DVD player is operated.
19. "◀◀" button
This button reverse a screen when the DVD player is operated.
20. "▶▶" button
This button plays or pauses a screen when the DVD player is operated.
21. "TRACK/CHAPTER ▼" button
This button selects track/chapter.
22. "TRACK/CHAPTER ▲" button
This button selects track/chapter.
23. "OPTION" button
This button indicates the control switches on the screen when the DVD player is operated.

REPLACING CONTROLLER BATTERY

For replacement, use 3 AA batteries.

CAUTION

Special care should be taken to prevent small children from swallowing the removed battery or components.

NOTICE

- ◆ *When replacing the battery, be careful not to lose the components.*
- ◆ *Replace only with the same or equivalent type recommended by a Toyota dealer.*
- ◆ *Dispose of used batteries according to the local laws.*

06 SIENNA_U (L/O 0603)

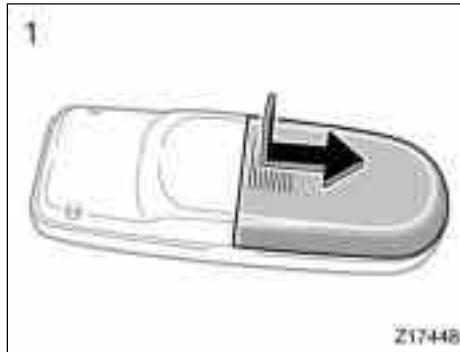

Replace the battery according to the following procedure:

1. Remove the cover of the controller as shown.

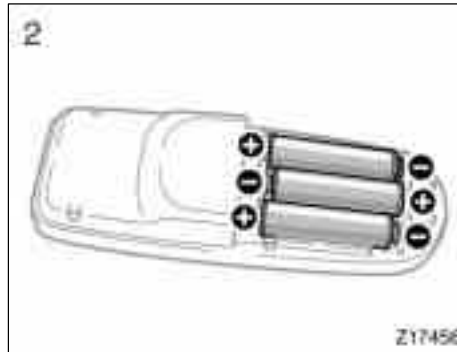

2. Remove the discharged batteries and put in the new batteries as shown. Install the cover.

NOTICE

- ◆ *Be sure that the positive side and negative side of the controller battery should be faced correctly.*
- ◆ *Do not replace the battery with wet hands. Water may cause rust.*
- ◆ *Do not touch or move any components inside of the controller, or it may interfere with proper operation.*
- ◆ *Be careful not to bend the electrode of the controller battery insertion.*
- ◆ *Close the battery case securely.*

After replacing the battery, check that the controller operates properly. If the controller still does not operate properly, contact your Toyota dealer.

06 SIENNA_U (L/O 0603)

►Buttons on the DVD player unit

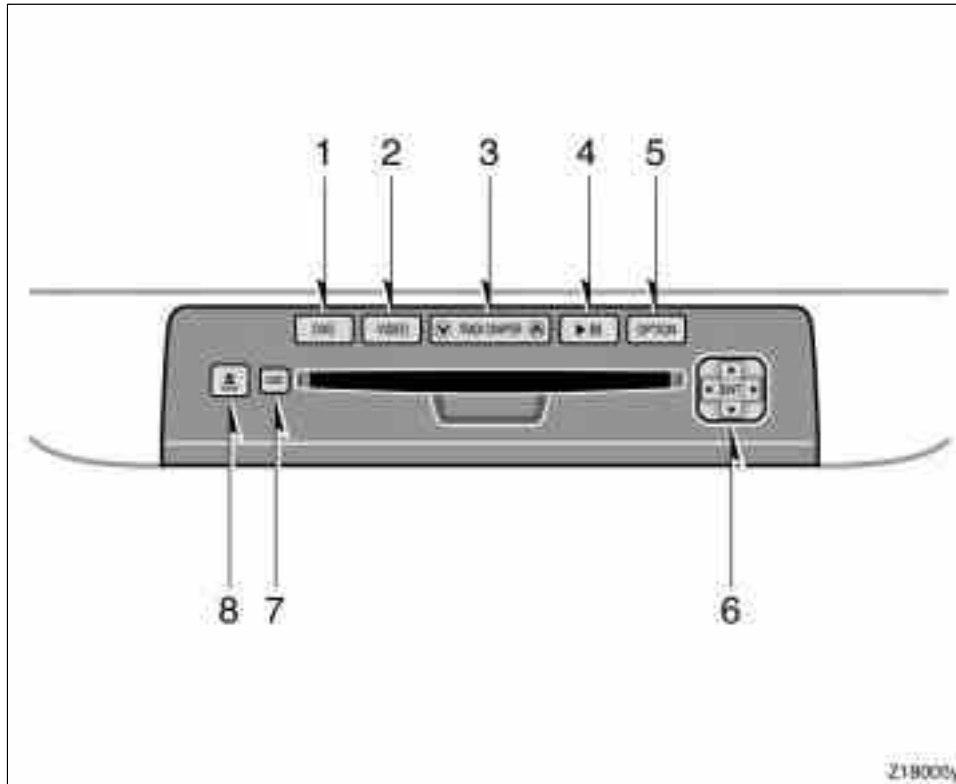

1. “DVD” button

This button turns on the rear seat entertainment system and selects the mode.

2. “VIDEO” button

This button causes the display to use the video signal from an external video device.

3. “∇TRACK-CHAPTER∧” button

This button skips directly to a desired track or chapter.

4. “▶||” button

This button plays or pauses a screen when the DVD player is operated.

5. “OPTION” button

This button indicates the control switches on the screen when the DVD player is operated.

6. Joystick/“ENT” button

The joystick selects a control switch, mode switch on the screen or the menu for the disc.

The “ENT” button inputs the selected switch or the selected menu for the disc.

06 SIENNA_U (L/O 0603)

—Turning the rear seat entertainment system on and off

7. “DISC” indicator light
This light indicates that the disc is loaded.
8. “▲” button
This button ejects a disc.



Controller

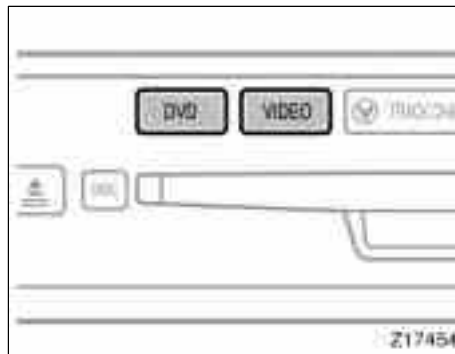

DVD player unit

To turn on the system, push the “DVD” button or “VIDEO” button.

When the “DVD” button is pushed, the disc load screen changes to the DVD player operation screen.

When the “VIDEO” button is pushed, the images and sounds from the personal audio machine are output.

The “DVD” button is effective only when a disc is inserted.

06 SIENNA_U (L/O 0603)



To turn off the system, push the “OFF” button.

When the front audio system is turned off, the rear audio system and the DVD player will be turned off simultaneously.

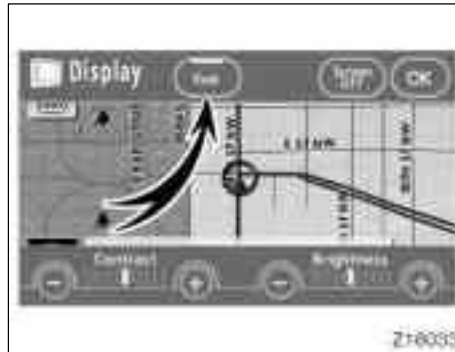

Vehicles with navigation system—The rear seat entertainment system can be switched ON and OFF by pushing the “Rear” switch on the front audio system.

—Front audio system operation

The rear DVD player can be operated through the front audio system.

06 SIENNA_U (L/O 0603)

—Rear system lock

The audio system controls in the instrument panel allow the operation of the rear seat entertainment system by rear seat passengers to be disabled.

Turning on the rear system lock prevents small children from using the remote controller or operation panel of the DVD player unit to operate the rear seat entertainment system during driving.

Turn the audio system on. Push the "AUDIO CONTROL" knob repeatedly until "RSE" is displayed. Then, turn the "AUDIO CONTROL" knob until "ON" is displayed, and then push the "AUDIO CONTROL" knob.

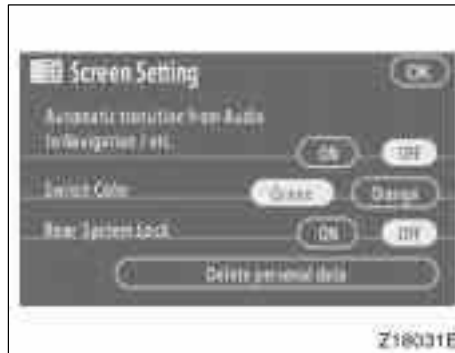

Vehicles with navigation system—

Push the "INFO" button to change the screen to "Screen Setting".

Push the "ON" switch on the "Screen Setting" screen to turn on the "Rear system lock". Then push "OK".



When the rear system lock is on and any button is pushed on the remote controller or the operation panel, the screen shown above is displayed for approximately 6 seconds.

Even when the rear system lock is turned on during play mode, the images and sounds continue without interruption.

The condition of the rear system lock is maintained, even when the ignition switch is turned off.

—DVD player

The DVD player can play audio CDs/MP3 CDs, DVD video discs, CD texts, dts-CDs and video CDs.

For appropriate discs for this player, see “Audio/video system operating hints” on page 297 in this Section.

The DVD player works when the ignition key is in the “ACC” or “ON” position.

To turn on the DVD player, a disc must be loaded in the player.

To turn off the player, eject the disc.

Error messages

If the player malfunctions, your audio system will display following error messages.

If “DISC CHECK” appears on the screen: It indicates that the disc is dirty, damaged or it was inserted upside down. Clean the disc or insert it correctly.

If “REGION ERROR” appears on the screen: It indicates that the DVD region code is not set properly.

If “DVD ERROR” appears on the screen: There is a problem inside the player. Eject the disc. Set the disc again.

If the malfunction still exists, take your vehicle to your Toyota dealer.

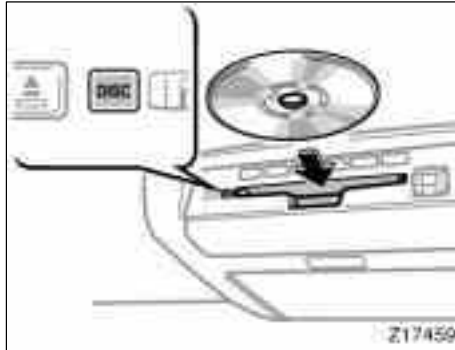

INSERTING THE DISC

Insert the compact disc into the slot with the label side up.

“DISC” indicator light turns on while the disc is loaded.

If the label faces down, the disc cannot be played. In this case, “DISC CHECK” and disc number appear on the screen.

If a disc which is not playable is inserted, “DISC CHECK” will also appear on the screen. For appropriate discs for this player, see “Audio/video system operating hints” on page 297 in this Section.

The player will play the track or chapter, and it will play from the beginning of the track or chapter again after it reaches the end.

NOTICE

Never try to disassemble or oil any part of the DVD player. Do not insert anything other than a disc into the slot.

06 SIENNA_U (L/O 0603)

8 cm (3 in.) compact disc singles

Your compact disc player needs an adaptor to play compact disc singles. Compact disc singles are about 8 cm (3 in.) in diameter-smaller than standard discs.

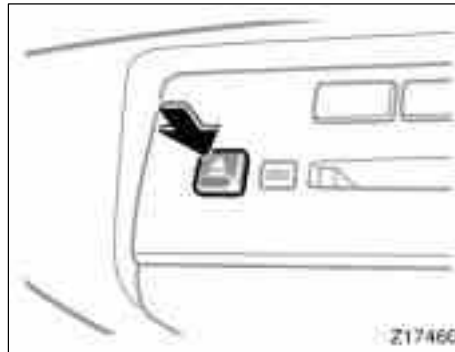

EJECTING THE DISC

Push the “▲” button.

—DVD player operation switches

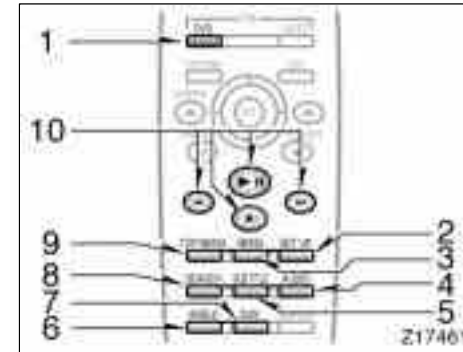

The DVD player can be operated with the controller buttons directly.

1. “DVD” button
2. “SET UP” button
3. “MENU” button
4. “AUDIO” button
5. “SUB TITLE” button
6. “ANGLE” button
7. “SIZE” button
8. “SEARCH” button
9. “TOP MENU” button
10. “▶|||”, “■”, “◀◀” and “▶▶” buttons

06 SIENNA_U (L/O 0603)



Controller

The player can also be operated with the switches on the screen.

To operate the switches on the screen, select the switch by the joystick and push the "ENT" button. You cannot select the switches on the screen by touching them directly.

When the switch is selected by the joystick, the outline of the switch changes to blue. Push the "ENT" button, and the switch will be highlighted in green.



Controller

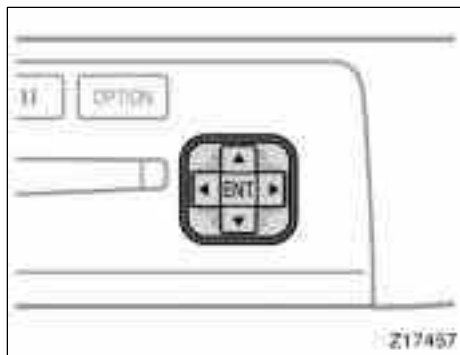

DVD player unit

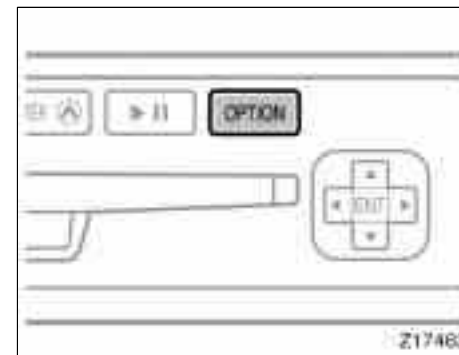

DVD player unit

06 SIENNA_U (L/O 0603)

TURNING THE OPERATION SWITCHES ON AND OFF

To turn on the operation switches, push the "OPTION" button on the controller.

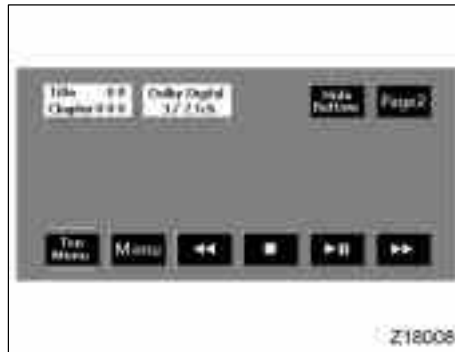

Top page (DVD video operation switch)



Top page (video CD)

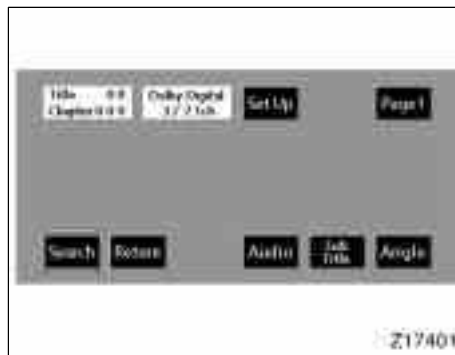

Second page (DVD video operation switch)

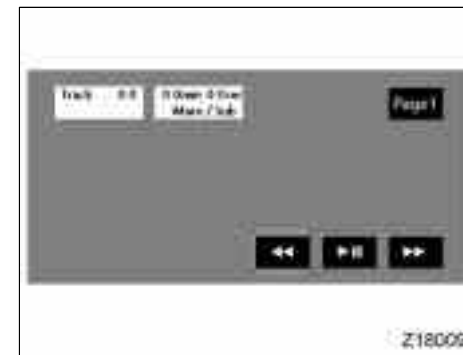

Second page (video CD)

06 SIENNA_U (L/O 0603)

There are operation switches on the "Page 1" and "Page 2" screens.

To change the screen, push the "Page 1" or "Page 2" switch on the screen.

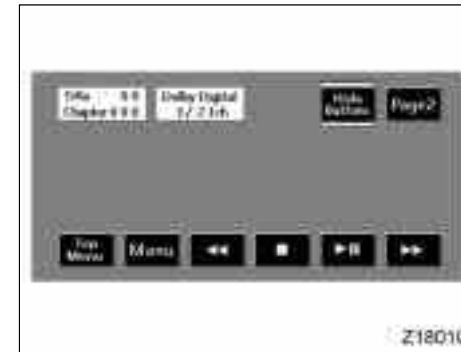

On the screen

If "⊘" appears on the screen when you select a switch, it indicates that the switch cannot work.

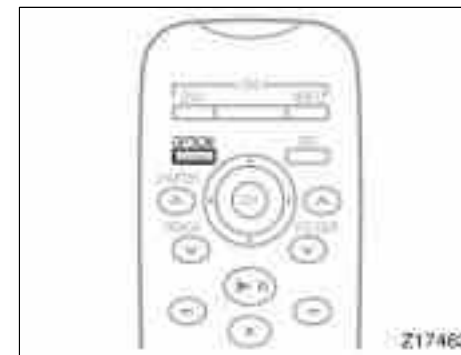

Controller

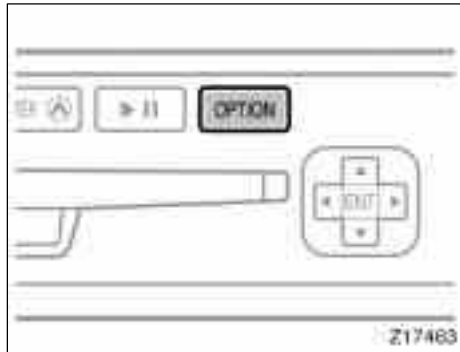

DVD player unit

To turn off the switches on the screen, push the "OPTION" button on the controller once again or push the "Hide Buttons" on the screen.

—DVD player operation

NOTE: The playback condition of some DVD video discs may be determined by the DVD video software producer. This DVD player plays discs as the software producer intended. Therefore, some functions may not work properly. Be sure to read the instruction manual for the DVD video disc separately provided. For detailed information about DVD video discs, see "—DVD video disc information" on page 293 in this Section.

Precautions for DVD video discs

When recording on a DVD video, video CD or audio tracks may not record in some cases while the menu is displayed. As audio will not play in this case, verify that the video tracks are playing and then activate playback.

The title/chapter number and playback time display may not appear while playing back certain DVD video discs.

CAUTION

Conversational speech on some DVDs is recorded at a low volume to emphasize the impact of sound effects. If you adjust the volume assuming that the conversations represent the maximum volume level available for the DVD, you may be startled by louder sound effects or when you change to a different audio source. Loud sounds may have a significant impact on the human body or pose a driving hazard. Keep this in mind when you adjust the volume.

06 SIENNA_U (L/O 0603)

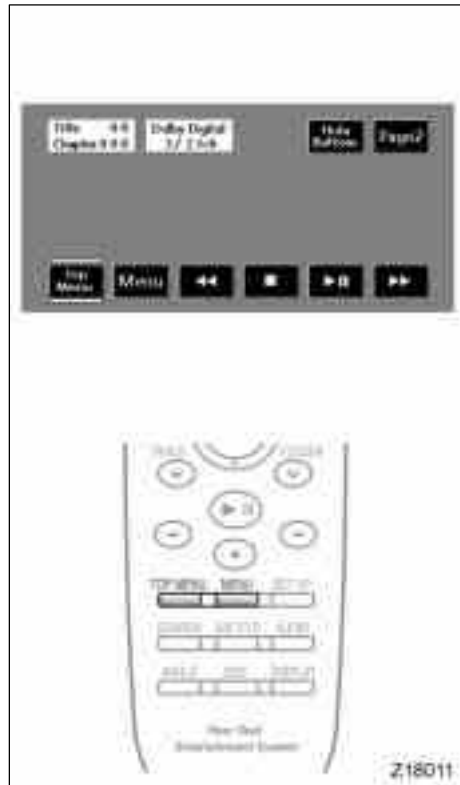

TURNING THE MENU SCREEN FOR THE DISC ON OR OFF

To turn on the menu screen for the disc, push the "Top Menu" or the "Menu" switch on the screen. You can also turn on the menu screen by pushing the "MENU" or "TOP MENU" button on the controller.

For the operation of the menu screen, see the separate manual for the DVD disc.

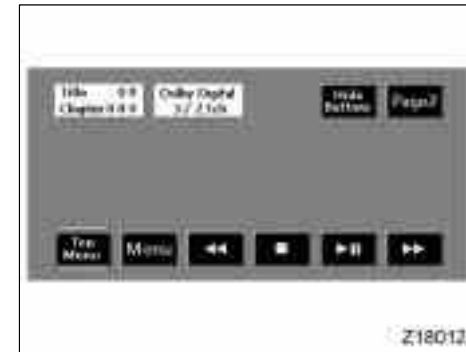

You can select the menu for the disc by the joystick and the "ENT" button on the controller.

06 SIENNA_U (L/O 0603)

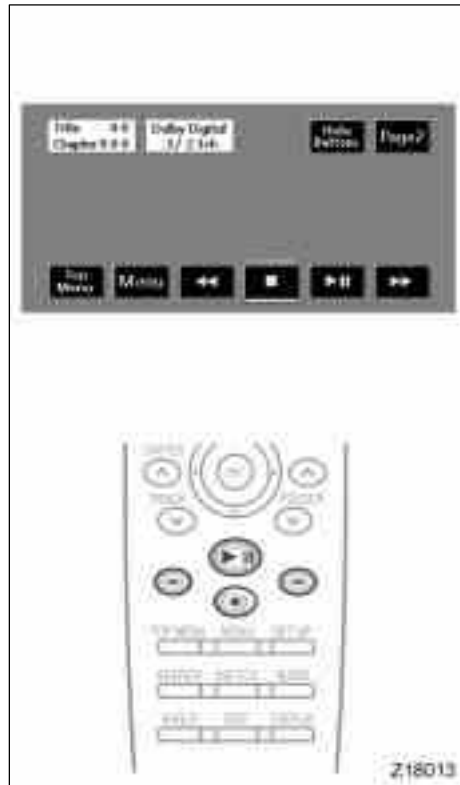

OPERATING THE “▶||”, “■”, “◀◀” AND “▶▶” SWITCHES/BUTTONS

“▶||” switch/button: Push this switch/button to pause the disc or to cancel the pause and return to normal playing.

“■” switch/button: This switch/button stops a screen when the DVD player is operated.

“◀◀” and “▶▶” switches/buttons: Push and hold the “◀◀” or “▶▶” switch/button to fast forward or reverse. When you release the switch/button, the DVD player will resume playing.

Push the “▶▶” switch/button while pausing, the DVD video plays the slow-motion video replay.



06 SIENNA_U (L/O 0603)

SKIPPING TO THE PREDETERMINED SCREEN

To skip to the predetermined screen, push the "Return" switch. The DVD player starts playing from the beginning of the predetermined screen.

For further details of the predetermined screen, see the separate manual for the DVD disc.

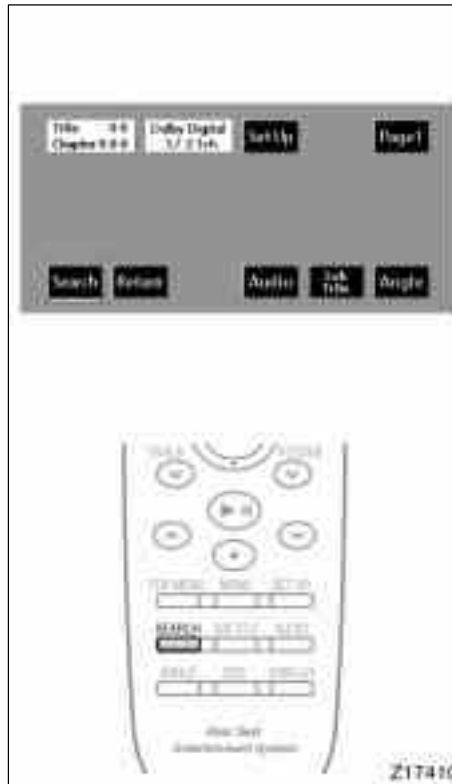

SELECTING THE TITLE

To display the searching title screen, push the "Search" switch on the screen. You can also display the screen by pushing the "SEARCH" button on the controller.

06 SIENNA_U (L/O 0603)



Select the title number by using the joystick and push the "ENT" button to enter the number. The player starts playing disc for that title selected. The selected title number will appear on the screen.

Push the "Back" switch to return to the menu screen.

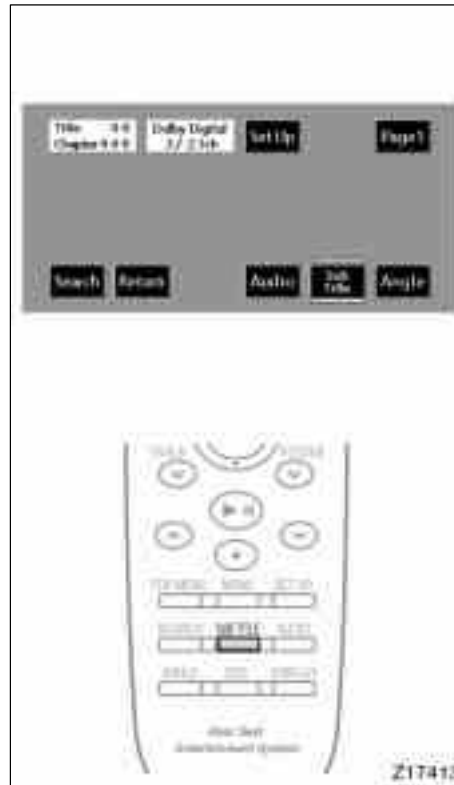

CHANGING THE SUBTITLE LANGUAGE

Push the "Sub Title" switch on the screen, and then the changing subtitle language screen will appear. You can also display the screen by pushing the "SUB TITLE" button on the controller.

06 SIENNA_U (L/O 0603)



Each time you push the "Sub Title" switch, another language stored on the disc is selected.

To turn off the subtitles, push the "Hide Buttons" switch.

Push the "Back" switch to return to the previous screen.

The selected subtitle language will appear on the screen.

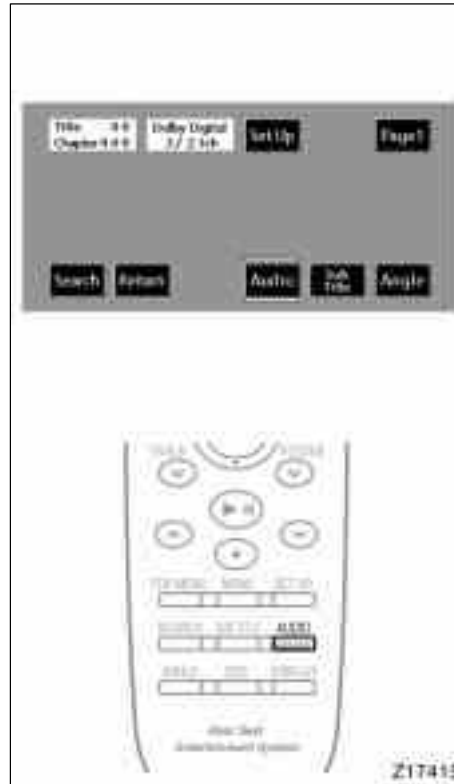

CHANGING AUDIO LANGUAGE

Push the "Audio" switch on the screen and then the changing audio language screen will appear. You can also display the screen by pushing the "AUDIO" button on the controller.

06 SIENNA_U (L/O 0603)



Each time you push the "Audio" switch, another language stored on the disc is selected.

To turn off the audio language screen, push the "Hide Buttons" switch.

Push the "Back" switch to return to the previous screen.

The selected audio language will appear on the screen.

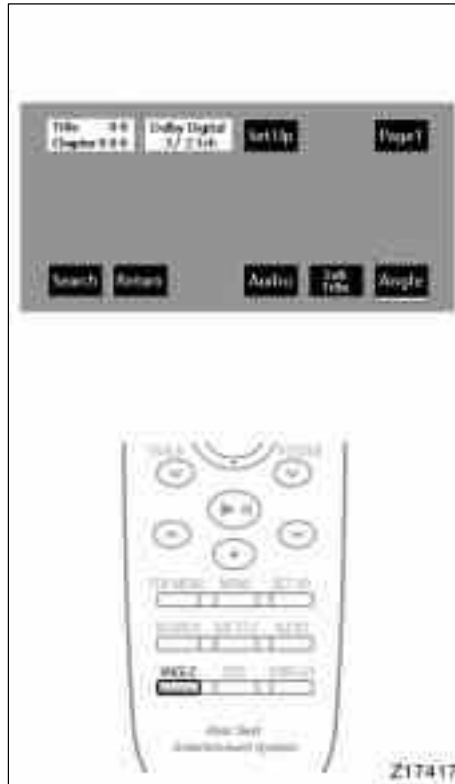

CHANGING ANGLE SCREEN

Push the "Angle" switch on the screen, and then the changing angle screen will appear. You can also display the screen by pushing the "ANGLE" button on the controller.

06 SIENNA_U (L/O 0603)



The angle can be selected for discs that are multi-angle compatible when the “” mark appears on the screen. Each time you push the “Angle” switch, the angle changes. The angle number which you can select will appear on the screen.

To turn off the screen, push the “Hide Buttons” switch.

Push the “Back” switch to return to the previous screen.

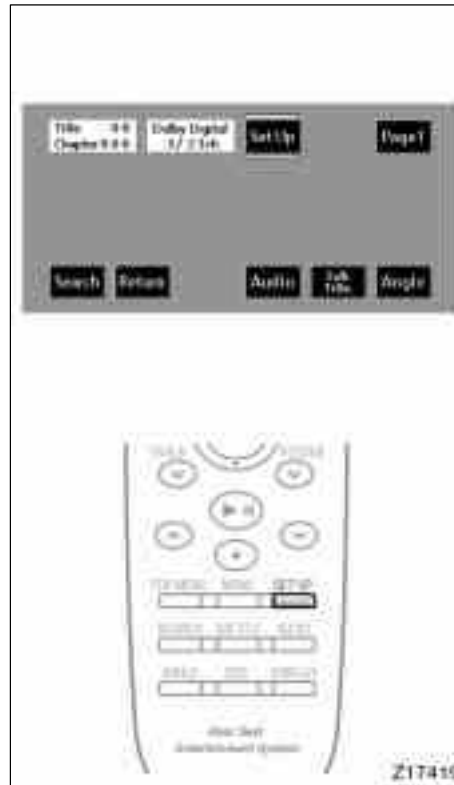

CHANGING THE INITIAL SETTING

Push the “Set Up” switch on the screen, and then the initial setting screen will appear. You can also display the screen by pushing the “SET UP” button on the controller. You can change the initial setting.

After the setting is done, the player plays from the beginning of the chapter or the track.

06 SIENNA_U (L/O 0603)

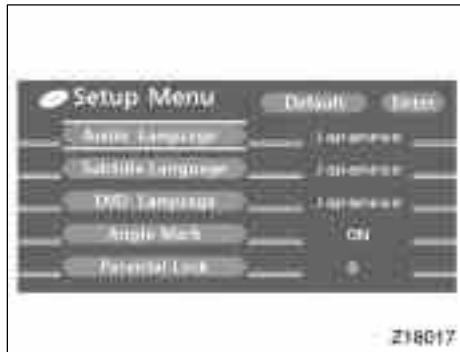

Setup Menu screen

There are initial setting switches on the "Setup Menu" screen.

After you change the initial setting, push the "Enter" switch. The initial setting switch will be turned off and return to the picture previously.

When the "Default" switch is pushed, all menus are initialized.

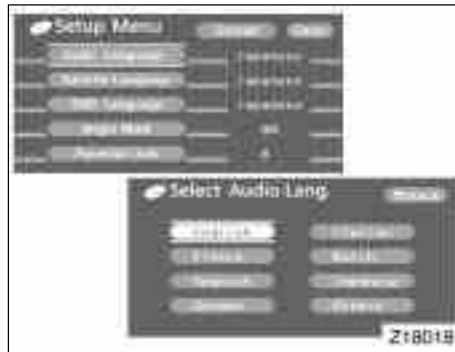

CHANGING THE AUDIO LANGUAGE

Push the "Audio Language" switch on the "Setup Menu" and the "Select Audio Lang." screen appears.

Select the language you want to hear by pushing the appropriate switch on the screen.

To return to the "Setup Menu" screen, push the "Back" switch.

If you cannot find the language you want to hear, push the "Others" switch. The "Enter Audio Lang. Code" screen will appear.



To select an audio language, use the joystick to enter the appropriate 4-digit language code. For details of the language codes, see the language code list.

If a code which is not on the list is entered and the "ENT" button is pushed, the "Incorrect Code" screen will appear. Enter the code of the language you want to hear again.

To return to the "Select Audio Lang." screen, push the "Back" switch.

06 SIENNA_U (L/O 0603)

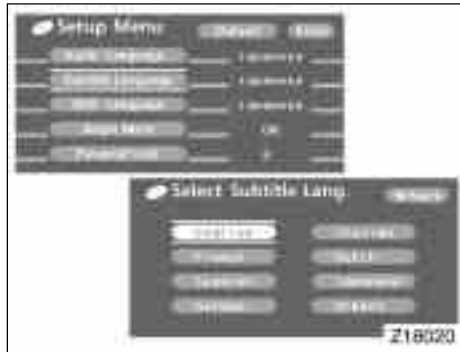

CHANGING THE SUBTITLE LANGUAGE

To display the “Select Subtitle Lang.” screen, push the “Subtitle Language” switch on the “Setup Menu” screen.

Select the language you want to read by pushing the appropriate switch on the screen.

To return to the “Setup Menu” screen, push the “Back” switch.

If you cannot find the language you want to read, push the “Others” switch. The “Enter Subtitle Lang. Code” screen will appear.

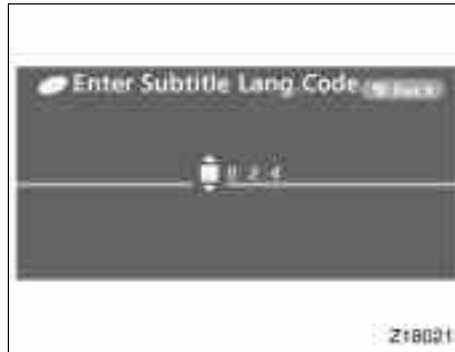

To enter the code of the language you want to read, use the joystick to enter the appropriate 4-digit language code. For details about the language codes, see the language code list.

Push the “ENT” button on the controller. If numbers which are not on the list are entered and the “ENT” button is pushed, the “Incorrect code” screen will appear. Enter the language code you want to read again.

To return to the “Select Subtitle Lang.” screen, push the “Back” switch on the screen.

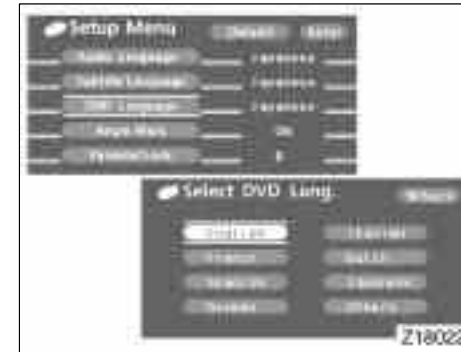

CHANGING THE DVD LANGUAGE

To display the “Select DVD Lang.” screen, push the “DVD Language” switch on the “Setup Menu” screen.

Select the language you want to read on the screen.

To return to the “Setup Menu” screen, push the “Back” switch.

If you cannot find a language you want to read, push the “Others” switch. The “Enter DVD Lang. Code” screen will appear.

06 SIENNA_U (L/O 0603)



To enter the code of the language you want to read, use the joystick to enter the appropriate 4-digit language code. For details about the language codes, see the language code list.

Push the “ENT” button on the controller. If numbers which are not on the list are entered and the “ENT” button is pushed, the “Incorrect code” screen will appear. Enter the language code you want to read again.

To return to the “Select DVD Lang.” screen, push the “Back” switch on the screen.



TURNING THE ANGLE MARK ON OR OFF

The angle mark can be turned on for discs that are multi-angle compatible.

Each time you push the “Angle Mark” switch on the screen, the angle mark turns on or off alternately.



SETTING LEVEL OF VIEWER RESTRICTIONS

You can restrict the play back screen by setting the viewer restrictions. You can prevent the restriction with a password. Some discs do not supply a restriction.

To set the level of viewer restriction, push the “Parental Lock” switch on the “Setup Menu” screen. The “Enter Personal Code” screen will appear.

06 SIENNA_U (L/O 0603)



Enter the password and push the “ENT” button. The “Select Restriction Level” screen will appear.

You cannot change the setting without inputting the password. When you forget or change the password, push the “◀” side of the joystick ten times to initialize the password.

To return to the “Setup Menu” screen, push the “Back” switch.



Push a parental level (1—8). The smaller the level number, the stricter the age limit. Push the “Back” switch to return to the “Setup Menu” screen.

SETTING THE DISPLAY MODE

Pushing the “SIZE” button on the controller causes the display modes to change sequentially as follows:

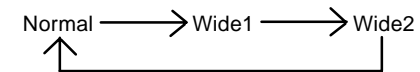

06 SIENNA_U (L/O 0603)

LANGUAGE CODE LIST

Code	Language
1001	Japanese
0514	English
0618	French
0405	German
0920	Italian
0519	Spanish
2608	Chinese
1412	Dutch
1620	Portuguese
1922	Swedish
1821	Russian
1115	Korean
0512	Greek
0101	Afar
0102	Abkhazian
0106	Afrikaans
0113	Amharic
0118	Arabic
0119	Assamese

0125	Aymara
0126	Azerbaijani
0201	Bashkir
0205	Byelorussian
0207	Bulgarian
0208	Bihari
0209	Bislama
0214	Bengali
0215	Tibetan
0218	Breton
0301	Catalan
0315	Corsican
0319	Czech
0325	Welsh
0401	Danish
0426	Bhutani
0515	Esperanto
0520	Estonian
0521	Basque
0601	Persian
0609	Finnish

0610	Fiji
0615	Faroese
0625	Frisian
0701	Irish
0704	Scots- Gaelic
0712	Galician
0714	Guarani
0721	Gujarati
0801	Hausa
0809	Hindi
0818	Croatian
0821	Hungarian
0825	Armenian
0901	Interlingua
0905	Interlingue
0911	Inupiak
0914	Indonesian
0919	Icelandic
0923	Hebrew
1009	Yiddish
1023	Javanese

06 SIENNA_U (L/O 0603)

1101	Georgian
1111	Kazakh
1112	Greenlandic
1113	Cambodian
1114	Kannada
1119	Kashmiri
1121	Kurdish
1125	Kirghiz
1201	Latin
1214	Lingala
1215	Laothian
1220	Lithuanian
1222	Latvian
1307	Malagasy
1309	Maori
1311	Macedonian
1312	Malayalam
1314	Mongolian
1315	Moldavian
1318	Marathi
1319	Malay

1320	Maltese
1325	Burmese
1401	Nauru
1405	Nepali
1415	Norwegian
1503	Occitan
1513	(Afan) Oromo
1518	Oriya
1601	Punjabi
1612	Polish
1619	Pashto, Pushto
1721	Quechua
1813	Rhaeto- Romance
1814	Kirundi
1815	Romanian
1823	Kinyarwanda
1901	Sanskrit
1904	Sindhi
1907	Sangho
1908	Serbo- Croatian
1909	Sinhalese

1911	Slovak
1912	Slovenian
1913	Samoan
1914	Shona
1915	Somali
1917	Albanian
1918	Serbian
1919	Siswati
1920	Sesotho
1921	Sundanese
1923	Swahili
2001	Tamil
2005	Telugu
2007	Tajik
2008	Thai
2009	Tigrinya
2011	Turkmen
2012	Tagalog
2014	Setswana
2015	Tonga
2018	Turkish

06 SIENNA_U (L/O 0603)

2019	Tsonga
2020	Tatar
2023	Twi
2111	Ukrainian
2118	Urdu
2126	Uzbek
2209	Vietnamese
2215	Volapük
2315	Wolof
2408	Xhosa
2515	Yoruba
2621	Zulu



USING THE CONTROL SCREEN

When playing a disc, push the “DVD” button on the controller. The status screen will appear on the screen.

SELECTING THE CHAPTER/TRACK

To select the chapter/track, push the “CHAPTER/TRACK ^” button or “CHAPTER/TRACK v” button on the controller until the number of the chapter/track you want to select appears on the screen.

—DVD player operation (video CD/audio CD/CD text/MP3)

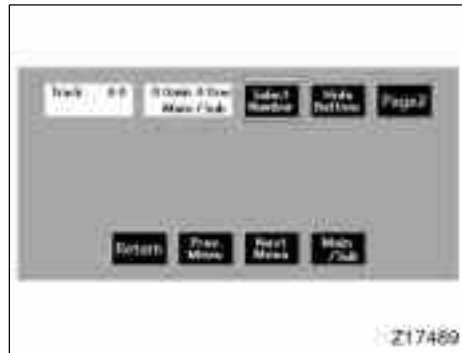

SELECTING THE DISC MENU NUMBER (video CD only)

Push the "Select Number" switch and then the disc menu number search screen will appear. You can also display the screen by pushing the "SEARCH" button on the controller.



Enter the disc menu number by using the joystick and push the "ENT" button. The player starts playing the disc from the entered disc menu number. The entered disc menu number will appear on the screen.

Push the "Back" switch to return to the menu screen.



OPERATING THE "▶||", "◀◀" AND "▶▶" SWITCHES (video CD only)

"▶||" switch: Push this switch to pause the disc or to cancel the pause and return to normal playing.

"◀◀" and "▶▶" switches: Push this switch to fast forward or reverse. If you want to return to the beginning of the current track, release the switch.

Video CD only—

Push the "▶▶" switch/button while pausing, the DVD video plays the slow-motion video replay.

06 SIENNA_U (L/O 0603)

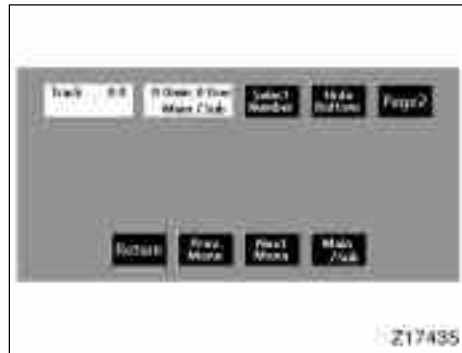

TURNING ON THE DISC MENU (video CD only)

Push the "Return" switch to turn on the menu screen for the disc.

For the operation of the menu screen, see the manual for the video CD.



CHANGING MENU PAGE OR TRACK (video CD only)

Push the "Next Menu" or "Prev. Menu" switch while the disc menu is displayed. The next or previous page will appear on the screen.

Push the "Next Menu" or "Prev. Menu" switch while the player is playing video. The next or previous track will be searched and played.

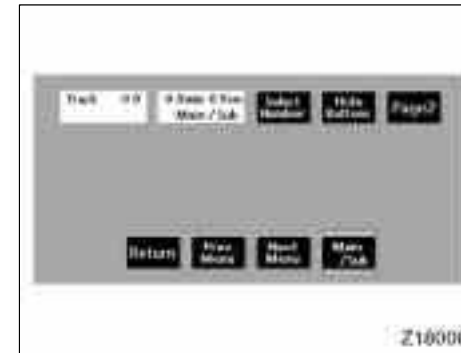

CHANGING A MULTIPLEX TRANSMISSION (video CD only)

Push the "Main/Sub" switch to change a multiplex transmission. The mode changes from Main/Sub to Main to Sub and back to Main/Sub by pushing the "Main/Sub" switch.

06 SIENNA_U (L/O 0603)

CHANGING THE INITIAL SETTING (video CD only)

Push the “Set Up” switch on the screen and then the initial setting screen will appear. You can also display the screen by pushing the “SET UP” button on the controller. You can change the initial setting. (See “CHANGING THE INITIAL SETTING” on page 280 in this Section for details.)

After the setting is done, the player plays from the beginning of the chapter or the track.



CD Text



CD MP3

USING THE CONTROL SCREEN

When playing a disc, push the “DVD” button on the controller. The control screen will appear on the screen.

CD text only—

The disc title and track title will appear on the screen when pushing the “DVD” button.

Details of the specific switches, controls and features are described below.

1. “RPT” switch (audio CD and CD text)

Push the “RPT” switch while the track is playing. When the track ends, it will automatically replay. To turn off the repeat feature, push this switch again.

2. “RAND” switch (audio CD and CD text)

Push the “RAND” switch. The player will play the tracks on the disc in random order. To turn off the random feature, push this switch again.

3. “SCAN” switch (audio CD and CD text)

Push the “SCAN” switch. The player will scan all the tracks on the disc. To stop scanning, push this switch again. When the player has scanned all the tracks on the disc, it will stop scanning.

06 SIENNA_U (L/O 0603)

MP3 only—

Folder and file names will appear on the screen when the “DVD” button is pushed.

The details of the specific switches, controls, and features are described below.

1. “RPT” switch

When the “RPT” switch is pushed while a track is played, the track file will be played repeatedly until the switch is pushed again. When the switch is pushed for at least 0.8 seconds, all the files in a folder will be played repeatedly. To turn off repeat play mode, push the switch again.

2. “RAND” switch

When the “RAND” switch is pushed, the files in a current folder will be played in random order. When the switch is pushed for at least 0.8 seconds, all the files in the disk will be played in random. To turn off random play mode, push the switch again.

3. “SCAN” switch

When the “SCAN” switch is pushed, all the files in a current folder will be scanned. Only the first 10 seconds of each file are played sequentially until all the files are scanned. When the switch is pushed for at least 0.8 seconds, the first 10 seconds of each initial file of all the folders in the disk will be played sequentially until the entire initial files are scanned. To stop scanning, push the switch again.

4. “FLD▲” switch

When the switch is pushed, the initial file of the next folder will be played.

5. “▼FLD” switch

When the switch is pushed, the initial file of the previous folder will be played.

6. “DETAIL” switch

When the switch is pushed while a track is played, the detailed file information of the track will be displayed.

—Screen adjustment

You can adjust the color, contrast, tone and brightness of the screen.

Push the “DISPLAY” button on the controller and the “Display” screen will appear.

The screen may turn purple to deflect the sunlight. This is not a malfunction.

06 SIENNA_U (L/O 0603)

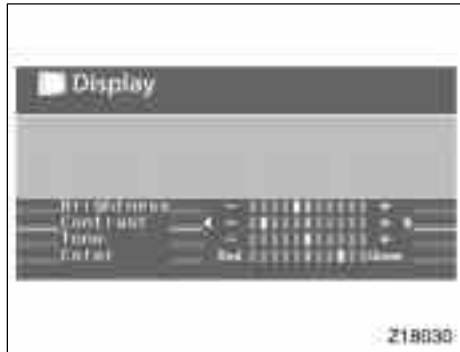

After adjusting the screen, push the “ENT” button or “DISPLAY” button to return to the previous screen.

Operate the joystick up and down to select Brightness, Contrast, Tone, or Color and left and right to make adjustments.

	- or “Red”	+ or “Green”
Brightness	Darkens	Brightens
Contrast	Weakens the contrast	Strengthens the contrast
Tone	Weakens the tone	Strengthens the tone
Color	Strengthens the red color	Strengthens the green color

—Selecting the video mode



The audio machine connected to the input terminal adapter can be played in the video mode.

To select the video mode, push the “VIDEO” button on the controller.

06 SIENNA_U (L/O 0603)







—DVD video disc information

DVD PLAYER AND DVD VIDEO DISCS

This DVD player conforms to NTSC color TV formats. DVD video discs conforming to other formats such as PAL or SECAM cannot be used.

Region codes: Some DVD video discs have a region code indicating where you can use. If the DVD video disc is not labeled "ALL" or "1", you cannot use it in this DVD player. If you attempt to play an inappropriate DVD video disc in this player, "REGION CODE ERROR" appears on the screen. Even if the DVD video disc does not have a region code, in some cases you cannot use it.

Marks shown on DVD video discs:

	Indicates NTSC format of color TV.
	Indicates the number of audio tracks.
	Indicates the number of language subtitles.
	Indicates the number of angles.
	Indicates the screen to be selected. Wide screen: 16:9 Standard: 4:3
	Indicates regions in which this video disc can be played. ALL: all countries Number: region code

DVD VIDEO DISC GLOSSARY

DVD video discs: Digital Versatile Disc that holds video. DVD video discs have adopted "MPEG2", one of the world standards of digital compression technologies. The picture data is compressed by 1/40 on average and stored. Variable rate encoded technology in which the volume of data assigned to the picture is changed depending on the picture format has also been adopted. Audio data is stored using PCM and Dolby digital, which enables higher quality of sound. Furthermore, multi-angle and multi-language features will also help you enjoy the more advanced technology of DVD video.

Viewer restrictions: This feature limits what can be viewed in conformity with the level of restrictions of the country. The level of restrictions varies depending on the DVD video disc. Some DVD video discs cannot be played at all, or violent scenes are skipped or replaced with other scenes.

Level 1: DVD video discs for children can be played.

Level 2—7: DVD video discs for children and G-rated movies can be played.

Level 8: All types of DVD video discs can be played.

Multi-angle feature: You can enjoy the same scene at different angles.

Multi-language feature: You can select the language of the subtitles and audio.

Region codes: Region codes are provided on DVD players and DVD discs. If the DVD video disc does not have the same region code as the DVD player, you cannot play the disc on the DVD player. For region codes, see page 293.

Audio: This DVD player can play liner PCM, Dolby digital, dts and MPEG audio format DVD. Other decoded type cannot be played.

Title and chapter: Video and audio programs stored on DVD video discs are divided in parts by title and chapter.

Title: The largest unit of the video and audio programs stored on DVD video discs. Usually, one piece of a movie, one album, or one audio program is assigned as a title.

Chapter: A unit smaller than a title. A title comprises plural chapters.

Manufactured under license from Dolby Laboratories. "Dolby", "Pro Logic", and the double-D symbol are trademarks of Dolby Laboratories. Confidential unpublished works.

©1992-1997 Dolby Laboratories. All rights reserved.

This product incorporates copyright protection technology that is protected by method claims of certain U.S. patents and other intellectual property rights owned by Macrovision Corporation and other rights owners. Use of this copyright protection technology must be authorized by Macrovision Corporation, and is intended for home and other limited viewing uses only unless otherwise authorized by Macrovision Corporation. Reverse engineering or disassembly is prohibited.

"dts" is a trademark of Digital Theater Systems, Inc.

—A/V input adapter

The rear entertainment system plays videos and sound when an audio-video equipment is connected to the A/V input adapter. For details, refer to the manufacturer's instructions.

06 SIENNA_U (L/O 0603)

—Power outlet

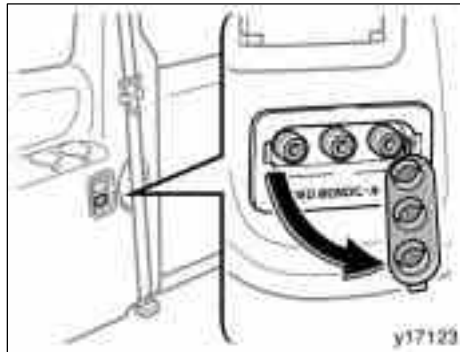

To use the adapter, open the cover.
The A/V input adapter is composed of 3 input adapters.

Yellow: Image input adapter
Red: Audio input adapter
White: Audio input adapter

NOTICE

Close the cover when the A/V input adapter is not in use. Inserting a foreign object other than the appropriate plug may cause electrical failure or short circuit.

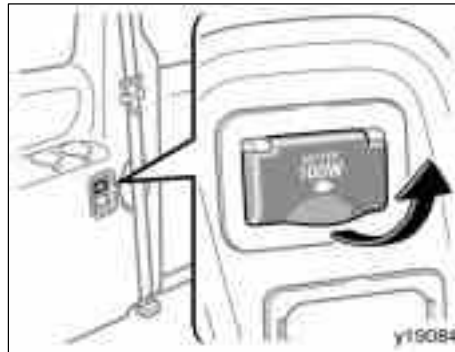

This power outlet is designed for use as a power supply for the audio device connected to the input terminal adapter.

The key must be in the "ON" position for the power outlet to be used.

The maximum capacity for this power outlet is 115 VAC/100W. If you attempt to use an appliance that requires more than 115 VAC or 100W, the protection circuit will activate and cut the power supply. The power supply will restart automatically when you use an appliance that operates within the 115 VAC/100W limits.

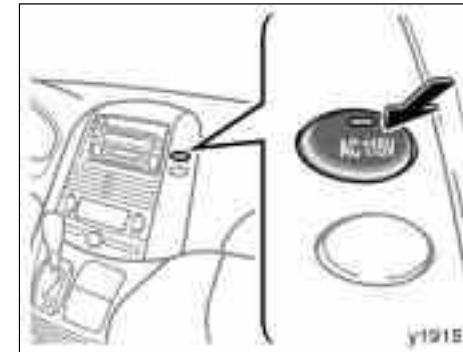

To use the power outlet, push the main switch on the instrument panel.

An indicator light will illuminate to indicate that the power outlet is ready for use.

Push the main switch once again to turn the power outlet off. When the power outlet is not in use, make sure that the main switch is turned off.

NOTICE

- ◆ *To prevent the battery from being discharged, do not use the power outlet longer than necessary when the engine is not running.*
- ◆ *Close the power outlet lid when the power outlet is not in use. Inserting a foreign object other than the appropriate plug that fits the outlet may cause electrical failure or short circuit.*

The power outlet is not designed for the following electric appliances even if their power consumption is under 115 VAC/100W. These appliances may not operate properly.

- Appliances with high initial peak wattage: cathode-ray tube type televisions, compressor-driven refrigerators, electric pumps, electric tools, etc.
- Measuring devices which process precise data: medical equipment, measuring instruments, etc.

- Other appliances requiring an extremely stable power supply: microcomputer-controlled electric blankets, touch sensor lamps, etc.
- Certain electrical appliances may cause radio noise.

—Headphone jacks

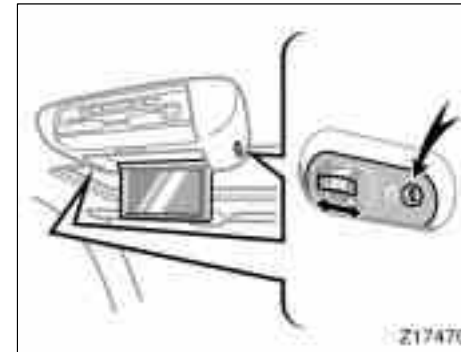

You can enjoy the rear seat entertainment system with commercial headphones.

To use the headphones, connect them to the jack.

The key must be in the “ACC” or “ON” position.

To adjust the volume of the headphones, turn the dial.

Left side dial: Turn it upward to increase the volume, turn it downward to decrease the volume.

Right side dial: Turn it downward to increase the volume, turn it upward to decrease the volume.

The maximum volume depends on the type of headphones.

The recommended headphone impedance is from 16 Ω to 32 Ω .

Please contact your Toyota dealer for further details.

 CAUTION
Adjust the volume when you connect the headphones to the jack. Loud sounds may have a significant impact on the human body.

Audio/video system operating hints

NOTICE
To ensure correct audio/video system operation:
◆ <i>Be careful not to spill beverages over the system.</i>
◆ <i>Do not put anything other than a compact disc into the slot.</i>
◆ <i>Do not put anything other than a DVD video, DVD audio, video CD, dts-CD or audio CD into the DVD player.</i>
◆ <i>The use of a cellular phone inside or near the vehicle may cause a noise from the speakers of the system which you are listening to. However, this does not indicate a malfunction.</i>

RADIO RECEPTION

Usually, a problem with radio reception does not mean there is a problem with your radio—it is just the normal result of conditions outside the vehicle.

For example, nearby buildings and terrain can interfere with FM reception. Power lines or telephone wires can interfere with AM signals. And of course, radio signals have a limited range. The farther you are from a station, the weaker its signal will be. In addition, reception conditions change constantly as your vehicle moves.

Here are some common reception problems that probably do not indicate a problem with your radio:

FM

Fading and drifting stations—Generally, the effective range of FM is about 40 km (25 miles). Once outside this range, you may notice fading and drifting, which increase with the distance from the radio transmitter. They are often accompanied by distortion.

Multi-path—FM signals are reflective, making it possible for two signals to reach your antenna at the same time. If this happens, the signals will cancel each other out, causing a momentary flutter or loss of reception.

Static and fluttering—These occur when signals are blocked by buildings, trees, or other large objects. Increasing the bass level may reduce static and fluttering.

Station swapping—If the FM signal you are listening to is interrupted or weakened, and there is another strong station nearby on the FM band, your radio may tune in the second station until the original signal can be picked up again.

AM

Fading—AM broadcasts are reflected by the upper atmosphere—especially at night. These reflected signals can interfere with those received directly from the radio station, causing the radio station to sound alternately strong and weak.

Station interference—When a reflected signal and a signal received directly from a radio station are very nearly the same frequency, they can interfere with each other, making it difficult to hear the broadcast.

Static—AM is easily affected by external sources of electrical noise, such as high tension power lines, lightning, or electrical motors. This results in static.

CARING FOR YOUR COMPACT DISC PLAYER, DVD PLAYER AND DISCS

- Extremely high temperatures can keep your compact disc player and DVD player from working. On hot days, use the air conditioning to cool the vehicle interior before you use the players.
- Bumpy roads or other vibrations may make your compact disc player and DVD player skip.
- If moisture gets into your compact disc player and DVD player, the players may not play even though they appear to be working. Remove the disc from the player and wait until it dries.





Compact disc player

- Use only compact discs marked as shown above. The following products may not be playable on your compact disc player.
 - SACD
 - dts- CD
 - Copy-protected CD
 - CD- R (CD- Recordable)
 - CD- RW (CD- Re- writable)
 - CD- ROM

CAUTION

Compact disc players and DVD players use an invisible laser beam which could cause hazardous radiation exposure if directed outside the unit. Be sure to operate the players correctly.

06 SIENNA_U (L/O 0603)

Audio CDs	
DVD video discs	
Video CDs	

DVD player

- Use only discs marked as shown above. The following products may not be playable on your DVD player.

SACD
 Copy-protected CD
 CD-R (CD-Recordable)
 CD-RW (CD-Re-writable)
 CD-ROM
 DVD-R
 DVD+R
 DVD+RW
 DVD-RW
 DVD-ROM
 DVD-RAM

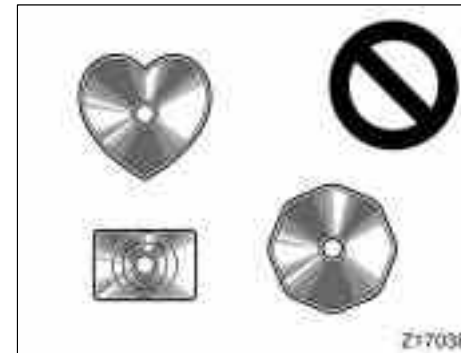

Special shaped discs

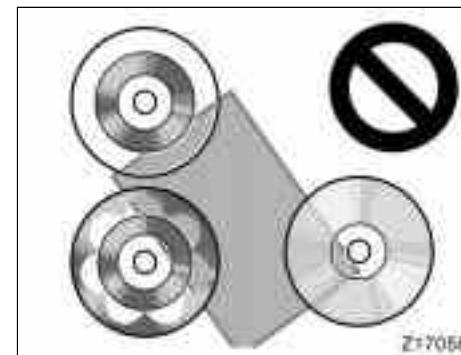

Transparent/translucent discs

06 SIENNA_U (L/O 0603)

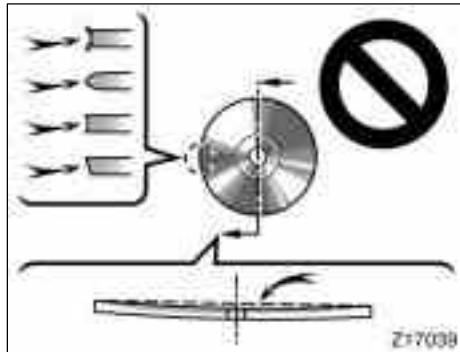

Low quality discs

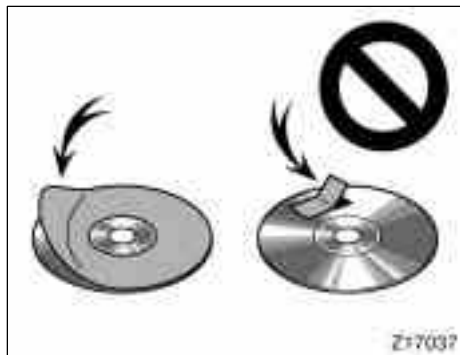

Labeled discs

NOTICE

Do not use special shaped, transparent/translucent, low quality or labeled discs such as those shown in the illustrations. The use of such discs may damage the player or changer, or it may be impossible to eject the disc.

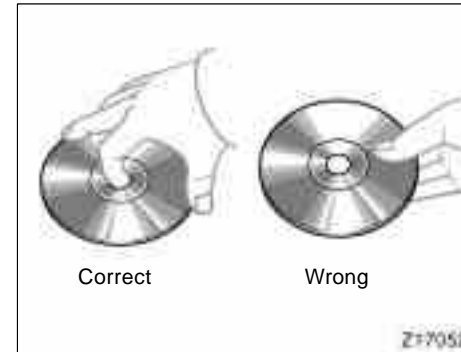

- Handle the discs carefully, especially when you are inserting them. Hold them on the edge and do not bend them. Avoid getting fingerprints on them, particularly on the shiny side.
- Dirt, scratches, warping, pin holes, or other disc damage could cause the player to skip or to repeat a section of a chapter or track. (To see a pin hole, hold the disc up to the light.)
- Remove discs from the compact disc player when you are not playing them. Store them in their plastic cases away from moisture, heat, and direct sunlight.



To clean a disc: Wipe it with a soft, lint-free cloth that has been dampened with water. Wipe in a straight line from the center to the edge of the disc (not in circles). Dry it with another soft, lint-free cloth. Do not use a conventional record cleaner or anti-static device.

MP3/WMA FILES

- MP3 (MPEG Audio Layer 3) and WMA (Windows Media Audio) are audio compression standards.
- The MP3/WMA player can play MP3 and WMA files on CD-ROM, CD-R and CD-RW discs.
The unit can play disc recordings compatible with ISO 9660 level 1 and level 2 and with the Romeo and Joliet file system.
- When naming an MP3 or WMA file, add the appropriate file extension (.mp3 or .wma).
- The MP3/WMA player plays back files with .mp3 or .wma file extensions as MP3 or WMA files. To prevent noise and playback errors, use the appropriate file extensions.
- Multi-session compatible CDs can also be played.
- MP3 files are compatible with the ID3 Tag Ver. 1.0, Ver. 1.1, Ver. 2.2, and Ver. 2.3 formats. The unit cannot display disc title, track title and artist name in other formats.

- WMA files can contain a WMA tag that is used in the same way as an ID3 tag. WMA tags carry information such as track title, artist name.
- The emphasis function is available only when playing MP3/WMA files recorded at 32, 44.1 and 48 kHz. (The system can play MP3 files with sampling frequencies of 16, 22.05, and 24 kHz. However, the emphasis function is not available for files recorded at these frequencies.)
- The sound quality of MP3/WMA files generally improves with higher bit rates. In order to achieve a reasonable level of sound quality, discs recorded with a bit rate of at least 128 kbps are recommended.

Playable bit rates

MP3 files:

MPEG1 LAYER3—64 to 320 kbps

MPEG2 LSF LAYER3—64 to 160 kbps

WMA files:

Ver. 7, 8 CBR—48 to 192 kbps

Ver. 9 CBR—48 to 320 kbps

06 SIENNA_U (L/O 0603)

- The MP3/WMA player does not play back MP3/WMA files from discs recorded using packet write data transfer (UDF format). Discs should be recorded using “pre-mastering” software rather than packet-write software.
- M3u playlists are not compatible with the audio player.
- MP3i (MP3 interactive) and MP3PRO formats are not compatible with the audio player.
- The MP3 player is compatible with VBR (Variable Bit Rate).
- When playing back files recorded as VBR (Variable Bit Rate) files, the play time will not be correctly displayed if fast-forward or reverse operations are used.
- It is not possible to check folders that do not include MP3/WMA files.
- MP3/WMA files in folders up to 8 levels deep can be played. However, the start of playback may be delayed when using discs containing numerous levels of folders. For this reason, we recommend creating discs with no more than two levels of folders.
- It is possible to play up to 192 folders or 255 files on one disc.

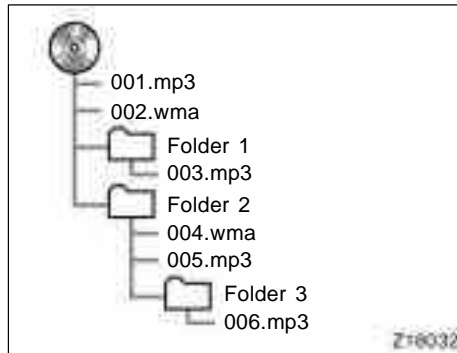

- The play order of the compact disc with the structure shown on the left is as follows:

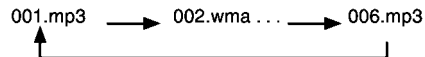

CD-R and CD-RW discs

- CD-R/CD-RW discs that have not been subject to the “finalizing process” (a process that allows discs to be played on a conventional CD player) cannot be played.
- It may not be possible to play CD-R/CD-RW discs recorded on a music CD recorder or a personal computer because of disc characteristics, scratches or dirt on the disc, or dirt, condensation, etc. on the lens of the unit.
- It may not be possible to play discs recorded on a personal computer depending on the application settings and the environment. Record with the correct format. (For details, contact the appropriate application manufacturers of the applications.)
- CD-R/CD-RW discs may be damaged by direct exposure to sunlight, high temperatures or other storage conditions. The unit may be unable to play some damaged discs.
- If you insert a CD-RW disc into the MP3/WMA player, playback will begin more slowly than with a conventional CD or CD-R disc.

06 SIENNA_U (L/O 0603)

- Recordings on CD-R/CD-RW cannot be played using the DDCD (Double Density CD) system.

TERMS

Packet write—

This is a general term that describes the process of writing data on-demand to CD-R, etc., in the same way that data is written to floppy or hard discs.

ID3 Tag—

This is a method of embedding track-related information in an MP3 file. This embedded information can include the track title, the artist's name, the album title, the music genre, the year of production, comments and other data. The contents can be freely edited using software with ID3 tag editing functions. Although the tags are restricted to the number of characters, the information can be viewed when the track is played back.

WMA Tag—

WMA files can contain a WMA tag that is used in the same way as an ID3 tag. WMA tags carry information such as track title, artist name.

ISO 9660 format—

This is the international standard for the formatting of CD-ROM folders and files. For the ISO 9660 format, there are two levels of regulations.

Level 1:

The file name is in 8.3 format (8 character file names, with a 3 character file extension. File names must be composed of one-byte capital letters and numbers. The “_” symbol may also be included.)

Level 2:

The file name can have up to 31 characters (including the separation mark “.” and file extension). Each folder must contain fewer than 8 hierarchies.

m3u—

Playlists created using “WINAMP” software have a playlist file extension (.m3u).

MP3—

MP3 is an audio compression standard determined by a working group (MPEG) of the ISO (International Standard Organization). MP3 compresses audio data to about 1/10 the size of that on conventional discs.

WMA—

WMA (Windows Media Audio) is an audio compression format developed by Microsoft. It compresses files into a size smaller than that of MP3 files. The decoding formats for WMA files are Ver. 7, 8, and 9.

06 SIENNA_U (L/O 0603)

SECTION 1-9

OPERATION OF INSTRUMENTS AND CONTROLS

Air conditioning system

Front manual air conditioning system

Controls	306
Air flow selector settings	309
Operating tips	309

Front automatic air conditioning system

Controls	312
Air flow selector settings	315
Operating tips	315

Side vents	317
------------------	-----

Rear manual air conditioning system

Controls	318
Air flow selector settings	319

Rear automatic air conditioning system

Controls	320
Air flow selector settings	322

Air conditioning filter	322
-------------------------------	-----

06 SIENNA_U (L/O 0603)

Front manual air conditioning system— —Controls

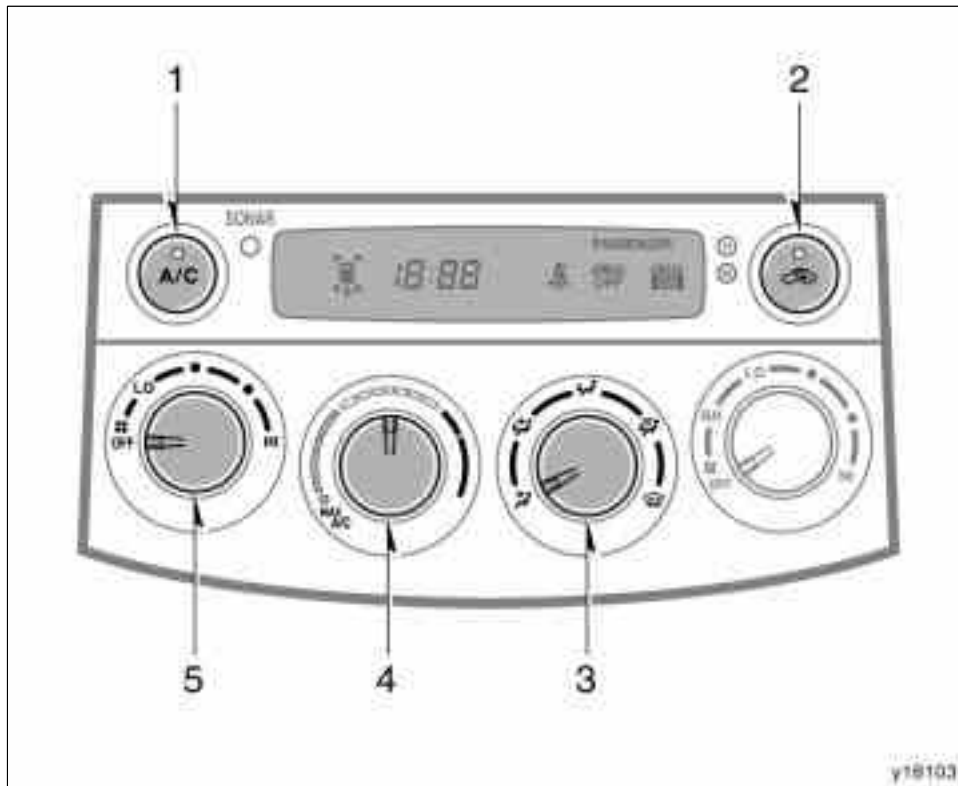

1. "A/C" button
2. Air intake selector
3. Air flow selector
4. Temperature selector
5. Fan speed selector

06 SIENNA_U (L/O 0603)

Fan speed selector

Turn the knob to adjust the fan speed—to the right to increase, to the left to decrease.

Temperature selector

Turn the knob to adjust the temperature—to the right to warm, to the left to cool.

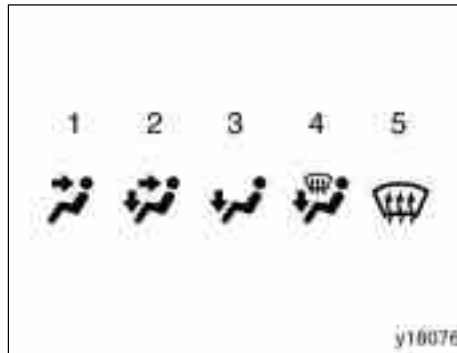

Air flow selector

Turn the knob to select the vents used for air flow.

- 1. Panel**—Air flows from the instrument panel vents.
- 2. Bi-level**—Air flows from both the floor vents and the instrument panel vents.
- 3. Floor**—Air flows mainly from the floor vents.
- 4. Floor/Windshield**—Air flows mainly from the floor vents and windshield vents.

Turning the air flow selector to the floor/windshield position turns on the defogging function with the purpose of clearing the front view.

This position allows the air intake to select FRESH automatically. This is to clean up the front view more quickly.

If you want to return the setting to RECIRCULATE mode, press the air intake selector button once again.

- 5. Windshield**—Air flows mainly from the windshield vents.

Turning the air flow selector to the windshield position turns on the defogging function with the purpose of clearing the front view.

This position allows the air intake to select FRESH automatically. This is to clean up the front view more quickly. It is not possible to select RECIRCULATE in this position.

For details about air flow selector settings, see “—Air flow selector settings” described below.

06 SIENNA_U (L/O 0603)

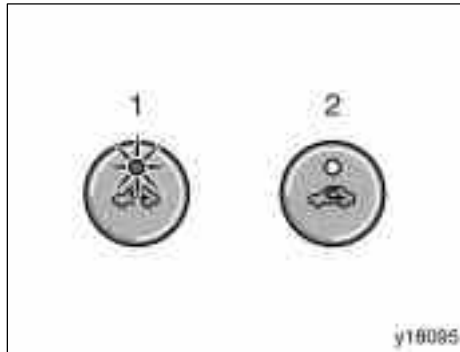

Air intake selector

Press the button to select the air source.

- 1. Recirculate**—Recirculates the air inside the vehicle.
- 2. Fresh**—Draws outside air into the system.

To prevent fogging up of the windshield, the air intake mode may change automatically to FRESH depending on the condition of the air conditioning system.

If the ambient temperature drops, the air intake mode will automatically change from RECIRCULATE to FRESH after a few minutes. This automatic change control mode can be cancelled by pushing and holding the button for longer than 2 seconds. The automatic change control mode will be reactivated if the ignition key is turned to the "LOCK" or "ACC" position.

"A/C" button

To turn on the air conditioning, press the "A/C" button. The "A/C" button indicator will come on. To turn the air conditioning off, press the button again.

06 SIENNA_U (L/O 0603)

—Air flow selector settings

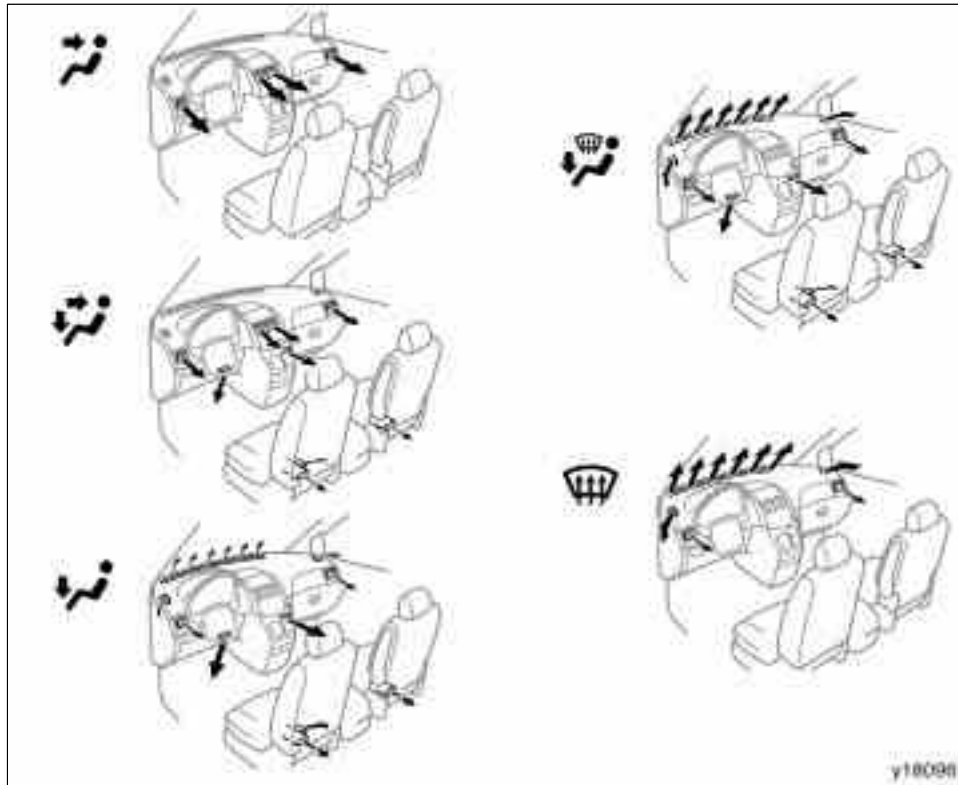

—Operating tips

- To cool off your Toyota after it has been parked in the hot sun, drive with the windows open for a few minutes. This vents the hot air, allowing the air conditioning to cool the interior more quickly.
- Make sure the air intake grilles in front of the windshield are not blocked (by leaves or snow, for example).
- On humid days, do not blow cold air on the windshield. The windshield could fog up because of the difference in air temperature on the inside and outside of the windshield.
- Keep the area under the front seats clear to allow air to circulate throughout the vehicle.
- On cold days, set the fan speed to high for a minute to help clear the intake ducts of snow or moisture. This can reduce the amount of fogging on the windows.
- When driving on dusty roads, close all windows. If dust thrown up by the vehicle is still drawn into the vehicle after closing the windows, it is recommended that the air intake selector be set to FRESH and the fan speed selector to any setting except "OFF".

06 SIENNA_U (L/O 0603)

- If following another vehicle on a dusty road, or driving in windy and dusty conditions, it is recommended that the air intake selector be temporarily set to RECIRCULATE, which will close off the outside passage and prevent outside air and dust from entering the vehicle interior.

Heating

For best results, set controls to:

Fan speed—Any setting except “OFF”
Temperature—Towards **WARM**
(red zone)
Air intake—**FRESH** (outside air)
Air flow—**FLOOR**
Air conditioning—**OFF**

- For quick heating, select recirculated air for a few minutes. To keep the windows from fogging, select fresh after the vehicle interior has been warmed.
- Press the “A/C” button on for dehumidified heating.
- Choose floor/windshield air flow to heat the vehicle interior while defrosting or defogging the windshield.

Air conditioning

For best results, set controls to:

Fan speed—Any setting except “OFF”
Temperature—Towards **COLD**
(blue zone)
Air intake—**FRESH** (outside air)
Air flow—**PANEL**
Air conditioning—**ON**

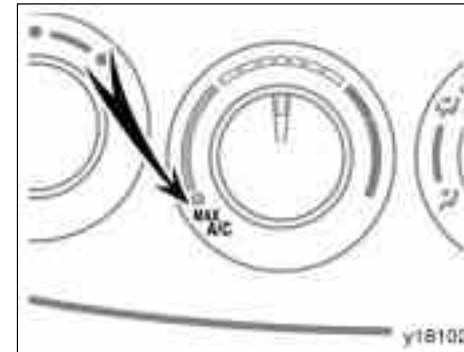

For quick cooling, turning the temperature selector knob fully towards COLD changes the air intake selector mode to RECIRCULATE. It is not possible to return to FRESH and to turn the air conditioning system off in this position.

06 SIENNA_U (L/O 0603)

Ventilation

For best results, set controls to:

Fan speed—Any setting except “OFF”
Temperature—Towards **COLD**
(blue zone)
Air intake—**FRESH** (outside air)
Air flow—**PANEL**
Air conditioning—**OFF**

Defogging

—The inside of the windshield

For best results, set controls to:

Fan speed—Any setting except “OFF”
Temperature—Towards **WARM**
(red zone) to heat;
COLD (blue zone) to
cool
Air flow—**WINDSHIELD**

Turning the air flow selector to the windshield or floor/windshield position turns on the defogging function with the purpose of clearing the front view.

When turning the air flow selector to the windshield or floor/windshield position, the air intake selects FRESH automatically. This is to clean up the front view more quickly. It is not possible to return to RECIRCULATE in this position.

- On humid days, do not blow cold air on the windshield—the difference between the outside and inside temperatures could make the fogging worse.

Defrosting

—The outside of the windshield

For best results, set controls to:

Fan speed—Any setting except “OFF”
Temperature—Towards **WARM**
(red zone)
Air flow—**WINDSHIELD**

Turning the air flow selector to the windshield or floor/windshield position turns on the defrosting function with the purpose of clearing the front view.

When turning the air flow selector to the windshield or floor/windshield position, the air intake selects FRESH automatically. This is to clean up the front view more quickly. It is not possible to return to RECIRCULATE in this position.

- To heat the vehicle interior while defrosting the windshield, choose floor/windshield air flow.

06 SIENNA_U (L/O 0603)

Front automatic air conditioning system— —Controls

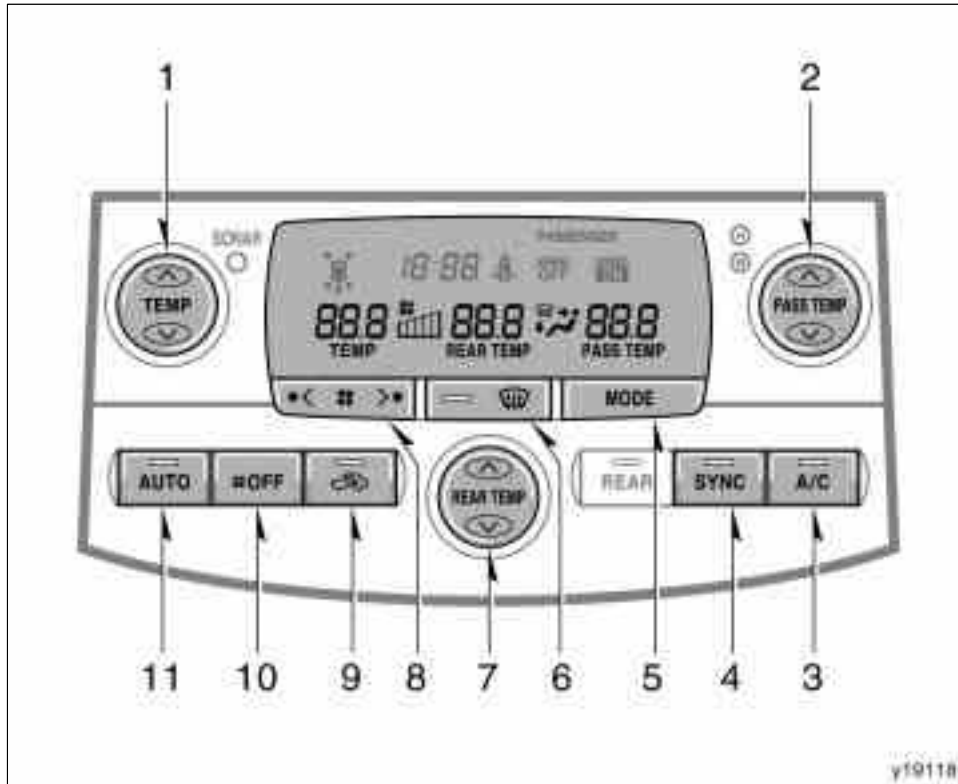

1. Temperature selector (“TEMP”) (with “SYNC” button indicator on—simultaneous setting on driver, front passenger and rear passenger sides) (with “SYNC” button indicator off—individual setting on driver side only)
2. Temperature selector (“PASS TEMP”) (individual setting on front passenger side only)
3. “A/C” button
4. “SYNC” button (with button indicator on—simultaneous temperature setting) (with button indicator off—individual temperature setting)
5. “MODE” button (air flow selector)
6. Windshield air flow button
7. Temperature selector (“REAR TEMP”) (individual setting on rear passenger side only)
8. Fan speed selector
9. Air intake selector
10. “OFF” button
11. “AUTO” button

06 SIENNA_U (L/O 0603)

“AUTO” button

For automatic operation of the air conditioning, press the “AUTO” button. An indicator light will illuminate to show that the automatic operation mode has been selected.

In the automatic operation mode, the air conditioning selects the most suitable fan speed, air flow, air intake and on-off of the air conditioning according to the temperature.

When you adjust the temperature selector button to maximum cooling, “LO” will appear on the display and the air intake mode will be automatically changed to RECIRCULATE.

You may use manual controls if you want to select your own settings.

Fan speed selector

Push the “>” (increase) or “<” (decrease) side of the button to adjust the fan speed.

In the automatic operation mode, the fan speed is adjusted automatically unless you desire another fan speed mode.

“SYNC” button

Push the button to change the mode of the temperature setting.

With the indicator on—Simultaneous temperature setting

With the indicator off—Individual temperature setting

With the indicator on, the rear air conditioning is turned on. However, controls on the rear control panel cannot be used. To cancel this function, push the “SYNC” button.

For details about the rear air conditioning, see “Rear automatic air conditioning system” on page 320 in this Section.

Temperature selectors

To increase the temperature, press the “^” side. To decrease it, press the “v” side.

“LO” appears when you adjust to maximum cooling, and “HI” appears when you adjust to maximum warming.

—“TEMP” button

With the “SYNC” button indicator on—This button changes the temperature on the driver side, front passenger side and rear passenger side simultaneously.

This function will be cancelled when the “PASS TEMP” or “REAR TEMP” button is pushed.

With the “SYNC” button indicator off—This button changes the temperature on the driver side only.

—“PASS TEMP” button

This button changes the temperature on the front passenger side only.

—“REAR TEMP” button

This button changes the temperature on the rear passenger side only when the rear air conditioning is turned on.

For details about the rear air conditioning, see “Rear automatic air conditioning system” on page 320 in this Section.

The temperature display changes between “°C” and “°F” when the unit of the outside temperature display is changed. (For details, see “Multi-information display” on page 326 in Section 1-10.)

“OFF” button

Push the button to turn off the air conditioning system.

06 SIENNA_U (L/O 0603)

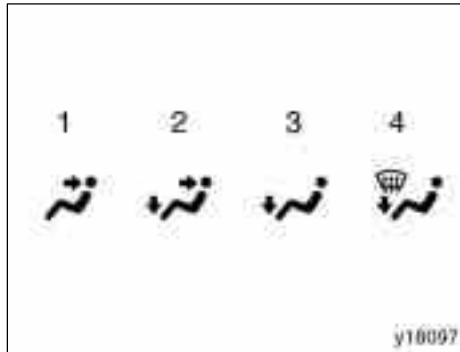

“MODE” button (air flow selector)

Push the “MODE” button to select the vents used for air flow.

In the automatic operation mode, the air flow mode is selected automatically among Panel, Bi-level, Floor and Floor/Windshield unless you desire another air flow mode.

1. **Panel**—Air flows from the instrument panel vents.
2. **Bi-level**—Air flows from both the floor vents and the instrument panel vents.
3. **Floor**—Air flows mainly from the floor vents.
4. **Floor/Windshield**—Air flows mainly from the floor vents and windshield vents.

314

Windshield air flow button

When this button is pressed, air flows mainly from the windshield vents and turns on the defogging function with the purpose of clearing the front view.

Pressing this button once again returns the air flow mode to the last one used.

This button allows the air intake to select FRESH automatically. This is to clean up the front view more quickly. It is not possible to return to RECIRCULATE in this mode.

For details about air flow selector settings, see “—Air flow selector settings” described below.

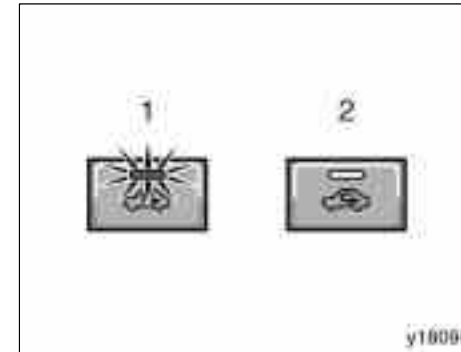

Air intake selector

Press the button to select the air source.

1. **Recirculate**—Recirculates the air inside the vehicle.
2. **Fresh**—Draws outside air into the system.

To prevent fogging up of the windshield, the air intake mode may change automatically to FRESH depending on the condition of the air conditioning system.

“A/C” button

To turn on the air conditioning, press the “A/C” button. The “A/C” button indicator will come on. To turn the air conditioning off, press the button again.

06 SIENNA_U (L/O 0603)

—Air flow selector settings

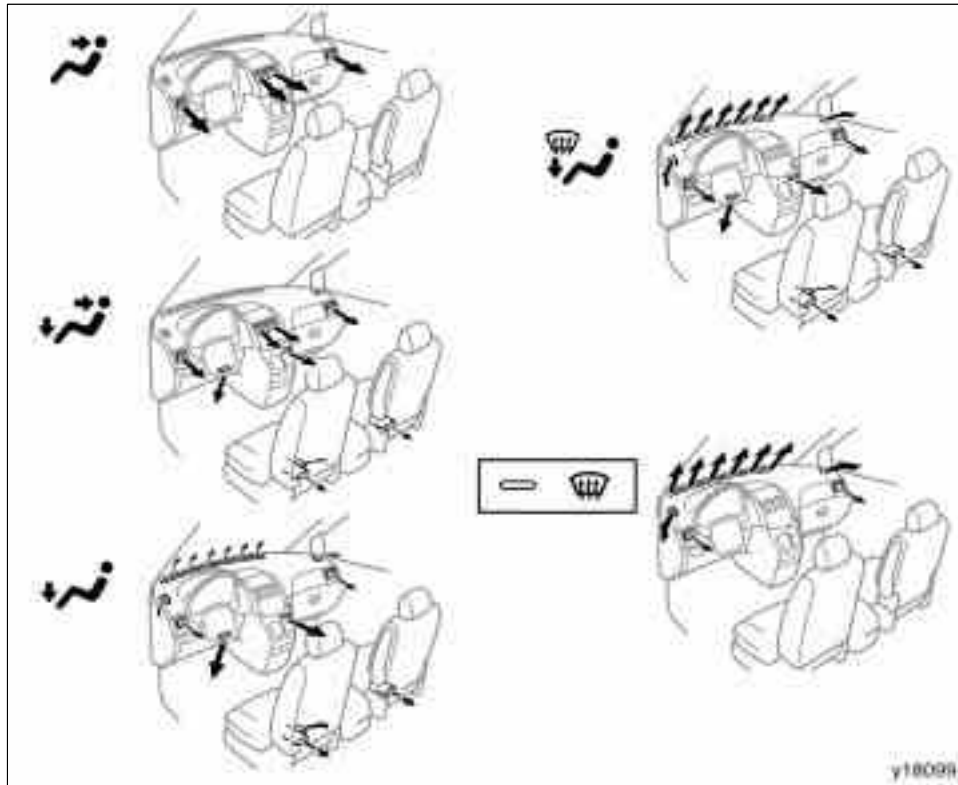

—Operating tips

- To cool off your Toyota after it has been parked in the hot sun, drive with the windows open for a few minutes. This vents the hot air, allowing the air conditioning to cool the interior more quickly.
- Make sure the air intake grilles in front of the windshield are not blocked (by leaves or snow, for example).
- On humid days, do not blow cold air on the windshield. The windshield could fog up because of the difference in air temperature on the inside and outside of the windshield.
- Keep the area under the front seats clear to allow air to circulate throughout the vehicle.
- On cold days, set the fan speed selector to adjust the fan speed high for a minute to help clear the intake ducts of snow or moisture. This can reduce the amount of fogging on the windows.
- When driving on dusty roads, close all windows. If dust thrown up by the vehicle is still drawn into the vehicle after closing the windows, it is recommended that the air intake selector be set to FRESH and the fan speed selector to any setting.

06 SIENNA_U (L/O 0603)

- If following another vehicle on a dusty road, or driving in windy and dusty conditions, it is recommended that the air intake selector be temporarily set to RECIRCULATE, which will close off the outside passage and prevent outside air and dust from entering the vehicle interior.

AUTOMATIC OPERATION

Press in the "AUTO" button.
Temperature—To the desired temperature

MANUAL OPERATION

For best results, set controls to:

Heating

Fan speed—To the desired fan speed
Temperature—Towards high temperature
Air intake—FRESH (outside air)
Air flow—FLOOR
Air conditioning—OFF

- For quick heating, select recirculated air for a few minutes. To keep the windows from fogging, select fresh after the vehicle interior has been warmed.
- Press the "A/C" button on for dehumidified heating.
- Choose floor/windshield air flow to heat the vehicle interior while defrosting or defogging the windshield.

Air conditioning

Fan speed—To the desired fan speed
Temperature—Towards low temperature
Air intake—FRESH (outside air)
Air flow—PANEL
Air conditioning—ON

- For quick cooling, select recirculated air for a few minutes.

Ventilation

Fan speed—To the desired fan speed
Temperature—Towards low temperature
Air intake—FRESH (outside air)
Air flow—PANEL
Air conditioning—OFF

06 SIENNA_U (L/O 0603)

Defogging

—The inside of the windshield

For best results, set controls to:

Fan speed—To the desired fan speed
Temperature—Towards high temperature to heat; low temperature to cool
Air flow—WINDSHIELD

Pressing the windshield air flow button turns on the defogging function with the purpose of clearing the front view.

When pressing the windshield air flow button, the air intake selects FRESH automatically. This is to clean up the front view more quickly. It is not possible to return to RECIRCULATE in this position.

- On humid days, do not blow cold air on the windshield—the difference between the outside and inside temperatures could make the fogging worse.

Defrosting

—The outside of the windshield

For best results, set controls to:

Fan speed—To the desired fan speed
Temperature—Towards high temperature
Air flow—WINDSHIELD

Pressing the windshield air flow button turns on the defrosting function with the purpose of clearing the front view.

When pressing the windshield air flow button, the air intake selects FRESH automatically. This is to clean up the front view more quickly. It is not possible to return to RECIRCULATE in this position.

- To heat the vehicle interior while defrosting the windshield, choose floor/windshield air flow.

Side vents

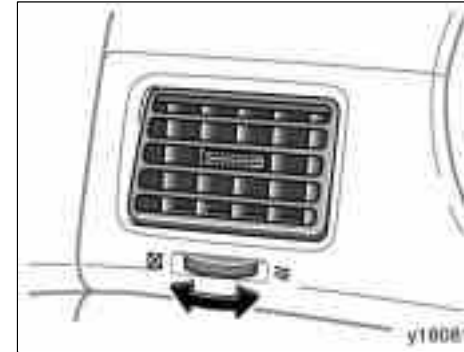

If air flow control is not satisfactory, check the side vents. The side vents may be opened or closed as shown.

06 SIENNA_U (L/O 0603)

Rear manual air conditioning system— —Controls

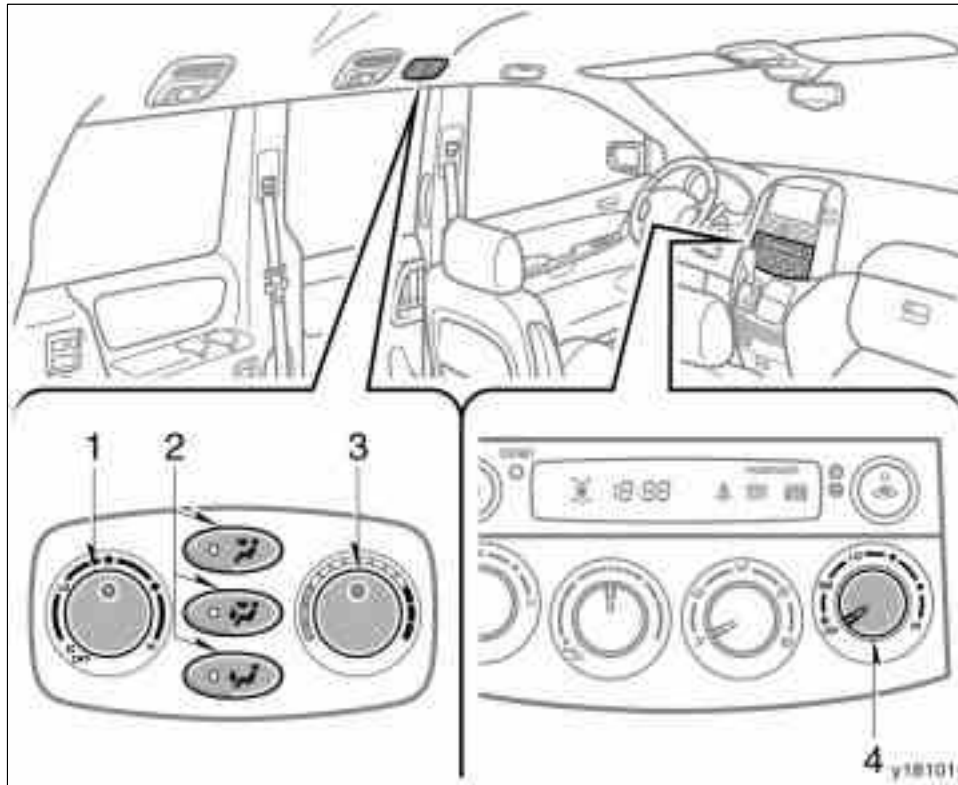

1. Fan speed selector (rear)
2. Air flow selectors
3. Temperature selector
4. Fan speed selector (front)

06 SIENNA_U (L/O 0603)

Fan speed selector (front)

This selector knob is used to turn the rear air conditioning system on/off and adjust the fan speed.

In the "REAR" position, you can operate the system by the rear controllers.

Turn the knob to adjust the fan speed—to the right to increase, to the left to decrease.

Turning the knob to the "OFF" position turns the system off and it cannot be operated by the rear controllers.

Fan speed selector (rear)

When the front fan speed selector is in the "REAR" position, you can operate the rear fan speed selector.

Turn the knob to adjust the fan speed—to the right to increase, to the left to decrease.

Temperature selector

Turn the knob to adjust the temperature—to the right to warm, to the left to cool.

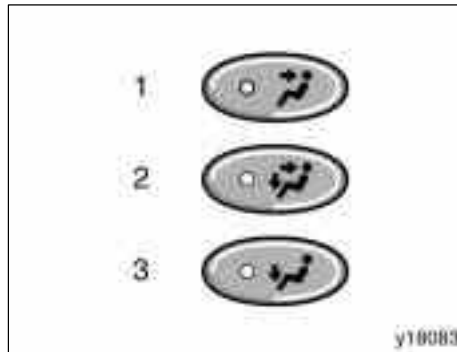

Air flow selectors

Push the button to select the vents used for air flow.

1. **Panel**—Air flows from the roof panel vents.
2. **Bi-level**—Air flows from both the roof panel vents and floor vent.
3. **Floor**—Air flows from the floor vent.

—Air flow selector settings

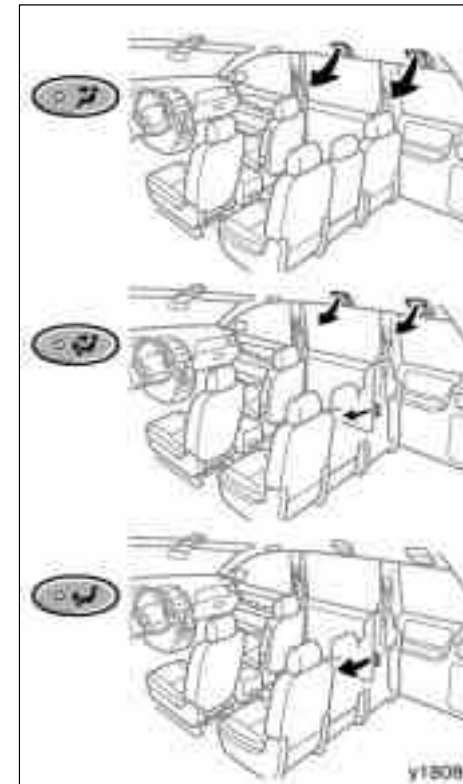

06 SIENNA_U (L/O 0603)

Rear automatic air conditioning system— —Controls

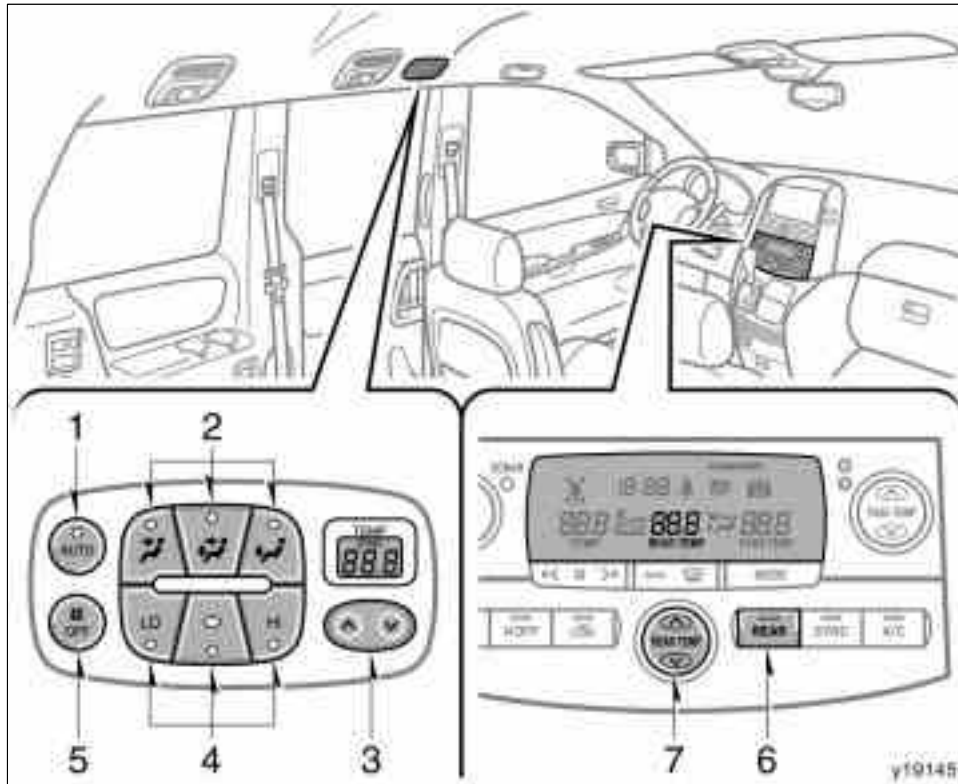

1. "AUTO" button
2. Air flow selectors
3. Temperature selector (rear)
4. Fan speed selectors
5. "OFF" button
6. "REAR" button
7. Temperature selector (front)

06 SIENNA_U (L/O 0603)

“AUTO” button

For automatic operation of the rear air conditioning, press the “AUTO” button. An indicator light will illuminate to show that the automatic operation mode has been selected.

In the automatic operation mode, the air conditioning selects the most suitable fan speed and air flow according to the temperature.

You may use manual controls if you want to select your own settings.

Fan speed selectors

Push the button to select the fan speed mode.

In the automatic operation mode, the fan speed is adjusted automatically unless you desire another fan speed mode.

Temperature selectors

To increase the temperature, press the “^” side. To decrease it, press the “v” side.

“LO” appears when you adjust to maximum cooling, and “HI” appears when you adjust to maximum warming.

When “SYNC” appears on the rear temperature display, rear controls cannot be used. Use the controls on the front control panel. To cancel this function, push the “SYNC” button. For details about the “SYNC” button, see “Front automatic air conditioning system” on page 312 in this Section.

The temperature display changes between “°C” and “°F” when the unit of the outside temperature display is changed. (For details, see “Multi-information display” on page 326 in Section 1-10.)

“REAR” button

To turn on the rear air conditioning system using the front control panel, push the button. To turn it off, push the button again.

“OFF” button

Push the button to turn off the rear air conditioning system.

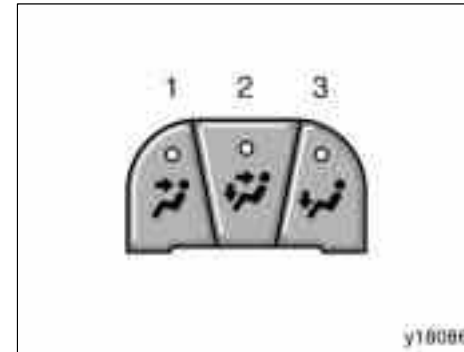

Air flow selectors

Push the button to select the vents used for air flow.

- 1. Panel**—Air flows from the roof panel vents.
- 2. Bi-level**—Air flows from both the roof panel vents and floor vent.
- 3. Floor**—Air flows from the floor vent.

—Air flow selector settings

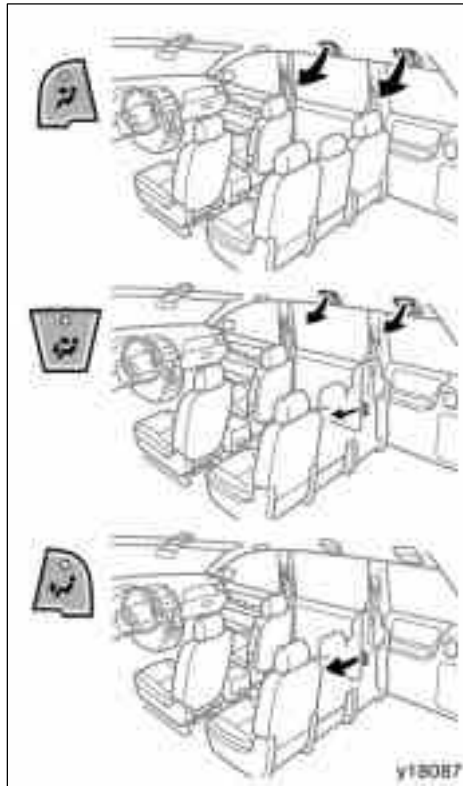

Air conditioning filter—

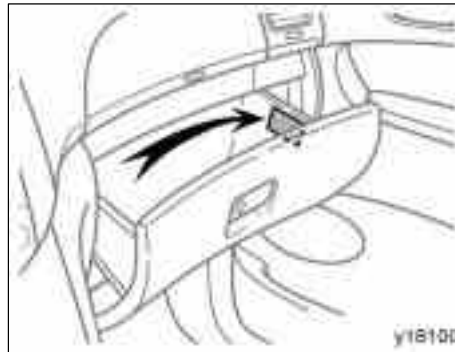

The air conditioning filter information label is placed on the right side of the glove box as shown and indicates that a filter has been installed.

The air conditioning filter prevents dust from entering the vehicle through the air conditioning vent.

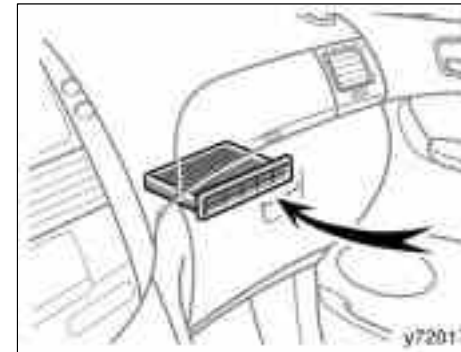

The air conditioning filter is behind the glove box.

06 SIENNA_U (L/O 0603)

—Checking and replacing the air conditioning filter

The air conditioning filter may clog after long use. The filter may need to be replaced if the air flow of the air conditioning and heater experiences extreme reductions in operating efficiency, or if the windows begin to fog up easily.

To maintain the air conditioning efficiency, inspect and replace the air conditioning filter according to the maintenance schedule. In dusty areas or areas with heavy traffic flow, such as inner city or desert areas, early replacement may be required. (For scheduled maintenance information, please refer to the “Scheduled Maintenance Guide” or “Owner’s Manual Supplement”.)



1. Open the glove box, and slide off the damper as shown.

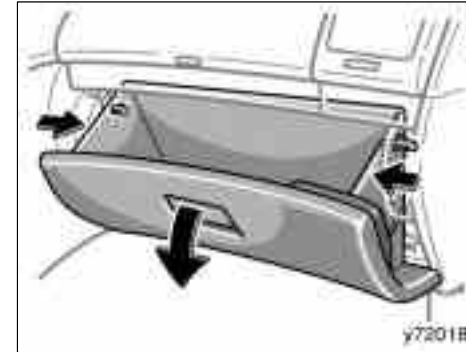

2. Push in each side of the glove box to disconnect the claws.

06 SIENNA_U (L/O 0603)

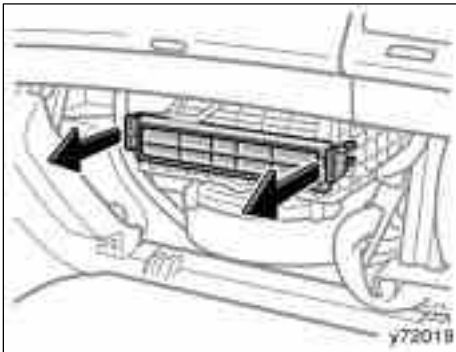

3. Remove the filter case from the filter outlet as shown in the illustration.

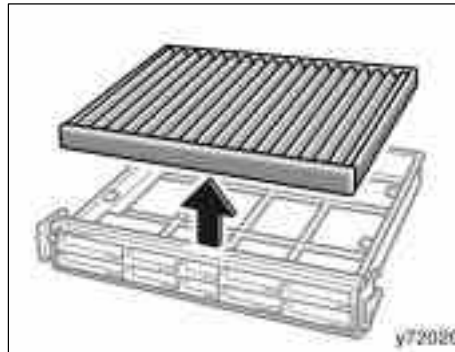

4. Remove the filter from the filter case.

5. Inspect the filter on the surface.

If it is dirty, it should be replaced.

INFORMATION

The air filter should be installed properly in position. The use of air conditioning with the air filter removed may cause deteriorated dustproof performance and then affect air conditioning performance.

SECTION 1- 10

OPERATION OF INSTRUMENTS AND CONTROLS

Other equipment

Multi- information display	326
Clock	338
Conversation mirror	339
Toyota park assist system	340
Rear view monitor system	348
Power outlets	351
Glove box	354
Garage door opener box	354
Auxiliary boxes	357
Coin holder	359
Cup holders	359
Bottle holders	361
Storage box	362
Removable console box	362
Note pad holder	367
Front seat side table	368
Coat hooks	369
Grocery bag hooks	369
Cargo net hooks	370
Tie- down hooks	371
Roof luggage carrier	372
Sun shade	373
Floor mat	373

06 SIENNA_U (L/O 0603)

Multi-information display—

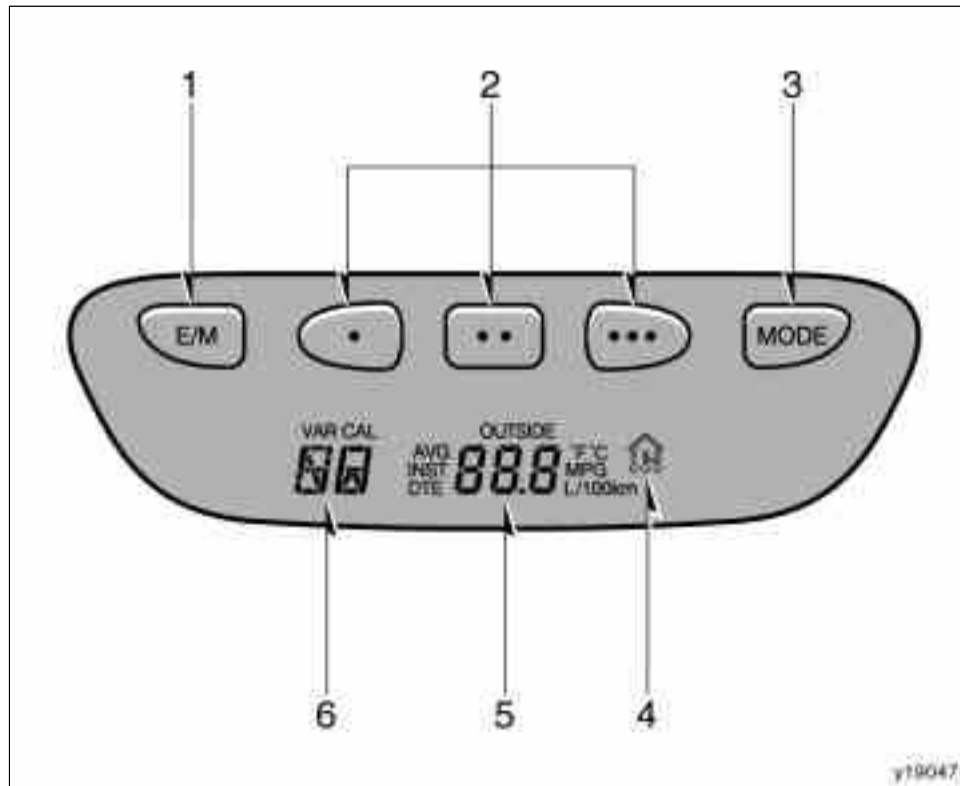

1. "E/M" button
2. Garage door opener buttons
3. "MODE" button
4. Garage door opener indicator
5. Outside temperature and cruise information display
6. Compass

06 SIENNA_U (L/O 0603)

—Before using the multi-information display

Operate the multi-information display with the ignition switch on.

When the ignition switch is turned to "ON", the last previously used mode displayed just before the ignition switch is turned off will appear.

When the instrument panel lights are turned on, the brightness of the display will be reduced.

"E/M" button

This button is used to switch between English/U.S. Customary System and metric units.

Each time you push this button, the display switches. This is also linked to the front and rear air conditioning displays. The display variations are as follows;

Indication	Outside temperature	Instantaneous fuel consumption/ Average fuel consumption	Distance to empty
English/U.S. Customary System (E)	°F	MPG	MI
Metric (M)	°C	L/100 km	km

“MODE” button

This button is used to select the item.

Every time you push the “MODE” button, the display toggles.

For more details, see “—Outside temperature and cruise information display” on page 332.

 **CAUTION**

Do not adjust the display while the vehicle is moving. Be sure to adjust the display only when the vehicle is stopped.

—Garage door opener

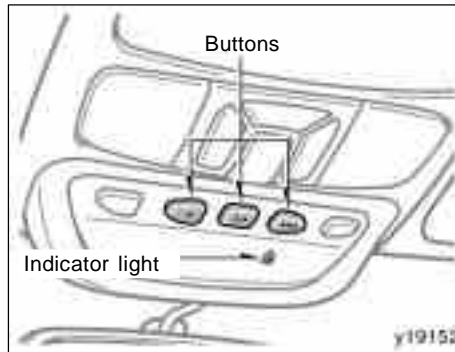

The garage door opener (**HomeLink® Universal Transceiver**) is manufactured under license from HomeLink® and can be programmed to operate garage doors, gates, entry doors, door locks, home lighting systems, and security systems, etc.

(a) Programming the HomeLink®

The HomeLink® in your vehicle has 3 buttons and you can store one program for each button.

To ensure correct programming into the HomeLink®, install a new battery in the hand-held transmitter prior to programming.

The battery side of the hand-held transmitter must be pointed away from the HomeLink® during the programming process.

For Canadian users, follow the procedure in “Programming an entrance gate/Programming all devices in the Canadian market”.

1. Decide which of 3 HomeLink® buttons you want to program. Push and hold down one of the buttons until the indicator corresponding to the selected channel begins to flash.

06 SIENNA_U (L/O 0603)

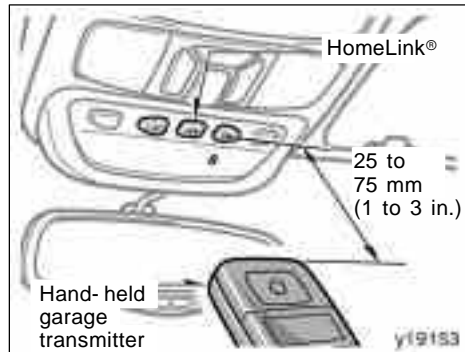

2. Place your hand-held garage transmitter 25 to 75 mm (1 to 3 in.) away from the surface of the HomeLink®.

Keep the indicator light on the HomeLink® in view while programming.



3. Simultaneously press and hold the hand-held garage transmitter button along with the selected HomeLink® button.

Do not release the buttons until step 4 has been completed.

4. When the indicator light on the HomeLink® changes from a slow to a rapid flash after 20 seconds, you can release both buttons.

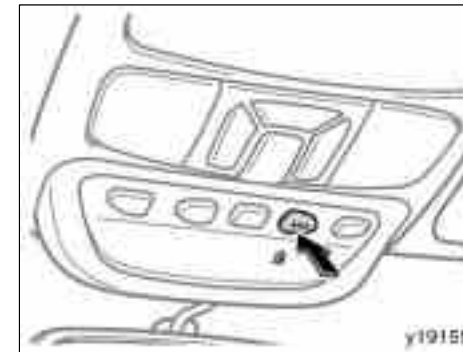

5. Test the operation of the HomeLink® by pressing the newly programmed button. If programming a garage door opener, check to see if the garage door opens and closes.

If the garage door does not operate, identify if your garage transmitter is of the "Rolling Code" type. Press and hold the programmed HomeLink® button. The garage door has the rolling code feature if the indicator light (on the HomeLink®) flashes rapidly and then remains lit after 2 seconds. If your garage transmitter is the "Rolling Code" type, proceed to the heading "Programming a rolling code system".

06 SIENNA_U (L/O 0603)

6. Repeat steps 2 through 5 for each remaining HomeLink[®] button to program another device.

Programming a rolling code system

If your device is “Rolling Code” equipped, it is necessary to follow steps 1 through 4 under the heading “Programming the HomeLink[®]” before proceeding with the steps listed below.

1. Locate the “training” button on the ceiling mounted garage door opener motor. The exact location and color of the button may vary by brand of garage door opener. Refer to the owner’s guide supplied by the garage door opener manufacturer for the location of this “training” button.
2. Press the “training” button on the ceiling mounted garage door opener motor.

Following this step, you have 30 seconds in which to initiate step 3 below.

3. Press and release the vehicle’s programmed HomeLink[®] button twice. The garage door may open. If the door does open, the programming process is complete. If the door does not open, press and release the button a third time. This third press and release will complete the programming process by opening the garage door.

The ceiling mounted garage door opener motor should now recognize the HomeLink[®] unit and be able activate the garage door up/down.

4. Repeat steps 1 through 3 for each remaining HomeLink[®] button to program another rolling code system.

Programming an entrance gate/programming all devices in the Canadian market

1. Decide which of the 3 HomeLink[®] buttons you want to program.
2. Place your hand-held gate/device transmitter 25 to 75 mm (1 to 3 in.) away from the surface of the HomeLink[®].

Keep the indicator light on the HomeLink[®] in view while programming.

3. Press and hold the selected HomeLink[®] button.
4. Continuously press and release (cycle) the hand-held gate/device transmitter button every two seconds until step 5 is complete.
5. When the indicator light on the HomeLink[®] changes from a slow to a rapid flash after 20 seconds, you can release both buttons.

6. Test the operation of the HomeLink[®] by pressing the newly programmed button. Check to see if the gate/device operates correctly.

7. Repeat steps 1 through 6 for each remaining HomeLink[®] button to program another device.

Programming other devices

To program other devices such as home security systems, home door locks or lighting, contact your authorized Toyota dealer for assistance.

Reprogramming a button

Individual HomeLink[®] buttons cannot be erased, however, to reprogram a single button, follow the procedure “Programming the HomeLink[®]”.

(b) Operating the HomeLink[®]

To operate the HomeLink[®], press the appropriate HomeLink[®] button to activate the programmed device. The HomeLink[®] indicator light should come on. The HomeLink[®] continues to send the signal for up to 20 seconds as long as the button is pressed.

06 SIENNA_U (L/O 0603)

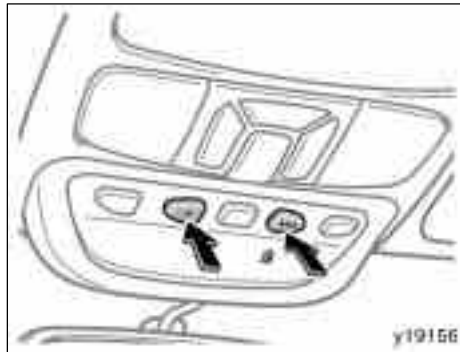

(c) Erasing the entire HomeLink® memory (all three programs)

To erase all previously programmed codes at one time, press and hold down the 2 outside buttons for 20 seconds until the indicator light flashes.

If you sell your vehicle, be sure to erase the programs stored in the HomeLink® memory.

For additional programming assistance with your HomeLink® Universal Transceiver call the:

- Toyota Customer Experience Center at 1-800-331-4331 (U.S.A.)
- Toyota Canada Customer Interaction Centre at 1-888-869-6828 (Canada)

Refer to HomeLink® on the internet at: WWW.HOMELINK.COM

CAUTION

- When programming the HomeLink® Universal Transceiver, you may be operating a garage door or other device. Make sure people and objects are out of the way of the garage door or other device to prevent potential harm or damage.
- Do not use this HomeLink® Universal Transceiver with any garage door opener that lacks the safety stop and reverse feature as required by federal safety standards. (This includes any garage door opener model manufactured before April 1, 1982.) A garage door opener which cannot detect an object (signaling the door to stop and reverse), does not meet current federal safety standards. Using a garage door opener without these features increases risk of serious injury or death.

06 SIENNA_U (L/O 0603)

—Outside temperature and cruise information display

This device complies with Part 15 of the FCC Rules and with RSS-210 of the IC Rules. Operation is subject to the following two conditions: (1) This device may not cause harmful interference, and (2) this device must accept any interference received, including interference that may cause undesired operation.

WARNING: This transmitter has been tested and complies with FCC and IC rules. Changes or modifications not expressly approved by the party responsible for compliance could void the user's authority to operate the device.

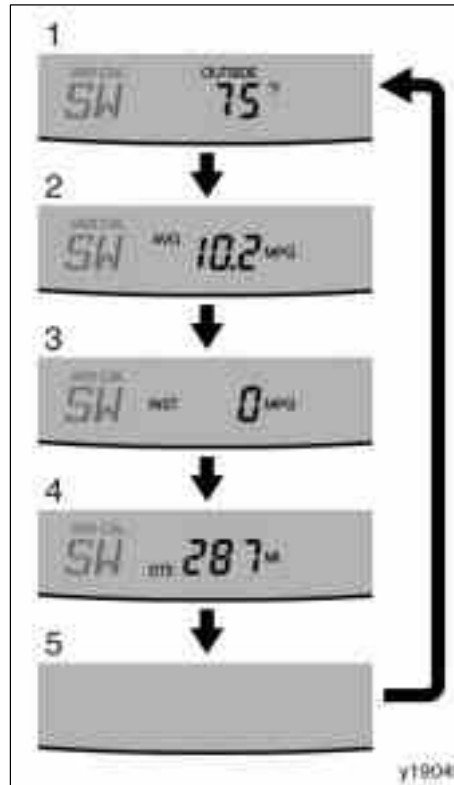

The outside temperature and cruise information display indicates the following information.

1. Outside temperature
2. Average fuel consumption
3. Instantaneous fuel consumption
4. Distance to empty
5. Display off (no compass)

Every time you push the "MODE" button, the display toggles through this information.

During the off mode, the compass display is also turned off.

The displayed values in the cruise information display indicate general driving conditions. Accuracy varies with driving habits and road conditions.

To set the unit, push the "E/M" button until the desired unit display appears. (At this time, front and rear air conditioning displays also change.)

06 SIENNA_U (L/O 0603)

1. Outside temperature (“OUTSIDE °C” or “OUTSIDE °F”)

The outside temperature display indicates the outside air temperature.

The displayed value is updated every 1 second.

The displayed temperature ranges from -30°C (-22°F) up to 50°C (122°F).

If an abnormality exists in the connection of the outside air temperature sensor, “- - °C” (“- - °F”) will appear on the display. If “- - °C” (“- - °F”) appears on the display, contact your Toyota dealer.

There may be a case that “- - °C” (“- - °F”) appears momentarily when the ignition is quickly turned to “ON”. It is normal if it goes out soon.

2. Average fuel consumption (“AVG MPG” or “AVG L/100 km”)

Average fuel consumption is calculated and displayed based on total driving distance and total fuel consumption with the engine running.

The displayed value is updated every 1 seconds.

To reset the calculations, return the mode to “AVG” and push and hold the “MODE” and “E/M” button simultaneously for 2 seconds.

3. Instantaneous fuel consumption (“INST MPG” or “INST L/100 km”)

The instantaneous fuel consumption is calculated and displayed based on distance and fuel consumption for 1 seconds with the engine running.

The displayed value is updated every 2 seconds.

Note that an accurate figure may not be shown in the following cases.

- The vehicle is stopped with the engine running. (The display will indicate the extremely high fuel consumption.)
- The vehicle is driving down a long slope applying the engine brake. (The display will indicate the extremely low fuel consumption.)

The calculation is reset when the ignition switch is turned off.

4. Distance to empty (“DTE MI” or “DTE km”)

The distance the vehicle can travel with the remaining fuel is calculated and displayed based on the quantity of remaining fuel and past fuel consumption.

The displayed value is updated every 1 second.

Every time you refuel the vehicle, the calculation is reset.

The actual driving range varies with driving habits and road conditions. If fuel consumption is good, the driving range will be longer. If fuel consumption is poor, the driving range will be shorter.

—Compass



The compass indicates the direction that the vehicle is heading. In the above case, it shows that the vehicle is heading south.

The direction display is updated every 2 seconds.

Displays	Directions
N	North
NE	Northeast
E	East
SE	Southeast
S	South
SW	Southwest
W	West
NW	Northwest

The compass may not show the correct direction in the following conditions:

- The vehicle is stopped immediately after turning.
The compass does not adjust while the vehicle is stopped.
- The ignition switch is turned off immediately after turning.
- The vehicle is on an inclined surface.
- The vehicle is in a place where the earth's magnetic field is subject to interference by artificial magnetic fields (underground parking, under a steel tower, between buildings, roof parking, near a crossing, near a large vehicle, etc.).
- The vehicle is magnetized. (There is a magnet or a metal object on or near the roof.)
- The battery has been disconnected.

The compass works to calibrate the direction automatically while the vehicle is in motion, if deviation is small.

For additional precision or for complete calibrating, see "CALIBRATING THE COMPASS" below.

If the direction is not indicated or the system does not operate properly, contact your Toyota dealer.

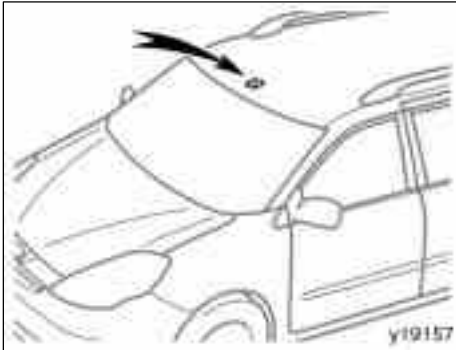

The compass sensor is on the roof of the vehicle.

NOTICE

Do not put magnets or a metal object on or near the roof of the vehicle. Doing this may cause malfunction of the compass sensor.

CALIBRATING THE COMPASS (deviation calibration)

The direction display on the compass deviates from the true direction determined by the earth's magnetic field. The angle of deviation varies according to the geographic position of the vehicle.

To adjust for this deviation;

1. Stop the vehicle in a level place and switch the display to the outside temperature. (To switch to this mode, see "—Outside temperature and cruise information display" on page 332.)
2. Push and hold both the "MODE" and "E/M" buttons simultaneously for 5 seconds until the "VAR" indication appears on the compass display.
3. Push the "E/M" button several times until the desired zone number appears on the compass display.

If the button is not pushed for 10 seconds, the display returns to the compass/outside temperature mode and the number that is last set is memorized.

To select the zone where the vehicle is currently located, refer to the following map.

06 SIENNA_U (L/O 0603)

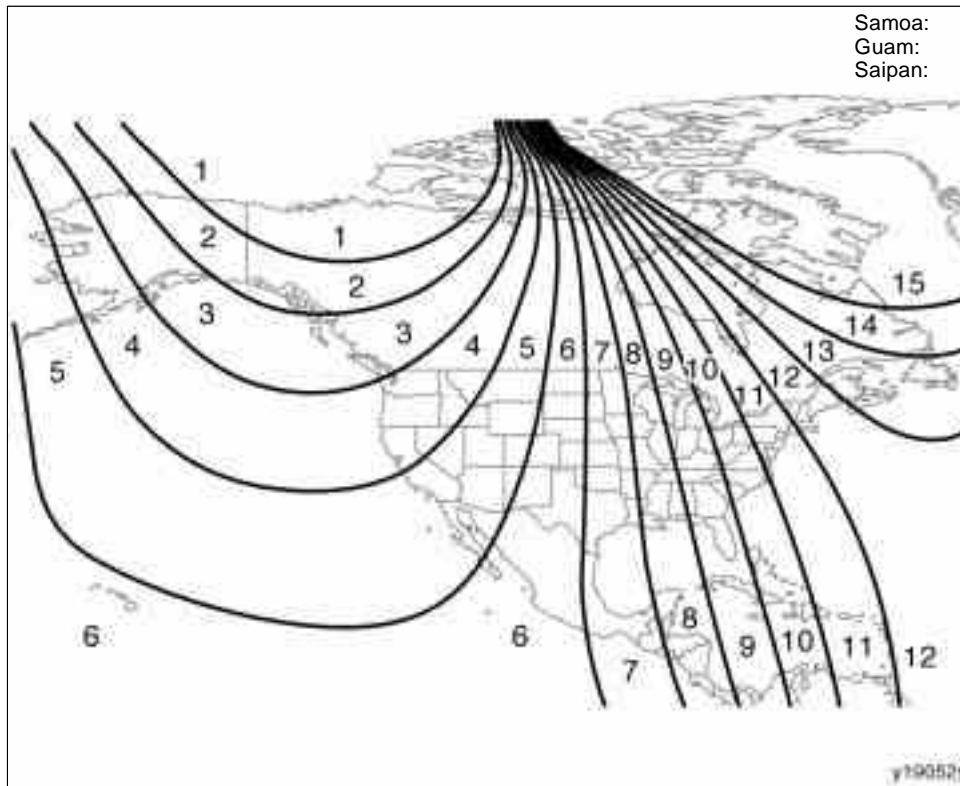

Zone number

336

After calibration, leaving the system for several seconds returns to the compass mode.

⚠ CAUTION

Do not adjust the display while the vehicle is moving. Be sure to adjust the display only when the vehicle is stopped.

06 SIENNA_U (L/O 0603)

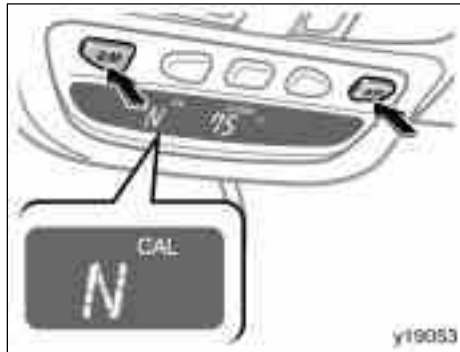

CALIBRATING THE COMPASS (circling calibration)

Sometimes the direction display on the compass may not change after a turn. In this case, the compass needs to be calibrated.

To calibrate the compass manually, do the following;

1. Stop the vehicle in a level place and switch the display to the outside temperature. (To switch to this mode, see “—Outside temperature and cruise information display” on page 332.)

2. Push and hold both the “MODE” and “E/M” buttons simultaneously for 10 seconds until the “CAL” indication appears on the compass display. (At this time, the compass display is locked in “N”.)

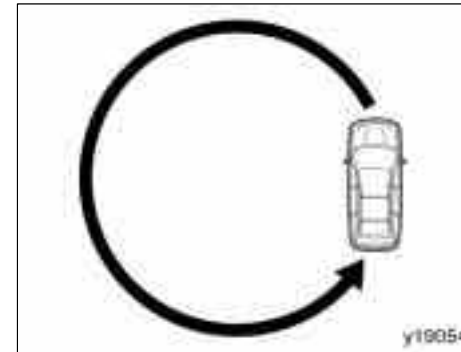

3. Drive the vehicle in a circle at 8 km/h (5 mph) or less. If there is not enough space to drive in a circle, drive around the block.

When the “CAL” indication goes off and the compass returns to the normal mode, calibration is complete.

If you want to restart the calibration before it is complete, push both of the “MODE” and “E/M” buttons simultaneously for 10 seconds again.

06 SIENNA_U (L/O 0603)

Perform circling calibration just after you have purchased your Toyota. And then always perform circling calibration after the battery has been removed, replaced or disconnected.

- Do not perform circling calibration of the compass in a place where the earth's magnetic field is subject to interference by artificial magnetic fields (underground parking, under a steel tower, between buildings, roof parking, near a crossing, near a large vehicle, etc.).
- During calibration, do not operate electric systems (moon roof, power windows, etc.) as they may interfere with the calibration.

CAUTION

- **When doing the circling calibration, be sure to secure a wide space, and watch out for people and vehicles in the neighborhood. Do not violate any local traffic rules while performing circling calibration.**
- **Do not adjust the display while the vehicle is moving. Be sure to adjust the display only when the vehicle is stopped.**

Clock

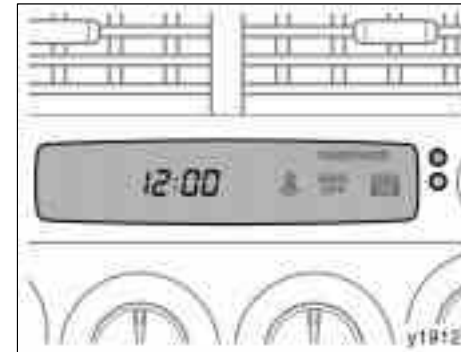

With manual air conditioning system

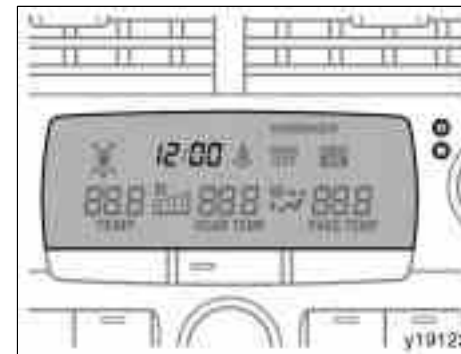

With automatic air conditioning system

06 SIENNA_U (L/O 0603)

To reset the hour: Push the "H" button.
To reset the minutes: Push the "M" button.
The key must be in the "ACC" or "ON" position.

If the electrical power source has been disconnected from the clock, the time display will automatically be set to 1:00.

When the instrument panel lights are turned on, the brightness of the time indication will be reduced.

Conversation mirror

The conversation mirror is designed for the driver and front passenger to be able to look at the rear passengers without turning around.



Do not adjust the mirror while the vehicle is moving. Be sure to adjust the mirror only when the vehicle is stopped.

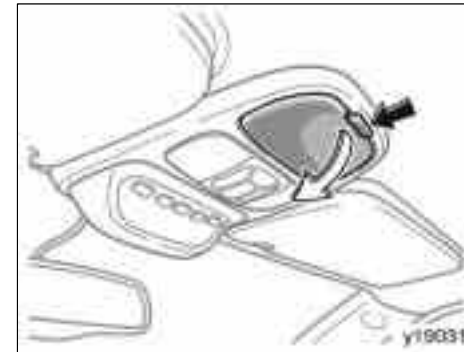

To use the mirror, push it down.

**Toyota park assist system
(type A)**

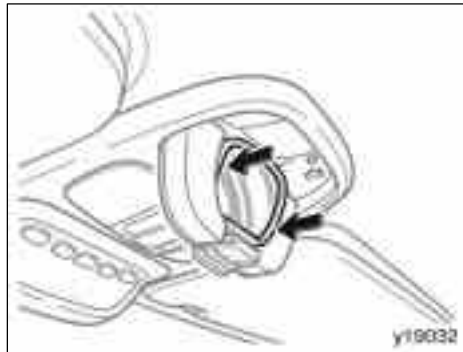

The mirror angle can be adjusted by pushing its edge.

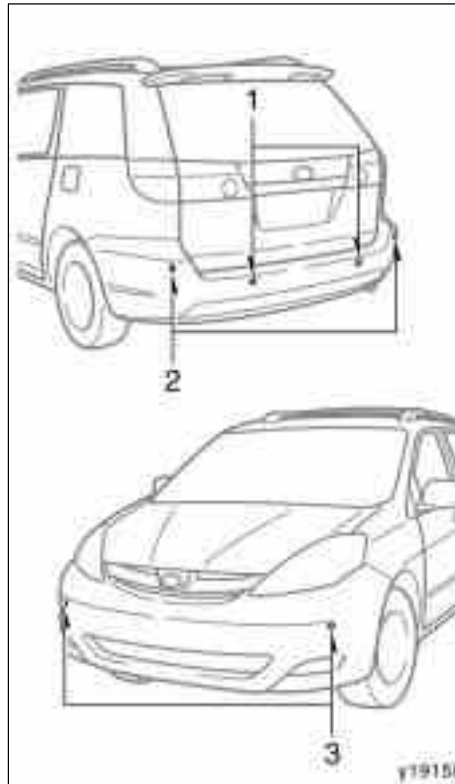

- 1: Rear sensors
- 2: Rear corner sensors
- 3: Front corner sensors

The Toyota park assist system is designed to inform you of the approximate distance between your vehicle and an obstruction by indicator and buzzer when parking the vehicle. This system uses sensors to detect obstructions.

This system works when the ignition key is at the "ON" position and the transmission is not in the "P" position.

- Rear and rear corner sensors work only when the transmission is in the "R" position.
- Front corner sensors work only when driving at approximate 10 km/h (6 mph) or less.
- When the vehicle is forwarding, the front corner sensors work.

06 SIENNA_U (L/O 0603)

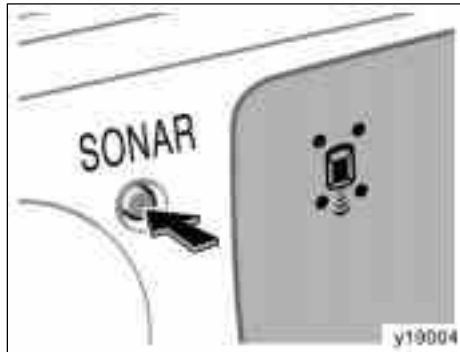

If the indicator is continuously on, have your Toyota dealer check the system.

If the indicator remains blinking but you do not hear the buzzer sound, clean the sensors with soft cloth.

To turn on: Push the switch.

The indicator comes on and the buzzer will sound.

To turn off: Push the switch again.

In the following cases, the buzzer will sound several times and the indicator will stay on to indicate that the system is not working properly.

- When the temperature is extremely low.
- When any of the sensors are malfunction.

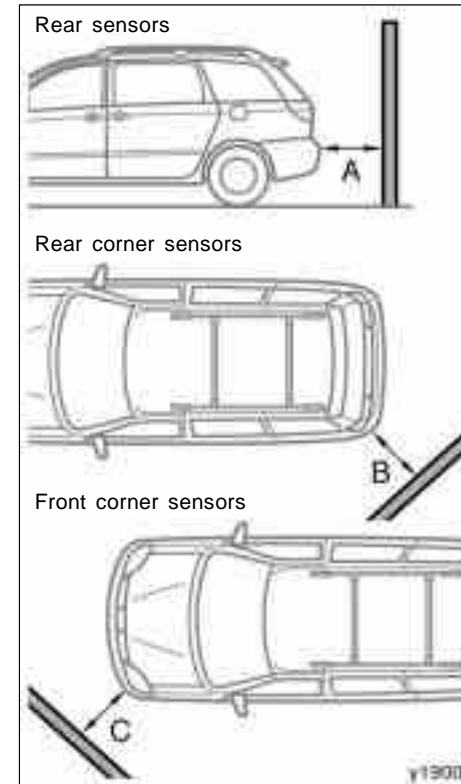

06 SIENNA_U (L/O 0603)

This system is designed to inform you of the approximate distance between your vehicle and an obstacle by indicator and buzzer.

Rear sensors

Distance shown as A in mm (in.)	Indicator and buzzer
Approximately 1800—900 (70.9—35.4)	Intermittent
Approximately 900—550 (35.4—21.7)	Fast intermittent
Approximately 550 (21.7) or less	Continuous

Rear corner sensors

Distance shown as B in mm (in.)	Indicator and buzzer
Approximately 850—520 (33.5—20.5)	Intermittent
Approximately 520—250 (20.5—9.8)	Fast intermittent
Approximately 250 (9.8) or less	Continuous

Front corner sensors

Distance shown as C in mm (in.)	Indicator and buzzer
Approximately 600—400 (23.6—15.7)	Intermittent
Approximately 400—250 (15.7—9.8)	Fast intermittent
Approximately 250 (9.8) or less	Continuous

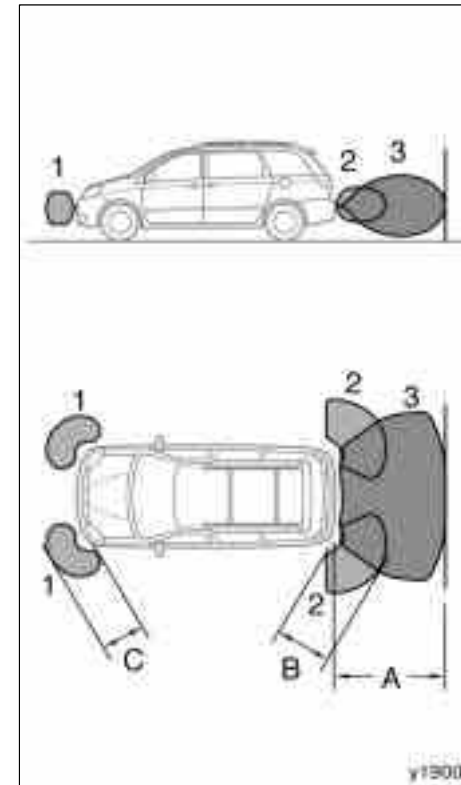

- 1: Front sensors
- 2: Rear corner sensors
- 3: Rear sensors

06 SIENNA_U (L/O 0603)

Perceptible area

- A: Approximately 1800 mm (70.9 in.)
B: Approximately 850 mm (33.5 in.)
C: Approximately 600 mm (23.6 in.)

Perceptible area is limited as shown in the previous illustration. Check the area around the vehicle before driving and start driving slowly.

 **CAUTION**

- **The Toyota park assist system is intended as an aid to assist you to park and is not a substitute for your personal judgment. Make your driving decisions based on your observations.**
- **Do not attach accessories or other objects to the vehicle within the sensor perceptible area. Doing so may cause the system to malfunction, which might result in an accident.**
- **In certain situations, the system will not function properly and when the vehicle approaches certain objects, the system will not detect those objects. Therefore, always observe the area around the vehicle and do not rely solely on the system.**

For vehicles sold in Canada

This ISM device complies with Canadian ICES-001.

06 SIENNA_U (L/O 0603)

In the following cases, the system may not work properly.

- When ice, snow, mud or other objects build up on the sensor.
- When the vehicle is parked in extremely high or extremely low temperature for a long period.
- When driving on bumpy or graveled roads or on grass
- When a device such as a horn from another vehicle, motorcycle engine, or an air brake sound from a heavy-duty vehicle, issues ultrasonic waves, near your vehicle
- When attaching a two-way radio antenna
- When rain or water splashes on the sensor.
- When operating the vehicle on an inclined surface
- When a radio antenna or fender pole is mounted on your vehicle.
- When a towing hitch is mounted on your vehicle.

The system may not detect the following.

- Thin objects such as a wire or rope
- Objects with a surface area too small to reflect ultrasonic waves such as wire gauze
- Sound wave absorbing objects or material such as cotton or snow
- A person near the vehicle (depending on the type of clothes worn)
- Objects with a sharp edge
- Small or short objects
- Tall objects with an upper part projecting toward the vehicle
- Objects just under the bumper
- Objects very close to your vehicle

In the following cases, have your Toyota dealer check the system.

- When the bumper is damaged.
- When the indicator is continuously on.

Toyota park assist system (type B)

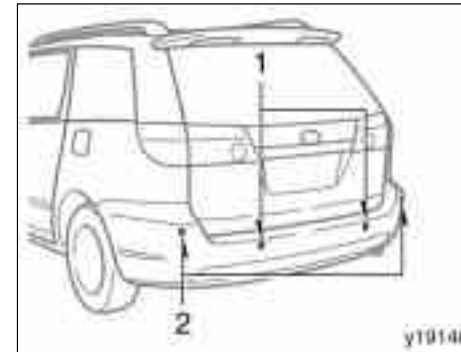

- 1: Rear sensors**
2: Rear corner sensors

The Toyota park assist system is designed to inform you of the approximate distance between your vehicle and an obstruction by indicator and buzzer when parking the vehicle. This system uses sensors to detect obstructions.

This system works when the ignition key is at the "ON" position and the transmission is in the "R" position.

The sensors work only when the transmission is in the "R" position.

06 SIENNA_U (L/O 0603)

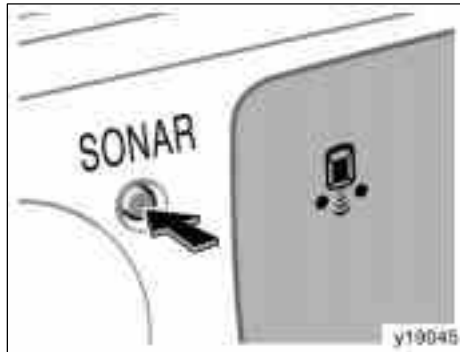

If the indicator is continuously on, have your Toyota dealer check the system.

If the indicator remains blinking but you do not hear the buzzer sound, clean the sensors with soft cloth.

To turn on: Push the switch.

The indicator comes on and the buzzer will sound.

To turn off: Push the switch again.

In the following cases, the buzzer will sound several times and the indicator will stay on to indicate that the system is not working properly.

- When the temperature is extremely low.
- When any of the sensors are malfunction.

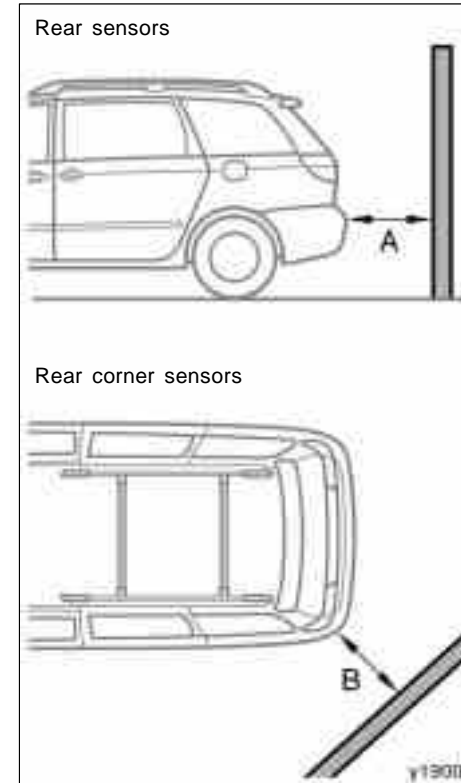

06 SIENNA_U (L/O 0603)

This system is designed to inform you of the approximate distance between your vehicle and an obstacle by indicator and buzzer.

Rear sensors

Distance shown as A in mm (in.)	Indicator and buzzer
Approximately 1800—900 (70.9—35.4)	Intermittent
Approximately 900—550 (35.4—21.7)	Fast intermittent
Approximately 550 (21.7) or less	Continuous

Rear corner sensors

Distance shown as B in mm (in.)	Indicator and buzzer
Approximately 850—520 (33.5—20.5)	Intermittent
Approximately 520—250 (20.5—9.8)	Fast intermittent
Approximately 250 (9.8) or less	Continuous

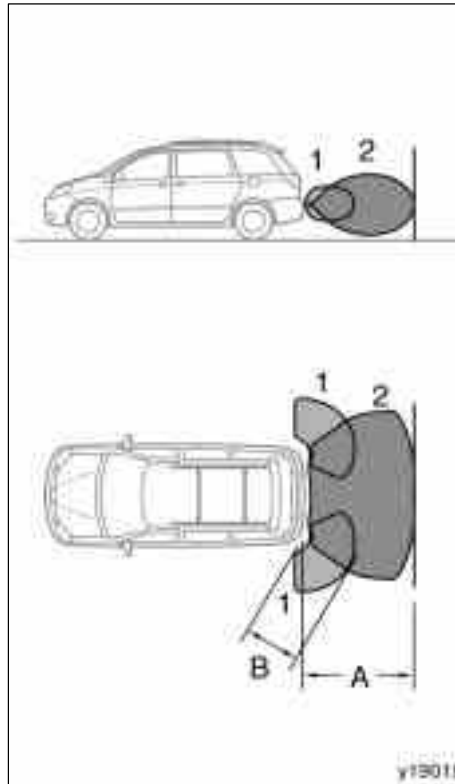

1: Rear corner sensors

2: Rear sensors

Perceptible area

A: Approximately 1800 mm (70.9 in.)

B: Approximately 850 mm (33.5 in.)

Perceptible area is limited as shown in the previous illustration. Check the area around the vehicle before driving and start driving slowly.

06 SIENNA_U (L/O 0603)

 CAUTION
<ul style="list-style-type: none">● The Toyota park assist system is intended as an aid to assist you to park and is not a substitute for your personal judgment. Make your driving decisions based on your observations.● Do not attach accessories or other objects to the vehicle within the sensor perceptible area. Doing so may cause the system to malfunction, which might result in an accident.● In certain situations, the system will not function properly and when the vehicle approaches certain objects, the system will not detect those objects. Therefore, always observe the area around the vehicle and do not rely solely on the system.

For vehicles sold in Canada

This ISM device complies with Canadian ICES-001.

In the following cases, the system may not work properly.

- When ice, snow, mud or other objects build up on the sensor.
- When the vehicle is parked in extremely high or extremely low temperature for a long period.
- When driving on bumpy or graveled roads or on grass
- When a device such as a horn from another vehicle, motorcycle engine, or an air brake sound from a heavy-duty vehicle, issues ultrasonic waves, near your vehicle
- When attaching a two-way radio antenna
- When rain or water splashes on the sensor.
- When operating the vehicle on an inclined surface
- When a radio antenna or fender pole is mounted on your vehicle.
- When a towing hitch is mounted on your vehicle.

The system may not detect the following.

- Thin objects such as a wire or rope
- Objects with a surface area too small to reflect ultrasonic waves such as wire gauze
- Sound wave absorbing objects or material such as cotton or snow
- A person near the vehicle (depending on the type of clothes worn)
- Objects with a sharp edge
- Small or short objects
- Tall objects with an upper part projecting toward the vehicle
- Objects just under the bumper
- Objects very close to your vehicle

In the following cases, have your Toyota dealer check the system.

- When the bumper is damaged.
- When the indicator is continuously on.

Rear view monitor system

The rear view monitor system assists the driver by displaying an image of the view behind the vehicle while backing up. The left and right displayed on the screen are the same as those of the inside rear view mirror.

To display the rear view image on the screen, place the selector lever in the "R" position when the ignition key in the "ON" position.

If you move the selector lever out of the "R" position, the screen returns to the previous screen. Operating another function of the navigation system will display another screen.

The rear view monitor system is a supplement device intended to assist back up. When backing up, be sure to check behind and all around the vehicle visually.

CAUTION

- Never depend on the rear view monitor system entirely when backing up. Always make sure your intended path is clear.
Use caution just as you would when backing up any vehicle.
- Never back up while looking only at the screen. The image on the screen is different from actual conditions. Depicted distances between objects and flat surfaces will differ from actual distances. If you back up while looking only at the screen, you may hit a vehicle, a person or an object. When backing up, be sure to check behind and all around the vehicle visually and with mirrors before proceeding.
- Do not use the system when the back door is not completely closed.

06 SIENNA_U (L/O 0603)

- If the back of the vehicle is hit, the position and mounting angle of the camera may change. Be sure to have the camera's position and mounting angle checked at your Toyota dealer.
- If the temperature changes rapidly, such as when hot water is poured on the vehicle in cold weather, the system may not operate normally.
- If the camera lens becomes dirty, it cannot transmit a clear image. If water droplets, snow, or mud adhere to the lens, rinse with water and wipe with a soft cloth. If the lens is extremely dirty, wash it with a mild cleanser and rinse.
- Use your own eyes to confirm the vehicle's surroundings, as the displayed image may become faint or dark, and moving images will be distorted, or not entirely visible when the outside temperature is low. When backing up, be sure to check behind and all around the vehicle visually and with mirror before proceeding.

When replacing the tires, please consult your Toyota dealer. If you replace the tires, the area displayed on the screen may change.

AREA DISPLAYED ON SCREEN

Image is displayed approximately level on screen.

06 SIENNA_U (L/O 0603)

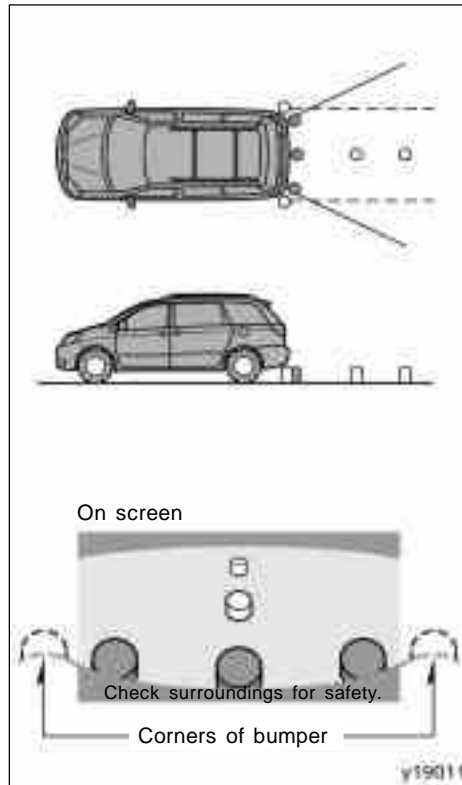

- The area detected by the camera is limited. The camera does not detect objects which are close to either corner of the bumper or under the bumper.
- The area displayed on the screen may vary according to vehicle orientation or road conditions.

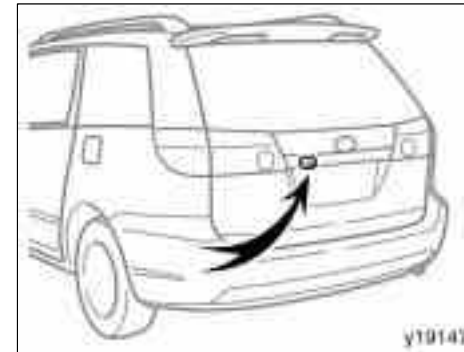

THE REAR VIEW MONITOR SYSTEM CAMERA

The rear view monitor system camera is located on the back door as shown in the illustration. The camera uses a special lens. The distance of the image that appears on the screen differs from the actual distance.

In the following cases, it may become difficult to see the images on the screen, even when the system is functioning.

- In the dark (for example, at night)
- When the temperature near the lens is high or low

06 SIENNA_U (L/O 0603)

- When water droplets are adhering to the camera, or when humidity is high (for example, when it rains)
- When foreign matter (for example, snow or mud) is adhering to the camera
- When the sun or the beam of headlights is shining directly into the camera lens



If a bright light (for example, sunlight reflected off the vehicle body) is picked up by the camera, the smear effect* peculiar to the camera may occur.

*: Smear effect—A phenomenon that occurs when a bright light (for example, sunlight reflected off the vehicle body) is picked up by the camera; when transmitted by the camera, the light source appears to have a vertical streak above and below it.

Power outlets (12 VDC)

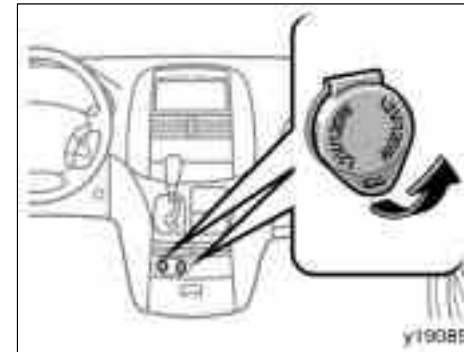

Front

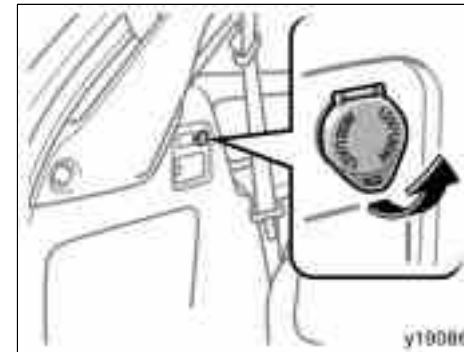

Rear

The power outlets (12 VDC) are designed for power supply for car accessories.

The key must be in the "ACC" or "ON" position for the power outlets to be used.

NOTICE

- ◆ *To prevent the fuse from being blown, do not use the electricity over the total vehicle capacity of 12 VDC/120W (front and rear outlets together).*
- ◆ *To prevent the battery from being discharged, do not use the power outlets longer than necessary when the engine is not running.*
- ◆ *Close the power outlet lids when the power outlets are not in use. Inserting anything other than an appropriate plug that fits the outlet, or allowing any liquid to get into the outlet may cause electrical failure or short circuits.*

Power outlets (115 VAC)

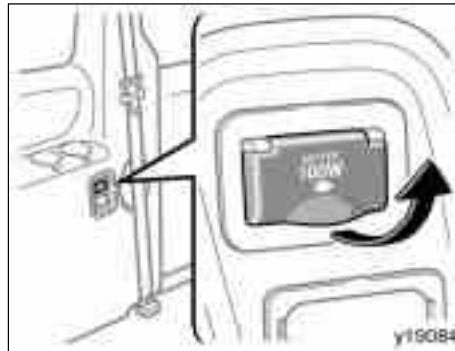

Beside second seat



Beside third seat

The power outlets (115 VAC) are designed for use as a power supply for electric appliances in the vehicle.

The key must be in the "ON" position for the power outlet to be used.

The maximum capacity for this power outlet is 115 VAC/100W. If you attempt to use an appliance that requires more than 115 VAC or 100W, the protection circuit will activate and cut the power supply. The power supply will restart automatically when you use an appliance that operates within the 115 VAC/100W limits.

06 SIENNA_U (L/O 0603)

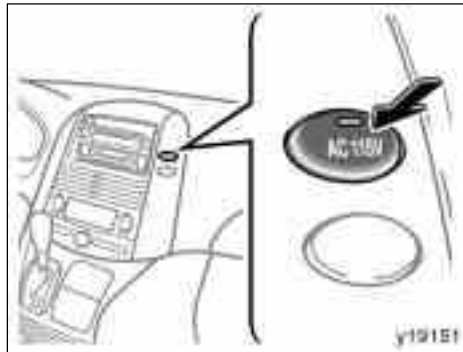

To use the power outlet, push the main switch on the instrument panel.

An indicator light will illuminate to indicate that the power outlet is ready for use.

Push the main switch once again to turn the power outlet off. When the power outlet is not in use, make sure that the main switch is turned off.

NOTICE

- ◆ *To prevent the battery from being discharged, do not use the power outlet longer than necessary when the engine is not running.*
- ◆ *Close the power outlet lids when the power outlets are not in use. Inserting anything other than an appropriate plug that fits the outlet, or allowing any liquid to get into the outlet may cause electrical failure or short circuits.*

The power outlet is not designed for the following electric appliances even though their power consumption is under 115 VAC/100W. These appliances may not operate properly.

- Appliances with high initial peak wattage: cathode-ray tube type televisions, compressor-driven refrigerators, electric pumps, electric tools, etc.
- Measuring devices which process precise data: medical equipment, measuring instruments, etc.
- Other appliances requiring an extremely stable power supply: microcomputer-controlled electric blankets, touch sensor lamps, etc.

Certain electrical appliances may cause radio noise.

06 SIENNA_U (L/O 0603)

Glove box

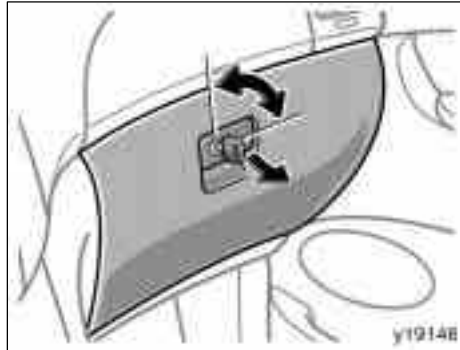

To use the glove box:

Open by pulling the lever.

Lock by inserting the master key and turning it clockwise.

Unlock by inserting the master key and turning it counterclockwise.



CAUTION

To reduce the chance of injury in case of an accident or a sudden stop, always keep the glove box door closed while driving.

Garage door opener box



The box is designed to store a garage door opener transmitter.

Open the cover and remove the Velcro loop.

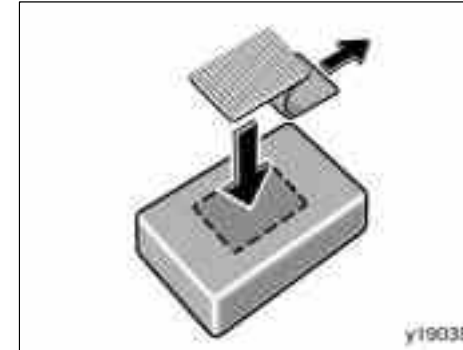

Remove the paper strip covering the adhesive on back side of loop and adhere loop to back side of the transmitter near center.

06 SIENNA_U (L/O 0603)

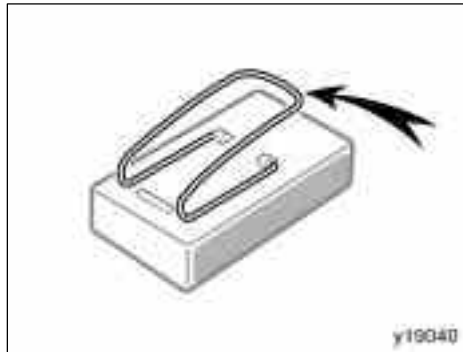

Please note if transmitter has wire clip for sun visor, this clip must be removed prior to adhesion of the Velcro.

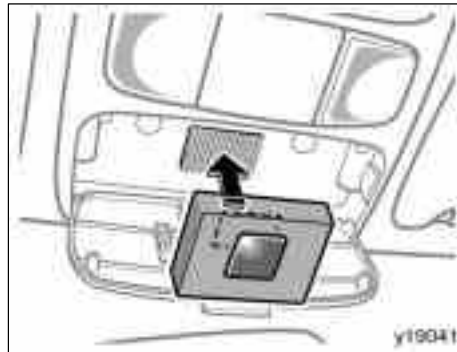

Place the transmitter with Velcro loop facing inside of box into the box. Make sure the transmitter button is located above button pins.

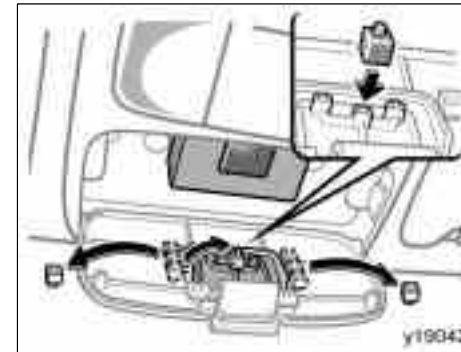

Remove spacers from the center panel. Place one spacer on the pin that would be below transmitter button when the cover is closed. Close the cover.

06 SIENNA_U (L/O 0603)

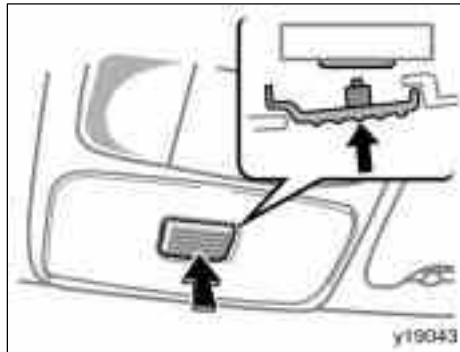

When the garage door opener transmitter is properly installed, you can operate the transmitter by pushing the center panel of the cover.

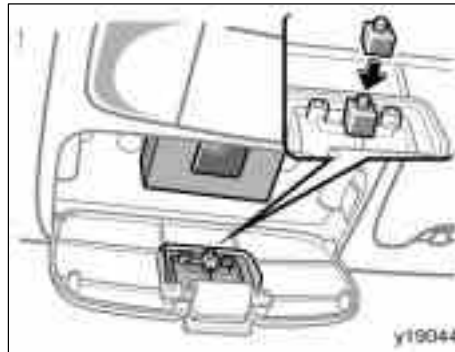

If the center panel does not contact your garage door opener transmitter:

- Check to see if spacer is on the correct pin.
- Attach another spacer to the top of original spacer. Check operation. If required, continue to add spacers until contact is achieved.

If the transmitter is clattering during driving, fill in a piece of felt or pad to prevent the transmitter from clattering.

CAUTION

- To reduce the chance of injury in case of an accident or a sudden stop, always keep the garage door opener box closed while driving.
- Keep the remaining spacers away from children.

Auxiliary boxes

To use the auxiliary box, open the lid as shown in the following illustrations.

Type C—The plate in the center of the auxiliary box can be adjusted or removed as shown in the illustration.

Type I—For details, see “Front seat side table” on page 368 in this Section.

CAUTION

- To reduce the chance of injury in case of an accident or a sudden stop, always keep the auxiliary box closed while driving.
- Type A—As these holders are designed for holding a light object such as an eyeglass, do not place any heavy objects in them. Heavy objects may cause the holder to open and contents to fly out resulting in injuries.

NOTICE

Type A—During hot weather, the interior of the vehicle becomes very hot. Do not leave anything flammable or deformable such as a lighter, glasses, etc. inside.

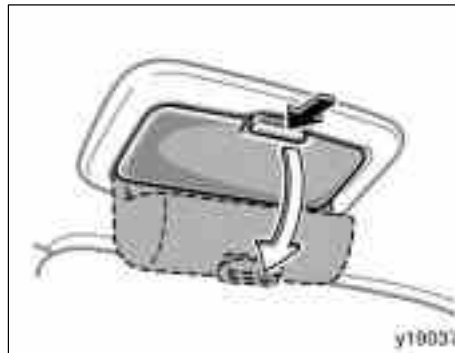

Type A (driver's side roof)

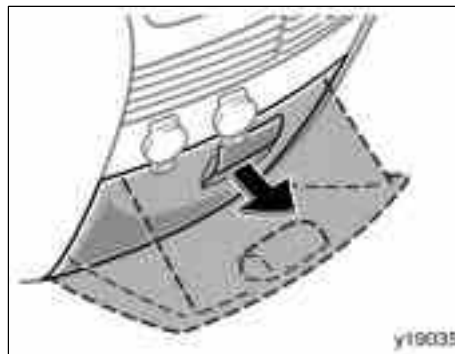

Type B (instrument panel)

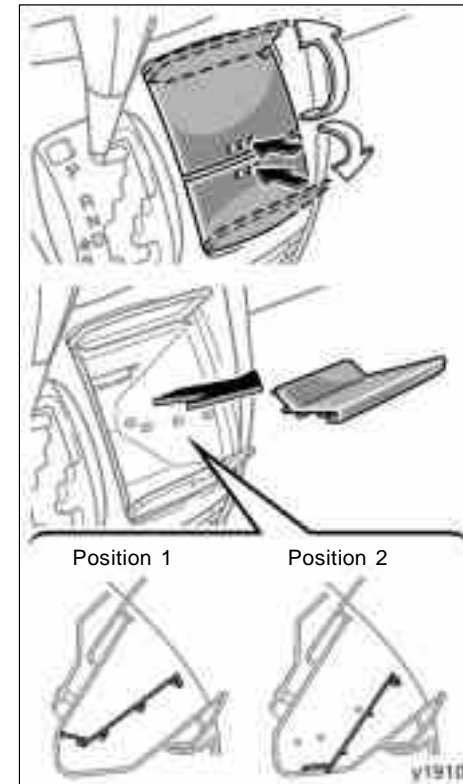

Type C (instrument panel without seat heater switches)

06 SIENNA_U (L/O 0603)



Type D (instrument panel with seat heater switches)

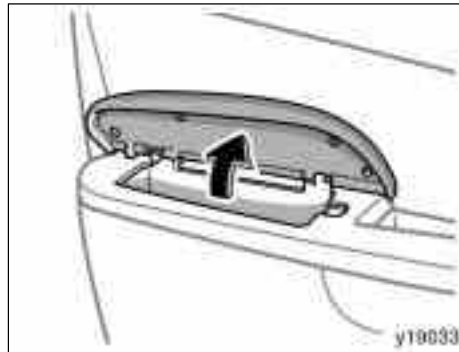

Type F (front door)

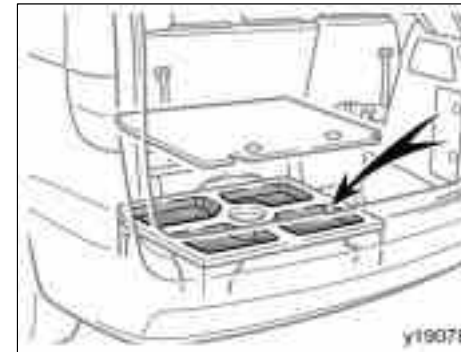

Type H (spare tire cover)

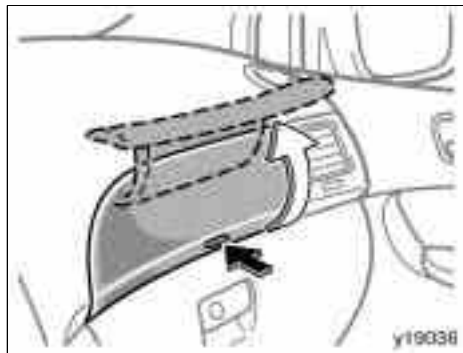

Type E (upper side of the glove box)

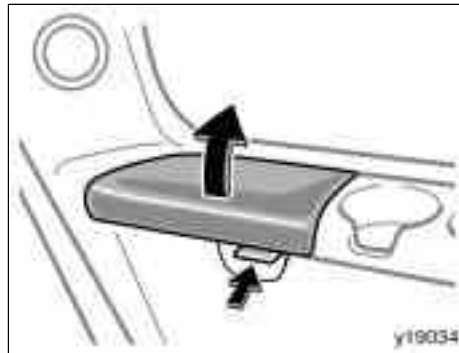

Type G (quarter trim)

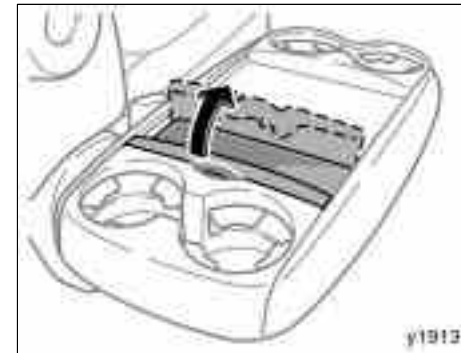

Type I (front seat side table)



Type J (rear side of console box)

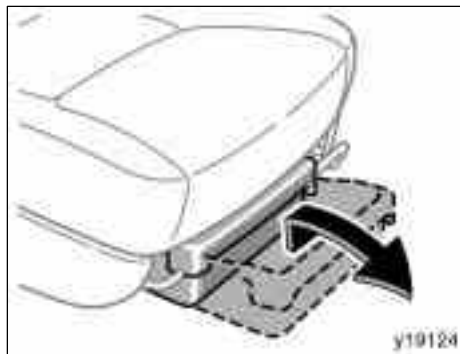

Type K (front passenger's seat)

Coin holder

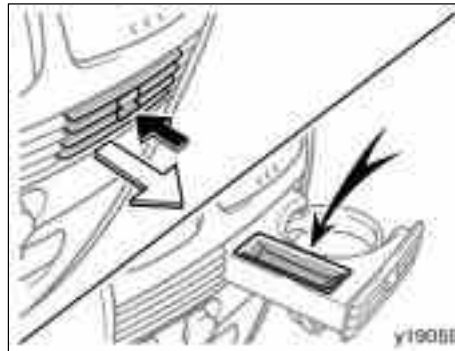

To use the coin holder, push the button.

CAUTION

To reduce the chance of injury in case of an accident or a sudden stop while driving, keep the coin holder closed when it is not in use.

Cup holders

The cup holder is designed for holding cups or drink-cans. To use them, observe the following illustrations.

Type C and D—For details, see “Front seat side table” on page 368 in this Section.

Type G—For details, see “Removable console box” on page 362 in this Section.

CAUTION

- Do not place anything else other than cups or drink-cans in the cup holder, as such items may be thrown about and possibly injure people in the vehicle during sudden braking or in an accident.
- Type A and F—To reduce the chance of injury in case of an accident or a sudden stop while driving, keep the cup holder closed when it is not in use.

06 SIENNA_U (L/O 0603)

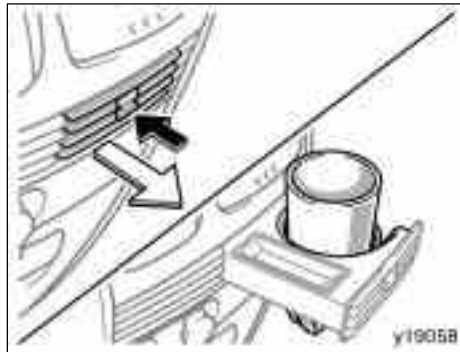

Type A (instrument panel)



Type C (front side of the front seat side table)



Type E (front side of console box)



Type B (quarter trim)

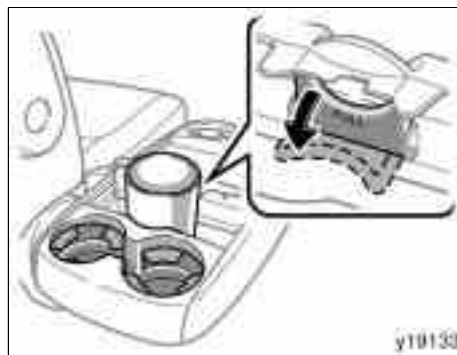

Type D (rear side of the front seat side table)

06 SIENNA_U (L/O 0603)

Bottle holders

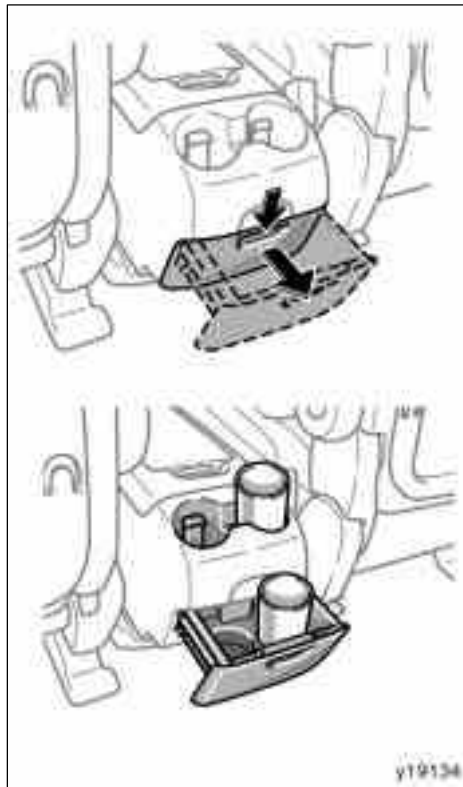

Type F (rear side of console box)

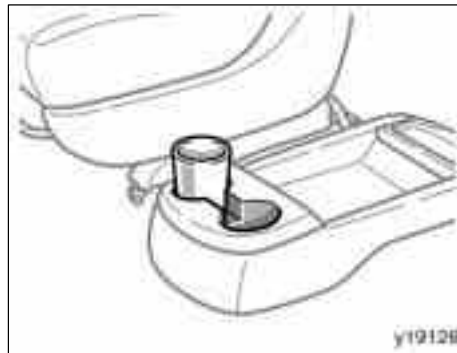

Type G (console box tray)

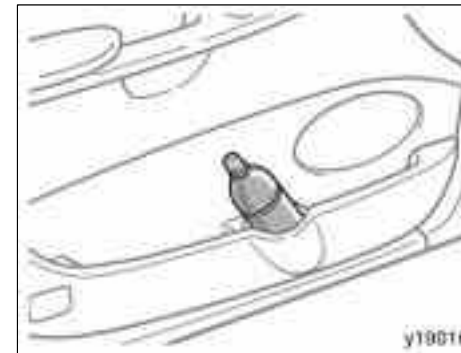

Front door



Sliding door

06 SIENNA_U (L/O 0603)

The bottle holders are designed to hold bottles securely.

CAUTION

Do not attempt to use the holder for any other purpose for which it was intended. Inappropriately sized or shaped objects may be thrown about in the compartment and possibly injure people in the vehicle during a sudden braking or an accident.

NOTICE

Do not put a cup or open bottle in the bottle holder because the contents may spill when the door opens or closes.

Storage box

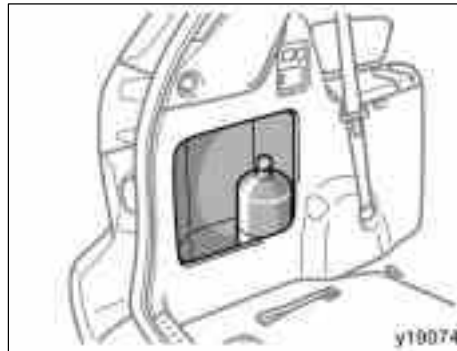

This box is designed to place things like bottles.

Removable console box

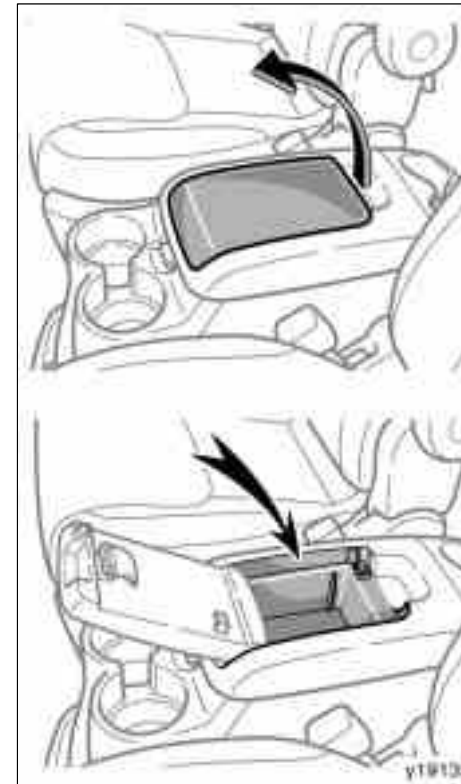

06 SIENNA_U (L/O 0603)

UPPER TRAY

To access the upper tray, raise the console box lid.



Between the front seats

CONSOLE BOX

To access the console box, pull up the lock release lever and raise the console box lid.



To reduce the chance of injury in case of an accident or a sudden stop, always keep the console box closed while driving.



Between the second seats

06 SIENNA_U (L/O 0603)

REMOVING AND INSTALLING THE CONSOLE BOX

The console box can be removed and installed between the front seats and between the second seats as shown in the illustrations.

When the console box is installed in the second seat position, the right side second seat must be in the outside position.



To remove the console box:
Open the auxiliary box of the rear side and pull up the lock release lever to disengage the rear lock. Then lift the console box and release the front hook.

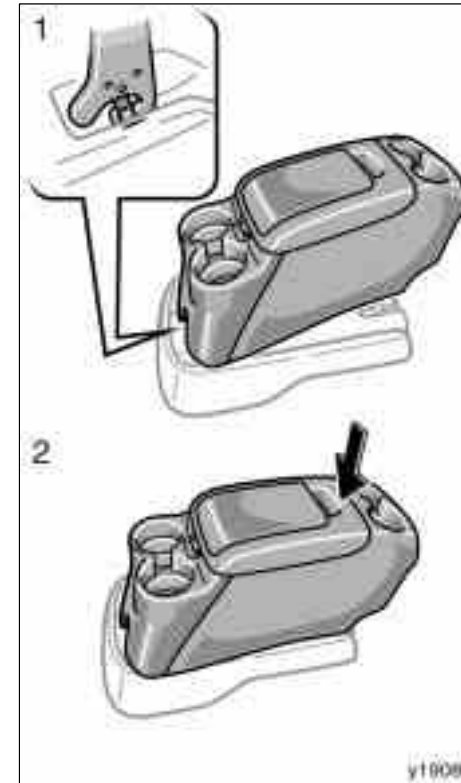

06 SIENNA_U (L/O 0603)

To install the console box between the front seats:

1. Install the front hook in the front striker of the console box under-tray.
2. Rotate down straight and push down to engage the rear lock.

CAUTION

- Be careful not to get your hands or feet pinched in the console box.
- Make sure the console box is securely locked by pushing forward, rearward, upward and sideways. Failure to do so may cause an unexpected accident or severe injury in the event of emergency braking or a collision.

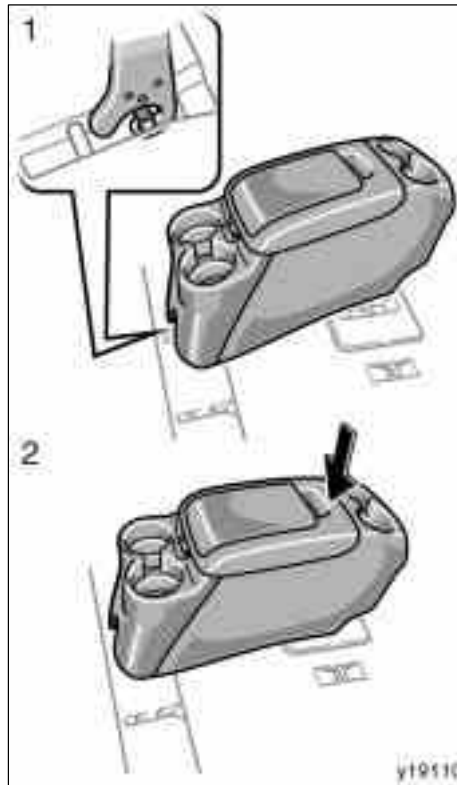

To install the console box between the second seats:

1. Install the front hook in the rear striker of the double striker set.

The striker is used as both the console box lock striker and the right second seat lock striker when the right second seat is in the inside position.

2. Rotate down straight and push down to engage the rear lock.

CAUTION

- Do not install the console box by any means other than the center striker between the second seats. Otherwise, the console box cannot be installed properly.
- Be careful not to get your hands or feet pinched in the console box.
- Make sure the console box is securely locked by pushing forward and rearward. Failure to do so may cause an unexpected accident or severe injury in the event of emergency braking or a collision.

06 SIENNA_U (L/O 0603)

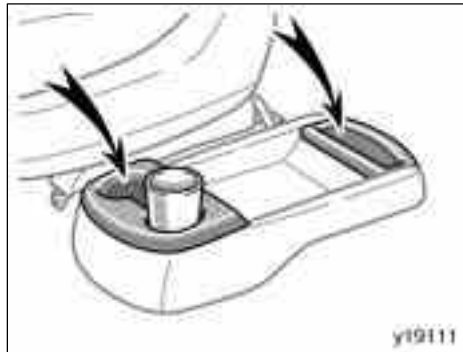

CONSOLE BOX TRAY

When the console box is not installed between the front seats, the cup holder and small tray can be installed in the console box under-tray between the front seats.

The cup holder and small tray are in the console box.

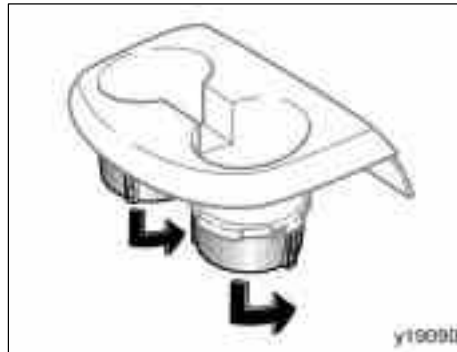

Before installing the cup holder, push down the bottom of the cup and turn it counterclockwise to lock.

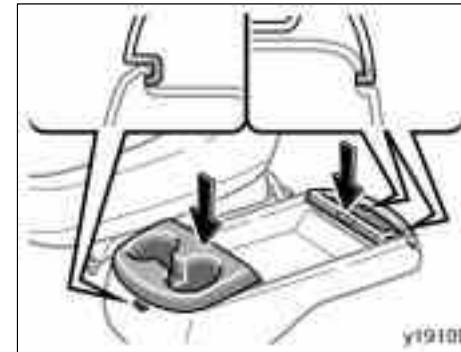

To install the cup holder and small tray:

Cup holder—Hook the front of the cup holder to the console box under-tray, then push down the back of the cup holder to secure it.

Small tray—Hook the back of the small tray to the console box under-tray, then push down the front of the small tray to secure it.

Make sure the cup holder and small tray are locked securely.

Note pad holder

⚠ CAUTION

- Make sure the the cup holder and small tray are securely locked by pushing forward and rearward when they are installed. Failure to do so may cause an unexpected accident or severe injury in the event of emergency braking or a collision.
- Do not place anything other than cups or drink cans in the cup holder, and do not place anything in the console box tray, as such items may be thrown about and possibly injure people in the vehicle during sudden braking or in an accident.
- To reduce the chance of injury in case of an accident or a sudden stop while driving, keep the cup holder and small tray stored when they are not in use.

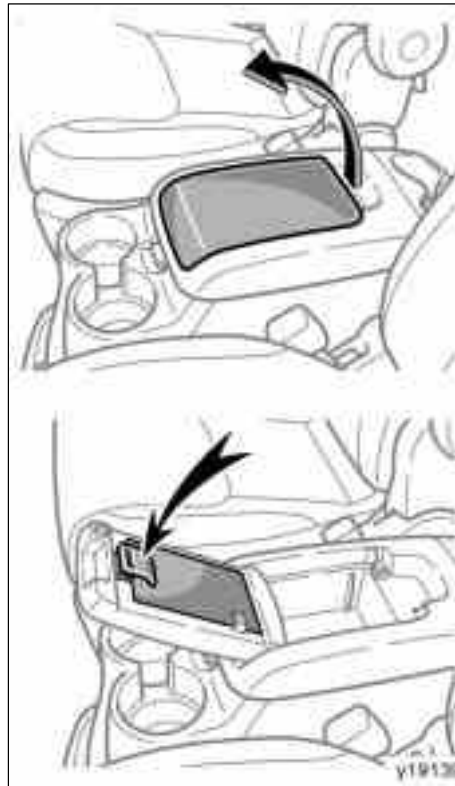

The note pad holder is designed to hold small paper such as note pads.

To use the holder, raise the console box upper lid.

⚠ CAUTION

- Do not write on the note pad holder while the vehicle is moving.
- Do not place anything else on the note pad holder. Such items may be thrown about in the compartment and possibly cause injury during sudden braking or an accident.
- To reduce the chance of injury in case of an accident or a sudden stop while driving, keep the console box upper lid closed when it is not in use.

06 SIENNA_U (L/O 0603)

Front seat side table



The front seat side table can be used as a cup holder or auxiliary box. It can be also used as a temporary table only when the vehicle is stopped.

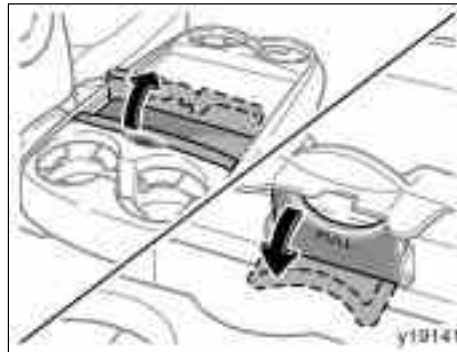

The auxiliary box of the table can also be used as a cup holder. To use as a cup holder, open the lid and pull down the tab as shown in the illustration.



To fold down the table, pull up the lock release lever and push against the driver's seat side.

Make sure the table is locked securely.

CAUTION

- Do not put heavy things on the front seat side table. The table may fall down and cause personal injury.
- To reduce the chance of injury in case of an accident or a sudden stop, always keep the auxiliary box closed while driving.
- Do not place anything else other than cups or drink-cans in the cup holder, as such items may be thrown about and possibly injure people in the vehicle during sudden braking or in an accident.
- To reduce the chance of injury in case of an accident or a sudden stop while driving, make sure the table is folded down and locked securely when it is not in use.

Coat hooks

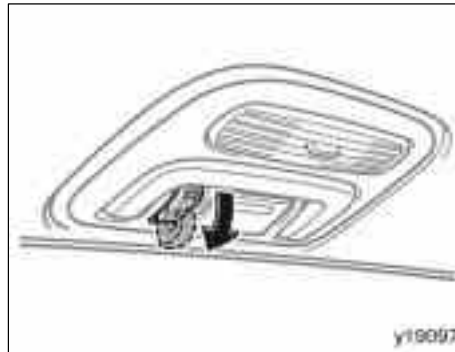

To use the coat hook, pull it down.

CAUTION

Vehicles with side airbags and curtain shield airbags—Do not hook a hanger, heavy or sharp pointed object on the coat hook. If the curtain shield airbag inflates, those items will be hurled away with great force or the curtain shield airbag may not activate correctly. When you hang clothes, hang them on the coat hook directly.

Grocery bag hooks

These hooks are designed to hang things like grocery bags.

Type A—To use the hook, pull it down.

Type D—To use the hook, pull it up.

CAUTION

Type A and D—To reduce the chance of injury in case of an accident or a sudden stop while driving, keep the hook stored when it is not in use.

NOTICE

- ◆ Type A, B, and C—To prevent damage to the hook, do not hang any object heavier than 4 kg (8.8 lb.) in it.
- ◆ Type D—To prevent damage to the hook, avoid hanging heavy loads on it.

06 SIENNA_U (L/O 0603)

Cargo net hooks

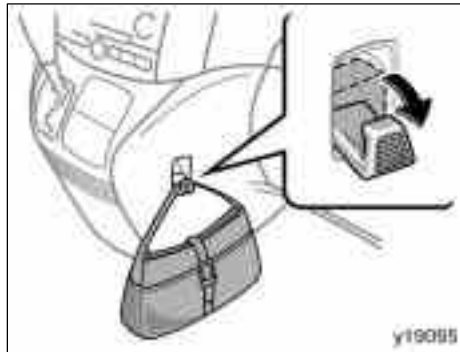

Type A (instrument panel)



Type C (third seats)



Pattern 1

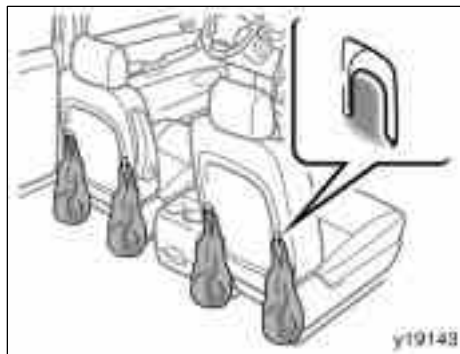

Type B (front seats)



Type D (under the back door)

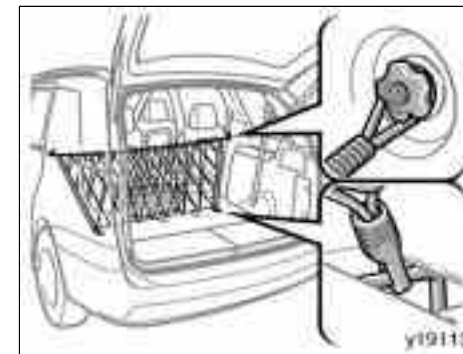

Pattern 2

06 SIENNA_U (L/O 0603)

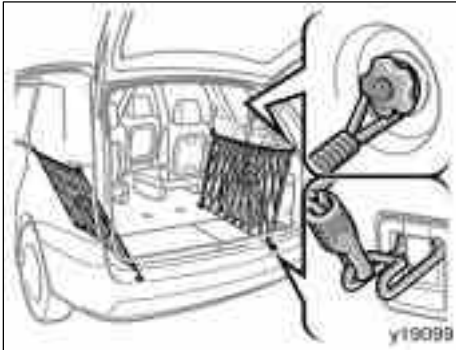

Pattern 3



Pattern 4

These hooks are designed to be used for the cargo net.

The cargo net can be used in a variety of ways as shown in the illustrations.

The cargo net itself is not included as an original equipment.

NOTICE

To prevent damage to the hooks, avoid using them for things other than the cargo net.

Tie-down hooks



To secure your luggage, use the tie-down hooks as shown above.

See “—Stowage precautions” on page 399 in Section 2 for precautions when loading luggage.

CAUTION

To avoid personal injury, keep the tie-down hooks folded when not in use.

Roof luggage carrier

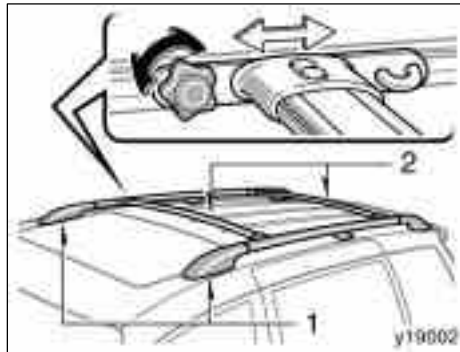

The roof luggage carrier consists of roof rails (1) attached to the roof and sliding cross rails (2).

To adjust the positions of cross rails, do this.

1. Turn the knobs counterclockwise to loosen the cross rails.
2. Slide the cross rails to the desired position for loading the luggages of various sizes.
3. After adjusting, be sure to tighten the cross rails by turning knobs clockwise.

Follow the manufacturer's instructions and precautions when installing the attachments or their equivalent.

372

CAUTION

When you load cargo on the roof luggage carrier, observe the following:

- Place the cargo so that its weight is distributed evenly between the front and rear axles.
- If loading long or wide cargo, never exceed the vehicle overall length or width. (See "Dimensions and weights" on page 496 in Section 8 for information on your vehicle overall length and width.)
- Before driving, make sure the cargo is securely fastened on the roof luggage carrier.
- Loading cargo on the roof luggage carrier will make the center of the vehicle gravity higher. Avoid high speeds, sudden starts, sharp turns, sudden braking or abrupt maneuvers, otherwise it may result in loss of control or vehicle rollover due to failure to operate this vehicle correctly.

- If driving for a long distance, on rough roads, or at high speeds, stop the vehicle now and then during the trip to make sure the cargo remains in its place.
- Do not exceed 68 kg (150 lb.) cargo weight on the roof luggage carrier.

NOTICE

When loading the luggages, be careful not to scratch the surface of the moon roof.

06 SIENNA_U (L/O 0603)

Sun shade

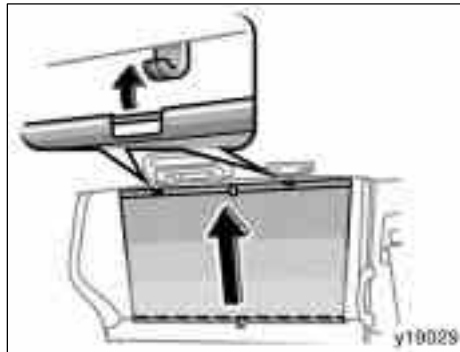

Rear window

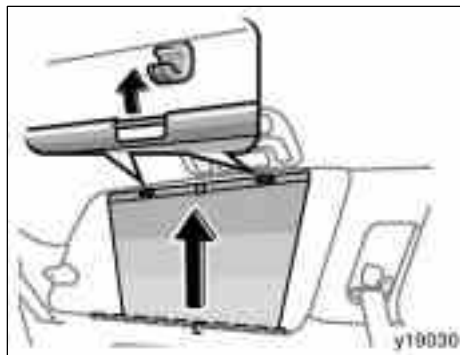

Quarter window

To use the sun shade, pull the tab of the shade and hook it on the anchors. To store the shade, pull the tab slightly to unhook the shade, and lower it slowly.

NOTICE

- ◆ Do not place anything where it might hinder the opening/closing of the shade.
- ◆ Do not place anything on the shade.

Floor mat

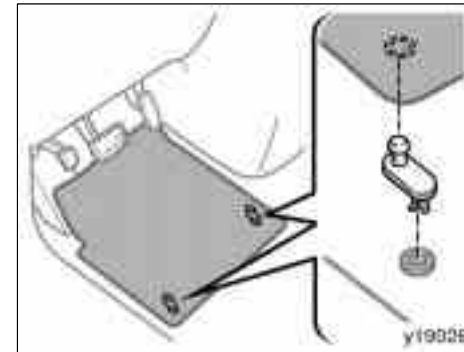

Use a floor mat of the correct size.

If the floor carpet and floor mat have two holes, then they are designed for use with two locking clips. Fix the floor mat with locking clips into the holes in the floor carpet.

06 SIENNA_U (L/O 0603)

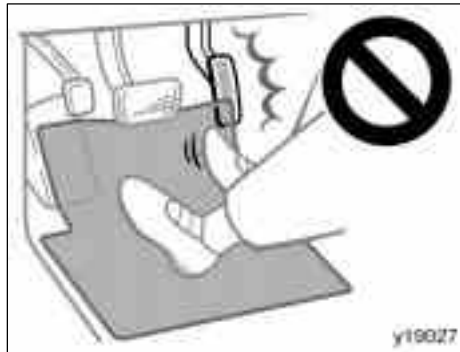

CAUTION

Make sure the floor mat is properly placed on the floor carpet. If the floor mat slips and interferes with the movement of the pedals during driving, it may cause an accident.

SECTION 2

INFORMATION BEFORE DRIVING YOUR TOYOTA

Information before driving your Toyota

Break- in period	376
Fuel	376
Fuel pump shut off system	378
Operation in foreign countries	378
Three- way catalytic converters	379
Engine exhaust cautions	380
Facts about engine oil consumption	380
Iridium- tipped spark plugs	381
Brake system	382
Brake pad wear limit indicators	386
Your Toyota's identification	386
Theft prevention labels	387
Suspension and chassis	387
Tire information	388
Vehicle load limits	398
Cargo and luggage	399
Types of tires	402

06 SIENNA_U (L/O 0603)

Break-in period

Drive gently and avoid high speeds.

Your vehicle does not need an elaborate break-in. But following a few simple tips for the first 1600 km (1000 miles) can add to the future economy and long life of your vehicle:

- Avoid full throttle acceleration when starting and driving.
- Avoid racing the engine.
- Try to avoid hard stops during the first 300 km (200 miles).
- Do not drive for a long time at any single speed, either fast or slow.
- Do not tow a trailer during the first 800 km (500 miles).

Fuel

FUEL TYPE

Your new vehicle must use only unleaded gasoline.

To help prevent gas station mix-ups, your Toyota has a smaller fuel tank opening. The special nozzle on pumps with unleaded fuel will fit it, but the larger standard nozzle on pumps with leaded gas will not.

At a minimum, the gasoline you use should meet the specifications of ASTM D4814 in the U.S.A. and CGSB 3.5-M93 in Canada.

NOTICE

Do not use leaded gasoline. Use of leaded gasoline will cause the three-way catalytic converter to lose its effectiveness and the emission control system to function improperly. Also, this can increase maintenance costs.

OCTANE RATING

Select Octane Rating 87 (Research Octane Number 91) or higher. For improved vehicle performance, use premium unleaded gasoline with an Octane Rating of 91 (Research Octane Number 96) or higher.

Use of unleaded gasoline with an octane rating or research octane number lower than stated above will cause persistent heavy knocking. If it is severe, this will lead to engine damage.

If your engine knocks...

If you detect heavy knocking even when using the recommended fuel, or if you hear steady knocking while holding a steady speed on level roads, consult your Toyota dealer.

However, occasionally, you may notice light knocking for a short time while accelerating or driving up hills. This is normal and there is no need for concern.

06 SIENNA_U (L/O 0603)

GASOLINE CONTAINING DETERGENT ADDITIVES

Toyota recommends the use of gasoline that contains detergent additives to avoid build-up of engine deposits.

However, all gasoline sold in the U.S. contains detergent additives to keep clean and/or clean intake systems.

QUALITY GASOLINE

Automotive manufacturers in the U.S., Europe and Japan have developed a specification for quality fuel named World-Wide Fuel Charter (WWFC) that is expected to be applied world wide. The WWFC consists of four categories that depend on required emission levels. In the U.S., category 4 has been adopted. The WWFC improves air quality by providing for better emissions in vehicle fleets, and customer satisfaction through better vehicle performance.

CLEANER BURNING GASOLINE

Cleaner burning gasoline, including reformulated gasoline that contains oxygenates such as ethanol or MTBE is available in many areas.

Toyota recommends the use of cleaner burning gasoline and appropriately blended reformulated gasoline. These types of gasoline provide excellent vehicle performance, reduce vehicle emissions, and improve air quality.

OXYGENATES IN GASOLINE

Toyota allows the use of oxygenate blended gasoline where the oxygenate content is up to 10% ethanol or 15% MTBE. If you use gasohol in your Toyota, be sure that it has an octane rating no lower than 87.

Toyota does not recommend the use of gasoline containing methanol.

GASOLINE CONTAINING MMT

Some gasoline contain an octane enhancing additive called MMT (Methylcyclopentadienyl Manganese Tricarbonyl).

Toyota does not recommend the use of gasoline that contains MMT. If fuel containing MMT is used, your emission control system may be adversely affected. The Malfunction Indicator Lamp on the instrument cluster may come on. If this happens, contact your Toyota dealer for service.

06 SIENNA_U (L/O 0603)

GASOLINE QUALITY

In a very few cases, you may experience driveability problems caused by the particular gasoline that you are using. If you continue to have unacceptable driveability, try changing gasoline brands. If this does not rectify your problem, then consult your Toyota dealer.

NOTICE

- ◆ *Do not use gasohol other than stated above. It will cause fuel system damage or vehicle performance problems.*
- ◆ *If driveability problems occur (poor hot starting, vaporizing, engine knock, etc.), discontinue the use.*
- ◆ *Take care not to spill gasohol during refueling. Gasohol may cause paint damage.*

FUEL TANK CAPACITY

79 L (21 gal., 17.5 Imp. gal.)

Fuel pump shut off system

The fuel pump shut off system stops supplying fuel to the engine to minimize the risk of fuel leakage when the engine stalls or an airbag inflates upon collision. To restart the engine after the fuel pump shut off system activates, turn the ignition switch to "ACC" or "LOCK" once and start it.



CAUTION

Inspect the ground under the vehicle before restarting the engine. If you find that liquid has leaked onto the ground, it is the fuel system has been damaged and it is in need of repair. In this case, do not restart the engine.

Operation in foreign countries

If you plan to drive your Toyota in another country...

First, comply with the vehicle registration laws.

Second, confirm the availability of the correct fuel (unleaded and minimum octane number).

Three- way catalytic converters

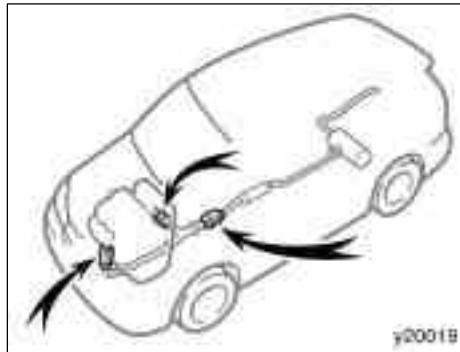

The three-way catalytic converter is an emission control device installed in the exhaust system.

The purpose is to reduce pollutants in the exhaust gas.

CAUTION

- Keep people and combustible materials away from the exhaust pipe while the engine is running. The exhaust gas is very hot.
- Do not drive, idle or park your vehicle over anything that might burn easily such as grass, leaves, paper or rags.

NOTICE

A large amount of unburned gases flowing into the three-way catalytic converter may cause it to overheat and create a fire hazard. To prevent this and other damage, observe the following precautions:

- ◆ Use only unleaded gasoline.
- ◆ Do not drive with an extremely low fuel level; running out of fuel could cause the engine to misfire, creating an excessive load on the three-way catalytic converter.
- ◆ Do not allow the engine to run at idle speed for more than 20 minutes.
- ◆ Avoid racing the engine.
- ◆ Do not push-start or pull-start your vehicle.
- ◆ Do not turn off the ignition while the vehicle is moving.

- ◆ Keep your engine in good running order. Malfunctions in the engine electrical system, electronic ignition system/distributor ignition system or fuel system could cause an extremely high three-way catalytic converter temperature.
- ◆ If the engine becomes difficult to start or stalls frequently, take your vehicle in for a check-up as soon as possible. Remember, your Toyota dealer knows your vehicle and its three-way catalytic converter system best.
- ◆ To ensure that the three-way catalytic converter and the entire emission control system operate properly, your vehicle must receive the periodic inspections required by the Toyota Maintenance Schedule. For scheduled maintenance information, refer to the "Scheduled Maintenance Guide" or "Owner's Manual Supplement".

Engine exhaust cautions

 **CAUTION**

- Avoid inhaling the engine exhaust. It contains carbon monoxide, which is a colorless and odorless gas. It can cause unconsciousness or even death.
- Make sure the exhaust system has no holes or loose connections. The system should be checked from time to time. If you hit something, or notice a change in the sound of the exhaust, have the system checked immediately.
- Do not run the engine in a garage or enclosed area except for the time needed to drive the vehicle in or out. The exhaust gases cannot escape, making this a particularly dangerous situation.
- Do not remain for a long time in a parked vehicle with the engine running. If it is unavoidable, however, do so only in an unconfined area and adjust the heating or cooling system to force outside air into the vehicle.

- Keep the back door and quarter windows closed while driving. An open or unsealed back door and quarter windows may cause exhaust gases to be drawn into the vehicle.
- To allow proper operation of your vehicle's ventilation system, keep the inlet grilles in front of the windshield clear of snow, leaves, or other obstructions.
- If you smell exhaust fumes in the vehicle, open the windows and close the back door and quarter windows to ensure plenty of fresh air enters the vehicle. If you can smell exhaust fumes even though there are no other vehicles in the surrounding area, have your vehicle checked by your Toyota dealer. Continued inhalation of exhaust fumes can lead to death by gas poisoning.

Facts about engine oil consumption

FUNCTIONS OF ENGINE OIL

Engine oil has the primary functions of lubricating and cooling the inside of the engine, and plays a major role in maintaining the engine in proper working order.

ENGINE OIL CONSUMPTION

It is normal that an engine should consume some engine oil during normal engine operation. The causes of oil consumption in a normal engine are as follows.

- Oil is used to lubricate pistons, piston rings and cylinders. A thin film of oil is left on the cylinder wall when a piston moves downwards in the cylinder. High negative pressure generated when the vehicle is decelerating sucks some of this oil into the combustion chamber. This oil as well as some part of the oil film left on the cylinder wall is burned by the high temperature combustion gases during the combustion process.
- Oil is also used to lubricate the stems of the intake valves. Some of this oil is sucked into the combustion chamber together with the intake air and is burned along with the fuel. High temperature exhaust gases also burn the oil used to lubricate the exhaust valve stems.

The amount of engine oil consumed depends on the viscosity of the oil, the quality of the oil and the conditions the vehicle is driven under.

More oil is consumed by high-speed driving and frequent acceleration and deceleration.

A new engine consumes more oil, since its pistons, piston rings and cylinder walls have not become conditioned.

Oil consumption: Max. 1.0 L per 1000 km (1.1 qt./600 miles, 0.9 Imp. qt./600 miles)

When judging the amount of oil consumption, note that the oil may become diluted and make it difficult to judge the true level accurately.

As an example, if a vehicle is used for repeated short trips, and consumes a normal amount of oil, the dipstick may not show any drop in the oil level at all, even after 1000 km (600 miles) or more. This is because the oil is gradually becoming diluted with fuel or moisture, making it appear that the oil level has not changed.

The diluting ingredients evaporate out when the vehicle is then driven at high speeds, as on an express way, making it appear that oil is excessively consumed after driving at high speeds.

IMPORTANCE OF ENGINE OIL LEVEL CHECK

One of the most important points in proper vehicle maintenance is to keep the engine oil at the optimum level so that oil function will not be impaired. Therefore, it is essential that the oil level be checked regularly. Toyota recommends that the oil level be checked every time you refuel the vehicle.

NOTICE

Failure to check the oil level regularly could lead to serious engine trouble due to insufficient oil.

For detailed information on oil level check, see "Checking the engine oil level" on page 466 in Section 7-2.

Iridium-tipped spark plugs

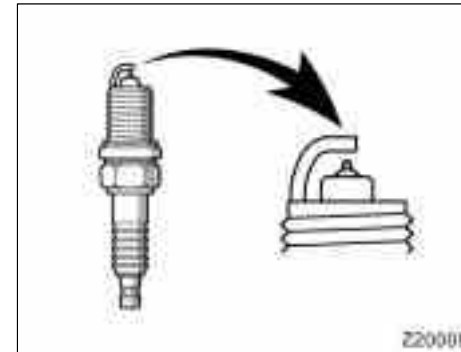

Your engine is fitted with iridium-tipped spark plugs.

NOTICE

Use only iridium-tipped spark plugs. Do not adjust gaps for engine performance or smooth driveability.

Brake system

The tandem master cylinder brake system is a hydraulic system with two separate sub-systems. If either sub-system should fail, the other will still work. However, the pedal will be harder to press, and your stopping distance will increase. Also, the brake system warning light may come on.



BRAKE BOOSTER

The brake booster uses engine vacuum to power-assist the brakes. If the engine should quit while you are driving, you can bring the vehicle to a stop with normal pedal pressure. There is enough reserved vacuum for one or two stops—but no more!

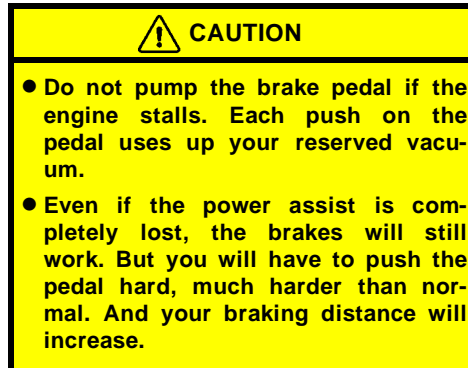

ANTI-LOCK BRAKE SYSTEM (with “ABS” warning light)

The anti-lock brake system is designed to help prevent lock-up of the wheels during a sudden braking or braking on slippery road surfaces. This assists in providing directional stability and steering performance of the vehicle under these circumstances.

Effective way to press the ABS brake pedal: When the anti-lock brake system function is in action, you may feel the brake pedal pulsating and hear a noise. In this situation, to let the anti-lock brake system work for you, just hold the brake pedal down more firmly. Do not pump the brake in a panic stop. This will result in reduced braking performance.

The anti-lock brake system becomes operative after the vehicle has accelerated to a speed in excess of approximately 10 km/h (6 mph). It stops operating when the vehicle decelerates to a speed below approximately 5 km/h (3 mph).

Depressing the brake pedal on slippery road surfaces such as on a manhole cover, a steel plate at a construction site, joints in a bridge, etc. on a rainy day tends to activate the anti-lock brake system.

You may hear a click or motor sound in the engine compartment for a few seconds when the engine is started or just after the vehicle begins to move. This means that the anti-lock brake system is in the self-check mode, and does not indicate a malfunction.

06 SIENNA_U (L/O 0603)

When the anti-lock brake system is activated, the following conditions may occur. They do not indicate a malfunction of the system:

- You may hear the anti-lock brake system operating and feel the brake pedal pulsating and the vibrations of the vehicle body and steering wheel. You may also hear the motor sound in the engine compartment even after the vehicle is stopped.
- At the end of the anti-lock brake system activation, the brake pedal may move a little forward.

CAUTION

Do not overestimate the anti-lock brake system: Although the anti-lock brake system assists in providing vehicle control, it is still important to drive with all due care and maintain a moderate speed and safe distance from the vehicle in front of you, because there are limits to the vehicle stability and effectiveness of steering wheel operation even with the anti-lock brake system on.

If tires grip performance exceeds its capability, or if hydroplaning occurs during high speed driving in the rain, the anti-lock brake system does not provide vehicle control.

Anti-lock brake system is not designed to shorten the stopping distance: Always drive at the moderate speed and maintain a safe distance from the vehicle in front of you. Compared with vehicles without an anti-lock brake system, your vehicle may require a longer stopping distance in the following cases:

- Driving on rough, gravel or snow-covered roads.
- Driving with tire chains installed.
- Driving over the steps such as the joints on the road.
- Driving on roads where the road surface is pitted or has other differences in surface height.

Install all 4 tires of specified size at appropriate pressure: The anti-lock brake system detects vehicle speeds using the speed sensors for respective wheels' turning speeds. The use of tires other than specified may fail to detect the accurate turning speed resulting in a longer stopping distance.

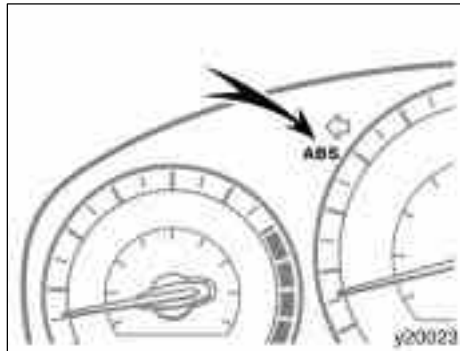

Type A

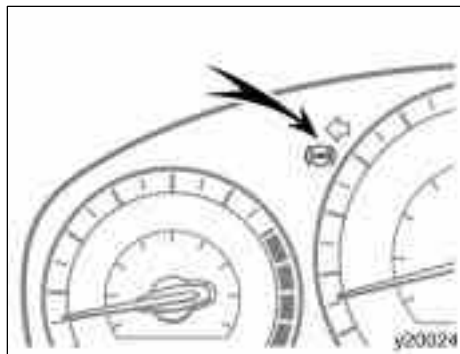

Type B

“ABS” warning light

Vehicles without the vehicle stability control system—

The light comes on when the ignition key is turned to the “ON” position. If the anti-lock brake system works properly, the light turns off after a few seconds. Thereafter, if either of the systems malfunctions, the light comes on again.

When the “ABS” warning light is on (and the brake system warning light is off), the anti-lock brake system does not operate, but the brake system still operates conventionally.

When the “ABS” warning light is on (and the brake system warning light is off), the anti-lock brake system does not operate but the brake assist system still operates. In this case the wheels could lock up during a sudden braking or braking on slippery road surfaces.

If either of the following conditions occurs, this indicates a malfunction somewhere in the components monitored by the warning light system. Contact your Toyota dealer as soon as possible to service the vehicle.

- The light does not come on when the ignition key is turned to the “ON” position, or remains on.
- The light comes on while you are driving.

A warning light turning on briefly during operation does not indicate a problem.

CAUTION

If the “ABS” warning light remains on together with the brake system warning light, immediately stop your vehicle at a safe place and contact your Toyota dealer.

In this case, not only the anti-lock brake system will fail but also the vehicle will become extremely unstable during braking.

06 SIENNA_U (L/O 0603)

Vehicles with the vehicle stability control system—

The light comes on when the ignition key is turned to the “ON” position. If the anti-lock brake system and the brake assist system work properly, the light turns off after a few seconds. Thereafter, if either of the systems malfunctions, the light comes on again.

When the “ABS” warning light is on (and the brake system warning light is off), the anti-lock brake system, the brake assist system, the traction control system and the vehicle stability control system do not operate, but the brake system still operates conventionally.

When the “ABS” warning light is on (and the brake system warning light is off), the anti-lock brake system does not operate so that the wheels could lock up during a sudden braking or braking on slippery road surfaces.

If either of the following conditions occurs, this indicates a malfunction somewhere in the components monitored by the warning light system. Contact your Toyota dealer as soon as possible to service the vehicle.

- The light does not come on when the ignition key is turned to the “ON” position, or remains on.
- The light comes on while you are driving.

A warning light turning on briefly during operation does not indicate a problem.

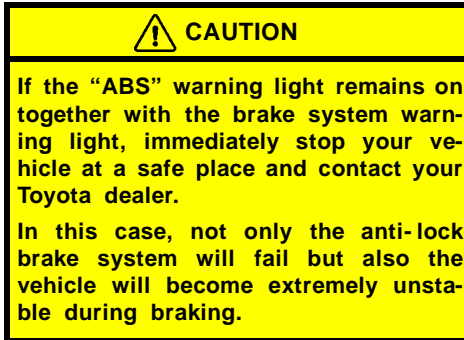

DRUM-IN-DISC TYPE PARKING BRAKE SYSTEM (with rear disc brake)

Your vehicle has a drum-in-disc type parking brake system. This type of brake system needs bedding-down of the brake shoes periodically or whenever the parking brake shoes and/or drums are replaced.

Have your Toyota dealer perform the bedding-down.

BRAKE ASSIST SYSTEM

When you slam the brakes on, the brake assist system judges as an emergency stop and provides more powerful braking for a driver who cannot hold down the brake pedal firmly.

When you slam the brakes on, more powerful braking will be applied. At this time, you may hear a sound in the engine compartment and feel the vibrations of the brake pedal. This does not indicate a malfunction.

Vehicles with the vehicle stability control system—

The brake assist system becomes operative after the vehicle has accelerated to a speed in excess of approximately 10 km/h (6 mph). It stops operating when the vehicle decelerates to a speed below approximately 5 km/h (3 mph).

For an explanation of this system’s warning light, see “Service reminder indicators and warning buzzers” on page 187 in Section 1-6.

Brake pad wear limit indicators

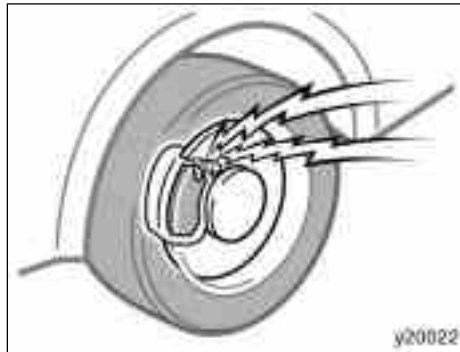

The brake pad wear limit indicators on your disc brakes give a warning noise when the brake pads are worn to where replacement is required.

If you hear a squealing or scraping noise while driving, have the brake pads checked and replaced by your Toyota dealer as soon as possible. Expensive rotor damage can result if the pads are not replaced when necessary.

**Your Toyota's identification—
—Vehicle identification number**

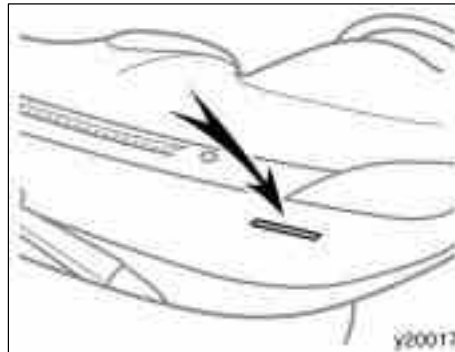

The vehicle identification number (VIN) is the legal identifier for your vehicle. This number is on the left top of the instrument panel, and can be seen through the windshield from outside.

This is the primary identification number for your Toyota. It is used in registering the ownership of your vehicle.

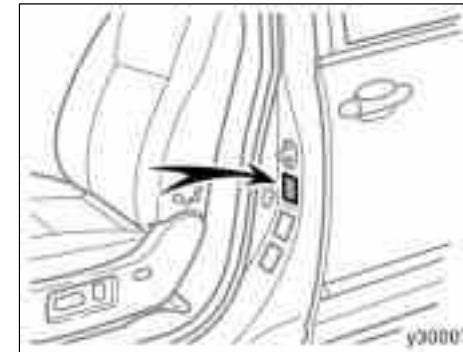

The vehicle identification number (VIN) is also on the Certification Label.

—Engine number

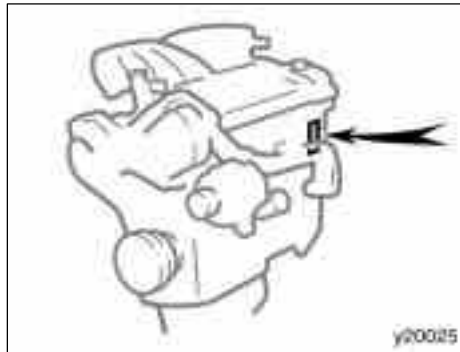

The engine number is stamped on the engine block as shown.

**Theft prevention labels
(except for Canada)**

Your new vehicle carries theft prevention labels which are approximately 47 mm (1.90 in.) by 12 mm (0.50 in.).

The purpose of these labels is to reduce the incidence of vehicle thefts by facilitating the tracing and recovery of parts from stolen vehicles. The label is designed so that once it is applied to a surface, any attempt to remove it will result in destroying the integrity of the label. Transferring these labels intact from one part to another, will be impossible.

NOTICE

You should not attempt to remove the theft prevention labels as it may violate certain state or federal laws.

Suspension and chassis

⚠ CAUTION

Do not modify the suspension/chassis with lift kits, spacers, springs, etc. It can cause dangerous handling characteristics, resulting in loss of control.

Tire information—
—Tire symbols (run-flat tire or standard tire)

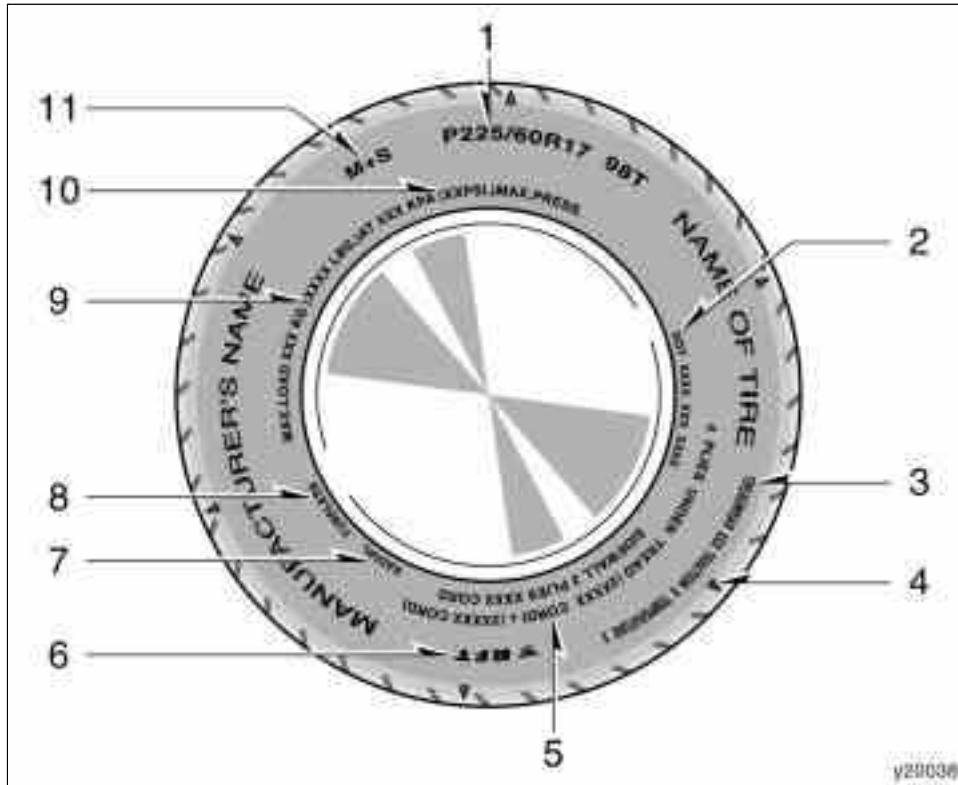

This illustration indicates typical tire symbols.

1. **Tire size**—For details, see “—Tire size” on page 392.
2. **DOT and Tire Identification Number (TIN)**—For details, see “—DOT and Tire Identification Number (TIN)” on page 391.
3. **Uniform tire quality grading**—For details, see “Uniform tire quality grading” that follows.
4. **The location of the tread wear indicators**—For details, see “Checking and replacing tires” on page 474.
5. **Tire ply composition and materials**—Plies mean a layer of rubber-coated parallel cords. Cords mean the strands forming the plies in the tire.

- 6. Run-flat tire (RFT) or standard tire**—This vehicle can be equipped with either run-flat tires (RFT) or standard tires. A “RFT” or “DSST” mark is molded on the sidewall of the run-flat tire. For details, see “Run-flat tires” on page 476.
- 7. Radial tire or bias-ply tires**—A radial tire has “RADIAL” on the sidewall. A tire not marked with “RADIAL” is a bias-ply tire.
- 8. “TUBELESS” or “TUBE TYPE”**—A tubeless tire does not have a tube inside the tire and air is directly filled in the tire. A tube type tire has a tube inside the tire and the tube maintains the air pressure.
- 9. Load limit at maximum cold tire inflation pressure**—For details, see “Checking and replacing tires” on page 474.
- 10. Maximum cold tire inflation pressure**—This means the pressure to which a tire may be inflated. For details about recommended cold tire inflation pressure, see “Tires” on page 501.
- 11. Summer tire or all season tire**—An all season tire has “M+S” on the sidewall. The tire not marked with “M+S” is a summer tire. For details, see “Types of tires” on page 402.

—Tire symbols (compact spare tire)

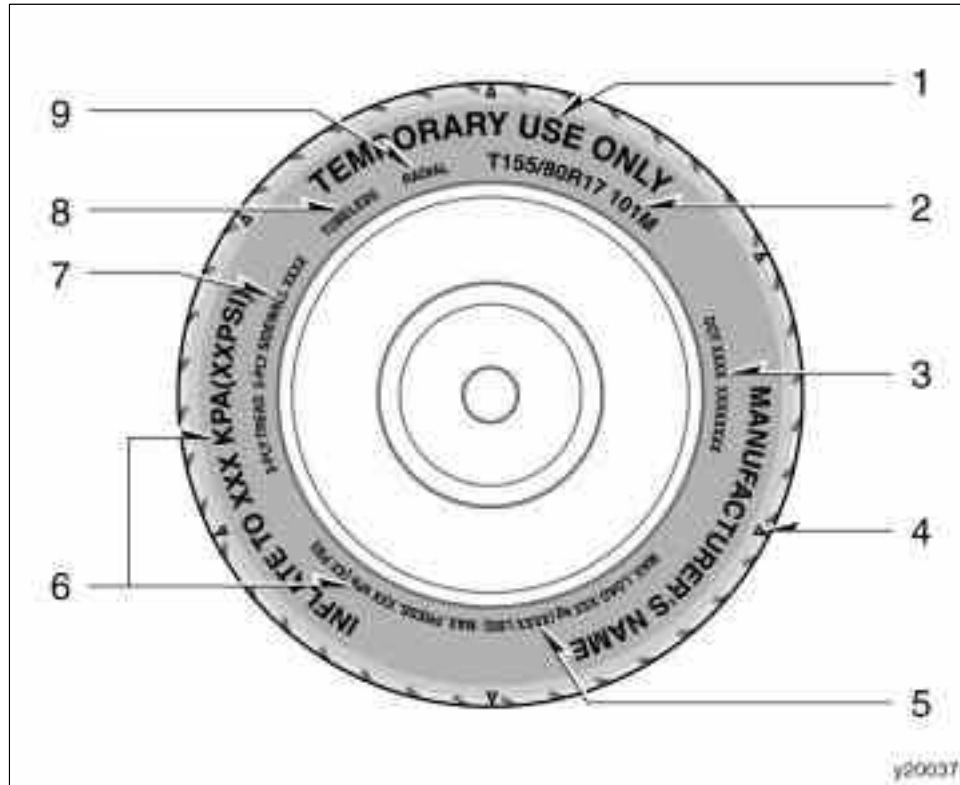

This illustration indicates typical tire symbols.

1. **“TEMPORARY USE ONLY”**—A compact spare tire is identified by the phrase “TEMPORARY USE ONLY” molded into its sidewall. This tire is designed for temporary emergency use only. For details, see “COMPACT SPARE TIRE” on page 421.
2. **Tire size**—For details, see “—Tire size” on page 392.
3. **DOT and Tire Identification Number (TIN)**—For details, see “—DOT and Tire Identification Number (TIN)” on page 391.
4. **The location of the tread wear indicators**—For details, see “Checking and replacing tires” on page 474.
5. **Load limit at maximum cold tire inflation pressure**—For details, see “Checking and replacing tires” on page 474.

6. **Maximum cold tire inflation pressure**—This means the pressure to which a tire may be inflated. For details about recommended cold tire inflation pressure, see “Tires” on page 501.
7. **Tire ply composition and materials**—Plies mean a layer of rubber-coated parallel cords. Cords mean the strands forming the plies in the tire.
8. **“TUBELESS” or “TUBE TYPE”**—A tubeless tire does not have a tube inside the tire and air is directly filled in the tire. A tube type tire has a tube inside the tire and the tube maintains the air pressure.
9. **Radial tire or bias-ply tires**—A radial tire has “RADIAL” on the sidewall. A tire not marked with “RADIAL” is a bias-ply tire.

—DOT and Tire Identification Number (TIN)

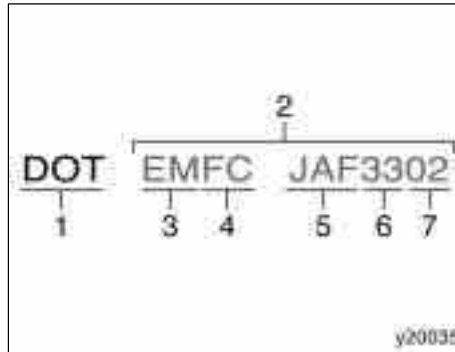

The “DOT” symbol certifies that the tire conforms to applicable Federal Motor Vehicle Safety Standards.

This illustration indicates typical DOT and Tire Identification Number (TIN).

1. “DOT” symbol
2. Tire Identification Number (TIN)
3. Tire manufacturer’s identification mark
4. Tire size code
5. Manufacturer’s optional tire type code (3 or 4 letters)
6. Manufacturing week
7. Manufacturing year

06 SIENNA_U (L/O 0603)

—Tire size

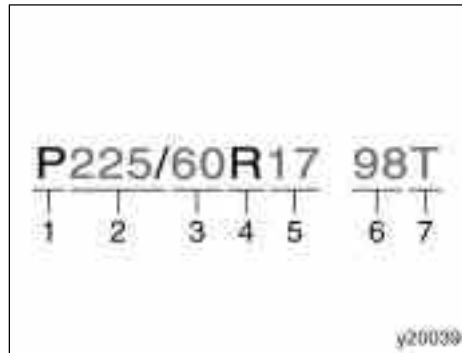

This illustration indicates typical tire size.

1. Tire use (P=Passenger car, T=Temporary use)
2. Section width (in millimeters)
3. Aspect ratio (tire height to section width)
4. Tire construction code (R=Radial, D=Diagonal)
5. Wheel diameter (in inches)
6. Load index (2 digits or 3 digits)
7. Speed symbol (alphabet with one letter)



1. Section width
2. Tire height
3. Wheel diameter

—Name of each section of tire

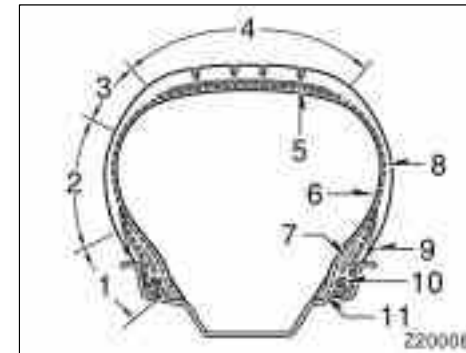

1. Bead
2. Sidewall
3. Shoulder
4. Tread
5. Belt
6. Inner liner
7. Reinforcing rubber
8. Carcass
9. Rim lines
10. Bead wires
11. Chafer

—Uniform tire quality grading

This information has been prepared in accordance with regulations issued by the National Highway Traffic Safety Administration of the U.S. Department of Transportation. It provides the purchasers and/or prospective purchasers of Toyota vehicles with information on uniform tire quality grading.

Your Toyota dealer will help answer any questions you may have as you read this information.

DOT quality grades—All passenger vehicle tires must conform to Federal Safety Requirements in addition to these grades. Quality grades can be found where applicable on the tire sidewall between tread shoulder and maximum section width. For example: Treadwear 200 Traction AA Temperature A

Treadwear—The treadwear grade is a comparative rating based on the wear rate of the tire when tested under controlled conditions on a specified government test course. For example, a tire graded 150 would wear one and a half (1- 1/2) times as well on the government course as a tire graded 100. The relative performance of tires depends upon the actual conditions of their use, however, and may depart significantly from the norm due to variations in driving habits, service practices and differences in road characteristics and climate.

Traction AA, A, B, C—The traction grades, from highest to lowest, are AA, A, B, and C, and they represent the tire's ability to stop on wet pavement as measured under controlled conditions on specified government test surfaces of asphalt and concrete. A tire marked C may have poor traction performance.

Warning: The traction grade assigned to this tire is based on braking (straight ahead) traction tests and does not include cornering (turning) traction.

Temperature A, B, C—The temperature grades are A (the highest), B, and C, representing the tire's resistance to the generation of heat and its ability to dissipate heat when tested under controlled conditions on a specified indoor laboratory test wheel. Sustained high temperature can cause the material of the tire to degenerate and reduce tire life, and excessive temperature can lead to sudden tire failure. The grade C corresponds to a level of performance which all passenger car tires must meet under the Federal Motor Vehicle Safety Standard No.109. Grades B and A represent higher levels of performance on the laboratory test wheel than the minimum required by law.

Warning: The temperature grades for this tire are established for a tire that is properly inflated and not overloaded. Excessive speed, underinflation, or excessive loading, either separately or in combination, can cause heat buildup and possible tire failure.

06 SIENNA_U (L/O 0603)

—Glossary of tire terminology

Tire related term	Meaning
Accessory weight	the combined weight (in excess of those standard items which may be replaced) of automatic transmission, power steering, power brakes, power windows, power seats, radio, and heater, to the extent that these items are available as factory-installed equipment (whether installed or not)
Cold tire inflation pressure	tire inflation pressure when the vehicle has been parked for at least 3 hours or more, or it has not been driven more than 1.5 km or 1 mile under that condition
Curb weight	the weight of a motor vehicle with standard equipment including the maximum capacity of fuel, oil, and coolant, and, if so equipped, air conditioning and additional weight optional engine
Intended outboard sidewall	(A) the sidewall that contains a whitewall, bears white lettering or bears manufacturer, brand, and/or model name molding that is higher or deeper than the same molding on the other sidewall of the tire, or (B) the outward facing sidewall of an asymmetrical tire that has a particular side that must always face outward when mounted on a vehicle
Maximum inflation pressure	the maximum cold inflation pressure to which a tire may be inflated and it is shown on the sidewall of the tire
Maximum loaded vehicle weight	the sum of— (a) curb weight; (b) accessory weight; (c) vehicle capacity weight; and (d) production options weight

06 SIENNA_U (L/O 0603)

Tire related term	Meaning
Normal occupant weight	68 kg (150 lb.) times the number of occupants specified in the second column of Table 1 that follows
Occupant distribution	distribution of occupants in a vehicle as specified in the third column of Table 1 that follows
Production options weight	the combined weight of those installed regular production options weighing over 2.3 kg (5 lb.) in excess of those standard items which they replace, not previously considered in curb weight or accessory weight, including heavy duty brakes, ride levelers, roof rack, heavy duty battery, and special trim
Recommended inflation pressure	cold tire inflation pressure recommended by a manufacturer
Rim	a metal support for a tire or a tire and tube assembly upon which the tire beads are seated
Rim diameter (Wheel diameter)	nominal diameter of the bead seat
Rim size designation	rim diameter and width
Rim type designation	the industry of manufacturer's designation for a rim by style or code
Rim width	nominal distance between rim flanges
Vehicle capacity weight (Total load capacity)	the rated cargo and luggage load plus 68 kg (150 lb.) times the vehicle's designated seating capacity
Vehicle maximum load on the tire	the load on an individual tire that is determined by distributing to each axle its share of the maximum loaded vehicle weight and dividing by two

06 SIENNA_U (L/O 0603)

Tire related term	Meaning
Vehicle normal load on the tire	the load on an individual tire that is determined by distributing to each axle its share of the curb weight, accessory weight, and normal occupant weight (distributed in accordance with Table 1 that follows) and dividing by two
Weather side	the surface area of the rim not covered by the inflated tire

Table 1—Occupant loading and distribution for vehicle normal load for various designated seating capacities

Designated seating capacity, number of occupants	Vehicle normal load, number of occupants	Occupant distribution in a normally loaded vehicle
2 through 4	2	2 in front
5 through 10	3	2 in front, 1 in second seat

Vehicle load limits

Vehicle load limits include total load capacity, seating capacity, towing capacity and cargo capacity. Follow the load limits shown below. Total load capacity and seating capacity are also described on the tire and loading information label. For location of the tire and loading information label, see "Checking tire inflation pressure" on page 471.

Total load capacity

Total load capacity means combined weight of occupants, cargo and luggage. Tongue load is included when trailer towing. For the total load capacity about your vehicle, see "Total load capacity" on page 497 in Section 8.

Seating capacity:

- 7- passenger models—
Total 7 (Front 2, Rear 5)
- 8- passenger models—
Total 8 (Front 2, Rear 6)

Seating capacity means the maximum number of occupants whose estimated average weight is 68 kg (150 lb.) per person. Depending on the weight of each person, the seating capacity given may exceed the total load capacity.

NOTICE

Even if the number of occupants are within the seating capacity, do not exceed the total load capacity.

Towing capacity:

1587 kg (3500 lb.)

Towing capacity means the maximum gross trailer weight (trailer weight plus its cargo weight) that your vehicle is able to tow.

Cargo capacity

Cargo capacity may increase or decrease depending on the size (weight) and the number of occupants. For details, see "Capacity and distribution" that follows.

CAUTION

Do not apply the load more than each load limit. That may cause not only damage to the tires, but also deterioration to the steering ability and braking ability, which may cause an accident.

**Cargo and luggage—
—Stowage precautions**

When stowing cargo and luggage in the vehicle, observe the following:

- Put cargo and luggage in the luggage compartment when at all possible. Be sure all items are secured in place.
- Be careful to keep the vehicle balanced. Locating the weight as far forward as possible helps maintain balance.
- For better fuel economy, do not carry unneeded weight.

 **CAUTION**

- **To prevent cargo and luggage from sliding forward during braking, do not stack anything in the luggage compartment higher than the seatbacks. Keep cargo and luggage low, as close to the floor as possible.**

- **Never allow anyone to ride in the luggage compartment. It is not designed for passengers. They should ride in their seats with their seat belts properly fastened. Otherwise, they are much more likely to suffer serious bodily injury, in the event of sudden braking or a collision.**
- **Do not drive with objects left on top of the instrument panel. They may interfere with the driver's field of view. Or they may move during sharp vehicle acceleration or turning, and impair the driver's control of the vehicle. In an accident they may injure the vehicle occupants.**

—Capacity and distribution

Cargo capacity depends on the total weight of the occupants.

(Cargo capacity) = (Total load capacity) – (Total weight of occupants)

Steps for Determining Correct Load Limit—

- (1) Locate the statement “The combined weight of occupants and cargo should never exceed XXX kg or XXX lbs.” on your vehicle's placard.
- (2) Determine the combined weight of the driver and passengers that will be riding in your vehicle.
- (3) Subtract the combined weight of the driver and passengers from XXX kg or XXX lbs.

- (4) The resulting figure equals the available amount of cargo and luggage load capacity. For example, if the “XXX” amount equals 1400 lbs. and there will be five 150 lb passengers in your vehicle, the amount of available cargo and luggage load capacity is 650 lbs. $(1400 - 750 (5 \times 150) = 650 \text{ lbs.})$
- (5) Determine the combined weight of luggage and cargo being loaded on the vehicle. That weight may not safely exceed the available cargo and luggage load capacity calculated in Step 4.
- (6) If your vehicle will be towing a trailer, load from your trailer will be transferred to your vehicle. Consult this manual to determine how this reduces the available cargo and luggage load capacity of your vehicle.

For details about trailer towing, see page 408.

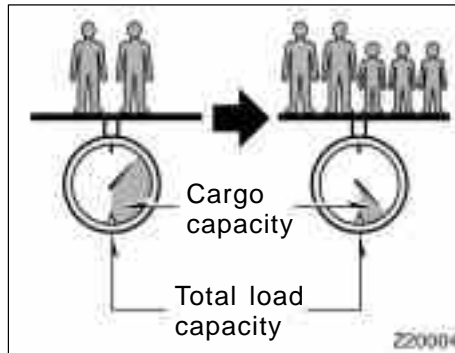

Example on Your Vehicle

In case that 2 people with the combined weight of A kg (lb.) are riding in your vehicle with the total load capacity of B kg (lb.), the available amount of cargo and luggage load capacity will be C kg (lb.) as follows:

$$B \text{ kg (lb.)} - A \text{ kg (lb.)} = C \text{ kg (lb.)}$$

From this condition, if 3 more passengers with the combined weight of D kg (lb.) get on, the available cargo and luggage load will be reduced E kg (lb.) as follows:

$$C \text{ kg (lb.)} - D \text{ kg (lb.)} = E \text{ kg (lb.)}$$

As shown in the above example, if the number of occupants increases, the cargo and luggage load equaling the combined weight of occupants who got on later must be reduced. In other words, if the increase in the number of occupants causes the excess of the total load capacity (combined weight of occupants plus cargo and luggage load), you have to reduce the cargo and luggage on your vehicle.

For details about total load capacity, see “Vehicle load limits” on page 398.

06 SIENNA_U (L/O 0603)

⚠ CAUTION

Even if the total load of occupant's weight and the cargo load is less than the total load capacity, do not apply the load unevenly. That may cause not only damage to the tire but also deterioration to the steering ability due to unbalance of the vehicle, causing an accident.

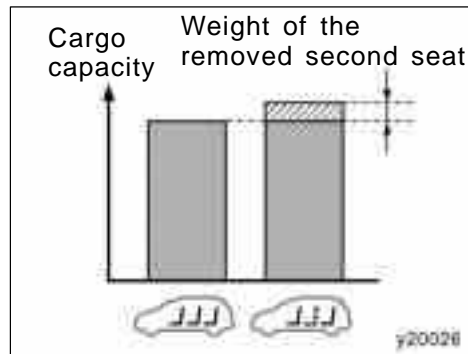

SEATING CONFIGURATION VARIATION

In case of removing the second seats, it is possible to load as much cargo as the weight of the removed seats.

(Cargo capacity) = (Total load capacity) - (Total weight of occupants) + (Weight of the removed second seats)

Second seats weights:

7- passenger models—
Right side 28 kg (61 lb.)
Left side 25 kg (55 lb.)

8- passenger models—
Right side 22 kg (48 lb.)
Left side 22 kg (48 lb.)
Center 24 kg (52 lb.)

Types of tires

Determine what kind of tires your vehicle is originally equipped with.

1. Summer tires

Summer tires are high-speed capability tires best suited to highway driving under dry conditions.

Since summer tires do not have the same traction performance as snow tires, summer tires are inadequate for driving on snow-covered or icy roads. For driving on snow-covered or icy roads, we recommend using snow tires. If installing snow tires, be sure to replace all four tires.

2. All season tires

All season tires are designed to provide better traction in snow and to be adequate for driving in most winter conditions, as well as for use all year round.

All season tires, however, do not have adequate traction performance compared with snow tires in heavy or loose snow. Also, all season tires fall short in acceleration and handling performance compared with summer tires in highway driving.

The details about how to distinguish summer tires from all season tires are described on page 388.

CAUTION

- **Do not mix summer and all season tires on your vehicle as this can cause dangerous handling characteristics, resulting in loss of control.**
- **Do not use tires other than the manufacturer's designated tires, and never mix tires or wheels of the sizes different from the originally equipped tires and wheels.**

SECTION 3

STARTING AND DRIVING

Starting and driving

Before starting the engine	404
How to start the engine	404
Tips for driving in various conditions	405
All-wheel driving tips	406
Winter driving tips	407
Dinghy towing	408
Trailer towing	408
How to save fuel and make your vehicle last longer	413



06 SIENNA_U (L/O 0603)

Before starting the engine

1. Check the area around the vehicle before entering it.
2. Adjust seat position, seatback angle, seat cushion height, head restraint height and steering wheel angle.
3. Adjust the inside and outside rear view mirrors.
4. Lock all doors.
5. Fasten seat belts.

How to start the engine— (a) Before cranking

1. Apply the parking brake firmly.
2. Turn off unnecessary lights and accessories.
3. Put the selector lever in "P". If you need to restart the engine while the vehicle is moving, put the selector lever in "N". A starter safety device will prevent the starter from operating if the selector lever is in any drive position.
4. Depress the brake pedal and hold it to the floor until driving off.

(b) Starting the engine

Before starting the engine, be sure to follow the instructions in "(a) Before cranking".

Normal starting procedure

The multipoint fuel injection system/sequential multipoint fuel injection system in your engine automatically controls the proper air-fuel mixture for starting. You can start a cold or hot engine as follows:

With your foot off the accelerator pedal, crank the engine by turning the key to "START". Release it when the engine starts.

Engine should be warmed up by driving, not in idle. For warming up, drive with smoothly turning engine until engine coolant temperature is within normal range.

If the engine stalls...

Simply restart it, using the correct procedure given in normal starting.

If the engine will not start...

See "If your vehicle will not start" on page 416 in Section 4.

NOTICE

- ◆ ***Do not crank for more than 30 seconds at a time. This may overheat the starter and wiring systems.***
- ◆ ***Do not race a cold engine.***
- ◆ ***If the engine becomes difficult to start or stalls frequently, have the engine checked immediately.***

Tips for driving in various conditions

- Always slow down in gusty crosswinds. This will allow you much better control.
- Drive slowly onto curbs and, if possible, at a right angle. Avoid driving onto high, sharp-edged objects and other road hazards. Failure to do so can lead to severe tire damage such as a tire burst.

Drive slowly when passing over bumps or travelling on a bumpy road. Otherwise, the impact could cause severe damage to the tires and/or wheels.
- When parking on a hill, turn the front wheels until they touch the curb so that the vehicle will not roll. Apply the parking brake, and place the transmission in "P". If necessary, block the wheels.
- Washing your vehicle or driving through deep water may get the brakes wet. To see whether they are wet, check that there is no traffic near you, and then press the pedal lightly. If you do not feel a normal braking force, the brakes are probably wet. To dry them, drive the vehicle cautiously while lightly pressing the brake pedal with the parking brake applied. If they still do not work safely, pull to the side of the road and call a Toyota dealer for assistance.

 **CAUTION**

- **Before driving off, make sure that the parking brake is fully released and the parking brake reminder light is off.**
- **Do not leave your vehicle unattended while the engine is running.**
- **Do not rest your foot on the brake pedal while driving. It can cause dangerous overheating, needless wear, and poor fuel economy.**
- **To drive down a long or steep hill, reduce your speed and downshift. Remember, if you ride the brakes excessively, they may overheat and not work properly.**
- **Be careful when accelerating, upshifting, downshifting or braking on a slippery surface. Sudden acceleration or engine braking could cause the vehicle to skid or spin.**

**All-wheel driving tips
(AWD models)**

- Do not drive in excess of the speed limit. Even if the legal speed limit permits it, do not drive over 140 km/h (85 mph) unless your vehicle has high-speed capability tires. Driving over 140 km/h (85 mph) may result in tire failure, loss of control and possible injury. Be sure to consult a tire dealer to determine whether the tires on your vehicle are high-speed capability tires or not before driving at such speeds.
- Do not continue normal driving when the brakes are wet. If they are wet, your vehicle will require a longer stopping distance, and it may pull to one side when the brakes are applied. Also, the parking brake will not hold the vehicle securely.

- If you need greater traction while driving on sand, mud or snow covered roadways, use tire chains on the front wheels.
- Always check your brakes for effectiveness immediately after driving across sand, mud, or water.
- If operating in adverse conditions frequently, vehicle maintenance should be increased. (See the separate "Scheduled Maintenance Guide" or "Owner's Manual Supplement".)

 **CAUTION**

Observe the following tire instructions. Otherwise, an accident may occur resulting in death or serious injuries.

- Keep your tire inflation pressure at the proper level. (See "Checking tire inflation pressure" on page 471 in Section 7-2.)
- Do not use tires (including snow tires) of different brands, sizes, construction or tread patterns. (See "Checking and replacing tires" on page 474 and "Installing snow tires and chains" on page 478 in Section 7-2.)

- Do not use tires with different tread wear. To equalize the tire wear, rotate tires at the appropriate interval. (See "Rotating tires" on page 476 in Section 7-2.)
- Use the manufacturer's recommended wheels. Do not use wheels of different sizes and types. (See "Replacing wheels" on page 480 in Section 7-2.)

NOTICE

Do not attempt to go off-road in your Toyota. It is not designed for off-road use.

Winter driving tips

Make sure your coolant is properly protected against freezing.

Only use "Toyota Super Long Life Coolant" or similar high quality ethylene glycol based non-silicate, non-amine, non-nitrite, and non-borate coolant with long-life hybrid organic acid technology. (Coolant with long-life hybrid organic acid technology is a combination of low phosphates and organic acids.)

See "Checking the engine coolant level" on page 468 in Section 7-2 for details of coolant type selection.

For the U.S.A.—"Toyota Super Long Life Coolant" is a mixture of 50% coolant and 50% deionized water. This coolant provides protection down to about -35°C (-31°F).

For Canada—"Toyota Super Long Life Coolant" is a mixture of 55% coolant and 45% deionized water. This coolant provides protection down to about -42°C (-44°F).

NOTICE

Do not use plain water alone.

Check the condition of the battery and cables.

Cold temperatures reduce the capacity of any battery, so it must be in top shape to provide enough power for winter starting. Section 7-3 tells you how to visually inspect the battery. Your Toyota dealer and most service stations will be pleased to check the level of charge.

Make sure the engine oil viscosity is suitable for the cold weather.

See page 466 in Section 7-2 for recommended viscosity. Leaving a heavy summer oil in your vehicle during winter months may cause harder starting. If you are not sure about which oil to use, call your Toyota dealer—they will be pleased to help.

Keep the door locks from freezing.

Squirt lock de-icer or glycerine into the locks to keep them from freezing.

Use a washer fluid containing an anti-freeze solution.

This product is available at your Toyota dealer and most auto parts stores. Follow the manufacturer's directions for how much to mix with water.

NOTICE

Do not use engine antifreeze or any other substitute because it may damage your vehicle's paint.

Do not use your parking brake when there is a possibility it could freeze.

When parking, put the transmission into "P" and block the rear wheels. Do not use the parking brake, or snow or water accumulated in and around the parking brake mechanism may freeze, making it hard to release.

Keep ice and snow from accumulating under the fenders.

Ice and snow built up under your fenders can make steering difficult. During bad winter driving, stop and check under the fenders occasionally.

Depending on where you are driving, we recommend you carry some emergency equipment.

Some of the things you might put in the vehicle are tire chains, window scraper, bag of sand or salt, flares, small shovel, jumper cables, etc.

Dinghy towing



Your vehicle is not designed to be dinghy towed (with four wheels on the ground) behind a motorhome.

NOTICE

Do not tow your vehicle with four wheels on the ground. This may cause serious damage to your vehicle.

Trailer towing

Your vehicle is designed primarily as a passenger- and load-carrying vehicle. Towing a trailer will have an adverse effect on handling, performance, braking, durability and driving economy (fuel consumption, etc.). Your safety and satisfaction depend on the proper use of correct equipment and cautious driving habits. For your safety and the safety of others, you must not overload your vehicle or trailer. Ask your local Toyota dealer for further details before towing.

WEIGHT LIMITS

Before towing, make sure the total trailer weight, gross combination weight, gross vehicle weight, gross axle weight and trailer tongue load are all within the limits.

The total trailer weight and tongue load can be measured with platform scales found at a highway weighing station, building supply company, trucking company, junk yard, etc.

CAUTION

- **The maximum gross trailer weight (trailer weight plus cargo weight) must never exceed the following.**
 1587 kg (3500 lb.)

If towing a trailer and cargo weighing over 907 kg (2000 lb.), it is necessary to use a sway control device with sufficient capacity. The combination of the gross trailer weight added to the total weight of the vehicle, occupants and vehicle cargo must never exceed a total of the following.

- Two-wheel drive models
3946 kg (8700 lb.)
- All-wheel drive models
3992 kg (8800 lb.)

06 SIENNA_U (L/O 0603)

Exceeding the maximum weight of the trailer, the vehicle, or the vehicle and trailer combination, can cause an accident resulting in serious personal injuries.

- Trailer hitch assemblies have different weight capacities established by the hitch manufacturer. Even though the vehicle may be physically capable of towing a higher weight, the operator must determine the maximum weight rating of the particular hitch assembly and never exceed the maximum weight rating specified for the trailer-hitch. Exceeding the maximum weight rating set by the trailer hitch manufacturer can cause an accident resulting in serious personal injuries.



- The gross vehicle weight must not exceed the Gross Vehicle Weight Rating (GVWR) indicated on the Certification Label. The gross vehicle weight is the sum of weights of the unloaded vehicle, driver, passengers, luggage, hitch and trailer tongue load. It also includes the weight of any special equipment installed on your vehicle.
- The load on either the front or rear axle resulting from distribution of the gross vehicle weight on both axles must not exceed the Gross Axle Weight Rating (GAWR) listed on the Certification Label.

Total trailer weight

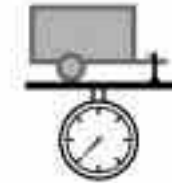

Tongue load

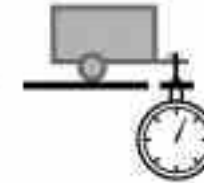

$$\frac{\text{Tongue load}}{\text{Total trailer weight}} \times 100 = 9 \text{ to } 11\% \text{ }^{(*)1}$$

$$\text{or } 15\% \text{ }^{(*)2}$$

y300003

- The trailer cargo load should be distributed so that the tongue load is 9 to 11% for weight carrying hitch ^{(*)1} or 15% for weight distributing hitch ^{(*)2} of the total trailer weight, not exceeding the maximum load of the following.

Weight carrying hitch

158 kg (350 lb.)

Weight distributing hitch

238 kg (525 lb.)

06 SIENNA_U (L/O 0603)

Never load the trailer with more weight in the back than in the front. About 60% of the trailer load should be in the front half of the trailer and the remaining 40% in the rear.

HITCHES

- If you wish to install a trailer hitch, you should consult with your Toyota dealer.
- Use only a hitch recommended by the hitch manufacturer and the one which conforms to the total trailer weight requirement.
- The hitch must be bolted securely to the vehicle frame and installed according to the hitch manufacturer's instructions.
- The hitch ball and king pin should have a light coat of grease.

- Toyota recommends removing the trailer hitch whenever you are not towing a trailer to reduce the possibility of additional damage caused by the hitch if your vehicle is struck from behind. After removing the hitch, seal any mounting holes in the vehicle body to prevent entry of pollutants such as exhaust fumes, dirt, water, etc.

NOTICE

Do not use axle-mounted hitches as they can cause damage to the axle housing, wheel bearings, wheels or tires. Also, never install a hitch which may interfere with the normal function of an Energy Absorbing Bumper, if so equipped.

BRAKES AND SAFETY CHAINS

- Toyota recommends trailers with brakes that conform to any applicable federal and state/provincial regulations.

- A safety chain must always be used between the towing vehicle and the trailer. Leave sufficient slack in the chain for turns. The chain should cross under the trailer tongue to prevent the tongue from dropping to the ground in case it becomes damaged or separated. For correct safety chain procedures, follow the hitch or trailer manufacturer's recommendations.

CAUTION

- If the total trailer weight exceeds 453 kg (1000 lb.), trailer brakes are required.
- Never tap into your vehicle's hydraulic system as it would lower its braking effectiveness.
- Never tow a trailer without using a safety chain securely attached to both the trailer and the vehicle. If damage occurs to the coupling unit or hitch ball, there is danger of the trailer wandering over into another lane.

06 SIENNA_U (L/O 0603)

TIRES

- Ensure that your vehicle's tires are properly inflated. See page 471 in Section 7-2 and page 501 in Section 8 for instructions.
- The trailer tires should be inflated to the pressure recommended by the trailer manufacturer in respect to the total trailer weight.

TRAILER LIGHTS

- Trailer lights must comply with federal, state/provincial and local regulations. See your local recreational vehicle dealer or rental agency for the correct type of wiring and relays for your trailer. Check for correct operation of the turn signals and stop lights each time you hitch up. Direct splicing may damage your vehicle's electrical system and cause a malfunction of your lights.

BREAK-IN SCHEDULE

- Toyota recommends that you do not tow a trailer with a new vehicle or a vehicle with any new power train component (engine, transmission, differential, wheel bearing, etc.) for the first 800 km (500 miles) of driving.

MAINTENANCE

- If you tow a trailer, your vehicle will require more frequent maintenance due to the additional load. For this information, please refer to the scheduled maintenance information in the "Scheduled Maintenance Guide" or "Owner's Manual Supplement".
- Retighten all fixing bolts of the towing ball and bracket after approximately 1000 km (600 miles) of trailer driving.

PRE-TOWING SAFETY CHECK

- Check that your vehicle remains level when a loaded or unloaded trailer is hitched. Do not drive if the vehicle has an abnormal nose-up or nose-down condition, and check for improper tongue load, overload, worn suspension or other possible causes.
- Make sure the trailer cargo is securely loaded so that it cannot shift.
- Check that your rear view mirrors conform to any applicable federal, state/provincial or local regulations. If not, install the rear view mirrors required for towing purpose.

TRAILER TOWING TIPS

When towing a trailer, your vehicle will handle differently than when not towing. The three main causes of vehicle-trailer accidents are driver error, excessive speed and improper trailer loading. Keep these in mind when towing:

- Before starting out, check operation of the lights and all vehicle-trailer connections. After driving a short distance, stop and recheck the lights and connections. Before actually towing a trailer, practice turning, stopping and backing with a trailer in an area away from traffic until you learn the feel.
- Backing with a trailer is difficult and requires practice. Grip the bottom of the steering wheel and move your hand to the left to move the trailer to the left. Move your hand to the right to move the trailer to the right. (This procedure is generally opposite to that when backing without a trailer.) Also, just turn the steering wheel a little at a time, avoiding sharp or prolonged turning. Have someone guide you when backing to reduce the risk of an accident.

06 SIENNA_U (L/O 0603)

- Because stopping distance may be increased, following distance should be increased when towing a trailer. For each 16 km/h (10 mph) of speed, allow at least one vehicle and trailer length between you and the vehicle ahead. Avoid sudden braking as you may skid, resulting in jackknifing and loss of control. This is especially true on wet or slippery surfaces.
- Avoid jerky starts or sudden acceleration.
- Avoid jerky steering and sharp turns. The trailer could hit your vehicle in a tight turn. Slow down before making a turn to avoid the necessity of sudden braking.
- Remember that when making a turn, the trailer wheels will be closer than the vehicle wheels to the inside of the turn. Therefore, compensate for this by making a larger than normal turning radius with your vehicle.
- Crosswinds and rough roads will adversely affect handling of your vehicle and trailer, causing sway. Pay attention to the rear from time to time to prepare yourself for being passed by large trucks or buses, which may cause your vehicle and trailer to sway. If swaying happens, firmly grip the steering wheel and reduce speed immediately but gradually. Never increase speed. Steer straight ahead. If you make no extreme correction with the steering or brakes, the vehicle and trailer will stabilize.
- Be careful when passing other vehicles. Passing requires considerable distance. After passing a vehicle, do not forget the length of your trailer and be sure you have plenty of room before changing lanes.
- In order to maintain engine braking efficiency, do not place the transmission in "D".
- Because of the added load of the trailer, your vehicle's engine may overheat on hot days (at temperatures over 30°C [85°F]) when going up a long or steep grade with a trailer. If the engine coolant temperature gauge indicates overheating, immediately turn off the air conditioning (if in use), pull off the road and stop in a safe spot. Refer to "If your vehicle overheats" on page 420 in Section 4.
- Always place wheel blocks under both the vehicle and trailer wheels when parking. Apply the parking brake firmly. Put the transmission in "P". Avoid parking on a slope with a trailer, but if it cannot be avoided, do so only after performing the following:
 1. Apply the brakes and hold.
 2. Have someone place wheel blocks under both the vehicle and trailer wheels.
 3. When the wheel blocks are in place, release your brakes slowly until the blocks absorb the load.
 4. Apply the parking brake firmly.
 5. Shift into "P" and turn off the engine.

06 SIENNA_U (L/O 0603)

When restarting out after parking on a slope:

1. With the transmission in “P”, start the engine. Be sure to keep the brake pedal depressed.
2. Shift into gear.
3. Release the parking brake and brake pedal and slowly pull or back away from the wheel blocks. Stop and apply your brakes.
4. Have someone retrieve the blocks.

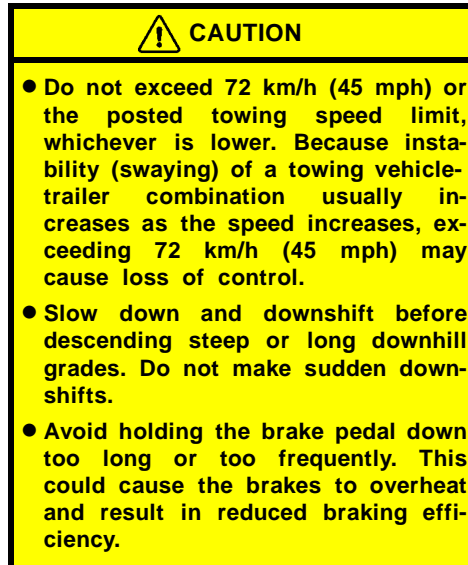

How to save fuel and make your vehicle last longer

Improving fuel economy is easy—just take it easy. It will help make your vehicle last longer, too. Here are some specific tips on how to save money on both fuel and repairs:

- **Keep your tires inflated at the correct pressure.** Underinflation causes tire wear and wastes fuel. See page 471 in Section 7-2 for instructions.
- **Do not carry unneeded weight in your vehicle.** Excess weight puts a heavier load on the engine, causing greater fuel consumption.
- **Avoid lengthy warm-up idling.** Once the engine is running smoothly, begin driving—but gently. Remember, however, that on cold winter days this may take a little longer.
- **Put the selector lever into the “D” when engine braking is not required.** Driving with the selector lever in “4” will reduce the fuel economy. (For details, see “Automatic transmission” on page 199 in Section 1-7.)
- **Accelerate slowly and smoothly.** Avoid jackrabbit starts. Get into high gear as quickly as possible.

06 SIENNA_U (L/O 0603)

- **Avoid long engine idling.** If you have a long wait and you are not in traffic, it is better to turn off the engine and start again later.
- **Avoid engine lugging or over-revving.** Use a gear position suitable for the road on which you are travelling.
- **Avoid continuous speeding up and slowing down.** Stop-and-go driving wastes fuel.
- **Avoid unnecessary stopping and braking.** Maintain a steady pace. Try to time the traffic signals so you only need to stop as little as possible or take advantage of through streets to avoid traffic lights. Keep a proper distance from other vehicles to avoid sudden braking. This will also reduce wear on your brakes.
- **Avoid heavy traffic or traffic jams whenever possible.**
- **Do not rest your foot on the brake pedal.** This causes premature wear, overheating and poor fuel economy.
- **Maintain a moderate speed on highways.** The faster you drive, the greater the fuel consumption. By reducing your speed, you will cut down on fuel consumption.
- **Keep the front wheels in proper alignment.** Avoid hitting the curb and slow down on rough roads. Improper alignment not only causes faster tire wear but also puts an extra load on the engine, which, in turn, wastes fuel.
- **Keep the bottom of your vehicle free from mud, etc.** This not only lessens weight but also helps prevent corrosion.
- **Keep your vehicle tuned-up and in top shape.** A dirty air cleaner, improper valve clearance, dirty plugs, dirty oil and grease, brakes not adjusted, etc. all lower engine performance and contribute to poor fuel economy. For longer life of all parts and lower operating costs, keep all maintenance work on schedule, and if you often drive under severe conditions, see that your vehicle receives more frequent maintenance. (For scheduled maintenance information, please refer to the "Scheduled Maintenance Guide" or "Owner's Manual Supplement".)

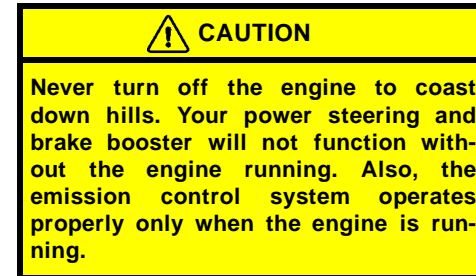

SECTION 4

IN CASE OF AN EMERGENCY

In case of an emergency

If your vehicle will not start	416
If your engine stalls while driving	419
If you cannot increase engine speed	419
If your vehicle overheats	420
If you have a flat tire	421
If your vehicle becomes stuck	436
If your vehicle needs to be towed	437
If you lose your keys	439
If you lose your wireless remote control transmitter	439
If you cannot shift automatic transmission selector lever	439
If you cannot operate back door opener	440

**If your vehicle will not start—
(a) Simple checks**

Before making these checks, make sure you have followed the correct starting procedure given in “How to start the engine” on page 404 in Section 3 and that you have sufficient fuel. If your vehicle is equipped with the engine immobilizer system, also check whether the other keys will start the engine. If they work, your key may be broken. Have the key checked at your Toyota dealer. If none of your keys work, there may be a malfunction in the immobilizer system. Call your Toyota dealer. (See “Keys (with engine immobilizer system)” on page 10 in Section 1-2.)

If the engine is not turning over or is turning over too slowly—

1. Check that the battery terminals are tight and clean.
2. If the battery terminals are O.K., switch on the interior light.
3. If the light is out, dim or goes out when the starter is cranked, the battery is discharged. You may try jump starting. See “(c) Jump starting” on page 417 for further instructions.

If the light is O.K., but the engine still will not start, it needs adjustment or repair. Call a Toyota dealer or qualified repair shop.

416

NOTICE

Do not pull- or push-start the vehicle. It may damage the vehicle or cause a collision when the engine starts. Also the three-way catalytic converter may overheat and become a fire hazard.

If the engine turns over at its normal speed but will not start—

1. Turn the ignition key to “ACC” or “LOCK” and try starting the engine again.
2. If the engine will not start, the engine may be flooded because of repeated cranking. See “(b) Starting a flooded engine” on page 416 for further instructions.
3. If the engine still will not start, it needs adjustment or repair. Call a Toyota dealer or qualified repair shop.

(b) Starting a flooded engine

If the engine will not start, your engine may be flooded because of repeated cranking.

If this happens, turn the key to “START” with the accelerator pedal fully depressed. Keep the key and accelerator pedal in these positions for 15 seconds and release them. Then try starting the engine with your foot off the accelerator pedal.

If the engine does not start after 15 seconds of cranking, release the key, wait a few minutes and try again.

If the engine still will not start, it needs adjustment or repair. Call a Toyota dealer or qualified repair shop for assistance.

NOTICE

Do not crank for more than 30 seconds at a time. This may overheat the starter and wiring systems.

(c) Jump starting

To avoid serious personal injury and damage to your vehicle which might result from battery explosion, acid burns, electrical burns, or damaged electronic components, these instructions must be followed precisely.

If you are unsure about how to follow this procedure, we strongly recommend that you seek the help of a competent mechanic or towing service.

 CAUTION
<ul style="list-style-type: none">● Batteries contain sulfuric acid which is poisonous and corrosive. Wear protective safety glasses when jump starting, and avoid spilling acid on your skin, clothing, or vehicle.● If you should accidentally get acid on yourself or in your eyes, remove any contaminated clothing and flush the affected area with water immediately. Then get immediate medical attention. If possible, continue to apply water with a sponge or cloth while en route to the medical office.

<ul style="list-style-type: none">● The gas normally produced by a battery will explode if a flame or spark is brought near. Use only standardized jumper cables and do not smoke or light a match while jump starting.

NOTICE
<p><i>The battery used for boosting must be 12 V. Do not jump start unless you are sure that the booster battery is correct.</i></p>

JUMP STARTING PROCEDURE

1. If the booster battery is installed in another vehicle, make sure the vehicles are not touching. Turn off all unnecessary lights and accessories.

When boosting, use the battery of matching or higher quality. Any other battery may be difficult to jump start with.

If jump starting is difficult, charge the battery for several minutes.

2. If required, remove all the vent plugs from the booster and discharged batteries. Lay a cloth over the open vents on the batteries. (This helps reduce the explosion hazard, personal injuries and burns.)
3. If the engine in the vehicle with the booster battery is not running, start it and let it run for a few minutes. During jump starting, run the engine at about 2000 rpm with the accelerator pedal lightly depressed.

06 SIENNA_U (L/O 0603)

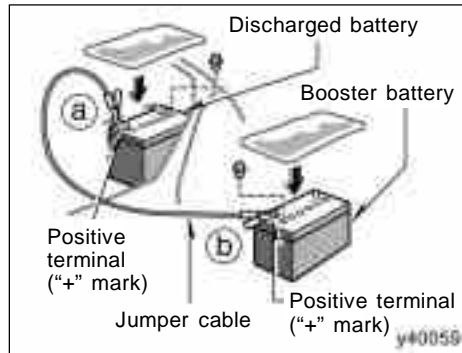

4. Make the cable connections in the order a, b, c, d.
- Connect the clamp of the positive (red) jumper cable to the positive (+) terminal on the discharged battery.
 - Connect the clamp at the other end of the positive (red) jumper cable to the positive (+) terminal on the booster battery.

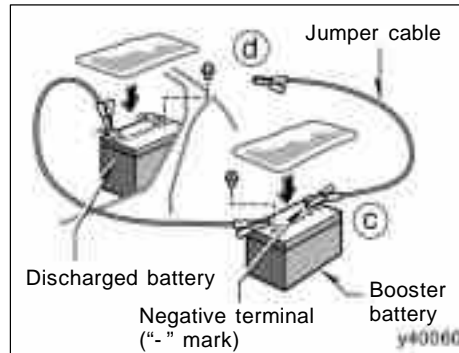

- Connect the clamp of the negative (black) jumper cable to the negative (-) terminal on the booster battery.
 - Connect the clamp at the other end of the negative (black) jumper cable to a solid, stationary, unpainted, metallic point of the vehicle with the discharged battery.
- The recommended connecting point is shown in the following illustration:

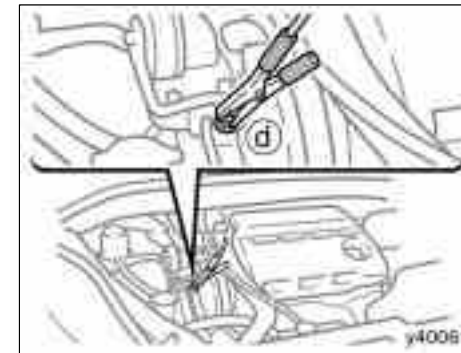

Connecting point

Do not connect the cable to or near any part that moves when the engine is cranked.

CAUTION

When making the connections, to avoid serious injury, do not lean over the battery or accidentally let the jumper cables or clamps touch anything except the correct battery terminals or the ground.

06 SIENNA_U (L/O 0603)

5. Start your engine in the normal way. After starting, run it at about 2000 rpm for several minutes with the accelerator pedal lightly depressed.
6. Carefully disconnect the cables in the exact reverse order: the negative cable and then the positive cable.
7. Carefully dispose of the battery cover cloths—they may now contain sulfuric acid.
8. If removed, replace all the battery vent plugs.

If the cause of your battery discharging is not apparent (for example, lights left on), you should have it checked at your Toyota dealer.

If the first start attempt is not successful...

Check that the clamp on the jumper cables are tight. Recharge the discharged battery with the jumper cables connected for several minutes and restart your engine in the normal way.

If the another attempt is not successful, the battery may be depleted. Have it checked at your Toyota dealer.

If your engine stalls while driving

If your engine stalls while driving...

1. Reduce your speed gradually, keeping a straight line. Move cautiously off the road to a safe place.
2. Turn on your emergency flashers.
3. Turn the ignition key to “ACC” or “LOCK”, and try starting the engine again.

If the engine will not start, see “If your vehicle will not start” on page 416 in this Section.

CAUTION

If the engine is not running, the power assist for the brakes and steering will not work so steering and braking will be much harder than usual.

If you cannot increase engine speed

If engine speed does not increase when the accelerator pedal is depressed, there may be a problem somewhere in the electronic throttle control system.

At this time, vibration may occur. However, if you depress the accelerator pedal more firmly and slowly, you can drive your vehicle at low speeds. Have your vehicle checked by your Toyota dealer as soon as possible.

Even if the abnormality of the electronic throttle control system is corrected during low speed driving, the system may not be recovered until the engine is stopped and the ignition key is turned to “ACC” or “LOCK” position.

CAUTION

Be especially careful to prevent erroneous pedal operation.

If your vehicle overheats

If your engine coolant temperature gauge indicates overheating, if you experience a loss of power, or if you hear a loud knocking or pinging noise, the engine has probably overheated. You should follow this procedure...

1. Pull safely off the road, stop the vehicle and turn on your emergency flashers. Put the transmission in "P" and apply the parking brake. Turn off the air conditioning if it is being used.
2. If coolant or steam is boiling out of the radiator or reservoir, stop the engine. Wait until the steam subsides before opening the hood. If there is no coolant boiling over or steam, leave the engine running and make sure the electric cooling fan is operating. If it is not, turn the ignition off.

CAUTION

To help avoid personal injury, keep the hood closed until there is no steam. Escaping steam or coolant is a sign of very high pressure.

3. Look for obvious coolant leaks from the radiator, hoses, and under the vehicle. However, note that water draining from the air conditioning is normal if it has been used.

CAUTION

When the engine is running, keep hands and clothing away from the moving fan and engine drive belts.

4. If the coolant is leaking, stop the engine immediately. Call a Toyota dealer for assistance.
5. If there are no obvious leaks, check the coolant reservoir. If it is dry, add coolant to the reservoir while the engine is running. Fill it about half full.

CAUTION

Do not attempt to remove the radiator cap when the engine and radiator are hot. Serious injury could result from scalding hot fluid and steam blown out under pressure.

6. After the engine coolant temperature has cooled to normal, again check the coolant level in the reservoir. If necessary, bring it up to half full again. Serious coolant loss indicates a leak in the system. You should have it checked as soon as possible at your Toyota dealer.

**If you have a flat tire—
—Standard tires information**

1. Reduce your speed gradually, keeping a straight line. Move cautiously off the road to a safe place well away from the traffic. Avoid stopping on the center divider of a highway. Park on a level spot with firm ground.
2. Stop the engine and turn on your emergency flashers.
3. Firmly set the parking brake and put the transmission in "P".
4. Have everyone get out of the vehicle on the side away from traffic.
5. Read the following instructions thoroughly.

NOTICE

Do not continue driving with a deflated tire. Driving even a short distance can damage a tire and wheel beyond repair.

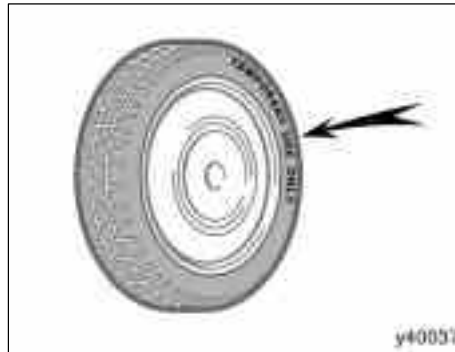

COMPACT SPARE TIRE

The compact spare tire is designed for temporary emergency use only.

The compact spare tire is identified by the distinctive wording "TEMPORARY USE ONLY" molded into the side wall of the tire.

The compact spare tire saves space in your luggage compartment, and its lighter weight helps to improve fuel economy and permits easier installation in case of a flat tire.

The compact spare tire can be used many times, if necessary. It has tread life of up to 4800 km (3000 miles) depending on road conditions and your driving habits. When tread wear indicators appear on the tire, replace the tire.

See also the tire information on page 471 in Section 7-2 for details on the tread wear indicators and other service information.

⚠ CAUTION

- **The compact spare tire was designed especially for your Toyota. Do not use it on any other vehicle.**
- **Do not use more than one compact spare tire at the same time.**
- **The pressure for the compact spare tire must be 420 kPa (4.2 kgf/cm² or bar, 60 psi).**
- **Do not exceed 80 km/h (50 mph) when driving with the compact spare tire.**

- Replace the compact spare tire with the standard tire as soon as possible.
- Avoid sudden acceleration, sudden deceleration and sharp turns with the compact spare tire.

NOTICE

Your ground clearance is reduced when the compact spare tire is installed so avoid driving over obstacles and drive slowly on rough, unpaved roads and speed bumps. Also, do not attempt to go through an automatic car wash as the vehicle may get caught, resulting in damage.

—Run-flat tires information



Some vehicles are equipped with run-flat (RFT) tires. The run-flat tire allows you to continue driving for up to 160 km (100 miles) at a speed below 90 km/h (55 mph) even if any tire goes flat. However, in some conditions (such as high temperatures), you could not continue driving for up to 160 km (100 miles).

A spare tire is not provided on vehicles with run-flat tires.

When the tire goes flat or when the tire pressure is below 100 kPa (1.0 kgf/cm² or bar, 15 psi), the tire must be replaced. If you are not sure, consult your Toyota dealer. Do not use the repaired tire.

There is an “RFT” or “DSST” mark on the sidewall of the run-flat tire.

For details about the run-flat tire, see “Run-flat tires” on page 476 in Section 7-2.

 CAUTION

As the run-flat tire allows you to continue driving if any tire goes flat, the tire performance is not the same as normal condition. If the run-flat tire goes flat, take your vehicle to the nearest Toyota dealer or authorized tire dealer as soon as possible, observing the following instructions:

- Decelerate as soon as possible to the lowest appropriate speed that conditions permit. Do not drive for longer than 160 km (100 miles) or over 90 km/h (55 mph).
- Avoid abrupt steering wheel maneuvering and braking. If the vehicle tires deteriorate, you could lose control of the steering wheel or the brakes, causing death or serious injury.

- Do not replace or repair the tire by yourself. When the tires must be replaced or repaired, consult your Toyota dealer or authorized tire dealer.

NOTICE

- ◆ *Take due care not to go over a curb stone and be careful of holes in the road because deflated tire pressure affects tire cushion performance. The wheels, tires, body, suspension and other components could be damaged.*
- ◆ *Your ground clearance is reduced if the run-flat tire goes flat, so avoid driving over obstacles and drive slowly on rough, unpaved roads and speed bumps. Also, do not attempt to go through an automatic car wash as the vehicle may get caught, resulting in damage.*

06 SIENNA_U (L/O 0603)

—Required tools and spare tire



1. Get the required tools and spare tire.

1. Wheel nut wrench
2. Jack handle
3. Jack
4. Spare tire (vehicles with standard tires)

To prepare yourself for an emergency, you should familiarize yourself with the use of the jack, each of the tools and their storage locations.

A spare tire is not provided on vehicles with run-flat tires.

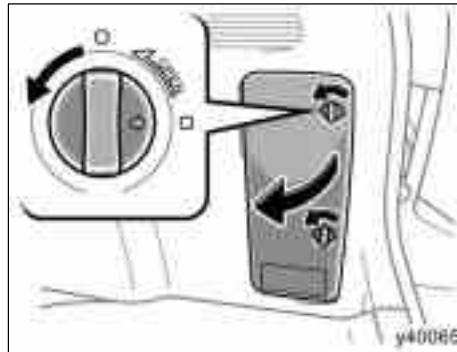

To remove the tools, turn the knob counterclockwise and remove the cover.

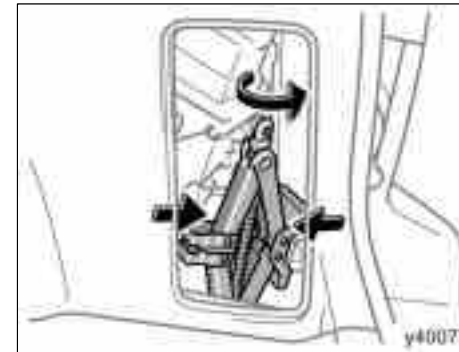

To remove the jack, turn the jack joint by hand until the jack becomes free.

06 SIENNA_U (L/O 0603)



To store the jack, turn the jack joint until the jack base fits securely with the vehicle body.

This prevents the jack from flying forward during a collision or sudden stop.



To remove the wheel nut wrench, first disengage the upper part of the wrench from the holding bracket and remove it.

When storing the wheel nut wrench, make sure the wrench is securely held.

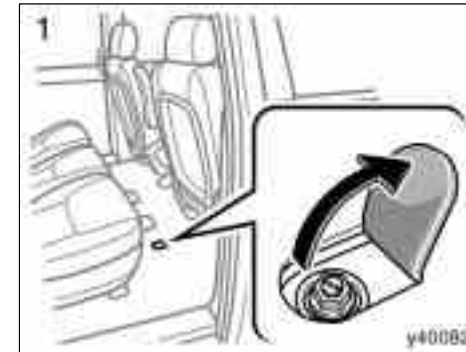

To remove the spare tire:

1. Slide the front passenger's seat to the front-most lock position and the right side second seat to the rear-most lock position so they will not interfere with the wheel nut wrench.

Open the right side sliding door and you will find the flap on the floor. Pull back the flap to find the spare tire clamp bolt.

06 SIENNA_U (L/O 0603)

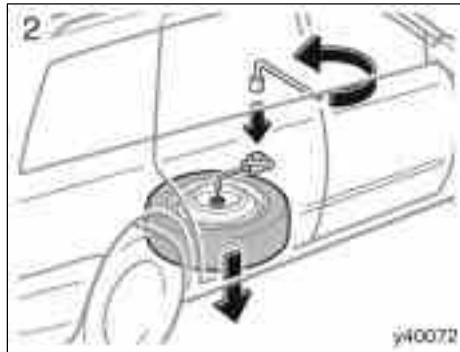

2. Loosen the spare tire clamp bolt by turning it counterclockwise with the wheel nut wrench.

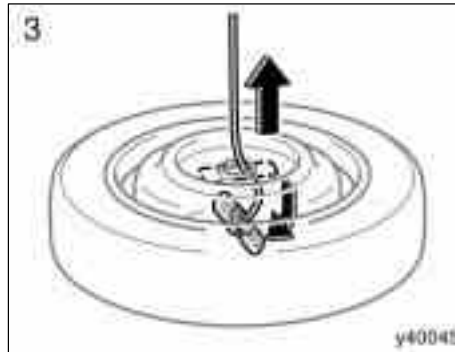

3. After the tire is lowered completely to the ground, remove the holding bracket.

When storing the spare tire, put it in place with the outer side of the wheel facing up. Then secure the tire, taking care that the tire goes straight up without catching on any other part, to prevent it from flying forward during a collision or sudden braking.

As the tire carrier is designed for the compact spare tire, the standard tire cannot be stored there.

CAUTION

Do not remove the spare tire when jacking up the vehicle. The tire carrier and the spare tire may interfere with the jack and cause a serious accident.

NOTICE

- ◆ **To secure spare tire clamp bolt:**
Do not use impact wrench, but wheel nut wrench.
- ◆ **After taking out or stowing the spare tire, make sure to secure the tire carrier by tightening the clamp bolt to prevent the holding bracket from hitting the under body of the vehicle during driving.**
- ◆ **Do not store the flat spare tire with the tire carrier so it may not be held securely.**

—Required tools and spare tire

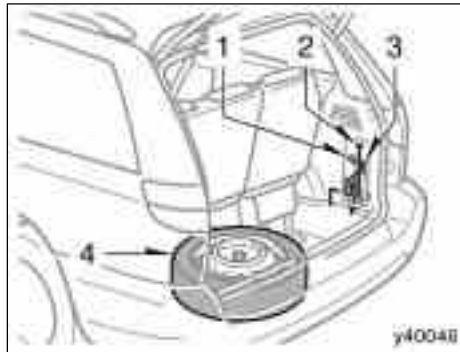

1. Get the required tools and spare tire.

1. Wheel nut wrench
2. Jack handle
3. Jack
4. Spare tire (vehicles with standard tires)

To prepare yourself for an emergency, you should familiarize yourself with the use of the jack, each of the tools and their storage locations.

A spare tire is not provided on vehicles with run-flat tires.

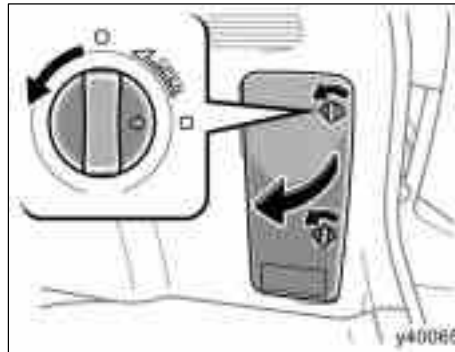

To remove the tools, turn the knob counterclockwise and remove the cover.

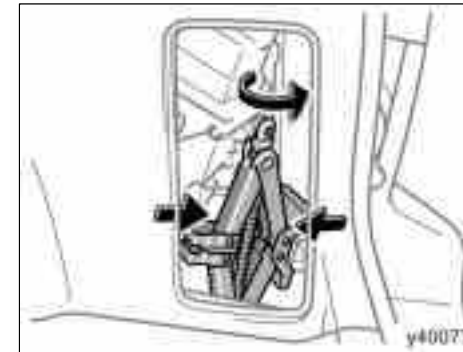

To remove the jack, turn the jack joint by hand until the jack becomes free.

06 SIENNA_U (L/O 0603)



To store the jack, turn the jack joint until the jack base fits securely with the vehicle body.

This prevents the jack from flying forward during a collision or sudden stop.



To remove the wheel nut wrench, first disengage the upper part of the wrench from the holding bracket and remove it.

When storing the wheel nut wrench, make sure the wrench is securely held.

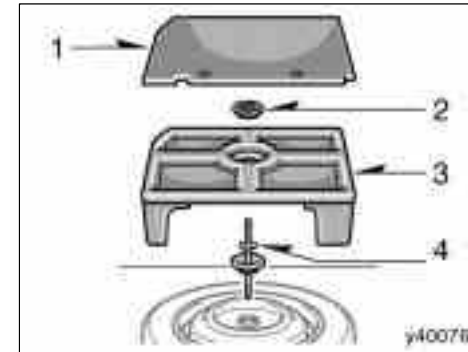

To remove the spare tire:

1. Remove the lid.
2. Loosen the nut and remove it.
3. Remove the spare tire cover.
4. Loosen the bolt, then remove the bolt and spacer.

Then take the spare tire out of the vehicle.

When storing the spare tire, put it in place with the outer side of the wheel facing up. Then secure the tire by repeating the above removal steps in reverse order to prevent it from flying forward during a collision or sudden braking.

—Blocking the wheel

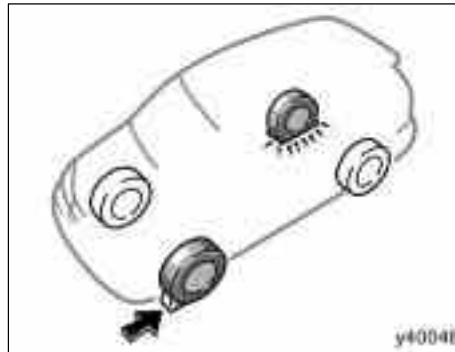

2. Block the wheel diagonally opposite the flat tire to keep the vehicle from rolling when it is jacked up.

When blocking the wheel, place a wheel block in front of one of the front wheels or behind one of the rear wheels.

—Removing wheel ornament (steel wheels)

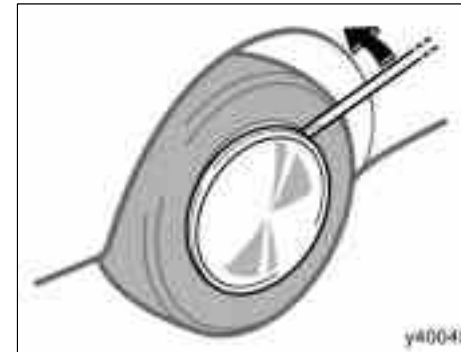

3. Remove the wheel ornament.
Pry off the wheel ornament, using the beveled end of the wheel nut wrench as shown.

CAUTION

Do not try to pull off the ornament by hand. Take due care in handling the ornament to avoid unexpected personal injury.

—Loosening wheel nuts

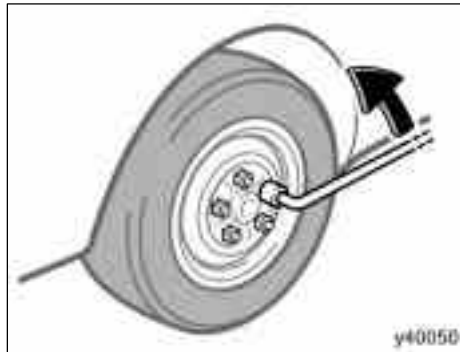

4. Loosen all the wheel nuts.

Always loosen the wheel nuts before raising the vehicle.

Turn the wheel nuts counterclockwise to loosen. To get maximum leverage, fit the wrench to the nut so that the handle is on the right side, as shown above. Grab the wrench near the end of the handle and pull up on the handle. Be careful that the wrench does not slip off the nut.

Do not remove the nuts yet—just unscrew them about one-half turn.

⚠ CAUTION

Never use oil or grease on the bolts or nuts. The nuts may loose and the wheels may fall off, which could cause a serious accident.

—Jacking up precaution

⚠ CAUTION

When jacking, be sure to observe the following to reduce the possibility of personal injury:

- Follow jacking instructions.
- Do not put any part of your body under the vehicle supported by the jack. Otherwise, personal injury may occur.
- Do not start or run the engine while your vehicle is supported by the jack.
- Stop the vehicle on a level firm ground, firmly set the parking brake and put the transmission in “P”. Block the wheel diagonally opposite to the one being changed if necessary.

- Make sure to set the jack properly in the jack point. Raising the vehicle with jack improperly positioned will damage the vehicle or may allow the vehicle to fall off the jack and cause personal injury.
- Never get under the vehicle when the vehicle is supported by the jack alone.
- Use the jack only for lifting your vehicle during wheel changing.
- Do not raise the vehicle with someone in the vehicle.
- When raising the vehicle, do not place any objects on top of or underneath the jack.
- Raise the vehicle only high enough to remove and change the tire.

- When jacking up the vehicle, turn off the power sliding door system and the power back door system, and close the sliding door and the back door completely.

—Positioning the jack

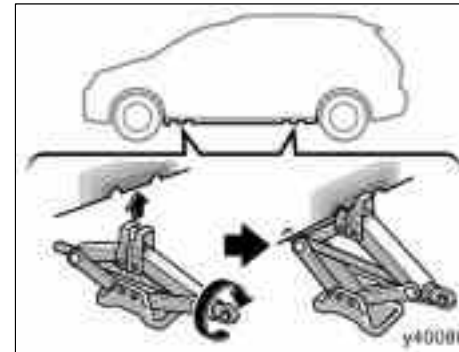

5. Position the jack at the correct jack point as shown.

Make sure the jack is positioned on a level and solid place.

—Raising your vehicle



6. After making sure that no one is in the vehicle, raise it high enough so that the spare tire can be installed.

Remember you will need more ground clearance when putting on the spare tire than when removing the flat tire.

To raise the vehicle, insert the jack handle into the jack (it is a loose fit) and turn it clockwise. As the jack touches the vehicle and begins to lift, double-check that it is properly positioned.

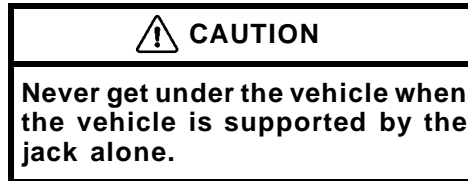

—Changing wheels



7. Remove the wheel nuts and change tires.

Lift the flat tire straight off and put it aside.

Roll the spare wheel into position and align the holes in the wheel with the bolts. Then lift up the wheel and get at least the top bolt started through its hole. Wiggle the tire and press it back over the other bolts.

—Reinstalling wheel nuts



Before putting on wheels, remove any corrosion on the mounting surfaces with a wire brush or such. Installation of wheels without good metal- to- metal contact at the mounting surface can cause wheel nuts to loosen and eventually cause a wheel to come off while driving.

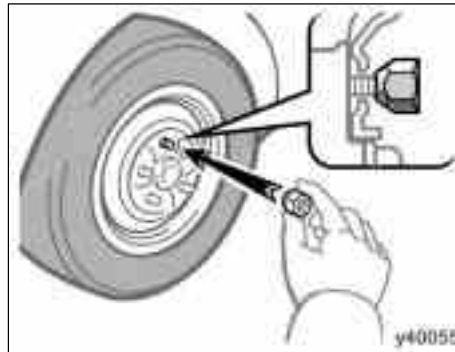

8. Reinstall all the wheel nuts finger tight.

Reinstall the wheel nuts (tapered end inward) and tighten them as much as you can by hand. Press back on the tire and see if you can tighten them more.

⚠ CAUTION

Never use oil or grease on the bolts or nuts. Doing so may lead to overtightening the nuts and damaging the bolts. The nuts may loose and the wheels may fall off, which could cause a serious accident. If there is oil or grease on any bolt or nut, clean it.

—Lowering your vehicle

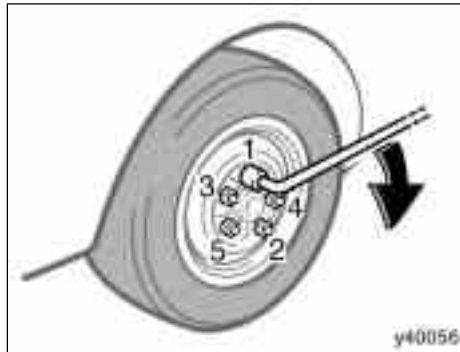

9. Lower the vehicle completely and tighten the wheel nuts.

Turn the jack handle counterclockwise to lower the vehicle.

Use only the wheel nut wrench to tighten the nuts. Do not use other tools or any additional leverage other than your hands, such as a hammer, pipe or your foot. Make sure the wrench is securely engaged over the nut.

Tighten each nut a little at a time in the order shown. Repeat the process until all the nuts are tight.

CAUTION

- When lowering the vehicle, make sure all portions of your body and all other persons around will not be injured as the vehicle is lowered to the ground.
- Have the wheel nuts tightened with torque wrench to 103 N·m (10.5 kgf·m, 76 ft·lbf), as soon as possible after changing wheels. Otherwise, the nuts may loosen and the wheels may fall off, which could cause a serious accident.
- Do not attach a heavily damaged plastic wheel ornament. It may fly off the wheel and cause accidents while the vehicle is moving.

—Reinstalling wheel ornament (steel wheels)

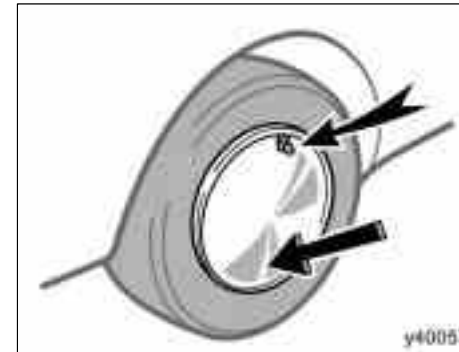

10. Reinstall the wheel ornament.

1. Put the wheel ornament into position.

Align the cutout of the wheel ornament with the valve stem as shown.

2. Press hand firmly on one side of wheel ornament and then firmly tap the other side around the edge of wheel ornament with the heel of your hand to snap into place.

 **CAUTION**

Take due care in handling the ornament to avoid unexpected personal injury.

—After changing wheels

11. Check the air pressure of the replaced tire.

Adjust the air pressure to the specification designated on page 501 in Section 8. If the pressure is lower, drive slowly to the nearest service station and fill to the correct pressure.

Do not forget to reinstall the tire inflation valve cap as dirt and moisture could get into the valve core and possibly cause air leakage. If the cap is missing, have a new one put on as soon as possible.

12. Restow all the tools and jack securely.



13. Wrap the flat tire in the tire bag and stow temporarily in the luggage compartment. The tire bag is stored with the jack handle.

As the tire carrier is designed for the compact spare tire, the standard tire cannot be stored there.

As soon after changing wheels as possible, tighten the wheel nuts to the torque specified on page 501 in Section 8 with a torque wrench. Have a technician repair the flat tire and replace the spare tire with it.

Initial adjustment of the tire pressure warning system is necessary after you have rotated your tires. See “Tire pressure warning system” on page 208 in Section 1-7.

 **CAUTION**

Before driving, make sure all the tools, jack and flat tire are securely in place in their storage location to reduce the possibility of personal injury during a collision or sudden braking.

If your vehicle becomes stuck

If your vehicle becomes stuck in snow, mud, sand, etc., then you may attempt to rock the vehicle free by moving it forward and backward.

Vehicles with traction control system (two-wheel drive models)—Turn off the traction control system to become unstuck to allow the tires to spin enough to remove the vehicle from the obstruction. (For details, see “Traction control system (two-wheel drive models)” on page 203 in Section 1-7.)

 **CAUTION**

Do not attempt to rock the vehicle free by moving it forward and backward if people or objects are anywhere near the vehicle. During the rocking operation the vehicle may suddenly move forward or backward as it becomes unstuck, causing injury or damage to nearby people or objects.

NOTICE

If you rock your vehicle, observe the following precautions to prevent damage to the transmission and other parts.

- ◆ *Do not depress the accelerator pedal while shifting the selector lever or before the transmission is completely shifted to forward or reverse gear.*
- ◆ *Do not race the engine and avoid spinning the wheels.*
- ◆ *If your vehicle remains stuck after rocking the vehicle several times, consider other ways such as towing.*

06 SIENNA_U (L/O 0603)

If your vehicle needs to be towed—

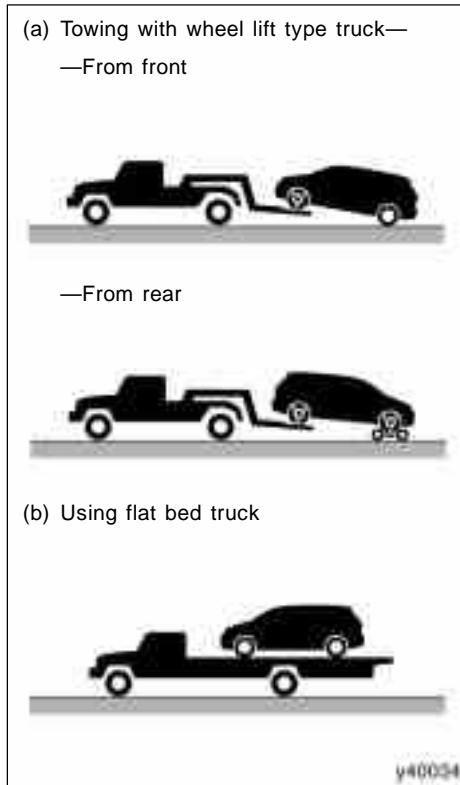

Two-wheel drive models

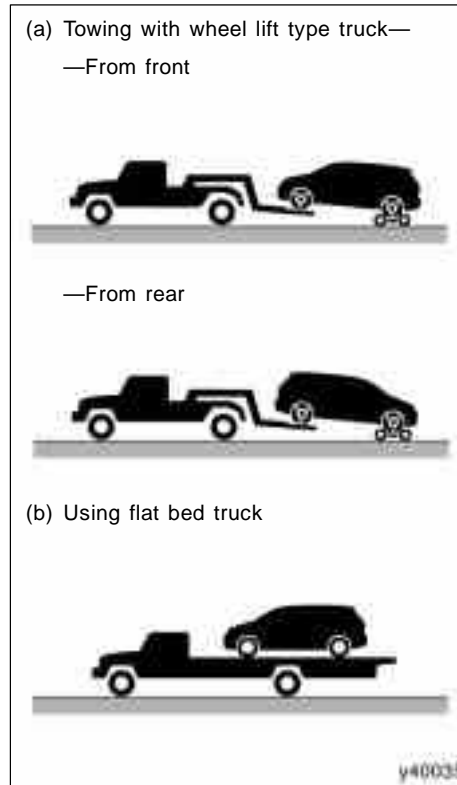

All-wheel drive models

If towing is necessary, we recommend you to have it done by your Toyota dealer or a commercial tow truck service. In consultation with them, have your vehicle towed using either (a) or (b).

Proper equipment will help ensure that your vehicle is not damaged while being towed. Commercial operators are generally aware of the state/provincial and local laws pertaining to towing.

Your vehicle can be damaged if it is towed incorrectly. Although most operators know the correct procedure, it is possible to make a mistake. To avoid damage to your vehicle, make sure the following precautions are observed. If necessary, show this page to the tow truck driver.

06 SIENNA_U (L/O 0603)

TOWING PRECAUTIONS:

Use a safety chain system for all towing, and abide by the state/provincial and local laws. The wheels and axle on the ground must be in good condition. If they are damaged, use a towing dolly.

Two-wheel drive models—

(a) Towing with wheel lift type truck

From front—Release the parking brake.

NOTICE

When lifting wheels, take care to ensure adequate ground clearance for towing at the opposite end of the raised vehicle. Otherwise, the bumper and/or underbody of the towed vehicle will be damaged during towing.

From rear—Use a towing dolly under the front wheels.

NOTICE

Never tow a vehicle with an automatic transmission from the rear with the front wheels on the ground, as this may cause serious damage to the transmission.

(b) Using flat bed truck

All-wheel drive models—

(a) Towing with wheel lift type truck

Use a towing dolly under the wheels not lifted by the truck.

(b) Using flat bed truck

(c) Towing with sling type truck

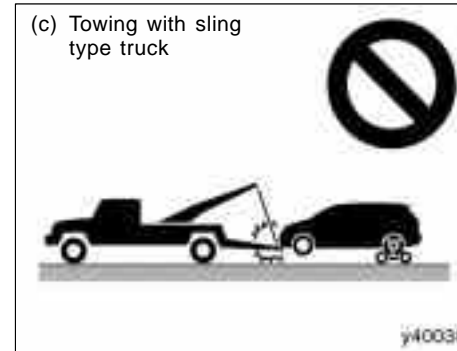

All models—

(c) Towing with sling type truck

NOTICE

Do not tow with sling type truck, either from the front or rear. This may cause body damage.

If you lose your keys

You can purchase a new key at your Toyota dealer if you can give them the key number. If your vehicle is equipped with the engine immobilizer system, the dealer will also need your master key.

Vehicles with engine immobilizer system— Even if you lose only one key, contact your Toyota dealer to make a new key. If you lose all your master keys, you cannot make new keys; the whole engine immobilizer system must be replaced.

See the suggestion given in “Keys” on page 10 in Section 1-2.

If your keys are locked in the vehicle and you cannot get a duplicate, many Toyota dealers can still open the door for you, using their special tools. If you must break a window to get in, we suggest breaking the smallest side window because it is the least expensive to replace. Be extremely cautious to avoid cuts from the glass.

If you lose your wireless remote control transmitter

Please contact your nearest Toyota dealer and you can purchase a new wireless remote control transmitter.

Have the registered identification numbers of your transmitters deleted from your vehicle by your Toyota dealer as soon as possible to avoid the possibility of theft or an accident. Then, have the identification number of your new transmitter registered. At the same time, you must bring all of the remaining transmitters to have them registered again as well.

You can use the wireless remote control system with the new transmitter. Contact your Toyota dealer for detailed information.

If you cannot shift automatic transmission selector lever

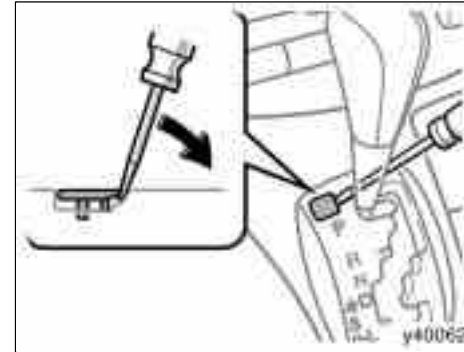

If you cannot shift the selector lever out of “P” position to other positions even though the brake pedal is depressed, use the shift lock override button as follows:

1. Turn the ignition key to “LOCK” position. Make sure the parking brake is applied.
2. Pry up the cover with a flathead screwdriver or equivalent.

06 SIENNA_U (L/O 0603)

If you cannot operate back door opener



3. Insert your finger into the hole to push down the shift lock override button. You can shift out of "P" position only while pushing the button.
4. Shift into "N" position.
5. Insert the cover.
6. Start the engine. For your safety, keep the brake pedal depressed.

Be sure to have the system checked by your Toyota dealer as soon as possible.

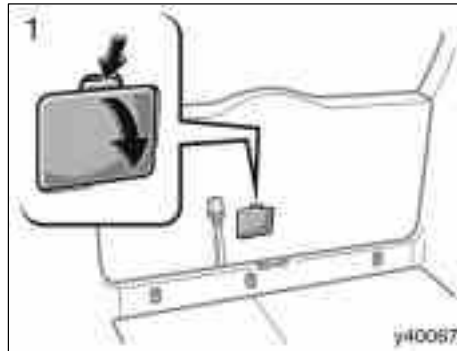

If the back door opener does not operate, you can open the back door from the inside.

To open the back door from inside, perform the following procedure.

1. Remove the cover on the back door trim.

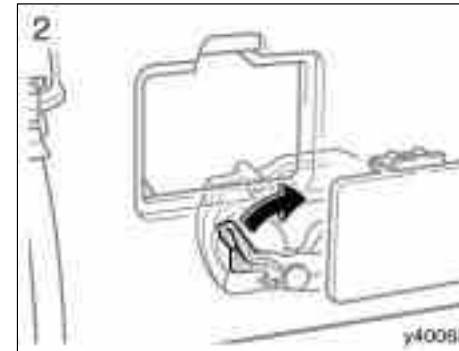

Without power back door system

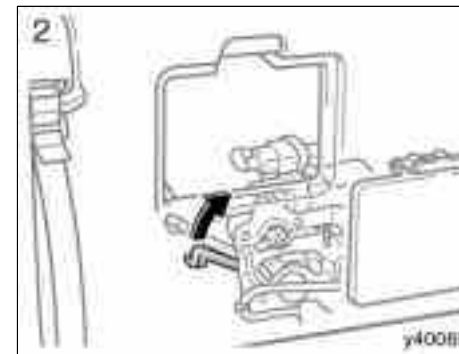

With power back door system

06 SIENNA_U (L/O 0603)

2. Pull the lever with the back door motor, open the back door.

Be sure to have the back door opener checked/repared by your Toyota dealer.

06 SIENNA_U (L/O 0603)

SECTION 5

CORROSION PREVENTION AND APPEARANCE CARE

Corrosion prevention and appearance care

Protecting your Toyota from corrosion	444
Washing and waxing your Toyota	445
Cleaning the interior	447



Protecting your Toyota from corrosion

Toyota, through the diligent research, design and use of the most advanced technology available, helps prevent corrosion and provides you with the finest quality vehicle construction. Now, it is up to you. Proper care of your Toyota can help ensure long-term corrosion prevention.

The most common causes of corrosion to your vehicle are:

- The accumulation of road salt, dirt and moisture in hard-to-reach areas under the vehicle.
- Chipping of paint, or undercoating caused by minor accidents or by stones and gravel.

Care is especially important if you live in particular areas or operate your vehicle under certain environmental conditions:

- Road salt or dust control chemicals will accelerate corrosion, as will the presence of salt in the air near the sea-coast or in areas of industrial pollution.
- High humidity accelerates corrosion especially when temperatures range just above the freezing point.

- Wetness or dampness to certain parts of your vehicle for an extended period of time, may cause corrosion even though other parts of the vehicle may be dry.
- High ambient temperatures can cause corrosion to those components of the vehicle which do not dry quickly due to lack of proper ventilation.

The above signifies the necessity to keep your vehicle, particularly the underside, as clean as possible and to repair any damage to paint or protective coatings as soon as possible.

To help prevent corrosion on your Toyota, follow these guidelines:

Wash your vehicle frequently. It is, of course, necessary to keep your vehicle clean by regular washing, but to prevent corrosion, the following points should be observed:

- If you drive on salted roads in the winter or if you live near the ocean, you should hose off the undercarriage at least once a month to minimize corrosion.

- High pressure water or steam is effective for cleaning the vehicle's underside and wheel housings. Pay particular attention to these areas as it is difficult to see all the mud and dirt. It will do more harm than good to simply wet the mud and debris without removing. The lower edge of doors, rocker panels and frame members have drain holes which should not be allowed to clog with dirt as trapped water in these areas can cause corrosion.

- Wash the underside of the vehicle thoroughly when winter is over.

See "Washing and waxing your Toyota" on page 445 in this Section for more tips.

Check the condition of your vehicle's paint and trim. If you find any chips or scratches in the paint, touch them up immediately to prevent corrosion from starting. If the chips or scratches have gone through the bare metal, have a qualified body shop make the repair.

Check the interior of your vehicle. Water and dirt can accumulate under the floor mats and could cause corrosion. Occasionally check under the mats to make sure the area is dry. Be particularly careful when transporting chemicals, cleansers, fertilizers, salt, etc.; these should be transported in proper containers. If a spill or leak should occur, immediately clean and dry the area.

Use mud shields on your wheels. If you drive on salted or gravel roads, mud shields help protect your vehicle. Full-size shields, which come as near to the ground as possible, are the best. We recommend that the fittings and the area where the shields are installed be treated to resist corrosion. Your Toyota dealer will be happy to assist in supplying and installing the shields if they are recommended for your area.

Keep your vehicle in a well ventilated garage or a roofed place. Do not park your vehicle in a damp, poorly ventilated garage. If you wash your vehicle in the garage, or if you drive it covered with water or snow, your garage may be so damp as to cause corrosion. Even if your garage is heated, a wet vehicle can corrode if the ventilation is poor.

Washing and waxing your Toyota

Washing your Toyota

Keep your vehicle clean by regular washing.

The following cases may cause weakness to the paint or corrosion to the body and parts. Wash your vehicle as soon as possible.

- When driving in a coastal area
- When driving on a road sprinkled with antifreeze
- When exposed to coal tar, tree sap, bird droppings and carcass of an insect
- When driving in areas where there is a lot of smoke, soot, dust, iron dust or chemical substances
- When the vehicle becomes remarkably dirty with dust and mud

Hand-washing your Toyota

Work in the shade and wait until the vehicle body is not warm to the touch.



- **When cleaning under floor or chassis, be careful not to injure your hands.**

● **Exhaust gases cause the exhaust pipe to become quite hot. When washing the vehicle, be careful not to touch the pipe until it has cooled sufficiently, as touching a hot exhaust pipe can cause burns.**

1. Rinse off loose dirt with a hose. Remove any mud or road salt from the underside of the vehicle or the wheel wells.
2. Wash with a mild car-wash soap, mixed according to the manufacturer's instructions. Use a soft cotton mitt and keep it wet by dipping it frequently into the wash water. Do not rub hard—let the soap and water remove the dirt.

Fuel filler door: Do not apply water (high-pressure car wash, for example) at or near the fuel tank inlet with the fuel filler door opened. If the water enters the air vent, you may experience trouble with refueling or rough engine idling.

Plastic wheel ornaments: The plastic wheel ornaments are damaged easily by organic substances. If any organic substances splash an ornament, be sure to wash them off with water and check if the ornament is damaged.

Aluminum wheels: Use only a mild soap or neutral detergent.

Plastic bumpers: Wash carefully. Do not scrub with abrasive cleaners. The bumper faces are soft.

Exterior lights: Wash carefully. Do not use organic substances or scrub them with a hard brush. This may damage the surfaces of the lights.

Road tar: Remove with turpentine or cleaners that are marked safe for painted surfaces.

3. Rinse thoroughly—dried soap can cause streaking. In hot weather you may need to rinse each section right after you wash it.
4. To prevent water spots, dry the vehicle using a clean soft cotton towel. Do not rub or press hard—you might scratch the paint.

NOTICE

- ◆ *Do not use organic substances (gasoline, kerosene, benzine or strong solvents), which may be toxic or cause damage.*
- ◆ *Do not scrub any part of the vehicle with a hard brush, which may cause damage.*

Automatic car wash

Your vehicle may be washed in an automatic car wash, but remember that the paint can be scratched by some types of brushes, unfiltered washing water, or the washing process itself. Scratching reduces paint durability and gloss, especially on darker colors. The manager of the car wash should be able to advise you whether the process is safe for the paint on your vehicle.

NOTICE

- ◆ *With mast type antenna: To prevent damage to the antenna, make sure it is removed before driving your Toyota through an automatic car wash.*
- ◆ *When your vehicle goes through an automatic car wash, make sure the power sliding door and power back door system are off.*

Waxing your Toyota

Polishing and waxing is recommended to maintain the original beauty of your Toyota's finish.

Apply wax once a month or if the vehicle surface does not repel water well.

1. Always wash and dry the vehicle before you begin waxing, even if you are using a combined cleaner and wax.
2. Use a good quality polish and wax. If the finish has become extremely weathered, use a car-cleaning polish, followed by a separate wax. Carefully follow the manufacturer's instructions and precautions. Be sure to polish and wax the chrome trim as well as the paint.

Windshield washer nozzles: Make sure that the nozzles do not become blocked when waxing. If a nozzle becomes blocked, contact your Toyota dealer to have the vehicle serviced.

NOTICE

If a nozzle becomes blocked, do not try to clear it with a pin or other object. The nozzle will be damaged.

Exterior lights: Do not apply wax on the surfaces of the lights. Wax may cause damage to the lenses. If you accidentally put wax on the light surfaces, wipe or wash it off.

3. Wax the vehicle again when water does not bead but remains on the surface in large patches.

Cleaning the interior

 **CAUTION**

- **Vehicles with side airbags and curtain shield airbags:**

Be careful not to splash water or spill liquid on the floor. This may prevent the side airbag and curtain shield airbag from activating correctly, resulting in serious injury.

- **Do not wash the vehicle floor with water, or allow water to get onto the floor when cleaning the vehicle interior or exterior. Water may get into audio components or other electrical components above or under the floor carpet (or mat) and cause a malfunction; and it may cause body corrosion.**

Vinyl interior

The vinyl upholstery may be easily cleaned with a mild soap or detergent and water.

First vacuum over the upholstery to remove loose dirt. Then, using a sponge or soft cloth, apply the soap solution to the vinyl. After allowing it to soak in for a few minutes to loosen the dirt, remove the dirt and wipe off the soap with a clean damp cloth. If all the dirt do not come off, repeat the procedure. Commercial foaming-type vinyl cleaners are also available which work well. Follow the manufacturer's instructions.

NOTICE

Do not use solvent, thinner, gasoline or window cleaner on the interior.

Carpets

Use a good foam-type shampoo to clean the carpets.

Begin by vacuuming thoroughly to remove as much dirt as possible. Several types of foam cleaners are available; some are in aerosol can and others are powders or liquids which you mix with water to produce a foam. To shampoo the carpets, use a sponge or brush to apply the foam. Rub in overlapping circles.

Do not apply water—the best results are obtained by keeping the carpet as dry as possible. Read the shampoo instructions and follow them closely.

Seat belts

The seat belts may be cleaned with mild soap and water or with lukewarm water.

Use a cloth or sponge. As you are cleaning, check the belts for excessive wear, fraying, or cuts.

NOTICE

- ◆ Do not use dye or bleach on the belts—it may weaken them.
- ◆ Do not use the belts until they become dry.

Windows

The windows may be cleaned with any household window cleaner.

NOTICE

- ◆ When cleaning the inside of the rear window, be careful not to scratch or damage the heater wires or connectors.
- ◆ With on-glass antenna: When cleaning the inside of the rear window, be careful not to scratch or damage the printed antenna.

Air conditioning control panel, audio panel, instrument panel, console panel, and switches

Use a soft damp cloth for cleaning.

Soak a clean soft cloth in water or lukewarm water then lightly wipe off dirt.

NOTICE

- ◆ Do not use organic substances (solvents, kerosene, alcohol, gasoline, etc.) or alkaline or acidic solutions. These chemicals can cause discoloring, staining or peeling of the surface.
- ◆ If you use cleaners or polishing agents, make sure their ingredients do not include the substances mentioned above.
- ◆ If you use a liquid car freshener, do not spill the liquid onto the vehicle's interior surfaces. It may contain the ingredients mentioned above. Immediately clean any spill using the method mentioned above.

Leather interior

The leather upholstery may be cleaned with neutral detergent for wool.

Remove dirt using a soft cloth dampened with 5% solution of neutral detergent for wool. Then thoroughly wipe off all traces of detergent with a clean damp cloth.

After cleaning or whenever any part of the leather gets wet, dry with a soft clean cloth. Allow the leather to dry in a ventilated shaded area.

NOTICE

- ◆ *If a stain should fail to come out with a neutral detergent, apply a cleaner that does not contain an organic solvent.*
- ◆ *Never use organic substances such as benzine, alcohol or gasoline, or alkaline or acid solutions for cleaning the leather as these could cause discoloring.*
- ◆ *Use of a nylon brush or synthetic fiber cloth, etc. may scratch the fine grained surface of the leather.*

- ◆ *Mildew may develop on soiled leather upholstery. Be especially careful to avoid oil spots. Try to keep your upholstery always clean.*
- ◆ *Long exposure to direct sunlight may cause the leather surface to harden and shrink. Keep your vehicle in a shaded area, especially in the summer.*
- ◆ *The interior of your vehicle is apt to heat up on hot summer days, so avoid placing on the upholstery items made of vinyl or plastic or containing wax as these tend to stick to leather when warm.*
- ◆ *Improper cleaning of the leather upholstery could result in discoloration or staining.*

If you have any questions about the cleaning of your Toyota, your local Toyota dealer will be pleased to answer them.

06 SIENNA_U (L/O 0603)

450

2006 SIENNA from March '06 Prod. (OM45443U)

SECTION 6

VEHICLE MAINTENANCE AND CARE

Vehicle maintenance and care

Maintenance requirements	452
General maintenance	453
Does your vehicle need repairing?	455
Emissions Inspection and Maintenance (I/M) programs	456

For scheduled maintenance information, please refer to the “Scheduled Maintenance Guide” or “Owner’s Manual Supplement”.



Maintenance requirements

Your Toyota vehicle has been designed for fewer maintenance requirements with longer service intervals to save both your time and money. However, each regular maintenance, as well as day-to-day care, is more important than ever before to ensure smooth, trouble-free, safe, and economical drivings.

It is the owner's responsibility to make sure the specified maintenance, including general maintenance service, is performed. Note that both the new vehicle and emission control system warranties specify that proper maintenance and care must be performed. See "Owner's Warranty Information Booklet" or "Owner's Manual Supplement" for complete warranty information.

General maintenance

General maintenance items are those day-to-day care practices that are important to your vehicle for proper operation. It is the owner's responsibility to insure that the general maintenance items are performed regularly.

These checks or inspections can be done either by yourself or a qualified technician, or if you prefer, your Toyota dealer will be pleased to do them at a nominal cost.

Scheduled maintenance

The scheduled maintenance items listed in the "Scheduled Maintenance Guide" or "Owner's Manual Supplement" are those required to be serviced at regular intervals.

For details of your maintenance schedule, read the "Scheduled Maintenance Guide" or "Owner's Manual Supplement".

It is recommended that any replacement parts used for maintenance or for the repair of the emission control system be Toyota supplied.

The owner may elect to use non-Toyota supplied parts for replacement purposes without invalidating the emission control system warranty. However, use of replacement parts which are not of equivalent quality may impair the effectiveness of the emission control systems.

You may also elect to have maintenance, replacement, or repair of the emission control devices and system performed by any automotive repair establishment or individual without invalidating this warranty. See "Owner's Warranty Information Booklet" or "Owner's Manual Supplement" for complete warranty information.

Where to go for service?

Toyota technicians are well-trained specialists and are kept up to date with the latest service information through technical bulletins, service tips, and in-dealership training programs. They learn to work on Toyotas before they work on your vehicle, rather than while they are working on it.

You can be confident that your Toyota dealer's service department performs the best job to meet the maintenance requirements on your vehicle—reliably and economically.

Your copy of the repair order is proof that all required maintenance has been performed for warranty coverage. If any problems should arise with your vehicle while under warranty, your Toyota dealer will promptly take care of it. Again, be sure to keep a copy of the repair order for any service performed on your Toyota.

What about do-it-yourself maintenance?

Many of the maintenance items are easy to do yourself if you have a little mechanical ability and a few basic automotive tools. Simple instructions for how to perform them are presented on page 457 in Section 7.

06 SIENNA_U (L/O 0603)

If you are a skilled do-it-yourself mechanic, the Toyota service manuals are recommended. Please be aware that do-it-yourself maintenance can affect your warranty coverage. See "Owner's Warranty Information Booklet" or "Owner's Manual Supplement" for the details.

General maintenance

Listed below are the general maintenance items that should be performed as frequently as specified. In addition to checking the items listed, if you notice any unusual noise, smell or vibration, you should investigate the cause or take your vehicle to your Toyota dealer or a qualified service shop immediately. It is recommended that any problem you notice be brought to the attention of your dealer or the qualified service shop for their advice.



CAUTION

Make these checks only with adequate ventilation if you run the engine.

IN THE ENGINE COMPARTMENT

Items listed below should be checked from time to time, e.g. each time when refueling.

Washer fluid

Make sure there is sufficient fluid in the tank. See page 487 in Section 7-3 for additional information.

Engine coolant level

Make sure the coolant level is between the "FULL" and "LOW" lines on the see-through reservoir when the engine is cold. See page 468 in Section 7-2 for additional information.

Radiator, condenser and hoses

Check that the front of the radiator and condenser are clean and not blocked with leaves, dirt, or insects. See page 469 in Section 7-2 for additional information.

Battery condition

Check the battery condition by the indicator color. See page 484 in Section 7-3 for additional information.

Brake fluid level

Make sure the brake fluid level is correct. See page 469 in Section 7-2 for additional information.

Engine oil level

Check the level on the dipstick with the engine turned off and the vehicle parked on a level spot. See page 466 in Section 7-2 for additional information.

06 SIENNA_U (L/O 0603)

Power steering fluid level

Check the level through the reservoir. The level should be in the "HOT" or "COLD" range depending on the fluid temperature. See page 470 in Section 7-2 for additional information.

Exhaust system

If you notice any change in the sound of the exhaust or smell exhaust fumes, have the cause located and corrected immediately. (See "Engine exhaust cautions" on page 380 in Section 2.)

INSIDE THE VEHICLE

Items listed below should be checked regularly, e.g. while performing periodic services, cleaning the vehicle, etc.

Lights

Make sure the headlights, stop lights, tail lights, turn signal lights, and other lights are all working. Check headlight aim.

Service reminder indicators and warning buzzers

Check that all service reminder indicators and warning buzzers function properly.

Steering wheel

Be alert for changes in steering condition, such as hard steering or strange noise.

Seats

Check that all seat controls such as seat adjusters, seatback recliner, etc. operate smoothly and that all latches lock securely in any position. Check that the head restraints move up and down smoothly and that the locks hold securely in any latched position. For folding-down rear seatbacks and detachable second seats, check that the latches lock securely.

Seat belts

Check that the seat belt system such as buckles, retractors and anchors operate properly and smoothly. Make sure the belt webbing is not cut, frayed, worn or damaged.

Accelerator pedal

Check the pedal for smooth operation and uneven pedal effort or catching.

Brake pedal

Check the pedal for smooth operation and that the pedal has the proper clearance. Check the brake booster function.

Brakes

In a safe place, check that the brakes do not pull to one side when applied.

Parking brake

Check that the pedal has the proper travel and that, on a safe incline, your vehicle is held securely with only the parking brake applied.

Automatic transmission "Park" mechanism

On a safe incline, check that your vehicle is held securely with the selector lever in "P" position and all brakes released.

OUTSIDE THE VEHICLE

Items listed below should be performed from time to time, unless otherwise specified.

Fluid leaks

Check underneath for leaking fuel, oil, water or other fluid after the vehicle has been parked for a while. If you smell fuel fumes or notice any leak, have the cause found and corrected immediately.

Doors and engine hood

Check that all the doors including back door operate smoothly and all latches lock securely. Make sure the engine hood secondary latch secures the hood from opening when the primary latch is released.

Tire inflation pressure

Check the pressure with a gauge every two weeks, or at least once a month. See page 471 in Section 7- 2 for additional information.

Tire surface and wheel nuts

Check the tires carefully for cuts, damage or excessive wear. See page 474 in Section 7- 2 for additional information. When checking the tires, make sure no nuts are missing, and check the nuts for looseness. Tighten them if necessary.

Tire rotation

Rotate the tires according to the maintenance schedule. (For scheduled maintenance information, please refer to the “Scheduled Maintenance Guide” or “Owner’s Manual Supplement”.) See page 476 in Section 7- 2 for additional information.

Does your vehicle need repairing?

Be on the alert for changes in performance, sounds, and visual tip-offs that indicate service is needed. Some important clues are as follows:

- Engine missing, stumbling, or pinging
- Appreciable loss of power
- Strange engine noises
- A leak under the vehicle (however, water dripping from the air conditioning after use is normal.)
- Change in exhaust sound (This may indicate a dangerous carbon monoxide leak. Drive with the windows open and have the exhaust system checked immediately.)
- Flat-looking tire; excessive tire squeal when cornering; uneven tire wear
- Vehicle pulls to one side when driving straight on a level road
- Strange noises related to suspension movement
- Loss of brake effectiveness; spongy feeling brake pedal; pedal almost touches floor; vehicle pulls to one side when braking
- Engine coolant temperature continually higher than normal

If you notice any of these clues, take your vehicle to your Toyota dealer as soon as possible. It probably needs adjustment or repair.



Do not continue driving with the vehicle unchecked. It could result in serious vehicle damage and possibly personal injury.

Emissions Inspection and Maintenance (I/M) programs

Some states have vehicle emission inspection programs which include OBD (On-Board Diagnostics) checks.

The OBD system monitors the operation of the emission control system. When the OBD system determines that a problem exists somewhere in the emission control system, the malfunction indicator lamp comes on. In this case, your vehicle may not pass the I/M test and need to be repaired. Contact your Toyota dealer to service the vehicle.

Even if the malfunction indicator lamp does not come on, your vehicle may not pass the I/M test as readiness codes have not been set in the OBD system.

Readiness codes are automatically set during ordinary driving. However, when the battery is disconnected or run down, the codes are erased. Also, depending on your driving habits, the codes may not be completely set.

Also, if the malfunction indicator lamp had come on recently due to temporary malfunction such as a loose fuel tank cap, your vehicle may not pass the I/M test.

The malfunction indicator lamp will go off after taking several driving trips, but the error code in the OBD system will not be cleared unless about 40 trips or more are taken.

If your vehicle does not pass the I/M test even the malfunction indicator lamp does not come on, contact your Toyota dealer to prepare the vehicle for re-testing.

SECTION 8

SPECIFICATIONS

Specifications

Dimensions and weights	496
Total load capacity	497
Engine	498
Fuel	498
Service specifications	498
Tires	501
Fuses	501

06 SIENNA_U (L/O 0603)

Dimensions and weights

Overall length	mm (in.)	5105 (201.0)
Overall width	mm (in.)	1965 (77.4)
Overall height	mm (in.)	1750 (68.9)* ¹
Wheelbase	mm (in.)	3030 (119.3)
Front tread	mm (in.)	1665 (65.6)* ² 1675 (65.9)* ³
Rear tread	mm (in.)	1700 (66.9)* ² 1710 (67.3)* ³
Towing capacity (trailer weight + cargo weight)	kg (lb.)	1587 (3500)

*1: Unladen vehicle

*2: With P215/65R16 tires

*3: With P225/60R17 tires

06 SIENNA_U (L/O 0603)

Total load capacity

For the U.S.A.—

kg (lb.)

Wagon	Front-wheel drive models	LE or CE grade	8-passengers models	550 (1210)
			7-passengers models	570 (1250)
		XLE or Limited grade	8-passengers models	565 (1250) 550 (1215)*
			7-passengers models	550 (1220) 535 (1185)*
	All-wheel drive models	LE grade	7-passengers models	500 (1100)
		XLE or Limited grade	7-passengers models	495 (1095) 480 (1060)*
Van				800 (1760)

For Canada—

kg (lb.)

Wagon	Front-wheel drive models	LE or CE grade	8-passengers models	550 (1210)
			7-passengers models	570 (1250)
		XLE or Limited grade	8-passengers models	565 (1250) 550 (1215)*
			7-passengers models	550 (1220) 535 (1185)*
	All-wheel drive models	LE or CE grade	7-passengers models	500 (1100)
		XLE or Limited grade	7-passengers models	495 (1095) 480 (1060)*
Van				800 (1760)

*: With moon roof

06 SIENNA_U (L/O 0603)

Engine

Model:
3MZ-FE

Type:
6 cylinder V type 4 cycle, gasoline

Bore and stroke, mm (in.):
92.0 × 83.0 (3.62 × 3.27)

Displacement, cm³ (cu. in.):
3311 (201.9)

Fuel

Fuel type:
Unleaded gasoline, Octane Rating 87 (Research Octane Number 91) or higher. For improved vehicle performance, use premium unleaded gasoline with an Octane Rating of 91 (Research Octane Number 96) or higher.

Fuel tank capacity, L (gal., Imp. gal.):
79 (21, 17.5)

Service specifications

ENGINE

Valve clearance (engine cold), mm (in.):

Intake	0.15—0.25 (0.006—0.010)
Exhaust	0.25—0.35 (0.010—0.014)

Spark plug type:

DENSO	SK20R11
NGK	IFR6A11

Spark plug gap, mm (in.):
1.1 (0.043)

Drive belt tension measured with
Borroughs drive belt tension gauge
No.BT-33-73F (used belt), lbf:

Generator belt	125 ± 10
Power steering pump belt	115 ± 20

ENGINE LUBRICATION

Oil capacity (drain and refill),
L (qt., Imp. qt.):

With filter	4.7 (5.0, 4.1)
Without filter	4.5 (4.8, 4.0)

“Toyota Genuine Motor Oil” is used in your Toyota vehicle. Use Toyota approved “Toyota Genuine Motor Oil” or equivalent to satisfy the following grade and viscosity.

Oil grade:
ILSAC multigrade engine oil

06 SIENNA_U (L/O 0603)

Recommended oil viscosity:
SAE 5W-30

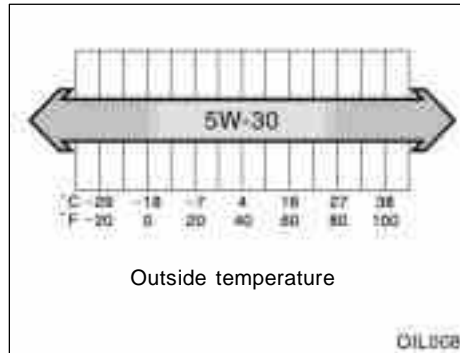

Please contact your Toyota dealer for further details.

COOLING SYSTEM

Total capacity, L (qt., Imp. qt.):
11.5 (12.2, 10.1)

Coolant type:

“Toyota Super Long Life Coolant” is used in your Toyota vehicle at factory fill. In order to avoid technical problems, only use “Toyota Super Long Life Coolant” or similar high quality ethylene glycol based non-silicate, non-amine, non-nitrite, and non-borate coolant with long-life hybrid organic acid technology. (Coolant with long-life hybrid organic acid technology is a combination of low phosphates and organic acids.)

Do not use plain water alone.

Please contact your Toyota dealer for further details.

BATTERY

Open voltage* at 20°C (68°F):
12.6—12.8 V Fully charged
12.2—12.4 V Half charged
11.8—12.0 V Discharged

*: Voltage that is checked 20 minutes after the key is removed with all the lights turned off

Charging rates:
5 A max.

AUTOMATIC TRANSAXLE

Fluid capacity (drain and refill), L (qt., Imp. qt.):
3.5 (3.7, 3.1)

Fluid type:

Toyota Genuine ATF Type T-IV

Change automatic transmission fluid only as necessary.

Generally, it is necessary to change automatic transmission fluid only if your vehicle is driven under one of the Special Operating Conditions listed in your “Scheduled Maintenance Guide” or “Owner’s Manual Supplement”. When changing the automatic transmission fluid, use only “Toyota Genuine ATF Type T-IV” (ATF JWS3309 or NWS6500) to aid in assuring optimum transaxle performance.

Notice: Using automatic transmission fluid other than “Toyota Genuine ATF Type T-IV” may cause deterioration in shift quality, locking up of your transmission accompanied by vibration, and ultimately damage the automatic transmission of your vehicle.

Please contact your Toyota dealer for further details.

06 SIENNA_U (L/O 0603)

TRANSFER

(all-wheel drive models)

Oil capacity, L (qt., Imp. qt.):
0.9 (1.0, 0.8)

Oil type:

Hypoid gear oil API GL-5

Recommended oil viscosity:

Above -18°C (0°F)

SAE 90

Below -18°C (0°F)

SAE 80W or 80W-90

REAR DIFFERENTIAL

(all-wheel drive models)

Oil capacity, L (qt., Imp. qt.):
0.9 (1.0, 0.8)

Oil type:

Hypoid gear oil API GL-5

Recommended oil viscosity:

Above -18°C (0°F)

SAE 90

Below -18°C (0°F)

SAE 80W or 80W-90

BRAKES

Minimum pedal clearance when depressed
with the force of 490 N (50 kgf, 110 lbf)
with the engine running, mm (in.):

52 (2.0)

Pedal free play, mm (in.):

1—6 (0.04—0.24)

Pad wear limit, mm (in.):

1.0 (0.04)

Lining wear limit, mm (in.):

1.0 (0.04)

Parking brake adjustment when depressed
with the force of 294 N (30 kgf, 66 lbf):

3—5 clicks

Fluid type:

SAE J1703 or FMVSS No.116 DOT 3

STEERING

Wheel free play:

Less than 30 mm (1.2 in.)

Power steering fluid type:

Automatic transmission fluid DEXRON®II
or III

06 SIENNA_U (L/O 0603)

Tires

Tire size and cold tire inflation pressure:

Front and rear

Tire size	Tire inflation pressure, kPa (kgf/cm ² or bar, psi)	Wheel size
P215/65R16 96T	240 (2.4, 35)	16 × 6 1/2JJ
P225/60R17 98T	240 (2.4, 35)	17 × 6 1/2JJ

Spare

Tire size	kPa (kgf/cm ² or bar, psi)	Wheel size
T155/80R17 101M	420 (4.2, 60)	17 × 4T

Wheel nut torque, N·m (kgf·m, ft·lbf):

103 (10.5, 76)

NOTE: For a complete information on tires (e.g. replacing tires or replacing wheels), see “Checking tire inflation pressure” through “Aluminum wheel precautions”, pages 471 through 481, in Section 7-2.

Fuses

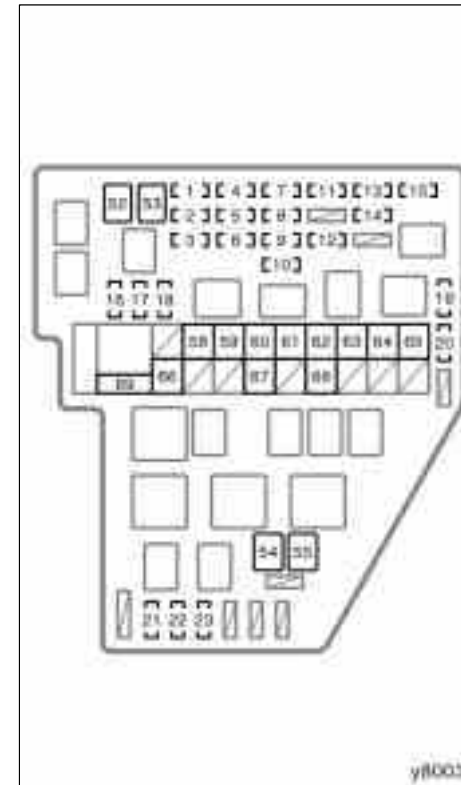

Engine compartment

06 SIENNA_U (L/O 0603)

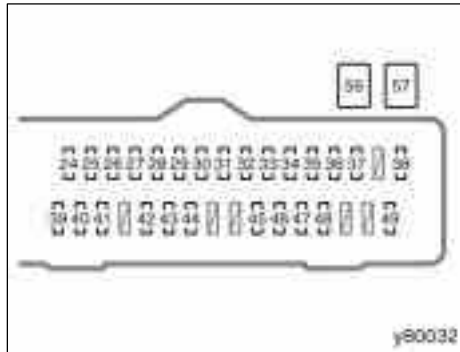

Instrument panel (driver's side)

Fuses (type A)

1. **ETCS 10 A:** Multiport fuel injection system/sequential multiport fuel injection system
2. **EFI NO. 1 20 A:** Multiport fuel injection system/sequential multiport fuel injection system, "EFI NO. 2" fuse
3. **H-LP RL 15 A:** Right-hand headlight (low beam)
4. **DRL 20 A:** Daytime running light system, "H-LP RH" and "H-LP LH" fuses
5. **ALT-S 7.5 A:** Charging system
6. **H-LP LL 15 A:** Left-hand headlight (low beam), front fog lights

502

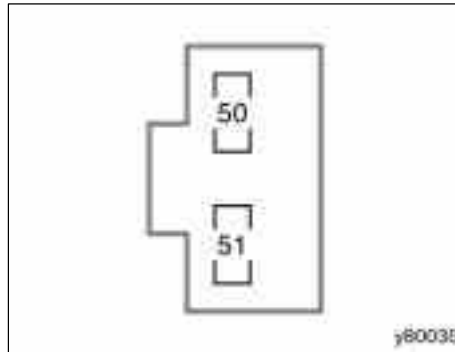

Instrument panel (passenger's side)

7. **DOOR NO. 2 25 A:** Power door lock system
8. **HAZ 15 A:** Turn signal lights, emergency flashers
9. **RAD NO. 3 30 A:** Audio system
10. **A/F 25 A:** Multiport fuel injection system/sequential multiport fuel injection system
11. **HORN 10 A:** Horns
12. **EFI NO. 2 10 A:** Multiport fuel injection system/sequential multiport fuel injection system

13. **DOME 10 A:** Personal lights, vanity lights, door courtesy lights, luggage compartment light, ignition switch light, multi-information display
14. **ECU-B 10 A:** Power sliding door, air conditioning system, power windows, multiplex communication system, meter and gauge, wireless remote control system
15. **RAD NO. 1 20 A:** Audio system, rear seat entertainment system
16. **SPARE 15 A:** Spare fuse
17. **SPARE 20 A:** Spare fuse
18. **SPARE 30 A:** Spare fuse
19. **SPARE 30 A:** Spare fuse
20. **SPARE 7.5 A:** Spare fuse
21. **H-LP RH 10 A:** Right-hand headlight
22. **H-LP LH 10 A:** Left-hand headlight
23. **RSE 7.5 A:** Rear seat entertainment system
24. **MIR HTR 10 A:** Outside rear view mirror heaters
25. **RAD2 7.5 A:** Audio system, navigation system, rear seat entertainment system
26. **PWR OUTLET 15 A:** Power outlets
27. **CIG 15 A:** Cigarette lighter

06 SIENNA_U (L/O 0603)

- 28. **ECU ACC 7.5 A:** Shift lock control system, air conditioning system, power rear view mirror control
 - 29. **GAUGE2 7.5 A:** Meter and gauge
 - 30. **IGN 7.5 A:** Multiport fuel injection system/sequential multiport fuel injection system, SRS airbag system, multiplex communication system
 - 31. **INJ 15 A:** Multiport fuel injection system/sequential multiport fuel injection system
 - 32. **RR WIP 15 A:** Rear window wiper
 - 33. **WIP 30 A:** Windshield wiper and rear window wiper
 - 34. **GAUGE1 10 A:** Back-up lights, turn signal lights, emergency flashers
 - 35. **S-HTR 15 A:** Seat heaters
 - 36. **WSH 20 A:** Windshield washer and rear window washer
 - 37. **HTR 10 A:** Air conditioning system
 - 38. **ECU-IG 10 A:** Toyota park assist system, rear view monitor system, multiplex communication system, multiport fuel injection system/sequential multiport fuel injection system, anti-lock brake system, traction control system, vehicle stability control system, shift lock control system, dynamic laser cruise control system, seat heaters, power back door, electronic moon roof, multi-information display, auto anti-glare inside rear view mirror, power windows, power outlets (115 V), power third seat, driving position memory system
 - 39. **PANEL 10 A:** Air conditioning system, seat heaters, audio system, navigation system, power sliding door, power back door, multi-information display, rear window defogger, emergency flashers, instrument panel lights, steering switch lights
 - 40. **TAIL 10 A:** Stop/tail lights, license plate lights, parking lights, side marker lights
 - 41. **S/ROOF 25 A:** Electronic moon roof
 - 42. **AC INV 15 A:** Power outlets (115 V)
 - 43. **FR DEF 15 A:** Windshield wiper deicer
 - 44. **AM1 7.5 A:** Multiport fuel injection system/sequential multiport fuel injection system, starter system
 - 45. **STOP 10 A:** Stop/tail lights, high mounted stoplight, shift lock control system, anti-lock brake system, traction control system, vehicle stability control system, multiport fuel injection system/sequential multiport fuel injection system, multiplex communication system
 - 46. **P/W 25 A:** Power windows, power rear view mirror
 - 47. **OBD 7.5 A:** On-board diagnosis system
 - 48. **FOG 15 A:** Front fog lights
 - 49. **P/VENT 15 A:** Power quarter windows
 - 50. **ST 7.5 A:** Multiport fuel injection system/sequential multiport fuel injection system
 - 51. **A/C 7.5 A:** Manual air conditioning system
- Fuses (type B)**
- 52. **MAIN 30 A:** Headlights, daytime running light system, "H-LP RL" and "H-LP LL" fuses
 - 53. **AM2 30 A:** "INJ", "IGN" and "GAUGE2" fuses

06 SIENNA_U (L/O 0603)

- 54. **L-RR2 SEAT 30 A:** Power third seat
- 55. **R-RR2 SEAT 30 A:** Power third seat
- 56. **P/SEAT 30 A:** Power front seats
- 57. **PWR 30 A:** Power windows

Fuses (type C)

- 58. **RR2 SEAT 50 A:** Power third seat
- 59. **HTR 50 A:** Air conditioning system, "A/C" fuse
- 60. **FAN 50 A:** Electric cooling fans
- 61. **PBD 30 A:** Power back door
- 62. **R-PSD 30 A:** Right side power sliding door
- 63. **L-PSD 30 A:** Left side power sliding door
- 64. **RR A/C 40 A:** Rear air conditioning system
- 65. **DEF 40 A:** Rear window defogger, "MIR HTR" fuse
- 66. **ABS1 50 A:** Anti-lock brake system, traction control system, vehicle stability control system
- 67. **ABS2 30 A:** Anti-lock brake system, traction control system, vehicle stability control system
- 68. **ST 30 A:** Starting system

Fuse (type D)

- 69. **ALT 140 A:** Charging system, "RR A/C", "HTR", "FAN", "PBD", "R-PSD", "L-PSD" and "DEF" fuses

SECTION 9

REPORTING SAFETY DEFECTS FOR U.S. OWNERS

Reporting safety defects for U.S. owners

[Reporting safety defects for U.S. owners](#) 506

06 SIENNA_U (L/O 0603)

Reporting safety defects for U.S. owners

If you believe that your vehicle has a defect which could cause a crash or could cause injury or death, you should immediately inform the National Highway Traffic Safety Administration (NHTSA) in addition to notifying Toyota Motor Sales, U.S.A., Inc. (Toll-free: 1-800-331-4331).

If NHTSA receives similar complaints, it may open an investigation, and if it finds that a safety defect exists in a group of vehicles, it may order a recall and remedy campaign. However, NHTSA cannot become involved in individual problems between you, your dealer, or Toyota Motor Sales, U.S.A., Inc.

To contact NHTSA, you may either call the Auto Safety Hotline toll-free at 1-888-327-4236 (or 366-0123 in Washington, D.C. area) or write to: NHTSA, U.S. Department of Transportation, Washington, D.C. 20590. You can also obtain other information about motor vehicle safety from the Hotline.

SECTION 7-1

DO- IT- YOURSELF MAINTENANCE

Introduction

Engine compartment overview	458
Fuse locations	459
Do- it- yourself service precautions	460
Positioning the jack	461
Parts and tools	463



06 SIENNA_U (L/O 0603)

Engine compartment overview

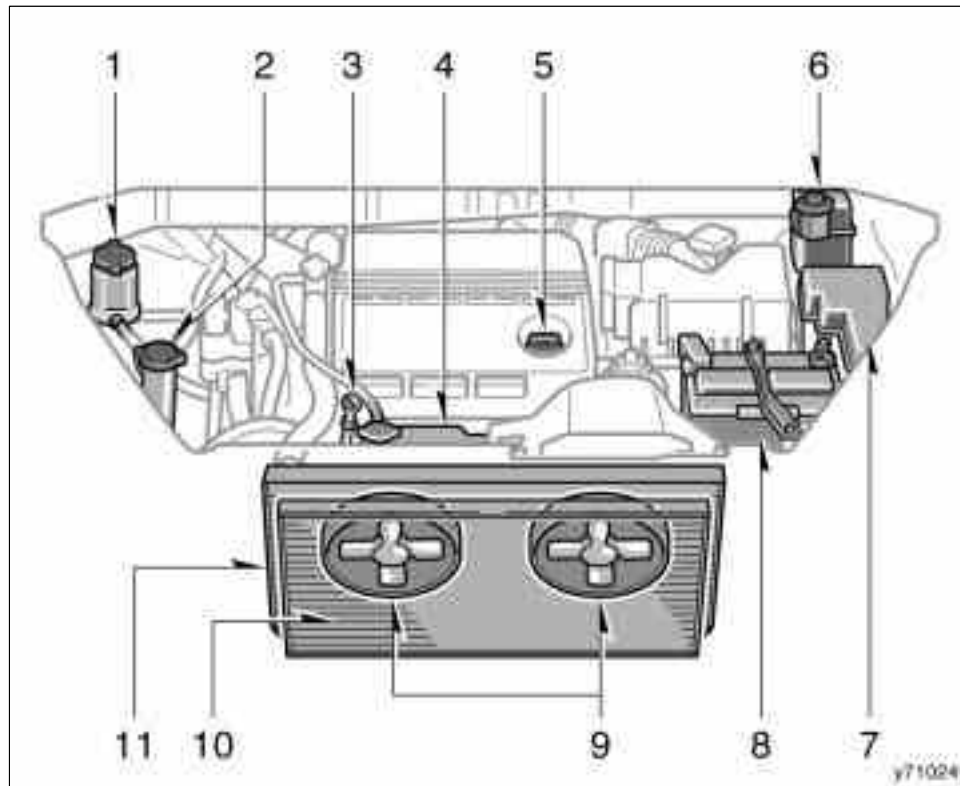

1. Power steering fluid reservoir
2. Windshield and rear window washer fluid tank
3. Engine oil level dipstick
4. Engine coolant reservoir
5. Engine oil filler cap
6. Brake fluid reservoir
7. Fuse block
8. Battery
9. Electric cooling fans
10. Condenser
11. Radiator

06 SIENNA_U (L/O 0603)

Fuse locations

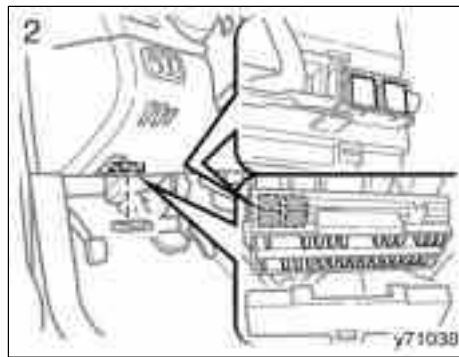
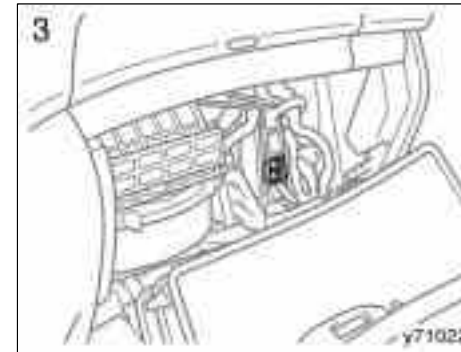
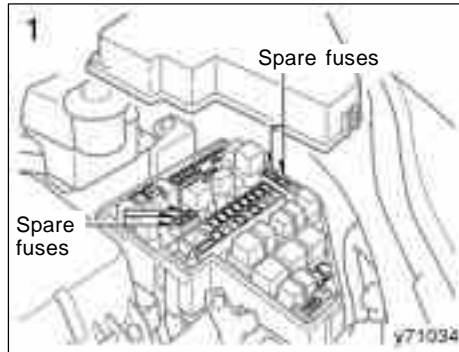
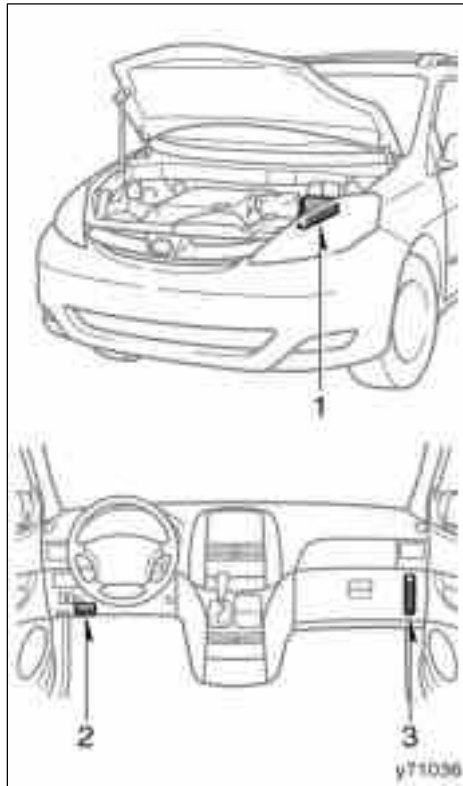

Do-it-yourself service precautions

If you perform maintenance by yourself, be sure to follow the correct procedure given in this Section.

You should be aware that improper or incomplete servicing may result in operating problems.

Performing do-it-yourself maintenance during the warranty period may affect your warranty coverage. Read the separate Toyota Warranty statement for details and suggestions.

This Section gives instructions only for those items that are relatively easy for an owner to perform. As explained in Section 6, there are still a number of items that must be done by a qualified technician with special tools.

For information on tools and Sections for do-it-yourself maintenance, see "Parts and tools" on page 463 in this Section.

Utmost care should be taken when working on your vehicle to prevent accidental injury. Here are a few precautions that you should be especially careful to observe:

CAUTION

- When the engine is running, keep hands, clothing, and tools away from the moving fan and engine drive belts. (Removing rings, watches, and ties is advisable.)
- Right after driving, the engine compartment—the engine, radiator, exhaust manifold and spark plug boots, etc.—will be hot. So be careful not to touch them. Oil, fluids and spark plugs may also be hot.
- If the engine is hot, do not remove the radiator cap or loosen the drain plugs to prevent burning yourself.
- Do not leave anything that may burn easily, such as paper or rags, in the engine compartment.
- Do not smoke, cause sparks or allow open flames around fuel or the battery. Their fumes are flammable.
- Do not get under your vehicle with just the body jack supporting it. Always use automotive jack stands or other solid supports.

- Be sure that the ignition is off if you work near the electric cooling fans or radiator grille. With the ignition on, the electric cooling fans will automatically start to run if the engine coolant temperature is high and/or the air conditioning is on.
- Use eye protection whenever you work on or under your vehicle where you may be exposed to flying or falling material, fluid spray, etc.
- Used engine oil contains potentially harmful contaminants which may cause skin disorders such as inflammation or skin cancer, so care should be taken to avoid prolonged and repeated contact with it. To remove used engine oil from your skin, wash thoroughly with soap and water.
- Do not leave used oil within the reach of children.
- Dispose of used oil and filter only in a safe and acceptable manner. Do not dispose of used oil and filter in household trash, in sewers or onto the ground. Call your dealer or a service station for information concerning recycling or disposal.

06 SIENNA_U (L/O 0603)

- Be extremely cautious when working on the battery. It contains poisonous and corrosive sulfuric acid.

NOTICE

- ◆ Remember that battery and ignition cables carry high currents or voltages. Be careful of accidentally causing a short circuit.
- ◆ Add only "Toyota Super Long Life Coolant" or similar high quality ethylene glycol based non-silicate, non-amine, non-nitrite, and non-borate coolant with long-life hybrid organic acid technology to fill the radiator. "Toyota Super Long Life Coolant" is a mixture of 50% coolant and 50% deionized water (for the U.S.A.) or 55% coolant and 45% deionized water (for Canada).
- ◆ If you spill some of the coolant, be sure to wash it off with water to prevent it from damaging the parts or paint.
- ◆ Do not allow dirt or anything else to fall through the spark plug holes.

- ◆ Use only spark plugs of the specified type. Using other types will cause engine damage, loss of performance or radio noise.
- ◆ Do not reuse iridium-tipped spark plugs by cleaning or regapping.
- ◆ Do not overfill automatic transmission fluid, or the transmission could be damaged.
- ◆ Do not drive with the air cleaner filter removed, or excessive engine wear could result. Also backfiring could cause a fire in the engine compartment.
- ◆ Be careful not to scratch the glass surface with the wiper frame.
- ◆ When closing the engine hood, check to see that you have not forgotten any tools, rags, etc.

Positioning the jack

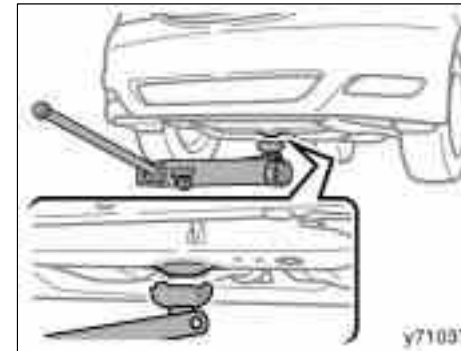

Front

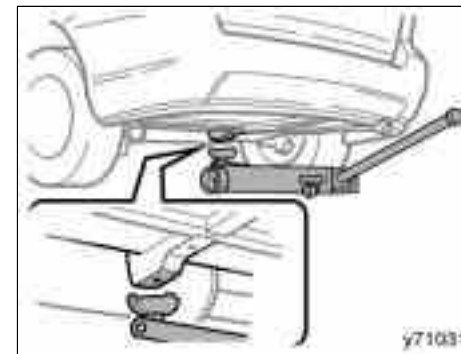

Rear (two-wheel drive models)

06 SIENNA_U (L/O 0603)

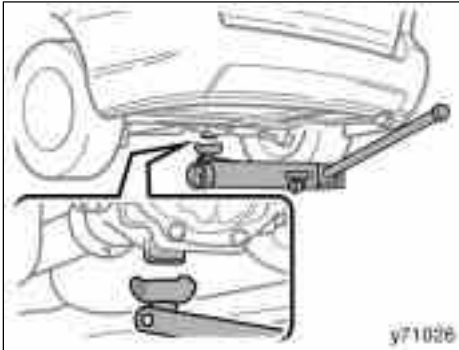

Rear (all-wheel drive models)

When jacking up your vehicle with the jack, position the jack correctly as shown in the illustrations.

CAUTION

When jacking, be sure to observe the following to reduce the possibility of personal injury:

- Follow jacking instructions.
- Do not put any part of your body under the vehicle supported by the jack. Personal injury may occur.
- Do not start or run the engine while your vehicle is supported by the jack.
- Stop the vehicle on a level firm ground, firmly set the parking brake and put the transmission in "P". Block the wheels on the opposite side of the jack up point if necessary.
- Make sure to set the jack properly in the jack point. Raising the vehicle with jack improperly positioned will damage the vehicle or may allow the vehicle to fall off the jack and cause personal injury.
- Never get under the vehicle when the vehicle is supported by the jack alone; use vehicle support stands.

- Do not raise the vehicle with someone in the vehicle.
- When raising the vehicle, do not place any objects on top of or underneath the jack.

NOTICE

Make sure to place the jack correctly, or your vehicle may be damaged.

06 SIENNA_U (L/O 0603)

Parts and tools

Here is a list of parts and tools you will need to perform do-it-yourself maintenance. Remember all Toyota parts are designed in metric sizes, so your tools must be metric.

CHECKING THE ENGINE OIL LEVEL

Parts (if level is low):

- “Toyota Genuine Motor Oil” or equivalent

See page 466 in Section 7-2 for details about engine oil selection.

Tools:

- Rag or paper towel
- Funnel (only for adding oil)

CHECKING THE ENGINE COOLANT LEVEL

Parts (if level is low):

- “Toyota Super Long Life Coolant” or similar high quality ethylene glycol based non-silicate, non-amine, non-nitrite, and non-borate coolant with long-life hybrid organic acid technology.

“Toyota Super Long Life Coolant” is a mixture of 50% coolant and 50% deionized water (for the U.S.A.) or 55% coolant and 45% deionized water (for Canada).

Tools:

- Funnel (only for adding coolant)

CHECKING BRAKE FLUID

Parts (if level is low):

- SAE J1703 or FMVSS No.116 DOT 3 brake fluid

Tools:

- Rag or paper towel
- Funnel (only for adding fluid)

CHECKING POWER STEERING FLUID

Parts (if level is low):

- Automatic transmission fluid DEXRON®II or III

Tools:

- Rag or paper towel
- Funnel (only for adding fluid)

CHECKING BATTERY CONDITION

Tools:

- Warm water
- Baking soda
- Grease
- Conventional wrench (for terminal clamp bolts)

CHECKING AND REPLACING FUSES

Parts (if replacement is necessary):

- Genuine Toyota fuse or equivalent with same amperage rating as original

ADDING WASHER FLUID

Parts:

- Water
- Washer fluid containing antifreeze (for winter use)

Tools:

- Funnel

REPLACING LIGHT BULBS

Parts:

- Bulb with same number and wattage rating as original (See charts in “Replacing light bulbs” on page 488 in Section 7-3.)

Tools:

- Screwdriver
- Wrench

06 SIENNA_U (L/O 0603)

SECTION 7- 2

DO- IT- YOURSELF MAINTENANCE

Engine and Chassis

Checking the engine oil level	466
Checking the engine coolant level	468
Checking the radiator and condenser	469
Checking brake fluid	469
Checking power steering fluid	470
Checking tire inflation pressure	471
Checking and replacing tires	474
Rotating tires	476
Run- flat tires	476
Installing snow tires and chains	478
Replacing wheels	480
Aluminum wheel precautions	481

Checking the engine oil level

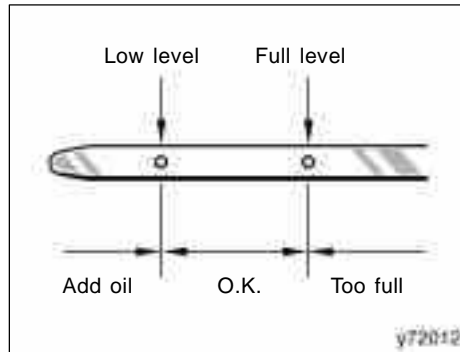

With the engine at operating temperature and turned off, check the oil level on the dipstick.

1. To get a correct reading, the vehicle should be on a level ground. After turning off the engine, wait a few minutes for the oil to drain back into the bottom of the engine.
2. Pull the dipstick out, hold a rag under the end and wipe it clean.
3. Reinsert the dipstick—push it in as far as it will go, or the reading will not be correct.
4. Pull the dipstick out and look at the oil level while holding a rag under the end.

466

CAUTION
 Be careful not to touch the hot exhaust manifold.

NOTICE
 Be careful not to drop engine oil on the vehicle components.

NOTICE

- ◆ Be careful not to spill engine oil on the vehicle components.
- ◆ Avoid overfilling, or the engine could be damaged.
- ◆ Check the oil level on the dipstick once again after adding the oil.

If the oil level is below or only slightly above the low level, add engine oil of the same type as already in the engine.

Remove the oil filler cap and add engine oil in small quantities at a time, checking the dipstick. We recommend that you use a funnel when adding oil.

The approximate quantity of oil needed to raise the level between low and full on the dipstick is indicated as follows:

1.5 L (1.6 qt., 1.3 Imp. qt.)

For the engine oil capacity, see “Service specifications” on page 498 in Section 8.

When the level reaches within the correct range, install the filler cap hand-tight.

06 SIENNA_U (L/O 0603)

Engine oil selection

"Toyota Genuine Motor Oil" is used in your Toyota vehicle. Use Toyota approved "Toyota Genuine Motor Oil" or equivalent to satisfy the following grade and viscosity.

Oil grade:

ILSAC multigrade engine oil

Recommended viscosity:

SAE 5W-30

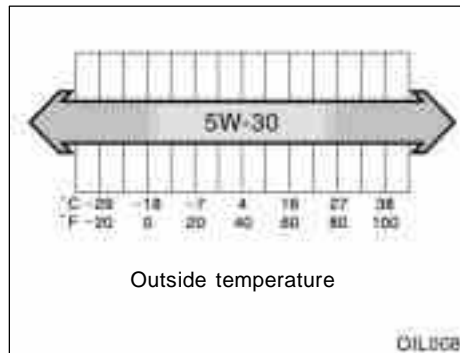

SAE 5W-30 is the best choice for good fuel economy and good starting in cold weather.

If SAE 5W-30 is not available, SAE 10W-30 may be used. However, it should be replaced with SAE 5W-30 at the next oil change.



Oil identification mark

The ILSAC (International Lubricant Standardization and Approval Committee) Certification Mark is added to some oil containers to help you select the oil you should use.



To ensure excellent lubrication performance for your engine, "Toyota Genuine Motor Oil" is available, which has been specifically tested and approved for all Toyota engines.

Please contact your Toyota dealer for further details about "Toyota Genuine Motor Oil".

Checking the engine coolant level

Look at the see-through coolant reservoir when the engine is cold. The coolant level is satisfactory if it is between the "FULL" and "LOW" lines on the reservoir. If the level is low, add the coolant. (For the coolant type, see "Coolant type selection" described below.)

The coolant level in the reservoir will vary with engine temperature. However, if the level is on or below the "LOW" line, add coolant. Bring the level up to the "FULL" line.

If the coolant level drops within a short time after replenishing, there may be a leak in the system. Visually check the radiator, hoses, engine coolant filler cap, radiator cap and drain cock and water pump.

If you can find no leak, have your Toyota dealer test the cap pressure and check for leaks in the cooling system.

CAUTION

To prevent burning yourself, do not remove the radiator cap when the engine is hot.

Coolant type selection

Use of improper coolants may damage your engine cooling system.

Only use "Toyota Super Long Life Coolant" or similar high quality ethylene glycol based non-silicate, non-amine, non-nitrite, and non-borate coolant with long-life hybrid organic acid technology. (Coolant with long-life hybrid organic acid technology is a combination of low phosphates and organic acids.)

For the U.S.A.—"Toyota Super Long Life Coolant" is a mixture of 50% coolant and 50% deionized water. This coolant provides protection down to about -35°C (-31°F).

For Canada—"Toyota Super Long Life Coolant" is a mixture of 55% coolant and 45% deionized water. This coolant provides protection down to about -42°C (-44°F).

NOTICE

Do not use plain water alone.



Toyota recommends "Toyota Super Long Life Coolant", which has been tested to ensure that it will not cause corrosion nor result in malfunction of your engine coolant system with proper usage. "Toyota Super Long Life Coolant" is formulated with long-life hybrid organic acid technology and has been specifically designed to avoid engine cooling system malfunction on Toyota vehicles.

Please contact your Toyota dealer for further details.

Checking the radiator and condenser

If any of the above parts are extremely dirty or you are not sure of their condition, take your vehicle to a Toyota dealer.

CAUTION

To prevent burning yourself, be careful not to touch the radiator or condenser when the engine is hot.

NOTICE

To prevent damage to the radiator and condenser, do not perform the work by yourself.

Checking brake fluid

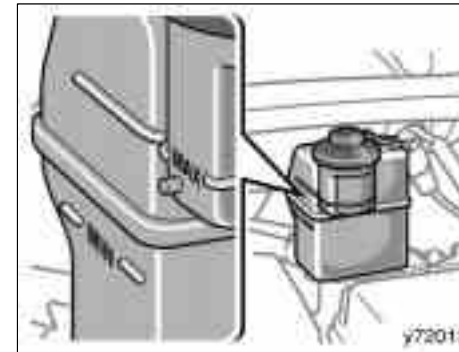

To check the fluid level, simply look at the see-through reservoir. The level should be between the "MAX" and "MIN" lines on the reservoir.

It is normal for the brake fluid level to go down slightly as the brake pads wear. So be sure to keep the reservoir filled.

If the reservoir needs frequent refilling, it may indicate a serious mechanical problem.

If the level is low, add SAE J1703 or FMVSS No.116 DOT 3 brake fluid to the brake reservoir.

Remove and replace the reservoir cap by hand. Fill the brake fluid to the dotted line. This brings the fluid to the correct level when you put the cap back on.

Use only newly opened brake fluid. Once opened, brake fluid absorbs moisture from the air, and excess moisture can cause a dangerous loss of braking.

When the brake fluid must be replaced, contact your Toyota dealer.

CAUTION

Take care when filling the reservoir because brake fluid can harm your hands or eyes. If fluid gets on your hands or in your eyes, flush the affected area with clean water immediately. If you still feel uncomfortable with your hands or eyes, go to the doctor.

NOTICE

If you spill some of the fluid, be sure to wipe it off to prevent it from damaging the parts or paintwork.

Checking power steering fluid

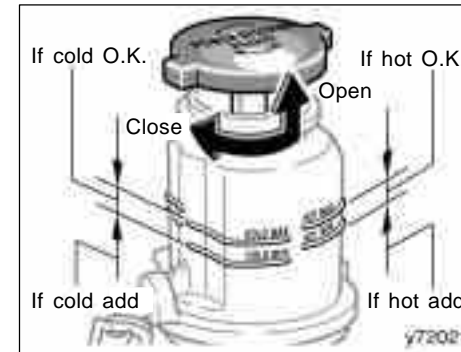

Check the fluid level through the reservoir. If necessary, add automatic transmission fluid DEXRON®II or III.

If the vehicle has been driven around 80 km/h (50 mph) for 20 minutes (a little more in frigid temperatures), the fluid is hot (60°C—80°C or 140°F—175°F). You may also check the level when the fluid is cold (about room temperature, 10°C—30°C or 50°F—85°F) if the engine has not been run for about five hours.

Checking tire inflation pressure

Clean all dirt from the outside of the reservoir tank and look at the fluid level. If the fluid is cold, the level should be in the "COLD" range. Similarly, if it is hot, the fluid level should be in the "HOT" range. If the level is at the low side of either range, add automatic transmission fluid DEXRON®II or III to bring the level within the range.

To remove the reservoir cap, turn it counterclockwise and lift up. To reinstall it, turn it clockwise. After replacing the reservoir cap, visually check the steering box case, vane pump and hose connections for leaks or damage.

CAUTION
The reservoir tank may be hot so be careful not to burn yourself.

NOTICE
Avoid overfilling, or the power steering could be damaged.



Keep your tire inflation pressures at the proper level.

The recommended cold tire inflation pressures, tire sizes and the combined weight of occupants and cargo (vehicle capacity weight) are described on page 497 and 501. They are also on the tire and loading information label.

You should check the tire inflation pressure every two weeks, or at least once a month. And do not forget the spare!

06 SIENNA_U (L/O 0603)

The following instructions for checking tire inflation pressure should be observed:

- **The pressure should be checked only when the tires are cold.** If your vehicle has been parked for at least 3 hours and has not been driven for more than 1.5 km or 1 mile since, you will get an accurate cold tire inflation pressure reading.
- **Always use a tire pressure gauge.** The appearance of a tire can be misleading. Besides, tire inflation pressures that are even just a few pounds off can degrade ride and handling.
- **Take special care when adding air to the compact spare tire.** The smaller tire size can gain pressure very quickly. Add compressed air in small quantities and check the pressure often until it reaches the specified pressure.

- **Do not bleed or reduce tire inflation pressure after driving.** It is normal for the tire inflation pressure to be higher after driving.
- **Never exceed the vehicle capacity weight.** Passenger and luggage weight should be located so that the vehicle is balanced.

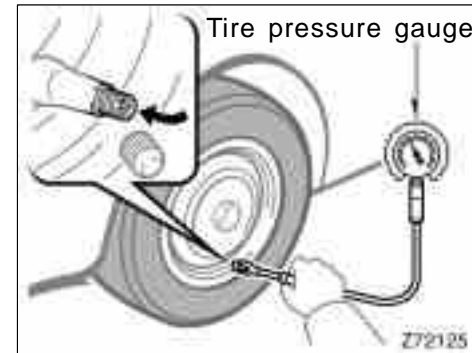

INSPECTION AND ADJUSTMENT PROCEDURE

1. Remove the tire valve cap.
2. Press the tip of the tire pressure gauge to the tire valve.
3. Read the pressure using the graduations of the gauge.
4. In case the tire inflation pressure is not within the prescribed range, insert the compressed air from the valve. In case of applying too much air, press the center of the valve and release the air to adjust.

5. After completing the tire inflation pressure measurement and adjustment, apply soapy water to the valve and check for leakage.

6. Install the tire valve cap.

If a gauge and air pump are not available, have your vehicle checked by your Toyota dealer.

 CAUTION
Be sure to reinstall the tire valve caps. Without the valve caps, dirt or moisture could get into the valve core and cause air leakage. If the caps have been lost, have new ones put on as soon as possible.

Incorrect tire inflation pressure may waste fuel, reduce the comfort of driving, reduce tire life and make your vehicle less safe to drive.

If a tire frequently needs refilling, have it checked by your Toyota dealer.

 CAUTION
Keep your tires properly inflated. Otherwise, the following conditions may occur and cause an accident resulting in death or serious injuries.
Low tire pressure (underinflation)—
<ul style="list-style-type: none">● Excessive wear● Uneven wear● Poor handling● Possibility of blowouts from an overheated tire● Poor sealing of the tire bead● Wheel deformation and/or tire separation● A greater possibility of tire damage from road hazards

High tire pressure (overinflation)—
<ul style="list-style-type: none">● Poor handling● Excessive wear● Uneven wear● A greater possibility of tire damage from road hazards

Checking and replacing tires

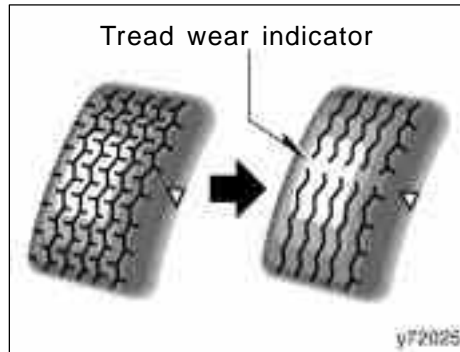

CHECKING YOUR TIRES

Check the tire's tread for tread wear indicators. If the indicators show, replace the tires. The location of tread wear indicators is shown by the "TWI" or "Δ" marks, etc., molded on the sidewall of each tire.

The tires on your Toyota have built-in tread wear indicators to help you know when the tires need replacement. When the tread depth wears to 1.6 mm (0.06 in.) or less, the indicators will appear. If you can see the indicators in two or more adjacent grooves, the tire should be replaced. The lower the tread, the higher the risk of skidding.

The effectiveness of snow tires is lost if the tread wears down below 4 mm (0.16 in.).

If you have tire damage such as cuts, splits, cracks deep enough to expose the fabric, or bulges indicating internal damage, the tire should be replaced.

If a tire often goes flat or cannot be properly repaired due to the size or location of a cut or other damage, it should be replaced. If you are not sure, consult with your Toyota dealer.

If air loss occurs while driving, do not continue driving. Driving even a short distance can damage a tire beyond repair.

Any tires which are over 6 years old must be checked by a qualified technician even if damage is not obvious.

Tires deteriorate with age even if they have never or seldom been used.

This applies also to the spare tire and tires stored for future use.

REPLACING YOUR TIRES

When replacing a tire, use a tire of the same size and construction, and the same or greater maximum load as the originally installed tires. Also, on all-wheel drive models, all the tires must be the same brand and have the same tread patterns.

06 SIENNA_U (L/O 0603)

Using any other size or type of tire may seriously affect handling, ride, speedometer/odometer calibration, ground clearance, and clearance between the body and tires or snow chains.

Check that the maximum load of the replaced tire is greater than 1/2 of the Gross Axle Weight Ratings (GAWR) of either the front axle or the rear axle, whichever is greater. As for the maximum load of the tire, see the load limit at maximum cold tire inflation pressure mentioned on the sidewall of the tire, and as for the Gross Axle Weight Ratings (GAWR), see the Certification Label.

For details about the side wall of the tire and the Certification Label, see pages 386 and 388.



CAUTION

Observe the following instructions. Otherwise, an accident may occur resulting in death or serious injuries.

- **Do not mix radial, bias belted, or bias-ply tires on your vehicle, as this may cause dangerous handling characteristics resulting in loss of control.**
- **Do not use tires other than the manufacturer's recommended size, as this may cause dangerous handling characteristics resulting in loss of control.**
- **All-wheel drive models: Do not use tires of different brands, sizes, construction or tread patterns, as this may cause dangerous handling characteristics resulting in loss of control.**

Toyota recommends all four tires, or at least both of the front or rear tires be replaced at a time as a set.

See "If you have a flat tire" on page 421 in Section 4 for tire change procedure.

When a tire is replaced, the wheel should always be balanced.

An unbalanced wheel may affect vehicle handling and tire life. Wheels can get out of balance with regular use and should therefore be balanced occasionally.

When replacing a tubeless tire, the air valve should also be replaced with a new one.

Initial adjustment of the tire pressure warning system is necessary after you have rotated your tires. See "Tire pressure warning system" on page 208 in Section 1-7.

Rotating tires

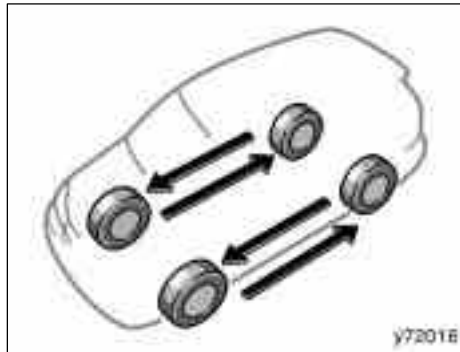

To equalize the wear and help extend tire life, Toyota recommends that you rotate your tires according to the maintenance schedule. (For scheduled maintenance information, please refer to the “Scheduled Maintenance Guide” or “Owner’s Manual Supplement”.) However, the most appropriate timing for tire rotation may vary according to your driving habits and road surface conditions.

See “If you have a flat tire” on page 421 in Section 4 for tire change procedure.

When rotating tires, check for uneven wear and damage. Abnormal wear is usually caused by incorrect tire pressure, improper wheel alignment, out-of-balance wheels, or severe braking.

CAUTION

Do not include a compact spare tire when rotating the tires. It is designed for temporary use only.

Initial adjustment of the tire pressure warning system is necessary after you have rotated your tires. See “Tire pressure warning system” on page 208 in Section 1-7.

Run-flat tires



Some vehicles are equipped with run-flat (RFT) tires. The run-flat tire allows you to continue driving for up to 160 km (100 miles) at a speed below 90 km/h (55 mph) even if any tire goes flat. However, in some conditions (such as high temperatures), you could not continue driving for up to 160 km (100 miles).

A spare tire is not provided on vehicles with run-flat tires.

When the tire goes flat or when the tire pressure is below 100 kPa (1.0 kgf/cm² or bar, 15 psi), the tire must be replaced. If you are not sure, consult your Toyota dealer. Do not use the repaired tire.

There is an "RFT" or "DSST" mark on the sidewall of the run-flat tire.

If you cannot distinguish between the standard tire and run-flat tire, consult your Toyota dealer.

The tire warranty book provides detailed information on the run-flat tires. For details, see the tire warranty book.

 **CAUTION**

- Do not use non-genuine wheels, as this may cause dangerous handling characteristics resulting in loss of control.
- Do not use the run-flat tires equipped on your vehicle on another model. These tires are especially for this model.

- Do not mix run-flat tires with standard tires.

If the tire pressure warning light comes on:

Decelerate at a speed below 90 km/h (55 mph), then adjust the tire pressure to the specified level as soon as possible. Do not drive more than 160 km (100 miles).

- When the tire pressure is below 140 kPa (1.4 kgf/cm² or bar, 20 psi), consult your Toyota dealer. If the tire is flat or the tire pressure is below 100 kPa (1.0 kgf/cm² or bar, 15 psi), the tire must be replaced. Do not use the repaired tire.
- When the tire pressure is 140 kPa (1.4 kgf/cm² or bar, 20 psi) or more, adjust it to specified level. (See "Tires" on page 501 in Section 8.)

See "Tire pressure warning system" on page 208 in Section 1-7 and "Checking tire inflation pressure" on page 471 in this Section.

 **CAUTION**

As the run-flat tire allows you to continue driving if any tire goes flat, the tire performance is not the same as normal condition. If the run-flat tire goes flat, take your vehicle to the nearest Toyota dealer or authorized tire dealer as soon as possible, observing the following instructions:

- Decelerate as soon as possible to the lowest appropriate speed that conditions permit. Do not drive for longer than 160 km (100 miles) or over 90 km/h (55 mph).

- Avoid abrupt steering wheel maneuvering and braking. If the vehicle tires deteriorate, you could lose control of the steering wheel or the brakes, causing death or serious injury.
- Do not replace or repair the tire by yourself. When the tires must be replaced or repaired, consult your Toyota dealer or authorized tire dealer.

NOTICE

◆ *Take due care not to go over a curb stone and be careful of the holes in the road because deflated tire pressure affects tire cushion performance. The wheels, tires, body, suspension and other components could be damaged.*

◆ *Your ground clearance is reduced if the run-flat tire goes flat so avoid driving over obstacles and drive slowly on rough, unpaved roads and speed bumps. Also, do not attempt to go through an automatic car wash as the vehicle may get caught, resulting in damage.*

Installing snow tires and chains

WHEN TO USE SNOW TIRES OR CHAINS

Snow tires or chains are recommended when driving on snow or ice.

On wet or dry roads, conventional tires provide better traction than snow tires.

SNOW TIRE SELECTION

If you need snow tires, select tires of the same size, construction and load capacity as the originally installed tires. Also, on all-wheel drive models, all the tires must be the same brand and have the same tread patterns.

Do not use tires other than those mentioned above. Do not install studded tires without first checking local regulations for possible restrictions.

06 SIENNA_U (L/O 0603)

 **CAUTION**

Observe the following instructions. Otherwise, an accident may occur resulting in death or serious injuries.

- Do not use snow tires other than the manufacturer's recommended size, as this may cause dangerous handling characteristics resulting in loss of control.
- All-wheel drive models: Do not use snow tires of different brands, sizes, construction or tread patterns, as this may cause dangerous handling characteristics resulting in loss of control.

SNOW TIRE INSTALLATION

Snow tires should be installed on all wheels.

Installing snow tires on the front wheels only can lead to an excessive difference in road grip capability between the front and rear tires which could cause loss of vehicle control.

When storing removed tires, you should store them in a cool dry place. Mark the direction of rotation and be sure to install them in the same direction when replacing.

 **CAUTION**

- Do not drive with the snow tires incorrectly inflated.
- Never drive over 120 km/h (75 mph) with any type of snow tires.
- Vehicles with run-flat tires—Do not replace or repair the tire by yourself. When the tires must be replaced or repaired, consult your Toyota dealer or authorized tire dealer.

TIRE CHAIN SELECTION

Use the tire chains of correct size and type.

Use SAE Class "S" type radial tire chains except radial cable chains or V-bar type chains.

Regulations regarding the use of tire chains vary according to location or type of road, so always check local regulations before installing chains.

CHAIN INSTALLATION

Install the chains on the front tires as tightly as possible. Do not use tire chains on the rear tires. Retighten chains after driving 0.5—1.0 km (1/4—1/2 mile).

When installing chains on your tires, carefully follow the instructions of the chain manufacturer.

If wheel covers are used, they will be scratched by the chain band, so remove the covers before putting on the chains.

 **CAUTION**

- Do not exceed 50 km/h (30 mph) or the chain manufacturer's recommended speed limit, whichever is lower.
- Drive carefully avoiding bumps, holes, and sharp turns, which may cause the vehicle to bounce.
- Avoid sharp turns or locked-wheel braking, as use of chains may adversely affect vehicle handling.
- When driving with chains installed, be sure to drive carefully. Slow down before entering curves to avoid losing control of the vehicle. Otherwise an accident may occur.

NOTICE

Do not attempt to use a tire chain on the compact spare tire, as it may result in damage to the vehicle as well as the tire.

Replacing wheels

WHEN TO REPLACE YOUR WHEELS

If you have wheel damage such as bending, cracks or heavy corrosion, the wheel should be replaced.

If you fail to replace a damaged wheel, the tire may slip off the wheel or cause loss of handling control.

WHEEL SELECTION

When replacing wheels, care should be taken to ensure that the wheels are replaced by ones with the same load capacity, diameter, rim width, and offset.

This must be observed on compact spare tires, too.

Correct replacement wheels are available at your Toyota dealer.

A wheel of a different size or type may adversely affect handling, wheel and bearing life, brake cooling, speedometer/odometer calibration, stopping ability, headlight aim, bumper height, vehicle ground clearance, and tire or snow chain clearance to the body and chassis.

Replacement with used wheels is not recommended as they may have been subjected to rough treatment or high mileage and could fail without warning. Also, bent wheels which have been straightened may have structural damage and therefore should not be used. Never use an inner tube in a leaking wheel which is designed for a tubeless tire.

 **CAUTION**

Observe the following instructions. Otherwise, an accident may occur resulting in death or serious injuries.

- Do not use wheels other than the manufacturer's recommended size, as this may cause dangerous handling characteristics resulting in loss of control.
- All-wheel drive models:
Do not use wheels of different brands, sizes and types, as this may cause dangerous handling characteristics resulting in loss of control.

Initial adjustment of the tire pressure warning system is necessary after you have replaced your wheels. See “Tire pressure warning system” on page 208 in Section 1-7.

Aluminum wheel precautions

- When installing aluminum wheels, check that the wheel nuts are tight after driving your vehicle the first 1600 km (1000 miles).
- If you have rotated, repaired, or changed your tires, check that the wheel nuts are still tight after driving 1600 km (1000 miles).
- When using tire chains, be careful not to damage the aluminum wheels.
- Use only Toyota wheel nuts and wrench designed for your aluminum wheels.
- When balancing your wheels, use only Toyota balance weights or equivalent and a plastic or rubber hammer.
- As with any wheel, periodically check your aluminum wheels for damage. If damaged, replace immediately.

06 SIENNA_U (L/O 0603)

SECTION 7- 3

DO- IT- YOURSELF MAINTENANCE

Electrical components

Checking battery condition	484
Battery recharging precautions	485
Checking and replacing fuses	486
Adding washer fluid	487
Replacing light bulbs	488

**Checking battery condition—
—Precautions**

⚠ CAUTION

BATTERY PRECAUTIONS

The battery produces flammable and explosive hydrogen gas.

- Do not cause a spark from the battery with tools.
- Do not smoke or light a match near the battery.

The electrolyte contains poisonous and corrosive sulfuric acid.

- Avoid contact with eyes, skin or clothes.
- Never ingest electrolyte.
- Wear protective safety glasses when working near the battery.
- Keep children away from the battery.

EMERGENCY MEASURES

- If electrolyte gets in your eyes, flush your eyes with clean water immediately and get immediate medical attention. If possible, continue to apply water with a sponge or cloth while en route to the medical office.

- If electrolyte gets on your skin, thoroughly wash the contact area. If you feel pain or burning, get medical attention immediately.
- If electrolyte gets on your clothes, there is a possibility of its soaking through to your skin, so immediately take off the exposed clothing and follow the procedure above, if necessary.
- If you accidentally swallow electrolyte, drink a large quantity of water or milk. Follow with milk of magnesia, beaten raw egg or vegetable oil. Then go immediately for emergency help.

—Checking battery exterior

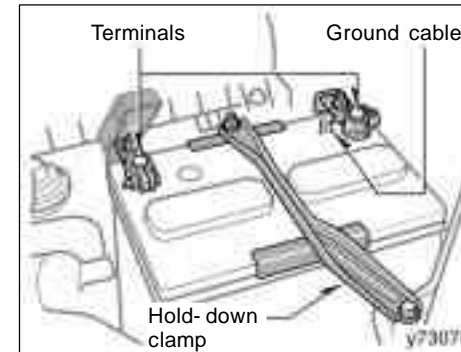

Check the battery for corroded or loose terminal connections, cracks, or loose hold-down clamp.

- a. If the battery is corroded, wash it off with a solution of warm water and baking soda. Coat the outside of the terminals with grease to prevent further corrosion.
- b. If the terminal connections are loose, tighten their clamp nuts—but do not overtighten.
- c. Tighten the hold-down clamp only enough to keep the battery firmly in place. Overtightening may damage the battery case.

NOTICE

- ◆ *Be sure the engine and all accessories are off before performing maintenance.*
- ◆ *When checking the battery, remove the ground cable from the negative terminal (“-” mark) first and reinstall it last.*
- ◆ *Be careful not to cause a short circuit with tools.*
- ◆ *Take care no solution gets into the battery when washing it.*

If the battery is disconnected or run down, the power window, power sliding door, power back door and moon roof may not operate correctly and the jam protection function will not function correctly, and does not open the back door after you reconnect, replace or recharge the battery. In any of these cases, you should normalize each system. To normalize them, see “Power sliding doors” on page 28, “Power back door” on page 37, “Power windows” on page 42 and “Electric moon roof” on page 52 in Section 1-2.

—Checking battery condition

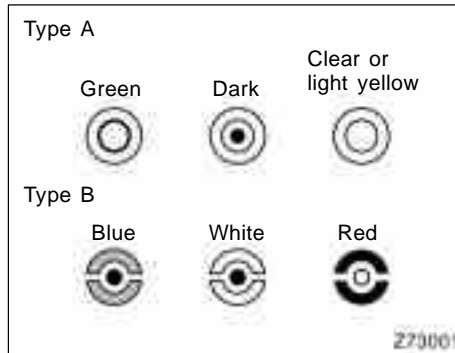

CHECKING BY INDICATOR

Check the battery condition by the indicator color.

Indicator color		Condition
Type A	Type B	
Green	Blue	Good
Dark	White	Charging necessary. Have battery checked by your Toyota dealer.
Clear or light yellow	Red	Have battery checked by your Toyota dealer.

Battery recharging precautions

During recharging, the battery is producing hydrogen gas.

Therefore, before recharging:

1. If recharging with the battery installed on the vehicle, be sure to disconnect the ground cable.
2. Be sure the power switch on the recharger is off when connecting the charger cables to the battery and when disconnecting them.

CAUTION

- **Always charge the battery in an unconfined area. Do not charge the battery in a garage or closed room where there is not sufficient ventilation.**
- **Only do a slow charge (5 A or less). Charging at a quicker rate is dangerous. The battery may explode, causing personal injuries.**

NOTICE

Never recharge the battery while the engine is running. Also, be sure all accessories are turned off.

Checking and replacing fuses

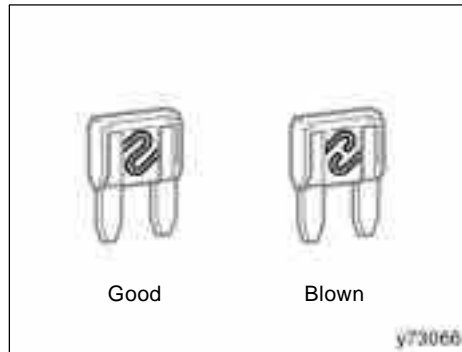

Type A

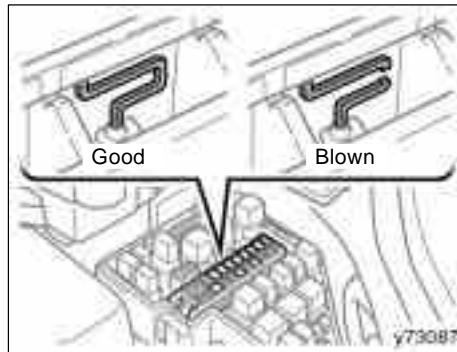

Type C

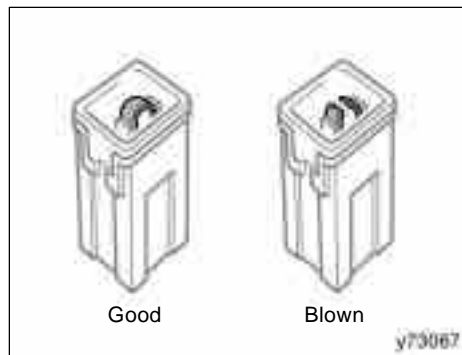
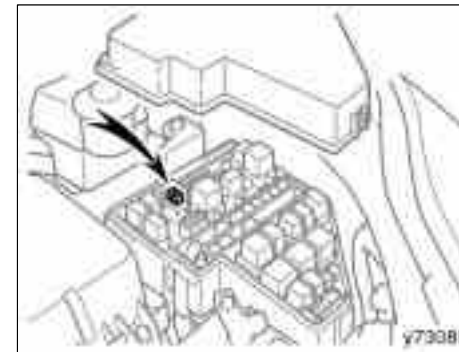

Type B

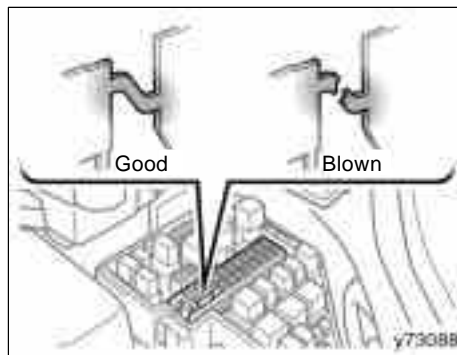

Type D

If the headlights or other electrical components do not work, check the fuses. If any of the fuses are blown, they must be replaced.

See "Fuse locations" on page 459 in Section 7-1 for locations of the fuses.

Turn the ignition switch and inoperative component off. Pull the suspected fuse straight out and check it.

Determine which fuse may be causing the problem. The lid of the fuse box shows the name of the circuit for each fuse. See page 501 in Section 8 for the functions controlled by each circuit.

Type C and D—When any of the fuses are blown, contact your Toyota dealer.

06 SIENNA_U (L/O 0603)

Type A fuses can be pulled out by the pull-out tool. The location of the pull-out tool is shown in the illustration.

If you are not sure whether the fuse has blown, try replacing the suspected fuse with one that you know is good.

If the fuse has blown, push a new fuse into the clip.

Only install a fuse with the amperage rating designated on the fuse box lid.

If you do not have a spare fuse, in an emergency you can pull out the "HTR" (10 A), "AC INV" or "RAD NO.1" fuse, which may be dispensable for normal driving, and use it if its amperage rating is the same.

If you cannot use one of the same amperage, use one that is lower, but as close to the rating as possible. If the amperage is lower than that specified, the fuse might blow out again but this does not indicate anything wrong. Be sure to get the correct fuse as soon as possible and return the substitute to its original clip.

It is a good idea to purchase a set of spare fuses and keep them in your vehicle for emergencies.

If the new fuse immediately blows out, there is a problem with the electrical system. Have your Toyota dealer correct it as soon as possible.

You should normalize the power window, power sliding door, power back door and moon roof if they do not operate automatically or the jam protection function does not operate correctly after replacing blown fuses. To normalize them, see "Power sliding doors" on page 28, "Power back door" on page 37, "Power windows" on page 42 and "Electric moon roof" on page 52 in Section 1-2.

CAUTION

Never use a fuse with a higher amperage rating, or any other object, in place of a fuse. This may cause extensive damage and possibly a fire.

Adding washer fluid

If any washer does not work or the low windshield washer fluid level warning light comes on, the washer tank may be empty. Add washer fluid.

You may use plain water as washer fluid. However, in cold areas where temperatures range below the freezing point, use washer fluid containing antifreeze. This product is available at your Toyota dealer and most auto parts stores. Follow the manufacturer's directions for how much to mix with water.

NOTICE

Do not use engine antifreeze or any other substitute because it may damage your vehicle's paint.

Replacing light bulbs—

The following illustrations show how to gain access to the bulbs. When replacing a bulb, make sure the ignition switch and light switch are off. Use bulbs with the wattage ratings given in the table.

The high mounted stoplight consists of a number of LEDs. If any of the LEDs burn out, take your vehicle to your Toyota dealer to have the light replaced.

 CAUTION
<ul style="list-style-type: none">● To prevent burning yourself, do not replace the light bulbs while they are hot.● Halogen bulbs have pressurized gas inside and require special handling. They can burst or shatter if scratched or dropped. Hold a bulb only by its plastic or metal case. Do not touch the glass part of a bulb with bare hands.● When replacing the rear light bulbs, turn off the power back door system to prevent an unexpected serious injury.

<p>Vehicles with discharge headlights—</p> <ul style="list-style-type: none">● Do not touch the high-intensity discharge headlight's high voltage socket when the headlights are turned on. An extremely high voltage of 20000 V will be discharged and could result in serious injury or death by electric shock.● Do not attempt to take apart or repair the low beam headlight bulbs, connectors, power supply circuits, or related components. Doing so could result in electric shock and serious injury or death. Call your Toyota dealer for headlight repair or servicing, including replacement of bulbs and bulb disposal.
--

NOTICE
<i>Only use a bulb of the listed type.</i>

The inside of the lens of exterior lights such as headlights may temporarily fog up when the lens becomes wet in the rain or in a car wash. This is not a problem because the fogging is caused by the temperature difference between the outside and inside of the lens, just like the windshield fogs up in the rain. However, if there is a large drop of water on the inside of the lens, or if there is water pooled inside the light, contact your Toyota dealer.

06 SIENNA_U (L/O 0603)

Light bulbs	Bulb No.	W	Type
Headlights (low beam)	—	35	A
With discharge headlights	9006	55	B
Without discharge headlights			
Headlights (high beam)	9005	60	C
Front fog lights	—	51	B
Front turn signal lights	3457A	27	E
Parking and front side marker lights	—	5	E
Rear turn signal lights	—	21	D
Stop/tail and rear side marker lights	—	21/5	D
Tail lights	—	3.8	D
Back- up lights	921	18	D
License plate lights	—	5	D
Front personal lights	—	4.9	F
Rear personal lights	—	4.9	F
Luggage compartment light	—	5	G
Vanity lights	—	3	G
Door courtesy lights	—	3.8	F

A: D2R discharge bulbs
 B: HB4 halogen bulbs
 C: HB3 halogen bulbs
 D: Wedge base bulbs (clear)
 E: Wedge base bulbs (amber)
 F: Single end bulbs
 G: Double end bulbs

06 SIENNA_U (L/O 0603)

—Headlights



1. Open the hood. Press the bulb base slightly and turn the bulb base counterclockwise to the front of the vehicle as shown.



2. Unplug the connector while depressing the lock release.
If the connector is tight, wiggle it.

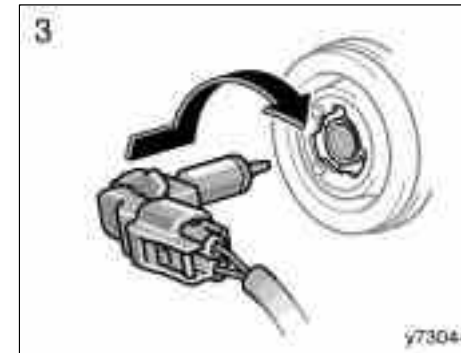

3. Plug in a new bulb into the connector and install it into the mounting hole.

Aiming is not necessary after replacing the bulb. When aiming adjustment is necessary, contact your Toyota dealer.

06 SIENNA_U (L/O 0603)

—Front fog lights

If either the left or right front fog light bulbs burns out, contact your Toyota dealer.

NOTICE

Do not try to replace the front fog light bulbs by yourself. You may damage the vehicle.

—Front turn signal lights

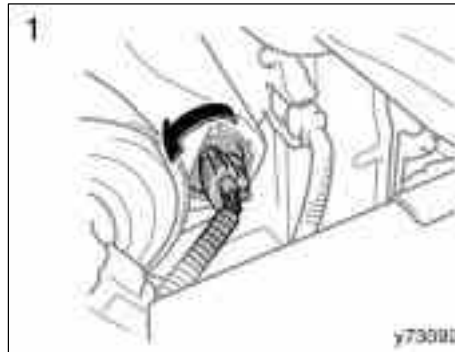

—Parking and front side marker lights

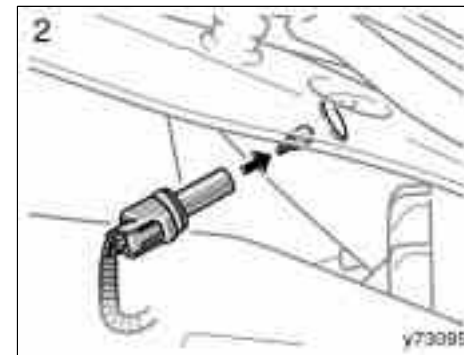
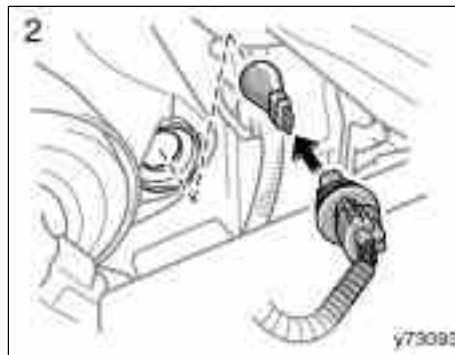
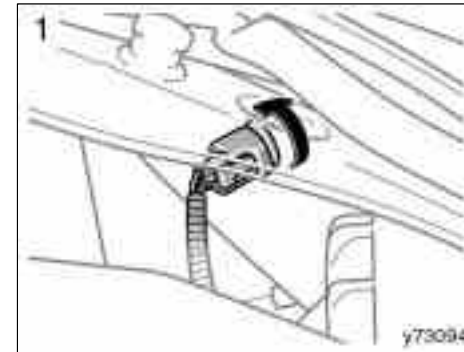

06 SIENNA_U (L/O 0603)

—Rear turn signal, stop/tail and rear side marker lights

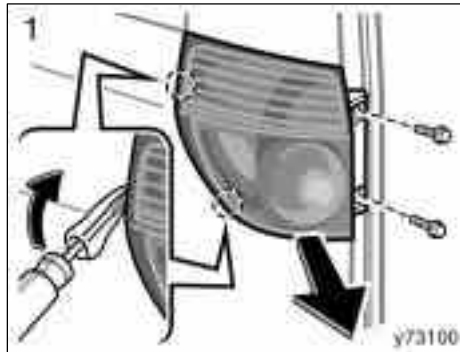

Remove the bolts. Remove the unit by pry the unit by using the flathead screwdriver with cloth.

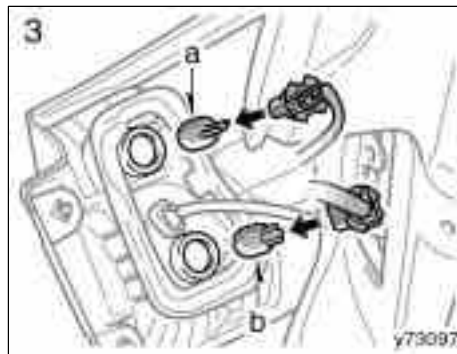
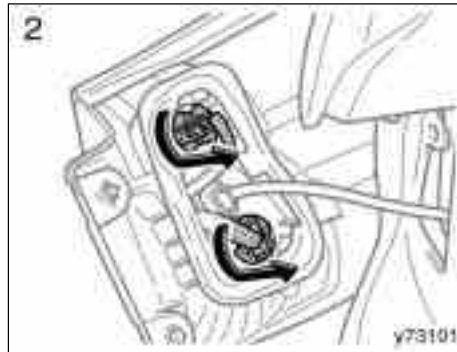

a: Rear turn signal light
b: Stop/tail and rear side marker light

—Tail and back-up lights

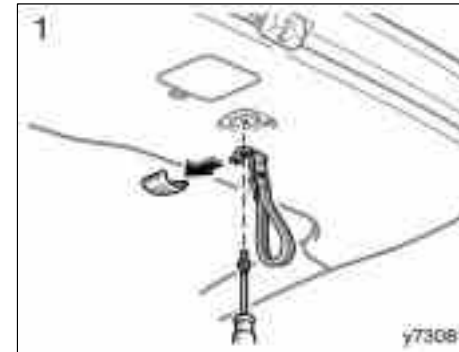

Remove the strap with a Phillips-head screwdriver.

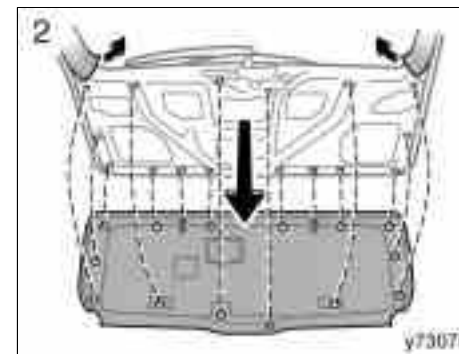

06 SIENNA_U (L/O 0603)

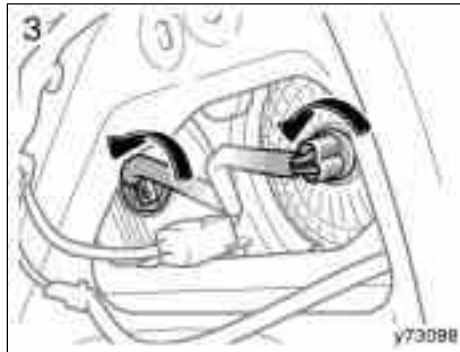

NOTICE

When installing the back door trim, be careful not to jam any wire harness and connector. Otherwise, they may be damaged.

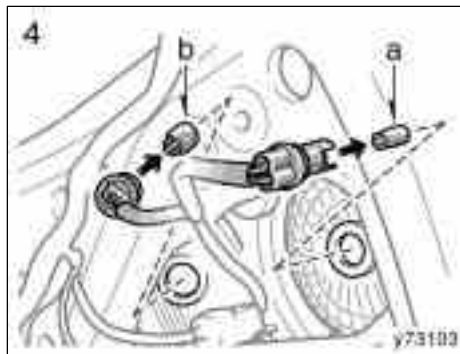

a: Tail light
b: Back-up light

—License plate lights

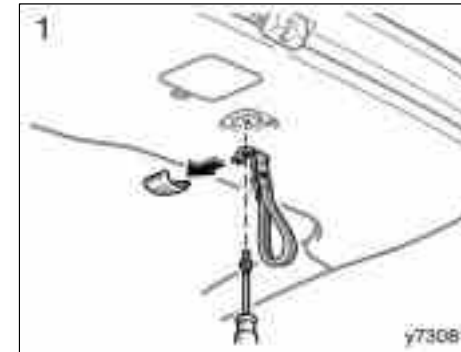

Remove the strap with a Phillips-head screwdriver.

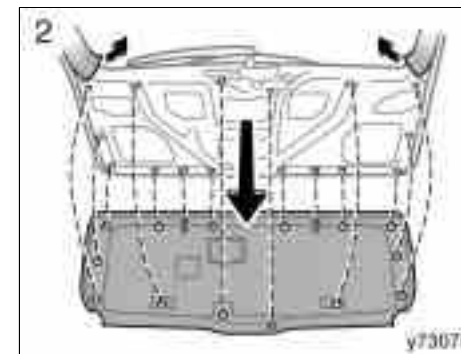

06 SIENNA_U (L/O 0603)

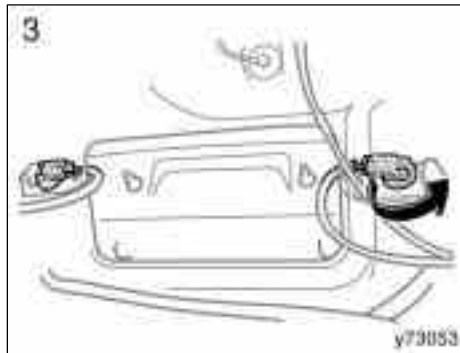

NOTICE

When installing the back door trim, be careful not to jam any wire harness and connector. Otherwise, they may be damaged.

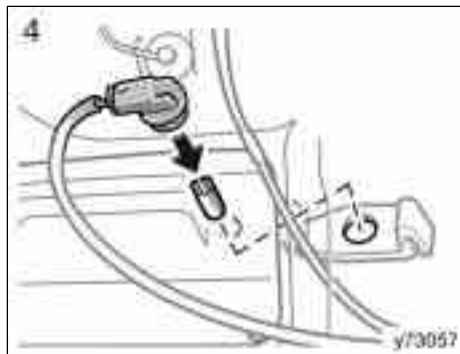

Introduction

Thank you for your purchase of the Navigation System. Please read this manual carefully to ensure proper use. Keep this manual in your vehicle at all times.

The Navigation System is one of the most technologically advanced vehicle accessories ever developed. The system receives satellite signals from the Global Positioning System (GPS) operated by the U.S. Department of Defense. Using these signals and other vehicle sensors, the system indicates your present position and assists in locating a desired destination.

The navigation system is designed to select efficient routes from your present starting location to your destination. The system is also designed to direct you to a destination that is unfamiliar to you in an efficient manner. The system uses DENSO maps. The calculated routes may not be the shortest nor the least traffic congested. Your own personal local knowledge or "short cut" may at times be faster than the calculated routes.

The navigation system's database includes about 75 Point of Interest categories to allow you to easily select destinations such as restaurants and banks. If a destination is not in the database, you can enter the street address or a major intersection close to it and the system will guide you there. The system will provide both a visual map and audio instructions. The audio instructions will announce the distance remaining and the direction to turn in approaching a fork or intersection. These voice instructions will help you keep your eyes on the road and are timed to provide enough time to allow you to maneuver, change lanes or slow down.

Please be aware that all current vehicle navigation systems have certain limitations that may affect their ability to perform properly. The accuracy of the vehicle's position depends on the satellite condition, road configuration, vehicle condition or other circumstances. For more information on the limitations of the system, refer to pages 198 through 200.

TOYOTA MOTOR CORPORATION

Important information about this manual

For safety reasons, this manual indicates items requiring particular attention with the following marks.

 CAUTION
This is a warning against anything which may cause injury to people if the warning is ignored. You are informed about what you must or must not do in order to reduce the risk of injury to yourself and others.

NOTICE
<i>This is a warning against anything which may cause damage to the vehicle or its equipment if the warning is ignored. You are informed about what you must or must not do in order to avoid or reduce the risk of damage to your vehicle and its equipment.</i>

INFORMATION
<i>This provides additional information.</i>

Safety Instruction



To use this system in the safest possible manner, follow all the safety tips shown below.

This system is intended to assist in reaching the destination and, if used properly, can do so. The driver is solely responsible for the safe operation of your vehicle and the safety of your passengers.

Do not use any feature of this system to the extent it becomes a distraction and prevents safe driving. The first priority while driving should always be the safe operation of the vehicle. While driving, be sure to observe all traffic regulations.

Prior to the actual use of this system, learn how to use it and become thoroughly familiar with it. Read the entire Navigation System Owner's Manual to make sure you understand the system. Do not allow other people to use this system until they have read and understood the instructions in this manual.

For your safety, some functions may become inoperable when driving. Unavailable touch-screen buttons are dimmed. Only when the vehicle is not moving, can the destination and route selection be done.



CAUTION

- **For safety, the driver should not operate the navigation system while he/she is driving. Insufficient attention to the road and traffic may cause an accident.**
- **While you are driving, be sure to obey the traffic regulations and maintain awareness of the road conditions. If a traffic sign on the road has been changed, route guidance may provide wrong information such as the direction of a one way street.**

While driving, listen to the voice instructions as much as possible and glance at the screen briefly and only when it is safe. However, do not totally rely on voice guidance. Use it just for reference. If the system cannot determine the current vehicle position correctly, there is a possibility of incorrect, late, or non-voice guidance.

The data in the system may occasionally be incomplete. Road conditions, including driving restrictions (no left turns, street closures, etc.) frequently change. Therefore, before following any instruction from the system, look to see whether the instruction can be done safely and legally.

This system cannot warn about such things as the safety of an area, condition of streets, and availability of emergency services. If unsure about the safety of an area, do not drive into it. **Under no circumstances is this system a substitute for the driver's personal judgement.**

Use this system only in locations where it is legal to do so. Some states/provinces may have laws prohibiting the use of video and navigation screens next to the driver.

SECTION I

BASIC FUNCTIONS

Basic information before operation

Display operation	2
Initial screen	2
Touch screen operation	4
Inputting letters and numbers/list screen operation	4
Function help	8
Map screen operation	9
Current position display	9
Screen scroll operation	9
Switching the screens	13
Map scale	15
Foot print map	16
Orientation of the map	18
Example of navigation system operation	18
Guiding the route	18
Registering home	20

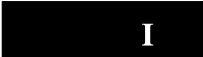

BASIC FUNCTIONS

Display operation

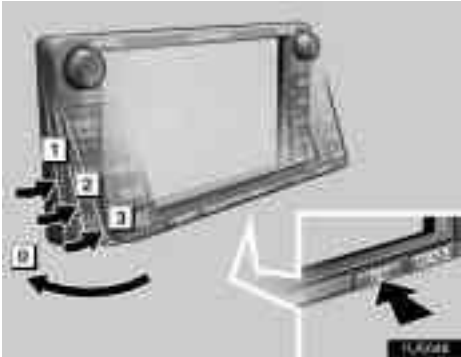

Adjustment of the angle of the display can be done by pushing the "TILT" button. Each push of the "TILT" button will tilt the display to positions **1**, **2**, **3** and then back to **0** in the reverse order.

If the ignition switch is set at OFF, the display will automatically move back to position **0**. The display will automatically resume the previous position when the ignition switch is set at ACC or ON.

CAUTION

Injury may result from placing a hand or any fingers on the display while it is moving.

NOTICE

Do not place any foreign objects on the display while it is moving. It could damage your navigation system.

INFORMATION

Under extremely cold conditions, the display may react slowly or operation sound may become louder.

Initial screen



When the ignition switch is set at ACC or ON, the initial screen will be displayed and the system will begin operating.

CAUTION

When the vehicle is stopped with the engine running, always apply the parking brake for safety.

After a few seconds, the "CAUTION" screen will be displayed.



Touch “English”, “Français” or “Español” to select a language.

When “I Agree” is touched on the screen, the map screen will be displayed.

The “CAUTION” screen will be displayed when the “INFO” button is pushed and “Language” is touched. Then select a language. (See “Select language” on page 149.)

● **Maintenance information**

This system informs about when to replace certain parts or components and shows dealer information (if registered) on the screen.

When the vehicle reaches a previously set driving distance or date specified for a scheduled maintenance check, the “Information” screen will be displayed when the navigation system is in operation.



To disable this screen, touch “Do Not Display This Message Again.”. This screen goes off if the screen is not operated for several seconds.

To prevent this information screen from being displayed again, touch “Do Not Display This Message Again.”.

To register “Maintenance information”, see “Maintenance information” on page 92.

● **Memo information**

This system notifies about a memo entry. At the specified date, the memo information will be displayed when the navigation system is in operation. The memo information screen will be displayed every time the system is turned on.



The memo of the current date can be viewed by touching “Memo”. (See “ — Editing a memo” on page 98.)

To disable this screen, touch “Do Not Display This Message Again.”. This screen goes off if the screen is not operated for several seconds.

To prevent this information screen from being displayed again, touch “Do Not Display This Message Again.”.

To register “Memo information”, see “Calendar with memo” on page 95.



BASIC FUNCTIONS

Touch screen operation

This system is operated mainly by the touch-screen buttons on the screen.

To prevent damage to the screen, lightly touch the touch-screen buttons on the screen with the finger. When a touch-screen button on the screen is touched, a beep sounds.

Do not use objects other than the finger to touch the screen.

- *Under extremely cold conditions, the map may not be displayed and the data input by a user may be deleted. Also, the touch-screen buttons may be harder than usual to depress.*

Inputting letters and numbers/list screen operation

When searching for an address or a name, or entering a memo, letters and numbers can be input via the touch screen.

INFORMATION

Key layout can be changed. (See “● Input key layout” on page 82.)

INFORMATION

- *If the system does not respond to a touch on a touch-screen button, move the finger away from the screen and then touch it again.*
- *Dimmed touch-screen buttons cannot be operated.*
- *Wipe off fingerprints on the surface of the display using a glass cleaning cloth.*
- *The displayed image may become darker and moving images may be slightly distorted when the display is cold.*

● **To input letters**

To display the alphabet keys, touch “A-Z” or “A-Y”.





Enter letters by touching the alphabet keys directly.

- : Touching this touch-screen button erases one letter. By holding this touch-screen button, letters will continue to be erase.

On certain letter entry screens, letters can be entered in upper or lower case.





- : To enter in lower case.
- : To enter in upper case.

● **To input numerals and symbols**

To display the number keys and symbol keys, touch “0-9”.



Enter numerals and symbols by touching the number keys and symbol keys directly.

- : Touching this touch-screen button erases one letter. By holding this touch-screen button, letters will continue to be erase.
- : Touching this touch-screen button displays other symbols.



BASIC FUNCTIONS

- **To display the list**



To search for an address or a name, touch “List”. Matching items from the database are listed even if the entered address or name is incomplete.

If the number of matches is four or less, the list is displayed without touching “List”.



INFORMATION

*The number of matching items is shown to the right side of the screen. If the number of matching items is more than 9,999, the system displays “****” on the screen.*

- **List screen operation**

When a list is displayed, use the appropriate touch-screen button to scroll through the list.



① To shift to the next or previous page.



② To scroll up or down one item at a time.



This expresses a displayed screen position.

- ▶ If ▶ appears to the right of the item name, the complete name is too long for the display. Touch ▶ to scroll to the end of the name.
- ▶ Touch ◀ to scroll to the beginning of the name.

• **Sorting**

The order of a list displayed on the screen can be rearranged.

TYPE A



1. Touch "Sort by".

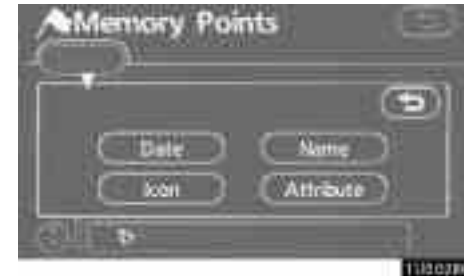

2. Select the desired sorting criteria.

Sorting criteria are as follows:

"Distance": To sort in the order of distance from your current location.

"Date": To sort in the order of the date.

"Category": To sort in the order of the category.

"Icon": To sort in the order of the icons.

"Name": To sort in order by name.

"Attribute": To sort in order by attribute.



BASIC FUNCTIONS

TYPE B



“Dist. Sort”: To sort in the order of distance from the current vehicle location. The distance from current vehicle position up to the destination is displayed to the right of the name.

“Name Sort”: To sort in alphabetical order by name.



Function help

Explanations for the functions of the “Destination”, “Setup”, and “Menu” screens can be viewed.



Touch “?”.



- : To view the previous page.
- : To view the next page.
- : To return to the previous screen.

Map screen operation — — Current position display

When starting the navigation system, the current position is displayed first.

This screen displays the current vehicle position and a map of the surrounding local area.



The current vehicle position mark (1) appears in the center or bottom center of the map screen.

A street name will appear on the bottom of the screen, depending on the scale of the map (2).

You can return to this map screen that shows your current position at any time from any screen by pushing the “MAP/VOICE” button.

While driving, the current vehicle position mark is fixed on the screen and the map moves.

The current position is automatically set as the vehicle receives signals from the GPS (Global Positioning System). If the current position is not correct, it is automatically corrected after the vehicle receives signals from the GPS.

INFORMATION

- *After battery disconnection, or on a new vehicle, the current position may not be correct. As soon as the system receives signals from the GPS, the correct current position is displayed.*
- *To correct the current position manually, see “• Current position/tire change calibration” on page 87.*

— Screen scroll operation (one-touch scroll)

When any point on the map is touched, that point moves to the center of the screen and is shown by the cursor mark (1).



Use the scroll feature to move the desired point to the center of the screen for looking at a point on the map that is different from the current position of the vehicle.

If the finger is continuously held on the screen, the map will continue scrolling in that direction until the finger is removed.

A street name, city name, etc. of the touched point will be shown, depending on the scale of the map (2). Distance from the current position to the touched point will also be shown (3).



BASIC FUNCTIONS

After the screen is scrolled, the map remains centered at the selected location until another function is activated. The current vehicle position mark will continue to move along your actual route and may move off the screen. When the **"MAP/VOICE"** button is pushed, the current vehicle position mark returns to the center of the screen and the map moves as the vehicle proceeds along the designated route.

INFORMATION

*When the one-touch scroll feature is used, the current vehicle position mark may disappear from the screen. Move the map with a one-touch scroll again or push the **"MAP/VOICE"** button to return to the current vehicle position map location display.*



- **To set the cursor position as a destination**

A specific point on the map can be set as a destination using the one-touch scroll function.



Touch "Enter" .

The screen changes and displays the map location of the selected destination and the route preference. (See "Starting route guidance" on page 43.)

If there is already a set destination, **"Add to **" or **"Replace **" are displayed.

"Add to ": To add a destination.

"Replace ": To delete the existing destinations and set a new one.

- **To register the cursor position as a memory point**

Memory point registration enables easy access to a specific point.



Touch "Mark".

When you touch **"Mark"**, the following screen appears for a few seconds, and then the map screen returns.



The registered point is shown by  on the map.

To change the icon or name, etc., see “ — Editing memory points” on page 71.

Up to 106 memory points can be registered. If there is an attempt to register more than 106, a message appears for confirmation.



- To see information about the icon where the cursor is set



To display information about an icon, set the cursor on it.

POI INFORMATION

When the cursor is set on a POI icon, the name and “Info.” are displayed on the top of the screen.



Touch “Info.”.





Information such as the name, address, and phone number are displayed.

If “Enter ” is touched, the position of the cursor is set as a destination.



BASIC FUNCTIONS

If there is already a set destination, “**Add to** ” and “**Replace** ” are displayed.

“**Add to** ”: To add a destination.

“**Replace** ”: To delete the existing destinations and set a new one.

To register this POI as a memory point, touch “**Mark**”. (See page 70.)

If  is touched, the registered telephone number can be called.

INFORMATION

The desired Point of Interest can be displayed on the map screen. (See “ — Display POI icons” on page 58.)

MEMORY POINT INFORMATION

When the cursor is set on a memory point icon, the name and “**Info.**” are displayed on the top of the screen.





Touch “**Info.**”.



Information such as the name, address, and phone number are displayed.

If “**Enter** ” is touched, the position of the cursor is set as a destination.

If there is already a set destination, “**Add to** ” and “**Replace** ” are displayed.

“**Add to** ”: To add a destination.

“**Replace** ”: To delete the existing destinations and set a new one.

To edit a memory point, touch “**Edit**”. (See “ — Editing memory points” on page 71.)

To delete a memory point, touch “**Delete**”.

If  is touched, the registered telephone number can be called.

DESTINATION INFORMATION

When the cursor is set on a destination icon, the name and **“Info.”** are displayed on the top of the screen.



Touch **“Info.”**.



Information such as the name, address, and phone number are displayed.

To delete a destination, touch **“Delete”**.

If  is touched, the registered telephone number can be called.

— Switching the screens

Any one of the screen configurations can be selected.



1. Touch this touch-screen button to display the following screen.









2. To select the desired screen configuration, touch one of the following touch-screen buttons.



BASIC FUNCTIONS

Depending on the conditions, certain screen configuration buttons cannot be selected.

- : To display the single map screen. (See page 14.)
- : To display the dual map screen. (See page 14.)
- : To display the compass mode screen. (See page 15.)
- : To display the turn list screen. (See page 50.)
- : To display the arrow screen. (See page 50.)
- : To display the freeway information screen. (See page 48.)
- : To display the intersection guidance screen or the guidance screen on the freeway. (See page 49.)

● Screen configurations

SINGLE MAP

This is a regular map screen.

While on a different screen, touching  will display the single map screen.



The screen shows the single map.

DUAL MAP

A map can be displayed split in two.

While on a different screen, touching  will display the dual map screen.

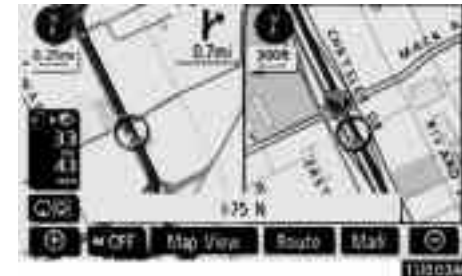

The screen shows the dual map. The map on the left is the main map.

The right side map can be edited by touching any specific point on the right side map.



This screen can perform the following procedures:

1. Changing the map scale
2. Displaying the POI icon
3. Changing the orientation of the map

Touch “OK” when you complete editing.

The screen returns to the dual map screen.

COMPASS MODE

Current vehicle position is indicated with a compass, not with a map.

While on a different screen, touching  will display the compass mode screen.



Information about the destination and current position, as well as a compass, is displayed on the screen.



The destination mark is displayed in the direction of the destination. When driving, refer to the longitude and latitude coordinates and the compass, to make sure that your vehicle is headed in the direction of the destination.



INFORMATION

When the vehicle goes out of the disc area, the guidance screen changes into compass mode.

— Map scale



Touch  or  to change the scale of the map display. The scale bar and indicator at the bottom of the screen indicates the map scale menu. The scale range is 150 feet (50 m) to 250 miles (400 km).

Touch  or  until the scale bar changes normally. By continuing to touch the touch-screen button, the scale bar changes smoothly.



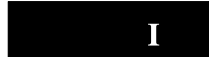

The scale of the map display can be changed by touching the scale bar directly. It is not available while driving.

The map scale is displayed under the north-up symbol or heading-up symbol at the top left of the screen.



BASIC FUNCTIONS

INFORMATION

When the map scale is at the maximum range of 250 miles (400 km),  is not shown. When the map scale is at the minimum range of 150 feet (50 m),  is not shown. However, in the area where the foot print map is contained, when the map scale is changed to 150 feet (50 m),  changes to .

— Foot print map

For the area which is covered by the foot print map (Some areas in the following cities; Detroit, Chicago, N.Y., L.A), you can switch to the foot print map on a scale of 75 feet (25 m).

- To switch to the foot print map

 changes into  when the map is scaled down to 150 feet (50 m).



To display the foot print map, touch .

To delete the foot print map display, touch



INFORMATION

- *If the map or the current position is moved to the area which is not covered by the foot print map, the screen scale automatically changes to 150 feet (50 m).*
- *On the foot print map, a one way street is displayed by .*
- *It is not possible to perform scrolling on the foot print map (one-touch scroll) while driving.*

● **To display building information**

Information is available only for buildings for which information is recorded on the map disc.



1. Touch "Info." while the foot print map is displayed.

If the map is displayed by a split screen, the map turned into a single map display.



2. Using an eight-direction arrow, move the cursor to the position of the building to display building information.

3. Touch "Building Info."

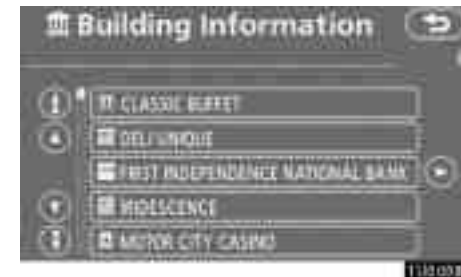

Details of POIs in some buildings may be displayed.

For detailed POI information, touch the building name. You can see details of the selected POIs.

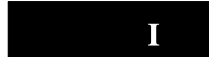

BASIC FUNCTIONS

— Orientation of the map



► North-up screen



► Heading-up screen

The orientation of the map can be changed from north-up to heading-up by touching the orientation symbol at the top left of the screen.

📍 North-up symbol

Regardless of the direction of vehicle travel, North is always up.

📍 Heading-up symbol

The direction of vehicle travel is always up. A red arrow indicates North.

Example of navigation system operation —

— Guiding the route

Guidance to a destination occurs by specifying the destination using the “POI Name”.

1. Push the “DEST” button.



2. Touch “POI Name”.

INFORMATION

There are 13 different methods to search destinations. (See “Destination search” on page 24.)



3. Enter the name of the destination.

Every touch on a letter key narrows the selection.

Letters that cannot be selected in the database are dimmed out.

When there are four or fewer database items, these items are displayed in a list.

Even if the entered name is incomplete, touching **“List”** displays the list.



4. Select the destination from the displayed list.



5. Touch “Enter”.

The system starts route search and displays recommended routes.



BASIC FUNCTIONS



6. Touch "Guide".

Route guidance starts.

Guidance is done by both the screen and voice. (See "Route guidance screen" and "Typical voice guidance prompts" on pages 48 and 50.)

INFORMATION

It is possible to change the route. (See "Starting route guidance" on page 43.)

— Registering home

The home button on the "Destination" screen can be used if your home has been registered. (See "— Destination search by Home" on page 26.)

1. Push the "MENU" button.



2. Touch "My Places".



3. Touch "Register".



4. Touch "Address".



5. Enter the house number.



6. Enter the street name.

Every touch on a letter key narrows the selection.

Letters that cannot be selected in the database are dimmed out.

When there are four or fewer database items, these items are displayed in a list.

Even if the entered name is incomplete, touching "List" displays the list.

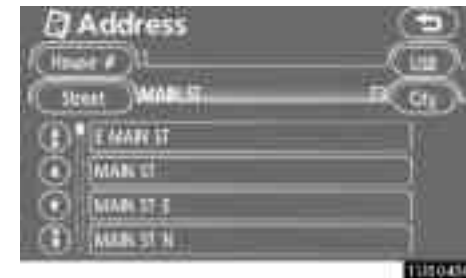

7. Select the street name from the displayed list.



BASIC FUNCTIONS



8. Touch “Enter”.

Registration of home is complete and the “Memory Point” screen is displayed.



Registered “Home” information will be displayed.

The icon, quick access, name, location, and phone number can be changed. (See “ — Editing memory points” on page 71.)

SECTION II

DESTINATION SEARCH

Destination search

Destination search	24
Selecting the search area	24
Destination search by Home	26
Destination search by Quick access	27
Destination search by "Address"	27
Destination search by "POI Name"	31
Destination search by "POI Category"	35
Destination search by "Emergency"	38
Destination search by "Memory"	39
Destination search by "Previous"	39
Destination search by "Map"	40
Destination search by "Intersection"	40
Destination search by "Freeway Ent./Exit"	41
Destination search by "Coordinates"	42
Destination search by "Phone #"	42
Starting route guidance	43



DESTINATION SEARCH

Destination search —

Push the “DEST” button and the “Destination” screen appears.



You can use one of 13 different methods to search your destination. (See pages 26 through 43.)

INFORMATION

When searching the destination, the response to the touch-screen button may be slow.

— Selecting the search area

SELECTING THE SEARCH AREA ON THE DESTINATION SCREEN



1. Touch “Change” on the “Destination” screen to display a map of the United States and Canada divided into 11 areas. (For map database information and updates, see “Map database information and updates” on page 200.)



2. Touch one of “US1” through “CAN” to select a search area.
3. Touch “OK” and the “Destination” screen returns.

SELECTING THE SEARCH AREA ON THE INPUT SCREEN

Change the search area in order to set a destination from a different area by using “Address”, “POI Name”, “Freeway Ent./Exit”, or “Intersection”.



1. Touch the search area button like “US9” on the input screen to display a map of the United States and Canada divided into 11 areas. (For map database information and updates, see “Map database information and updates” on page 200.)



2. Touch one of “US1” through “CAN” to select a search area.
3. Touch “OK” and the previous screen returns.

U.S.A.	
Button	States included in the search area
“US1”	Idaho Oregon Washington
“US2”	California Nevada
“US3”	Arizona Colorado Montana New Mexico Utah Wyoming
“US4”	Iowa Kansas Minnesota Missouri North Dakota Nebraska South Dakota
“US5”	Oklahoma Texas
“US6”	Illinois Indiana Kentucky Michigan Ohio Wisconsin



DESTINATION SEARCH

"US7"	Arkansas Alabama Louisiana Mississippi Tennessee
"US8"	Connecticut Massachusetts Maine New Hampshire New Jersey New York Rhode Island Vermont
"US9"	Washington, D.C. Delaware Maryland New Jersey Pennsylvania Virginia West Virginia
"US10"	Florida Georgia North Carolina South Carolina

Canada	
Button	Provinces and regions included in the search area
"CAN"	All provinces and regions in Canada included in this button.

— Destination search by Home



Touch the home touch-screen button on the "Destination" screen.

The screen changes and displays the map location for home and the route preference. (See "Starting route guidance" on page 43.)

To use this function, it is necessary to set "Home" for the memory point. (To register "Home", see page 75.)

INFORMATION

Guidance starts from the current vehicle position to your home if "Enter" is touched even while driving.

— Destination search by Quick access



Touch any of the quick access touch-screen buttons on the “Destination” screen.

The screen changes and displays the map location of the quick access point and the route preference. (See “Starting route guidance” on page 43.)

To use this function, it is necessary to set “Quick access” for each memory point. (To register “Quick Access”, see page 73.)

INFORMATION

Guidance starts from the current vehicle position to the quick access point if “Enter” is touched even while driving.

— Destination search by “Address”

There are 2 ways to input a destination by address.

Touch “Address” on the “Destination” screen.



(a) Inputting a house number and a street name



1. Touch numerals directly on the screen to input a house number.

After inputting a house number, touch “OK” to display the screen for inputting a street name.

It is possible to input a street name first. Touch “Street” to display the screen for inputting a street name.



DESTINATION SEARCH



2. Input the street name.

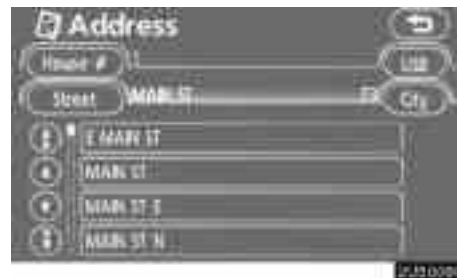

3. When the desired street name is found, touch the corresponding touch-screen button.

The screen changes and displays the map location of the selected destination and the route preference. (See “Starting route guidance” on page 43.)

If the same address exists in more than one city, the current screen changes to the city list screen.



4. Select or enter the desired city.

“Input Name”: To narrow down the listed items by inputting the city name.



If inputting a street name first, the screen changes. The house number can then be input.

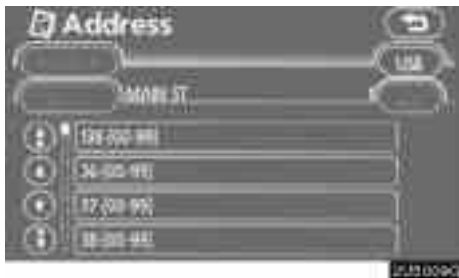

If the above screen appears, an address range on the screen can be selected.



If the same address exists in more than one city, the current screen changes to the city list screen.

(b) Selecting a city to search



Touch "City".



DESTINATION SEARCH



To search by city, the following three methods are possible.

1. Input the city name
2. Select from the nearest 5 cities
3. Select from the last 5 cities

INFORMATION

- ***To change the search area, touch “Search Area”.***
- ***To cancel the city setting, touch “Any City”.***

INPUTTING THE CITY NAME

1. Touch “Input City Name”.



2. Input a city name.



3. Touch the touch-screen button of the desired city name from the displayed list.

“Map”: To display the selected destination and the route preference. (See “Starting route guidance” on page 43.)

The current screen changes to the screen for inputting a house number or a street name. (See “(a) Inputting a house number and a street name” on page 27.)

SELECTING FROM THE NEAREST 5 CITIES

1. Touch “Nearest 5 Cities”.



2. Touch the touch-screen button of the desired city name from the displayed list.

The current screen changes to the screen for inputting a house number or a street name. (See “(a) Inputting a house number and a street name” on page 27.)

SELECTING FROM THE LAST 5 CITIES



- Touch the touch-screen button of the desired city name.

If the navigation has not be used, no cities will be displayed on the screen.

The current screen changes to the screen for inputting a house number or a street name. (See “(a) Inputting a house number and a street name” on page 27.)

— Destination search by “POI Name”

1. Touch “POI Name” on the “Destination” screen.



2. Input the name of the Point of Interest.



DESTINATION SEARCH



3. Touch the touch-screen button of the desired destination.

The screen changes and displays the map location of the selected destination and the route preference. (See “Starting route guidance” on page 43.)

When inputting the name of a specific Point of Interest, and there are two or more sites with the same name, the list screen is displayed.

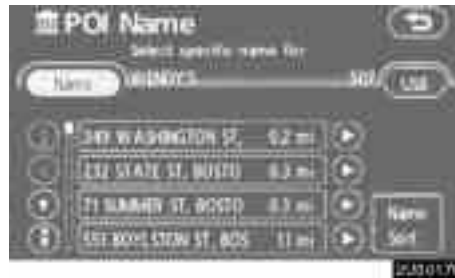

Touch the touch-screen button of the desired destination.

If the same name exists in more than one city, a search can be performed more easily with “City” and “Category”. (See “(a) Selecting a city to search” on page 32 and “(b) Selecting from the categories” on page 34.)

INFORMATION

The desired Point of Interest can be displayed on the map screen. (See “ — Display POI icons” on page 58.)

(a) Selecting a city to search



Touch “City”.



INPUTTING THE CITY NAME

1. Touch "Input City Name".



2. Input the city name.



3. Touch the touch-screen button of the desired city name from the displayed list.

SELECTING FROM THE NEAREST 5 CITIES

1. Touch "Nearest 5 Cities".



2. Touch the touch-screen button of the desired city name.

To search by city, the following three methods are possible.

1. Input the city name
2. Select from the nearest 5 cities
3. Select from the last 5 cities

INFORMATION

- To change the search area, touch "Search Area".
- To cancel the city setting, touch "Any City".



DESTINATION SEARCH

SELECTING FROM THE LAST 5 CITIES



Touch the touch-screen button of the desired city name.

If the navigation has not been used, no cities will be displayed on the screen.

(b) Selecting from the categories



Touch "Category".



If the desired POI category is on the screen, touch the name to display a detailed list of the POI category.

If the desired POI category is not on the screen, touch "List All Categories" to list all POI categories.



When the desired category is touched, the POI name list screen is displayed.

— Destination search by “POI Category”

The destination can be set by selecting the search point and the POI category.

Touch “POI Category” on the “Destination” screen.



Set the search point by the following method:

1. Input the city center
2. Set the current position as the search point
3. Set the search point via the map screen
4. Set the search point from any destination

It is possible to display the names of POIs located within approximately 20 miles (32 km) from the selected search point.

INPUTTING THE CITY CENTER

1. Touch “Input City Center”.



2. Input the city center name.



3. Touch the touch-screen button of the desired city center name.



When an arrow facing the desired point is touched, the map scrolls in that direction. Releasing the finger from the arrow will stop the scrolling

4. Touch “Enter”.

The search point is set and the “POI Category” screen will be displayed.



DESTINATION SEARCH

SETTING THE CURRENT POSITION AS THE SEARCH POINT

Touch “Current Position”.

The search point is set at the current position, and the “POI Category” screen will be displayed.

SETTING THE SEARCH POINT VIA THE MAP SCREEN

1. Touch “Map”.

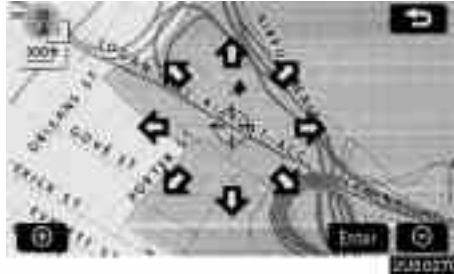

When an arrow facing the desired point is touched, the map scrolls in that direction. Releasing the finger from the arrow will stop the scrolling

2. Touch “Enter”.

The search point is set and the “POI Category” screen will be displayed.

SETTING THE SEARCH POINT FROM DESTINATIONS

1. Touch the destination buttons at the bottom of the screen.



When an arrow facing the desired point is touched, the map scrolls in that direction. Releasing the finger from the arrow will stop the scrolling

2. Touch “Enter”.

The search point is set and the “POI Category” screen will be displayed.

● **To search POIs near the search point**

When the search point is set, the “POI Category” screen will be displayed.



Select the desired POI categories.

“**List**”: If the desired POI categories have already been selected, a list of POI will be displayed from among the selected categories.

The selected category icon appears on the top left of the screen.

If the desired POI category is not on the screen, touch “**List All Categories**” to list all POI categories.



Select the desired POI categories from the list and touch “OK”.

The selected category icon appears on the top left of the screen.



“**Select Category**”: To return to the POI category selection screen.

“**Show List**”: To display the list of POIs in the selected categories.



DESTINATION SEARCH



By touching the touch-screen button of the desired item, the screen changes and displays the map location of the selected destination and the route preference. (See “Starting route guidance” on page 43.)

“On Route”: When the indicator is illuminated by touching this touch-screen button, the list of the items searched along the route is displayed.

— Destination search by “Emergency”

1. Touching “Emergency” on the “Destination” screen.

The display changes to a screen to select police stations, dealers, hospitals or fire stations. While driving, only nearby police stations, dealers, hospitals, or fire stations are shown. The current position is shown with an address, and the latitude and the longitude at the top of the screen.



2. Touch the desired emergency category.

The selected emergency category list is displayed.



3. Touch the touch-screen button of the desired destination.

The screen changes and displays the map location of the selected destination and the route preference. (See “Starting route guidance” on page 43.)

INFORMATION

The navigation system does not guide in areas where route guidance is unavailable. (See page 199.)

— Destination search by “Memory”

1. Touch “Memory” on the “Destination” screen.

A list of registered memory points is displayed. (To register or edit memory points, see “My places” on page 69.)



2. Touch the touch-screen button of your desired memory point.

The screen changes and displays the map location of the selected destination and the route preference. (See “Starting route guidance” on page 43.)

— Destination search by “Previous”

1. Touch “Previous” on the “Destination” screen.



The previous starting point and up to 100 previously set destinations are displayed on the screen.

2. Touch the touch-screen button of the desired destination.

The screen changes and displays the map location of the selected destination and the route preference. (See “Starting route guidance” on page 43.)

INFORMATION

The list of previous destinations can be deleted while the vehicle is stopped, if these destinations are no longer necessary. (See “— Deleting previous points” on page 80.)



DESTINATION SEARCH

— Destination search by “Map”

Touch “Map” on the “Destination” screen.



The screen changes and displays the map location that was previously displayed just before the destination input operation and the route preference. (See “Starting route guidance” on page 43.)

INFORMATION

Guidance starts if “Enter” is touched even while driving. However, the cursor cannot be moved.

— Destination search by “Intersection”

1. Touch “Intersection” on the “Destination” screen.



2. **Input the name of the two intersecting streets which are located near the destination to be set.**

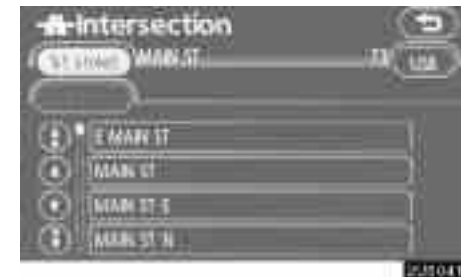

3. **Touch the touch-screen button of the desired item.**

After inputting the two intersecting streets, the screen changes and displays the map location of the selected destination and the route preference. (See “Starting route guidance” on page 43.)

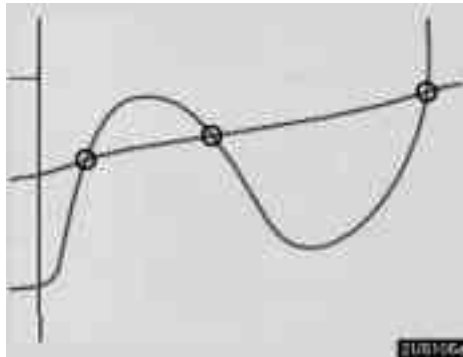

If the same two streets cross at more than one intersection, the screen changes and displays the menu to select the city name where the streets intersect. Select the city, and the map location of the selected destination and the route preference. (See “Starting route guidance” on page 43.)

— Destination search by “Freeway Ent./Exit”

1. To input a freeway entrance or exit, touch “Freeway Ent./Exit” on the “Destination” screen.



Be sure to use the complete name of the freeway or highway, including the hyphen, when entering the destination. Freeways and interstates use an “I” (I-405). US highways use the state designation before the number (CA-118).

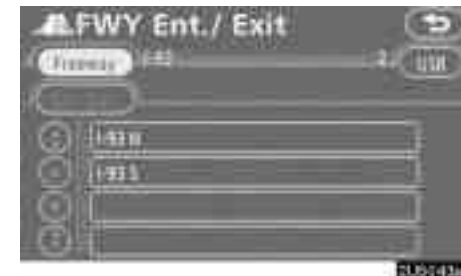

2. Select the desired freeway by touching the touch-screen button.



3. Either a freeway “Entrance” or “Exit” can be selected.



DESTINATION SEARCH



4. Touch the touch-screen button of the desired entrance or exit name.

The screen changes and displays the map location of the selected destination and the route preference. (See "Starting route guidance" on page 43.)

"Input Name": An applicable list is displayed by touching this touch-screen button and inputting the name.

— Destination search by "Coordinates"

1. Touch "Coordinates" on the "Destination" screen.



2. Input the latitude and the longitude.

3. When the input is finished, touch "OK".

By touching the touch-screen button of the desired point, the screen changes and displays the map location of the selected destination and the route preference. (See "Starting route guidance" on page 43.)

— Destination search by "Phone #"

1. Touch "Phone #" on the "Destination" screen.



2. Input a telephone number.

3. After inputting a telephone number, touch "OK".

The screen changes and displays the map location of the selected destination and the road preference. (See "Starting route guidance" on page 43.)

If there is more than one site having the same number, the following screen will be displayed.

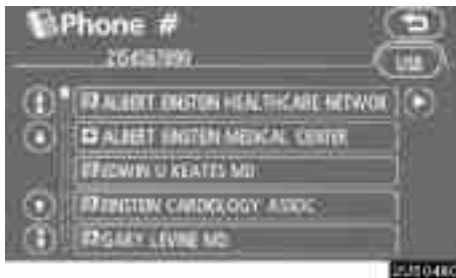

Starting route guidance

After inputting the destination, the screen changes and displays the map location of the selected destination and the route preference.

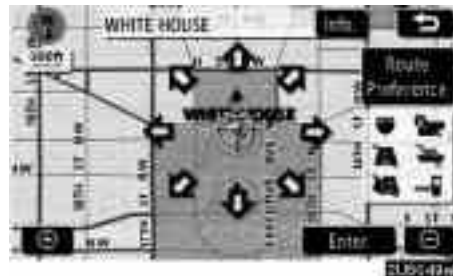

1. When an arrow facing the desired point is touched, the map scrolls in that direction.

Releasing the finger from the arrow will stop the scrolling.

2. Touch "Enter".

The system starts route search and displays recommended routes.

If there is already a set destination, "Add to" and "Replace" are displayed.

"Add to": To add a destination.

"Replace": To delete the existing destinations and set a new one.

"Route Preference": To change the route preference. (See page 45.)

"Info.": If this touch-screen button is displayed on the top of the screen, touch the switch to view items such as name, address, and phone number.

INFORMATION

- If there is no match for the telephone number inputted, a list of identical numbers with different area codes will be displayed.
- To set a memory point as a destination using the phone number, the number must be registered previously. (See page 75.)



DESTINATION SEARCH



- 1 Current position
- 2 Destination point
- 3 Type of the route and the distance
- 4 Distance of the entire route

3. To start guidance, touch “Guide”.

“3 Routes”: To select the desired route from three possible routes. (See page 45.)

“Route”: To change the route. (See pages 53 and 55.)

INFORMATION

- *Guidance can be suspended or resumed. (See “Suspending and resuming guidance” on page 66.)*
- *If “Guide” is touched until a beep sounds, Demo mode will start. Push the “MAP/VOICE” button to finish Demo mode.*
- *The route for returning may not be the same as that for going.*
- *The route guidance to the destination may not be the shortest route nor a route without traffic congestion.*
- *Route guidance may not be available if there is no road data for the specified location.*
- *When setting the destination on a map with a scale larger than 0.5 miles (800 m), the map scale changes to 0.5 miles (800 m) automatically. Set the destination again.*
- *If a destination is entered, the road nearest to the point you selected is set as the destination.*

CAUTION

Be sure to obey traffic regulations and keep road conditions in mind while driving. If a traffic sign on the road has been changed, the route guidance may provide wrong information.

- To change the route before starting guidance

ROUTE PREFERENCE

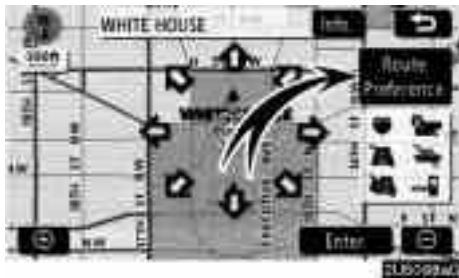

1. You can change route preference by touching "Route Preference".



2. Turn the indicator on or off by touching the touch-screen button.

When searching for a route, the system functions to avoid routes where the indicator is dimmed.

3. After choosing conditions, touch "OK".

INFORMATION
<ul style="list-style-type: none"> ● Even if the "Allow Freeway" indicator is dimmed, the route cannot avoid including a freeway in some cases. ● If the calculated route includes a trip by ferry, the route guidance shows a sea route. After you travel by ferry, the current vehicle position may be incorrect. Upon reception of GPS signals, it is automatically corrected.

3 ROUTES SELECTION

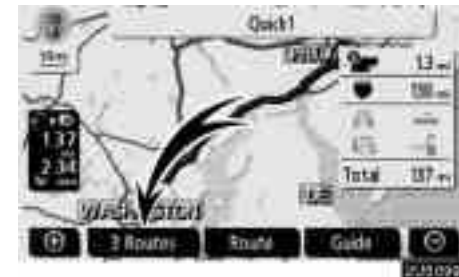

1. To select the desired route from three routes, touch "3 Routes".



2. Touch "Quick1", "Quick2" or "Short" to select the desired route.

"Quick1": Recommended route. This route is indicated by an orange line.

"Quick2": Other route. This route is indicated by a purple line.



DESTINATION SEARCH

“Short”: A route by which you can reach the destination in the shortest distance.
This route is indicated by a green line.

“Info.”: To display the following information about each of the 3 routes.



- 1 Time necessary for the entire trip
- 2 Distance of the entire trip
- 3 Toll road
- 4 Freeway
- 5 Ferry

SECTION III

ROUTE GUIDANCE

Route guidance

Route guidance screen	48
Typical voice guidance prompts	50
Distance and time to destination	52
Setting and deleting destination	53
Adding destinations	53
Reordering destinations	54
Deleting destination	55
Setting route	55
Search condition	55
Detour setting	56
Route preference	57
Starting route from adjacent road	58
Map view	58
Display POI icons	58
Route overview	61
Route preview	62
Route trace	63



ROUTE GUIDANCE

Route guidance screen

During route guidance, various types of guidance screens can be displayed depending on conditions.

- **Screen layout**



- 1 Distance to the next turn and the arrow indicating turning direction
- 2 Current street name
- 3 Distance and travel/arrival time to the destination
- 4 Current position
- 5 Guidance route

INFORMATION

- *If the vehicle goes off the guidance route, the route is searched again.*
- *For some areas, the roads have not been completely digitized in our database. For this reason, the route guidance may select road that should not be traveled on.*

- **During freeway driving**

During freeway driving, the freeway information screen will be displayed.

This screen displays the distance to the next junction and exit, or POIs in the vicinity of the freeway exit.



- 1 Current position
 - 2 Points of Interest that are close to a freeway exit.
 - 3 Exit number and junction name
 - 4 Distance from the current position to the exit or junction
 - 5 Current street name
- ①: To display the selected map of the exit vicinity.

- ▲: To scroll for farther junctions or exits.
- ▼: To scroll for closer junctions or exits.
- 📍: To scroll for the closest three junctions or exits.

- **When approaching a freeway entrance, exit or junction**

When the vehicle approaches an entrance, exit, or junction, the guidance screen for the freeway will be displayed.



- 1 Road/area name
- 2 Distance from the current position to the entrance, exit, or junction
- 3 Current position

“OFF”: The guidance screen on freeway disappears and the map screen appears.

When touching  or pushing the “MAP/VOICE” button, the guidance screen on freeway reappears.

- **When approaching an intersection**

When the vehicle approaches an intersection, the intersection guidance screen will be displayed.

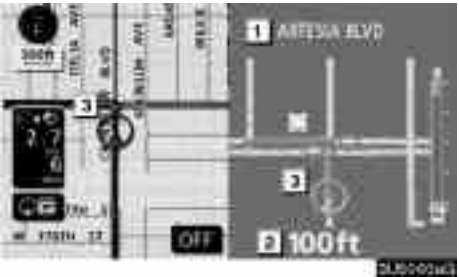

- 1 Next street name
- 2 Distance to the intersection
- 3 Current position

“OFF”: The intersection guidance screen disappears and the map screen appears.

When touching  or pushing the “MAP/VOICE” button, the intersection guidance screen reappears.



ROUTE GUIDANCE

- Other screens

TURN LIST SCREEN

On this screen, the list of turns on the guidance route can be viewed.

Touching  during guidance displays the turn list.

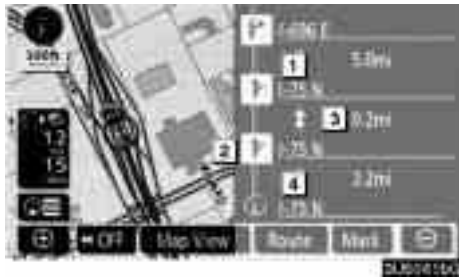

- 1 Next street name or destination name
- 2 Turn direction
- 3 Distance to the next turn
- 4 Current street name

ARROW SCREEN

On this screen, information about next turns on the guidance route can be viewed.

Touching  during guidance displays the arrow screen.





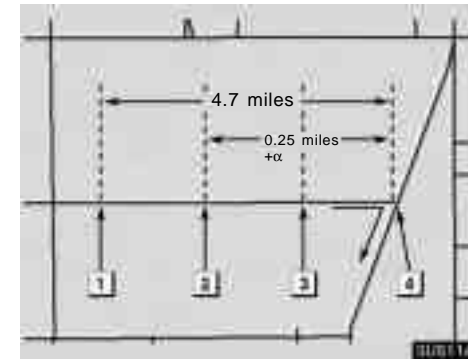

- 1 Exit number, street name containing number or next street name
- 2 Turn direction
- 3 Distance to the next turn
- 4 Current street name

Typical voice guidance prompts

The voice guidance provides various messages as you approach an intersection, or other point where you need to maneuver the vehicle.



- 1  "Proceed about 5 miles."
- 2  "In a quarter of a mile, right turn."
- 3  "Right turn."
- 4  (Beep sound only)

INFORMATION

On freeways, interstates or other highways with higher speed limits, the voice guidance will be made at earlier points than on city streets in order to allow time to maneuver.

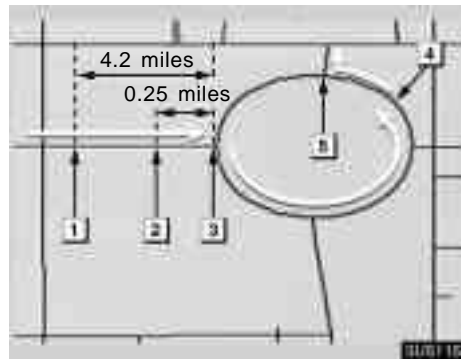

- 1 "Proceed about 4 miles to the traffic circle."
- 2 "In a quarter of a mile, traffic circle ahead, and then 3rd exit ahead."
- 3 "The 3rd exit ahead."
- 4 "The exit ahead."
- 5 (Beep sound only)

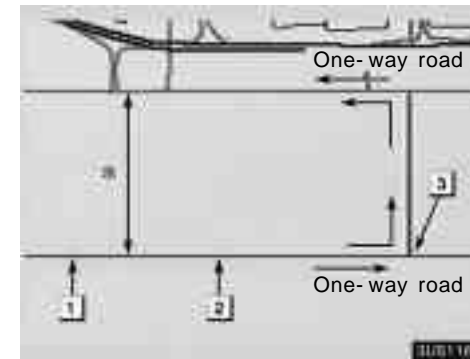

*: The system indicates a U-turn if the distance between two one-way roads (of opposite directions) is less than 50 feet (15 m) in residential areas or 164 feet (50 m) in non-residential areas.



- 1 "In half of a mile, make a legal U-turn."
- 2 "Make a legal U-turn ahead."
- 3 (Beep sound only)

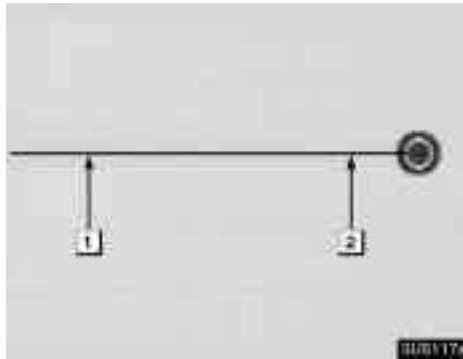

ROUTE GUIDANCE



The system announces the approach to the final destination.

- 1  "Your destination is ahead."
- 2  "You have arrived at your destination. The route guidance is now finished."

INFORMATION

- *If the system cannot determine the current vehicle position correctly (in cases of poor GPS signal reception), the voice guidance may be made early or delayed.*
- *If you did not hear the voice guidance command, push the "MAP/VOICE" button to hear it again.*
- *To adjust the voice guidance volume, see "Volume" on page 67.*

Distance and time to destination



When the vehicle is on the guidance route, the distance and the estimated travel/arrival time to the destination are displayed. When the vehicle is not on the guidance route, the distance and the direction of the destination are displayed.

When driving on the guidance route and more than one destination is set, the distance and the estimated travel/arrival time from the current position to each destination are displayed.

1. **Touch this touch-screen button to display the following screen.**



2. Touch the number button to display the desired destination.

The distance, the estimated travel time and the estimated arrival time from the current position to the selected destination are displayed.



Estimated travel time is displayed.



Estimated arrival time is displayed.



To switch to estimated arrival time.



To switch to estimated travel time.



Displayed while driving off the guidance route. The destination direction is indicated by an arrow.

INFORMATION

When the vehicle is on the guidance route, the distance measured along the route is displayed. Travel time and arrival time is calculated based on the set vehicle speed information. (See page 81.) However, when the vehicle is not on the guidance route, the distance is the linear distance between the current position and the destination.

**Setting and deleting destination —
— Adding destinations**

Adding destinations and searching again for the routes can be done.



1. Touch "Route".



2. Touch "Add".



ROUTE GUIDANCE

3. Input an additional destination in the same way as the destination search. (See “Destination search” on page 24.)



4. Touch the desired “Add” to determine the arrival order of the additional destination.

— Reordering destinations

When more than one destination is set, you can change the arrival order of the destinations.



1. Touch “Route”.

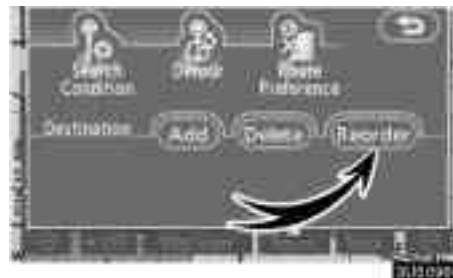

2. Touch “Reorder”.



3. Select the destination in the order of arrival by touching the destination button.

Reordered number of arrival is displayed on the right side of the screen.

Touching “Undo” will cancel each selected order number from the previously input number.

4. After selecting the destinations, touch “OK”.

The system searches for the guidance route again, and displays the entire route. Even if “OK” is not touched, the entire route is displayed automatically within a few seconds when the order is fixed.

— Deleting destinations

A set destination can be deleted.



1. Touch "Route".



2. Touch "Delete".

When more than one destination is set, a list will be displayed on the screen.



3. Touch the destination for deletion.

"Delete All": To delete all destinations on the list.

A message appears to confirm the request to delete.

4. To delete the destination(s), touch "Yes".

If "Yes" is touching, the data cannot be recovered.

If "No" is touching, the previous screen will return.

5. If more than one destination is set, touch "OK" after deleting the destination(s).

The system searches for the guidance route again, and displays the entire route.

**Setting route —
— Search condition**

You can designate the route conditions of the route to the destination.



1. Touch "Route".

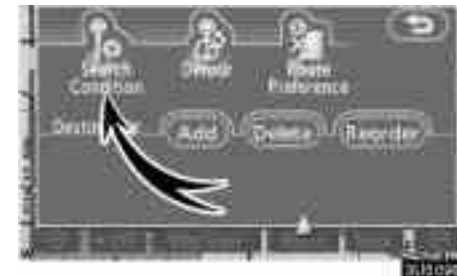

2. Touch "Search Condition".



ROUTE GUIDANCE



3. Touch “Quick”, “Quick1”, “Quick2” or “Short” and touch “OK”.



The entire route from the starting point to the destination is displayed.

“**Guide**”: To start guidance.

“**Route**”: To change a route. (See pages 53 and 55.)

— Detour setting

While the route guidance is operating, you can change the route to detour around a section of the route where a delay is caused by road repairs, or an accident, etc.



1. Touch “Route”.



2. Touch “Detour”.



3. Select the touch-screen button below to select the desired detour distance.

“**1 mile (km)**”, “**3 miles (km)**” or “**5 miles (km)**”: Touch one of these touch-screen buttons to start the detour process. After detouring, the system returns to the original guidance route.

“**Whole Route**”: By touching this touch-screen button, the system will calculate an entire new route to the destination.

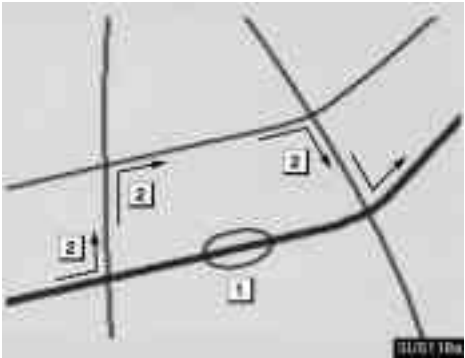

This picture shows an example of how the system would guide around a delay caused by a traffic jam.

- 1 This position indicates the location of a traffic jam caused by road repairs or an accident.
- 2 This route indicates the detour suggested by the system.

INFORMATION
<ul style="list-style-type: none"> • <i>When your vehicle is on a freeway, the detour distance selections are 5, 15, and 25 miles (km).</i> • <i>The system may not be able to calculate a detour route depending on the selected distance and surrounding road conditions.</i>

— Route preference

A number of choices are provided on the conditions which the system uses to determine the route to the destination.



1. Touch "Route".

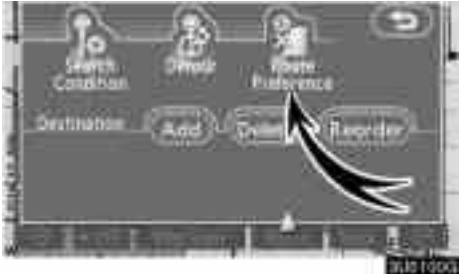

2. Touch "Route Preference" to change the conditions which are to determine the route to the destination.



3. The indicator can be turned on or off by touching the button.

When searching for a route, the system functions to avoid routes where the indicator is dimmed.

4. After choosing the conditions, touch "OK".



ROUTE GUIDANCE

— Starting route from adjacent road

You can start the route guidance from the adjacent road.

(ex. When route guidance is set on the freeway, but the vehicle is driven parallel along the freeway.)



1. Touch “Route”.



2. Touch “Start from Adjacent Road”.

When there is no adjacent road, this button will not be displayed.

Map view — — Display POI icons

Points of Interest such as gas stations and restaurants can be displayed on the map screen. You can also set their location as a destination and use them for route guidance.



1. Touch “Map View”.

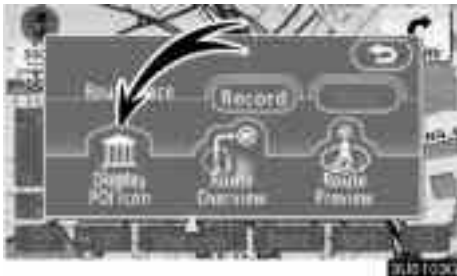

2. Touch “Display POI Icon” to display a particular type of Point of Interest on the screen.



A screen with a limited choice of Points of Interest will be displayed. (To change the displayed POI, see page 84.)

● **Selecting POIs to be displayed**

Up to 5 categories of icons can be displayed on the screen.



Touch the desired Point of Interest category to display POI location symbols on the map screen.

By selecting the desired POI category and then touching “OK”, the selected POI icons are displayed on the map screen.

To turn off the Points of Interest icon on the map screen, touch “Delete”.

“Other POI’s”: If the desired Point of Interest can not be found on the limited choice screen, touch this button. The screen then displays the complete POI listing screen.

“Local POI List”: When searching for the nearest Point of Interest, touch this touch-screen button. The system will list the points within 20 miles (32 km). (See page 60.)

Touch “Other POI’s” on the “Display POI Icons” screen.

When a Point of Interest category is selected from either the limited list or the complete list, the screen will display symbols at those locations on the map screen.



Select the desired POI categories.

The selected category icon appears on the top left of the screen.

By selecting the desired POI category and then touching “OK”, the selected POI icons are displayed on the map screen.

If the desired POI category is not on the screen, touch “List All Categories” to list all POI categories.



ROUTE GUIDANCE



Select the desired POI categories from the list.

The selected category icon appears on the top left of the screen.

By selecting the desired POI category and then touching “OK”, the selected POI icons are displayed on the map screen.

To return to the POI category selection screen, touch “More”.

- To display the local POI list

Points of Interest that are within 20 miles (32 km) of the current position will be listed from among the selected categories.



1. Touch “Local POI List” on the “Display POI icons” screen.

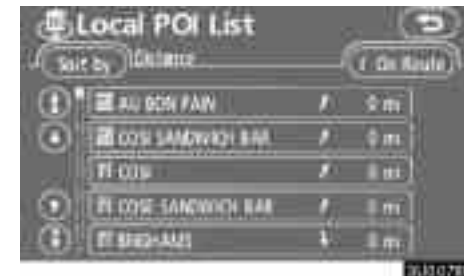

2. Touch the touch-screen button of the desired Point of Interest.

The selected Points of Interest are displayed on the map screen.

“On Route”: When the indicator is illuminated by touching this touch-screen button, the list of the items searched along the route is displayed

● **To set a POI as a destination**

You can select one of the Points of Interest icons on the map screen as a destination and use it for route guidance.



1. Directly touch the Point of Interest icon that you want to set as a destination.

The map will shift so that the icon is centered on the screen and overlaps with the cursor. At this time, the distance from the current position is displayed on the screen. The distance shown is measured as a straight line from the current vehicle position to the POI.

2. When the desired Point of Interest overlaps with the cursor, touch “Enter”.

The screen changes and displays the map location of the selected destination and route preference. (See “Starting route guidance” on page 43.)

— **Route overview**



1. Touch “Map View”.



2. Touch “Route Overview”.



The entire route from the current position to the destination is displayed.

“**Guide**”: To start guidance.



“**Route**”: To change the route. (See pages 53 and 55.)



“**Turn List**”: The following screen displays the list of the roads up to the destination.



ROUTE GUIDANCE



You can scroll through the list of roads by touching  or . However, not all road names in the route may appear on the list. If a road changes its name without requiring a turn (such as on a street that runs through two or more cities), the name change will not appear on the list. The street name closest to the starting point will be displayed with the mileage to the next turn.

-  These marks indicate the direction in which you should turn at an intersection.
- 

Touch “Map” on the “Turn List” screen.

The point which you choose is displayed on the map screen.



— Route preview





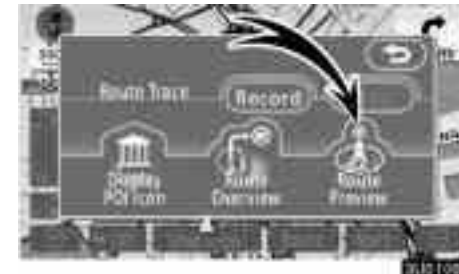



1. Touch “Map View”.



2. Touch “Route Preview”.



-  : To indicate the next destination.
-  : To preview the route to the next destination.
-  : To preview the route to the next destination in fast-forward mode.
-  : To stop the preview.
-  : To review the route to the previous destination or starting point.
-  : To review the route to the previous destination or starting point in fast-forward mode.
-  : To indicate the previous destination or starting point.

— Route trace

It is possible to store the traveled route up to 124 miles (200 km) and retrace the route on the display.

INFORMATION

This feature is available on the map with more detailed map scale than 30 mile (50 km).



Touch "Map View".



"Record": To start recording the route trace.

"Stop": To stop recording the route trace.

If you touch **"Stop"** to display the following screen.



Touching **"Yes"** stops recording and the route trace remains displayed on the screen.

Touching **"No"** stops recording and the route trace is erased.



ROUTE GUIDANCE

SECTION IV

ADVANCED FUNCTIONS

Descriptions of functions for more effective use

Suspending and resuming guidance	66
Volume	67
User selection	67
My places	69
Registering memory points	70
Editing memory points	71
Deleting memory points	75
Registering home	75
Deleting home	76
Registering area to avoid	76
Editing area to avoid	77
Deleting area to avoid	79
Delete previous points	80
Setup	80



ADVANCED FUNCTIONS

Suspending and resuming guidance

- To suspend guidance

1. Push the “MENU” button.



2. Touch “Suspend Guidance”.

INFORMATION

Without route guidance, “Suspend Guidance” cannot be used.



The screen will return to the current position map without route guidance.

- To resume guidance

1. Push the “MENU” button.



2. Touch “Resume Guidance”.



The screen will change to the current position map with route guidance.

Volume

Voice guidance can be used when approaching a destination.

The volume of the voice or turn off voice guidance can be adjusted.

1. Push the “MENU” button.



2. Touch “Volume”.



To adjust the volume, select the desired level by touching the appropriate number.

If voice guidance is unneeded, touch “OFF”.

The selected item is highlighted.

INFORMATION

During route guidance, the voice guidance continues even if the navigation screen is changed to other screens.

“Adaptive Volume Control”: By turning “Adaptive Volume Control” on, the volume is turned up automatically when the vehicle speed exceeds 50 mph (80 km/h).

To turn the “Adaptive Volume Control” system on, touch the button. The indicator will be highlighted.

User selection

The system can memorize the following settings for up to three users.

- Map direction
- Map scale
- Map configuration
- Guidance mode
- Setup
- Volume
- Language
- Route trace
- Travel time/arrival time
- Right screen of dual map
- Road preference
- Maintenance notification



ADVANCED FUNCTIONS

1. Push the “MENU” button.



2. Touch “Select User”.

- To register



1. Touch “Memorize”.

The confirmation screen will be displayed.

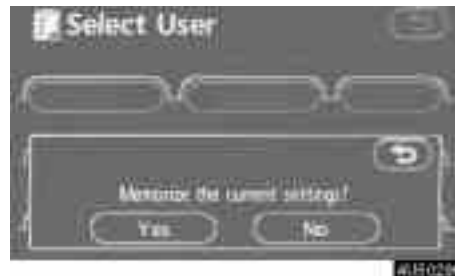

2. To register, touch “Yes”. To return to the previous screen, touch “No” or .

When a touch-screen button that is already registered is touched, the following screen appears.



To replace, touch “Yes”. To cancel the replacement, touch “No” or .

● To change user



Touch "User number".

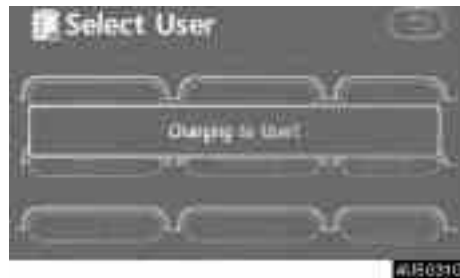

The above message appears, then the map screen will be displayed.

● To delete user



1. Touch "Delete".

The confirmation screen will be displayed.

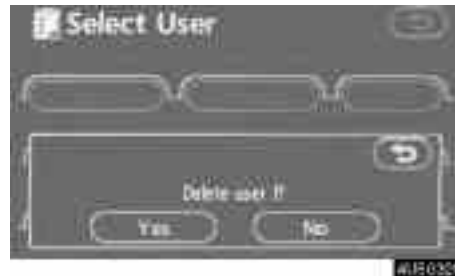

2. To delete, touch "Yes". To return to the previous screen, touch "No" or .

My places —

Points or areas on the map can be registered.

The registered points can be used on the "Destination" screen. (See " — Destination search by Home" on page 26 and " — Destination search by Quick access" on page 27.)

Registered areas are avoided at the time of route search.

1. Push the "MENU" button.



2. Touch "My Places".



ADVANCED FUNCTIONS

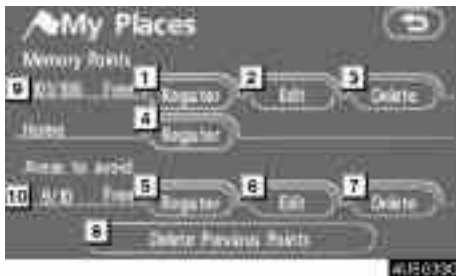

On this screen, the following operations can be performed.

- 1 Registers memory points.** (See “ — Registering memory points” on page 70.)
- 2 Edits memory points.** (See “ — Editing memory points” on page 71.)
- 3 Deletes memory points.** (See “ — Deleting memory points” on page 75.)
- 4 Registers or deletes home.** (See “ — Registering home” or “ — Deleting home” on pages 75 or 76.)
- 5 Registers areas to avoid.** (See “ — Registering area to avoid” on page 76.)
- 6 Edits areas to avoid.** (See “ — Editing area to avoid” on page 77.)
- 7 Deletes areas to avoid.** (See “ — Deleting area to avoid” on page 79.)

- 8 Deletes previous points.** (See “ — Deleting previous points” on page 80.)
- 9 Number of remaining memory points**
- 10 Number of remaining areas to avoid**

— Registering memory points



- 1. Touch “Register”.**



- 2. Enter the location in the same way as for a destination search.** (See “Destination search” on page 24.)

After memory point registration is completed, the “Memory Point” screen will be displayed.



3. Touch “OK”.

To edit registered information, see “ — Editing memory points” on page 71.

INFORMATION

Up to 106 memory points can be registered.

— Editing memory points

The icon, attribute, name, location and/or telephone number of a registered memory point can be edited.

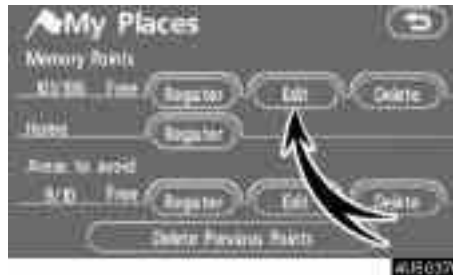

1. Touch “Edit”.



2. Touch the desired memory point button.



3. Touch the touch-screen button to be edited.

“**Icon**”: To select icons to be displayed on the map. (See page 72.)

“**Quick Access**”: To set an attribute. Memory points with a set attribute can be used as a “Quick access” or “Home” button. (See page 73.)

“**Name**”: To edit memory point names. The names can be displayed on the map. (See page 74.)

“**Location**”: To edit location information. (See page 74.)

“**Phone #**”: To edit telephone numbers. (See page 75.)

4. Touch “OK”.

ADVANCED FUNCTIONS

- To change “Icon”

1. Touch “Icon” on the “Memory Point” screen.



2. Touch the desired icon.

Turn the page by touching “Page 1”, “Page 2” or “with Sound”.

SOUND ICONS

When the vehicle approaches the memory point, the selected sound will be heard.

1. Touch “with Sound” on the “Change Icon” screen.



2. Touch the desired sound icon.

The next screen appears when “Bell (with Direction)” is touched.



Touch either  or  to adjust the direction. Touch “Enter”.

The bell sounds only when the vehicle approaches this point in the direction that has been set.

● **To change “Quick Access”**

It is possible to change attributes of the quick access points. Memory points with a set attribute can be used as a “Quick access” or “Home” touch-screen button. (See “ — Destination search by Home” on page 26 and “ — Destination search by Quick access” on page 27.)

1. Touch “Quick Access” on the “Memory Point” screen.



2. Touch the desired attribute.

It is possible to replace a registered attribute.



3. To replace the attribute, touch “Yes”. To return to the previous screen, touch “No” or .

INFORMATION

One “Home” and five “Quick access” can be set.

DELETING “Quick Access”



1. Touch “Del.”.

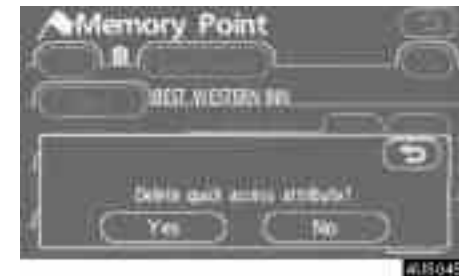

2. To delete an attribute, touch “Yes”. To return to the previous screen, touch “No” or .

ADVANCED FUNCTIONS

- To change “Name”

1. Touch “Name” on the “Memory Point” screen.



2. Enter the name using the alphanumeric keys.

Up to 24 letters can be entered.

3. Touch “OK”.

The previous screen will be displayed.

DISPLAYING MEMORY POINT NAMES

The name of a memory point that may be displayed on the map can be set.



To show the name, touch “ON” on the “Memory Point” screen. To not show it, touch “OFF”.

- To change “Location”

1. Touch “Location” on the “Memory Point” screen.



2. Touch the eight directional touch-screen button to move the cursor to the desired point on the map.

3. Touch “Enter”.

The previous screen will be displayed.

- To change “Phone #” (telephone number)

1. Touch “Phone #” on the “Memory Point” screen.



2. Enter the number using numeral keys.
3. Touch “OK”.

The previous screen will be displayed.

— Deleting memory points



1. Touch “Delete”.



2. Touch the touch-screen button to be deleted.

“Delete All”: To delete all memory points in the system.

3. To delete the memory point, touch “Yes”. To cancel the deletion, touch “No”.

— Registering home

If home has been registered, that information can be recalled by using the “Home” touch-screen button on the “Destination” screen. (See “ — Destination search by Home” on page 26.)



1. Touch “Register”.



ADVANCED FUNCTIONS



2. Enter the location in the same way as for a destination search. (See “Destination search” on page 24.)

When registration of home is completed, the “Memory Point” screen will be displayed.



3. Touch “OK”.

To edit registered information, see “ — Editing memory points” on page 71.

— Deleting home



1. Touch “Delete”.

2. To delete home, touch “Yes”. To cancel the deletion, touch “No”.

— Registering area to avoid

Areas you want to avoid because of traffic jams, construction work or other reasons can be registered as areas to avoid.



1. Touch “Register”.





2. Enter the location in the same way as for a destination search, or display the map of the area to be avoided. (See “Destination search” on page 24.)



3. Set the cursor  in the center of the area to avoid, and touch “Enter”.



4. Touch either  or  to change the size of the area to be avoided.

5. Touch “OK”.

INFORMATION

- *If a destination is input in the area to avoid or the route calculation cannot be made without running through the area to avoid, a route passing through the area to be avoided may be shown.*
- *Up to 10 locations can be registered as points/areas to avoid. If there are 10 locations already registered, the following message will be displayed: “Unable to register additional points. Perform operation again after deleting unnecessary points.”.*

— Editing area to avoid

The name, location and/or area size of a registered area can be edited.



1. Touch “Edit”.

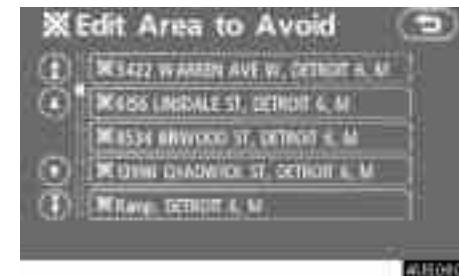

2. Touch the desired area button.

ADVANCED FUNCTIONS



3. Touch the touch-screen button to be edited.

“Name”: To edit the name of the area to avoid. The names can be displayed on the map. (See page 78.)

“Location”: To edit area location. (See page 79.)

“Area Size”: To edit area size. (See page 79.)

“Active”: To turn on or off the area to avoid feature. To turn on the feature touch **“ON”** on the “Edit Area to Avoid” screen. To turn off the feature touch **“OFF”** on the “Edit Area to Avoid” screen.

4. Touch “OK”.

● To change “Name”

1. Touch “Name” on the “Edit Area to Avoid” screen.



2. Enter the name using alphanumeric keys.

Up to 24 letters can be entered.

3. Touch “OK”.

The previous screen will be displayed.

DISPLAYING NAMES OF AREAS TO BE AVOIDED

The name of an area to be avoided that may be displayed on the map can be set.



To show the name, touch **“ON”** on the “Edit Area to Avoid” screen. To not show it, touch **“OFF”**.

- To change “Location”

1. Touch “Location” on the “Edit Area to Avoid” screen.



2. Touch the eight directional touch-screen button to move the cursor to the desired point on the map.



3. Touch “Enter”.

The previous screen will be displayed.

- To change “Area Size”

1. Touch “Area Size” on the “Edit Area to Avoid” screen.



2. Touch either  or  to change the size of the area to be avoided.

3. Touch “OK”.

The previous screen will be displayed.

— Deleting area to avoid



1. Touch “Delete” on the “My Places” screen.



2. Touch the touch-screen button to be deleted.

“Delete All”: To delete all registered areas to avoid in the system.

3. To delete the area, touch “Yes”. To cancel the deletion, touch “No”.



ADVANCED FUNCTIONS

— Deleting previous points

The previous destination can be deleted.



1. Touch “Delete Previous Points”.



2. Touch the touch-screen button you want to delete.

“Delete All”: To delete all previous points in the system.



3. To delete the point, touch “Yes”. To cancel the deletion, touch “No”.

Setup

Setting the items shown on the “Setup” screen can be done. (See page ix.)

1. Push the “MENU” button.



2. Touch “Setup”.



3. Touch the items to be set.
4. Touch "OK".

The previous screen will be displayed.

INFORMATION

To reset all setup items, touch "Default".

● **Distance unit**

Distance unit can be changed.

1. Touch "Setup" on the "Menu" screen.



2. Touch "km" or "miles" of "Distance" to choose the distance unit.

The selected button is highlighted.

3. Touch "OK".

INFORMATION

This function is available only in English or Spanish. To switch language, see "Select language" on page 149.

● **Estimated travel time**

The speed that is used for the calculation of the estimated travel time and the estimated arrival time can be set.



1. Touch "Setup" on the "Menu" screen.



2. Touch "Set Speed" of the "Estimated Travel Time".

ADVANCED FUNCTIONS



3. Touch  or  to set the average vehicle speeds for “Residential”, “Main street”, and “Freeway”.

To set the default speeds, touch “Default”.

4. After setting of the desired speeds is completed, touch “OK”.

INFORMATION

- *The displayed time to the destination is the approximate driving time that is calculated based on the selected speeds and the actual position along the guidance route.*
- *The time shown on the screen may vary greatly depending on progress along the route, which may be affected by road conditions such as traffic jams, and construction work.*
- *It is possible to display up to 99 hours 59 minutes.*

- **Input key layout**

Key layout can be changed.

1. Touch “Setup” on the “Menu” screen.



2. Touch “ABC” or “QWE” of “Keyboard Layout” to choose the Input key layout.

LAYOUT TYPE



► “ABC” type



► “QWE” type

The selected button is highlighted.

3. Touch “OK”.

● Time zone

Time zone can be changed.

1. Touch “Setup” on the “Menu” screen.



2. Touch “Change” of “Time Zone”.

The “Adjust Time Zone” screen will be displayed on the display.



3. Touch the desired time zone.

The selected button is highlighted.

“Daylight Saving Time”: Daylight saving time can be set or cancelled.

To set daylight saving time, touch “ON”, and to cancel it, touch “OFF”.

4. Touch “OK”.



ADVANCED FUNCTIONS

- **Screen layout function ( Function)**

Each touch-screen button and current street name on the map screen can be displayed or hidden.

1. Touch “Setup” on the “Menu” screen.



2. Touch “Change” of “  Function”.



3. Touch the touch-screen button to be turned off. The button becomes dimmed.

To set the default, touch “Default”.

4. Touch “OK”.

- **POI category change (Display POI Icons)**

Select from among the 6 icons displayed on the “Display POI Icons” top screen, so that setting of the icons to be displayed on the map screen can be done easily.

1. Touch “Setup” on the “Menu” screen.

Then touch  to display page 2 of the “Setup” screen.



2. Touch “Change” of “Display POI Icons”.



3. Touch the category button to be changed.



4. Touch the category button to be displayed on the “Display POI Icons” top screen.

5. Touch “OK”.

● **Display of building shape**

When the “Display Building Shapes” feature is turned on, the system will display the building shape on the map screen using a scale of 150 feet (50 m) to 300 feet (100 m).

To turn the “Display Building Shapes” on:

1. Touch “Setup” on the “Menu” screen.

Then touch ⓘ to display page 2 of the “Setup” screen.



2. Touch “ON” of “Display Building Shapes”.

The selected button is highlighted.

3. Touch “OK”.

● **Notifying traffic restriction**

When the “Traffic Restrict. Notification” feature is turned on, the system notifies you of traffic or seasonal restrictions.

To turn the “Traffic Restrict. Notification” on:

1. Touch “Setup” on the “Menu” screen.

Then touch ⓘ to display page 2 of the “Setup” screen.



2. Touch “ON” of “Traffic Restrict. Notification”.

The selected button is highlighted.

3. Touch “OK”.

ADVANCED FUNCTIONS

- **Voice recognition guidance**

When the “Voice Recognition Guidance” feature is turned on, the voice recognition guidance can be heard automatically.

To turn the “Voice Recognition Guidance” on:

1. Touch **“Setup”** on the **“Menu”** screen.

Then touch ⓘ to display page 2 of the “Setup” screen.



2. Touch **“ON”** of **“Voice Recognition Guidance”**.

The selected button is highlighted.

3. Touch **“OK”**.

- **Voice guidance in all modes**

When the “Voice Guidance in All Modes” feature is turned on, the voice guidance in all modes can be heard.

When the “Voice Guidance in All Modes” feature is turned off, voice guidance cannot be heard when using the audio system.

To turn the “Voice Guidance in All Modes” on:

1. Touch **“Setup”** on the **“Menu”** screen.

Then touch ⓘ to display page 2 of the “Setup” screen.



2. Touch **“ON”** of **“Voice Guidance in All Modes”**.

The selected button is highlighted.

3. Touch **“OK”**.

- **Auto voice guidance**

When the “Auto Voice Guidance” feature is turned on, the voice guidance can be heard automatically.

When the “Auto Voice Guidance” feature is turned off, the voice guidance can be heard only if the **“MAP/VOICE”** button is pushed.

To turn the “Auto Voice Guidance” mode on:

1. Touch **“Setup”** on the **“Menu”** screen.

Then touch ⓘ twice to display page 3 of the “Setup” screen.



2. Touch **“ON”** of **“Auto Voice Guidance”**.

The selected button is highlighted.

3. Touch **“OK”**.

● **Pop-up message**

When the “Pop-up Message” is turned on, the Pop-up message will be displayed.

To turn the “Pop-up Message” on:

1. Touch “Setup” on the “Menu” screen.

Then touch ⓘ twice to display page 3 of the “Setup” screen.



2. Touch “ON” of “Pop-up Message”.

The selected button is highlighted.

3. Touch “OK”.

When the “Pop-up Message” is turned off, following messages are not displayed.



This message appears when the system is in the POI mode and the map scale is 1 mile (1.6 km) or greater.



The message appears when the map is switched to the dual map screen mode.

● **Current position/tire change calibration**

The current vehicle position mark can be adjusted manually. Miscalculation of the distance caused by tire replacement can also be adjusted.

1. Touch “Setup” on the “Menu” screen.

Then touch ⓘ twice to display page 3 of the “Setup” screen.



2. Touch “Adjust” of “Calibration”.

ADVANCED FUNCTIONS



3. Touch the desired touch-screen button.

INFORMATION

For additional information on the accuracy of a current vehicle position, see "Limitations of the navigation system" on page 198.

POSITION/DIRECTION CALIBRATION

When driving, the current vehicle position mark will be automatically corrected by GPS signals. If GPS reception is poor due to location, you can manually adjust the current vehicle position mark.



1. Touch "Position/Direction".



2. Touch the scroll arrows to move the cursor to your desired location.
3. Touch "Enter".



4. Touch either [left arrow] or [right arrow] to adjust the direction of the current vehicle position mark.

5. Touch "Enter".

The map screen will be displayed.

TIRE CHANGE CALIBRATION

The tire change calibration function will be used when replacing the tires. This function will adjust the mis-calculation caused by the circumference difference between the old and new tires. If this procedure is not performed when tires are replaced, the current vehicle position mark may be incorrectly displayed.



To perform a distance calibration procedure, touch “Tire Change” on the “Calibration” screen.

The message appears and the quick distance calibration is automatically started. A few seconds later, a map screen will be displayed.

ADVANCED FUNCTIONS

SECTION V

OTHER FUNCTIONS

Other functions

Maintenance information	92
Maintenance information setting	92
Dealer setting	93
Calendar with memo	95
Adding a memo	96
Editing a memo	98
Memo list	98
Hands-free system	99
Speech command system	142
Help screen	144
Screen adjustment	145
Screen setting	146
Beep setting	149
Select language	149



OTHER FUNCTIONS

Maintenance information — — Maintenance information setting

When the Navigation System is turned on, the “Information” screen displays when it is time to replace a part or certain components. (See page 3.)

1. Push the “INFO” button.



2. Touch “Maintenance”.



3. Touch the desired touch-screen button.

For details of each touch-screen button, see “INFORMATION ITEMS” on page 92.

“Delete All”: To cancel all conditions which have been inputted.

“Reset All”: To reset the item which has satisfied a condition.

“Set Dealer”: To register or edit dealer information. (See “ — Dealer setting” on page 93.)

If “ON” is selected, the system gives maintenance information with the “Information” screen when the system is turned on. (See page 3.)

If “OFF” is selected, the “Information” screen is disabled.

When the vehicle needs to be serviced, the touch-screen button color will change to orange.

INFORMATION ITEMS

“ENGINE OIL”: Replace engine oil

“OIL FILTER”: Replace engine oil filter

“ROTATION”: Rotate tires

“TIRES”: Replace tires

“BATTERY”: Replace battery

“BRAKE PAD”: Replace brake linings

“WIPERS”: Replace wiper blades

“LLC”: Replace engine coolant

“BRAKE OIL”: Replace brake fluid

“ATF”: Replace ATF

“SERVICE”: Scheduled maintenance

“AIR FILTER”: Replace air filter

“PERSONAL”: New information items can be created separately from provided ones



4. Input the conditions.

Notice of "Date": The next maintenance date can be input.

Notice of "Distance": The driving distance until the next maintenance check can be input.

"Delete": To cancel the date and distance conditions.

"Reset": To reset the date and distance conditions.

5. Touch "OK".

The screen then returns to the "Maintenance" screen.

INFORMATION

- *For scheduled maintenance information, please refer to the "Scheduled Maintenance Guide" or "Owner's Manual Supplement".*
- *Depending on driving or road conditions, the actual date and distance may differ from the stored date and distance in the system.*

— Dealer setting

It is possible to register a dealer in the system. With dealer information registered, route guidance to the dealer is available.

1. Touch "Set Dealer" on the "Maintenance" screen.



2. If the dealer has not been registered, enter the location of the dealer in the same way as for a destination search. (See "Destination search" on page 24.)

When "Set Dealer" registration is finished, the "Edit Dealer" screen will be displayed.

OTHER FUNCTIONS



3. Touch the touch-screen button to be edited.

“**Dealer**”*: To enter the name of a dealer. (See page 94.)

“**Contact**”*: To enter the name of a dealer member. (See page 94.)

“**Location**”*: To set a location. (See page 94.)

“**Phone #**”*: To set a telephone number. (See page 95.)

“**Delete Dealer**”*: To delete the dealer information displayed on the screen.

“**Enter** ”*: To set the displayed dealer as a destination. (See “Starting route guidance” on page 43.)

● To edit “Dealer” or “Contact”

1. Touch “Dealer” or “Contact” on the “Edit Dealer” screen.



2. Enter the name using the alphanumeric keys.

Up to 24 letters can be entered.

3. Touch “OK”.

The previous screen will be displayed.

● To edit “Location”

1. Touch “Location” on the “Edit Dealer” screen.



2. Touch the eight directional touch-screen button to move the cursor  to the desired point on the map.

3. Touch “Enter”.

The previous screen will be displayed.

- To edit “Phone #” (telephone number)
1. Touch “Phone #” on the “Edit Dealer” screen.



2. Enter the number using numeral keys.
3. Touch “OK”.

The previous screen will be displayed.

Calendar with memo —

It is possible to enter memos for particular dates on the calendar. The system informs you of the memo entry when the system is turned on. (See page 3.) Memos can also be used for route guidance if the memo has been registered with location information.

1. Push the “INFO” button.



2. Touch “Calendar”.



On this screen, the current date is highlighted in yellow.

▲M or **▼M**: To change month.

▲Y or **▼Y**: To change year.

“Today”: To display the current month calendar (if another month will be displayed).

“List”: To display the list of registered memos. (See “ — Memo list” on page 98.)

Touching a date button on the “Calendar” screen displays the “Memo” screen.



OTHER FUNCTIONS



Memos can be edited by touching the list button. (See “ — Editing a memo” on page 98.)

“**Add Memo**”: To add a memo. (See “ — Adding a memo” on page 96.)

“**Mark ○**”: To change the color of the mark displayed next to the date. To default the mark color, touch “**Delete**” on the “Mark color” screen.

“**Date ○**”: To change the color of the date. To default the date color, touch “**Delete**” on the “Date color” screen.

“**Prev. Day**”: To go to the “Memo” screen of the previous date.

“**Today**”: To go to the “Memo” screen for the current date.

“**Next Day**”: To go to the “Memo” screen of the next date.

— Adding a memo

If a memo is added, the system informs of the memo entry when the system is started on the memo date. (See page 3.)

1. Touch the date you want to add a memo on the “Calendar” screen.



2. Touch “Add Memo”.

Up to 100 memos can be added.



3. Touch “Memo”.



4. Enter text using the keys.

Up to 24 letters can be entered.

After entering the text, touch “OK” at the bottom right of the screen.



5. When registering information on the memo, touch “Location”.

A screen similar to the destination search screen appears. Search the same way as searching a destination. (See “Destination search” on page 24.)

OTHER FUNCTIONS

— Editing a memo

The registered memo can be edited.

1. Touch the day you want to edit a memo on the “Calendar” screen.



2. Touch the memo to be edited.



3. Touch the item to be edited.

“**Memo**”: To edit a memo. (See “ — Adding a memo” on page 96.)

“**Location**”: To change a registered location. (See “ — Adding a memo” on page 96.)

“**Enter**”: To set the registered location as a destination. (See “Starting route guidance” on page 43.)

“**Delete**”: To delete the memo.

— Memo list

It is possible to display a memo list by setting a condition.

1. Touch “List” on the “Calendar” screen.



2. Touch the desired search condition to list the memos.

“**This Week**”: To display the list of memos for the current week.

“**This Month**”: To display the list of memos for the current month.

“**Future**”: To display a list of future memos.

“**Past**”: To display the list of past memos.

“**All**”: To display the list of all memos.

“**Period**”: To display the list of memos for a specified period. (See page 99.)



3. To delete and/or edit the memo, touch the desired memo button.

“Delete All”: To delete all the displayed memos.

A message will be displayed.

4. To delete, touch “Yes”. To cancel the deletion, touch “No”.

● To display memos for a specified period of time

1. Touch “Period” on the “Memo Search” screen.

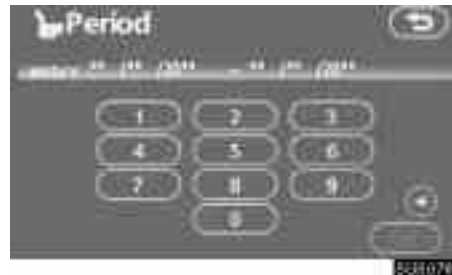

2. Enter the period using the numeral keys.

The period from January 1, 2005 through December 31, 2024 can be set for searching.

3. After setting the period, touch “OK”.

The “Memo List” screen will be displayed.

Hands-free system

Hands-free system allows you to make or receive a call without taking your hands off the steering wheel by connecting your cellular phone.

This system supports Bluetooth. Bluetooth is a wireless data system by which you can call without your cellular phone being connected with a cable or placed on a cradle.

If your cellular phone does not support Bluetooth, this system can not function.

CAUTION

While you are driving, do not use a cellular phone or connect the Bluetooth phone.

NOTICE

Do not leave your cellular phone in the car. The temperature indoor may be high and damage the phone.

OTHER FUNCTIONS

INFORMATION

In the following conditions, the system may not function.

- *The cellular phone is turned OFF.*
- *The current position is outside the communication area.*
- *The cellular phone is not connected.*
- *The cellular phone has a low battery.*



By pushing the telephone switch above, you can receive a call or hang up without taking your hands off the steering wheel.



You can use the microphone above when talking on the phone.

The other party's voice outputs from the driver's speaker. When the received calls or received voice outputs, the audio from the Audio system or voice guidance from the Navigation system will be muted.

INFORMATION

- *Talk alternately with the other party on the phone. If you talk at the same time, the voice may not reach each other. (It is not a malfunction.)*
- *Keep the volume of receiving voice down. Otherwise, echo is coming up. When you talk on the phone, speak clearly towards the microphone.*
- *In the following situations, your voice may not reach the other party.*
 - *Driving on unpaved road. (Making a traffic noise.)*
 - *Driving at the high speed.*
 - *The window is open.*
 - *Turning the air-conditioning vents towards the microphone.*
 - *The sound of the air-conditioning fan is loud.*



1 Indicates the condition of Bluetooth connection.

“Blue” indicates an excellent connection to Bluetooth.

“Yellow” indicates a bad connection to Bluetooth, resulting in possible deterioration of voice quality.

 : no connection to Bluetooth.

2 Indicates the amount of battery charge left.



It is not displayed while the Bluetooth is connecting or the phone book data is being transferred.

The amount left does not always correspond with the one of your cellular phone. This system doesn't have a charging function.

3 Indicates the receiving area.

“Rm” is displayed when receiving in Roaming area.

“Hm” is displayed when receiving in Home area.

4 Indicates the level of reception.



The level of reception does not always correspond with the one of your cellular phone.

INFORMATION

This system supports the following service.

- *HFP (Hands Free Profile) Ver. 1.0*
- *OPP (Object Push Profile) Ver. 1.1*

If your cellular phone does not support HFP, you cannot enter the Bluetooth phone, and take OPP service individually.

An antenna for the Bluetooth connection is built in the display. The indication of the Bluetooth connection may turn yellow and the system may not function when you use the Bluetooth phone in the following conditions and places.

- Your cellular phone is hiding behind the display (behind the seat or in the glove box and console box).
- Your cellular phone touches or is covered with metal materials.

Leave the Bluetooth phone on the place where “Blue” indication is displayed.



Bluetooth is a trademark owned by Bluetooth SIG, Inc.



OTHER FUNCTIONS

When you release your car:

A lot of personal data is registered when you use the Hands-free system. When you release your car, initialize your data.

If you initialize it, the former state will never come back again. Pay much attention when initializing the data.

You can initialize the following data in the system.

- Phone book data
- Dialed numbers and received calls
- Speed dial
- Bluetooth phone data
- Security code

FCC ID: HYQDNNS016
IC ID: 1551A-DNNS016
MADE IN JAPAN

This device complies with Part 15 of the FCC Rules and RSS-210. Operation is subject to the following two conditions: (1) This device may not cause harmful interference, and (2) This device must accept any interference received, including interference that may cause undesired operation.



CAUTION

Changes or modifications not expressly approved by the party responsible for compliance could void the user's authority to operate the equipment.

NOTE: This equipment has been tested and found to comply with the limits for a Class B digital device, pursuant to part 15 of the FCC Rules. These limits are designed to provide reasonable protection against harmful interference in a residential installation. This equipment generates, uses and can radiate radio frequency energy and, if not installed and used in accordance with the instructions, may cause harmful interference to radio communications. However, there is no guarantee that interference will not occur in a particular installation. If this equipment does cause harmful interference to radio or television reception, which can be determined by turning the equipment off and on, the user is encouraged to try to correct the interference by one or more of the following measures:

- Reorient or relocate the receiving antenna.
- Increase the separation between the equipment and receiver.
- Connect the equipment into an outlet on a circuit different from that to which the receiver is connected.
- Consult the dealer or an experienced radio/TV technician for help.

CAUTION: Radio Frequency Radiation Exposure

This equipment complies with FCC radiation exposure limits set forth for uncontrolled equipment and meets the FCC radio frequency (RF) Exposure Guidelines in Supplement C to OET65. This equipment has very low levels of RF energy that it deemed to comply without maximum permissive exposure evaluation (MPE). But it is desirable that it should be installed and operated with at least 20 cm and more between the radiator and person's body (excluding extremities: hands, wrists, feet and legs).

Co-location: This transmitter must not be co-located or operated in conjunction with any other antenna or transmitter.

(a) Enter a Bluetooth phone

To use the hands-free system, you need to enter your phone into the system. Once you have registered it, you can make a hands-free call.

1. Push the “INFO” button to display the “Information” screen.



2. Touch “Telephone” to display “Telephone” screen.

You can also push the  switch of the steering wheel to display this screen when the vehicle is stopped.



3. Touch “Settings” to display “Settings” screen.



4. Touch “Bluetooth” to display the “Bluetooth Settings” screen.



OTHER FUNCTIONS



5. Touch “Register” to connect your cellular phone to the system.



6. When this screen is displayed, input the Passkey displayed on the screen into the phone.

For the operation of the phone, see the manual that comes with your cellular phone.

If you want to cancel it, touch “Cancel”.



7. When the connection is completed, this screen is displayed.

You do not need to enter the phone in case of using the same one.



When this screen is displayed, follow the guidance on the screen to try again.

● Connecting a Bluetooth phone

(i) Automatically



When you register your phone, auto connection will be turned on. Always set it to this mode and leave the Bluetooth phone in a condition where connection can be established.

Each time you touch “Auto Connect”, auto connection will be switched on or off.



When the ignition switch is set at ACC or ON, the selected Bluetooth phone will be automatically connected and the connection result is displayed.

This screen appears when the Bluetooth phone is first connected after the ignition switch is set at ACC or ON.

(ii) Manually

When the auto connection failed or turned off, you have to connect Bluetooth manually.



Touch "Connect" after having enabled the Bluetooth connection on the phone.



When the connection is completed, this screen is displayed.

Now you can use the Bluetooth phone.

● Reconnecting the Bluetooth phone

If the Bluetooth phone is disconnected with a poor reception from the Bluetooth network when the ignition switch is set at ACC or ON, the system automatically reconnects the Bluetooth phone. In this case, the connection result is not displayed.

If the Bluetooth is disconnected on purpose such as you turned your cellular phone OFF, this does not happen. Reconnect it by the following methods.

- Select the Bluetooth phone again.
- Enter the Bluetooth phone.

OTHER FUNCTIONS

(b) Call on the Bluetooth phone

After you enter the Bluetooth phone, you can call by using hands-free system. You can call using the 7 methods described below.

(i) By dial

You can call by inputting the telephone number.

This cannot be operated while driving.



Touch the desired key to input the telephone number.

Each time you touch ◀, an inputted digit is deleted.

When you touch ▶, the number you called last is inputted.

Touch 📞 or push the 📞 switch of the steering wheel.

(ii) By phone book

You can call by phone book data which is transferred from your cellular phone.

The system has one phone book. You can register up to 1000 numbers.

This cannot be operated while driving.



Touch the desired key to input the telephone number.

1. Touch "Phone Book" to display "Phone Book" screen.



2. Select the desired number from the list.



Touch 📞 or push the 📞 switch of the steering wheel.

(iii) By dialed numbers

You can call by dialed number. The system memorize up to 5 dialed numbers. If it is over than 5, the oldest number is deleted.

This cannot be operated while driving.



1. Touch “Call Log” to display “Outgoing Call” screen.



- When you call by phone book, the name (if registered) is displayed.
 - When you call the same number continuously, only the newest number is registered.
2. Select the desired number from the list.



Touch or push the switch of the steering wheel.

(iv) By received calls

You can call by received calls. When a call is received, the system memorize up to 5 numbers. If it is over than 5, the oldest number is deleted.

This cannot be operated while driving.



1. Touch “Call Log” to display “Outgoing Call” screen.



2. Touch “Incoming Call” to display “Incoming Call” screen.





OTHER FUNCTIONS



- When a telephone number registered in the phone book is received, the name and the number are displayed.
- Received calls which you did not answer are also memorized in the system and “Abs.” is displayed on the left side of the number.
- Unnoticed telephone number such as a public telephone is not memorized in the system.

3. Select the desired number from the list.



Touch  or push the  switch of the steering wheel.

- A international phone call may not be made depending on the cellular phone which you have.

(v) By speed dial

You can call by registered telephone number which you selected from a phone book, dialed numbers and received calls. (See page 114 for registering the speed dial.)



1. Touch “Speed Dial” to display “Speed Dial” screen.



2. Touch the desired number to call. You can change the page by touching “Speed Dial 2” or “Speed Dial 3”.

When you push the telephone button while driving, the screen above appears. Touch the desired name to call. (The telephone number is not displayed.)

(vi) By voice recognition



You can call by giving a command. (For the operation and command of voice recognition, see “Speech command system” on page 142 and “Help screen” on page 144.)

- Dialing by name

You can call by giving a voice tag registered in the phone book. For setting the voice recognition, see “Setting the voice recognition” on page 126.

Example: Call Charlize



OTHER FUNCTIONS

- You: Push the talk switch.
System: "After the beep, please say the name."
You: "Charlize."
System: "Charlize chosen, when ready, please briefly push the talk switch or push the off-hook switch to dial."
You: Push the talk switch.
System: "After the beep, please say "Dial"."
You: "Dial."
System: "Dialing the name."
Now you can call Charlize.



"Next" is displayed when multiple entries are found for a searched name.

Up to 6 entries can be displayed including the first searched one.

Do the following to change the entry to the next one.

- Touch "Next"
- Push the talk switch to say "Next Candidate".

Calling without the voice recognition

After the entry number is displayed, you can also call by pushing the telephone switch or touching "Dial".

Canceling the voice recognition

The voice recognition will be cancelled when you do the following.

- Keep on pushing the talk switch
- Push the  switch of the steering wheel.
- Touch "Cancel". (Except for recognizing the command)
- Say "Cancel"

● **Dialing by phone number**

You can call by giving a desired number.



You: Push the talk switch.
 System: "After the beep, please say the number."
 You: "812387"
 System: "When ready, please briefly push the talk switch or push the off-hook switch to dial."
 You: Push the talk switch.
 System: "After the beep, please continue to add numbers or say "Dial"."
 You: "Dial."
 System: "Dialing the number."
 Now you can call 812387.

● **Sending a tone**

You can send a tone by giving a desired number.

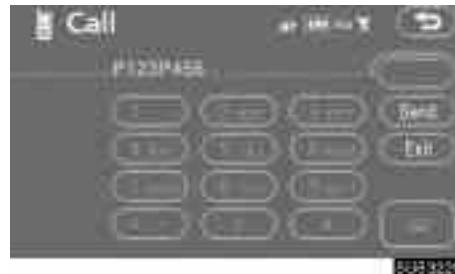

You: Push the talk switch.
 System: "Say numbers, pound, or star."
 You: "1234."
 System: "1234." "Push the talk switch."
 You: Push the talk switch.
 System: "Send? Say Yes or No."
 You: "Yes."
 System: "Sending."
 Now you can send the tone.

(vii) **By POI call**





You can call by touching  when it is displayed on the screen from Navigation system. (See page 11 for details.)





(c) Receive on the Bluetooth phone



When a call is received, this screen is displayed with a sound. Touch  or push the  switch of the steering wheel to talk on the phone.

To hang up the phone:

Touch  or push the  switch of the steering wheel again.

To refuse to receive the call:

Touch  and hold it.

To adjust the volume of received call:

Touch “-” or “+” or use the volume switch of the steering wheel.

On the international phone call, the other party's name may not be displayed correctly depending on the cellular phone which you have.

(d) Talk on the Bluetooth phone





While you are talking on the phone, this screen is displayed. You can do the operation below on the screen.

To adjust the volume of the other party's voice:

Touch “-” or “+” or use the volume switch of the steering wheel.

To hang up the phone:

Touch  or push the  switch of the steering wheel.

To mute your voice:

Touch “Mute”.

To input a Key:

Touch “0-9” .

To transfer the call

Touch “Transfer Call”.

You cannot change from Hands-free call to cellular phone call while driving.



When you change from cellular phone call to Hands-free call, the Hands-free screen will be displayed and you can operate it on the screen.

Transferring method and behavior are different depending on the cellular phone which you have.



For the operation of the phone, see the manual that comes with your cellular phone.

OTHER FUNCTIONS



Touch the desired number to input the key.
To hang up the phone:
Touch  or push the  switch of the steering wheel.
This cannot be operated while driving.



If the continuous tone signal is registered in a phone book, this screen appears. (If not registered, "Send" and "Exit" are not displayed.)
Confirm the number displayed on the screen and touch "Send". The number before marked sign will be sent.
When you touch "Exit", this function will be finished and normal tone screen appears.
To hang up the phone:
Touch  or push the  switch of the steering wheel.
The continuous tone signal is the marked sign (p or w) and the number following telephone number. (ex. 056133p0123w#1*)

You can do this operation when you want to operate an answering machine or use a telephone service in bank for example. You can register the phone number and the code number in the phone book.



OTHER FUNCTIONS

- Sending a tone by the speed tone

You can send a tone by the speed tone. (For registering the speed tone, see “Registering the speed tone” on page 117.)



1. Touch “Speed Tone”.



2. Touch the desired switch to send a tone.

(e) Change the settings of the Bluetooth phone



Touch “Settings” to display “Settings” screen.



You can change the settings of the phone.

(i) Registering the speed dial

You can register the desired telephone number from phone book, dialed numbers and received calls. Up to 17 speed dial numbers can be registered.

The 6th entry is the speed dial for redialing.



1. Touch “Speed Dial” to display the “Speed Dial Settings” screen.



2. Touch “Register” of “Speed Dial”.



3. Select the data you want to register.



4. Touch the desired telephone number.



5. Touch the touch-screen button you want to register in.

The latest dialed number is registered in the 6th item (speed redial).

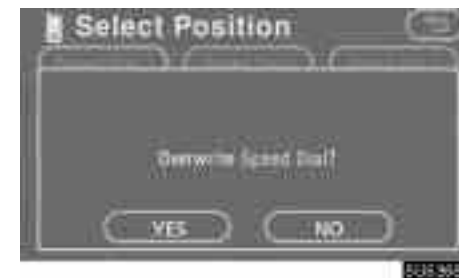

6. If you select a touch-screen button you registered before, this screen is displayed.

Touch “YES” if you want to overwrite it.



OTHER FUNCTIONS

- **Deleting the speed dial individually**

You can delete “01” - “17” of the speed dial individually.

If you delete them all at once, all of 17 numbers are deleted.



1. Touch “Delete” of “Speed Dial”.



2. Touch the touch-screen button you want to delete.



3. Touch “YES”.

- **Deleting all of the speed dial**



1. Touch “Delete All” of “Speed Dial”.



2. Touch “YES”.

(ii) Registering the speed tone

You can register the desired tone number. Up to 6 speed tone numbers can be registered.



1. Touch "Register" of "Speed Tone".



2. Use the software keyboard to input the name.



3. Input the number and touch "OK".

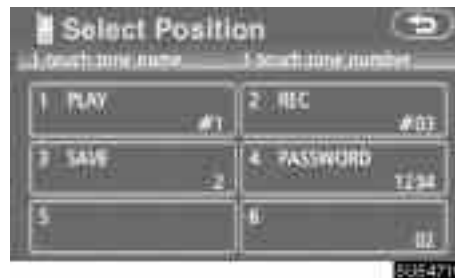

4. Touch the desired touch-screen button you want to register in.



5. If you select a touch-screen button you register before, this screen is displayed. Touch "YES" if you want to overwrite it.

OTHER FUNCTIONS

- Editing the speed tone.
You can edit the speed tone.



1. Touch "Edit" of "Speed Tone".



2. Touch the touch-screen button you want to edit.



3. Use the software keyboard to input the name.



4. Input the number and touch "OK".



5. Touch "YES".

- Deleting the speed tone individually.
You can delete “1” to “6” of the speed tone.

If you delete them all at once, all of 6 numbers are deleted.



1. Touch “Delete” of “Speed Tone”.



2. Touch the touch-screen button you want to delete.



3. Touch “YES”.

- Deleting all the speed tone



1. Touch “Delete All” of “Speed Tone”.



2. Touch “YES”.



OTHER FUNCTIONS

(iii) Setting the volume



1. Touch “Volume” to display the “Volume Setting” screen.



2. Touch “-” or “+” to adjust the “Voice Volume” or “Ring Volume”.

Voice Volume . . Adjusting the other party’s voice.

Ring Volume . . . Adjusting the ring volume.

- Automatic volume settings for high speed

You can set the volume one step up when the speed is over 80 km/h. (When it is under 70 km/h, previous volume is back.)

Each time you touch “Adaptive Volume Control”, you can switch on or off.

- Initializing the settings

You can initialize the settings.

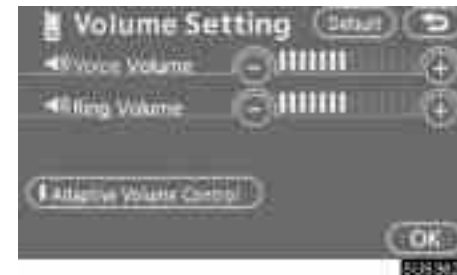

Touch “Default”.



Touch “YES”.

(iv) Setting the screen



1. Touch "Screen" to display the "Screen Settings" screen.



2. Do the detail settings of the screen and touch "OK".

● Receiving Call Display

You can select the method of the receiving call display.



Touch "Full" or "Icon".

Full mode When a call is received, the Hands-free screen is displayed and you can operate it on the screen.

Icon mode The message is displayed on the upper side of the screen. You can only operate the steering switch.

● Auto answer

When a call is received, the display automatically changes to the talking screen and you can start to talk on the phone (without touching any switch) after the preset time.



Touch "On" of "Auto Answer" and "-" or "+" to adjust the waiting time of auto answer within 1 - 60 seconds.



OTHER FUNCTIONS

- The Bluetooth connection status at startup



When the ignition switch is set at ACC or ON and the Bluetooth is automatically connected, the connection check is displayed.



Touch "On" or "Off" of "Show Bluetooth connection status at start up".

- Initializing the settings
You can initialize the settings.



Touch "Default".



Touch "YES".

- (v) Setting the phone book

You can register phone numbers in the phone book.



Touch "Phone Book" to display the "Phone Book Management" screen.



You can do the detail settings of phone book.

- **Transferring a telephone number**

You can transfer the telephone numbers in your Bluetooth phone to the system. Up to 1000 person's data (up to 2 numbers a person) can be registered in the phone book.

Transfer it while the engine is running.



1. Touch "Transfer Data" to display "Select Group" screen.



2. Select the group you want to transfer to.



3. Touch "Overwrite" or "Add to".



4. Transfer the phone book data to the system using the Bluetooth phone.

This screen appears while transferring. To cancel it, touch "Cancel". If the transferring is interrupted on the way, the phone book data transferred until then can be memorized in the system.



5. When this screen is displayed, the transfer is completed.

OTHER FUNCTIONS



When this screen is displayed, try the transfer operation again.

- Registering the phone book data
You can register the phone book data.



1. Touch "Register" of "Phone Book".



2. Touch the desired touch-screen button to edit the phone book.



3. When you complete the edit, touch "OK".

- Editing the name

When you don't input the name, the number is displayed.



1. Touch "Name".



2. Use the software keyboard to input the name.

- Editing the phone number

You can register the phone number in "TEL1" and "TEL 2" separately. Up to 2 numbers a person can be registered.



1. Touch "TEL 1" or "TEL 2".



2. Input the number and touch "OK".



3. Select the desired icon.



OTHER FUNCTIONS

- **Selecting the group**

You can set a group for a contact (for example: “Family”, “Friends”, “Office”...). It will then be easier for you to find this contact when needed, by using the group display.

You can select “No group” or “Group 01” to “Group 19”.

“No group” is displayed if you don’t set the group.



1. Touch “Group”.



2. Select the desired group.

- **Setting the voice recognition**

You can set the voice recognition. Up to 20 numbers can be registered for the voice recognition.



1. Touch “Voice Rec.”.



2. Select the phone number and touch “REC” to record a voicetag.



3. Touch “PLAY” to play the voicetag.
If you want to delete it, touch “Delete” and “OK”.

- Adding the data to the phone book
You can add data to the phone book.



1. Touch “Add to”.



2. Select the data you want to add log data to.



3. Confirm the added data on the screen and touch “OK”.



OTHER FUNCTIONS

- **Editing the data**

You can edit the registered data.



1. Touch "Edit".

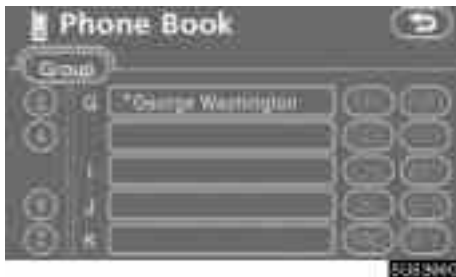

2. Select the data you want to edit.



3. Touch the desired touch-screen button.

When you edit the data, touch "OK".



When you also touch "Edit" on this screen, you can edit it.

- **Deleting the data**

You can delete the data.

When you release your car, delete all your data on the system.



1. Touch "Delete" of "Phone Book".

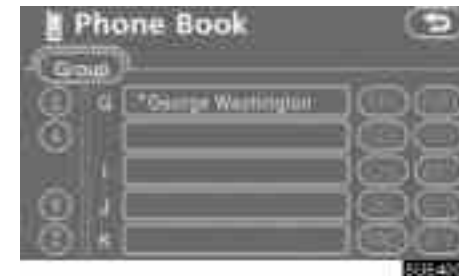

2. Touch the desired touch-screen button.



3. Touch "YES".

You can also delete it in the following way.



1. Touch "Phone Book".



2. Select the desired data.



3. Touch "Delete".



4. Touch "YES".



OTHER FUNCTIONS

- Deleting all the phone data



1. Touch "Delete All" of "Phone book".



2. Select the deleting method.

Group Data Deleting all the phone data in group.

All Contact Data . . . Deleting all the phone data.

3. When you select "Group Data", the "Select Group" screen is displayed.



4. Select the desired group.



5. Touch "YES".

You can also delete it in the following way.



1. Touch "Phone Book".



2. Touch "Delete All".



3. Touch "YES".

- Registering a group name

You can register 20 groups. "No Group", "Group 01" - "Group 19" is registered by default.

You can change "Group 01" - "Group 19" into desired names.



1. Touch "Register" of "Group Name".



2. Select the group you want to register.



3. When you complete all the edit, touch "OK".

OTHER FUNCTIONS

- **Selecting a group icon**



1. Touch "Icon".



2. Select the desired icon.

- **Editing a group name**



1. Touch "Name".



2. Use the software keyboard to input the name.

- **Deleting a group name**

You can delete the group names individually or all at once. If you delete a group name, that group will return to the default setting. (excluding "No Group")



1. Touch "Delete" of "Group Name".



2. Select the group you want to delete the name of.



3. Touch "YES".

● Deleting all the group name



1. Touch "Delete All" of "Group Name".



2. Touch "YES".

● Deleting the log data

You can delete the log data individually or all at once.

When you release your car, delete all the data on the system.

(a) Individually



1. Touch "Delete" on the "Log Data" screen.



2. Touch "YES".



OTHER FUNCTIONS

(b) All at once



1. Touch "Delete All" on the "Outgoing Call" or "Incoming Call" screen.



2. Touch "YES".

(vi) Setting the security

When you set the security, you can prevent people from using some functions of the Hands-free system. It is useful when you leave your car with the hotel or you don't want others to see the data you registered.

When you set or unlock the security, you have to input the security code. Be sure to change the default code when you use the security for the first time.

● Changing the security code

The security code is 4 digits and the default is "0000".

Change a new code that is hard for other people to know.

When you change the security code, don't forget the code. The dealers cannot unlock the security when you forget it.



1. Touch "Phone Book Lock".



2. Touch “Change”.



3. Input the security code.

Each time you touch ◀, an inputted digit is deleted.



4. Touch “YES”.

● **Phone Book Lock**

When you set the phone book lock, you can have the following functions locked.

- Display of the phone book screen and transferring, registering, editing, deleting the phone book data.
- Display of speed dial screen, registering, deleting the speed dial and speed dialing.
- Display of the other party's name for calls being received or made.
- Display of dialed numbers screen and received calls screen, deleting dialed numbers and received numbers.
- Display of phone information screen.
- Changing the security code.

When you set this function, the speed dial screen is not displayed while you are driving.

OTHER FUNCTIONS



1. Touch "On".



2. Input the security code and touch "OK".

- Initializing the security code
You can initialize the settings.



1. Touch "Default".



2. Input the security code and touch "OK".



3. Touch "YES".

(f) Set a Bluetooth phone

- Selecting a Bluetooth phone

In case you register more than one Bluetooth phone, you need to choose a favorite one.



1. Touch “Settings” to display “Settings” screen.



2. Touch “Select Telephone” to display “Select Telephone” screen. You can select the Bluetooth phone from a maximum of 6 numbers.

“Empty” is displayed when you have not registered a Bluetooth phone yet.

Bluetooth mark is displayed when you choose the phone.



Although you can register up to 6 Bluetooth phones in the system, only one Bluetooth phone can function at a time.



3. Touch “OK”.



When the result message is displayed, you can use the Bluetooth phone.



OTHER FUNCTIONS

When another Bluetooth phone is trying to connect, this screen is displayed.



Touch "YES" or "NO".

● Displaying Bluetooth information

You can see or set the information of the Bluetooth phone on the system.

Device Name The name of Bluetooth phone which is displayed on the screen. You can change it into a desired name.

Bluetooth Device Address The address peculiar to the system. You cannot change it.



1. Select the desired phone and touch "Information".



2. Touch "Change".



3. When you complete the setting, touch



● **Changing a Device Name**

You can change a Device Name. If you change a Device Name, the name registered in your cellular phone is not changed.



1. Touch “Change”.



2. Use the software keyboard to input the Device name.

● **Changing the Bluetooth settings**

You can change the display and settings of Bluetooth information on the system.

The information displays the following items.

Device Name The name in the Bluetooth network. You can change it.

Passkey The password when you register your cellular phone in the system. You can change it into the figure of 4-8 digits.

Bluetooth Device Address

. The address peculiar to the system. You can not change it. If you have registered two Bluetooth phones with the same Device Name or Passkey and you cannot distinguish one from the other, refer to it.

When you change the Device Name or Passkey, do the followings.



1. Touch “Bluetooth”.



2. Touch “Change” of “Device Name” or “Passkey”.



OTHER FUNCTIONS



3. Use the software keyboard to input the Device Name.

You can input up to 20 characters.



4. Input a Passkey with 4 - 8 digits.

When you touch ◀, the inputted number is deleted.



5. When you complete the setting, touch



- Initializing the Bluetooth settings.
You can initialize the settings.



1. Touch "Default".



2. Touch "YES".

- Deleting a Bluetooth phone



1. Touch “Delete” of “Bluetooth Telephone”.



2. Select the telephone you want to delete and touch “OK”.



3. Touch “YES”.

When you delete the telephone while another Bluetooth phone is connecting, this message is displayed.



Touch “YES”.

- Displaying the information of the Bluetooth phone you delete

You can display the information of the Bluetooth phone before you delete it and you can make sure whether the telephone you delete is correct or not.



1. Select the telephone you want to display the information about.



OTHER FUNCTIONS



2. When you complete confirming it, touch  .

Speech command system

The speech command system enables you to operate the navigation system by giving a command.

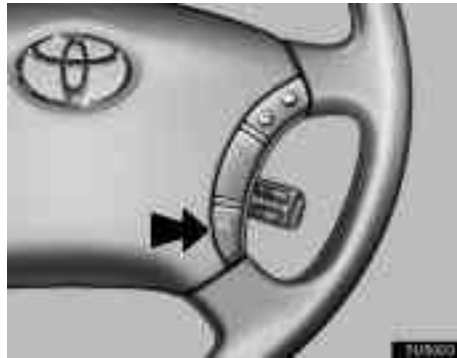

1. Push the speech command switch.

A beep sounds and on screen message is displayed with an indicator at the top left.



2. Give a command while an indicator is shown in the display. If you want to check the command list, touch "Help" to display the Help screen. (See "Help screen" on page 144.) When you touch "Cancel", the previous screen returns.

If the navigation system does not respond or the confirmation screen does not disappear, please push the speech command switch and try again.

If no command is given, a beep sounds and the indicator disappears 6 seconds later.

If the system does not recognize your speech, the system will respond with this message ("System does not recognize this command, please rephrase your command."). Start the operation from the beginning.



►Microphone

It is unnecessary to speak directly into the microphone when giving a command.

Speech command example: Searching for a route to your home.

1. Push the speech command switch.
2. Say **"Home"**.

You can also say the street name or address. (ex. say *"Woodridge Avenue"*.)

If your home is not registered, you will hear *"Home is not registered"*.



3. If the system recognized the command, the recognition result **"Home"** is displayed on the top of the screen with the screen message. (Displayed message and the switches on the screen depend on the situation.)

Touch or say *"Cancel"*, and the system will be canceled. Touch or say *"Help"*, and displays the *"Help"* screen.



4. Touch **"Enter"** or say **"Enter destination"**, and the system starts searching for a route to your home. (If the destination is already registered, **"Add"** or **"Replace"** is displayed on the screen.)

Touch or say *"Cancel"*, and the search will be canceled.

When you search the destination by **"POI Name"**, this screen is displayed.



Touch **"Enter"** or say *"Enter destination"*.



OTHER FUNCTIONS

When you touch “Show List”, you can search another spot in its category.

INFORMATION

In the following conditions, the system may not recognize the command properly.

- *The command is not correct or clear.*
- *There are some noises such as wind noise, etc.*

Help screen

This system has a function which displays the voice recognition help screen. You can see the command list and operating guide on it.

(a) Command List



1. Touch the “Command List” tab on the upper side of the screen and the touch-screen buttons on the right side of the screen to select the desired category.

2. You can scroll through the list of the command list by touching “▲” or “▼”.

Touch “OK” after you check it.

(b) Operating Guide



1. Touch the “Operating Guide” tab on the upper side of the screen and the touch-screen buttons on the right side of the screen to select the desired category.

2. You can scroll through the list of the operating guide by touching “▲” or “▼”.

Touch “OK” after you check it.

Screen adjustment

The brightness or contrast of the screen can be adjusted depending on the brightness of your surroundings. You can also turn the display off.

To display the "Display" screen, push the "DISPLAY" button.

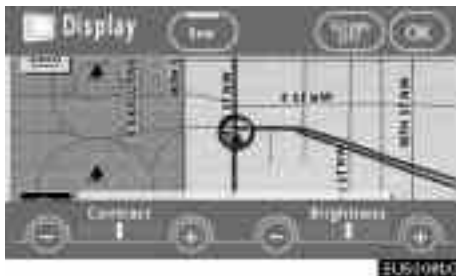

Contrast and brightness adjustment

"Contrast" "+":

Strengthens the contrast of the screen.

"Contrast" "-":

Weakens the contrast of the screen.

"Brightness" "+":

Brightens the screen.

"Brightness" "-":

Darkens the screen.

After adjusting the screen, touch "OK".

If your vehicle is equipped with the rear seat entertainment system, the rear screen turns on or off when "Rear" is touched.

The screen goes off when "Screen Off" is touched. To turn the display screen back on, push any button such as "INFO", etc. The selected screen appears.

INFORMATION

When you do not touch any touch-screen button on the screen for 20 seconds the "Display" screen goes off.



Color and tone adjustment (with rear seat entertainment system)

You can adjust the color and the tone while the DVD video and video CD are being played.

"Color" "R":

Strengthens the red color of the screen.

"Color" "G":

Strengthens the green color of the screen.

"Tone" "+": Strengthens the tone of the screen.

"Tone" "-": Weakens the tone of the screen.

After adjusting the screen, touch "OK".

The rear screen turns on or off when "Rear" is touched.

OTHER FUNCTIONS

The screen turns off when “**Screen Off**” is touched. To turn the screen back on, push any button such as “**INFO**”, etc. The selected screen appears.

INFORMATION

When you do not touch any touch-screen button on the screen for 20 seconds the “Display” screen goes off.



Depending on the position of the headlight switch, the screen changes to either day mode or night mode.

To display the screen in the day mode even with the headlight switch on, touch “**Day Mode**” on the adjustment screen for brightness and contrast control.

If the screen is set in the day mode with the headlight switch turned on, this condition is memorized in the system even with the engine turned off.

Screen setting

1. Push the “**INFO**” button to display the “**Information**” screen.



2. Touch “**Screen Setting**”.

(a) Automatic transition

You can select a function that enables automatic return to the navigation screen from the audio screen.



Select “ON” or “OFF” and then touch “OK”.

“ON”: The navigation screen automatically returns from the audio screen 20 seconds after the end of audio operation.

“OFF”: The audio screen remains on.

(b) Switch color

You can select a color of touch-screen buttons.

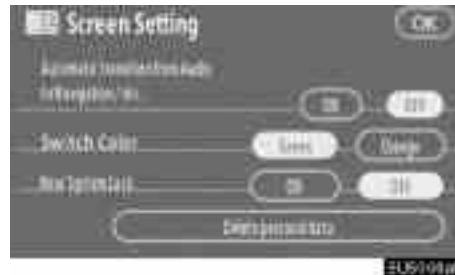

Select “Green” or “Orange” and then touch “OK”.

(c) Rear system lock (with rear seat entertainment system)

If the vehicle is equipped with the rear seat entertainment system, the rear seat entertainment system can be locked to prevent rear passengers from operating the entertainment system.



Select “ON” or “OFF” and then touch “OK”.

“ON”: The rear passengers cannot operate the rear seat entertainment system. Only front passengers can operate the system.

“OFF”: Both the front and rear passengers can operate the rear seat entertainment system.



OTHER FUNCTIONS

(d) Delete personal data

The following personal data can be deleted or returned to their default settings:

- Maintenance conditions
- Maintenance information “off” setting
- Memory points
- Areas to avoid
- Previous points
- Route trace
- User selection settings
- Phone book data
- Dialed numbers and received calls
- Speed dial
- Bluetooth phone data
- Security code

This function is available only when the vehicle is not moving.



1. Touch “Delete personal data”. The “Delete personal data” screen appears.



2. Touch “Delete”. The “Confirmation to delete all personal data” screen appears.



3. Touch “Yes”.

Beep setting

You can set a beep sound off.



Touch “Beep Off”. “Beep Off” is highlighted. To set the beep sound on, touch “Beep Off” again.

Select language

The language of the touch-screen buttons, pop-up messages and the voice guidance can be changed.

1. Push the “INFO” button.



2. Touch “Language”.



3. Touch “English”, “Français” or “Español” to select a language.

4. Touch “I Agree”.

The language is changed and the screen returns to the map display.

OTHER FUNCTIONS

SECTION VI

AUDIO/VIDEO SYSTEM

Audio/video system

Quick reference	152
Using your audio/video system	153
Audio/video system operating hints	189

Quick reference



- 1 Function menu display screen**
To control the radio, CD changer or DVD player, touch the touch-screen buttons. For details, see page 154.
- 2 “TUNE-FILE” knob**
Turn this knob to move the station band and files up or down. For details, see pages 157 and 168.
- 3 “AM” button**
Push this button to choose an AM station. For details, see pages 154 and 157.
- 4 “FM” button**
Push this button to choose an FM station. For details, see pages 154 and 157.
- 5 “DISC-AUX” button**
Push this button to turn the CD changer, DVD player and AUX on. For details, see pages 154, 157, 163 and 171.
- 6 “SCAN” button**
Push this button to scan radio stations or scan the tracks, discs, files or folders. For details, see pages 158, 165, 169, 173 and 176.
- 7 “LOAD-▲” button**
Push this button to display the “LOAD-EJECT” screen or close the display. For details, see page 160.

- 8** “**AUDIO**” button
Push this button to display the audio control screen. For details, see page 153.
- 9** “**SEEK/TRACK**” button
Push either side of this button to seek up or down for a station, or to access a desired track, file or chapter. For details, see pages 158, 164, 168, 172 and 175.
- 10** “**PWR-VOL**” knob
Push this knob to turn the audio system on and off, and turn it to adjust the volume. For details, see page 153.

Using your audio/video system — — Some basics

This section describes some of the basic features of your audio system. Some information may not pertain to your system.

Your audio system works when the ignition switch is set at ACC or ON.

NOTICE

To prevent the battery from being discharged, do not leave the audio system on longer than necessary when the engine is not running.



(a) Turning the system on and off

“**PWR-VOL**”: Push this knob to turn the audio system on and off. Turn this knob to adjust the volume. The system turns on in the last mode used.

“**AUDIO**”: Push this button to display touch-screen buttons for audio system (audio control mode).

You can select the function that enables automatic return to the previous screen from the audio screen. See page 146 for details.

AUDIO/VIDEO SYSTEM



Push “AM”, “FM” or “DISC-AUX” button to turn on the desired mode. The selected mode turns on immediately.

Push these buttons if you want to switch from one mode to another.

If the disc is not set, the CD changer does not turn on.

You can turn off the CD changer by ejecting all the discs. If the audio system was previously off, then the entire audio system will be turned off when you eject all the discs. If the other function was previously playing, it will come on again.



The touch-screen buttons for radio, CD changer and DVD player operation are displayed on the function touch-screen button display screen when the audio control mode is selected. Touch them lightly and directly on the screen.

The selected switch is highlighted.

INFORMATION

- If the system does not respond to a touch of a touch-screen button, move your finger away from the screen and then touch it again.
- You cannot operate dimmed touch-screen buttons.
- Wipe off fingerprints on the surface of the display using a glass cleaning cloth.

(b) Tone and balance

How good an audio program sounds to you is largely determined by the mix of the treble, midrange, and bass levels. In fact, different kinds of music and vocal programs usually sound better with different mixes of treble, mid-range, and bass.

A good balance of the left and right stereo channels and of the front and rear sound levels is also important.

Keep in mind that if you are listening to a stereo recording or broadcast, changing the right/left balance will increase the volume of one group of sounds while decreasing the volume of another.

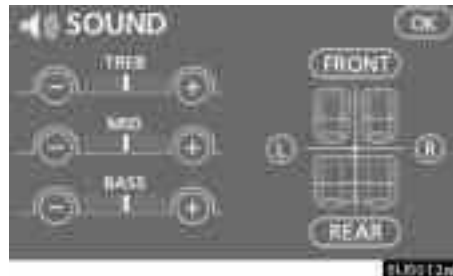

Touching “SOUND” displayed on the screen at the audio control mode will display the sound control mode. Adjust the tone and balance as follows:

To adjust the tone, touch “+” or “-” on the screen. To adjust the balance between the front and rear speakers, touch “FRONT” or “REAR” on the screen, and to adjust the balance between the left and right, touch “L” or “R” on the screen.

“TREB”: Adjusts high-pitched tones.

“MID”: Adjusts mid-pitched tones.

“BASS”: Adjusts low-pitched tones.

As the yellow display approaches “+”, each tone is more emphasized.

(c) DSP control

Touching “DSP” displayed on the screen at the audio control mode will display the DSP control mode. You can turn on/off the surround function and the automatic sound levelizer on the DSP screen.

Surround function:

Select “ON” of “SURROUND” and touch “OK”.

The surround function will turn on.

Automatic sound levelizer (ASL):

When the audio sound becomes difficult to be heard due to road noise, wind noise or other noises while driving, the system adjusts to the optimum volume according to the noise level.

Select “ON” of “ASL” and touch “OK”.

AUDIO/VIDEO SYSTEM

(d) Selecting screen size (with rear seat entertainment system)



Touching **“WIDE”** displayed on the screen in the video control mode will display the wide mode control screen.

“NORMAL”: Displays a 3 × 4 screen, with either side in black.

“WIDE 1”: Widens the 3 × 4 screen horizontally to fill the screen.

“WIDE 2”: Widens the 3 × 4 screen vertically and horizontally, in the same ratio, to fill the screen.

When you touch , the previous screen returns.

(e) Your CD changer

When you insert a disc, touch **“LOAD”** and gently push the disc in with the label side up. This CD changer can store up to four discs. The changer will play from track 1 through to the end of the disc. Then it will play from track 1 of the next disc.

The changer is intended for use with 12 cm (4.7 in.) discs only.



NOTICE

- **Do not stack up two discs for insertion, or it will cause damage to the changer. Insert only one disc into slot at a time.**
- **Never try to disassemble or oil any part of the changer. Do not insert anything other than a disc into the slot.**

**(f) Your DVD player
(with rear seat entertainment system)**

The sound of the rear seat entertainment system can be enjoyed by pushing the "DISC-AUX" button.

(g) AUX adapter

The sound of portable audio players connected to the AUX adapter can be enjoyed. Push the "DISC-AUX" button to switch to AUX mode. For details, refer to the "Owner's Manual".

— Radio operation**(a) Listening to the radio**

Push these buttons to choose either an AM or FM station.

"AM", "FM1" or "FM2" appears on the screen.



Turn the knob clockwise to step up the station band or counterclockwise to step down.

Your radio automatically changes to stereo reception when a stereo broadcast is received. "ST" appears on the screen. If the signal becomes weak, the radio reduces the amount of channel separation to prevent the weak signal from creating noise. If the signal becomes extremely weak, the radio switches from stereo to mono reception. In this case, "ST" disappears from the screen.



(b) Presetting a station

1. Tune in the desired station.
2. Touch one of the touch-screen buttons (1 — 6) you want and hold it until a beep is heard. This sets the station to the touch-screen button and the frequency appears on the touch-screen button.

Each radio mode (AM, FM1 or FM2) can store up to 6 stations. To change the preset station to a different one, follow the same procedure.

The preset station memory is cancelled when the power source is interrupted by battery disconnection or a blown fuse.

(c) Selecting a station

Tune in the desired station using one of the following methods.

Preset tuning: Touch the touch-screen button (1 — 6) for the station you want. The touch-screen button is highlighted and the station frequency appears on the screen.

Seek tuning: Push the “SEEK/TRACK” button on either side. The radio will begin seeking up or down for a station of the nearest frequency and will stop on reception. Each time you push the button, the stations will be searched automatically one after another.

To scan all the frequencies: Touch “SCAN” on the screen or push the “SCAN” button briefly. “SCAN” appears on the screen. The radio will find the next station and stay there for a few seconds, and then scan again. To select a station, touch “SCAN” or push the “SCAN” button again.

To scan the preset stations: Touch “SCAN” on the screen or push the “SCAN” button for longer than a second. “P. SCAN” appears on the screen. The radio will tune in the next preset station, stay there for a few seconds, and then move to the next preset station. To select a station, touch “SCAN” or push the “SCAN” button again.

(d) Radio Data System

Your audio system is equipped with Radio Data Systems (RDS). RDS mode provides you to receive text messages from radio stations that utilize RDS transmitters.

- When RDS is on, the radio can
- only select stations of a particular program type,
 - display messages from radio stations,
 - search for a stronger signal station.

RDS features are available for the use only on FM stations which broadcast RDS information.



“TYPE ◀▶”

If the system receives no RDS stations, “NO PTY” appears on the display.

Each time you touch “TYPE ◀” or “TYPE ▶”, the program type changes as in the following:

- ROCK
- MISC (Miscellaneous)
- INFORM (Information)
- EASY LIS (Easy listening)
- CLS/JAZZ (Classical music and Jazz)
- R & B (Rhythm and Blues)
- RELIGION
- ALARM (Emergency message)

“TYPE SEEK”

When a program is set, “TYPE SEEK” appears. Touch the switch and the system starts to seek the station in the relevant program type.

If any type program station is not found, “NOTHING” appears on the display.

“MSG” (MESSAGE)

If the system receives a radio text from RDS station, “MSG” appears on the display. Touch “MSG”, and a text message is displayed on the screen. This function is available only when the vehicle is not moving.

In case a text message is not accepted in a screen, you can touch “MSG” and hold it to display the rest of the message.

When the system can show the station name, “RDS” appears on the display. Each time you touch “MSG”, indication on the display changes from the band to the station name, a radio text in this order. After six seconds passes, indication returns to the band.



**(e) Traffic announcement
“TRAF”**

A station that regularly broadcasts traffic information is automatically located.

When you touch “TRAF”, “TRAF SEEK” appears on the display and the radio will start seeking any traffic program station.

If no traffic program station is found, “NOTHING” appears on the display.

If a traffic program station is found, the name for traffic program station is displayed and “TRAF” is lit for a while until a traffic announcement is received.

— CD changer operation



(a) Inserting discs

The ignition switch must be set at ACC or ON.

Your CD changer can store up to 4 discs.

You can set a disc at the lowest empty disc number.

1. Push the “LOAD-▲” button. The “LOAD-EJECT” screen appears.



2. Touch “LOAD”. The display opens.



3. The amber indicators at either side of the slot start blinking. When the indicators change to green, insert only one disc. After the disc is loaded, the amber indicators at either side of the slot start blinking again. When the indicators change to green, you can insert the next disc.

4. Push the “LOAD-▲” button to close the display.

The changer will automatically start playing from the last disc you inserted.

If the label faces down, the disc cannot be played. In this case, “CD CHECK” appears on the screen.

⚠ CAUTION

- Do not place anything on the opened display, as such items may be thrown about and possibly injure people in the vehicle during sudden braking or in an accident.
- To reduce the chance of injury in case of an accident or sudden stop while driving, keep the display closed.
- Take care not to jam your hand while the display is moving. Otherwise, you could be injured.

NOTICE

- Do not obstruct the display while it is moving. It could damage your audio system.
- Do not insert one disc stacked on top of another one or feed them in continuously, to prevent discs from getting stuck in the changer.

INFORMATION

Under extremely cold conditions, the display may react slowly or operation sound may become louder.

(b) Ejecting discs

- A single disc alone:



1. Push the “LOAD-▲” button. The “LOAD-EJECT” screen appears.



2. Touch the disc number to be ejected.

AUDIO/VIDEO SYSTEM

The display opens and the amber indicators at either side of the slot start blinking. After the disc is ejected, the amber indicators change to green. A disc can be inserted.

- **All the discs:**

1. Push the “LOAD-

2. Touch “All CD 

The display opens and the amber indicators at either side of the slot start blinking. After the disc is ejected, the blinking indicators stay on.

3. **Remove the disc.**

The indicators start blinking again and the next disc is ejected.

If a disc is not remove within 15 seconds after it is ejected, the operation will be canceled.

When all the discs are removed, the amber indicators change to green. A disc can be inserted.

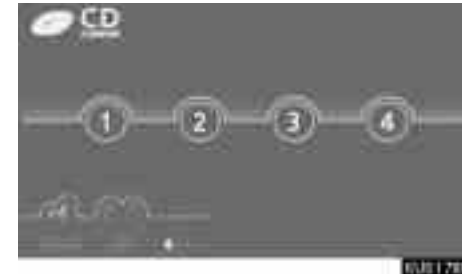

The numbers of the trays where the disc is not set are dimmed.



(c) Playing a disc

Push the “DISC-AUX” button if the discs are already loaded in the changer.

“CD CHANGER” appears on the screen.

The discs set in the changer are played continuously, starting with the last disc you inserted. The disc number of the disc currently being played, the track number and the time from the beginning of the program appear on the screen.

When play of one disc ends, the first track of the following disc starts. When play of the final disc ends, play of the first disc starts again.

The changer will skip any empty disc trays.

Vehicles with rear entertainment system —
If the DVD player is turned on, push the “DISC-AUX” button again to switch to the CD changer.

If the rear seat entertainment system is on, pushing the “DISC-AUX” button switches the sound of the front audio system and that of the rear seat entertainment system.



(d) Selecting a desired disc

Touch the desired disc number on the screen.

The selected disc number is highlighted.

The changer will start playing the selected disc from the first track.



(e) Playing an audio disc
Push the “AUDIO” button to display this screen.



SELECTING A DESIRED TRACK

“**SEEK/TRACK**” button: Use for a direct access to a desired track.

Push either side of the “SEEK/TRACK” button and repeat it until the desired track number appears on the screen. As you release the button, the changer will start playing the selected track from the beginning.

“**TRACK LIST**”: The desired track can be selected from a list. This function is available only when the vehicle is not moving.

Touch “TRACK LIST”. The track list is displayed.



Touch the desired track number. The changer will start playing the selected track from the beginning.

▲: By touching this touch-screen button, the list moves up by 6 track groups. If this touch-screen button is touched when the top page of the list is displayed, the last page is displayed.

▼: By touching this touch-screen button, the list moves down by 6 track groups. If this touch-screen button is touched when the last page of the list is displayed, the top page is displayed.

Vehicles with rear entertainment system — While the DVD player is in operation, the chapter or track can be changed by pushing either side of the “SEEK/TRACK” button.

Fast forward: Push “^” side of the “SEEK/TRACK” button and hold it to fast forward the disc. When you release the button, the changer will resume playing from that position.

Reverse: Push “v” side of the “SEEK/TRACK” button and hold it to reverse the disc. When you release the button, the changer will resume playing.



SEARCHING FOR A DESIRED TRACK OR DISC

Searching for a desired track —

Touch “SCAN” on the screen or push the “SCAN” button briefly while the disc is playing.

“SCAN” appears on the screen. The changer will play the next track for 10 seconds, then scan again. To select a track, touch “SCAN” on the screen or push the “SCAN” button a second time. If the changer reaches the end of the disc, it will continue scanning at track 1.

After all the tracks are scanned in one pass, normal play resumes.

Searching for a desired disc —

Touch “SCAN” on the screen or push the “SCAN” button for longer than a second while the disc is playing.

“D-SCAN” appears on the screen. The program at the beginning of each audio disc will be played for 10 seconds. To continue listening to the program of your choice, touch “SCAN” on the screen or push the “SCAN” button a second time.

After all the audio discs are scanned in one pass, normal play resumes.

AUDIO/VIDEO SYSTEM



OTHER FUNCTIONS

“RPT”: Use it for automatic repeat of the track or disc you are currently listening to.

Repeating a track —

Touch “RPT” briefly while the track is playing. “RPT” appears on the screen. When the track is finished, the changer will automatically go back to the beginning of the track and play the track again. To cancel it, touch “RPT” once again.

Repeating a disc —

Touch “RPT” for longer than a second while the disc is playing. “D-RPT” appears on the screen. When the disc is finished, the changer will automatically go back to the beginning of the disc and play the disc again. To cancel it, touch “RPT” once again.

“RAND”: Use it for automatic and random selection.

Playing the tracks on one disc in random order —

Touch “RAND” briefly while the disc is playing. “RAND” appears on the screen. The system selects a track on the disc being listened to in random order. To cancel it, touch “RAND” once again.

Playing the tracks on all the audio discs in random order —

Touch “RAND” for longer than a second while the disc is playing. “D-RAND” appears on the screen. The system selects a track on all the audio discs in the changer in random order. To cancel it, touch “RAND” once again.

If a CD-TEXT disc is inserted, the title of the disc and track will be displayed. Up to 29 letters can be displayed.



(f) Playing a MP3/WMA disc

Push the “AUDIO” button and touch a MP3/WMA disc number to display this screen.

SELECTING A DESIRED FOLDER

“**FOLDER▲**” : Touch this touch-screen button to go to the next folder.

“**FOLDER▼**” : Touch this touch-screen button to go to the previous folder.

“**FOLDER LIST**” : The desired folder can be selected in a list. This function is available only when the vehicle is not moving.

Touch “**FOLDER LIST**”. The folder list is displayed.

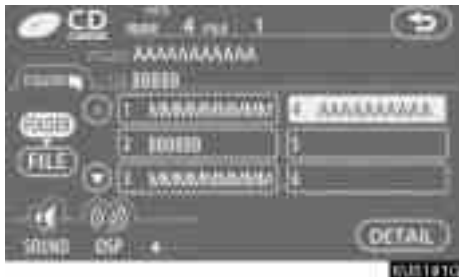

Touch the desired folder number. The changer will start playing the first file of the selected folder.

▲ : By touching this touch-screen button, the list moves up by 6 folder groups. If this touch-screen button is touched when the top page of the list is displayed, the last page is displayed.

▼ : By touching this touch-screen button, the list moves down by 6 folder groups. If this touch-screen button is touched when the last page of the list is displayed, the top page is displayed.

“**FILE**” : The file list is displayed.

“**DETAIL**” : Details of the file currently playing is displayed. This function is available only when the vehicle is not moving.



AUDIO/VIDEO SYSTEM

SELECTING A DESIRED FILE

“SEEK/TRACK” button: Use for direct access to a desired file.

Push either side of the “SEEK/TRACK” button and repeat it until the desired file number appears on the display. As you release the button, the changer will start playing the selected file from the beginning. When “RAND” or “FLD-RPT” is on, the file number within the folder you are currently being listened to appears.

Fast forward: Push “^” side of the “SEEK/TRACK” button and hold it to fast forward the disc. When you release the button, the changer will resume playing from that position.

Reverse: Push “v” side of the “SEEK/TRACK” button and hold it to reverse the disc. When you release the button, the changer will resume playing.

“TUNE-FILE” knob: Use for direct access to a desired file in the disc.

Turn the “TUNE-FILE” knob to step up or down all the files in the disc you are currently listening to. The file number appears on the display. When “RAND” or “FLD. RPT” is on, all the files in the folder you are currently being listened to can be stepped up or down.

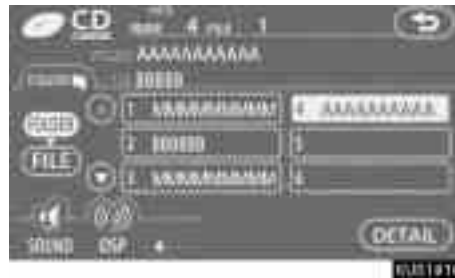

“FILE”: The desired file can be selected in a list. This function is available only when the vehicle is not moving.

Touch “FILE”. The file list is displayed.

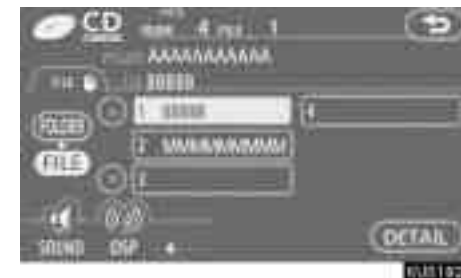

Touch the desired file number. The changer will start playing the selected file from the beginning.

▲: By touching this touch-screen button, the list moves up by 6 file groups. If this touch-screen button is touched when the top page of the list is displayed, the last page is displayed.

▼: By touching this touch-screen button, the list moves down by 6 file groups. If this touch-screen button is touched when the last page of the list is displayed, the top page is displayed.

“FOLDER”: The folder list is displayed.

“DETAIL”: Details of the file currently playing is displayed. This function is available only when the vehicle is not moving.



SEARCHING FOR A DESIRED FILE

Touch “SCAN” on the screen or push the “SCAN” button briefly while the disc is playing.

“SCAN” appears on the screen. The changer will play the next file in the folder for 10 seconds, then scan again. To select a file, touch “SCAN” on the screen or push the “SCAN” button a second time. If the changer reaches the end of the folder, it will continue scanning from file 1.

After all the files are scanned in one pass, normal play resumes.



SEARCHING FOR A DESIRED FOLDER

Touch “SCAN” on the screen or push the “SCAN” button for longer than a second while the disc is playing.

“FLD.SCAN” appears on the screen. The program at the beginning of each folder will be played for 10 seconds. To continue listening to the program of your choice, touch “SCAN” on the screen or push the “SCAN” button a second time.

After all the folders are scanned in one pass, normal play resumes.



OTHER FUNCTIONS

“RPT”: Use it for automatic repeat of the file or folder you are currently listening to.

Repeating a file —

Touch “RPT” briefly while the file is playing. “RPT” appears on the screen. When the file is finished, the changer will automatically go back to the beginning of the file and play the file again. To cancel it, touch “RPT” once again.

Repeating a folder —

Touch “RPT” for longer than a second while the folder is playing. “FLD.RPT” appears on the screen. When the folder is finished, the changer will automatically go back to the beginning of the folder and play the folder again. To cancel it, touch “RPT” once again.

AUDIO/VIDEO SYSTEM

“RAND”: Use it for automatic and random selection of the folder or the disc which you are currently listening to.

Playing the files in one folder in random order —

Touch “RAND” briefly while the disc is playing. “RAND” appears on the screen. The system selects a file in the folder you are currently listening to. To cancel it, touch “RAND” once again.

Playing the files in all the folders on one disc in random order —

Touch “RAND” for longer than a second while the disc is playing. “FLD.RAND” appears on the screen. The system selects a file in all the folders. To cancel it, touch “RAND” once again.

When a file is skipped or the system is inoperative, touch “RAND” to reset.

(g) If the player malfunctions

If “CD ERROR” appears on the screen, audio signals of the disc cannot be read or the system has trouble. Push the “DISC” button once again.

If the changer does not operate, check that the disc surface is not soiled or damaged. If the disc is O.K., the temperature of the changer’s internal mechanism may be raised because of high external temperature. Remove the disc from the changer to cool it.

If the changer still does not operate, have it checked by your dealer.

If an MP3/WMA disc contains CD-DA files, only CD-DA files are played. If an MP3/WMA disc contains files other than CD-DA, only MP3/WMA files are played.

—DVD player operation

The DVD player can play DVD video, audio CD, video CD, CD text, dts-CD or MP3 disc only when a disc is loaded in the DVD player. A WMA disc cannot be played.

Refer to “Rear seat entertainment system” for details.

For appropriate discs for this player, see “Audio/video system operating hints” on page 189.

(a) Inserting the disc



Insert the disc into the slot with the label side up.

An adapter must be used for 8 cm (3 in.) discs which are loaded in the same manner as for 12 cm (4.7 in.) discs.



The indicator light turns on while the disc is loaded.

If the label faces forward, the disc cannot be played. In this case, "DISC CHECK" appears on the screen.

If a disc which is not playable is inserted, "DISC CHECK" will also appear on the screen. For appropriate discs for this player, see "Audio/video system operating hints" on page 189.

NOTICE

Never try to disassemble or oil any part of the DVD player. Do not insert anything other than a disc into the slot.



(b) Ejecting a disc

Push the  button.



(c) Playing a disc

Push the "DISC-AUX" button if a disc is already loaded in the player.

"DVD" appears on the screen. (If the CD changer is turned on, push the "DISC" button again to switch to the DVD player.)



(d) Operating an audio CD
PLAYING AN AUDIO CD

CD text only — The disc title and track title will appear on the screen when pushing the “DISC-AUX” button.

Push the “AUDIO” button to display this screen.



SELECTING A DESIRED TRACK

“SEEK/TRACK” button: Use for direct access to a desired track.

Push either side of the “SEEK/TRACK” button and repeat it until the desired track number appears on the display. As you release the button, the player will start playing the selected track from the beginning.

“TRACK LIST”: The desired track can be selected from a list. This function is available only when the vehicle is not moving.

Touch “TRACK LIST”. The track list is displayed.

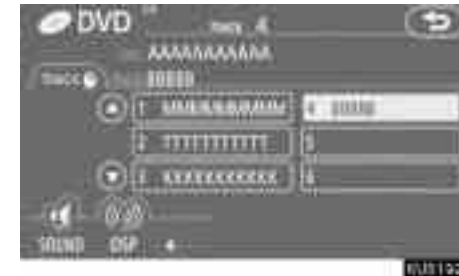

Touch the desired track number. The player will start playing the selected track from the beginning.

▲: By touching this touch-screen button, the list moves up by 6 track groups. If this touch-screen button is touched when the top page of the list is displayed, the last page is displayed.

▼: By touching this touch-screen button, the list moves down by 6 track groups. If this touch-screen button is touched when the last page of the list is displayed, the top page is displayed.

Fast forward: Touch “^” side of “SEEK/TRACK” button and hold it to fast forward the disc. When you release the button, the player will resume playing from that position.

Reverse: Touch “∨” side of the “SEEK/TRACK” button and hold it to reverse the disc. When you release the button, the player will resume playing.



SEARCHING FOR A DESIRED TRACK

Touch “SCAN” on the screen or push the “SCAN” button.

“SCAN” will be highlighted on the screen. The player will play the next track for 10 seconds, then scan again. To select a track, touch “SCAN” on the screen or push the “SCAN” button a second time. If the player reaches the end of the disc, it will continue scanning at track 1.

After all the tracks are scanned in one pass, normal play resumes.



OTHER FUNCTIONS

“RPT”: Use it for automatic repeat of the track you are currently listening to.

Touch “RPT” while the track is playing. When the track is finished, the player will automatically go back to the beginning of the track and play the track again. To cancel it, touch “RPT” once again.

“RAND”: Use it for automatic and random selection of the disc which you are currently listening to.

When “RAND” is touched, the system selects a track in the disc you are currently listening to. To cancel it, touch “RAND” once again.

If a CD-TEXT disc is inserted, the title of the disc and track will be displayed. Up to 29 letters can be displayed.



**(e) Operating a MP3 DISC
PLAYING A MP3 DISC**

Push the “AUDIO” button to display this screen.

SELECTING A DESIRED FOLDER

“**FOLDER▲**” : Touch this touch-screen button briefly to go to the next folder.

“**FOLDER▼**” : Touch this touch-screen button briefly to go to the previous folder. To jump up to the first folder, touch and hold this touch-screen button until the beep sounds.

“**FOLDER LIST**” : The desired folder can be selected in a list. This function is available only when the vehicle is not moving.

Touch “FOLDER LIST”. The folder list is displayed.



Touch the desired folder number. The player will start playing the first file of the selected folder.

▲ : By touching this touch-screen button, the list moves up by 6 folder groups. If this touch-screen button is touched when the top page of the list is displayed, the last page is displayed.

▼ : By touching this touch-screen button, the list moves down by 6 folder groups. If this touch-screen button is touched when the last page of the list is displayed, the top page is displayed.

FILE : The file list is displayed.

DETAIL : Details of the file currently playing is displayed. This function is available only when the vehicle is not moving.



SELECTING A DESIRED FILE

“SEEK/TRACK” button: Use for direct access to a desired file.

Push either side of the “SEEK/TRACK” button and repeat it until the desired file number appears on the display. As you release the button, the player will start playing the selected file from the beginning.

Fast forward: Push “^” side of the “SEEK/TRACK” button and hold it to fast forward the disc. When you release the button, the player will resume playing from that position.

Reverse: Push “v” side of the “SEEK/TRACK” button and hold it to reverse the disc. When you release the button, the player will resume playing.

“FILE”: The desired file can be selected in a list. This function is available only when the vehicle is not moving.

Touch “FILE”. The file list is displayed.

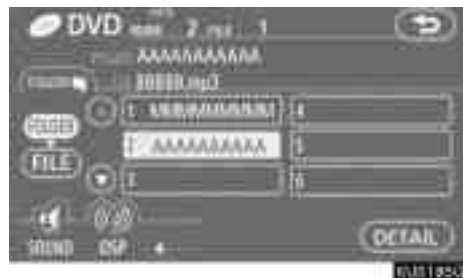

Touch the desired file number. The player will start playing the selected file from the beginning.

▲: By touching this touch-screen button, the list moves up by 6 file groups. If this touch-screen button is touched when the top page of the list is displayed, the last page is displayed.

▼: By touching this touch-screen button, the list moves down by 6 file groups. If this touch-screen button is touched when the last page of the list is displayed, the top page is displayed.

“FOLDER”: The folder list is displayed.

“DETAIL”: Details of the file currently playing is displayed. This function is available only when the vehicle is not moving.

AUDIO/VIDEO SYSTEM



SEARCHING FOR A DESIRED FILE

Touch “SCAN” on the screen or push the “SCAN” button briefly.

“SCAN” appears on the screen. The DVD player will play the next file in the folder for 10 seconds, then scan again. To select a file, touch “SCAN” on the screen or push the “SCAN” button a second time. If the player reaches the end of the folder, it will continue scanning from file 1.

After all the files are scanned in one pass, normal play resumes.



SEARCHING FOR A DESIRED FOLDER

Touch and hold “SCAN” on the screen or push the “SCAN” button until the beep sounds.

“FLD.SCAN” appears on the screen. The DVD player will play the file at the beginning of each folder for 10 seconds, then scan again. To select a file, touch “SCAN” on the screen or push the “SCAN” button a second time.

After all the folders are scanned in one pass, normal play resumes.



OTHER FUNCTIONS

“RPT”: Use it for automatic repeat of the file or folder you are currently listening to.

Repeating a file —

Touch “RPT” briefly while the file is playing. “RPT” appears on the screen. When the file is finished, the player will automatically go back to the beginning of the file and play the file again. To cancel it, touch “RPT” once again.

Repeating a folder —

Touch and hold “RPT” until the beep sounds while the folder is playing. “FLD.RPT” appears on the screen. When the folder is finished, the player will automatically go back to the beginning of the folder and play the folder again. To cancel it, touch “RPT” once again.

“RAND”: Use it for automatic and random selection of the folder which you are currently listening to or of all the folders.

Playing the files in one folder in random order —

Touch “RAND” briefly. “RAND” appears on the screen. The system selects a file in the folder you are currently listening to. To cancel it, touch “RAND” once again.

Playing the files in all the folders in random order —

Touch and hold “RAND” until the beep sounds. “FLD.RAND” appears on the screen. The system selects a file in the folders of all the trays which are set and plays it. To cancel it, touch “RAND” once again.

When a file is skipped or the system is inoperative, touch “RAND” to reset.

(f) Operating a DVD video disc

NOTE: The playback condition of some DVD video discs may be determined by a DVD video software producer. This DVD player plays a disc as the software producer intended. So some functions may not work properly. Be sure to read the instruction manual for the DVD video disc separately provided. For the detailed information about DVD video discs, see “(h) DVD player and DVD video disc information”.

Precautions on DVD video disc

When recording with a DVD video or video CD, audio tracks may not record in some cases while the menu is displayed. As audio will not play in this case, verify that the video tracks are playing and then activate playback.

When playback of a disc is completed:

- If an audio CD or MP3 disc is playing, the first track or file starts.
- If a DVD video or video CD is playing, playback will stop or the menu screen will be displayed.

The title/chapter number and playback time display may not appear while playing back certain DVD video discs.

CAUTION

Conversational speech on some DVDs is recorded at a low volume to emphasize the impact of sound effects. If you adjust the volume assuming that the conversations represent the maximum volume level that the DVD will play, you may be startled by louder sound effects or when you change to a different audio source. The louder sounds may have a significant impact on the human body or pose a driving hazard. Keep this in mind when you adjust the volume.

AUDIO/VIDEO SYSTEM



This "DVD Hint!" screen appears when the video screen is first displayed after the ignition switch is set at ACC or ON.

Touch "OK" when you read the message.



PLAYING A DVD DISC

Push the "AUDIO" button to display this screen.

When you touch "WIDE", the screen mode can be changed.

If you touch "PICTURE" when the vehicle is completely stopped and the parking brake is applied, the video screen returns.



DISPLAYING DVD CONTROLS

If you touch a part of the screen, where controls are not located while watching video, DVD controls will appear.

"Page2": Touching this will display on the second page of DVD controls.

"Page1": Touching this will display the top page of DVD controls.

“Hide Buttons”: Touching this will turn off the controls from the screen.

If “” appears on the screen when you touch a control, the operation relevant to the control is not permitted.

DESCRIPTION OF DVD CONTROLS

● Top page of DVD video controls

“Menu” and “Top Menu”: If you touch any of the above controls, the menu screen for DVD video appears. (For the operation, see the manual that come with the DVD video disc provided separately.)

: The menu control key appears on the screen. (See page 179.)

: Touching this will pause the video screen. When you touch this again, the video screen advances frame by frame.

: Touching this will fast reverse during playback.

: Touching this will stop the video screen.

: Touching this will pause during playback and resume normal play during pause or slow forward.

: Touching this will fast forward during playback and forward slowly during pause.

● Second page of DVD video controls

“Setup”: The initial set up screen appears. (See page 181.)

“Search”: The title search screen appears. (See page 180.)

“Return”: Touching this will display the pre-determined scene and start playing from there.





“AUDIO”: The audio changing screen appears. (See page 180.)

“Subtitle”: The subtitle changing screen appears. (See page 180.)

“Angle”: The angle selection screen appears. (See page 181.)



SELECTING A MENU ITEM

Enter the menu item using , ,  and  and touch “Enter”. The player starts playing video for that menu item. (For details, see the manual that comes with the DVD video disc provided separately.)

Each time you touch “Move Buttons”, the controls on the screen move upward and downward.

When you touch “<<OFF”, the controls will disappear. To display them again, touch “ON”.

When you touch , the previous screen returns.

AUDIO/VIDEO SYSTEM



SEARCHING BY TITLE

Enter the title number and touch “Enter”. The player starts playing video for that title number.

When you push either side of the “SEEK/TRACK” button, you can select a chapter.

If you enter the wrong numbers, touch “Clear” to delete the numbers.

When you touch , the previous screen returns.



CHANGING THE SUBTITLE LANGUAGE

Each time you touch “Subtitle”, the language is selected from the ones stored in the discs and changed.

When you touch , the previous screen returns.



CHANGING THE AUDIO LANGUAGE

Each time you touch “AUDIO”, the language is selected from the ones stored in the discs and changed.

When you touch , the previous screen returns.



CHANGING THE ANGLE

The angle can be selected for discs that are multi-angle compatible when the angle mark appears on the screen.

Each time you touch “Angle”, the angle changes.

When you touch , and the previous screen returns.



SETUP MENU

There are initial setting touch-screen buttons on the “Setup Menu” screen.

After you change the initial setting, touch “Enter”. The initial setting screen will be turned off and return to the picture previously.

When “Default” is touched, all menus are initialized.

The initial setting can be changed.

- **Audio language**

You can change the audio language.

1. Touch “Audio Language”.
2. Touch the language you want to hear on the “Select Audio Language” screen.

If you cannot find the language you want to hear on this screen, touch “Others” and enter a language code. For the entry of language code, see the following “ENTER AUDIO LANGUAGE CODE”.

To return to the “Setup Menu” screen, touch the .

- **Subtitle language**

You can change the subtitle language.

1. Touch “Subtitle Language”.
2. Touch a language you want to read on the “Select Subtitle Language” screen.

AUDIO/VIDEO SYSTEM

If you cannot find the language you want to read on this screen, touch “Others” and enter a language code. For the entry of language code, see the following “ENTER AUDIO LANGUAGE CODE”.

To return to the “Setup Menu” screen, touch the .

● DVD language

You can change the language on the DVD video menu.

1. Touch “DVD Language”.
2. Touch the language you want to read on the “DVD Language” screen.

If you cannot find the language you want to read on this screen, touch “Others” and enter a language code. For the entry of language code, see the following “ENTER AUDIO LANGUAGE CODE”.

To return to the “Setup Menu” screen, touch .

● Angle mark

The multi-angle mark can be turned on or off on the screen while the disc which is multi-angle compatible is being played.

Each time you touch “Angle Mark”, the angle mark on the screen turns on or off alternately.

● Parental lock

The level of viewer restrictions can be changed.

1. Touch “Parental Lock”.
2. Enter the 4-digit personal code on the “Enter Personal Code” screen.

If you enter the wrong numbers, touch “Clear” to delete the numbers.

10 touches of “Clear” will initialize the personal code.

To return to the “Setup Menu” screen, touch .

3. Touch a parental level (1 — 8) on the “Select Restriction Level” screen. Touch the  switch to return to the “Setup Menu” screen.

ENTER AUDIO LANGUAGE CODE

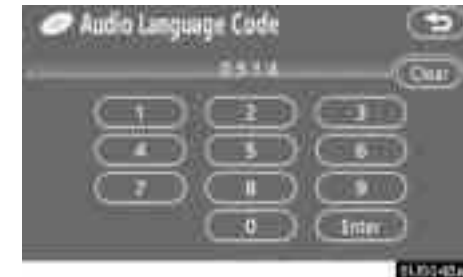

If you touch “Others” on the “Select Audio Language” screen, “Select Subtitle Language” screen or “DVD Language” screen, you can select the language you want to hear or read by entering a language code.

1. Enter the 4-digit language code.

If you enter the wrong numbers, touch “Clear” to delete the numbers.

2. Touch “Enter”.

Code	Language
1001	Japanese
0514	English
0618	French
0405	German

AUDIO/VIDEO SYSTEM

0920	Italian
0519	Spanish
2608	Chinese
1412	Dutch
1620	Portuguese
1922	Swedish
1821	Russian
1115	Korean
0512	Greek
0101	Afar
0102	Abkhazian
0106	Afrikaans
0113	Amharic
0118	Arabic
0119	Assamese
0125	Aymara
0126	Azerbaijani
0201	Bashkir
0205	Byelorussian
0207	Bulgarian
0208	Bihari

0209	Bislama
0214	Bengali
0215	Tibetan
0218	Breton
0301	Catalan
0315	Corsican
0319	Czach
0325	Welsh
0401	Danish
0426	Bhutani
0515	Esperanto
0520	Estonian
0521	Basque
0601	Persian
0609	Finnish
0610	Fiji
0615	Faroese
0625	Frisian
0701	Irish
0704	Scots-Gaelic
0712	Galician

0714	Guarani
0721	Gujarati
0801	Hausa
0809	Hindi
0818	Croatian
0821	Hungarian
0825	Armenian
0901	Interlingua
0905	Interlingue
0911	Inupiak
0914	Indonesian
0919	Icelandic
0923	Hebrew
1009	Yiddish
1023	Javanese
1101	Georgian
1111	Kazakh
1112	Greenlandic
1113	Cambodian
1114	Kannada
1119	Kashmiri

AUDIO/VIDEO SYSTEM

1121	Kurdish
1125	Kirghiz
1201	Latin
1214	Lingala
1215	Laothian
1220	Lithuanian
1222	Latvian
1307	Malagasy
1309	Maori
1311	Macedonian
1312	Malayalam
1314	Mongolian
1315	Moldavian
1318	Marathi
1319	Malay
1320	Maltese
1325	Burmese
1401	Nauru
1405	Nepali
1415	Norwegian
1503	Occitan

1513	(Afan)Oromo
1518	Oriya
1601	Panjabi
1612	Polish
1619	Pashto, Pushto
1721	Quechua
1813	Rhaeto-Romance
1814	Kirundi
1815	Romanian
1823	Kinyarwanda
1901	Sanskrit
1904	Sindhi
1907	Sangho
1908	Serbo-Croatian
1909	Sinhalese
1911	Slovak
1912	Slovenian
1913	Samoaan
1914	Shona
1915	Somali
1917	Albanian

1918	Serbian
1919	Siswati
1920	Sesotho
1921	Sundanese
1923	Swahili
2001	Tamil
2005	Telugu
2007	Tajik
2008	Thai
2009	Tigrinya
2011	Turkmen
2012	Tagalog
2014	Setswana
2015	Tonga
2018	Turkish
2019	Tsonga
2020	Tatar
2023	Twi
2111	Ukrainian
2118	Urdu
2126	Uzbek

2209	Vietnamese
2215	Volapük
2315	Wolof
2408	Xhosa
2515	Yoruba
2621	Zulu

SETUP OPERATION FROM THE REAR SEAT



This screen appears when a rear passenger selects the setup menu.

If you want to cancel the setup operation from the rear seat, touch "PLAY". The player will resume normal play.

Under the same condition, the rear passenger can cancel the setup operation from the front seat.

To lock the operation of the player from the rear seat, see "(c) Rear system lock" on page 147.



(g) Operating a video CD

PLAYING A VIDEO CD

Push the "AUDIO" button to display this screen.

When you touch "WIDE", the screen mode can be changed.

If you touch "PICTURE" when the vehicle is completely stopped and the parking brake is applied, the video screen returns.



DISPLAYING VIDEO CD CONTROLS

If you touch the part where controls are not located while you are watching video on the video CD, video CD controls will appear.

“Page2”: Touching this will display on the second page of video CD controls.

“Page1”: Touching this will display on the top page of video CD controls.

“Hide Buttons”: Touching this will turn off the controls from the screen.

If “” appears on the display when you touch a control, the operation is not permitted.

DESCRIPTION OF VIDEO CD CONTROLS

● **Controls on top page**

“Select Number”: The track or number search screen appears. (See “SEARCHING BY TRACK” on page 187.)

“Prev. Menu”: When you touch this while the disc menu is displayed, the previous page appears on the screen. If you touch this while the player is playing video, the previous track is searched and played.

“Next Menu”: When you touch this while the disc menu is displayed, the next page appears on the display. If you touch this while the player is playing video, the next track is searched and played.

“Main/Sub”: A multiplex transmission changing control. The mode changes from Main/Sub to Main, to Sub and back to Main/Sub by touching this control.

“Return”: Touching this will display the predetermined scene and start playing from there.

● **Controls on second page**

: Use this to pause the video screen. When you touch this again, the video screen advance frame by frame.

: Touch this to fast reverse during playback.

: Touch this to pause during playback and resume playing during pause.

: Touch this to fast forward during the playback and start playing slowly during pause.



SEARCHING BY TRACK

Enter the track numbers and touch “Enter”. The player starts playing video for that title number.

You can select a track number by pushing “^” or “v” on the “SEEK/TRACK” button.

If you enter the wrong numbers, touch “Clear” to delete the numbers.

Touch , and the previous screen returns.

(h) If the player malfunctions

If the player or another unit equipped with the player malfunction, your audio system will display following messages.

If “DISC CHECK” appears on the display: It indicates that the disc dirty, damaged, or it was inserted upside down. Clean the disc or insert it correctly. If a disc which is not playable is inserted, “DISC CHECK” will also appear on the screen. For appropriate discs for this player, see “Audio/video system operating hints” on page 189.

If “REGION CODE ERROR” appears on the display: It indicates that the DVD region code is not set properly.

If “DVD ERROR” appears on the display: It indicates that the inside of the player unit may be too hot due to the very high ambient temperature. Remove the disc from the player and allow the player to cool down.

If the malfunction is not rectified: Take your vehicle to your dealer.

If an MP3 disc contains CD-DA files, only CD-DA files are played. If an MP3 disc contains files other than CD-DA, only MP3 files are played.

(i) DVD player and DVD video disc information







DVD VIDEO DISCS

This DVD player conforms to NTSC color TV formats. The DVD video disc conforming to another formats such as PAL or SE-CAM cannot be used.

Region codes: Some DVD video discs have a region code indicating a country where you can use the DVD video disc on this DVD player. If the DVD video disc is not labeled as “ALL” or “1”, you cannot use it on this DVD player. If you attempt to play an inappropriate DVD video disc on this player, “REGION CODE ERROR” appears on the screen. Even if the DVD video disc does not have a region code, there is a case that you cannot use it.

AUDIO/VIDEO SYSTEM

Marks shown on DVD video discs:

	Indicates NTSC format of color TV.
	Indicates the number of audio tracks.
	Indicates the number of language subtitles.
	Indicates the number of angles.
	Indicates the screen to be selected. Wide screen: 16:9 Standard: 4:3
	Indicates a region code by which this video disc can be played. ALL: in all countries Number: region code

DVD VIDEO DISC GLOSSARY

DVD video discs: Digital versatile Disc that holds video. DVD video discs have adopted "MPEG2", one of the world standards of digital compression technologies. The picture data is compressed by 1/40 on average and stored. Variable rate encoded technology in which the volume of data assigned to the picture is changed depending on the picture format has also been adopted. Audio data is stored using PCM and Dolby digital, which enables higher quality of sound. Furthermore, multi-angle and multi-language features will also help you enjoy the more advanced technology of DVD video.

Viewer restrictions: This feature limits what can be viewed in conformity with a level of restrictions of the country. The level of restrictions varies depending on the DVD video disc. Some DVD video discs cannot be played at all, or violent scenes are skipped or replaced with other scenes.

Level 1: DVD video discs for children can be played.

Level 2 - 7: DVD video discs for children and G-rated movie can be played.

Level 8: All types of the DVD video discs can be played.

Multi-angle feature: You can enjoy the same scene at different angles.

Multi-language feature: You can select a language of the subtitle and audio.

Region codes: The region codes are provided on DVD players and DVD discs. If the DVD video disc does not have the same region code as the DVD player, you cannot play the disc on the DVD player. For region codes, see page 188.

Audio: This DVD player can play liner PCM, Dolby digital and MPEG audio format DVD. Other decoded type cannot be played.

Title and chapter: Video and audio programs stored in DVD video disc are divided in parts by title and chapter.

Title: The largest unit of the video and audio programs stored on DVD video discs. Usually, one piece of movie, one album, or one audio program is assigned as a title.

Chapter: The unit smaller than that of title. A title comprises plural chapters.

Manufactured under license from Dolby Laboratories. "Dolby", "Pro Logic", and the double-D symbol are trademarks of Dolby Laboratories. Confidential unpublished works.

©1992-1997 Dolby Laboratories. All rights reserved.

This product incorporates copyright protection technology that is protected by method claims of certain U.S. patents and other intellectual property rights owned by Macrovision Corporation and other rights owners. Use of this copyright protection technology must be authorized by Macrovision Corporation, and is intended for home and other limited viewing uses only unless otherwise authorized by Macrovision Corporation. Reverse engineering or disassembly is prohibited.

“DTS” is a trademark of Digital Theater Systems, Inc.

Audio/video system operating hints

NOTICE

To ensure correct audio/video system operations:

- *Be careful not to spill beverages over the audio system.*
- *Do not put anything other than a disc into the slot.*
- *Do not put anything other than an appropriate disc into the DVD player.*
- *The use of a cellular phone inside or near the vehicle may cause a noise from the speakers of the audio system which you are listening to. However, this does not indicate a malfunction.*

RADIO RECEPTION

Usually, a problem with radio reception does not mean there is a problem with your radio — it is just the normal result of conditions outside the vehicle.

For example, nearby buildings and terrain can interfere with FM reception. Power lines or telephone wires can interfere with AM signals. And of course, radio signals have a limited range. The farther you are from a station, the weaker its signal will be. In addition, reception conditions change constantly as your vehicle moves.

Here are some common reception problems that probably do not indicate a problem with your radio:

FM

Fading and drifting stations — Generally, the effective range of FM is about 40 km (25 miles). Once outside this range, you may notice fading and drifting, which increase with the distance from the radio transmitter. They are often accompanied by distortion.

Multi-path — FM signals are reflective, making it possible for two signals to reach your antenna at the same time. If this happens, the signals will cancel each other out, causing a momentary flutter or loss of reception.

Static and fluttering — These occur when signals are blocked by buildings, trees, or other large objects. Increasing the bass level may reduce static and fluttering.

AUDIO/VIDEO SYSTEM

Station swapping — If the FM signal you are listening to is interrupted or weakened, and there is another strong station nearby on the FM band, your radio may tune in the second station until the original signal can be picked up again.

AM

Fading — AM broadcasts are reflected by the upper atmosphere — especially at night. These reflected signals can interfere with those received directly from the radio station, causing the radio station to sound alternately strong and weak.

Station interference — When a reflected signal and a signal received directly from a radio station are very nearly the same frequency, they can interfere with each other, making it difficult to hear the broadcast.

Static — AM is easily affected by external sources of electrical noise, such as high tension power lines, lightning, or electrical motors. This results in static.

CARING FOR YOUR CD CHANGER, DVD PLAYER AND DISCS

- Your CD changer is intended for use with 12 cm (4.7 in.) discs only.
- Extremely high temperatures can keep your CD changer and DVD player from working. On hot days, use the air conditioning to cool the vehicle interior before you use the changer and player.
- Bumpy roads or other vibrations may make your CD changer and DVD player skip.
- If moisture gets into your CD changer and DVD player, you may not play even though they appear to be working. Remove the disc from the changer and player and wait until it dries.

CAUTION



CD changers and DVD players use an invisible laser beam which could cause hazardous radiation exposure if directed outside the unit. Be sure to operate the changers and players correctly.



CD changer

- Use only discs marked as shown above. The following products may not be playable on your changer.

Copy-protected CD
CD-R (CD-Recordable)
CD-R W (CD-Re-writable)
CD-ROM

Audio CDs	
DVD video discs	
Video CDs	

DVD player

- Use only discs marked as shown above. The following products may not be playable on your player.

- SACD
- Copy-protected CD
- CD-ROM
- DVD-R
- DVD+R
- DVD-R W
- DVD+RW
- DVD-ROM
- DVD-RAM



▶ Special shaped discs

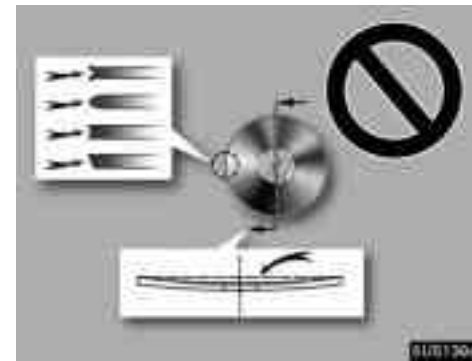

▶ Low quality discs



▶ Transparent/translucent discs



▶ Labeled discs

NOTICE

Do not use special shaped, transparent/translucent, low quality or labeled discs such as those shown in the illustrations. The use of such discs may damage the player or changer, or it may be impossible to eject the disc.

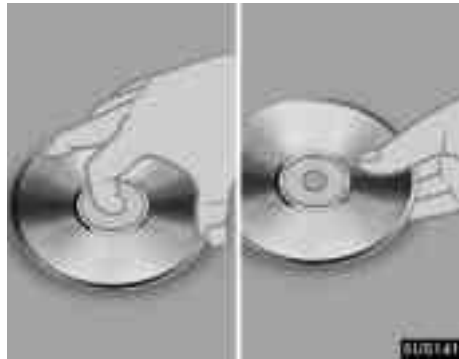

▶ Correct

▶ Wrong

- Handle discs carefully, especially when you are inserting them. Hold them on the edge and do not bend them. Avoid getting fingerprints on them, particularly on the shiny side.
- Dirt, scratches, warping, pin holes, or other disc damage could cause the player to skip or to repeat a section of a track. (To see a pin hole, hold the disc up to the light.)
- Remove discs from the players when you are not using them. Store them in their plastic cases away from moisture, heat, and direct sunlight.



To clean a compact disc: Wipe it with a soft, lint-free cloth that has been dampened with water. Wipe in a straight line from the center to the edge of the disc (not in circles). Dry it with another soft, lint-free cloth. Do not use a conventional record cleaner or anti-static device.

MP3/WMA FILES

- MP3 (MPEG Audio Layer 3) and WMA (Windows Media Audio) are audio compression standards.
- The MP3/WMA player can play MP3 and WMA files on CD-ROM, CD-R and CD-RW discs.

The unit can play disc recordings compatible with ISO 9660 level 1 and level 2 and with the Romeo and Joliet file system.

- When naming an MP3 or WMA file, add the appropriate file extension (.mp3 or .wma).
- The MP3/WMA player plays back files with .mp3 or .wma file extensions as MP3 or WMA files. To prevent noise and playback errors, use the appropriate file extensions.
- The player can play only the first session using multi-session compatible CDs.
- MP3 files are compatible with the ID3 Tag Ver. 1.0, Ver. 1.1, Ver. 2.2, and Ver. 2.3 formats. The unit cannot display disc title, track title and artist name in other formats.
- WMA files can contain a WMA tag that is used in the same way as an ID3 tag. WMA tags carry information such as track title, artist name.

- The emphasis function is available only when playing MP3/WMA files recorded at 32, 44.1 and 48 kHz. (The system can play MP3 files with sampling frequencies of 16, 22.05, and 24 kHz. However, the emphasis function is not available for files recorded at these frequencies.)
- The sound quality of MP3/WMA files generally improves with higher bit rates. In order to achieve a reasonable level of sound quality, discs recorded with a bit rate of at least 128 kbps are recommended.

Playable bit rates

MP3 files:

MPEG1 LAYER3—64 to 320 kbps

MPEG2 LSF LAYER3—64 to 160 kbps

WMA files:

Ver. 7, 8 CBR—48 to 192 kbps

Ver. 9 CBR—48 to 320 kbps

- The MP3/WMA player does not play back MP3/WMA files from discs recorder using packet write data transfer (UDF format). Discs should be recorded using “pre-mastering” software rather than packet-write software.
- M3u playlists are not compatible with the audio player.
- MP3i (MP3 interactive) and MP3PRO formats are not compatible with the audio player.

- The MP3 player is compatible with VBR (Variable Bit Rate).
- When playing back files recorded as VBR (Variable Bit Rate) files, the play time will not be correctly displayed if fast-forward or reverse operations are used.
- It is not possible to check folders that do not include MP3/WMA files.
- MP3/WMA files in folders up to 8 levels deep can be played. However, the start of playback may be delayed when using discs containing numerous levels of folders. For this reason, we recommend creating discs with no more than two levels of folders.
- It is possible to play up to 192 folders or 255 files on one disc.

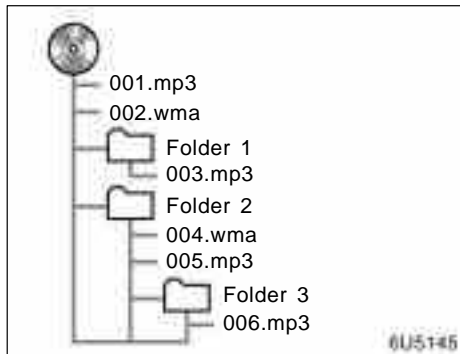

- The play order of the compact disc with the structure shown on the left is as follows:

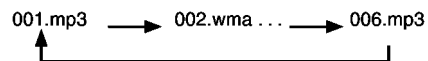

CD-R and CD-RW discs

- CD-R/CD-R W discs that have not been subject to the “finalizing process” (a process that allows discs to be played on a conventional CD player) cannot be played.
- It may not be possible to play CD-R/CD-RW discs recorded on a music CD recorder or a personal computer because of disc characteristics, scratches or dirt on the disc, or dirt, condensation, etc. on the lens of the unit.
- It may not be possible to play discs recorded on a personal computer depending on the application settings and the environment. Record with the correct format. (For details, contact the appropriate application manufacturers of the applications.)
- CD-R/CD-R W discs may be damaged by direct exposure to sunlight, high temperatures or other storage conditions. The unit may be unable to play some damaged discs.
- If you insert a CD-RW disc into the MP3/WMA player, playback will begin more slowly than with a conventional CD or CD-R disc.
- Recordings on CD-R/CD-RW cannot be played using the DDCD (Double Density CD) system.

TERMS

Packet write—

This is a general term that describes the process of writing data on-demand to CD-R, etc., in the same way that data is written to floppy or hard discs.

ID3 Tag—

This is a method of embedding track-related information in an MP3 file. This embedded information can include the track title, the artist's name, the album title, the music genre, the year of production, comments and other data. The contents can be freely edited using software with ID3 tag editing functions. Although the tags are restricted to the number of characters, the information can be viewed when the track is played back.

WMA Tag—

WMA files can contain a WMA tag that is used in the same way as an ID3 tag. WMA tags carry information such as track title, artist name.

ISO 9660 format—

This is the international standard for the formatting of CD-ROM folders and files. For the ISO 9660 format, there are two levels of regulations.

Level 1:

The file name is in 8.3 format (8 character file names, with a 3 character file extension. File names must be composed of one-byte capital letters and numbers. The “_” symbol may also be included.)

Level 2:

The file name can have up to 31 characters (including the separation mark “.” and file extension). Each folder must contain fewer than 8 hierarchies.

m3u—

Playlists created using “WINAMP” software have a playlist file extension (.m3u).

MP3—

MP3 is an audio compression standard determined by a working group (MPEG) of the ISO (International Standard Organization). MP3 compresses audio data to about 1/10 the size of that on conventional discs.

WMA—

WMA (Windows Media Audio) is an audio compression format developed by Microsoft. It compresses files into a size smaller than that of MP3 files. The decoding formats for WMA files are Ver. 7, 8, and 9.

AUDIO/VIDEO SYSTEM

SECTION VII

APPENDIX

Appendix

Limitations of the navigation system	198
Map database information and updates	200

Limitations of the navigation system

This navigation system calculates the current vehicle position using satellite signals, various vehicle signals, map data, etc. However, the accurate position may not be shown depending on the satellite condition, road configuration, vehicle condition or other circumstances.

The Global Positioning System (GPS) developed and operated by the U.S. Department of Defense provides an accurate current vehicle position using 3 to 4 satellites. The GPS system has a certain level of inaccuracy. While the navigation system will compensate for this most of the time, occasional positioning errors of up to 300 feet (100 m) can and should be expected. Generally, position errors will be corrected within a few seconds.



When your vehicle is receiving signals from the satellites, the “GPS” mark appears at the top left of the screen.

The GPS signal may be physically obstructed, leading to inaccurate vehicle position on the map display. Tunnels, tall buildings, trucks, or even the placement of objects on the instrument panel may obstruct the GPS signals.

The GPS satellites may not send signals due to repairs or improvements being made to them.

Even when the navigation system is receiving clear GPS signals, the vehicle position may not be shown accurately or inappropriate route guidance may occur in some cases.

NOTICE

The installation of window tinting may obstruct the GPS signals. Most window tinting contains some metallic content that will interfere with GPS signal reception. We advise against the use of window tinting on vehicles equipped with navigation systems.

(a) Accurate current vehicle position may not be shown in the following cases:

- When driving on a small angled Y-shaped road.
- When driving on a winding road.
- When driving on a slippery road such as in sand, gravel, snow, etc.
- When driving on a long straight road.
- When freeway and surface streets run in parallel.
- After moving by ferry or vehicle carrier.
- When a long route is searched during high speed driving.
- When driving without setting the current position calibration correctly.
- After repeating a change of direction by going forward and backward, or turning on a turntable in the parking lot.
- When leaving a covered parking lot or parking garage.
- When a roof carrier is installed.
- When driving with tire chains installed.
- When the tires are worn.
- After replacing a tire or tires.
- When using tires that are smaller or larger than the factory specifications.

- When the tire pressure in any of the four tires is not correct.

INFORMATION

If your vehicle cannot receive GPS signals, you can correct the current position manually. For information on setting the current position calibration, see “● Current position/tire change calibration” on page 87.

(b) Inappropriate route guidance may occur in the following cases:

- When turning at an intersection off the designated route guidance.
- If you set more than one destination but skip any of them, auto reroute will display a route returning to the destination on the previous route.
- When turning at an intersection for which there is no route guidance.
- When passing through an intersection, there is no route guidance.
- During auto reroute, the route guidance may not be available for the next turn to the right or left.
- It may take a long time to operate auto reroute during high speed driving. In auto reroute, a detour route may be shown.
- After auto reroute, the route may not be changed.
- An unnecessary U-turn may be shown or announced.
- A location may have multiple names and the system will announce one or more.
- Some routes may not be searched.
- If the route to your destination includes gravel, unpaved roads or alleys, the route guidance may not be shown.

APPENDIX

- Your destination point might be shown on the opposite side of the street.
- When a portion of the route has regulations prohibiting the entry of the vehicle that vary by time or season or other reasons.
- The road and map data stored in your navigation system may not be complete or may not be the latest version.

After replacing the tire, implement the operation described in the “● Current position/tire change calibration”. (See page 87.)

This navigation system uses tire turning data and is designed to work with factory-specified tires for your vehicle. Installing tires that are larger or smaller than the originally equipped diameter may cause inaccurate display of the vehicle's position. The tire pressure also affects the diameter of the tires so please make sure the tire pressure of all four tires is correct.

Map database information and updates

This system uses the maps of DENSO.

© GDT, Geographic Data Technology, Inc.
© 2004 NAVTEQ. All rights reserved.
Data by infoUSA Copyright ©2004, All Rights Reserved.
© 2004 VISA Corporation
National Research Bureau ©2004
The Bullseye Design is a registered trademark of Target Brands, Inc.

END USER LICENSE AGREEMENT

PLEASE READ THIS AGREEMENT CAREFULLY BEFORE USING THE NAVIGATION SYSTEM

THIS IS A LICENSE AGREEMENT FOR YOUR COPY OF THE MAP DATABASE (“The DATABASE”), ORIGINALLY MADE BY Geographic Data Technology, Inc. (“GDT”), USED IN THE NAVIGATION SYSTEM. BY USING THE DATABASE, YOU ACCEPT AND AGREE TO ALL TERMS AND CONDITIONS SET FORTH BELOW.

OWNERSHIP

The DATABASE and the copyrights and intellectual property or neighboring rights therein are owned by GDT or its licensors.

LICENSE GRANT

GDT grants you a non-exclusive license to use your copy of the DATABASE for your personal use or for use in your business' internal operations. This license does not include the right to grant sub-licenses.

LIMITATIONS ON USE

The DATABASE is restricted for use in the specific system for which it was created. Except to the extent explicitly permitted by mandatory laws, you may not extract or re-utilize any portion of the contents of the DATABASE, nor reproduce, copy, modify, adapt, translate, disassemble, decompile, or reverse engineer any portion of the DATABASE.

TRANSFER

You may not transfer the DATABASE to third parties, except together with the system for which it was created, provided that you do not retain any copy of the DATABASE, and provided that the transferee agrees to all terms and conditions of this AGREEMENT.

DISCLAIMER OF WARRANTY

GDT does not warrant or make any representations regarding, either express or implied, regarding the use or results of the use of the DATABASE in terms of its correctness, accuracy, reliability, or otherwise, and expressly disclaims any implied warranties of quality, performance, merchantability, fitness for a particular purpose or non-infringement. GDT does not warrant that the DATABASE is or will be error free. No oral or written information or advice provided by GDT, your supplier or any other person shall create a warranty.

LIMITATION OF LIABILITY

The price of the DATABASE does not include any consideration for assumption of risk of consequential, indirect or unlimited direct damages which may arise in connection with your use of the DATABASE. Accordingly, in no event shall GDT or supplier of the navigation system using the DATABASE ("Supplier") be liable for any consequential, special, incidental or indirect damages, including without limitation, loss of revenue, data, or use, incurred by you or any third party arising out of your use of the DATABASE, whether in an action in contract or tort or based on a warranty, even if GDT or the Supplier has been advised of the possibility of such damages. In any event GDT's liability for direct damages is limited to the price of your copy of the DATABASE.

THE DISCLAIMER OF WARRANTY AND LIMITATION OF LIABILITY, SET FORTH IN THIS AGREEMENT, DO NOT AFFECT OR PREJUDICE YOUR STATUTORY RIGHTS WHERE YOU HAVE ACQUIRED THE DATABASE OTHERWISE THAN IN THE COURSE OF A BUSINESS. Some states and laws do not allow the exclusion of implied warranties, so the above disclaimer may not apply to you.

WARNINGS

The DATABASE reflects reality as existing before you received the DATABASE and it comprises data and information from government and other sources, which may contain errors and omissions. Accordingly, the DATABASE may contain inaccurate or incomplete information due to the passage of time, changing circumstances, and due to the nature of the sources used. The DATABASE does not include or reflect information on - inter alia - neighborhood safety; law enforcement; emergency assistance; construction work; road or lane closures; vehicle or speed restrictions; road slope or grade; bridge height, weight or other limits; road or traffic conditions; special events; traffic congestion; or travel time.

APPENDIX

GOVERNMENT END USERS

If the DATABASE is for a region of North America and is being acquired by or on behalf of the United States government or any other entity seeking or applying rights similar to those customarily claimed by the United States government, the DATABASE is licensed with "limited rights." Utilization of the DATABASE is subject to the restrictions specified in the "Rights in Technical Data and Computer Database" clause at DFARS 252.227-7013, or the equivalent clause for non-defense agencies. Manufacturer of the DATABASE for North America is Geographic Data Technology, Inc., at 11 Lafayette Street, Lebanon, New Hampshire 03766, USA.

END USER NOTICE

PLEASE READ THIS NOTICE CAREFULLY BEFORE USING THIS NAVIGATION SYSTEM

The Point Of Interest Data ("POI" Data) in the navigation system is in part provided by infoUSA Inc. ("infoUSA"). By using the POI Data, you accept and agree to all terms and conditions set forth below.

1. Ownership

All rights, title and interest to the infoUSA POI Data shall be retained by infoUSA.

2. Limitations on use

Except to the extent explicitly permitted by mandatory laws, you may not extract or re-utilize any portion of the contents of the POI Data, nor reproduce, copy, modify, adapt, translate, disassemble, decompile, or reverse engineer any portion of the POI Data.

3. Transfer

You may not transfer the POI Data to third parties, except together with the system for which it was created, provided that you do not retain any copy of the POI Data.

4. Disclaimer of warranty

EXCEPT AS STATED HEREIN, INFOUSA MAKES NO EXPRESS OR IMPLIED WARRANTIES, INCLUDING, WITHOUT LIMITATION, ANY EXPRESS OR IMPLIED WARRANTY OF FITNESS FOR A PARTICULAR PURPOSE OR WARRANTY OF MERCHANTABILITY.

5. Limitation of Liability

EITHER INFOUSA OR SUPPLIER OF POI DATA SHALL NOT BE LIABLE FOR ANY INDIRECT, CONSEQUENTIAL OR INCIDENTAL DAMAGES MADE OR ALLEGED IN CONNECTION WITH YOUR USE OF THE POI DATA.

END USER LICENSE AGREEMENT

Personal Use Only. You agree to use this information for solely personal, non-commercial purposes, and not for service bureau, time-sharing or other similar purposes. You may not modify the information or remove any copyright notices that appear on the information in any way. You may not decompile, disassemble or reverse engineer any portion of this information, and may not transfer or distribute it in any form, for any purpose. Without limiting the foregoing, you may not use this information with any products, systems, or applications installed or otherwise connected to or in communication with vehicles, capable of vehicle navigation, positioning, dispatch, real time route guidance, fleet management or similar applications.

No Warranty. This information is provided to you "as is," and you agree to use it at your own risk. DENSO and its licensors (and their licensors and suppliers, collectively "DENSO") make no guarantees, representations or warranties of any kind, express or implied, arising by law or otherwise, including but not limited to, and DENSO expressly disclaims any warranties regarding content, quality, accuracy, completeness, effectiveness, reliability, fitness for a particular purpose, non-infringement, usefulness, use or results to be obtained from this information, or that the information or server will be uninterrupted or error-free. Some states, territories and countries do not allow certain warranty exclusions, so to that extent, the above exclusion may not apply to you.

Disclaimer of Liability: DENSO SHALL NOT BE LIABLE TO YOU FOR ANY CLAIM, DEMAND OR ACTION, IRRESPECTIVE OF ITS NATURE, ALLEGING ANY LOSS, INJURY OR DAMAGES, WHETHER DIRECT, INDIRECT, INCIDENTAL, SPECIAL OR CONSEQUENTIAL DAMAGES, INCLUDING ANY LOSS OF PROFIT, REVENUE OR CONTRACTS ARISING OUT OF YOUR POSSESSION, USE OF OR INABILITY TO USE THIS INFORMATION, ANY DEFECT IN THE INFORMATION, OR THE BREACH OF THESE TERMS OR CONDITIONS, WHETHER IN AN ACTION IN CONTRACT OR TORT OR BASED ON A WARRANTY, EVEN IF DENSO OR ITS LICENSORS HAVE BEEN ADVISED OF THE POSSIBILITY OF SUCH DAMAGES. Some states, territories and countries do not allow certain liability exclusions or damages limitations, so to that extent the above may not apply to you.

APPENDIX

Indemnity. You agree to indemnify, defend and hold DENSO and its licensors (including their respective licensors, suppliers, assignees, subsidiaries, affiliated companies, and the respective officers, directors, employees, shareholders, agents and representatives of each of them) free and harmless from and against any liability, loss, injury (including injuries resulting in death), demand, action, cost, expense, or claim of any kind or character, including but not limited to attorney's fees, arising out of or in connection with any use or possession by you of this information.

END USER NOTICE

The marks of companies displayed by this product to indicate business locations are the marks of their respective owners. The use of such marks in this product does not imply any sponsorship, approval, or endorsement by such companies of this product.

END-USER TERMS

The Map Data Disc ("Data") is provided for your personal, internal use only and not for resale. It is protected by copyright, and is subject to the following terms and conditions which are agreed to by you, on the one hand, and DENSO CORPORATION ("LICENSEE") and its licensors (including their licensors and suppliers) on the other hand. Such licensors include NAVTEQ North America, LLC. Without limiting the foregoing, you agree that NAVTEQ North America, LLC shall have the right to enforce these Terms directly against you.

© 2004 NAVTEQ. All rights reserved.

The Data for areas of Canada includes information taken with permission from Canadian authorities, including: © Her Majesty the Queen in Right of Canada, © Queen's Printer for Ontario, © Canada Post Corporation, Geobase ®.

TERMS AND CONDITIONS

Personal Use Only. You agree to use this Data for the solely personal, non commercial purposes for which you were licensed, and not for service bureau, time-sharing or other similar purposes. Accordingly, but subject to the restrictions set forth in the following paragraphs, you may copy this Data only as necessary for your personal use to (i) view it, and (ii) save it, provided that you do not remove any copyright notices that appear and do not modify the Data in any way. You agree not to otherwise reproduce, copy, modify, decompile, disassemble or reverse engineer any portion of this Data, and may not transfer or distribute it in any form, for any purpose, except to the extent permitted by mandatory laws. You may transfer the Data and all accompanying materials on a permanent basis if you retain no copies and the recipient agrees to these End-User Terms. Multi-disc sets may not be transferred on a divided basis.

Restrictions. Except where you have been specifically licensed to do so by [LICENSEE] and without limiting the preceding paragraph, you may not (a) use this Data with any products, systems, or applications installed or otherwise connected to or in communication with vehicles, capable of vehicle navigation, positioning, dispatch, real time route guidance, fleet management or similar applications; or (b) with or in communication with any positioning devices or any mobile or wireless-connected electronic or computer devices, including without limitation cellular phones, palmtop and handheld computers, pagers, and personal digital assistants or PDAs.

No Warranty. This Data is provided to you "as is," and you agree to use it at your own risk. [LICENSEE] and its licensors (and their licensors and suppliers) make no guarantees, representations or warranties of any kind, express or implied, arising by law or otherwise, including but not limited to, content, quality, accuracy, completeness, effectiveness, reliability, fitness for a particular purpose, usefulness, use or results to be obtained from this Data, or that the Data or server will be uninterrupted or error-free.

Disclaimer of Warranty: [LICENSEE] AND ITS LICENSORS (INCLUDING THEIR LICENSORS AND SUPPLIERS) DISCLAIM ANY WARRANTIES, EXPRESS OR IMPLIED, OF QUALITY, PERFORMANCE, MERCHANTABILITY, FITNESS FOR A PARTICULAR PURPOSE OR NON-INFRINGEMENT. Some States, Territories and Countries do not allow certain warranty exclusions, so to that extent the above exclusion may not apply to you.

Disclaimer of Liability: [LICENSEE] AND ITS LICENSORS (INCLUDING THEIR LICENSORS AND SUPPLIERS) SHALL NOT BE LIABLE TO YOU IN RESPECT OF ANY CLAIM, DEMAND OR ACTION, IRRESPECTIVE OF THE NATURE OF THE CAUSE OF THE CLAIM, DEMAND OR ACTION ALLEGING ANY LOSS, INJURY OR DAMAGES, DIRECT OR INDIRECT, WHICH MAY RESULT FROM THE USE OR POSSESSION OF THE INFORMATION; OR FOR ANY LOSS OF PROFIT, REVENUE, CONTRACTS OR SAVINGS, OR ANY OTHER DIRECT, INDIRECT, INCIDENTAL, SPECIAL OR CONSEQUENTIAL DAMAGES ARISING OUT OF YOUR USE OF OR INABILITY TO USE THIS INFORMATION, ANY DEFECT IN THE INFORMATION, OR THE BREACH OF THESE TERMS OR CONDITIONS, WHETHER IN AN ACTION IN CONTRACT OR TORT OR BASED ON A WARRANTY, EVEN IF [LICENSEE] OR ITS LICENSORS HAVE BEEN ADVISED OF THE POSSIBILITY OF SUCH DAMAGES.

Some States, Territories and Countries do not allow certain liability exclusions or damages limitations, so to that extent the above may not apply to you.

APPENDIX

Export Control. You agree not to export from anywhere any part of the Data provided to you or any direct product thereof except in compliance with, and with all licenses and approvals required under, applicable export laws, rules and regulations.

Entire Agreement. These terms and conditions constitute the entire agreement between [LICENSEE] (and its licensors, including their licensors and suppliers) and you pertaining to the subject matter hereof, and supersedes in their entirety any and all written or oral agreements previously existing between us with respect to such subject matter.

Governing Law. The above terms and conditions shall be governed by the laws of the Illinois, without giving effect to (i) its conflict of laws provisions, or (ii) the United Nations Convention for Contracts for the International Sale of Goods, which is explicitly excluded. You agree to submit to the jurisdiction of Illinois for any and all disputes, claims and actions arising from or in connection with the Data provided to you hereunder.

Government End Users. If the Licensed Data is being acquired by or on behalf of the United States government or any other entity seeking or applying rights similar to those customarily claimed by the United States government, (i) for acquisitions conducted by the Department of Defense, the Licensed Data is licensed with "Limited Rights" in accordance with the rights set forth at DFARS 252.227-7013(b)(3), TECHNICAL DATA-NONCOMMERCIAL ITEMS, and Licensed Data delivered or otherwise furnished with "Limited Rights" shall be marked with the following "Limited Rights Notice" set forth at DFARS 252.227-7013(f)(3), and shall be treated in accordance with such Notice:

LIMITED RIGHTS

CONTRACTOR (MANUFACTURER/
SUPPLIER) NAME:

NAVTEQ North America, LLC

CONTRACTOR (MANUFACTURER/
SUPPLIER) ADDRESS:

222 Merchandise Mart Plaza,
Suite 900, Chicago, Illinois 60654

The Government's rights to use, modify, reproduce, release, perform, display, or disclose these technical data are restricted by paragraph (b)(3) of the Rights in Technical Data-Non-commercial Items clause contained in the above identified contract. Any reproduction of technical data or portions thereof marked with this legend must also reproduce the markings. Any person, other than the Government, who has been provided access to such data must promptly notify the above named Contractor.

and; (ii) for civilian agency acquisitions, the Licensed Data is licensed in accordance with the rights set forth at FAR 52.227-14(g)(1), RIGHTS IN DATA-GENERAL (*Protection of limited rights data and computer software*). In the event that the Contracting Officer requires the delivery of limited rights Licensed Data that has been withheld or would otherwise be withholdable in accordance with FAR 52.227-14(g)(1), the Licensed Data is licensed with "Limited Rights" as set forth in the following "Limited Rights Notice" at FAR 52.227-14(g)(2) (Alternate II), which shall be affixed to the Licensed Data and the Licensed Data shall be treated in accordance with such Notice (which shall be marked on any reproduction of these data, in whole or in part):

**LIMITED RIGHTS NOTICE
(JUN 1987)**

These data may be reproduced and used by the Government with the express limitation that they will not, without written permission of the Contractor, be used for purposes of manufacture nor disclosed outside the Government; except that the Government may disclose these data outside the Government for the following purposes, if any, provided that the Government makes such disclosure subject to prohibition against further use and disclosure: *There are no additional purposes permitting disclosure of such Data.*

The manufacturer/supplier of the Data is NAVTEQ North America, LLC, 222 Merchandise Mart Plaza, Suite 900, Chicago, Illinois 60654.

If the Contracting Officer refuses to use either of the licenses provided in (i) or (ii), herein, the Contracting Officer must notify NAVTEQ North America, LLC prior to seeking additional or alternative rights in the Licensed Data.

There are two types of areas available for route guidance. In one type of area, primarily around metropolitan centers, detailed route guidance is available for the entire area. In the other type of area, all roads are displayed on the map but route guidance is limited. The navigation route might lack precision because the data (no right turns, one-way traffic, etc.) is not complete. It is still possible to reach the destination by following the arrow direction and distance as shown on the bottom left of the screen. The arrow points in the direction of the destination. The distance shown is as measured in a straight line from the current vehicle position to the destination area.

In order to provide you with as accurate map information as possible, we are always gathering information such as on road repairs and carrying out on-site investigations. However, the names of roads, streets, facilities, and their locations are often changed. In some places, construction on roads may be in progress. For that reason, information on some areas in this system might be different from the actual location.

— Changing the map
DVD-ROM



1. Push the “LOAD-▲” button. The “LOAD-EJECT” screen appears.



2. Touch “MAP ▲”. The display opens and the map disc is ejected.



3. Insert the new map DVD-ROM with the label side up.

4. Push the “LOAD-▲” button to close the display.

The map database is normally updated once a year. Contact your dealer for information about the availability and pricing of an update.

CAUTION

- Do not place anything on the opened display, as such items may be thrown about and possibly injure people in the vehicle during sudden braking or in an accident.
- To reduce the chance of injury in the case of an accident or sudden stopping while driving, keep the display closed.
- Take care not to jam your hand while the display is moving. Otherwise, you could be injured.

NOTICE

Do not obstruct the display while it is moving. It could damage your navigation system.

INFORMATION

Under extremely cold conditions, the display may react slowly or operation sound may become louder.

- To confirm the database version and disc coverage area

1. Push the “MENU” button.



2. Touch “Map DVD”.



Make sure the version of the database on this screen. (The database version on the screen above may be different from the actual screen.)

To display the disc coverage area, touch “Covered Area”. Confirm the covered area on the screen.

Contact your dealer to find out if there is a more recent update released.

APPENDIX

You should know as much about the quality and importance of proper maintenance of your new vehicle as the people who built it.

The Toyota authorized Repair Manual tells you how to maintain your vehicle and enables you to correctly perform your own maintenance.



The best way to keep your new vehicle in top running order is to maintain it properly from the moment you drive it off the showroom floor.

The Toyota authorized Repair Manual is packed with literally everything you need to know to perform your own maintenance in virtually every area of your new vehicle.

Maintenance procedures for the engine, chassis, body, electrical system, and more, are clearly explained and illustrated.

Periodic maintenance and tune-up

Periodic maintenance and tune-up helps to prevent small problems from growing into larger ones later on. The repair manual outlines exactly what maintenance is required and clearly explains how to do the work yourself step-by-step.

Areas covered include such things as spark plug replacement, valve clearance adjustment and engine oil and filter replacement.

**Where to obtain the
Repair Manual**

The repair manual for SIENNA may be purchased from any Toyota dealer or the Material Distribution Center. To purchase the repair manual, please contact your Toyota dealer or call the Material Distribution Center toll-free at 1- 800- 622- 2033.

WE REALLY CARE ABOUT YOU — PLEASE BUCKLE UP

Toyota has made a special effort to encourage use of seat belts.

Toyota belts are:

- **Comfortable**
- **Easy to use**
- **Convenient**

We encourage you to use your belts every time you drive.

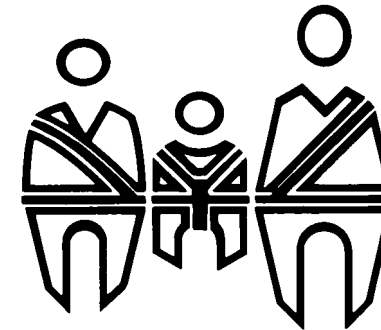

gU-5

Quick index

- If a service reminder indicator or warning buzzer comes on 187
- If your vehicle will not start 416
- If your engine stalls while driving 419
- If your vehicle overheats 420
- If you have a flat tire 421
- If your vehicle needs to be towed 437
- Tips for driving during break-in period 376
- How to start the engine 404
- General maintenance 453
- Complete index NO TAG

Gas station information

Fuel type:

UNLEADED gasoline, Octane Rating 87 (Research Octane Number 91) or higher. For improved vehicle performance, use premium unleaded gasoline with an Octane Rating of 91 (Research Octane Number 96) or higher.

See page 376 for detailed information.

Fuel tank capacity: 79 L (21 gal., 17.5 Imp. gal.)

Engine oil:

ILSAC multigrade engine oil is recommended.

See page 467 for detailed information.

Tire information: See pages 471 through 481.

Tire inflation pressure: See page 501.

Publication No. OM45443U

Part No. 01999-45443

Printed in Japan 01-0603-00 