

Foreword

This supplement contains explanations and instructions for correctly operating the following systems.

- Navigation System
- Audio and Visual System
- Handsfree System

If your vehicle contains one of the systems above, be sure to check the contents of this supplement carefully.

If you transfer the ownership of the vehicle to another person, make sure that this supplement is provided with the Owner's Manual inside the vehicle.

The information, specifications and illustrations in this supplement are valid at the time of publication. Fuji Heavy Industries reserves the right to change the specifications and design without prior notice, with no obligation to perform the same or equivalent changes to vehicles sold in the past.

This Owner's Manual supplement applies to all models, and describes all devices, including manufacturer-installed options. This means that information may be included about devices that are not installed in your vehicle.

FUJI HEAVY INDUSTRIES LTD., TOKYO, JAPAN

 **SUBARU** is a registered trademark of Fuji Heavy Industries Ltd.

©Copyright 2011, Fuji Heavy Industries Ltd.

Read First

The symbols described below are found in this instruction manual as well as on the unit itself to insure its proper and safe usage and to prevent injury or damage to property. Make sure you understand the meaning of these symbols before reading the rest of this manual.

Precautions for Use

We recommend that you wait until the positioning stabilizes before starting to drive.

- If you start to drive while the positioning is not complete, the indicated position may differ from the actual vehicle position. We recommend waiting until the GPS indicator displays  before starting to drive.

* The screens shown in this manual may differ from the actual screens depending on the data type or when the map data was created.

Information in this manual that must be observed for the unit, and information that is useful to know is indicated as follows.

WARNING

This sign indicates a situation in which incorrect handling through disregard of written information might result in death or serious personal injury.

CAUTION

This sign indicates a situation in which incorrect handling through disregard of written information might result in personal injury or damage to property.

NOTE

Useful Information

- Be sure to read all materials such as manuals and warranties that come with the product. Fuji Heavy Industries is not responsible for problems that arise due to failure to follow these instructions.
- Changes to product specifications may result in differences between the content of the manual and the features of the unit.

CAUTION

The touch buttons on the display screen may not operate properly if condensation forms inside them. If this happens, do not attempt to operate the touch buttons until the condensation has disappeared.

Take good care of this manual.
If you forcibly spread this manual, or remove pages, you may cause damage to the spine of the book.
Handle the manual gently.

Table of Contents

Introduction

Before Use	8
Safety Precautions	8
Viewing This Document	11
About This Unit	12
■ Part Names and Operations	12
■ Turning the Power On or Off	14
■ Loading and Unloading a Disc	15
■ Loading and Unloading an SD Memory Card	16
■ Connecting (or Disconnecting) the USB Memory	19
■ About the Unit Modes	20
■ Selecting a Mode	21
■ Operation Conditions for the Unit	23
Unit Settings	24
■ Various Unit Settings	24
Screen Adjustment and Setting	38
■ Displaying the picture quality adjustment screen	38
Precautions for Using Bluetooth Devices	40
Bluetooth Handsfree Operation	42
■ Using Bluetooth Handsfree	42
■ Setting and Editing Bluetooth Handsfree	56
■ Using the messaging function	69

Navigation

Before Using the Navigation System	80
Information on Warnings and Safety	82
Read First	83
Navigation Menu	85
On-screen Buttons and Other buttons	86
■ Using the Keyboard	88
■ Screen Operations Other than Single Touch	89
Map Screen	90
■ Navigating on the Map	90
■ Position Marker	92
■ Map Objects	93
■ Quick Menu	101
■ Check Current Position (Where Am I?)	103
Navigation	105
Select route destination	105
■ Enter all or part of the address	105
■ Selecting the destination from your favorite spots (POI: Point Of Interest)	120
■ Selecting a Map Position as the Destination	134
■ Selecting the Destination from the Destination List	135
■ Selecting a Frequently Used Destination (Smart History)	137
■ Selecting a Recent Destination from History	138
■ Creating a Route from the Destination List (Route Creator)	140
Displaying the Entire Route on the Map	141
Confirming Route Settings and Calling Route Related Functions	142
■ Setting the avoidance route	143

Changing the Route	144
■ Selecting a new destination after the route has been set: new route, waypoint, and final destination	144
■ Setting a New Starting Point for the Route	145
■ Editing the Destination List (Route Editing)	147
■ Pausing Route Navigation	148
■ Canceling Route Navigation	148
■ Changing the Method for Searching for a Route (Other Routes, etc.)	149
■ Changing the Road Categories used for the Route Search	150
Saving a Position to the Destination List	152
Displaying a Simulation of the Route	153
Voice Control Navigation	155
Reference Data	157
Feature	157
■ Smart Zoom	157
■ Switching between Day and Night Screens	157
■ Route Search/Search Again	158
■ GPS Positioning Quality Indicator	159
■ Online Road Information Saved in Route Search	159
“More” Menu	162
Settings Menu	163
■ Sound and Warnings	164
■ Customize Quick Menu	166
■ Traffic	168
■ Route Settings	169
■ Map Settings	170
■ Visual Guidance	172
■ Units and Formats	173
■ Trip Monitor	173

Glossary	174
End-user License Agreement	176
Further Information	181
Display Connection Status Information	181
■ Display Connection Status Information	181
Accuracy & error calculation	182
■ Regarding Precision Accuracy	182
■ Regarding the Properties of the GPS Electro-Magnetic Waves and Signal Reception	182
■ Regarding Errors in Current Position Display	183
■ Regarding Vehicle Position Detection Correction Using Map Matching	184
■ Regarding the Accuracy of the Current Position and Route Navigation	184
■ Regarding Roads and Place Name Data	186
■ Regarding Route Navigation	186

Audio and Visual

Before Using the Audio and Visual System 190

Precautions When Using the System 190

Precautions for Use 193

■ About Discs 194

Basic Operation 198

Switching the Audio Source 198

■ Switching the Audio Source 198

■ Displaying the Audio Operations Screen 199

■ Stopping the Audio Mode 199

Source Operations Screen 200

Volume Control 202

■ Main Volume Control 202

■ Displaying the Sound Settings Screen 203

■ Adjusting the Sound Quality 204

■ Adjusting the Audio Balance 205

■ Setting the Source Volume Control 207

■ Setting the Automatic Sound Levelizer 208

Audio Operations 209

Using the Radio 209

■ Using the Radio 209

Using the SAT Radio 216

■ Using the SAT Radio 216

Using the CD Player 226

■ Using the CD Player 226

Using the MP3/WMA Player 230

■ Using the MP3/WMA Player 230

■ About MP3/WMA 235

■ Creating and Playing MP3/WMA Files 238

Using the USB Music File Player 240

■ Using the USB Music File Player 240

■ About USB Devices 244

Visual Operations 247

Using the USB Video File Player 247

■ Before Using the USB Video File Player 247

■ Using the USB Video File Player 248

■ Displaying DivX VOD code 255

■ About USB Devices 258

How to Operate Portable Audio Devices 260

Using the iPod® Player 260

■ Using the iPod Player 260

■ About the Supported iPods 266

Using Bluetooth Audio 267

■ Before Using Bluetooth Audio 267

■ Using a Portable Device 274

■ About the Compatible Bluetooth-Supporting Devices 279

Using AUX 280

■ Using AUX 280

Others

Other Operations	282
Picture Function Operations	282
■ Using the Picture Function	282
■ About the Supported Image Data	285
About Steering Wheel Switches	287
■ Compatibility with Steering Wheel Buttons	287
Voice Control System Operations	291
■ About the Voice Control System	291
■ Using the Voice Control System	292
■ Displaying the Command List	293
■ Examples of Using the Voice Control System	294
■ Voice Command Lists	298
Reference	324
Useful Information	324
■ If the Following Messages Appear	324
■ When You Think There Is a Malfunction	332
■ Glossary	334
■ About Trademarks	335

The image features a minimalist design with a white background. On the left side, there are two vertical bars: a thin dark grey line and a wider, taller dark grey rectangle. On the right side, there is a dark grey square. The word "Introduction" is centered in the lower half of the page in a large, bold, black sans-serif font.

Introduction

Before Use

Safety Precautions

WARNING

- The main unit requires a 12 V DC power supply. The main unit should not be installed in any vehicle which does not have a 12 V power system with a ground-connected negative side. An installation other than the one intended may cause severe damage to the main unit, and electric shock or serious injury to the users.
- Even when using the route guidance of the navigation system, be sure to drive by following the actual traffic regulations. If you drive by following only the route guidance of the navigation system, you may violate the actual traffic regulations and cause a traffic accident.
- To ensure safety, the driver should not operate the navigation system while driving. Operating the navigation system while driving may result in an accidental steering wheel operation or otherwise cause an accident. Stop the vehicle before operating the navigation system. Also, do not watch the screen while driving. Because doing so is dangerous and may be unlawful. Inattention to road conditions ahead may result in an accident.
- The driver should not perform operations such as volume adjustment while driving. Inattention to road conditions ahead may result in an accident, so be sure to stop the vehicle in a safe place before performing the operation.

- The driver should not change discs while driving. Inattention to road conditions ahead may result in an accident, so be sure to stop the vehicle in a safe place before performing the operation.
- The driver should not perform operations such as adding a location or setting the memory while driving. Inattention to road conditions ahead may result in an accident, so be sure to stop the vehicle in a safe place before performing the operation.
- Before viewing a video, be sure to stop the vehicle in a safe place and apply the parking brake. To ensure safety, videos are not displayed during driving.
- To ensure safety, never operate a cell phone while driving.
- Do not let foreign objects enter the disc slot or SD memory card slot. Doing so may result in a fire or electric shock.
- Do not disassemble or modify the unit. Doing so may result in an accident, fire or electric shock.
- Do not let water or foreign objects enter the internal parts of the unit. Doing so may result in smoke, fire or an electric shock.
- Do not use the unit when it is malfunctioning, such as when the screen is not lit or no sound comes out. Doing so may result in an accident, fire or electric shock.

- Always replace fuses with fuses of the same specified capacity (amperage). Using a fuse with a higher capacity than the specification may result in a fire.
- If a foreign object or water enters the unit, smoke or a strange odor may be emitted. If such an abnormality occurs, stop using the unit immediately and contact your SUBARU dealer. An accident, fire or electric shock may result if you continue to use the unit under these conditions.
- In a thunderstorm, do not touch the antenna line or the unit. Lightning may cause an electric shock.
- Do not park or stop in prohibited areas to use the unit.
- If direct sunlight shines into the vehicle, light may reflect off the product. Be very careful while driving.
- Never use headphones or earphones while driving. Driving while not being able to hear sounds from outside the vehicle may result in a traffic accident.

 CAUTION

- Although the unit can be used when the ignition switch is set to either ON or ACC, to protect the battery, start the engine before using the unit.
- Do not use the unit anywhere other than in a vehicle. Doing so may result in an electric shock or other injury.

- While driving, keep the volume low enough for you to hear outside sounds. Driving while not being able to hear sounds from outside the vehicle may result in an accident.
- Be careful of the volume when turning on the power. If a loud noise is emitted suddenly when you turn on the power, it may damage your hearing.
- Do not apply a strong force to the display. Doing so may result in a malfunction.
- Do not put your fingers or hands into the disc slot or SD memory card slot. Doing so may result in an injury.
- Do not touch the hot parts of the unit. The hot parts may burn you.
- Do not use while there is an abnormality such as sound breakup or distortion. Doing so may result in a fire.
- Using the unit during extremely high or low temperature may result in mistaken operation or a malfunction. In particular, the temperature inside the vehicle can often rise to a high level during the summer. Cool the vehicle, for example by opening a window, before using the unit.
- Be careful if metal or water enters the unit, or the unit is exposed to a strong impact, because it may result in a malfunction.
- The touch buttons on the display screen may not operate correctly if condensation forms inside them. If this happens, do not attempt to operate the switches until the condensation has disappeared.

NOTE

- Fuji Heavy Industries is not responsible for any damages to the purchaser or third parties that occur from using the map data.
 - We do not provide any replacements or refunds for any mistakes there may be in the map data displays or contents, such as misspelling, omissions or misaligned positions.
 - Fuji Heavy Industries makes no guarantee that the functions included in the map data will be appropriate for the specific objectives of the purchaser.
 - Functions that cannot be operated while driving have their colors toned down when the vehicle is being driven, and their operation is disabled. Touching a disabled switch may result in the display of an operation prohibited message on the screen.
 - During strong vibrations, such as when driving on a poor road surface, the unit may no longer be able to read the data from the disc or "SD memory card", and it will not operate correctly. When the vibration lessens, normal operation will return after a short time.
 - Immediately after turning on the heater when the temperature is low, dew (water drops) may adhere to the lens of the CD reader (condensation). If this happens, leaving the unit for about an hour should remove the condensation and return the unit to normal operation. If the unit does not return to normal operation even after several hours, contact your SUBARU dealer.
 - When using the unit for the first time after purchase, or after the battery was removed for a long time, the current position may not be displayed correctly. Wait a short time until the GPS positioning corrects the displayed position.
 - This device is precision-engineered equipment and the recorded data can be lost as a result of static electricity, electrical noise, vibration, or other influences. To protect the device against data loss, we recommend keeping a separate record of the data that you record after purchase.
- Note that the following events are not covered by the warranty.
 1. Corruption or loss of the data recorded on the "SD memory card" by the purchaser resulting from failure, incorrect operation or malfunction of the unit, or any problems associated with it, or due to the effects of electrical noise or other influences.
 2. Corruption or loss of the map data or basic program stored in the "SD memory card" resulting from the incorrect use of the unit by the purchaser or a third party.
 3. Corruption or loss of data recorded on the "SD memory card" by the purchaser resulting from the malfunction or repair of the unit.
 - * Note that by installing or using the unit, you are regarded as having consented to the points above.
 - The unit has been designed to withstand electrical noise from other electronic devices. However, if an electronic device that emits strong noise is used next to the unit, the unit may show malfunctions such as screen interference or noise. If this happens, stop using the electronic device that you think is causing the problem.
 - The liquid-crystal display may be difficult to read when wearing polarized glasses.

Viewing This Document

Item title



A title is assigned for each item.

Operation title

A title is assigned for each operation objective.

NOTE

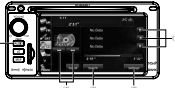
Describes information related to the operation.

<p>Audio Operations</p> <p>Using the CD Player</p> <p>Using the CD Player</p>  <p>(1) Title information scroll buttons* (2) Settings button (3) Search button (4) Track up/down and fast forward (last reverse) buttons (5) AUDIO button * It will be displayed if the length of the information is too long and it cannot be displayed.</p>		<p>Section title</p> <p>The section title is displayed here.</p>
<p>Listening to a CD</p> <p>Insert a CD into the disc slot, and it will start playing.</p> <p>1 Press CD.</p> <p>2 Touch CD (CD).</p> <ul style="list-style-type: none"> The playback starts.  <p>NOTE</p> <ul style="list-style-type: none"> Playback may be intermittent when there is a scratch on the CD or when the recorded side is dirty. If track titles and other data are recorded in the CD-TEXT format, they can be displayed. It may not be possible to display the CD-TEXT of CD-R/RW discs. If no CD-TEXT data exist in the disc, "No Data" appears in the section where the track titles and other data are displayed. 		<p>Operation procedure</p> <p>Describes the operation. Follow the numerical order.</p>
<p>NOTE</p> <p>Some of the functions may not be available when vehicle is in motion.</p> <p>226 Audio and Visual</p>		<p>Operation screen</p> <p>The screen to be operated is displayed.</p>

NOTE

In this document, the unit is generally described using the screens which appear when the optional devices are connected. Navigation is mostly described using the Heading - upwards 1 screen.

About button display

When a panel button should be pressed, button names are shown as **MAP** **AUDIO** , etc.).

When a touch button on the screen should be touched, button names are shown as  or [OOO].

About This Unit

Part Names and Operations

You can operate the unit by pressing the buttons on the panel (panel buttons) or by directly touching the buttons displayed on the screen (touch buttons).

■ Panel buttons

Press a panel button to operate it.

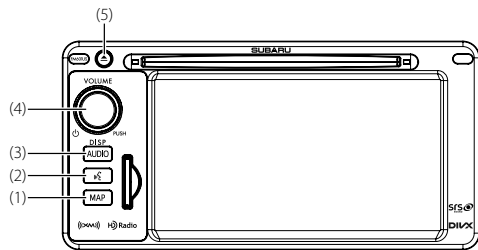

(1)	MAP button	Press to display the navigation screen.
(2)	Voice recognition button	Press to use voice recognition control.
(3)	AUDIO button	Press to use the audio or hands free function. Press for 1 second or more to adjust the picture quality or screen brightness.
(4)	POWER/VOL button	Pressing: Audio Power ON or OFF. Rotating: Adjust the volume.
(5)	EJECT button	Press to eject the DISC.

■ Touch Screen Button

Touch a button on the screen to operate it.



Touch the touch buttons with your finger. Operating touch buttons with the point of hard objects such as ballpoint pens or mechanical pencils may damage the screen.

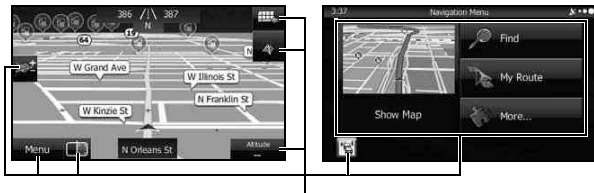

Touch Screen Buttons

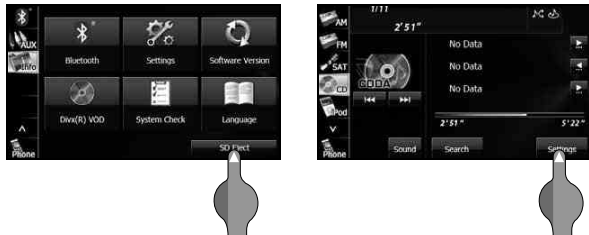

About touch button operations

- Keep touching the touch button until a “beep” is emitted in response. (When the guide tone is set to ON.)
- To protect the screen, touch the touch button lightly with your finger.
- When there is no response from a button, remove your finger from the screen and touch it again.
- Touch buttons that cannot be operated have their colors toned down.
- When the button function is enabled, the touch button returns to a brighter color.

Turning the Power On or Off

This unit switches on automatically at ignition, and when started for the first time, it displays the Navigation setting screen*. When the engine is switched off, the unit also switches off.

- * The second and subsequent times that the unit is started, the mode screen that was last in use is displayed. If the last mode in use was the Navigation screen, then your current position will be displayed. If it was the Audio operation screen, then the audio selection that was last playing will be displayed.

■ Turning on the power

1 The Caution screen is displayed automatically. When you touch **I Agree** (I Agree), the “SD Eject” Caution screen appears.

- **I Agree** (I Agree) turns down the tone during system startup. Touch to increase the tone after system startup.
- To select a language, touch **Languages** (Languages) to display the Languages screen. Touch the language that you want to use from the list. For details, see “Language setting” on Page 36.

2 Touch **OK** (OK) to display the Navigation setting screen.

- To stop the “SD Eject” Caution screen from being displayed again, touch **The message won't be indicated from now onward** (The message won't be indicated from now onward) and then touch **OK** (OK).

14 Introduction

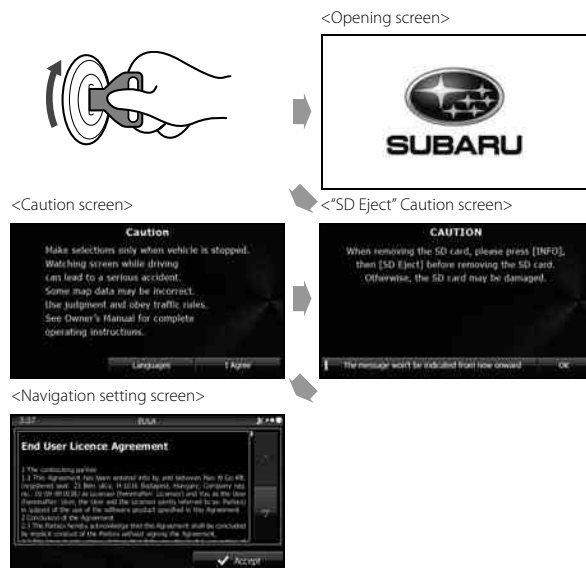

NOTE

Do not press **⏻** (Main Unit/Steering Wheel Switch) without pressing the “I Agree” button on the Caution screen. Otherwise, Navigation commands cannot be used.

■ Turning off the audio

- Press  (POWER/VOL).

NOTE

- When the audio power is turned off, on the Source screen, touch the source to which you want to change. For details, see “Switching the Audio Source” on Page 198.
- You cannot turn off the navigation power.

Loading and Unloading a Disc

To listen to music, insert a music CD into the slot.

■ Loading a disc

1 Insert a disc into the slot.

- Hold the disc by the center hole and the edges, and insert it with the label facing upward.
- When the disc is inserted, playback of the music CD or MP3/WMA starts.
- For disc details, see “About Discs” on Page 194.

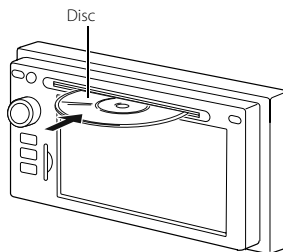

■ Unloading a disc

CAUTION

When removing a disc from the unit, pull it out horizontally. Do not strongly pull up the disc. Also, do not strongly push down the disc while removing it. Doing so may damage the disc or cause the playback to jump.

1 Press .

- The disc is ejected automatically.

Loading and Unloading an SD Memory Card

.....

Insert an SD memory card into the slot.

■ Loading an SD memory card

CAUTION

- Position the SD memory card with the  mark at the far end and insert it until it makes a “click” sound. When it makes contact with the stopper inside, the card cannot be inserted any further. Do not try to forcibly push the card.
- Before inserting a miniSD card, microSD card, miniSDHC card or microSDHC card, be sure to attach the card to the special adapter. (If you insert only the miniSD card, microSD card, miniSDHC card or microSDHC card, you may not be able to remove it.)

1 Insert the SD memory card.

- Insert the SD memory card with the label on the left side.
- Make sure that the SD memory card is fully inserted.

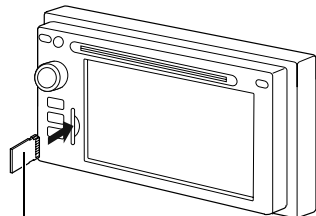

SD memory card

NOTE

- Insert the map SD card without locking it.
- If you insert an SD memory card that contains image data, you can preview the images, play a slideshow, or set an image as the Opening screen. (See Page 282.)

About SD memory cards

- SD memory cards that are marked as follows can be used.



SD Logo is a trademark of SD-3C, LLC.



SDHC Logo is a trademark of SD-3C, LLC.



miniSD Logo is a trademark of SD-3C, LLC.



miniSDHC Logo is a trademark of SD-3C, LLC.



microSD Logo is a trademark of SD-3C, LLC.



microSDHC Logo is a trademark of SD-3C, LLC.

- Multi Media Cards (MMC) cannot be used.
- Supported capacities: 512 MB to 8 GB
- Supported speed class: Class 2 to Class 10

■ Unloading an SD memory card

⚠ CAUTION

- Touch **SD Eject** (SD Eject) before removing the map SD card. Removing the card without first touching **SD Eject** (SD Eject) may damage the data. No compensation will be given for any damaged data.
- When removing a disc or SD memory card from the unit, pull it out horizontally. Do not strongly pull to the right side. Also, do not strongly push to the left side while removing it. Doing so may damage the SD memory card.

1 Press **AUDIO**.

2 Touch **Info**.

- If **Info** is not displayed, touch **∨**.

3 Touch **SD Eject** (SD Eject).



4 After checking the caution screen, touch **Yes** (Yes).

- This screen does not appear if the card is not the specified SD memory card.

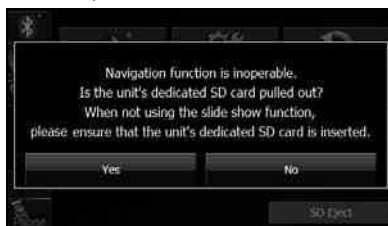

5 When "Please eject SD card." appears, remove the SD memory card.

- Press in the SD memory card until you hear it "click", let go of the card, and then pull it straight out.

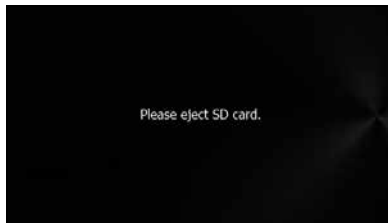

Connecting (or Disconnecting) the USB Memory

1 Connect (or disconnect) the USB memory.

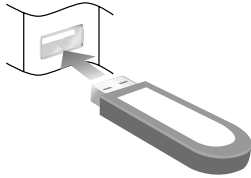

NOTE

- This unit supports USB memory in the following formats.
 - Supported class: Mass storage class
 - Supported USB Ver.: USB1.0/1.1/2.0 (maximum transfer speed is same as USB 2.0)
 - Maximum consumption current: Less than 1.0 A
 - Supported capacities: 16 MB to 8 GB
 - Do not connect USB memory devices other than those conforming to the specifications above. There is a possibility that some USB memory devices that do conform to specifications will not function correctly, due to many variables. We suggest testing your USB device prior to departing to your destination.
 - This unit does not support commercially available USB hubs, multi card readers, external hard discs or portable audio players with USB connectors.
 - If the USB memory connection cord of this unit is connected to a USB device via an extension cord, it may not function correctly.
 - If you lose the data in the USB memory while using it with this unit, no compensation will be given for the lost data. It is always a good practice to back up data, and only access a copy for in-vehicle use.
- Leaving the USB memory for a long time in a place exposed to direct sunlight may result in deformation or discoloration due to the high temperature, or cause a malfunction. In such cases, Fuji Heavy Industries will not give any compensation. When you are not using the USB memory, keep it in a place away from direct sunlight. Further, when leaving the vehicle, do not keep the USB memory inside.
 - When the audio source is USB, do not disconnect the USB memory. Doing so may damage the data in the USB memory. Before disconnecting the USB memory, turn the ignition switch to the Off position or switch the audio source to a source other than USB, and then disconnect it.

About the Unit Modes

The modes of this unit can be broadly divided into 3 categories: Navigation, Audio and Multi.

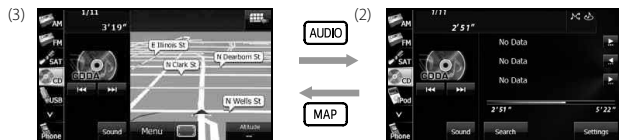

Mode	Main functions
(2) Audio	<ul style="list-style-type: none"> • Receiving AM/FM/SAT radio • CD, MP3/WMA player operations • USB music/video file player operations • AUX display • iPod operations • Bluetooth audio operations • Audio menu display • Audio source selection • Handsfree operation screen display • Info menu display
(3) Multi	<ul style="list-style-type: none"> • Navigation screen and Audio operations screen selection • Audio source selection • Audio source operations • Navigation screen display and operations (current position display, destination setting, destination guidance, destination registration, etc.) • Navigation menu display

* Some functions cannot be operated while driving.

Mode	Main functions
(1) Navigation	<ul style="list-style-type: none"> • Navigation screen display and operations (current position display, destination setting, destination guidance, destination registration, etc.) • Navigation menu display

Selecting a Mode

Press the following buttons to select the screens.

■ Navigation screen

1 Press **MAP**.



■ Audio operations screen

1 Press **AUDIO**.

<When the CD player is operating>



- Displayed while the audio function is operating. For the audio operations, see “Switching the Audio Source” on Page 198.

<OFF screen>



- Displayed when the audio function is off.

■ Multi screen

You can position the Navigation screen and Audio operations screen on the left and right to display them at the same time.

1 On the Navigation screen, touch .

- The Multi screen appears.



<Multi screen>



NOTE

On the Multi screen, touch  to return to the Navigation screen.

■ About the on-screen display

If a disc is loaded while the Navigation screen is displayed, an on-screen display appears.

After a short time, the on-screen display disappears automatically.

On-screen display



Operation Conditions for the Unit

The operability of the unit's functions varies according to the following conditions (the ignition switch position).

O: Operable x: Inoperable

Function	Ignition switch			ON, vehicle in motion
	OFF	ACC	ON, vehicle stopped ^{*1}	
Navigation/ settings and information	x	O	O	When the vehicle is in motion, some functions become inoperable for safety reasons ^{*2}
Audio function	x	O	O	When the vehicle is in motion, some functions become inoperable for safety reasons
Video function	x	O	O	When the vehicle is in motion, some functions become inoperable for safety reasons ^{*3}
Handsfree	x	O	O	When the vehicle is in motion, some functions become inoperable for safety reasons

*1 When the parking brake is applied.

*2 When the navigation safety function is on.

*3 Video is not displayed.

NOTE

Buttons that cannot be operated have their colors toned down. Operating a button that is disabled while driving may result in the display of an operation prohibited message on the screen.

Unit Settings

In addition to settings for navigation and audio operations, the following settings can be performed for the unit.

- Bluetooth setting (See Page 25.)
- Interface Customization (See Page 26.)
- Opening screen setting (See Page 27.)
- Clock setting (See Page 28.)
- Time display setting (See Page 28.)
- Time zone setting (See Page 29.)
- Link to Day/Night View setting (See Page 30.)
- Voice recognition setting (See Page 32.)
- Guide tone setting (See Page 33.)
- Deleting Personal Data (See Page 34.)
- Initializing Settings menu (See Page 35.)
- Language setting (See Page 36.)

Various Unit Settings

■ Displaying the Info screen

Display the Info screen to perform various settings.

1 Press **AUDIO**.

2 Touch **Info**.

- If **Info** is not displayed, touch **∨**.

3 Touch the button that you want to set.

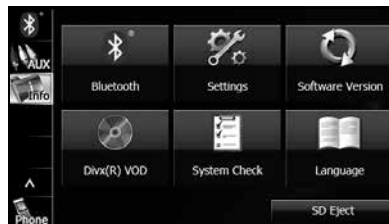

NOTE**Bluetooth**

Perform the Bluetooth settings. (See Page 25.)

Settings (Settings):

Perform the unit settings. (See Page 26 - 35.)

Software Version (Software Version):

View information such as the map data that is stored on the unit or version information for the audio application. (See Page 37.)

DivX(R) VOD (DivX(R) VOD):

Display DivX VOD code. (See Page 255.)

System Check (System Check):

Check the sensitivity of the GPS signal reception, or the connection of the parking and reverse signals. (See Page 181.)

Language (Language):

Perform the language setting (See Page 36.)

SD Eject (SD Eject):

Touch to remove the map SD card or the SD memory card that contains the picture data. (See Page 16.)

Bluetooth setting

Touch **Bluetooth** to perform the various Bluetooth settings.

1 On the Info screen, touch **Bluetooth**.

2 Touch the button that you want to set.

- Touch  to return to the previous screen.



- **Registered Devices** (Registered Devices): Register or delete a Bluetooth device, or display information for connected devices. (See pages 44, 269.)
- **Connect Phone** (Connect Phone): Register a cell phone or perform the connection settings. (See Page 46.)
- **Connect Portable Player** (Connect Portable Player): Register a Bluetooth audio device or perform the connection settings. (See Page 271.)
- **Detailed Bluetooth Settings** (Detailed Bluetooth Settings): Display or set the detailed Bluetooth information for this unit. (See Page 67.)

Passcode Settings (Passcode Settings):
Set the passcode (passkey). (See Page 68.)

■ Interface Customization

You can set the color pattern (Black/Green/Amber/Blue) for the screen.

1 On the Info screen, touch **Settings** (Settings).



2 Touch the color that you want to use as the skin pattern.

- The setting changes to the color pattern that you touched.



NOTE

- Touch **Delete Personal Data** (Delete Personal Data) to initialize your personal data and all settings. (See Page 34.)
- Touch **Initialize** (Initialize) to return the settings in the Settings screen to their initial values.

■ Opening screen setting

You can change the Opening screen to display the image of your choice. You can also display image data imported from an SD memory card as the Opening screen.

Changing the Opening screen

You can change the Opening screen of the unit (the screen that is displayed when the power is turned on).

- 1 On the Info screen, touch **Settings** (Settings).



- 2 Touch **Customized** (Customized) or **Initialize** (Initialize) in Start Up Screen.

- Touch **Customized** (Customized) to change to the Opening screen that was set with the picture function. (See Page 282.)
- Touch **Initialize** (Initialize) to return Start Up Screen to its initial value.



NOTE

- Touch **Delete Personal Data** (Delete Personal Data) to Initialize your personal data and all settings. (See Page 34.)
- Touch **Initialize** (Initialize) to return the settings in the Settings screen to their initial values.

■ Clock setting

You can turn the clock display on or off, change the time display, and set the time zone. (Only applies to navigation mode)

- 1 On the Info screen, touch **Settings** (Settings).



- 2 Touch **On** (On) or **Off** (Off) in Clock.



NOTE

- Touch **Delete Personal Data** (Delete Personal Data) to Initialize your personal data and all settings. (See Page 34.)
- Touch **Initialize** (Initialize) to return the settings in the Settings screen to their initial values.

■ Time display setting

- 1 On the Info screen, touch **Settings** (Settings).



- 2 Touch **12:00 am** or **24:00** in Time Display.



NOTE

- Touch **Delete Personal Data** (Delete Personal Data) to Initialize your personal data and all settings. (See Page 34.)
- Touch **Initialize** (Initialize) to return the settings in the Settings screen to their initial values.

■ Time zone setting

1 On the Info screen, touch **Settings** (Settings).



2 Touch **Set** (Set) in Time Zone.



3 Touch **On** (On) or **Off** (Off) in Auto Time Zone.

- Touch **On** (On) in Auto Time Zone to set the time zone automatically.
- When Auto Time Zone is "Off", touch **-** or **+** in Manual Time Zone to adjust the time zone manually.
- Touch **+** for 1 second or more to raise the time continuously. Touch **-** for 1 second or more to lower the time continuously.
- After configuring the setting, touch **Done** (Done) to save the setting and return to the previous screen.



NOTE

- On the Settings screen, touch **Delete Personal Data** (Delete Personal Data) to initialize your personal data and all settings. (See Page 34.)
- On the Settings screen, touch **Initialize** (Initialize) to return the settings in the Settings screen to their initial values.

■ Link to Day/Night View setting

- 1 On the Info screen, touch **Settings** (Settings).



- 2 Touch **Headlight** (Headlight), **Time** (Time) or **None** (None) in Link to Day/Night View.

- If Link to Day/Night View is not displayed, touch  to change the page.



- **Headlight** (Headlight):
Change to night view when the lights (sidelights, tail lights, license plate lights) are turned on.
- **Time** (Time):
Change to night view or day view at the set times.
- **None** (None):
Change to night view or day view manually.

Day/night view changeover time setting

When Link to Day/Night View is set to "Time", you can set the time at which to change to the day view.

- 1 On the Settings screen, touch **Time** (Time) in Link to Day/Night View.

- 2 Touch **Time Settings** (Time Settings).



3 Touch ▲ or ▼.

- You can set the “Sunrise” and “Sunset” time for the day view.
- After configuring the setting, touch **Done** (Done) to save the setting and return to the previous screen.



NOTE

- On the Settings screen, touch **Delete Personal Data** (Delete Personal Data) to initialize your personal data and all settings. (See Page 34.)
- On the Settings screen, touch **Initialize** (Initialize) to return the settings in the Settings screen to their initial values.

Changing to the night view or day view

When Link to Day/Night View is set to “None”, you can change to the night view or day view manually.

1 On the Settings screen, touch **None** (None) in Link to Day/Night View.

2 Touch **Day** (Day) or **Night** (Night).



NOTE

- Touch **Delete Personal Data** (Delete Personal Data) to Initialize your personal data and all settings. (See Page 34.)
- Touch **Initialize** (Initialize) to return the settings in the Settings screen to their initial values.

■ Voice recognition setting

You can set the volume of the voice recognition.

⚠ CAUTION

Be sure to set the volume of the audio at an appropriate level. Improper volume setting may result in hearing damage or a traffic accident.

1 On the Info screen, touch **Settings** (Settings).



2 Touch **Set** (Set) in Voice Recognition.

- If Voice Recognition is not displayed, touch ▼ to change the page.



3 Touch **-** or **+**.

- **+** (right side):
Volume up
- **-** (left side):
Volume down



NOTE

- On the Settings screen, touch **Delete Personal Data** (Delete Personal Data) to Initialize your personal data and all settings. (See Page 34.)
- Touch **Initialize** (Initialize) to return the settings in the different screens to their initial values.

■ Guide tone setting

You can set the sound for button operations to on or off.

- 1 On the Info screen, touch **Settings** (Settings).



- 2 Touch **On** (On) or **Off** (Off) in Guide Tone.

- If Guide Tone is not displayed, touch ▼ to change the page.
- When Guide Tone is set to "Off", button operations do not emit a sound.

**NOTE**

- Touch **Delete Personal Data** (Delete Personal Data) to Initialize your personal data and all settings. (See Page 34.)
- Touch **Initialize** (Initialize) to return the settings in the Settings screen to their initial values.

■ Deleting Personal Data

You can delete the data items that you registered and return them to their factory default values.

Deleted personal data items

Item	Deleted data
Navigation	<ul style="list-style-type: none"> • Navigation settings • Map display setting • Route learning function • Indication setting of facilities • Current position
Settings	<ul style="list-style-type: none"> • Clock setting • Language Setting • Guide tone setting • Skin pattern setting, Opening screen setting (including data registered in "Customized") • Screen settings • Day/night view changeover setting • Voice recognition setting (including song data and phone book data) • Display settings for the "SD Eject" caution screen
General audio	<ul style="list-style-type: none"> • Volume setting • Sound quality setting • Screen setting
Radio	<ul style="list-style-type: none"> • AM/FM/SAT preset channels • Parental Lock setting
Bluetooth audio	<ul style="list-style-type: none"> • Bluetooth audio registered data • Settings and edited items related to Bluetooth audio

Item	Deleted data
Handsfree	<ul style="list-style-type: none"> • Phone book data • Outgoing call history and incoming call history • Speed Dial data • Bluetooth phone registered data • Unread messages and read messages • Reply Messages list • Settings and edited items related to handsfree messages

Deleting personal data

1 Touch **Info**.

- If the Navigation screen is displayed, change to the Multi screen or Audio operations screen before performing this operation.
- If **Info** is not displayed, touch **∇**.

2 Touch **Settings** (Settings).

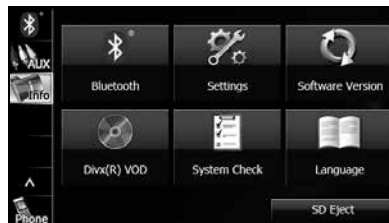

3 Touch **Delete Personal Data** (Delete Personal Data).



4 Touch **Delete** (Delete).

- Touch **Do Not Delete** (Do Not Delete) to cancel the Delete Personal Data.

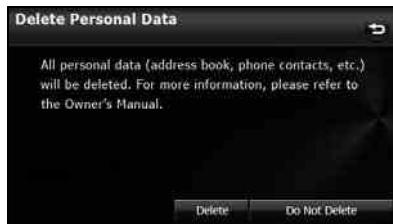

5 Touch **Yes** (Yes).



NOTE

Once the information (data) is initialized (deleted), it cannot be restored. Be very careful when performing initialization.

■ Initializing Settings menu

You can delete the contents (Skin Pattern, Start Up Screen, Clock, Time Display, Time Zone, Link to Day/Night View, Voice Recognition, Guide Tone) set in the Settings screen and return them to this Unit's initial settings.

1 On the Info screen, touch **Settings** (Settings).

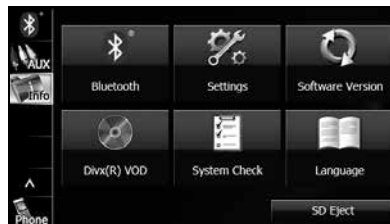

2 Touch **Initialize** (Initialize).



3 Touch **Yes** (Yes).



■ **Language setting**

You can change the navigation and audio display language, and the voice recognition language.

1 On the Info screen, touch **Language** (Language).



2 Touch the language that you want to use.



3 Touch **Yes** (Yes).



■ Checking the Software Version

You can check the version of the navigation and audio software.

Displaying the Software Version screen

1 Touch **Info**.

- If the Navigation screen is displayed, change to the Multi screen or Audio operations screen before performing this operation.
- If **Info** is not displayed, touch **∨**.

2 Touch **Software Version** (Software Version).

- The Software Version screen appears.

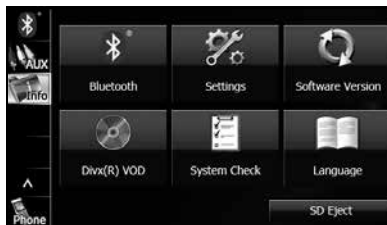

<Software Version screen>



Screen Adjustment and Setting

When Link to Day/Night View on the Settings screen is set to "Headlight" (See Page 30.), day view or night view is selected based on whether the lights (sidelights, tail lights, license plate light) are on or off, to make it easier to view the screen. When "Time" is set (See Page 30.), the view changes at the set time.

Also, when set to "None" (See Page 31.), you can manually switch to a day view or a night view screen at any time.

Displaying the picture quality adjustment screen

The picture quality adjustment screen has different adjustment items depending on whether it is the operations screen or video screen of the navigation or audio.

- 1 Press **AUDIO** for 1 second or more.
- 2 After completing the adjustment, touch **Done** (Done).

<For the operations screen>



<For the video screen>

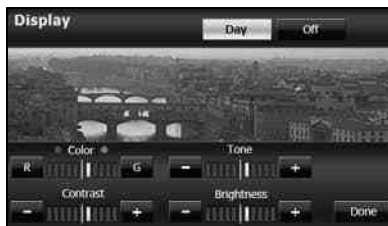

■ Changing to the night view or day view

1 Touch **Night** (Night) (**Day** (Day)) if the day (night) view is displayed on the image quality adjustment screen.

- The view changes between night view and day view each time you touch the screen.

NOTE

When Link to Day/Night View is set to "None" on the Settings screen, **Day** (Day) or **Night** (Night) are not displayed.

■ Closing the screen

1 On the picture quality adjustment screen, touch **Off** (Off).

- To display the screen again, press **MAP** or **AUDIO**.

■ Adjusting the picture quality

You can independently adjust the day view and night view.

1 Display the day view or night view.

- For details on changing the view, see "Changing to the night view or day view" on Page 39.

2 Adjust to the desired picture quality.

- Contrast:
Touch **+** to increase contrast and touch **-** to decrease contrast.
- Brightness:
Touch **+** to increase brightness and touch **-** to decrease brightness.
- Color (only applies to video screens):
Touch **G** (G) to strengthen green colors and touch **R** (R) to strengthen red colors.
- Tone (only applies to video screens):
Touch **+** to darken colors and touch **-** to lighten colors.

Precautions for Using Bluetooth Devices

Be careful of the following when using Bluetooth devices.

WARNING

- To ensure safety, the driver should not operate Bluetooth-connected phones while driving.
- Do not make calls on a cell phone while driving. If you receive a call on your phone, calmly stop the vehicle in a safe place and then answer the call. If you must answer the call, use the handsfree function to inform the caller that you will call back later. Then, stop the vehicle in a safe place and call back.
- Buttons on the touch screen that cannot be used have their colors toned down.
Operating the navigation system while driving could cause your attention to be distracted from the current traffic conditions. This could result in a severe or fatal accident. Follow the descriptions of all operations and the instructions for safety given in this manual without fail.
- When using a cell phone in a vehicle, be sure to observe the local laws and regulations.

CAUTION

- Do not leave a Bluetooth-connected phone inside the vehicle.
(Direct sunlight may cause the vehicle interior to rise to a very high temperature.)
- When using a Bluetooth-connected phone, keep away from devices inside the vehicle. If you get too close to a device inside the vehicle, the sound or connection quality may drop.

- The frequency band used by these devices is the same band that is used by microwave ovens, wireless devices used in factory production lines for identifying moving objects (license required), special low output wireless devices (license not required), amateur radios (license required), and other industrial, scientific and medical devices. (The 3 types of wireless devices above are hereafter called “other wireless devices”.) When using a Bluetooth-connected phone, check whether “other wireless devices” are used nearby. If the Bluetooth-connected phone causes harmful radio wave interference in “other wireless devices”, immediately move the phone to a different location to stop the wireless interference. The frequency band used by Bluetooth-connected phones is the 2.4 GHz band. The FH-SS modulation scheme is used. The estimated distance in which interference may occur is less than 10 m. The band used by Bluetooth-connected phones is the full band, which helps avoid interference with the band used by devices that identify moving objects.

Bluetooth Handsfree Operation

Using Bluetooth Handsfree

Bluetooth-supporting cell phones that utilize Bluetooth wireless communication technology can be used with this unit. Connecting to this unit allows you to make calls without touching your cell phone. To use a Bluetooth-supporting cell phone with this unit, it is necessary to perform Bluetooth registration and connection settings.

The cell phone connected to this unit must support the following specifications. Be aware that the available functions may vary depending on the type of cell phone.

• Supported Bluetooth Specifications

- Bluetooth Specification Ver. 1.1 or higher (Ver. 2.0 + EDR or higher is recommended)

• Supported Profiles

- HFP (Hands Free Profile) Ver. 1.0
- OPP (Object Push Profile) Ver. 1.1
- DUN (Dial-up Networking Profile) Ver. 1.1
- SYNC (Synchronization Profile)
- PBAP (Phone Book Access Profile)
- MAP (Message Access Profile)

- Bluetooth is a short-range wireless technology for connecting cell phones, computers and other such devices.



The Bluetooth® word mark and logos are registered trademarks owned by Bluetooth SIG, Inc. and any of such marks by FUJITSU TEN LIMITED is under license. Other trademarks and trade names are those of their respective owners.



- (1) Bluetooth signal icon
- (2) Battery level indicator
- (3) Roaming area icon
- (4) Reception indicator

■ Bluetooth signal quality icon

Displays the Bluetooth connection status of a cell phone.

- When a Bluetooth connection is established, "B" and reception level are displayed.

NOTE

- A Bluetooth communication antenna is embedded in the car display. If a Bluetooth-enabled cell phone is used in the following locations or conditions, the Bluetooth connection status display may turn gray or Bluetooth connection may not be possible.
 - When the cell phone is hidden from the display (when the cell phone is behind or under a seat or in the glove box or console box).
 - When the cell phone is touching or covered by a metal object.
- To use a Bluetooth-enabled cell phone, move the phone to a location where the blue display appears.
- When setting the cell phone to power saving mode, the Bluetooth connection may be automatically disconnected. If this happens, switch off the power saving mode of the cell phone.

■ Battery indicator

Displays the battery power remaining for the cell phone.

- The battery indicator may not match the battery indicator of the cell phone. Depending on the model, it may not be possible to display the battery power remaining.

■ Roaming area icon

Displayed when connected in the roaming area.

■ Reception indicator

Displays the reception level.

- When "No Service" is displayed, the location is either outside the service area or cannot be reached by the signal. In such situations, the cell phone itself cannot be used. Move to a location where the "No Service" display is no longer shown.
- Observe the following point when using hands-free operation with a cell phone.
 - The reception level may not match the display of the cell phone. Depending on the model, it may not be possible to display the reception level.

■ Displaying the handsfree screen

1 Press **AUDIO**.

2 Touch **Phone** (Phone).

- The handsfree screen appears.
- <Handsfree screen>



■ Registering a cell phone

⚠ WARNING

Do not register a cell phone while driving. Be sure to park the vehicle in a safe location and apply the parking brake before registering a cell phone.

You can register cell phones on this unit. Up to 5 cell phones can be registered on the unit. The order of connection precedence is always 1 to 5. When a cell phone is added or deleted, the order of connection precedence is updated.

1 Press **AUDIO**.

2 Touch **Info**.

- If **Info** is not displayed, touch **∨**.

3 Touch **Bluetooth**.



4 Touch **Registered Devices** (Registered Devices).



5 Touch **Add New** (Add New).



6 Operate the cell phone to enter the passcode (passkey) of the unit.

- The name of the unit is CAR MULTIMEDIA.
- The initial setting for the passcode (passkey) is 0000.
- Operate the cell phone while the Registered Devices screen is displayed.

<Registered Devices screen>



7 When the registration is complete, "Connection Completed" appears.

- The cell phone registration is complete.
- After the registration completed message is displayed, "Do you want to transfer the phonebook from your mobile?" appears. Touch **Yes** (Yes) or **No** (No). For the procedure when you press **Yes** (Yes), see step 4 in "Transferring the phone book data from a cell phone" on Page 59.

NOTE

- If the registration fails, "Connection failed" appears on the screen. If this happens, perform the registration operation again.
- For details of operations on the cell phone, see the cell phone's instruction manual.
- When processing a Bluetooth connection, the Bluetooth Audio may skip.

■ Deleting a cell phone registration

You can delete cell phones that are registered on the unit.

- 1 Press **AUDIO**.
- 2 Touch **Info**.
 - If **Info** is not displayed, touch **∇**.
- 3 Touch **Bluetooth**.



4 Touch **Registered Devices** (Registered Devices).



5 Select the cell phone that you want to delete.



6 Touch **Delete** (Delete).

- “Are you sure you want to delete this device?” appears on the screen. Touch **Yes** (Yes) or **No** (No).
- After touching “Yes”, when the deletion is complete, “Completed” appears.
- The cell phone deletion is complete.

NOTE

When a cell phone registration is deleted, the outgoing call history, incoming call history and phone book data that are saved in the unit are also deleted.

■ Connecting a cell phone

You can connect a cell phone that is registered on the unit.

- Make the preparations necessary for connecting to the unit, for example by setting the cell phone's Bluetooth standby to “On”.
- For details of operations on the cell phone, see the cell phone's instruction manual.

1 On the handsfree screen, touch **Settings** (Settings).



2 Touch **Connection** (Connection).



3 Select the cell phone that you want to connect.

- The Bluetooth mark is displayed for cell phones with an active Bluetooth connection.



4 Touch **Connect** (Connect).

5 When the connection is complete, "Connection Completed" appears.

- The connection between the cell phone and the unit is complete. The Bluetooth signal icon, battery level indicator, roaming area icon (only when in a roaming area) and reception indicator appear on the screen.

NOTE

- If the connection fails, "Connection failed" appears on the screen. If this happens, perform the connection operation again.
- Connection is not possible if no cell phones are registered.
- On the Connect Phone screen, touch **Add New** (Add New) to register a cell phone.
- When processing a Bluetooth connection, the Bluetooth Audio may skip.

■ Canceling a cell phone connection

1 On the handsfree screen, touch **Settings** (Settings).



2 Touch **Connection** (Connection).



- 3 Select the cell phone with the connection that you want to cancel.



- 4 Touch **Disconnect** (Disconnect).

- “Another device is already connected. Do you want to disconnect this device?” appears on the screen. Touch **Yes** (Yes) or **No** (No).

- 5 After touching **Yes** (Yes), when the cancelation is complete, “Connection with the mobile telephone was disconnect.” appears.

- The cancelation of the cell phone connection is complete. The Bluetooth signal icon, battery level indicator, roaming area icon (only when in a roaming area) and reception indicator disappear from the screen.

NOTE

On the Connect Phone screen, touch **Add New** (Add New) to register a cell phone.

■ Making a call

⚠ WARNING

Do not make a call while driving. Be sure to park the vehicle in a safe location and apply the parking brake before making a call.

You can make calls from the unit by entering a telephone number, using a stored number (phone book or Speed Dial), or calling from the incoming (missed call) or outgoing call history.

Making a call by entering a telephone number

- 1 On the handsfree screen, touch **0** and **1** through **9** to enter the telephone number.

- You can enter telephone numbers of up to 24 digits.
- Touch **⌫** to delete 1 digit from the entered number. Touch for 1 second or more to delete the digits continuously.



2 After entering the telephone number, touch .

- A call is made to the entered telephone number.



Calling from call history

1 On the handsfree screen, touch **Contacts** (Contacts).



2 To call from the incoming call history, touch **Incoming Calls** (Incoming Calls). To call from the outgoing call history, touch **Outgoing Calls** (Outgoing Calls).



3 Select the name or telephone number to call from the history.

- Touch  or  to scroll the history list.

4 Touch **Call**.

- A call is made to the telephone number that you selected from the history.



- Touch **Add to Speed Dial** (Add to Speed Dial) to register the displayed history item in "Speed Dial". (See Page 62.)

NOTE

The incoming and outgoing call histories can each store 10 calls for each registered cell phone. In the incoming call history, 5 missed calls and 5 other calls can be stored. When 10 calls are stored (5 missed incoming calls and 5 other calls), the oldest call is deleted from the history at the next call.

Calling from the phone book

- 1 On the handsfree screen, touch **Contacts** (Contacts).



- 2 Touch **Phone book** (Phone book).



3 Select a person (name or telephone number) to call.

- Touch ▲ or ▼ on the scroll function to scroll the List Page of names or telephone numbers.
- Touch ▲ or ▼ on the index function to display in the list the names or telephone numbers that start with the selected letter or number.

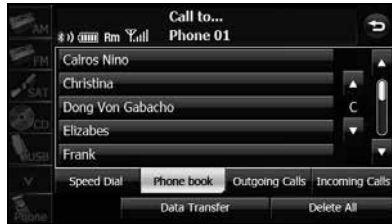

- Touch **Data Transfer** (Data Transfer) to transfer the cell phone's phone book to the unit. (See Page 59.)
- Touch **Delete All** (Delete All) to delete all the list data in the phone book.
- If 2 or more telephone numbers are registered for the selected person (name or telephone number), the telephone number selection screen appears. Touch the telephone number that you want to call.

<Telephone number selection screen>



4 Touch .

- A call is made to the selected person's telephone number.



- Touch **Add to Speed Dial** (Add to Speed Dial) to register the displayed item in "Speed Dial". (See Page 62.)
- Touch **Delete** (Delete) to delete the displayed item from each phone book.

Calling from Speed Dial

- 1 On the handsfree screen, touch **Contacts** (Contacts).



- 2 Touch **Speed Dial** (Speed Dial).

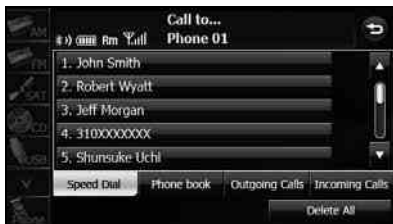

- 3 Select a person (name or telephone number) to call.

- Touch ▲ or ▼ to scroll the List Page of names or telephone numbers.



- Touch **Delete All** (Delete All) to delete all the list data in the Speed Dial.

- 4 Touch .

- A call is made to the selected person's telephone number.



- Touch **Delete** (Delete) to delete the displayed "Speed Dial" item.

NOTE

For details on "Speed Dial" registration, see "Registering a Speed Dial number" on Page 62.

■ Receiving a call

You can receive incoming calls when any source mode is selected. When a call arrives, the Incoming call screen appears automatically.

1 When you hear the ringtone, touch .

- You are connected and able to talk.
- Touch  to hang up and refuse the incoming call.

<Incoming call screen>

**NOTE**

You can also receive calls automatically. See "Auto Answer setting" on Page 57.

■ Operations during a call

During a call, the outgoing call or incoming call Talking screen is displayed, and you can perform the following operations.

- Adjust the volume for phone calls
- End the call
- Enter numeric keys
- Perform call waiting

<Talking screen for outgoing calls>



<Talking screen for incoming calls>



Adjust the volume for phone calls

1 On the Talking screen, touch **Mic Level** (Mic Level).

2 Adjust by touching **+** or **-**.

- **+**:
Call volume up
- **-**:
Call volume down
- Touch **+** for 1 second or more to raise the volume continuously.
Touch **-** for 1 second or more to lower the volume continuously.



Transferring a call (private mode ↔ handsfree mode)

When using a Bluetooth cell phone, you can transfer calls between the unit and the cell phone.

The call is switched from a handsfree call to a cell phone call, or from a cell phone call to a handsfree call.

Operating with the screen

1 Touch **Transfer** (Transfer).

- Touch **Transfer** (Transfer) again to switch to a handsfree call.



Operating with the cell phone

You can transfer calls while making a call, while talking, while receiving a call, and while a call is on hold.

- Switch from a cell phone call to a handsfree call to enable touch button operations.
- The transfer method and operations vary depending on the type of cell phone. For details of operations on the cell phone, see the instruction manual that is supplied with the cell phone.

NOTE

- Calls cannot be transferred while driving.
- If a call is transferred on the screen, the transfer may fail and cut off the sound of the call.

Ending a call

On the Talking screen, touch  to end the call. You can also end the call by hanging up the cell phone. When a call ends, the handsfree screen disappears.

Entering numeric keys

On the Talking screen for outgoing calls, touch  (Dial Tone) to display the Dial Tone screen and enable numeric key input.





- **Send** (Send):
Send a dial tone that has already been registered in the phone book.
- **Exit** (Exit):
Skip the tones.

Call waiting

If a call arrives from another phone while you are already talking, you can put the current call on temporary hold by using the Talking screen and receive the new incoming call.

1 When you hear the ringtone, touch  on the Talking screen.

- You can put the current call on hold and connect to the new call.
- To end call waiting, touch . When call waiting ends, the phone connects to the call that was put on hold and you can continue the previous call.
- During call waiting, touch  again to switch between the callers.

**NOTE**

If a call waiting contract has not been setup for the cell phone itself, you cannot use the call waiting function.

Setting and Editing Bluetooth Handsfree

⚠ WARNING

Do not set or edit cell phones while driving. Be sure to park the vehicle in a safe location before performing setting or editing operations.

■ Handsfree settings

You can perform settings for handsfree operation on the phone Settings screen. You can perform settings individually for each registered cell phone. For details on switching the cell phone, see “Connecting a cell phone” on Page 46.

- 1 On the handsfree screen, touch **Settings** (Settings).



- 2 On the phone Settings screen, you can perform the following settings by touching the setting buttons for each item.

<Phone Settings screen (page 1)>



<Phone Settings screen (page 2)>



Item	Function
Handsfree	Set the handsfree function to on or off.
Bluetooth	Set the Bluetooth function to on or off.
Auto Answer	Set automatic call acceptance.
Auto Connect	Set automatic connection between a registered cell phone and the unit.

Item	Function
Auto Phonebook Transfer	Automatically transfer the phone book to the unit when a cell phone is registered.
Initialize	Return the settings displayed on the phone Settings screen to their initial values.
Connection	Display the Connect Phone screen to register a cell phone or perform connection settings. (See Page 46.)
Volume Settings	Display the Volume Settings screen to perform settings for the ringtone or call volume.

Handsfree setting

Set the handsfree function to on or off.

- When handsfree is set to "Off", you cannot be sent a telephone number from a this unit.

1 Touch **On** (On) or **Off** (Off).

Bluetooth setting

Set the Bluetooth function to on or off.

1 Touch **On** (On) or **Off** (Off).

Auto Answer setting

Start the call automatically 5 seconds after the arrival of an incoming call.

1 Touch **On** (On) or **Off** (Off).

Auto Connect setting

Set automatic connection between a registered cell phone and the unit.

1 Touch **On** (On) or **Off** (Off).

Auto Phonebook Transfer setting

Automatically transfer the phone book to the unit when a cell phone is registered.

1 Touch **On** (On) or **Off** (Off).

Setting initialization

Touch **Initialize** (Initialize) to return the "Handsfree", "Bluetooth", "Auto Answer", "Auto Connect" and "Auto Phonebook Transfer" settings to their initial values.

■ Volume setting (handsfree)

You can set the handsfree volume on the Volume Settings screen. You can perform settings individually for each registered cell phone. For details on switching the cell phone, see "Connecting a cell phone" on Page 46.

⚠ CAUTION

Be sure to set the volume of the audio at an appropriate level. Improper volume setting may result in hearing damage or a traffic accident.

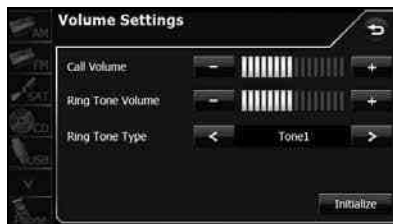

Call Volume setting

You can adjust the call volume.

1 Adjust by touching **+** or **-**.

- **+**:
Call volume up
- **-**:
Call volume down
- Touch **+** for 1 second or more to raise the volume continuously.
Touch **-** for 1 second or more to lower the volume continuously.

Ring Tone Volume setting

You can adjust the volume of the ringtone.

1 Adjust by touching **+** or **-**.

- **+**:
Ringtone volume up
- **-**:
Ringtone volume down
- Touch **+** for 1 second or more to raise the volume continuously.
Touch **-** for 1 second or more to lower the volume continuously.

Ring Tone Type setting

You can set the ringtone.

1 Touch **<** or **>**.

- Tone 1 ↔ Tone 2 ↔ Tone 3 ↔ Tone 1 ↔ ...

Initializing the settings

Touch **Initialize** (Initialize) to return the sound settings (handsfree) to their initial values.

■ **Editing the phone book**

You can register telephone numbers in the phone book of the unit by transferring the phone book that is registered in the cell phone.

Transferring the phone book data from a cell phone

You can transfer the telephone numbers (phone book data) that are registered in the cell phone to the unit. In the phone book of this unit, you can register up to 4 telephone numbers for each person in each registered cell phone, and you can register data for up to 1000 persons.

1 On the handsfree screen, touch **Contacts** (Contacts).



2 Touch **Phone book** (Phone book).

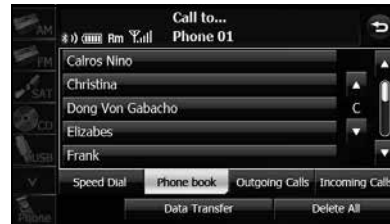

3 Touch **Data Transfer** (Data Transfer).

4 When the phone book transfer screen appears, operate the cell phone to transfer the phone book data.

- Perform the transfer operation on the cell phone while the phone book transfer screen is displayed.
- When the transfer is in progress, wait until the transfer completed message appears.
- When the transfer is complete, the transfer completed message appears.

<Phone book transfer screen>



NOTE

- Start the engine to prevent the battery from running out during transfer.
- This function cannot be used with cell phones that do not support PBAP (Phone Book Access Profile) or OPP (Object Push Profile).
- Some cell phones are not able to transfer the phone book data.
- The method of transferring the phone book data from the cell phone varies depending on the cell phone. For details, see the cell phone's instruction manual.
- When transferring the phone book data, the following restrictions apply to the data items.
 - If 5 or more telephone numbers are registered for 1 person in the phone book of the cell phone, the top 4 telephone numbers are registered in the order "Mobile", "Home", "Work", and "Other". If the 4 entries have not been filled, the number is registered in the highest available slot.
 - Names are also transferred at the same time as the telephone numbers, but symbols may not be transferred by some models, and sometimes not all the characters may be transferred. Also, even if the data is transferred, it may not be displayed correctly.
 - Normally, a secret memory cannot be read. (Although it may be possible depending on the specifications of the cell phone.)
 - Group names that are registered in the cell phone are not transferred.
- In models where batch transfer is possible, the following applies when transferring the phone book data.
 - The time taken for the transfer depends on the number of telephone numbers and the size of the phone book data that are transferred. Depending on the data, it may take 30 minutes or longer.
 - You can change to another screen even when the phone book data transfer screen is displayed. If you do this, the transfer of the phone book data continues.
- Operations when phone book data transfer is in progress are dealt with as follows.
 - If there is an incoming call during phone book data transfer, one of the operations is prioritized depending on the circumstances. When the incoming call is prioritized, the incoming call is taken on the cell phone. In this case, perform the transfer operation again after completing the call.
 - If the ignition switch is turned to OFF (LOCK) during the phone book data transfer, the transfer is canceled. If this happens, start the engine and perform the transfer operation again.
- In the following cases, the phone book data that has already been transferred is saved in the phone book of the unit.
 - When the transfer ends partway because the memory capacity of the unit is reached
 - When the transfer is canceled due to some reason
- The phone book of the unit cannot be transferred to a cell phone.
- During phone book data transfer, the Bluetooth Audio may skip.

Deleting the phone book data

You can delete the phone book data by selecting 1 number from a phone book, or by deleting all the phone book data.

1 On the phone book screen, touch the data item that you want to delete.

- Touch **Delete All** (Delete All) to delete all the phone book data.

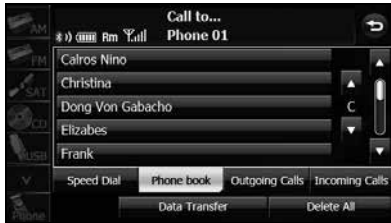

- If 2 or more telephone numbers are registered for the selected person (name or telephone number), the telephone number selection screen appears. Touch the telephone number.

<Telephone number selection screen>



2 Touch **Delete** (Delete).



3 Touch **Yes** (Yes).

NOTE

- When transferring the ownership of your vehicle, initialize your personal data. (See Page 34.)
- When "Auto Phonebook Transfer" setting is "On", the phone book data will be automatically transferred if your cell phone is reconnected even after deleting the phone book data.

■ Registering a Speed Dial number

You can register telephone numbers from the phone book or call histories as Speed Dial numbers. You can register up to 5 telephone numbers for each cell phone that is registered on the unit.

Registering a Speed Dial number from the phone book

- 1 On the phone book screen, touch the data item that you want to register.

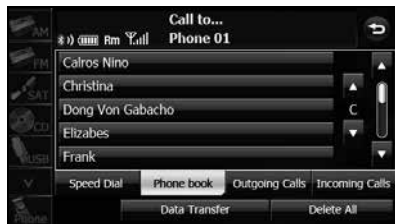

- If 2 or more telephone numbers are registered for the selected person (name or telephone number), the telephone number selection screen appears. Touch the telephone number that you want to register.

<Telephone number selection screen>



- 2 Touch **Add to Speed Dial** (Add to Speed Dial).



3 Touch the number in the Speed Dial list where you want to register the telephone number.

- “Speed Dial Saved.” appears and the Speed Dial registration is complete.

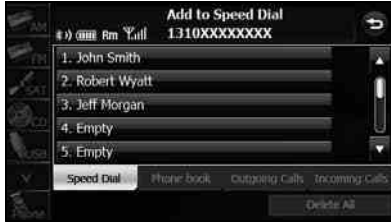

NOTE

If Speed Dial data already exists for the number, “Are you sure to overwrite the entry?” appears. To overwrite the existing data, touch **Yes** (Yes).

Registering a Speed Dial number from a history

- 1 On the history screen, touch the data item that you want to register.



- 2 Touch **Add to Speed Dial** (Add to Speed Dial).



3 Touch the number in the Speed Dial list where you want to register the telephone number.

- “Speed Dial Saved.” appears and the Speed Dial registration is complete.



NOTE

If Speed Dial data already exists for the number, “Are you sure to overwrite the entry?” appears. To overwrite the existing data, touch **Yes** (Yes).

Registering from “Empty” in the Speed Dial list

- 1 On the Speed Dial screen, touch the “Empty” item where you want to register the telephone number.

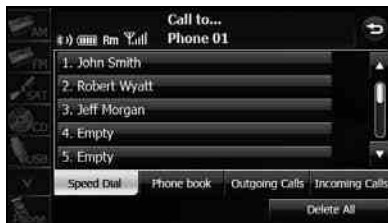

- 2 Touch **Yes** (Yes).

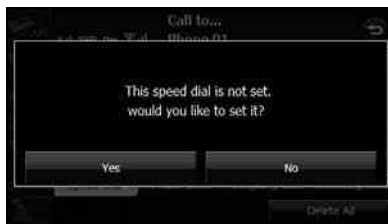

3 In the phone book or a call history, touch the data item that you want to register.

- If you touch a data item in the phone book that has 2 or more registered telephone numbers, the telephone number selection screen appears. Touch the telephone number that you want to register.
- “Speed Dial Saved.” appears and the Speed Dial registration is complete.

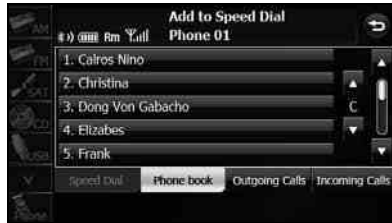

■ Displaying Device Details

In the Device Details screen, you can display and set information related to the cell phones that are registered in the unit.

The following information items are displayed.

- Device Name
This is the name of the cell phone that is displayed on the unit and cannot be changed.
- Device Address
This is the unique address of the device and cannot be changed.
- My Phone Number
The telephone number of the cell phone.
- Connection Method
You can select “From Headunit” or “From Device” as the connection method.

<Device Details screen>



1 Press **AUDIO**.

2 Touch **Info**.

- If **Info** is not displayed, touch **∨**.

3 Touch **Bluetooth**.



4 Touch **Registered Devices** (Registered Devices).



5 Touch the cell phone for which to display the detailed information.



6 Touch **Detail** (Detail).

- The Device Details screen appears.

■ Displaying Detailed Bluetooth Settings for the unit

In the Detailed Bluetooth Settings screen, you can display and set information related to Bluetooth devices that are registered on the unit.

The following information items are displayed.

<Detailed Bluetooth Settings screen>



- Device Name
The name of the unit within the Bluetooth network.
- Device Address
The unique address of the device that is registered on the unit.
- Passcode (passkey)
A number for registering the cell phone. You can change this to any number with 4 to 8 digits. (See Page 68.)
- Display Phone Status
You can set whether or not to display the result of connecting via Bluetooth to a cell phone when turning the ignition switch from OFF (LOCK) to ACC or ON.

- Display Portable Player Status
You can set whether or not to display the result of connecting via Bluetooth to a portable player when turning the ignition switch from OFF (LOCK) to ACC or ON.

1 Press **AUDIO**.

2 Touch **Info**.

- If **Info** is not displayed, touch **∇**.

3 Touch **Bluetooth**.



4 Touch **Detailed Bluetooth Settings** (Detailed Bluetooth Settings).

- The Detailed Bluetooth Settings screen appears.



■ **Changing the passcode (passkey)**

You can change the passcode (passkey) for cell phone registration to any number with 4 to 8 digits.

1 Press **AUDIO**.

2 Touch **Info**.

- If **Info** is not displayed, touch **∨**.

3 Touch **Bluetooth**.

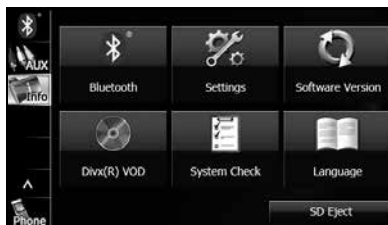

4 Touch **Passcode Settings** (Passcode Settings).



5 Enter a number by touching 1 digit at a time, and enter a number with 4 to 8 digits.

- If you make a mistake, touch  to delete 1 digit at a time.
Touch for 1 second or more to delete the digits continuously.



6 Touch **Done** (Done).

Using the messaging function

You can read messages that are received on the cell phone or send messages that are created on the unit.

3 message types can be used on this unit: SMS (Short Message Service), MMS (Multimedia Messaging Service) and e-mail.

You can also check received messages through audio playback.

NOTE

- Compatible Profiles:
 - HFP (Hands Free Profile) Ver.1.0 or later (Conformed Ver.1.5)
 - MAP (Message Access Profile)
- This function cannot be used with cell phones that do not support HFP (Hands Free Profile) and MAP (Message Access Profile). For details, see the cell phone's instruction manual.

■ Displaying the Messages screen

1 On the handsfree screen, touch **Messages** (Messages).

- The Messages screen appears.



<Messages screen>



Icon for unread data Account list

- Touch an account list to display the corresponding message list.
- Touch ▲ or ▼ to scroll the pages in the message list.
- Touch ⋮ to scroll the addresses and title data. During or after scrolling, touch ⏪ to return to the beginning of the data.
- > :
Advance to the message list of the next account.
- < :
Return to the message list of the previous account.

- **Message Transfer** (Message Transfer):
Start the transfer of messages from the cell phone to update the message list.
- **Settings** (Settings):
Use to perform various settings for the messaging function. (See Page 75.)
- ⏪ :
Return to the handsfree screen.

NOTE

You cannot delete the messages that are received. When 50 messages are stored, the oldest messages is deleted from the account list.

■ **Checking received messages**

- 1 On the Messages screen, touch the message that you want to check.



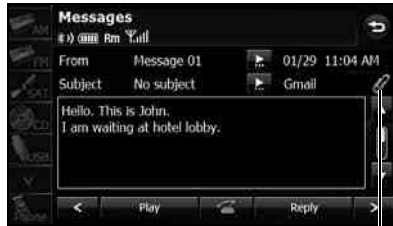

<MMS and e-mail details screen>







Attached file icon

<SMS details screen>



- Touch  or  to scroll the pages in the message list.
- Touch  to scroll the addresses and title data. During or after scrolling, touch  to return to the beginning of the data.

- : Advance to the next message.
- : Return to the previous message.
- **Play** (Play): Perform audio playback of the message.
- **Reply** (Reply): Display the message reply screen.
- : If there is telephone number data in the address, you can touch  to call the number.
- : Return to the Messages screen.

NOTE

When a file is attached, an icon is displayed in the message details screen. The contents of the attached file are not displayed. Check them with the cell phone.

■ Replying to a message

You can select a reply destination from the Messages list and send a message that you created on the unit.

- 1 On the Messages screen, touch the message to which you want to reply.

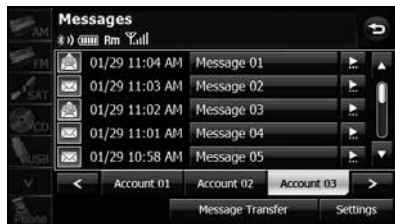

- 2 Touch **Reply** (Reply).

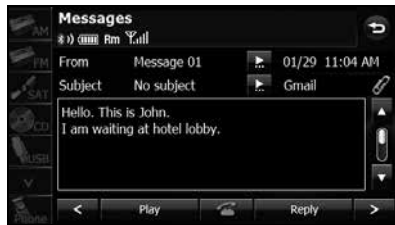

- 3 Touch the message that you want to use from the Reply Messages list.



- Touch **▲** or **▼** to scroll the pages of the Reply Messages list.
- **Edit** (Edit):
Edit a registered reply message. (See Page 73.)
- **Free Message** (Free Message):
Create any message and use it as the reply. (See Page 73.)
- **↶**:
Return to the message details screen.

- 4 Touch **Send** (Send).

- The message is sent.

NOTE

18 messages are registered in Reply Messages in the initial setting.

Editing the Reply Messages list

You can edit the messages that are registered in the list.

- 1 On the Reply Messages screen, touch the message that you want to change.



- 2 Touch **Edit** (Edit).
- 3 Touch the keyboard and enter any message.
 - For details on entering the characters, see “Entering characters” on Page 74.



- 4 Touch **Done** (Done).

- The message is registered.

NOTE

You can enter up to 160 single-byte characters in a reply message.

Sending a Free Message

You can create any message and use it as the reply.

- 1 On the Reply Messages screen, touch **Free Message** (Free Message).



2 Enter a message.

- For details on entering the characters, see “Entering characters” on Page 74.



3 Touch **Send** (Send).

- The message is sent.

NOTE





You can enter up to 160 single-byte characters in a free message.

Entering characters

Touch the following buttons to enter characters.



(1)		Return to the previous screen.
(2)		Move the cursor. (Previous, next, up, down)
(3)		Delete 1 character. <ul style="list-style-type: none"> Touch for 1 second or more to delete the characters continuously.
(4)		Touch a button to enter the corresponding character.

- (5)  Switch between upper case and lower case characters.
-  Scroll the pages.
(Only in the 0-9-% character display)
- (6)  Touch to change the characters in the following order:
Latin characters, Umlaut, 0-9-%.
Latin characters → Umlaut → 0-9-% → Latin characters → ...
- (7)  Enter a blank space.
(Space)
- (8)  Switch between keyboard layouts.
Alphabet layout → QWERTY layout → Alphabet layout → ...

■ Various message settings

You can perform message settings on the Message Settings screen. You can perform message settings individually for each registered cell phone. For details on switching the cell phone, see “Connecting a cell phone” on Page 46.

- 1 On the Messages screen, touch **Settings** (Settings).

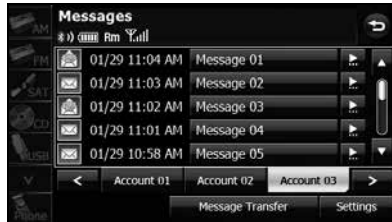

- 2 On the message Settings screen, you can perform the following settings by touching the setting buttons for each item.

<Message Settings screen>



- Touch **Initialize** (Initialize) to return the settings in the message Settings screen to their initial values.

Item	Function
Auto Message Transfer	Set messages to be transferred automatically.
New Message Pop-up	Set a new message pop-up to be displayed.
Auto Readout Message	Set messages to be read out automatically.
Volume Settings	Display the message volume setting screen to set the various volumes.

Auto Message Transfer setting

On the handsfree screen, touch **Messages** (Messages) to transfer messages from the cell phone automatically.

- 1 Touch **On** (On) or **Off** (Off).



New Message Pop-up setting

You can set a new message pop-up to be displayed on the screen when a message is received.

- 1 Touch **On** (On) or **Off** (Off).

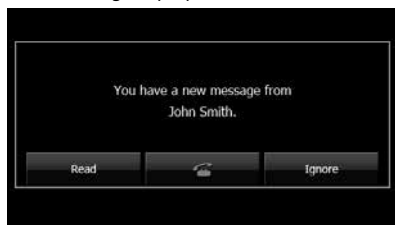
<New Message Pop-up>



- **Read** (Read):
Display the Messages screen.
- :
If there is telephone number data in the address, you can touch  to call the number.
- **Ignore** (Ignore):
Return to the previous screen.

Auto Readout Message setting

You can set messages to be played with audio playback when they are received.

- 1 Touch **On** (On) or **Off** (Off).

■ Setting the message volumes

You can set the various message volumes on the Volume Settings screen. You can perform message settings individually for each registered cell phone. For details on switching the cell phone, see “Connecting a cell phone” on Page 46.



CAUTION

Be sure to set the volume of the audio at an appropriate level. Improper volume setting may result in hearing damage or a traffic accident.

- 1 On the message Settings screen, touch **Volume Settings** (Volume Settings).
- 2 You can perform the following settings by touching the setting buttons for each item.

<Volume Settings screen>

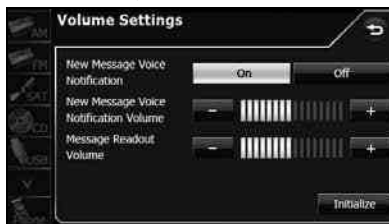

- Touch **Initialize** (Initialize) to return the settings in the Volume Settings screen to their initial values.

NOTE

MMS messaging function can not display the picture on the audio screen, only message characters.

New Message Voice Notification setting

You can set a voice notification for when a new message is received.

1 Touch **On** (On) or **Off** (Off).

New Message Voice Notification Volume setting

You can adjust the volume of the new message voice notification.

1 Touch **-** or **+**.

- **+** (right side):
Volume up
- **-** (left side):
Volume down
- Touch **+** for 1 second or more to raise the volume continuously.
Touch **-** for 1 second or more to lower the volume continuously.

Message Readout Volume setting

You can adjust the volume of the message readout.

1 Touch **-** or **+**.

- **+** (right side):
Volume up
- **-** (left side):
Volume down
- Touch **+** for 1 second or more to raise the volume continuously.
Touch **-** for 1 second or more to lower the volume continuously.

■ About the messaging function

- Supported message standards:
SMS (Short Message Service)
MMS (Multimedia Messaging Service)
E-mail
- Maximum number of address characters:
256 single-byte characters
- Maximum number of subject characters:
256 single-byte characters
- Maximum number of message characters:
160 single-byte characters
- Maximum receivable message size:
50 KB or less

The image features a minimalist design with a white background. On the left side, there are two vertical bars: a thin dark gray line and a wider, solid dark gray bar. On the right side, there is a solid dark gray square. The word "Navigation" is centered in the lower half of the image in a large, bold, black sans-serif font.

Navigation

Before Using the Navigation System

WARNING

Read this manual first

Read this manual carefully before using the navigation system. We are not liable for accidents or other problems resulting from failure to follow the instructions in this manual.

Follow all road signs and traffic rules

When driving using guidance from the navigation system, be sure to follow the actual road signs and traffic regulations. If road signs and traffic regulations are changed, the data on the SD card may be out of date. Also, the data on the map SD card does not take into account factors such as weather, time zones, and occurrences such as differences in congestion situations and temporary road closures due to construction work. Always give precedence to road signs and traffic rules over instructions from the navigation system.

Not following the road signs and traffic rules could lead to injury or traffic violations.

Drive safely

- Before following instructions from the navigation system (changing lanes and so on), check that you can carry out the maneuver safely given the current traffic conditions. Always put safety first before following any instructions.
- Do not watch the navigation screen while driving. Ignoring surrounding traffic could lead to an accident. If you need to look at the screen while driving, make sure you only glance at the screen.
- You should stop the vehicle in a safe place before operating the navigation system. For safety's sake, some of the navigation system's buttons and functions cannot be used unless the vehicle is stationary.
- When you need to look at the navigation screen, do so for the shortest time possible. Looking away from the road for too long could lead to an accident.
- Make sure this system is installed in a position legally allowed in the country where you intend to use it. Some countries and regions do not allow video screens to be installed within the driver's line of sight.

- If you stare at the display too much or operate the buttons of the system while driving, the navigation system could distract your attention from the current traffic conditions. Be sure to enter as much information as possible into the system before departing. Also, be sure to stop your vehicle in a safe place if you need to enter information.
- Buttons on the touch screen that cannot be used have their colors toned down.
Operating the navigation system while driving could cause your attention to be distracted from the current traffic conditions. This could result in a severe or fatal accident. Be sure to follow all the operation descriptions and safety instructions given in this manual.

Volume

- Keep the system's volume level low enough for you to be able to hear outside sounds while driving. Otherwise, you may not be able to react appropriately to traffic conditions, resulting in an accident.

CAUTION

Foreign objects

Do not place foreign objects, such as fingers, into the disc insertion slot.
If foreign objects enter the system's main unit, it could lead to electric shock or fire. If the system emits smoke or an unusual smell, stop using it immediately and contact the nearest SUBARU dealer.

Never disassemble or modify the system

Never disassemble or modify any parts of the system. Doing so may lead to a fire, an electric shock, or some other type of accident.

Do not continue using the navigation system if it malfunctions

If the system shows any sign of malfunctioning (for example, the monitor displays no picture), stop using it immediately and contact the nearest SUBARU dealer.

Continuing to use the system could lead to a fire, an electric shock, or some other type of accident.

If the navigation system gets contaminated, or emits smoke or an odd smell, stop using it

If a foreign object gets inside the system, liquid is spilled onto the system, or the system emits smoke or an unusual smell, stop using it immediately and contact the nearest SUBARU dealer. Continuing to use the system could lead to a fire, an electric shock, or some other type of accident.

NOTE

In the interest of safety, the use of some functions may be unavailable while driving. Buttons on the touch screen that cannot be used have their colors toned down.

Information on Warnings and Safety

The navigation system uses a built-in GPS receiver to guide you to your destination. This software does not transmit the GPS position of your vehicle, and cannot be used to track the vehicle.

Do not look at the navigation screen if it is not safe to do so. If the driver is operating the navigation system, we strongly recommend operating the software before you start driving. Program the route before leaving, and stop your vehicle in a safe place if you need to change the route.

Follow all road signs and road conditions. If you deviate from the recommended route while driving, the software updates the route according to your current position.

For details, see “End-user License Agreement” on Page 176.

Read First

This software is designed for optimum performance when used for car navigation. It does not need a stylus for operation. You can easily use buttons and maps on the screen by touching them with the tip of your finger.

When you start the navigation software for the first time, the initial settings screen is automatically displayed. Follow the steps below to use the initial settings screen.

- 1 Confirm the end-user license agreement. Touch **Accept** (Accept) to continue.

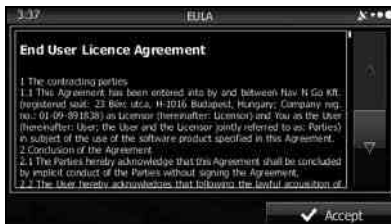

- 2 The Setup Wizard starts. Touch **Next** (Next) to continue.



- 3 Select the language and narrator you want to use for voice guidance messages. Touch **Next** (Next) to continue. You can change this at any time from Sound and Warnings settings. (See Page 164.)



- When the TTS Voice mode is selected, the voice control navigation and street guidance can be used. These functions cannot be used when the Natural Voice mode is selected.

- 4 Change the unit settings if necessary. Touch **Next** (Next) to continue. You can change this at any time from Units and Formats. (See Page 173.)



- 5 Change the initial route plan settings if necessary. Touch **Next** (Next) to continue. You can change this at any time from Route Settings. (See Page 169.)



- 6 This completes the initial setup. Touch **Finish** (Finish) to continue. After setting up, you can run the Setup Wizard at any time from the Settings menu. (See Page 163.)



After the initial setup, the navigation menu is displayed and you can start using the software.

Navigation Menu

When you touch **Menu** (Menu) on the navigation screen or the multi screen, the navigation menu (main menu) appears. You can access all of the software's functions from this menu.



The following options are available.







- Touch **Find** (Find), and then select which method to use to reach your destination by entering the address, selecting a favorite spot, selecting a position on the map, or selecting from the destination list. You can also select recent destinations from Smart History, or enter coordinates into the system.
- When you touch **My Route** (My Route), each point on the route, or a path log on the map is displayed for the entire journey. You can also perform various route related functions such as editing or Canceling the route, setting the route departure point, selecting a different route, avoiding a part of the route, performing a navigation simulation, or adding an entry to the destination list.



- When you touch **More** (More), you can set the navigation software operating method, start the tutorial, show a demo route simulation, or start various other auxiliary applications.
- Touch **Show Map** (Show Map) to start navigation on the map. The button itself shows the current position, recommended route, and reduces the surrounding area to display on the map being used. Press the button to enlarge the map to full-screen size.
- Touch  to open the Traffic Summary screen.

On-screen Buttons and Other buttons

To use this software, you normally have to touch the buttons on the touch screen.

You only need to confirm selections and changes when the application needs to be restarted, when an important setting is changed, or when a section of the user's data/settings may be lost. Other than that, when using the button selected content is saved immediately without requiring confirmation, and the new setting is applied.

Type	Example	Explanation	Use
Button		Touch to start a function, open a new screen, and save settings.	Touch once.
Button with numbers displayed		Current fields or settings are displayed on the button. Touch this button to change the value. After changing, the value you enter is displayed on the button.	Touch once.
Icon		Displays status information.	Some icons can also be used as buttons. Touch once.
List		If there are multiple options available, the selection items are displayed as a list.	To view the list, touch and slide your finger up and down. Because the scrolling speed changes depending on the speed of the slide, you can reach the end of the list, with just a small, quick flick of your finger. Also, when using the   buttons, touch the number you want to move through the pages.
Radio button		When there are only a few selection items, you can use the radio buttons instead of a list. Where only one value can be selected.	Touch this button to select the new value.

Type	Example	Explanation	Use
Check Box		If there are only two choices available, you can enable or disable the function by entering a check mark.	Touch to turn the switch On or Off.
Virtual keyboard		Keyboard for entering text and numbers.	Each key represents a button on the touch screen.

Using the Keyboard

This navigation system has been designed to keep the entry of text and numbers to a minimum. However, you can enter text and numbers when necessary by using the full-screen keyboard. You can select the keyboard layout from English, Greek characters, numbers, and so on.



Operation	Explanation
Button keyboard layouts, for example from English to Greek	Touch More (More) and select another keyboard layout from the list.
Correcting entered values using the keyboard	Touch ← to delete characters entered by mistake. Touch & hold (touch the screen and do not remove your finger) to delete a part or all of the entered text.
Enter a space between first names and family names, or between address display names	Press the ⏏ button at the bottom center of the screen.









Operation	Explanation
Entering numbers and symbols	Touch 123 to switch to the numbers keyboard. Touch QWERTY to switch to the symbols keyboard.
Confirm keyboard input (confirm the displayed search results)	Touch ✓ .
Set keyboard input (confirm search results list)	Touch Results (Results).
Set keyboard input (save entry)	Touch Done (Done).
Cancel keyboard input (return to main screen)	Touch Back (Back).

NOTE

Even if a candidate term is displayed when the keyboard screen appears, you can touch the keyboard and input a new term directly.

Screen Operations Other than Single Touch

Normally, you only need to touch the screen once (single touch) to perform an operation. However, you can make use of convenient functions by combining different touch operations on the touch screen. The following touch combinations are available.

Operation	How to
Screen Touch & Hold	<p>You can call additional functions by performing touch & hold (touch the screen and do not remove your finger) with the next button.</p> <ul style="list-style-type: none"> • On the List and Menu screens, touch & hold Back (Back) to display the Map screen. • On the Map screen, touch & hold any of the     , or  buttons to rotate, tilt, enlarge, or reduce the map. • On the keyboard screen, touch & hold  to quickly delete multiple characters. • On long lists, touch & hold  or  to scroll through the page.
Gesturing (drag & drop)	<p>You may need to drag & drop in the following cases.</p> <ul style="list-style-type: none"> • Scrolling a list: To view the list, touch and slide your finger up and down. Because the scrolling speed changes depending on the speed of the slide, you can reach the end of the list, with just a small, quick flick of your finger. • Moving the map in map display mode: Touch the map and move it in the direction you want.

Map Screen

Navigating on the Map

In the navigation menu startup screen, the currently active map is reduced and displayed in **Show Map** (Show Map).



To enlarge the map, touch **Show Map** (Show Map) to open the Map screen.

This map shows the current position (shown as the vehicle marked as a blue arrow), recommended routes (orange lines), and the immediate surrounding area.

When GPS positioning is not active, the vehicle marker is clear. The latest confirmed position is displayed.

Colored spots are displayed on the circle around the satellite icon in the top left corner. The more spots there are on the circle, the higher the accuracy of the GPS positioning.



When GPS positioning is active, the vehicle marker is displayed in full-color, and the current position is shown.

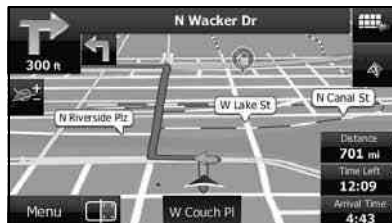

Buttons and data fields are displayed on the screen, and you can perform navigation. During navigation, route information is displayed on the screen.



The data fields display differs when no destination is set during navigation (no orange line is displayed). When performing navigation, the number of the data fields displayed on the screen is three. Up to two data fields can be displayed when no destination is set (no orange line is displayed).

Default data fields when no destination is set while driving

Field	Explanation
Altitude (Altitude)	Shows the altitude of the road currently being driven and measured by the GPS receiver. (There may be a maximum ± 50 m of differences depending on the reception status of GPS satellites.)
Time (Time)	Displays the current time corrected using the time zone offset. Accurate time is acquired from the GPS satellite, while time zone information is acquired from the map. You can also make manual settings in Units and Formats. (Only for the Menu screen, the current time is shown in the bottom left corner of the screen.)

Default data fields when performing navigation (you can change the values in fields by using touch & hold):

Field	Explanation
Distance (Distance)*	Displays the distance on the route to the final destination.
Time Left (Time Left)	Displays the time left until arrival at the final destination based on the information available for the remainder of the journey. This is calculated according to prior traffic data or traffic patterns when ever available. If a TMC receiver is connected to the main unit and is receiving data, any traffic jams along the route are also factored into calculations. However, the accuracy of these calculations varies greatly.

Field	Explanation
Arrival Time (Arrival Time)*	Displays the estimated arrival time at the final destination based on the information available for the remainder of the journey. This is calculated according to prior traffic data or traffic patterns when ever available. If a TMC receiver is connected to the main unit and is receiving data, any traffic jams along the route are also factored into calculations. However, the accuracy of these calculations varies greatly.
Time (Time)	Displays the current time corrected using the time zone offset. Accurate time is acquired from the GPS satellite, while time zone information is acquired from the map. You can also make manual settings in Units and Formats. (Only for the Menu screen, the current time is shown in the bottom left corner of the screen.)
Altitude (Altitude)	Shows the altitude of the road currently being driven and measured by the GPS receiver. (There may be a maximum ± 50 m of differences depending on the reception status of GPS satellites.)

* Time and distance to the destination cannot be displayed when your vehicle is located in the place other than roads and Highways. After the vehicle returns to a road or Highway, time and distance are displayed.

Position Marker

■ Vehicle Marker and Lock-on-Road

If GPS positioning is available, the current position is shown using the vehicle marker.

- When any vehicle is selected, the vehicle marker may not display an accurate GPS position and direction of travel. If there is a road nearby, the GPS positioning error is corrected based on the shortest distance to the road to, and the direction of the icon is adjusted to match the direction of the road.

■ Selected map location (cursor)

Use one of the following methods to mark a map location.

- Touch the map during navigation.
- Touch the map when the destination you want is displayed in the search results.
- Touch the map in "Map Search". (See Page 134.)

After selecting a map location, a cursor is displayed at the point selected on the map. The cursor is displayed as a red point (📍) and can be checked at all zoom levels.

You can use the cursor's position as the route's destination, search for locations around the cursor, and save the position in the destination list.

Map Objects

■ Direction display

If no destination is set while driving, the direction is shown on the screen in heads-up display.

Each letter indicates a direction: N (North), NE (North East), E (East), SE (South East), S (South), SW (South West), W (West), and NW (North West). However, this is not displayed while driving on an expressway.

Direction display



■ Advanced confirmation of route changes and next road

During navigation, information on the next route event (the next change in the route), as well as the next city or town, is displayed at the top of the Map screen.

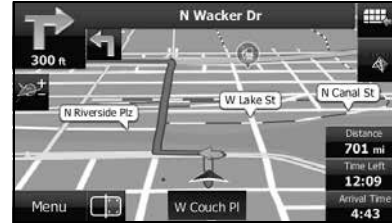



















The next change in the route is displayed in the field at the top left corner of the screen. Displays the type of route event (right or left turn, roundabout, expressway interchange, and so on) and the distance from the current position.

When the next route change approaches, the type of route change is displayed as a small icon next to the main icon. Only the next route change is displayed.



Most of these icons can be understood intuitively. The following table shows the most frequently displayed route events. The symbol design is the same in each field.

Icon	Explanation	Icon	Explanation
	Turn left		Turn right
	U-turn		Keep right at the fork in the road.
	Turn left & sharp curve.		Turn right & sharp curve.
	Stay in the left lane.		Stay in the right lane.
	Go straight ahead at the intersection.		Turn left at the T junction.
	Go left at the roundabout. Third exit (next change in direction).		Join the roundabout (the route change after the next change).
	Join the expressway.		Leave the expressway.
	Board the ferry.		Disembark from the ferry.
	You are half way to your destination.		You have arrived at your destination.

■ Lane information & signs

When using route guidance on roads with two or more lanes, it is important that you drive in the correct lane. When lane information is available on the Map, the lane and direction are indicated below the map with small arrows. The lane that you should drive in is highlighted.



When detailed information is available, the arrows are removed and signs are displayed. Signs are displayed at the top of the map. The color and design of the signs is the same as signs actually found at the side of the road or overhead signs. These signs show the district and the route number for the lane direction.

All signs are displayed in the same manner even when driving without using the navigation system. During navigation, only the sign that shows the lane in which you should drive is highlighted, the other signs are toned down.



■ Junction display

When approaching an expressway exit or a complicated intersection, the map switches to a 3D display if the necessary information can be displayed. An arrow indicates the lane in which you should drive. Signs are also displayed if the information is available.





■ Types of 3D Objects

The following 3D object types are supported.

Type	Explanation
3D Topography	On a 2D map, the changes in topography or undulations in the ground are displayed; and when using 3D this data is used to create a route map image during navigation. On a 3D map, hills and mountains are displayed in the background, whilst on a 2D map they are expressed using changes in color and shading.
Elevated Roads	Complicated intersections and three dimensional road objects (such as overpasses or overhead bridges) are displayed in 3D.

■ Items displayed during route navigation

The route is displayed using the following methods.

Symbol	Name	Explanation
	Current GPS position and departure point	<p>Current location of the user displayed on the map</p> <ul style="list-style-type: none"> When you select a vehicle in route search, and if there is a road nearby, the position of the icon is corrected based on the nearest road. <p>When the GPS position is available, the route usually starts from the current position. If there is no GPS position available, the last confirmed available GPS position is used as the departure point.</p>
	Waypoint (midway point)	The midway point target point before arrival at the target destination.
	Destination (final point)	The final destination on the route.
	Route color	Displays using colors that are easy to understand and that stand out in daytime or night time color mode.
	Roads excluded from navigation	Select whether or not to exclude a road from navigation. (See Page 169.)
	Roads affected by traffic conditions	Any section of the road may be affected depending on the received traffic conditions. Roads affected by traffic conditions are displayed in a different color, and a small icon representing the type of traffic condition is displayed at the side of the route.

■ Traffic condition

Road sections affected by traffic conditions are displayed in a different color on the map, and a small icon representing the type of traffic condition is displayed above the road. You can change the items displayed by setting the Traffic. (See Page 168.)



To check traffic conditions outside the display, touch . The Traffic Summary screen is displayed.



Touch **Event List** (Event List) to open the following Event List screen.



On this screen, you can select one entry from the list to view list of the traffic conditions for that section of the road.



On this screen, you can select one entry from the list to view full details of the traffic conditions for that section of the road.

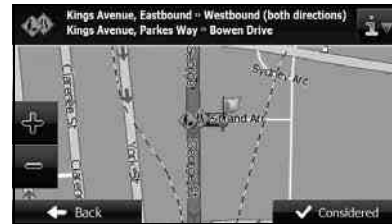

Touch **i** to open another screen displaying information on the selected map position.

■ Highway Services

When driving on the expressway, this displays information on the next three highway service areas. By default, gas stations, restaurants, rest rooms, and mechanics are displayed. You can change the items displayed by setting the Visual Guidance. (See Page 172.)

When information is available for the highway service area,  is displayed.

Touch  to display the highway service area information (distance, time needed, and services provided).



When you touch highway service information, a list is displayed.



Highway service area information

Select one from the list to display more details. You can check it on the map and set it as a waypoint or as a destination.





■ Smart zoom display

When the navigation screen is set to auto zoom, this function is turned on.

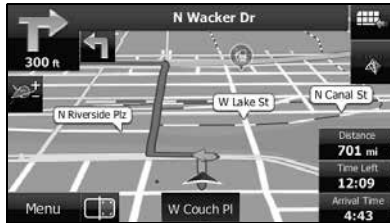
Touch  to display the control button.



Touch  to enlarge the display, and touch  to reduce the display. When expanding or reducing, the smart zoom function is switched off, and  is displayed. Touch  to turn on the smart zoom function.

If no operations are made for about six seconds, the previous screen is displayed.

<Smart Zoom On>





<Smart Zoom Off>





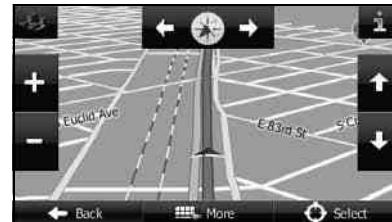

■ Map operations

You can touch a position on the map, and then check that position during navigation. The map's current position tracking function stops (the car marker (a blue arrow by default) is not fixed in position on the screen), and the control buttons are displayed allowing you to change the map display.



Operation	Button	Explanation
Using drag & drop to move the map	No buttons	You can move the map in any direction you want by touching and holding the map, and moving your finger in the direction you want to move the map.
Zoom in/Zoom out		Change the area of the map displayed on the screen. Road names and other characters are always displayed in the correct direction and at the same font size, and you only need to check necessary roads and icons. In 3D mode, the map cannot be reduced endlessly. The map changes to 2D mode if you zoom out beyond the defined amount. The display changes slowly if you tap the button, or changes in a smooth, continuous motion if you touch & hold the button.
Tilt up/Tilt down		In 3D mode, you can change the vertical display angle of the map. The display changes slowly if you tap the button, or changes in a smooth, continuous motion if you touch & hold the button.

Operation	Button	Explanation
Rotate left/Rotate right		Changes the horizontal display angle of the map. The display changes slowly if you tap the button, or changes in a smooth, continuous motion if you touch & hold the button.
2D or 3D display		Touch this button to switch the map display mode between a 3D bird's-eye view and a flat 2D view.
Compass in 2D or 3D map display mode		The compass direction indicates North. Touch this button to change to a North Up display, and then touch it again to return to the direction previously displayed.
Point information		Touch this button to open another screen displaying information on the selected map position (cursor).
Return to normal navigation	Back (Back)	Touch this button to return the map to the current GPS position. Auto map rotation is also enabled. The map operation buttons are hidden, and navigation restarts.
Additional functions	More (More)	Touch this button to display the additional functions list. For example, saving the cursor to the destination list, and searching the area around the cursor.
Selecting a destination	Select (Select)	Touch this button to select the cursor as a new destination. The route is researched automatically.

Quick Menu

Frequently used buttons and functions used during navigation are all displayed on the Quick menu. Touch  to open directly from the Map screen.



The menu closes if no operations are performed for a few seconds, or if you touch .

Touch another button to open a new screen displaying the option you selected.

You can assign functions to shortcuts from the Menu screen. See the following items for more details.

The following explains the buttons and functions displayed on this screen.

Button	Explanation	Primary Location
	Touch this button to return to the Map screen.	N/A

Button	Explanation	Primary Location
Guidance volume slider	Adjusts the guidance volume. This adjusts all volumes in the guidance volume adjustment application.	More / Settings / Sound and Warnings / Volume / Master slider (See Page 164.)
Quick Place Search (Quick Place Search)	Touch this button to search around a point on the route, or your current position (when a route search has not been performed).	Find / Find Places / Quick Search (See Page 120.)
Favorites (Favorites)	Touch this button to select an item from the destination list.	Find / Favorite (See Page 135.)
History (History)	Touch this button to select previously set destinations from the history list.	Find / History (See Page 137.)
Create Route (Create Route)/ Edit Route (Edit Route)	Touch this button to change the route.	My Route / Create (Edit) Route (See Page 140.)
Route Settings (Route Settings)	Touch this button to change route related settings.	More / Settings / Route Settings (See Page 169.)

Button	Explanation	Primary Location
Map Settings (Map Settings)	Touch this button to change map related settings.	More / Settings / Map Settings (See Page 170.)
Where Am I? (Where Am I?)	Touch this button to display a special screen with a button that searches for information on your current position and determines the nearest emergency assistance or roadside assistance. See the following section for more details.	N/A
Cancel Route (Cancel Route)	Touch this button to clear the route and cancel navigation. This button is available when only one destination is set.	My Route / Cancel Route (See Page 148.)
Remove Next Waypoint (Remove Next Waypoint)	Touch this button to remove the next waypoint from the route. When multiple destinations are set, the previous waypoint is displayed. This button is available when only two or more destinations are set.	N/A

In Settings, you can change the Quick menu buttons to use other functions. (See Page 166.) The following functions are available.

102 Navigation

Button	Explanation	Primary Location
Overview (Overview)	Reduces the scale of the 2D map to display the entire route.	My Route / Overview (See Page 141.)
Visual Guidance (Visual Guidance)	Opens the Visual Guidance settings screen.	More / Settings / Visual Guidance (See Page 172.)
Traffic (Traffic)	Opens the Traffic Summary screen.	Touch the navigation menu or the Map screen's road icons.
Avoid (Avoid)	Avoids part of the recommended route.	My Route / Avoidances
Trip Monitor (Trip Monitor)	Opens the trip monitor screen from which you can manage your saved trip logs and path logs.	More / Trip Monitor (See Page 162.)
Itinerary (Itinerary)	Opens a list of changes in the route (distances).	Touch the top of the Map screen during navigation.
Save Route (Save Route)	The route being navigated is saved to be used later.	My Route / More / Save Route





Button	Explanation	Primary Location
Load Route (Load Route)	Changes to a saved, previously navigated route.	My Route / More / Load Route
Find Places (Find Places)	Searches for your favorite spots using a variety of methods.	Find / Find Places (See Page 120.)
Simulate Navigation (Simulate Navigation)	The Map screen opens and a simulation of the route being navigated starts.	My Route / More / Simulate Navigation (See Page 153.)
GPS Info (GPS Info)	Opens the GPS information screen showing satellite positions and signal strength.	Touch the top of the Map screen if there is no GPS reception.

Check Current Position (Where Am I?)

You can open this function from the Quick menu. The button on this screen searches for information on the current position (if there is no GPS reception it uses the last confirmed position) and recommended spots in the area, and displays them on the screen.



This screen provides the following information.

-   Latitude/Longitude (Current positional coordinates use the WGS84 land survey system)
-  Altitude (Advanced information acquired by the GPS receiver - may not be accurate)
-  Address of current position on left
-  Address of current position on right
- The latest location information is displayed in the center of the screen, or the time after the latest information was acquired is displayed.

- A detailed address (when available) for the current position is displayed at the bottom of the screen.

The following functions are also available on this screen.

Touch **More** (More) to save the current position in the destination list.

You can also search for nearby help around the current position. Touch **Help Nearby** (Help Nearby) to open a new screen and perform a quick search.



You can search for the following services around your current position or the latest confirmed position.

- **Car Repair Around Here** (Car Repair Around Here):
Vehicle repairs / Road-side assistance services
- **Health Around Here** (Health Around Here):
Hospitals / Emergency services
- **Police Around Here** (Police Around Here):
Police stations
- **Gas Station Around Here** (Gas Station Around Here):
Gas stations

Touch a button and then select an item from the list to display the route navigation to the location.

Navigation

You can select one of the following methods to perform navigation.

- To start navigation right away, select a destination and set the route for standard navigation.
- You can search for a route regardless of the current GPS position (or if there is no GPS reception). To do this, turn off the GPS receiver, touch the flag icon for the current position, and set a new departure point using My Route / Edit Route.

You can create a route plan even if you have multiple destinations. Select the destination. When selecting the next destination, if it is added to the route currently being created, a multiple destination route is created. There is no limit on the number of destinations you can set.

Select route destination

You can use any of the following methods to select the destination.

- Enter all or part of the address. For example: Instead of entering the address, you can just enter the name of the street or intersection.
- Enter the address by using the ZIP Code. (See Page 117.) This allows you to search for the street name quickly, even if you have not selected a district name.
- Use one of your pre-entered favorite spots as the destination. (See Page 120.)
- Use the Find on Map function to select a destination. (See Page 134.)
- Use the list of previously saved destinations. (See Page 135.)
- You can select a destination from the history of previous destinations. (See pages 137, 138.)

Enter all or part of the address



Entering part of the address is the quickest way to select the destination for your route.

You can specify the address by entering the following items on the same screen.

- An accurate address, such as the house number
- City/town center
- Intersection
- Street name
- Enter any of the items above, and then search using the ZIP Code (See Page 117.)

■ Entering an address

Follow the steps below to enter an address as the destination.

- 1 If the Map screen is displayed, touch **Menu** (Menu) to return to the navigation menu.
- 2 On the navigation menu, touch **Find** (Find).
- 3 Touch **Find Address** (Find Address).
- 4 By default, the country and district for your current position are displayed. If necessary, touch **Country or State** (Country or State) and then enter the first few letters of the country name. You can then select the country from the list displayed.



5 If necessary, select the city/town again.

- (1) Touch **City** (City).
- (2) Use the keyboard to enter the start of the city/town.
 - For the keyboard, see "Using the Keyboard" on Page 88.
- (3) Follow the steps below to find the city/town you entered.
 - The most likely city/town names are displayed in the entry field. Touch **✓** to use the name displayed.
 - If the name you want is not automatically entered, enter a few more letters from the name until it is displayed in the list (touch **Results** (Results) to open the results list before the search results are automatically displayed). Select the city/town from the list.





6 Enter the street name as follows.

- (1) Touch **Street** (Street).
- (2) Use the keyboard to enter the start of the street name.
 - For the keyboard, see “Using the Keyboard” on Page 88.
- (3) Find the street name to enter as follows.
 - The most likely street name is displayed in the entry field. Touch  to use the name displayed.

- If the name you want is not automatically entered, enter a few more letters from the name until it is displayed in the list (touch **Results** (Results) to open the results list before the search results are automatically displayed). Select the street from the list.



7 Enter the house number as follows.

- (1) Touch **House Number** (House Number).
- (2) Enter the house number with the keyboard. (Enter the number(s), and then touch **Done**)
 - For the keyboard, see “Using the Keyboard” on Page 88.
- (3) Touch **Done** (Done) to finish entering the address. (If the house number is not found, the center of the street is selected as the destination.)



- 8 The map is displayed in full-screen mode with the selected point at the center. If necessary, you can touch another point on the map to change the destination. The cursor () is displayed at the new position. Touch **Next** (Next) to set the destination, or touch **Back** (Back) to select another destination.



- 9 After a summary of the route plan is displayed, the entire route is displayed on the map. The route is researched automatically. Touch **More** (More) to change the route plan, or touch **Go!** (Go!) to start navigation. (When the countdown is displayed in the “Go!” button, guidance begins automatically after 10 seconds even if you do not touch the button.)



NOTE

If the destination will be used frequently, you can save it to the destination list as follows before touching **Next** (Next). Touch **More** (More), and then touch **Add to Favorites** (Add to Favorites). Enter a name for the destination you want to save, and then touch **Done** (Done). You are automatically returned to the map with the destination set. Start driving following the navigation.

■ Entering the center of the street as the destination

If you do not know the house number, you can navigate by setting the center of the street as the destination.

- 1 If the Map screen is displayed, touch **Menu** (Menu) to return to the navigation menu.
- 2 On the navigation menu, touch **Find** (Find).
- 3 Touch **Find Address** (Find Address).
- 4 If necessary, change the country and district as mentioned above. (See Page 106.)

5 Enter the street name as follows.

- (1) Touch **Street** (Street).
- (2) Use the keyboard to enter the start of the street name.
 - For the keyboard, see “Using the Keyboard” on Page 88.
- (3) Find the street name to enter as follows.
 - The most likely street name is displayed in the entry field. Touch  to use the name displayed.
 - If the name you want is not automatically entered, enter a few more letters from the name until it is displayed in the list (touch **Results** (Results) to open the results list before the search results are automatically displayed). Select the street from the list.



- 6 Touch **Select Street** (Select Street) without entering an address. The center of the street is selected as the destination.



- 7 The map is displayed in full-screen mode with the selected point at the center. If necessary, you can touch another point on the map to change the destination. The cursor (👆) is displayed at the new position. Touch **Next** (Next) to set the destination, or touch **Back** (Back) to select another destination.



- 8 After a summary of the route plan is displayed, the entire route is displayed on the map. The route is researched automatically. Touch **More** (More) to change the route plan, or touch **Go!** (Go!) to start navigation. (When the countdown is displayed in the “Go!” button, guidance begins automatically after 10 seconds even if you do not touch the button.)



■ Selecting an intersection as the destination

Follow the steps below to enter an intersection as the destination.

- 1 If the Map screen is displayed, touch **Menu** (Menu) to return to the navigation menu.
- 2 On the navigation menu, touch **Find** (Find).
- 3 Touch **Find Address** (Find Address).
- 4 If necessary, change the country and district as mentioned above. (See Page 106.)
- 5 Enter the street name as follows.
 - (1) Touch **Street** (Street).
 - (2) Use the keyboard to enter the start of the street name.
 - For the keyboard, see “Using the Keyboard” on Page 88.
 - (3) Find the street name to enter as follows.
 - The most likely street name is displayed in the entry field. Touch  to use the name displayed.

- If the name you want is not automatically entered, enter a few more letters from the name until it is displayed in the list (touch **Results** (Results) to open the results list before the search results are automatically displayed). Select the street from the list.



6 Enter the intersection name as follows.

- (1) Touch **Intersecting Street** (Intersecting Street).



- If there are only a few roads at the intersection, the list is displayed immediately.
- If the road is a long way off, the keyboard screen is displayed. Use the keyboard to enter the start of the intersection name. (For the keyboard, see “Using the Keyboard” on Page 88.) A list is automatically displayed when the entered road name matches and can be displayed on one screen. Select from the list.



- 7 The map is displayed in full-screen mode with the selected point at the center. If necessary, you can touch another point on the map to change the destination. The cursor (👆) is displayed at the new position. Touch **Next** (Next) to set the destination, or touch **Back** (Back) to select another destination.



- 8 After a summary of the route plan is displayed, the entire route is displayed on the map. The route is researched automatically. Touch **More** (More) to change the route plan, or touch **Go!** (Go!) to start navigation. (When the countdown is displayed in the “Go!” button, guidance begins automatically after 10 seconds even if you do not touch the button.)

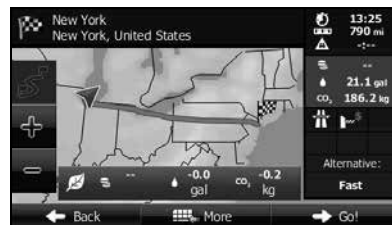

■ Selecting a city/town center as the destination

The center of the city/town is not the geographical center of the city/town, but a location set by the cartographer. In towns and villages, this is usually the most important intersection, while in larger cities it is selected from multiple important intersections.

- 1 If the Map screen is displayed, touch **Menu** (Menu) to return to the navigation menu.
- 2 On the navigation menu, touch **Find** (Find).
- 3 Touch **Find Address** (Find Address).
- 4 If necessary, change the country as mentioned above. (See Page 106.)
- 5 Select the city/town as follows.
 - (1) Touch **City** (City).
 - (2) Use the keyboard to enter the start of the city/town.
 - For the keyboard, see “Using the Keyboard” on Page 88.
 - (3) Follow the steps below to find the city/town you entered.
 - The most likely city/town names are displayed in the entry field. Touch  to use the name displayed.

- If the name you want is not automatically entered, enter a few more letters from the name until it is displayed in the list (touch **Results** (Results) to open the results list before the search results are automatically displayed). Select the city/town from the list.



- 6 Touch **Select City** (Select City) without entering the street name. Set the city/town center displayed as the route's destination.



- 7 The map is displayed in full-screen mode with the selected point at the center. If necessary, you can touch another point on the map to change the destination. The cursor (Ⓜ) is displayed at the new position. Touch **Next** (Next) to set the destination, or touch **Back** (Back) to select another destination.



- 8 After a summary of the route plan is displayed, the entire route is displayed on the map. The route is researched automatically. Touch **More** (More) to change the route plan, or touch **Go!** (Go!) to start navigation. (When the countdown is displayed in the "Go!" button, guidance begins automatically after 10 seconds even if you do not touch the button.)



■ Using a ZIP Code

By entering the ZIP Code, you can perform the address search mentioned above, even if you do not know the district name. The following is an example of entering an accurate address.

- 1 If the Map screen is displayed, touch **Menu** (Menu) to return to the navigation menu.
- 2 On the navigation menu, touch **Find** (Find).
- 3 Touch **Find Address** (Find Address).
- 4 If necessary, change the country as mentioned above. (See Page 106.)
- 5 Enter the city/town by using the ZIP Code.
 - (1) Touch **City** (City).
 - (2) Touch **123** to open the number pad.
 - (3) Start entering the ZIP Code.
 - (4) Follow the steps below to find the city/town you entered.
 - The most likely ZIP Code is displayed in the entry field. Touch  to use the name displayed.

- If the ZIP Code you want to enter is not displayed, touch **Results** (Results) to open the search results list. Select the ZIP Code from the list.



- 6 Enter the street name as follows.
 - (1) Touch **Street** (Street).
 - (2) Use the keyboard to enter the start of the street name.
 - For the keyboard, see "Using the Keyboard" on Page 88.
 - (3) Find the street name to enter as follows.
 - The most likely street name is displayed in the entry field. Touch  to use the name displayed.

- If the name you want is not automatically entered, enter a few more letters from the name until it is displayed in the list (touch **Results** (Results) to open the results list before the search results are automatically displayed). Select the street from the list.



7 Enter the house number as follows.

- (1) Touch **House Number** (House Number).
 - (2) Enter the house number with the keyboard. (Enter the number(s), and then touch **Done**.)
- For the keyboard, see "Using the Keyboard" on Page 88.
- (3) Touch **Done** (Done) to finish entering the address. (If the house number is not found, the center of the street is selected as the destination.)



- 8 The map is displayed in full-screen mode with the selected point at the center. If necessary, you can touch another point on the map to change the destination. The cursor (👆) is displayed at the new position. Touch **Next** (Next) to set the destination, or touch **Back** (Back) to select another destination.



- 9 After a summary of the route plan is displayed, the entire route is displayed on the map. The route is researched automatically. Touch **More** (More) to change the route plan, or touch **Go!** (Go!) to start navigation. (When the countdown is displayed in the "Go!" button, guidance begins automatically after 10 seconds even if you do not touch the button.)



■ Hints for quick address entry

- When entering a city/town name or a street name:
 - Only characters that can be displayed in the search results are shown on the keyboard. Other characters are grayed out.
 - While entering text, the most likely search result is always displayed in the text entry field. If the search result is correct, touch  to select it.
 - If you touch **Results** (Results) after entering two characters, items that contain those two characters are displayed in the list.
- You can find intersections easily by using the following method.
 - First, when searching for an uncommon road name, you only need to enter the first few letters to acquire the name.
 - When one street name is shorter than the other, the shorter one is searched for first. This shortens the search time for the road with the longer name.
- You can search by road category as well as road name. When the same word is included in names such as the street, road, and main street, by entering the first character for the type of road, you can quickly bring up the search results. For example, if you are searching for "Pine Avenue" and you enter "Pi A", roads such as "Pine Street" or "Pickwick Road" are not displayed.
- You can also search by using the ZIP Code. If the ZIP Code only contains a few characters, you can search more quickly than when entering the city/town name.

Selecting the destination from your favorite spots (POI: Point Of Interest)

.....

You can select your destination from the favorite spots that have already been saved in the software.

You can use the same screen to find a spot using the following various methods.

- Using the quick search function, you can quickly search for spots around the name.
- Using the preset search function, you can search for the most popular spots with a few quick touches.
- Search using spot categories.
- Search using spot names.

You can also search for special services from the "Where Am I?" screen.

■ Performing a quick search for favorite spots

Using the quick search function, you can quickly search for spots by name. You can use the following search items.

- Around the recommended route (when a recommended route is available)
- Around the current location (when no destination is set)

1 Follow the steps below to start a quick search.

- If the Map screen is displayed, touch  and then touch **Quick Place Search** (Quick Place Search). (Only when registered to the Quick Menu.)
- If the Map screen is displayed, touch **Menu** (Menu), **Find** (Find), **Find Places** (Find Places), and then touch **Quick Search Along Route** (Quick Search Along Route).

2 Use the keyboard to enter the start of the spot name.

- For the keyboard, see “Using the Keyboard” on Page 88.



- 3 Touch **Results** (Results) after entering the first few characters to open a list of spot names that include the characters you entered.



- 4 (Optional) You can display spots on the list in name order, in order of the distance from the current position or previously confirmed position, or in order of necessary detour distance (during navigation). If you want to change the order in which entries are presented in the list, touch **More** (More) and select the style that you want. Also, you can display all of the spots on the list on the map.



- 5 Find the item you want on the list, and then touch that item. The map is displayed in full-screen mode with the selected point at the center. The name and address of the spot are displayed at the top of the screen.
- 6 (Optional) Touch **i** to display details about the selected spot. Touch **Back** (Back) to return to the map.
- 7 If necessary, you can touch another point on the map to change the destination. The cursor (👉) is displayed at the new position. Touch **Next** (Next) to set the destination, or touch **Back** (Back) to select another destination.



- 8 After a summary of the route plan is displayed, the entire route is displayed on the map. The route is researched automatically. Touch **More** (More) to change the route plan, or touch **Go!** (Go!) to start navigation. (When the countdown is displayed in the “Go!” button, guidance begins automatically after 10 seconds even if you do not touch the button.)



■ Searching for favorite spots using a preset category

By using the preset search function, you can quickly selected popular spots.

- 1 If the Map screen is displayed, touch **Menu** (Menu) to return to the navigation menu.
- 2 On the navigation menu, touch **Find** (Find).
- 3 Touch **Find Places** (Find Places).
- 4 Display preset search categories as follows.



Gas Station Along Route (Gas Station Around Route):

- Searches for gas stations along the route during route navigation.
- Searches around the current position if navigation is not being performed (if no destination is set).
- Searches the area around the last confirmed position if the current position is unavailable (no GPS signal).

Parking Around Here (Parking Around Here):

- Searches for parking lots at the destination during route navigation.
- Searches around the current position if navigation is not being performed (if no destination is set).
- Searches the area around the last confirmed position if the current position is unavailable (no GPS signal).

Restaurant Along Route (Restaurant Along Route):

- Searches for restaurants along the route during route navigation.
- Searches around the current position if navigation is not being performed (if no destination is set).
- Searches the area around the last confirmed position if the current position is unavailable (no GPS signal).

Accommodation Around Here (Accommodation Around Here):

- Searches for accommodation at the destination during route navigation.
- Searches around the current position if navigation is not being performed (if no destination is set).
- Searches the area around the last confirmed position if the current position is unavailable (no GPS signal).

- 5 Press the Favorites Quick Search button to display a basic list of spots.



- 6 (Optional) You can display spots on the list in name order, in order of the distance from the current position or previously confirmed position, or in order of necessary detour distance (during navigation). If you want to change the order in which entries are presented in the list, touch **More** (More) and select the style that you want. Also, you can display all of the spots on the list on the map.



- 7 Find the item you want on the list, and then touch that item. The map is displayed in full-screen mode with the selected point at the center. The name and address of the spot are displayed at the top of the screen.

- 8 (Optional) Touch **i** to display details about the selected spot. Touch **Back** (Back) to return to the map.

- 9 If necessary, you can touch another point on the map to change the destination. The cursor (Ⓜ) is displayed at the new position. Touch **Next** (Next) to set the destination, or touch **Back** (Back) to select another destination.

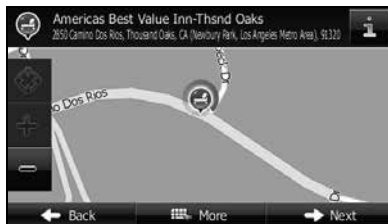

- 10** After a summary of the route plan is displayed, the entire route is displayed on the map. The route is researched automatically. Touch **More** (More) to change the route plan, or touch **Go!** (Go!) to start navigation. (When the countdown is displayed in the “Go!” button, guidance begins automatically after 10 seconds even if you do not touch the button.)

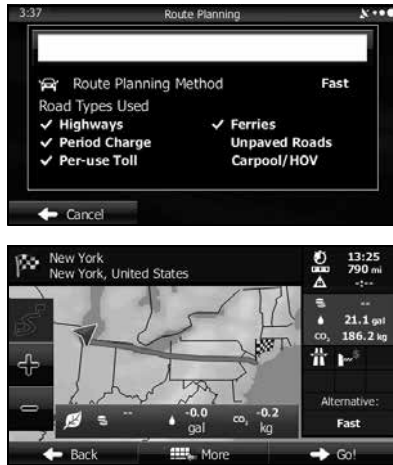

■ Searching for a favorite spot by category

You can search for favorite spots by category or sub-category.

- 1** If the Map screen is displayed, touch **Menu** (Menu) to return to the navigation menu.
- 2** On the navigation menu, touch **Find** (Find).
- 3** Touch **Find Places** (Find Places).
- 4** Touch **Custom Search** (Custom Search).
- 5** Select the spot area you want to search for as follows.
 - Touch **Around Here** (Around Here) or **Around Last Known Position** (Around Last Known Position) to search around your current position, or the latest confirmed position.
 - Touch **In a City** (In a City) to search for city/town spots.
 - Touch **Around Destination** (Around Destination) to search for spots at the destination during route navigation.

- Touch **Along Route** (Along Route) to search along the route being navigated, rather than around an optional point. This is useful when you want to search for a gas station or restaurant and so on along the route taking the smallest detour to get there.



- (Optional) If you select **In a City** (In a City), you can select a city/town displayed by the search.



- See "Entering an address" on Page 106 for information about how to select a "Country or State" or "City".

- 6 By selecting a main category (such as accommodations), or by touching **List All Places** (List All Places), the entire list of spots around the position you selected or along the route is displayed.



- 7 By selecting a sub-category (such as hotels or motels) from the main category, or by touching **List All Places** (List All Places), the entire list of spots around the position you selected or along the route is displayed.



- 8 Brand names of services may also be displayed depending on the sub-category of the selected spot. By selecting a brand name, or by touching **List All Places** (List All Places), the entire list of spots around the position you selected or along the route is displayed.

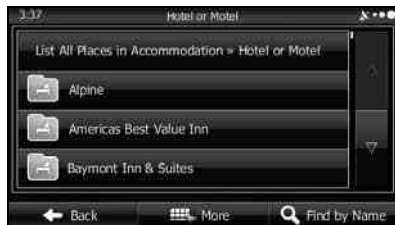

- 9 The final search results are displayed as a list.



- 10 (Optional) You can display spots on the list in name order, in order of the distance from the current position or previously confirmed position, or in order of necessary detour distance (during navigation). If you want to change the order in which entries are presented in the list, touch **More** (More) and select the style that you want. Also, you can display all of the spots on the list on the map.



- 11 Find the item you want on the list, and then touch that item. The map is displayed in full-screen mode with the selected point at the center. The name and address of the spot are displayed at the top of the screen.

- 12** (Optional) Touch **i** to display details about the selected spot. Touch **Back** (Back) to return to the map.
- 13** If necessary, you can touch another point on the map to change the destination. The cursor (⌵) is displayed at the new position. Touch **Next** (Next) to set the destination, or touch **Back** (Back) to select another destination.

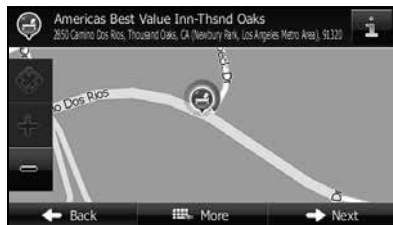

- 14** After a summary of the route plan is displayed, the entire route is displayed on the map. The route is researched automatically. Touch **More** (More) to change the route plan, or touch **Go!** (Go!) to start navigation. (When the countdown is displayed in the "Go!" button, guidance begins automatically after 10 seconds even if you do not touch the button.)



■ Searching for a favorite spot by name

You can search for a favorite spot by name. You can search the entire spot database or select a category/sub-category for another location or for the route being navigated.

- 1 If the Map screen is displayed, touch **Menu** (Menu) to return to the navigation menu.
- 2 On the navigation menu, touch **Find** (Find).
- 3 Touch **Find Places** (Find Places).
- 4 Touch **Custom Search** (Custom Search).
- 5 Select the spot area you want to search for as follows.
 - Touch **Around Here** (Around Here) or **Around Last Known Position** (Around Last Known Position) to search around your current position, or the latest confirmed position.
 - Touch **In a City** (In a City) to search for city/town spots.
 - Touch **Around Destination** (Around Destination) to search for spots at the destination during route navigation.

- Touch **Along Route** (Along Route) to search along the route being navigated, rather than around an optional point. This is useful when you want to search for a gas station or restaurant and so on along the route taking the smallest detour to get there.



- (Optional) If you select **In a City** (In a City), you can select a city/town displayed by the search.



- See "Entering an address" on Page 106 for information about how to select a "Country or State" or "City".

- 6 By selecting a main category (such as accommodations), or by touching **Find by Name** (Find by Name), you can search all spots.

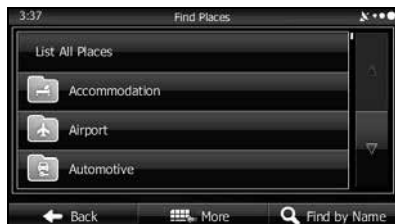

- 7 By selecting a sub-category (such as hotels or motels) from the main category, or by touching **Find by Name** (Find by Name), you can search in the main category you selected.

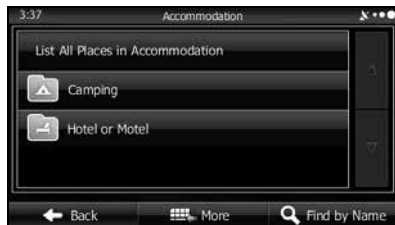

- 8 Touch **Find by Name** (Find by Name) to search a sub-category of the selected spot.

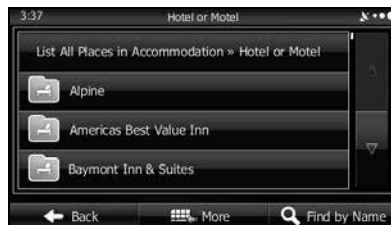

- 9 Use the keyboard to enter the start of the spot name.
- For the keyboard, see "Using the Keyboard" on Page 88.



- 10** Touch **Results** (Results) after entering the first few characters to open a list of spot names that include the characters you entered.



- 11** Find the item you want on the list, and then touch that item. The map is displayed in full-screen mode with the selected point at the center. The name and address of the spot are displayed at the top of the screen.

- 12** (Optional) Touch **i** to display details about the selected spot. Touch **Back** (Back) to return to the map.

- 13** If necessary, you can touch another point on the map to change the destination. The cursor (Ⓜ) is displayed at the new position. Touch **Next** (Next) to set the destination, or touch **Back** (Back) to select another destination.

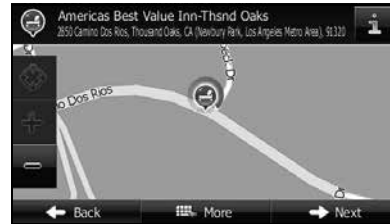

- 14** After a summary of the route plan is displayed, the entire route is displayed on the map. The route is researched automatically. Touch **More** (More) to change the route plan, or touch **Go!** (Go!) to start navigation. (When the countdown is displayed in the “Go!” button, guidance begins automatically after 10 seconds even if you do not touch the button.)



■ Using “Where Am I?” to select the closest assistance service

You can search for the closest assistance service by using the “Where Am I?” screen.

- 1** Touch  on the Map screen to open the Quick menu.



- 2** Touch **Where Am I?** (Where Am I?), and then touch **Help Nearby** (Help Nearby).



- 3** The preset search categories are displayed. This button searches for everything around your current position (or the latest confirmed position if it is unavailable).
- **Car Repair Around Here** (Car Repair Around Here)
Vehicle repairs / Road-side assistance services
 - **Health Around Here** (Health Around Here):
Hospitals / Emergency services
 - **Police Around Here** (Police Around Here):
Police stations
 - **Gas Station Around Here** (Gas Station Around Here):
Gas stations
- 4** Press any of the quick search buttons to display a basic list for the service you selected.



- 5** Find the item you want on the list, and then touch that item. The map is displayed in full-screen mode with the selected point at the center. The name and address of the spot are displayed at the top of the screen.
- 6** (Optional) Touch **i** to display details about the selected spot. Touch **Back** (Back) to return to the map.
- 7** If necessary, you can touch another point on the map to change the destination. The cursor (👆) is displayed at the new position. Touch **Next** (Next) to set the destination, or touch **Back** (Back) to select another destination.



- 8 After a summary of the route plan is displayed, the entire route is displayed on the map. The route is researched automatically. Touch **More** (More) to change the route plan, or touch **Go!** (Go!) to start navigation. (When the countdown is displayed in the “Go!” button, guidance begins automatically after 10 seconds even if you do not touch the button.)



Selecting a Map Position as the Destination

- 1 If the Map screen is displayed, touch **Menu** (Menu) to return to the navigation menu.
- 2 On the navigation menu, touch **Find** (Find).
- 3 Touch **Find on Map** (Find on Map).
- 4 Search for the destination on the map as follows. Move or enlarge/reduce the map as necessary.
 
- 5 Touch the position you want to select as the destination. The cursor () is displayed.
- 6 Touch **Select** (Select) to select the cursor as the destination.

- 7 After a summary of the route plan is displayed, the entire route is displayed on the map. The route is researched automatically. Touch **More** (More) to change the route plan, or touch **Go!** (Go!) to start navigation. (When the countdown is displayed in the “Go!” button, guidance begins automatically after 10 seconds even if you do not touch the button.)



Selecting the Destination from the Destination List

You can set a position that has been saved in the destination list as the destination.

See “Editing the Destination List (Route Editing)” on Page 147 for more details on registering a position to the destination list.

1 Display the destination list as follows.

- If the Map screen is displayed, touch **More** and then touch **Favorites** (Favorites). (Only when registered to the Quick Menu.)
- If the Map screen is displayed, touch **Menu** (Menu), **Find** (Find) and then touch **Favorites** (Favorites).

2 The destination list is displayed.



- 3 Touch the position you want to select as the destination. If necessary, you can scroll through the list, or touch **Filter** (Filter) and enter a few letters from the item name to search the list.
- 4 The map is displayed in full-screen mode with the selected point at the center. If necessary, you can touch another point on the map to change the destination. The cursor (👉) is displayed at the new position. Touch **Next** (Next) to set the destination, or touch **Back** (Back) to select another destination.



- 5 After a summary of the route plan is displayed, the entire route is displayed on the map. The route is researched automatically. Touch **More** (More) to change the route plan, or touch **Go!** (Go!) to start navigation. (When the countdown is displayed in the "Go!" button, guidance begins automatically after 10 seconds even if you do not touch the button.)



Selecting a Frequently Used Destination (Smart History)

Destinations that have been set previously are displayed in the History list. The two most recent destinations are displayed on the destination menu allowing you to select them easily. Smart History uses conditions such as the current time, date, and position, and displays a position in response to the user's navigation habits. The more you use the navigation system, the more accurate the anticipated destination becomes.

- 1 If the Map screen is displayed, touch **Menu** (Menu) to return to the navigation menu.



- 2 Touch **Find** (Find) on the navigation menu.



- 3 Touch destination **#1** or **#2** in the History field.

- 4 The map is displayed in full-screen mode with the selected point at the center. If necessary, you can touch another point on the map to change the destination. The cursor () is displayed at the new position. Touch **Next** (Next) to set the destination, or touch **Back** (Back) to select another destination.

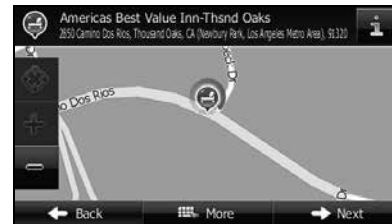

- 5 After a summary of the route plan is displayed, the entire route is displayed on the map. The route is researched automatically. Touch **More** (More) to change the route plan, or touch **Go!** (Go!) to start navigation. (When the countdown is displayed in the “Go!” button, guidance begins automatically after 10 seconds even if you do not touch the button.)

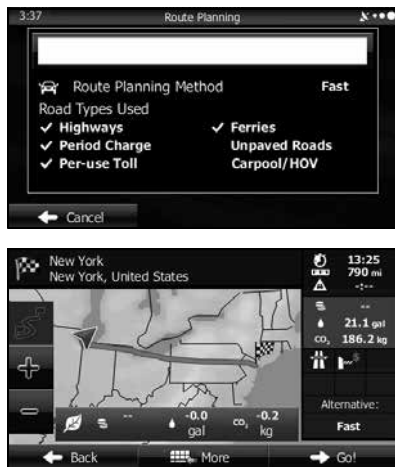

Selecting a Recent Destination from History

Destinations that have been set previously are displayed in the History list.

- 1 Use the History function as follows.
 - If the Map screen is displayed, touch **More** (More) and then touch **History** (History). (Only when registered to the Quick Menu.)
 - If the Map screen is displayed, touch **Menu** (Menu), **Find** (Find) and then touch **History** (History).
- 2 A list of recently entered destinations is displayed. A History search displays three destination on the top page based on previously entered routes (destinations with the highest likelihood of use). Other destinations are displayed based on the time they were entered in the past. If necessary, scroll through the list to display older entries and select the destination.



- 3 Select a destination from the list.
- 4 The map is displayed in full-screen mode with the selected point at the center. If necessary, you can touch another point on the map to change the destination. The cursor (Ⓜ) is displayed at the new position. Touch **Next** (Next) to set the destination, or touch **Back** (Back) to select another destination.

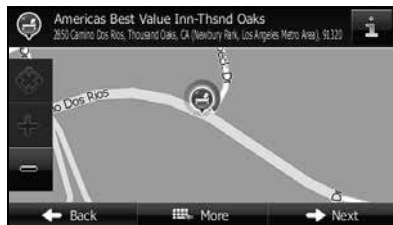

- 5 After a summary of the route plan is displayed, the entire route is displayed on the map. The route is researched automatically. Touch **More** (More) to change the route plan, or touch **Go!** (Go!) to start navigation. (When the countdown is displayed in the "Go!" button, guidance begins automatically after 10 seconds even if you do not touch the button.)

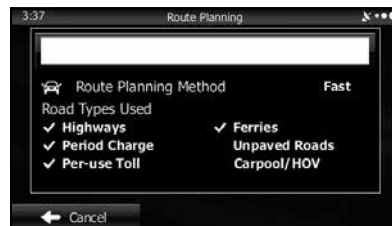

Creating a Route from the Destination List (Route Creator)

You can create a route for each destination in the saved routes menu.

- 1 If the Map screen is displayed, touch **Menu** (Menu) to return to the navigation menu.
- 2 Touch **My Route** (My Route) on the navigation menu.
- 3 Touch **Create Route** (Create Route).
- 4 Only one row showing the route's start point (current position displayed) is displayed in the route point list.



- 5 Touch  to select a destination.

- 6 When the destination menu is displayed, select the route's destination using the same method as described previously.



- 7 After selecting a new destination, you are returned to the list.



- 8 To add another destination, touch  at the point where you want to add a new route point to the list, and repeat the steps above.

Displaying the Entire Route on the Map

You can easily display an overview of the entire route currently being navigated. Follow the steps below to use the initial settings screen.

- 1 Touch **Menu** (Menu) on the Map screen.

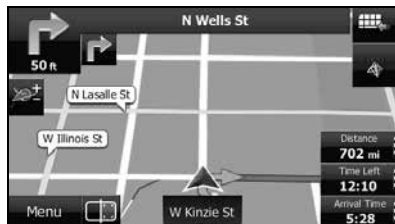

- 2 Touch **My Route** (My Route) on the navigation menu.

- 3 Touch **Overview** (Overview). The entire route currently being navigated is displayed on the map along with detailed information and buttons.



Confirming Route Settings and Calling Route Related Functions

You can check a variety of route settings recommended by the software.

- 1 If the Map screen is displayed, touch **Menu** (Menu) to return to the navigation menu.
- 2 Touch **My Route** (My Route) on the navigation menu.
- 3 The following information items are displayed.



- Destination Name/Address
- Displays detailed information (unpaved roads, toll roads, and so on) on the warning icons (depending on conditions) for the current route.
- Total time for route
- Total distance for route
- Estimated delay times calculated from traffic conditions on the route
- Route planning method ("Priority to time" and so on)

- 4 The following options are displayed on the screen (see the next section for more detailed information).

- Touch **Edit Route** (Edit Route) to add or delete a destination, or change the order for the destinations. You can set the route departure point, excluding the current position. This is useful for creating a route in advance and saving it for later use.
- Touch **Overview** (Overview) to display the entire route on the map. (See Page 141.)
- Touch **Avoidances** (Avoidances) to avoid a section of the route. (See Page 143.)
- Touch **Cancel Route** (Cancel Route) to delete the route currently being navigated. (See Page 148.)
- Touch **More** (More) to display a list of various options such as selecting another route, changing the route settings, running a simulation of the route, saving the route being navigated, and reading a previously saved route.
- Touch **Back** (Back) to return to the navigation menu.

Setting the avoidance route

The Avoidances feature allows you to remove any of the roads or special sections on the planned route.

- **Avoid Special Sections** (Avoid Special Sections):
Avoid Special Sections allows you to remove any special road types (e.g. motorways or ferries) from your route. This feature is only available if there are special sections along the planned route.
- **Avoid Route Ahead** (Avoid Route Ahead):
The Avoid Route Ahead option skips a predefined length of the planned route (500m, 1000m, etc.) right ahead of the current position.
- **Avoid Specific Road** (Avoid Specific Road):
Avoid Specific Road allows you to skip a specific road from your calculated route.
- **Restore Original Route** (Restore Original Route):
Touch "Restore Original Route" to delete the avoid route being navigated.

In each case, the result of the selected avoidance is shown on the map with an indication of additional or saved time and distance. The user can review and confirm the avoidance on this screen.

Note that avoidances are not permanent: they are only applied for the active route.

Changing the Route

When navigation has already begun, you can change the route being navigated by using one of the following methods. The methods are explained in the following section.

Selecting a new destination after the route has been set: new route, waypoint, and final destination

.....

If a recommended route is already available, and a new destination has been selected using the method described in the previous section, the start new route, add a new waypoint (midway point), and add the destination you selected as the final destination buttons are displayed.



- Touch **New Route** (New Route) to create a new route at the position you selected. Previous destinations and waypoints are deleted.
- Touch **Waypoint** (Waypoint) to add the position you selected as a new waypoint for the current route. Other destinations for the route are already enabled. Note: Waypoints are set so that the optimum route is maintained between destinations. You can use the route editing function to set the position for waypoints on the route.
- Touch **Final Destination** (Final Destination) to add the destination you selected as the final destination for the current route. Other destinations for the route are already enabled. Up to now, the position marked as the final destination becomes the final waypoint.

Setting a New Starting Point for the Route

In standard navigation, all routes are created from the current position. You can turn off the GPS so that you can study a route that is not currently being driven, run a simulation, and check the time or distance for the route. This way, you can set a start point for the route without using the current GPS position.

- 1 If the Map screen is displayed, touch **Menu** (Menu) to return to the navigation menu.
- 2 Touch **My Route** (My Route) on the navigation menu.
- 3 If a route is already available, touch **Edit Route** (Edit Route). If a route has already started, touch **Create Route** (Create Route).

- 4 The first row shows the start position (displays the current position) for the route. When you touch **+**, if a warning message is displayed, select which operation to perform.





- 5 When the destination menu is displayed, select the route's start point by using the same method as selecting the destination.



- 6 Set the new start point, and then touch **Go!** (Go!).

- 7 The vehicle marker goes clear on the map, indicating that there is no GPS reception. If a route is already being navigated, it is recalculated using the position selected at that time.



- 8 To return to standard navigation, touch **Turn on GPS** (Turn on GPS), and if a warning message is displayed, select which operation to perform.



Editing the Destination List (Route Editing)

You can change the destination list and edit the route. You can add or delete destinations, change the start point, or change the order of the list.



1 Use the Route Editing function as follows.

- If the Map screen is displayed, touch  and then touch **Edit Route** (Edit Route) to start operation from Step 3. (Only when registered to the Quick Menu.)
- If the Map screen is displayed, touch **Menu** (Menu) and then touch **My Route** (My Route).

2 Touch **Edit Route** (Edit Route).

3 The following options are available.



- Touch  to add a new destination.
- Touch  to delete a destination.
- Touch  to change the start point of the route.
- Touch **More** (More) to change the display order of the list. You can also manually select the optimum route in the application.

Pausing Route Navigation

.....

You do not need to pause a route currently being navigated. When you start driving again, the software automatically restarts audio navigation from the current position.

Canceling Route Navigation

.....

Perform one of the following procedures to cancel a route that is currently being navigated.

- If the Map screen is displayed, touch  and then touch **Cancel Route** (Cancel Route). (If waypoints are set on the route, you need to touch **Remove Next Waypoint** (Remove Next Waypoint) until all waypoints have been deleted.)
- On the Map screen is displayed, touch **Menu** (Menu), **My Route** (My Route), and then touch **Cancel Route** (Cancel Route). The route being navigated is deleted, including all waypoints.

Changing the Method for Searching for a Route (Other Routes, etc.)

Change the Route settings to perform a new search for the route being navigated using a different method. (See Page 169.) You can even search again by comparing different routes. Follow the steps below to use the initial settings screen.

- 1 If the Map screen is displayed, touch **Menu** (Menu) to return to the navigation menu.
- 2 Touch **My Route** (My Route) on the navigation menu.
- 3 Touch **More** (More).



- 4 Touch **Route Alternatives** (Route Alternatives).



- 5 Using the current search method, three routes are displayed in order of recommendation. Touch **More Results** (More Results) to search using a different method. Also, if only a short distance is being navigated or only a few search candidates are found, each search method displays only one route.



- **Fast** (Fast):
Searches all roads for the quickest route following the speed limits of the roads.
 - **Short** (Short):
Searches for the shortest distance in all possible routes.
 - **Green** (Green):
Searches for the route that conserves the most energy, taking into account the merits of “Fast” and “Short”.
 - **Easy** (Easy):
Searches for a route that is easiest to drive, with few right and left turns. Using this option, the program allows you to avoid combinations of smaller roads and to take the expressway.
- 6** Touch **Back** (Back) to return to the previous screen. The route is searched again using the selected method. The new recommended route is indicated by an orange line.

Changing the Road Categories used for the Route Search

You can use the following method to search the current route again using different road categories. This can also be changed in Settings. (See Page 169.)

1 Use the “Route Settings” function as follows.

- If the Map screen is displayed, touch  and then touch **Route Settings** (Route Settings). (Only when registered to the Quick Menu.)
- If the Map screen is displayed, touch **Menu** (Menu), **More** (More), **Settings** (Settings) and then touch **Route Settings** (Route Settings).

2 Touch one of the road categories displayed in the list to change the route. If necessary, scroll the list to view all road categories. The following items are available (the order differs depending on the type of vehicle selected).



- **Vehicle** (Vehicle):
Sets various factors to take into account when performing a search, such as fuel consumption, vehicle model, fuel costs, and maximum speeds on normal roads and expressways.
- **Navigation Mode** (Navigation Mode):
You can change between On-road and Off-road.
Set to On-road to perform normal navigation, or set to Off-road to navigate using the straightest possible route to the destination.
- **Route Planning Method** (Route Planning Method):
By changing the route search method, you can search for the optimum route for a variety of situations and types of vehicle. See the following items for more details.
- **Highways** (Highways):
Select whether or not to use the expressway when creating the route.
- **Period Charge** (Period Charge):
Select whether or not to use toll roads (Period Charge) when creating the route.
- **Per-use Toll** (Per-use Toll):
Select whether or not to use toll roads (Per-use Toll) when creating the route.
- **Ferries** (Ferries):
Select whether or not to use ferries when creating the route. (However, ferries might not always be selected for the route.) However, information on temporary service ferries may not be displayed on the map. There may be a fee for using the ferry.
- **Carpool/HOV** (Carpool/HOV):
Select whether or not to use Carpool/HOV lanes when creating the route.
- **Unpaved Roads** (Unpaved Roads):
Select whether or not to use unpaved roads when creating the route.
- **Calculate Green Alternative** (Calculate Green Alternative):
Select whether or not to consider energy efficiency when creating the route.

3 Touch **Back** (Back) to set the changes. The route is searched again, and the new recommended route is indicated by an orange line.

Saving a Position to the Destination List

The destination list is a list of frequently used destinations. You can add any destination to this list. See “Selecting the Destination from the Destination List” on Page 135 for more details on searching for a route using a destination from the destination list.

- 1 Select a destination.
- 2 When the map is displayed in full-screen mode with the selected point at the center, touch **More** (More).
- 3 Touch **Add to Favorites** (Add to Favorites).



- 4 (Optional) You can use the keyboard to change the initial display name in the destination list. Touch **123** to enter numbers or symbols.

- For the keyboard, see “Using the Keyboard” on Page 88.



- 5 Touch **Done** (Done) to save the position as a new entry on the destination list.

Displaying a Simulation of the Route

You can run a simulation of the route currently being navigated. Follow the steps below to use the initial settings screen.

- 1 If the Map screen is displayed, touch **Menu** (Menu) to return to the navigation menu.
- 2 Touch **My Route** (My Route) on the navigation menu.
- 3 Touch **More** (More).







- 4 Scroll down through the list, and then touch **Simulate Navigation** (Simulate Navigation). The simulation begins from the start point and works through the entire route at the recommended speed.

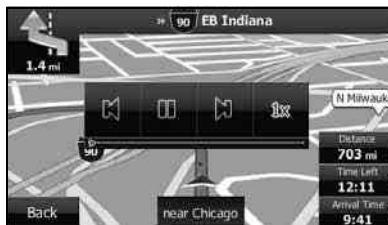

- 5 (Optional) You can use the following buttons during the simulation (although the control buttons disappear after a few seconds, you can touch the map to show them again).



- : Returns to the previous route event (the previous change in the route)
- : Pauses the simulation.
- : Goes to the next route event (the next change in the route)
- : Changes the speed of the simulation. You can select from speeds of x4, x8, or x16. Touch again to return to normal speed.

6 Touch **Back** (Back) to stop the simulation.

Voice Control Navigation

By using the voice control system (voice input microphone and button), you can set the destination by giving voice commands. This enables you to use functions that are usually inoperable while driving.

- 1 By using the voice recognition trigger or voice recognition button you can use voice commands to operate the navigation. (See Page 292.)

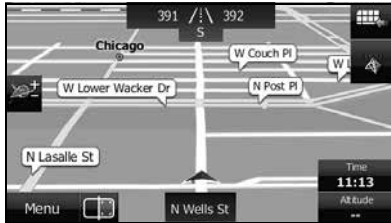

- 2 When using voice commands to operate the navigation, a command list is displayed. 155
- 3 Voice a command after the “beep”. From then on, you can give voice commands that are displayed on the command list to set the destination in the same manner.



- Voice control navigation can be interrupted by touching the microphone icon on the screen. When the icon is touched, the screen background color changes (green ↔ blue). To resume navigation voice control, touch the microphone icon again. The differences in background colors are explained below.
- **Command standby screen (green):**
This is the voice control command standby screen. When this screen is displayed, you can speak a command to perform navigation control. You can also perform control by directly touching the commands that are displayed on the screen.

- **Manual mode screen (blue):**

This screen appears when voice control is interrupted. You can perform control by directly touching the commands that are displayed on the screen.

- **Talkback screen (yellow):**

This screen appears while the talkback voice is being played when a command is recognized.

- **Command recognition failed screen (red):**

This screen appears when command recognition failed.

NOTE

“Address” searching using voice commands is only available when the device is used within the USA and its language setting is set to English.

Reference Data

The following pages explain the software's various features and menu screens.

Feature

Smart Zoom

.....

Smart zoom offers a large improvement over standard zoom functions.

- **While driving the route:** When approaching an intersection, the screen is enlarged and the viewpoint raised so that you can easily see which way to drive at the next intersection. After navigating the intersection, the screen is reduced and the angle lowered to check the road in front.
- **When driving without route navigation:** The screen is enlarged as you slow down and reduced as you speed up.

Switching between Day and Night Screens

.....

For the Map screen and menu screen, the colors differ between day and night.

- During daytime, the screen's colors are the same as those of a printed map, and the menu is brighter.
- At night, the screen uses dark colors for large objects and reduces the overall brightness of the screen.

The screen's color scheme differs between day and night. Using the current time and GPS position, you can also switch automatically between day and night screen settings just before sunrise (at dawn) and just after sunset (at dusk).

Route Search/Search Again

You can search for routes to suit your preferences.

Route search methods:

- **Fast** (Fast):
Searches all roads for the quickest route following the speed limits of the roads.
- **Green** (Green):
Searches for the route that conserves the most energy, taking into account the merits of “Fast” and “Short”.
- **Short** (Short):
Searches for the shortest distance in all possible routes.
- **Easy** (Easy):
Searches for a route that is easiest to drive, with few right and left turns. Using this option, the program allows you to avoid combinations of smaller roads and to take the expressway.

Search for a route by using or avoiding certain road categories:

- **Highways** (Highways)
- **Period Charge** (Period Charge)
- **Per-use Toll** (Per-use Toll)
- **Ferries** (Ferries)
- **Carpool/HOV** (Carpool/HOV)
- **Unpaved Roads** (Unpaved Roads)
- **Calculate Green Alternative** (Calculate Green Alternative)





The route may change drastically when real time traffic conditions are factored in. (See Page 159.)

If you leave the route that was searched for based on your current position, and new information is received regarding traffic conditions for the recommended route, the software automatically searches for another route.

See “Route Settings” on Page 169 for detailed information on Route settings.

GPS Positioning Quality Indicator

The GPS reception quality icon at the top right of the menu screen indicates the current accuracy of positional information.

Icon	Explanation
	The software is not connected to the GPS receiver. Cannot perform GPS navigation. Products with a built-in GPS receiver are always connected. This icon is not normally displayed for those products.
	Although the software is connected to the GPS receiver, the signal is too weak to measure the GPS. Cannot perform GPS navigation.
	Only a few satellites are transmitting. Positional information is available, but altitude (elevation above sea level) cannot be calculated. GPS navigation is possible, but large positional errors may occur.
	Elevation above sea level is available, and measurements can be performed in 3D. GPS navigation is available.

Online Road Information Saved in Route Search

This unit can provide you with even better routes, if real-time traffic information (TMC: Traffic Message Channel) is available.

If public traffic data is broadcast at your location, this unit automatically takes into account the traffic data received. You do not need to set anything in the program. The decoded information will immediately be used in route planning. The moment unit receives traffic information that may affect your route, the program recalculates the route, and this unit will continue with a new route that is optimal based on the most up-to-date traffic conditions.

Real-time traffic information (TMC)

TMC (Traffic Message Channel) offers real-time traffic conditions. This can help you to avoid traffic jams that could not be anticipated due to road closures or accidents.

TMC uses a dedicated FM Radio Data System (RDS) to broadcast real-time traffic and weather reports.

The default settings use traffic information when searching for a route. The TMC receiver necessary to receive traffic condition reports is built-in to some products, but not for others. Contact your nearest SUBARU dealer.

If traffic data normally broadcast in your region can be accessed, this received information is automatically taken into account. This does not need to be manually set. FM radio stations broadcasting TMC data are searched for automatically, and decoded information is immediately used to search for routes. If traffic information that might affect the current route is received, a warning is displayed indicating that the route will be searched for again, and navigation continues using a new, optimal route taking into account the latest traffic conditions.

By delaying the timing before applying a route that has been searched again, the user can check the route and fine-tune the details creating the optimal search results. You can set this from Traffic settings. (See Page 168.)

When traffic information is being received, a special icon  is displayed on the map. When there is no traffic information available for the route, this icon indicates the status of the traffic information receiver, and when information is received, the type of upcoming traffic information is displayed.

Road sections affected by traffic conditions are displayed in a different color on the map, and a small icon representing the type of traffic condition is displayed above the road.



Touch  to display the Traffic Summary screen.



Touch **Event List** (Event List) to check the traffic information that has been received.



On this screen, you can select one entry from the list to view list of the traffic conditions for that section of the road.



On this screen, you can select one entry from the list to view full details of the traffic conditions for that section of the road.



Touch  to open another screen displaying information on the selected map position.

NOTE

- This function is only available when TMC is installed in the product being used.
- The TMC service is not available for all regions. There are also times when it may not be available in your country or district. For more information on availability, contact your nearest SUBARU dealer.

“More” Menu

Various options are available from the “Others” menu. Touch **More** (More) on the navigation menu.

- 1 If the Map screen is displayed, touch **Menu** (Menu) to return to the navigation menu.
- 2 Touch **More** (More) on the navigation menu.



- **Settings** (Settings): Configures programs and changes operational patterns for the software. Performs functions such as fine tuning route search options, changing the Map screen design, turning warnings on or off, and launching the Setup Wizard.

- **Sunrise & Sunset** (Sunrise & Sunset): You can check global sunrise and sunset times. Places a mark on the map to show the user's current position and route points. Touch the Details button to check accurate sunrise and sunset times for all points along the route (current position, all waypoints, final destination).
- **Trip Monitor** (Trip Monitor): Displays a list of all trip logs, whether they are saved by the user upon reaching the destination or whether they are saved automatically. By touching an item from the trip that is displayed, you can check trip data, speeds, and more detailed contents. When a path log has been saved, you can display it on the map in the color selected. You can use the path log for other purposes by exporting it as a GPX file.
- **Help** (Help): Displays a tutorial allowing for a quick grasp of the software's functions, and starts a demonstration showing a sample route simulation to check the navigation functions. The About section displays product information. Here you can view the software and database user license agreements, search for the contents license, and check the software ID. You can check statistical data for program use.

Settings Menu

Configures programs and changes operational patterns for the software. On the navigation menu, touch **More** (More), and then touch **Settings** (Settings).

The Settings menu contains a variety of options. Touch  or scroll the list with your finger to view the entire list.



- **Sound and Warnings** (Sound and Warnings): Performs volume adjustment or changes the voice guidance language. Also enables various warnings and warning settings. (See Page 164.)
- **Customize Quick Menu** (Customize Quick Menu): Allows you to set Quick menu items to suit your needs. Touch the button you want to change, and then select another function from the list. (See Page 166.)

- **Traffic** (Traffic): Sets On/Off of traffic information display and the method to use the received real-time traffic information on route search. (See Page 168.)
- **Route Settings** (Route Settings): Sets the route search method. Select the type of vehicle you are using, the road category to use for the route search, and the route search method. (See Page 169.)
- **Map Settings** (Map Settings): Fine tunes the Map screen appearance. Performs adjustments for your selected map display, selects from a list of color designs used for daytime and nighttime, turns the path log on or off, and manages the spot display categories (allows you to select the type of spot displayed on the map). (See Page 170.)
- **Visual Guidance** (Visual Guidance): Changes settings related to Map screen guidance. (See Page 172.)
- **Units and Formats** (Units and Formats): Sets display units and the date display. (See Page 173.)
- **Trip Monitor** (Trip Monitor): Contains useful information on the user's distance moved in the trip logs and path logs. You can save trip logs automatically by turning this setting on, or save them manually when arriving at a destination. (See Page 173.)
- **Start Configuration Wizard** (Start Configuration Wizard): Changes basic software configurations set during the initial setup process. See step 3 in "Read First" on Page 83.

Sound and Warnings

Performs volume adjustment or changes the voice guidance language. Also enables various warnings and warning settings.

CAUTION

Be sure to set the volume of the audio at an appropriate level. Improper volume setting may result in hearing damage or a traffic accident.

- **Volume** (Volume):
Touch this button to adjust various volumes in the application. The type and buttons for various different volumes is displayed on a new screen. See the following items for more details.
- **Voice Language** (Voice Language):
This button displays the current language for voice guidance. Touch this button to select a new language/narrator from the available languages and list of narrators. When you touch an item from the list, a sample of the audio is played back. Touch **Back** (Back) after selecting a new voice language.
- **TTS Pro** (TTS Pro):
Touch this button to select the frequency of voice information, as well as turning on or off various voice information such as information on traffic conditions.

- **Verbosity Level** (Verbosity Level):
You can select the Verbosity Level from “Minimal”, “Compact”, or “Verbose”.
- **Voice Recognition** (Voice Recognition):
Touch this button to turn on or off talk back voice recognition results, or change the voice recognition method.
- **Alert Point Settings** (Alert Point Settings):
Displays driver warning information on the map. Touch this button to turn these warnings on or off, and set how far from the danger the warning should be generated. You can make individual settings for each type of warning.
- **Warning Sign Alerts** (Warning Sign Alerts):
Displays driver warning information on the map. Touch this button to turn these warnings on or off, and set how far from the danger the warning should be generated. You can make individual settings for each type of warning.

You can adjust the volume for the following voice categories.

- Guidance:
Changes the volume for the guidance voice (when guiding using a narrator).
- Alert Beeps:
Changes the volume for audio warnings (the beep).

Adjustment buttons for each audio classification:

- Volume slider:
Adjusts the volume of the associated audio.

Customize Quick Menu

Allows you to set Quick menu items to suit your needs. (See Page 101.) Touch the button you want to change, and then select another function from the list.

Button	Explanation	Primary Location
Quick Place Search (Quick Place Search)	Touch this button to search around a point on the route, or your current position (when a route search has not been performed).	Find / Find Places / Quick Search (See Page 120.)
Favorites (Favorites)	Touch this button to select an item from the destination list.	Find / Favorite (See Page 135.)
History (History)	Touch this button to select previously set destinations from the history list.	Find / History (See Page 137.)
Create Route (Create Route)/ Edit Route (Edit Route)	Touch this button to change the route.	My Route / Create (Edit) Route (See Page 140.)
Route Settings (Route Settings)	Touch this button to change route related settings.	More / Settings / Route Settings (See Page 169.)
Map Settings (Map Settings)	Touch this button to change map related settings.	More / Settings / Map Settings (See Page 170.)
Where Am I? (Where Am I?)	Touch this button to display a special screen with a button that searches for information on your current position and determines the nearest emergency assistance or road-side assistance. See the following section for more details.	N/A
Cancel Route (Cancel Route)	Touch this button to clear the route and cancel navigation. This button is available when only one destination is set.	My Route / Cancel Route (See Page 148.)
Remove Next Waypoint (Remove Next Waypoint)	Touch this button to remove the next waypoint from the route. When multiple destinations are set, the previous waypoint is displayed. This button is available when only two or more destinations are set.	N/A
Overview (Overview)	Reduces the scale of the 2D map to display the entire route.	My Route / Overview (See Page 141.)

Button	Explanation	Primary Location
Visual Guidance (Visual Guidance)	Opens the Visual Guidance settings screen.	More / Settings / Visual Guidance (See Page 172.)
Traffic (Traffic)	Opens the overall traffic conditions screen.	Touch the navigation menu or the Map screen's road icons.
Avoid (Avoid)	Avoids part of the recommended route.	My Route / Avoidances
Trip Monitor (Trip Monitor)	Opens the trip monitor screen from which you can manage your saved trip logs and path logs.	More / Trip Monitor (See Page 162.)
Itinerary (Itinerary)	Opens a list of changes in the route (distances).	Touch the top of the Map screen during navigation.
Save Route (Save Route)	The route being navigated is saved to be used later.	My Route / More / Save Route
Load Route (Load Route)	Changes to a saved, previously navigated route.	My Route / More / Load Route
Find Places (Find Places)	Searches for your favorite spots using a variety of methods.	Find / Find Places (See Page 120.)
Simulate Navigation (Simulate Navigation)	The Map screen opens and a simulation of the route being navigated starts.	My Route / More / Simulate Navigation (See Page 153.)
GPS Info (GPS Info)	Opens the GPS information screen showing satellite positions and signal strength.	Touch the top of the Map screen if there is no GPS reception.

Traffic

Sets On/Off of traffic information display and the method to use the received real-time traffic information on route search.

- **Traffic Receiver** (Traffic Receiver):
Turns on or off the traffic information display.
- **Detour** (Detour):
Set to use real-time traffic information when searching for a route. When searching for a new route, or when it is necessary to search again based on the traffic information received, it searches for merits to avoiding the current traffic conditions.
Set so that confirmation is needed every time you perform another search by delaying the timing when the search is remade.
 - **Never offer detour** (Never offer detour):
When this button is touched, routes that do not satisfy traffic conditions are not searched.
 - **Offer detour if the calculated route saves more than:** (Offer detour if the calculated route saves more than):
When this button is touched, routes that satisfy traffic conditions are searched.
Time slider:
Adjust the timing before starting another route search. (You can set 0 to 60 every 5 minutes)
 - **Do you want to confirm the offered route?** (Do you want to confirm the offered route?):
You can turn the route confirmation display on or off for each new search.

- **Event Types** (Event Types):
Touch this button to open a list of types of traffic conditions, and select the events to take into consideration when searching for a route.

Settings button for each type of traffic condition

- **All events in this category will be:** (All events in this category will be):
You can select "Considered" or "Ignored" when searching for a route.
- **Visible on map** (Visible on map):
You can turn the icon display on the map on or off.

Route Settings

Sets the route search method.

- **Vehicle** (Vehicle):
Sets various factors to take into account when performing a search, such as fuel consumption, vehicle model, fuel costs, and maximum speeds on normal roads and expressways.
- **Navigation Mode** (Navigation Mode):
You can change between On-road and Off-road.
Set to On-road to perform normal navigation, or set to Off-road to navigate using the straightest possible route to the destination.
- **Route Planning Method** (Route Planning Method):
By changing the route search method, you can search for the optimum route for a variety of situations and types of vehicle. See the following items for more details.

You can set which road categories to include or to avoid in the route to match the user's preferences.

Avoiding a road category is simply a matter of changing the priority level. This does not mean that the selected road category will never be used. If the navigation cannot reach the destination without using a road category that should be avoided, the road category will be used, but only as little as possible. If this does happen, a warning icon is displayed on the My Route screen.

In the road category list you can check the number of sections used for each road category on the current route and the overall distance.

- **Highways** (Highways):
Select whether or not to use the expressway when creating the route.
- **Period Charge** (Period Charge):
Select whether or not to use toll roads (Period Charge) when creating the route.
- **Per-use Toll** (Per-use Toll):
Select whether or not to use toll roads (Per-use Toll) when creating the route.
- **Ferries** (Ferries):
Select whether or not to use ferries when creating the route. (However, ferries might not always be selected for the route.) However, information on temporary service ferries may not be displayed on the map. There may be a fee for using the ferry.
- **Carpool/HOV** (Carpool/HOV):
Select whether or not to use Carpool/HOV lanes when creating the route.
- **Unpaved Roads** (Unpaved Roads):
Select whether or not to use unpaved roads when creating the route.

- **Calculate Green Alternative** (Calculate Green Alternative):
Select whether or not to consider energy efficiency when creating the route.

Type of route search method:

- **Fast** (Fast):
Searches all roads for the quickest route following the speed limits of the roads.
- **Green** (Green):
Searches for the route that conserves the most energy, taking into account the merits of "Fast" and "Short".
- **Short** (Short):
Searches for the shortest distance in all possible routes.
- **Easy** (Easy):
Searches for a route that is easiest to drive, with few right and left turns. Using this option, the program allows you to avoid combinations of smaller roads and to take the expressway.

Map Settings

Fine tunes the Map screen appearance. Performs adjustments for your selected map display, selects from a list of color designs used for daytime and nighttime, turns the path log on or off, and manages the spot display categories (allows you to select the type of spot displayed on the map).

Because the map is displayed on the screen, you can check the results as you change settings.



- **View Mode 3D** (View Mode 3D):
Select the display mode from a 3D bird's-eye view, a 2D heads-up flat view, or a 2D North Up flat view.
- **Viewpoint Normal** (Viewpoint Normal):
You can adjust the standard zoom and the angle of tilt to suit your needs. You can set the level in three stages.
- **Automatic Overview** (Automatic Overview):
Automatically reduces the scale of the 2D map to display the entire route. You can turn this function on and off.

- **Day Map Color** (Day Map Color):
Select the screen color used in daytime mode.

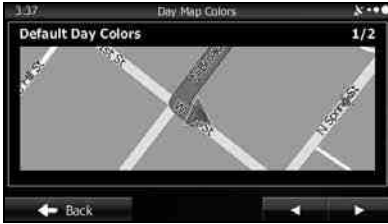

- The view changes between night view and day view each time you touch  or .

- **Night Map Color** (Night Map Color):
Select the screen color used in nighttime mode.



- The view changes between night view and day view each time you touch  or .

- **Track Logs** (Track Logs):
Turns the path log save function on or off (saves in positional order for each trip).
- **Place Markers** (Place Markers):
Select a spot displayed on the map during navigation. We recommend reducing the number of spots displayed as much as possible as the map is difficult to see if there are too many spots. Because of this, the software is designed to allow multiple spot displays. Follow the steps below.
 - Touch the check box to show or hide the spot category.
 - Touch the spot category name to open a sub-category.
 - Touch **More** (More) to save the currently displayed spot position, or read spot displays saved previously. You can also restore the default display settings.

Visual Guidance

Changes settings related to Map screen guidance.

- **Data Fields** (Data Fields):
You can set the data fields displayed at the corner of the Map screen to match your needs. Touch this button and select the guidance you want to display. Values may differ when driving without having set a destination in route navigation. You can select current speed or altitude and so on for a standard trip data, or select route data related to the final destination or the next waypoint on the route.
- **Highway Services** (Highway Services):
Displays service area information while driving on the expressway. You can turn this function on and off.
- **Facility Types** (Facility Types):
Touch this button and select the service area information display items you want to display.
- **Signposts** (Signposts):
When information is available, lane information similar to overhead road traffic signs is displayed at the top of the map. You can turn this function on and off.
- **Junction View** (Junction View):
When approaching an expressway exit or a complicated intersection, the map switches to a 3D display if the necessary information can be displayed.
- **Route Progress Bar** (Route Progress Bar):
Turns on the route progress bar which is displayed as a straight line to the left of the map. This shows the progress made on the current route. When a blue arrow is used to indicate position, the arrow continues to rise as you drive towards your destination. Waypoints and traffic conditions are displayed on the line.

Units and Formats

Sets display units and the date display.

- **Units and Formats** (Units and Formats):
Sets the units used by the program to measure distance. Voice guidance languages do not support all units displayed in the list. You can select to display the time in various international date formats.

Types of display units and date display settings:

- **Distance** (Distance):
Buttons the units used to display distance.
- **Fuel Economy** (Fuel Economy):
Buttons the units used to display fuel consumption.
- **Currency** (Currency):
Displays the keyboard screen allowing you to enter the currency name. (For the keyboard, see “Using the Keyboard” on Page 88.)
- **Date Format** (Date Format):
Buttons the units used to display the date.
- **Date Delimiter** (Date Delimiter):
Buttons the date delimiter.
- **Coordinate Display Format** (Coordinate Display Format):
Buttons the coordinate display format.

Trip Monitor

Contains useful information on the user's distance moved in the trip logs and path logs. You can save trip logs automatically by turning this setting on, or save them manually when arriving at a destination. You can view all logs on the trip monitor. Launch the trip monitor from the “Others” menu.

- **Enable Auto-Saving** (Enable Auto-Saving):
The trip monitor saves statistical data for the distance traveled. You can set it so that the route is saved automatically if you need a log after driving.
- Trip Database Size:
This is not a button. This line indicates the current size of the trip database. This shows the total for all saved trip logs and path logs.
- **Save Track Log** (Save Track Log):
You can save path logs (positional order acquired from GPS receiver) in the trip log.

Glossary

2D/3D GPS reception

The GPS receiver uses signals from satellites to calculate its current position (the user's position), but to acquire a 3D position at least four signals are necessary, including altitude. The GPS device may not be able to acquire signals from four satellites as they are constantly moving and obstacles may block satellite signals. Although the accuracy decreases when only three signals can be acquired, and altitude data cannot be sent, the receiver can calculate a latitude and longitude GPS position. Only 2D reception is possible.

Route being navigated

The route currently being navigated. When a destination is set, the route will be continuously navigated until the destination is deleted, you arrive at the destination, or the software is closed. Also see "Route".

City center

The center of the city/town is not the geographical center of the city/town, but a location set by the cartographer. In towns and villages, this is usually the most important intersection, while in larger cities it is selected from multiple important intersections.

Color design

The color design used for the map and menu screens differs for daytime and nighttime. Each design has a different graphic setting, with 2D and 3D each having colors for roads, blocks, seas, and lakes, whilst shadow changes and shadows are displayed differently in 3D mode.

Daytime screen and nighttime screen designs for the map and menu are selected one at a time. The design changes automatically when day becomes night and night becomes day.

GPS accuracy

Various factors can contribute to a margin of error between the user's actual position and the position acquired from the GPS device. For example, signal delays in the ionosphere or reflections from objects around the GPS equipment, can influence the accuracy with which the GPS device can calculate the user's position.

Maps

Although this software uses digital maps, these are not simply digital conversions from printed maps. The 2D mode digital map represents roads in the same way as a traditional printed map, using color classifications to show streets, roads, and changes in altitude.

In 3D mode, you can confirm differences in altitude for mountains, valleys, highland roads and so on, and display areas of cities using 3D landmarks and 3D images of buildings.

The digital map can be used interactively. You can zoom in and out (enlarge/reduce), tilt up and down, and rotate left and right. By using navigation that supports GPS, you can easily plan your route with the digital maps.

North Up Map Direction

North Up mode rotates the map so that North is always at the top of the map. You can use this direction with Find On Map and so on. Also see "Heads-up Map Direction".

Route

The route is an ordered arrangement of the route events (the next change in the route - right or left turns, roundabouts, and so on), presenting them as they occur until you reach your destination. If there is one starting point, there must be at least one destination. On startup, the start point is the current position (or the last confirmed position). If you need to check a route that is not currently being driven, you can move the start point to wherever you want.

Heads-up Map Direction

Heads-up mode rotates the map so that the direction you are currently traveling is always at the top of the map. This is the default direction in 3D map display mode. Also see "North Up Map Direction".

End-user License Agreement

1 The contracting parties

1.1 This Agreement has been entered into by and between Nav N Go Kft. (registered seat: 23 Bérc utca, H-1016 Budapest, Hungary; Company reg.no.: 01-09-891838) as Licensor (hereinafter: Licensor) and You as the User (hereinafter: User; the User and the Licensor jointly referred to as: Parties) in subject of the use of the software product specified in this Agreement.

2 Conclusion of the Agreement

2.1 The Parties hereby acknowledge that this Agreement shall be concluded by implicit conduct of the Parties without signing the Agreement.

2.2 The User hereby acknowledges that following the lawful acquisition of the software product constituting the object of this Agreement (Section 4), any degree of use, installation into a computer or other hardware, installation of such hardware into a vehicle, pressing of the "Accept" button displayed by the software during installation or use (hereinafter referred to as Use) shall mean that the User has accepted the terms and conditions of this Agreement as legally binding.

2.3 This Agreement shall by no means authorize use of the software product by those persons having unlawfully acquired the software product or having unlawfully installed it on a computer or in a vehicle.

3 Relevant laws and regulations

3.1 Any action related to this Agreement will be governed by the laws of the Republic of Hungary, with specific reference to Act IV of 1959 on the Civil Code and to Act LXXVI of 1999 on Copyrights shall apply.

3.2 The original language version of this Agreement is the Hungarian version. This Agreement has versions in other languages as well. In case of dispute the Hungarian version shall prevail.

4 Object of the Agreement and Termination

4.1 The object of this Agreement shall be the navigation guidance software product of Licensor (hereinafter referred to as the Software Product).

4.2 The Software Product shall include the operating computer program, its complete documentation, the map database pertaining thereto and any third-party content and services accessible through the Software Product (hereinafter: Database).

4.3 Any form of display, storage, coding, including printed, electronic or graphic display, storage, source or object code, or any other as yet undefined form of display, storage, or coding, or any medium thereof shall be deemed parts of the Software Product.

4.4 Error corrections, additions, updates used by the User following the conclusion of this Agreement shall also be deemed parts of the Software Product.

4.5 Your rights under this Agreement will terminate immediately without notice from Licensor if you materially breach it or take any action in derogation of Licensor's and/or its Licensor's rights to the Software Product. Licensor may terminate this Agreement should any Software Product become, or Licensor's reasonable opinion likely to become, the subject of a claim of intellectual property infringement or trade secret misappropriation. Upon termination, you will cease use of, and destroy Software Product and confirm compliance in writing to Licensor

5 Rights under copyright

- 5.1 Unless otherwise provided by law or contractual provisions, the Licensor is the sole and exclusive owner of all material copyrights vested in the Software Product.
- 5.2 Copyrights extend to the whole Software Product and to its parts separately as well.
- 5.3 The owner(s) of the copyrights of the Database forming part of the Software Product is (are) the natural person(s) or corporate entity(ies) listed in the Appendix to this Agreement or in the "About" menu item of the operating computer program (hereinafter referred to as Database Owner). The user's manual of the Software Product includes the name of the menu option where all the owners of the Database items are listed. The Licensor hereby states that it has obtained sufficient usage and representation rights from the Database owners in order to utilise the Database, to offer it for utilisation and to transfer it for utilisation as set forth in this Agreement.
- 5.4 Pursuant to this Agreement, all rights vested in the Software Product shall remain in the ownership of the Licensor, except for those to which the User is entitled under law or by virtue of this Agreement.

6 Rights of the User

- 6.1 The User is entitled to install the Software Product into one hardware device (desktop, handheld, portable computer, navigation device), and to run and use one copy of the Software Product or a preinstalled copy of the Software Product thereon.
- 6.2 The User is entitled to make one backup copy of the Software Product. However, if the Software Product operates after installation without the use of the original media copy, then the original media copy shall be deemed to be a backup copy. In all other cases, the User is only entitled to use the backup copy if the original media copy of the Software Product has been ascertainably and unequivocally rendered unsuitable for its lawful and intended use.

7 Limitations of use

- 7.1 The User is not entitled
 - 7.1.1 to duplicate the Software Product (to make a copy thereof);
 - 7.1.2 to lease, rent or lend it or to transfer it to a third person for any reason;
 - 7.1.3 to translate the Software Product (including translation (compilation) to other programming languages);
 - 7.1.4 to decompile the Software Product;
 - 7.1.5 to evade the protection of the Software Product or to modify, circumvent or obviate such protection through technological or by any other means;
 - 7.1.6 to modify, extend, transform the Software Product (in whole or in part), to separate it into parts, combine it with other products, install it in other products, utilise it in other products, not even for the purpose of achieving interoperability with other devices;
 - 7.1.7 apart from using the computer program, to obtain information from the Database as a part of the Software Product, to decompile the Database, to use, copy, modify, extend, transform the Database in whole or in part or the group of data stored therein, or to install it in other products or otherwise, utilise it in other products or to transfer it, not even with the aim of achieving interoperability with other products.
- 7.2 The User may only use the contents available through the Software Product and provided by third parties and the data received through the services provided by third parties (including but not limited to the traffic data received from the RDS TMC traffic information service) for his/her own personal benefit and at his/her own risk. It is strictly prohibited to store, to transfer or to distribute these data or contents or to disclose them in full or in part to the public in any format or to download them from the product.

8 No warranty, limitation of responsibility

- 8.1 The Licensor hereby informs the User that although the greatest care was taken in producing the Software Product, given the nature of the Software Product and its technical limitations, the Licensor does not provide a warranty for the Software Product being completely error-free, and the Licensor is not bound by any contractual obligation whereby the Software Product obtained by the User should be completely error-free.
- 8.2 The Licensor does not warrant that the Software Product is suitable for any purpose defined either by the Licensor or the User, and does not warrant that the Software Product is capable of interoperating with any other system, device or product (e.g. software or hardware).
- 8.3 The Licensor does not assume any responsibility for damages incurred due to an error in the Software Product (including errors of the computer program, the documentation and the Database).
- 8.4 The Licensor does not assume any responsibility for damages incurred due to the Software Product not being applicable for any defined purpose, or due to the error or incompatibility of the Software Product with any other system, device or product (e.g. software or hardware).
- 8.5 The Licensor also draws the attention of the User to the fact that, when using the Software Product in any form of vehicle, observing the traffic regulations and rules (e.g. use of obligatory and/or reasonable and suitable security measures, proper and generally expected care and attention in the given situation, and special care and attention required due to the use of the Software Product) is the exclusive responsibility of the User. The Licensor shall not assume any responsibility for any damages occurred in relation to use of the Software Product in a motor vehicle.
- 8.6 By concluding the Agreement, the User shall, in particular, acknowledge the information stated in Section 8 above.

9 Sanctions

- 9.1 The Licensor hereby informs the User that, if the Licensor finds its rights under the Copyright Act to be breached, the Licensor may
- 9.1.1 seek judicial recognition of this breach;
- 9.1.2 demand that the breach cease and order the person in breach to refrain from continuing such actions;
- 9.1.3 demand that the person under breach give proper compensation (even by way of publicity at the expense of the person in breach);
- 9.1.4 claim the return of the increase of assets due to the breach;
- 9.1.5 demand the cease of the wrongful action and, demand restitution to its state before the breach was committed at the expense of the person in breach, and may demand the destruction of instruments and materials used to commit the breach as well as of the products created by the breach;
- 9.1.6 claim for damages.
- 9.2 The Licensor hereby also informs the User that the breach of copyrights and related rights is a crime under Act IV of 1978 on the Hungarian Criminal Code, which may be sentenced of two years in prison in basic cases and up to eight years in prison in aggravated cases.

9.3 Contents and services provided by third parties

The Licensor hereby excludes any liability of its own for the Database in the Software Product and for any content or service provided by a third party by using the Database. The Licensor does not warrant the quality, suitability, accuracy, fitness for a specific purpose or territorial coverage of the product or service or the availability of the service, and it specifically excludes any liability for the suspension of the service, and any damage arising in relation to the service or for complete cancellation of the service.

The User hereby acknowledges that the contents and services provided by third parties may only be used at the risk of the User and for the personal benefit of the User.

9.4 The parties hereby agree that the courts of the Republic of Hungary will have exclusive jurisdiction to rule on any disputes arising in connection with this Agreement.

10 Anonymous data collection

- 10.1 The User hereby acknowledges that the Software Product may collect and store data connected to the usage of the Software Product by the User (e.g. movement/route data, user interaction data). Such data collection functions may be disabled or enabled by User any time from within the corresponding menu. The collected data is connected to the device type identifier of the device running the Software Product and not associated in any way with any personal information of the User itself.
- 10.2 The collected data may be uploaded to licensor's database and used exclusively of the purpose of enhancing and improving the features and services of the Software Product and the Databases. Uploading is executed through Licensor's special software or by the User navigation device, and the upload may be enabled or disabled by User. After successful data upload, the collected data is deleted from the Software Product storage media.
- 10.3 Collected data is transmitted, stored and handled anonymously and no connection of the data with the User shall be established by Licensor or any third party.

Further Information

Display Connection Status Information

You can check the connection between the unit and the vehicle, such as GPS information, parking signals and so on.

Display Connection Status Information

- 1 Press **AUDIO**.
- 2 Touch **Info**.
 - If **Info** is not displayed, touch **∨**.
- 3 Touch **System Check** (System Check).
 - Displays the connection status information screen.

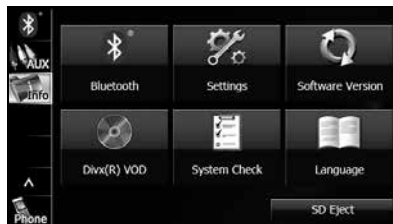

<Connection status information screen>



Information	Content
GPS information	Displays the number of GPS satellites currently sending information.
Parking signal	On When the parking brake is applied.
	Off When the parking brake is not applied.
Reverse signal	On When shifting into reverse.
	Off When shifting into another gear.

Accuracy & error calculation

Regarding Precision Accuracy

.....

Since the GPS satellites are controlled by the US Department of Defense they do have a very high level of accuracy, however a multipath due to reflections from buildings and so on could cause errors to occur.

Regarding the Properties of the GPS Electro-Magnetic Waves and Signal Reception

.....

If there are any obstacles between the GPS antenna and the GPS satellite, electromagnetic-waves cannot be received from the satellite. It is also impossible to use GPS positioning in the following locations as at least three simultaneous electromagnetic-waves are necessary to take measurements.

Also, if there are any obstacles around the GPS antenna, electromagnetic-waves cannot be received from the satellite.

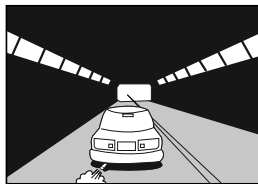

- In tunnels

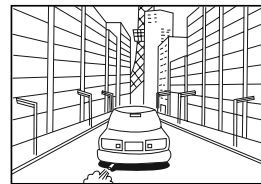

- If the immediate area is enclosed by large objects such as skyscrapers

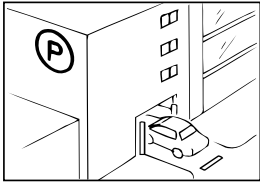

- In underground buildings and indoor parking lots

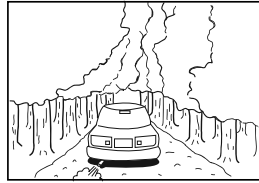

- In places with a lot of overgrown trees and so on

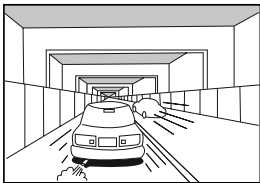

- Under elevated roads

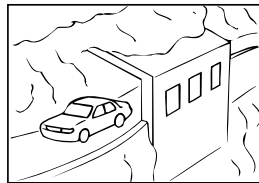

- Roads at the base of cliffs and caves

NOTE

- Because the GPS satellite is in orbit around the earth, the reception status for the electromagnetic waves changes depending on their position at that point in time, even if your vehicle is in the same place. Also, electromagnetic-waves from satellites near the horizon can be easily influenced by surrounding obstacles.
- At times, satellites under the control of the US Department of Defence will intentionally drop positioning accuracy.

Regarding Errors in Current Position Display

To pinpoint the current position, the unit uses information from GPS satellite electromagnetic waves. If any of these contain errors, the current position may not match the actual position.

Regarding Vehicle Position Detection Correction Using Map Matching

Map matching is a method of comparing information on the current position acquired by GPS and so on, with the road driven up to that point, and correcting the current position based on the most likely road.

This unit uses information on the current position combined with independent navigation and satellite navigation and matches it to the shape of the road to create the correction.

However, as it cannot avoid the error margins at the current position, the current position may shift away from the actual position even when correcting using map matching.

Also, the vehicle marker may shift if the map data and the shape of the road being driven on differ.

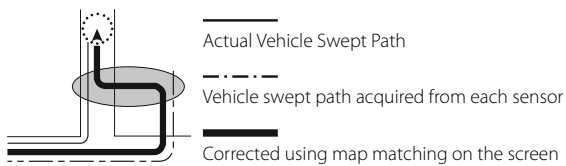

NOTE

Because it takes a short time for operations to stabilize just after turning on the unit, the vehicle mark may not immediately match the vehicle as it moves. After driving for a while, operations stabilize, and the marker should match the actual driving position.

Regarding the Accuracy of the Current Position and Route Navigation

As in the following images, an accurate display of the current position or route navigation may not be provided, however this is not an indication of a malfunction in the unit, but is due to road conditions or driving conditions.

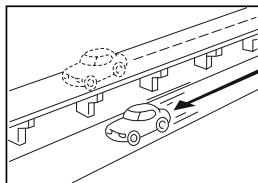

- Shows the current position on roads running in parallel.

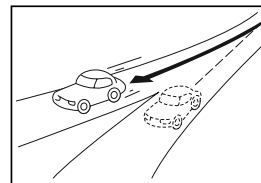

- Shows the current position on the other road when there is a narrow fork in the road.

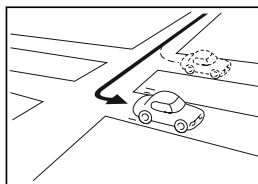

- Shows the current position on the road ahead or behind when turning right or left.

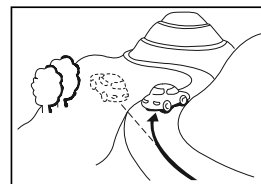

- Shows the current position when traveling up a steep hill.

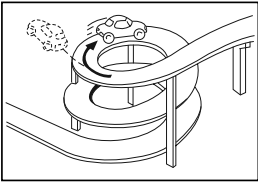

- Shows the current position if the road continues to curve around on itself in the same direction.

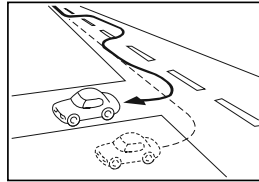

- Shows the current position after a sudden change in lanes.

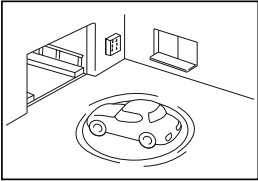

- Shows the current position when the vehicle is on a parking garage turntable and the ACC is off.

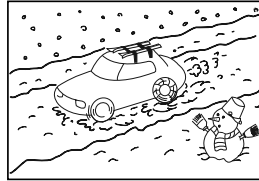

- Shows the current position when driving on snowy roads where the vehicle may slip easily, or when driving with snow chains.

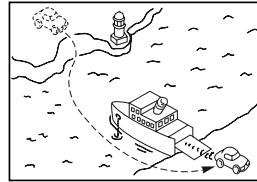

- Shows the current position in the last confirmed position before moving when using another means of transport, such as a ferry, until the GPS can determine the new position.

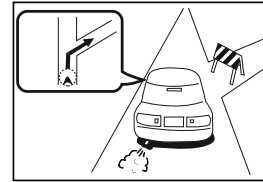

- It actually navigates through roads that cannot be driven (no entry and so on).

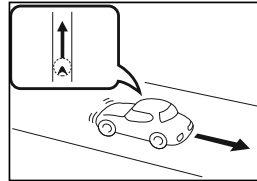

- Shows the current position when reversing.

Regarding Roads and Place Name Data

Because road and place names may change after the map data has been created, there may be times when road and place names do not match.

When no information is available in the map data, function such as display of road names, searching for facilities, and route guidance cannot be used.

Regarding Route Navigation

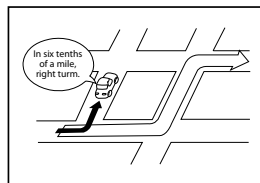

- It may deviate from the route navigation when there is a turn at an intersection etc., and a mistake in the voice navigation.

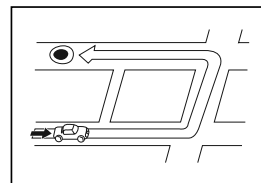

- When searching for the route, it may take the long way around.

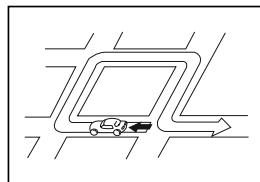

- The route may need you to make a U-turn during navigation.

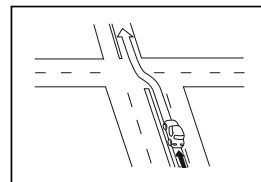

- When driving on a straight road, information may be displayed indicating that you should go straight ahead. (When the intersection shape is not clear and so on.)

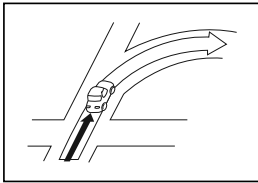

- The navigation may not indicate that the road curves at an intersection.

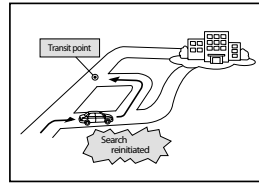

- The navigation may guide you back to a waypoint if you search for the route again after passing the waypoint and are heading to your destination.

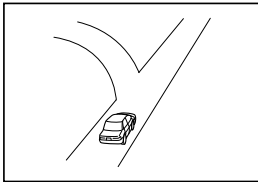

- Many place names may be displayed when navigating a district.

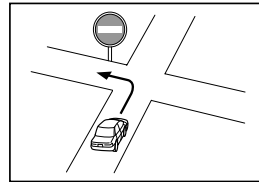

- Always drive by following the actual traffic regulations.

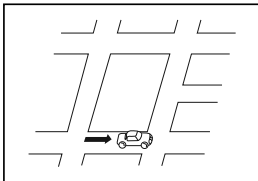

Route search complete

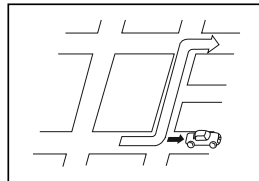

- When searching for a route, it may not be displayed quick enough for the next left or right turn.

- Performing a new search while traveling at high speeds may take some time.
- The route may not change even after performing another search.
- When isolated locations or roads with no surrounding available information are set as the current position/destination, you may not be able to search for a route.
- A route may not be displayed when the current position is close to the destination.
- Even if you select toll roads as a priority, the route may not guide you through a toll road.

In a similar way, toll roads may be displayed even if you prioritize other roads over toll roads.
(When it is possible to select a toll road or a normal road to create the route, priority is given to the user's toll road preference - use toll roads, or avoid toll roads.)



Audio and Visual

Before Using the Audio and Visual System

Precautions When Using the System

WARNING

Read this manual first

Read this supplement carefully before using the audio and visual system. We are not liable for accidents or other problems resulting from failure to follow the instructions in this supplement.

Avoid operating the audio and visual system while driving

You should stop the vehicle in a safe place before operating the audio and visual system. For safety, some of the audio and visual system's functions cannot be used unless the vehicle is stopped.

If you stare at the display too much or operate the buttons of the system while driving, the navigation system could distract your attention from the current traffic conditions. Be sure to enter as much information as possible into the system before departing. Also, be sure to stop your vehicle in a safe place if you need to enter information.

The touch button on the display screen that cannot be used have their colors toned down.

Operating the navigation system while driving could cause your attention to be distracted from the current traffic conditions. This could result in a severe or fatal accident. Follow the descriptions of all operations and the instructions for safety given in this manual without fail.

Look at the audio and visual system screen only when necessary

When you need to look at the audio and visual system screen, do so for the shortest time possible. Looking away from the road for too long could lead to an accident.

Keep the volume low enough for you to hear outside sounds

Keep the system's volume level low enough for you to be able to hear outside sounds while driving. Otherwise, you may not be able to react appropriately to traffic conditions, resulting in an accident.

⚠ CAUTION**Never disassemble or modify the audio and visual system**

Never disassemble or modify the system. Doing so may lead to a fire, an electric shock, or some other type of accident.

Do not continue using the audio and visual system if it malfunctions

If the system shows any sign of malfunctioning (for example, the monitor displays no picture), stop using it immediately and contact the nearest SUBARU dealer. Continuing to use the system could lead to a fire, an electric shock, or some other type of accident.

If the audio and visual system gets dirty, or emits smoke or an odd smell, stop using it

If a foreign object gets inside the system, liquid is spilled onto the system, or the system emits smoke or an unusual smell, stop using it immediately and contact the nearest SUBARU dealer. Continuing to use the system could lead to a fire, an electric shock, or some other type of accident.

■ About the audio and visual system

- Subjecting the control buttons or liquid crystal display to excessive shock could result in audio and visual screen deformation or other damage.
- Keep any heat source (including lighted cigarettes) away from the audio and visual system. If a heat source is brought into contact with the audio and visual system cabinet or panel, they could be deformed or otherwise degraded.
- In extreme cold, the audio and visual screen may operate sluggishly and the display may dim. Such conditions do not indicate a problem. They will disappear when the temperature inside the vehicle rises to a normal temperature.
- Tiny black and white dots may occasionally appear on the liquid crystal display. These dots are a normal characteristic of the display. They do not indicate a problem.
- When the audio and visual screen requires cleaning, gently wipe it with a silicone cloth or other soft cloth. If necessary, spray the cloth with neutral cleaning fluid. Be sure to wipe away any cleaning fluid left on the audio and visual screen. Do not spray the cleaning fluid directly onto the audio and visual screen. Spraying cleaning fluid directly onto the audio and visual screen could cause an adverse effect on internal components. It is also not recommended to wipe the audio and visual screen with a stiff cloth or attempt to clean it using thinners, alcohol, or any other volatile solvent. Doing so could leave scratches or erase the control button labels.

- Do not allow the audio and visual screen to get wet. If the screen gets wet (for example, from a spilled drink or wet umbrella), its internal electronic circuitry may malfunction.
- In hot weather, cool the passenger compartment before using the audio and visual system. The liquid crystal display operates correctly at temperatures between 0°C and 60°C (32°F and 140°F). When the temperature exceeds 60°C (140°F), the audio and visual system circuit protection function is activated, causing the display to dim.

NOTE

- For safety, the use of some functions are unavailable while driving. Buttons on the touch screen that cannot be used have their colors toned down.
- The liquid-crystal display may be difficult to read when wearing polarized glasses.

Precautions for Use

⚠ CAUTION

- Be very careful and pay full attention to safety when operating the audio controls while driving. Otherwise, an accident may occur. Also, be sure to set the volume low enough for you to still adequately hear sounds outside the vehicle. Improper use may result in a traffic accident.
- Never continue to use the system if it is malfunctioning in any way. If smoke, abnormal noises or abnormal odors are noticed, turn off the power immediately. In such situations, turn off the power of the audio and visual system immediately.

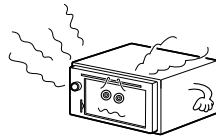
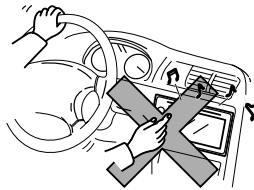

- Exercise caution regarding the temperature inside the vehicle. The temperature inside the vehicle can increase during hot weather. Wait for the temperature inside the vehicle to decrease before using this unit. Otherwise, damage may result.
- Do not disassemble or modify this unit. The unit has a precisely designed structure, so consult your SUBARU dealer in the event any unsatisfactory performance is observed.
- Do not apply excessive force to the monitor. Damage could result.

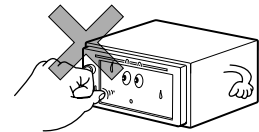
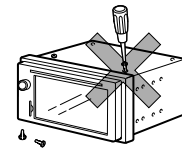
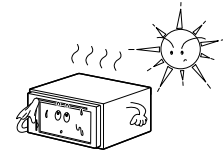

- **Never insert any objects other than discs into the disc slot. Damage could result.**

- **When removing a disc or “SD memory card” from the unit, remove it horizontally. Do not apply excessive force vertically or sideways while removing it.**

Improper removal may result in the disc becoming scratched, causing the unit to output unusual noises. Improper removal of the “SD memory card” may damage it.

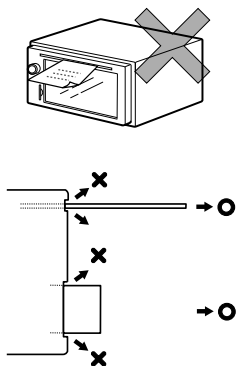

About Discs

NOTE

- In cold or rainy weather, just as the interior glass surface becomes fogged, dew (water condensation) may also form on the unit. When this occurs, disc playback may jump or stop. Ventilate or dehumidify the air in the vehicle for a while before resuming playback.
- If a problem occurs, the player function stops automatically to protect its internal parts. If the player does not operate even when you follow the on-screen messages, the player may have failed. Consult your SUBARU dealer.
- Playback may jump when the player is subjected to severe vibrations while traveling over a rough surface.
- Do not use a commercially available lens cleaner because it may damage the pickup of the player.

■ About the supported discs

- An audio disc bearing one of the marks below can be played.



- It is possible that a CD-R (CD-Recordable) or CD-RW (CD-ReWritable) disc will not play on the unit due to the recording condition, disc characteristics, scratches, dirt, or deterioration caused by long-term storage in the vehicle. Also, a CD-R or CD-RW disc that has not been finalized and a CD-R or CD-RW disc recorded in UDF format cannot be played.
- The CD-TEXT function can be used only for commercially available CDs that support CD-text. Characters written on CD-R and CD-RW discs may not be displayed correctly.
- Do not use a CD or See Through disc that has a transparent or semi-transparent recording area as they may fail to load or unload or play their contents.

- A Copy Control CD (CCCD) may not be played as it does not meet the official CD Standard.



■ Handling discs

- Do not place a disc in direct sunlight. Store each disc in its protective case. Otherwise, discs may warp and fail to play.

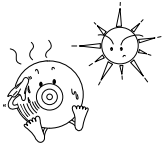

- Do not attach paper-based tape to either the recording side or label side of a disc. Damage could result.

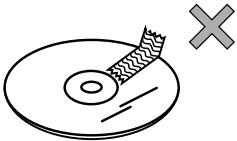

- Do not use cracked or badly warped discs. Damage could result.



- Do not touch the recording area (the rainbow colored) side of a disc. Otherwise, the disc may become dirty and playback may jump.

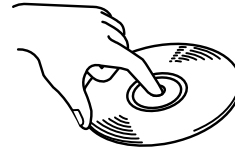

- If you play a dirty disc, the disc surface may be scratched and the playback may jump.

Use a commercially available compact disc cleaner to clean the CD, wiping gently from the center to the edge.



■ Brand new CDs

- You may notice that some brand new discs have “rough edges” around the center hole or outside. In such cases, remove the “rough edges” or flakes around the edge using the side of a ballpoint pen before using the new disc. Not doing so may result in the “rough edges” or flakes attaching to the recording side, preventing playback.

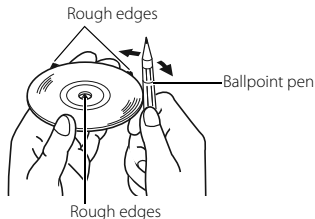

■ Rental discs

- Do not use a rental disc with glue or remnants of adhesive tape or labels attached to the disc. They may cause the disc to get stuck inside or damage the unit.

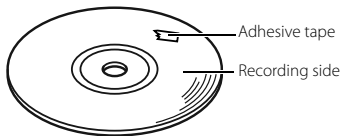

■ Irregularly-shaped CDs

- Irregularly-shaped discs, such as octagonal CDs or heart-shaped CDs, cannot be played. Do not play this type of disc, even with an adapter. Damage to the player could result.

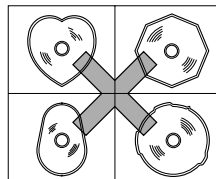

■ Disc accessories

- Do not use accessories (such as stabilizers, protective seals, laser lens cleaners) sold for improving sound performance or protecting CDs. The changes in CD thickness or outside dimensions made by these accessories may cause problems in the player.



- Do not attach any ring-shape protector (or other accessory) to the disc. Although these protectors are commercially available and said to protect discs and improve sound quality (and anti-vibration effect), in normal use they can do more harm than good. The most common problems are disc insertion and ejection problems and abnormal playback problems due to the protector ring coming off in the disc mechanism.

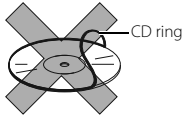

Basic Operation

Switching the Audio Source

Switching the Audio Source

.....

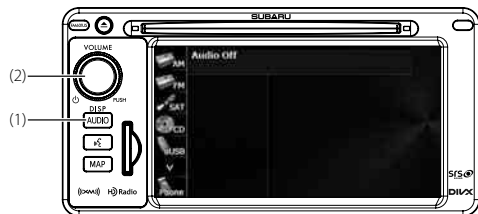

- (1) AUDIO button
- (2) POWER/VOL button

- 1 Press **AUDIO**.
- 2 Touch **▼** or **▲** to scroll the screens.

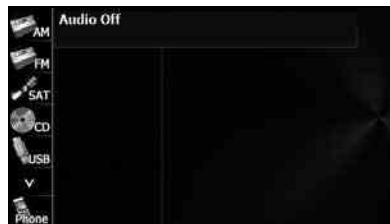



- 3 Select the audio mode that you want to use.

Displaying the Audio Operations Screen

- 1 Press **AUDIO**.

Stopping the Audio Mode

- 1 Press  (POWER/VOL).

 - Press  (POWER/VOL) again to receive the station you were receiving, the music you were playing or the video you were playing before you stopped the audio mode.



Source Operations Screen

The operations screen for the audio sources are as follows.

<Radio (AM) operations screen>



<Radio (FM) operations screen>



<Radio (SAT) operations screen>



<CD player operations screen>



<MP3/WMA operations screen>



<USB music file player operations screen>



<USB video file player operations screen>



<iPod operations screen>



<Bluetooth audio operations screen>



<AUX operations screen>

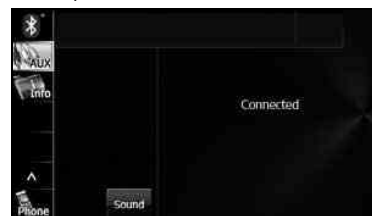

Volume Control

Main Volume Control

.....



NOTE

- Adjust to a volume level that will not prevent safe driving.
- You can adjust the level from 0 to 63. Max is displayed when the volume is 63.
- The volume may change when you switch the audio source. Adjust the volume to a level appropriate for the audio source you select.

(1) POWER/VOL button

1 Turn  (POWER/VOL).

- Turn to right:
Volume up
- Turn to left:
Volume down

Displaying the Sound Settings Screen

When you switch to the Sound Settings screen from any of the Audio operations screens, the following operations are available.

- Adjusting the sound quality
- Adjusting the audio balance
- Setting the source volume control
- Adjusting the automatic sound levelizer

- 1 Touch **Sound** (Sound) on any of the audio operations screens.



- 2 Touch the button that you want to set.



Adjusting the Sound Quality

You can adjust the sound quality from the low band to the high band.

■ Adjusting the sound quality

- 1 On the Sound Settings screen, touch **Adjust** (Adjust) in EQ Settings.

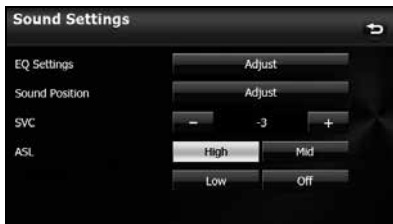

- 2 Touch the sound band that you want to adjust.

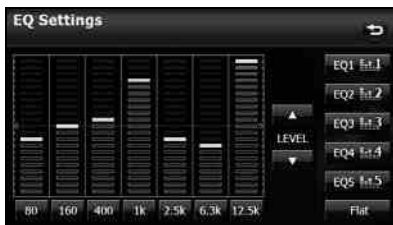

- 3 Touch **▲** or **▼**.

- When you touch and hold, the value changes continuously but stops at the center value. Touch **▲** or **▼** again to restart.
- You can also adjust to the desired level by touching the screen.
- The maximum adjustment is +10 and the minimum adjustment is -10.
- To reset the sound quality, touch **Flat** (Flat).
- After completing the adjustment, touch **➡** to save the adjusted settings and return to the previous screen.

■ Saving the sound quality

You can save the adjusted sound quality settings.

- 1 Adjust the sound quality.
- 2 Touch any button from **EQ1** to **EQ5** for 2 seconds or more.
 - Values cannot be saved for **Flat** (Flat).

■ Using a preset sound quality

- 1 On the Sound Settings screen, touch **Adjust** (Adjust) in EQ Settings.
- 2 Touch any button from **EQ1** to **EQ5** to activate the corresponding preset sound quality.
 - To reset the sound quality, touch **Flat** (Flat).

■ Resetting the EQ curve

You can return the adjusted value for the currently stored equalizer to its initial value.

- 1 Touch **Flat** (Flat) for 2 seconds or more.
 - The adjusted values for the stored **EQ1** to **EQ5** are returned to their initial values.

Adjusting the Audio Balance

■ Adjusting the positioning selector

You can change the sound localization according to the number and position of passengers. Also, you can adjust the sound balance from front to rear and left to right to optimize the sound from speakers from which sound has difficulty traveling.

- 1 On the Sound Settings screen, touch **Adjust** (Adjust) in Sound Position.



2 Touch the seat that you want to set.

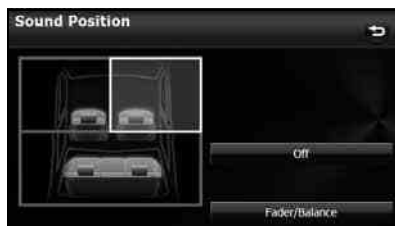

- A frame appears around the set position. Touch again to cancel the setting.
- 4 positions are available for setting: the front right seat, the front left seat, both front seats, or the rear seats.
- Touch **Off** (Off) to cancel all the settings.
- After completing the adjustment, touch **↩** to save the adjusted settings and return to the previous screen.

NOTE

You cannot set positioning selector adjustments at the same time as the volume balance.

■ Adjusting the audio balance







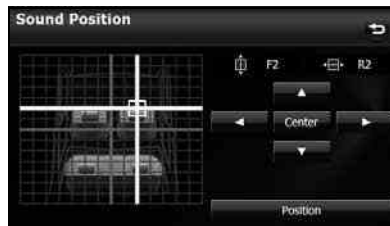

You can adjust the sound balance from front to rear and left to right.

- 1 On the Sound Position screen, touch **Fader/Balance** (Fader/Balance).



- 2 Touch the balance point that you want to use.



- To fine adjust, touch any of the balance adjusting buttons , ,  or  to change the value by 1 step. When you touch and hold one of the balance adjusting buttons , ,  or , the value changes continuously but stops at the center value. To continue to change the balance, touch one of the balance adjusting buttons again.
- You can also adjust to the desired balance by touching the screen.
- Touch **Center** (Center) to cancel the Fader/Balance setting and return to the center value.
- After completing the adjustment, touch  to save the adjusted settings and return to the Sound Settings screen.

NOTE

You cannot set the volume balance at the same time as positioning selector adjustments.

Setting the Source Volume Control

1 On the Sound Settings screen, touch or in SVC.

- You can set a volume difference for each audio mode. The differences between the volume of the FM mode in the initial setting (initial value: 19), which is used as reference, and the volume levels set for each audio mode are saved.



- After completing the adjustment, touch  to save the adjusted settings and return to the previous screen.

Setting example:

Audio mode	FM	AM	CD	USB	BT-Audio
Initial value (Volume level)	Reference (19)	0 (19)	0 (19)	0 (19)	0 (19)
SVC setting (Volume level)	Reference (19)	+15 (34)	-10 (9)	+5 (24)	-5 (14)
When volume level is adjusted from 19→35 in FM mode	35	34→50	9→25	24→40	14→30

Audio mode	FM	AM	CD	USB	BT-Audio
When volume level is adjusted from 25→45 in CD mode	35→55	50→ Max (70)*	45	40→60	30→50
When volume level is adjusted from Max→20 in AM mode	55→5	20	45→ 0(-5)*	60→10	50→0
When volume level is adjusted from 10→30 in USB mode	5→25	20→40	0→15	30	0→20

* You can set the volume level in a range of 0 to 63 (Max). Set the volume level differences in a range of -10 to +20.

Setting the Automatic Sound Levelizer

The Automatic Sound Levelizer (ASL) function detects the noise level inside the vehicle as it changes according to the driving speed and road conditions, and automatically increases the audio volume when the noise increases.

1 On the Sound Settings screen, touch **High** (High), **Mid** (Mid), **Low** (Low) or **Off** (Off) in ASL.

- **High** (High):
Set the sensitivity for detecting noise inside the vehicle to High.
- **Mid** (Mid):
Set the sensitivity for detecting noise inside the vehicle to Mid.
- **Low** (Low):
Set the sensitivity for detecting noise inside the vehicle to Low.
- **Off** (Off):
Cancel the ASL setting.



- After completing the adjustment, touch **↶** to save the adjusted settings and return to the previous screen.

Audio Operations

Using the Radio

Using the Radio

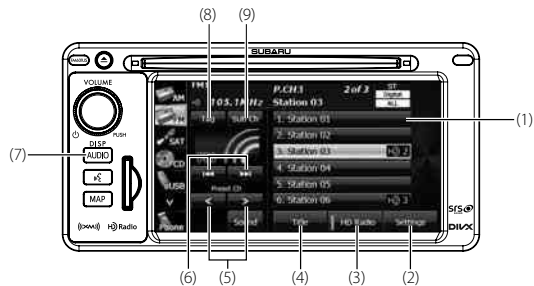

- (1) Preset button
- (2) Settings button
- (3) HD Radio button
- (4) Title button
- (5) Preset CH up/down buttons
- (6) Tune up/down buttons
- (7) AUDIO button
- (8) Tag button
- (9) Sub Ch button*

* Displayed only in FM radio mode.

NOTE

- When a digital HD Radio™ broadcast is received, “Digital” is displayed.
- About HD Radio™ Technology

HD Radio™

HD Radio Technology manufactured under license from iBiquity Digital Corporation. U.S. and Foreign Patents. HD Radio™ and the HD, HD Radio, and “Arc” logos are proprietary trademarks of iBiquity Digital Corp.

■ Listening to the radio

- 1 Press **AUDIO**.
- 2 Touch **AM** (AM) or **FM** (FM).



NOTE

Digital Sound

Digital, CD-quality sound. HD Radio Technology enables local radio stations to broadcast a clean digital signal. AM sounds like today's FM and FM sounds like a CD.

■ Tuning a station

Manual selection

1 Touch  or .



Move up 1 step.



Move down 1 step.

Auto tuning

1 Touch  or  for 1 second or more.

- The tuner moves automatically to the station closest to the frequency currently displayed on the screen and stops. To cancel auto tuning while it is operating, touch the button again.

NOTE

- In some cases, it is difficult to maintain the optimum reception because the position of the antenna on the vehicle is always changing (relative to the station antenna), and so the strength of the received wireless signal changes continuously. Also, obstructions such as the natural topography or the pillars of signboards may affect the reception.
- Auto tuning may not be possible in areas where the received signal is weak.

Selecting from a preset button

1 Touch a preset button saved in the memory.

- The saved preset channel is selected and the corresponding station is received.

■ Selecting a radio band

In FM radio mode only, you can select the reception band.

1 Press .

2 Touch  (FM).

- Touch  (FM) to change the reception band in the following order.

FM1 → FM2 → FM3

- The band currently being received is displayed at the top left of the screen.

■ Saving a station

You can save radio stations manually or automatically.

Manual saving

- 1 Select the station that you want to save using manual tuning or auto tuning.
- 2 Touch the preset button that you want to use for 2 seconds or more.
 - The selected station is saved and displayed on the preset button.



- To manually set additional stations for the remaining preset channels, repeat this procedure for each channel.
- You can set 6 stations each for FM 1, 2 and 3, and 6 stations for AM, making a total of 24 stations.

Automatic saving

- 1 Touch **Settings** (Settings).



- 2 Touch **Auto.P** (Auto.P) for 2 seconds or more.

- To cancel "Auto.P" while it is operating, touch the switch again.
- The tuner searches for stations starting from the lowest frequency and progressing toward higher frequencies. Once stations with sufficiently strong reception are found, the stations will be stored under FM3 preset buttons [1] to [6]. When this process is complete, a beep sound is heard, and the reception of the station that was stored last continues.



NOTE

- You can select a station in a one-touch operation simply by touching a preset button ([1] to [6]). The frequency of the selected station is displayed.
- When the new stations are set in the memory, the stations that were previously set are deleted.
- If the number of receivable stations is less than six, the remaining buttons are blank.

■ Displaying title information

In FM radio mode only, you can display a song's album name, track name, artist name and genre name during a broadcast.

1 Touch **Title** (Title).**2** Touch **Preset** (Preset) to return to the previous screen.**NOTE**

Program Service Data: Presents song name, artist, station IDs, and other relevant data streams.

■ Scrolling title information

If the Album, Title, Artist or Genre information cannot be fully displayed because it is too long, you can scroll the display.

1 Touch on the item that you want to scroll.

- The selected title information scrolls to the left.
- Touch  to stop the scrolling and return to the start of the title.
- If driving is detected while the display is being scrolled, the scrolling stops and returns to the start of the title.
- When the end of the title information is displayed, the scrolling stops.



■ Acquiring tag information

If tag information exists for the track being broadcast, you can acquire the track's tag information.

1 Touch (Tag).

- If an iPod is connected, the tag information is transferred to the iPod.
- If an iPod is not connected, maximum 50 Tags will be stored in the HD Radio tuner. It is transferred to iPod at the time of iPod connection on the next time and is deleted from Tuner.



NOTE

iTunes® Tagging

iTunes® Tagging provides you the opportunity to discover a wide range of content and the means to “tag” that content for later review and purchase from the iTunes® Store. Also refer to the Apple Automotive specifications for implementing iTunes® Tagging.

■ Receiving sub channel broadcasts

In FM radio mode only, you can receive a sub channel broadcast if one exists for the currently broadcasting station.

1 Touch **Sub Ch** (Sub Ch).

- The sub channel changes each time you touch the screen.
- The current channel and the number of sub-channel reception is displayed at the upper right of the screen.

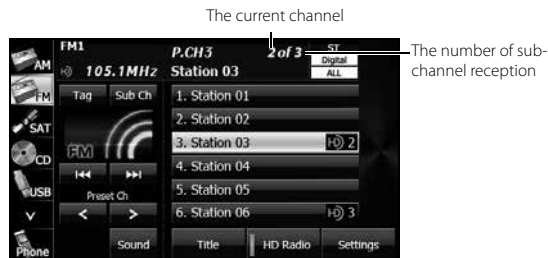

NOTE

HD2/HD3

FM stations can provide additional digital-only audio programming on HD2/HD3 Channels.

■ Changing the reception mode

1 Touch **Settings** (Settings).



2 Touch **ALL** (ALL), **HD** or **Analog** (Analog).

- Touch **X** to return to the previous screen.



ALL (ALL):

Receive by giving precedence to digital broadcasts.

HD :

Receive by giving precedence to digital broadcasts and setting the seek operation to digital broadcasts only.

Analog (Analog):

Receive analog broadcasts.

■ Changing the audio synchronization function of the HD Radio receiver

1 Touch **HD Radio** (HD Radio).



Indicator

- ON (indicator lit):
Audio is output according to the HD Radio setting and reception quality.
- OFF (indicator off):
Audio is output in analog regardless of the HD Radio setting or reception quality.
- Touch **HD Radio** (HD Radio) to switch between ON and OFF.

NOTE

When the reception mode is analog, the setting is OFF.

Using the SAT Radio

Using the SAT Radio

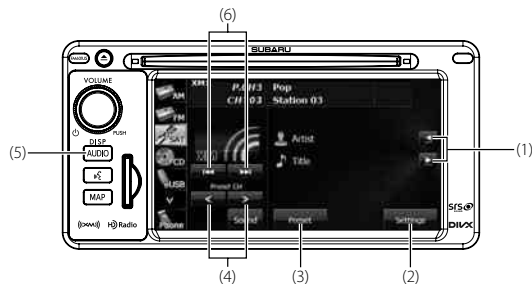

- (1) Title information scroll buttons*
- (2) Settings button
- (3) Preset button
- (4) Preset CH up/down buttons
- (5) AUDIO button
- (6) Channel up/down buttons

* It will be displayed if the length of the information is too long and it cannot be displayed.

■ Listening to the SAT radio

The SAT radio (XM satellite radio) has more than 100 channels, including music, news and leisure programs. You can select the channel that you want from different categories such as dance or rock, or you can select a channel by directly entering its number. The SAT radio can be received by using a paid-for subscription service.

1 Press **AUDIO**.

2 Touch **SAT** (SAT).

- In SAT radio mode, the title and artists information for the currently playing track is displayed.



■ Selecting a channel

Manual selection

1 Touch **▶▶** or **◀◀**.

- **▶▶**:
Select 1 channel higher.
- **◀◀**:
Select 1 channel lower.

NOTE

Invalid channels and non-subscribed channels are skipped.

Manual tuning (continuous)

1 Touch **▶▶** or **◀◀** for 1 second or more.

- **▶▶**:
Moves up the channels continuously until you release your finger from the button.
- **◀◀**:
Moves down the channels continuously until you release your finger from the button.

NOTE

Invalid channels, non-subscribed channels and channels set with the parental lock are skipped.

Selecting from a preset button

1 Touch **Preset** (Preset).



2 Touch **Preset** (Preset).



3 Touch one of the preset buttons on the display from [1] to [6].

- When selecting an item being Parental Locked in the list, the screen for code input is displayed.

Selecting from a channel list

1 Touch **Preset** (Preset).



2 Touch **Channel** (Channel).



3 Touch the channel to which you want to listen.

- If there are more pages, touch ▲ or ▼ to scroll the pages.
- When selecting an item being Parental Locked in the channel, the screen for code input is displayed.

**Selecting a channel by entering it directly**

1 Touch **Preset** (Preset).



2 Touch **Direct** (Direct).



3 Enter a channel number by touching 1 digit at a time.

- If you make a mistake, touch  to delete 1 digit at a time. Touch for 1 second or more to delete the digits continuously.



4 Touch **Done** (Done).

- When selecting an item being Parental Locked in the channel, the screen for code input is displayed.

NOTE

A reception possible broadcasting station is received.

Selecting by category

1 Touch **Preset** (Preset).



2 Touch **Category** (Category).



3 Touch the category to which you want to listen.

- If there are more pages, touch ▲ or ▼ to scroll the pages.
- When selecting an item being Parental Locked in the category, the screen for code input is displayed.



NOTE

A reception possible broadcasting station is received.

■ Changing the SAT band

You can change the reception band of the SAT radio.

1 Press **AUDIO**.

2 Touch **SAT** (SAT).

- Touch **SAT** (SAT) to change the reception band in the following order.

XM1 → XM2 → XM3

- The band currently being received is displayed at the top left of the screen.

■ Saving a channel

- 1 Select the channel that you want to save.
- 2 Touch **Preset** (Preset).



- 3 Touch **Preset** (Preset).



- 4 Touch the preset button that you want to use for 2 seconds or more.

- The selected channel is saved and displayed on the preset button.
- To manually set additional channels for the remaining preset channels, repeat this procedure for each channel.
- You can set 6 stations each for XM 1, 2 and 3, making a total of 18 stations.

NOTE

- You can select a channel in a one-touch operation simply by touching a preset button ([1] to [6]). The channel number of the selected channel is displayed.
- When the new channels are set in the memory, the channels that were previously set are deleted.

■ Scrolling title information

If the title or artist information cannot be fully displayed because it is too long, you can scroll the display.

1 Touch on the item that you want to scroll.

- The selected title information scrolls to the left.
- Touch  to stop the scrolling and return to the start of the title.
- If driving is detected while the display is being scrolled, the scrolling stops and returns to the start of the title.
- When the end of the title information is displayed, the scrolling stops.



■ Checking the radio ID

1 Touch **Preset** (Preset).



2 Touch **Direct** (Direct).



3 Touch "0".

- If you make a mistake, touch  to delete 1 digit at a time.
Touch for 1 second or more to delete the digits continuously.



4 Touch **Done** (Done).

5 Touch .

- An 8-digit numerical code appears.



■ Restricting operation



1 Touch **Settings** (Settings).



2 Touch **Parental Lock** (Parental Lock).



3 Enter the 4-digit parental lock code.



- When setting for the first time, enter any code that you want to use.
- Touch  to delete 1 digit from the entered number. Touch for 1 second or more to delete the digits continuously.
- Touching  10 times continuously clears the parental lock code.



4 Touch **Done** (Done).

- If the code is correct, the setting screen appears.
- If an incorrect code is entered, "Incorrect code. Please try again." appears and the number is cleared.

5 Select the channel with the settings that you want to change, and touch **Lock** (Lock) or **Unlock** (Unlock).

- If the channel is restricted,  appears.
- If there are more pages, touch  or  to scroll the pages.
- When you touch **All Unlock** (All Unlock), the all restricted channels are canceled.



- After configuring the setting, touch  to save the setting and return to the initial screen.
- If you have locked the currently listening channel, the channel buttons to the next receivable (unlocked) channel.

■ Clearing the parental lock

- 1 Enter the parental lock code, and then touch **Done** (Done).
 - Touch  to delete 1 digit from the entered number. Touch for 1 second or more to delete the digits continuously.

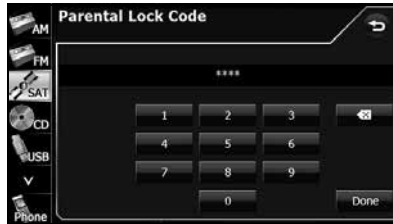

Using the CD Player

Using the CD Player

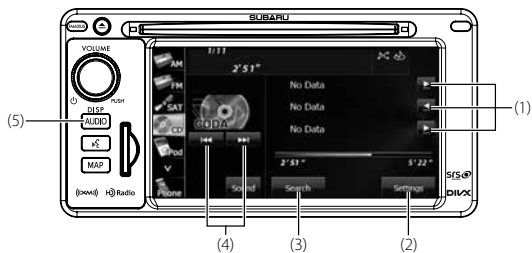

- (1) Title information scroll buttons*
- (2) Settings button
- (3) Search button
- (4) Track up/down and fast forward (fast reverse) buttons
- (5) AUDIO button

* It will be displayed if the length of the information is too long and it cannot be displayed.

NOTE

Some of the functions may not be available when vehicle is in motion.

■ Listening to a CD

Insert a CD into the disc slot, and it will start playing.

1 Press **AUDIO**.

2 Touch **CD** (CD).

- The playback starts.



NOTE

- Playback may be intermittent when there is a scratch on the CD or when the recorded side is dirty.
- If track titles and other data are recorded in the CD-Text format, they can be displayed.
- It may not be possible to display the CD-Text of CD-R/RW discs.
- If no CD-Text data exist in the disc, "No Data" appears in the section where the track titles and other data are displayed.

■ Selecting a track

You can cue the track to which you want to listen.

1 Touch or .

- Right:
Advance to the next track.
- Left (touch once):
Return to the start of the currently playing track.
- Left (touch twice or more):
Return to a previous track.

■ Fast forwarding and fast reversing

You can fast forward or fast reverse the currently playing track.

1 Touch or for 1 second or more.



- Right:
Fast forward the track.
- Left:
Fast reverse the track.
- Fast forward (or fast reverse) operates until you release your finger from the button.

■ Finding a track

1 Touch (Search).



2 Touch the track to which you want to listen.

- The selected track starts to play.
- If there are more pages, touch  or  to scroll the pages.
- Touch  to return to the previous screen.



■ Repeating the same track

1 Touch **Settings** (Settings).



2 Touch **On** (On) in Repeat.

- Repeat playback is set for the currently playing track.
- When **On** (On) in Repeat is touched, the repeat playback of the track continues until the function is canceled.
- Touch **Off** (Off) in Repeat to cancel the repeat playback of the track.
- Touch **X** to return to the previous screen.



NOTE

When On is selected in Repeat,  is displayed in the top right of the screen as confirmation that the function is on.

■ Playing tracks randomly

1 Touch **Settings** (Settings).



2 Touch **On** (On) in Random.

- All tracks from the currently playing CD are played randomly.
- When **On** (On) in Random is touched, the random playback of the tracks continues until the function is canceled.
- Touch **Off** (Off) in Random to cancel the random playback of the tracks.

- Touch  to return to the previous screen.

**NOTE**

When On is selected in Random,  is displayed in the top right of the screen as confirmation that the function is on.

Using the MP3/WMA Player

Using the MP3/WMA Player

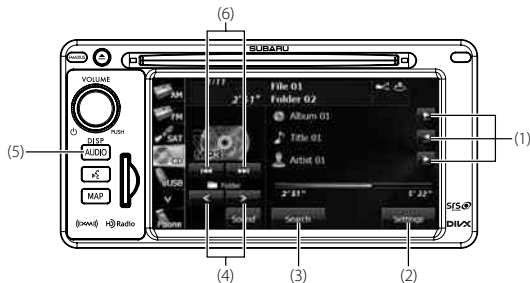

- (1) Title information scroll buttons*
- (2) Settings button
- (3) Search button
- (4) Folder selection buttons
- (5) AUDIO button
- (6) File up/down and fast forward (fast reverse) buttons

* It will be displayed if the length of the information is too long and it cannot be displayed.

NOTE

Some of the functions may not be available when vehicle is in motion.

■ Listening to an MP3/WMA file

Insert a CD-R/RW that contains an MP3/WMA file into the disc slot, and it will start playing.

1 Press **AUDIO**.

2 Touch **CD** (CD).

- The playback starts.
- The usual playing order is 1 → 2 → 3 → 4 → 5 → 6. (See Page 237.)
- If multiple MP3/WMA files and folders are located in the same hierarchy, they are played in the ascending order of folder name and file name.
- If you try to play a non-MP3/WMA format file, "No Support" is displayed.



NOTE

- Playback may be intermittent when there is a scratch on the CD or when the recorded side is dirty.
- For CD-ROMs, a function is available for selecting the folder and file.
- If a non-MP3/WMA file has the ".mp3" or ".wma" file extension, it may be recognized erroneously as an MP3 or WMA file. When such a file is played, a loud noise may be output and damage the speakers. Take care not to assign the ".mp3" or ".wma" extension to non- MP3/WMA files.

■ Selecting a folder

You can select the folder that you want to use from the disc.

1 Touch < or >.

- **<**:
Return to the previous folder and play the first file in the folder.
- **>**:
Advance to the next folder and play the first file in the folder.

**■ Selecting a music file**

You can select the file that you want to play from a folder.



Selecting with a file name button**1 Touch Search (Search).**

2 Touch the folder that you want to use.

- If there are more pages, touch  or  to scroll the pages.
- Touch  to return to the previous screen.





3 Touch the file that you want to play.

- The selected file starts to play.
- If there are more pages, touch  or  to scroll the pages.
- Touch  to return to the previous screen.



Selecting consecutive files



1 Touch or .

- : Advance to the next file.
-  (Press once): Return to the start of the currently playing file.
-  (Press twice or more): Return to the previous file.
- The selected file starts to play.

Fast forwarding and fast reversing

You can fast forward or fast reverse the currently playing file.

1 Touch or for 1 second or more.

- : Fast forward the file.
- : Fast reverse the file.
- Fast forward (or fast reverse) operates until you release your finger from the button.

■ Repeating the music file

1 Touch **Settings** (Settings).





2 Touch **File** (File) or **Folder** (Folder) in Repeat.

- Repeat playback is set for the currently playing file or folder.
- To cancel, touch **Off** (Off) in Repeat.
- Touch **X** to return to the previous screen.



NOTE

When the file repeat or folder repeat function is selected,  or  is displayed in the top right of the screen as confirmation that the function is on.

■ Playing randomly

1 Touch **Settings** (Settings).





2 Touch **ALL** (ALL) or **Folder** (Folder) in Random.

- Folder random playback:
The files in the currently playing folder are played randomly.
- All random playback:
The files in all folders are played randomly.
- Touch **File** (File) in Repeat during random playback to repeat the currently playing file. Touch **Off** (Off) in Repeat to return to random playback.
- To cancel, touch **Off** (Off) in Random.

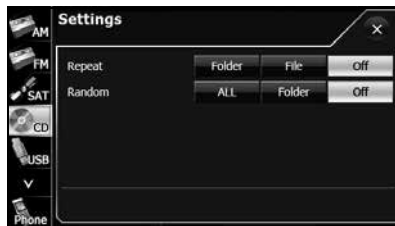
- Touch  to return to the previous screen.



NOTE

When the folder random or all random function is selected,  or  is displayed in the top right of the screen as confirmation that the function is on.

■ Scrolling title information

If the Album, Title or Artist information cannot be fully displayed because it is too long, you can scroll the display.

1 Touch on the item that you want to scroll.

- The selected title information scrolls to the left.
- Touch  to stop the scrolling and return to the start of the title.
- If driving is detected while the display is being scrolled, the scrolling stops and returns to the start of the title.
- When the end of the title information is displayed, the scrolling stops.



About MP3/WMA

MP3 (MPEG Audio Layer 3) is a standard format for audio compression. By using MP3, a file can be compressed to about 1/10 of the original size.

WMA (Windows Media Audio) is Microsoft's audio compression technology. WMA files can be compressed to a size even smaller than MP3 files.

This unit only supports certain MP3/WMA file standards, recorded media and formats. Take note of the following when writing MP3/WMA files onto a disc.

■ About the supported MP3 file standards

- Supported standards:
 - MPEG1/2/2.5 Audio Layer 3
- Supported sampling frequencies (kHz):
 - MP3 (MPEG1 Audio Layer 3): 32, 44.1, 48
 - MP3 (MPEG2 Audio Layer 3): 16, 22.05, 24
 - MP3 (MPEG2.5 Audio Layer 3): 8, 11.025, 12
- Supported bit rates (kbps):
 - MP3 (MPEG1 Audio Layer 3): 32, 40, 48, 56, 64, 80, 96, 112, 128, 160, 192, 224, 256, 320
 - MP3 (MPEG2/2.5 Audio Layer 3): 8, 16, 24, 32, 40, 48, 56, 64, 80, 96, 112, 128, 144, 160
 - * Supports VBR (Variable Bit Rate).
 - * Does not support Audio Layer 1/2.
 - * Emphasis supports only 50/15ms.
 - * Does not support free format.
 - * Does not support DRM (Digital Rights Management).
- Supported channel modes:
 - Stereo, Joint Stereo, Dual channels, Monaural

■ About the supported WMA file standards

- Supported standards:
 - WMA Ver. 7 to 9
- Supported sampling frequencies (kHz):
 - 22.05, 24, 32, 44.1, 48
- Supported bit rates (kbps):
 - WMA Ver. 7, 8: 48, 64, 80, 96, 128, 160, 192
 - WMA Ver. 9: 48, 63, 64, 80, 95, 96, 127, 128, 160, 191, 192, 256, 320
 - * Supports 2-channel play only.
 - * Supports VBR (Variable Bit Rate).
 - * Does not support WMA9 Professional/Lossless/Voice.
 - * Does not support DRM (Digital Rights Management).
- Supported channel modes:
 - Stereo, Monaural

■ About ID3/WMA tags

In MP3/WMA files, you can enter textual attribute information known as ID3 tags/WMA tags to save information such as track titles and artist names.

This unit supports ID3v.1.0, 1.1, 2.2, 2.3 and 2.4 tags. This unit supports the ISO 8859-1, 2, 5 and 7 codes only. Use only the ISO 8859-1, 2, 5 or 7 codes to record tags. If characters not included in ISO8859-1, 2, 5 or 7 codes are recorded, they may not be readably displayed.

This unit supports the WMA tag ASF revision (v1.20.02). WMA tags using only Unicode are supported. Always use Unicode characters to enter the information.

- * When Ver. 1.x and Ver. 2.x of the ID3 tags both exist, precedence is given to Ver. 2.x.

■ About the supported media types

You can play MP3/WMA files recorded on a CD-ROM, CD-R or CD-RW disc. Compared to the CD-ROM media commonly used for music discs, CD-R and CD-RW discs are fragile in high temperature and high humidity environments. It may not be possible to play some CD-R/CD-RW discs. Fingerprints or scratches on a disc may prevent playback or cause skipping during playback.

Some CD-R/CD-RW discs may deteriorate if left inside a vehicle for a long time.

We recommend that you store UV-sensitive CD-R and CD-RW discs in shield cases.

■ About the supported disc formats

You can use media in the following formats.

- CD-ROM formats:
CD-ROM MODE 1, CD-ROM XA MODE 2 Form 1
- File formats:
ISO9660 Level 1 or Level 2
ROMEO system, JOLIET system
MP3/WMA files recorded in a format other than those described above may result in files that cannot be played normally or file names and folder names that do not display properly.

In addition to these standards, the following limitations apply.

- Maximum number of directory layers:
8 layers
- Supported characters for folder and file names:
A to Z, 0 to 9, and underscore (_)
- Number of files that can be stored on a single disc:
999
- Number of folders that can be stored on a single disc:
255

<A configuration example of an MP3/WMA-supporting CD>

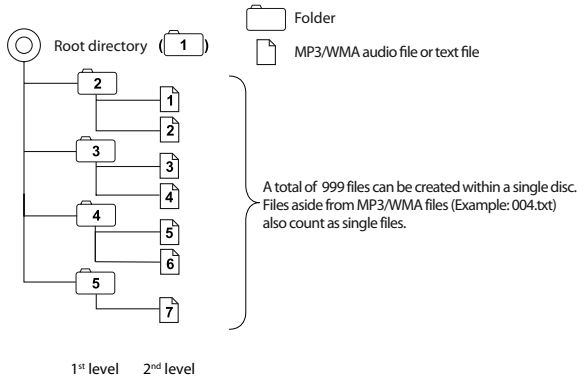

■ About the file names

Only a file with the “.mp3” or “.wma” extension is recognized as an MP3 or WMA file. Always save an MP3/WMA file with the “.mp3” or “.wma” extension.

The “.mp3” or “.wma” file extension must be single-byte lower case letters.

NOTE

If a non-MP3/WMA file has the “.mp3” or “.wma” file extension, it may be recognized erroneously as an MP3 or WMA file. When such a file is played, a loud noise may be output and damage the speakers. Do not save a non-MP3/WMA file with the “.mp3” or “.wma” extension.

■ Multi-sessions

Multi-sessions are supported and CD-R/RW with recorded MP3/WMA files can be played.

However, when writing with Track-At-Once, be sure to finalize the disc with session close or write protect.

■ About MP3/WMA playback

When you load a disc containing MP3/WMA files, the system first checks all files recorded on the disc. If the disc has many files and folders, the system may take a while to check them.

While the system is checking the disc, the music that was playing continues to play.

To allow quick checking of files, we recommend that you do not save non-MP3/WMA files or create unnecessary folders on the disc.

Also, we recommend that you write the all data in a single session because the system takes longer to read the CD control information of a multi-session disc.

■ About the MP3/WMA playing time display

It is possible that the playing time will not be correct, depending on the writing condition of the MP3/WMA file.

- * It is possible that the playing time will not be correct when VBR (Variable Bit Rate) Fast Up/Down is operated.

Creating and Playing MP3/WMA Files

Creating MP3/WMA files by recording them from sources such as broadcasts, records, recordings, videos and live performances without permission from the copyright holder for uses other than personal enjoyment is prohibited.

CAUTION

- **To ensure stable sound quality during playback, we recommend fixing the bit rate to 128 kbps and the sampling frequency to 44.1 kHz.**
- **Note that it may not be possible to read some CD-R or CD-RW discs, depending on their characteristics.**
- **There are many types of MP3/WMA encoding software available, including commercial and freeware programs. Depending on the encoder and the file format, the audio quality may deteriorate, noise may be generated when playing starts, or some recordings may not play.**
- **When files other than MP3/WMA files are recorded on a disc, the system may take some time to recognize the disc and it may not play.**

■ **Downloading from MP3/WMA music sites on the Internet**

You can find various types of MP3/WMA music distribution sites on the Internet, including online shopping, trial listening, and free download sites. You can download music files from these sites by following their payment and other downloading rules.

■ **Converting a music CD into MP3/WMA files**

Prepare a computer and a commercially available MP3/WMA encoder (conversion) software (some can be found for free on the Internet). Load a music CD into the computer's CD-ROM drive and compress the music CD by following the procedure of the MP3/WMA encoder software. MP3/WMA-format music data files are created. A 12 cm music CD (with a maximum of 74 minutes of recording/650 MB of data) can be compressed to 65 MB (about 1/10 of the original size).

■ **Writing MP3/WMA files on a CD-R/RW disc**

MP3/WMA files can be recorded on a CD-R/RW disc by using a CD-R/RW drive connected to a computer. Record by setting the recording format of the recording software to ISO9660 level 1 or level 2 (not including the extension format).

Select CD-ROM (mode 1) or CD-ROM XA (mode 2) as the disc format.

■ **Playing a CD-R/RW disc**

Insert a CD-R/RW disc on which MP3/WMA files are recorded. When you load a disc, the system automatically determines whether it is a music CD or a CD-R/RW disc that contains MP3/WMA files, and plays it correctly. However, note that depending on the type of disc being used, the disc may not play.

Using the USB Music File Player

Using the USB Music File Player

This unit can play music files stored in a USB memory. Only MP3/WMA playback is supported.

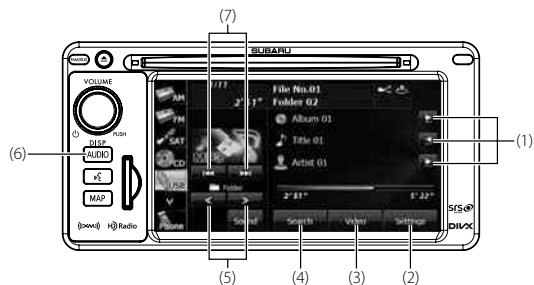

- (1) Title information scroll buttons*
- (2) Settings button
- (3) Video button
- (4) Search button
- (5) Folder selection buttons
- (6) AUDIO button
- (7) File up/down and fast forward (fast reverse) buttons

* It will be displayed if the length of the information is too long and it cannot be displayed.

NOTE

- Touch **Video** (Video) to operate the USB video file player. (See Page 247.)
- Some of the functions may not be available when vehicle is in motion.

■ Listening to a USB music file

⚠ CAUTION

Connect the USB cable correctly so that it does not interfere with safe operation of the vehicle.

- 1 Connect a USB memory that contains music files to the USB connector.
- 2 Press **AUDIO**.
- 3 Touch **USB** (USB).
 - The playback starts.



NOTE

When a USB memory device is connected, the unit may take some time to scan and read the file tag information. To shorten this scan time, try to store only MP3/WMA files in the USB memory and minimize the number of folders.

■ Selecting a folder

You can select the folder that you want to use from the USB memory.

1 Touch **<** or **>**.

- **<**:
Return to the previous folder and play the first file in the folder.
- **>**:
Advance to the next folder and play the first file in the folder.

NOTE

If no MP3/WMA files exist in the folder, "No Data" appears in the section where the file name and folder name are displayed.

■ Selecting a music file



You can select the file that you want to play from a folder.

Selecting with a file name button**1** Touch **Search** (Search).**2** Touch the folder that you want to use.

- If there are more pages, touch **▲** or **▼** to scroll the pages.
- Touch **⏪** to return to the previous screen.





3 Touch the file that you want to play.

- The selected file starts to play.
- If there are more pages, touch  or  to scroll the pages.
- Touch  to return to the previous screen.



Selecting consecutive files



1 Touch or .

- :
Advance to the next file.
-  (Press once):
Return to the start of the currently playing file.
-  (Press twice or more):
Return to the previous file.
- The selected file starts to play.

■ Fast forwarding and fast reversing

You can fast forward or fast reverse the currently playing file.

1 Touch or for 1 second or more.

- :
Fast forward the file.
 - :
Fast reverse the file.
- Fast forward (or fast reverse) operates until you release your finger from the button.

■ Repeating the music file

1 Touch (Settings).





2 Touch (File) or (Folder) in Repeat.

- Repeat playback is set for the currently playing file or folder.
- To cancel, touch  (Off) in Repeat.

- Touch **X** to return to the previous screen.



NOTE

When the file repeat or folder repeat function is selected,  or  is displayed in the top right of the screen as confirmation that the function is on.

■ Playing randomly

- 1 Touch **Settings** (Settings).





- 2 Touch **ALL** (ALL) or **Folder** (Folder) in Random.

- Folder random playback:
The files in the currently playing folder are played randomly.
- All random playback:
The files in all folders are played randomly.
- Touch **File** (File) in Repeat during random playback to repeat the currently playing file. Touch **Off** (Off) in Repeat to return to random playback.
- To cancel, touch **Off** (Off) in Random.
- Touch **X** to return to the previous screen.



NOTE

When the folder random or all random function is selected,  or  is displayed in the top right of the screen as confirmation that the function is on.

■ Scrolling title information

If the Album, Title or Artist information cannot be fully displayed because it is too long, you can scroll the display.

1 Touch on the item that you want to scroll.

- The selected title information scrolls to the left.
- Touch  to stop the scrolling and return to the start of the title.
- If driving is detected while the display is being scrolled, the scrolling stops and returns to the start of the title.
- When the end of the title information is displayed, the scrolling stops.



About USB Devices

■ About the supported USB memory standards

- Supported file formats:
FAT 32
- Supported audio formats:
MP3/WMA
- Maximum current:
1.0 A
- Supported capacities:
16 MB to 8 GB
- Compatibility:
USB1.0/1.1/2.0 (maximum transfer speed is same as USB 2.0)
- Mass memory support:
Supports USB mass storage class.
- Does not support USB hubs or multi card readers.

■ Supported MP3 file standards

- Supported standards:
MPEG1/2/2.5 Audio Layer 3
- Supported sampling frequencies (kHz):
 - MP3 (MPEG1 Audio Layer 3): 32, 44.1, 48
 - MP3 (MPEG2 Audio Layer 3): 16, 22.05, 24
 - MP3 (MPEG2.5 Audio Layer 3): 8, 11.025, 12
- Supported bit rates (kbps):
 - MPEG1 Audio Layer : 32, 40, 48, 56, 64, 80, 96, 112, 128, 160, 192, 224, 256, 320
 - MPEG2, 2.5 Audio Layer : 8, 16, 24, 32, 40, 48, 56, 64, 80, 96, 112, 128, 144, 160
 - * Supports VBR (Variable Bit Rate).
 - * Emphasis supports only 50/15ms.
 - * Does not support free format.
 - * Does not support DRM (Digital Rights Management).
- Supported channel modes:
Stereo, Joint Stereo, Dual channels, Monaural

■ Supported WMA file standards

- Supported standards:
WMA Ver. 7 to 9
- Supported sampling frequencies (kHz):
22.05, 24, 32, 44.1, 48
- Supported bit rates (kbps):
 - WMA Ver. 7, 8: 48, 64, 80, 96, 128, 160, 192
 - WMA Ver. 9: 48, 63, 64, 80, 95, 96, 127, 128, 160, 191, 192, 256, 320
 - * Supports 2-channel play only.
 - * Supports VBR (Variable Bit Rate).
 - * Does not support WMA9 Professional/Lossless/Voice.
 - * Does not support DRM (Digital Rights Management).
- Supported channel modes:
Stereo, Monaural

■ About ID3/WMA tags

In MP3/WMA files, you can enter textual attribute information known as ID3 tags/WMA tags to save information such as track titles and artist names.

This unit supports ID3v.1.0, 1.1, 2.2, 2.3 and 2.4 tags.

This unit supports the ISO 8859-1, 2, 5 and 7 codes only. Use only the ISO 8859-1, 2, 5 or 7 codes to record tags. If characters not included in ISO8859-1, 2, 5 or 7 codes are recorded, they may not be readably displayed.

This unit supports the WMA tag ASF revision (v1.20.02). WMA tags using only Unicode are supported. Always use Unicode characters to enter the information.

* When Ver. 1.x and Ver. 2.x of the ID3 tags both exist, precedence is given to Ver. 2.x.

■ USB memory format

The control items in this standard are described below.

- Maximum number of directory layers:
8 layers
- Maximum number of characters for file names:
128 byte
- Supported characters for file names:
A to Z, 0 to 9, and underscore (_)
(Range of alpha-numeric ISO-8859-1)
- Number of files that can be stored in a single memory device:
9999

<A configuration example of an MP3/WMA-supporting USB memory>

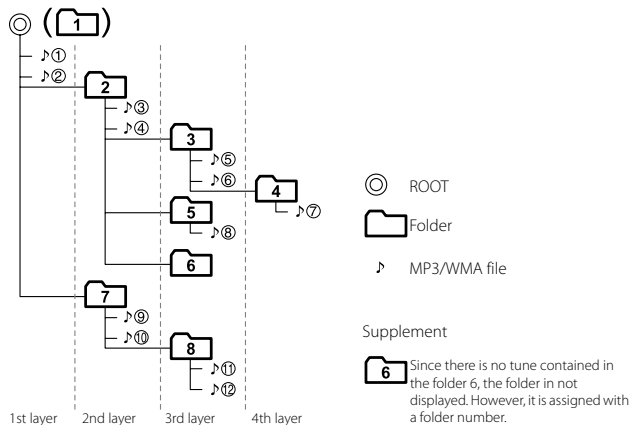

Using the USB Video File Player

Before Using the USB Video File Player

.....

▲ WARNING

To ensure safety, you cannot watch a video while driving.

■ About DivX

DivX is a highly evaluated media technology developed by DivX, Inc. DivX media files enable you to compress with a high compression ratio while maintaining high image quality. Menus, subtitles, and sub audio tracks can be included in the file compressed by DivX. DivX.com has a variety of DivX media files. It is possible to create original content by downloading these media and using the DivX dedicated tools.

■ About DivX Certified

- DivX Certified products have been tested by the DivX creators, and have been officially tested and certified that they can be played on DivX ver. 4, 5 and 6 (the DivX ver. 3 are not supported). A DivX Certified logo on a product shows that it is a portable video or HD video that complies with the DivX Profiles Standard.



- DivX, DivX Certified and associated logos are trademarks of DivX, Inc. These trademarks are used with the permission of DivX, Inc.
- Covered by one or more of the following U.S. patents: 7,295,673; 7,460,668; 7,515,710; 7,519,274
- **ABOUT DivX VIDEO:**
DivX® is a digital video format created by DivX, Inc. This is an official DivX Certified® device that plays DivX video. Visit divx.com for more information and software tools to convert your files into DivX video.

• **ABOUT DivX VIDEO-ON-DEMAND:**

This DivX Certified® device must be registered in order to play purchased DivX Video-on-Demand (VOD) movies. To obtain your registration code, locate the DivX VOD section in your device setup menu. Go to vod.divx.com for more information on how to complete your registration.

DivX Certified® to play DivX® video, including premium content.

- This unit supports playback of DivX files recorded in USB memory. It does not support the playback of DivX files recorded on discs.
- To ensure safety, only DivX music can be played while the vehicle is in motion.
- Manufactured under license from Dolby Laboratories.

NOTE

- You can watch a USB video file only when you have stopped your vehicle and applied the parking brake to ensure safety, and turned the ignition switch to ON or ACC ON. (If the source is switched to USB while the vehicle is in motion, only the audio function operates.)
- This unit supports playback of video files recorded in USB memory. It does not support the playback of video files recorded on discs.

Using the USB Video File Player

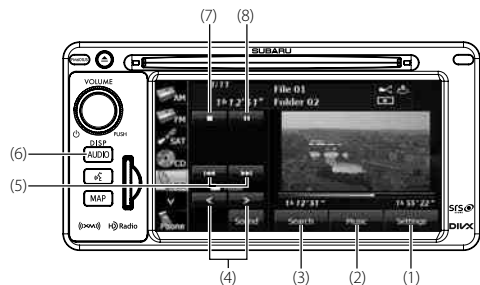

- (1) Settings button
- (2) Music button
- (3) Search button
- (4) Folder selection buttons
- (5) File up/down and fast forward (fast reverse) buttons
- (6) AUDIO button
- (7) Stop button
- (8) Play/Pause button

NOTE

- Touch **Music** (Music) to operate the USB music file player. (See Page 240.)
- Some of the functions may not be available when vehicle is in motion.

■ Viewing a USB video file

⚠ CAUTION

Connect the USB cable correctly so that it does not interfere with the safe operation of the vehicle.

- 1 Connect a USB memory that contains video files to the USB connector.
- 2 Press **AUDIO**.
- 3 Touch **USB** (USB).
 - The playback starts.
 - Touch the video to show it in a full-screen display. To display the operation buttons (touch buttons) again, touch the full-screen display.



<Full-screen display>



NOTE

When a USB memory device is connected, the unit may take some time to scan and read the file tag information. To shorten this scan time, try to store only video files in the USB memory and minimize the number of folders.

■ Selecting a folder

You can select the folder that you want to use from the USB memory.

- 1 Touch **<** or **>**.

- **<**:
Return to the previous folder and play the first video in the folder.
- **>**:
Advance to the next folder and play the first video in the folder.

NOTE

If no video files exist in the folder, "No Data" appears in the section where the file name and folder name are displayed.

■ Selecting a file

You can select the file that you want to play from a folder.

Selecting with a file name button

1 Touch **Search** (Search).



2 Touch the folder that you want to use.

- If there are more pages, touch **▲** or **▼** to scroll the pages.
- Touch **⏪** to return to the previous screen.



3 Touch the file that you want to play.

- The selected file starts to play.
- If there are more pages, touch **▲** or **▼** to scroll the pages.
- Touch **⏪** to return to the previous screen.



NOTE

- When the list is displayed, touch the video to show it in a full-screen display.
- A message is displayed on the screen when DivX VOD Rental files are played. Read the displayed contents carefully, and touch either **Yes** (Yes) or **No** (No).
 - This message is only displayed if there are rental frequency limitations.
 - When you touch **Yes** (Yes), the rental frequency decreases and the selected image is played back.

Selecting consecutive files

- 1 Touch **▶▶** or **◀◀**.
 - **▶▶**: Advance to the next file.
 - **◀◀** (Press once): Return to the start of the currently playing file.
 - **◀◀** (Press twice or more): Return to the previous file.

Fast forwarding and fast reversing

You can fast forward or fast reverse the currently playing video.

- 1 Touch **▶▶▶** or **◀◀◀** for 1 second or more.
 - **▶▶▶**: Fast forward the video.
 - **◀◀◀**: Fast reverse the video.

Fast forward (or fast reverse) operates until you release your finger from the button.

Pausing a video

- 1 Touch **⏸**.
 - During pause, touch **▶** to restart playback.

Stopping a video

- 1 Touch **⏹**.

Repeating the video file



- 1 Touch **Settings** (Settings).



- 2 Touch **File** (File) or **Folder** (Folder) in Repeat.
 - Repeat playback is set for the currently playing file or folder.
 - To cancel, touch **Off** (Off) in Repeat.
 - Touch **X** to return to the previous screen.





NOTE

When the file repeat or folder repeat function is selected,  or  is displayed in the top right of the screen as confirmation that the function is on.

■ Playing randomly**1** Touch **Settings** (Settings).**2** Touch **ALL** (ALL) or **Folder** (Folder) in Random.

- Folder random playback:
The files in the currently playing folder are played randomly.
All random playback:
The files in all folders are played randomly.
- Touch **File** (File) in Repeat during random playback to repeat the currently playing video. Touch **Off** (Off) in Repeat to return to random playback.
- To cancel, touch **Off** (Off) in Random.
- Touch **X** to return to the previous screen.

**NOTE**

When the folder random or all random function is selected,  or  is displayed in the top right of the screen as confirmation that the function is on.

■ Changing the subtitle language

If the video file stores multiple subtitle languages, you can change the subtitle language that is used.

1 Touch **Settings** (Settings).



2 Touch **Subtitle** (Subtitle).



3 Touch **Change Subtitle** (Change Subtitle).

- Each time you touch **Change Subtitle** (Change Subtitle), the subtitle number changes, and the subtitle languages recorded on the video file change in sequence.
- Touch **Subtitle Off** (Subtitle Off) to play without displaying subtitles on the screen.



■ Changing the audio language

If the video file stores multiple audio languages, you can change the audio language that is used.

1 Touch **Settings** (Settings).



2 Touch **Audio**.



3 Touch **Change Audio** (Change Audio).

- Each time you touch **Change Audio** (Change Audio), the audio number changes, and the audio languages recorded on the video file change in sequence.



■ Changing the video output

1 Touch **Settings** (Settings).



2 Touch **Aspect** (Aspect).



3 Touch **Original** (Original) or **Zoom** (Zoom).

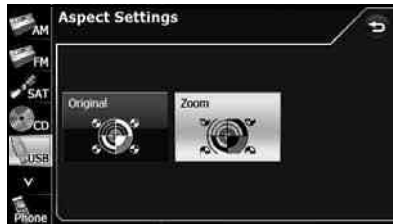

- **Original** (Original):
Display the video in its original size.
- **Zoom** (Zoom):
Expand the video until its vertical or horizontal dimension reaches the maximum size. (For DivX image files, the image is enlarged to 4.5 times its original size.)

NOTE

You are allowed to watch a video on the zoom screen for personal enjoyment. However, if you compress or enlarge the screen for commercial purposes or to display to the public, it may infringe copyright that is protected by copyright laws.

Displaying DivX VOD code

■ Displaying the DivX VOD registration code

To play DivX VOD (Video On Demand) content, first register this unit with the content provider. To register, the DivX VOD registration code is required.

You can display the DivX® Video On Demand registration code.

1 Touch **Info**.

- If **Info** is not displayed, touch **∨**.



2 Touch **DivX(R) VOD** (DivX(R) VOD).

- The DivX(R) VOD Set Up screen appears.



3 Touch **Register** (Register).



- Touch **OK** (OK) to return to the Info screen.



■ Displaying the DivX VOD deregistration code

To cancel the unit's registration with the content provider, the DivX VOD deregistration code is required. You can display the DivX[®] Video On Demand deregistration code.

1 Touch **Info**.

- If **Info** is not displayed, touch **∨**.

2 Touch **DivX(R) VOD** (DivX(R) VOD).

- The DivX(R) VOD Set Up screen appears.

3 Touch **Deregister** (Deregister).



- Touch **OK** (OK) to return to the Info screen.



4 Touch **Yes** (Yes).

- Touch **No** (No) to return to the previous screen.



■ **Caution display while playing VOD rental files**

A message is displayed on the screen when DivX VOD rental files are played. Read the displayed contents carefully, and touch either **Yes** (Yes) or **No** (No).

About USB Devices

■ Supported DivX standards

- Supported extensions:
DivX, Div, AVI (single-byte characters only, not case-sensitive)
- Maximum number of directory layers:
8 layers (including the root folder)
- Number of folders that can be stored in the USB memory:
3000 (including the root folder)
- Number of files that can be stored in the USB memory:
9999
- Standard level:
DivX Certified
 - * Only title 1 can be played in the DivX media format. The menu is not displayed.
- Codec support:
DivX Ver. 4.x, 5.x, 6.x (supports NTSC/PAL)
- Profile:
DivX Home Theater 3.0
- Maximum resolution:
720×480 (30 fps), 720×576 (25 fps)
- Supported audio codec:
MP1, MP2, MP3, AC3
 - Supported sampling frequencies (kHz):
AC3: 32 - 320
 - * For the other audio codec, see "About USB Devices" on Page 244.
 - Supported channel modes:
Stereo, Monaural

■ Supported WMV standards

- Supported extensions:
WMV (single-byte characters only, not case-sensitive)
- Maximum number of directory layers:
8 layers (including the root folder)
- Number of folders that can be stored in the USB memory:
3000 (including the root folder)
- Number of files that can be stored in the USB memory:
9999
- Codec support:
WMV Windows Media Video 9 (VC-1)
 - * Does not support WMA9 Professional/lossless/Voice
- Maximum resolution:
720×480 (30 fps), 720×576 (25 fps)
- Supported audio codec:
MP3, WMA
 - * For the other audio codec, see "About USB Devices" on Page 244.
- Supported channel modes:
Stereo, Monaural

■ Supported MP4 standards

- Supported extensions:
MP4, M4V (single-byte characters only, not case-sensitive)
- Maximum number of directory layers:
8 layers (including the root folder)
- Number of folders that can be stored in the USB memory:
255 (including the root folder)
- Number of files that can be stored in the USB memory:
9999
- Codec support:
Complies with MPEG1 Windows Media standards
MPEG4 MPEG-4 Simple Profile
- Maximum resolution:
720×480 (30 fps), 720×576 (25 fps)
- Supported audio codec:
MP3, AC3
 - Supported sampling frequencies (kHz):
AC3: 32 - 320
 - * For the other audio codec, see "About USB Devices" on Page 244.
 - Supported channel modes:
Stereo, Monaural

How to Operate Portable Audio Devices

Using the iPod® Player

Using the iPod Player

When an iPod is connected, you can play iPod music files. On this unit, you can perform operations such as selecting a file from a list or changing to the random playback mode. Note that you cannot connect an iPod cable and USB at the same time.

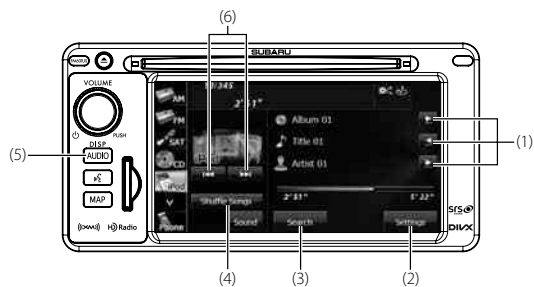

- (1) Title information scroll buttons*
- (2) Settings button
- (3) Search button
- (4) Shuffle Songs button
- (5) AUDIO button
- (6) File up/down and fast forward (fast reverse) buttons

* It will be displayed if the length of the information is too long and it cannot be displayed.

NOTE

- iPod and iTunes may be used with materials without copyright, or materials for which copying or playback are legally allowed for the purposes of private copying or playback. The infringement of copyright is prohibited by law.
- The picture display and audiobook functions of iPod are not supported.
- The podcast function is supported, but it may operate differently to that on iPod or iPhone.
- “Made for iPod” and “Made for iPhone” mean that an electronic accessory has been designed to connect specifically to iPod or iPhone, respectively, and has been certified by the developer to meet Apple performance standards. Apple is not responsible for the operation of this device or its compliance with safety and regulatory standards.



- iPhone, iPod, iPod classic, iPod nano, and iPod touch are trademarks of Apple Inc., registered in the U.S. and other countries.
- To connect an iPod, first purchase a connection cord.
- For details on the iPod functions, see the iPod's instruction manual.
- For the iPod types (generations) supported by this unit, see “About the Supported iPods” on Page 266.
- Some of the functions may not be available when vehicle is in motion.

■ Playing an iPod

⚠ CAUTION

Connect the connection cord correctly so that it does not interfere with the safe operation of the vehicle.

- 1 Connect an iPod that contains music files to the iPod connector.
- 2 Press **AUDIO**.
- 3 Touch **iPod**.
 - The playback starts.



NOTE

- When the ignition switch is in the "ACC" or "ON" position, the battery of the connected iPod is charged. However, it may take some time until the iPod is turned on, depending on the remaining power in the battery.
- Disconnect headphones and other accessories from the iPod before connecting it to this unit. Failure to do so may make it impossible to operate the iPod from this unit.
- If the iPod's equalizer has been customized, the sound output may be distorted when it is connected to the optional dedicated connection cable.
- If this unit does not support the language used in the iPod, album names, titles, and artist names are displayed as blank.
- iPod may not be recognized in ACC OFF/ON. In this case, remove the iPod and reconnect it.
- When you connect your iPod, the music file starts playing from the previous position. Also, if you switch the power of the iPod off and on, the music file starts playing from the previous position. But if the unit cannot detect the file that was playing previously, it will start playing from the first file.
- If there are multiple music files stored on your iPod or iPhone, it may take some time until the playback starts.
- If the iPod is set to Shuffle Songs and is connected to this unit,  is not shown on the display.

■ Fast forwarding and fast reversing

You can fast forward or fast reverse the currently playing file.

1 Touch **⏮** or **⏭** for 1 second or more.



Fast forward the file.



Fast reverse the file.

Fast forward (or fast reverse) operates until you release your finger from the button.

■ Selecting a music file

You can select the music file that you want to play.

1 Touch **⏮** or **⏭**.



Advance to the next file.



Return to the start of the currently playing file.

⏮ (Press twice or more):

Return to the previous file.

The selected music file starts to play.

■ Finding a music file

1 Touch **iPod**.

2 Touch **Search** (Search).



3 To select a file or program to play, touch **Playlists** (Playlists), **Albums** (Albums), **Artists** (Artists), **Songs** (Songs) or **Others** (Others).

- The list screen for the selected mode appears.





- Touch **⏪** to return to the previous screen.









4 Touch the list that you want to use.

- The list order depends on the selection mode, as shown below.
 - Playlists:
Playlist screen → Music file screen
 - Albums:
Album screen → Music file screen
 - Artists:
Artist screen → Album screen → Music file screen
 - Songs:
Music file screen
 - Others:
Others screen → Genre screen → Artist screen → Album screen → Music file screen
 - Others screen → Program screen → Episode screen
 - Others screen → Book screen
 - Others screen → Composer screen → Album screen → Music file screen

5 Touch the music file that you want to play.

- The selected music file starts to play.
- Touch  or  on the scroll function to scroll the display pages of the music file list.
- Touch  or  on the index function to display in the list the names that start with the selected letter or number.
- Touch  to return to the previous screen.

■ Repeating the same music file

- Touch .
- Touch  (Settings).
- Touch  (On) in Repeat.
 - Repeat playback is set for the currently playing music file.
 - When you touch  (On), repeat is continued until you cancel it. Touch  (Off) to cancel the repeat playback.
 - When Repeat is canceled, repeat playback is performed for the list that is playing back.
 - Touch  to return to the previous screen.



NOTE

When On is selected in Repeat,  is displayed in the top right of the screen as confirmation that the function is on.

■ Playing music files randomly

Playing files from the current list randomly

- 1 Touch **iPod**.
- 2 Touch **Settings** (Settings).
- 3 Touch **Song** (Song) in Shuffle.
 - When you touch **Song** (Song), random playback is continued until you cancel it. Touch **Off** (Off) to cancel random playback.
 - Touch **X** to return to the previous screen.



NOTE

When the list random function is selected,  is displayed in the top right of the screen as confirmation that the function is on.

Playing albums randomly

You can play albums randomly. Note that the music files within the albums are played in order from the first.

- 1 Touch **iPod**.
- 2 Touch **Settings** (Settings).
- 3 Touch **Album** (Album) in Shuffle.
 - When you touch **Album** (Album), random playback is continued until you cancel it. Touch **Off** (Off) to cancel random playback.
 - Touch **X** to return to the previous screen.

NOTE

When the album random function is selected,  is displayed in the top right of the screen as confirmation that the function is on.

■ Playing the Shuffle Songs

You can play all the music files randomly.

1 Touch **iPod**.

2 Touch **Shuffle Songs** (Shuffle Songs).

- When you touch **Shuffle Songs** (Shuffle Songs), random playback is continued until you cancel it.



NOTE

When the all random function is selected, **X** is displayed in the top right of the screen as confirmation that the function is on.

■ Changing the audiobook playback speed

1 Touch **iPod**.

2 Touch **Settings** (Settings).

3 Touch **Slow** (Slow), **Normal** (Normal) or **Fast** (Fast) in **Audiobook Speed**.

- **Slow** (Slow):
Slow down the reading speed of the audiobook.
- **Normal** (Normal):
Set the reading speed of the audiobook to normal.
- **Fast** (Fast):
Speed up the reading speed of the audiobook.
- Touch **X** to return to the previous screen.

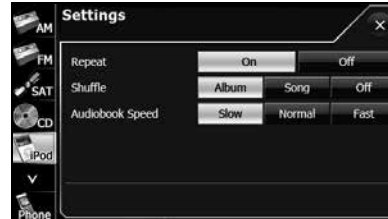

■ Scrolling title information

If the Album, Title or Artist information cannot be fully displayed because it is too long, you can scroll the display.

1 Touch on the item that you want to scroll.

- The selected title information scrolls to the left.
- Touch  to stop the scrolling and return to the start of the title.
- If driving is detected while the display is being scrolled, the scrolling stops and returns to the start of the title.
- When the end of the title information is displayed, the scrolling stops.

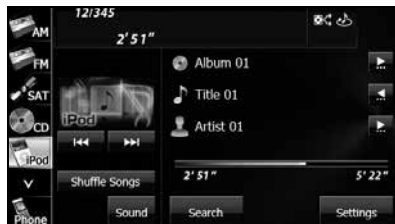

About the Supported iPods

This unit can be used with the following iPods.

Type	Generation	Firmware version or OS
iPod	5G	1.3
iPod nano	1G	1.3.1
	2G	1.1.3
	3G	1.1.3
	4G	1.0.4
	5G	1.0.2
iPod classic	1G	1.1.2
	2G (120 GB)	2.0.1
	2009 (160 GB)	2.0.4
iPod touch	1G	iOS 3.1.3
	2G	iOS 4
	Late 2009 (8 GB/16 GB)	iOS 4
	Late 2009 (32 GB/64 GB)	iOS 4
	3G	iOS 3.1.3
iPhone	1G (iPhone)	iOS 4
	2G (iPhone 3G)	iOS 4
	3G (iPhone 3GS)	iOS 4
	iPhone 4	iOS 4

NOTE

- Note that the warranty does not apply if an unsupported iPod is connected.
- The video playback function is not supported.

Using Bluetooth Audio

Before Using Bluetooth Audio

A Bluetooth-supporting portable audio player (“portable device” hereafter) can be used as a source for this unit by utilizing the Bluetooth wireless communication technology. To use a Bluetooth-supporting portable device with this unit, it is necessary to perform Bluetooth registration and connection settings.

- The Bluetooth-supporting portable device connected to the unit must be a portable device which supports the relevant Bluetooth specifications. For the Bluetooth specifications supported by this unit, see “About the Compatible Bluetooth-Supporting Devices” on Page 279.
- Bluetooth is a short-range wireless technology for connecting cell phones, computers and other such devices.



The Bluetooth® word mark and logos are registered trademarks owned by Bluetooth SIG, Inc. and any of such marks by FUJITSU TEN LIMITED is under license. Other trademarks and trade names are those of their respective owners.

- **For vehicles sold in the U.S.A.**

FCC ID: BABFT0021A

- This device complies with part 15 of the FCC Rules. Operation is subject to the following two conditions: (1) This device may not cause harmful interference, and (2) this device must accept any interference received, including interference that may cause undesired operation.

FCC WARNING

Changes or modifications not expressly approved by the party responsible for compliance could void the user's authority to operate the equipment.

CAUTION: Radio Frequency Radiation Exposure

This equipment complies with FCC radiation exposure limits set forth for uncontrolled equipment and meets the FCC radio frequency (RF) Exposure Guidelines in Supplement C to OET65. This equipment has very low levels of RF energy that it deemed to comply without maximum permissive exposure evaluation (MPE). But it is desirable that it should be installed and operated with at least 20cm and more between the radiator and person's body (excluding extremities: hands, wrists, feet and ankles).

Co-location: This transmitter must not be co-located or operated in conjunction with any other antenna or transmitter.

- **For vehicles sold in Canada**

IC: 2024B-FT0021A

- **English:**

Operation is subject to the following two conditions: (1) this device may not cause interference, and (2) this device must accept any interference, including interference that may cause undesired operation of the device.

- **Français:**

L'utilisation de ce dispositif est autorisée seulement aux deux conditions suivantes : (1) il ne doit pas produire de brouillage, et (2) l'utilisateur du dispositif doit être prêt à accepter tout brouillage radioélectrique reçu, même si ce brouillage est susceptible de compromettre le fonctionnement du dispositif.

CAUTION: Radio Frequency Radiation Exposure

This equipment complies with IC radiation exposure limits set forth for uncontrolled equipment and meets the RSS-102 of the IC radio frequency (RF) Exposure rules. This equipment has very low levels of RF energy that it deemed to comply without maximum permissive exposure evaluation (MPE). But it is desirable that it should be installed and operated with at least 20cm and more between the radiator and person's body (excluding extremities: hands, wrists, feet and ankles).

- This Category II radiocommunication device complies with Industry Canada Standard RSS-310.

Ce dispositif de radiocommunication de catégorie II respecte la norme CNR-310 d'Industrie Canada.

 **CAUTION**

- **The frequency band used by this unit is the same band that is used by industrial, scientific and medical devices such as microwave ovens, facility wireless stations used for identifying moving objects in factory production lines and other locations (wireless station that requires a license), special low output wireless stations (wireless station that does not require a license), and amateur radios (wireless station that requires a license). (The 3 types of wireless stations above are hereafter called "other wireless stations".) Before operating this unit, make sure that no "other wireless stations" are operating nearby. If the unit causes harmful radio wave interference in "other wireless stations", immediately change the location to stop the radio wave interference.**
- **The frequency band used by this unit is the 2.4 GHz band.**
- **The FH-SS modulation scheme is used.**
- **The estimated distance in which interference may occur is less than 10 m.**
- **This unit uses the full band, making it possible to avoid the band of devices that identify moving objects.**
- **This unit complies with the standards specified by the Radio Act and Telecommunications Business Act in Japan. The stickers attached to the product certify this. Do not remove the stickers.**
- **Disassembling or modifying this unit is punishable by law.**

NOTE

- This unit can be used with Bluetooth-supporting portable devices.
- For details of Bluetooth operations, see the portable device or cell phone instruction manual.
- Factors in the surrounding environment may negatively affect the connection status and prevent Bluetooth audio operations on the unit.
- BTA feature is subject to portable devices or cell phone compatibility.

■ Registering a portable device

You can register portable devices on this unit. Up to 5 portable devices can be registered on the unit. The order of registration precedence is always 1 to 5. When a portable device is added or deleted, the order of precedence is updated.

⚠ WARNING

Do not register a portable device while driving. Be sure to park the vehicle in a safe location and apply the parking brake before registering a device.

1 Press **AUDIO**.

2 Touch **Info**.

- If **Info** is not displayed, touch **∨**.

3 Touch **Bluetooth**.



4 Touch **Registered Devices** (Registered Devices).



5 Touch **Add New** (Add New).



6 Operate the portable device to enter the passcode (passkey) of the unit.

- The name of the unit is CAR MULTIMEDIA.
- The initial setting for the passcode (passkey) is 0000.
- Operate the portable device while the Registered Devices screen is displayed.

<Registered Devices screen>



7 When the registration is complete, "Connection Completed" appears.

- The portable device registration is complete.
- After the registration completed message is displayed, "Connection established successfully!" appears.

NOTE

- If the registration fails, "Connection failed." appears on the screen. If this happens, perform the registration operation again.
- For details of operations on the portable device, see the portable device's instruction manual.

■ Deleting a portable device registration

You can delete portable devices that are registered on the unit.

1 Press **AUDIO**.

2 Touch **Info**.

- If **Info** is not displayed, touch **∇**.

3 Touch **Bluetooth**.

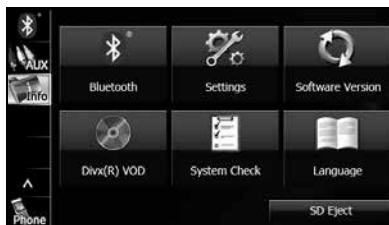

4 Touch **Registered Devices** (Registered Devices).



5 Select the portable device that you want to delete.



6 Touch **Delete** (Delete).

- “Are you sure you want to delete this device?” appears on the screen. Touch **Yes** (Yes) or **No** (No).

7 After touching “Yes”, when the deletion is complete, “Completed” appears.

- The portable device deletion is complete.

■ Connecting a portable device

You can connect portable devices that are registered on the unit.

- Make the preparations necessary for connecting to the unit, for example by setting the portable device's Bluetooth standby to On. For details of operations on the portable device, see the portable device's instruction manual.

1 Press **AUDIO**.

2 Touch **Info**.

- If **Info** is not displayed, touch **∨**.

3 Touch **Bluetooth**.



4 Touch **Connect Portable Player** (Connect Portable Player).



5 Select the portable device that you want to connect.

- The Bluetooth mark is displayed for portable devices with an active Bluetooth connection.



6 Touch **Connect** (Connect).

- The connection screen appears.

7 When the connection is complete, "Connection Completed" appears.

- The connection between the portable device and the unit is complete.

NOTE

- If the connection fails, "Connection failed." appears on the screen. If this happens, perform the connection operation again.
- Connection is not possible if no portable devices are registered.
- On the Connect Portable Player screen, touch **Add New** (Add New) to register a portable device.

■ Canceling a portable device connection

- 1 Press **AUDIO**.
- 2 Touch **Info**.
 - If **Info** is not displayed, touch **∨**.
- 3 Touch **Bluetooth**.



- 4 Touch **Connect Portable Player** (Connect Portable Player).



- 5 Select the portable device with the connection that you want to cancel.



- 6 Touch **Disconnect** (Disconnect).
 - “Another device is already connected. Do you want to disconnect this device?” appears. Touch **Yes** (Yes) or **No** (No).
- 7 After touching “Yes”, when the cancelation is complete, “Connection with the mobile telephone was disconnected.” appears.
 - The cancelation of the portable device connection is complete.

Using a Portable Device

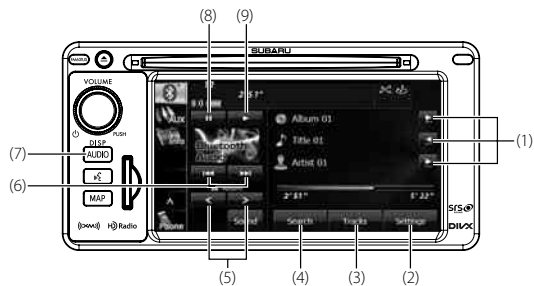

- (1) Title information scroll buttons *1 *2
- (2) Settings button
- (3) Tracks button *1
- (4) Search button *1
- (5) Album selection buttons *1
- (6) Track up/down and fast forward (fast reverse) buttons *1
- (7) AUDIO button
- (8) Pause button
- (9) Play button

*1 May not be displayed, and operations may not function depending on the portable device type.

*2 It will be displayed if the length of the information is too long and it cannot be displayed.

NOTE

Some of the functions may not be available when vehicle is in motion.

■ Listening to a portable device

1 Press .

2 Touch .

3 Touch .

- The playback starts on the connected portable device.



NOTE

If the playback does not start when you touch  on the unit, press the play button on the portable device.

■ Pausing the playback

1 Touch **⏸**.

- To start the playback again, touch **▶**.



■ Selecting a track

1 Touch **⏮** or **⏭**.

- **⏭**: Advance to the next track.
- **⏮** (Once): Return to the start of the currently playing track.
- **⏮** (Twice or more): Return to the previous track.

■ Selecting a music album

1 Touch **➤** or **➤**.

- **➤**: Advance to the next music album.
- **➤**: Return to the previous music album.

■ Fast forwarding and fast reversing

1 Touch **⏩** or **⏪** for 1 second or more.

- **⏩**: Fast forward the track.
 - **⏪**: Fast reverse the track.
- Fast forward (or fast reverse) operates until you release your finger from the button.

■ Finding a music album

1 Touch **Search** (Search).



2 Touch the music album that you want to play.

- The selected music album starts to play.
- Touch ▲ or ▼ on the scroll function to scroll the display pages of the music track screen.
- Touch ↶ to return to the previous screen.



■ Finding a music track

1 Touch **Tracks** (Tracks).



2 Touch the music track that you want to play.

- The selected music track starts to play.
- Touch ▲ or ▼ on the scroll function to scroll the display pages of the music album screen.
- Touch ↶ to return to the previous screen.



■ Scrolling title information

If the Album, Title or Artist information cannot be fully displayed because it is too long, you can scroll the display.

1 Touch  on the item that you want to scroll.

- The selected title information scrolls to the left.
- Touch  to stop the scrolling and return to the start of the title.
- If driving is detected while the display is being scrolled, the scrolling stops and returns to the start of the title.
- When the end of the title information is displayed, the scrolling stops.



■ Various portable device settings

WARNING

Do not set a portable device while driving. Be sure to park the vehicle in a safe location and apply the parking brake before performing the settings.

1 Touch **Settings** (Settings).



2 On the portable device Settings screen, you can perform the following settings by touching the setting buttons for each item.

- Portable device settings screen

Item	Function
Repeat	Set repeat playback to on or off.
Random	Set random playback to on or off.
Bluetooth	Set the Bluetooth function to on or off.
Auto Connect	Set automatic connection between a portable device and the unit to on or off.
Connection	Display the Connect Portable Player screen to register a portable device or perform the connection settings. (See Page 271.)

- Touch **X** to return to the previous screen.



Repeat setting

Set the repeat function to on or off.

- 1 Touch **On** (On) or **Off** (Off).

NOTE

When On is selected in Repeat,  is displayed in the top right of the screen as confirmation that the function is on.

Random setting

Set the random function to on or off.

- 1 Touch **On** (On) or **Off** (Off).

NOTE

When On is selected in Random,  is displayed in the top right of the screen as confirmation that the function is on.

Bluetooth setting

Set the Bluetooth function to on or off.

- 1 Touch **On** (On) or **Off** (Off).

Auto Connect setting

Set automatic connection between a registered portable device and the unit.

- 1 Touch **On** (On) or **Off** (Off).

About the Compatible Bluetooth-Supporting Devices

.....

The following Bluetooth-supporting portable audio devices can be used.

Specification	<ul style="list-style-type: none">• Bluetooth Specification Ver. 1.1 or higher (Ver. 2.0 + EDR or higher is recommended)
Profile	<ul style="list-style-type: none">• A2DP (Advanced Audio Distribution Profile) Ver. 1.0 or higher• AVRCP (Audio/Video Remote Control Profile) Ver. 1.0 or higher (Ver. 1.4 or higher is recommended)

NOTE

The available functions may vary depending on the type of Bluetooth audio device.

Using AUX

Using AUX

When you connect a device such as a commercially available portable audio device to the AUX (RCA) connector, you can use this unit to play music recorded on the portable audio device.

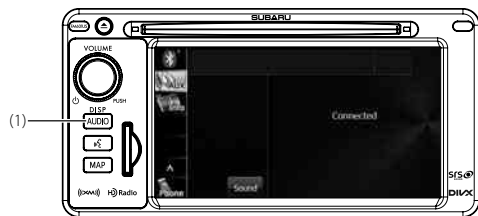

(1) AUDIO button

NOTE

- To connect a portable audio device, first purchase a connection cord.
- Before using a portable audio device with this unit, be sure to read the instruction manual of the portable audio device carefully to make sure that there will be no problems when using it with the unit.

■ Using AUX to listen to music

⚠ CAUTION

Connect the connection cord correctly so that it does not interfere with the safe operation of the vehicle.

- 1 Connect a commercially available portable audio device and start playback.
- 2 Press **AUDIO**.
- 3 Touch **AUX**.
 - The AUX screen appears, and the sound of the portable audio device playback is output from the speakers.

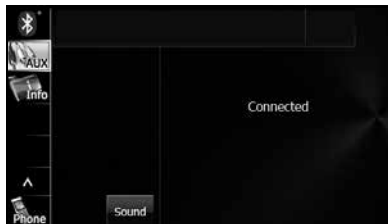

NOTE

For details of operations on the portable audio device, see the portable audio device's instruction manual.



Others



Other Operations

Picture Function Operations

Using the Picture Function

.....

If you insert an SD memory card that contains image data, you can play a slide show of the images, or set an image as the Opening screen.

⚠ CAUTION

Before inserting an SD memory card that contains image data, touch **SD Eject** (SD Eject) and remove the map SD card. Removing the card without first touching **SD Eject** (SD Eject) may damage the data. No compensation will be given for any damaged data. (See Page 18.)

NOTE

Some of the functions may not be available when vehicle is in motion.



■ Displaying the picture operations screen

1 Insert a different SD memory card that contains image data. (See Page 16.)

2 Display the picture operations screen.



- **Menu** (Menu):
You can display a picture list or set a slide show.
- **◀◀**:
Display the previous image.
- **▶▶**:
Display the next image.
- **▶** (or **||**):
The slide show starts. Touch **||** to stop the slide show.
- **Start-up Screen** (Start-up Screen):
Register the displayed image data as the “Customized” opening screen setting.

- : Display the Audio/Multi screen. To display the picture operations screen again, touch .
 - Touch the screen to show only the image on the display. To display the picture operations screen again, touch the screen.
- <Picture screen display>



■ Replacing the Opening screen with your own image data

You can register image data (1 picture only) imported from an SD memory card as the “Customized” opening screen setting.

- 1 Insert an SD memory card that contains the image data. (See Page 16.)

- 2 Display the image that you want to set and touch **Start-up Screen** (Start-up Screen).



- 3 “Are you sure to overwrite the start-up screen?” appears on the screen. Touch **Yes** (Yes).
 - The picture is registered as the “Customized” opening screen setting.

■ Selecting an image file from the picture list

You can select the image file that you want to view from a folder.

1 On the picture operations screen, touch **Menu** (Menu).

2 Touch **Search** (Search) in Picture.

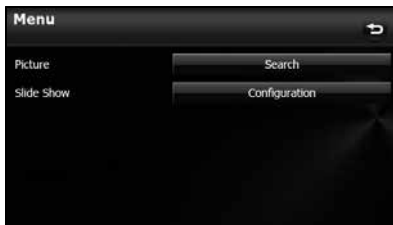

3 Touch the folder that you want to use.

- If there are more pages, touch ▲ or ▼ to scroll the pages.
- Touch ⏪ to return to the previous screen.



4 Touch the file that you want to view.

- The selected file is displayed. Touch the displayed image to show it in a Picture screen display.
- If there are more pages, touch ▲ or ▼ to scroll the pages.
- Touch ⏪ to return to the previous screen.

■ Slide show setting

On the Slide Show Configuration screen, you can set a slide show.

1 On the picture operations screen, touch **Menu** (Menu).

2 Touch **Configuration** (Configuration) in Slide Show.

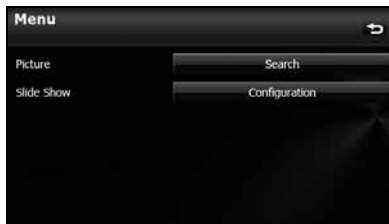

- 3** You can perform the following settings by touching the setting buttons for each item.



Interval setting

You can change the display interval of the slide show.

- 1** Touch **+** or **-**.
- 5 sec ↔ 10 sec ↔ 15 sec

Pattern setting

You can change the pattern of the slide show.

- 1** Touch **<** or **>**.
- Standard ↔ Effect 1 ↔ Effect 2 ↔ Effect 3 ↔ Effect 4 ↔ Random
↔ Standard ↔ ...

About the Supported Image Data

About the supported image file standards

- Supported standards:
jpg (does not support jpg2000)
- Supported file names:
Supports single-byte characters (alphanumerics, symbols, kana) and double-byte characters (alphanumerics, symbols, Chinese characters, kana)
- Supported character code:
UNICODE
- Number of characters that can be displayed:
30 single-byte characters, 15 double-byte characters (+.jpg)
 - * Only single-byte numbers, single-byte letters (upper case), "_", (underscore), symbols, Chinese characters (not all Chinese characters can be displayed)
 - * Although more than 30 single-byte characters can be read, only 30 characters are displayed.
 - * The .jpg extension is not displayed.
- Image data size:
10 MB or less (per file)
- Number of images that can be imported from an SD memory card:
500

<A configuration example of an jpg-supporting SD memory card>

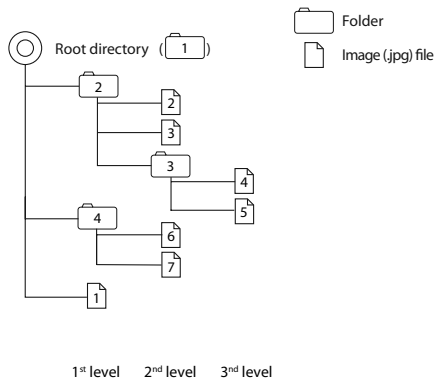
**NOTE**





- When the image size is larger than horizontal 400 × vertical 234 dots, the original image is compressed to the standard size before display. The areas without an image are displayed as black bars.
- When the image size is smaller than horizontal 400 × vertical 234 dots, the image is displayed at the center of the display without changing the image size.

About Steering Wheel Switches

You can use these buttons to perform the main audio controls and other operations.

Compatibility with Steering Wheel Buttons

The table below shows the compatibility between the steering wheel buttons and this unit.







Operation	Button	Name	Function	Explanation of operation
Common operations	(+)	Volume button	When these buttons are pressed briefly, the volume changes by 1 step. When these buttons are pressed and held, the volume changes continuously.	(+): Increases the volume (in BT-TEL mode, the ringtone volume, call volume and readout volume or in voice recognition mode, the guidance volume).
	(-)			(-): Decreases the volume (in BT-TEL mode, the ringtone volume, call volume and readout volume or in voice recognition mode, the guidance volume).
	(MODE)	Mode selection button	<ul style="list-style-type: none"> When this switch is pressed while the power is off, the power turns on. The mode changes in the following order. FM → SAT → DISC* (CD, MP3/WMA) → USB/iPod* → BT-Audio* → AUX* → AM → returns to FM. Ends voice recognition. 	<p>When the power is on, the mode changes each time (MODE) is pressed.</p> <p>Cannot be operated while making a calling, receiving a call, or talking in BT-TEL mode.</p> <p>On the voice recognition mode, press and hold (MODE) to end voice recognition.</p>
		Voice recognition trigger	<ul style="list-style-type: none"> Starts voice recognition. Skips guidance voice, talkback voice, or help voice. Ends voice recognition. 	<p>Press  briefly to start voice recognition.</p> <p>Press  during guidance voice, talkback voice, or help voice to skip the audio.</p> <p>Hold down  during voice recognition to close the voice recognition screen.</p> <p>Press  during voice recognition to close the voice recognition screen.</p>

Other Operations

Operation	Button	Name	Function	Explanation of operation
AM / FM (HD included) radio operations	(\wedge)	Channel selection buttons	<ul style="list-style-type: none"> • Selects in order the stations saved in the memory. • Selects automatically the channel closest to the currently received frequency. • Selects in order the stations in the station list. 	Press (\wedge) or (\vee) briefly to select the stations in order. Press and hold (\wedge) or (\vee) to start the automatic station selection operation. Keep pressing (\wedge) or (\vee) to start SEEK to search a frequency quickly. The nearest broadcasting station from the frequency where the button was released can be received.
	(MODE)			
SAT radio operations	(\wedge)	Channel selection buttons	<ul style="list-style-type: none"> • Selects in order the channels saved in the memory. • Selects automatically the channel closest to the currently received frequency. • Selects in order the channels in the station list. 	Press (\wedge) or (\vee) briefly to select the channels in order. Press and hold (\wedge) or (\vee) to start the automatic channel selection operation. Keep pressing (\wedge) or (\vee) to start SEEK to search a frequency quickly. The nearest broadcasting channel from the frequency where the button was released can be received.
	(MODE)			
CD player operations*1	(\wedge)	Track selection buttons	<ul style="list-style-type: none"> • Selects the next track, previous track, or start of the current track. • Fast forwarding or fast reversing 	Press (\wedge) or (\vee) briefly to select the next or previous track. Press and hold (\wedge) or (\vee) to fast forward or fast reverse the track.
	(MODE)			

Operation	Button	Name	Function	Explanation of operation
MP3/WMA player operations* ¹	(∧) (∨)	File selection buttons	<ul style="list-style-type: none"> • Selects the next file, previous file, or start of the current file. • Selects the next or previous folder. 	<p>Press (∧) or (∨) briefly to select the next or previous file.</p> <p>Press and hold (∧) or (∨) to select the next or previous folder.</p>
	(MODE)	Mode selection button	Pauses or plays.	Press and hold to pause or play.
USB operations* ¹	(∧) (∨)	File selection buttons	<ul style="list-style-type: none"> • Selects the next file, previous file, or start of the current file. • Selects the next or previous folder. 	<p>Press (∧) or (∨) briefly to select the next or previous file.</p> <p>Press and hold (∧) or (∨) to select the next or previous folder.</p>
	(MODE)	Mode selection button	Pauses or plays.	Press and hold to pause or play.
iPod and BT-Audio operations* ¹	(∧) (∨)	Track selection buttons	<ul style="list-style-type: none"> • Selects the next track, previous track, or start of the current track. • Fast forwarding or fast reversing 	<p>Press (∧) or (∨) briefly to select the next or previous track.</p> <p>Press and hold (∧) or (∨) to fast forward or fast reverse the track.</p>
	(MODE)	Mode selection button	Pauses or plays.	Press and hold to pause or play.
AUX operations* ¹	(MODE)	Mode selection button	Mutes or cancels the mute.	Press and hold to mute or cancel the mute.

Other Operations

Operation	Button	Name	Function	Explanation of operation
BT-TEL operations*1		On Hook	<ul style="list-style-type: none"> Ending a call. Canceling a call. Refuse the incoming call. Holding the incoming call.*2 	<p>Press  briefly to end a call or cancel a call.</p> <p>Press and hold  to end the all call.</p> <p>When in incoming call, press  briefly to hold the incoming call.</p>
		Off Hook	<ul style="list-style-type: none"> Selects the telephone mode. Making a call. Receiving the incoming call. Connecting the call on hold. 	<p>Press  briefly to make or receive a call. When in a different mode, changes to the telephone mode.</p> <p>On the incoming call on hold, press  briefly to receive a call.</p>
	(MODE)	Mode selection button	Mutes or cancels the mute.	Press and hold to mute or cancel the mute.

*1 Enabled only when operation is possible

*2 The Holding function is only available on the operation on the cell phone side.

Voice Control System Operations

About the Voice Control System

.....

By using the voice control system (voice input microphone and button), you can perform navigation and audio operation by saying voice commands. This enables you to use functions that are usually inoperable while driving.

The voice control system may not recognize the voice command if you do not say it correctly.

Be aware of the following points that will assist correct recognition.

- Speak after you hear the “beep”. If you speak before or at the same time as the “beep”, your command will not be recognized.
- Speak in a loud and clear voice.
- Some voices may be difficult to recognize.
- Keep the windows closed as much as possible while speaking. Noise such as wind or other external sounds may prevent correct recognition. Also, if the air conditioner fan is too loud, it may prevent correct recognition.
- The system does not support regional variations or alternative phrases. Be sure to say the specified phrases.

Under the following conditions, the voice recognition mode will be turned off:

- Within 8 seconds after guidance, talkback or help voice finishes playing, no voice is recognized.
(When the screen is operated, counting of 8 seconds starts again after the screen is touched.)
- The button is pressed and held.
- The Steering button or Hard button (excluding the Voice Recognition button) is pressed.
- A call is received.

NOTE

When voice recognition is started, the current audio output is muted or paused.

Using the Voice Control System

When the voice control system is activated, you may speak the controls displayed on the screen, or you may touch the corresponding button.

NOTE



For the following instructions found in this manual, we will use "000" as a placeholder for the command text available on your actual system. "000" is only for demonstration purposes.

1 Press .

- The screen changes to the Main Menu.

"Voice recognition on" mark



-  000 :
"000" or touch the button.
-  000 :
Operate by saying "000".

2 After the "Voice command please." voice guidance, a "beep" sounds.



3 Say the operation command.

- After you hear the "beep", speak or operate the screen while a "recognition mark (green-faced icon)" is displayed (within approx. 8 seconds).
- If you said the wrong command or the recognition result is incorrect, cancel the operation by saying "Cancel" after the talkback voice finishes playing.



- When the  button is pressed while guidance voice, talkback voice or help voice is being played, you can skip the voice guidance.
- When you say "Help" while the Main Menu is displayed, a list of the currently usable commands appears on the screen.

NOTE

A caution display appears after pressing  (Main Unit/Steering Wheel Switch) while a Bluetooth device, USB device or iPod is connected, and the stored data is being read. Be sure to start the operation after the caution display disappears.



Displaying the Command List

You can display a list of the usable commands on the screen.

1 Press .

- The screen changes to the Main Menu, and after the "Voice command please." voice guidance, a "beep" sounds.

2 Say "Help".

- The command list appears.
- If there are more pages, touch  or  to scroll the list.



- **Change** (Change):
Display the next page of the command list.
- **AV Operation** (AV Operation):
Display the command list for the current audio operation. (Only when an audio source is being used.)
- **AV Source** (AV Source):
Display the audio source command list.
- **Phone** (Phone):
Display the handsfree operation command list. (Only during handsfree connection.)
- **Navigation** (Navigation):
Display the navigation operation command list.

3 Check the command that you want to use in the command list.

- You can perform the operation by saying the displayed command.

Examples of Using the Voice Control System

.....

This section describes examples of operating the voice control system. For the voice commands, see "Voice Command Lists" on Page 298.

The notations used in the commands are as follows.

- <OOO>: Commands to be spoken
- → OOO: Names to be spoken

■ Changing the audio mode

1 Perform a voice input for the audio mode to which you want to change. (USB in this example.)

- Say "USB".
- The mode changes to USB.

■ Changing the radio frequency

1 Say "Seek up".

- The current frequency switches to the next receivable frequency.
- Saying "Seek down" switches the current frequency to the previous receivable frequency.

■ Changing the preset channel

1 Say "Preset 1".

- The current frequency switches to the frequency registered in the preset channel 1.
- Up to 6 preset channels can be changed.

■ Changing the frequency

(AM radio frequency is used as an example of changing frequencies.)

1 Say "Frequency 522".

- The current frequency switches to 522 kHz.
- For the rules of frequencies, see "Radio Frequency Lists" on Page 316.

■ Changing the channel

1 Say "Channel 100".

- The current channel switches to 100 ch.
- For the rules of channels, see "XM Channel Lists" on Page 320.

■ Changing the currently playing track

1 Say "Track up".

- The playback changes to the next track.
- Say "Track down" to change the playback to the previous track or start of the track.

■ Changing the currently playing track number

1 Say "Track 1".

- The currently playing track number switches to track 1.

■ Calling the list screen

1 Say "Show list".

- The screen changes to the list screen.

■ Changing the currently playing folder

1 Say "Folder up".

- The playback changes to the start of the next folder.
- Say "Folder down" to change the playback to the start of the previous folder.

■ Specifying a folder

(Switching USB folders)

1 Say "Folder".

- After you hear "Folder" spoken back to you, the current mode changes to the folder specification mode.
(The screen also changes.)

2 After the voice guidance, say the name of the folder that you want to play.

- Starting from the first track of the specified folder, all tracks in the folder will be switched from one to the next after your voice command.
- * iPod mode allows you to specify the desired music track from artist, genre or playlist.
- * A maximum of 1000 music tracks can be specified (when specifying from genre or playlist, a maximum of 100).

■ Making a call with the phone book

1 Say "Phone".

- After you hear "Hands-Free" spoken back to you, the current mode changes to the hands-free menu mode.
(The screen also changes.)

2 After the voice guidance, say "Call <Name>".

- If there are multiple candidates, follow the voice guidance and say a list number.
- If there are multiple telephone numbers, follow the voice guidance and say a location.
- Under the following conditions, some of registered names and telephone numbers will be deleted from the multiple candidates.
 - When multiple registered names of completely identical characters are found, the first name to be found will be the candidate.
 - When there are multiple identical locations registered in one phone book, the first location to be found will be the candidate.

3 After notifying the name of the person you want to call by the voice guidance, if you hear the name of the right person spoken back to you, say "Yes".

- A call is made to the selected person's telephone number.
- If the name of the selected person is wrong, say "No".

■ Using the speed dial to make a call

- 1 Say "Hands-Free".**
 - After you hear "Hands-Free" spoken back to you, the current mode changes to the hands-free menu mode.
(The screen also changes.)
- 2 Say "Speed Dial 1".**
 - The candidate registered in the Speed Dial 1 will be selected.
- 3 After notifying the number of the Speed Dial by the voice guidance, if you hear the name of the right person spoken back to you, say "Yes".**
 - A call is made to the selected Speed Dial number.
 - If the number of the selected Speed Dial is wrong, say "No".

■ Using the Dial to make a call

- 1 Say "Hands-Free".**
 - After you hear "Hands-Free" spoken back to you, the current mode changes to the hands-free menu mode.
(The screen also changes.)
- 2 Say "Dial".**
 - After you hear "Dial" spoken back to you, the current mode changes to the dial calling mode.
- 3 Say "123" (dial number).**
 - The dial calling mode allows you to say the desired dial number with any number of digit at a time.
- 4 Notify "123" by voice command.**
 - When adding a dial number, speak the number you want to add as in step 3.
(Notify the added dial number by voice command.)
 - When you dial the wrong number, speak "Delete" to delete the digits of the number that you spoke last.
(After the delete, notify all of the remaining dial number.)
- 5 Say "Call".**
 - A call is made to the selected dial number.

Voice Command Lists

The navigation or audio control function enables you to operate the navigation or audio system by voice, using the voice input microphone and button. This section shows the voice command lists for voice control operations.

The notations used in the commands are as follows.

- [○○○]: Commands that need not to be spoken
- <○○○>: Numbers or names to be spoken
- →○○○: Commands to be spoken after the voice guidance

■ Commands for changing the audio mode

Enabled in all screens.

Voice command	Phrase	Function
AM	[Play] AM	Sets to AM mode
FM	[Play] FM	Sets to FM mode
SAT	[Play] Satellite radio	Sets to SAT mode
CD*	[Play] CD	Sets to CD mode
USB*	[Play] USB	Sets to USB mode
iPod*	[Play] iPod	Sets to iPod mode
BTA	[Play] Bluetooth audio , [Play] BTA	Sets to Bluetooth audio mode
AUX*	[Play] Auxiliary , [Play] ox , [Play] AUX	Sets to AUX mode
Audio OFF	Audio off	Turns the audio system off

Voice command	Phrase	Function
Radio	Radio	Sets to radio mode (Changes to the last mode used: FM, AM, or satellite radio.)

* Enabled only when operation is possible

■ Command for changing to the handsfree mode

Enabled in all screens.

Voice command	Phrase	Function
Phone	Handsfree, Phone	Sets to handsfree mode

■ Command for changing to the navigation mode

Enabled in all screens.

Voice command	Phrase	Function
Navigation	Navigation	Changes to the Navigation screen

■ Commands available with AM radio

Enabled when the audio mode is AM radio.

Voice command	Phrase	Function
Seek up	Seek up	Tunes in the higher frequency direction
Seek down	Seek down	Tunes in the lower frequency direction
AM frequency	Frequency <Frequency>	Tunes using a frequency
AM preset number	Preset <Number>	Tunes using a preset number

■ Commands available with FM radio

Enabled when the audio mode is FM radio.

Voice command	Phrase	Function
Seek up	Seek up	Tunes in the higher frequency direction
Seek down	Seek down	Tunes in the lower frequency direction
FM frequency	Frequency <Frequency>	Tunes using a frequency
FM preset number	Preset <Number>	Tunes using a preset number
FM	FM	Changes the band

■ Commands available with SAT radio

Enabled when the audio mode is SAT radio.

Voice command	Phrase	Function
SAT search channel	Channel <Number>	Tunes using a channel number
SAT preset number	Preset <Number>	Tunes using a preset number
Search type	Type <pop, rock, classical, more music channels, latin & world, dance & electronic, jazz, blues & standards, christian, country, hip-hop, r & b, sports, talk, news & npr, entertainment, family & health, religion, comedy, traffic & weather>	Tunes using a type
SAT	Satellite radio	Changes the band

* Some commands may not be recognized depending on the convenience of SAT radio station.

■ Commands available with CD operation

Enabled when the audio mode is CD.

Voice command	Phrase	Function
Track up	Next track, Track up	Selects the next track
Track down	Previous track, Track down	Selects the current track (cues)
Show list	Show list	Displays the list screen
Track number	Track <Number>	Selects using a track number

■ Commands available with MP3/WMA and Bluetooth audio

Enabled when the audio mode is MP3/WMA or Bluetooth audio.

Voice command	Phrase	Function
Track up	Next track, Track up	Selects the next track
Track down	Previous track or Track down	Selects the current track (cues)
Folder up	Next folder, Folder up	Plays from the start of the next folder
Folder down	Previous folder, Folder down	Plays from the start of the previous folder
Show list	Show list	Displays the list screen

■ Commands available with USB

Enabled when the audio mode is USB.

Voice command	Phrase	Function
Track up	Next track, Track up	Selects the next track
Track down	Previous track, Track down	Selects the current track (cues)
Folder up	Next folder or Folder up	Plays from the start of the next folder
Folder down	Previous folder, Folder down	Plays from the start of the previous folder
Show list	Show list	Displays the list screen
Search folder	Folder → <Folder Name>	Searches for a folder

■ Commands available with iPod

Enabled when the audio mode is iPod.

Voice command	Phrase	Function
Track up	Next track, Track up	Selects the next track
Track down	Previous track, Track down	Selects the current track (cues)
Folder up	Next folder or Folder up	Plays from the start of the next playlist
Folder down	Previous folder, Folder down	Plays from the start of the previous playlist
Show list	Show list	Displays the list screen
Search artist	Artist → <Artist Name>	Searches using an artist
Search genre	Genre → <Genre Name>	Searches using a genre
Search playlist	Playlist → <Playlist Name>	Searches using a playlist
Shuffle On/Off	Shuffle	Plays randomly

■ Commands available in handsfree mode

Enabled when the audio mode is handsfree.

Voice command	Phrase	Function
Call name	Call <Phone Name> → <1~3> → <Home, Work, Mobile, Other> → <Yes, Yeah, Yep>, <No, Nope>	Makes a call by using the phone book
Call name location	Call <Phone Name> <Home, Work, Mobile, Other> → <Yes, Yeah, Yep>, <No, Nope>	Makes a call by using the phone book and specifying a location
Speed dial	Speed dial → <Number> → <Yes, Yeah, Yep>, <No, Nope>	Makes a call by using the Speed dial list
	Speed dial <Number> → <Yes, Yeah, Yep>, <No, Nope>	Makes a call by specifying a speed dial number
History	History → Outgoing [Call], Incoming [Call] → <Number> → <Yes, Yeah, Yep>, <No, Nope>	Makes a call by using the call history

Voice command	Phrase	Function
Dial number	Dial <Number(0~9, Plus, Hash or Star)> → Call, Delete	Makes a call by entering a telephone number
	Dial [Number] → <Number(0~9, Plus, Hash, Star)> → Call, Delete	
Redial	Redial → <Yes, Yeah, Yep>, <No, Nope>	Makes a call by using the outgoing call history

- If there are multiple candidates in the phone book, up to 3 are read out in a list.
- If there are multiple names that match exactly, the first candidate to be found is read out.
- If there are locations of the same name in the phone book, the first candidate to be found is read out.

■ Commands available in navigation mode

Enabled when the audio mode is navigation.

NOTE

- Do not press  (Main Unit/Steering Wheel Switch) without pressing the "I Agree" button on the Caution screen. Otherwise, Navigation commands cannot be used.

Quick Commands

Voice command	Phrase	Function
Accommodation*	Accommodation	Narrows down POI search targets to accommodations
Accommodation along route	Accommodation along route	Searches for accommodations along the route
Accommodation at my destination	Accommodation at my destination	Searches for accommodations around the destination
Accommodation near here	Accommodation near here	Searches for accommodations around the current position
Address	Address	Transits to the screen that allows you to search for the destination by reading the address
Avoid	Avoid	Transits to the screen that allows you to set detour routes
Delete route	Delete route	Deletes the route that has been set
Favorite	Favorite	Selects the conditions to set the destination from your favorite spots
Find	Find	Transits to the destination search screen
Help	Help	Transits to the voice recognition mode's help screen

Other Operations

Voice command	Phrase	Function
History	History	Sets the destination from the search history results
Info	Info	Reads the route information that has been set (after the voice recognition mode is turned off)
More	More	Transits to the information list reception screen
Parking*	Parking	Narrows down POI search targets to parking lots
Parking along route	Parking along route	Searches for parking lots along the route
Parking at my destination	Parking at my destination	Searches for parking lots around the destination
Parking near here	Parking near here	Searches for parking lots around the current position
Place	Place	Selects POI search as the destination search method (POI search method searches only for petrol stations, accommodations, parking lots and restaurants.)
Gas station*	Gas station	Narrows down POI search targets to gas stations
Gas station along route	Gas station along route	Searches for gas stations along the route
Gas station at my destination	Gas station at my destination	Searches for gas stations around the destination
Gas station near here	Gas station near here	Searches for gas stations around the current position

Voice command	Phrase	Function
Restaurant*	Restaurant	Narrows down POI search targets to restaurants
Restaurant along route	Restaurant along route	Searches for restaurants along the route
Restaurant at my destination	Restaurant at my destination	Searches for restaurants around the destination
Restaurant near here	Restaurant near here	Searches for restaurants around the current position
Route	Route	Transits to the route editing screen
Where am i	Where am i	Displays the vehicle position information

* Searches for candidates close to your vehicle's position.

Full Commands

Voice command	Phrase	Function
Accept	Accept	Accepts questions (such as talkback)
Accommodation along route	[<i>Find , Go to , Search for , Look for</i>][<i>a , an</i>] Accommodation [<i>along , around , near , on</i>][<i>the</i>] route	Searches for accommodations along the route
	[<i>Find , Go to , Search for , Look for</i>][<i>a , an</i>] Hotel [<i>along , around , near , on</i>][<i>the</i>] route	
	[<i>Find , Go to , Search for , Look for</i>][<i>a , an</i>] Motel [<i>along , around , near , on</i>][<i>the</i>] route	
	[<i>Find , Go to , Search for , Look for</i>][<i>a , an</i>] Guest house [<i>along , around , near , on</i>][<i>the</i>] route	
Accommodation at my destination	[<i>Find , Go to , Search for , Look for</i>][<i>a , an</i>] Accommodation [<i>at , near</i>][<i>my , the</i>] destination	Searches for accommodations around the destination
	[<i>Find , Go to , Search for , Look for</i>][<i>a , an</i>] Hotel [<i>at , near</i>][<i>my , the</i>] destination	
	[<i>Find , Go to , Search for , Look for</i>][<i>a , an</i>] Motel [<i>at , near</i>][<i>my , the</i>] destination	
	[<i>Find , Go to , Search for , Look for</i>][<i>a , an</i>] Guest house [<i>at , near</i>][<i>my , the</i>] destination	

Voice command	Phrase	Function
Accommodation near here	[<i>Find , Go to , Search for , Look for</i>] [<i>an</i>] Accommodation [<i>near</i>] here	Searches for accommodations around the current position
	[<i>Find , Go to , Search for , Look for</i>] [<i>an</i>] Accommodation nearby	
	[<i>Find , Go to , Search for , Look for</i>] [<i>an</i>] Accommodation around here	
	[<i>Find , Go to , Search for , Look for</i>] [<i>an</i>] Accommodation in the <neighborhood, vicinity, area>	
	[<i>Find , Go to , Search for , Look for</i>] [<i>an</i>] Hotel [<i>near</i>] here	
	[<i>Find , Go to , Search for , Look for</i>] [<i>an</i>] Hotel nearby	
	[<i>Find , Go to , Search for , Look for</i>] [<i>an</i>] Hotel around here	
	[<i>Find , Go to , Search for , Look for</i>] [<i>an</i>] Hotel in the <neighborhood, vicinity, area>	
	[<i>Find , Go to , Search for , Look for</i>] [<i>an</i>] Hotel around here	
Accommodation*	[<i>Find , Go to , Search for , Look for</i>] Accommodation	Narrows down POI search targets to accommodations
	[<i>Find , Go to , Search for , Look for</i>] [<i>a</i>] Motel	
	[<i>Find , Go to , Search for , Look for</i>] [<i>a</i>] Hotel	
Address	[<i>Find , Go to , Search for , Look for</i>] [<i>an</i>] Address	Transits to the screen that allows you to search for the destination by reading the address
Along route	Along route	Narrows down the selected POI search candidates to places along the route
	On route	
	On the way	
	Along the way	
At my destination	[<i>At , Near , Close to , Around</i>] [<i>my , the</i>] Destination	Narrows down the selected POI search candidates to places around the destination

Other Operations

Voice command	Phrase	Function
Avoid	Avoid	Transits to the screen that allows you to set detour routes
	Bypass	
Back	Back	Transits to the previous screen
Bottom	[<i>Go</i> , <i>Jump</i> , <i>Move</i> , <i>Scroll</i>] [<i>to</i>] [<i>the</i>] Bottom	Transits to the bottom of the list
Cancel	Cancel	Exits from the voice recognition mode and transits to the map, main or other menu.
Change city	Change [<i>the</i>] city	Changes the city name in the address currently being recognized (in the voice recognition mode)
	Change [<i>the</i>] town	
Change house number	Change [<i>the</i>] house number	Changes the house number in the address currently being recognized (in the voice recognition mode)
Change street in line 1	Change [<i>the</i>] street in line 1	Changes the city name listed in the first line of the list and currently being recognized (on the screen that allows you to select a list when addresses are recognized in the voice recognition mode)
Change street in line 2	Change [<i>the</i>] street in line 2	Changes the city name listed in the second line of the list and currently being recognized (on the screen that allows you to select a list when addresses are recognized in the voice recognition mode)

Voice command	Phrase	Function
Change street in line 3	Change [the] street in line 3	Changes the city name listed in the third line of the list and currently being recognized (on the screen that allows you to select a list when addresses are recognized in the voice recognition mode)
Change street in line 4	Change [the] street in line 4	Changes the city name listed in the fourth line of the list and currently being recognized (on the screen that allows you to select a list when addresses are recognized in the voice recognition mode)
Change street	Change [the] street	Changes the street name in the address currently being recognized (in the voice recognition mode)
Delete route	Delete [my , the] route	Deletes the route that has been set
Delete	Delete	
Destination	Destination	Sets the selected route as the destination
Down	[Page , Scroll , Move] Down	Moves the list on the list screen one page down
Favorite	[Find , Select , Search for , Look for] [a] Favorite	Selects the conditions to set the destination from your favorite spots
	[Find] Favorites	
Find	Find	Transits to the destination search screen
	Go to	
	Search [for]	
	Look for	

Other Operations

Voice command	Phrase	Function
Go map	[<i>Go</i>] [<i>to</i>] [<i>the</i>] Map [<i>screen</i>]	Transits to the Map screen
	Show [<i>me</i>] [<i>the</i>] map	
Go	Go	Reflects the selected route and starts the navigation guidance
Half	Half	Reduces the detour distance set on the avoid route screen by half
Help	Help	Transits to the voice recognition mode's help screen
History	[<i>Find</i>] [<i>in</i>] History	Sets the destination from the search history results
House number	House number	Transits to the house number reception screen (when searching for the address)
	Street number	
Less	Less	Reduces the detour distance set (on the avoid route screen)
Line 1	[<i>Line</i>] 1	Selects the item listed in the first line of the list (on the screen where the list is displayed)
	First [<i>line</i>]	
Line 2	[<i>Line</i>] 2	Selects the item listed in the second line of the list (on the screen where the list is displayed)
	Second [<i>line</i>]	
Line 3	[<i>Line</i>] 3	Selects the item listed in the third line of the list (on the screen where the list is displayed)
	Third [<i>line</i>]	
Line 4	[<i>Line</i>] 4	Selects the item listed in the fourth line of the list (on the screen where the list is displayed)
	Fourth [<i>line</i>]	

Voice command	Phrase	Function
Middle	[<i>Go</i> , <i>Jump</i> , <i>Move</i> , <i>Scroll</i>][<i>to</i>][<i>the</i>] Middle	Transits to the middle of the list (on the screen where the list is displayed)
More	More	Transits to the information list reception screen
Near here	[<i>Near</i>] Here	Narrows down the selected POI search candidates to places along the route
	Nearby	
	Around here	
	In the neighborhood	
New route	New route	Registers the selected destination as a new destination
Next	Next	Transits to the next screen
No	No	Rejects questions or other contents spoken to you
	Nope	
	Nop	
Parking along route	[<i>Find</i> , <i>Go to</i> , <i>Search for</i> , <i>Look for</i>][<i>a</i>] Parking [<i>lot</i>][<i>along</i> , <i>around</i> , <i>near</i> , <i>on</i>][<i>the</i>] route	Searches for parking lots along the route
	[<i>Find</i> , <i>Go to</i> , <i>Search for</i> , <i>Look for</i>][<i>a</i>] Car park [<i>lot</i>][<i>along</i> , <i>around</i> , <i>near</i> , <i>on</i>][<i>the</i>] route	
Parking at my destination	[<i>Find</i> , <i>Go to</i> , <i>Search for</i> , <i>Look for</i>][<i>a</i>] Parking [<i>lot</i>][<i>at</i> , <i>near</i>][<i>my</i> , <i>the</i>] destination	Searches for parking lots around the destination
	[<i>Find</i> , <i>Go to</i> , <i>Search for</i> , <i>Look for</i>][<i>a</i>] Car park [<i>at</i> , <i>near</i>][<i>my</i> , <i>the</i>] destination	

Voice command	Phrase	Function
Parking near here	[<i>Find</i> , <i>Go to</i> , <i>Search for</i> , <i>Look for</i>][<i>a</i>] Parking [<i>lot</i>] [<i>near</i>] here	Searches for parking lots around the current position
	[<i>Find</i> , <i>Go to</i> , <i>Search for</i> , <i>Look for</i>][<i>a</i>] Parking [<i>lot</i>] nearby	
	[<i>Find</i> , <i>Go to</i> , <i>Search for</i> , <i>Look for</i>][<i>a</i>] Parking [<i>lot</i>] around here	
	[<i>Find</i> , <i>Go to</i> , <i>Search for</i> , <i>Look for</i>][<i>a</i>] Parking [<i>lot</i>] in the <neighborhood, vicinity, area>	
	[<i>Find</i> , <i>Go to</i> , <i>Search for</i> , <i>Look for</i>][<i>a</i>] Car park [<i>near</i>] here	
	[<i>Find</i> , <i>Go to</i> , <i>Search for</i> , <i>Look for</i>][<i>a</i>] Car park nearby	
	[<i>Find</i> , <i>Go to</i> , <i>Search for</i> , <i>Look for</i>][<i>a</i>] Car park around here	
	[<i>Find</i> , <i>Go to</i> , <i>Search for</i> , <i>Look for</i>][<i>a</i>] Car park in the <neighborhood, vicinity, area>	
Parking*	[<i>Find</i> , <i>Go to</i> , <i>Search for</i> , <i>Look for</i>][<i>a</i>] Parking [<i>lot</i>]	Narrows down POI search targets to parking lots
	[<i>Find</i> , <i>Go to</i> , <i>Search for</i> , <i>Look for</i>][<i>a</i>] Car park	
Gas station along route	[<i>Find</i> , <i>Go to</i> , <i>Search for</i> , <i>Look for</i>][<i>a</i>] Gas station [<i>along</i> , <i>around</i> , <i>near</i> , <i>on</i>] [<i>the</i>] route	Searches for gas stations along the route
	[<i>Find</i> , <i>Go to</i> , <i>Search for</i> , <i>Look for</i>][<i>a</i>] Petrol [<i>station</i>] [<i>along</i> , <i>around</i> , <i>near</i> , <i>on</i>] [<i>the</i>] route	
Gas station at my destination	[<i>Find</i> , <i>Go to</i> , <i>Search for</i> , <i>Look for</i>][<i>a</i>] Gas station [<i>at</i> , <i>near</i>] [<i>my</i> , <i>the</i>] destination	Searches for gas stations around the destination
	[<i>Find</i> , <i>Go to</i> , <i>Search for</i> , <i>Look for</i>][<i>a</i>] Petrol [<i>station</i>] [<i>at</i> , <i>near</i>] [<i>my</i> , <i>the</i>] destination	
Gas station near here	[<i>Find</i> , <i>Go to</i> , <i>Search for</i> , <i>Look for</i>][<i>a</i>] Gas station [<i>near</i>] here	Searches for gas stations around the current position
	[<i>Find</i> , <i>Go to</i> , <i>Search for</i> , <i>Look for</i>][<i>a</i>] Petrol [<i>station</i>] [<i>near</i>] here	
	[<i>Find</i> , <i>Go to</i> , <i>Search for</i> , <i>Look for</i>][<i>a</i>] Petrol [<i>station</i>] nearby	
	[<i>Find</i> , <i>Go to</i> , <i>Search for</i> , <i>Look for</i>][<i>a</i>] Gas station nearby	
	[<i>Find</i> , <i>Go to</i> , <i>Search for</i> , <i>Look for</i>][<i>a</i>] Petrol [<i>station</i>] around here	
	[<i>Find</i> , <i>Go to</i> , <i>Search for</i> , <i>Look for</i>][<i>a</i>] Petrol [<i>station</i>] in the <neighborhood, vicinity, area>	

Voice command	Phrase	Function
Gas station*	[<i>Find</i> , <i>Go to</i> , <i>Search for</i> , <i>Look for</i>] [<i>a</i>] Gas station	Narrows down POI search targets to gas stations
	[<i>Find</i> , <i>Go to</i> , <i>Search for</i> , <i>Look for</i>] [<i>a</i>] Petrol [station]	
Place	[<i>Find</i> , <i>Go to</i> , <i>Search for</i> , <i>Look for</i>] [<i>a</i>] Place	Selects POI search as the destination search method (POI search method searches only for petrol stations, accommodations, parking lots and restaurants.)
	[<i>Find</i> , <i>Go to</i> , <i>Search for</i> , <i>Look for</i>] Places	
	[<i>Find</i> , <i>Go to</i> , <i>Search for</i> , <i>Look for</i>] [<i>a</i>] Point of interest	
	[<i>Find</i> , <i>Go to</i> , <i>Search for</i> , <i>Look for</i>] [<i>a</i>] POI	
Read out	Read [it] out	Reads the search results on the list displayed on the screen
Restaurant along route	[<i>Find</i> , <i>Go to</i> , <i>Search for</i> , <i>Look for</i>] [<i>a</i>] Restaurant [along , around , near , on] [the] route	Searches for restaurants along the route
	[<i>Find</i> , <i>Go to</i> , <i>Search for</i> , <i>Look for</i>] [<i>a</i>] Food [along , around , near , on] [the] route	
Restaurant at my destination	[<i>Find</i> , <i>Go to</i> , <i>Search for</i> , <i>Look for</i>] [<i>a</i>] Restaurant at [my , the] destination	Searches for restaurants around the destination
	[<i>Find</i> , <i>Go to</i> , <i>Search for</i> , <i>Look for</i>] Food [at , near] [my , the] destination	
Restaurant near here	[<i>Find</i> , <i>Go to</i> , <i>Search for</i> , <i>Look for</i>] [<i>a</i>] Restaurant [near] here	Searches for restaurants around the current position
	[<i>Find</i> , <i>Go to</i> , <i>Search for</i> , <i>Look for</i>] Food [near] here	
	[<i>Find</i> , <i>Go to</i> , <i>Search for</i> , <i>Look for</i>] [<i>a</i>] Restaurant nearby	
	[<i>Find</i> , <i>Go to</i> , <i>Search for</i> , <i>Look for</i>] Food nearby	
	[<i>Find</i> , <i>Go to</i> , <i>Search for</i> , <i>Look for</i>] [<i>a</i>] Restaurant around here	
	[<i>Find</i> , <i>Go to</i> , <i>Search for</i> , <i>Look for</i>] Food around here	
	[<i>Find</i> , <i>Go to</i> , <i>Search for</i> , <i>Look for</i>] [<i>a</i>] Restaurant in the <neighborhood, vicinity , area>	
	[<i>Find</i> , <i>Go to</i> , <i>Search for</i> , <i>Look for</i>] Food in the <neighborhood, vicinity , area>	
Restaurant*	[<i>Find</i> , <i>Go to</i> , <i>Search for</i> , <i>Look for</i>] [<i>a</i>] Restaurant	Narrows down POI search targets to restaurants
	[<i>Find</i> , <i>Go to</i> , <i>Search for</i> , <i>Look for</i>] Food	

Other Operations

Voice command	Phrase	Function
Route info	Route info	Reads the route information that has been set (after the voice recognition mode is turned off)
	Route information	
	Route summary	
Info	Info	
	Information	
Route	[<i>My</i>] Route	Transits to the route editing screen
Street center	[<i>Street</i>] Center	Sets the center of the street as the address (when addresses are recognized in the voice recognition mode)
	[<i>Street</i>] Midpoint	
Top	[<i>Go</i> , <i>Jump</i> , <i>Move</i> , <i>Scroll</i>] [<i>to</i>] [<i>the</i>] Top	Transits to the top of the list (on the screen where the list is displayed)
Up	[<i>Page</i> , <i>Scroll</i> , <i>Move</i>] Up	Moves the list one page up (on the screen where the list is displayed)
Waypoint	Waypoint	Registers the selected destination as a relay point
Where am i	Where am i	Displays the vehicle position information (When there is a self-car location in the location besides the road, this function can't be used.)
Yes	Yes	Accepts questions or other contents spoken to you
	Yep	
	Yeah	

* Searches for candidates close to your vehicle's position.

- Commands on the touch screen that cannot be operated have their colors toned down.

■ Other Commands

Enabled in the Main Menu.

Voice command	Phrase	Function
Time	[<i>What's the</i>] Time, What time is it now	Reads out the current time
Cancel	Cancel	Closes the voice recognition screen
Help	Help	Displays the help screen
Back	[<i>Go</i>] Back	Returns to the previous screen
Repeat	Repeat	Repeats the guidance voice
Change	Change, Next	Changes the display screen

■ Radio Frequency Lists

AM frequency:

Frequency (530~1710)	Rule
530	five thirty
540	five forty
550	five fifty
560	five sixty
570	five seventy
580	five eighty
590	five ninety
600	six hundred
610	six ten
620	six twenty
630	six thirty
640	six forty
650	six fifty
660	six sixty
670	six seventy
680	six eighty
690	six ninety
700	seven hundred
710	seven ten
720	seven twenty
730	seven thirty

Frequency (530~1710)	Rule
740	seven forty
750	seven fifty
760	seven sixty
770	seven seventy
780	seven eighty
790	seven ninety
800	eight hundred
810	eight ten
820	eight twenty
830	eight thirty
840	eight forty
850	eight fifty
860	eight sixty
870	eight seventy
880	eight eighty
890	eight ninety
900	nine hundred
910	nine ten
920	nine twenty
930	nine thirty
940	nine forty
950	nine fifty
960	nine sixty
970	nine seventy

Frequency (530~1710)	Rule
980	nine eighty
990	nine ninety
1000	one thousand
1010	ten ten
1020	ten twenty
1030	ten thirty
1040	ten forty
1050	ten fifty
1060	ten sixty
1070	ten seventy
1080	ten eighty
1090	ten ninety
1100	eleven hundred
1110	eleven ten
1120	eleven twenty
1130	eleven thirty
1140	eleven forty
1150	eleven fifty
1160	eleven sixty
1170	eleven seventy
1180	eleven eighty
1190	eleven ninety
1200	twelve hundred
1210	twelve ten

Frequency (530~1710)	Rule	Frequency (530~1710)	Rule	Frequency (530~1710)	Rule
1220	twelve twenty	1460	fourteen sixty	1700	seventeen hundred
1230	twelve thirty	1470	fourteen seventy	1710	seventeen ten
1240	twelve forty	1480	fourteen eighty		
1250	twelve fifty	1490	fourteen ninety		
1260	twelve sixty	1500	fifteen hundred		
1270	twelve seventy	1510	fifteen ten		
1280	twelve eighty	1520	fifteen twenty		
1290	twelve ninety	1530	fifteen thirty		
1300	thirteen hundred	1540	fifteen forty		
1310	thirteen ten	1550	fifteen fifty		
1320	thirteen twenty	1560	fifteen sixty		
1330	thirteen thirty	1570	fifteen seventy		
1340	thirteen forty	1580	fifteen eighty		
1350	thirteen fifty	1590	fifteen ninety		
1360	thirteen sixty	1600	sixteen hundred		
1370	thirteen seventy	1610	sixteen ten		
1380	thirteen eighty	1620	sixteen twenty		
1390	thirteen ninety	1630	sixteen thirty		
1400	fourteen hundred	1640	sixteen forty		
1410	fourteen ten	1650	sixteen fifty		
1420	fourteen twenty	1660	sixteen sixty		
1430	fourteen thirty	1670	sixteen seventy		
1440	fourteen forty	1680	sixteen eighty		
1450	fourteen fifty	1690	sixteen ninety		

Other Operations

FM frequency:

Frequency (87.7~107.9)	Rule
87.7	eighty seven [point] seven
87.9	eighty seven [point] nine
88.1	eighty eight [point] one
88.3	eighty eight [point] three
88.5	eighty eight [point] five
88.7	eighty eight [point] seven
88.9	eighty eight [point] nine
89.1	eighty nine [point] one
89.3	eighty nine [point] three
89.5	eighty nine [point] five
89.7	eighty nine [point] seven
89.9	eighty nine [point] nine
90.1	ninety point one
90.3	ninety point three
90.5	ninety point five
90.7	ninety point seven
90.9	ninety point nine
91.1	ninety one [point] one
91.3	ninety one [point] three
91.5	ninety one [point] five
91.7	ninety one [point] seven
91.9	ninety one [point] nine

Frequency (87.7~107.9)	Rule
92.1	ninety two [point] one
92.3	ninety two [point] three
92.5	ninety two [point] five
92.7	ninety two [point] seven
92.9	ninety two [point] nine
93.1	ninety three [point] one
93.3	ninety three [point] three
93.5	ninety three [point] five
93.7	ninety three [point] seven
93.9	ninety three [point] nine
94.1	ninety four [point] one
94.3	ninety four [point] three
94.5	ninety four [point] five
94.7	ninety four [point] seven
94.9	ninety four [point] nine
95.1	ninety five [point] one
95.3	ninety five [point] three
95.5	ninety five [point] five
95.7	ninety five [point] seven
95.9	ninety five [point] nine
96.1	ninety six [point] one
96.3	ninety six [point] three
96.5	ninety six [point] five
96.7	ninety six [point] seven

Frequency (87.7~107.9)	Rule
96.9	ninety six [point] nine
97.1	ninety seven [point] one
97.3	ninety seven [point] three
97.5	ninety seven [point] five
97.7	ninety seven [point] seven
97.9	ninety seven [point] nine
98.1	ninety eight [point] one
98.3	ninety eight [point] three
98.5	ninety eight [point] five
98.7	ninety eight [point] seven
98.9	ninety eight [point] nine
99.1	ninety nine [point] one
99.3	ninety nine [point] three
99.5	ninety nine [point] five
99.7	ninety nine [point] seven
99.9	ninety nine [point] nine
100.1	one hundred point one
100.3	one hundred point three
100.5	one hundred point five
100.7	one hundred point seven
100.9	one hundred point nine
101.1	one oh one [point] one
101.3	one oh one [point] three
101.5	one oh one [point] five

Frequency (87.7~107.9)	Rule	Frequency (87.7~107.9)	Rule
101.7	one oh one [point] seven	106.5	one oh six [point] five
101.9	one oh one [point] nine	106.7	one oh six [point] seven
102.1	one oh two [point] one	106.9	one oh six [point] nine
102.3	one oh two [point] three	107.1	one oh seven [point] one
102.5	one oh two [point] five	107.3	one oh seven [point] three
102.7	one oh two [point] seven	107.5	one oh seven [point] five
102.9	one oh two [point] nine	107.7	one oh seven [point] seven
103.1	one oh three [point] one	107.9	one oh seven [point] nine
103.3	one oh three [point] three		
103.5	one oh three [point] five		
103.7	one oh three [point] seven		
103.9	one oh three [point] nine		
104.1	one oh four [point] one		
104.3	one oh four [point] three		
104.5	one oh four [point] five		
104.7	one oh four [point] seven		
104.9	one oh four [point] nine		
105.1	one oh five [point] one		
105.3	one oh five [point] three		
105.5	one oh five [point] five		
105.7	one oh five [point] seven		
105.9	one oh five [point] nine		
106.1	one oh six [point] one		
106.3	one oh six [point] three		

■ XM Channel Lists

Channel (1~255)	Rule
1	one
2	two
3	three
4	four
5	five
6	six
7	seven
8	eight
9	nine
10	ten
11	eleven
12	twelve
13	thirteen
14	fourteen
15	fifteen
16	sixteen
17	seventeen
18	eighteen
19	nineteen
20	twenty
21	twenty one
22	twenty two

Channel (1~255)	Rule
23	twenty three
24	twenty four
25	twenty five
26	twenty six
27	twenty seven
28	twenty eight
29	twenty nine
30	thirty
31	thirty one
32	thirty two
33	thirty three
34	thirty four
35	thirty five
36	thirty six
37	thirty seven
38	thirty eight
39	thirty nine
40	forty
41	forty one
42	forty two
43	forty three
44	forty four
45	forty five
46	forty six

Channel (1~255)	Rule
47	forty seven
48	forty eight
49	forty nine
50	fifty
51	fifty one
52	fifty two
53	fifty three
54	fifty four
55	fifty five
56	fifty six
57	fifty seven
58	fifty eight
59	fifty nine
60	sixty
61	sixty one
62	sixty two
63	sixty three
64	sixty four
65	sixty five
66	sixty six
67	sixty seven
68	sixty eight
69	sixty nine
70	seventy

Channel (1~255)	Rule	Channel (1~255)	Rule	Channel (1~255)	Rule
71	seventy one	95	ninety five	119	one nineteen
72	seventy two	96	ninety six	120	one twenty
73	seventy three	97	ninety seven	121	one twenty one
74	seventy four	98	ninety eight	122	one twenty two
75	seventy five	99	ninety nine	123	one twenty three
76	seventy six	100	one hundred	124	one twenty four
77	seventy seven	101	one oh one	125	one twenty five
78	seventy eight	102	one oh two	126	one twenty six
79	seventy nine	103	one oh three	127	one twenty seven
80	eighty	104	one oh four	128	one twenty eight
81	eighty one	105	one oh five	129	one twenty nine
82	eighty two	106	one oh six	130	one thirty
83	eighty three	107	one oh seven	131	one thirty one
84	eighty four	108	one oh eight	132	one thirty two
85	eighty five	109	one oh nine	133	one thirty three
86	eighty six	110	one ten	134	one thirty four
87	eighty seven	111	one eleven	135	one thirty five
88	eighty eight	112	one twelve	136	one thirty six
89	eighty nine	113	one thirteen	137	one thirty seven
90	ninety	114	one fourteen	138	one thirty eight
91	ninety one	115	one fifteen	139	one thirty nine
92	ninety two	116	one sixteen	140	one forty
93	ninety three	117	one seventeen	141	one forty one
94	ninety four	118	one eighteen	142	one forty two

Other Operations

Channel (1~255)	Rule	Channel (1~255)	Rule	Channel (1~255)	Rule
143	one forty three	167	one sixty seven	191	one ninety one
144	one forty four	168	one sixty eight	192	one ninety two
145	one forty five	169	one sixty nine	193	one ninety three
146	one forty six	170	one seventy	194	one ninety four
147	one forty seven	171	one seventy one	195	one ninety five
148	one forty eight	172	one seventy two	196	one ninety six
149	one forty nine	173	one seventy three	197	one ninety seven
150	one fifty	174	one seventy four	198	one ninety eight
151	one fifty one	175	one seventy five	199	one ninety nine
152	one fifty two	176	one seventy six	200	two hundred
153	one fifty three	177	one seventy seven	201	two oh one
154	one fifty four	178	one seventy eight	202	two oh two
155	one fifty five	179	one seventy nine	203	two oh three
156	one fifty six	180	one eighty	204	two oh four
157	one fifty seven	181	one eighty one	205	two oh five
158	one fifty eight	182	one eighty two	206	two oh six
159	one fifty nine	183	one eighty three	207	two oh seven
160	one sixty	184	one eighty four	208	two oh eight
161	one sixty one	185	one eighty five	209	two oh nine
162	one sixty two	186	one eighty six	210	two ten
163	one sixty three	187	one eighty seven	211	two eleven
164	one sixty four	188	one eighty eight	212	two twelve
165	one sixty five	189	one eighty nine	213	two thirteen
166	one sixty six	190	one ninety	214	two fourteen

322 Other

Channel (1~255)	Rule	Channel (1~255)	Rule
215	two fifteen	239	two thirty nine
216	two sixteen	240	two forty
217	two seventeen	241	two forty one
218	two eighteen	242	two forty two
219	two nineteen	243	two forty three
220	two twenty	244	two forty four
221	two twenty one	245	two forty five
222	two twenty two	246	two forty six
223	two twenty three	247	two forty seven
224	two twenty four	248	two forty eight
225	two twenty five	249	two forty nine
226	two twenty six	250	two fifty
227	two twenty seven	251	two fifty one
228	two twenty eight	252	two fifty two
229	two twenty nine	253	two fifty three
230	two thirty	254	two fifty four
231	two thirty one	255	two fifty five
232	two thirty two		
233	two thirty three		
234	two thirty four		
235	two thirty five		
236	two thirty six		
237	two thirty seven		
238	two thirty eight		

Reference

Useful Information

If the Following Messages Appear

If the following messages appear, check by referring to the cause and action below.

Message	Cause	Action
Common operations		
Temperature is too high. Restart after a few minutes.	The temperature inside the unit is abnormally high.	Wait until the temperature decreases.
Temperature is too low. Restart after a few minutes.	The temperature inside the unit is abnormally low.	Wait until the temperature increases.
Program loading is necessary. Please insert SD card.	The "SD memory card" containing the update program is not inserted.	Insert the "SD memory card" containing the update program.
Unable to read program. Please check SD card or the program.	Cannot read the "SD memory card" for some reason.	Check the "SD memory card".
Installing failed.	Failed to install the software.	Install again.
No map data found. Please insert the unit's dedicated SD card again.	The "SD memory card" containing the map data is not inserted.	Insert the "SD memory card" containing the map data.
Unable to read data. Please check SD card.	Cannot read the "SD memory card" for some reason.	Check the "SD memory card".
Unable to read map data. Please check SD card.	An "SD memory card" other than the one containing the map data is inserted.	Insert the "SD memory card" containing the map data.
Map/application authorization failed. Please check SD card.	Failed to authorize the map or application.	Check the "SD memory card".
Please insert a SD card.	The "SD memory card" is missing.	Insert an "SD memory card".

Message	Cause	Action
In HD radio mode		
iPod full. Tags cannot be stored.	There is no space remaining in the iPod memory.	Connect an iPod with space remaining in its memory.
No HD Radio signal available.	The HD radio reception is poor.	Try to receive the signal again in a location free from obstructions.
Saving the HD Radio tag failed.	Failed to save the tag information.	Acquire the tag information again.
Storing tag information. Please wait. . .	Cannot save the tag information because of an error.	Acquire the tag information again.
The maximum of 50 HD Radio tags have been stored. Please connect your iPod to transfer these tags before storing more tags.	Cannot save the tag information because the maximum number of tags that can be saved in the unit has been reached.	Connect an iPod and transfer the tag information that is saved in the unit to the iPod.
In SAT mode		
Check Antenna	The XM antenna has disconnected.	Check the connection of the XM antenna.
Check XM Tuner	The XM tuner has disconnected.	Check the connection of the XM tuner.
No Signal	Displayed when the XM satellite radio signal is lost (while accessing).	Try to receive the signal again in a location free from obstructions.
Channel Off Air	Displayed when the tuned XM channel is not currently broadcasting.	Select a channel that is currently broadcasting.
Channel Unavailable	Displayed when the tuned XM channel cannot be received.	Select a channel that can be received.
Channel Unauthorized	Displayed when you are not authorized to receive the tuned XM channel, or while the code is being updated.	Select a channel that can be received.
There is not the input number.	Displayed when the channel does not exist.	Select a channel that can be received.
Incorrect code. Please try again.	The parental lock code is incorrect.	Enter the correct number.

Message	Cause	Action
In CD or MP3/WMA mode		
Check DISC.	The disc is dirty or damaged.	The inserted disc is dirty or upside down. Check the disc for dirt and check its orientation. If the disc is dirty, clean it. If the disc is upside down, orient it correctly. Do not use scratched or warped discs.
DISC Error.	The CD•MP3/WMA player is not operating for some reason.	Eject the disc.
Error (temperature is too high).	The temperature of the CD•MP3/WMA player is abnormally high.	Wait until the temperature decreases without performing any operations.*
No music files found.	No playable music data is recorded on the CD-R/RW disc.	Insert a CD-R/RW disc on which playable music data is recorded.
No support.	Non-supported music data is recorded, or license-controlled music data is detected.	Insert a CD-R/RW disc on which playable music data is recorded.

Message	Cause	Action
In USB mode		
Check USB.	Playback failure or communication abnormality.	Reconnect the USB memory.
No music files found.	No playable music data is stored in the USB memory.	Connect a USB memory in which playable music data is stored.
No support files.	No supported files are stored in the USB memory.	Check the files.
Error	<ul style="list-style-type: none"> • Because playback stopped due to a factor in the main unit. (File access failure etc.) • Because an over current was detected. 	Stop using the device for a short time and then try again.
Authorization Error. Your devices not authorized to play this DivX protected video.	The files are copyright-protected. DivX files purchased with a registration code other than the code of this unit cannot be played.	Check the files.
This DivX rental has used ** of ** views. Continue? [Yes]/[No]	Displays the remaining views for the file.	Follow the instructions on the screen.
Rental Expired. Your device is not authorized to play this DivX protected video. Currently this function is disabled.	The view limit has been reached.	Connect a USB memory that contains a video file with remaining views.
Reading INDEX ** %	A function was selected that cannot be used while the vehicle is in motion.	Park the vehicle and apply the parking brake.
Reading INDEX ** %	The file reading percentage display.	Do not operate until the file reading is complete.
Video framerate not supported.	The video frame rate is not supported.	Connect a USB memory in which playable video files are stored.
Video resolution not supported.	The video resolution is not supported.	Connect a USB memory in which playable video files are stored.
Audio format not supported.	No playable audio format is stored in the USB memory.	Connect a USB memory in which a playable audio format is stored.
No video files found.	No playable video files are stored in the USB memory.	Connect a USB memory in which playable video files are stored.

Reference

Message	Cause	Action
In iPod mode		
iPod error.	Playback failure or communication abnormality.	Reconnect the iPod.
Please check the iPod firmware version.	A communication error, a playback error, the iPod software is not supported, or a control target error.	Connect a playable iPod. Reconnect the iPod.
No music files found.	No playable music data is stored in the iPod.	Connect an iPod in which playable music data is stored.
Searching iPod. Please wait...	Displayed if play is not possible when the iPod source is selected. Also displayed when waiting for skip when up/down is initially operated.	Wait for a few moments before operating.
iPod authorization failed.	Failed to authorize the iPod, or reauthorization is required.	Reconnect the iPod.

Message	Cause	Action
In Bluetooth Audio mode		
No music files found.	No playable music data is stored in the portable device.	Connect a portable device in which playable music data is stored.
In handsfree mode		
Transfer failed.	Displayed when phonebook transfer failed.	Transfer the phonebook again.
Connection failed.	Displayed when phone connection failed.	Connect the phone again.
The part of telephone book data was not able to transfer	Displayed when a portion of the phonebook data could not be transferred.	Transfer the phonebook again.
Telephone call transferring is failed.	Displayed when call transfer was not successful.	Perform call transfer again.
Messages not retrieved.	Displayed when automatic message transfer failed.	Touch Message Transfer (Message Transfer) on the Messages screen to transfer the message.
	Displayed when the phone does not support the MAP profile.	Connect a phone which supports the MAP profile before using.
The message could not be retrieved.	Displayed when message retrieval failed.	Touch Message Transfer (Message Transfer) to perform transfer again.
Unable to dial	Displayed when call dialing failed.	Check that the phone is connected correctly.
Unable to transfer contacts. The Phone is in use	Displayed if the phone was in use when manual phonebook transfer was executed.	Finish using the phone before transferring the phonebook.
In picture mode		
No data	No displayable image data is recorded on the SD memory card.	Insert an SD memory card on which displayable image data is recorded.
Updating failed.	Displayed when updating the Opening screen failed.	Perform Opening screen update again.
Please wait...	Displayed when image data that is 5 MB or larger is being read.	Do not operate until the data reading is complete.

* If this happens, wait for a brief period. When the temperature inside the device returns to normal, the message disappears and playback starts. If the message does not disappear even after waiting a long time, contact your SUBARU dealer.

Message	Cause	Action
In Voice Control System		
Please repeat.	Displayed when the voice command could not be recognized.	Speak the command again.
Voice recognition mode has been cancelled.	Displayed when the voice recognition mode is ended.	-
That command is not available at this time.	Displayed when it is not possible to change the audio mode.	Check that the disc has been inserted correctly. Check that the device has been connected correctly.
That command is not available at this time.	Displayed when it is not possible to change to the navigation mode.	Check that the SD card containing the map data has been inserted correctly. Check that a language other than Russian is selected for the language setting. If the problem is still not resolved, please contact the nearest SUBARU dealer.
That command is not available at this time.	Displayed when that data does not exist. Displayed when the voice command cannot be used.	Use the command only when the corresponding data exists. Speak the name of the data again. Speak a permitted voice command again.
That command is not available at this time.	Displayed when the connected device is not a supported product.	Use when a supported product is connected.
That frequency is not available.	Displayed when that frequency is not available.	Speak the command again.
There is no corresponding data.	Displayed when the corresponding data does not exist.	Use the command only when the corresponding data exists.
That channel cannot be selected.	Displayed when the requested channel data does not exist.	Use the command only when the channel data exists.
The call cannot be placed. There is no phone number information.	Displayed when no phone number data is registered in the phonebook.	Register in the phonebook before using.
(Phonebook name) (Location) is not in the phonebook.	Displayed when the phone number data is not registered in the designated location.	Register in the phonebook before using.

Message	Cause	Action
The phonebook is empty.	Displayed when there is no data registered in the phonebook.	Register in the phonebook before using.
The call cannot be placed. There is no phone number information.	Displayed when that information does not exist.	Speak the information again.
You can't add more digits.	Displayed when the maximum number of telephone number digits has been exceeded.	Make a call to the entered phone number or delete digits before entering.
There are no phones set up to make calls.	Displayed when a Bluetooth-supporting phone is not registered.	Check that a Bluetooth-supporting phone is registered.
The phone is not connected. Please check the phone.	Displayed when a Bluetooth-supporting phone is not connected.	Check that a Bluetooth-supporting phone has been connected.
Please check the usb.	Displayed when USB is disconnected.	Check that USB is connected correctly.
Please check the ipod.	Displayed when the iPod battery is depleted. Displayed when the iPod is disconnected.	Check the iPod battery level. Check that the iPod is connected correctly.
Please check the phone.	Displayed when the phone is disconnected. Displayed when the phone battery is depleted. Displayed when the phone link is disconnected.	Check the phone battery level. Check that the phone is connected correctly.
Loading Voice Recognition...	Displayed when voice recognition cannot yet be started.	Wait for a few moments before operating.

* When a correct command is recognized, the system speaks back the same voice command.

When You Think There is a Malfunction

A slight change in operation may be mistaken for a malfunction. Please check the items in the following table first.
If the unit does not improve even after taking the appropriate action, contact your SUBARU dealer for an inspection.

Condition	Possible cause	Action
The screen is dark for a brief period when the power is turned on at low temperatures.	This is a characteristic of TFTs.	This is not a malfunction. Wait for a brief period.
The display is distorted for a brief period after the power is turned on.	This is a characteristic of TFT backlighting.	This is not a malfunction. The display will stabilize after a brief period.
No sound comes out.	The volume is poorly adjusted.	Turn the VOL button to adjust the volume.
	The music is muted in the following cases. <ul style="list-style-type: none"> • When the voice guidance function is operating. • When talking in handsfree mode. 	This is not a malfunction. The music can be heard again when the voice guidance finishes or the handsfree mode is turned off.
Sound comes out of only one side (left or right, front or rear).	The volume is poorly adjusted.	Check the balance and fader adjustments.
Sound quality does not change even after making adjustments.	The adjusted sound quality band is not included in the radio broadcast or disc.	Check by changing the radio station or disc.
Cannot insert a disc into the deck.	The power is not turned on.	Turn the vehicle ignition switch to "ACC" or "ON".
	A disc is already inserted and you are trying to insert a second disc.	Eject the previously inserted disc before inserting the new disc.
Cannot play a disc.	There is water condensation inside the device.	Stop using the device for a short time and then try again.
	The disc is significantly scratched or warped.	Insert a different disc.
	The disc is very dirty.	Clean the disc.
	The disc is upside down.	Insert the disc in the correct orientation.
	A non-supported disc type is inserted.	Insert a supported disc into the deck.

Condition	Possible cause	Action
Audio is output, but not video (even when the vehicle is stopped).	The parking brake is not applied.	Apply the parking brake.
Neither audio nor video is output.	The vehicle ignition switch is not turned on.	Turn the vehicle ignition switch to "ACC" or "ON".
There are dots that are always lit on the screen.	At least 99.99% of the pixels on TFT panels function correctly, but 0.01% of the pixels may not light or may stay lit.	This is not a defect, so please use the device in this condition.

Glossary

To enhance your enjoyment of this product, please familiarize yourself with the following terms.

- **GPS (Global Positioning System)**

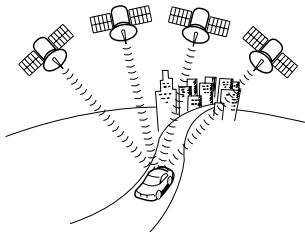

GPS is a system that detects the current location (latitude, longitude, altitude) by receiving radio waves from 4 or more GPS satellites in normal situations, or sometimes from 3 satellites.

These satellites are launched and managed by the US Department of Defense mainly for military use, but they are also open for private use. This unit performs navigation using GPS information, various sensors, and road map data.

- **Wide area map, detailed map**

The wide area map is a map of a large area, and the detailed map is a map of a small area. The scales of the maps are 1/20,480,000, 1/10,240,000, 1/5,120,000, 1/2,560,000, 1/1,280,000, 1/640,000, 1/320,000, 1/160,000, 1/80,000, 1/40,000, 1/20,000, 1/10,000, and 1/5,000.

- **Positioning**



The quality of the GPS positioning is displayed in the top right of the menu screen. The greater the number of displayed symbols, the higher the precision of the GPS positioning.

• 2D positioning and 3D positioning

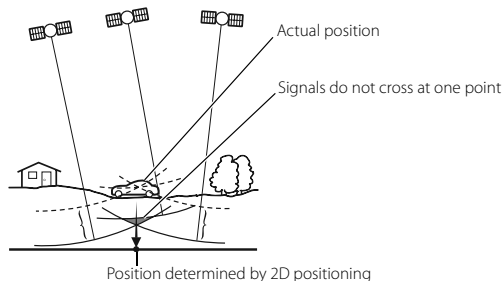

GPS calculates positions using triangulation.

The distance to the satellite can be determined when the radio wave from that satellite is received, and the current location can be measured by receiving radio waves from 3 satellites.

However, because there is a margin of error in the GPS satellites and navigation unit, positioning is performed in only the 2 dimensions of latitude and longitude when radio waves from only 3 satellites can be received. The precision will be lower in this case. When radio waves from 4 or more GPS satellites are received, positioning is performed in the 3 dimensions of latitude, longitude, and altitude. 3D positioning is more precise than 2D positioning, and it reduces the margin of error in the vehicle location display.

About Trademarks

- This product uses the NetFront FlexUI of ACCESS Co., Ltd. ACCESS, the ACCESS logo and NetFront are the trademarks and registered trademarks of ACCESS Co., Ltd. in Japan, the USA and other countries.

ACCESS™

NetFront™

© 2010 ACCESS CO., LTD. All rights reserved.

Some parts of the software in this product contain modules developed by the Independent JPEG Group.

- NAVTEQ ON BOARD is a trademark of NAVTEQ in the USA and other countries.



© 1993 - 2010 NAVTEQ. All rights reserved.

- Tone and balance



The audio systems utilize SRSFOCUS™ and SRS TruBass® audio enhancement technologies, under license from SRS Labs, Inc., in all mode except AM radio mode.

FOCUS, TruBass, SRS and  symbol are trademarks of SRS Labs, Inc. FOCUS and TruBass technologies are incorporated under license from SRS Labs, Inc.

SRS FOCUS™ raises the audio image from non-optimally placed speakers up to the natural listening height at ear level.

SRS TruBass® enhances the perception of bass frequencies to provide deep, rich bass response from any size speaker.