

# 2009 Saturn VUE Green Line Hybrid Owner Manual

## Seats and Restraint

<b>System</b> .....	1-1
Head Restraints .....	1-2
Front Seats .....	1-3
Rear Seats .....	1-9
Safety Belts .....	1-10
Child Restraints .....	1-22
Airbag System .....	1-41
Restraint System Check .....	1-56

## Features and Controls

Keys .....	2-2
Doors and Locks .....	2-6
Windows .....	2-9
Theft-Deterrent Systems .....	2-10
Starting and Operating Your Vehicle .....	2-14
Mirrors .....	2-27
OnStar® System .....	2-29
Universal Home Remote System .....	2-32
Storage Areas .....	2-37

## Instrument Panel

Instrument Panel Overview .....	3-4
Climate Controls .....	3-17
Warning Lights, Gages, and Indicators .....	3-22
Driver Information Center (DIC) .....	3-36
Audio System(s) .....	3-56

## Driving Your Vehicle

Your Driving, the Road, and the Vehicle .....	4-1
Towing .....	4-22

## Service and Appearance Care

Service .....	5-3
Fuel .....	5-5
Checking Things Under the Hood .....	5-9
Headlamp Aiming .....	5-33
Bulb Replacement .....	5-35

Windshield Wiper Blade Replacement .....	5-38
Tires .....	5-38
Appearance Care .....	5-66
Vehicle Identification .....	5-74
Electrical System .....	5-74
Capacities and Specifications .....	5-81

## Maintenance Schedule

Maintenance Schedule .....	6-1
----------------------------	-----

## Customer Assistance

<b>Information</b> .....	7-1
Customer Assistance and Information .....	7-1
Reporting Safety Defects .....	7-12
Vehicle Data Recording and Privacy .....	7-14

## Index

Index .....	i-1
-------------	-----

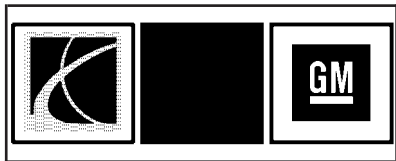

SATURN, the SATURN Emblem, and the name VUE are registered trademarks of Saturn Corporation. GENERAL MOTORS and GM are registered trademarks of General Motors Corporation.

This manual includes the latest information at the time it was printed. Saturn reserves the right to make changes after that time without further notice.

This manual describes features that may or may not be on your specific vehicle.

Read this manual from beginning to end to learn about the vehicle's features and controls. Pictures, symbols, and words work together to explain vehicle operation.

Keep this manual in the vehicle for quick reference.

### **Canadian Owners**

A French language copy of this manual can be obtained from your dealer/retailer or from:

Helm, Incorporated  
P.O. Box 07130  
Detroit, MI 48207  
1-800-551-4123  
helminc.com

### **Propriétaires Canadiens**

On peut obtenir un exemplaire de ce guide en français auprès de concessionnaire ou à l'adresse suivante:

Helm Incorporated  
P.O. Box 07130  
Detroit, MI 48207  
1-800-551-4123  
helminc.com

### **About Driving Your Vehicle**

As with other vehicles of this type, failure to operate this vehicle correctly may result in loss of control or an accident. Be sure to read the "on-pavement" and "off-road" driving guidelines which follow in this manual in the section called "Your Driving, the Road, and Your Vehicle".

## Index

To quickly locate information about the vehicle use the Index in the back of the manual. It is an alphabetical list of what is in the manual and the page number where it can be found.

## Safety Warnings and Symbols



A circle with a slash through it is a safety symbol which means “Do Not,” “Do not do this” or “Do not let this happen.”

A box with the word CAUTION is used to tell about things that could hurt you or others if you were to ignore the warning.

### CAUTION

These mean there is something that could hurt you or other people.

Cautions tell what the hazard is and what to do to avoid or reduce the hazard. Read these cautions.

A notice tells about something that can damage the vehicle.

**Notice:** These mean there is something that could damage your vehicle.

Many times, this damage would not be covered by the vehicle's warranty, and it could be costly. The notice tells what to do to help avoid the damage.

There are also warning labels on the vehicle which use the same words, CAUTION or Notice.

## Vehicle Symbols

The vehicle has components and labels that use symbols instead of text. Symbols are shown along with the text describing the operation or information relating to a specific component, control, message, gage, or indicator.

 : This symbol is shown when you need to see your owner manual for additional instructions or information.

 : This symbol is shown when you need to see a service manual for additional instructions or information.

### Vehicle Symbol Chart

Here are some additional symbols that may be found on the vehicle and what they mean. For more information on the symbol, refer to the index.

 : Airbag Readiness Light

 : Air Conditioning

 : Antilock Brake System (ABS)

 : Audio Steering Wheel Controls or OnStar<sup>®</sup>

 : Brake System Warning Light

 : Charging System

 : Cruise Control

 : Engine Coolant Temperature

 : Exterior Lamps

 : Fog Lamps

 : Fuel Gage

 : Fuses

 : Headlamp High/Low-Beam Changer

 : LATCH System Child Restraints

 : Malfunction Indicator Lamp

 : Oil Pressure

 : Power

 : Remote Vehicle Start

 : Safety Belt Reminders

 : Tire Pressure Monitor

 : Traction Control

 : Windshield Washer Fluid

# Seats and Restraint System

## Head Restraints

Head Restraints .....1-2

## Front Seats

Manual Seats .....1-3  
 Seat Height Adjuster .....1-4  
 Power Seat .....1-4  
 Manual Lumbar .....1-5  
 Heated Seats .....1-5  
 Reclining Seatbacks .....1-5  
 Passenger Folding  
 Seatback .....1-7

## Rear Seats

Split Folding Rear Seat .....1-9

## Safety Belts

Safety Belts: They Are  
 for Everyone .....1-10  
 How to Wear Safety  
 Belts Properly .....1-13

Lap-Shoulder Belt .....1-17  
 Safety Belt Use During  
 Pregnancy .....1-22  
 Safety Belt Extender .....1-22

## Child Restraints

Older Children .....1-22  
 Infants and Young  
 Children .....1-25  
 Child Restraint Systems ....1-27  
 Where to Put the  
 Restraint .....1-29  
 Lower Anchors and  
 Tethers for Children  
 (LATCH) .....1-31  
 Securing a Child  
 Restraint in a Rear  
 Seat Position .....1-36  
 Securing a Child  
 Restraint in the Right  
 Front Seat Position .....1-38

## Airbag System

Airbag System .....1-41  
 Where Are the Airbags? ...1-44  
 When Should an Airbag  
 Inflate? .....1-45

What Makes an Airbag  
 Inflate? .....1-47  
 How Does an Airbag  
 Restrain? .....1-47  
 What Will You See After  
 an Airbag Inflates? .....1-48  
 Passenger Sensing  
 System .....1-49  
 Servicing Your  
 Airbag-Equipped  
 Vehicle .....1-54  
 Adding Equipment to  
 Your Airbag-Equipped  
 Vehicle .....1-55

## Restraint System Check

Checking the Restraint  
 Systems .....1-56  
 Replacing Restraint  
 System Parts After a  
 Crash .....1-57

## 1-2 Seats and Restraint System

### Head Restraints

The front and rear seats have adjustable head restraints in the outboard seating positions.

#### CAUTION

With head restraints that are not installed and adjusted properly, there is a greater chance that occupants will suffer a neck/spinal injury in a crash. Do not drive until the head restraints for all occupants are installed and adjusted properly.



Adjust the head restraint so that the top of the restraint is at the same height as the top of the occupant's head. This position reduces the chance of a neck injury in a crash.



Pull the head restraint up to raise it. To lower the head restraint, press the button, located on the top of the seatback, and push the restraint down.

Push down on the head restraint after the button is released to make sure that it is locked in place.

The head restraints are not designed to be removed.

### Active Head Restraint System

The vehicle has an active head restraint system in the front outboard seating positions. The active head restraints automatically tilt forward to reduce the risk of neck injury if the vehicle is hit from behind.

## Front Seats

### Manual Seats

 **CAUTION**

You can lose control of the vehicle if you try to adjust a manual driver's seat while the vehicle is moving. The sudden movement could startle and confuse you, or make you push a pedal when you do not want to. Adjust the driver's seat only when the vehicle is not moving.

To move a manual seat forward or rearward:

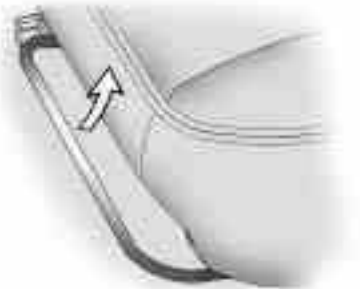

1. Lift the bar to unlock the seat.
2. Slide the seat to the desired position and release the bar.

Try to move the seat with your body to be sure the seat is locked in place.

## 1-4 Seats and Restraint System

---

### Seat Height Adjuster



If the vehicle has a manual driver seat height adjuster, it is located on the outboard side of the seat near the front of the seat cushion.

To raise the seat, move the lever upward repeatedly until the seat is at the desired height.  
To lower the seat, move the lever downward repeatedly until the seat is at the desired height.

### Power Seat

 : To adjust the seat:



Move the seat forward or rearward.



Raise or lower the front or rear part of the seat cushion.



## Manual Lumbar



If the vehicle has this feature, the knob is located on the inboard side of the driver seatback.

Turn the knob clockwise or counterclockwise to increase or decrease the lumbar support.

## Heated Seats

On vehicles with heated front seats the controls are located on the center console. The engine must be running to operate the heated seats.

 **(Heated Seat):** Press this button to turn on the heated seat.

The indicator light on the button shows that the feature is on and the level of heat, three being the highest. Press the button to choose the level of heat.

The passenger seat may take longer to heat up.

## Reclining Seatbacks

### Manual Reclining Seatbacks

#### CAUTION

You can lose control of the vehicle if you try to adjust a manual driver's seat while the vehicle is moving. The sudden movement could startle and confuse you, or make you push a pedal when you do not want to. Adjust the driver's seat only when the vehicle is not moving.

#### CAUTION

If either seatback is not locked, it could move forward in a sudden stop or crash. That could cause injury to the person sitting there. Always push and pull on the seatbacks to be sure they are locked.



On seats with manual reclining seatbacks, the lever used to operate them is located on the outboard side of the seat.

## 1-6 Seats and Restraint System

To recline the seatback:

1. Lift the recline lever.
2. Move the seatback to the desired position, then release the lever to lock the seatback in place.
3. Push and pull on the seatback to make sure it is locked.

To return the seatback to an upright position:

1. Lift the lever fully without applying pressure to the seatback and the seatback returns to the upright position.
2. Push and pull on the seatback to make sure it is locked.

### Power Reclining Seatbacks



If the seats have power reclining seatbacks, the control used to recline them is located on the outboard side of the seat.

- To recline the seatback, tilt the top of the control rearward.
- To bring the seatback forward, tilt the top of the control forward.

### CAUTION

Sitting in a reclined position when your vehicle is in motion can be dangerous. Even if you buckle up, your safety belts cannot do their job when you are reclined like this.

The shoulder belt cannot do its job. In a crash, you could go into it, receiving neck or other injuries.

The lap belt cannot do its job either. In a crash the belt could go up over your abdomen. The belt forces would be there, not at your pelvic bones. This could cause serious internal injuries.

For proper protection when the vehicle is in motion, have the seatback upright. Then sit well back in the seat and wear your safety belt properly.



Do not have a seatback reclined if the vehicle is moving.

### Passenger Folding Seatback

The front passenger seatback may fold flat.

#### CAUTION

If you fold the seatback forward to carry longer objects, such as skis, be sure any such cargo is not near an airbag. In a crash, an inflating airbag might force that object toward a person. This could cause severe injury or even death. Secure objects away from the area in which an airbag would inflate. For more information, see *Where Are the Airbags?* on page 1-44 and *Loading the Vehicle* on page 4-18.

#### CAUTION

Things you put on this seatback can strike and injure people in a sudden stop or turn, or in a crash. Remove or secure all items before driving.

To fold the seatback:

1. Lower the head restraint all the way.
2. Lift the bar under the front of the seat to unlock it. Slide the seat as far back as it will go and release the bar. Try to move the seat back and forth to make sure it is locked into place.

## 1-8 Seats and Restraint System



3. Lift the recliner lever, located on the outboard side of the seat, up fully and fold the seatback forward until it disengages.
4. Continue to fold the seat forward into the folded position.
5. Pull up on the seatback to be sure it is locked.

To raise the seatback:

1. Lift the recliner lever, located on the outboard side of the seat, up fully and push up on the seatback.
2. Continue raising the seatback until the seatback re-engages.



### CAUTION

If either seatback is not locked, it could move forward in a sudden stop or crash. That could cause injury to the person sitting there. Always push and pull on the seatbacks to be sure they are locked.

3. Push and pull on the seatback to make sure it is locked in place.

The recliner lever is also used to recline the seatback while a passenger is seated. See *Reclining Seatbacks* on page 1-5.

## Rear Seats

### Split Folding Rear Seat

The rear split bench seatbacks can be folded forward, upright, or partially reclined, independent of the other seatback position.

#### CAUTION

If either seatback is not locked, it could move forward in a sudden stop or crash. That could cause injury to the person sitting there. Always push and pull on the seatbacks to be sure they are locked.

#### CAUTION

A safety belt that is improperly routed, not properly attached, or twisted will not provide the protection needed in a crash. The person wearing the belt could be seriously injured. After raising the rear seatback, always check to be sure that the safety belts are properly routed and attached, and are not twisted.

To fold the seatback down:

**Notice:** Folding a rear seat with the safety belts still fastened may cause damage to the seat or the safety belts. Always unbuckle the safety belts and return them to their normal stowed position before folding a rear seat.

1. Unbuckle all three safety belts and put the front seatback in an upright position.



2. Lift the lever located on the top of the seatback to release the seatback and fold the seatback forward.

To recline the seatback:

1. Lift and hold the lever located on top of the seatback.
2. Tilt the seatback rearward, then release the lever.

### Safety Belts

#### Safety Belts: They Are for Everyone

This section of the manual describes how to use safety belts properly. It also describes some things not to do with safety belts.

#### CAUTION

Do not let anyone ride where a safety belt cannot be worn properly. In a crash, if you or your passenger(s) are not wearing safety belts, the injuries can be much worse. You can hit things inside the vehicle harder or be ejected from the vehicle. You and your passenger(s) can be seriously injured or killed. In the same crash, you might not be, if you are buckled up. Always fasten your safety belt, and check that your passenger(s) are restrained properly too.

#### CAUTION

It is extremely dangerous to ride in a cargo area, inside or outside of a vehicle. In a collision, people riding in these areas are more likely to be seriously injured or killed. Do not allow people to ride in any area of your vehicle that is not equipped with seats and safety belts. Be sure everyone in your vehicle is in a seat and using a safety belt properly.

This vehicle has indicators as a reminder to buckle the safety belts. See *Safety Belt Reminders on page 3-24* for additional information.

In most states and in all Canadian provinces, the law requires wearing safety belts. Here is why:

You never know if you will be in a crash. If you do have a crash, you do not know if it will be a serious one.

A few crashes are mild, and some crashes can be so serious that even buckled up, a person would not survive. But most crashes are in between. In many of them, people who buckle up can survive and sometimes walk away. Without safety belts they could have been badly hurt or killed.

After more than 40 years of safety belts in vehicles, the facts are clear. In most crashes buckling up does matter... a lot!

## Why Safety Belts Work

When you ride in or on anything, you go as fast as it goes.



Take the simplest vehicle. Suppose it is just a seat on wheels.



Put someone on it.



Get it up to speed. Then stop the vehicle. The rider does not stop.



The person keeps going until stopped by something. In a real vehicle, it could be the windshield...

## 1-12 Seats and Restraint System

---



or the instrument panel...



or the safety belts!

With safety belts, you slow down as the vehicle does. You get more time to stop. You stop over more distance, and your strongest bones take the forces. That is why safety belts make such good sense.

### Questions and Answers About Safety Belts

**Q: Will I be trapped in the vehicle after a crash if I am wearing a safety belt?**

**A:** You *could* be — whether you are wearing a safety belt or not. But your chance of being conscious during and after an accident, so you *can* unbuckle and get out, is *much* greater if you are belted. And you can unbuckle a safety belt, even if you are upside down.

**Q: If my vehicle has airbags, why should I have to wear safety belts?**

**A:** Airbags are supplemental systems only; so they work *with* safety belts — not instead of them. Whether or not an airbag is provided, all occupants still have to buckle up to get the most protection. That is true not only in frontal collisions, but especially in side and other collisions.



**Q: If I am a good driver, and I never drive far from home, why should I wear safety belts?**

**A:** You may be an excellent driver, but if you are in a crash — even one that is not your fault — you and your passenger(s) can be hurt. Being a good driver does not protect you from things beyond your control, such as bad drivers.

Most accidents occur within 25 miles (40 km) of home. And the greatest number of serious injuries and deaths occur at speeds of less than 40 mph (65 km/h).

Safety belts are for everyone.

## How to Wear Safety Belts Properly

This section is only for people of adult size.

Be aware that there are special things to know about safety belts and children. And there are different rules for smaller children and infants. If a child will be riding in the vehicle, see *Older Children on page 1-22* or *Infants and Young Children on page 1-25*. Follow those rules for everyone's protection.

It is very important for all occupants to buckle up. Statistics show that unbelted people are hurt more often in crashes than those who are wearing safety belts.

Occupants who are not buckled up can be thrown out of the vehicle in a crash. And they can strike others in the vehicle who are wearing safety belts.

First, before you or your passenger(s) wear a safety belt, there is important information you should know.



Sit up straight and always keep your feet on the floor in front of you. The lap part of the belt should be worn low and snug on the hips, just touching the thighs. In a crash, this applies force to the strong pelvic bones and you would be less likely to slide under the lap belt. If you slid under it, the belt would apply force on your abdomen. This could cause serious or even

## 1-14 Seats and Restraint System

fatal injuries. The shoulder belt should go over the shoulder and across the chest. These parts of the body are best able to take belt restraining forces.

The shoulder belt locks if there is a sudden stop or crash.

**Q: What is wrong with this?**

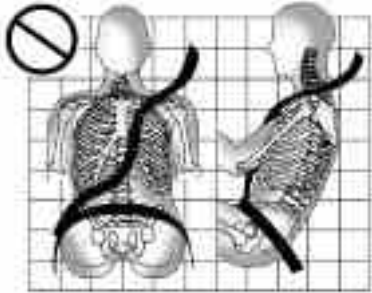

**A:** The shoulder belt is too loose. It will not give as much protection this way.

### ⚠ CAUTION

You can be seriously hurt if your shoulder belt is too loose. In a crash, you would move forward too much, which could increase injury. The shoulder belt should fit snugly against your body.

**Q: What is wrong with this?**



**A:** The lap belt is too loose. It will not give nearly as much protection this way.

### ⚠ CAUTION

You can be seriously hurt if your lap belt is too loose. In a crash, you could slide under the lap belt and apply force on your abdomen. This could cause serious or even fatal injuries. The lap belt should be worn low and snug on the hips, just touching the thighs.

**Q: What is wrong with this?**

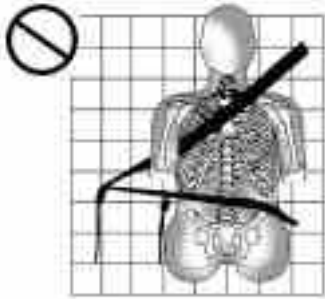

**A:** The belt is buckled in the wrong buckle.

**⚠ CAUTION**

You can be seriously injured if your belt is buckled in the wrong place like this. In a crash, the belt would go up over your abdomen. The belt forces would be there, not on the pelvic bones. This could cause serious internal injuries. Always buckle your belt into the buckle nearest you.

**⚠ CAUTION**

You can be seriously injured if your belt goes over an armrest like this. The belt would be much too high. In a crash, you can slide under the belt. The belt force would then be applied on the abdomen, not on the pelvic bones, and that could cause serious or fatal injuries. Be sure the belt goes under the armrests.

**Q: What is wrong with this?**

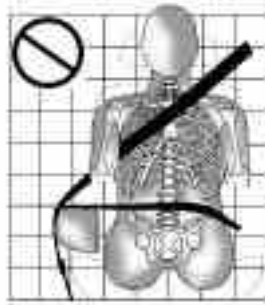

**A:** The belt is over an armrest.

## 1-16 Seats and Restraint System

**Q:** What is wrong with this?

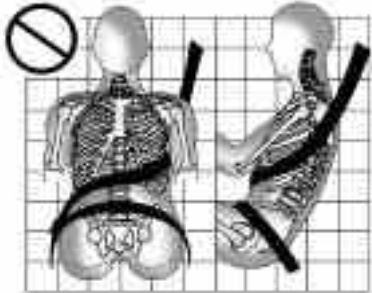

**A:** The shoulder belt is worn under the arm. It should be worn over the shoulder at all times.

### CAUTION

You can be seriously injured if you wear the shoulder belt under your arm. In a crash, your body would move too far forward, which would increase the chance of head and neck injury. Also, the belt would apply too much force to the ribs, which are not as strong as shoulder bones. You could also severely injure internal organs like your liver or spleen. The shoulder belt should go over the shoulder and across the chest.

**Q:** What is wrong with this?

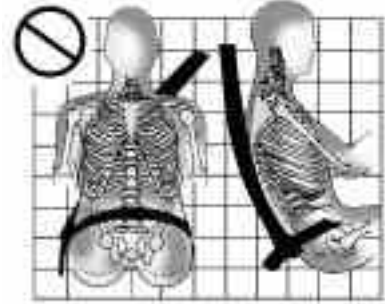

**A:** The belt is behind the body.

**⚠ CAUTION**

You can be seriously injured by not wearing the lap-shoulder belt properly. In a crash, you would not be restrained by the shoulder belt. Your body could move too far forward increasing the chance of head and neck injury. You might also slide under the lap belt. The belt force would then be applied right on the abdomen. That could cause serious or fatal injuries. The shoulder belt should go over the shoulder and across the chest.

**Q: What is wrong with this?**

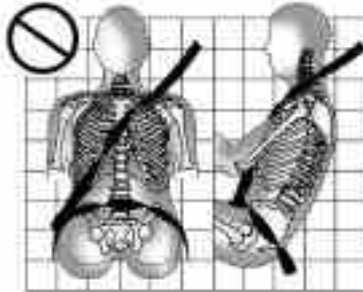

**A: The belt is twisted across the body.**

**⚠ CAUTION**

You can be seriously injured by a twisted belt. In a crash, you would not have the full width of the belt to spread impact forces. If a belt is twisted, make it straight so it can work properly, or ask your dealer/retailer to fix it.

**Lap-Shoulder Belt**

All seating positions in the vehicle have a lap-shoulder belt.

The following instructions explain how to wear a lap-shoulder belt properly.

1. Adjust the seat, if the seat is adjustable, so you can sit up straight. To see how, see “Seats” in the Index.



2. Pick up the latch plate and pull the belt across you. Do not let it get twisted.

## 1-18 Seats and Restraint System

The lap-shoulder belt may lock if you pull the belt across you very quickly. If this happens, let the belt go back slightly to unlock it. Then pull the belt across you more slowly.

If the shoulder portion of a passenger belt is pulled out all the way, the child restraint locking feature may be engaged. If this happens, let the belt go back all the way and start again.

Engaging the child restraint locking feature in the right front seating position may affect the passenger sensing system. See *Passenger Sensing System* on page 1-49 for more information.



3. Push the latch plate into the buckle until it clicks.  
Pull up on the latch plate to make sure it is secure. If the belt is not long enough, see *Safety Belt Extender* on page 1-22.  
Position the release button on the buckle so that the safety belt could be quickly unbuckled if necessary.
4. If equipped with a shoulder belt height adjuster, move it to the height that is right for you. See "Shoulder Belt Height

Adjustment" later in this section for instructions on use and important safety information.



5. To make the lap part tight, pull up on the shoulder belt.  
It may be necessary to pull the stitching on the safety belt through the latch plate to fully tighten the lap belt on smaller occupants.



To unlatch the belt, push the button on the buckle. The belt should return to its stowed position. Slide the latch plate up the safety belt webbing when the safety belt is not in use. The latch plate should rest on the stitching on the safety belt, near the guide loop on the side wall.

Before a door is closed, be sure the safety belt is out of the way. If a door is slammed against a safety belt, damage can occur to both the safety belt and the vehicle.

### Shoulder Belt Height Adjuster

The vehicle has a shoulder belt height adjuster for the driver and right front passenger seating positions.

Adjust the height so that the shoulder portion of the belt is centered on the shoulder. The belt should be away from the face and neck, but not falling off of the shoulder. Improper shoulder belt height adjustment could reduce the effectiveness of the safety belt in a crash.

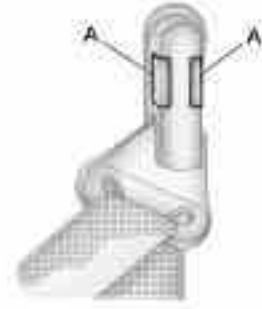

Squeeze the release buttons (A) together and move the height adjuster up or down to the desired position.

After the adjuster is set to the desired position, try to move it up or down without squeezing the release buttons to make sure it has locked into position.

## 1-20 Seats and Restraint System

---

### Safety Belt Pretensioners

This vehicle has safety belt pretensioners for the front outboard occupants. Although the safety belt pretensioners cannot be seen, they are part of the safety belt assembly. They can help tighten the safety belts during the early stages of a moderate to severe frontal, near frontal, or rear crash if the threshold conditions for pretensioner activation are met. And, for vehicles with side impact airbags, safety belt pretensioners can help tighten the safety belts in a side crash or a rollover event.

Pretensioners work only once. If the pretensioners activate in a crash, they will need to be replaced, and probably other new parts for the vehicle's safety belt system. See *Replacing Restraint System Parts After a Crash* on page 1-57.

### Rear Safety Belt Comfort Guides

Rear shoulder belt comfort guides may provide added safety belt comfort for older children who have outgrown booster seats and for some adults. When installed on a shoulder belt, the comfort guide positions the shoulder belt away from the neck and head.

There is one guide for each outboard passenger position in the rear seat. Here is how to install a comfort guide to the safety belt:

1. Remove the guide from its storage location, which is a pocket on the side of the seat.



2. Place the guide over the belt and insert the two edges of the belt into the slots of the guide.



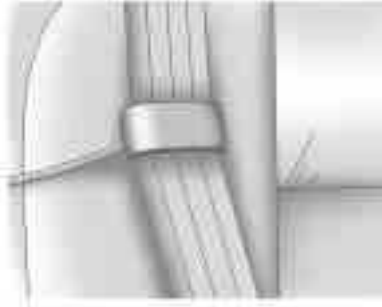

3. Be sure that the belt is not twisted and it lies flat. The elastic cord must be under the belt and the guide on top.

### CAUTION

A safety belt that is not properly worn may not provide the protection needed in a crash. The person wearing the belt could be seriously injured. The shoulder belt should go over the shoulder and across the chest. These parts of the body are best able to take belt restraining forces.



4. Buckle, position, and release the safety belt as described previously in this section. Make sure that the shoulder belt crosses the shoulder.

To remove and store the comfort guide, squeeze the belt edges together so that the safety belt can be removed from the guide. Store the comfort guide in its storage location, which is a pocket on the side of the seat.

## 1-22 Seats and Restraint System

---

### Safety Belt Use During Pregnancy

Safety belts work for everyone, including pregnant women. Like all occupants, they are more likely to be seriously injured if they do not wear safety belts.



A pregnant woman should wear a lap-shoulder belt, and the lap portion should be worn as low as possible, below the rounding, throughout the pregnancy.

The best way to protect the fetus is to protect the mother. When a safety belt is worn properly, it is more likely that the fetus will not be hurt in a crash. For pregnant women, as for anyone, the key to making safety belts effective is wearing them properly.

### Safety Belt Extender

If the safety belt will fasten around you, you should use it.

But if a safety belt is not long enough, your dealer/retailer will order you an extender. When you go in to order it, take the heaviest coat you will wear, so the extender will be long enough for you. To help avoid personal injury, do not let someone else use it, and use it only for the seat it is made to fit. The extender has been designed for adults. Never use it for securing child seats. To wear it, attach it to the regular safety belt. For more information, see the instruction sheet that comes with the extender.

## Child Restraints

### Older Children



Older children who have outgrown booster seats should wear the vehicle's safety belts.

The manufacturer's instructions that come with the booster seat, state the weight and height limitations for that booster. Use a booster seat with a lap-shoulder belt until the child passes the below fit test:

- Sit all the way back on the seat. Do the knees bend at the seat edge? If yes, continue. If no, return to the booster seat.
- Buckle the lap-shoulder belt. Does the shoulder belt rest on the shoulder? If yes, continue. If no, try using the rear safety belt comfort guide. See "Rear Safety Belt Comfort Guides" under *Lap-Shoulder Belt on page 1-17* for more information. If the shoulder belt still does not rest on the shoulder, then return to the booster seat.
- Does the lap belt fit low and snug on the hips, touching the thighs? If yes, continue. If no, return to the booster seat.

- Can proper safety belt fit be maintained for the length of the trip? If yes, continue. If no, return to the booster seat.

**Q: What is the proper way to wear safety belts?**

**A:** An older child should wear a lap-shoulder belt and get the additional restraint a shoulder belt can provide. The shoulder belt should not cross the face or neck. The lap belt should fit snugly below the hips, just touching the top of the thighs. This applies belt force to the child's pelvic bones in a crash. It should never be worn over the abdomen, which could cause severe or even fatal internal injuries in a crash.

Also see "Rear Safety Belt Comfort Guides" under *Lap-Shoulder Belt on page 1-17*.

According to accident statistics, children and infants are safer when properly restrained in a child restraint system or infant restraint system secured in a rear seating position.

In a crash, children who are not buckled up can strike other people who are buckled up, or can be thrown out of the vehicle. Older children need to use safety belts properly.

## 1-24 Seats and Restraint System

### CAUTION

Never do this.

Never allow two children to wear the same safety belt. The safety belt can not properly spread the impact forces. In a crash, the two children can be crushed together and seriously injured. A safety belt must be used by only one person at a time.



### CAUTION

Never do this.

Never allow a child to wear the safety belt with the shoulder belt behind their back. A child can be seriously injured by not wearing the lap-shoulder belt properly. In a crash, the child would not be restrained by the shoulder belt. The child could move too far forward increasing the chance of head and neck injury. The child might also slide under the lap belt. The belt force would then be applied right on the abdomen. That could cause serious or fatal injuries. The shoulder belt should go over the shoulder and across the chest.



## Infants and Young Children

Everyone in a vehicle needs protection! This includes infants and all other children. Neither the distance traveled nor the age and size of the traveler changes the need, for everyone, to use safety restraints. In fact, the law in every state in the United States and in every Canadian province says children up to some age must be restrained while in a vehicle.

### CAUTION

Children can be seriously injured or strangled if a shoulder belt is wrapped around their neck and the safety belt continues to tighten. Never leave children unattended in a vehicle and never allow children to play with the safety belts.

Airbags plus lap-shoulder belts offer protection for adults and older children, but not for young children and infants. Neither the vehicle's safety belt system nor its airbag system is designed for them. Every time infants and young children ride in vehicles, they should have the protection provided by appropriate child restraints.

Children who are not restrained properly can strike other people, or can be thrown out of the vehicle.

### CAUTION

Never do this.

Never hold an infant or a child while riding in a vehicle. Due to crash forces, an infant or a child will become so heavy it is not possible to hold it during a crash.

(Continued)

### CAUTION (Continued)

For example, in a crash at only 25 mph (40 km/h), a 12 lb (5.5 kg) infant will suddenly become a 240 lb (110 kg) force on a person's arms. An infant should be secured in an appropriate restraint.



## 1-26 Seats and Restraint System

### CAUTION

Never do this.

Children who are up against, or very close to, any airbag when it inflates can be seriously injured or killed. Never put a rear-facing child restraint in the right front seat. Secure a rear-facing child restraint in a rear seat. It is also better to secure a forward-facing child restraint in a rear seat. If you must secure a forward-facing child restraint in the right front seat, always move the front passenger seat as far back as it will go.



### **Q: What are the different types of add-on child restraints?**

**A:** Add-on child restraints, which are purchased by the vehicle's owner, are available in four basic types. Selection of a particular restraint should take into consideration not only the child's weight, height, and age but also whether or not the restraint will be compatible with the motor vehicle in which it will be used.

For most basic types of child restraints, there are many different models available. When purchasing a child restraint, be sure it is designed to be used in a motor vehicle. If it is, the restraint will have a label saying that it meets federal motor vehicle safety standards.

The restraint manufacturer's instructions that come with the restraint state the weight and height limitations for a particular child restraint. In addition, there are many kinds of restraints available for children with special needs.

**⚠ CAUTION**

To reduce the risk of neck and head injury during a crash, infants need complete support. This is because an infant's neck is not fully developed and its head weighs so much compared with the rest of its body. In a crash, an infant in a rear-facing child restraint settles into the restraint, so the crash forces can be distributed across the strongest part of an infant's body, the back and shoulders. Infants should always be secured in rear-facing child restraints.

**⚠ CAUTION**

A young child's hip bones are still so small that the vehicle's regular safety belt may not remain low on the hip bones, as it should. Instead, it may settle up around the child's abdomen. In a crash, the belt would apply force on a body area that is unprotected by any bony structure. This alone could cause serious or fatal injuries. To reduce the risk of serious or fatal injuries during a crash, young children should always be secured in appropriate child restraints.

**Child Restraint Systems**



**(A) Rear-Facing Infant Seat**

A rear-facing infant seat (A) provides restraint with the seating surface against the back of the infant.

The harness system holds the infant in place and, in a crash, acts to keep the infant positioned in the restraint.



**(B) Forward-Facing Child Seat**

A forward-facing child seat (B) provides restraint for the child's body with the harness.

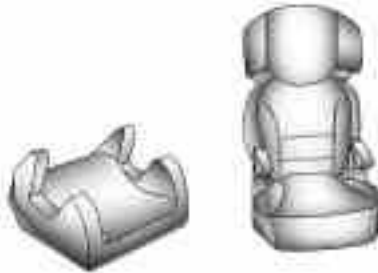

**(C) Booster Seats**

A booster seat (C) is a child restraint designed to improve the fit of the vehicle's safety belt system. A booster seat can also help a child to see out the window.

### Securing an Add-On Child Restraint in the Vehicle

 **CAUTION**

A child can be seriously injured or killed in a crash if the child restraint is not properly secured in the vehicle. Secure the child restraint properly in the vehicle using the vehicle's safety belt or LATCH system, following the instructions that came with that child restraint and the instructions in this manual.



To help reduce the chance of injury, the child restraint must be secured in the vehicle. Child restraint systems must be secured in vehicle seats by lap belts or the lap belt portion of a lap-shoulder belt, or by the LATCH system. See *Lower Anchors and Tethers for Children (LATCH)* on page 1-31 for more information. A child can be endangered in a crash if the child restraint is not properly secured in the vehicle.

When securing an add-on child restraint, refer to the instructions that come with the restraint which may be on the restraint itself or in a booklet, or both, and to this manual. The child restraint instructions are important, so if they are not available, obtain a replacement copy from the manufacturer.

Keep in mind that an unsecured child restraint can move around in a collision or sudden stop and injure people in the vehicle. Be sure to properly secure any child restraint in the vehicle — even when no child is in it.

### Securing the Child Within the Child Restraint



A child can be seriously injured or killed in a crash if the child is not properly secured in the child restraint. Secure the child properly following the instructions that came with that child restraint.

### Where to Put the Restraint

According to accident statistics, children and infants are safer when properly restrained in a child restraint system or infant restraint system secured in a rear seating position.

We recommend that children and child restraints be secured in a rear seat, including: an infant or a child riding in a rear-facing child restraint; a child riding in a forward-facing child seat; an older child riding in a booster seat; and children, who are large enough, using safety belts.

## 1-30 Seats and Restraint System

---

A label on the sun visor says, "Never put a rear-facing child restraint in the front." This is because the risk to the rear-facing child is so great, if the airbag deploys.

### CAUTION

A child in a rear-facing child restraint can be seriously injured or killed if the right front passenger airbag inflates. This is because the back of the rear-facing child restraint would be very close to the inflating airbag. A child in a forward-facing child restraint can be seriously injured or killed if the right front passenger airbag inflates and the passenger seat is in a forward position.

(Continued)

### CAUTION (Continued)

Even if the passenger sensing system has turned off the right front passenger frontal airbag, no system is fail-safe. No one can guarantee that an airbag will not deploy under some unusual circumstance, even though it is turned off.

Secure rear-facing child restraints in a rear seat, even if the airbag is off. If you secure a forward-facing child restraint in the right front seat, always move the front passenger seat as far back as it will go. It is better to secure the child restraint in a rear seat.

See *Passenger Sensing System on page 1-49* for additional information.

If the vehicle does not have a rear seat that will accommodate a rear-facing child restraint, a rear-facing child restraint should not be installed in the vehicle, even if the airbag is off.

When securing a child restraint in a rear seating position, study the instructions that came with your child restraint to make sure it is compatible with this vehicle.

Wherever a child restraint is installed, be sure to secure the child restraint properly.

Keep in mind that an unsecured child restraint can move around in a collision or sudden stop and injure people in the vehicle. Be sure to properly secure any child restraint in the vehicle — even when no child is in it.

## Lower Anchors and Tethers for Children (LATCH)

The LATCH system holds a child restraint during driving or in a crash. This system is designed to make installation of a child restraint easier. The LATCH system uses anchors in the vehicle and attachments on the child restraint that are made for use with the LATCH system.

Make sure that a LATCH-compatible child restraint is properly installed using the anchors, or use the vehicle's safety belts to secure the restraint, following the instructions that came with that restraint, and also the instructions in this manual. When installing a child restraint with a top tether, you must also use either the lower anchors or the safety belts to properly secure the child restraint. A child restraint must never be installed using only the top tether and anchor.

In order to use the LATCH system in your vehicle, you need a child restraint that has LATCH attachments. The child restraint manufacturer will provide you with instructions on how to use the child restraint and its attachments. The following explains how to attach a child restraint with these attachments in your vehicle.

Not all vehicle seating positions or child restraints have lower anchors and attachments or top tether anchors and attachments.

### Lower Anchors



Lower anchors (A) are metal bars built into the vehicle. There are two lower anchors for each LATCH seating position that will accommodate a child restraint with lower attachments (B).

## 1-32 Seats and Restraint System

### Top Tether Anchor

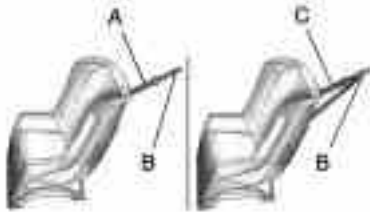

A top tether (A, C) anchors the top of the child restraint to the vehicle. A top tether anchor is built into the vehicle. The top tether attachment (B) on the child restraint connects to the top tether anchor in the vehicle in order to reduce the forward movement and rotation of the child restraint during driving or in a crash.

Your child restraint may have a single tether (A) or a dual tether (C). Either will have a single attachment (B) to secure the top tether to the anchor.

Some child restraints that have top tethers are designed for use with or without the top tether being attached. Others require the top tether always to be attached.

In Canada, the law requires that forward-facing child restraints have a top tether, and that the tether be attached. Be sure to read and follow the instructions for your child restraint.

If the child restraint does not have a top tether, one can be obtained, in kit form, for many child restraints. Ask the child restraint manufacturer whether or not a kit is available.

### Lower Anchor and Top Tether Anchor Locations

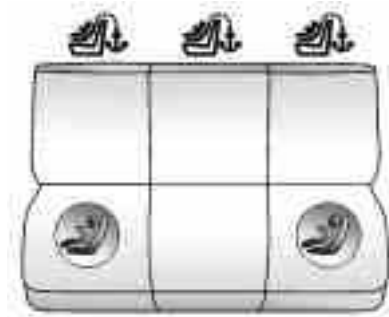

Rear Seat

 (Top Tether Anchor): Seating positions with top tether anchors.

 (Lower Anchor): Seating positions with two lower anchors.



To assist you in locating the lower anchors, each seating position with lower anchors has two labels, near the crease between the seatback and the seat cushion.



To assist you in locating the top tether anchors, the top tether anchor symbol is located near the top tether anchors.

The top tether anchors are located on the back of the rear seatback. Be sure to use an anchor located on the same side of the vehicle as the seating position where the child restraint will be placed.



Do not secure a child restraint in a position without a top tether anchor if a national or local law requires that the top tether be attached, or if the instructions that come with the child restraint say that the top tether must be attached.

Accident statistics show that children are safer if they are restrained in the rear rather than the front seat. See *Where to Put the Restraint on page 1-29* for additional information.

## 1-34 Seats and Restraint System

---

### Securing a Child Restraint Designed for the LATCH System

#### CAUTION

If a LATCH-type child restraint is not attached to anchors, the child restraint will not be able to protect the child correctly. In a crash, the child could be seriously injured or killed. Install a LATCH-type child restraint properly using the anchors, or use the vehicle's safety belts to secure the restraint, following the instructions that came with the child restraint and the instructions in this manual.

#### CAUTION

Do not attach more than one child restraint to a single anchor. Attaching more than one child restraint to a single anchor could cause the anchor or attachment to come loose or even break during a crash. A child or others could be injured. To reduce the risk of serious or fatal injuries during a crash, attach only one child restraint per anchor.

#### CAUTION

Children can be seriously injured or strangled if a shoulder belt is wrapped around their neck and the safety belt continues to tighten. Buckle any unused safety belts behind the child restraint so children cannot reach them. Pull the shoulder belt all the way out of the retractor to set the lock, if your vehicle has one, after the child restraint has been installed.

**Notice:** Do not let the LATCH attachments rub against the vehicle's safety belts. This may damage these parts. If necessary, move buckled safety belts to avoid rubbing the LATCH attachments.

**Do not fold the empty rear seat with a safety belt buckled. This could damage the safety belt or the seat. Unbuckle and return the safety belt to its stowed position, before folding the seat.**

1. Attach and tighten the lower attachments to the lower anchors. If the child restraint does not have lower attachments or the desired seating position does not have lower anchors, secure the child restraint with the top tether and the safety belts. Refer to your child restraint manufacturer instructions and the instructions in this manual.
  - 1.1. Find the lower anchors for the desired seating position.
  - 1.2. Put the child restraint on the seat.
  - 1.3. Attach and tighten the lower attachments on the child restraint to the lower anchors.

2. If the child restraint manufacturer recommends that the top tether be attached, attach and tighten the top tether to the top tether anchor, if equipped. Refer to the child restraint instructions and the following steps:
  - 2.1. Find the top tether anchor.
  - 2.2. Route, attach, and tighten the top tether according to your child restraint instructions and the following instructions:



If the position you are using does not have a headrest or head restraint and you are using a single tether, route the tether over the seatback.



If the position you are using does not have a headrest or head restraint and you are using a dual tether, route the tether over the seatback.



If the position you are using has an adjustable headrest or head restraint and you are using a dual tether, route the tether around the headrest or head restraint.



If the position you are using has an adjustable headrest or head restraint and you are using a single tether, raise the headrest or head restraint and route the tether under the headrest or head restraint and in between the headrest or head restraint posts.

3. Push and pull the child restraint in different directions to be sure it is secure.

### Securing a Child Restraint in a Rear Seat Position

When securing a child restraint in a rear seating position, study the instructions that came with the child restraint to make sure it is compatible with this vehicle.

If the child restraint has the LATCH system, see *Lower Anchors and Tethers for Children (LATCH)* on page 1-31 for how and where to install the child restraint using LATCH. If a child restraint is secured in the vehicle using a safety belt and it uses a top tether, see *Lower Anchors and Tethers for Children (LATCH)* on page 1-31 for top tether anchor locations.

Do not secure a child seat in a position without a top tether anchor if a national or local law requires that the top tether be anchored, or if the instructions that come with the child restraint say that the top strap must be anchored.



In Canada, the law requires that forward-facing child restraints have a top tether, and that the tether be attached.

If the child restraint does not have the LATCH system, you will be using the safety belt to secure the child restraint in this position. Be sure to follow the instructions that came with the child restraint. Secure the child in the child restraint when and as the instructions say.

If more than one child restraint needs to be installed in the rear seat, be sure to read *Where to Put the Restraint on page 1-29*.

1. Put the child restraint on the seat.
2. Pick up the latch plate, and run the lap and shoulder portions of the vehicle's safety belt through or around the restraint. The child restraint instructions will show you how.



3. Push the latch plate into the buckle until it clicks. Position the release button on the buckle so that the safety belt could be quickly unbuckled if necessary.



4. Pull the rest of the shoulder belt all the way out of the retractor to set the lock.



5. To tighten the belt, push down on the child restraint, pull the shoulder portion of the belt to tighten the lap portion of the belt and feed the shoulder belt back into the retractor. When installing a forward-facing child restraint, it may be helpful to use your knee to push down on the child restraint as you tighten the belt.

6. If the child restraint has a top tether, follow the child restraint manufacturer's instructions regarding the use of the top tether. See *Lower Anchors and Tethers for Children (LATCH)* on page 1-31 for more information.
7. Push and pull the child restraint in different directions to be sure it is secure.

To remove the child restraint, unbuckle the vehicle safety belt and let it return to the stowed position. If the top tether is attached to a top tether anchor, disconnect it.

### Securing a Child Restraint in the Right Front Seat Position

The vehicle has airbags. A rear seat is a safer place to secure a forward-facing child restraint. See *Where to Put the Restraint* on page 1-29.

In addition, the vehicle has a passenger sensing system which is designed to turn off the right front passenger frontal airbag under certain conditions. See *Passenger Sensing System* on page 1-49 and *Passenger Airbag Status Indicator* on page 3-26 for more information, including important safety information.

A label on the sun visor says, "Never put a rear-facing child seat in the front." This is because the risk to the rear-facing child is so great, if the airbag deploys.

 **CAUTION**

A child in a rear-facing child restraint can be seriously injured or killed if the right front passenger airbag inflates. This is because the back of the rear-facing child restraint would be very close to the inflating airbag. A child in a forward-facing child restraint can be seriously injured or killed if the right front passenger airbag inflates and the passenger seat is in a forward position.

Even if the passenger sensing system has turned off the right front passenger frontal airbag, no system is fail-safe. No one can guarantee that an airbag will not deploy under some unusual circumstance, even though it is turned off.

(Continued)

**CAUTION (Continued)**

Secure rear-facing child restraints in a rear seat, even if the airbag is off. If you secure a forward-facing child restraint in the right front seat, always move the front passenger seat as far back as it will go. It is better to secure the child restraint in a rear seat.

See *Passenger Sensing System* on page 1-49 for additional information.

If the vehicle does not have a rear seat that will accommodate a rear-facing child restraint, a rear-facing child restraint should not be installed in the vehicle, even if the airbag is off.

If the child restraint has the LATCH system, see *Lower Anchors and Tethers for Children (LATCH)* on page 1-31 for how and where to install the child restraint using LATCH. If a child restraint is secured using a safety belt and it uses a top tether, see *Lower Anchors and Tethers for Children (LATCH)* on page 1-31 for top tether anchor locations.

Do not secure a child seat in a position without a top tether anchor if a national or local law requires that the top tether be anchored, or if the instructions that come with the child restraint say that the top strap must be anchored.

In Canada, the law requires that forward-facing child restraints have a top tether, and that the tether be attached.

## 1-40 Seats and Restraint System

---

You will be using the lap-shoulder belt to secure the child restraint in this position. Follow the instructions that came with the child restraint.

1. Move the seat as far back as it will go before securing the forward-facing child restraint.

When the passenger sensing system has turned off the right front passenger frontal airbag, the off indicator on the passenger airbag status indicator should light and stay lit when the vehicle is started. See *Passenger Airbag Status Indicator* on page 3-26.

2. Put the child restraint on the seat.
3. Pick up the latch plate, and run the lap and shoulder portions of the vehicle's safety belt through or around the restraint. The child restraint instructions will show you how.



4. Push the latch plate into the buckle until it clicks. Position the release button on the buckle so that the safety belt could be quickly unbuckled if necessary.

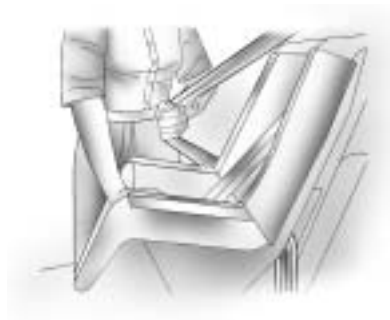

5. Pull the rest of the shoulder belt all the way out of the retractor to set the lock.



6. To tighten the belt, push down on the child restraint, pull the shoulder portion of the belt to tighten the lap portion of the belt and feed the shoulder belt back into the retractor. When installing a forward-facing child restraint, it may be helpful to use your knee to push down on the child restraint as you tighten the belt.

7. If the vehicle does not have a rear seat and the child restraint has a top tether, follow the child restraint manufacturer's instructions regarding the use of the top tether. See *Lower Anchors and Tethers for Children (LATCH)* on page 1-31 for more information.
8. Push and pull the child restraint in different directions to be sure it is secure.

If the airbag is off, the off indicator in the passenger airbag status indicator will come on and stay on when the vehicle is started.

If a child restraint has been installed and the on indicator is lit, see "If the On Indicator is Lit for a Child Restraint" under *Passenger Sensing System* on page 1-49 for more information.

To remove the child restraint, unbuckle the vehicle safety belt and let it return to the stowed position.

## Airbag System

The vehicle has the following airbags:

- A frontal airbag for the driver.
- A frontal airbag for the right front passenger.
- A seat-mounted side impact airbag for the driver.
- A seat-mounted side impact airbag for the right front passenger.
- A roof-rail airbag for the driver and the passenger seated directly behind the driver.
- A roof-rail airbag for the right front passenger and the passenger seated directly behind the right front passenger.

All of the airbags in the vehicle will have the word AIRBAG embossed in the trim or on an attached label near the deployment opening.

## 1-42 Seats and Restraint System

---

For frontal airbags, the word AIRBAG will appear on the middle part of the steering wheel for the driver and on the instrument panel for the right front passenger.

With seat-mounted side impact airbags, the word AIRBAG will appear on the side of the seatback closest to the door.

With roof-rail airbags, the word AIRBAG will appear along the headliner or trim.

Even if you do not have a right front passenger seat in the vehicle there is still an active frontal airbag in the right side of the instrument panel. Do not place cargo in front of this airbag.

### CAUTION

Be sure that cargo is not near an airbag. In a crash, an inflating airbag might force that object toward a person. This could cause severe injury or even death. Secure objects away from the area in which an airbag would inflate. For more information, see *Where Are the Airbags?* on page 1-44 and *Loading the Vehicle* on page 4-18.

Airbags are designed to supplement the protection provided by safety belts. Even though today's airbags are also designed to help reduce the risk of injury from the force of an inflating bag, all airbags must inflate very quickly to do their job.

Here are the most important things to know about the airbag system:

### CAUTION

You can be severely injured or killed in a crash if you are not wearing your safety belt — even if you have airbags. Airbags are designed to work with safety belts, but do not replace them. Also, airbags are not designed to deploy in every crash. In some crashes safety belts are your only restraint. See *When Should an Airbag Inflate?* on page 1-45.

Wearing your safety belt during a crash helps reduce your chance of hitting things inside the vehicle or being ejected from it. Airbags are “supplemental restraints” to the safety belts. Everyone in your vehicle should wear a safety belt properly — whether or not there is an airbag for that person.

 **CAUTION**

Airbags inflate with great force, faster than the blink of an eye. Anyone who is up against, or very close to, any airbag when it inflates can be seriously injured or killed. Do not sit unnecessarily close to the airbag, as you would be if you were sitting on the edge of your seat or leaning forward. Safety belts help keep you in position before and during a crash. Always wear your safety belt, even with airbags. The driver should sit as far back as possible while still maintaining control of the vehicle.

Occupants should not lean on or sleep against the door or side windows in seating positions with seat-mounted side impact airbags and/or roof-rail airbags.

 **CAUTION**

Children who are up against, or very close to, any airbag when it inflates can be seriously injured or killed. Airbags plus lap-shoulder belts offer protection for adults and older children, but not for young children and infants. Neither the vehicle's safety belt system nor its airbag system is designed for them. Young children and infants need the protection that a child restraint system can provide. Always secure children properly in your vehicle. To read how, see *Older Children on page 1-22* or *Infants and Young Children on page 1-25*.



There is an airbag readiness light on the instrument panel cluster, which shows the airbag symbol.

The system checks the airbag electrical system for malfunctions. The light tells you if there is an electrical problem. See *Airbag Readiness Light on page 3-25* for more information.

## 1-44 Seats and Restraint System

---

### Where Are the Airbags?



The driver frontal airbag is in the middle of the steering wheel.



The right front passenger frontal airbag is in the instrument panel on the passenger side.



**Driver Side shown, Passenger Side similar**

The seat-mounted side impact airbags for the driver and right front passenger are in the side of the seatbacks closest to the door.





**Driver Side shown, Passenger Side similar**

The roof-rail airbags for the driver, right front passenger, and second row outboard passengers are in the ceiling above the side windows.

**⚠ CAUTION**

If something is between an occupant and an airbag, the airbag might not inflate properly or it might force the object into that person causing severe injury or even death. The path of an inflating airbag must be kept clear. Do not put anything between an occupant and an airbag, and do not attach or put anything on the steering wheel hub or on or near any other airbag covering.

Do not use seat accessories that block the inflation path of a seat-mounted side impact airbag.

Never secure anything to the roof of a vehicle with roof-rail airbags by routing a rope or tie down through any door or window opening. If you do, the path of an inflating roof-rail airbag will be blocked.

**When Should an Airbag Inflate?**

Frontal airbags are designed to inflate in moderate to severe frontal or near-frontal crashes to help reduce the potential for severe injuries mainly to the driver's or right front passenger's head and chest. However, they are only designed to inflate if the impact exceeds a predetermined deployment threshold. Deployment thresholds are used to predict how severe a crash is likely to be in time for the airbags to inflate and help restrain the occupants.

Whether the frontal airbags will or should deploy is not based on how fast your vehicle is traveling. It depends largely on what you hit, the direction of the impact, and how quickly your vehicle slows down.

## 1-46 Seats and Restraint System

---

Frontal airbags may inflate at different crash speeds. For example:

- If the vehicle hits a stationary object, the airbags could inflate at a different crash speed than if the vehicle hits a moving object.
- If the vehicle hits an object that deforms, the airbags could inflate at a different crash speed than if the vehicle hits an object that does not deform.
- If the vehicle hits a narrow object (like a pole), the airbags could inflate at a different crash speed than if the vehicle hits a wide object (like a wall).
- If the vehicle goes into an object at an angle, the airbags could inflate at a different crash speed than if the vehicle goes straight into the object.

Thresholds can also vary with specific vehicle design.

Frontal airbags are not intended to inflate during vehicle rollovers, rear impacts, or in many side impacts.

In addition, the vehicle has dual-stage frontal airbags. Dual-stage airbags adjust the restraint according to crash severity. The vehicle has electronic frontal sensors, which help the sensing system distinguish between a moderate frontal impact and a more severe frontal impact. For moderate frontal impacts, dual-stage airbags inflate at a level less than full deployment. For more severe frontal impacts, full deployment occurs.

The vehicle has seat-mounted side impact and roof-rail airbags. See *Airbag System on page 1-41*. Seat-mounted side impact and roof-rail airbags are intended to inflate in moderate to severe side crashes. In addition, these roof-rail airbags are intended to inflate during a rollover or in a severe frontal impact. Seat-mounted side impact and roof-rail airbags will inflate if the crash severity is above the

system's designed threshold level. The threshold level can vary with specific vehicle design.

Seat-mounted side impact airbags are not intended to inflate in frontal impacts, near-frontal impacts, rollovers, or rear impacts. Roof-rail airbags are not intended to inflate in rear impacts. A seat-mounted side impact airbag is intended to deploy on the side of the vehicle that is struck. Both roof-rail airbags will deploy when either side of the vehicle is struck, or if the sensing system predicts that the vehicle is about to roll over, or in a severe frontal impact.

In any particular crash, no one can say whether an airbag should have inflated simply because of the damage to a vehicle or because of what the repair costs were. For frontal airbags, inflation is determined by what the vehicle hits, the angle of the impact, and how quickly the vehicle slows down. For seat-mounted side impact and roof-rail airbags, deployment

is determined by the location and severity of the side impact. In a rollover event, roof-rail airbag deployment is determined by the direction of the roll.

### What Makes an Airbag Inflate?

In a deployment event, the sensing system sends an electrical signal triggering a release of gas from the inflator. Gas from the inflator fills the airbag causing the bag to break out of the cover and deploy. The inflator, the airbag, and related hardware are all part of the airbag module.

Frontal airbag modules are located inside the steering wheel and instrument panel. For vehicles with seat-mounted side impact airbags, there are airbag modules in the side of the front seatbacks closest to the door. For vehicles with roof-rail airbags, there are airbag modules

in the ceiling of the vehicle, near the side windows that have occupant seating positions.

### How Does an Airbag Restrain?

In moderate to severe frontal or near frontal collisions, even belted occupants can contact the steering wheel or the instrument panel. In moderate to severe side collisions, even belted occupants can contact the inside of the vehicle.

Airbags supplement the protection provided by safety belts. Frontal airbags distribute the force of the impact more evenly over the occupant's upper body, stopping the occupant more gradually. Seat-mounted side impact and roof-rail airbags distribute the force of the impact more evenly over the occupant's upper body.

Rollover capable roof-rail airbags are designed to help contain the head and chest of occupants in the outboard seating positions in the first and second rows. The rollover capable roof-rail airbags are designed to help reduce the risk of full or partial ejection in rollover events, although no system can prevent all such ejections.

But airbags would not help in many types of collisions, primarily because the occupant's motion is not toward those airbags. See *When Should an Airbag Inflate?* on page 1-45 for more information.

Airbags should never be regarded as anything more than a supplement to safety belts.

### What Will You See After an Airbag Inflates?

After the frontal airbags and seat-mounted side impact airbags inflate, they quickly deflate, so quickly that some people may not even realize an airbag inflated. Roof-rail airbags may still be at least partially inflated for some time after they deploy. Some components of the airbag module may be hot for several minutes. For location of the airbag modules, see *What Makes an Airbag Inflate?* on page 1-47.

The parts of the airbag that come into contact with you may be warm, but not too hot to touch. There may be some smoke and dust coming from the vents in the deflated airbags. Airbag inflation does not prevent the driver from seeing out of the windshield or being able to steer the vehicle, nor does it prevent people from leaving the vehicle.

#### CAUTION

When an airbag inflates, there may be dust in the air. This dust could cause breathing problems for people with a history of asthma or other breathing trouble. To avoid this, everyone in the vehicle should get out as soon as it is safe to do so. If you have breathing problems but cannot get out of the vehicle after an airbag inflates, then get fresh air by opening a window or a door. If you experience breathing problems following an airbag deployment, you should seek medical attention.

The vehicle has a feature that may automatically unlock the doors, turn the interior lamps on, and turn the hazard warning flashers on when the airbags inflate. You can lock the doors, turn the interior lamps off, and turn the hazard warning flashers off by using the

controls for those features. You must first, however, turn the ignition key to the following ignition switch positions:

1. Turn the ignition key to LOCK/OFF.
2. Turn the ignition key to ON/RUN.

In many crashes severe enough to inflate the airbag, windshields are broken by vehicle deformation. Additional windshield breakage may also occur from the right front passenger airbag.

- Airbags are designed to inflate only once. After an airbag inflates, you will need some new parts for the airbag system. If you do not get them, the airbag system will not be there to help protect you in another crash. A new system will include airbag modules and possibly other parts. The service manual for your vehicle covers the need to replace other parts.

- The vehicle has a crash sensing and diagnostic module which records information after a crash. See *Vehicle Data Recording and Privacy on page 7-14* and *Event Data Recorders on page 7-14*.
- Let only qualified technicians work on the airbag systems. Improper service can mean that an airbag system will not work properly. See your dealer/retailer for service.

## Passenger Sensing System

The vehicle has a passenger sensing system for the right front passenger position. The passenger airbag status indicator will be visible on the instrument panel when the vehicle is started.



United States



Canada

The words ON and OFF, or the symbol for on and off, are visible during the system check. If you are using remote start, if equipped, to start the vehicle from a distance, you may not see the system

check. When the system check is complete, either the word ON or OFF, or the symbol for on or off, will be visible. See *Passenger Airbag Status Indicator on page 3-26*.

The passenger sensing system turns off the right front passenger frontal airbag and seat-mounted side impact airbag under certain conditions. The driver airbags and the roof-rail airbags are not affected by the passenger sensing system.

The passenger sensing system works with sensors that are part of the right front passenger seat and safety belt. The sensors are designed to detect the presence of a properly-seated occupant and determine if the right front passenger frontal airbag and seat-mounted side impact airbag should be enabled (may inflate) or not.

## 1-50 Seats and Restraint System

---

According to accident statistics, children are safer when properly secured in a rear seat in a correct child restraint for their weight and size.

We recommend that children be secured in a rear seat, including: an infant or a child riding in a rear-facing child restraint; a child riding in a forward-facing child seat; an older child riding in a booster seat; and children, who are large enough, using safety belts.

A label on the sun visor says, "Never put a rear-facing child seat in the front." This is because the risk to the rear-facing child is so great, if the airbag deploys.

### CAUTION

A child in a rear-facing child restraint can be seriously injured or killed if the right front passenger airbag inflates. This is because the back of the rear-facing child restraint would be very close to the inflating airbag. A child in a forward-facing child restraint can be seriously injured or killed if the right front passenger airbag inflates and the passenger seat is in a forward position.

Even if the passenger sensing system has turned off the right front passenger frontal airbag and seat-mounted side impact airbag

(Continued)

### CAUTION (Continued)

(if equipped), no system is fail-safe. No one can guarantee that an airbag will not deploy under some unusual circumstance, even though the airbag(s) are off.

Secure rear-facing child restraints in a rear seat, even if the airbag(s) are off. If you secure a forward-facing child restraint in the right front seat, always move the front passenger seat as far back as it will go. It is better to secure the child restraint in a rear seat.

If the vehicle does not have a rear seat that will accommodate a rear-facing child restraint, a rear-facing child restraint should not be installed in the vehicle, even if the airbag is off.

The passenger sensing system is designed to turn off the right front passenger airbag and seat-mounted side impact airbag if:

- The right front passenger seat is unoccupied.
- The system determines that an infant is present in a rear-facing infant seat.
- The system determines that a small child is present in a child restraint.

- The system determines that a small child is present in a booster seat.
- A right front passenger takes his/her weight off of the seat for a period of time.
- The right front passenger seat is occupied by a smaller person, such as a child who has outgrown child restraints.
- Or, if there is a critical problem with the airbag system or the passenger sensing system.

When the passenger sensing system has turned off the right front passenger frontal airbag and seat-mounted side impact airbag, the off indicator will light and stay lit to remind you that the airbags are off. See *Passenger Airbag Status Indicator* on page 3-26.

The passenger sensing system is designed to turn on (may inflate) the right front passenger frontal airbag and seat-mounted side impact airbag anytime the system senses that a person of adult size is sitting properly in the right front passenger seat.

When the passenger sensing system has allowed the airbags to be enabled, the on indicator will light and stay lit to remind you that the airbags are active.

## 1-52 Seats and Restraint System

---

For some children who have outgrown child restraints and for very small adults, the passenger sensing system may or may not turn off the right front passenger frontal airbag and seat-mounted side impact airbag, depending upon the person's seating posture and body build. Everyone in the vehicle who has outgrown child restraints should wear a safety belt properly —whether or not there is an airbag for that person.

### CAUTION

If the airbag readiness light ever comes on and stays on, it means that something may be wrong with the airbag system. To help avoid injury to yourself or others, have the vehicle serviced right away. See *Airbag Readiness Light* on page 3-25 for more information, including important safety information.

### **If the On Indicator is Lit for a Child Restraint**

If a child restraint has been installed and the on indicator is lit:

1. Turn the vehicle off.
2. Remove the child restraint from the vehicle.
3. Remove any additional items from the seat such as blankets, cushions, seat covers, seat heaters, or seat massagers.
4. Reinstall the child restraint following the directions provided by the child restraint manufacturer and refer to *Securing a Child Restraint in the Right Front Seat Position* on page 1-38.

5. If, after reinstalling the child restraint and restarting the vehicle, the on indicator is still lit, turn the vehicle off. Then slightly recline the vehicle seatback and adjust the seat cushion, if adjustable, to make sure that the vehicle seatback is not pushing the child restraint into the seat cushion.

Also make sure the child restraint is not trapped under the vehicle head restraint. If this happens, adjust the head restraint. See *Head Restraints* on page 1-2.

6. Restart the vehicle.  
If the on indicator is still lit with an infant present in a child restraint, secure the child restraint in a rear seat position in the vehicle and see your dealer/retailer.



### If the Off Indicator is Lit for an Adult-Size Occupant



If a person of adult-size is sitting in the right front passenger seat, but the off indicator is lit, it could be because that person is not sitting properly in the seat.

If this happens, use the following steps to allow the system to detect that person and enable the right front passenger frontal airbag and seat-mounted side impact airbag:

1. Turn the vehicle off.
2. Remove any additional material from the seat, such as blankets, cushions, seat covers, seat heaters, or seat massagers.
3. Place the seatback in the fully upright position.
4. Have the person sit upright in the seat, centered on the seat cushion, with legs comfortably extended.
5. Restart the vehicle and have the person remain in this position for two to three minutes after the on indicator is lit.

### Additional Factors Affecting System Operation

Safety belts help keep the passenger in position on the seat during vehicle maneuvers and braking, which helps the passenger sensing system maintain the passenger airbag status. See “Safety Belts” and “Child Restraints” in the Index for additional information about the importance of proper restraint use.

## 1-54 Seats and Restraint System

A thick layer of additional material, such as a blanket or cushion, or aftermarket equipment such as seat covers, seat heaters, and seat massagers can affect how well the passenger sensing system operates. We recommend that you not use seat covers or other aftermarket equipment except when approved by GM for your specific vehicle. See *Adding Equipment to Your Airbag-Equipped Vehicle on page 1-55* for more information about modifications that can affect how the system operates.

### CAUTION

Stowing of articles under the passenger seat or between the passenger seat cushion and seatback may interfere with the proper operation of the passenger sensing system.

## Servicing Your Airbag-Equipped Vehicle

Airbags affect how the vehicle should be serviced. There are parts of the airbag system in several places around the vehicle. Your dealer/retailer and the service manual have information about servicing the vehicle and the airbag system. To purchase a service manual, see *Service Publications Ordering Information on page 7-13*.

### CAUTION

For up to 10 seconds after the ignition is turned off and the battery is disconnected, an airbag can still inflate during improper service. You can be injured if you are close to an airbag when it inflates. Avoid yellow connectors. They are probably part of the airbag system. Be sure to follow proper service procedures, and make sure the person performing work for you is qualified to do so.

## Adding Equipment to Your Airbag-Equipped Vehicle

**Q:** Is there anything I might add to or change about the vehicle that could keep the airbags from working properly?

**A:** Yes. If you add things that change the vehicle's frame, bumper system, height, front end or side sheet metal, they may keep the airbag system from working properly. Changing or moving any parts of the front seats, safety belts, the airbag sensing and diagnostic module, steering wheel, instrument panel, roof-rail airbag modules, ceiling headliner or pillar garnish trim, front sensors, side impact sensors, rollover sensor module, or airbag wiring can affect the operation of the airbag system.

In addition, the vehicle has a passenger sensing system for the right front passenger position, which includes sensors that are part of the passenger seat. The passenger sensing system may not operate properly if the original seat trim is replaced with non-GM covers, upholstery or trim, or with GM covers, upholstery or trim designed for a different vehicle. Any object, such as an aftermarket seat heater or a comfort enhancing pad or device, installed under or on top of the seat fabric, could also interfere with the operation of the passenger sensing system. This could either prevent proper deployment of the passenger airbag(s) or prevent the passenger sensing system from properly turning off the passenger airbag(s). See *Passenger Sensing System on page 1-49*.

If you have questions, call Customer Assistance. The phone numbers and addresses for Customer Assistance are in Step Two of the Customer Satisfaction Procedure in this manual. See *Customer Satisfaction Procedure on page 7-1*.

If the vehicle has rollover roof-rail airbags, see *Different Size Tires and Wheels on page 5-53* for additional important information.

**Q:** Because I have a disability, I have to get my vehicle modified. How can I find out whether this will affect my airbag system?

**A:** If you have questions, call Customer Assistance. The phone numbers and addresses for Customer Assistance are in Step Two of the Customer Satisfaction Procedure in this manual. See *Customer Satisfaction Procedure on page 7-1*.

In addition, your dealer/retailer and the service manual have information about the location of the airbag sensors, sensing and diagnostic module and airbag wiring.

## Restraint System Check

### Checking the Restraint Systems

#### Safety Belts

Now and then, check that the safety belt reminder light, safety belts, buckles, latch plates, retractors, and anchorages are all working properly.

Look for any other loose or damaged safety belt system parts that might keep a safety belt system from doing its job. See your dealer/retailer to have it repaired. Torn or frayed safety belts may not protect you in a crash. They can rip apart under impact forces. If a belt is torn or frayed, get a new one right away.

Make sure the safety belt reminder light is working. See *Safety Belt Reminders on page 3-24* for more information.

Keep safety belts clean and dry. See *Care of Safety Belts on page 5-69*.

#### Airbags

The airbag system does not need regularly scheduled maintenance or replacement. Make sure the airbag readiness light is working. See *Airbag Readiness Light on page 3-25* for more information.

**Notice:** If an airbag covering is damaged, opened, or broken, the airbag may not work properly. Do not open or break the airbag coverings. If there are any opened or broken airbag covers, have the airbag covering and/or airbag module replaced. For the location of the airbag modules, see *What Makes an Airbag Inflate? on page 1-47*. See your dealer/retailer for service.

## Replacing Restraint System Parts After a Crash

### CAUTION

A crash can damage the restraint systems in your vehicle. A damaged restraint system may not properly protect the person using it, resulting in serious injury or even death in a crash. To help make sure your restraint systems are working properly after a crash, have them inspected and any necessary replacements made as soon as possible.

After a minor crash, replacement of safety belts may not be necessary. But the safety belt assemblies that were used during any crash may have been stressed or damaged. See your dealer/retailer to have the safety belt assemblies inspected or replaced.

If the vehicle has the LATCH system and it was being used during a crash, you may need new LATCH system parts.

New parts and repairs may be necessary even if the safety belt or LATCH system (if equipped), was not being used at the time of the crash.

If an airbag inflates, you will need to replace airbag system parts. See the part on the airbag system earlier in this section.

Have the safety belt pretensioners checked if the vehicle has been in a crash, if the airbag readiness light stays on after you start the vehicle, or while you are driving. See *Airbag Readiness Light on page 3-25*.

If an airbag inflates or the vehicle has been in a crash, the vehicle's sensing system may command the automatic hybrid battery disconnect to open. The battery will disconnect. The hybrid battery will be off and the vehicle will not start. The airbag readiness light may come on. See *Airbag Readiness Light on page 3-25* for more information. To operate the vehicle, the automatic hybrid battery disconnect must be reconnected by a qualified service technician and sensing system parts will need to be replaced. Have the vehicle serviced right away.



## Features and Controls

### Keys

Keys .....	2-2
Remote Keyless Entry (RKE) System .....	2-3
Remote Keyless Entry (RKE) System Operation .....	2-4

### Doors and Locks

Door Locks .....	2-6
Power Door Locks .....	2-6
Delayed Locking .....	2-6
Automatic Door Lock .....	2-7
Automatic Door Unlock .....	2-7
Rear Door Security Locks .....	2-7
Lockout Protection .....	2-7
Liftgate .....	2-8

### Windows

Windows .....	2-9
Power Windows .....	2-9
Sun Visors .....	2-10

### Theft-Deterrent Systems

Theft-Deterrent Systems .....	2-10
Content Theft-Deterrent .....	2-10
PASS-Key® III+ Electronic Immobilizer .....	2-12
PASS-Key® III+ Electronic Immobilizer Operation .....	2-12

### Starting and Operating Your Vehicle

New Vehicle Break-In .....	2-14
Ignition Positions .....	2-14
Retained Accessory Power (RAP) .....	2-15
Starting the Engine (Automatic Engine Start/Stop) .....	2-15
Engine Coolant Heater .....	2-19
Automatic Transmission Operation .....	2-20
Parking Brake .....	2-22

Regenerative Braking .....	2-23
Shifting Into Park .....	2-23
Shifting Out of Park .....	2-25
Parking Over Things That Burn .....	2-25
Engine Exhaust .....	2-26
Running the Vehicle While Parked .....	2-26

### Mirrors

Manual Rearview Mirror .....	2-27
Automatic Dimming Rearview Mirror .....	2-27
Outside Power Mirrors .....	2-28
Outside Convex Mirror .....	2-28
Outside Heated Mirrors .....	2-28

### OnStar® System

OnStar® System .....	2-29
----------------------	------

### Universal Home Remote System

Universal Home Remote System .....	2-32
Universal Home Remote System Operation .....	2-33

## 2-2 Features and Controls

### Storage Areas

Glove Box .....	2-37
Cupholders .....	2-37
Sunglasses Storage	
Compartment .....	2-37
Center Console Storage ....	2-37
Driver Storage	
Compartment .....	2-38
Rear Seat Armrest .....	2-38
Convenience Net .....	2-38
Cargo Cover .....	2-38
Cargo Tie Downs .....	2-39
Cargo Management	
System .....	2-39

### Keys

#### CAUTION

Leaving children in a vehicle with the ignition key is dangerous for many reasons, children or others could be badly injured or even killed. They could operate the power windows or other controls or even make the vehicle move. The windows will function with the keys in the ignition and children could be seriously injured or killed if caught in the path of a closing window. Do not leave the keys in a vehicle with children.



The two keys can be used for the ignition and all locks.

The key code is stamped on the key number plate and can be used to make new keys at any dealer/retailer. Store this information in a safe place outside the vehicle.



**Notice: If you ever lock your keys in the vehicle, you may have to damage the vehicle to get in. Be sure you have spare keys.**

If you are locked out of the vehicle, contact Roadside Assistance. See *Roadside Assistance Program on page 7-5* for more information.

## Remote Keyless Entry (RKE) System

If this vehicle has the Remote Keyless Entry (RKE) system, it operates on a radio frequency subject to Federal Communications Commission (FCC) Rules and with Industry Canada.

This device complies with Part 15 of the FCC Rules. Operation is subject to the following two conditions:

1. This device may not cause interference.
2. This device must accept any interference received, including interference that may cause undesired operation of the device.

This device complies with RSS-210 of Industry Canada. Operation is subject to the following two conditions:

1. This device may not cause interference.
2. This device must accept any interference received, including interference that may cause undesired operation of the device.

Changes or modifications to this system by other than an authorized service facility could void authorization to use this equipment.

If there is a decrease in the RKE operating range, try this:

- Check the distance. The transmitter may be too far from the vehicle. Stand closer during rainy or snowy weather.
- Check the location. Other vehicles or objects may be blocking the signal. Take a few steps to the left or right, hold the transmitter higher, and try again.
- Check the transmitter's battery. See "Battery Replacement" later in this section.
- If the transmitter is still not working correctly, see your dealer/retailer or a qualified technician for service.

## 2-4 Features and Controls

---



### Remote Keyless Entry (RKE) System Operation

The Remote Keyless Entry (RKE) transmitter functions work up to 65 feet (20 m) away from the vehicle.

There are other conditions which can affect the performance of the transmitter. See *Remote Keyless Entry (RKE) System* on page 2-3.



 **(Lock):** Press to lock all the doors, including the liftgate.

 **(Unlock):** Press once to unlock the driver door. If  is pressed again within five seconds, all other doors unlock. The interior lamps come on for 20 seconds or until the ignition is turned on.

 **(Vehicle Locator/Panic Alarm):** Press and release to activate the alarm. The turn signal lamps flash and the horn sounds three times.

Press and hold  for more than two seconds and the turn signal lamps flash and the horn sounds for 30 seconds.

To turn the alarm off, press  again or turn the ignition to ON/RUN.

## Programming Transmitters to the Vehicle

Only RKE transmitters programmed to the vehicle will work. If a transmitter is lost or stolen, a replacement can be purchased and programmed through your dealer/retailer. When the replacement transmitter is programmed to the vehicle, all remaining transmitters must also be programmed. Any lost or stolen transmitters no longer work once the new transmitter is programmed. Each vehicle can have up to eight transmitters programmed to it. See "HOLD STEM TO RELEARN REMOTE KEY" under *DIC Operation and Displays on page 3-36*.

## Battery Replacement

Replace the battery if the REPLACE REMOTE KEY FOB BATTERY message displays on the Driver Information Center (DIC). See "REPLACE REMOTE KEY FOB BATTERY" under *DIC Warnings and Messages on page 3-42*.

**Notice:** When replacing the battery, do not touch any of the circuitry on the transmitter. Static from your body could damage the transmitter.



To replace the battery:

1. Separate the transmitter with a flat thin object inserted into the notch on the side.
2. Remove the old battery. Do not use a metal object.
3. Insert the new battery, positive side facing down. Replace with a CR2032 or equivalent battery.
4. Reassemble the transmitter.

# Doors and Locks

## Door Locks

### CAUTION

Unlocked doors can be dangerous.

- Passengers, especially children, can easily open the doors and fall out of a moving vehicle. When a door is locked, the handle will not open it. You increase the chance of being thrown out of the vehicle in a crash if the doors are not locked. So, wear safety belts properly and lock the doors whenever you drive.

(Continued)

### CAUTION (Continued)

- Young children who get into unlocked vehicles may be unable to get out. A child can be overcome by extreme heat and can suffer permanent injuries or even death from heat stroke. Always lock your vehicle whenever you leave it.
- Outsiders can easily enter through an unlocked door when you slow down or stop your vehicle. Locking your doors can help prevent this from happening.

To lock or unlock a door, use the key from the outside or the door lock from the inside.

## Power Door Locks

: The power door lock switches are located on the driver door.

- Press the right side of the switch to unlock the doors.
- Remove the ignition key and press the left side of the switch to lock all of the doors.

## Delayed Locking

A chime will sound to indicate a door or liftgate is open when you try to lock the doors with the power door lock switch. The doors will not lock, and the theft-deterrent system will not arm until all the doors are closed and five seconds have passed.

## Automatic Door Lock

The doors are programmed to automatically lock when the shift lever is moved into a forward gear.

The automatic door lock feature cannot be disabled.

## Automatic Door Unlock

The doors will automatically unlock when the shift lever is moved into (P) Park.

## Rear Door Security Locks

The vehicle has rear door security locks to prevent passengers from opening the rear doors from the inside.

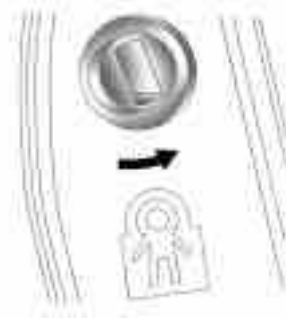

Open the rear doors to access the security locks on the inside edge of each door.

To set the locks, insert a key into the slot and turn it to the horizontal position. The door can only be opened from the outside with the door unlocked. To return the door to normal operation, turn the slot to the vertical position.

## Lockout Protection

When the power door lock switch is pressed with the key in the ignition, and any door is open, all the doors lock and the driver door unlocks. When doors are closed with the key in the ignition, the horn will sound as a reminder.

If the doors are locked with the Remote Keyless Entry (RKE) transmitter, and the key is in the ignition, a chime sounds and all except the driver door lock.

The lockout protection feature can be overridden by holding the power door lock switch for three seconds.

### Liftgate

#### CAUTION

Exhaust gases may enter the vehicle if it is driven with the liftgate, trunk/hatch open, or with any objects that pass through the seal between the body and the trunk/hatch or liftgate. Engine exhaust contains Carbon Monoxide (CO) which cannot be seen or smelled. It can cause unconsciousness and even death.

If the vehicle must be driven with the liftgate, or trunk/hatch open:

- Close all of the windows.
- Fully open the air outlets on or under the instrument panel.
- Adjust the Climate Control system to a setting that brings in only outside air and set the fan speed to the highest setting. See Climate Control System in the Index.

(Continued)

#### CAUTION (Continued)

- If the vehicle is equipped with a power liftgate, disable the power liftgate function.

For more information about carbon monoxide, see *Engine Exhaust* on page 2-26.

To lock or unlock the liftgate, press the button on the Remote Keyless Entry (RKE) transmitter twice or the power door lock switch.

To open the liftgate, press the touchpad on the underside of the liftgate handle and pull up.

To close the liftgate, pull down using the handle and close until it latches.

#### Liftgate Operation with Loss of Power



To open the liftgate if the vehicle's battery is disconnected or the voltage is low, access the release lever. Remove the interior trim cover on the inside of the liftgate. Use a tool to push the lever on the latch until the liftgate releases.

## Windows

### CAUTION

Leaving children, helpless adults, or pets in a vehicle with the windows closed is dangerous. They can be overcome by the extreme heat and suffer permanent injuries or even death from heat stroke. Never leave a child, a helpless adult, or a pet alone in a vehicle, especially with the windows closed in warm or hot weather.



## Power Windows

### CAUTION

Leaving children in a vehicle with the keys is dangerous for many reasons, children or others could be badly injured or even killed. They could operate the power windows or other controls or even make the vehicle move.

(Continued)

### CAUTION (Continued)

The windows will function and they could be seriously injured or killed if caught in the path of a closing window. Do not leave keys in a vehicle with children.

When there are children in the rear seat use the window lockout button to prevent unintentional operation of the windows.



The window switches for all doors are located on the driver door. Each door also has a switch.

## 2-10 Features and Controls

---

To open or close a window, press or pull up on the switch.

The power windows operate when the ignition is in ON/RUN or ACC/ACCESSORY, or while in Retained Accessory Power (RAP). See *Retained Accessory Power (RAP)* on page 2-15.

### Express-Down Window

The driver window switch has an express-down feature that lowers the window without holding the switch. Press the switch part way and the window will open a small amount. Press the switch down all the way and release it and the window lowers all the way.

To stop the window while it is lowering, press and release the switch.

### Window Lockout

 **(Window Lockout):** The vehicle has a lockout feature to prevent rear seat passengers from operating the windows. Press the lockout button, located with the power window switches, to turn the feature on and off.

### Sun Visors

To block out glare, swing the sun visor down, or detach the driver sun visor from the center mount and slide it along the rod from side-to-side.

On a visor with a mirror, lift the cover to use it.

## Theft-Deterrent Systems

Vehicle theft is big business, especially in some cities. This vehicle has theft-deterrent features, however, they do not make it impossible to steal.

### Content Theft-Deterrent



This vehicle may have a content theft-deterrent alarm system.





**United States shown,  
Canada similar**

The security light is located near the center of the instrument panel.





To arm the theft-deterrent system, close all doors and press  on the RKE transmitter. The security light comes on solid for approximately 30 seconds and then flashes slowly. If  is pressed a second time, the theft-deterrent system activates immediately. The content theft deterrent alarm is not armed until the security light flashes slowly.

If any door or the liftgate are opened without using the key or pressing  on the RKE transmitter, the exterior lamps flash and the horn sounds for about 30 seconds. If  or  on the RKE transmitter is not pressed, the alarm sounds and periodically repeats. If the system does not operate as described above, see your dealer/retailer for service.

The theft-deterrent system also activates if the doors are locked with the key.

To avoid setting off the alarm by accident, always unlock a door with the RKE transmitter or a key. Unlocking a door any other way sets off the alarm if the system has been armed.

If the alarm is set off by accident, press  or  on the RKE transmitter or place the key in the ignition and turn it to START to turn it off.

### Testing the Alarm

To test the alarm:

1. From inside the vehicle, lower the driver's window and open the driver door.
2. Get out of the vehicle, close the door and activate the system by pressing  on the RKE transmitter.

3. Wait for the security light to flash slowly.
4. Reach in through the window to unlock the door with the manual door lock and open the door. This should set off the alarm.

If the alarm does not sound when it should, but the vehicle's headlamps flash, check to see if the horn works. The horn fuse may be blown. To replace the fuse, see *Fuses and Circuit Breakers on page 5-75*.

If the alarm does not sound or the vehicle's headlamps do not flash, see your dealer/retailer for service.

## 2-12 Features and Controls

---

### **PASS-Key® III+ Electronic Immobilizer**

The PASS-Key III+ system operates on a radio frequency subject to Federal Communications Commission (FCC) Rules and with Industry Canada.

This device complies with Part 15 of the FCC Rules. Operation is subject to the following two conditions:

1. This device may not cause harmful interference.
2. This device must accept any interference received, including interference that may cause undesired operation.

This device complies with RSS-210 of Industry Canada. Operation is subject to the following two conditions:

1. This device may not cause interference.
2. This device must accept any interference received, including interference that may cause undesired operation of the device.

Changes or modifications to this system by other than an authorized service facility could void authorization to use this equipment.

PASS-Key III+ uses a radio frequency transponder in the key that matches a decoder in the vehicle.

### **PASS-Key® III+ Electronic Immobilizer Operation**

This vehicle has PASS-Key® III+ (Personalized Automotive Security System) theft-deterrent system. PASS-Key® III+ is a passive theft-deterrent system.

The system is automatically armed when the key is removed from the ignition.

You do not have to manually arm or disarm the system.

The security light comes on if there is a problem with arming or disarming the theft-deterrent system.

When the PASS-Key® III+ system senses that someone is using the wrong key, it prevents the vehicle from starting. Anyone using a trial-and-error method to start the vehicle will be discouraged because of the high number of electrical key codes.

When trying to start the vehicle if the engine does not start and the security light on the instrument panel cluster comes on, there may be a problem with your theft-deterrent system. Turn the ignition off and try again.

If the engine still does not start, and the key appears to be not damaged, wait about five minutes and try another ignition key and check the fuse. See *Fuses and Circuit Breakers on page 5-75*. If the engine still does not start with the other key, the vehicle needs service. If the vehicle does start, the first key may be faulty. See your dealer/retailer who can service the PASS-Key® III+ to have a new key made. In an emergency, contact Roadside Assistance. See *Roadside Assistance Program on page 7-5*.

It is possible for the PASS-Key® III+ decoder to “learn” the transponder value of a new or replacement key. Up to 10 keys may be programmed for the vehicle. The following procedure is for programming additional keys only. If all the currently programmed keys are lost or do not operate, you must see your dealer/retailer or a locksmith who can service PASS-Key® III+ to have keys made and programmed to the system.

See your dealer/retailer or a locksmith who can service PASS-Key® III+ to get a new key blank that is cut exactly as the ignition key that operates the system.

To program the new key:

1. Verify that the new key has a ⊕ stamped on it.
2. Insert the already programmed key in the ignition and start the engine. If the engine does not start, see your dealer/retailer for service.

3. After the engine has started, turn the key to LOCK/OFF, and remove the key.
4. Insert the key to be programmed and turn it to the ON/RUN position within five seconds of the original key being turned to the LOCK/OFF position.  
The security light turns off once the key has been programmed.
5. Repeat Steps 1 through 4 if additional keys are to be programmed.

If the PASS-Key® III+ key is lost or damaged, see your dealer/retailer or a locksmith to have a new key made.

Do not leave the key or device that disarms or deactivates the theft deterrent system in the vehicle.

# Starting and Operating Your Vehicle

## New Vehicle Break-In

**Notice:** The vehicle does not need an elaborate break-in. But it will perform better in the long run if you follow these guidelines:

- Do not drive at any one constant speed, fast or slow, for the first 500 miles (805 km). Do not make full-throttle starts. Avoid downshifting to brake or slow the vehicle.
- Avoid making hard stops for the first 200 miles (322 km) or so. During this time the new brake linings are not yet broken in. Hard stops with new linings can mean premature wear and earlier replacement. Follow this breaking-in guideline every time you get new brake linings.

- Do not tow a trailer during break-in. See *Towing a Trailer* on page 4-26 for the trailer towing capabilities of your vehicle and more information.

Following break-in, engine speed and load can be gradually increased.

## Ignition Positions



The ignition switch has four different positions.

To shift out of P (Park), turn the ignition to ON/RUN and apply the regular brake pedal.

**Notice:** Using a tool to force the key to turn in the ignition could cause damage to the switch or break the key. Use the correct key, make sure it is all the way in, and turn it only with your hand. If the key cannot be turned by hand, see your dealer/retailer.

**LOCK/OFF:** This position locks the ignition. It also locks the steering wheel and the transmission. The key can only be removed in LOCK/OFF. The shift lever must be in P (Park) to turn the ignition switch to LOCK/OFF.

The steering can bind with the wheels turned off center. If this happens, move the steering wheel from right to left while turning the key to ACC/ACCESSORY. If this doesn't work, the vehicle needs service.

**ACC (ACC/ACCESSORY):** This is the position in which you can operate the electrical accessories or items plugged into the accessory power outlets.

Use this position if the vehicle must be pushed or towed.

**ON/RUN:** This position can be used to operate the electrical accessories and to display some instrument panel cluster warning and indicator lights. The switch stays in this position when the engine is running. The transmission is also unlocked in this position. If you leave the key in the ACC/ACCESSORY or ON/RUN positions with the engine off, the battery could be drained. You may not be able to start the vehicle if the battery is allowed to drain for an extended period of time.

**START:** This is the position that starts the engine. When the engine starts, release the key. The ignition switch returns to ON/RUN for driving.

A warning tone will sound when the driver door is opened, the ignition is in ACC/ACCESSORY or LOCK/OFF and the key is in the ignition.

### Retained Accessory Power (RAP)

These vehicle accessories may be used for up to 10 minutes after the ignition key is turned off:

- Outside Mirror
- Power Windows
- Radio

All these features work when the ignition key is in the ON/RUN or ACC/ACCESSORY positions, until a door is opened.

### Starting the Engine (Automatic Engine Start/Stop)

Place the transmission in the proper gear.

Move the shift lever to P (Park) or N (Neutral). The engine will not start in any other position. To restart the engine when the vehicle is already moving, use N (Neutral) only.

**Notice:** Do not try to shift to P (Park) if the vehicle is moving. If you do, you could damage the transmission. Shift to P (Park) only when the vehicle is stopped.

#### Starting Procedure

1. With your foot off the accelerator pedal, turn the ignition key to START. When the engine starts, let go of the key. The idle speed will go down as your engine gets warm. Do not race the engine immediately after starting it.

## 2-16 Features and Controls

---

Operate the engine and transmission gently to allow the oil to warm up and lubricate all moving parts.

The vehicle has a Computer-Controlled Cranking System. This feature assists in starting the engine and protects components. If the ignition key is turned to the START position, and then released when the engine begins cranking, the engine will continue cranking for a few seconds or until the vehicle starts. If the engine does not start and the key is held in START, cranking stops after 15 seconds to prevent cranking motor damage. To prevent gear damage, this system also prevents cranking if the engine is already running. Engine cranking can be stopped by turning the ignition switch to the ACC/ACCESSORY or LOCK/OFF position.

**Notice:** Cranking the engine for long periods of time, by returning the key to the START position immediately after cranking has ended, can overheat and damage the cranking motor, and drain the battery. Wait at least 15 seconds between each try, to let the cranking motor cool down.

2. If the engine does not start after 5-10 seconds, especially in very cold weather (below 0°F or -18°C), it could be flooded with too much gasoline. Try pushing the accelerator pedal all the way to the floor and holding it there as you hold the key in START for a maximum of 15 seconds. Wait at least 15 seconds between each try, to allow the cranking motor to cool down. When the engine starts, let go of the key and

accelerator. If the vehicle starts briefly but then stops again, repeat the procedure. This clears the extra gasoline from the engine. Do not race the engine immediately after starting it. Operate the engine and transmission gently until the oil warms up and lubricates all moving parts.

**Notice:** Your engine is designed to work with the electronics in your vehicle. If you add electrical parts or accessories, you could change the way the engine operates. Before adding electrical equipment, check with your dealer/retailer. If you do not, your engine might not perform properly. Any resulting damage would not be covered by your vehicle's warranty.

## Automatic Engine Start/Stop

### CAUTION

There is something about the vehicle that can make it move suddenly, and you or others can be seriously injured. This can happen if the vehicle is in the Auto Stop mode, and the shift lever is in D (Drive). Because the vehicle has the Automatic Engine Start/Stop feature, the vehicle's engine might seem to be shut off when you come to a complete stop. However, if you then start to exit the vehicle, as soon as you take your foot off the brake pedal, the engine will start again and the vehicle can move forward. If you are going to exit the vehicle, first shift to P (Park) and turn the ignition to LOCK/OFF. Then exit.

The vehicle has an automatic engine start/stop feature that is a part of the hybrid system. After the engine is started and has reached operating temperature, the AUTO STOP feature may turn the engine off when you apply the brakes and come to a complete stop. When you take your foot off the brake pedal or press the accelerator pedal, the engine will start. The engine will continue to run until the next AUTO STOP.

The AUTO STOP mark on the tachometer indicates that the engine is in AUTO STOP mode. If the driver door is opened while in AUTO STOP mode, a chime will sound.

If you are on an incline, the vehicle may roll backwards a short distance until the engine performs an AUTO START. The Hill Start Assist feature will help start the vehicle on a moderate or steep incline. To restart the engine during the AUTO STOP, release the brake pedal or press the accelerator pedal. The engine starts immediately. The vehicle continues to run until the next stop.

There are several conditions that may prevent an AUTO STOP or cause an AUTO START.

## 2-18 Features and Controls

---

### The Engine Will Remain Running When:

- The engine, transmission, or hybrid battery is not warmed up yet.
- The outside temperature is high — usually above 95°F (35°C) and the climate control system is working to cool the vehicle in A/C mode (yellow light illuminated on A/C button) or if defrost is selected. See *Automatic Climate Control System on page 3-17* for more information.
- The shift lever is in P (Park), R (Reverse), N (Neutral) or M (Manual Mode).
- The hybrid battery pack charge is low.
- The 12V vehicle battery charge is low, or loads are high.
- The hood is not fully closed.

### The Engine Will Restart When:

- The brake pedal is released.
- The accelerator pedal is applied.
- When shifting from D (Drive) to P (Park), R (Reverse), N (Neutral) or M (Manual Mode), the engine will restart immediately.
- If the A/C button (green light illuminated on A/C) button is selected, the duration of the AUTO STOP will depend on the outside temperature. This economy mode improves fuel economy by limiting the effects of the air conditioning. The warmer it is outside, the shorter the time before the engine is restarted to provide cabin cooling.

- The climate control system is turned from Off to On (econ or normal A/C, or floor/defog/defrost) See *Automatic Climate Control System on page 3-17* for more information.
- The engine is required to run for either heater or climate control performance. See “Air Conditioning and Engine Start/Stop” under *Automatic Climate Control System on page 3-17* for more information.
- The hybrid battery pack charge is low and requires recharging.
- Auto Stop time is greater than two minutes.



## Engine Coolant Heater

The engine coolant heater can provide easier starting and better fuel economy during engine warm-up in cold weather conditions at or below 0°F (-18°C). Vehicles with an engine coolant heater should be plugged in at least four hours before starting. Some models may have an internal thermostat in the cord which will prevent engine coolant heater operation at temperatures above 0°F (-18°C).

### To Use the Engine Coolant Heater

1. Turn off the engine.
2. Open the hood and unwrap the electrical cord. The engine coolant heater cord is located near the air cleaner box on the passenger side of the engine compartment. See *Engine Compartment Overview on page 5-10* for more information on location.
3. Plug the cord into a normal, grounded 110-volt AC outlet.

### CAUTION

Plugging the cord into an ungrounded outlet could cause an electrical shock. Also, the wrong kind of extension cord could overheat and cause a fire. You could be seriously injured. Plug the cord into a properly grounded three-prong 110-volt AC outlet. If the cord will not reach, use a heavy-duty three-prong extension cord rated for at least 15 amps.

4. Before starting the engine, be sure to unplug and store the cord as it was before to keep it away from moving engine parts. If you do not, it could be damaged.

The length of time the heater should remain plugged in depends on several factors. Ask a dealer/retailer in the area where you will be parking the vehicle for the best advice on this.

### Automatic Transmission Operation

The shift lever is located on the console between the seats.



There are several different positions for the automatic transmission.

**P (Park):** This position locks the front wheels. It is the best position to use when you start the engine because the vehicle cannot move easily.

#### CAUTION

It is dangerous to get out of the vehicle if the shift lever is not fully in P (Park) with the parking brake firmly set. The vehicle can roll.

Do not leave the vehicle when the engine is running unless you have to. If you have left the engine running, the vehicle can move suddenly. You or others could be injured. To be sure the vehicle will not move, even when you are on fairly level ground, always set the parking brake and move the shift lever to P (Park). See *Shifting Into Park* on page 2-23. If you are pulling a trailer, see *Towing a Trailer* on page 4-26.

Make sure the shift lever is fully in P (Park) before starting the engine. The vehicle has an automatic transmission shift lock control system. You have to fully apply the regular brakes first and then press

the shift lever button before you can shift from P (Park) when the ignition key is in RUN. If you cannot shift out of P (Park), ease pressure on the shift lever and push the shift lever all the way into P (Park) as you maintain brake application. Then press the shift lever button and move the shift lever into another gear. See *Shifting Out of Park* on page 2-25.

**R (Reverse):** Use this gear to back up.

**Notice:** Shifting to R (Reverse) while the vehicle is moving forward could damage the transmission. The repairs would not be covered by the vehicle warranty. Shift to R (Reverse) only after the vehicle is stopped.

To rock the vehicle back and forth to get out of snow, ice or sand without damaging the transmission, see *If Your Vehicle is Stuck in Sand, Mud, Ice, or Snow* on page 4-17.

**N (Neutral):** In this position, the engine does not connect with the wheels. To restart the engine when the vehicle is already moving, use N (Neutral) only. Also, use N (Neutral) when your vehicle is being towed.

 **CAUTION**

Shifting into a drive gear while the engine is running at high speed is dangerous. Unless your foot is firmly on the brake pedal, the vehicle could move very rapidly. You could lose control and hit people or objects. Do not shift into a drive gear while the engine is running at high speed.

**Notice:** Shifting out of P (Park) or N (Neutral) with the engine running at high speed may damage the transmission. The repairs would not be covered by the vehicle warranty. Be sure the engine is not running at high speed when shifting the vehicle.

**D (Drive):** This position is for normal driving with the automatic transmission. It provides the best fuel economy. If you need more power for passing, and you are:

- Going less than about 35 mph (55 km/h), push the accelerator pedal about halfway down.
- Going about 35 mph (55 km/h), push the accelerator all the way down.

Downshifting the transmission in slippery road conditions could result in skidding, see “Skidding” under *Loss of Control on page 4-11*.

**M (Manual Mode):** This position allows you to change gears similar to a manual transmission. If the vehicle has this feature, see Manual Shift Mode.

**Notice:** Spinning the tires or holding the vehicle in one place on a hill using only the accelerator pedal may damage the transmission. The repair will not be covered by the vehicle warranty. If you are stuck, do not spin the tires. When stopping on a hill, use the brakes to hold the vehicle in place.

## 2-22 Features and Controls

---

### Manual Shift Mode (MSM) (Automatic Transmission)

To use this feature, do the following:

1. Move the shift lever from D (Drive) rearward to the M (Manual Mode).

The display will show a 3 for third gear.

When coming to a stop in the manual position, the vehicle will automatically shift to 1 (First) gear.

2. Press the plus (+) button to upshift or the minus (-) button to downshift.

While driving in MSM, the vehicle will have sportier performance. Use this when you want the vehicle to stay in gear longer or to downshift for more power or engine braking.

The transmission will only allow you to shift into a gear range appropriate for the vehicle speed.

- The transmission will not automatically shift to the next higher gear range without pressing the button on the shifter handle.
- The transmission will not allow shifting to the next lower gear if the vehicle speed is too high.

If the vehicle does not respond to a gear change, or detects a problem with the transmission, the range of gears may be reduced and the Malfunction Indicator Lamp will come on. See *Malfunction Indicator Lamp* on page 3-30.

### Parking Brake



The parking brake lever is located in the center console between the front seats.

To set the parking brake, hold the brake pedal down and pull up on the parking brake lever. If the ignition is in ON/RUN, the brake system warning light will come on.

To release the parking brake, hold the brake pedal down. Pull the parking brake lever up until you can press the release button. Hold the release button in as you move the brake lever all the way down.

Release the parking brake before driving the vehicle.

**Notice:** Driving with the parking brake on can overheat the brake system and cause premature wear or damage to brake system parts. Make sure that the parking brake is fully released and the brake warning light is off before driving.

## Regenerative Braking

Regenerative braking takes some of the energy from the moving vehicle and turns it back into electrical energy. This energy is then stored back into the vehicle's hybrid battery system, contributing to increased fuel efficiency.

The system works whenever you take your foot off the accelerator pedal while the vehicle is moving in a forward gear. This causes the vehicle to slow down more quickly. It may feel like the brake pedal is being pressed, even when it is not.

## Shifting Into Park



It can be dangerous to get out of the vehicle if the shift lever is not fully in P (Park) with the parking brake firmly set. The vehicle can roll. If you have left the engine running, the vehicle can move suddenly. You or others could be injured. To be sure the vehicle will not move, even when you are on fairly level ground, use the steps that follow. If you are pulling a trailer, see *Towing a Trailer on page 4-26*.

1. Hold the brake pedal down and set the parking brake. See *Parking Brake on page 2-22* for more information.
2. Move the shift lever into P (Park) by pressing the button on the shift lever and pushing the lever all the way toward the front of the vehicle.

## 2-24 Features and Controls

---

3. Turn the ignition key to LOCK/OFF.
4. Remove the key and take it with you. If you can leave the vehicle with the key, the vehicle is in P (Park).

### Leaving the Vehicle With the Engine Running

#### CAUTION

It can be dangerous to leave the vehicle with the engine running. The vehicle could move suddenly if the shift lever is not fully in P (Park) with the parking brake firmly set. And, if you leave the vehicle with the engine running, it could overheat and even catch fire. You or others could be injured. Do not leave the vehicle with the engine running.

If you have to leave the vehicle with the engine running, be sure the vehicle is in P (Park) and the parking brake is firmly set before you leave it. After you have moved the shift lever into P (Park), hold the regular brake pedal down. Then, see if you can move the shift lever away from P (Park) without first pressing the button on the console shift lever. If you can, it means that the shift lever was not fully locked into P (Park).

#### Torque Lock

If you are parking on a hill and you do not shift the transmission into P (Park) properly, the weight of the vehicle may put too much force on the parking pawl in the transmission.

You may find it difficult to pull the shift lever out of P (Park). This is called “torque lock.” To prevent torque lock, set the parking brake and then shift into P (Park) properly before you leave the driver seat. To find out how, see *Shifting Into Park on page 2-23*.

When you are ready to drive, move the shift lever out of P (Park) before you release the parking brake.

If torque lock does occur, you may need to have another vehicle push yours a little uphill to take some of the pressure from the parking pawl in the transmission, so you can pull the shift lever out of P (Park).

## Shifting Out of Park

The vehicle has an electronic shift lock release system. The shift lock release is designed to:

- Prevent ignition key removal unless the shift lever is in P (Park) with the shift lever button fully released.
- Prevent movement of the shift lever out of P (Park), unless the ignition is in ON/RUN and the regular brake pedal is applied.

The shift lock release is always functional except in the case of an uncharged or low voltage (less than 9 volt) battery.

If the vehicle has an uncharged battery or a battery with low voltage, try charging or jump starting the battery. See *Jump Starting on page 5-28* for more information.

To shift out of P (Park):

1. Apply the brake pedal.
2. Press the shift lever button.
3. Move the shift lever to the desired position.

If you still are unable to shift out of P (Park):

1. Fully release the shift lever button.
2. Hold the brake pedal down and press the shift lever button again.
3. Move the shift lever to the desired position.

If you still cannot move the shift lever from P (Park), consult your dealer/retailer or a professional towing service.

## Parking Over Things That Burn



Things that can burn could touch hot exhaust parts under the vehicle and ignite. Do not park over papers, leaves, dry grass, or other things that can burn.

### Engine Exhaust

#### CAUTION

Engine exhaust contains Carbon Monoxide (CO) which cannot be seen or smelled. Exposure to CO can cause unconsciousness and even death.

Exhaust may enter the vehicle if:

- The vehicle idles in areas with poor ventilation (parking garages, tunnels, deep snow that may block underbody airflow or tail pipes).
- The exhaust smells or sounds strange or different.
- The exhaust system leaks due to corrosion or damage.
- The vehicle's exhaust system has been modified, damaged or improperly repaired.

(Continued)

#### CAUTION (Continued)

- There are holes or openings in the vehicle body from damage or after-market modifications that are not completely sealed.

If unusual fumes are detected or if it is suspected that exhaust is coming into the vehicle:

- Drive it only with the windows completely down.
- Have the vehicle repaired immediately.

Never park the vehicle with the engine running in an enclosed area such as a garage or a building that has no fresh air ventilation.

### Running the Vehicle While Parked

It is better not to park with the engine running. But if you ever have to, here are some things to know.

#### CAUTION

Exiting the vehicle, without first shifting into P (Park), may cause the vehicle to move, and you or others can be seriously injured. Because the vehicle has the Automatic Engine Start/Stop feature, the vehicle's engine might seem to be shut off when you come to a complete stop. However, once the brake pedal is released, the vehicle can move. The vehicle's engine can also restart at any time.

Shift to P (Park) and turn the ignition to LOCK/OFF, before exiting the vehicle.



 **CAUTION**

Idling a vehicle in an enclosed area with poor ventilation is dangerous. Engine exhaust may enter the vehicle. Engine exhaust contains Carbon Monoxide (CO) which cannot be seen or smelled. It can cause unconsciousness and even death. Never run the engine in an enclosed area that has no fresh air ventilation. For more information, see *Engine Exhaust on page 2-26*.

Follow the proper steps to be sure the vehicle will not move. See *Shifting Into Park on page 2-23*.

If parking on a hill and pulling a trailer, see *Towing a Trailer on page 4-26*.

## Mirrors

### Manual Rearview Mirror

The vehicle has a manual rearview mirror. It can be adjusted by holding the mirror in the center to move it for a clearer view behind your vehicle. Reduce the glare of headlamps from behind by pushing the lever forward or pulling it back for daytime/nighttime use.

### Automatic Dimming Rearview Mirror

The vehicle has an automatic dimming rearview mirror.

Vehicles with OnStar<sup>®</sup> have three additional control buttons for the OnStar<sup>®</sup> system. See your dealer/retailer for more information

about OnStar<sup>®</sup> and how to subscribe to it. See *OnStar<sup>®</sup> System on page 2-29* for more information about the services OnStar<sup>®</sup> provides.

 **(On/Off):** Press to turn the dimming feature on or off.

### Automatic Dimming Mirror Operation

The automatic dimming mirror reduces the glare from the headlamps of the vehicle behind you. The dimming feature comes on and the indicator light illuminates each time the ignition is turned to start.

### Outside Power Mirrors



Controls for the outside power mirrors are located on the driver door.

To adjust the power mirrors:

1. Turn the knob to choose the left (L) or the right (R) mirror.
2. Adjust each mirror so that you can see the side of your vehicle and the area behind your vehicle.
3. Return the control to the center position so the mirror cannot be moved.

The mirrors can be manually folded inward toward the vehicle. Return to the original position to use correctly.

### Outside Convex Mirror



A convex mirror can make things (like other vehicles) look farther away than they really are. If you cut too sharply into the right lane, you could hit a vehicle on the right. Check the inside mirror or glance over your shoulder before changing lanes.

The passenger side mirror is convex shaped. A convex mirror's surface is curved so more can be seen from the driver seat.

### Outside Heated Mirrors

For vehicles with outside heated mirrors:

 **(Rear Window Defogger):**

Press to heat the outside rearview mirrors. See "Rear Window Defogger" under *Automatic Climate Control System* on page 3-17 for more information.

## OnStar® System



OnStar uses several innovative technologies and live advisors to provide a wide range of safety, security, information, and convenience services. If the airbags deploy, the system is designed to make an automatic call to OnStar Emergency advisors who can request emergency services be sent to your location. If the keys are locked in the vehicle, call OnStar at 1-888-4-ONSTAR to have a signal sent to unlock the doors. OnStar Hands-Free Calling, including 30 trial minutes good for 60 days, is available on most vehicles. OnStar Turn-by-Turn Navigation service, with one trial route, is available on most vehicles. Press the OnStar button to have an OnStar advisor contact Roadside Service.

OnStar service is provided subject to the OnStar Terms and Conditions included in the OnStar Subscriber glove box literature.

Some services such as Remote Door Unlock or Stolen Vehicle Location Assistance may not be available until the owner of the vehicle registers with OnStar. After the first prepaid year, contact OnStar to select a monthly or annual subscription payment plan. If a payment plan is not selected, the OnStar system and all services, including airbag notification and emergency services, may be deactivated and no longer available. For more information visit [www.onstar.com](http://www.onstar.com) (U.S.) or [www.onstar.ca](http://www.onstar.ca) (Canada), or press the OnStar button to speak with an advisor.

Not all OnStar services are available on all vehicles. To check if this vehicle is able to provide the services described below, or for a full description of OnStar services and system limitations, see the OnStar Owner's Guide in the glove box or visit [www.onstar.com](http://www.onstar.com) (U.S.) or [www.onstar.ca](http://www.onstar.ca) (Canada), contact OnStar at 1-888-4-ONSTAR (1-888-466-7827) or TTY 1-877-248-2080, or press the OnStar button to speak with an OnStar advisor 24 hours a day, 7 days a week.

### OnStar Services Available with the Safe & Sound Plan

- Automatic Notification of Airbag Deployment
- Advanced Automatic Crash Notification (AACN) (If equipped)
- Link to Emergency Services
- Roadside Assistance
- Stolen Vehicle Location Assistance

## 2-30 Features and Controls

---

- Remote Door Unlock/  
Vehicle Alert
- OnStar Vehicle Diagnostic Email
- GM Goodwrench On Demand  
Diagnostics
- OnStar Hands-Free Calling  
with 30 trial minutes
- OnStar Virtual Advisor  
(U.S. Only)

### **OnStar Services Included with Directions & Connections Plan**

- All Safe and Sound Plan Services
- OnStar Turn-by-Turn Navigation  
(If equipped) or Driving  
Directions - Advisor delivered
- RideAssist
- Information and Convenience  
Services

### **OnStar Hands-Free Calling**

OnStar Hands-Free Calling allows eligible OnStar subscribers to make and receive calls using voice commands. Hands-Free Calling is fully integrated into the vehicle, and can be used with OnStar Pre-Paid Minute Packages. Most vehicles include 30 trial minutes good for 60 days. Hands-Free Calling can also be linked to a Verizon Wireless service plan in the U.S. or a Bell Mobility service plan in Canada, depending on eligibility. To find out more, refer to the OnStar Owner's Guide in the vehicle's glove box, visit [www.onstar.com](http://www.onstar.com) or [www.onstar.ca](http://www.onstar.ca), or speak with an OnStar advisor by pressing the OnStar button or calling 1-888-4-ONSTAR (1-888-466-7827).

### **OnStar Turn-by-Turn Navigation**

Vehicles with the OnStar Turn-by-Turn Navigation system can provide voice-guided driving directions. Press the OnStar button to have an OnStar advisor locate a business or address and download driving directions to the vehicle. Voice-guided directions to the desired destination will play through the audio system speakers. See the OnStar Owner's Guide for more information.

### **OnStar Virtual Advisor**

OnStar Virtual Advisor is a feature of OnStar Hands-Free Calling that uses minutes to access location-based weather, local traffic reports, and stock quotes. Press the phone button and give a few simple voice commands to browse through the various topics. See the OnStar Owner's Guide for more information. This feature is only available in the continental U.S.

## OnStar Steering Wheel Controls

This vehicle may have a Talk/Mute button that can be used to interact with OnStar Hands-Free Calling. See *Audio Steering Wheel Controls* on page 3-82 for more information.

OnStar voice command does not work unless Personal Calling is activated. To activate Personal Calling, see the OnStar Owner's Guide.

On some vehicles, the mute button can be used to dial numbers into voice mail systems, or to dial phone extensions. See the OnStar Owner's Guide for more information.

## How OnStar Service Works

The OnStar system can record and transmit vehicle information. This information is automatically sent to an OnStar Call Center when the OnStar button is pressed, the emergency button is pressed, or if the airbags or AACN system deploy. This information usually includes the vehicle's GPS location and, in the event of a crash, additional information regarding the crash that the vehicle was involved in (e.g. the direction from which the vehicle was hit). When the Virtual Advisor feature of OnStar Hands-Free Calling is used, the vehicle also sends OnStar the vehicle's GPS location so they can provide services where it is located.

OnStar service cannot work unless the vehicle is in a place where OnStar has an agreement with a wireless service provider for service in that area. OnStar service also cannot work unless the vehicle is in

a place where the wireless service provider OnStar has hired for that area has coverage, network capacity and reception when the service is needed, and technology that is compatible with the OnStar service. Not all services are available everywhere, particularly in remote or enclosed areas, or at all times.

Location information about the vehicle is only available if the GPS satellite signals are unobstructed and available.

The vehicle must have a working electrical system, including adequate battery power, for the OnStar equipment to operate. There are other problems OnStar cannot control that may prevent OnStar from providing OnStar service at any particular time or place. Some examples are damage to important parts of the vehicle in a crash, hills, tall buildings, tunnels, weather or wireless phone network congestion.

### Your Responsibility

Increase the volume of the radio if the OnStar advisor cannot be heard. If the light next to the OnStar buttons is red, the system may not be functioning properly. Press the OnStar button and request a vehicle diagnostic. If the light appears clear (no light is appearing), your OnStar subscription has expired and all services have been deactivated. Press the OnStar button to confirm that the OnStar equipment is active.

### Universal Home Remote System

The Universal Home Remote System provides a way to replace up to three hand-held Radio-Frequency (RF) transmitters used to activate devices such as garage door openers, security systems, and home lighting.

This device complies with Part 15 of the FCC Rules. Operation is subject to the following two conditions:

1. This device may not cause harmful interference.
2. This device must accept any interference received, including interference that may cause undesired operation.

This device complies with RSS-210 of Industry Canada. Operation is subject to the following two conditions:

1. This device may not cause interference.
2. This device must accept any interference received, including interference that may cause undesired operation of the device.

Changes or modifications to this system by other than an authorized service facility could void authorization to use this equipment.

## Universal Home Remote System Operation



If there is one triangular Light Emitting Diode (LED) indicator light above the Universal Home Remote buttons, follow the instructions below.

This system provides a way to replace up to three remote control transmitters used to activate devices such as garage door openers, security systems, and home automation devices.

Do not use the Universal Home Remote with any garage door opener that does not have the stop and reverse feature. This includes any garage door opener model manufactured before April 1, 1982.

Read the instructions completely before attempting to program the Universal Home Remote. Because of the steps involved, it may be helpful to have another person available to assist you in the programming the Universal Home Remote.

Keep the original hand-held transmitter for use in other vehicles as well as for future Universal Home Remote programming. It is also recommended that upon the sale of the vehicle, the programmed Universal Home Remote buttons should be erased for security purposes. See “Erasing Universal Home Remote Buttons” later in this section.

When programming a garage door, park outside of the garage. Park directly in line with and facing the garage door opener motor-head or gate motor-head. Be sure that people and objects are clear of the garage door or gate that is being programmed.

It is recommended that a new battery be installed in your hand-held transmitter for quicker and more accurate transmission of the radio-frequency signal.

### Programming the Universal Home Remote System

For questions or help programming the Universal Home Remote System, call 1-800-355-3515 or go to [homelink.com](http://homelink.com).

Programming a garage door opener involves time-sensitive actions, so read the entire procedure before starting. Otherwise, the device will time out and the procedure will have to be repeated.

## 2-34 Features and Controls

---

To program up to three devices:

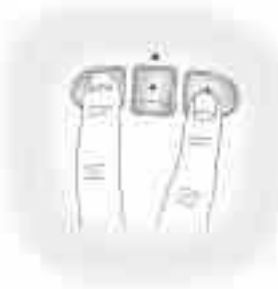

1. From inside the vehicle, press and hold down the two outside buttons at the same time, releasing only when the Universal Home Remote indicator light begins to flash, after 20 seconds. This step will erase the factory settings or all previously programmed buttons.  
Do not hold down the buttons for longer than 30 seconds and do not repeat this step to program the remaining two Universal Home Remote buttons.

2. Hold the end of your hand-held transmitter about 1 to 3 inches (3 to 8 cm) away from the Universal Home Remote buttons while keeping the indicator light in view. The hand-held transmitter was supplied by the manufacturer of your garage door opener receiver (motor head unit).
3. At the same time, press and hold both the Universal Home Remote button to be used to control the garage door and the hand-held transmitter button. Do not release the Universal Home Remote button or the hand-held transmitter button until Step 4 has been completed.  
Some entry gates and garage door openers may require substitution of Step 3 with the procedure noted in "Gate Operator and Canadian Programming" later in this section.

4. The indicator light on the Universal Home Remote will flash slowly at first and then rapidly after Universal Home Remote successfully receives the frequency signal from the hand-held transmitter. Release both buttons.
5. Press and hold the newly-trained Universal Home Remote button and observe the indicator light.  
If the indicator light stays on continuously, the programming is complete and the garage door should move when the Universal Home Remote button is pressed and released. There is no need to continue programming Steps 6 through 8.  
If the Universal Home Remote indicator light blinks rapidly for two seconds and then turns to a constant light, continue with the programming Steps 6 through 8.



It may be helpful to have another person assist with the remaining steps.



6. After Steps 1 through 5 have been completed, locate inside the garage the garage door opener receiver (motor-head unit). Locate the “Learn” or “Smart” button. The name and color of the button may vary by manufacturer.

7. Firmly press and release the “Learn” or “Smart” button. After you press this button, you will have 30 seconds to complete Step 8.
8. Immediately return to the vehicle. Firmly press and hold the Universal Home Remote button, chosen in Step 3 to control the garage door, for two seconds, and then release it. If the garage door does not move, press and hold the same button a second time for two seconds, and then release it. Again, if the door does not move, press and hold the same button a third time for two seconds, and then release.

The Universal Home Remote should now activate the garage door.

To program the remaining two Universal Home Remote buttons, begin with Step 2 of “Programming the Universal Home Remote System.” Do not repeat Step 1, as this will erase all previous programming from the Universal Home Remote buttons.

### **Gate Operator and Canadian Programming**

If you have questions or need help programming the Universal Home Remote System, call 1-800-355-3515 or go to [homelink.com](http://homelink.com).

Canadian radio-frequency laws require transmitter signals to time out or quit after several seconds of transmission. This may not be long enough for Universal Home Remote to pick up the signal during programming. Similarly, some U.S. gate operators are manufactured to time out in the same manner.

## 2-36 Features and Controls

---

If you live in Canada, or you are having difficulty programming a gate operator or garage door opener by using the "Programming Universal Home Remote" procedures, regardless of where you live, replace Step 3 under "Programming Universal Home Remote" with the following:

Continue to press and hold the Universal Home Remote button while you press and release every two seconds (cycle) the hand-held transmitter button until the frequency signal has been successfully accepted by the Universal Home Remote. The Universal Home Remote indicator light will flash slowly at first and then rapidly.

Proceed with Step 4 under "Programming Universal Home Remote" to complete.

### **Using Universal Home Remote**

Press and hold the appropriate Universal Home Remote button for at least half of a second. The indicator light will come on while the signal is being transmitted.

### **Erasing Universal Home Remote Buttons**

The programmed buttons should be erased when the vehicle is sold or the lease ends.

To erase all programmed buttons on the Universal Home Remote device:



1. Press and hold down the two outside buttons until the indicator light begins to flash, after 20 seconds.
2. Release both buttons.

## Reprogramming a Single Universal Home Remote Button

To reprogram any of the three Universal Home Remote buttons, repeat the programming instructions earlier in this section, beginning with Step 2.

For help or information on the Universal Home Remote System, call the customer assistance phone number under *Customer Assistance Offices on page 7-5*.

## Storage Areas

### Glove Box

To open the glove box, lift up on the lever. The glove box divider can be removed. The slots on the left side are for storing the divider.

### Cupholders

There are cupholders located in front of and behind the center console.



To access the cupholders behind the center console, push the button.

## Sunglasses Storage Compartment

Your vehicle may have a sunglasses storage compartment located near the rearview mirror. Push the cover to open.

## Center Console Storage

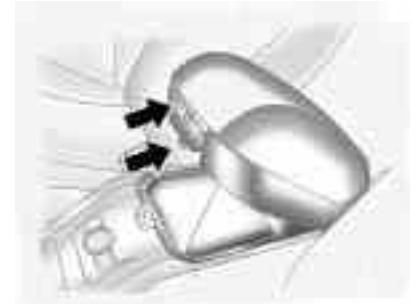

Your vehicle has a center console with an upper, lower and rear storage area. To access the upper storage area, lift up on the top lever. To access the lower storage area, lift up on the bottom lever.

## 2-38 Features and Controls

---

The top of the center console can extend forward. To adjust, hold the top of the lever up and pull the top of the center console forward.



To open the cover of the the rear storage area, push the button located at the top.

### Driver Storage Compartment

Your vehicle has a storage area located to left of the steering wheel. Pull down on the handle to access.

### Rear Seat Armrest



To access the rear seat armrest, pull the handle down. Lift the top of the armrest to access the storage area.

### Convenience Net

Use the convenience net, located in the rear, to store small loads as far forward as possible. The net should not be used to store heavy loads.

### Cargo Cover

For vehicles with a cargo cover, use it to cover items in the rear of the vehicle.

To remove the cover and remove it from the vehicle, pull both ends toward each other. To reinstall, place each end of the cover in the holes behind the rear seat.

## Cargo Tie Downs

Four cargo tie-downs are located in the rear compartment of the vehicle. The tie-downs can be used to secure small loads.

## Cargo Management System

If the vehicle has a cargo management system in the rear of the vehicle, it will have rails with adapters and hooks. These are used to hold the net and mesh pocket.



The adapters are used to hold the net. Slide the adapters to the desired location on the upper and lower rail and turn the handle up to lock it in place. Compress the rods of the net and insert them into the corresponding openings of the adapter. The longer rod is for the upper adapter.

The hooks hold the mesh pocket. To insert a hook on the rail, place the hook in the upper groove of the rail and press it into the lower groove.



## Instrument Panel

### Instrument Panel Overview

Instrument Panel Overview .....	3-4
Hazard Warning Flashers .....	3-5
Horn .....	3-5
Tilt Wheel .....	3-6
Turn Signal/Multifunction Lever .....	3-6
Turn and Lane-Change Signals .....	3-6
Headlamp High/Low-Beam Changer .....	3-7
Flash-to-Pass .....	3-7
Windshield Wipers .....	3-7
Rainsense™ II Wipers .....	3-8
Windshield Washer .....	3-8
Rear Window Wiper/Washer .....	3-9

Cruise Control .....	3-9
Exterior Lamps .....	3-12
Wiper Activated Headlamps .....	3-12
Daytime Running Lamps (DRL) .....	3-13
Automatic Headlamp System .....	3-13
Instrument Panel Brightness .....	3-14
Dome Lamp .....	3-14
Entry Lighting .....	3-14
Reading Lamps .....	3-14
Electric Power Management .....	3-14
Battery Run-Down Protection .....	3-15
Accessory Power Outlet(s) .....	3-16

### Climate Controls

Automatic Climate Control System .....	3-17
Outlet Adjustment .....	3-22

### Warning Lights, Gages, and Indicators

Warning Lights, Gages, and Indicators .....	3-22
Instrument Panel Cluster .....	3-23
Speedometer and Odometer .....	3-24
Trip Odometer .....	3-24
Tachometer .....	3-24
Safety Belt Reminders .....	3-24
Airbag Readiness Light .....	3-25
Passenger Airbag Status Indicator .....	3-26
Charging System Light .....	3-27
Brake System Warning Light .....	3-27
Antilock Brake System (ABS) Warning Light .....	3-28
StabiliTrak®/Traction Control System (TCS) Warning Light .....	3-28
Engine Coolant Temperature Warning Light .....	3-29

## 3-2 Instrument Panel

---

Tire Pressure Light .....	3-29
Malfunction Indicator Lamp .....	3-30
Oil Pressure Light .....	3-33
Change Engine Oil Light ...	3-33
Security Light .....	3-33
Cruise Control Light .....	3-33
Highbeam On Light .....	3-34
Low Washer Fluid Warning Light .....	3-34
Fuel Gage .....	3-34
Low Fuel Warning Light ...	3-34
Auto Stop Mode .....	3-35
Charge/Assist Gage .....	3-35
Fuel Economy Light .....	3-35

### Driver Information Center (DIC)

Driver Information Center (DIC) .....	3-36
DIC Operation and Displays .....	3-36
DIC Compass .....	3-40
DIC Warnings and Messages .....	3-42
DIC Vehicle Customization .....	3-49

### Audio System(s)

Audio System(s) .....	3-56
Setting the Clock .....	3-56
Radio(s) .....	3-58
Using an MP3 .....	3-66
XM Radio Messages .....	3-71
Bluetooth® .....	3-72
Theft-Deterrent Feature .....	3-82
Audio Steering Wheel Controls .....	3-82
Radio Reception .....	3-83
Fixed Mast Antenna .....	3-84
XM™ Satellite Radio Antenna System .....	3-84
Chime Level Adjustment ...	3-84





## Instrument Panel Overview

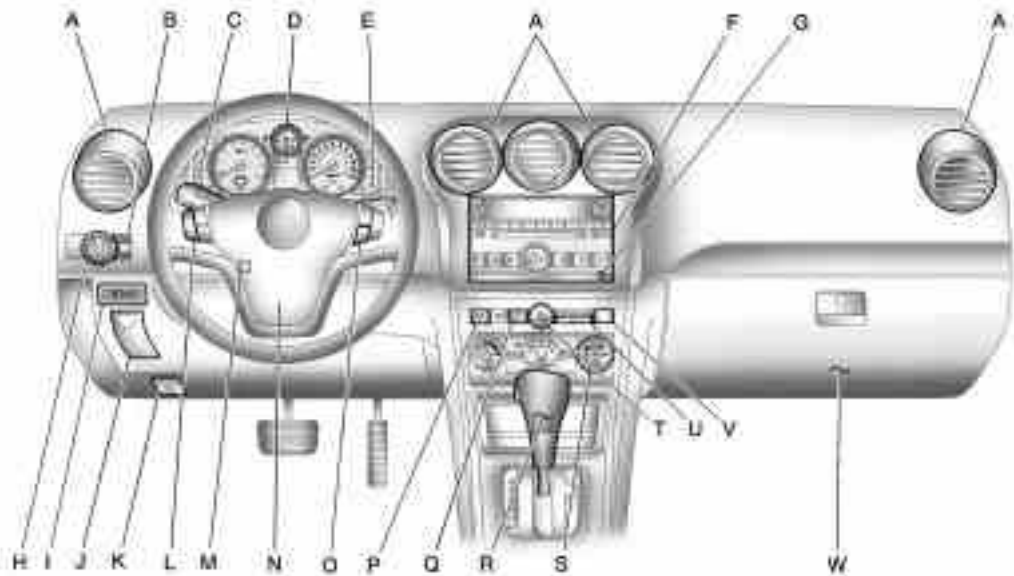

The main components of the instrument panel are the following:

- A. *Outlet Adjustment on page 3-22.*
- B. *Instrument Panel Brightness on page 3-14.*
- C. *Turn Signal/Multifunction Lever on page 3-6.*
- D. *Instrument Panel Cluster on page 3-23.*
- E. *Windshield Wipers on page 3-7.*
- F. *Audio System(s) on page 3-56.*
- G. *Auxiliary Input Jack. See Radio(s) on page 3-58.*
- H. *Exterior Lamps on page 3-12.*
- I. *Driver Information Center (DIC) on page 3-36.*
- J. *Driver Storage Compartment on page 2-38.*
- K. *Hood Release on page 5-9.*
- L. *Cruise Control on page 3-9.*
- M. *Tilt Wheel on page 3-6.*
- N. *Horn on page 3-5.*
- O. *Audio Steering Wheel Controls on page 3-82.*
- P. *Rear Window Wiper/Washer on page 3-9.*
- Q. *Traction Control System (TCS) on page 4-8*
- R. *Shift Lever. See Automatic Transmission Operation on page 2-20.*
- S. *Automatic Climate Control System on page 3-17.*
- T. *Hazard Warning Flashers on page 3-5.*
- U. *Passenger Airbag Status Indicator on page 3-26.*
- V. *Safety Belt Reminders on page 3-24.*
- W. *Glove Box on page 2-37.*

## Hazard Warning Flashers

### (Hazard Warning Flasher):

Press this button located on the instrument panel, to make the front and rear turn signal lamps flash on and off. This warns others that you are having trouble.

Press  again to turn the flashers off.

## Horn

Press near or on the horn symbols on the steering wheel pad to sound the horn.

## 3-6 Instrument Panel

### Tilt Wheel

The tilt lever lets the steering wheel be adjusted.



The tilt lever is located on the left side of the steering column.

To adjust the steering wheel, hold the wheel and push the lever down. Then move the wheel to a comfortable position and pull the lever up firmly to lock the steering column in place.

### Turn Signal/Multifunction Lever



The lever on the left side of the steering column includes:

↔ : Turn and Lane-Change Signals

≡D : Headlamp High/Low-Beam Changer

Flash-to-Pass Feature.

Information for these features is on the pages following.

### Turn and Lane-Change Signals



An arrow on the instrument panel cluster flashes in the direction of the turn or lane change.

Move the lever all the way up or down to signal a turn.

Raise or lower the lever until the arrow starts to flash and then release, to signal a lane change. The turn signal flashes automatically three times.

The lever returns to its starting position whenever it is released.

If after signaling a turn or lane change the arrow flashes rapidly or does not come on, a signal bulb may be burned out.

Have the bulbs replaced. If a bulb is not burned out, check the fuse. See *Fuses and Circuit Breakers on page 5-75* and for burned-out bulbs.

## Headlamp High/Low-Beam Changer

 **Headlamp High/Low Beam Changer:** Push the turn signal/multifunction lever away from you to turn the high beams on.

Pull the lever towards you to return to low beams.



This indicator light turns on in the instrument panel cluster when the high beam headlamps are on.

## Flash-to-Pass

This feature lets you use your high-beam headlamps to signal a driver in front of you that you want to pass.

To flash the high beams from low beam, pull the turn signal/multifunction lever all the way towards you. Then release it.

## Windshield Wipers





The windshield wiper lever is located on the right side of the steering column.

Push up or pull down on the lever to place it in one of the following positions.

 **(Mist):** For a single wiping cycle. The lever returns to its starting position when released. For more cycles, hold the lever down before releasing it.

 **(Off):** Turns the wipers off.

 **(Intermittent):** Sets a delay between wipes. To set for a shorter or longer delay between wipes, move the switch on top of the lever left or right to decrease or increase wiper movement.

 **(Low):** For slow, steady wiping cycles.

 **(High):** For rapid wiping cycles.

Clear ice and snow from the wiper blades before using them. If the wiper blades are frozen to the windshield, gently loosen or thaw them. If they become damaged, install new blades or blade inserts. See *Windshield Wiper Blade Replacement on page 5-38*.

## 3-8 Instrument Panel

Heavy snow or ice can overload the wiper motor. A circuit breaker will stop the motor until it cools down.

### Rainsense™ II Wipers

For vehicles with Rainsense™ II windshield wipers, the moisture sensor is located next to the inside rearview mirror and is mounted on the windshield. When active, these sensors are able to detect moisture on the windshield and automatically turn on the wipers.

To turn on the Rainsense feature, the wipers must be set to one of the five delay settings on the multifunction lever. Each of the five settings adjusts the sensitivity of the sensor.

Since different drivers have different setting preferences, it is recommended that the mid-range setting (position 3) be used initially. For more wipes, select the higher settings; for fewer wipes, select the lower settings located closer to the off position on the multifunction lever.

The sensor will automatically control the frequency of the wipes from the off setting to the high speed setting according to the weather conditions. The wipers can be left in a rainsense mode even when it is not raining.

When Rainsense is active, the headlamps will turn on automatically if the exterior lamp control is in the AUTO position and the wipers are active.

**Notice:** Going through an automatic car wash with the wipers on can damage them. Turn the wipers off when going through an automatic car wash.

## Windshield Washer



In freezing weather, do not use your washer until the windshield is warmed. Otherwise the washer fluid can form ice on the windshield, blocking your vision.

Pull the windshield wiper lever toward you to spray washer fluid on the windshield. The wipers will run for a few cycles to clear the windshield. For more wash cycles, pull the lever forward and hold.

### Heated Windshield Washer Nozzles

This feature prevents the windshield washer fluid from freezing on the nozzle during cold conditions. The heated nozzles are turned on when the rear window defogger is activated. See *Automatic Climate Control System* on page 3-17.

## Rear Window Wiper/Washer

The rear wiper and rear wash button is located on the instrument panel above the climate control system.

 **(Rear Wiper/Washer):** Press to wash and wipe the rear window.

The rear window washer uses the same reservoir as the windshield washer. Check the windshield washer reservoir level if the front windshield can be worked, but no fluid is sprayed when the rear washer is activated. See *Windshield Washer Fluid* on page 5-24.

 **(Delay):** Press to turn the delayed wiping on or off.

## Cruise Control

With cruise control, the vehicle can maintain a speed of about 25 mph (40 km/h) or more without keeping your foot on the accelerator. Cruise control does not work at speeds below 25 mph (40 km/h).

For vehicles with the StabiliTrak<sup>®</sup> system that begins to limit wheel spin while you are using cruise control, the cruise control will automatically disengage. See *StabiliTrak<sup>®</sup> System* on page 4-7.

### CAUTION

Cruise control can be dangerous where you cannot drive safely at a steady speed. So, do not use the cruise control on winding roads or in heavy traffic.

Cruise control can be dangerous on slippery roads. On such roads, fast changes in tire traction can cause excessive wheel slip, and you could lose control. Do not use cruise control on slippery roads.

## 3-10 Instrument Panel

### Setting Cruise Control

#### CAUTION

If you leave your cruise control on when you are not using cruise, you might hit a button and go into cruise when you do not want to. You could be startled and even lose control. Keep the cruise control switch off until you want to use cruise control.

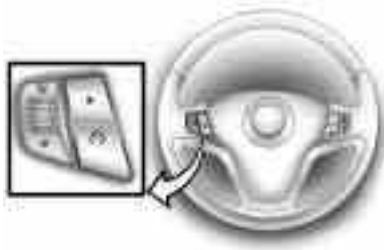

The cruise control buttons are located on the left side of the steering wheel.

 **(On/Off):** Press to turn the cruise control system on and off. An indicator light comes on.

**RES+ (Resume/Accel):** Move the thumbwheel up to resume a set speed or to accelerate to a higher speed.

**–SET(Set/Coast):** Move the thumbwheel down to set a speed or to decrease the speed.

To set a speed:

1. Press  to turn cruise control on. The indicator light on the button comes on.
2. Get to the speed desired.
3. Press the thumbwheel toward –SET and release it.
4. Take your foot off the accelerator pedal.

When the brakes are applied, the cruise control shuts off.

### Resuming a Set Speed

If the cruise control is set at a desired speed and then the brakes are applied, the cruise control is disengaged. The indicator light on the instrument panel cluster goes out when the cruise is no longer engaged. To return to the previously set speed, press the thumbwheel up toward RES+ briefly when the vehicle has reached a speed of about 25 mph (40 km/h) or more.

This accelerates the vehicle to the previously selected speed.

### Increasing Speed While Using Cruise Control

To increase the cruise speed while using cruise control:

- Press the thumbwheel up toward RES+ and hold it until the vehicle accelerates to the desired speed, and then release the switch.



- To increase the speed in small amounts, press the thumbwheel up toward RES+ briefly and then release it. Each time this is done, the vehicle goes about 1 mph (1.6 km/h) faster.
- Use the accelerator pedal to reach the desired speed and press the thumbwheel towards –SET. The new desired speed must be greater than the previous set speed by typically 5 mph.

### Reducing Speed While Using Cruise Control

If the cruise control system is already engaged,

- Push the thumbwheel toward –SET and hold until the desired lower speed is reached, then release it.
- To slow down in very small amounts, push the thumbwheel toward –SET briefly. Each time this is done, the vehicle goes about 1 mph (1.6 km/h) slower.

### Passing Another Vehicle While Using Cruise Control

Use the accelerator pedal to increase the vehicle's speed. When you take your foot off the pedal, the vehicle will slow down to the previously set cruise control speed.

### Using Cruise Control on Hills

How well the cruise control works on hills depends upon the vehicle's speed, load, and the steepness of the hills. When going up steep hills, you might have to step on the accelerator pedal to maintain the vehicle's speed. When going downhill, you might have to brake or shift to a lower gear to maintain the vehicle's speed. For some vehicles the transmission may automatically downshift when going down hills to help maintain the vehicle's speed. When the brakes are applied the cruise control shuts off.

### Ending Cruise Control

There are three ways to disengage the cruise control:

- Step lightly on the brake pedal or clutch; when cruise control disengages, the indicator light on the instrument panel cluster goes out.
- Press  to turn off the cruise control system.

### Erasing Speed Memory

The cruise control set speed memory is erased when the cruise control or the ignition is turned off.

### Exterior Lamps



The exterior lamp control is located on the instrument panel to the left of the steering wheel.

The exterior lamp control can be turned to the following positions:

○ **(Off):** Turns off the exterior lamps. The knob returns to the AUTO position after it is released.

**AUTO (Automatic):** Automatically turns the exterior lamps on and off, depending on outside lighting.

☰ **(Parking Lamps):** Turns on the parking lamps together with the following:

- Sidemarkers Lamps
- Taillamps
- License Plate Lamps
- Instrument Panel Lights

☰ **(Headlamps):** Turns on the headlamps, together with the previously listed lamps and lights.

#### Lamps On Reminder

A warning chime sounds, if the driver door is opened while the ignition is off and the lamps are on.

### Wiper Activated Headlamps

This feature automatically turns on the headlamps and parking lamps if the exterior lamp control is set in the AUTO position and the windshield wipers are turned on and have completed eight wipe cycles. See *Exterior Lamps on page 3-12* for additional information.

When the ignition is turned off, the wiper-activated headlamps immediately turn off. They also turn off if the windshield wiper control is turned off.

## Daytime Running Lamps (DRL)

Daytime Running Lamps (DRL) can make it easier for others to see the front of your vehicle during the day. Fully functional daytime running lamps are required on all vehicles first sold in Canada.

The DRL system makes the low-beam headlamps come on in daylight when the following conditions are met:

- The engine is running,
- The exterior lamp band is in AUTO, and
- The light sensor determines it is daytime.

When the DRL are on, the low-beam headlamps will be on. The taillamps, sidemarker, instrument panel lights and other lamps will not be on.

When the exterior lamp band is turned to the headlamp position, the regular headlamps will come on. The other lamps that come on with the headlamps will also come on.

When the headlamps are turned off, the regular lamps also turn off, and the low-beam headlamps turn on.

The regular headlamp system should be used when needed.

## Automatic Headlamp System

When it is dark enough outside, the headlamps come on automatically.

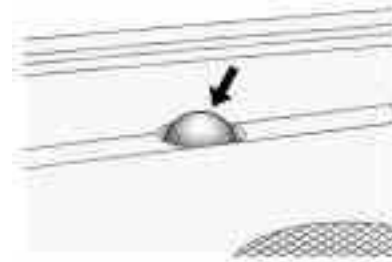

There is a light sensor located on top of the instrument panel. Do not cover the sensor or the headlamps will come on when they are not needed.

The system may also turn on the headlamps when driving through a parking garage or tunnel.

### Instrument Panel Brightness

This feature controls the brightness of the instrument panel lights.



The thumbwheel for this feature is located on the left side of the steering wheel next to the exterior lamps control.

Turn the thumbwheel to the right or left to brighten or dim the lights.

### Dome Lamp

 **(Dome Lamp Override):** Press this button to keep the dome lamps and other interior lamps turned off while any door is open. Press this button again to return it to the out position and the lamps automatically come on when any door is opened.

 **(On/Off):** Press this button to turn the dome lamps on and off while the doors are closed.

### Entry Lighting

If the dome lamp override button is in the out position, the lamps inside the vehicle automatically come on when any door is opened or when the Remote Keyless Entry (RKE) unlock button is pressed. After the door is opened the lights remain on and stay on for 20 seconds after the doors are closed, or until the key is put into the ignition and turned to the

ACC/ACCESSORY position. The lights will then gradually dim until it is no longer lit.

### Reading Lamps

The reading lamps are located on the overhead console.

To turn the reading lamps on or off, press the button located next to each lamp.

### Electric Power Management

The vehicle has Electric Power Management (EPM) that estimates the battery's temperature and state of charge. It then adjusts the voltage for best performance and extended life of the battery.

When the battery's state of charge is low, the voltage is raised slightly to quickly bring the charge back up. When the state of charge is high, the voltage is lowered slightly to prevent overcharging. If the vehicle has a voltmeter gage or a voltage display

on the Driver Information Center (DIC), you may see the voltage move up or down. This is normal. If there is a problem, an alert will be displayed.

The battery can be discharged at idle if the electrical loads are very high. This is true for all vehicles. This is because the generator (alternator) may not be spinning fast enough at idle to produce all the power that is needed for very high electrical loads.

A high electrical load occurs when several of the following are on, such as: headlamps, high beams, fog lamps, rear window defogger, climate control fan at high speed, heated seats, engine cooling fans, trailer loads, and loads plugged into accessory power outlets.

EPM works to prevent excessive discharge of the battery. It does this by balancing the generator's output and the vehicle's electrical needs. It can increase engine idle speed to generate more power, whenever needed. It can temporarily reduce the power demands of some accessories.

Normally, these actions occur in steps or levels, without being noticeable. In rare cases at the highest levels of corrective action, this action may be noticeable to the driver. If so, a Driver Information Center (DIC) message might be displayed, such as BATTERY SAVER ACTIVE, BATTERY VOLTAGE LOW, or LOW BATTERY. If this message is displayed, it is recommended that the driver reduce the electrical loads as much as possible. See *DIC Warnings and Messages on page 3-42*.

## Battery Run-Down Protection

The battery saver feature is designed to protect the vehicle's battery.

If any interior or exterior lamp is left on and the ignition is turned off, the battery rundown protection system automatically turns the lamp off after 10 minutes.

### Accessory Power Outlet(s)

The accessory power outlets can be used to connect electrical equipment, such as a cellular phone.

The accessory power outlets are located on the rear of the center storage console and in the rear cargo compartment. There may be a power outlet located inside the instrument panel storage area below the climate controls.

To use the outlets, remove the cover. When not in use, always cover the outlet with the protective cap.

**Notice:** Leaving electrical equipment on for extended periods will drain the battery. Always turn off electrical equipment when not in use and do not plug in equipment that exceeds the maximum 20 ampere rating.

Certain electrical accessories may not be compatible with the accessory power outlet and could result in blown vehicle or adapter fuses. If you experience a problem, see your dealer/retailer for additional information on the accessory power outlet.

**Notice:** Adding any electrical equipment to your vehicle may damage it or keep other components from working as they should. The repairs would not be covered by your warranty. Check with your dealer/retailer before adding electrical equipment.

When adding electrical equipment, be sure to follow the installation instructions included with the equipment.

**Notice:** Improper use of the power outlet can cause damage not covered by the warranty. Do not hang any type of accessory or accessory bracket from the plug because the power outlets are designed for accessory power plugs only.

## Climate Controls

### Automatic Climate Control System

The heating, cooling, and ventilation for the vehicle can be controlled with this system.

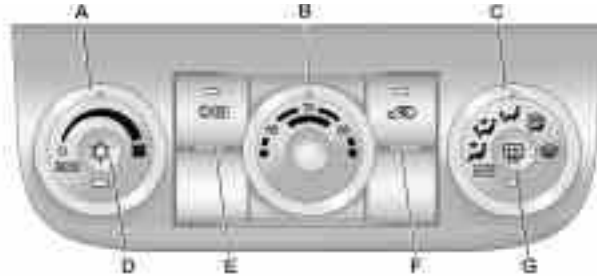

- A. Fan Control
- B. Temperature Control
- C. Air Delivery Mode Control
- D. Normal Air Conditioning

- E. Hybrid Air Conditioning
- F. Recirculation
- G. Rear Window Defogger

### Climate Control Influence on Hybrid Operation and Fuel Economy

To maximize your fuel economy, use the following settings (as indicated by the green marking):

- Set the fan knob to AUTO.
- Set the air delivery knob to AUTO.
- Select an air temperature setting near 75°F (23°C).
- Select the Hybrid A/C button, if A/C is required.

Avoid using these settings that may lead to fewer auto stops and to higher fuel consumption:

- Manual fan speed operation.
- Defrost mode. Only use this setting to clear the windows.
- Extreme cold or hot air temperature settings, such as 60°F (16°C) or 90°F (32°C).
- Normal air conditioning mode, if A/C is required.

## 3-18 Instrument Panel

---

### Automatic Operation

This climate control system automatically maintains the desired temperature inside the vehicle.

Do not cover the sensor located on the top of the instrument panel near the windshield or the sensor grille below the climate control faceplate. These two sensors help regulate the inside air temperature.

**AUTO (Automatic Fan):** Turn the fan knob to AUTO for the system to automatically adjust the fan speed to reach the desired inside temperature.

**Temperature Control:** Select the desired air temperature between 60-90°F (16-32°C). Typically, the best setting is near 75°F (23°C). Choosing the coldest or warmest temperature setting does not cause the system to heat or cool any faster.

**AUTO (Automatic Air Delivery Mode):** Turn the air delivery mode knob to AUTO for the system to automatically control the direction of the airflow to help reach the desired inside temperature.



The system automatically controls the air inlet to supply the outside air or recirculated inside air needed to cool the vehicle faster. The indicator light on the recirculation button will be lit whenever the system changes to recirculation. Press the recirculation button to change to outside air. However, the recirculation mode may turn back on automatically.

In cold weather, if the fan and air delivery modes are in automatic, the system starts at lower fan speeds to avoid directing cold air into the vehicle until warmer air is available. The climate control system directs air to the floor, but may automatically change modes as the vehicle warms up to maintain the chosen temperature setting.

The length of time needed to warm the interior depends on the outside temperature and inside temperature of the vehicle.

### Manual Operation

It is best to use the automatic settings to maximize fuel economy.

** (Fan Control):** Turn clockwise or counterclockwise to increase or decrease the fan speed. To turn the fan off, turn the left knob to the  position. In any setting other than off, the fan runs continuously with the ignition on. The fan must be turned on to run the air conditioning compressor. There will be some airflow noticeable from the various outlets when driving, even with the fan in the off position. This is to ensure some fresh air is always available in the vehicle. To turn off the air completely, turn the fan to  and select the recirculation button.





**Temperature Control:** Turn clockwise or counterclockwise to increase or decrease the temperature. Typically, the best setting is near 75°F (23°C). Choosing the coldest or warmest temperature setting does not cause the system to heat or cool any faster.

**Air Delivery Mode Control:** Turn clockwise or counterclockwise to change the direction of the airflow inside the vehicle.

Select from the following air delivery modes:

 **(Vent):** Air is directed to the instrument panel outlets.

 **(Bi-Level):** Air is divided between the instrument panel and the floor outlets.

 **(Floor):** Air is directed to the floor outlets with some air directed to the windshield. When this mode is selected, the system turns the recirculation mode off. Recirculation mode cannot be selected while in floor mode. This is to help prevent window fogging.

 **(Defog):** This mode clears the windows of fog or moisture. Air is directed to the floor outlets, with some air directed to the windshield and side window outlets. In this mode, the system turns the recirculation mode off and runs the air conditioning compressor unless the outside air is at or below freezing. Recirculation mode cannot be selected while in defog mode. This helps prevent window fogging.

 **(Defrost):** This mode removes fog or frost from the windshield more quickly. Air is directed to the windshield, with some air directed to the side window outlets and the floor outlets. In this mode, the system turns the recirculation mode off automatically and runs the air conditioning compressor unless the outside air is at or below freezing. The recirculation mode cannot be selected while in defrost mode. This helps prevent window fogging and moisture building up inside the vehicle. In this mode, the climate control system prevents all automatic engine start/stop operations. This ensures the best defrost performance.

For best results, clear all snow and ice from the windshield before defrosting.

## 3-20 Instrument Panel

---

### **(Normal Air Conditioning):**

Press to turn the air conditioning system on or off. An indicator light comes on to show that the air conditioning is on. Normal Air Conditioning (A/C) can be selected in any mode as long as the fan is on and the outside air temperature is above freezing. Normal A/C cannot be selected at the same time as Hybrid Air Conditioning (A/C). A flashing indicator light indicates that the air conditioning compressor is currently not available.

When Normal A/C is selected, the climate control system prevents all automatic engine start/stop operations. This will ensure the cabin comfort is maintained. See “Air Conditioning and Automatic Engine Start/Stop” later in this section.

### **(Hybrid Air Conditioning):**

Press to turn the Hybrid A/C system on or off. An indicator light comes on to show that Hybrid A/C is on. Hybrid A/C can be selected in

any mode, except defrost as long as the fan is on and the outside air temperature is above freezing. Hybrid A/C cannot be selected at the same time as the normal air conditioning. A flashing indicator light shows the air conditioning compressor is not available.

The Hybrid A/C works to balance fuel economy and air conditioning comfort. When Hybrid A/C is used in warm weather, the vehicle gets better fuel economy by allowing more frequent start/stops. For additional cooling, select Normal A/C. See “Air Conditioning and Automatic Engine Start/Stop” later in this section.

 **(Recirculation):** Press to toggle between the recirculation and outside air modes. The indicator light turns on when the recirculation mode is selected. This mode can be used to prevent outside air and odors from entering the vehicle or to help cool the air inside the vehicle more quickly. Avoid using

the recirculation mode during high periods of humidity and cool outside temperatures since this may result in increased window fogging. If window fogging is experienced, select the defrost mode.

Recirculation mode is not available in floor, defog or defrost modes. If the button is selected in these modes, the indicator will flash. This helps prevent window fogging and moisture building up inside the vehicle.

### **Rear Window Defogger**

The rear window defogger uses a warming grid to remove fog from the rear window.

The rear window defogger will only work when the ignition is in ON/RUN.

### **(Rear Window Defogger):**

Press to turn the rear window defogger on or off. An indicator light on the button comes on to show that it is activated.

The rear window defogger stays on for about 10 minutes if the vehicle remains at slower vehicle speeds or until the button is pressed, or unless the ignition is turned to ACC/ACCESSORY or LOCK/OFF. If turned on again, the defogger only runs for about five minutes before turning off again. At higher vehicle speeds, the defogger may stay on continuously. The defogger can also be turned off by turning off the ignition.

**Notice:** Do not use anything sharp on the inside of the rear window. If you do, you could cut or damage the warming grid, and the repairs would not be covered by the vehicle warranty. Do not attach a temporary vehicle license, tape, a decal or anything similar to the defogger grid.

### Air Conditioning and Engine Start/Stop

On hot days, use the automatic fan and automatic air delivery mode settings and the vehicle will reach the desired temperature more quickly. The desired fan and air delivery mode settings can still be adjusted manually. Open the windows to let the hot inside air escape, then close them. This helps reduce the time it takes for the vehicle to cool down and helps the system to operate more efficiently.

When either the Normal A/C or Hybrid A/C modes are active, the air conditioning system removes moisture from the air, so a small amount of water may drip under the vehicle while idling or after turning off the engine. This is normal.

The use of Normal A/C causes the engine to keep running while the vehicle is at a complete stop to allow the climate control system to continue cooling.

The use of Hybrid A/C allows automatic engine start/stop operations while the vehicle is at a complete stop. The air conditioning compressor can not run when the engine is not running, resulting in reduced cooling performance. The climate control system may keep the engine running or restart the engine during a stop to continue cooling. Selecting the Normal A/C button forces the engine and air conditioning compressor to restart automatically. For more information about Engine Start/Stop operation, see *Starting the Engine (Automatic Engine Start/Stop)* on page 2-15.

### Outlet Adjustment

Use the louvers located on the air outlets to change the direction of the airflow.

### Operation Tips

- Clear away any ice, snow, or leaves from the air inlets at the base of the vehicle that may block the flow of air into the vehicle.
- Do not use any non-GM approved hood deflectors that could adversely affect the performance of the system.
- Keep the path under the front seats clear of objects to help circulate the air inside of the vehicle more effectively.

### Warning Lights, Gages, and Indicators

Warning lights and gages can signal that something is wrong before it becomes serious enough to cause an expensive repair or replacement. Paying attention to the warning lights and gages could prevent injury.

Warning lights come on when there may be or is a problem with one of the vehicle's functions. Some warning lights come on briefly when the engine is started to indicate they are working.

Gages can indicate when there may be or is a problem with one of the vehicle's functions. Often gages and warning lights work together to indicate a problem with the vehicle.

When one of the warning lights comes on and stays on while driving, or when one of the gages shows there may be a problem, check the section that explains what to do. Follow this manual's advice. Waiting to do repairs can be costly and even dangerous.

## Instrument Panel Cluster

The instrument panel cluster is designed to indicate how the vehicle is running. It shows how fast the vehicle is going, about how much fuel the vehicle has left and many other things needed to drive safely and economically.



United States cluster, Canada similar

### Speedometer and Odometer

The speedometer shows the vehicle's speed in both miles per hour (mph) and kilometers per hour (km/h).

The odometer shows how far the vehicle has been driven, in either miles or kilometers.

If the vehicle needs a new odometer installed, the new one is set to the mileage total of the old odometer. If it cannot, it will be set at zero and a label must be put on the driver's door to show the old mileage reading when the new odometer was installed. If the mileage is unknown, the label should then indicate that the previous mileage is unknown.

### Trip Odometer

The trip odometer is located on the instrument panel and shows how far the vehicle has been driven since the trip odometer was last reset. To reset the trip odometer to zero, press and hold the trip/reset button on the speedometer for about two seconds. Press the trip/reset button to switch between the trip odometer and odometer.

### Tachometer



**U.S. shown, Canada similar**

The tachometer displays the engine speed in revolutions per minute (rpm).

The auto stop indicator is located at the bottom of the tachometer. For more information see *Auto Stop Mode* on page 3-35.

### Safety Belt Reminders

#### Driver Safety Belt Reminder Light

When the engine is started, a chime sounds for several seconds to remind the driver to fasten their safety belt, unless it is already buckled.



The safety belt light comes on and stays on for several seconds, then flashes for several more.

This chime and light are repeated if the driver safety belt remains unbuckled and the vehicle is in motion. If the driver safety belt is already buckled, neither the chime nor the light comes on.

## Passenger Safety Belt Reminder Light

Several seconds after the engine is started, a chime sounds for several seconds to remind the front passenger to buckle their safety belt. This only occurs if the passenger airbag is enabled. See *Passenger Sensing System on page 1-49* for more information. The passenger safety belt light, located on the instrument panel, comes on and stays on for several seconds and then flashes for several more.



This chime and light are repeated if the passenger remains unbuckled and the vehicle is in motion.

If the passenger safety belt is buckled before the engine is started, neither the chime nor the light comes on.

The front passenger safety belt warning light and chime may turn on if an object is put on the seat such as a briefcase, handbag, grocery bag, laptop or other electronic device. To turn off the warning light and or chime, remove the object from the seat or buckle the safety belt.

## Airbag Readiness Light

There is an airbag readiness light on the instrument panel cluster, which shows the airbag symbol. The system checks the airbag's electrical system for malfunctions. The light indicates if there is an electrical problem. The system check includes the airbag sensor, the pretensioners, the airbag modules, the wiring and the crash sensing and diagnostic module. For more information on the airbag system, see *Airbag System on page 1-41*.

### CAUTION

If the airbag readiness light stays on after the vehicle is started or comes on while driving, it means the airbag system might not be working properly. The airbags in the vehicle might not inflate in a crash, or they could even inflate without a crash. To help avoid injury, have the vehicle serviced right away.



The airbag readiness light comes on when the vehicle is started, and flashes for a few seconds. The light goes out when the system is ready.

## 3-26 Instrument Panel

If the airbag readiness light stays on after the vehicle is started or comes on while driving, the airbag system may not work properly. Have the vehicle serviced right away.

The airbag readiness light should flash for a few seconds when the engine is started. If the light does not come on then, have it fixed immediately. If there is a problem with the airbag system, an airbag Driver Information Center (DIC) message may also come on. See *DIC Warnings and Messages* on page 3-42 for more information.

### Passenger Airbag Status Indicator

The vehicle has the passenger sensing system. See *Passenger Sensing System* on page 1-49 for important safety information. The instrument panel has a passenger airbag status indicator.



United States



Canada

When the vehicle is started, the passenger airbag status indicator will light ON and OFF, or the symbol for on and off, for several seconds as a system check. Then, after several more seconds, the status indicator will light either ON or OFF,

or either the on or off symbol to let you know the status of the right front passenger frontal and seat-mounted side impact airbags.

If the word ON or the on symbol is lit on the passenger airbag status indicator, it means that the right front passenger frontal airbag and seat-mounted side impact airbag are enabled (may inflate).

If the word OFF or the off symbol is lit on the airbag status indicator, it means that the passenger sensing system has turned off the right front passenger frontal airbag and seat-mounted side impact airbag.

If, after several seconds, both status indicator lights remain on, or if there are no lights at all, there may be a problem with the lights or the passenger sensing system. See your dealer/retailer for service.



**⚠ CAUTION**

If the airbag readiness light ever comes on and stays on, it means that something may be wrong with the airbag system. To help avoid injury to yourself or others, have the vehicle serviced right away. See *Airbag Readiness Light on page 3-25* for more information, including important safety information.

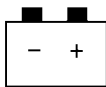
**Charging System Light**

The charging system light comes on briefly when the ignition is turned on, but the engine is not running, as a check to show the light is working. It should go out when the engine is started.

If the light stays on, or comes on while driving, there could be a problem with the electrical charging system. Have it checked by your dealer/retailer. Driving while this light is on could drain the battery.

If a short distance must be driven with the light on, be sure to turn off all accessories, such as the radio and air conditioner.

**Brake System Warning Light****BRAKE****United States****Canada**

The brake indicator light should come on briefly as the engine is started. If it does not come on have the vehicle serviced by your dealer/retailer.

When the ignition is on, the brake system warning light comes on when the parking brake is set. The

light stays on if the parking brake does not fully release. If it stays on after the parking brake is fully released, there is a brake problem. Have the brake system inspected immediately.

**⚠ CAUTION**

The brake system might not be working properly if the brake system warning light is on. Driving with the brake system warning light on can lead to a crash. If the light is still on after the vehicle has been pulled off the road and carefully stopped, have the vehicle towed for service.

If the light comes on while driving, a chime sounds. Pull off the road and stop. The pedal might be harder to push or go closer to the floor. It might also take longer to stop. If the light is still on, have the vehicle towed for service. See *Towing Your Vehicle on page 4-22*.

### Antilock Brake System (ABS) Warning Light



For vehicles with the Antilock Brake System (ABS), this light should come on briefly as the engine is started. If it does not come on have the vehicle serviced by your dealer/retailer.

If the ABS light stays on longer than a few seconds after engine is started, or comes on and stays on while driving, try resetting the system. To reset the system:

1. While driving, pull over when it is safe to do so.
2. Place the vehicle in P (PARK).
3. Turn off the ignition.
4. Then restart the engine.

If the ABS light remains on after resetting the system or comes on again while driving, the vehicle needs service. If the ABS light is on, but the regular brake system warning light is not on, the antilock brakes are not working properly, but the regular brakes are still functioning. Have the vehicle serviced right away. If both brake lights are on, the vehicle does not have antilock brakes, and there is a problem with the regular brakes as well. Have the vehicle towed for service. See *Towing Your Vehicle on page 4-22*.

### StabiliTrak<sup>®</sup>/Traction Control System (TCS) Warning Light



The Traction Control System (TCS)/StabiliTrak<sup>®</sup> system warning light comes on briefly as the engine is started.

If it does not, have the vehicle serviced by your dealer/retailer. If the system is working normally the indicator lights go off.

This light flashes while the Traction Control System (TCS) and/or the StabiliTrak system are working. It also flashes when the Antilock Brake System (ABS) is activated.

If the light comes on and stays on while driving there is a problem with the Traction Control System (TCS) or the StabiliTrak system. The

TCS and/or StabiliTrak system automatically turns off and vehicle needs service.

When this light is on, the TCS system does not limit wheel spin and/or the StabiliTrak system does not assist with vehicle control.

When the Traction Control system and/or StabiliTrak system are turned off, the light comes on.

When the Traction Control System and/or StabiliTrak system are turned on, the light turns off.

See *Traction Control System (TCS) on page 4-8* and *StabiliTrak® System on page 4-7* for more information.

## Engine Coolant Temperature Warning Light

The engine coolant temperature light should come on briefly as the engine is started. If it does not come on have the vehicle serviced by your dealer/retailer.



**Notice:** Driving with the engine coolant temperature warning light on could cause the vehicle to overheat. See *Engine Overheating on page 5-23*. The vehicle's engine could be damaged, and it might not be covered by the vehicle warranty. Never drive with the engine coolant temperature warning light on.

If this light comes on and stays on, the engine has overheated. Pull over and see *Engine Overheating on page 5-23* for more information.

## Tire Pressure Light



If the vehicle has a tire pressure monitoring system, the tire pressure light should come on briefly as the engine is started. If it does not, have the vehicle serviced by your dealer/retailer. It provides information about tire pressures and the Tire Pressure Monitoring System.

### When the Light is On Steady

This indicates that one or more of the tires are significantly underinflated.

A tire pressure message in the Driver Information Center (DIC), can accompany the light. See *DIC*

## 3-30 Instrument Panel

*Warnings and Messages on page 3-42 for more information. Stop and check the tires as soon as it is safe to do so. If underinflated, inflate to the proper pressure. See Tires on page 5-38 for more information.*

### **When the Light Flashes First and Then is On Steady**

This indicates that there could be a problem with the Tire Pressure Monitor System. The light flashes for about a minute and stays on steady for the remainder of the ignition cycle. This sequence repeats with every ignition cycle. See *Tire Pressure Monitor System on page 5-45* for more information.

## **Malfunction Indicator Lamp**

### **Check Engine Light**

A computer system called OBD II (On-Board Diagnostics-Second Generation) monitors operation of the fuel, ignition, and emission control systems. It ensures that emissions are at acceptable levels for the life of the vehicle, helping to produce a cleaner environment.

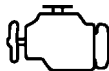

This light comes on when the ignition is on, but the engine is not running, as a check to show it is working. If it does not, have the vehicle serviced by your dealer/retailer.

If the check engine light comes on and stays on, while the engine is running, this indicates that there is an OBD II problem and service is required.

Malfunctions often are indicated by the system before any problem is apparent. Being aware of the light can prevent more serious damage to the vehicle. This system assists the service technician in correctly diagnosing any malfunction.

**Notice:** If the vehicle is continually driven with this light on, after a while, the emission controls might not work as well, the vehicle's fuel economy might not be as good, and the engine might not run as smoothly. This could lead to costly repairs that might not be covered by the vehicle warranty.

**Notice:** Modifications made to the engine, transmission, exhaust, intake, or fuel system of the vehicle or the replacement of the original tires with other than those of the same Tire Performance Criteria (TPC) can affect the vehicle's emission controls and can cause this light to come on. Modifications to these systems could lead to costly repairs not covered by the vehicle warranty. This could also result in a failure to pass a required Emission Inspection/Maintenance test. See *Accessories and Modifications on page 5-3*.

This light comes on during a malfunction in one of two ways:

**Light Flashing:** A misfire condition has been detected. A misfire increases vehicle emissions and could damage the emission control system on the vehicle. Diagnosis and service might be required.

The following can prevent more serious damage to the vehicle:

- Reduce vehicle speed.
- Avoid hard accelerations.
- Avoid steep uphill grades.
- If towing a trailer, reduce the amount of cargo being hauled as soon as it is possible.

If the light continues to flash, when it is safe to do so, stop the vehicle. Find a safe place to park the vehicle. Turn the key off, wait at least 10 seconds, and restart the engine. If the light is still flashing, follow the previous steps and see your dealer/retailer for service as soon as possible.

**Light On Steady:** An emission control system malfunction has been detected on the vehicle. Diagnosis and service might be required.

An emission system malfunction might be corrected by:

- Make sure the fuel cap is fully installed. See *Filling the Tank on page 5-7*. The diagnostic system can determine if the fuel cap has been left off or improperly installed. A loose or missing fuel cap allows fuel to evaporate into the atmosphere. A few driving trips with the cap properly installed should turn the light off.
- If the vehicle has been driven through a deep puddle of water, the vehicle's electrical system might be wet. The condition is usually corrected when the electrical system dries out. A few driving trips should turn the light off.

## 3-32 Instrument Panel

---

- Make sure to fuel the vehicle with quality fuel. Poor fuel quality causes the engine not to run as efficiently as designed and may cause: stalling after start-up, stalling when the vehicle is changed into gear, misfiring, hesitation on acceleration, or stumbling on acceleration. These conditions might go away once the engine is warmed up.

If one or more of these conditions occurs, change the fuel brand used. It will require at least one full tank of the proper fuel to turn the light off.

See *Gasoline Octane* on page 5-5.

If none of the above have made the light turn off, your dealer/retailer can check the vehicle. The dealer/retailer has the proper test equipment and diagnostic tools to fix any mechanical or electrical problems that might have developed.

### Emissions Inspection and Maintenance Programs

Some state/provincial and local governments have or might begin programs to inspect the emission control equipment on the vehicle. Failure to pass this inspection could prevent getting a vehicle registration.

Here are some things to know to help the vehicle pass an inspection:

- The vehicle will not pass this inspection if the check engine light is on with the engine running, or if the key is in ON/RUN and the light is not on.
- The vehicle will not pass this inspection if the OBD II (on-board diagnostic) system determines that critical emission control systems have not been completely diagnosed by the system. The vehicle would be considered not ready for inspection. This can happen if the battery has recently been replaced or if the battery has run down. The diagnostic system is designed to evaluate critical emission control systems during normal driving. This can take several days of routine driving. If this has been done and the vehicle still does not pass the inspection for lack of OBD II system readiness, your dealer/retailer can prepare the vehicle for inspection.

## Oil Pressure Light



Do not keep driving if the oil pressure is low. The engine can become so hot that it catches fire. Someone could be burned. Check the oil as soon as possible and have the vehicle serviced.

**Notice:** Lack of proper engine oil maintenance can damage the engine. The repairs would not be covered by the vehicle warranty. Always follow the maintenance schedule in this manual for changing engine oil.



The oil pressure light should come on briefly as the engine is started. If it does not come on have the vehicle serviced by your dealer/retailer.

If the light comes on and stays on, it means that oil is not flowing through the engine properly. The vehicle could be low on oil and might have some other system problem.

## Change Engine Oil Light



Change engine oil light means that service is required on the vehicle.

See *Scheduled Maintenance on page 6-3* and *Engine Oil on page 5-11* for more information.

After the engine oil is changed the engine oil life system needs to be reset in order to turn off this light. See *Engine Oil Life System on page 5-14* for more information.

## Security Light



For information regarding this light and the vehicle's security system, see *PASS-Key® III+ Electronic Immobilizer on page 2-12*.

## Cruise Control Light



The cruise control light comes on whenever the cruise control is set.

The light goes out when the cruise control is turned off. See *Cruise Control on page 3-9* for more information.

### Highbeam On Light



The highbeam on light comes on when the high-beam headlamps are in use.

See *Headlamp High/Low-Beam Changer* on page 3-7 for more information.

### Low Washer Fluid Warning Light



The low washer fluid warning light comes on when the windshield washer fluid is low. See *Windshield Washer Fluid* on page 5-24 for more information.

### Fuel Gage

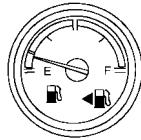

#### United States

When the ignition is on, the fuel gage shows about how much fuel is in the fuel tank.

An arrow on the fuel gage indicates the side of the vehicle the fuel door is on.

When the indicator nears empty, the low fuel light comes on. There still is a little fuel left, but the fuel tank should be refueled soon. See *Low Fuel Warning Light* on page 3-34 for more information.

Four things that can happen but do not mean the fuel gage is not functioning properly are:

- At the service station, the fuel pump shuts off before the gage reads full.

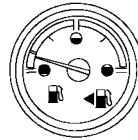

#### Canada

- It takes a little more or less fuel to fill up than the fuel gage indicates.
- The gage moves a little while turning a corner or accelerating.
- The gage takes a few seconds to stabilize after the ignition is turned on, and goes back to empty after the ignition is turned off.

For the fuel tank capacity, see *Capacities and Specifications* on page 5-81.

### Low Fuel Warning Light



The low fuel warning light, below the fuel gage, comes on briefly when the engine is started.



This light also comes on when the fuel tank is low on fuel. When fuel is added, the light should go off. If it does not, have the vehicle serviced.

## Auto Stop Mode

**AUTO  
STOP**

United States

This mark on the tachometer signifies that the engine is in Auto Stop mode which is a fuel saving operation.

When the vehicle is off, the tachometer needle moves to OFF. If the driver's door is opened while in Auto Stop, a chime sounds.



Canada

## Charge/Assist Gage



The CHARGE/ASSIST gage displays the charge into and out of the hybrid battery.

When the gage indicates ASSIST, the electric motor is performing an automatic restart of the engine, or the electric motor is assisting for maximum acceleration.

When the gage indicates CHARGE, the electric motor operates as a generator to perform regenerative braking, while decelerating. See *Regenerative Braking* on page 2-23 for more information.

The gage also indicates CHARGE when the system is recharging the hybrid battery.

If the hybrid battery or other hybrid components are very hot or cold, the CHARGE and ASSIST functions can be suspended until the component temperatures are normal.

## Fuel Economy Light

**eco**

The ECO light comes on when the vehicle is achieving fuel economy close to its rated performance.

Driving habits that improve fuel economy increases the time that the fuel economy light is on.

To enable or disable the fuel economy light, while in park, press the Vehicle Info button on the DIC until PRESS ✓ TO SET ECO is displayed. Then press the set/reset button to select off or on. For more information see *Trip Odometer* on page 3-24 and *DIC Operation and Displays* on page 3-36.

### Driver Information Center (DIC)

Your vehicle has a Driver Information Center (DIC).

All information appears in the DIC display located in the instrument panel cluster.

The DIC comes on when the ignition is on. After a short delay, the DIC displays the information that was last displayed before the engine was turned off.

The DIC displays trip, fuel, and vehicle system information, and warning messages if a system problem is detected.

The DIC also displays the compass direction, outside air temperature, and shift position indicator at the top of the DIC display. If there is a problem with the system that controls the temperature display, the numbers will be replaced with dashes. If this occurs, have the vehicle serviced by your dealer/

retailer. If an abnormal temperature reading is displayed for an extended period of time, consult your dealer/retailer. Under certain circumstances, especially when the engine is idling, a delay updating the temperature display is normal.

See *DIC Compass on page 3-40* and *Automatic Transmission Operation on page 2-20* for more information.

### DIC Operation and Displays

The DIC has different displays which can be accessed by pressing the DIC buttons located on the instrument panel, below the headlamp switch.

The DIC displays trip, fuel, and vehicle system information, and warning messages if a system problem is detected.

The DIC also allows some features to be customized. See *DIC Vehicle Customization on page 3-49* for more information.

### DIC Buttons



The buttons are the trip/fuel, vehicle information, customization, and set/reset buttons. The button functions are detailed in the following pages.

** (Trip/Fuel):** Press this button to display the odometer, trip odometer, fuel range, average economy, and instantaneous economy. The compass and outside temperature will also be shown in the display. The temperature will be shown in °F or °C depending on the units selected.

 **(Vehicle Information):** Press this button to display the oil life, units, tire pressure readings for vehicles with the Tire Pressure Monitor System (TPMS), Remote Keyless Entry (RKE) transmitter programming, economy light on/off, compass zone setting, and compass recalibration on vehicles with this feature.

 **(Customization):** Press this button to customize the feature settings on your vehicle. See *DIC Vehicle Customization* on page 3-49 for more information.

✓ **(Set/Reset):** Press this button to set or reset certain functions and to turn off or acknowledge messages on the DIC.

## Trip/Fuel Menu Items

 **(Trip/Fuel):** Press this button to scroll through the following menu items:

### Odometer

Press the trip/fuel button until ODOMETER displays. This display shows the distance the vehicle has been driven in either miles (mi) or kilometers (km). Pressing the trip odometer reset stem will also display the odometer.

To switch between English and metric measurements, see “Units” later in this section.

### Trip Odometer

Press the trip/fuel button until TRIP displays. This display shows the current distance traveled in either miles (mi) or kilometers (km) since the last reset for the trip odometer. Pressing the trip odometer reset stem will also display the trip odometer.

The trip odometer can be reset to zero by pressing the set/reset button while the trip odometer is displayed. You can also reset the trip odometer while it is displayed by pressing and holding the trip odometer reset stem.

### Fuel Range

Press the trip/fuel button until FUEL RANGE displays. This display shows the approximate number of remaining miles (mi) or kilometers (km) the vehicle can be driven without refueling. The display will show LOW if the fuel level is low.

The fuel range estimate is based on an average of the vehicle's fuel economy over recent driving history and the amount of fuel remaining in the fuel tank. This estimate will change if driving conditions change. For example, if driving in traffic and making frequent stops, this display may read one number, but if the vehicle is driven on a freeway, the number may change even though the same

## 3-38 Instrument Panel

---

amount of fuel is in the fuel tank. This is because different driving conditions produce different fuel economies. Generally, freeway driving produces better fuel economy than city driving. Fuel range cannot be reset.

If the vehicle is low on fuel, the FUEL LEVEL LOW message will be displayed. See “FUEL LEVEL LOW” under *DIC Warnings and Messages on page 3-42*.

### Average Fuel Economy

Press the trip/fuel button until AVERAGE FUEL ECONOMY displays. This display shows the approximate average miles per gallon (mpg) or liters per 100 kilometers (L/100 km). This number is calculated based on the number of mpg (L/100 km) recorded since the last time this menu item was reset. To reset the AVERAGE FUEL ECONOMY, press and hold the set/reset button. The display will show zero.

### Instantaneous Fuel Economy

If the vehicle has this display, press the trip/fuel button until INSTANT FUEL ECONOMY displays. This display shows the current fuel economy at a particular moment and will change frequently as driving conditions change. This display shows the instantaneous fuel economy in miles per gallon (mpg) or liters per 100 kilometers (L/100 km). Unlike average fuel economy, this display cannot be reset.

### Blank Display

This display shows no information.

### Vehicle Information Menu Items

 **(Vehicle Information):** Press this button to scroll through the following menu items:

#### Oil Life

Press the vehicle information button until OIL LIFE REMAINING displays. This display shows an estimate of the oil's remaining useful life. If you see 99% OIL LIFE REMAINING on the display, that means 99% of the current oil life remains. The engine oil life system will alert you to change the oil on a schedule consistent with your driving conditions.

When the remaining oil life is low, the CHANGE ENGINE OIL SOON message will appear on the display. See “CHANGE ENGINE OIL SOON” under *DIC Warnings and Messages on page 3-42*. You should change the oil as soon as you can. See *Engine Oil on page 5-11*. In addition to the engine

oil life system monitoring the oil life, additional maintenance is recommended in the Maintenance Schedule in this manual. See *Scheduled Maintenance on page 6-3* for more information.

### Units

Press the vehicle information button until UNITS displays. This display allows you to select between English or Metric units of measurement. Once in this display, press the set/reset button to select between ENGLISH or METRIC units. All of the vehicle information will then be displayed in the unit of measurement selected.

### Tire Pressure

If your vehicle has the Tire Pressure Monitor System (TPMS), the pressure for each tire can be viewed in the DIC. The tire pressure will be shown in either pounds per square inch (psi) or kilopascals (kPa). Press the vehicle information button until the DIC displays

FRONT TIRES PSI (kPa) LEFT ## RIGHT ##. Press the vehicle information button again until the DIC displays REAR TIRES PSI (kPa) LEFT ## RIGHT ##.

If a low or high tire pressure condition is detected by the system while driving, a message advising you to check the pressure in a specific tire will appear in the display. See *Inflation - Tire Pressure on page 5-43* and *DIC Warnings and Messages on page 3-42* for more information.

If the tire pressure display shows dashes instead of a value, there may be a problem with your vehicle. If this consistently occurs, see your dealer/retailer for service.

### Relearn Remote Key

This display allows you to match Remote Keyless Entry (RKE) transmitters to your vehicle. To match an RKE transmitter to your vehicle:

1. Press the vehicle information button until PRESS ✓ TO RELEARN REMOTE KEY displays.
2. Press the set/reset button until REMOTE KEY LEARNING ACTIVE is displayed.
3. Press and hold the lock and unlock buttons on the first transmitter at the same time for about 15 seconds.

A chime will sound indicating that the transmitter is matched and REMOTE KEY LEARNING COMPLETE will be shown on the display.

## 3-40 Instrument Panel

---

4. To match additional transmitters at this time, repeat Step 3.  
Each vehicle can have a maximum of eight transmitters matched to it.
5. To exit the programming mode, you must cycle the key to LOCK/OFF.

### Compass Zone Setting

This display allows for setting the compass zone. See *DIC Compass on page 3-40* for more information.

### Compass Recalibration

This display allows for calibrating the compass. See *DIC Compass on page 3-40* for more information.

### ECO (Economy) Light On/Off

This display allows you to turn the ECO light in the cluster on and off. See *Fuel Economy Light on page 3-35* for more information. Press the vehicle information button until PRESS ✓ SET ECO displays. This display will only

be available when the vehicle is in P (Park). Once in the display, press the set/reset button to select ON or OFF.

### Blank Display

This display shows no information.

### DIC Compass

Your vehicle may have a compass in the Driver Information Center (DIC).

### Compass Zone

The zone is set to zone eight upon leaving the factory. Your dealer/retailer will set the correct zone for your location.

Under certain circumstances, such as during a long distance cross-country trip or moving to a new state or province, it will be necessary to compensate for compass variance by resetting the zone through the DIC if the zone is not set correctly.

Compass variance is the difference between the earth's magnetic north and true geographic north. If the compass is not set to the zone where you live, the compass may give false readings. The compass must be set to the variance zone in which the vehicle is traveling.

To adjust for compass variance, use the following procedure:

### Compass Variance (Zone) Procedure

1. Do not set the compass zone when the vehicle is moving. Only set it when the vehicle is in P (Park).  
Press the vehicle information button until PRESS ✓ TO SET COMPASS ZONE: ## displays.

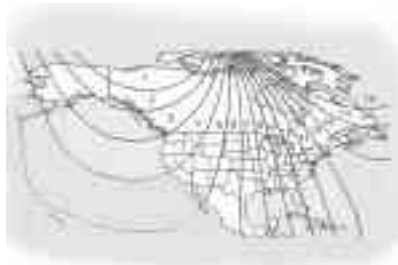

2. Find the vehicle's current location and variance zone number on the map. Zones 1 through 15 are available.
3. Press and hold the set/reset button to scroll through and select the appropriate variance zone.
4. Press the trip/fuel button until the vehicle heading, for example, N for North, is displayed in the DIC.

5. If calibration is necessary, calibrate the compass. See "Compass Calibration Procedure" following.

### Compass Calibration

The compass can be manually calibrated. Only calibrate the compass in a magnetically clean and safe location, such as an open parking lot, where driving the vehicle in circles is not a danger. It is suggested to calibrate away from tall buildings, utility wires, manhole covers, or other industrial structures, if possible.

If CAL should ever appear in the DIC display, the compass should be calibrated.

If the DIC display does not show a heading, for example, N for North, or the heading does not change after making turns, there may be a strong magnetic field interfering with the compass. Such interference may be caused by a magnetic CB or cell phone

antenna mount, a magnetic emergency light, magnetic note pad holder, or any other magnetic item. Turn off the vehicle, move the magnetic item, then turn on the vehicle and calibrate the compass.

To calibrate the compass, use the following procedure:

### Compass Calibration Procedure

1. Before calibrating the compass, make sure the compass is set to the variance zone in which the vehicle is located. See "Compass Variance (Zone) Procedure" earlier in this section. Do not operate any switches such as window, sunroof, climate controls, seats, etc. during the calibration procedure.
2. Press the vehicle information button until PRESS ✓ TO CALIBRATE COMPAS (Compass) displays.

## 3-42 Instrument Panel

---

3. Press the set/reset button to start the compass calibration.
4. The DIC will display **CALIBRATING COMPASS: TURN IN CIRCLES**. Drive the vehicle in tight circles at less than 5 mph (8 km/h) to complete the calibration. The DIC will display **COMPASS CALIBRATION COMPLETE** for a few seconds when the calibration is complete. The DIC display will then return to the previous menu.

### DIC Warnings and Messages

Messages are displayed on the DIC to notify the driver that the status of the vehicle has changed and that some action may be needed by the driver to correct the condition. Multiple messages may appear one after another.

Some messages may not require immediate action, but you can press any of the DIC buttons, or the trip odometer reset stem on the

instrument panel cluster to acknowledge that you received the messages and to clear them from the display.

Some messages cannot be cleared from the DIC display because they are more urgent. These messages require action before they can be cleared. Take any messages that appear on the display seriously and remember that clearing the messages will only make the messages disappear, not correct the problem.

The following are the possible messages that can be displayed and some information about them.

#### BATTERY SAVER ACTIVE

This message displays when the charging system detects that the battery is being drained. You may notice that the vehicle attempts to reduce the drain for you by turning off accessories, such as interior fans, rear defogger, and heated seats. Turn off all

accessories. If the vehicle is not running, start and run the engine for at least 10 minutes to allow the battery to recharge. If the engine is running and the condition persists, see your dealer/retailer immediately.

#### CALIBRATING COMPASS: TURN IN CIRCLES

This message displays when calibrating the compass. Drive the vehicle in circles at less than 5 mph (8 km/h) to complete the calibration. See *DIC Compass on page 3-40*.

#### CHANGE ENGINE OIL SOON

This message displays when service is required for the vehicle. See your dealer/retailer. See *Engine Oil on page 5-11* and *Scheduled Maintenance on page 6-3* for more information.



Acknowledging this message will not reset the OIL LIFE REMAINING display. That must be done at the OIL LIFE screen. See “OIL LIFE” under *DIC Operation and Displays on page 3-36* and *Engine Oil Life System on page 5-14* for more information.

## CHANGE TRANSMISSION FLUID

**Notice:** Use of the incorrect automatic transmission fluid may damage the vehicle, and the damages may not be covered by the vehicle’s warranty. Always use the automatic transmission fluid listed in *Recommended Fluids and Lubricants on page 6-11*.

This message displays when the life of the transmission fluid has expired and it should be changed. See *Scheduled Maintenance on page 6-3* and *Recommended Fluids and Lubricants on page 6-11* for the proper fluid and change intervals.

## CHECK TIRE PRESSURE

On vehicles with the Tire Pressure Monitor System (TPMS), this message displays when the pressure in one or more of the vehicle’s tires needs to be checked. This message also displays LEFT FRONT, RIGHT FRONT, LEFT REAR, or RIGHT REAR to indicate which tire needs to be checked. You can receive more than one tire pressure message at a time. To read the other messages that may have been sent at the same time, press the set/reset button. If a tire pressure message appears on the DIC, stop as soon as you can. Have the tire pressures checked and set to those shown on the Tire Loading Information label. See *Tires on page 5-38*, *Loading the Vehicle on page 4-18*, and *Inflation - Tire Pressure on page 5-43*. The DIC also shows the tire pressure values. See *DIC Operation and Displays on page 3-36*. If the tire pressure is

low, the low tire pressure warning light comes on. See *Tire Pressure Light on page 3-29*.

## COMPASS CALIBRATION COMPLETE

This message displays when the compass calibration is complete. See *DIC Compass on page 3-40*.

## CRUISE CONTROL SET TO XXX

This message displays whenever the cruise control is set. See *Cruise Control on page 3-9* for more information.

## DRIVER DOOR OPEN

This message displays when the driver door is not closed properly. Close the door completely.

### **ENGINE HOT A/C (Air Conditioning) OFF**

This message displays when the engine coolant becomes hotter than the normal operating temperature. To avoid added strain on a hot engine, the air conditioning compressor is automatically turned off. When the coolant temperature returns to normal, the A/C operation automatically resumes. You can continue to drive your vehicle.

### **ENGINE OIL LOW: ADD OIL**

Your vehicle may have an engine oil level sensor. If it does, this message displays when the oil is low. See *Engine Oil* on page 5-11 for more information.

### **ENGINE OVERHEATED IDLE ENGINE**

**Notice:** If you drive your vehicle while the engine is overheating, severe engine damage may occur. If an overheat warning appears on the instrument panel cluster

and/or DIC, stop the vehicle as soon as possible. Do not increase the engine speed above normal idling speed. See *Engine Overheating* on page 5-23 for more information.

This message displays when the engine coolant temperature is too hot. Stop and allow the vehicle to idle until it cools down.

### **ENGINE OVERHEATED STOP ENGINE**

**Notice:** If you drive your vehicle while the engine is overheating, severe engine damage may occur. If an overheat warning appears on the instrument panel cluster and/or DIC, stop the vehicle as soon as possible. See *Engine Overheating* on page 5-23 for more information.

This message displays along with a continuous chime when the engine has overheated. Stop and

turn the engine off immediately to avoid severe engine damage. See *Engine Overheating* on page 5-23.

### **ENGINE POWER IS REDUCED**

This message displays when the vehicle's engine power is reduced. Reduced engine power can affect the vehicle's ability to accelerate. If this message is on, but there is no reduction in performance, proceed to your destination. The performance may be reduced the next time the vehicle is driven. The vehicle may be driven at a reduced speed while this message is on, but acceleration and speed may be reduced. Anytime this message stays on, the vehicle should be taken to your dealer/retailer for service as soon as possible.

## FUEL LEVEL LOW

This message displays when your vehicle is low on fuel. Refill the fuel tank as soon as possible. See *Fuel Gage on page 3-34* and *Filling the Tank on page 5-7* for more information.

## HOOD OPEN

This message displays on some vehicles when the hood is not closed properly. Close the hood completely. See *Hood Release on page 5-9*.

## ICE POSSIBLE DRIVE WITH CARE

This message displays when the outside air temperature is cold enough to create icy road conditions. Adjust your driving accordingly.

## LIFTGATE OPEN

This message displays when the liftgate is not closed completely. Close the liftgate completely. See *Liftgate on page 2-8*.

## OIL PRESSURE LOW STOP ENGINE

**Notice:** If you drive your vehicle while the engine oil pressure is low, severe engine damage may occur. If a low oil pressure warning appears on the Driver Information Center (DIC), stop the vehicle as soon as possible. Do not drive the vehicle until the cause of the low oil pressure is corrected. See *Engine Oil on page 5-11* for more information.

This message displays when the vehicle's engine oil pressure is low. The oil pressure light also appears on the instrument panel cluster. See *Oil Pressure Light on page 3-33*.

Stop the vehicle immediately, as engine damage can result from driving a vehicle with low oil pressure. Have the vehicle serviced by your dealer/retailer as soon as possible when this message is displayed.

## PASSENGER DOOR OPEN

This message displays when one or more of the passenger doors are not closed properly. Close the doors completely.

## REMOTE KEY LEARNING ACTIVE

This message displays while matching a Remote Keyless Entry (RKE) transmitter to your vehicle. See "MATCHING TRANSMITTERS TO YOUR VEHICLE" under *Remote Keyless Entry (RKE) System Operation on page 2-4* and *DIC Operation and Displays on page 3-36* for more information.

### **REMOTE KEY LEARNING COMPLETE**

This message displays while matching a Remote Keyless Entry (RKE) transmitter to your vehicle. See "MATCHING TRANSMITTERS TO YOUR VEHICLE" under *Remote Keyless Entry (RKE) System Operation on page 2-4* and *DIC Operation and Displays on page 3-36* for more information.

### **REPLACE REMOTE KEY FOB BATTERY**

This message displays if a Remote Keyless Entry (RKE) transmitter battery is low. The battery needs to be replaced in the transmitter. See "Battery Replacement" under *Remote Keyless Entry (RKE) System Operation on page 2-4*.

### **SERVICE A/C (Air Conditioning) SYSTEM**

This message displays when there is a problem detected in the air conditioning system. Have the vehicle serviced by your dealer/retailer.

### **SERVICE AIR BAG**

This message displays when there is a problem with the airbag system. Have your vehicle serviced by your dealer/retailer immediately. See *Airbag Readiness Light on page 3-25* for more information.

### **SERVICE BRAKE SYSTEM**

This message displays along with the brake system warning light if there is a problem with the brake system or when the brake fluid level is low. See *Brake System Warning Light on page 3-27*. Have the brake system serviced by your dealer/retailer as soon as possible.

### **SERVICE HILL START ASSIST**

This message displays if there is a problem with the hill start assist function. Have your vehicle serviced by your dealer/retailer.

### **SERVICE HYBRID SYSTEM**

This message displays if the hybrid components need to be serviced. Have your vehicle serviced by your dealer/retailer.

### **SERVICE POWER STEERING**

This message displays if there has been a problem detected with the power steering. See *Steering on page 4-9* for more information.

## SERVICE STABILITRAK

This message displays if there has been a problem detected with StabiliTrak®. A warning light also appears on the instrument panel cluster. See *StabiliTrak®/Traction Control System (TCS) Warning Light on page 3-28*. See *StabiliTrak® System on page 4-7* for more information.

If this message turns on while you are driving, pull off the road as soon as possible and stop carefully. Try resetting the system by turning the ignition off and then back on. If this message still stays on or turns back on again while you are driving, your vehicle needs service. Have the system inspected by your dealer/retailer as soon as possible.

## SERVICE TIRE MONITORING SYSTEM

On vehicles with the Tire Pressure Monitor System (TPMS), this message displays if a part on the TPMS is not working properly. The tire pressure light also flashes and then remains on during the same ignition cycle. See *Tire Pressure Light on page 3-29*. Several conditions may cause this message to appear. See *Tire Pressure Monitor Operation on page 5-46* for more information. If the warning comes on and stays on, there may be a problem with the TPMS. See your dealer/retailer.

## SERVICE TRACTION CONTROL

This message displays when the Traction Control System (TCS) is not functioning properly. A warning light also appears on the instrument panel cluster. See *StabiliTrak®/Traction Control System (TCS) Warning Light on page 3-28* and *Traction Control System*

*(TCS) on page 4-8* for more information. Have the TCS serviced by your dealer/retailer as soon as possible.

## SERVICE TRANSMISSION

This message displays when there is a problem with the transmission. See your dealer/retailer for service.

## SERVICE VEHICLE SOON

This message displays when a non-emissions related malfunction occurs. Have the vehicle serviced by your dealer/retailer as soon as possible.

## SPEED LIMITED TO XXX MPH (KM/H)

This message displays when your vehicle speed is limited to 80 mph (128 km/h) because the vehicle detects a problem in the speed variable assist steering system. Have your vehicle serviced by your dealer/retailer.

### **STABILITRAK NOT READY**

If your vehicle has StabiliTrak, this message may display and the StabiliTrak indicator light on the instrument panel cluster may be on after first driving the vehicle and exceeding 20 mph (32 km/h) for 30 seconds. The StabiliTrak system is not functional until the light has turned off. See *StabiliTrak® System on page 4-7* for more information.

### **STABILITRAK OFF**

If your vehicle has StabiliTrak, this message displays when you turn off the StabiliTrak, or when the stability control has been automatically disabled. To limit wheel spin and realize the full benefits of the stability enhancement system, you should normally leave StabiliTrak on. However, you should turn StabiliTrak off if your vehicle gets stuck in sand, mud, ice, or snow and you want to rock your vehicle to attempt to free it, or if you are driving in extreme

off-road conditions and require more wheel spin. See *If Your Vehicle is Stuck in Sand, Mud, Ice, or Snow on page 4-17*. To turn the StabiliTrak system on or off, see *StabiliTrak® System on page 4-7*.

### **TIGHTEN GAS CAP**

This message may display along with the check engine light on the instrument panel cluster if the vehicle's fuel cap is not tightened properly. See *Malfunction Indicator Lamp on page 3-30*. Reinstall the fuel cap fully. See *Filling the Tank on page 5-7*. The diagnostic system can determine if the fuel cap has been left off or improperly installed. A loose or missing fuel cap allows fuel to evaporate into the atmosphere. A few driving trips with the cap properly installed should turn this light and message off.

### **TIRE LEARNING ACTIVE**

On vehicles with the Tire Pressure Monitor System (TPMS), this message displays when the TPMS is re-learning the tire positions on your vehicle. The tire positions must be re-learned after rotating the tires or after replacing a tire or sensor. See *Tire Inspection and Rotation on page 5-50*, *Tire Pressure Monitor System on page 5-45*, and *Inflation - Tire Pressure on page 5-43* for more information.

### **TRACTION CONTROL OFF**

This message displays when the Traction Control System (TCS) turns off. See *Traction Control System (TCS) on page 4-8* for more information.

This message only displays while the ignition is in ON/RUN and disappears after 10 seconds, unless it is acknowledged or an urgent warning appears.

Any of the following conditions may cause the TCS to turn off:

- The TCS is turned off by pressing the TCS/StabiliTrak button. See *StabiliTrak® System on page 4-7* for more information.
- The battery is low.
- There is a TCS failure. See your dealer/retailer for service.

### TRACTION CONTROL ON

This message displays when the Traction Control System (TCS) turns on. See *StabiliTrak® System on page 4-7* for more information.

### TRANSMISSION HOT IDLE ENGINE

**Notice:** If you drive your vehicle while the transmission fluid is overheating and the transmission temperature warning is displayed on the instrument panel cluster and/or DIC, you can damage the transmission. This could lead to costly repairs that would not be covered by your warranty.

### Do not drive your vehicle with overheated transmission fluid or while the transmission temperature warning is displayed.

This message displays along with a chime if the transmission fluid in the vehicle gets hot. Driving with the transmission fluid temperature high can cause damage to the vehicle. Stop the vehicle and let it idle to allow the transmission to cool. This message clears and the chime stops when the fluid temperature reaches a safe level.

### TURN SIGNAL ON

This message displays and a chime sounds as a reminder to turn off the turn signal if you drive your vehicle for more than about 3/4 mile (1.2 km) with a turn signal on. See *Turn and Lane-Change Signals on page 3-6* for more information.

### DIC Vehicle Customization

Your vehicle may have customization capabilities that allow you to program certain features to one preferred setting. Customization features can only be programmed to one setting on the vehicle and cannot be programmed to a preferred setting for two different drivers.

All of the customization options may not be available on your vehicle. Only the options available will be displayed on the DIC.

The default settings for the customization features were set when your vehicle left the factory, but may have been changed from their default state since then.

The customization preferences are automatically recalled.

## 3-50 Instrument Panel

---

To change customization preferences, use the following procedure.

### Entering the Feature Settings Menu

1. Turn the ignition on and place the vehicle in P (Park).

To avoid excessive drain on the battery, it is recommended that the headlamps are turned off.

2. Press the customization button to scroll through the available customizable options.

### Feature Settings Menu Items

The following are customization features that allow you to program settings to the vehicle:

#### DISPLAY IN ENGLISH

This feature will only display if a language other than English has been set. This feature allows you to change the language in which the DIC messages appear to English.

Press the customization button until the PRESS ✓ TO DISPLAY IN ENGLISH screen appears on the DIC display. Press the set/reset button once to display all DIC messages in English.

#### DISPLAY LANGUAGE

This feature allows you to select the language in which the DIC messages will appear.

Press the customization button until the PRESS ✓ TO SET DISPLAY LANGUAGE screen appears on the DIC display. Press the set/reset button once to access the settings for this feature. Then press the customization button to scroll through the following settings:

**ENGLISH (default):** All messages will appear in English.

**FRANCAIS:** All messages will appear in French.

**ESPANOL:** All messages will appear in Spanish.

**NO CHANGE:** No change will be made to this feature. The current setting will remain.

To select a setting, press the set/reset button while the desired setting is displayed on the DIC.

#### AUTO DOOR LOCK

This feature allows you to select when the vehicle's doors will automatically lock. See *Automatic Door Lock on page 2-7* for more information.

Press the customization button until PRESS ✓ TO SET AUTO DOOR LOCK appears on the DIC display. Press the set/reset button once to access the settings for this feature. Then press the customization button to scroll through the following settings:

#### SHIFT OUT OF PARK (default):

The doors will automatically lock when the vehicle is shifted out of P (Park).



**AT VEHICLE SPEED:** The doors will automatically lock when the vehicle speed is above 8 mph (13 km/h) for three seconds.

**NO CHANGE:** No change will be made to this feature. The current setting will remain.

To select a setting, press the set/reset button while the desired setting is displayed on the DIC.

#### **AUTO DOOR UNLOCK**

This feature allows you to select whether or not to turn off the automatic door unlocking feature. It also allows you to select which doors and when the doors will automatically unlock. See *Automatic Door Unlock on page 2-7* for more information.

Press the customization button until **PRESS ✓ TO SET AUTO DOOR UNLOCK** appears on the DIC display. Press the set/reset button once to access the settings for this feature. Then press the customization button to scroll through the following settings:

**OFF:** None of the doors will automatically unlock.

**DRIVER DOOR AT KEY OUT:** Only the driver's door will unlock when the key is taken out of the ignition.

**DRIVER DOOR IN PARK:** Only the driver's door will unlock when the vehicle is shifted into P (Park).

**ALL DOORS AT KEY OUT:** All of the doors will unlock when the key is taken out of the ignition.

#### **ALL DOORS IN PARK (default):**

All of the doors will unlock when the vehicle is shifted into P (Park).

**NO CHANGE:** No change will be made to this feature. The current setting will remain.

To select a setting, press the set/reset button while the desired setting is displayed on the DIC.

#### **REMOTE DOOR LOCK**

This feature allows you to select the type of feedback you will receive when locking the vehicle with the Remote Keyless Entry (RKE) transmitter. You will not receive feedback when locking the vehicle with the RKE transmitter if the doors are open. See *Remote Keyless Entry (RKE) System Operation on page 2-4* for more information.

## 3-52 Instrument Panel

---

Press the customization button until **PRESS ✓ TO SET REMOTE DOOR LOCK** appears on the DIC display. Press the set/reset button once to access the settings for this feature. Then press the customization button to scroll through the following settings:

**VERIFICATION OFF:** There will be no feedback when you press the lock button on the RKE transmitter.

**VERIFICATION LIGHTS ONLY:** The exterior lamps will flash when you press the lock button on the RKE transmitter.

**VERIFICATION HORN ONLY:** The horn will sound on the second press of the lock button on the RKE transmitter.

### **VERIFICATION HORN & LIGHTS**

**(default):** The exterior lamps will flash when you press the lock button on the RKE transmitter, and the horn will sound when the lock button is pressed again within five seconds of the previous command.

**VERIFICATION NO CHANGE:** No change will be made to this feature. The current setting will remain.

To select a setting, press the set/reset button while the desired setting is displayed on the DIC.

### **REMOTE DOOR UNLOCK**

This feature allows you to select the type of feedback you will receive when unlocking the vehicle with the Remote Keyless Entry (RKE) transmitter. You will not receive feedback when unlocking the vehicle with the RKE transmitter if the doors are open. See *Remote*

*Keyless Entry (RKE) System Operation on page 2-4* for more information.

Press the customization button until **PRESS ✓ TO SET REMOTE DOOR UNLOCK** appears on the DIC display. Press the set/reset button once to access the settings for this feature. Then press the customization button to scroll through the following settings:

**VERIF LIGHTS OFF:** The exterior lamps will not flash when you press the unlock button on the RKE transmitter.

**VERIF LIGHTS ON (default):** The exterior lamps will flash when you press the unlock button on the RKE transmitter.

**VERIF NO CHANGE:** No change will be made to this feature. The current setting will remain.

To select a setting, press the set/reset button while the desired setting is displayed on the DIC.

### **DELAY DOOR LOCK**

On vehicles with a crew cab, this feature allows you to select whether or not the locking of the vehicle's doors will be delayed. When locking the doors with the power door lock switch and a door is open, this feature will delay locking the doors until five seconds after the last door is closed. You will hear three chimes to signal that the delayed locking feature is in use. The key must be out of the ignition for this feature to work. You can temporarily override delayed locking by pressing the power door lock switch twice or the lock button on the RKE transmitter twice. See *Delayed Locking on page 2-6* for more information.

Press the customization button until **PRESS ✓ TO SET DELAY DOOR LOCK** appears on the DIC display. Press the set/reset button once to access the settings for this feature. Then press the customization button to scroll through the following settings:

**OFF:** There will be no delayed locking of the vehicle's doors.

**ON (default):** The doors will not lock until five seconds after the last door is closed.

**NO CHANGE:** No change will be made to this feature. The current setting will remain.

To select a setting, press the set/reset button while the desired setting is displayed on the DIC.

### **EXIT LIGHTING**

This feature allows you to select the amount of time you want the exterior lamps to remain on when it is dark enough outside. This happens after the key is turned from ON/RUN to LOCK/OFF.

Press the customization button until **PRESS ✓ TO SET EXIT LIGHTING** appears on the DIC display. Press the set/reset button once to access the settings for this feature. Then press the customization button to scroll through the following settings:

**OFF:** The exterior lamps will not turn on.

**10 SECONDS (default):** The exterior lamps will stay on for 10 seconds.

**30 SECONDS:** The exterior lamps will stay on for 30 seconds.

**2 MINUTES:** The exterior lamps will stay on for two minutes.

## 3-54 Instrument Panel

---

**NO CHANGE:** No change will be made to this feature. The current setting will remain.

To select a setting, press the set/reset button while the desired setting is displayed on the DIC.

### APPROACH LIGHTING

This feature allows you to select whether or not to have the exterior lights turn on briefly during low light periods after unlocking the vehicle using the Remote Keyless Entry (RKE) transmitter.

Press the customization button until **PRESS ✓ TO SET APPROACH LIGHTING** appears on the DIC display. Press the set/reset button once to access the settings for this feature. Then press the customization button to scroll through the following settings:

**OFF:** The exterior lights will not turn on when you unlock the vehicle with the RKE transmitter.

**ON (default):** If it is dark enough outside, the exterior lights will turn on briefly when you unlock the vehicle with the RKE transmitter.

The lights will remain on for 20 seconds or until the lock button on the RKE transmitter is pressed, or the vehicle is no longer off. See *Remote Keyless Entry (RKE) System Operation on page 2-4* for more information.

**NO CHANGE:** No change will be made to this feature. The current setting will remain.

To select a setting, press the set/reset button while the desired setting is displayed on the DIC.

### CHIME VOLUME

This feature allows you to select the volume level of the chime.

Press the customization button until **PRESS ✓ TO SET CHIME VOLUME** appears on the DIC display. Press the set/reset button once to access the settings for this feature. Then press the customization button to scroll through the following settings:

**NORMAL:** The chime volume will be set to a normal level.

**LOUD:** The chime volume will be set to a loud level.

**NO CHANGE:** No change will be made to this feature. The current setting will remain.

There is no default for chime volume. The volume will stay at the last known setting.

To select a setting, press the set/reset button while the desired setting is displayed on the DIC.

## FACTORY SETTINGS

This feature allows you to set all of the customization features back to their factory default settings.

Press the customization button until **PRESS ✓ TO RESTORE FACTORY SET** appears on the DIC display. Press the set/reset button once to access the settings for this feature. Then press the customization button to scroll through the following settings:

**RESTORE ALL (default):** The customization features will be set to their factory default settings.

**DO NOT RESTORE:** The customization features will not be set to their factory default settings.

To select a setting, press the set/reset button while the desired setting is displayed on the DIC.

## EXIT FEATURE SETTINGS

This feature allows you to exit the feature settings menu.

Press the customization button until **PRESS ✓ TO EXIT FEATURE SETTINGS** appears in the DIC display. Press the set/reset button once to exit the menu.

If you do not exit, pressing the customization button again will return you to the beginning of the feature settings menu.

## Exiting the Feature Settings Menu

The feature settings menu will be exited when any of the following occurs:

- The vehicle is no longer in ON/RUN.
- The trip/fuel or vehicle information DIC buttons are pressed.
- The end of the feature settings menu is reached and exited.
- A 40 second time period has elapsed with no selection made.

### Audio System(s)

Determine which radio the vehicle has and read the following pages to become familiar with its features.

#### CAUTION

Taking your eyes off the road for extended periods could cause a crash resulting in injury or death to you or others. Do not give extended attention to entertainment tasks while driving.

This system provides access to many audio and non audio listings.

To minimize taking your eyes off the road while driving, do the following while the vehicle is parked:

- Become familiar with the operation and controls of the audio system.
- Set up the tone, speaker adjustments, and preset radio stations.

For more information, see *Defensive Driving* on page 4-3.

**Notice:** Contact your dealer/retailer before adding any equipment.

**Adding audio or communication equipment could interfere with the operation of the vehicle's engine, radio, or other systems, and could damage them. Follow federal rules covering mobile radio and telephone equipment.**



**Notice:** The chime signals related to safety belts, parking brake, and other functions of your vehicle operate through the radio/entertainment system. If that equipment is replaced or additional equipment is added to your vehicle, the chimes may not work. Make sure that replacement or additional equipment is compatible with your vehicle before installing it. See *Accessories and Modifications* on page 5-3.

The vehicle has Retained Accessory Power (RAP). With RAP, the audio system can be played even after the ignition is turned off. See *Retained Accessory Power (RAP)* on page 2-15 for more information.

### Setting the Clock

#### Radio with Single CD (MP3) Player

To set the time and date:

1. Turn the ignition key to ACC/ACCESSORY or ON/RUN. Press  to turn the radio on.
2. Press  and the HR, MIN, MM, DD, YYYY (hour, minute, month, day, and year) displays.
3. Press the softkey located below any one of the tabs that you want to change.

4. To increase the time or date do one of the following:
  - Press the softkey located below the selected tab.
  - Press **▷ SEEK**, or **▷▷ FWD**.
  - Turn **🎵** clockwise.
5. To decrease the time or date do one of the following:
  - Press **◀ SEEK** or **◀◀ REV**.
  - Turn **🎵** counterclockwise.

The date does not automatically display. To see the date press **⌚** while the radio is on. The date with display times out after a few seconds and goes back to the normal radio and time display.

To change the time default setting from 12 hour to 24 hour or to change the date default setting from month/day/year to day/month/year:

1. Press **⌚** and then the softkey located below the forward arrow label. Once the time 12H and 24H, and the date MM/DD/YYYY (month, day, and year) and DD/MM/YYYY (day, month, and year) displays.
2. Press the softkey located below the desired option.
3. Press **⌚** again to apply the selected default, or let the screen time out.

### Six-Disc CD (MP3) Player

To set the time and date:

1. Turn the ignition key to ACC/ACCESSORY or ON/RUN. Press **⏻** to turn the radio on.
2. Press MENU.

3. Press the softkey below the **⌚** tab. The HR, MIN, MM, DD, YYYY displays.
4. Press the softkey below any one of the tabs you want to change.
5. To increase the time or date do one of the following:
  - Press the softkey located below the selected tab.
  - Press **▷ SEEK**, or **▷▷ FWD**.
  - Turn **🎵** clockwise.
6. To decrease the time or date do one of the following:
  - Press **◀ SEEK** or **◀◀ REV**.
  - Turn **🎵** counterclockwise.

The date does not automatically display. To see the date press MENU and then softkey below the **⌚** tab while the radio is on. The date with display times out after a few seconds and goes back to the normal radio and time display.

## 3-58 Instrument Panel

To change the time default setting from 12 hour to 24 hour or to change the date default setting from month/day/year to day/month/year:

1. Press MENU, and then the softkey below the  $\odot$  tab. The HR, MIN, MM, DD, YYYY displays.
2. Press the softkey below the forward arrow tab. The time 12H and 24H, and the date MM/DD/YYYY (month, day, and year) and DD/MM/YYYY (day, month, and year) displays.
3. Press the softkey located below the desired option.
4. Press MENU again to apply the selected default, or let the screen time out.

## Radio(s)



Radio with CD shown, Radio with Six-Disc CD similar

### Radio Data System (RDS)

The audio system has a Radio Data System (RDS). The RDS feature is available for use only on FM stations that broadcast RDS information. This system relies upon receiving specific information

from these stations and only works when the information is available. While the radio is tuned to an FM-RDS station, the station name or call letters displays. In rare cases, a radio station can broadcast incorrect information that causes



the radio features to work improperly. If this happens, contact the radio station.

## Playing the Radio



 **(Power/Volume):** Press to turn the system on and off.

Turn to increase or decrease the volume.

## Finding a Station

**BAND:** Press to switch between AM, FM, or XM™ (if equipped).

 **(Tune):** Turn to select radio stations.

 **SEEK**  : Press to go to the previous or to the next station.

To scan stations, press and hold either arrow for a few seconds until a beep sounds. The radio goes to a station, plays for a few seconds, then goes to the next station. Press either arrow again to stop scanning.

The radio only seeks and scans stations with a strong signal that are in the selected band.

 **(Information) (XM™ Satellite Radio Service, MP3, and RDS Features):** Press to display additional text information related to the current FM-RDS station, XM station, or MP3 song. If information is available, the song title information displays on the top line of the display and artist information displays on the bottom line. When information is not available, “NO INFO” displays.

## Storing a Radio Station as a Favorite

Drivers are encouraged to set up their radio station favorites while the vehicle is parked. Tune to favorite stations using the presets, favorites button, and steering wheel controls, if the vehicle has them. See *Defensive Driving on page 4-3*.

**FAV (Favorites):** A maximum of 36 stations can be programmed as favorites using the six pushbuttons positioned below the radio station frequency labels and by using the FAV button (radio favorites page). Press the FAV button to go through up to six pages of favorites, each having six favorite stations available per page. Each page of favorites can contain any combination of AM, FM, or XM stations. To store a station as a favorite:

1. Tune to the desired radio station.
2. Press the FAV button to display the page where the station is to be stored.
3. Press and hold one of the six pushbuttons until a beep sounds. When that pushbutton is pressed and released, the station that was set, returns.
4. Repeat the steps for each pushbutton radio station to be stored as a favorite.





## 3-60 Instrument Panel

---

The number of favorites pages can be setup using the MENU button. To setup the number of favorites pages:

1. Press the MENU button to display the radio setup menu.
2. Press the pushbutton located below the FAV 1-6 label.
3. Select the desired number of favorites pages by pressing the pushbutton located below the displayed page numbers.
4. Press the FAV button, or let the menu time out, to return to the original main radio screen showing the radio station frequency tabs and to begin the process of programming favorites for the chosen amount of numbered pages.

### Setting the Tone (Bass/Midrange/Treble)

**BASS/MID/TREB (Bass, Midrange, or Treble):** To adjust bass, midrange, or treble, press the  knob until the tone control tabs display. Continue pressing to highlight the desired tab, or press the pushbutton positioned under the desired tab. Turn the  knob to adjust the highlighted setting. Bass, midrange, or treble can also be adjusted by pressing either SEEK arrow,  FWD, or  REV when the setting is highlighted until the desired level is obtained. If a station's frequency is weak, or has static, decrease the treble.

To quickly adjust bass, midrange, or treble to the middle position, press the pushbutton positioned under the BASS, MID, or TREB tab for more than two seconds. A beep sounds and the level adjusts to the middle position.



To quickly adjust all tone and speaker controls to the middle position, press the  knob for more than two seconds until a beep sounds.

**EQ (Equalization):** Press to select preset equalization settings.

To return to the manual mode, press the EQ button until Manual displays or manually adjust the bass, midrange, or treble by pressing the  knob.

### Adjusting the Speakers (Balance/Fade)

**BAL/FADE (Balance/Fade):** To adjust balance or fade, press the tune knob until the speaker control labels display. Continue pressing to highlight the desired tab, or press the pushbutton positioned under the desired label.



Turn the  knob clockwise or counterclockwise to adjust the highlighted setting. The highlighted setting can also be adjusted by pressing either SEEK arrow,  FWD, or  REV until the desired levels are obtained.

To quickly adjust balance or fade to the middle position, press the pushbutton positioned under the BAL or FADE label for more than two seconds. A beep sounds and the level adjusts to the middle position.

To quickly adjust all speaker and tone controls to the middle position, press the  knob for more than two seconds until a beep sounds.

### Finding a Category (CAT) Station

**CAT (Category):** The CAT button is used to find XM stations when the radio is in the XM mode. To find XM channels within a desired category, perform the following:

1. Press the BAND button until the XM frequency displays. Press the CAT button to display the category tabs on the radio display. Continue pressing the CAT button until the desired category name displays.
  2. Press either of the two buttons below the desired category tab to immediately tune to the first XM station associated with that category.
  3. Turn the  knob, press the buttons below the right or left arrows displayed, or press either SEEK arrow to go to the previous or to the next XM station within the selected category.
  4. To exit the category search mode, press the FAV button or BAND button to display favorites again.
- Undesired XM categories can be removed through the setup menu. To remove an undesired category:
1. Press the MENU button to display the radio setup menu.
  2. Press the pushbutton located below the XM CAT tab.
  3. Turn the  knob to display the category to be removed.
  4. Press the pushbutton located under the Remove tab until the category name along with the word Removed displays.
  5. Repeat the steps to remove more categories.

## 3-62 Instrument Panel

---

Removed categories can be restored by pressing the pushbutton under the Add tab when a removed category is displayed or by pressing the pushbutton under the Restore All tab.

The radio does not allow categories to be removed or added while the vehicle is moving faster than 5 mph (8 km/h).

### **XM™ Satellite Radio Service**

XM is a satellite radio service that is based in the 48 contiguous United States and 10 Canadian provinces. XM Satellite Radio has a wide variety of programming and commercial-free music, coast-to-coast, and in digital-quality sound. During your trial or when you subscribe, you will get unlimited access to XM Radio Online for when you are not in the vehicle. A service fee is required to receive the XM service. For more information, contact XM at [xmradio.com](http://xmradio.com) or

call 1-800-929-2100 in the U.S. and [xmradio.ca](http://xmradio.ca) or call 1-877-438-9677 in Canada.

### **Radio Messages for XM Only**

See *XM Radio Messages on page 3-71* later in this section for further detail.

### **Radio Messages**

**Calibration Error:** The audio system has been calibrated for the vehicle from the factory. If Calibration Error displays, it means that the radio has not been configured properly for the vehicle and it must be returned to your dealer/retailer for service.

**Locked:** This message displays when the THEFTLOCK® system has locked up the radio. Take the vehicle to your dealer/retailer for service.

If any error occurs repeatedly or if an error cannot be corrected, contact your dealer/retailer.

### **Playing a CD (Single CD Player)**

Insert a CD partway into the slot, label side up. The player pulls it in and the CD should begin playing.



### **Playing a CD(s) (Six-Disc CD Player)**

**LOAD** : Press to load CDs into the CD player. This CD player holds up to six CDs.

To insert one CD:

1. Press and release the  button.
2. Wait for the message to insert the disc.
3. Load a CD. Insert the CD partway into the slot, label side up. The player pulls the CD in.

To insert multiple CDs:

1. Press and hold the  button for two seconds. A beep sounds and Load All Discs displays.
2. Follow the displayed instruction on when to insert the discs. The CD player takes up to six CDs.
3. Press the  button again to cancel loading more CDs.

If the ignition or radio is turned off, with a CD in the player, it stays in the player. When the ignition or radio is turned on, the CD starts playing where it stopped, if it was the last selected audio source.

When a CD is inserted, the CD symbol displays on the CD. As each new track starts to play, the track number displays.

The CD player can play the smaller 3 inch (8 cm) single CDs with an adapter ring. Full-size CDs and the smaller CDs are loaded in the same manner.

### Care of CDs

If playing a CD-R, the sound quality can be reduced due to CD-R quality, the method of recording, the quality of the music that has been recorded, and the way the CD-R has been handled. Handle them carefully. Store CD-R(s) in their original cases or other protective cases and away from direct sunlight and dust. The CD player scans the bottom surface of the disc. If the surface of a CD is damaged, such as cracked, broken, or scratched, the CD does not play properly or not at all. Do not touch the bottom side of a CD while handling it; this could damage the surface. Pick up CDs by grasping the outer edges or the edge of the hole and the outer edge.

If the surface of a CD is soiled, take a soft, lint free cloth or dampen a clean, soft cloth in a mild, neutral detergent solution mixed with water, and clean it. Make sure the wiping process starts from the center to the edge.

### Care of the CD Player

Do not add any label to a CD, it could get caught in the CD player. If a CD is recorded on a personal computer and a description label is needed, try labeling the top of the recorded CD with a marking pen.

To prevent contaminating the lens of the disc optics with lubricants internal to the player mechanism the use of disc lens cleaners is not advised.

**Notice:** If a label is added to a CD, or more than one CD is inserted into the slot at a time, or an attempt is made to play scratched or damaged CDs, the CD player could be damaged. While using the CD player, use only CDs in good condition without any label, load one CD at a time, and keep the CD player and the loading slot free of foreign materials, liquids, and debris.

If an error displays, see “CD Messages” later in this section.



## 3-64 Instrument Panel

---

 **EJECT:** To eject the CD that is currently playing, press and release this button. A beep sounds and Ejecting Disc displays. Once the disc is ejected, Remove Disc displays. The CD can be removed. If the CD is not removed, after several seconds, the CD automatically pulls back into the player and begins playing.

For the Six-Disc CD player, press and hold  for two seconds to eject all discs.

 **(Tune):** Turn to select tracks on the CD currently playing.

 **SEEK**  : Press the left arrow to go to the start of the current track, if more than ten seconds have played. Press the right arrow to go to the next track. If either the left or right arrow is held, or pressed multiple times, the player continues moving backward or forward through the tracks on the CD.

 **REV (Fast Reverse):** Press and hold to reverse playback quickly within a track. Sound is heard at a reduced volume. Release to resume playing the track. The elapsed time of the track displays.

 **FWD (Fast Forward):** Press and hold to advance playback quickly within a track. Sound is heard at a reduced volume. Release to resume playing the track. The elapsed time of the track displays.

**RDM (Random):** With the random setting, the tracks can be listened to in random, rather than sequential order, on one CD or all CDs in a six-disc CD player.

To use random:

- Press the pushbutton positioned under the RDM tab until Random Current Disc displays to play the tracks from a CD in random order. Press again to turn off random play.

- Press the pushbutton positioned under the RDM tab until Randomize All Discs displays to play tracks from all CDs loaded in a six-disc CD player in random order. Press again to turn off random play.

**BAND:** Press to listen to the radio when a CD is playing. The CD remains inside the radio for future listening.

**CD/AUX (CD/Auxiliary):** Press to play a CD when listening to the radio. The CD icon and track number displays when a CD is in the player.

The radio system has an auxiliary input jack located on the lower right side of the faceplate. An external audio device such as a portable audio player can be connected to the auxiliary input jack for use as another source for playing CDs.

Press the CD/AUX button again and the system begins playing audio from the connected portable audio player. If a portable audio player is not connected, “No Input Device Found” displays.

### Playing an MP3 CD-R or CD-RW Disc

The vehicle's radio system may have the MP3 feature. If it has this feature, it is capable of playing an MP3 CD-R or CD-RW disc. For more information on how to play an MP3 CD-R or CD-RW disc, see *Using an MP3 on page 3-66* later in this section.

### CD Messages

**CHECK DISC:** If this message displays and/or the CD comes out, it could be:

- It is very hot. When the temperature returns to normal, the CD should play.

- The road is very rough. When the road becomes smoother, the CD should play.
- The CD is dirty, scratched, wet, or upside down.
- The air is very humid. If so, wait about an hour and try again.
- There could have been a problem while burning the CD.
- The label could be caught in the CD player.

If the CD is not playing correctly, for any other reason, try a known good CD.

If any error occurs repeatedly or if an error cannot be corrected, contact your dealer/retailer. If the radio displays an error message, write it down and provide it to your dealer/retailer when reporting the problem.

### Using the Auxiliary Input Jack

The radio system has an auxiliary input jack located on the lower right side of the faceplate. This is not an audio output; do not plug the headphone set into the front auxiliary input jack. An external audio device such as an iPod™, laptop computer, MP3 player, CD changer, etc. can be connected to the auxiliary input jack for use as another audio source.

Drivers are encouraged to set up any auxiliary device while the vehicle is in P (Park). See *Defensive Driving on page 4-3* for more information on driver distraction.

To use a portable audio player, connect a 3.5 mm (1/8 inch) cable to the radio's front auxiliary input jack. When a device is connected, press the radio CD/AUX button to begin playing audio from the device over the vehicle speakers.

 (**Power/Volume**): Turn to increase or decrease the volume of the portable player. Additional volume adjustments might have to be made from the portable device if the volume is not loud or soft enough.

**BAND**: Press to listen to the radio when a portable audio device is playing. The portable audio device continues playing.

**CD/AUX (CD/Auxiliary)**: Press to play a CD when a portable audio device is playing. Press again and the system begins playing audio from the connected portable audio player. If a portable audio player is not connected, “No Input Device Found” displays.

### Using an MP3

#### MP3 CD-R or CD-RW Disc

The radio plays MP3 files that were recorded on a CD-R or CD-RW disc. The files can be recorded with the following fixed bit rates: 32 kbps, 40 kbps, 56 kbps, 64 kbps, 80 kbps, 96 kbps, 112 kbps, 128 kbps, 160 kbps, 192 kbps, 224 kbps, 256 kbps, and 320 kbps or a variable bit rate. Song title, artist name, and album are available for display by the radio when recorded using ID3 tags version 1 and 2.

#### Compressed Audio

The radio also plays discs that contain both uncompressed CD audio (.CDA files) and MP3 files. By default the radio reads only the uncompressed audio and ignore the MP3 files. Pressing the CAT (category) button toggles between compressed and uncompressed audio format.

#### MP3 Format

To burn an MP3 disc on a personal computer:

- Make sure the MP3 files are recorded on a CD-R or CD-RW disc.
- Do not mix standard audio and MP3 files on one disc.
- The CD player is able to read and play a maximum of 50 folders, 50 playlists, and 255 files.
- Create a folder structure that makes it easy to find songs while driving. Organize songs by albums using one folder for each album. Each folder or album should contain 18 songs or less.
- Avoid subfolders. The system can support up to eight subfolders deep, however, keep the total number of folders to a minimum in order to reduce the complexity and confusion in trying to locate a particular folder during playback.



- Make sure playlists have a .mp3 or .wpl extension, other file extensions may not work.
- Minimize the length of the file, folder or playlist names. Long file, folder, or playlist names, or a combination of a large number of files and folders, or playlists can cause the player to be unable to play up to the maximum number of files, folders, playlists, or sessions. To play a large number of files, folders, playlists or sessions, minimize the length of the file, folder, or playlist name. Long names also take up more space on the display, potentially getting cut off.
- Finalize the audio disc before burning it. Trying to add music to an existing disc can cause the disc not to function in the player.

Playlists can be changed by using the previous and next folder buttons, the tune knob, or the SEEK arrows. An MP3 CD-R or CD-RW that was recorded using no file folders can

also be played. If a CD-R or CD-RW contains more than the maximum of 50 folders, 50 playlists, and 255 files, the player can access and navigate up to the maximum, but all items over the maximum are not accessible.

### Root Directory

The root directory of the CD-R or CD-RW is treated as a folder. If the root directory has compressed audio files, the directory displays as F1 ROOT. All files contained directly under the root directory are accessed prior to any root directory folders. However, playlists (Px) are always accessed before root folders or files.

### Empty Directory or Folder

If a root directory or a folder exists somewhere in the file structure that contains only folders/subfolders and no compressed files directly beneath them, the player advances to the next folder in the file structure that contains compressed audio files. The empty folder does not display.

### No Folder

When the CD contains only compressed files, the files are located under the root folder. The next and previous folder functions do not display on a CD that was recorded without folders or playlists. When displaying the name of the folder the radio displays ROOT.

When the CD contains only playlists and compressed audio files, but no folders, all files are located under the root folder. The folder down and up buttons searches playlists (Px) first and then go to the root folder. When the radio displays the name of the folder the radio displays ROOT.

### Order of Play

Tracks recorded to the CD-R or CD-RW are played in the following order:

- Play begins from the first track in the first playlist and continues sequentially through all tracks in each playlist. When the last track of the last playlist has played, play continues from the first track of the first playlist.
- Play begins from the first track in the first folder and continues sequentially through all tracks in each folder. When the last track of the last folder has been played, play continues from the first track of the first folder.

When play enters a new folder, the display does not automatically show the new folder name unless the folder mode is chosen as the default display. The new track name displays.

### File System and Naming

The song name that is displayed is the song name that is contained in the ID3 tag. If the song name is not present in the ID3 tag, then the radio displays the file name without the extension (such as .mp3) as the track name.

Track names longer than 32 characters or four pages are shortened. Parts of words on the last page of text and the extension of the filename does not display.

### Preprogrammed Playlists

Preprogrammed playlists that were created by WinAmp™, MusicMatch™, or Real Jukebox™ software can be accessed, however, they cannot be edited using the radio. These playlists are treated as special folders containing compressed audio song files.

### Playing an MP3

Insert a CD-R or CD-RW partway into the slot (Single CD Player), or press the  button and wait for the message to insert disc (Six-Disc CD Player), label side up. The player pulls it in, and the CD-R or CD-RW should begin playing.

If the ignition or radio is turned off with a CD-R or CD-RW in the player, it stays in the player. When the ignition or radio is turned on, the CD-R or CD-RW starts to play where it stopped, if it was the last selected audio source.

As each new track starts to play, the track number and song title displays.

 **EJECT:** Press and release to eject the CD-R or CD-RW that is playing. A beep sounds and Ejecting Disc displays. Once the disc is ejected, Remove Disc displays. The CD-R or CD-RW can be removed. If the CD-R or

CD-RW is not removed, after several seconds, the CD-R or CD-RW automatically pulls back into the player and begins playing.

For the Six-Disc CD player, press and hold this button for two seconds to eject all discs.

**🎵 (Tune):** Turn to select MP3 files on the CD-R or CD-RW currently playing.

**⏮ SEEK ⏭ :** Press the left arrow to go to the start of the current MP3 file, if more than ten seconds have played. Press the right arrow to go to the next MP3 file. If either arrow is held or pressed multiple times, the player continues moving backward or forward through MP3 files on the CD.

**⏪ 📁 (Previous Folder):** Press the pushbutton positioned under the Folder label to go to the first track in the previous folder.

**📁 ⏩ (Next Folder):** Press the pushbutton positioned under the Folder label to go to the first track in the next folder.

**⏮ REV (Reverse):** Press and hold to reverse playback quickly within an MP3 file. Sound is heard at a reduced volume. Release to resume playing the file. The elapsed time of the file displays.

**⏭ FWD (Fast Forward):** Press and hold to advance playback quickly within an MP3 file. Sound is heard at a reduced volume. Release to resume playing the file. The elapsed time of the file displays.

**RDM (Random):** With the random setting, the MP3 files on the CD-R or CD-RW can be listened to in random, rather than sequential order, on one CD-R/CD-RW or all discs in a six-disc CD player. To use random, do one of the following:

1. To play MP3 files from the CD-R or CD-RW in random order, press the pushbutton positioned under the RDM label until Random Current Disc displays. Press the same pushbutton again to turn off random play.
2. To play songs from all CDs loaded in a six-disc CD player in random order, press the pushbutton positioned under the RDM label until Randomize All Discs displays. Press the same pushbutton again to turn off random play.

## 3-70 Instrument Panel

---

 **(Music Navigator):** Use the music navigator feature to play MP3 files on the CD-R or CD-RW in order by artist or album. Press the pushbutton located below the music navigator label. The player scans the disc to sort the files by artist and album ID3 tag information. It can take several minutes to scan the disc depending on the number of MP3 files recorded to the CD-R or CD-RW. The radio can begin playing while it is scanning the disc in the background. When the scan is finished, the CD-R or CD-RW begins playing again.

Once the disc has been scanned, the player defaults to playing MP3 files in order by artist. The current artist playing is shown on the second line of the display between the arrows. Once all songs by that artist are played, the player moves to the next artist in alphabetical order on the CD-R/CD-RW and begins playing MP3 files by that artist. To listen to MP3 files by another artist, press the pushbutton located below either

arrow button. The disc goes to the next or previous artist in alphabetical order. Continue pressing either button until the desired artist is displayed.

To change from playback by artist to playback by album, press the pushbutton located below the Sort By label. From the sort screen, push one of the buttons below the album button. Press the pushbutton below the back label to return to the main music navigator screen. Now the album name is displayed on the second line between the arrows and songs from the current album begins to play. Once all songs from that album are played, the player moves to the next album in alphabetical order on the CD-R/CD-RW and begins playing MP3 files from that album.

To exit music navigator mode, press the pushbutton below the Back label to return to normal MP3 playback.

**BAND:** Press to listen to the radio while a CD is playing. The inactive CD remains inside the radio for future listening.

**CD/AUX (CD/Auxiliary):** Press to play a CD while listening to the radio. The CD icon and a message showing disc and/or track number displays while a CD is in the player. Press this button again and the system automatically searches for an auxiliary input device such as a portable audio player. If a portable audio player is not connected, "No Aux Input Device" displays.

## XM Radio Messages

### XL (Explicit Language Channels):

These channels, or any others, can be blocked at a customer's request, by calling 1-800-852-XXMM (9696).

**XM Updating:** The encryption code in the receiver is being updated, and no action is required. This process should take no longer than 30 seconds.

**No XM Signal:** The system is functioning correctly, but the vehicle is in a location that is blocking the XM™ signal. When the vehicle is moved into an open area, the signal should return.

**Loading XM:** The audio system is acquiring and processing audio and text data. No action is needed. This message should disappear shortly.

**Channel Off Air:** This channel is not currently in service. Tune in to another channel.

**Channel Unauth:** This channel is blocked or cannot be received with your XM Subscription package.

**Channel Unavail:** This previously assigned channel is no longer assigned. Tune to another station. If this station was one of the presets, choose another station for that preset button.

**No Artist Info:** No artist information is available at this time on this channel. The system is working properly.

**No Title Info:** No song title information is available at this time on this channel. The system is working properly.

**No CAT Info:** No category information is available at this time on this channel. The system is working properly.

**No Information:** No text or informational messages are available at this time on this channel. The system is working properly.

**CAT Not Found:** There are no channels available for the selected category. The system is working properly.

**XM Theftlocked:** The XM™ receiver in your vehicle could have previously been in another vehicle. For security purposes, XM™ receivers cannot be swapped between vehicles. If this message is received after having your vehicle serviced, check with your dealer/retailer.

**XM Radio ID:** If tuned to channel 0, this message alternates with the XM™ Radio 8 digit radio ID label. This label is needed to activate the service.

**Unknown:** If this message is received when tuned to channel 0, there could be a receiver fault. Consult with your dealer/retailer.

## 3-72 Instrument Panel

---

**Check XM Receiver:** If this message does not clear within a short period of time, the receiver could have a fault. Consult with your dealer/retailer.

**XM Not Available:** If this message does not clear within a short period of time, the receiver could have a fault. Consult with your dealer/retailer.

### Bluetooth®

Vehicles with a Bluetooth system can use a Bluetooth capable cell phone with a Hands Free Profile to make and receive phone calls. The system can be used while the key is in ON/RUN or ACC/ACCESSORY position. The range of the Bluetooth system can be up to 30 ft. (9.1 m). Not all phones support all functions, and not all phones are guaranteed to work with the in-vehicle Bluetooth system. See [gm.com/bluetooth](http://gm.com/bluetooth) for more information on compatible phones.

### Voice Recognition

The Bluetooth system uses voice recognition to interpret voice commands to dial phone numbers and name tags.

**Noise:** Keep interior noise levels to a minimum. The system may not recognize voice commands if there is too much background noise.

**When to Speak:** A short tone sounds after the system responds indicating when it is waiting for a voice command. Wait until the tone and then speak.

**How to Speak:** Speak clearly in a calm and natural voice.



### Audio System

When using the in-vehicle Bluetooth system, sound comes through the vehicle's front audio system speakers and overrides the audio system. Use the audio system volume knob, during a call, to change the volume level. The adjusted volume level remains

in memory for later calls. To prevent missed calls, a minimum volume level is used if the volume is turned down too low.

### Bluetooth Controls

Use the buttons located on the steering wheel to operate the in-vehicle Bluetooth system. See *Audio Steering Wheel Controls on page 3-82* for more information.

 /  **(Push To Talk):** Press to answer incoming calls, confirm system information, and to start speech recognition.

 **(Phone On Hook):** Press to end a call and to cancel an operation.

### Pairing

A Bluetooth enabled cell phone must be paired to the in-vehicle Bluetooth system first and then connected to the vehicle before it can be used. See the cell phone manufacturers user guide for



Bluetooth functions before pairing the cell phone. If a Bluetooth phone is not connected, calls will be made using OnStar<sup>®</sup> Hands-Free Calling, if available. Refer to the OnStar owner's guide for more information.

#### Pairing Information:

- Up to five cell phones can be paired to the in-vehicle Bluetooth system.
- The pairing process is disabled when the vehicle is moving.
- The in-vehicle Bluetooth system automatically links with the first available paired cell phone in the order the phone was paired.
- Only one paired cell phone can be connected to the in-vehicle Bluetooth system at a time.
- Pairing should only need to be completed once, unless changes to the pairing information have been made or the phone is deleted.

To link to a different paired phone, see Linking to a Different Phone later in this section.

#### Pairing a Phone

1. Press and hold  /  for two seconds. The system responds with "Ready" followed by a tone.
2. Say "Bluetooth". The system responds with "Bluetooth ready" followed by a tone.
3. Say "Pair". The system responds with instructions and a four digit PIN number. The PIN number will be used in Step 4.
4. Start the Pairing process on the cell phone that will be paired to the vehicle. Reference the cell phone manufacturers user guide for information on this process.



Locate the device named "General Motors" in the list on the cellular phone and follow the instructions on the cell phone to enter the four digit PIN number that was provided in Step 3.

5. The system prompts for a name for the phone. Use a name that best describes the phone. This name will be used to indicate which phone is connected. The system then confirms the name provided.
6. The system responds with "<Phone name> has been successfully paired" after the pairing process is complete.
7. Repeat Steps 1 through 7 for additional phones to be paired.



## 3-74 Instrument Panel

---

### Listing All Paired and Connected Phones



1. Press and hold  /  for two seconds. The system responds with “Ready” followed by a tone.
2. Say “Bluetooth”. The system responds with “Bluetooth ready” followed by a tone.
3. Say “List”. The system lists all the paired Bluetooth devices. If a phone is connected to the vehicle, the system will say “Is connected” after the connected phone.

### Deleting a Paired Phone

1. Press and hold  /  for two seconds. The system responds with “Ready” followed by a tone.
2. Say “Bluetooth”. The system responds with “Bluetooth ready” followed by a tone.

3. Say “Delete”. The system asks which phone to delete followed by a tone.
4. Say the name of the phone to be deleted. If the phone name is unknown, use the “List” command for a list of all paired phones. The system responds with “Would you like to delete <phone name>? Yes or No” followed by a tone.
5. Say “Yes” to delete the phone. The system responds with “OK, deleting <phone name>”.

### Linking to a Different Phone

1. Press and hold  /  for two seconds. The system responds with “Ready” followed by a tone.
2. Say “Bluetooth”. The system responds with “Bluetooth ready” followed by a tone.

3. Say “Change phone”. The system responds with “Please wait while I search for other phones”.
  - If another phone is found, the response will be “<Phone name> is now connected”.
  - If another phone is not found, the original phone remains connected.

### Storing Name Tags

The system can store up to thirty phone numbers as name tags that are shared between the Bluetooth and OnStar systems.



The system uses the following commands to store and retrieve phone numbers:

- Store
- Digit Store
- Directory



### Using the Store Command

The store command allows a phone number to be stored without entering the digits individually.



1. Press and hold  /  for two seconds. The system responds with “Ready” followed by a tone.
2. Say “Store”. The system responds with “Store, number please” followed by a tone.
3. Say the complete phone number to be stored at once with no pauses.
  - If the system recognizes the number it responds with “OK, Storing” and repeats the phone number.

4. After the system stores the phone number, it responds with “Please say the name tag” followed by a tone.
5. Say a name tag for the phone number. The name tag is recorded and the system responds with “About to store <name tag>. Does that sound OK?”.
  - If the name tag does not sound correct, say “No” and repeat Step 5.

- If the name tag sounds correct, say “Yes” and the name tag is stored. After the number is stored the system returns to the main menu.

### Using the Digit Store Command

The digit store command allows a phone number to be stored by entering the digits individually.



1. Press and hold  /  for two seconds. The system responds with “Ready” followed by a tone.
2. Say “Digit Store”. The system responds with “Please say the first digit to store” followed by a tone.

3. Say the first digit to be stored. The system will repeat back the digit it heard followed by a tone. Continue entering digits until the number to be stored is complete.
  - If an unwanted number is recognized by the system, say "Clear" at any time to clear the last number.
  - To hear all of the numbers recognized by the system, say "Verify" at any time and the system will repeat them.
4. After the complete number has been entered, say "Store". The system responds with "Please say the name tag" followed by a tone.

5. Say a name tag for the phone number. The name tag is recorded and the system responds with "About to store <name tag>. Does that sound OK?".
  - If the name tag does not sound correct, say "No" and repeat Step 5.
  - If the name tag sounds correct, say "Yes" and the name tag is stored. After the number is stored the system returns to the main menu.

### Using the Directory Command

The directory command lists all of the name tags stored by the system. To use the directory command:

1. Press and hold  /  for two seconds. The system responds with "Ready" followed by a tone.

2. Say "Directory". The system responds with "Directory" and then plays back all of the stored name tags. When the list is complete, the system returns to the main menu.

### Deleting Name Tags



The system uses the following commands to delete name tags:

- Delete
- Delete all name tags

### Using the Delete Command

The delete command allows specific name tags to be deleted.

To use the delete command:



1. Press and hold  /  for two seconds. The system responds with "Ready" followed by a tone.
2. Say "Delete". The system responds with "Delete, please say the name tag" followed by a tone.

3. Say the name tag to be deleted. The system responds with "Would you like to delete, <name tag>? Please say yes or no".
  - If the name tag is correct, say "Yes" to delete the name tag. The system responds with "OK, deleting <name tag>, returning to the main menu."
  - If the name tag is incorrect, say "No". The system responds with "No. OK, let's try again, please say the name tag."

### Using the Delete All Name Tags Command

The delete all name tags command deletes all stored phone book name tags and route name tags for OnStar (if present).

To use the delete all name tags command:



1. Press and hold  /  for two seconds. The system responds with "Ready" followed by a tone.
2. Say "Delete all name tags". The system responds with "You are about to delete all name tags stored in your phone directory and your route destination directory. Are you sure you want to do this? Please say yes or no."
  - Say "Yes" to delete all name tags.
  - Say "No" to cancel the function and return to the main menu.

### Making a Call



Calls can be made using the following commands:

- Dial
- Digit Dial
- Call
- Re-dial

### Using the Dial Command



1. Press and hold  /  for two seconds. The system responds with "Ready" followed by a tone.
2. Say "Dial". The system responds with "Dial using <phone name>." "Number please" followed by a tone.
3. Say the entire number without pausing.
  - If the system recognizes the number, it responds with "OK, Dialing" and dials the number.
  - If the system does not recognize the number, it confirms the numbers followed by a tone. If the number is correct, say "Yes". The system responds with "OK, Dialing" and dials the number. If the number is not correct, say "No". The system will ask for the number to be re-entered.

### Using the Digit Dial Command

1. Press and hold  /  for two seconds. The system responds with “Ready” followed by a tone.
2. Say “Digit Dial”. The system responds with “Digit dial using <phone name>, please say the first digit to dial” followed by a tone.
3. Say the digit to be dialed one at a time. Following each digit, the system will repeat back the digit it heard followed by a tone.
4. Continue entering digits until the number to be dialed is complete. After the whole number has been entered, say “Dial”. The system responds with “OK, Dialing” and dials the number.
  - If an unwanted number is recognized by the system, say “Clear” at any time to clear the last number.

- To hear all of the numbers recognized by the system, say “Verify” at any time and the system will repeat them.



### Using the Call Command

1. Press and hold  /  for two seconds. The system responds with “Ready” followed by a tone.
2. Say “Call”. The system responds with “Call using <phone name>. Please say the name tag” followed by a tone.
3. Say the name tag of the person to call.
  - If the system clearly recognizes the name tag it responds with “OK, calling, <name tag>” and dials the number.

- If the system is unsure it recognizes the right name tag, it confirms the name tag followed by a tone. If the name tag is correct, say “Yes”. The system responds with “OK, calling, <name tag>” and dials the number. If the name tag is not correct, say “No”. The system will ask for the name tag to be re-entered.

Once connected, the person called will be heard through the audio speakers.



### Using the Re-dial Command

1. Press and hold  /  for two seconds. The system responds with “Ready” followed by a tone.
2. After the tone, say “Re-dial”. The system responds with “Re-dial using <phone name>” and dials the last number called from the connected Bluetooth phone.

Once connected, the person called will be heard through the audio speakers.





### Receiving a Call

When an incoming call is received, the audio system mutes and a ring tone is heard in the vehicle.

- Press  /  and begin speaking to answer the call.
- Press – /  to ignore a call.

### Call Waiting





Call waiting must be supported on the Bluetooth phone and enabled by the wireless service carrier to work.

- Press  /  to answer an incoming call when another call is active. The original call is placed on hold.
- Press  /  again to return to the original call.

- To ignore the incoming call, continue with the original call with no action.
- Press – /  to disconnect the current call and switch to the call on hold.

### Three-Way Calling

Three-Way Calling must be supported on the Bluetooth phone and enabled by the wireless service carrier to work.

1. While on a call press  / . The system responds with “Ready” followed by a tone.
2. Say “Three-way call”. The system responds with “Three-way call, please say dial or call”.
3. Use the dial or call command to dial the number of the third party to be called.
4. Once the call is connected, press  /  to link all the callers together.



### Ending a Call

Press – /  to end a call.



### Muting a Call

During a call, all sounds from inside the vehicle can be muted so that the person on the other end of the call cannot hear them.

#### To Mute a call

1. Press  / . The system responds with “Ready” followed by a tone.
2. Say “Mute Call”. The system responds with “Call muted”.

#### To Cancel Mute

1. Press  / . The system responds with “Ready” followed by a tone.
2. After the tone, say “Mute Call”. The system responds with “Resuming call”.

## 3-80 Instrument Panel



---

### Transferring a Call

Audio can be transferred between the in-vehicle Bluetooth system and the cell phone.



#### To Transfer Audio to the Cell Phone

During a call with the audio in the vehicle:

1. Press  / . The system responds with “Ready” followed by a tone.
2. Say “Transfer Call.” The system responds with “Transferring call” and the audio will switch from the vehicle to the cell phone.



#### To Transfer Audio to the In-Vehicle Bluetooth System

The cellular phone must be paired and connected with the Bluetooth system before a call can be transferred. The connection process can take up to two minutes after the key is turned to the ON/RUN or ACC/ACCESSORY position.

During a call with the audio on the cell phone, press  /  for more than two seconds. The audio switches from the cell phone to the vehicle.

### Voice Pass-Thru

Voice Pass-Thru allows access to the voice recognition commands on the cell phone. See the cell phone manufacturers user guide to see if the cell phone supports this feature. This feature can be used to verbally access contacts stored in the cell phone.

1. Press and hold  /  for two seconds. The system responds with “Ready” followed by a tone.
2. Say “Bluetooth”. The system responds with “Bluetooth ready” followed by a tone.



3. Say “Voice”. The system responds with “OK, accessing <phone name>”.

- The cell phone’s normal prompt messages will go through its cycle according to the phone’s operating instructions.

### Dual Tone Multi-Frequency (DTMF) Tones



The in-vehicle Bluetooth system can send numbers and numbers stored as name tags during a call. This is used when calling a menu driven phone system. Account numbers can be programmed into the phonebook for retrieval during menu driven calls.

#### Sending a Number During a Call

1. Press  / . The system responds with “Ready” followed by a tone.
2. Say “Dial”. The system responds with “Say a number to send tones” followed by a tone.

3. Say the number to send.
  - If the system clearly recognizes the number it responds with “OK, Sending Number” and the dial tones are sent and the call continues.
  - If the system is not sure it recognized the number properly, it responds “Dial Number, Please say yes or no?” followed by a tone. If the number is correct, say “Yes”. The system responds with “OK, Sending Number” and the dial tones are sent and the call continues.

### **Sending a Stored Name Tag During a Call**

1. Press  / . The system responds with “Ready” followed by a tone.
2. Say “Send name tag.” The system responds with “Say a name tag to send tones” followed by a tone.

3. Say the name tag to send.
  - If the system clearly recognizes the name tag it responds with “OK, Sending <name tag>” and the dial tones are sent and the call continues.
  - If the system is not sure it recognized the name tag properly, it responds “Dial <name tag>, Please say yes or no?” followed by a tone. If the name tag is correct, say “Yes”. The system responds with “OK, Sending <name tag>” and the dial tones are sent and the call continues.

### **Clearing the System**

Unless information is deleted out of the in-vehicle Bluetooth system, it will be retained indefinitely. This includes all saved name tags in the phonebook and phone pairing information. For information on how to delete this information, see

the above sections on Deleting a Paired Phone and Deleting Name Tags.

### **Other Information**

The Bluetooth® word mark and logos are owned by the Bluetooth® SIG, Inc. and any use of such marks by General Motors is under license. Other trademarks and trade names are those of their respective owners.

This device complies with Part 15 of the FCC Rules. Operation is subject to the following two conditions:

1. This device may not cause harmful interference.
2. This device must accept any interference received, including interference that may cause undesired operation.

## 3-82 Instrument Panel

This device complies with RSS-210 of Industry Canada. Operation is subject to the following two conditions:

1. This device may not cause interference.
2. This device must accept any interference received, including interference that may cause undesired operation of the device.

Changes or modifications to this system by other than an authorized service facility could void authorization to use this equipment.

### Theft-Deterrent Feature

THEFTLOCK<sup>®</sup> is designed to discourage theft of the vehicle's radio by learning a portion of the Vehicle Identification Number (VIN). The radio does not operate if it is stolen or moved to a different vehicle.

### Audio Steering Wheel Controls

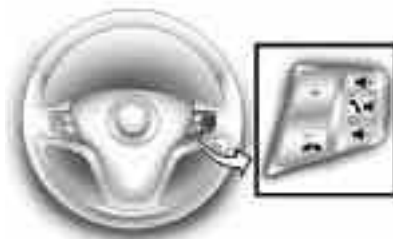

Some audio controls can be adjusted at the steering wheel. They include the following:

**+ / - (Next/Previous):** Press and release to go to the next or the previous preset radio station or CD track.

**📞 (End Call):** For vehicles with the OnStar<sup>®</sup> system, press to end a Hands-Free call, an OnStar<sup>®</sup> call, cancel an incoming call, or end the Advisor Playback.

For vehicles with Bluetooth<sup>®</sup>, press to end a call, or cancel an incoming call.

**🔊 + 🔊 -(Volume):** Move the thumbwheel up or down to increase or to decrease the volume.

**🔇 (Call / Mute):** Press and release to mute the system. Press it again to turn the sound back on.

For vehicles with OnStar<sup>®</sup> or Bluetooth systems, press and hold for longer than two seconds to interact with those systems. See *OnStar<sup>®</sup> System on page 2-29* and *Bluetooth<sup>®</sup> on page 3-72* in this manual for more information.



## Radio Reception

Frequency interference and static can occur during normal radio reception if items such as cell phone chargers, vehicle convenience accessories, and external electronic devices are plugged into the accessory power outlet. If there is interference or static, unplug the item from the accessory power outlet.

### AM

The range for most AM stations is greater than for FM, especially at night. The longer range can cause station frequencies to interfere with each other. For better radio reception, most AM radio stations boost the power levels during the day, and then reduce these levels during the night. Static can also occur when things like storms and power lines interfere with radio reception. When this happens, try reducing the treble on the radio.

## FM Stereo

FM signals only reach about 10 to 40 miles (16 to 65 km). Although the radio has a built-in electronic circuit that automatically works to reduce interference, some static can occur, especially around tall buildings or hills, causing the sound to fade in and out.

### XM™ Satellite Radio Service

XM Satellite Radio Service gives digital radio reception from coast-to-coast in the 48 contiguous United States, and in Canada. Just as with FM, tall buildings or hills can interfere with satellite radio signals, causing the sound to fade in and out. In addition, traveling or standing under heavy foliage, bridges, garages, or tunnels may cause loss of the XM signal for a period of time.

## Cellular Phone Usage

Cellular phone usage may cause interference with the vehicle's radio. This interference may occur when making or receiving phone calls, charging the phone's battery, or simply having the phone on. This interference causes an increased level of static while listening to the radio. If static is received while listening to the radio, unplug the cellular phone and turn it off.

### Fixed Mast Antenna

The fixed mast antenna can withstand most car washes without being damaged as long as it is securely attached to the base. If the mast becomes slightly bent, straighten it out by hand. If the mast is badly bent, replace it.

Occasionally check to make sure the antenna is tightened to its base. If tightening is required, tighten by hand.

### XM™ Satellite Radio Antenna System

The XM Satellite Radio antenna is located on the roof of the vehicle. Keep the antenna clear of obstructions for clear radio reception.

If the vehicle has a sunroof, the performance of the XM system may be affected if the sunroof is open.

### Chime Level Adjustment

The radio may be used to adjust the vehicle's chime level. If the radio can be used to change the volume level of the chime, press and hold the sixth FAV softkey with the ignition on and the radio power off. The volume level changes between Normal and Loud. The selected volume level appears on the radio display.

Removing the radio and not replacing it with a factory radio or chime module will disable vehicle chimes.

## Driving Your Vehicle

### Your Driving, the Road, and the Vehicle

Driving Your Vehicle .....	4-1
Driver Behavior .....	4-2
Driving Environment .....	4-2
Vehicle Design .....	4-2
Driving for Better Fuel	
Economy .....	4-3
Defensive Driving .....	4-3
Drunk Driving .....	4-4
Control of a Vehicle .....	4-4
Braking .....	4-5
Antilock Brake	
System (ABS) .....	4-6
Braking in Emergencies .....	4-6
StabiliTrak <sup>®</sup> System .....	4-7
Traction Control	
System (TCS) .....	4-8
Steering .....	4-9

Off-Road Recovery .....	4-10
Passing .....	4-11
Loss of Control .....	4-11
Driving at Night .....	4-12
Driving in Rain and on	
Wet Roads .....	4-13
Before Leaving on a	
Long Trip .....	4-14
Highway Hypnosis .....	4-14
Hill and Mountain	
Roads .....	4-14
Winter Driving .....	4-15
If Your Vehicle is Stuck	
in Sand, Mud, Ice,	
or Snow .....	4-17
Rocking Your Vehicle to	
Get It Out .....	4-17
Loading the Vehicle .....	4-18

### Towing

Towing Your Vehicle .....	4-22
Recreational Vehicle	
Towing .....	4-23
Towing a Trailer .....	4-26

## Your Driving, the Road, and the Vehicle

### Driving Your Vehicle

Whenever we drive, we are taking on an important responsibility. This is true for any motor vehicle — passenger car, van, truck, sport utility. Driver behavior, the driving environment, and the vehicle's design all affect how well a vehicle performs. But statistics show that the most important factor, by far, is how we drive.

Knowing how these three factors work together can help you understand how your vehicle handles and what you can do to avoid many types of crashes, including a rollover crash.

## 4-2 Driving Your Vehicle

---

### Driver Behavior

The single most important thing is this: everyone in the vehicle, including the driver, should buckle up. See *Safety Belts: They Are for Everyone on page 1-10*. In fact, most serious injuries and fatalities to unbelted occupants can be reduced or prevented by the use of safety belts. In a rollover crash, an unbelted person is significantly more likely to die than a person wearing a seat belt. In addition, avoiding excessive speed, sudden or abrupt turns, and drunken or aggressive driving can help make trips safer and avoid the possibility of a crash, especially a rollover crash. This section provides many useful tips to help you drive more safely.

### Driving Environment

You can also help avoid a rollover or other type of crash by being prepared for driving in inclement weather, at night, or during other times where visibility or traction may be limited, such as on curves, slippery roads, or hilly terrain. Unfamiliar surroundings can also have hidden hazards.

To help you learn more about driving in different conditions, this section contains information about city, freeway, and off-road driving, as well as other hints for driving in various weather conditions.

### Vehicle Design

According to the U.S. Department of Transportation, utility vehicles have a significantly higher rollover rate than other types of vehicles.

Utility vehicles do have higher ground clearance and a narrower track or shorter wheelbase than passenger cars, to make them more capable for off-road driving. Specific design characteristics like these give the driver a better view of the road, but also give utility vehicles a higher center of gravity than other types of vehicles. This means that you should not expect a utility vehicle to handle the same way a vehicle with a lower center of gravity, like a car, would in similar situations.

But driver behavior factors are far more often the cause of a utility vehicle rollover than are environmental or vehicle factors. Safe driver behavior and understanding the environment in which you will be driving can help avoid a rollover crash in any type of vehicle, including utility vehicles.

## Driving for Better Fuel Economy

Driving habits can affect fuel mileage. Here are some driving tips to get the best fuel economy possible.

- Avoid fast starts and accelerate smoothly.
- Brake gradually and avoid abrupt stops.
- Avoid idling the engine for long periods of time.
- When road and weather conditions are appropriate, use cruise control, if equipped.

- Always follow posted speed limits or drive more slowly when conditions require.
- Keep vehicle tires properly inflated.
- Combine several trips into a single trip.
- Replace the vehicle's tires with the same TPC Spec number molded into the tire's sidewall near the size.
- Follow recommended scheduled maintenance.

## Defensive Driving

Defensive driving means “always expect the unexpected.” The first step in driving defensively is to wear your safety belt — See *Safety Belts: They Are for Everyone on page 1-10*.

### CAUTION

Assume that other road users (pedestrians, bicyclists, and other drivers) are going to be careless and make mistakes. Anticipate what they might do and be ready. In addition:

- Allow enough following distance between you and the driver in front of you.
- Focus on the task of driving.

Driver distraction can cause collisions resulting in injury or possible death. These simple defensive driving techniques could save your life.

### Drunk Driving

#### CAUTION

Drinking and then driving is very dangerous. Your reflexes, perceptions, attentiveness, and judgment can be affected by even a small amount of alcohol. You can have a serious — or even fatal — collision if you drive after drinking. Do not drink and drive or ride with a driver who has been drinking. Ride home in a cab; or if you are with a group, designate a driver who will not drink.

Death and injury associated with drinking and driving is a global tragedy.

Alcohol affects four things that anyone needs to drive a vehicle: judgment, muscular coordination, vision, and attentiveness.

Police records show that almost 40 percent of all motor vehicle-related deaths involve alcohol. In most cases, these deaths are the result of someone who was drinking and driving. In recent years, more than 17,000 annual motor vehicle-related deaths have been associated with the use of alcohol, with about 250,000 people injured.

For persons under 21, it is against the law in every U.S. state to drink alcohol. There are good medical, psychological, and developmental reasons for these laws.

The obvious way to eliminate the leading highway safety problem is for people never to drink alcohol and then drive.

Medical research shows that alcohol in a person's system can make crash injuries worse, especially injuries to the brain, spinal cord, or heart. This means that when anyone who has been drinking — driver or passenger — is in a crash, that person's chance of being killed or permanently disabled is higher than if the person had not been drinking.

### Control of a Vehicle

The following three systems help to control the vehicle while driving —brakes, steering, and accelerator. At times, as when driving on snow or ice, it is easy to ask more of those control systems than the tires and road can provide. Meaning, you can lose control of the vehicle. See *Traction Control System (TCS)* on page 4-8.

Adding non-dealer/non-retailer accessories can affect vehicle performance. See *Accessories and Modifications* on page 5-3.

## Braking

See *Brake System Warning Light on page 3-27*.

Braking action involves perception time and reaction time. Deciding to push the brake pedal is perception time. Actually doing it is reaction time.

Average reaction time is about three-fourths of a second. But that is only an average. It might be less with one driver and as long as two or three seconds or more with another. Age, physical condition, alertness, coordination, and eyesight all play a part. So do alcohol, drugs, and frustration. But even in three-fourths of a second, a vehicle moving at 60 mph (100 km/h) travels 66 feet (20 m). That could be a lot of distance in an emergency, so keeping enough space between the vehicle and others is important.

And, of course, actual stopping distances vary greatly with the surface of the road, whether it is pavement or gravel; the condition of the road, whether it is wet, dry, or icy; tire tread; the condition of the brakes; the weight of the vehicle; and the amount of brake force applied.

Avoid needless heavy braking. Some people drive in spurts — heavy acceleration followed by heavy braking — rather than keeping pace with traffic. This is a mistake. The brakes might not have time to cool between hard stops. The brakes will wear out much faster with a lot of heavy braking. Keeping pace with the traffic and allowing realistic following distances eliminates a lot of unnecessary braking. That means better braking and longer brake life.

If the engine ever stops while the vehicle is being driven, brake normally but do not pump the brakes. If the brakes are pumped, the pedal could get harder to push down. If the engine stops, there will still be some power brake assist but it will be used when the brake is applied. Once the power assist is used up, it can take longer to stop and the brake pedal will be harder to push.

Adding non-dealer/non-retailer accessories can affect vehicle performance. See *Accessories and Modifications on page 5-3*.

### Antilock Brake System (ABS)

This vehicle has the Antilock Brake System (ABS), an advanced electronic braking system that helps prevent a braking skid.

When the engine is started and the vehicle begins to drive away, ABS checks itself. A momentary motor or clicking noise might be heard while this test is going on, and it might even be noticed that the brake pedal moves a little. This is normal.



If there is a problem with ABS, this warning light stays on. See *Antilock Brake System (ABS) Warning Light* on page 3-28.

Let us say the road is wet and you are driving safely. Suddenly, an animal jumps out in front of you. You slam on the brakes and continue braking. Here is what happens with ABS:

A computer senses that the wheels are slowing down. If one of the wheels is about to stop rolling, the computer will separately work the brakes at each wheel.

ABS can change the brake pressure to each wheel, as required, faster than any driver could. This can help the driver steer around the obstacle while braking hard.

As the brakes are applied, the computer keeps receiving updates on wheel speed and controls braking pressure accordingly.

Remember: ABS does not change the time needed to get a foot up to the brake pedal or always decrease stopping distance. If you get too close to the vehicle in front of you, there will not be enough time to apply the brakes if that vehicle suddenly slows or stops. Always leave enough room up ahead to stop, even with ABS.

### Using ABS

Do not pump the brakes. Just hold the brake pedal down firmly and let antilock work. The antilock pump or motor operating might be heard and the brake pedal might be felt to pulsate, but this is normal.

### Braking in Emergencies

ABS allows the driver to steer and brake at the same time. In many emergencies, steering can help more than even the very best braking.



## StabiliTrak<sup>®</sup> System

The vehicle has a vehicle stability enhancement system called StabiliTrak which combines antilock brake, traction and stability control systems and helps the driver maintain directional control of the vehicle in most driving conditions.

StabiliTrak activates when the computer senses a discrepancy between the intended path and the direction the vehicle is actually traveling. StabiliTrak selectively applies braking pressure at any one of the vehicle's brakes to assist the driver with keeping the vehicle on the intended path.

When the vehicle is started and begins to move, the system performs several diagnostic checks to insure there are no problems.

The system may be heard or felt while it is working. This is normal and does not mean there is a problem with the vehicle.



This light is located on the instrument panel cluster.

It will flash when StabiliTrak is both on and activated.

If the system fails to turn on or activate, this light will be on solid. When the light is on solid, the system will not assist the driver maintain directional control of the vehicle. Adjust your driving accordingly.

The StabiliTrak system automatically comes on whenever the vehicle is started. To assist the driver with vehicle directional control, especially in slippery road conditions, the system should always be left on. StabiliTrak can be turned off if needed.



OFF

The Traction Control System (TCS)/StabiliTrak button is located on the instrument panel.

TCS can be turned off or turned on by pressing and releasing the TCS/StabiliTrak button. To disable both StabiliTrak and TCS, press and hold the button until the TCS/StabiliTrak warning light turns on solid.

## 4-8 Driving Your Vehicle

---

It is recommended to leave the system on for normal driving conditions, but it may be necessary to turn the system off if the vehicle is stuck in sand, mud, ice or snow, and you want to “rock” the vehicle to attempt to free it.

StabiliTrak may also turn off automatically if it determines that a problem exists with the system. The TCS/StabiliTrak warning light will be on solid to warn the driver that StabiliTrak is disabled and requires service. If the problem does not clear itself after restarting the vehicle, see your dealer/retailer for service.

If cruise control is being used when StabiliTrak activates, the cruise control automatically disengages. The cruise control can be re-engaged when road conditions allow. See *Cruise Control* on page 3-9.

### Trailer Sway Control (TSC)

The vehicle has a Trailer Sway Control (TSC) feature as part of the StabiliTrak system. If the vehicle is towing a trailer and the system detects that the trailer is swaying, the vehicle’s brakes are applied without the driver pressing the brake pedal. The TCS/StabiliTrak warning light will flash on the instrument panel cluster to notify the driver to reduce speed. If the trailer continues to sway, StabiliTrak will reduce engine torque to help slow the vehicle.

Adding non-dealer/non-retailer accessories can affect the vehicle’s performance. See *Accessories and Modifications* on page 5-3 for more information.

### Traction Control System (TCS)

The vehicle has a Traction Control System (TCS) that limits wheel spin. This is especially useful in slippery road conditions. The system operates only if it senses that one or both of the front wheels are spinning or beginning to lose traction. When this happens, TCS applies the brakes to limit wheel spin and also reduces engine power. The system may be heard or felt while it is working, but this is normal.



This light will flash when TCS is limiting wheel spin.

It is recommended to leave the system on for normal driving conditions, but it may be necessary to turn the system off if the vehicle is stuck in sand, mud, ice, or snow, and you want to “rock” the vehicle to

attempt to free it. See *Rocking Your Vehicle to Get It Out* on page 4-17 and *If Your Vehicle is Stuck in Sand, Mud, Ice, or Snow* on page 4-17 for more information.



The TCS/StabiliTrak<sup>®</sup> button is located on the instrument panel.

Press and release this button to turn off TCS. The TCS warning light will be displayed on the instrument panel. The traction control system can be turned back on by pressing the TCS/StabiliTrak button.

If the system is limiting wheel spin when the button is pressed, the system will not turn off until there is no longer a current need to limit wheel spin. The system can be turned back on at any time by pressing the button again. If the TCS light does not come on,

TCS may not be functioning properly and the vehicle should be serviced at your dealer/retailer.

Adding non-dealer/non-retailer accessories can affect the vehicle's performance. See *Accessories and Modifications* on page 5-3 for more information.

## Steering

### Electric Power Steering

If the engine stalls while driving, the power steering assist system will continue to operate until you are able to stop the vehicle. If power steering assist is lost because the electric power steering system is not functioning, the vehicle can be steered but it will take more effort.

If you turn the steering wheel in either direction several times until it stops, or hold the steering wheel in the stopped position for an extended amount of time, you may

notice a reduced amount of power steering assist. The normal amount of power steering assist should return shortly after a few normal steering movements.

The electric power steering system does not require regular maintenance. If you suspect steering system problems and/or the Service Vehicle Soon light comes on, contact your dealer/retailer for service repairs.

### Steering Tips

It is important to take curves at a reasonable speed.

Traction in a curve depends on the condition of the tires and the road surface, the angle at which the curve is banked, and vehicle speed. While in a curve, speed is the one factor you can control.

If there is a need to reduce speed, do it before entering the curve, while the front wheels are straight.

## 4-10 Driving Your Vehicle

---

Try to adjust the speed so you can drive through the curve. Maintain a reasonable, steady speed. Wait to accelerate until out of the curve, and then accelerate gently into the straightaway.

### Steering in Emergencies

There are times when steering can be more effective than braking. For example, you come over a hill and find a truck stopped in your lane, or a car suddenly pulls out from nowhere, or a child darts out from between parked cars and stops right in front of you. These problems can be avoided by braking — if you can stop in time. But sometimes you cannot stop in time because there is no room. That is the time for evasive action — steering around the problem.

The vehicle can perform very well in emergencies like these. First apply the brakes. See *Braking on page 4-5*. It is better to remove as much speed as possible from a

collision. Then steer around the problem, to the left or right depending on the space available.



An emergency like this requires close attention and a quick decision. If holding the steering wheel at the recommended 9 and 3 o'clock positions, it can be turned a full 180 degrees very quickly without removing either hand. But you have to act fast, steer quickly, and just as quickly straighten the wheel once you have avoided the object.

The fact that such emergency situations are always possible is a good reason to practice defensive driving at all times and wear safety belts properly.

### Off-Road Recovery

The vehicle's right wheels can drop off the edge of a road onto the shoulder while driving.



If the level of the shoulder is only slightly below the pavement, recovery should be fairly easy.

Ease off the accelerator and then, if there is nothing in the way, steer so that the vehicle straddles the edge of the pavement. Turn the steering wheel 3 to 5 inches, 8 to 13 cm, (about one-eighth turn) until the right front tire contacts the pavement edge. Then turn the steering wheel to go straight down the roadway.

## Passing

Passing another vehicle on a two-lane road can be dangerous. To reduce the risk of danger while passing:

- Look down the road, to the sides, and to crossroads for situations that might affect a successful pass. If in doubt, wait.
- Watch for traffic signs, pavement markings, and lines that could indicate a turn or an intersection. Never cross a solid or double-solid line on your side of the lane.

- Do not get too close to the vehicle you want to pass. Doing so can reduce your visibility.
- Wait your turn to pass a slow vehicle.
- When you are being passed, ease to the right.

## Loss of Control

Let us review what driving experts say about what happens when the three control systems — brakes, steering, and acceleration — do not have enough friction where the tires meet the road to do what the driver has asked.

In any emergency, do not give up. Keep trying to steer and constantly seek an escape route or area of less danger.

## Skidding

In a skid, a driver can lose control of the vehicle. Defensive drivers avoid most skids by taking reasonable care suited to existing conditions, and by not overdriving those conditions. But skids are always possible.

The three types of skids correspond to the vehicle's three control systems. In the braking skid, the wheels are not rolling. In the steering or cornering skid, too much speed or steering in a curve causes tires to slip and lose cornering force. And in the acceleration skid, too much throttle causes the driving wheels to spin.

Remember: Any traction control system helps avoid only the acceleration skid. If the traction control system is off, then an acceleration skid is best handled by easing your foot off the accelerator pedal.

## 4-12 Driving Your Vehicle

---

If the vehicle starts to slide, ease your foot off the accelerator pedal and quickly steer the way you want the vehicle to go. If you start steering quickly enough, the vehicle may straighten out. Always be ready for a second skid if it occurs.

Of course, traction is reduced when water, snow, ice, gravel, or other material is on the road. For safety, slow down and adjust your driving to these conditions. It is important to slow down on slippery surfaces because stopping distance will be longer and vehicle control more limited.

While driving on a surface with reduced traction, try your best to avoid sudden steering, acceleration, or braking, including reducing vehicle speed by shifting to a lower gear. Any sudden changes could cause the tires to slide. You may not realize the surface is slippery until the

vehicle is skidding. Learn to recognize warning clues — such as enough water, ice, or packed snow on the road to make a mirrored surface — and slow down when you have any doubt.

Remember: Any Antilock Brake System (ABS) helps avoid only the braking skid.

### Driving at Night

Night driving is more dangerous than day driving because some drivers are likely to be impaired — by alcohol or drugs, with night vision problems, or by fatigue.

Night driving tips include:

- Drive defensively.
- Do not drink and drive.
- Reduce headlamp glare by adjusting the inside rearview mirror.

- Slow down and keep more space between you and other vehicles because headlamps can only light up so much road ahead.
- Watch for animals.
- When tired, pull off the road.
- Do not wear sunglasses.
- Avoid staring directly into approaching headlamps.
- Keep the windshield and all glass on your vehicle clean — inside and out.
- Keep your eyes moving, especially during turns or curves.

No one can see as well at night as in the daytime. But, as we get older, these differences increase. A 50-year-old driver might need at least twice as much light to see the same thing at night as a 20-year-old.

## Driving in Rain and on Wet Roads

Rain and wet roads can reduce vehicle traction and affect your ability to stop and accelerate. Always drive slower in these types of driving conditions and avoid driving through large puddles and deep-standing or flowing water.

### CAUTION

Wet brakes can cause crashes. They might not work as well in a quick stop and could cause pulling to one side. You could lose control of the vehicle.

(Continued)

### CAUTION (Continued)

After driving through a large puddle of water or a car/vehicle wash, lightly apply the brake pedal until the brakes work normally.

Flowing or rushing water creates strong forces. Driving through flowing water could cause your vehicle to be carried away. If this happens, you and other vehicle occupants could drown. Do not ignore police warnings and be very cautious about trying to drive through flowing water.

### Hydroplaning

Hydroplaning is dangerous. Water can build up under your vehicle's tires so they actually ride on the water. This can happen if the

road is wet enough and you are going fast enough. When your vehicle is hydroplaning, it has little or no contact with the road.

There is no hard and fast rule about hydroplaning. The best advice is to slow down when the road is wet.

### Other Rainy Weather Tips

Besides slowing down, other wet weather driving tips include:

- Allow extra following distance.
- Pass with caution.
- Keep windshield wiping equipment in good shape.
- Keep the windshield washer fluid reservoir filled.
- Have good tires with proper tread depth. See *Tires on page 5-38*.
- Turn off cruise control.

### Before Leaving on a Long Trip

To prepare your vehicle for a long trip, consider having it serviced by your dealer/retailer before departing.

Things to check on your own include:

- *Windshield Washer Fluid:* Reservoir full? Windows clean — inside and outside?
- *Wiper Blades:* In good shape?
- *Fuel, Engine Oil, Other Fluids:* All levels checked?
- *Lamps:* Do they all work and are lenses clean?
- *Tires:* Are treads good? Are tires inflated to recommended pressure?
- *Weather and Maps:* Safe to travel? Have up-to-date maps?

### Highway Hypnosis

Always be alert and pay attention to your surroundings while driving. If you become tired or sleepy, find a safe place to park your vehicle and rest.

Other driving tips include:

- Keep the vehicle well ventilated.
- Keep interior temperature cool.
- Keep your eyes moving — scan the road ahead and to the sides.
- Check the rearview mirror and vehicle instruments often.

### Hill and Mountain Roads

Driving on steep hills or through mountains is different than driving on flat or rolling terrain. Tips for driving in these conditions include:

- Keep the vehicle serviced and in good shape.
- Check all fluid levels and brakes, tires, cooling system, and transmission.
- Going down steep or long hills, shift to a lower gear.

#### CAUTION

If you do not shift down, the brakes could get so hot that they would not work well. You would then have poor braking or even none going down a hill. You could crash. Shift down to let the engine assist the brakes on a steep downhill slope.



 **CAUTION**

Coasting downhill in N (Neutral) or with the ignition off is dangerous. The brakes will have to do all the work of slowing down and they could get so hot that they would not work well. You would then have poor braking or even none going down a hill. You could crash. Always have the engine running and the vehicle in gear when going downhill.

- Stay in your own lane. Do not swing wide or cut across the center of the road. Drive at speeds that let you stay in your own lane.
- Top of hills: Be alert — something could be in your lane (stalled car, accident).

- Pay attention to special road signs (falling rocks area, winding roads, long grades, passing or no-passing zones) and take appropriate action.

## Winter Driving

### Driving on Snow or Ice

Drive carefully when there is snow or ice between the tires and the road, creating less traction or grip. Wet ice can occur at about 32°F (0°C) when freezing rain begins to fall, resulting in even less traction. Avoid driving on wet ice or in freezing rain until roads can be treated with salt or sand.

Drive with caution, whatever the condition. Accelerate gently so traction is not lost. Accelerating too quickly causes the wheels to spin and makes the surface under the tires slick, so there is even less traction.

Try not to break the fragile traction. If you accelerate too fast, the drive wheels will spin and polish the surface under the tires even more.

The *Antilock Brake System (ABS)* on page 4-6 improves vehicle stability during hard stops on slippery roads, but apply the brakes sooner than when on dry pavement.

Allow greater following distance on any slippery road and watch for slippery spots. Icy patches can occur on otherwise clear roads in shaded areas. The surface of a curve or an overpass can remain icy when the surrounding roads are clear. Avoid sudden steering maneuvers and braking while on ice.

Turn off cruise control, if equipped, on slippery surfaces.

## 4-16 Driving Your Vehicle

### Blizzard Conditions

Being stuck in snow can be a serious situation. Stay with the vehicle unless there is help nearby. If possible, use the *Roadside Assistance Program on page 7-5*. To get help and keep everyone in the vehicle safe:

- Turn on the *Hazard Warning Flashers on page 3-5*.
- Tie a red cloth to an outside mirror.

#### CAUTION

Snow can trap engine exhaust under the vehicle. This may cause exhaust gases to get inside. Engine exhaust contains carbon monoxide (CO) which cannot be seen or smelled. It can cause unconsciousness and even death.

(Continued)

#### CAUTION (Continued)

If the vehicle is stuck in the snow:

- Clear away snow from around the base of your vehicle, especially any that is blocking the exhaust pipe.
- Check again from time to time to be sure snow does not collect there.
- Open a window about two inches (5 cm) on the side of the vehicle that is away from the wind to bring in fresh air.
- Fully open the air outlets on or under the instrument panel.
- Adjust the Climate Control system to a setting that circulates the air inside the vehicle and set the fan speed to the highest setting. See Climate Control System in the Index.

(Continued)

#### CAUTION (Continued)

For more information about carbon monoxide, see *Engine Exhaust on page 2-26*.

Snow can trap exhaust gases under your vehicle. This can cause deadly CO (carbon monoxide) gas to get inside. CO could overcome you and kill you. You cannot see it or smell it, so you might not know it is in your vehicle. Clear away snow from around the base of your vehicle, especially any that is blocking the exhaust.

Run the engine for short periods only as needed to keep warm, but be careful.

To save fuel, run the engine for only short periods as needed to warm the vehicle and then shut the engine off and close the window most of the way to save heat.

Repeat this until help arrives but only when you feel really uncomfortable from the cold. Moving about to keep warm also helps.

If it takes some time for help to arrive, now and then when you run the engine, push the accelerator pedal slightly so the engine runs faster than the idle speed. This keeps the battery charged to restart the vehicle and to signal for help with the headlamps. Do this as little as possible to save fuel.

## If Your Vehicle is Stuck in Sand, Mud, Ice, or Snow

Slowly and cautiously spin the wheels to free the vehicle when stuck in sand, mud, ice, or snow. See *Rocking Your Vehicle to Get It Out* on page 4-17.

If the vehicle has a traction system, it can often help to free a stuck vehicle. Refer to the vehicle's traction system in the Index. If stuck too severely for the traction system to free the vehicle, turn the traction system off and use the rocking method.

### CAUTION

If you let your vehicle's tires spin at high speed, they can explode, and you or others could be injured. The vehicle can overheat, causing an engine compartment fire or other damage. Spin the wheels as little as possible and avoid going above 35 mph (55 km/h) as shown on the speedometer.

For information about using tire chains on the vehicle, see *Tire Chains* on page 5-57.

## Rocking Your Vehicle to Get It Out

Turn the steering wheel left and right to clear the area around the front wheels. Turn off any traction system. Shift back and forth between R (Reverse) and a forward gear, spinning the wheels as little as possible. To prevent transmission wear, wait until the wheels stop spinning before shifting gears. Release the accelerator pedal while shifting, and press lightly on the accelerator pedal when the transmission is in gear. Slowly spinning the wheels in the forward and reverse directions causes a rocking motion that could free the vehicle. If that does not get the vehicle out after a few tries, it might need to be towed out. If the vehicle does need to be towed out, see *Towing Your Vehicle* on page 4-22.

### Loading the Vehicle

It is very important to know how much weight your vehicle can carry. This weight is called the vehicle capacity weight and includes the weight of all occupants, cargo, and all nonfactory-installed options.

Two labels on your vehicle show how much weight it may properly carry, the Tire and Loading Information label and the Certification/Tire label.

#### CAUTION

Do not load the vehicle any heavier than the Gross Vehicle Weight Rating (GVWR), or either the maximum front or rear Gross Axle Weight Rating (GAWR). If you do, parts on the vehicle can break, and it can change the way your vehicle handles. These could cause you to lose control and crash. Also, overloading can shorten the life of the vehicle.

### Tire and Loading Information Label

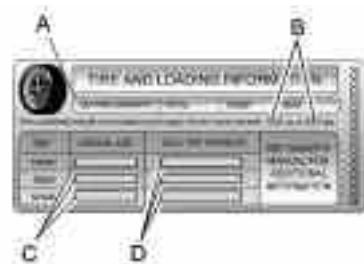

#### Example Label

A vehicle specific Tire and Loading Information label is attached to the center pillar (B-pillar) of your vehicle. With the driver's door open, you will find the label attached below the door lock post (striker). The tire and loading information label shows the number of occupant seating positions (A), and the maximum vehicle capacity weight (B) in kilograms and pounds.

The Tire and Loading Information label also shows the size of the original equipment tires (C) and the recommended cold tire inflation pressures (D). For more information on tires and inflation see *Tires on page 5-38* and *Inflation - Tire Pressure on page 5-43*.

There is also important loading information on the vehicle Certification/Tire label. It tells you the Gross Vehicle Weight Rating (GVWR) and the Gross Axle Weight Rating (GAWR) for the front and rear axle. See "Certification/Tire Label" later in this section.

#### **Steps for Determining Correct Load Limit**

1. Locate the statement "The combined weight of occupants and cargo should never exceed XXX kg or XXX lbs" on your vehicle's placard.
2. Determine the combined weight of the driver and passengers that will be riding in your vehicle.
3. Subtract the combined weight of the driver and passengers from XXX kg or XXX lbs.
4. The resulting figure equals the available amount of cargo and luggage load capacity. For example, if the "XXX" amount equals 1400 lbs and there will be five 150 lb passengers in your vehicle, the amount of available cargo and luggage load capacity is 650 lbs (1400 – 750 (5 x 150) = 650 lbs).
5. Determine the combined weight of luggage and cargo being loaded on the vehicle. That weight may not safely exceed the available cargo and luggage load capacity calculated in Step 4.
6. If your vehicle will be towing a trailer, the load from your trailer will be transferred to your vehicle. Consult this manual to determine how this reduces the available cargo and luggage load capacity for your vehicle.

See *Towing a Trailer on page 4-26* for important information on towing a trailer, towing safety rules, and trailering tips.

## 4-20 Driving Your Vehicle

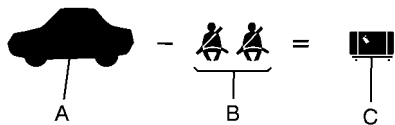

### Example 1

- A. Vehicle Capacity Weight for Example 1 = 1,000 lbs (453 kg).
- B. Subtract Occupant Weight 150 lbs (68 kg)  $\times$  2 = 300 lbs (136 kg).
- C. Available Occupant and Cargo Weight = 700 lbs (317 kg).

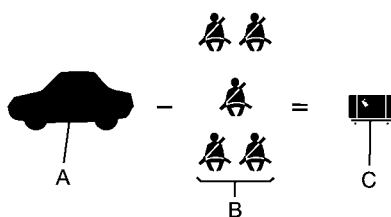

### Example 2

- A. Vehicle Capacity Weight for Example 2 = 1,000 lbs (453 kg).
- B. Subtract Occupant Weight 150 lbs (68 kg)  $\times$  5 = 750 lbs (340 kg).
- C. Available Cargo Weight = 250 lbs (113 kg).

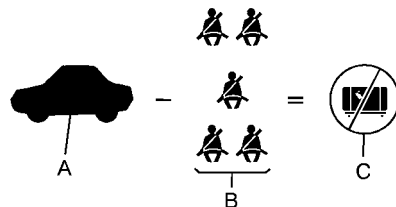

### Example 3

- A. Vehicle Capacity Weight for Example 3 = 1,000 lbs (453 kg).
- B. Subtract Occupant Weight 200 lbs (91 kg)  $\times$  5 = 1,000 lbs (453 kg).
- C. Available Cargo Weight = 0 lbs (0 kg).

Refer to your vehicle's tire and loading information label for specific information about your vehicle's capacity weight and seating positions. The combined weight of the driver, passengers, and cargo should never exceed your vehicle's capacity weight.

## Certification/Tire Label

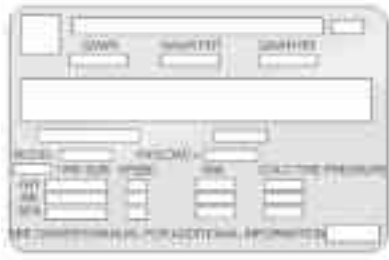

### Label Example

A vehicle specific Certification/Tire label is attached to the lower area of the center pillar (B-Pillar).

The label shows the gross weight capacity of your vehicle. This is called the Gross Vehicle Weight Rating (GVWR).

The GVWR includes the weight of the vehicle, all occupants, fuel, cargo, and trailer tongue weight, if the vehicle is pulling a trailer.

The Certification/Tire label also tells you the maximum weights for the front and rear axles, called the Gross Axle Weight Rating (GAWR). To find out the actual loads on your front and rear axles, you need to go to a weigh station and weigh your vehicle. Your dealer/retailer can help you with this. Be sure to spread out your load equally on both sides of the centerline.

Never exceed the GVWR for your vehicle or the GAWR for either the front or rear axle.

### CAUTION

Do not load the vehicle any heavier than the Gross Vehicle Weight Rating (GVWR), or either the maximum front or rear Gross Axle Weight Rating (GAWR). If you do, parts on the vehicle can break, and it can change the way your vehicle handles. These could cause you to lose control and crash. Also, overloading can shorten the life of the vehicle.

**Notice: Overloading your vehicle may cause damage. Repairs would not be covered by your warranty. Do not overload your vehicle.**

## 4-22 Driving Your Vehicle

---

If you put things inside your vehicle — like suitcases, tools, packages, or anything else, they will go as fast as the vehicle goes. If you have to stop or turn quickly, or if there is a crash, they will keep going.

### CAUTION

Things you put inside your vehicle can strike and injure people in a sudden stop or turn, or in a crash.

- Put things in the cargo area of your vehicle. Try to spread the weight evenly.
- Never stack heavier things, like suitcases, inside the vehicle so that some of them are above the tops of the seats.

(Continued)

### CAUTION (Continued)

- Do not leave an unsecured child restraint in your vehicle.
- When you carry something inside the vehicle, secure it whenever you can.
- Do not leave a seat folded down unless you need to.

## Towing

### Towing Your Vehicle

To avoid damage, the disabled vehicle should be towed with all four wheels off the ground. Consult your dealer/retailer or a professional towing service if the disabled vehicle must be towed. See *Roadside Assistance Program on page 7-5*.

To tow the vehicle behind another vehicle for recreational purposes, such as behind a motorhome, see “Recreational Vehicle Towing” following.



## Recreational Vehicle Towing

Recreational vehicle towing means towing the vehicle behind another vehicle – such as behind a motorhome. The two most common types of recreational vehicle towing are known as dinghy towing and dolly towing. Dinghy towing is towing the vehicle with all four wheels on the ground. Dolly towing is towing the vehicle with two wheels on the ground and two wheels up on a device known as a dolly.

Here are some important things to consider before recreational vehicle towing:

- What is the towing capacity of the towing vehicle? Be sure to read the tow vehicle manufacturer's recommendations.
- What is the distance that will be travelled? Some vehicles have restrictions on how far and how long they can tow.

- Is the proper towing equipment going to be used? See your dealer/retailer or trailering professional for additional advice and equipment recommendations.
- Is the vehicle ready to be towed? Just as preparing the vehicle for a long trip, make sure the vehicle is prepared to be towed. See *Before Leaving on a Long Trip* on page 4-14.

### Dinghy Towing

This vehicle may be dinghy towed from the front. This vehicle may also be towed by putting the front wheels on a dolly. See “Dolly Towing” later in this section.

For vehicles being dinghy towed, the vehicle should be run at the beginning of each day and at each RV fuel stop for about five minutes. This will ensure proper lubrication of transmission components.

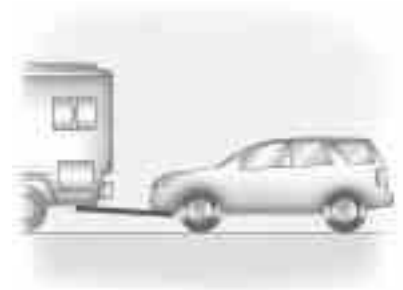

To tow the vehicle from the front with all four wheels on the ground:

1. Position the vehicle that will be towed and secure it to the towing vehicle.
2. Turn the ignition key to ACC/ACCESSORY.

## 4-24 Driving Your Vehicle

---

3. Shift the transmission to N (Neutral).
4. Turn fog lamps and all accessories off.
5. To prevent the battery from draining while the vehicle is being towed, remove the 2 amp IGN SW fuse from the instrument panel fuse block and store it in a safe location. See *Instrument Panel Fuse Block* on page 5-76

**Notice:** If the vehicle is towed without performing each of the steps listed under “Dinghy Towing,” the automatic transmission could be damaged. Be sure to follow all steps of the dinghy towing procedure prior to and after towing the vehicle.

**Notice:** If the vehicle has a four-speed automatic transmission, it can be dinghy towed from the front for unlimited miles at 65 mph (105 km/h). The vehicle could be damaged if 65 mph (105 km/h) is exceeded while towing the vehicle. The repairs would not be covered by the vehicle warranty. Never exceed 65 mph (105 km/h) while towing the vehicle.

Once the destination has been reached:

1. Set the parking brake.
2. Shift the transmission to P (Park).
3. Reinstall the 2 amp IGN SW fuse to the instrument panel fuse block.
4. Turn the ignition key to LOCK/OFF and remove the key from the ignition.

**Notice:** Too much or too little fluid can damage the transmission. Be sure that the transmission fluid is at the proper level before towing with all four wheels on the ground.

**Notice:** Do not tow a vehicle with the front drive wheels on the ground if one of the front tires is a compact spare tire. Towing with two different tire sizes on the front of the vehicle can cause severe damage to the transmission.

## Dolly Towing (Front-Wheel-Drive Vehicles)

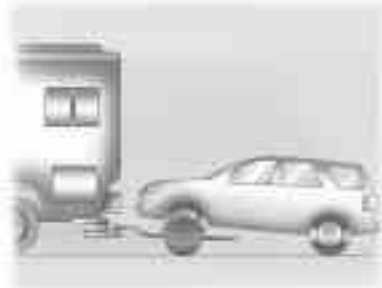

To tow the vehicle from the front with the rear wheels on the ground, do the following:

1. Put the front wheels on a dolly.
2. Move the shift lever to P (Park).
3. Set the parking brake.

4. Clamp the steering wheel in a straight-ahead position with a clamping device designed for towing.
5. Remove the key from the ignition.
6. Secure the vehicle to the dolly.
7. Release the parking brake.

## Towing the Vehicle From the Rear



**Notice:** Towing the vehicle from the rear could damage it. Also, repairs would not be covered by the vehicle warranty. Never have the vehicle towed from the rear.

### Towing a Trailer

#### CAUTION

The driver can lose control when pulling a trailer if the correct equipment is not used or the vehicle is not driven properly. For example, if the trailer is too heavy, the brakes may not work well — or even at all. The driver and passengers could be seriously injured. The vehicle may also be damaged; the resulting repairs would not be covered by the vehicle warranty. Pull a trailer only if all the steps in this section have been followed. Ask your dealer/retailer for advice and information about towing a trailer with the vehicle.

**Notice:** Pulling a trailer improperly can damage the vehicle and result in costly repairs not covered by the vehicle warranty. To pull a trailer correctly, follow the advice in this section and see your dealer/retailer for important information about towing a trailer with the vehicle.

The vehicle can tow a trailer if it is equipped with the proper trailer towing equipment.

To identify the trailering capacity of the vehicle, read the information in “Weight of the Trailer” that appears later in this section.

Trailering is different than just driving the vehicle by itself. Trailering means changes in handling, acceleration, braking, durability and fuel economy. Successful, safe trailering takes correct equipment, and it has to be used properly.

The following information has many time-tested, important trailering tips and safety rules. Many of these are important for your safety and that of your passengers. So please read this section carefully before pulling a trailer.

Load-pulling components such as the engine, transmission, rear axle, wheel assemblies and tires are forced to work harder against the drag of the added weight. The engine is required to operate at relatively higher speeds and under greater loads, generating extra heat. The trailer also adds considerably to wind resistance, increasing the pulling requirements.

The vehicle has Trailer Sway Control (TSC). See “Trailer Sway Control (TSC)” in *StabiliTrak® System on page 4-7* for more information.

## Pulling A Trailer

Here are some important points:

- There are many different laws, including speed limit restrictions, having to do with trailering. Make sure the rig will be legal, not only where you live but also where you will be driving. A good source for this information can be state or provincial police.
- Do not tow a trailer at all during the first 500 miles (800 km) the new vehicle is driven. The engine, axle or other parts could be damaged.
- Then, during the first 500 miles (800 km) that a trailer is towed, do not drive over 50 mph (80 km/h) and do not make starts at full throttle. This helps the engine and other parts of the vehicle wear in at the heavier loads.

- Vehicles can tow in D (Drive). Shift the transmission to a lower gear if the transmission shifts too often under heavy loads and/or hilly conditions.
- Obey speed limit restrictions when towing a trailer. Do not drive faster than the maximum posted speed for trailers, or no more than 55 mph (90 km/h), to save wear on the vehicle's parts.
- Do not tow a trailer when the outside temperature is above 100°F (38°C).

Three important considerations have to do with weight:

- The weight of the trailer
- The weight of the trailer tongue
- The total weight on the vehicle's tires

## Weight of the Trailer

How heavy can a trailer safely be?

It should never weigh more than 1,500 lbs (680 kg). But even that can be too heavy.

It depends on how the rig is used. For example, speed, altitude, road grades, outside temperature and how much the vehicle is used to pull a trailer are all important. It can depend on any special equipment on the vehicle, and the amount of tongue weight the vehicle can carry. See "Weight of the Trailer Tongue" later in this section for more information.

Maximum trailer weight is calculated assuming only the driver is in the tow vehicle and it has all the required trailering equipment. The weight of additional optional equipment, passengers and cargo in the tow vehicle must be subtracted from the maximum trailer weight.

Ask your dealer/retailer for trailering information or advice.

## 4-28 Driving Your Vehicle

### Weight of the Trailer Tongue

The tongue load (A) of any trailer is an important weight to measure because it affects the total gross weight of the vehicle. The Gross Vehicle Weight (GVW) includes the curb weight of the vehicle, any cargo carried in it, and the people who will be riding in the vehicle. If there are a lot of options, equipment, passengers or cargo in the vehicle, it will reduce the tongue weight the vehicle can carry, which will also reduce the trailer weight the vehicle can tow. If towing a trailer, the tongue load must be added to the GVW because the vehicle will be carrying that weight, too. See *Loading the Vehicle* on page 4-18 for more information about the vehicle's maximum load capacity.

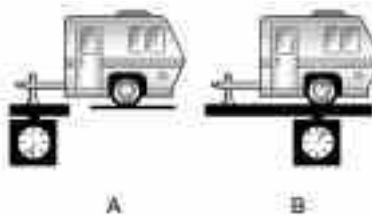

For a weight-carrying hitch, the trailer tongue (A) should weigh 10 percent of the total loaded trailer weight (B).

After loading the trailer, weigh the trailer and then the tongue, separately, to see if the weights are proper. If they are not, adjustments might be made by moving some items around in the trailer.

Trailer may be limited by the vehicle's ability to carry tongue weight. Tongue weight cannot cause the vehicle to exceed the GVWR (Gross Vehicle Weight Rating) or the RGAWR (Rear Gross Axle Weight Rating).

The effect of additional weight may reduce the trailering capacity more than the total of the additional weight.

Consider the following example:

A vehicle model base weight is 5,500 lbs (2 495 kg); 2,800 lbs (1 270 kg) at the front axle and 2,700 lbs (1 225 kg) at the rear axle. It has a GVWR of 7,200 lbs (3 266 kg), a RGAWR of 4,000 lbs (1 814 kg) and a GCWR (Gross Combination Weight Rating) of 14,000 lbs (6 350 kg). The trailer rating should be:

14,000 lbs (6350 kg)	GCWR
<u>-5,500 lbs (2495 kg)</u>	Vehicle Weight
8,500 lbs (3855 kg)	Trailer Rating

Expect tongue weight to be at least 10 percent of trailer weight (850 lbs (386 kg)) and because the weight is applied well behind the rear axle, the effect on the rear axle is greater than just the weight itself, as much as 1.5 times as much.

The weight at the rear axle could be 850 lbs (386 kg) X 1.5 = 1,275 lbs (578 kg). Since the rear axle already weighs 2,700 lbs (1 225 kg), adding 1,275 lbs (578 kg) brings the total to 3,975 lbs (1 803 kg). This is very close to, but within the limit for RGAWR as well. The vehicle is set to trailer up to 8,500 lbs (3 856 kg).

If the vehicle has many options and there is a front seat passenger and two rear seat passengers with some luggage and gear in the vehicle as well, 300 lbs (136 kg) could be added to the front axle weight and 400 lbs (181 kg) to the rear axle weight. The vehicle now weighs:

2,800 lbs (1270 kg)	+ 300 lbs (136 kg)	Front
2,700 lbs (1225 kg)	+ 400 lbs (181 kg)	Rear
6,200 lbs (2812 kg)		Total

Weight is still below 7,200 lbs (3 266 kg) and you might think 700 additional pounds (318 kg) should be subtracted from the trailering capacity to stay within GCWR limits.

The maximum trailer would only be 7,800 lbs (3 538 kg). You may go further and think the tongue weight should be limited to less than 1,000 lbs (454 kg) to avoid exceeding GVWR. But the effect on the rear axle must still be considered. Because the rear axle now weighs 3,100 lbs (1 406 kg), 900 lbs (408 kg) can be put on the rear axle without exceeding RGAWR. The effect of tongue weight is about 1.5 times the actual weight. Dividing the 900 lbs (408 kg) by 1.5 leaves only 600 lbs (272 kg) of tongue weight that can be handled. Since tongue weight is usually at least 10 percent of total loaded trailer weight, expect that the largest trailer the vehicle can properly handle is 6,000 lbs (2 721 kg).

It is important that the vehicle does not exceed any of its ratings — GCWR, GVWR, RGAWR, Maximum Trailer Rating or Tongue Weight. The only way to be sure it is not exceeding any of these ratings is to weigh the vehicle and trailer.

### Total Weight on the Vehicle's Tires

Be sure the vehicle's tires are inflated to the upper limit for cold tires. These numbers can be found on the Certification label or see *Loading the Vehicle on page 4-18* for more information. Make sure not to go over the GVW limit for the vehicle, or the GAWR, including the weight of the trailer tongue.

### Hitches

It is important to have the correct hitch equipment. Crosswinds, large trucks going by and rough roads are a few reasons why the right hitch is needed.

- The rear bumper on the vehicle is not intended for hitches. Do not attach rental hitches or other bumper-type hitches to it. Use only a frame-mounted hitch that does not attach to the bumper.

## 4-30 Driving Your Vehicle

- Will any holes be made in the body of the vehicle when the trailer hitch is installed? If so, be sure to seal the holes when the hitch is removed. If they are not sealed, deadly carbon monoxide (CO) from the engine's exhaust can get into the vehicle. See *Engine Exhaust on page 2-26*. Sealing the holes will also prevent dirt and water from entering the vehicle.

### Safety Chains

Always attach chains between the vehicle and the trailer. Cross the safety chains under the tongue of the trailer to help prevent the tongue from contacting the road if it becomes separated from the hitch. Instructions about safety chains may be provided by the hitch manufacturer or by the trailer

manufacturer. Follow the manufacturer's recommendation for attaching safety chains and do not attach them to the bumper. Always leave just enough slack so the rig can turn. Never allow safety chains to drag on the ground.

### Trailer Brakes

A loaded trailer that weighs more than 1,000 lbs (900 kg) needs to have its own brake system that is adequate for the weight of the trailer. Be sure to read and follow the instructions for the trailer brakes so they are installed, adjusted and maintained properly. Because the vehicle has StabiliTrak<sup>®</sup>, do not try to tap into the vehicle's hydraulic brake system. If you do, both brake systems will not work well, or at all.

## Driving with a Trailer



When towing a trailer, exhaust gases may collect at the rear of the vehicle and enter if the liftgate, trunk/hatch, or rear-most window is open.

Engine exhaust contains carbon monoxide (CO) which cannot be seen or smelled. It can cause unconsciousness and even death.

To maximize safety when towing a trailer:

- Have the exhaust system inspected for leaks and make necessary repairs before starting a trip.
- Never drive with the liftgate, trunk/hatch, or rear-most window open.
- Fully open the air outlets on or under the instrument panel.

(Continued)



**CAUTION (Continued)**

- Adjust the Climate Control system to a setting that brings in only outside air and set the fan speed to the highest setting. See Climate Control System in the Index.

For more information about carbon monoxide, see *Engine Exhaust on page 2-26*.

Towing a trailer requires a certain amount of experience. Get to know the rig before setting out for the open road. Get acquainted with the feel of handling and braking with the added weight of the trailer. And always keep in mind that the vehicle you are driving is now longer and not as responsive as the vehicle is by itself.

Before starting, check all trailer hitch parts and attachments, safety chains, electrical connectors, lamps, tires and mirror adjustments.

If the trailer has electric brakes, start the vehicle and trailer moving and then apply the trailer brake controller by hand to be sure the brakes are working. This checks the electrical connection at the same time.

During the trip, check occasionally to be sure that the load is secure, and that the lamps and any trailer brakes are still working.

**Following Distance**

Stay at least twice as far behind the vehicle ahead as you would when driving the vehicle without a trailer. This can help to avoid situations that require heavy braking and sudden turns.

**Passing**

More passing distance is needed when towing a trailer. Because the rig is longer, it is necessary to go much farther beyond the passed vehicle before returning to the lane.

**Backing Up**

Hold the bottom of the steering wheel with one hand. Then, to move the trailer to the left, move that hand to the left. To move the trailer to the right, move your hand to the right. Always back up slowly and, if possible, have someone guide you.

**Making Turns**

**Notice:** Making very sharp turns while trailering could cause the trailer to come in contact with the vehicle. The vehicle could be damaged. Avoid making very sharp turns while trailering.

When turning with a trailer, make wider turns than normal. Do this so the trailer will not strike soft shoulders, curbs, road signs, trees or other objects. Avoid jerky or sudden maneuvers. Signal well in advance.

### Turn Signals When Towing a Trailer

The arrows on the instrument panel flash whenever signaling a turn or lane change. Properly hooked up, the trailer lamps also flash, telling other drivers the vehicle is turning, changing lanes or stopping.

When towing a trailer, the arrows on the instrument panel flash for turns even if the bulbs on the trailer are burned out. For this reason you may think other drivers are seeing the signal when they are not. It is important to check occasionally to be sure the trailer bulbs are still working.

### Driving on Grades

**Notice:** Do not tow on steep continuous grades exceeding 6 miles (9.6 km). Extended, higher than normal engine and transmission temperatures may result and damage the vehicle. Frequent stops are very important to allow the engine and transmission to cool.

Vehicles can tow in D (Drive). Shift the transmission to a lower gear if the transmission shifts too often under heavy loads and/or hilly conditions. Reduce speed and shift to a lower gear *before* starting down a long or steep downgrade. If the transmission is not shifted down, the brakes might have to be used so much that they would get hot and no longer work well.

On a long uphill grade, shift down and reduce the vehicle's speed to around 45 mph (70 km/h) to reduce the possibility of the engine and the transmission overheating.

When towing at high altitude on steep uphill grades, consider the following: Engine coolant will boil at a lower temperature than at normal altitudes. If the engine is turned off immediately after towing at high altitude on steep uphill grades, the vehicle may show signs similar to engine overheating. To avoid this, let the engine run while parked, preferably on level ground, with the automatic transmission in P (Park) for a few minutes before turning the engine off. If the overheat warning comes on, see *Engine Overheating on page 5-23*.

## Parking on Hills

### CAUTION

Parking the vehicle on a hill with the trailer attached can be dangerous. If something goes wrong, the rig could start to move. People can be injured, and both the vehicle and the trailer can be damaged. When possible, always park the rig on a flat surface.

If parking the rig on a hill:

1. Press the brake pedal, but do not shift into P (Park) yet. Turn the wheels into the curb if facing downhill or into traffic if facing uphill.
2. Have someone place chocks under the trailer wheels.

3. When the wheel chocks are in place, release the regular brakes until the chocks absorb the load.
4. Reapply the brake pedal. Then apply the parking brake and shift into P (Park).
5. Release the brake pedal.

### Leaving After Parking on a Hill

1. Apply and hold the brake pedal while you:
  - Start the engine
  - Shift into a gear
  - Release the parking brake
2. Let up on the brake pedal.
3. Drive slowly until the trailer is clear of the chocks.
4. Stop and have someone pick up and store the chocks.

### Maintenance When Trailer Towing

The vehicle needs service more often when pulling a trailer. See *Scheduled Maintenance on page 6-3* for more information. Things that are especially important in trailer operation are automatic transmission fluid, engine oil, axle lubricant, belts, cooling system and brake system. It is a good idea to inspect these before and during the trip.

Check periodically to see that all hitch nuts and bolts are tight.

### Engine Cooling When Trailer Towing

The cooling system may temporarily overheat during severe operating conditions. See *Engine Overheating on page 5-23*.



## Service and Appearance Care

### Service

Service .....	5-3
Accessories and Modifications .....	5-3
California Proposition 65 Warning .....	5-3
California Perchlorate Materials Requirements .....	5-4
Doing Your Own Service Work .....	5-4
Adding Equipment to the Outside of the Vehicle .....	5-4

### Fuel

Fuel .....	5-5
Gasoline Octane .....	5-5
Gasoline Specifications .....	5-5
California Fuel .....	5-5
Additives .....	5-5

Fuels in Foreign Countries .....	5-6
Filling the Tank .....	5-7
Filling a Portable Fuel Container .....	5-8

### Checking Things Under the Hood

Checking Things Under the Hood .....	5-9
Hood Release .....	5-9
Engine Compartment Overview .....	5-10
Engine Oil .....	5-11
Engine Oil Life System .....	5-14
Engine Air Cleaner/Filter .....	5-15
Automatic Transmission Fluid .....	5-17
Cooling System .....	5-17
Engine Coolant .....	5-20
Coolant Surge Tank Pressure Cap .....	5-22
Engine Overheating .....	5-23
Windshield Washer Fluid .....	5-24

Brakes .....	5-25
Battery .....	5-27
Jump Starting .....	5-28

### Headlamp Aiming

Headlamp Aiming .....	5-33
-----------------------	------

### Bulb Replacement

Bulb Replacement .....	5-35
Halogen Bulbs .....	5-35
Headlamps .....	5-35
Front Turn Signal and Parking Lamps .....	5-36
Taillamps, Turn Signal, Stoplamps and Back-up Lamps .....	5-36
License Plate Lamp .....	5-37
Replacement Bulbs .....	5-37

### Windshield Wiper Blade Replacement

Windshield Wiper Blade Replacement .....	5-38
--	------

## 5-2 Service and Appearance Care

---

### Tires

Tires .....	5-38
Tire Sidewall Labeling .....	5-39
Tire Terminology and Definitions .....	5-41
Inflation - Tire Pressure .....	5-43
Tire Pressure Monitor System .....	5-45
Tire Pressure Monitor Operation .....	5-46
Tire Inspection and Rotation .....	5-50
When It Is Time for New Tires .....	5-51
Buying New Tires .....	5-51
Different Size Tires and Wheels .....	5-53
Uniform Tire Quality Grading .....	5-54
Wheel Alignment and Tire Balance .....	5-55
Wheel Replacement .....	5-55
Tire Chains .....	5-57
If a Tire Goes Flat .....	5-58

Tire Sealant and Compressor Kit .....	5-59
Tire Sealant and Compressor Kit Storage .....	5-66

### Appearance Care

Interior Cleaning .....	5-66
Fabric/Carpet .....	5-68
Leather .....	5-68
Instrument Panel, Vinyl, and Other Plastic Surfaces .....	5-69
Care of Safety Belts .....	5-69
Weatherstrips .....	5-69
Washing Your Vehicle .....	5-69
Cleaning Exterior Lamps/Lenses .....	5-70
Finish Care .....	5-70
Windshield and Wiper Blades .....	5-71
Aluminum Wheels .....	5-72
Tires .....	5-72
Sheet Metal Damage .....	5-73
Finish Damage .....	5-73
Underbody Maintenance .....	5-73
Chemical Paint Spotting .....	5-73

### Vehicle Identification

Vehicle Identification Number (VIN) .....	5-74
Service Parts Identification Label .....	5-74

### Electrical System

Intermediate Voltage Devices and Wiring .....	5-74
Add-On Electrical Equipment .....	5-75
Windshield Wiper Fuses .....	5-75
Power Windows and Other Power Options .....	5-75
Fuses and Circuit Breakers .....	5-75
Instrument Panel Fuse Block .....	5-76
Underhood Fuse Block .....	5-77

### Capacities and Specifications

Capacities and Specifications .....	5-81
--	------

## Service

For service and parts needs, visit your dealer/retailer. You will receive genuine Saturn parts and Saturn-trained and supported service people.

Genuine Saturn parts have one of these marks.

***ACDelco***<sup>®</sup>

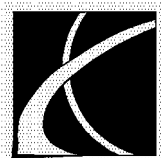

**SATURN**<sup>®</sup>

## Accessories and Modifications

When non-dealer/non-retailer accessories are added to the vehicle, they can affect vehicle performance and safety, including such things as airbags, braking, stability, ride and handling, emissions systems, aerodynamics, durability, and electronic systems like antilock brakes, traction control, and stability control. Some of these accessories could even cause malfunction or damage not covered by the vehicle warranty.

Damage to vehicle components resulting from the installation or use of non-GM certified parts, including control module modifications, are not covered under the terms of the vehicle warranty and may affect remaining warranty coverage for affected parts.

GM Accessories are designed to complement and function with other systems on the vehicle.

Your GM dealer/retailer can accessorize the vehicle using genuine GM Accessories. When you go to your GM dealer/retailer and ask for GM Accessories, you will know that GM-trained and supported service technicians will perform the work using genuine GM Accessories.

Also, see *Adding Equipment to Your Airbag-Equipped Vehicle* on page 1-55.

## California Proposition 65 Warning

Most motor vehicles, including this one, contain and/or emit chemicals known to the State of California to cause cancer and birth defects or other reproductive harm. Engine exhaust, many parts and systems (including some inside the vehicle), many fluids, and some component wear by-products contain and/or emit these chemicals.

## 5-4 Service and Appearance Care

### California Perchlorate Materials Requirements

Certain types of automotive applications, such as airbag initiators, seat belt pretensioners, and lithium batteries contained in remote keyless transmitters, may contain perchlorate materials. Special handling may be necessary. For additional information, see [www.dtsc.ca.gov/hazardouswaste/perchlorate](http://www.dtsc.ca.gov/hazardouswaste/perchlorate).

### Doing Your Own Service Work

#### CAUTION

Never try to do your own service on hybrid components. You can be injured and the vehicle can be damaged if you try to do your own service work. Service and repair of these hybrid components should only be performed by a trained service technician with the proper knowledge and tools.

#### CAUTION

You can be injured and the vehicle could be damaged if you try to do service work on a vehicle without knowing enough about it.

- Be sure you have sufficient knowledge, experience, the proper replacement parts, and tools before attempting any vehicle maintenance task.
- Be sure to use the proper nuts, bolts, and other fasteners. English and metric fasteners can be easily confused. If the wrong fasteners are used, parts can later break or fall off. You could be hurt.

If doing some of your own service work, use the proper service manual. It tells you much more about how to service the vehicle than this manual can. To order the proper service manual, see *Service Publications Ordering Information* on page 7-13.

This vehicle has an airbag system. Before attempting to do your own service work, see *Servicing Your Airbag-Equipped Vehicle* on page 1-54.

Keep a record with all parts receipts and list the mileage and the date of any service work performed. See *Maintenance Record* on page 6-14.

### Adding Equipment to the Outside of the Vehicle

Things added to the outside of the vehicle can affect the airflow around it. This can cause wind noise and can affect fuel economy and windshield washer performance. Check with your dealer/retailer before adding equipment to the outside of the vehicle.



## Fuel

Use of the recommended fuel is an important part of the proper maintenance of this vehicle. To help keep the engine clean and maintain optimum vehicle performance, we recommend the use of gasoline advertised as TOP TIER Detergent Gasoline.

### Gasoline Octane

Use regular unleaded gasoline with a posted octane rating of 87 or higher. If the octane rating is less than 87, you might notice an audible knocking noise when you drive, commonly referred to as spark knock. If this occurs, use a gasoline rated at 87 octane or higher as soon as possible. If you are using gasoline rated at 87 octane or higher and you hear heavy knocking, the engine needs service.

### Gasoline Specifications

At a minimum, gasoline should meet ASTM specification D 4814 in the United States or CAN/CGSB-3.5 or 3.511 in Canada. Some gasolines contain an octane-enhancing additive called methylcyclopentadienyl manganese tricarbonyl (MMT). We recommend against the use of gasolines containing MMT. See *Additives on page 5-5* for additional information.

### California Fuel

If the vehicle is certified to meet California Emissions Standards, it is designed to operate on fuels that meet California specifications. See the underhood emission control label. If this fuel is not available in states adopting California emissions standards, the vehicle will operate satisfactorily on fuels meeting federal specifications, but emission control system performance might be affected. The malfunction indicator lamp could turn on and the vehicle

might fail a smog-check test. See *Malfunction Indicator Lamp on page 3-30*. If this occurs, return to your authorized dealer/retailer for diagnosis. If it is determined that the condition is caused by the type of fuel used, repairs might not be covered by the vehicle warranty.

### Additives

To provide cleaner air, all gasolines in the United States are now required to contain additives that help prevent engine and fuel system deposits from forming, allowing the emission control system to work properly. In most cases, you should not have to add anything to the fuel. However, some gasolines contain only the minimum amount of additive required to meet U.S. Environmental Protection Agency regulations. To help keep fuel injectors and intake valves clean, or if the vehicle experiences problems due to dirty injectors or valves, look for gasoline that is advertised as TOP TIER Detergent Gasoline.

## 5-6 Service and Appearance Care

---

For customers who do not use TOP TIER Detergent Gasoline regularly, one bottle of GM Fuel System Treatment PLUS, added to the fuel tank at every engine oil change, can help clean deposits from fuel injectors and intake valves. GM Fuel System Treatment PLUS is the only gasoline additive recommended by General Motors.

Also, your dealer/retailer has additives that will help correct and prevent most deposit-related problems.

Gasolines containing oxygenates, such as ethers and ethanol, and reformulated gasolines might be available in your area. We recommend that you use these gasolines, if they comply with the specifications described earlier. However, E85 (85% ethanol) and other fuels containing more than 10% ethanol must not be used in vehicles that were not designed for those fuels.

**Notice:** This vehicle was not designed for fuel that contains methanol. Do not use fuel containing methanol. It can corrode metal parts in the fuel system and also damage plastic and rubber parts. That damage would not be covered under the vehicle warranty.

Some gasolines that are not reformulated for low emissions can contain an octane-enhancing additive called methylcyclopentadienyl manganese tricarbonyl (MMT); ask the attendant where you buy gasoline whether the fuel contains MMT. We recommend against the use of such gasolines. Fuels containing MMT can reduce the life of spark plugs and the performance of the emission control system could be affected. The malfunction indicator lamp might turn on. If this occurs, return to your dealer/retailer for service.

## Fuels in Foreign Countries

If you plan on driving in another country outside the United States or Canada, the proper fuel might be hard to find. Never use leaded gasoline or any other fuel not recommended in the previous text on fuel. Costly repairs caused by use of improper fuel would not be covered by the vehicle warranty.

To check the fuel availability, ask an auto club, or contact a major oil company that does business in the country where you will be driving.

## Filling the Tank

### ⚠ CAUTION

Fuel vapor burns violently and a fuel fire can cause bad injuries. To help avoid injuries to you and others, read and follow all the instructions on the pump island. Turn off the engine when you are refueling. Do not smoke if you are near fuel or refueling the vehicle. Do not use cellular phones. Keep sparks, flames, and smoking materials away from fuel. Do not leave the fuel pump unattended when refueling the vehicle. This is against the law in some places. Do not re-enter the vehicle while pumping fuel. Keep children away from the fuel pump; never let children pump fuel.



Unlock the gas cap door by pressing the door lock switch located on the driver door trim.

The tethered fuel cap is located behind a hinged fuel door on the driver side of the vehicle.

To remove the fuel cap, turn it slowly counterclockwise. The fuel cap has a spring in it; if the cap is released too soon, it will spring back to the right. To avoid fuel contact on the painted surface of the vehicle when filling the fuel tank, place the tethered cap on the fuel filler door.

### ⚠ CAUTION

Fuel can spray out on you if you open the fuel cap too quickly. If you spill fuel and then something ignites it, you could be badly burned. This spray can happen if the tank is nearly full, and is more likely in hot weather. Open the fuel cap slowly and wait for any hiss noise to stop. Then unscrew the cap all the way.

Be careful not to spill fuel. Do not top off or overfill the tank and wait a few seconds after you have finished pumping before removing the nozzle. Clean fuel from painted surfaces as soon as possible. See *Washing Your Vehicle on page 5-69*.

When replacing the fuel cap, turn it clockwise until it clicks. Make sure the cap is fully installed. The diagnostic system can determine if the fuel cap has been left off or improperly installed.

## 5-8 Service and Appearance Care

This would allow fuel to evaporate into the atmosphere. See *Malfunction Indicator Lamp on page 3-30*.

### CAUTION

If a fire starts while you are refueling, do not remove the nozzle. Shut off the flow of fuel by shutting off the pump or by notifying the station attendant. Leave the area immediately.

**Notice:** If you need a new fuel cap, be sure to get the right type. Your dealer/retailer can get one for you. If you get the wrong type, it might not fit properly. This can cause the malfunction indicator lamp to light and can damage the fuel tank and emissions system. See *Malfunction Indicator Lamp on page 3-30*.

## Filling a Portable Fuel Container

### CAUTION

Never fill a portable fuel container while it is in the vehicle. Static electricity discharge from the container can ignite the fuel vapor. You can be badly burned and the vehicle damaged if this occurs. To help avoid injury to you and others:

- Dispense fuel only into approved containers.
- Do not fill a container while it is inside a vehicle, in a vehicle's trunk, pickup bed, or on any surface other than the ground.

(Continued)

### CAUTION (Continued)

- Bring the fill nozzle in contact with the inside of the fill opening before operating the nozzle. Contact should be maintained until the filling is complete.
- Do not smoke while pumping fuel.
- Do not use a cellular phone while pumping fuel.

## Checking Things Under the Hood

### CAUTION

An electric fan under the hood can start up and injure you even when the engine is not running. Keep hands, clothing, and tools away from any underhood electric fan.

### CAUTION

Things that burn can get on hot engine parts and start a fire. These include liquids like fuel, oil, coolant, brake fluid, windshield washer and other fluids, and plastic or rubber. You or others could be burned. Be careful not to drop or spill things that will burn onto a hot engine.

## Hood Release

To open the hood, do the following:



1. Pull the handle with this symbol on it. It is located under the instrument panel on the driver side of the vehicle.

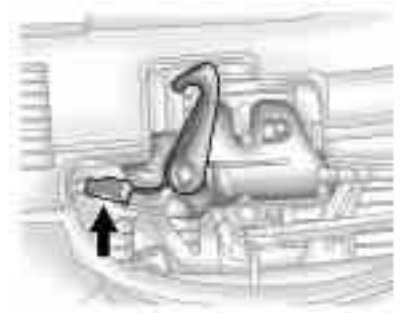

2. Then go to the front of the vehicle and lift up on the secondary hood release lever.
3. Lift the hood.

Before closing the hood, be sure all the filler caps are on properly. Then pull the hood down and close it firmly.

## 5-10 Service and Appearance Care

---

### Engine Compartment Overview

When you open the hood, you will see the following:

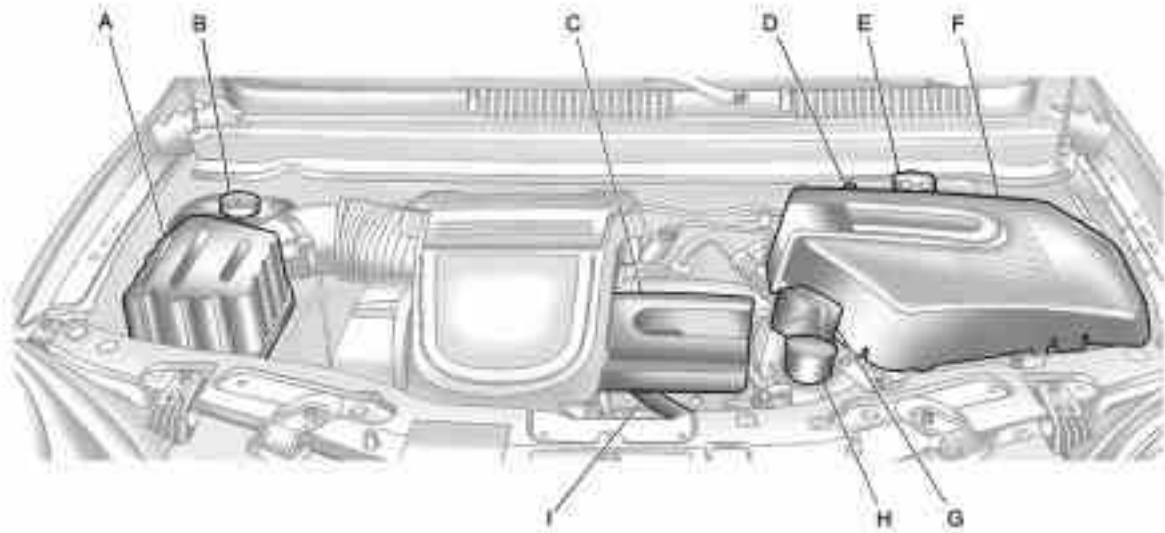

- A. See *Engine Air Cleaner/Filter* on page 5-15.
- B. Remote Negative (–) Terminal. See *Jump Starting* on page 5-28.
- C. Engine Oil Fill Cap. See *Engine Oil* on page 5-11.
- D. Engine Coolant Surge Tank. See *Cooling System* on page 5-17.
- E. Engine Coolant Surge Tank Protection Cap. See *Coolant Surge Tank Pressure Cap* on page 5-22.
- F. See *Underhood Fuse Block* on page 5-77.
- G. Remote Positive (+) Terminal. See *Jump Starting* on page 5-28.

- H. Windshield Washer Fluid Reservoir. See *Windshield Washer Fluid* on page 5-24.
- I. Engine Oil Dipstick (out of view). See *Engine Oil* on page 5-11.

## Engine Oil

### Checking Engine Oil

It is a good idea to check the engine oil level at each fuel fill. In order to get an accurate reading, the oil must be warm and the vehicle must be on level ground.

The engine oil dipstick handle is a yellow loop. See *Engine Compartment Overview* on page 5-10 for the location of the engine oil dipstick.

1. Turn off the engine and give the oil several minutes to drain back into the oil pan. If this is not done, the oil dipstick might not show the actual level.
2. Pull the dipstick and clean it with a paper towel or cloth, then push it back in all the way. Remove it again, keeping the tip down and check the level.

## 5-12 Service and Appearance Care

### When to Add Engine Oil



If the oil is below the MIN (minimum) mark, add at least one quart/liter of the recommended oil. This section explains what kind of oil to use. For engine oil crankcase capacity, see *Capacities and Specifications on page 5-81*.

**Notice:** Do not add too much oil. If the engine has so much oil that the oil level gets above the upper mark that shows the proper operating range, the engine could be damaged.

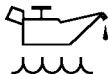

See *Engine Compartment Overview on page 5-10* for the location of the engine oil fill cap.

Add enough oil to put the level somewhere in the proper operating range. Push the dipstick all the way back in when through.

### What Kind of Engine Oil to Use

Look for three things:

#### RECOMMENDED SAE VISCOSITY GRADE

HOT WEATHER



SAE 5W-30

COLD WEATHER

DO NOT USE SAE 10W-40, SAE 20W-50  
OR ANY OTHER VISCOSITY GRADE  
OIL NOT RECOMMENDED



- GM6094M  
Use only an oil that meets GM Standard GM6094M.
- SAE 5W-30  
SAE 5W-30 is best for the vehicle. These numbers on an oil container show its viscosity, or thickness. Do not use other viscosity oils such as SAE 20W-50.
- American Petroleum Institute (API) starburst symbol



Oils meeting these requirements should have the starburst symbol on the container. This symbol indicates that the oil has been certified by the American Petroleum Institute (API).

**Notice:** Use only engine oil identified as meeting GM Standard GM6094M and showing the American Petroleum Institute Certified For Gasoline Engines starburst symbol. Failure to use the recommended oil can result in engine damage not covered by the vehicle warranty.

### Cold Temperature Operation

If in an area of extreme cold, where the temperature falls below  $-20^{\circ}\text{F}$  ( $-29^{\circ}\text{C}$ ), use either an SAE 5W-30 synthetic oil or an SAE 0W-30 engine oil. Both provide easier cold starting for the engine at extremely low temperatures. Always use an oil that meets the required specification, GM6094M. See “What Kind of Engine Oil to Use” for more information.

### Engine Oil Additives / Engine Oil Flushes

Do not add anything to the oil. The recommended oils with the starburst symbol that meet GM Standard GM6094M are all that is needed for good performance and engine protection.

Engine oil system flushes are not recommended and could cause engine damage not covered by the vehicle warranty.

### Engine Oil Life System

#### When to Change Engine Oil

This vehicle has a computer system that indicates when to change the engine oil and filter. This is based on engine revolutions and engine temperature, and not on mileage. Based on driving conditions, the mileage at which an oil change is indicated can vary considerably. For the oil life system to work properly, the system must be reset every time the oil is changed.

When the system has calculated that oil life has been diminished, it indicates that an oil change is necessary. A change engine oil light comes on. See *Change Engine Oil Light* on page 3-33. Change the oil as soon as possible within the next

600 miles (1 000 km). It is possible that, if driving under the best conditions, the oil life system might not indicate that an oil change is necessary for over a year. However, the engine oil and filter must be changed at least once a year and at this time the system must be reset. Your dealer/retailer has trained service people who will perform this work using genuine parts and reset the system. It is also important to check the oil regularly and keep it at the proper level.

If the system is ever reset accidentally, the oil must be changed at 3,000 miles (5 000 km) since the last oil change. Remember to reset the oil life system whenever the oil is changed.

#### How to Reset the Engine Oil Life System

The Engine Oil Life System calculates when to change the engine oil and filter based on vehicle use. Whenever the oil is changed, reset the system so it can calculate when the next oil change is required. If a situation occurs where the oil is changed prior to a change engine oil light being turned on, reset the system.

After changing the engine oil, reset the system:

1. Turn the ignition key to ON/RUN with the engine off.
2. Fully press and release the accelerator pedal three times within five seconds.

If the change engine oil light is not on, the system is reset.

If the light comes on again and stays on for 30 seconds at the next ignition cycle, it did not reset. The system needs to be reset again.

### **What to Do with Used Oil**

Used engine oil contains certain elements that can be unhealthy for your skin and could even cause cancer. Do not let used oil stay on your skin for very long. Clean your skin and nails with soap and water, or a good hand cleaner. Wash or properly dispose of clothing or rags containing used engine oil. See the manufacturer's warnings about the use and disposal of oil products.

Used oil can be a threat to the environment. If you change your own oil, be sure to drain all the oil from the filter before disposal. Never dispose of oil by putting it in the trash, pouring it on the ground, into sewers, or into streams or bodies of water. Recycle it by taking it to a place that collects used oil.

### **Engine Air Cleaner/Filter**

See *Engine Compartment Overview on page 5-10* for the location of the engine air cleaner/filter.

### **When to Inspect the Engine Air Cleaner/Filter**

Inspect the air cleaner/filter at the Maintenance II intervals and replace it at the first oil change after each 50,000 mile (80 000 km) interval. See *Scheduled Maintenance on page 6-3* for more information. If you are driving in dusty/dirty conditions, inspect the filter at each engine oil change.

## 5-16 Service and Appearance Care

### How to Inspect the Engine Air Cleaner/Filter

To inspect the air cleaner/filter remove the filter from the vehicle and lightly shake the filter to release loose dust and dirt. If the filter remains caked with dirt, a new filter is required.

To inspect or replace the engine air cleaner/filter, do the following:



1. Remove the clamp on the air duct hose.
2. Disconnect the hose.

3. Remove the four bolts on the side of the air cleaner assembly.
4. Turn the cover upward to disengage the cover hinges.
5. Remove the air cleaner cover assembly and air filter element.
6. Inspect or replace the air filter element.

If the air filter element is dirty, you should replace it. If it is only dusty, it may be cleaned by blowing compressed air through it from the clean side.

Make sure you are away from the engine compartment when cleaning the air filter with compressed air.

Wipe all dust from inside of the housing and inspect the air cleaner and air outlet duct for cracks, cuts and deterioration. The air outlet duct must be replaced if damaged.

7. Reverse Steps 1 through 5 to reinstall the engine air cleaner/filter cover and air duct hose.

### CAUTION

Operating the engine with the air cleaner/filter off can cause you or others to be burned. The air cleaner not only cleans the air; it helps to stop flames if the engine backfires. If it is not there and the engine backfires, you could be burned. Do not drive with it off, and be careful working on the engine with the air cleaner/filter off.

**Notice:** If the air cleaner/filter is off, a backfire can cause a damaging engine fire. And, dirt can easily get into the engine, which will damage it. Always have the air cleaner/filter in place when you are driving.

## Automatic Transmission Fluid

It is not necessary to check the transmission fluid level. A transaxle fluid leak is the only reason for fluid loss. If a leak occurs, take the vehicle to your dealer/retailer service department and have it repaired as soon as possible.

Change the fluid and filter at the intervals listed in *Additional Required Services on page 6-5*, and be sure to use the transaxle fluid listed in *Recommended Fluids and Lubricants on page 6-11*.

**Notice:** Use of the incorrect automatic transaxle fluid may damage your vehicle, and the damages may not be covered by your warranty. Always use the automatic transaxle fluid listed in *Recommended Fluids and Lubricants on page 6-11*.

## Cooling System

When you decide it is safe to lift the hood, here is what you will see:

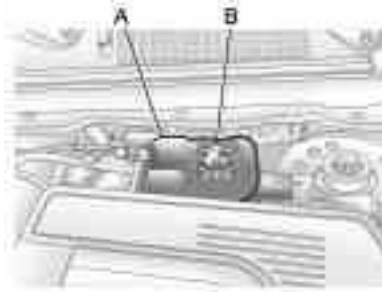

- A. Coolant Surge Tank
- B. Pressure Cap

### CAUTION

An electric engine cooling fan under the hood can start up even when the engine is not running and can cause injury. Keep hands, clothing, and tools away from any underhood electric fan.

If the coolant inside the coolant surge tank is boiling, do not do anything else until it cools down. The vehicle should be parked on a level surface.

The coolant level should be between the MIN and MAX lines. If it is not, you may have a leak at the radiator hoses, heater hoses, radiator, water pump, or somewhere else in the cooling system.

### CAUTION

Heater and radiator hoses, and other engine parts, can be very hot. Do not touch them. If you do, you can be burned.

Do not run the engine if there is a leak. If you run the engine, it could lose all coolant. That could cause an engine fire, and you could be burned. Get any leak fixed before you drive the vehicle.

If there seems to be no leak, with the engine on, check to see if the electric engine cooling fan is running. If the engine is overheating, the fan should be running. If it is not, your vehicle needs service. Turn off the engine.

**Notice:** Engine damage from running the engine without coolant is not covered by the warranty.

**Notice:** Using coolant other than DEX-COOL<sup>®</sup> can cause premature engine, heater core, or radiator corrosion. In addition, the engine coolant could require changing sooner, at 30,000 miles (50 000 km) or 24 months, whichever occurs first. Any repairs would not be covered by the vehicle warranty. Always use DEX-COOL<sup>®</sup> (silicate-free) coolant in the vehicle.

### How to Add Coolant to the Coolant Surge Tank

**Notice:** This vehicle has a specific coolant fill procedure. Failure to follow this procedure could cause the engine to overheat and be severely damaged.

If you have not found a problem yet, check to see if coolant is visible in the surge tank. If coolant is visible but the coolant level is not at between the MIN and MAX lines, add a 50/50 mixture of clean,

drinkable water and DEX-COOL<sup>®</sup> coolant at the coolant surge tank, but be sure the cooling system, including the coolant surge tank pressure cap, is cool before you do it. See *Engine Coolant* on page 5-20 for more information.

### CAUTION

Steam and scalding liquids from a hot cooling system can blow out and burn you badly. They are under pressure, and if you turn the coolant surge tank pressure cap — even a little — they can come out at high speed. Never turn the cap when the cooling system, including the coolant surge tank pressure cap, is hot. Wait for the cooling system and coolant surge tank pressure cap to cool if you ever have to turn the pressure cap.

**⚠ CAUTION**

Adding only plain water to the cooling system can be dangerous. Plain water, or some other liquid such as alcohol, can boil before the proper coolant mixture will. The vehicle's coolant warning system is set for the proper coolant mixture. With plain water or the wrong mixture, the engine could get too hot but you would not get the overheat warning. The engine could catch fire and you or others could be burned. Use a 50/50 mixture of clean, drinkable water and DEX-COOL<sup>®</sup> coolant.

**Notice:** In cold weather, water can freeze and crack the engine, radiator, heater core and other parts. Use the recommended coolant and the proper coolant mixture.

**⚠ CAUTION**

You can be burned if you spill coolant on hot engine parts. Coolant contains ethylene glycol and it will burn if the engine parts are hot enough. Do not spill coolant on a hot engine.



1. You can remove the coolant surge tank pressure cap when the cooling system, including the coolant surge tank pressure cap and upper radiator hose, is no longer hot. Turn the pressure cap slowly counterclockwise about one-quarter of a turn. If you hear a hiss, wait for that to stop. This will allow any pressure still left to be vented out the discharge hose.
2. Then keep turning the pressure cap slowly, and remove it.



3. Fill the coolant surge tank with the proper DEX-COOL<sup>®</sup> coolant mixture, to between the MIN and MAX lines.
4. With the coolant surge tank pressure cap off, start the engine and let it run until you can feel the upper radiator hose getting hot. Watch out for the engine cooling fan.

By this time, the coolant level inside the coolant surge tank may be lower. If the level is lower, add more of the proper DEX-COOL<sup>®</sup> coolant mixture to the coolant surge tank until the level reaches between the MIN and MAX lines.

5. Then replace the pressure cap. Be sure the pressure cap is hand-tight.

Check the level in the surge tank when the cooling system has cooled down. If the coolant is not at the proper level, repeat Steps 1 through 3 and reinstall the pressure cap. If the coolant still is not at the proper level when the system cools down again, see your dealer/retailer.

### Engine Coolant

The cooling system in your vehicle is filled with DEX-COOL<sup>®</sup> engine coolant. This coolant is designed to remain in your vehicle for five years or 150,000 miles (240 000 km), whichever occurs first, if you add only DEX-COOL<sup>®</sup> extended life coolant.

The following explains your cooling system and how to add coolant when it is low. If you have a problem with engine overheating, see *Engine Overheating on page 5-23*.

A 50/50 mixture of clean, drinkable water and DEX-COOL<sup>®</sup> coolant will:

- Give freezing protection down to -34°F (-37°C).
- Give boiling protection up to 265°F (129°C).



- Protect against rust and corrosion.
- Help keep the proper engine temperature.
- Let the warning lights and gauges work as they should.

**Notice:** Using coolant other than DEX-COOL<sup>®</sup> can cause premature engine, heater core, or radiator corrosion. In addition, the engine coolant may require changing sooner, at the first maintenance service after each 30,000 miles (50 000 km) or 24 months, whichever occurs first. Any repairs would not be covered by the vehicle warranty. Always use DEX-COOL<sup>®</sup> (silicate-free) coolant in the vehicle.

### What to Use

Use a mixture of one-half clean, drinkable water and one-half DEX-COOL<sup>®</sup> coolant which will not damage aluminum parts. If you use this coolant mixture, you do not need to add anything else.

#### CAUTION

Adding only plain water to the cooling system can be dangerous. Plain water, or some other liquid such as alcohol, can boil before the proper coolant mixture will. The vehicle's coolant warning system is set for the proper coolant mixture. With plain water or the wrong mixture, the engine could get too hot but you would not get the overheat warning. The engine could catch fire and you or others could be burned. Use a 50/50 mixture of clean, drinkable water and DEX-COOL<sup>®</sup> coolant.

**Notice:** If an improper coolant mixture is used, the engine could overheat and be badly damaged. The repair cost would not be covered by the vehicle warranty. Too much water in the mixture can freeze and crack the engine, radiator, heater core, and other parts.

If you have to add coolant more than four times a year, have your dealer/retailer check your cooling system.

**Notice:** If extra inhibitors and/or additives are used in the vehicle's cooling system, the vehicle could be damaged. Use only the proper mixture of the engine coolant listed in this manual for the cooling system. See *Recommended Fluids and Lubricants* on page 6-11 for more information.

## 5-22 Service and Appearance Care

### Checking Coolant

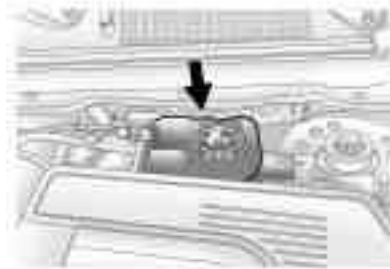

The surge tank is located on the driver side of the engine compartment. See *Engine Compartment Overview* on page 5-10 for more information on location.

#### CAUTION

Turning the surge tank pressure cap when the engine and radiator are hot can allow steam and scalding liquids to blow out and burn you badly. Never turn the surge tank pressure cap — even a little — when the engine and radiator are hot.

The vehicle must be on a level surface. When your engine is cold, the coolant level should be between the MIN and MAX lines.

#### Adding Coolant

If you need more coolant, add the proper DEX-COOL<sup>®</sup> coolant mixture at the surge tank, but only when the engine is cool. See *Cooling System* on page 5-17 for instructions on “How to Add Coolant to the Coolant Surge Tank”.

#### CAUTION

You can be burned if you spill coolant on hot engine parts. Coolant contains ethylene glycol, and it will burn if the engine parts are hot enough. Do not spill coolant on a hot engine.

When replacing the pressure cap, make sure it is hand-tight and fully seated.

### Coolant Surge Tank Pressure Cap

**Notice:** If the pressure cap is not tightly installed, coolant loss and possible engine damage may occur. Be sure the cap is properly and tightly secured.

If you need to replace your coolant surge tank pressure cap, see your retailer.

## Engine Overheating

There is a coolant temperature warning light on your vehicle's instrument panel. See *Engine Coolant Temperature Warning Light* on page 3-29.

### If Steam Is Coming From Your Engine

#### CAUTION

Steam from an overheated engine can burn you badly, even if you just open the hood. Stay away from the engine if you see or hear steam coming from it. Just turn it off and get everyone away from the vehicle until it cools down. Wait until there is no sign of steam or coolant before you open the hood.

(Continued)

#### CAUTION (Continued)

If you keep driving when your engine is overheated, the liquids in it can catch fire. You or others could be badly burned. Stop your engine if it overheats, and get out of the vehicle until the engine is cool.

**Notice:** If the engine catches fire because of being driven with no coolant, your vehicle can be badly damaged. The costly repairs would not be covered by the vehicle warranty.

### If No Steam Is Coming From Your Engine

If you get an engine overheat warning, but see or hear no steam, the problem may not be too serious. Sometimes the engine can get a little too hot when you:

- Climb a long hill on a hot day.
- Stop after high-speed driving.
- Idle for long periods in traffic.
- Tow a trailer.

If you get the overheat warning with no sign of steam, try this for a minute or so:

1. If you have an air conditioner and it is on, turn it off.
2. Turn on your heater to full hot at the highest fan speed and open the windows as necessary.
3. Try to minimize engine load. If you are in a traffic jam, shift to N (Neutral); otherwise, shift to the highest gear possible while driving.

## 5-24 Service and Appearance Care

---

If you no longer have the overheat warning, you can drive. Just to be safe, drive slower for about ten minutes. If the warning does not come back on, you can drive normally.

If the warning continues and you have not stopped, pull over, stop, and park your vehicle right away.

If there is still no sign of steam, idle the engine for three minutes while you are parked. If the warning continues, turn off the engine and get everyone out of the vehicle until it cools down.

You may decide not to lift the hood but to get service help right away.

### Windshield Washer Fluid

#### What to Use

When you need windshield or rear window washer fluid, be sure to read the manufacturer's instructions before use. If you will be operating your vehicle in an area where the temperature may fall below freezing, use a fluid that has sufficient protection against freezing.

#### Adding Windshield Washer Fluid



Open the cap with the washer symbol on it. Add washer fluid until the tank is full. See *Engine Compartment Overview* on page 5-10 for reservoir location.

#### Notice:

- When using concentrated washer fluid, follow the manufacturer's instructions for adding water.
- Do not mix water with ready-to-use washer fluid. Water can cause the solution to freeze and damage your washer fluid tank and other parts of the washer system. Also, water does not clean as well as washer fluid.
- Fill the washer fluid tank only three-quarters full when it is very cold. This allows for fluid expansion if freezing occurs, which could damage the tank if it is completely full.
- Do not use engine coolant (antifreeze) in your windshield washer. It can damage the vehicle's windshield washer system and paint.

## Brakes

### Brake Fluid



The brake master cylinder reservoir is filled with either DOT-3 or DOT-4 brake fluid as indicated on the reservoir cap. See *Engine Compartment Overview* on page 5-10 for the location of the reservoir.

There are only two reasons why the brake fluid level in the reservoir might go down:

- The brake fluid level goes down because of normal brake lining wear. When new linings are installed, the fluid level goes back up.

- A fluid leak in the brake hydraulic system can also cause a low fluid level. Have the brake hydraulic system fixed, since a leak means that sooner or later the brakes will not work well.

Do not top off the brake fluid. Adding fluid does not correct a leak. If fluid is added when the linings are worn, there will be too much fluid when new brake linings are installed. Add or remove brake fluid, as necessary, only when work is done on the brake hydraulic system.

#### CAUTION

If too much brake fluid is added, it can spill on the engine and burn, if the engine is hot enough. You or others could be burned, and the vehicle could be damaged. Add brake fluid only when work is done on the brake hydraulic system.

When the brake fluid falls to a low level, the brake warning light comes on. See *Brake System Warning Light* on page 3-27.

#### What to Add

If the vehicle has DOT-3 brake fluid, as indicated on the reservoir cap, use only new DOT-3 brake fluid from a sealed container. See *Recommended Fluids and Lubricants* on page 6-11.

If the vehicle has DOT-4 brake fluid, as indicated on the reservoir cap, use only new DOT-4 brake fluid from a sealed container. See *Recommended Fluids and Lubricants* on page 6-11. DOT-4 brake fluid requires the brake hydraulic system to be flushed and refilled with new DOT-4 brake fluid at a regular maintenance service every two years. See *Additional Required Services* on page 6-5.

## 5-26 Service and Appearance Care

Always clean the brake fluid reservoir cap and the area around the cap before removing it. This helps keep dirt from entering the reservoir.

### CAUTION

With the wrong kind of fluid in the brake hydraulic system, the brakes might not work well. This could cause a crash. Always use the proper brake fluid.

#### **Notice:**

- **Using the wrong fluid can badly damage brake hydraulic system parts. For example, just a few drops of mineral-based oil, such as engine oil, in the brake hydraulic system can damage brake hydraulic system parts so badly that they will have to be replaced. Do not let someone put in the wrong kind of fluid.**

- **If brake fluid is spilled on the vehicle's painted surfaces, the paint finish can be damaged. Be careful not to spill brake fluid on the vehicle. If you do, wash it off immediately. See *Washing Your Vehicle on page 5-69*.**

### **Brake Wear**

This vehicle has disc brakes. Disc brake pads have built-in wear indicators that make a high-pitched warning sound when the brake pads are worn and new pads are needed. The sound can come and go or be heard all the time the vehicle is moving, except when applying the brake pedal firmly.

### CAUTION

The brake wear warning sound means that soon the brakes will not work well. That could lead to an accident. When the brake wear warning sound is heard, have the vehicle serviced.

**Notice: Continuing to drive with worn-out brake pads could result in costly brake repair.**

Some driving conditions or climates can cause a brake squeal when the brakes are first applied or lightly applied. This does not mean something is wrong with the brakes.

Properly torqued wheel nuts are necessary to help prevent brake pulsation. When tires are rotated, inspect brake pads for wear and evenly tighten wheel nuts in the proper sequence to torque specifications in *Capacities and Specifications on page 5-81*.

Brake linings should always be replaced as complete axle sets.

### **Brake Pedal Travel**

See your dealer/retailer if the brake pedal does not return to normal height, or if there is a rapid increase in pedal travel. This could be a sign that brake service might be required.

## Brake Adjustment

Every time the brakes are applied, with or without the vehicle moving, the brakes adjust for wear.

## Replacing Brake System Parts

The braking system on a vehicle is complex. Its many parts have to be of top quality and work well together if the vehicle is to have really good braking. The vehicle was designed and tested with top-quality brake parts. When parts of the braking system are replaced — for example, when the brake linings wear down and new ones are installed — be sure to get new approved replacement parts. If this is not done, the brakes might not work properly. For example, if someone puts in brake linings that are wrong for the vehicle, the balance between the front and

rear brakes can change — for the worse. The braking performance expected can change in many other ways if the wrong replacement brake parts are installed.

## Battery



Batteries have acid that can burn you and gas that can explode. You can be badly hurt if you are not careful. See *Jump Starting on page 5-28* for tips on working around a battery without getting hurt.

**Warning:** Battery posts, terminals, and related accessories contain lead and lead compounds, chemicals known to the State of California to cause cancer and reproductive harm. Wash hands after handling.

This vehicle has a standard 12-volt battery and a 36-volt hybrid battery system.

## 12-Volt Battery

When a new standard 12-volt battery is needed, see your dealer/retailer for one that has the replacement number shown on the original battery's label.

## 36-Volt Battery System

If a new 36-volt hybrid battery system is needed, see your dealer/retailer.

## Vehicle Storage

**Infrequent Usage:** If the vehicle is driven infrequently, remove the 12-volt battery black, negative (–) cable from the battery, the one that is exposed. This helps keep the battery from running down.

## 5-28 Service and Appearance Care

Extended Storage: For extended storage of the vehicle, remove the 12-volt battery black, negative (-) cable from the battery or use a battery trickle charger. This helps maintain the charge of the battery over an extended period of time.

Remember to reconnect the battery when ready to drive the vehicle.

**Notice:** The 36-volt hybrid battery system should be serviced only by a qualified facility to avoid battery system damage. See your dealer/retailer if service is needed.

**Notice:** If the vehicle is not driven for over two months, the 36-volt hybrid battery can be permanently damaged.

The 36-volt battery is located behind the rear seat, under the cargo floor. If the vehicle is stored for an extended period of time, drive the vehicle every two months for about half an hour to keep the 36-volt hybrid battery charged and in good working condition.

### Jump Starting

The hybrid vehicle has a standard 12-volt battery in the engine compartment, and a 36-volt battery under the rear load floor.

#### CAUTION

Personal injury or damage to the vehicle can result if you try jump starting or using a battery charger on the 36-volt battery. Use only the 12-volt battery for jump starting and charging.

If your vehicle's standard 12-volt battery has run down, you may want to use another vehicle and some jumper cables to start your vehicle. Be sure to use the following steps to do it safely.

#### CAUTION

Batteries can hurt you. They can be dangerous because:

- They contain acid that can burn you.
- They contain gas that can explode or ignite.
- They contain enough electricity to burn you.

If you do not follow these steps exactly, some or all of these things can hurt you.



**Notice:** Ignoring these steps could result in costly damage to the vehicle that would not be covered by the warranty.

**Trying to start the vehicle by pushing or pulling it will not work, and it could damage the vehicle.**

1. Check the other vehicle. It must have a 12-volt battery with a negative ground system.

**Notice:** If the other vehicle's system is not a 12-volt system with a negative ground, both vehicles can be damaged. Only use vehicles with 12-volt systems with negative grounds to jump start your vehicle.

2. Get the vehicles close enough so the jumper cables can reach, but be sure the vehicles are not touching each other. If they are, it could cause a ground connection you do not want. You would not be able to start your vehicle, and the bad grounding could damage the electrical systems.

To avoid the possibility of the vehicles rolling, set the parking brake firmly on both vehicles involved in the jump start procedure. Put an automatic transmission in P (Park) or a manual transmission in N (Neutral) before setting the parking brake.

**Notice:** If you leave the radio or other accessories on during the jump starting procedure, they could be damaged. The repairs would not be covered by the warranty. Always turn off the radio and other accessories when jump starting the vehicle.

3. Turn off the ignition on both vehicles. Unplug unnecessary accessories plugged into the cigarette lighter or the accessory power outlet. Turn off the radio and all lamps that are not needed. This will avoid sparks and help save both batteries. And it could save the radio!

4. Open each vehicle's hood and locate the positive (+) and negative (-) terminal locations of the other vehicle. Your vehicle has a remote positive (+) 12-volt jump starting terminal (B) and a remote negative (-) jump starting terminal (A). You should always use these remote terminals instead of the terminals on the battery. The remote positive (+) terminal is located inside the junction box located above the engine cover. To access the remote positive (+) terminal, unlatch the box cover.

## 5-30 Service and Appearance Care

---

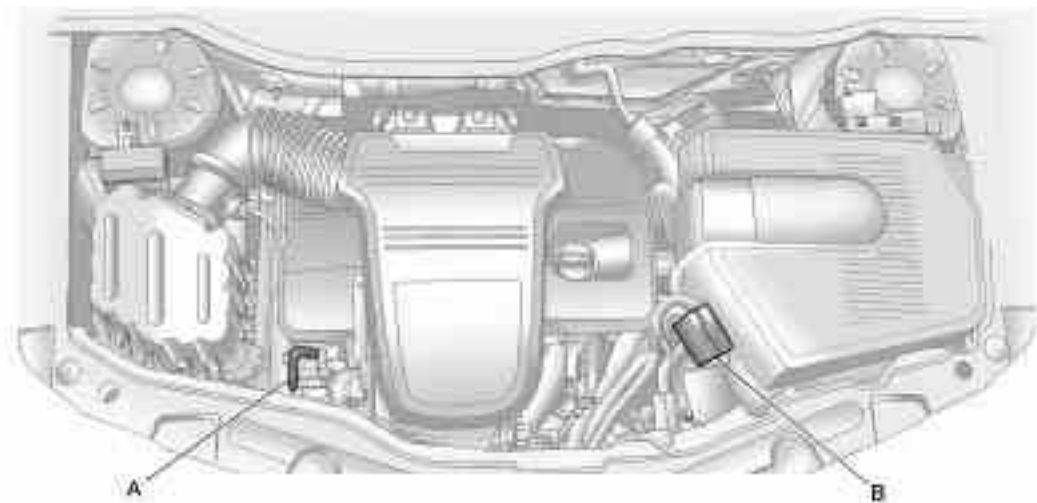

A. Remote Negative (-)

B. Remote Positive (+)

- The remote negative (-) terminal is a stud on the driver side near the underhood fuse block.

 **CAUTION**

Using a match near a battery can cause battery gas to explode. People have been hurt doing this, and some have been blinded. Use a flashlight if you need more light.

Be sure the battery has enough water. You do not need to add water to the battery installed in your new vehicle. But if a battery has filler caps, be sure the right amount of fluid is there. If it is low, add water to take care of that first. If you do not, explosive gas could be present.

(Continued)

**CAUTION (Continued)**

Battery fluid contains acid that can burn you. Do not get it on you. If you accidentally get it in your eyes or on your skin, flush the place with water and get medical help immediately.

 **CAUTION**

An electric fan can start up even when the engine is not running and can injure you. Keep hands, clothing and tools away from any underhood electric fan.

 **CAUTION**

Fans or other moving engine parts can injure you badly. Keep your hands away from moving parts once the engine is running.

- Check that the jumper cables do not have loose or missing insulation. If they do, you could get a shock. The vehicles could be damaged too. Before you connect the cables to the other vehicle, here are some basic things you should know. Positive (+) will go to positive (+) or to a remote positive terminal (+) if the vehicle has one. Negative (-) will go to a heavy, unpainted metal engine part or to a remote negative (-) terminal, if the vehicle has one. Do not connect positive (+) to negative (-) or you will get a short that would damage the battery and maybe other parts too.
- Connect the red positive (+) cable to the remote positive (+) terminal of your hybrid vehicle.
- Do not let the other end touch metal. Connect it to the positive (+) terminal of the good battery. Use a remote positive (+) terminal if the other vehicle has one.

## 5-32 Service and Appearance Care

9. Now connect the black negative (-) cable to the negative (-) terminal of the good battery. Use a remote negative (-) terminal if the vehicle has one. Do not let the other end touch anything until the next step. The other end of the negative (-) cable does not go to the dead battery. It goes to your vehicle's remote negative (-) terminal. The electrical connection is just as good there, and the chance of sparks getting back to the battery is much less.

10. Try to start the hybrid vehicle.

**Notice:** If the jumper cables are connected or removed in the wrong order, electrical shorting may occur and damage the vehicle. The repairs would not be covered by the vehicle warranty. Always connect and remove the jumper cables in the correct order, making sure that the cables do not touch each other or other metal.

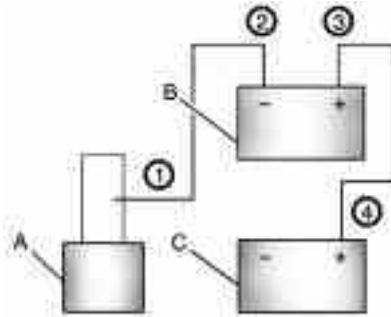

### Jumper Cable Removal

- A. Heavy, Unpainted Metal Engine Part or Remote Negative (-) Terminal
- B. Good Battery or Remote Positive (+) and Remote Negative (-) Terminals
- C. Dead Battery or Remote Positive (+) Terminal

To disconnect the jumper cables from both vehicles, do the following:

1. Disconnect the black negative (-) cable from the vehicle that had the dead battery.
2. Disconnect the black negative (-) cable from the vehicle with the good battery.
3. Disconnect the red positive (+) cable from the vehicle with the good battery.
4. Disconnect the red positive (+) cable from the other vehicle.
5. Close the remote positive junction box cover.

## Headlamp Aiming

The headlamp aiming system has been preset at the factory.

If the vehicle is damaged in an accident, the aim of the headlamps may be affected and adjustment may be necessary.

It is recommended that a dealer/retailer adjust the headlamps. To re-aim the headlamps yourself, use the following procedure.

The vehicle should be properly prepared as follows:

- The vehicle should be placed so the headlamps are 25 ft. (7.6 m) from a light colored wall.
- The vehicle must have all four tires on a level surface which is level all the way to the wall.

- The vehicle should be placed so it is perpendicular to the wall or other flat surface.
- The vehicle should not have any snow, ice, or mud on it.
- The vehicle should be fully assembled and all other work stopped while headlamp aiming is being performed.
- The vehicle should be normally loaded with a full tank of fuel and one person or 160 lbs (75 kg) sitting on the driver's seat.
- Tires should be properly inflated.

Headlamp aiming is done with the vehicle's low-beam headlamps. The high-beam headlamps will be correctly aimed if the low-beam headlamps are aimed properly.

To adjust the vertical aim, do the following:

1. Open the hood. See *Hood Release* on page 5-9 for more information.

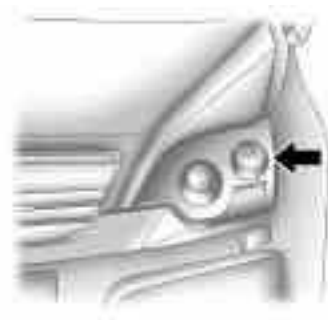

2. Locate the aim dot on the lens of the low-beam headlamp.
3. Measure the distance from the ground to the aim dot on the low-beam headlamp. Record the distance.

## 5-34 Service and Appearance Care



4. At the wall measure from the ground upward (A) to the recorded distance from Step 3 and mark it.
5. Draw or tape a horizontal line (B) on the wall the width of the vehicle at the height of the mark in Step 4.

**Notice:** Do not cover a headlamp to improve beam cut-off when aiming. Covering a headlamp may cause excessive heat build-up which may cause damage to the headlamp.

6. Turn on the low-beam headlamps and place a piece of cardboard or equivalent in front of the headlamp not being adjusted. This allows only the beam of light from the headlamp being adjusted to be seen on the flat surface.



7. Locate the vertical headlamp aiming screws, which are under the hood near each headlamp assembly. The adjustment screw can be turned with a E8 Torx<sup>®</sup> socket.

8. Turn the vertical aiming screw until the headlamp beam is aimed to the horizontal tape line. Turn it clockwise or counterclockwise to raise or lower the angle of the beam.



9. Make sure that the light from the headlamp is positioned at the bottom edge of the horizontal tape line. The lamp on the left (A) shows the correct headlamp aim. The lamp on the right (B) shows the incorrect headlamp aim.
10. Repeat Steps 7 through 9 for the opposite headlamp.

## Bulb Replacement

For the proper type of replacement bulbs, see *Replacement Bulbs* on page 5-37.

For any bulb changing procedure not listed in this section, contact your dealer/retailer.

## Halogen Bulbs

### CAUTION

Halogen bulbs have pressurized gas inside and can burst if you drop or scratch the bulb. You or others could be injured. Be sure to read and follow the instructions on the bulb package.

## Headlamps

To replace one of the headlamp bulbs, use the following procedure. To replace the parking/turn signal lamp bulb, see *Front Turn Signal and Parking Lamps* on page 5-36.

1. Open the hood. See *Hood Release* on page 5-9 for more information.
2. Remove the two screws from the top of the front fascia and grille. They are inboard of the headlamp assembly.
3. Remove the three screws retaining the headlamp assembly.
4. Insert a flat blade tool through the opening in the top. Make sure the tool fits through the opening in the headlamp bracket lower arm.
5. Push the locking tab toward the rear of the vehicle with the tool to lift the headlamp bracket lower arm.

6. Pull back on the front fascia and then pull the headlamp assembly out from the vehicle. Another person might be needed to assist with this step.

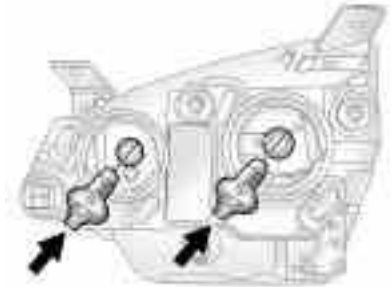

7. Disconnect the electrical connector from the bulb assembly.
8. Turn the bulb assembly counterclockwise to remove it from the housing.
9. Replace the old bulb with a new one.
10. Reverse Steps 1 through 8 to reinstall.

## 5-36 Service and Appearance Care

### Front Turn Signal and Parking Lamps

To replace a front turn signal or parking lamp bulb:

1. Follow Steps 1 through 6 under *Headlamps* on page 5-35 to access the front turn signal or parking lamp.

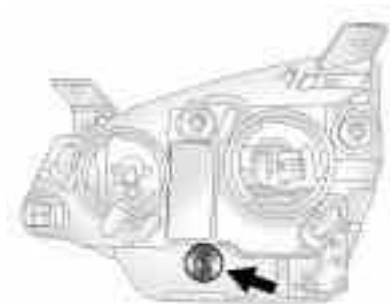

2. Turn the bulb to be replaced counterclockwise to remove it from the headlamp assembly.

3. Pull the bulb out of the bulb socket assembly.
4. Push the new bulb into the bulb socket assembly.
5. Insert the bulb assembly into the headlamp assembly.
6. Turn the bulb assembly clockwise until seated.
7. Reverse the steps to reinstall the headlamp assembly.

### Taillamps, Turn Signal, Stoplamps and Back-up Lamps

To replace one of these bulbs:

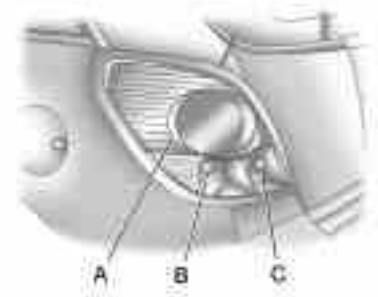

- A. Taillamp/Stoplamp
- B. Turn Signal Lamp
- C. Back-up Lamp



1. Open the liftgate.

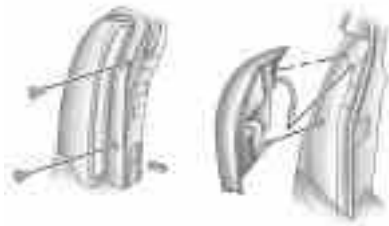

2. Remove the two screws holding in the taillamp assembly.
3. Slide the taillamp assembly rearward and away from the vehicle.
4. Turn the bulb socket being replaced counterclockwise to disconnect it.
5. Pull the bulb out of the bulb socket.
6. Push the new bulb into the bulb socket.
7. Reverse Steps 2 through 4 to reinstall the taillamp assembly.

## License Plate Lamp

To replace one of these bulbs:

1. Remove the two screws holding each of the license plate lamps to the fascia.

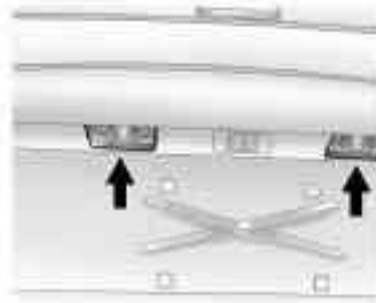

2. Turn and pull the license plate lamp forward through the fascia opening.
3. Turn the bulb socket counterclockwise and pull the bulb straight out of the socket.

4. Push the new bulb into the bulb socket and turn it clockwise to lock it into place.
5. Push and turn the license plate back through the fascia opening.
6. Reinstall the two screws holding the license plate lamps to the fascia.

## Replacement Bulbs

Exterior Lamp	Bulb Number
Back-up Lamp	3156
Front Turn Signal/Parking	3157K
Headlamps	
High-beam	9005 or HB3
Low-beam/DRL	9006 or HB4
Rear Turn Signal, Stoplamp and Taillamp	3057

For replacement bulbs not listed here, contact your dealer/retailer.

## Windshield Wiper Blade Replacement

Windshield wiper blades should be inspected for wear and cracking. See *Scheduled Maintenance on page 6-3* for more information.

Replacement blades come in different types and are removed in different ways. For proper type and length, see *Maintenance Replacement Parts on page 6-12*.

To replace the windshield wiper blade:



1. Lift the wiper arm away from the windshield.

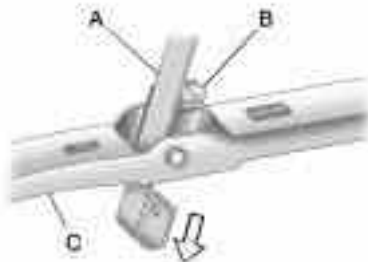

2. Push the release lever (B) to disengage the hook and push the wiper arm (A) out of the blade (C).
3. Push the new wiper blade securely on the wiper arm until you hear the release lever click into place.

To replace the rear wiper blade, lift the rear wiper arm from the window and pull the blade.

## Tires

Your new vehicle comes with high-quality tires made by a leading tire manufacturer. If you ever have questions about your tire warranty and where to obtain service, see your vehicle Warranty booklet for details. For additional information refer to the tire manufacturer.

### CAUTION

Poorly maintained and improperly used tires are dangerous.

- Overloading your vehicle's tires can cause overheating as a result of too much flexing. You could have an air-out and a serious accident. See *Loading the Vehicle on page 4-18*.

(Continued)

**CAUTION (Continued)**

- Underinflated tires pose the same danger as overloaded tires. The resulting accident could cause serious injury. Check all tires frequently to maintain the recommended pressure. Tire pressure should be checked when your vehicle's tires are cold. See *Inflation - Tire Pressure on page 5-43*.
- Overinflated tires are more likely to be cut, punctured, or broken by a sudden impact — such as when you hit a pothole. Keep tires at the recommended pressure.
- Worn, old tires can cause accidents. If the tire's tread is badly worn, or if your vehicle's tires have been damaged, replace them.

**Tire Sidewall Labeling**

Useful information about a tire is molded into its sidewall. The example below shows a typical passenger (p-metric) tire sidewall.

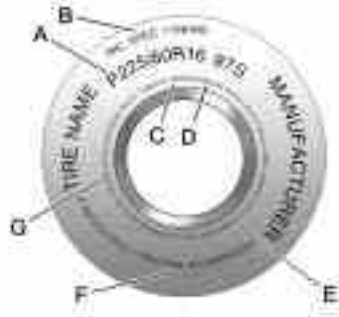

**Passenger (P-Metric) Tire Example**

**(A) Tire Size:** The tire size is a combination of letters and numbers used to define a particular tire's width, height, aspect ratio, construction type, and service description.

See the "Tire Size" illustration later in this section for more detail.

**(B) TPC Spec (Tire Performance Criteria Specification):**

Original equipment tires designed to GM's specific tire performance criteria have a TPC specification code molded onto the sidewall. GM's TPC specifications meet or exceed all federal safety guidelines.

**(C) DOT (Department of Transportation):**

The Department of Transportation (DOT) code indicates that the tire is in compliance with the U.S. Department of Transportation Motor Vehicle Safety Standards.

**(D) Tire Identification Number (TIN):**

The letters and numbers following DOT code are the Tire Identification Number (TIN). The TIN shows the manufacturer and plant code, tire size, and date the tire was manufactured.

## 5-40 Service and Appearance Care

The TIN is molded onto both sides of the tire, although only one side may have the date of manufacture.

**(E) Tire Ply Material:** The type of cord and number of plies in the sidewall and under the tread.

**(F) Uniform Tire Quality Grading (UTQG):** Tire manufacturers are required to grade tires based on three performance factors: treadwear, traction and temperature resistance. For more information see *Uniform Tire Quality Grading on page 5-54*.

**(G) Maximum Cold Inflation Load Limit:** Maximum load that can be carried and the maximum pressure needed to support that load.

### Tire Size

The following illustration shows an example of a typical passenger (p-metric) vehicle tire size.

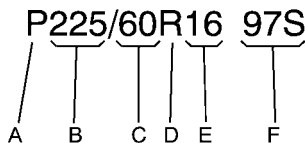

### (A) Passenger (P-Metric)

**Tire:** The United States version of a metric tire sizing system. The letter P as the first character in the tire size means a passenger vehicle tire engineered to standards set by the U. S. Tire and Rim Association.

**(B) Tire Width:** The three-digit number indicates the tire section width in millimeters from sidewall to sidewall.

**(C) Aspect Ratio:** A two-digit number that indicates the tire height-to-width measurements.

For example, if the tire size aspect ratio is 60, as shown in item C of the illustration, it would mean that the tire's sidewall is 60 percent as high as it is wide.

**(D) Construction Code:** A letter code is used to indicate the type of ply construction in the tire. The letter R means radial ply construction; the letter D means diagonal or bias ply construction; and the letter B means belted-bias ply construction.

**(E) Rim Diameter:** Diameter of the wheel in inches.

**(F) Service Description:** These characters represent the load range and speed rating of the tire. The load index represents the load carry capacity a tire is certified to carry. The load index can range from 1 to 279. The speed rating is the maximum speed a tire is certified to carry a load. Speed ratings range from A to Z.

## Tire Terminology and Definitions

**Air Pressure:** The amount of air inside the tire pressing outward on each square inch of the tire. Air pressure is expressed in pounds per square inch (psi) or kilopascal (kPa).

**Accessory Weight:** This means the combined weight of optional accessories. Some examples of optional accessories are, automatic transmission, power steering, power brakes, power windows, power seats, and air conditioning.

**Aspect Ratio:** The relationship of a tire's height to its width.

**Belt:** A rubber coated layer of cords that is located between the plies and the tread. Cords may be made from steel or other reinforcing materials.

**Bead:** The tire bead contains steel wires wrapped by steel cords that hold the tire onto the rim.

**Bias Ply Tire:** A pneumatic tire in which the plies are laid at alternate angles less than 90 degrees to the centerline of the tread.

**Cold Tire Pressure:** The amount of air pressure in a tire, measured in pounds per square inch (psi) or kilopascals (kPa) before a tire has built up heat from driving. See *Inflation - Tire Pressure on page 5-43*.

**Curb Weight:** The weight of a motor vehicle with standard and optional equipment including the maximum capacity of fuel, oil, and coolant, but without passengers and cargo.

**DOT Markings:** A code molded into the sidewall of a tire signifying that the tire is in compliance with the U.S. Department of Transportation (DOT) motor vehicle safety standards. The DOT code includes the Tire Identification Number (TIN), an alphanumeric designator which can also identify the tire manufacturer, production plant, brand, and date of production.

**GVWR:** Gross Vehicle Weight Rating. See *Loading the Vehicle on page 4-18*.

**GAWR FRT:** Gross Axle Weight Rating for the front axle. See *Loading the Vehicle on page 4-18*.

**GAWR RR:** Gross Axle Weight Rating for the rear axle. See *Loading the Vehicle on page 4-18*.

## 5-42 Service and Appearance Care

---

### **Intended Outboard**

**Sidewall:** The side of an asymmetrical tire, that must always face outward when mounted on a vehicle.

**Kilopascal (kPa):** The metric unit for air pressure.

**Light Truck (LT-Metric) Tire:** A tire used on light duty trucks and some multipurpose passenger vehicles.

**Load Index:** An assigned number ranging from 1 to 279 that corresponds to the load carrying capacity of a tire.

### **Maximum Inflation**

**Pressure:** The maximum air pressure to which a cold tire can be inflated. The maximum air pressure is molded onto the sidewall.

**Maximum Load Rating:** The load rating for a tire at the maximum permissible inflation pressure for that tire.

### **Maximum Loaded Vehicle**

**Weight:** The sum of curb weight, accessory weight, vehicle capacity weight, and production options weight.

**Normal Occupant Weight:** The number of occupants a vehicle is designed to seat multiplied by 150 lbs (68 kg). See *Loading the Vehicle on page 4-18*.

### **Occupant**

**Distribution:** Designated seating positions.

**Outward Facing Sidewall:** The side of an asymmetrical tire that has a particular side that faces outward when mounted on a vehicle. The side of the tire that contains a whitewall, bears white lettering, or bears manufacturer, brand, and/or model name molding that is higher or deeper than the same moldings on the other sidewall of the tire.

**Passenger (P-Metric) Tire:** A tire used on passenger cars and some light duty trucks and multipurpose vehicles.

### **Recommended Inflation**

**Pressure:** Vehicle manufacturer's recommended tire inflation pressure as shown on the tire placard. See *Inflation - Tire Pressure on page 5-43* and *Loading the Vehicle on page 4-18*.

**Radial Ply Tire:** A pneumatic tire in which the ply cords that extend to the beads are laid at 90 degrees to the centerline of the tread.

**Rim:** A metal support for a tire and upon which the tire beads are seated.

**Sidewall:** The portion of a tire between the tread and the bead.

**Speed Rating:** An alphanumeric code assigned to a tire indicating the maximum speed at which a tire can operate.

**Traction:** The friction between the tire and the road surface. The amount of grip provided.

**Tread:** The portion of a tire that comes into contact with the road.

**Treadwear Indicators:** Narrow bands, sometimes called wear bars, that show across the tread of a tire when only 1/16 inch (1.6 mm) of tread remains. See *When It Is Time for New Tires* on page 5-51.

**UTQGS (Uniform Tire Quality Grading Standards):** A tire information system that provides consumers with ratings for a tire's traction, temperature, and treadwear. Ratings are determined by tire manufacturers using government testing procedures. The ratings are molded into the sidewall of the tire. See *Uniform Tire Quality Grading* on page 5-54.

**Vehicle Capacity Weight:** The number of designated seating positions multiplied by 150 lbs (68 kg) plus the rated cargo load. See *Loading the Vehicle* on page 4-18.

**Vehicle Maximum Load on the Tire:** Load on an individual tire due to curb weight, accessory weight, occupant weight, and cargo weight.

**Vehicle Placard:** A label permanently attached to a vehicle showing the vehicle's capacity weight and the original equipment tire size and recommended inflation pressure. See "Tire and Loading Information Label" under *Loading the Vehicle* on page 4-18.

## Inflation - Tire Pressure

Tires need the correct amount of air pressure to operate effectively.

**Notice:** Do not let anyone tell you that under-inflation or over-inflation is all right. It is not. If your tires do not have enough air (under-inflation), you can get the following:

- Too much flexing
- Too much heat
- Tire overloading
- Premature or irregular wear
- Poor handling
- Reduced fuel economy

If your tires have too much air (over-inflation), you can get the following:

- Unusual wear
- Poor handling
- Rough ride
- Needless damage from road hazards

A vehicle specific Tire and Loading Information label is attached to your vehicle.

## 5-44 Service and Appearance Care

---

This label shows your vehicle's original equipment tires and the correct inflation pressures for your tires when they are cold. The recommended cold tire inflation pressure, shown on the label, is the minimum amount of air pressure needed to support your vehicle's maximum load carrying capacity.

For additional information regarding how much weight your vehicle can carry, and an example of the Tire and Loading Information label, see *Loading the Vehicle on page 4-18*. How you load your vehicle affects vehicle handling and ride comfort. Never load your vehicle with more weight than it was designed to carry.

### **When to Check**

Check your tires once a month or more.

### **How to Check**

Use a good quality pocket-type gage to check tire pressure. You cannot tell if your tires are properly inflated simply by looking at them. Radial tires may look properly inflated even when they are under-inflated. Check the tire's inflation pressure when the tires are cold. Cold means your vehicle has been sitting for at least three hours or driven no more than 1 mile (1.6 km).

Remove the valve cap from the tire valve stem. Press the tire gage firmly onto the valve to get a pressure measurement.

If the cold tire inflation pressure matches the recommended pressure on the Tire and Loading Information label, no further adjustment is necessary. If the inflation pressure is low, add air until you reach the recommended amount.

If you overfill the tire, release air by pushing on the metal stem in the center of the tire valve. Re-check the tire pressure with the tire gage.

Be sure to put the valve caps back on the valve stems. They help prevent leaks by keeping out dirt and moisture.



## Tire Pressure Monitor System

The Tire Pressure Monitor System (TPMS) uses radio and sensor technology to check tire pressure levels. The TPMS sensors monitor the air pressure in your vehicle's tires and transmit tire pressure readings to a receiver located in the vehicle.

Each tire, including the spare (if provided), should be checked monthly when cold and inflated to the inflation pressure recommended by the vehicle manufacturer on the vehicle placard or tire inflation pressure label. (If your vehicle has tires of a different size than the size indicated on the vehicle placard or tire inflation pressure label, you should determine the proper tire inflation pressure for those tires.)

As an added safety feature, your vehicle has been equipped with a tire pressure monitoring system (TPMS) that illuminates a low tire pressure telltale when one or more of your tires is significantly under-inflated.

Accordingly, when the low tire pressure telltale illuminates, you should stop and check your tires as soon as possible, and inflate them to the proper pressure. Driving on a significantly under-inflated tire causes the tire to overheat and can lead to tire failure. Under-inflation also reduces fuel efficiency and tire tread life, and may affect the vehicle's handling and stopping ability.

Please note that the TPMS is not a substitute for proper tire maintenance, and it is the driver's responsibility to maintain correct tire pressure, even if under-inflation has not reached the level to trigger illumination of the TPMS low tire pressure telltale.

Your vehicle has also been equipped with a TPMS malfunction indicator to indicate when the system is not operating properly. The TPMS malfunction indicator is combined with the low tire pressure telltale. When the

system detects a malfunction, the telltale will flash for approximately one minute and then remain continuously illuminated. This sequence will continue upon subsequent vehicle start-ups as long as the malfunction exists.

When the malfunction indicator is illuminated, the system may not be able to detect or signal low tire pressure as intended. TPMS malfunctions may occur for a variety of reasons, including the installation of replacement or alternate tires or wheels on the vehicle that prevent the TPMS from functioning properly. Always check the TPMS malfunction telltale after replacing one or more tires or wheels on your vehicle to ensure that the replacement or alternate tires and wheels allow the TPMS to continue to function properly.

See *Tire Pressure Monitor Operation* on page 5-46 for additional information.

### **Federal Communications Commission (FCC) and Industry and Science Canada**

The Tire Pressure Monitor System (TPMS) operates on a radio frequency and complies with Part 15 of the FCC Rules. Operation is subject to the following two conditions:

1. This device may not cause harmful interference.
2. This device must accept any interference received, including interference that may cause undesired operation.

The TPMS operates on a radio frequency and complies with RSS-210 of Industry and Science Canada. Operation is subject to the following two conditions:

1. This device may not cause interference.
2. This device must accept any interference received, including interference that may cause undesired operation of the device.

Changes or modifications to this system by other than an authorized service facility could void authorization to use this equipment.

### **Tire Pressure Monitor Operation**

This vehicle may have a Tire Pressure Monitor System (TPMS). The TPMS is designed to warn the driver when a low tire pressure condition exists. TPMS sensors are mounted onto each tire and wheel assembly. The TPMS sensors monitor the air pressure in the vehicle's tires and transmits the tire pressure readings to a receiver located in the vehicle.



When a low tire pressure condition is detected, the TPMS turns on the low tire pressure warning light located on the instrument panel cluster.

At the same time a message to check the pressure in a specific tire appears on the Driver Information Center (DIC) display. The low tire pressure warning light and the DIC warning message come on at each ignition cycle until the tires are inflated to the correct inflation pressure. Using the DIC, tire pressure levels can be viewed by the driver. For additional information and details about the DIC operation and displays see *DIC Operation and Displays on page 3-36* and *DIC Warnings and Messages on page 3-42*.

The low tire pressure warning light may come on in cool weather when the vehicle is first started, and then turn off as you start to drive. This could be an early indicator that the air pressure in the tire(s) are getting low and need to be inflated to the proper pressure.

A Tire and Loading Information label shows the size of your vehicle's original equipment tires and the correct inflation pressure for your vehicle's tires when they are cold. See *Loading the Vehicle on page 4-18*, for an example of the Tire and Loading Information label and its location on your vehicle. Also see *Inflation - Tire Pressure on page 5-43*.

Your vehicle's TPMS system can warn you about a low tire pressure condition but it does not replace normal tire maintenance. See *Tire Inspection and Rotation on page 5-50* and *Tires on page 5-38*.

**Notice:** Using non-approved tire sealants could damage the Tire Pressure Monitor System (TPMS) sensors. TPMS sensor damage caused by using an incorrect tire sealant is not covered by the vehicle warranty. Always use the GM approved tire sealant available through your dealer/retailer.

Your vehicle, when new, included a factory-installed Tire Inflator Kit. This kit uses a GM approved liquid tire sealant. Using non-approved tire sealants could damage the TPMS sensors. See Tire Sealant and Compressor Kit for information regarding the inflator kit materials and instructions.

### TPMS Malfunction Light and Message

The TPMS will not function properly if one or more of the TPMS sensors are missing or inoperable. When the system detects a malfunction, the low tire warning light flashes for about one minute and then stays on for the remainder of the ignition cycle. A DIC warning message is also displayed. The low tire warning light and DIC warning message come on at each ignition cycle until the problem is corrected. Some of the conditions that can cause the malfunction light and DIC message to come on are:

- The TPMS sensor matching process was started but not completed or not completed successfully after rotating the vehicle's tires. The DIC message and TPMS malfunction light should go off once the TPMS sensor matching process is performed successfully. See "TPMS Sensor Matching Process" later in this section.

- One or more TPMS sensors are missing or damaged. The DIC message and the TPMS malfunction light should go off when the TPMS sensors are installed and the sensor matching process is performed successfully. See your dealer/retailer for service.
- Replacement tires or wheels do not match your vehicle's original equipment tires or wheels. Tires and wheels other than those recommended for your vehicle could prevent the TPMS from functioning properly. See *Buying New Tires on page 5-51*.
- Operating electronic devices or being near facilities using radio wave frequencies similar to the TPMS could cause the TPMS sensors to malfunction.

If the TPMS is not functioning it cannot detect or signal a low tire condition. See your dealer/retailer for service if the TPMS malfunction light and DIC message comes on and stays on.

### TPMS Sensor Matching Process

Each TPMS sensor has a unique identification code. Any time you replace one or more of the TPMS sensors or rotate the vehicle's tires, the identification codes need to be matched to the new tire/wheel location. The sensors are matched, to the tire/wheel locations, in the following order: driver side front tire, passenger side front tire, passenger side rear tire, and driver side rear tire using a TPMS diagnostic tool. See your dealer/retailer for service.

The TPMS sensors can also be matched to each tire/wheel position by increasing or decreasing the tire's air pressure. When increasing the tire's pressure, do not exceed the maximum inflation pressure indicated on the tire's sidewall. To decrease the tire's air-pressure use the pointed end of the valve cap, a pencil-style air pressure gage, or a key.

You have two minutes to match each tire and wheel position. If it takes longer than two minutes to match any tire and wheel position, the matching process stops and you need to start over.

The TPMS matching process is outlined below:

1. Set the parking brake.
2. Turn the ignition switch to ON/RUN with the engine off.
3. Press and hold the Remote Keyless Entry (RKE) transmitter's LOCK and UNLOCK buttons, at the same time, for about five seconds to start the TPMS learn mode. The horn sounds twice indicating the TPMS receiver is ready and in learn mode.
4. Start with the driver side front tire. The driver side front turn signal also comes on to indicate that corner's sensor is ready to be learned.
5. Remove the valve cap from the tire's valve stem. Activate the TPMS sensor by increasing or decreasing the tire's air pressure for about eight seconds. The horn chirp, can take up to 30 seconds to sound. It chirps one time and then all the turn signals flash one time to confirm the sensor identification code has been matched to the tire/wheel position.
6. The passenger side front turn signal comes on to indicate that corner sensor is ready to be learned. Proceed to the passenger side front tire and repeat the procedure in Step 5.
7. The passenger side rear turn signal comes on to indicate that corner sensor is ready to be learned. Proceed to the passenger side rear tire and repeat the procedure in Step 5.
8. The driver side rear turn signal comes on to indicate that corner sensor is ready to be learned. Proceed to the driver side rear tire, and repeat the procedure in Step 5.
9. After hearing the single horn chirp for the driver side rear tire, two additional horn chirps sound to indicate the tire learning process is done. Turn the ignition switch to LOCK/OFF. If no tires are learned after entering the TPMS learn mode, or if communication with the receiver stops, or if the time limit has expired, turn the ignition switch to LOCK/OFF and start over beginning with Step 2.
10. Set all four tires to the recommended air pressure level as indicated on the Tire and Loading Information label.
11. Put the valve caps back on the valve stems.

### Tire Inspection and Rotation

We recommend that you regularly inspect the vehicle's tires, including the spare tire, for signs of wear or damage. See *When It Is Time for New Tires on page 5-51* for more information.

Tires should be rotated every 5,000 to 8,000 miles (8 000 to 13 000 km). See *Scheduled Maintenance on page 6-3*.

The purpose of a regular tire rotation is to achieve a uniform wear for all tires on the vehicle. This will ensure that the vehicle continues to perform most like it did when the tires were new.

Any time you notice unusual wear, rotate the tires as soon as possible and check wheel alignment. Also check for damaged tires or wheels.

See *When It Is Time for New Tires on page 5-51* and *Wheel Replacement on page 5-55*.

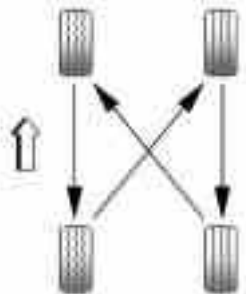

When rotating the vehicle's tires, always use the correct rotation pattern shown here.

After the tires have been rotated, adjust the front and rear inflation pressures as shown on the Tire and Loading Information label. See *Inflation - Tire Pressure on page 5-43* and *Loading the Vehicle on page 4-18*.

Reset the Tire Pressure Monitor System. See *Tire Pressure Monitor Operation on page 5-46*.

Make certain that all wheel nuts are properly tightened. See "Wheel Nut Torque" under *Capacities and Specifications on page 5-81*.

#### CAUTION

Rust or dirt on a wheel, or on the parts to which it is fastened, can make wheel nuts become loose after a time. The wheel could come off and cause a crash. When you change a wheel, remove any rust or dirt from places where the wheel attaches to the vehicle. In an emergency, you can use a cloth or a paper towel to do this; but be sure to use a scraper or wire brush later, if you need to, to get all the rust or dirt off.

## When It Is Time for New Tires

Various factors, such as maintenance, temperatures, driving speeds, vehicle loading, and road conditions influence when you need new tires.

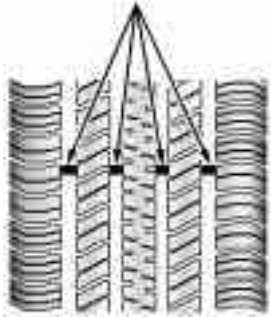

One way to tell when it is time for new tires is to check the treadwear indicators, which will appear when the tires have only 1/16 inch (1.6 mm) or less of tread remaining.

You need new tires if any of the following statements are true:

- You can see the indicators at three or more places around the tire.
- You can see cord or fabric showing through the tire's rubber.
- The tread or sidewall is cracked, cut, or snagged deep enough to show cord or fabric.
- The tire has a bump, bulge, or split.
- The tire has a puncture, cut, or other damage that cannot be repaired well because of the size or location of the damage.

The rubber in tires degrades over time, even if they are not being used. This is also true for the spare tire, if the vehicle has one. Multiple conditions affect how fast this aging takes place, including temperatures, loading conditions, and inflation pressure maintenance.

With proper care and maintenance tires typically wear out before they degrade due to age. If you are unsure about the need to replace the tires as they get older, consult the tire manufacturer for more information.

## Buying New Tires

GM has developed and matched specific tires for your vehicle. The original equipment tires installed on your vehicle, when it was new, were designed to meet General Motors Tire Performance Criteria Specification (TPC spec) system rating. If you need replacement tires, GM strongly recommends that you get tires with the same TPC Spec rating. This way, your vehicle will continue to have tires that are designed to give the same performance and vehicle safety, during normal use, as the original tires.

## 5-52 Service and Appearance Care

GM's exclusive TPC Spec system considers over a dozen critical specifications that impact the overall performance of your vehicle, including brake system performance, ride and handling, traction control, and tire pressure monitoring performance. GM's TPC Spec number is molded onto the tire's sidewall near the tire size. If the tires have an all-season tread design, the TPC spec number will be followed by a MS, for mud and snow. See *Tire Sidewall Labeling* on page 5-39 for additional information.

GM recommends replacing tires in sets of four. This is because uniform tread depth on all tires will help keep your vehicle performing most like it did when the tires were new. Replacing less than a full set of tires can affect the braking

and handling performance of your vehicle. See *Tire Inspection and Rotation* on page 5-50 for information on proper tire rotation.

### CAUTION

Mixing tires could cause you to lose control while driving. If you mix tires of different sizes, brands, or types (radial and bias-belted tires) the vehicle may not handle properly, and you could have a crash. Using tires of different sizes, brands, or types may also cause damage to your vehicle. Be sure to use the correct size, brand, and type of tires on your vehicle's wheels.

### CAUTION

If you use bias-ply tires on the vehicle, the wheel rim flanges could develop cracks after many miles of driving. A tire and/or wheel could fail suddenly, causing a crash. Use only radial-ply tires with the wheels on the vehicle.

If you must replace your vehicle's tires with those that do not have a TPC Spec number, make sure they are the same size, load range, speed rating, and construction type (radial and bias-belted tires) as your vehicle's original tires.



Vehicles that have a tire pressure monitoring system could give an inaccurate low-pressure warning if non-TPC Spec rated tires are installed on your vehicle. Non-TPC Spec rated tires may give a low-pressure warning that is higher or lower than the proper warning level you would get with TPC Spec rated tires. See *Tire Pressure Monitor System* on page 5-45.

Your vehicle's original equipment tires are listed on the Tire and Loading Information label. See *Loading the Vehicle* on page 4-18, for more information about the Tire and Loading Information label and its location on your vehicle.

## Different Size Tires and Wheels

If you add wheels or tires that are a different size than your original equipment wheels and tires, this may affect the way your vehicle performs, including its braking, ride and handling characteristics, stability, and resistance to rollover. Additionally, if your vehicle has electronic systems such as, anti-lock brakes, rollover airbags, traction control, and stability control, the performance of these systems can be affected.

### CAUTION

If you add different sized wheels, your vehicle may not provide an acceptable level of performance and safety if tires not recommended for those wheels are selected. You may increase the chance that you will crash and suffer serious injury. Only use Saturn specific wheel and tire systems developed for your vehicle, and have them properly installed by a Saturn certified technician.

See *Buying New Tires* on page 5-51 and *Accessories and Modifications* on page 5-3 for additional information.

### Uniform Tire Quality Grading

Quality grades can be found where applicable on the tire sidewall between tread shoulder and maximum section width. For example:

#### Treadwear 200 Traction AA Temperature A

The following information relates to the system developed by the United States National Highway Traffic Safety Administration (NHTSA), which grades tires by treadwear, traction, and temperature performance. This applies only to vehicles sold in the United States. The grades are molded on the sidewalls of most passenger car tires. The Uniform Tire Quality Grading (UTQG) system does not apply to deep tread, winter-type snow tires, space-saver, or temporary use spare tires, tires with nominal

rim diameters of 10 to 12 inches (25 to 30 cm), or to some limited-production tires.

While the tires available on General Motors passenger cars and light trucks may vary with respect to these grades, they must also conform to federal safety requirements and additional General Motors Tire Performance Criteria (TPC) standards.

#### Treadwear

The treadwear grade is a comparative rating based on the wear rate of the tire when tested under controlled conditions on a specified government test course. For example, a tire graded 150 would wear one and a half (1.5) times as well on the government course as a tire graded 100. The relative performance of tires depends upon the actual conditions of their use, however, and may depart significantly from the norm

due to variations in driving habits, service practices, and differences in road characteristics and climate.

#### Traction – AA, A, B, C

The traction grades, from highest to lowest, are AA, A, B, and C. Those grades represent the tire's ability to stop on wet pavement as measured under controlled conditions on specified government test surfaces of asphalt and concrete. A tire marked C may have poor traction performance.

#### WARNING

The traction grade assigned to this tire is based on straight-ahead braking traction tests, and does not include acceleration, cornering, hydroplaning, or peak traction characteristics.

## Temperature – A, B, C

The temperature grades are A (the highest), B, and C, representing the tire's resistance to the generation of heat and its ability to dissipate heat when tested under controlled conditions on a specified indoor laboratory test wheel. Sustained high temperature can cause the material of the tire to degenerate and reduce tire life, and excessive temperature can lead to sudden tire failure. The grade C corresponds to a level of performance which all passenger car tires must meet under the Federal Motor Vehicle Safety Standard No. 109. Grades B and A represent higher levels of performance on the laboratory test wheel than the minimum required by law.

### WARNING

The temperature grade for this tire is established for a tire that is properly inflated and not overloaded. Excessive speed, underinflation, or excessive loading, either separately or in combination, can cause heat buildup and possible tire failure.

## Wheel Alignment and Tire Balance

The tires and wheels on your vehicle were aligned and balanced carefully at the factory to give you the longest tire life and best overall performance. Adjustments to wheel alignment and tire balancing will not be necessary on a regular

basis. However, if you notice unusual tire wear or your vehicle pulling to one side or the other, the alignment might need to be checked. If you notice your vehicle vibrating when driving on a smooth road, the tires and wheels might need to be rebalanced. See your dealer/retailer for proper diagnosis.

## Wheel Replacement

Replace any wheel that is bent, cracked, or badly rusted or corroded. If wheel nuts keep coming loose, the wheel, wheel bolts, and wheel nuts should be replaced. If the wheel leaks air, replace it (except some aluminum wheels, which can sometimes be repaired). See your dealer/retailer if any of these conditions exist.

## 5-56 Service and Appearance Care

Your dealer/retailer will know the kind of wheel you need.

Each new wheel should have the same load-carrying capacity, diameter, width, offset and be mounted the same way as the one it replaces.

### CAUTION

Using the wrong replacement wheels, wheel bolts, or wheel nuts on your vehicle can be dangerous. It could affect the braking and handling of your vehicle, make your tires lose air and make you lose control. You could have a collision in which you or others could be injured. Always use the correct wheel, wheel bolts, and wheel nuts for replacement.

If you need to replace any of your wheels, wheel bolts, or wheel nuts, replace them only with new Saturn original equipment parts. This way, you will be sure to have the right wheel, wheel bolts, and wheel nuts for your vehicle.

**Notice:** The wrong wheel can also cause problems with bearing life, brake cooling, speedometer or odometer calibration, headlamp aim, bumper height, vehicle ground clearance, and tire clearance to the body and chassis.

### CAUTION

Rust or dirt on a wheel, or on the parts to which it is fastened, can make wheel nuts become loose after a time. The wheel could come off and cause a crash. When you change a wheel, remove any rust or dirt from places where the wheel attaches to the vehicle. In an emergency, you can use a cloth or a paper towel to do this; but be sure to use a scraper or wire brush later, if you need to, to get all the rust or dirt off.

### CAUTION

Never use oil or grease on studs or the threads of the wheel nuts. If you do, the wheel nuts might come loose and the wheel could fall off, causing a crash.

 CAUTION

Incorrect wheel nuts or improperly tightened wheel nuts can cause the wheel to become loose and even come off. This could lead to a crash. Be sure to use the correct wheel nuts. If you have to replace them, be sure to get new Saturn original equipment wheel nuts.

**Notice:** Improperly tightened wheel nuts can lead to brake pulsation and rotor damage. To avoid expensive brake repairs, evenly tighten the wheel nuts in the proper sequence and to the proper torque specification.

## Used Replacement Wheels

 CAUTION

Putting a used wheel on your vehicle is dangerous. You cannot know how it has been used or how far it has been driven. It could fail suddenly and cause a crash. If you have to replace a wheel, use a new Saturn original equipment wheel.

## Tire Chains

 CAUTION

Do not use tire chains. There is not enough clearance. Tire chains used on a vehicle without the proper amount of clearance can cause damage to the brakes, suspension or other vehicle parts.

(Continued)

## CAUTION (Continued)

The area damaged by the tire chains could cause you to lose control of the vehicle and you or others may be injured in a crash.

Use another type of traction device only if its manufacturer recommends it for use on the vehicle and tire size combination and road conditions. Follow that manufacturer's instructions. To help avoid damage to the vehicle, drive slowly, readjust or remove the device if it is contacting the vehicle, and do not spin the vehicle's wheels. If you do find traction devices that will fit, install them on the front tires.

### If a Tire Goes Flat

This vehicle has a tire sealant and compressor kit. See *Tire Sealant and Compressor Kit on page 5-59*. There is no spare tire, no tire changing equipment, and no place to store a tire.

It is unusual for a tire to blow out while you are driving, especially if you maintain your tires properly. See *Tires on page 5-38*. If air goes out of a tire, it is much more likely to leak out slowly. But, if you should ever have a blow out, here are a few tips about what to expect and what to do:

If a front tire fails, the flat tire will create a drag that pulls the vehicle toward that side. Take your foot off the accelerator pedal and grip the steering wheel firmly. Steer to maintain lane position, and then gently brake to a stop well out of the traffic lane.

A rear blow out, particularly on a curve, acts much like a skid and may require the same correction you would use in a skid. In any rear blow out, remove your foot from the accelerator pedal. Get the vehicle under control by steering the way you want the vehicle to go. It may be very bumpy and noisy, but you can still steer. Gently brake to a stop, well off the road if possible.

If a tire goes flat, avoid further tire and wheel damage by driving slowly to a level place and stopping.

1. Turn on the hazard warning flashers. See *Hazard Warning Flashers on page 3-5*.
2. Park the vehicle. Set the parking brake firmly and put the shift lever in P (Park). See *Shifting Into Park on page 2-23*.

3. Turn off the engine.
4. Inspect the flat tire.

If the tire has been separated from the wheel, has damaged sidewalls, or has a puncture larger than a ¼ inch (6 mm), the tire is too severely damaged for the tire sealant and compressor kit to be effective. See *Roadside Assistance Program on page 7-5*.

If the tire has a puncture less than a ¼ inch (6 mm) in the tread area of the tire, see *Tire Sealant and Compressor Kit on page 5-59*.

## Tire Sealant and Compressor Kit

### CAUTION

Idling a vehicle in an enclosed area with poor ventilation is dangerous. Engine exhaust may enter the vehicle. Engine exhaust contains Carbon Monoxide (CO) which cannot be seen or smelled. It can cause unconsciousness and even death. Never run the engine in an enclosed area that has no fresh air ventilation. For more information, see *Engine Exhaust* on page 2-26.

### CAUTION

Over-inflating a tire could cause the tire to rupture and you or others could be injured. Be sure to read and follow the tire sealant and compressor kit instructions and inflate the tire to its recommended pressure. Do not exceed the recommended pressure.

### CAUTION

Storing the tire sealant and compressor kit or other equipment in the passenger compartment of the vehicle could cause injury. In a sudden stop or collision, loose equipment could strike someone. Store the tire sealant and compressor kit in its original location.

If this vehicle has a tire sealant and compressor kit, there may not be a spare tire, tire changing equipment, and on some vehicles there may not be a place to store a tire.

The tire sealant and compressor can be used to temporarily seal punctures up to ¼ inch (6 mm) in the tread area of the tire. It can also be used to inflate an under inflated tire.

## 5-60 Service and Appearance Care

If the tire has been separated from the wheel, has damaged sidewalls, or has a large puncture, the tire is too severely damaged for the tire sealant and compressor kit to be effective. See *Roadside Assistance Program* on page 7-5.

Read and follow all of the tire sealant and compressor kit instructions.

The kit includes:

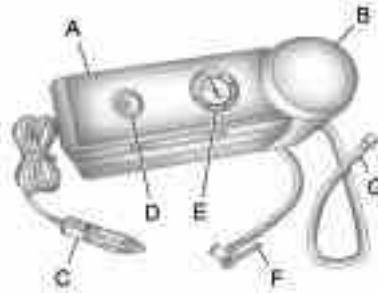

- A. Air Compressor
- B. Tire Sealant Canister
- C. Power Plug
- D. On/Off Button
- E. Pressure Gauge
- F. Air Only Hose (Black)
- G. Sealant/Air Hose (Clear)

### Tire Sealant

Read and follow the safe handling instructions on the label adhered to the sealant canister.

Check the tire sealant expiration date on the sealant canister. The sealant canister should be replaced before its expiration date. Replacement sealant canisters are available at your local dealer/retailer. See "Removal and Installation of the Sealant Canister" following.

There is only enough sealant to seal one tire. After usage, the sealant canister and sealant/air hose assembly must be replaced. See "Removal and Installation of the Sealant Canister" following.



## Using the Tire Sealant and Compressor Kit to Temporarily Seal and Inflate a Punctured Tire

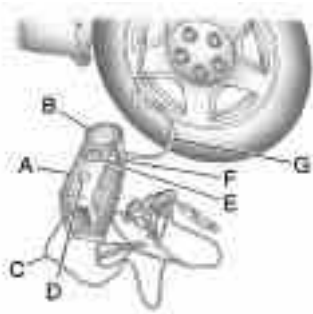

When using the tire sealant and compressor kit during cold temperatures, warm the kit in a heated environment for 5 minutes. This will help to inflate the tire faster.

Always do a safety check first. See *If a Tire Goes Flat* on page 5-58.

1. Remove the tire sealant and compressor kit from its storage location. See *Tire Sealant and Compressor Kit Storage* on page 5-66.

Make sure the on/off button (D) is in the off (O) position.

2. Unwrap the sealant/air hose (F) and the power plug (C).
3. Place the kit on the ground. Make sure the tire valve stem is positioned close to the ground so the hose will reach it.
4. Remove the valve stem cap from the flat tire by turning it counterclockwise.

5. Attach the sealant/air hose (F) onto the tire valve stem. Turn it clockwise until it is tight.
6. Plug the power plug (C) into the accessory power outlet in the vehicle. Unplug all items from other accessory power outlets. See *Accessory Power Outlet(s)* on page 3-16.

If the vehicle has an accessory power outlet, do not use the cigarette lighter.

If the vehicle only has a cigarette lighter, use the cigarette lighter.

Do not pinch the power plug cord in the door or window.

7. Start the vehicle. The vehicle must be running while using the air compressor.

## 5-62 Service and Appearance Care

---

8. Press the on/off (D) button to turn the tire sealant and compressor kit on.

The compressor will inject sealant and air into the tire.

The pressure gage (E) will initially show a high pressure while the compressor pushes the sealant into the tire. Once the sealant is completely dispersed into the tire, the pressure will quickly drop and start to rise again as the tire inflates with air only.

9. Inflate the tire to the recommended inflation pressure using the pressure gage (E). The recommended inflation pressure can be found on the Tire and Loading Information label. See *Inflation - Tire Pressure on page 5-43*.

The pressure gage (E) may read higher than the actual tire pressure while the compressor is on. Turn the compressor off to get an accurate pressure reading. The compressor may be turned on/off until the correct pressure is reached.

**Notice:** If the recommended pressure cannot be reached after approximately 25 minutes, the vehicle should not be driven farther. The tire is too severely damaged and the tire sealant and compressor kit cannot inflate the tire. Remove the power plug from the accessory power outlet and unscrew the inflating hose from the tire valve. See *Roadside Assistance Program on page 7-5*.

10. Press the on/off button (D) to turn the tire sealant and compressor kit off.

The tire is not sealed and will continue to leak air until the vehicle is driven and the sealant is distributed in the tire, therefore, Steps 11 through 17 must be done immediately after Step 10.

Be careful while handling the tire sealant and compressor kit as it could be warm after usage.

11. Unplug the power plug (C) from the accessory power outlet in the vehicle.
12. Turn the sealant/air hose (F) counterclockwise to remove it from the tire valve stem.
13. Replace the tire valve stem cap.

14. Replace the sealant/air hose (F), and the power plug (C) back in their original location.



15. If the flat tire was able to inflate to the recommended inflation pressure, remove the maximum speed label from the sealant canister (B) and place it in a highly visible location.

The label is a reminder not to exceed 55 mph (90 km/h) until the damaged tire is repaired or replaced.

16. Return the equipment to its original storage location in the vehicle.

17. Immediately drive the vehicle 5 miles (8 km) to distribute the sealant in the tire.

18. Stop at a safe location and check the tire pressure. Refer to Steps 1 through 11 under “Using the Tire Sealant and Compressor Kit without Sealant to Inflate a Tire (Not Punctured).”

If the tire pressure has fallen more than 10 psi (68 kPa) below the recommended inflation pressure, stop driving the vehicle. The tire is too severely damaged and the tire sealant cannot seal the tire. See *Roadside Assistance Program* on page 7-5.

If the tire pressure has not dropped more than 10 psi (68 kPa) from the recommended inflation pressure, inflate the tire to the recommended inflation pressure.

19. Wipe off any sealant from the wheel, tire or vehicle.

20. Dispose of the used sealant canister (B) and sealant/air hose (F) assembly at a local dealer/retailer or in accordance with local state codes and practices.

21. Replace it with a new canister available from your dealer/retailer.

22. After temporarily sealing a tire using the tire sealant and compressor kit, take the vehicle to an authorized dealer/retailer within a 100 miles (161 km) of driving to have the tire repaired or replaced.

## 5-64 Service and Appearance Care

### Using the Tire Sealant and Compressor Kit without Sealant to Inflate a Tire (Not Punctured)

To use the air compressor to inflate a tire with air only and not sealant:

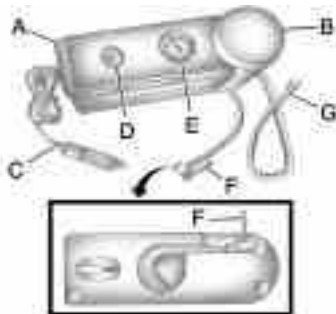

Always do a safety check first. See *If a Tire Goes Flat on page 5-58*.

1. Remove the tire sealant and compressor kit from its storage location. See *Tire Sealant and Compressor Kit Storage on page 5-66*.

2. Unlock the air only hose (F) from the sealant canister (B) by pulling up on the lever.
3. Pull the air only hose (F) from the sealant canister (B).
4. Remove the power plug (C) from the air compressor (A).

5. Place the kit on the ground.

Make sure the tire valve stem is positioned close to the ground so the hose will reach it.

6. Remove the tire valve stem cap by turning it counterclockwise.
7. Attach the air only hose (F) onto the tire valve stem and press the lever down to secure it.
8. Plug the power plug (C) into the accessory power outlet in the vehicle. Unplug all items from other accessory power outlets. See *Accessory Power Outlet(s) on page 3-16*.

If the vehicle has an accessory power outlet, do not use the cigarette lighter.

If the vehicle only has a cigarette lighter, use the cigarette lighter.

Do not pinch the power plug cord in the door or window.

9. Start the vehicle. The vehicle must be running while using the air compressor.
10. Press the on/off (D) button to turn the compressor on.  
The compressor will inflate the tire with air only.
11. Inflate the tire to the recommended inflation pressure using the pressure gage (E). The recommended inflation pressure can be found on the Tire and Loading Information label. See *Inflation - Tire Pressure on page 5-43*.

The pressure gage (E) may read higher than the actual tire pressure while the compressor is on. Turn the compressor off to get an accurate reading. The compressor may be turned on/off until the correct pressure is reached.

12. Press the on/off button (D) to turn the tire sealant and compressor kit off.  
Be careful while handling the tire sealant and compressor kit as it could be warm after usage.
13. Unplug the power plug (C) from the accessory power outlet in the vehicle.
14. Disconnect the air only hose (F) from the tire valve stem, by turning it counterclockwise, and replace the tire valve stem cap.
15. Replace the air only hose (F) and the power plug (C) back in its original location.
16. Place the equipment in the original storage location in the vehicle.

### Removal and Installation of the Sealant Canister

To remove the sealant canister:



1. Unlock the air only hose (F) from the sealant canister (B) by pulling up on the lever.
2. Pull the air only hose (F) from the sealant canister (B).
3. Unwrap the sealant/air hose (F) from the compressor (A).



4. Turn the sealant canister (B) so the inflator filling hose is aligned with the slot in the compressor.

5. Lift the sealant canister (B) from the compressor and replace with a new sealant canister. See your dealer/retailer for more information.

To install a new sealant canister:

1. Align the sealant/air hose (F) with the slot in the air compressor.
2. Push the sealant canister (B) down and turn it clockwise.
3. Wrap the sealant/air hose (F) around the air compressor channel to stow it in its original location.
4. Push the air compressor inflator hose (F) onto the sealant canister inlet and push the lever down.

## Tire Sealant and Compressor Kit Storage

To access the tire sealant and compressor kit:

1. Open the liftgate. See *Liftgate* on page 2-8.

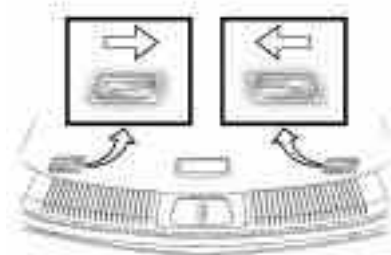

2. Push in the levers and lift the load floor up.

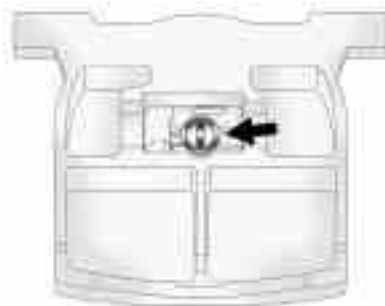

3. Turn the retainer counterclockwise and remove the tire sealant and compressor kit.

To store the tire sealant and compressor kit, reverse the steps.

## Appearance Care

### Interior Cleaning

The vehicle's interior will continue to look its best if it is cleaned often. Although not always visible, dust and dirt can accumulate on the upholstery. Dirt can damage carpet, fabric, leather, and plastic surfaces. Regular vacuuming is recommended to remove particles from the upholstery. It is important to keep the upholstery from becoming and remaining heavily soiled. Soils should be removed as quickly as possible. The vehicle's interior may experience extremes of heat that could cause stains to set rapidly.

Lighter colored interiors may require more frequent cleaning. Use care because newspapers and garments that transfer color to home furnishings may also transfer color to the vehicle's interior.

When cleaning the vehicle's interior, only use cleaners specifically designed for the surfaces being cleaned. Permanent damage may result from using cleaners on surfaces for which they were not intended. Use glass cleaner only on glass. Remove any accidental over-spray from other surfaces immediately. To prevent over-spray, apply cleaner directly to the cleaning cloth.

**Notice:** Using abrasive cleaners when cleaning glass surfaces on the vehicle, could scratch the glass and/or cause damage to the rear window defogger. When cleaning the glass on the vehicle, use only a soft cloth and glass cleaner.

Many cleaners contain solvents that may become concentrated in the vehicle's breathing space. Before using cleaners, read and adhere to all safety instructions on the label. While cleaning the vehicle's interior, maintain adequate ventilation by opening the vehicle's doors and windows.

Dust may be removed from small buttons and knobs using a small brush with soft bristles.

Products that remove odors from the vehicle's upholstery and clean the vehicle's glass can be obtained from your dealer/retailer.

Do not clean the vehicle using:

- A knife or any other sharp object to remove a soil from any interior surface.
- A stiff brush. It can cause damage to the vehicle's interior surfaces.

- Heavy pressure or aggressive rubbing with a cleaning cloth. Use of heavy pressure can damage the interior and does not improve the effectiveness of soil removal.
- Laundry detergents or dishwashing soaps with degreasers can leave residue that streaks and attracts dirt. For liquid cleaners, about 20 drops per gallon (3.78 L) of water is a good guide. Use only mild, neutral-pH soaps.
- Too much cleaner that saturates the upholstery.
- Organic solvents such as naphtha, alcohol, etc. that can damage the vehicle's interior.

### Fabric/Carpet

Use a vacuum cleaner with a soft brush attachment frequently to remove dust and loose dirt. A canister vacuum with a beater bar in the nozzle may only be used on floor carpet and carpeted floor mats. For any soil, always try to remove it first with plain water or club soda. Before cleaning, gently remove as much of the soil as possible using one of the following techniques:

- For liquids: gently blot the remaining soil with a paper towel. Allow the soil to absorb into the paper towel until no more can be removed.
- For solid dry soils: remove as much as possible and then vacuum.

To clean:

1. Saturate a lint-free, clean white cloth with water or club soda.
2. Wring the cloth to remove excess moisture.

3. Start on the outside edge of the soil and gently rub toward the center. Continue cleaning, using a clean area of the cloth each time it becomes soiled.
4. Continue to gently rub the soiled area until the cleaning cloth remains clean.
5. If the soil is not completely removed, use a mild soap solution and repeat the cleaning process that was used with plain water.

If any of the soil remains, a commercial fabric cleaner or spot lifter may be necessary. When a commercial upholstery cleaner or spot lifter is to be used, test a small hidden area for colorfastness first. If the locally cleaned area gives any impression that a ring formation may result, clean the entire surface.

After the cleaning process has been completed, a paper towel can be used to blot excess moisture from the fabric or carpet.

### Leather

A soft cloth dampened with water can be used to remove dust. If a more thorough cleaning is necessary, a soft cloth dampened with a mild soap solution can be used. Allow the leather to dry naturally. Do not use heat to dry. Never use steam to clean leather. Never use spot lifters or spot removers on leather. Many commercial leather cleaners and coatings that are sold to preserve and protect leather may permanently change the appearance and feel of the leather and are not recommended. Do not use silicone or wax-based products, or those containing organic solvents to clean the vehicle's interior because they can alter the appearance by increasing the gloss in a non-uniform manner. Never use shoe polish on leather.



## Instrument Panel, Vinyl, and Other Plastic Surfaces

A soft cloth dampened with water may be used to remove dust. If a more thorough cleaning is necessary, a clean soft cloth dampened with a mild soap solution can be used to gently remove dust and dirt. Never use spot lifters or removers on plastic surfaces. Many commercial cleaners and coatings that are sold to preserve and protect soft plastic surfaces may permanently change the appearance and feel of the interior and are not recommended. Do not use silicone or wax-based products, or those containing organic solvents to clean the vehicle's interior because they can alter the appearance by increasing the gloss in a non-uniform manner.

Some commercial products may increase gloss on the instrument panel. The increase in gloss may cause annoying reflections in the windshield and even make it difficult to see through the windshield under certain conditions.

## Care of Safety Belts

Keep belts clean and dry.

### CAUTION

Do not bleach or dye safety belts. It may severely weaken them. In a crash, they might not be able to provide adequate protection. Clean safety belts only with mild soap and lukewarm water.

## Weatherstrips

Silicone grease on weatherstrips will make them last longer, seal better, and not stick or squeak. Apply silicone grease with a clean cloth. During very cold, damp weather frequent application may be required. See *Recommended Fluids and Lubricants* on page 6-11.

## Washing Your Vehicle

The best way to preserve the vehicle's finish is to keep it clean by washing it often.

**Notice:** Certain cleaners contain chemicals that can damage the emblems or nameplates on the vehicle. Check the cleaning product label. If it states that it should not be used on plastic parts, do not use it on the vehicle or damage may occur and it would not be covered by the warranty.

## 5-70 Service and Appearance Care

---

Do not wash the vehicle in direct sunlight. Use a car washing soap. Do not use cleaning agents that are petroleum based or that contain acid or abrasives, as they can damage the paint, metal or plastic on the vehicle. Approved cleaning products can be obtained from your dealer/retailer. Follow all manufacturers' directions regarding correct product usage, necessary safety precautions and appropriate disposal of any vehicle care product.

Rinse the vehicle well, before washing and after to remove all cleaning agents completely. If they are allowed to dry on the surface, they could stain.

Dry the finish with a soft, clean chamois or an all-cotton towel to avoid surface scratches and water spotting.

High pressure car washes may cause water to enter the vehicle. Avoid using high pressure washes closer than 12 inches (30 cm) to the surface of the vehicle. Use of power washers exceeding 1,200 psi (8 274 kPa) can result in damage or removal of paint and decals.

### **Cleaning Exterior Lamps/Lenses**

Use only lukewarm or cold water, a soft cloth and a car washing soap to clean exterior lamps and lenses. Follow instructions under *Washing Your Vehicle* on page 5-69.

### **Finish Care**

Occasional waxing or mild polishing of the vehicle by hand may be necessary to remove residue from the paint finish. Approved cleaning products can be obtained from your dealer/retailer.

If the vehicle has a basecoat/clearcoat paint finish, the clearcoat gives more depth and gloss to the colored basecoat. Always use waxes and polishes that are non-abrasive and made for a basecoat/clearcoat paint finish.

**Notice:** Machine compounding or aggressive polishing on a basecoat/clearcoat paint finish may damage it. Use only non-abrasive waxes and polishes that are made for a basecoat/clearcoat paint finish on the vehicle.

Foreign materials such as calcium chloride and other salts, ice melting agents, road oil and tar, tree sap, bird droppings, chemicals from industrial chimneys, etc., can damage the vehicle's finish if they remain on painted surfaces. Wash the vehicle as soon as possible. If necessary, use non-abrasive cleaners that are marked safe for painted surfaces to remove foreign matter.

Exterior painted surfaces are subject to aging, weather and chemical fallout that can take their toll over a period of years. To help keep the paint finish looking new, keep the vehicle garaged or covered whenever possible.

### **Protecting Exterior Bright Metal Parts**

Bright metal parts should be cleaned regularly to keep their luster. Washing with water is all that is usually needed. However, chrome polish may be used on chrome or stainless steel trim, if necessary.

Use special care with aluminum trim. To avoid damaging protective trim, never use auto or chrome polish, steam or caustic soap to clean aluminum. A coating of wax, rubbed to high polish, is recommended for all bright metal parts.

### **Windshield and Wiper Blades**

Clean the outside of the windshield with glass cleaner.

Clean the rubber blades using a lint free cloth or paper towel soaked with windshield washer fluid or a mild detergent. Wash the windshield thoroughly when cleaning the blades. Bugs, road grime, sap, and a buildup of vehicle wash/wax treatments may cause wiper streaking. Replace the wiper blades if they are worn or damaged.

Wipers can be damaged by:

- Extreme dusty conditions
- Sand and salt
- Heat and sun
- Snow and ice, without proper removal

### Aluminum Wheels

**Notice:** Chrome wheels and other chrome trim may be damaged if the vehicle is not washed after driving on roads that have been sprayed with magnesium, calcium or sodium chloride. These chlorides are used on roads for conditions such as ice and dust. Always wash the vehicle's chrome with soap and water after exposure.

**Notice:** Using strong soaps, chemicals, abrasive polishes, cleaners, brushes, or cleaners that contain acid on aluminum or chrome-plated wheels, could damage the surface of the wheel(s). The repairs would not be covered by the warranty. Use only approved cleaners on aluminum or chrome-plated wheels.

Keep the wheels clean using a soft clean cloth with mild soap and water. Rinse with clean water. After rinsing thoroughly, dry with a soft clean towel. A wax may then be applied.

**Notice:** Using chrome polish on aluminum wheels could damage the wheels. The repairs would not be covered by the warranty. Use chrome polish on chrome wheels only.

The surface of these wheels is similar to the painted surface of the vehicle. Do not use strong soaps, chemicals, abrasive polishes, abrasive cleaners, cleaners with acid, or abrasive cleaning brushes on them because the surface could be damaged. Do not use chrome polish on aluminum wheels.

**Notice:** Driving the vehicle through an automatic car wash that has silicone carbide tire cleaning brushes, could damage the aluminum or chrome-plated wheels. The repairs would not be covered by the warranty. Never drive a vehicle equipped with aluminum or chrome-plated wheels through an automatic car wash that uses silicone carbide tire cleaning brushes.

### Tires

To clean the tires, use a stiff brush with tire cleaner.

**Notice:** Using petroleum-based tire dressing products on the vehicle may damage the paint finish and/or tires. When applying a tire dressing, always wipe off any overspray from all painted surfaces on the vehicle.

## Sheet Metal Damage

If the vehicle is damaged and requires sheet metal repair or replacement, make sure the body repair shop applies anti-corrosion material to parts repaired or replaced to restore corrosion protection.

Original manufacturer replacement parts will provide the corrosion protection while maintaining the vehicle warranty.

## Finish Damage

Any stone chips, fractures or deep scratches in the finish should be repaired right away. Bare metal will corrode quickly and may develop into major repair expense.

Minor chips and scratches can be repaired with touch-up materials available from your dealer/retailer. Larger areas of finish damage can be corrected in your dealer's/retailer's body and paint shop.

## Underbody Maintenance

Chemicals used for ice and snow removal and dust control can collect on the underbody. If these are not removed, corrosion and rust can develop on the underbody parts such as fuel lines, frame, floor pan, and exhaust system even though they have corrosion protection.

At least every spring, flush these materials from the underbody with plain water. Clean any areas where mud and debris can collect. Dirt packed in close areas of the frame should be loosened before being flushed. Your dealer/retailer or an underbody car washing system can do this.

## Chemical Paint Spotting

Some weather and atmospheric conditions can create a chemical fallout. Airborne pollutants can fall upon and attack painted surfaces on the vehicle. This damage can take two forms: blotchy, ring-shaped discolorations, and small, irregular dark spots etched into the paint surface.

Although no defect in the paint job causes this, we will repair, at no charge to the owner, the surfaces of new vehicles damaged by this fallout condition within 12 months or 12,000 miles (20 000 km) of purchase, whichever occurs first.

## Vehicle Identification

### Vehicle Identification Number (VIN)



This is the legal identifier for the vehicle. It appears on a plate in the front corner of the instrument panel, on the driver side. It can be seen through the windshield from outside the vehicle. The VIN also appears on the Vehicle Certification and Service Parts labels and the certificates of title and registration.

### Engine Identification

The eighth character in the VIN is the engine code. This code helps identify the vehicle's engine, specifications, and replacement parts. See "Engine Specifications" under *Capacities and Specifications on page 5-81* for the vehicle's engine code.

## Service Parts Identification Label

This label is on the inside of the glove box. It is very helpful if parts need to be ordered. The label has the following information:

- Vehicle Identification Number (VIN)
- Model designation
- Paint information
- Production options and special equipment

Do not remove this label from the vehicle.

## Electrical System

### Intermediate Voltage Devices and Wiring



Exposure to intermediate voltage can cause shock and burns. The intermediate voltage systems in the vehicle can only be serviced by technicians with special training.

Intermediate voltage devices are identified by labels. Do not remove, open, take apart, or modify these devices. Intermediate voltage cable or wiring has blue covering. Do not probe, tamper with, cut, or modify intermediate voltage cable or wiring.

## Add-On Electrical Equipment

**Notice:** Do not add anything electrical to the vehicle unless you check with your dealer/retailer first. Some electrical equipment can damage the vehicle and the damage would not be covered by the vehicle's warranty. Some add-on electrical equipment can keep other components from working as they should.

Add-on equipment can drain the vehicle's battery, even if the vehicle is not operating.

The vehicle has an airbag system. Before attempting to add anything electrical to the vehicle, see *Servicing Your Airbag-Equipped Vehicle* on page 1-54.

## Windshield Wiper Fuses

The windshield wiper motor is protected by a circuit breaker and a fuse. If the motor overheats due to heavy snow or ice, the wiper will stop until the motor cools. If the overload is caused by some electrical problem, have it fixed.

## Power Windows and Other Power Options

Circuit breakers in the fuse block protect the power windows and other power accessories. When the current load is too heavy, the circuit breaker opens and closes, protecting the circuit until the problem is fixed or goes away.

## Fuses and Circuit Breakers

The wiring circuits in your vehicle are protected from short circuits by fuses. This greatly reduces the chance of circuit overload and fire caused by electrical problems.

There are three fuse blocks - the main underhood fuse block, the auxiliary hybrid underhood fuse block and the instrument panel fuse block.

To identify and check fuses and relays, refer to the Fuse Usage Chart on the inside surface of the fuse panel door.





Fuses	Usage
ISRVM	Inside Rearview Mirror
CLUSTER	Instrument Panel Cluster
AIR BAG	Airbag System
OSRVM	Outside Rearview Mirror
KEY CAP	Key Capture Solenoid
WHL S/W	Steering Wheel Switch
F/DR LCK	Front Driver Door Lock
APO2	Accessory Power Outlet 2
BCM (VB3)	Body Control Module (BCM) (VB3)
DR LCK	Door Lock
BCM (VB6)	Body Control Module (VB6)
BCM (VB4)	Body Control Module (VB4)

Fuses	Usage
BCM (VB5)	Body Control Module (VB5)
TRL	Trailer
AIRCON	Air Conditioner
AUDIO	Audio
BCM (VB7)	Body Control Module (VB7)
IGN SW	Ignition Switch
AIR BAG	Air Bag System
WASHER	Washer Pump
APO1	Accessory Power Outlet 1
FSCM	Fuel Storage Control Module
RR CLR	Rear Closure
BCM (VB2)	Body Control Module (VB2)
DRL	Daytime Running Light
BCM (VB1)	Body Control Module (VB1)
ONSTAR	OnStar®

Relays	Usage
RELAY ACC/RAP	Accessory, Retained Accessory Power (RAP) Relay
RELAY RUN/C RANK	Run/Crank Relay

### Underhood Fuse Block

The underhood fuse block is located on the driver side of the engine compartment, near the battery.

**Notice:** Spilling liquid on any electrical components on the vehicle may damage it. Always keep the covers on any electrical component.



Fuses	Usage
AMP	Amplifier
HORN	Horn
ABS	Antilock Brake System Module
I/P BEC	Instrument Panel Bussed Electrical Center
FRT FOG	Front Fog Lamps
I/P BEC	Instrument Panel Bussed Electrical Center
DRL	Daytime Running Light
T/LAMP RT	Right Turn and Parking Lamps
T/LAMP LT	Left Turn and Parking Lamps
TRLR T/LAMP	Trailer Parking Lamps
HDLP HI LT	Passenger Side High-Beam Headlamp
STOP LP	Stoplamps
DEFOG	Defroster Fog

Fuses	Usage
HDLP LO RT	Driver Side Low-Beam Headlamp
HDLP LO LT	Passenger Side Low-Beam Headlamp
HDLP HI RT	Driver Side High-Beam Headlamp
OSRVM HTR	Outside Rearview Mirror Heating

Relays	Usage
FAN MAIN RLY	Cooling Fan Main Relay
FAN CTRL RLY	Cooling Fan Control Relay
FAN AUX RLY	Cooling Fan Auxiliary Relay
PWR/TRN RLY	Engine Control Module/CAM, Canister, Injectors, Electronic Throttle Control Relay

Relays	Usage
STRTR RLY	Starter Relay
RUN RLY	Run Relay
A/C CLTCH RLY	Air Conditioning Compressor Relay
WPR SPD RLY	Windshield Wiper Speed Relay
HORN RLY	Horn Relay
WPR CNTRL RLY	Windshield Wiper Control Relay
T/LAMP RLY	Parking Lamp Relay
HDLP HI RLY	High-Beam Headlamp Relay
HDLP LO RLY	Low-Beam Headlamp Relay
FRT FOG RLY	Front Foglamp Relay
STOP LP RLY	Stoplamp Relay
DEFOG RLY	Defogger Relay

## 5-80 Service and Appearance Care

---

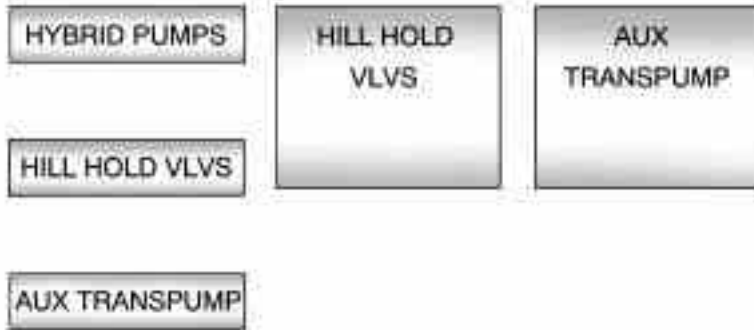

Fuses	Usage
HYBRID PUMPS	Hybrid Pumps
HILL HOLD VLVS	Hill Hold Valves
AUX TRANSPUMP	Auxiliary Transmission Pump

Relays	Usage
HILL HOLD VLVS	Hill Hold Valves
AUX TRANSPUMP	Auxiliary Transmission Pump

## Capacities and Specifications

Application	Capacities	
	English	Metric
Air Conditioning Refrigerant R134a	For the air conditioning system refrigerant charge amount, see the refrigerant caution label located under the hood. See your retailer for more information.	
Cooling System	9.5 qt	9.0 L
Engine Oil with Filter	5.0 qt	4.7 L
Fuel Tank	18.0 gal	68.1 L
Transmission (Bottom Pan Removal)	6.9 qt	6.5 L
Wheel Nut Torque	100 ft lb	140 N•m
All capacities are approximate. When adding, be sure to fill to the approximate level, as recommended in this manual. Recheck fluid level after filling.		

### Engine Specifications

Engine	VIN Code	Transmission	Spark Plug Gap
2.4L L4 Engine	Z	Automatic	0.040 in (1.01 mm)



# Maintenance Schedule

## Maintenance Schedule

Introduction .....	6-1
Maintenance Requirements .....	6-1
Your Vehicle and the Environment .....	6-2
Using the Maintenance Schedule .....	6-2
Scheduled Maintenance .....	6-3
Additional Required Services .....	6-5
Maintenance Footnotes .....	6-7
Owner Checks and Services .....	6-8

At Each Fuel Fill .....	6-8
At Least Once a Month .....	6-9
At Least Once a Year .....	6-9
Recommended Fluids and Lubricants .....	6-11
Maintenance Replacement Parts .....	6-12
Engine Drive Belt Routing .....	6-13
Maintenance Record .....	6-14

# Maintenance Schedule

## Introduction

**Important:** Keep engine oil at the proper level and change as recommended.

## Maintenance Requirements

**Notice:** Maintenance intervals, checks, inspections, replacement parts, and recommended fluids and lubricants as prescribed in this manual are necessary to keep this vehicle in good working condition. Any damage caused by failure to follow scheduled maintenance might not be covered by the vehicle warranty.

## 6-2 Maintenance Schedule

### Your Vehicle and the Environment

Proper vehicle maintenance not only helps to keep the vehicle in good working condition, but also helps the environment. All recommended maintenance is important. Improper vehicle maintenance can even affect the quality of the air we breathe. Improper fluid levels or the wrong tire inflation can increase the level of emissions from the vehicle. To help protect the environment, and to keep the vehicle in good condition, be sure to maintain the vehicle properly.

### Using the Maintenance Schedule

We want to help keep this vehicle in good working condition. But we do not know exactly how you will drive it. You might drive very short distances only a few times a week. Or you might drive long distances all the time in very hot, dusty weather. You might use

the vehicle in making deliveries. Or you might drive it to work, to do errands, or in many other ways.

Because of all the different ways people use their vehicles, maintenance needs vary. You might need more frequent checks and replacements. So please read the following and note how you drive. If you have any questions on how to keep the vehicle in good condition, see your dealer/retailer.

This schedule is for vehicles that:

- carry passengers and cargo within recommended limits on the Tire and Loading Information label. See *Loading the Vehicle on page 4-18*.
- are driven on reasonable road surfaces within legal driving limits.
- use the recommended fuel. See *Gasoline Octane on page 5-5*.

The services in *Scheduled Maintenance on page 6-3* should be performed when indicated. See *Additional Required Services*

*on page 6-5 and Maintenance Footnotes on page 6-7 for further information.*



Performing maintenance work on a vehicle can be dangerous. In trying to do some jobs, you can be seriously injured. Do your own maintenance work only if you have the required know-how and the proper tools and equipment for the job. If you have any doubt, see your dealer/retailer to have a qualified technician do the work. See *Doing Your Own Service Work on page 5-4*.

Some maintenance services can be complex. So, unless you are technically qualified and have the necessary equipment, have your dealer/retailer do these jobs.



When you go to your dealer/retailer for service, trained and supported service technicians will perform the work using genuine parts.

To purchase service information, see *Service Publications Ordering Information on page 7-13*.

*Owner Checks and Services on page 6-8* tells what should be checked, when to check it, and what can easily be done to help keep the vehicle in good condition.

The proper replacement parts, fluids, and lubricants to use are listed in *Recommended Fluids and Lubricants on page 6-11* and *Maintenance Replacement Parts on page 6-12*. When the vehicle is serviced, make sure these are used. All parts should be replaced and all necessary repairs done before you or anyone else drives the vehicle. We recommend the use of genuine parts from your dealer/retailer.

## Scheduled Maintenance

When the Change Engine Oil light displays, service is required for the vehicle. Have the vehicle serviced as soon as possible within the next 600 miles (1 000 km). It is possible that, if driving under the best conditions, the engine oil life system may not indicate that vehicle service is necessary for over a year. However, the engine oil and filter must be changed at least once a year and at this time the system must be reset. Your dealer/retailer has trained service technicians who will perform this work using genuine parts and reset the system.

If the engine oil life system is ever reset accidentally, service the vehicle within 3,000 miles (5 000 km) since the last service. Remember to reset the oil life system whenever the oil is changed. See *Engine Oil Life System on page 5-14* for information on the Engine Oil Life System and resetting the system.

When the Change Engine Oil light appears, certain services, checks, and inspections are required. Required services are described in the following for "Maintenance I" and "Maintenance II." Generally, it is recommended that the first service be Maintenance I, the second service be Maintenance II, and then alternate Maintenance I and Maintenance II thereafter. However, in some cases, Maintenance II may be required more often.

## 6-4 Maintenance Schedule

**Maintenance I** — Use Maintenance I if the Change Engine Oil light displays within 10 months since the vehicle was purchased or Maintenance II was performed.

**Maintenance II** — Use Maintenance II if the previous service performed was Maintenance I. Always use

Maintenance II whenever the light displays 10 months or more since the last service or if the light has not come on at all for one year.

### Scheduled Maintenance

Service	Maintenance I	Maintenance II
Change engine oil and filter. See <i>Engine Oil</i> on page 5-11. Reset oil life system. See <i>Engine Oil Life System</i> on page 5-14. An <i>Emission Control Service</i> .	•	•
Visually check for any leaks or damage. See footnote (j).	•	•
Inspect engine air cleaner filter. If necessary, replace filter. See <i>Engine Air Cleaner/Filter</i> on page 5-15. See footnote (l).		•
Rotate tires and check inflation pressures and wear. See <i>Tire Inspection and Rotation</i> on page 5-50 and “Tire Wear Inspection” in <i>At Least Once a Month</i> on page 6-9.	•	•
Inspect brake system. See footnote (a).	•	•
Check engine coolant and windshield washer fluid levels and add fluid as needed.	•	•
Perform any needed additional services. See “Additional Required Services” in this section.	•	•
Inspect suspension and steering components. See footnote (b).		•
Inspect engine cooling system. See footnote (c).		•

**Scheduled Maintenance (cont'd)**

Service	Maintenance I	Maintenance II
Inspect wiper blades. <i>See footnote (d).</i>		•
Inspect restraint system components. <i>See footnote (e).</i>		•
Lubricate body components. <i>See footnote (f).</i>		•
Replace passenger compartment air filter. <i>See footnote (k).</i>		•
Inspect throttle system. <i>See footnote (g).</i>		•

**Additional Required Services**

The following services should be performed at the first maintenance service (I or II) after the indicated miles (kilometers) shown for each item.

**Additional Required Services**

Service and Miles (Kilometers)	25,000 (40 000)	50,000 (80 000)	75,000 (120 000)	100,000 (160 000)	125,000 (200 000)	150,000 (240 000)
Inspect fuel system for damage or leaks.	•	•	•	•	•	•
Inspect exhaust system for loose or damaged components.	•	•	•	•	•	•
Replace engine air cleaner filter. <i>See Engine Air Cleaner/Filter on page 5-15.</i>		•		•		•
Change automatic transmission fluid (severe service). <i>See footnote (h).</i>		•		•		•

## 6-6 Maintenance Schedule

### Additional Required Services (cont'd)

Service and Miles (Kilometers)	25,000 (40 000)	50,000 (80 000)	75,000 (120 000)	100,000 (160 000)	125,000 (200 000)	150,000 (240 000)
Change automatic transmission fluid (normal service).				•		
Replace spark plugs. <i>An Emission Control Service.</i>				•		
Engine cooling system service (or every five years, whichever occurs first). <i>An Emission Control Service. See footnote (i).</i>						•
Inspect engine accessory drive belt. <i>An Emission Control Service. See footnote (m).</i>						•
Vehicles with DOT-4 brake fluid only: Change brake hydraulic fluid at a regular maintenance service every two years. <i>See footnote (n).</i>						

## Maintenance Footnotes

(a) *Visually inspect brake lines and hoses for proper hook-up, binding, leaks, cracks, chafing, etc. Inspect disc brake pads for wear and rotors for surface condition. Inspect other brake parts, including calipers, parking brake, etc.*

(b) *Visually inspect front and rear suspension and steering system for damaged, loose, or missing parts or signs of wear.*

(c) *Visually inspect hoses and have them replaced if they are cracked, swollen, or deteriorated. Inspect all pipes, fittings, and clamps; replace with genuine parts as needed. To help ensure proper operation, a pressure test of the cooling system and pressure cap and cleaning the outside of the radiator and air conditioning condenser is recommended at least once a year.*

(d) *Inspect wiper blades for wear, cracking, or contamination. Clean the windshield and wiper blades, if contaminated. Replace wiper blades that are worn or damaged. See Windshield Wiper Blade Replacement on page 5-38 and Windshield and Wiper Blades on page 5-71 for more information.*

(e) *Make sure the safety belt reminder light and safety belt assemblies are working properly. Look for any other loose or damaged safety belt system parts. If you see anything that might keep a safety belt system from doing its job, have it repaired. Have any torn or frayed safety belts replaced. Also see Checking the Restraint Systems on page 1-56.*

(f) *Lubricate all key lock cylinders, door hinges and latches, hood hinges and latches, glove box hinges, sunroof (if equipped), and any folding seat hardware. More frequent lubrication may be required when exposed to a corrosive*

*environment. Applying silicone grease on weatherstrips with a clean cloth will make them last longer, seal better, and not stick or squeak.*

(g) *Check system for interference or binding and for damaged or missing parts. Replace parts as needed. Replace any components that have high effort or excessive wear.*

(h) *Severe service is when the vehicle is mainly driven under one or more of these conditions:*

- In heavy city traffic where the outside temperature regularly reaches 90°F (32°C) or higher.*
- In hilly or mountainous terrain.*
- When doing frequent trailer towing.*
- Uses such as found in taxi, police, or delivery service.*

(i) *Drain, flush, and refill cooling system. This service can be complex; you should have your dealer/retailer perform this service.*

## 6-8 Maintenance Schedule

---

See *Engine Coolant* on page 5-20 for what to use. Inspect hoses. Clean radiator, condenser, pressure cap, and filler neck. Pressure test the cooling system and pressure cap.

(j) A fluid loss in any vehicle system could indicate a problem. Have the system inspected and repaired and the fluid level checked. Add fluid if needed.

(k) Or every 12 months, whichever occurs first. If driving regularly under dusty conditions, the filter may require replacement more often.

(l) If driving regularly under dusty conditions, inspect the filter at each engine oil change.

(m) Visually inspect belt for fraying, excessive cracks, or obvious damage. Replace belt if necessary.

(n) Vehicles using DOT-4 brake fluid only: Drain, flush, and refill brake hydraulic system at a regular maintenance service (I or II) every two years. This service can be complex; you should have

your dealer/retailer perform this service. See *Brakes* on page 5-25 and *Recommended Fluids and Lubricants* on page 6-11.

### Owner Checks and Services

These owner checks and services should be performed at the intervals specified to help ensure vehicle safety, dependability, and emission control performance. Your dealer/retailer can assist with these checks and services.

Be sure any necessary repairs are completed at once. Whenever any fluids or lubricants are added to the vehicle, make sure they are the proper ones, as shown in *Recommended Fluids and Lubricants* on page 6-11.

### At Each Fuel Fill

It is important to perform these underhood checks at each fuel fill.

#### Engine Oil Level Check

**Notice:** It is important to check the engine oil regularly and keep it at the proper level. Failure to keep the engine oil at the proper level can cause damage to the engine not covered by the vehicle warranty.

Check the engine oil level and add the proper oil if necessary. See *Engine Oil* on page 5-11.

#### Engine Coolant Level Check

Check the engine coolant level and add DEX-COOL<sup>®</sup> coolant mixture if necessary. See *Engine Coolant* on page 5-20.

### Windshield Washer Fluid Level Check

Check the windshield washer fluid level in the windshield washer fluid reservoir and add the proper fluid if necessary.

### At Least Once a Month Tire Inspection and Inflation Check

Inspect the vehicle's tires for wear and make sure they are inflated to the correct pressures. See *Inflation - Tire Pressure on page 5-43*.

### At Least Once a Year Starter Switch Check

#### CAUTION

When you are doing this inspection, the vehicle could move suddenly. If the vehicle moves, you or others could be injured.

1. Before starting this check, be sure there is enough room around the vehicle.
2. Firmly apply both the parking brake and the regular brake. See *Parking Brake on page 2-22*. Do not use the accelerator pedal, and be ready to turn off the engine immediately if it starts.
3. Try to start the engine in each gear. The vehicle should start only in P (Park) or N (Neutral). If the vehicle starts in any other position, contact your dealer/retailer for service.

### Automatic Transmission Shift Lock Control System Check

#### CAUTION

When you are doing this inspection, the vehicle could move suddenly. If the vehicle moves, you or others could be injured.

1. Before starting this check, be sure there is enough room around the vehicle. It should be parked on a level surface.
2. Firmly apply the parking brake. See *Parking Brake on page 2-22*. Be ready to apply the regular brake immediately if the vehicle begins to move.
3. With the engine off, turn the ignition to ON/RUN, but do not start the engine. Without applying the regular brake, try to move the shift lever out of P (Park) with normal effort. If the

## 6-10 Maintenance Schedule

---

shift lever moves out of P (Park), contact your dealer/retailer for service.

### Ignition Transmission Lock Check

While parked, and with the parking brake set, try to turn the ignition to LOCK/OFF in each shift lever position.

- The ignition should turn to LOCK/OFF only when the shift lever is in P (Park).
- The ignition key should come out only in LOCK/OFF.

Contact your dealer/retailer if service is required.

### Parking Brake and Automatic Transmission P (Park) Mechanism Check



When you are doing this check, the vehicle could begin to move. You or others could be injured and property could be damaged. Make sure there is room in front of the vehicle in case it begins to roll. Be ready to apply the regular brake at once should the vehicle begin to move.

Park on a fairly steep hill, with the vehicle facing downhill. Keeping your foot on the regular brake, set the parking brake.

- To check the parking brake's holding ability: With the engine running and the transmission in N (Neutral), slowly remove foot pressure from the regular brake pedal. Do this until the vehicle is held by the parking brake only.

- To check the P (Park) mechanism's holding ability: With the engine running, shift to P (Park). Then release the parking brake followed by the regular brake.

Contact your dealer/retailer if service is required.

### Underbody Flushing Service

At least every spring, use plain water to flush any corrosive materials from the underbody. Take care to clean thoroughly any areas where mud and other debris can collect.

### Tire Sealant and Compressor Kit

Check the sealant expiration date printed on the instruction label of the Tire Sealant and Compressor Kit at least once a year. See your dealer/retailer for a replacement canister.



## Recommended Fluids and Lubricants

Fluids and lubricants identified below by name, part number, or specification can be obtained from your dealer/retailer.

Usage	Fluid/Lubricant
Engine Oil	Engine oil which meets GM Standard GM6094M and displays the American Petroleum Institute Certified for Gasoline Engines starburst symbol. To determine the proper viscosity for your vehicle's engine, see <i>Engine Oil on page 5-11</i> .
Engine Coolant	50/50 mixture of clean, drinkable water and use only DEX-COOL <sup>®</sup> Coolant. See <i>Engine Coolant on page 5-20</i> .
Hydraulic Brake System	Vehicles with DOT-3 brake fluid only: Delco <sup>®</sup> Supreme 11 Brake Fluid or equivalent DOT-3 brake fluid. Vehicles with DOT-4 brake fluid only: DOT-4 Brake Fluid (GM Part No. U.S. 88862828, in Canada 88862829).
Windshield Washer	Optikleen <sup>®</sup> Washer Solvent.
Parking Brake Cable Guides	Chassis Lubricant (GM Part No. 12377985, in Canada 88901242) or lubricant meeting requirements of NLGI #2, Category LB or GC-LB.
Automatic Transmission	DEXRON <sup>®</sup> -VI Automatic Transmission Fluid.
Key Lock Cylinders	Multi-Purpose Lubricant, Superlube (GM Part No. U.S. 12346241, in Canada 10953474).
Hood Latch Assembly, Secondary Latch, Pivots, Spring Anchor, and Release Pawl	Lubriplate Lubricant Aerosol (Saturn Part No. 21038869 or GM Part No. U.S. 12346293, in Canada 992723) or lubricant meeting requirements of NLGI #2, Category LB or GC-LB.
Hood, Liftgate Door, and Rear Folding Seat Hinges	Multi-Purpose Lubricant, Superlube (GM Part No. U.S. 12346241, in Canada 10953474).

## 6-12 Maintenance Schedule

---

Usage	Fluid/Lubricant
Sunroof Track	Lubriplate Lubricant Aerosol (Saturn Part No. 21038869 or GM Part No. U.S. 12346293, in Canada 992723) or lubricant meeting requirements of NLGI #2, Category LB or GC-LB.
Weatherstrip Conditioning	Weatherstrip Lubricant (GM Part No. U.S. 3634770, in Canada 10953518) or Dielectric Silicone Grease (GM Part No. U.S. 12345579, in Canada 992887).

## Maintenance Replacement Parts

Replacement parts identified below by name, part number, or specification can be obtained from your retailer.

Part	GM Part Number	ACDelco Part Number
Engine Air Cleaner/Filter	96815102	—
Engine Oil Filter	12605566	PF457G
Passenger Compartment Air Filter Element	19130294	—
Spark Plugs	12625058	41-103
Wiper Blades		
Driver Side – 24 in (60.0 cm)	25925618	—
Passenger Side – 16 in (40.0 cm)	25925620	—
Rear – 12.0 in (30.0 cm)	96624648	—

## Engine Drive Belt Routing

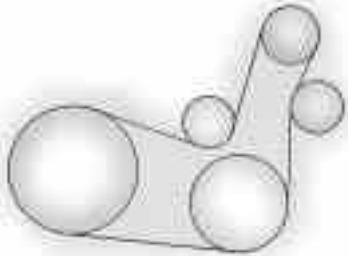

The engine drive belt on this hybrid vehicle is under a higher tension than the engine drive belt on a non-hybrid vehicle and requires a special tool to service. See your dealer/retailer for service.







## Customer Assistance Information

### Customer Assistance and Information

Customer Satisfaction Procedure .....	7-1
Online Owner Center .....	7-4
Customer Assistance for Text Telephone (TTY) Users .....	7-4
Customer Assistance Offices .....	7-5
GM Mobility Reimbursement Program ...	7-5
Roadside Assistance Program .....	7-5
Scheduling Service Appointments .....	7-7
Courtesy Transportation .....	7-8
Collision Damage Repair .....	7-9

### Reporting Safety Defects

Reporting Safety Defects to the United States Government .....	7-12
Reporting Safety Defects to the Canadian Government .....	7-12
Reporting Safety Defects to Saturn .....	7-13
Service Publications Ordering Information .....	7-13

### Vehicle Data Recording and Privacy

Vehicle Data Recording and Privacy .....	7-14
Event Data Recorders .....	7-14
OnStar® .....	7-15
Navigation System .....	7-15
Radio Frequency Identification (RFID) .....	7-15

## Customer Assistance and Information

### Customer Satisfaction Procedure

Your satisfaction and goodwill are important to your retailer and to Saturn. Together we are committed to providing our customers with unparalleled service, before, during, and after the purchase of a Saturn vehicle, for total customer satisfaction. We call this the Saturn Difference. Normally, any concerns with the sales transaction or the operation of the vehicle are resolved by the retailer's sales or service departments. If, for any reason, your ownership experience falls below your expectations, we suggest you take the following action:

**STEP ONE:** Contact the Retail Customer Assistance Liaison. Any member of the retail management team has the authority and the desire to resolve your concerns.

## 7-2 Customer Assistance Information

---

Normally, concerns can be quickly resolved at this level.

**STEP TWO:** Should you need additional assistance, in the U.S., contact the Saturn Customer Assistance Center by calling 1-800-553-6000. In Canada, call the Saturn Customer Communication Centre at 1-800-263-1999. A Saturn Customer Assistance Center team member will handle your call and assist in providing product and warranty information, the nearest retailer location, roadside assistance, brochures, literature and discuss any concerns you may have.

We encourage you to call the toll-free number in order to give your inquiry prompt attention. Please have the following information available to give the Customer Assistance Representative:

- Vehicle Identification Number (VIN). This 17-digit number can be found on the vehicle registration or title, on the upper

driver side corner of the instrument panel, or on your roadside assistance key card.

- The name of your selling and servicing retail facility.
- Vehicle delivery date and present mileage.
- Your daytime and evening phone numbers.

When contacting Saturn, please remember that your concern will likely be resolved at a retailer's facility. That is why we suggest you follow Step One first.

**STEP THREE (U.S. Owners):** Both Saturn and its retailers are committed to making sure you are completely satisfied with your Saturn vehicle. However, if you continue to remain unsatisfied after following the procedure outlined in Steps One and Two, Saturn and its retailers offer the additional

assistance of a neutral party through our voluntary participation in a mediation/arbitration program called Better Business Bureau (BBB) Auto Line.

The BBB Auto Line Program is an out-of-court program administered by the Council of Better Business Bureaus to settle automotive disputes regarding vehicle repairs or the interpretation of the New Vehicle Limited Warranty. This program is available at no cost to you, our customer.

Although you may be required to resort to this informal dispute resolution program prior to filing a court action, use of the program is free of charge and your case is generally heard within 40 days. If you do not agree with the decision given in your case, you can reject it and proceed with any other venue for relief available to you.



Contact the BBB Auto Line Program by using the toll-free telephone number or by writing them at the following address:

BBB Auto Line Program  
Council of Better Business  
Bureaus, Inc.  
4200 Wilson Boulevard  
Suite 800  
Arlington, VA 22203-1838  
Telephone: 1-800-955-5100  
dr.bbb.org/goauto

This program is available in all 50 states and the District of Columbia. Eligibility is limited by vehicle age, mileage and other factors. Saturn Corporation reserves the right to change eligibility limitations and/or discontinue its participation in this program.

**STEP THREE (Canadian Owners):**

**General Motors Participation in the Mediation/Arbitration Program**

In the event that you do not feel your concerns have been addressed after following the procedure outlined in Steps 1 and 2, General Motors of Canada Limited has committed to binding arbitration of owner disputes involving factory-related vehicle service claims. The program provides for the review of the facts involved by an impartial third party arbiter, and may include an informal hearing before the arbiter. The program is designed so that the entire dispute settlement process, from the time you file your complaint to the final decision, should be completed in approximately 70 days. We believe our impartial program offers advantages over courts in most jurisdictions because it is informal, quick, and free of charge.

For further information concerning eligibility in the Canadian Motor Vehicle Arbitration Plan (CAMVAP), call toll-free 1-800-207-0685. Alternatively, you may call the Saturn Customer Communication Centre, 1-800-263-1999, or you may write to:

Mediation/Arbitration Program  
c/o Customer Communication  
Centre  
General Motors of Canada Limited  
Mail Code: CA1-163-005  
1908 Colonel Sam Drive  
Oshawa, Ontario L1H 8P7  
Telephone: 1-800-955-5100

Your inquiry should be accompanied by the Vehicle Identification Number (VIN).

## 7-4 Customer Assistance Information

---

### Online Owner Center

**Online Owner Center (U.S.)** — [www.gmownercenter.com/saturn](http://www.gmownercenter.com/saturn)

Information and services customized for your specific vehicle — all in one convenient place.

- Digital owner manual, warranty information, and more
- Online service and maintenance records
- Find Saturn retailers for service nationwide
- Exclusive privileges and offers
- Recall notices for your specific vehicle
- OnStar® and GM Cardmember Services Earnings summaries

#### Other Helpful Links:

Saturn – [www.saturn.com](http://www.saturn.com)

Saturn Merchandise — [www.saturncollection.com](http://www.saturncollection.com)

Help Center — [www.saturn.com/helpcenter](http://www.saturn.com/helpcenter)

- FAQ
- Contact Us

### My GM Canada (Canada) — [www.gm.ca](http://www.gm.ca)

My GM Canada is a password-protected section of [www.gm.ca](http://www.gm.ca) where you can save information on GM vehicles, get personalized offers, and use handy tools and forms with greater ease.

Here are a few of the valuable tools and services you will have access to:

- My Showroom: Find and save information on vehicles and current offers in your area.
- My Dealers/Retailers: Save details such as address and phone number for each of your preferred GM dealers/retailers.
- My Driveway: Access quick links to parts and service estimates, check trade-in values, or schedule

a service appointment by adding the vehicles you own to your driveway profile.

- My Preferences: Manage your profile and use tools and forms with greater ease.

To sign up, visit the My GM Canada section within [www.gm.ca](http://www.gm.ca).

### Customer Assistance for Text Telephone (TTY) Users

To assist owners who have hearing difficulties, Saturn has installed special TDD (Telecommunication Devices for the Deaf) equipment in its Saturn Customer Assistance Center.

Any hearing or speech-impaired customer who has access to a TDD or to a conventional Text Telephone (TTY) can communicate with Saturn by dialing 1-800-TDD-6000. TTY users in Canada may dial 1-800-263-3830.

## Customer Assistance Offices

Saturn encourages customers to call the toll-free number for assistance. If a customer wishes to write to Saturn, the letter should be addressed to:

Saturn Customer Assistance Center  
P.O. Box 33173  
Detroit, MI 48232-5173

1-800-553-6000  
1-800-833-6000 (For Text Telephone devices (TTYs))  
Roadside Assistance:  
1-800-553-6000

In Canada, write to:

Saturn Customer Communication Centre  
General Motors of Canada Ltd.  
CA1-163-005  
1908 Colonel Sam Drive  
Oshawa, Ontario L1H 8P7  
GMcanada.com  
1-800-263-1999  
1-800-263-3830 (For Text Telephone devices (TTYs))  
Roadside Assistance:  
1-800-268-6800

## GM Mobility Reimbursement Program



This program, available to qualified applicants, can reimburse you up to \$1,000 toward eligible aftermarket driver or passenger adaptive equipment you may require for your vehicle such as hand controls, wheelchair/scooter lifts, etc.

The offer is available for a limited period of time from the date of vehicle purchase/lease.

For more details, or to determine your vehicle's eligibility, visit your Saturn retailer or call the Saturn Customer Assistance Center at 1-800-553-6000. Text telephone (TTY) users, call 1-800-833-6000.

In Canada, customers may call the Saturn Customer Communication Centre at 1-800-263-1999. TTY users in Canada may call 1-800-263-3830.

## Roadside Assistance Program

For U.S. purchased vehicles, call **1-800-553-6000; (Text Telephone (TTY): 1-800-889-2438)**.

For Canadian purchased vehicles, call **1-800-268-6800**.

Service is available 24 hours a day, 365 days a year.

## Calling for Assistance

When calling Roadside Assistance, have the following information ready:

- Your name, home address, and home telephone number
- Telephone number of your location
- Location of the vehicle

## 7-6 Customer Assistance Information

---

- Model, year, color, and license plate number of the vehicle
- Odometer reading, Vehicle Identification Number (VIN), and delivery date of the vehicle
- Description of the problem

### Coverage

Services are provided up to 5 years/100,000 miles (160 000 km), whichever comes first.

In the U.S., anyone driving the vehicle is covered. In Canada, a person driving the vehicle without permission from the owner is not covered.

Roadside Assistance is not a part of the New Vehicle Limited Warranty. Saturn and General Motors of Canada Limited reserve the right to make any changes or discontinue the Roadside Assistance program at any time without notification.

Saturn and General Motors of Canada Limited reserve the right to limit services or payment to an

owner or driver if they decide the claims are made too often, or the same type of claim is made many times.

### Services Provided

- **Emergency Fuel Delivery:** Delivery of enough fuel for the vehicle to get to the nearest service station.
- **Lock-Out Service:** Service is provided to unlock the vehicle if you are locked out. A remote unlock may be available if you have OnStar<sup>®</sup>. For security reasons, the driver must present identification before this service is given.
- **Emergency Tow From a Public Road or Highway:** Tow to the nearest Saturn retailer for warranty service, or if the vehicle was in a crash and cannot be driven. Assistance is also given when the vehicle is stuck in sand, mud, or snow.

- **Flat Tire Change:** Service is provided to change a flat tire with the spare tire. The spare tire, if equipped, must be in good condition and properly inflated. It is the owner's responsibility for the repair or replacement of the tire if it is not covered by the warranty.
- **Battery Jump Start:** Service is provided to jump start a dead battery.
- **Trip Interruption Benefits and Assistance:** If your trip is interrupted due to a warranty failure, incidental expenses may be reimbursed during the 5 years/100,000 miles (160 000 km) Powertrain warranty period. Items considered are hotel, meals, and rental car.

### Services Not Included in Roadside Assistance

- Impound towing caused by violation of any laws.
- Legal fines.

- Mounting, dismounting or changing of snow tires, chains, or other traction devices.
- Towing or services for vehicles driven on a non-public road or highway.

### Services Specific to Canadian Purchased Vehicles

- **Fuel delivery:** Reimbursement is approximately \$5 Canadian. Diesel fuel delivery may be restricted. Propane and other fuels are not provided through this service.
- **Lock-Out Service:** Vehicle registration is required.
- **Trip Routing Service:** Detailed maps of North America are provided when requested either with the most direct route or the most scenic route. There is a limit of six requests per year. Additional travel information is also available. Allow three weeks for delivery.

- **Trip Interruption Benefits and Assistance:** Must be over 250 kilometres from where your trip was started to qualify. General Motors of Canada Limited requires pre-authorization, original detailed receipts, and a copy of the repair orders. Once authorization has been received, the Roadside Assistance advisor will help you make arrangements and explain how to receive payment.
- **Alternative Service:** If assistance cannot be provided right away, the Roadside Assistance advisor may give you permission to get local emergency road service. You will receive payment, up to \$100, after sending the original receipt to Roadside Assistance. Mechanical failures may be covered, however any cost for parts and labor for repairs not covered by the warranty are the owner responsibility.

### Scheduling Service Appointments

When your vehicle requires warranty service, contact your dealer/retailer and request an appointment. By scheduling a service appointment and advising your service consultant of your transportation needs, your dealer/retailer can help minimize your inconvenience.

If your vehicle cannot be scheduled into the service department immediately, keep driving it until it can be scheduled for service, unless, of course, the problem is safety-related. If it is, please call your dealership/retailer, let them know this, and ask for instructions.

If the dealer/retailer requests you to bring the vehicle for service, you are urged to do so as early in the work day as possible to allow for the same day repair.

## 7-8 Customer Assistance Information

---

### Courtesy Transportation

To enhance your ownership experience, we and our participating retailers are proud to offer Courtesy Transportation, a customer support program for vehicles with the Bumper to Bumper (Base Warranty Coverage period in Canada), extended powertrain, and hybrid specific warranties in both the U.S. and Canada.

Several courtesy transportation options are available to assist in reducing your inconvenience when warranty repairs are required.

Courtesy Transportation is not a part of the New Vehicle Limited Warranty. A separate booklet entitled "Warranty and Owner Assistance Information" furnished with each new vehicle provides detailed warranty coverage information.

### Transportation Options

Warranty service can generally be completed while you wait. However, if you are unable to wait, Saturn helps to minimize your inconvenience by providing several transportation options. Depending on the circumstances, your retailer can offer you one of the following:

#### Shuttle Service

Shuttle service is the preferred means of offering Courtesy Transportation. Retailers may provide you with shuttle service to get you to your destination with minimal interruption of your daily schedule. This includes one-way or round trip shuttle service within reasonable time and distance parameters of the retailer's area.

#### Public Transportation or Fuel Reimbursement

If your vehicle requires overnight warranty repairs, and public transportation is used instead of the

retailer's shuttle service, the expense must be supported by original receipts and can only be up to the maximum amount allowed by Saturn for shuttle service. In addition, for U.S. customers, should you arrange transportation through a friend or relative, limited reimbursement for reasonable fuel expenses may be available. Claim amounts should reflect actual costs and be supported by original receipts. See your retailer for information regarding the allowance amounts for reimbursement of fuel or other transportation costs.

#### Courtesy Rental Vehicle

Your retailer may arrange to provide you with a courtesy rental vehicle or reimburse you for a rental vehicle that you obtain if your vehicle is kept for an overnight warranty repair. Rental reimbursement will be limited and must be supported by original receipts. This requires that you sign and complete a rental agreement

and meet state/ provincial, local, and rental vehicle provider requirements. Requirements vary and may include minimum age requirements, insurance coverage, credit card, etc. You are responsible for fuel usage charges and may also be responsible for taxes, levies, usage fees, excessive mileage, or rental usage beyond the completion of the repair.

It may not be possible to provide a like-vehicle as a courtesy rental.

### **Additional Program Information**

All program options, such as shuttle service, may not be available at every retailer. Please contact your retailer for specific information about availability. All Courtesy Transportation arrangements will be administered by appropriate retailer personnel.

*Saturn reserves the right to unilaterally modify, change or discontinue Courtesy Transportation*

*at any time and to resolve all questions of claim eligibility pursuant to the terms and conditions described herein at its sole discretion.*

### **Collision Damage Repair**

If your vehicle is involved in a collision and it is damaged, have the damage repaired by a qualified technician using the proper equipment and quality replacement parts. Poorly performed collision repairs diminish your vehicle's resale value, and safety performance can be compromised in subsequent collisions.

### **Collision Parts**

Genuine GM Collision parts are new parts made with the same materials and construction methods as the parts with which your vehicle was originally built. Genuine GM Collision parts are your best choice to ensure that your vehicle's designed appearance, durability, and safety are preserved. The use

of Genuine GM parts can help maintain your GM New Vehicle Warranty.

Recycled original equipment parts may also be used for repair. These parts are typically removed from vehicles that were total losses in prior crashes. In most cases, the parts being recycled are from undamaged sections of the vehicle. A recycled original equipment GM part, may be an acceptable choice to maintain your vehicle's originally designed appearance and safety performance, however, the history of these parts is not known. Such parts are not covered by your GM New Vehicle Limited Warranty, and any related failures are not covered by that warranty.

Aftermarket collision parts are also available. These are made by companies other than GM and may not have been tested for your vehicle. As a result, these parts may fit poorly, exhibit premature durability/corrosion problems, and

## 7-10 Customer Assistance Information

---

may not perform properly in subsequent collisions. Aftermarket parts are not covered by your GM New Vehicle Limited Warranty, and any vehicle failure related to such parts are not covered by that warranty.

### Repair Facility

We recommend that you choose a collision repair facility that meets your needs before you ever need collision repairs. Your dealer/retailer may have a collision repair center with GM-trained technicians and state of the art equipment, or be able to recommend a collision repair center that has GM-trained technicians and comparable equipment.

### Insuring Your Vehicle

Protect your investment in your GM vehicle with comprehensive and collision insurance coverage. There are significant differences in the quality of coverage afforded by various insurance policy terms.

Many insurance policies provide reduced protection to your GM vehicle by limiting compensation for damage repairs by using aftermarket collision parts. Some insurance companies will not specify aftermarket collision parts. When purchasing insurance, we recommend that you assure your vehicle will be repaired with GM original equipment collision parts. If such insurance coverage is not available from your current insurance carrier, consider switching to another insurance carrier.

If your vehicle is leased, the leasing company may require you to have insurance that assures repairs with Genuine GM Original Equipment Manufacturer (OEM) parts or Genuine Manufacturer replacement parts. Read your lease carefully, as you may be charged at the end of your lease for poor quality repairs.

### If a Crash Occurs

Here is what to do if you are involved in a crash.

- Check to make sure that you are all right. If you are uninjured, make sure that no one else in your vehicle, or the other vehicle, is injured.
- If there has been an injury, call emergency services for help. Do not leave the scene of a crash until all matters have been taken care of. Move your vehicle only if its position puts you in danger or you are instructed to move it by a police officer.
- Give only the necessary and requested information to police and other parties involved in the crash. Do not discuss your personal condition, mental frame of mind, or anything unrelated to the crash. This will help guard against post-crash legal action.



- If you need roadside assistance, call GM Roadside Assistance. See *Roadside Assistance Program* on page 7-5 for more information.
- If your vehicle cannot be driven, know where the towing service will be taking it. Get a card from the tow truck operator or write down the driver's name, the service's name, and the phone number.
- Remove any valuables from your vehicle before it is towed away. Make sure this includes your insurance information and registration if you keep these items in your vehicle.
- Gather the important information you will need from the other driver. Things like name, address, phone number, driver's license number, vehicle license plate, vehicle make, model and model year, Vehicle Identification Number (VIN), insurance company and policy

number, and a general description of the damage to the other vehicle.

- If possible, call your insurance company from the scene of the crash. They will walk you through the information they will need. If they ask for a police report, phone or go to the police department headquarters the next day and you can get a copy of the report for a nominal fee. In some states/provinces with "no fault" insurance laws, a report may not be necessary. This is especially true if there are no injuries and both vehicles are driveable.
- Choose a reputable collision repair facility for your vehicle. Whether you select a dealer/retailer or a private collision repair facility to fix the damage, make sure you are comfortable with them. Remember, you will have to feel comfortable with their work for a long time.

- Once you have an estimate, read it carefully and make sure you understand what work will be performed on your vehicle. If you have a question, ask for an explanation. Reputable shops welcome this opportunity.

### **Managing the Vehicle Damage Repair Process**

In the event that your vehicle requires damage repairs, GM recommends that you take an active role in its repair. If you have a pre-determined repair facility of choice, take your vehicle there, or have it towed there. Specify to the facility that any required replacement collision parts be original equipment parts, either new Genuine GM parts or recycled original GM parts. Remember, recycled parts will not be covered by your GM vehicle warranty.

## 7-12 Customer Assistance Information

---

Insurance pays the bill for the repair, but you must live with the repair. Depending on your policy limits, your insurance company may initially value the repair using aftermarket parts. Discuss this with your repair professional, and insist on Genuine GM parts. Remember if your vehicle is leased you may be obligated to have the vehicle repaired with Genuine GM parts, even if your insurance coverage does not pay the full cost.

If another party's insurance company is paying for the repairs, you are not obligated to accept a repair valuation based on that insurance company's collision policy repair limits, as you have no contractual limits with that company. In such cases, you can have control of the repair and parts choices as long as cost stays within reasonable limits.

### **Reporting Safety Defects**

#### **Reporting Safety Defects to the United States Government**

If you believe that your vehicle has a defect which could cause a crash or could cause injury or death, you should immediately inform the National Highway Traffic Safety Administration (NHTSA), in addition to notifying Saturn Corporation.

If NHTSA receives similar complaints, it could open an investigation, and if it finds that a safety defect exists in a group of vehicles, it could order a recall and remedy campaign. However, NHTSA cannot become involved in individual problems between you, your retailer or Saturn Corporation.

To contact NHTSA, call the Vehicle Safety Hotline toll-free at 1-888-327-4236 (TTY: 1-800-424-9153); go to [Safercar.gov](http://Safercar.gov); or write to:

Administrator, NHTSA  
1200 New Jersey Avenue, S.E.  
Washington D.C., 20590

You can also obtain other information about motor vehicle safety from [Safercar.gov](http://Safercar.gov).

#### **Reporting Safety Defects to the Canadian Government**

If you live in Canada, and you believe that your vehicle has a safety defect, notify Transport Canada immediately, in addition to notifying General Motors of Canada Limited. Call them at 1-800-333-0510 or write to:

Transport Canada  
Road Safety Branch  
2780 Sheffield Road  
Ottawa, Ontario K1B 3V9

## Reporting Safety Defects to Saturn

In addition to notifying NHTSA (or Transport Canada) in a situation like this, please notify Saturn.

Call 1-800-553-6000, or write:

Saturn Corporation  
100 Saturn Parkway  
Mail Drop 371-999-S24  
Spring Hill, TN 37174-1500

In Canada, call 1-800-263-1999,  
or write:

Saturn Customer Communication  
Centre  
General Motors of Canada Limited  
CA1-163-005  
1908 Colonel Sam Drive  
Oshawa, Ontario L1H 8P7

## Service Publications Ordering Information

### Service Manuals

A variety of publications are available to you. Saturn service manuals are written for trained technicians, and in some cases, specialized tools and equipment are necessary to complete certain repairs. However, the manuals are available to owners who either have the training, or wish to gain a greater understanding of the technical aspect of their Saturn.

For additional publications information or to order publications in the United States, call toll free 1-800-2-SATURN or visit [Saturn-publications.com](http://Saturn-publications.com) to order on-line.

In Canada, Saturn service manuals are available by calling toll free 1-800-551-4123.

## Owner Publications

Information on how to obtain product bulletins and as described below is applicable only in the fifty U.S. states and the District of Columbia, and only for cars and light trucks with a Gross Vehicle Weight Rating (GVWR) less than 10,000 pounds (4 536 kg). Copies of individual bulletins are also at your participating Saturn retailer. You can ask to see them.

In Canada, information relating to product service bulletins can be obtained by contacting your Saturn retailer.

### Service Bulletins

Saturn regularly sends its retailers useful service bulletins about Saturn products. Saturn monitors product performance in the field. We then prepare bulletins for servicing our products better. You can get these bulletins, too.

Bulletins cover various subjects. Some pertain to the proper use and care of your vehicle. Some describe costly repairs. Others describe inexpensive repairs which, if done on time with the latest parts, may avoid future costly repairs.

Some bulletins tell a technician how to repair a new or unexpected condition. Others describe a quicker way to fix your vehicle. They can help a technician service your vehicle better.

Most bulletins apply to conditions affecting a small number of vehicles. Your Saturn retailer or a qualified technician may have to determine if a specific bulletin applies to your vehicle. To order Saturn bulletins, call Saturn Publications at 1-800-2-SATURN or visit [saturn-publications.com](http://saturn-publications.com) to order online.

### Vehicle Data Recording and Privacy

Your Saturn vehicle has a number of sophisticated computers that record information about the vehicle's performance and how it is driven. For example, your vehicle uses computer modules to monitor and control engine and transmission performance, to monitor the conditions for airbag deployment and deploy airbags in a crash and, if so equipped, to provide antilock braking to help the driver control the vehicle. These modules may store data to help your dealer/retailer technician service your vehicle. Some modules may also store data about how you operate the vehicle, such as rate of fuel consumption or average speed. These modules may also retain the owner's personal preferences, such as radio pre-sets, seat positions, and temperature settings.

### Event Data Recorders

This vehicle has an Event Data Recorder (EDR). The main purpose of an EDR is to record, in certain crash or near crash-like situations, such as an airbag deployment or hitting a road obstacle, data that will assist in understanding how a vehicle's systems performed. The EDR is designed to record data related to vehicle dynamics and safety systems for a short period of time, typically 30 seconds or less. The EDR in this vehicle is designed to record such data as:

- How various systems in your vehicle were operating
- Whether or not the driver and passenger safety belts were buckled/fastened
- How far, if at all, the driver was pressing the accelerator and/or brake pedal
- How fast the vehicle was traveling

This data can help provide a better understanding of the circumstances in which crashes and injuries occur.

**Important:** EDR data is recorded by your vehicle only if a non-trivial crash situation occurs; no data is recorded by the EDR under normal driving conditions and no personal data (e.g., name, gender, age, and crash location) is recorded. However, other parties, such as law enforcement, could combine the EDR data with the type of personally identifying data routinely acquired during a crash investigation.

To read data recorded by an EDR, special equipment is required, and access to the vehicle or the EDR is needed. In addition to the vehicle manufacturer, other parties, such as law enforcement, that have the special equipment, can read the information if they have access to the vehicle or the EDR.

Saturn will not access this data or share it with others except: with the consent of the vehicle owner or, if the vehicle is leased, with the consent of the lessee; in response to an official request of police or similar government office; as part of Saturn's defense of litigation through the discovery process; or, as required by law. Data that Saturn collects or receives may also be used for Saturn research needs or may be made available to others for research purposes, where a need is shown and the data is not tied to a specific vehicle or vehicle owner.

### **OnStar®**

If your vehicle has OnStar and you subscribe to the OnStar services, please refer to the OnStar Terms and Conditions for information on data collection and use. See also *OnStar® System on page 2-29* in this manual for more information.

### **Navigation System**

If your vehicle has a navigation system, use of the system may result in the storage of destinations, addresses, telephone numbers, and other trip information. Refer to the navigation system operating manual for information on stored data and for deletion instructions.

### **Radio Frequency Identification (RFID)**

RFID technology is used in some vehicles for functions such as tire pressure monitoring and ignition system security, as well as in connection with conveniences such as key fobs for remote door locking/unlocking and starting, and in-vehicle transmitters for garage door openers. RFID technology in Saturn vehicles does not use or record personal information or link with any other Saturn system containing personal information.



**A**

About Driving Your Vehicle ..... ii

Accessories and  
Modifications ..... 5-3

Accessory Power Outlets ..... 3-16

Adding Equipment to Your  
Airbag-Equipped Vehicle .... 1-55

Additives, Fuel ..... 5-5

Add-On Electrical  
Equipment ..... 5-75

Air Cleaner/Filter, Engine ..... 5-15

Air Conditioning ..... 3-17

Airbag  
Passenger Status  
Indicator ..... 3-26

Readiness Light ..... 3-25

Airbag System ..... 1-41

Adding Equipment to  
Your Airbag-Equipped  
Vehicle ..... 1-55

How Does an Airbag  
Restrain? ..... 1-47

Passenger Sensing  
System ..... 1-49

Airbag System (cont.)  
Servicing Your  
Airbag-Equipped  
Vehicle ..... 1-54

What Makes an Airbag  
Inflate? ..... 1-47

What Will You See After an  
Airbag Inflates? ..... 1-48

When Should an Airbag  
Inflate? ..... 1-45

Where Are the Airbags? .... 1-44

Antenna, Fixed Mast ..... 3-84

Antenna, XM™ Satellite  
Radio Antenna System ..... 3-84

Antilock Brake  
System (ABS) ..... 4-6

Antilock Brake, System  
Warning Light ..... 3-28

Appearance Care  
Aluminum Wheels ..... 5-72

Care of Safety Belts ..... 5-69

Chemical Paint Spotting .... 5-73

Cleaning Exterior Lamps/  
Lenses ..... 5-70

Fabric/Carpet ..... 5-68

Appearance Care (cont.)  
Finish Care ..... 5-70

Finish Damage ..... 5-73

Instrument Panel, Vinyl,  
and Other Plastic  
Surfaces ..... 5-69

Interior Cleaning ..... 5-66

Leather ..... 5-68

Sheet Metal Damage ..... 5-73

Tires ..... 5-72

Underbody Maintenance .... 5-73

Washing Your Vehicle ..... 5-69

Weatherstrips ..... 5-69

Windshield and Wiper  
Blades ..... 5-71

Appointments, Scheduling  
Service ..... 7-7

Audio System ..... 3-56

Audio Steering Wheel  
Controls ..... 3-82

Chime Level Adjustment .... 3-84

Fixed Mast Antenna ..... 3-84

Radio Reception ..... 3-83

Setting the Clock ..... 3-56

Theft-Deterrent Feature ..... 3-82

XM™ Satellite Radio  
Antenna System ..... 3-84

## i-2 INDEX

---

Audio System(s) .....	3-58
Auto Stop Mode .....	3-35
Automatic Climate Control System .....	3-17
Automatic Door Lock .....	2-7
Automatic Door Unlock .....	2-7
Automatic Headlamp System .....	3-13
Automatic Transmission Fluid .....	5-17
Operation .....	2-20

### B

Battery .....	5-27
Electric Power Management .....	3-14
Run-Down Protection .....	3-15
Bluetooth® .....	3-72
Brake Emergencies .....	4-6
Brake Fluid .....	5-25
Brakes .....	5-25
Regenerative Braking .....	2-23
System Warning Light .....	3-27
Braking .....	4-5

Braking in Emergencies .....	4-6
Break-In, New Vehicle .....	2-14
Bulb Replacement .....	5-35
Front Turn Signal and Parking Lamps .....	5-36
Halogen Bulbs .....	5-35
Headlamp Aiming .....	5-33
Headlamps .....	5-35
License Plate Lamps .....	5-37
Replacement Bulbs .....	5-37
Taillamps, Turn Signal, Stoplamps and Back-up Lamps .....	5-36
Buying New Tires .....	5-51

### C

Calibration .....	3-40
California Fuel .....	5-5
California Perchlorate Materials Requirements .....	5-4
California Proposition 65 Warning .....	5-3
Canadian Owners .....	ii
Capacities and Specifications .....	5-81

Carbon Monoxide .....	2-26, 4-15
Care of Safety Belts .....	5-69
Cargo Cover .....	2-38
Cargo Management System .....	2-39
Cargo Tie Downs .....	2-39
CD, MP3 .....	3-66
Center Console Storage Area .....	2-37
Chains, Tire .....	5-57
Charge/Assist Gage .....	3-35
Charging System Light .....	3-27
Check Engine Lamp .....	3-30
Checking Things Under the Hood .....	5-9
Chemical Paint Spotting .....	5-73
Child Restraints Child Restraint Systems .....	1-27
Infants and Young Children .....	1-25
Lower Anchors and Tethers for Children .....	1-31
Older Children .....	1-22
Securing a Child Restraint in a Rear Seat Position .....	1-36



Child Restraints (cont.)	Collision Damage Repair .....	7-9	Customer Assistance Information
Securing a Child Restraint	Compass .....	3-40	(cont.)
in the Right Front Seat	Compressor Kit		GM Mobility
Position .....	Storing .....	5-66	Reimbursement
Where to Put the	Compressor Kit, Tire		Program .....
Restraint .....	Sealant .....	5-59	7-5
Chime Level Adjustment .....	Content Theft-Deterrent .....	2-10	Reporting Safety Defects to
Cleaning	Control of a Vehicle .....	4-4	Saturn .....
Aluminum Wheels .....	Convenience Net .....	2-38	7-13
Exterior Lamps/Lenses .....	Coolant		Reporting Safety Defects to
Fabric/Carpet .....	Engine .....	5-20	the Canadian
Finish Care .....	Engine Temperature		Government .....
Instrument Panel, Vinyl,	Warning Light .....	3-29	7-12
and Other Plastic	Surge Tank		Reporting Safety Defects to
Surfaces .....	Pressure Cap .....	5-22	the United States
Interior .....	Cooling System .....	5-17	Government .....
Leather .....	Cruise Control .....	3-9	7-12
Tires .....	Cruise Control Light .....	3-33	Roadside Assistance
Underbody Maintenance .....	Cupholders .....	2-37	Program .....
Washing Your Vehicle .....	Customer Assistance		7-5
Weatherstrips .....	Information		Service Publications
Windshield and Wiper	Courtesy Transportation .....	7-8	Ordering Information .....
Blades .....	Customer Assistance for		7-13
7-71	Text Telephone (TTY)		
Climate Control System	Users .....	7-4	
Automatic .....	Customer Assistance		
Outlet Adjustment .....	Offices .....	7-5	
Clock, Setting .....	Customer Satisfaction		
3-56	Procedure .....	7-1	
			<b>D</b>
			Daytime Running Lamp .....
			3-13
			Defensive Driving .....
			4-3
			Delayed Locking .....
			2-6
			DIC Compass .....
			3-40
			Disc, MP3 .....
			3-66
			Doing Your Own
			Service Work .....
			5-4
			Dome Lamp .....
			3-14

Door			
Automatic Door Lock .....	2-7		
Automatic Door Unlock .....	2-7		
Delayed Locking .....	2-6		
Locks .....	2-6		
Power Door Locks .....	2-6		
Rear Door Security Locks ....	2-7		
Driver			
Seat Height Adjuster .....	1-4		
Driver Behavior .....	4-2		
Driver Information			
Center (DIC) .....	3-36		
DIC Operation and Displays .....	3-36		
DIC Vehicle Customization .....	3-49		
DIC Warnings and Messages .....	3-42		
Driver Storage Compartment .....	2-38		
Driving			
At Night .....	4-12		
Before a Long Trip .....	4-14		
Defensive .....	4-3		
Drunken .....	4-4		
Driving (cont.)			
Environment .....	4-2		
Highway Hypnosis .....	4-14		
Hill and Mountain Roads ....	4-14		
In Rain and on Wet Roads .....	4-13		
Rocking Your Vehicle to Get it Out .....	4-17		
Winter .....	4-15		
Driving for Better Fuel Economy .....	4-3		
		<b>E</b>	
EDR .....	7-14		
Electrical System			
Add-On Equipment .....	5-75		
Fuses and Circuit Breakers .....	5-75		
Instrument Panel Fuse Block .....	5-76		
Power Windows and Other Power Options .....	5-75		
Underhood Fuse Block .....	5-77		
Windshield Wiper Fuses ....	5-75		
Electronic Immobilizer PASS-Key® III+ .....	2-12		
Electronic Immobilizer Operation PASS-Key® III+ .....	2-12		
Engine			
Air Cleaner/Filter .....	5-15		
Change Engine Oil Light ....	3-33		
Check and Service Engine Soon Lamp .....	3-30		
Coolant .....	5-20		
Coolant Heater .....	2-19		
Coolant Temperature Warning Light .....	3-29		
Drive Belt Routing .....	6-13		
Engine Compartment Overview .....	5-10		
Exhaust .....	2-26		
Oil .....	5-11		
Oil Life System .....	5-14		
Overheating .....	5-23		
Starting .....	2-15		
Entry Lighting .....	3-14		
Event Data Recorders .....	7-14		
Extender, Safety Belt .....	1-22		
Exterior Lamps .....	3-12		

**F**

Filter  
 Engine Air Cleaner ..... 5-15  
 Finish Damage ..... 5-73  
 Fixed Mast Antenna ..... 3-84  
 Flashers, Hazard Warning ..... 3-5  
 Flash-to-Pass ..... 3-7  
 Flat Tire ..... 5-58  
 Fluid  
   Automatic Transmission ..... 5-17  
   Windshield Washer ..... 5-24  
 Folding Rear Seat ..... 1-9  
 Folding Seatback,  
   Passenger ..... 1-7  
 Fuel ..... 5-5  
   Additives ..... 5-5  
   California Fuel ..... 5-5  
   Driving for Better  
     Economy ..... 4-3  
   Filling a Portable Fuel  
     Container ..... 5-8  
   Filling the Tank ..... 5-7  
   Fuels in Foreign Countries ... 5-6  
   Gage ..... 3-34  
   Gasoline Octane ..... 5-5  
   Gasoline Specifications ..... 5-5  
   Low Warning Light ..... 3-34

Fuel Economy Light ..... 3-35  
 Fuses  
   Fuses and Circuit  
     Breakers ..... 5-75  
   Instrument Panel Fuse  
     Block ..... 5-76  
   Underhood Fuse Block ..... 5-77  
   Windshield Wiper ..... 5-75

**G**

Gage  
   Fuel ..... 3-34  
   Speedometer ..... 3-24  
   Tachometer ..... 3-24  
 Gage, Charge/Assist ..... 3-35  
 Garage Door Opener ..... 2-32  
 Gasoline  
   Octane ..... 5-5  
   Specifications ..... 5-5  
 Glove Box ..... 2-37  
 GM Mobility Reimbursement  
   Program ..... 7-5

**H**

Hazard Warning Flashers ..... 3-5  
 Head Restraints ..... 1-2

Headlamp  
   Aiming ..... 5-33  
 Headlamps ..... 5-35  
   Bulb Replacement ..... 5-35  
   Daytime Running Lamp ..... 3-13  
   Exterior Lamps ..... 3-12  
   Flash-to-Pass ..... 3-7  
   Front Turn Signal and  
     Parking Lamps ..... 5-36  
   Halogen Bulbs ..... 5-35  
   High/Low Beam Changer ..... 3-7  
   Wiper Activated ..... 3-12  
 Heated Seats ..... 1-5  
 Heater ..... 3-17  
   Engine Coolant ..... 2-19  
 Height Adjuster, Driver Seat .... 1-4  
 Highbeam On Light ..... 3-34  
 Highway Hypnosis ..... 4-14  
 Hill and Mountain Roads ..... 4-14  
 Hood  
   Checking Things Under ..... 5-9  
   Release ..... 5-9  
 Horn ..... 3-5  
 How to Wear Safety Belts  
   Properly ..... 1-13

**I**

Ignition Positions .....	2-14
Infants and Young Children, Restraints .....	1-25
Inflation - Tire Pressure .....	5-43
Inflator Kit, Tire .....	5-59
Instrument Panel	
Brightness .....	3-14
Cluster .....	3-23
Overview .....	3-4
Intermediate Voltage Devices and Wiring .....	5-74

**J**

Jump Starting .....	5-28
---------------------	------

**K**

Keyless Entry System .....	2-3
Keys .....	2-2

**L**

Labeling, Tire Sidewall .....	5-39
Lamp	
Malfunction Indicator .....	3-30

Lamps	
Dome .....	3-14
Reading .....	3-14
Lap-Shoulder Belt .....	1-17
LATCH System for Child Restraints .....	1-31
License Plate Lamps .....	5-37
Liftgate	
Carbon Monoxide .....	2-8
Light	
Airbag Readiness .....	3-25
Antilock Brake System (ABS) Warning .....	3-28
Brake System Warning .....	3-27
Change Engine Oil .....	3-33
Charging System .....	3-27
Cruise Control .....	3-33
Engine Coolant Temperature Warning .....	3-29
Fuel Economy .....	3-35
Highbeam On .....	3-34
Low Fuel Warning .....	3-34
Low Washer Fluid Warning .....	3-34
Oil Pressure .....	3-33
Passenger Airbag Status Indicator .....	3-26

Light (cont.)	
Safety Belt Reminders .....	3-24
Security .....	3-33
StabiliTrak® /Traction Control System (TCS) Warning Light .....	3-28
Tire Pressure .....	3-29
Light, Auto Stop Mode .....	3-35
Lighting	
Entry .....	3-14
Lights	
Exterior Lamps .....	3-12
Flash-to-Pass .....	3-7
High/Low Beam Changer .....	3-7
Loading Your Vehicle .....	4-18
Lockout Protection .....	2-7
Locks	
Automatic Door Lock .....	2-7
Automatic Door Unlock .....	2-7
Delayed Locking .....	2-6
Door .....	2-6
Lockout Protection .....	2-7
Power Door .....	2-6
Rear Door Security Locks .....	2-7
Loss of Control .....	4-11
Low Fuel Warning Light .....	3-34
Low Washer Fluid Warning Light .....	3-34

Lower Anchors and Tethers  
 for Children ..... 1-31  
 Lumbar  
 Manual Controls ..... 1-5

**M**

Maintenance Schedule  
 Additional Required  
 Services ..... 6-5  
 At Each Fuel Fill ..... 6-8  
 At Least Once a Month ..... 6-9  
 At Least Once a Year ..... 6-9  
 Introduction ..... 6-1  
 Maintenance Footnotes ..... 6-7  
 Maintenance Record ..... 6-14  
 Maintenance Replacement  
 Parts ..... 6-12  
 Maintenance  
 Requirements ..... 6-1  
 Owner Checks and  
 Services ..... 6-8  
 Recommended Fluids and  
 Lubricants ..... 6-11  
 Scheduled Maintenance ..... 6-3  
 Using ..... 6-2  
 Your Vehicle and the  
 Environment ..... 6-2

Malfunction Indicator Lamp .... 3-30  
 Manual Lumbar Controls ..... 1-5  
 Manual Seats ..... 1-3  
 Message  
 DIC Warnings and  
 Messages ..... 3-42  
 Mirrors  
 Automatic Dimming  
 Rearview ..... 2-27  
 Manual Rearview Mirror .... 2-27  
 Outside Convex Mirror ..... 2-28  
 Outside Heated Mirrors ..... 2-28  
 Outside Power Mirrors ..... 2-28  
 MP3 ..... 3-66  
 MyGMLink.com ..... 7-4

**N**

Navigation System, Privacy ... 7-15  
 New Vehicle Break-In ..... 2-14

**O**

Odometer ..... 3-24  
 Odometer, Trip ..... 3-24  
 Off-Road Recovery ..... 4-10

Oil  
 Change Engine Oil Light .... 3-33  
 Engine ..... 5-11  
 Pressure Light ..... 3-33  
 Oil, Engine Oil Life System .... 5-14  
 Older Children, Restraints ..... 1-22  
 Online Owner Center ..... 7-4  
 OnStar, Privacy ..... 7-15  
 OnStar® System, see  
 OnStar® Manual ..... 2-29  
 Operation, Universal Home  
 Remote System ..... 2-33  
 Outlet Adjustment ..... 3-22  
 Outlets  
 Accessory Power ..... 3-16  
 Outside  
 Convex Mirror ..... 2-28  
 Heated Mirrors ..... 2-28  
 Power Mirrors ..... 2-28  
 Owner Checks and Services ... 6-8  
 Owners, Canadian ..... ii

**P**

Paint, Damage ..... 5-73

Park

- Shifting Into ..... 2-23
- Shifting Out of ..... 2-25

Park Brake ..... 2-22

Parking

- Over Things That Burn ..... 2-25

Passenger Airbag Status

- Indicator ..... 3-26

Passenger Sensing System ... 1-49

Passing ..... 4-11

PASS-Key® III+ Electronic Immobilizer ..... 2-12

PASS-Key® III+ Electronic Immobilizer Operation ..... 2-12

Perchlorate Materials

- Requirements, California ..... 5-4

Phone

- Bluetooth® ..... 3-72

Power

- Door Locks ..... 2-6
- Electrical System ..... 5-75
- Retained Accessory ..... 2-15
- Seat ..... 1-4
- Windows ..... 2-9

Privacy ..... 7-14

- Event Data Recorders ..... 7-14
- Navigation System ..... 7-15
- OnStar ..... 7-15
- Radio Frequency Identification ..... 7-15

**R**

Radio Frequency Identification (RFID), Privacy ..... 7-15

Radio(s) ..... 3-58

Radios

- Reception ..... 3-83
- Setting the Clock ..... 3-56
- Theft-Deterrent ..... 3-82

Rainsense™ II Wipers ..... 3-8

Reading Lamps ..... 3-14

Rear Door Security Locks ..... 2-7

Rear Seat Armrest ..... 2-38

Rear Windshield Washer/Wiper ..... 3-9

Rearview Mirror, Automatic

- Dimming ..... 2-27

Rearview Mirrors ..... 2-27

Reclining Seatbacks ..... 1-5

Recommended Fluids and Lubricants ..... 6-11

Recreational Vehicle Towing ... 4-23

Regenerative Braking ..... 2-23

Remote Keyless Entry (RKE) System ..... 2-3

Remote Keyless Entry (RKE) System, Operation ..... 2-4

Replacement Bulbs ..... 5-37

Replacement Parts, Maintenance ..... 6-12

Reporting Safety Defects

- Canadian Government ..... 7-12
- Saturn ..... 7-13
- United States Government ..... 7-12

Restraint System Check

- Checking the Restraint Systems ..... 1-56
- Replacing Restraint System Parts After a Crash ..... 1-57

Retained Accessory Power ... 2-15

Roadside Assistance Program ..... 7-5

Rocking Your Vehicle to Get it Out ..... 4-17

Routing, Engine Drive Belt .... 6-13  
 Running the Vehicle While  
   Parked ..... 2-26

**S**

Safety Belt Reminders ..... 3-24  
 Safety Belts  
   Care of ..... 5-69  
   How to Wear Safety Belts  
     Properly ..... 1-13  
   Lap-Shoulder Belt ..... 1-17  
   Safety Belt Extender ..... 1-22  
   Safety Belt Use During  
     Pregnancy ..... 1-22  
   Safety Belts Are for  
     Everyone ..... 1-10  
 Safety Warnings and Symbols .... iii  
 Scheduled Maintenance ..... 6-3  
 Seatback, Folding  
   Passenger ..... 1-7  
 Seats  
   Driver Seat Height  
     Adjuster ..... 1-4  
   Heated Seats ..... 1-5  
   Manual Lumbar ..... 1-5

Seats (cont.)  
   Passenger Folding  
     Seatback ..... 1-7  
   Power Seat ..... 1-4  
   Reclining Seatbacks ..... 1-5  
   Split Folding Rear Seat ..... 1-9  
 Securing a Child Restraint  
   Rear Seat Position ..... 1-36  
   Right Front Seat Position ... 1-38  
 Security Light ..... 3-33  
 Service ..... 5-3  
   Accessories and  
     Modifications ..... 5-3  
   Adding Equipment to the  
     Outside of the Vehicle .... 5-4  
   California Perchlorate  
     Materials Requirements .... 5-4  
   California Proposition 65  
     Warning ..... 5-3  
   Doing Your Own Work ..... 5-4  
   Engine Soon Lamp ..... 3-30  
   Publications Ordering  
     Information ..... 7-13  
 Service, Scheduling  
   Appointments ..... 7-7

Servicing Your  
   Airbag-Equipped Vehicle .... 1-54  
 Setting the Clock ..... 3-56  
 Sheet Metal Damage ..... 5-73  
 Shifting Into Park ..... 2-23  
 Shifting Out of Park ..... 2-25  
 Signals, Turn and  
   Lane-Change ..... 3-6  
 Specifications, Capacities ..... 5-81  
 Speedometer ..... 3-24  
 Split Folding Rear Seat ..... 1-9  
 StabiliTrak® System ..... 4-7  
 StabiliTrak®/TCS Warning  
   Light ..... 3-28  
 Starting the Engine ..... 2-15  
 Steering ..... 4-9  
 Steering Wheel Controls,  
   Audio ..... 3-82  
 Steering Wheel, Tilt Wheel .... 3-6  
 Storage Areas  
   Cargo Management  
     System ..... 2-39  
   Center Console Storage  
     Area ..... 2-37  
   Convenience Net ..... 2-38

Storage Areas (cont.)	
Cupholders .....	2-37
Driver Storage	
Compartment .....	2-38
Glove Box .....	2-37
Rear Seat Armrest .....	2-38
Sunglasses Storage	
Compartment .....	2-37
Storing the Tire Sealant and	
Compressor Kit .....	5-66
Stuck in Sand, Mud, Ice,	
or Snow .....	4-17
Sun Visors .....	2-10

## **T**

Tachometer .....	3-24
Taillamps	
Turn Signal, Stoplamps and	
Back-up Lamps .....	5-36
Theft-Deterrent, Radio .....	3-82
Theft-Deterrent Systems .....	2-10
Content Theft-Deterrent .....	2-10
PASS-Key® III+ Electronic	
Immobilizer .....	2-12
PASS-Key® III+ Electronic	
Immobilizer Operation .....	2-12

Tilt Wheel .....	3-6
Time, Setting .....	3-56
Tire	
Pressure Light .....	3-29
Tire Sealant	
Storing .....	5-66
Tires .....	5-38
Aluminum Wheels,	
Cleaning .....	5-72
Buying New Tires .....	5-51
Chains .....	5-57
Cleaning .....	5-72
Different Size .....	5-53
If a Tire Goes Flat .....	5-58
Inflation - Tire Pressure .....	5-43
Inspection and Rotation .....	5-50
Pressure Monitor	
Operation .....	5-46
Pressure Monitor System .....	5-45
Tire Sealant and	
Compressor Kit .....	5-59
Tire Sidewall Labeling .....	5-39
Tire Terminology and	
Definitions .....	5-41
Uniform Tire Quality	
Grading .....	5-54

Tires (cont.)	
Wheel Alignment and Tire	
Balance .....	5-55
Wheel Replacement .....	5-55
When It Is Time for New	
Tires .....	5-51
Towing	
Recreational Vehicle .....	4-23
Towing a Trailer .....	4-26
Your Vehicle .....	4-22
Traction	
Control System (TCS) .....	4-8
StabiliTrak® System .....	4-7
Transmission	
Fluid, Automatic .....	5-17
Transmission Operation,	
Automatic .....	2-20
Trip Odometer .....	3-24
Turn and Lane-Change	
Signals .....	3-6
Turn Signal/Multifunction	
Lever .....	3-6



**U**

Uniform Tire Quality Grading .. 5-54  
 Universal Home Remote  
     System ..... 2-32  
     Operation ..... 2-33

**V**

Vehicle  
     Control ..... 4-4  
     Design ..... 4-2  
     Loading ..... 4-18  
     Running While Parked ..... 2-26  
     Symbols ..... iii  
 Vehicle Customization, DIC .... 3-49  
 Vehicle Data Recording and  
     Privacy ..... 7-14

Vehicle Identification  
     Number (VIN) ..... 5-74  
     Service Parts Identification  
         Label ..... 5-74  
 Ventilation Adjustment ..... 3-22  
 Visors ..... 2-10

**W**

Warning Lights, Gages, and  
     Indicators ..... 3-22  
 Warnings  
     DIC Warnings and  
         Messages ..... 3-42  
     Hazard Warning Flashers .... 3-5  
     Safety and Symbols ..... iii  
 Washer Fluid, Low Warning  
     Light ..... 3-34

Wheels  
     Alignment and Tire  
         Balance ..... 5-55  
         Different Size ..... 5-53  
         Replacement ..... 5-55  
 Where to Put the Restraint .... 1-29  
 Windows ..... 2-9  
     Power ..... 2-9  
 Windshield  
     Rainsense™ II Wipers ..... 3-8  
     Washer ..... 3-8  
     Washer Fluid ..... 5-24  
     Wiper Blade  
         Replacement ..... 5-38  
     Wiper Blades, Cleaning .... 5-71  
     Wiper Fuses ..... 5-75  
     Wipers ..... 3-7  
 Windshield, Rear Washer/  
     Wiper ..... 3-9  
 Winter Driving ..... 4-15  
 Wiper Activated Headlamps ... 3-12

**X**

XM Radio Messages .....	3-71
XM™ Satellite Radio Antenna System .....	3-84

**Y**

Your Driving, the Road and Your Vehicle .....	4-1
Your Vehicle and the Environment .....	6-2