

2009 Saturn ASTRA

Seats and Restraints	1-1	Driver Information		Tires	9-40
Front Seats	1-2	Center (DIC)	4-25	Tire Changing	9-60
Rear Seats	1-7	OnStar® System	4-38	Jump Starting	9-69
Safety Belts	1-8	Lighting	5-1	Towing	9-73
Airbag System	1-24	Lighting	5-1	Appearance Care	9-73
Child Restraints	1-38	Infotainment	6-1	Technical Data	10-1
Keys, Doors and Windows	2-1	Audio System(s)	6-1	Vehicle Identification	10-1
Keys	2-2	Climate Controls	7-1	Capacities and Specifications	10-2
Doors and Locks	2-5	Climate Controls	7-1	Service and Maintenance	11-1
Theft-Deterrent Systems ...	2-8	Driving and Operating	8-1	Service and Maintenance	11-1
Windows	2-10	Starting and Operating Your Vehicle	8-2	Customer Information	12-1
Mirrors	2-11	Driving Your Vehicle	8-15	Customer Information	12-1
Sunroof	2-12	Fuel	8-34	Reporting Safety Defects	12-14
Storage	3-1	Vehicle Service and Care	9-1	Vehicle Data Recording and Privacy	12-16
Storage	3-1	Service	9-2	Index	i-1
Instruments and Controls	4-1	Owner Checks	9-4		
Instrument Panel Overview	4-2	Headlamp Aiming	9-26		
Warning Lights, Gages, and Indicators	4-11	Bulb Replacement	9-28		
		Electrical System	9-34		

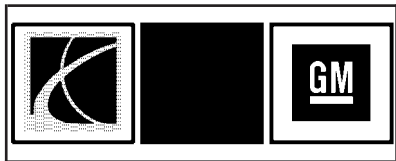

SATURN and the SATURN Emblem are registered trademarks, and the name ASTRA is a trademark of Saturn Corporation. GENERAL MOTORS and GM are registered trademarks of General Motors Corporation.

This manual includes the latest information at the time it was printed. Saturn reserves the right to make changes after that time without further notice.

This manual describes features that may or may not be on your specific vehicle.

Read this manual from beginning to end to learn about the vehicle's features and controls. Pictures, symbols, and words work together to explain vehicle operation.

Keep this manual in the vehicle for quick reference.

Canadian Owners

A French language copy of this manual can be obtained from your dealer/retailer or from:

Helm, Incorporated
P.O. Box 07130
Detroit, MI 48207
1-800-551-4123
helminc.com

Propriétaires Canadiens

On peut obtenir un exemplaire de ce guide en français auprès de concessionnaire ou à l'adresse suivante:

Helm Incorporated
P.O. Box 07130
Detroit, MI 48207
1-800-551-4123
helminc.com

Index

To quickly locate information about the vehicle use the Index in the back of the manual. It is an alphabetical list of what is in the manual and the page number where it can be found.

Cautions and Notices



A circle with a slash through it is a safety symbol which means “Do Not,” “Do not do this” or “Do not let this happen.”

A box with the word CAUTION is used to tell about things that could hurt you or others if you were to ignore the warning.



These mean there is something that could hurt you or other people.

Cautions tell what the hazard is and what to do to avoid or reduce the hazard. Read these cautions.

A notice tells about something that can damage the vehicle.

Notice: These mean there is something that could damage your vehicle.

Many times, this damage would not be covered by the vehicle’s warranty, and it could be costly. The notice tells what to do to help avoid the damage.

There are also warning labels on the vehicle which use the same words, CAUTION or Notice.

Vehicle Symbols

The vehicle has components and labels that use symbols instead of text. Symbols are shown along with the text describing the operation or information relating to a specific component, control, message, gage, or indicator.

 : This symbol is shown when you need to see your owner manual for additional instructions or information.

 : This symbol is shown when you need to see a service manual for additional instructions or information.

Vehicle Symbol Chart

Here are some additional symbols that may be found on the vehicle and what they mean. For more information on the symbol, refer to the index.

 : Airbag Readiness Light

 : Air Conditioning

 : Antilock Brake System (ABS)

 : Audio Steering Wheel Controls or OnStar[®]

 : Brake System Warning Light

 : Charging System

 : Cruise Control

 : Engine Coolant Temperature

 : Exterior Lamps

 : Fog Lamps

 : Fuel Gage

 : Fuses

 : Headlamp High/Low-Beam Changer

 : LATCH System Child Restraints

 : Malfunction Indicator Lamp

 : Oil Pressure

 : Power

 : Remote Vehicle Start

 : Safety Belt Reminders

 : Tire Pressure Monitor

 : Traction Control

 : Windshield Washer Fluid

Seats and Restraints

Front Seats

Manual Seats	1-2
Seat Height Adjuster	1-2
Lumbar Seat Adjustment	1-3
Reclining Seatbacks	1-3
Head Restraints	1-5
Heated Seats	1-6

Rear Seats

Rear Seat Operation	1-7
---------------------------	-----

Safety Belts

Safety Belts	1-8
How to Wear Safety Belts Properly	1-12
Lap-Shoulder Belt	1-18
Safety Belt Use During Pregnancy	1-22
Safety Belt Extender	1-22
Safety Belt Check	1-22

Care of Safety Belts	1-23
Replacing Safety Belt System Parts After a Crash	1-23

Airbag System

Airbag System	1-24
Where Are the Airbags? ...	1-26
When Should an Airbag Inflate?	1-27
What Makes an Airbag Inflate?	1-28
How Does an Airbag Restrain?	1-28
What Will You See After an Airbag Inflates?	1-29
Passenger Sensing System	1-30
Servicing Your Airbag-Equipped Vehicle	1-35
Adding Equipment to Your Airbag-Equipped Vehicle	1-36
Airbag System Check	1-37
Replacing Airbag System Parts After a Crash	1-37

Child Restraints

Older Children	1-38
Infants and Young Children	1-40
Child Restraint Systems	1-43
Where to Put the Restraint	1-44
Lower Anchors and Tethers for Children (LATCH)	1-46
Replacing LATCH System Parts After a Crash	1-50
Securing Child Restraints (Rear Seat)	1-51
Securing Child Restraints (Right Front Seat)	1-53

Front Seats

Manual Seats

 **CAUTION**

You can lose control of the vehicle if you try to adjust a manual driver's seat while the vehicle is moving. The sudden movement could startle and confuse you, or make you push a pedal when you do not want to. Adjust the driver's seat only when the vehicle is not moving.

To move a manual seat forward or rearward:



1. Lift the bar to unlock the seat.
2. Slide the seat to the desired position and release the bar.

Try to move the seat with your body to be sure the seat is locked in place.

Seat Height Adjuster



To raise and lower the manual seat, move the lever up or down repeatedly until the seat is at the desired height.

Lumbar Seat Adjustment



On seats with this feature, turn the knob clockwise or counterclockwise to increase or decrease the lumbar support.

Reclining Seatbacks

⚠ CAUTION

You can lose control of the vehicle if you try to adjust the seat while the vehicle is moving. The sudden movement could startle and confuse you, or make you push a pedal when you do not want to. Adjust the driver's seat only when the vehicle is not moving.



⚠ CAUTION

Sitting in a reclined position when the vehicle is in motion can be dangerous. Even if when buckled up, the safety belts cannot do their job when reclined like this.

The shoulder belt cannot do its job because it will not be against your body. Instead, it will be in front of you. In a crash, you could go into it, receiving neck or other injuries.

The lap belt cannot do its job either. In a crash, the belt could go up over your abdomen. The belt forces would be there, not at your pelvic bones. This could cause serious internal injuries.

For proper protection when the vehicle is in motion, have the seatback upright. Then sit well back in the seat and wear the safety belt properly.

1-4 Seats and Restraints



To adjust a manual reclining seatback, turn the knob. Do not lean on the seatback while adjusting it.

Seatback Latches (Three Door Model)

For easy entry/exit to the rear seats on three door models:



1. Lift the lever, and tilt the seatback forward.
2. Lower the lever and move the entire seat completely forward.

CAUTION

If either seatback is not locked, it could move forward in a sudden stop or crash. That could cause injury to the person sitting there. Always push and pull on the seatbacks to be sure they are locked.

To return the seat to the upright position:

1. Remove any objects in front of or behind the seat.
2. Move the entire seat rearward.
3. Lift the lever located on the outboard side of the seat and return the seatback to the upright position.
4. Lower the lever then push and pull on the seatback to be sure it is locked in place.

Head Restraints

The vehicle's front seats have adjustable head restraints.

CAUTION

With head restraints that are not installed and adjusted properly, there is a greater chance that occupants will suffer a neck/spinal injury in a crash. Do not drive until the head restraints for all occupants are installed and adjusted properly.



Adjust the head restraint so that the top of the restraint is at the same height as the top of the occupant's head.

This position reduces the chance of a neck injury in a crash.



To adjust the head restraint, press the button located on the side of the head restraint. Pull up or push down on the restraint to adjust it.

Try to move the head restraint after the button is released to make sure that it is locked in place.

The vehicle's front seat head restraints are not designed to be removed.

1-6 Seats and Restraints

Active Head Restraint System



The vehicle has an active head restraint system in the front seating positions.

These automatically tilt forward to reduce the risk of neck injury if the vehicle is hit from behind.

Rear Seat Headrests

The vehicle has headrests in all seating positions of the rear seats. The headrests in the rear outboard positions adjust like the front seat head restraints.

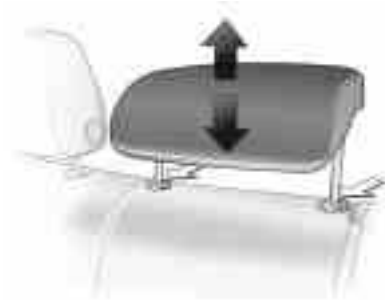

To adjust the headrest in the rear seat center position, pull up to raise it.

To lower the headrest, press the buttons located on the top of the seatback and push the head rest down.

The vehicle's rear seat headrests are not designed to be removed.

Heated Seats

On vehicles with heated front seats, the controls for each seat are located on the center of the instrument panel. To operate the heated seats the ignition must be on.

 **(Heated Seat):** Press this button to turn on the heated seat.

The light on the button will come on to indicate that the feature is working. Press the button to cycle through the temperature settings of high, medium, and low and to turn the heat to the seat off. The number of indicator lights above the button will show the level of heat selected: three for high, two for medium, and one for low.

Rear Seats

Rear Seat Operation

CAUTION

If either seatback is not locked, it could move forward in a sudden stop or crash. That could cause injury to the person sitting there. Always push and pull on the seatbacks to be sure they are locked.

CAUTION

A safety belt that is improperly routed, not properly attached, or twisted will not provide the protection needed in a crash. The person wearing the belt could be seriously injured. After raising the rear seatback, always check to be sure that the safety belts are properly routed and attached, and are not twisted.

Folding the Seatback

Notice: Folding a rear seat with the safety belts still fastened may cause damage to the seat or the safety belts. Always unbuckle the safety belts and return them to their normal stowed position before folding a rear seat.

Before folding the seatback down, the safety belt must be unbuckled and not in the storage clip.

The front seat must be moved all the way forward, and not reclined. The headrest must be completely lowered.

To lower the seatback:



1. Press the button located on the top of the seatback to release it.
2. Fold the seatback forward.

1-8 Seats and Restraints

To return the seat to the sitting position:



1. Make sure the safety belt is through the storage clip.
2. Lift the seatback and push it rearward until it is locked in the sitting position.

3. Push and pull on the seatback to make sure it is locked.
4. Remove the safety belt from the storage clip.

The seatback must be locked or you will not be able to pull out and use the rear center safety belt. Always push and pull on the seatback to be sure it is locked.

Safety Belts

This section of the manual describes how to use safety belts properly. It also describes some things not to do with safety belts.

CAUTION

Do not let anyone ride where a safety belt cannot be worn properly. In a crash, if you or your passenger(s) are not wearing safety belts, the injuries can be much worse. You can hit things inside the vehicle harder or be ejected from the vehicle. You and your passenger(s) can be seriously injured or killed. In the same crash, you might not be, if you are buckled up. Always fasten your safety belt, and check that your passenger(s) are restrained properly too.

⚠ CAUTION

It is extremely dangerous to ride in a cargo area, inside or outside of a vehicle. In a collision, people riding in these areas are more likely to be seriously injured or killed. Do not allow people to ride in any area of your vehicle that is not equipped with seats and safety belts. Be sure everyone in your vehicle is in a seat and using a safety belt properly.

This vehicle has indicators as a reminder to buckle the safety belts. See *Safety Belt Reminders on page 4-13* for additional information.

In most states and in all Canadian provinces, the law requires wearing safety belts. Here is why:

You never know if you will be in a crash. If you do have a crash, you do not know if it will be a serious one.

A few crashes are mild, and some crashes can be so serious that even buckled up, a person would not survive. But most crashes are in between. In many of them, people who buckle up can survive and sometimes walk away. Without safety belts they could have been badly hurt or killed.

After more than 40 years of safety belts in vehicles, the facts are clear. In most crashes buckling up does matter... a lot!

Why Safety Belts Work

When you ride in or on anything, you go as fast as it goes.



Take the simplest vehicle. Suppose it is just a seat on wheels.

1-10 Seats and Restraints

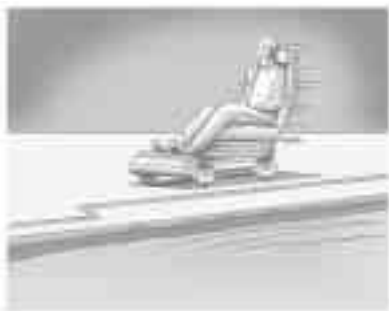

Put someone on it.

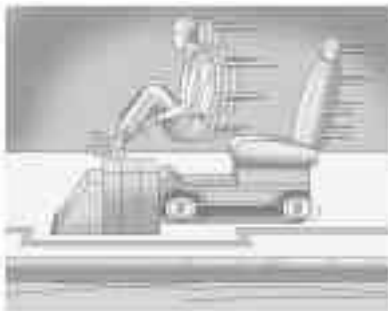

Get it up to speed. Then stop the vehicle. The rider does not stop.



The person keeps going until stopped by something. In a real vehicle, it could be the windshield...



or the instrument panel...



or the safety belts!

With safety belts, you slow down as the vehicle does. You get more time to stop. You stop over more distance, and your strongest bones take the forces. That is why safety belts make such good sense.

Questions and Answers About Safety Belts

Q: Will I be trapped in the vehicle after a crash if I am wearing a safety belt?

A: You *could* be — whether you are wearing a safety belt or not. But your chance of being conscious during and after an accident, so you *can* unbuckle and get out, is *much* greater if you are belted. And you can unbuckle a safety belt, even if you are upside down.

1-12 Seats and Restraints

Q: If my vehicle has airbags, why should I have to wear safety belts?

A: Airbags are supplemental systems only; so they work *with* safety belts — not instead of them. Whether or not an airbag is provided, all occupants still have to buckle up to get the most protection. That is true not only in frontal collisions, but especially in side and other collisions.

Q: If I am a good driver, and I never drive far from home, why should I wear safety belts?

A: You may be an excellent driver, but if you are in a crash — even one that is not your fault — you and your passenger(s) can be hurt. Being a good driver does not protect you from things beyond your control, such as bad drivers.

Most accidents occur within 25 miles (40 km) of home. And the greatest number of serious injuries and deaths occur at speeds of less than 40 mph (65 km/h).

Safety belts are for everyone.

How to Wear Safety Belts Properly

This section is only for people of adult size.

Be aware that there are special things to know about safety belts and children. And there are different rules for smaller children and infants. If a child will be riding in the vehicle, see *Older Children on page 1-38* or *Infants and Young Children on page 1-40*. Follow those rules for everyone's protection.

It is very important for all occupants to buckle up. Statistics show that unbelted people are hurt more often in crashes than those who are wearing safety belts.

Occupants who are not buckled up can be thrown out of the vehicle in a crash. And they can strike others in the vehicle who are wearing safety belts.

First, before you or your passenger(s) wear a safety belt, there is important information you should know.



Sit up straight and always keep your feet on the floor in front of you. The lap part of the belt should be worn low and snug on the hips, just touching the thighs. In a crash,

this applies force to the strong pelvic bones and you would be less likely to slide under the lap belt. If you slid under it, the belt would apply force on your abdomen. This could cause serious or even fatal injuries. The shoulder belt should go over the shoulder and across the chest. These parts of the body are best able to take belt restraining forces.

The shoulder belt locks if there is a sudden stop or crash.

Q: What is wrong with this?

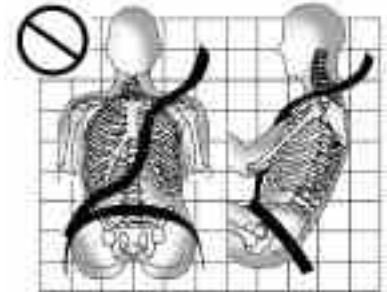

A: The shoulder belt is too loose. It will not give as much protection this way.

⚠ CAUTION

You can be seriously hurt if your shoulder belt is too loose. In a crash, you would move forward too much, which could increase injury. The shoulder belt should fit snugly against your body.

1-14 Seats and Restraints

Q: What is wrong with this?

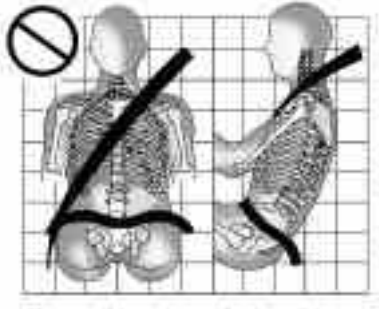

A: The lap belt is too loose.
It will not give nearly as much protection this way.

CAUTION

You can be seriously hurt if your lap belt is too loose. In a crash, you could slide under the lap belt and apply force on your abdomen. This could cause serious or even fatal injuries. The lap belt should be worn low and snug on the hips, just touching the thighs.

Q: What is wrong with this?

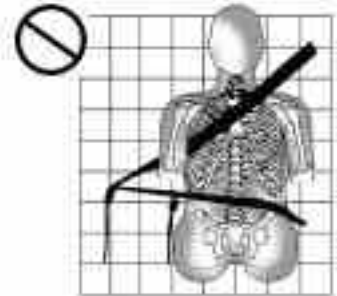

A: The belt is buckled in the wrong buckle.

⚠ CAUTION

You can be seriously injured if your belt is buckled in the wrong place like this. In a crash, the belt would go up over your abdomen. The belt forces would be there, not on the pelvic bones. This could cause serious internal injuries. Always buckle your belt into the buckle nearest you.

Q: What is wrong with this?

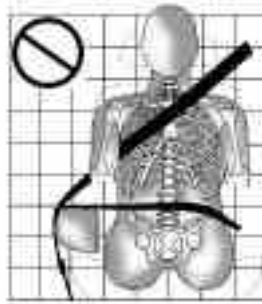

A: The belt is over an armrest.

⚠ CAUTION

You can be seriously injured if your belt goes over an armrest like this. The belt would be much too high. In a crash, you can slide under the belt. The belt force would then be applied on the abdomen, not on the pelvic bones, and that could cause serious or fatal injuries. Be sure the belt goes under the armrests.

1-16 Seats and Restraints

Q: What is wrong with this?

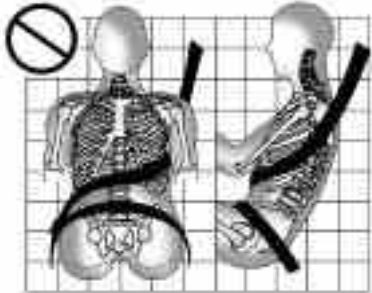

A: The shoulder belt is worn under the arm. It should be worn over the shoulder at all times.

CAUTION

You can be seriously injured if you wear the shoulder belt under your arm. In a crash, your body would move too far forward, which would increase the chance of head and neck injury. Also, the belt would apply too much force to the ribs, which are not as strong as shoulder bones. You could also severely injure internal organs like your liver or spleen. The shoulder belt should go over the shoulder and across the chest.

Q: What is wrong with this?

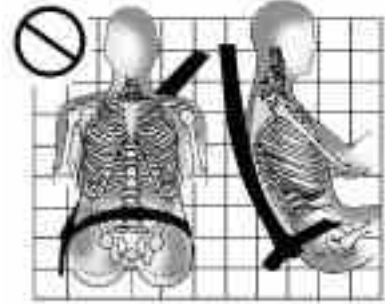

A: The belt is behind the body.

⚠ CAUTION

You can be seriously injured by not wearing the lap-shoulder belt properly. In a crash, you would not be restrained by the shoulder belt. Your body could move too far forward increasing the chance of head and neck injury. You might also slide under the lap belt. The belt force would then be applied right on the abdomen. That could cause serious or fatal injuries. The shoulder belt should go over the shoulder and across the chest.

Q: What is wrong with this?

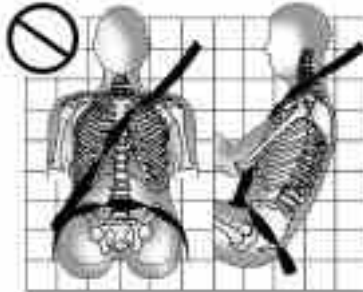

A: The belt is twisted across the body.

⚠ CAUTION

You can be seriously injured by a twisted belt. In a crash, you would not have the full width of the belt to spread impact forces. If a belt is twisted, make it straight so it can work properly, or ask your dealer/retailer to fix it.

Lap-Shoulder Belt

All seating positions in the vehicle have a lap-shoulder belt.

The following instructions explain how to wear a lap-shoulder belt properly.

1. Adjust the seat, if the seat is adjustable, so you can sit up straight. To see how, see “Seats” in the Index.



2. Pick up the latch plate and pull the belt across you. Do not let it get twisted.

The lap-shoulder belt may lock if you pull the belt across you very quickly. If this happens, let the belt go back slightly to unlock it. Then pull the belt across you more slowly.

If the shoulder portion of a passenger belt is pulled out all the way, the child restraint locking feature may be engaged. If this happens, let the belt go back all the way and start again.



3. Push the latch plate into the buckle until it clicks.

Pull up on the latch plate to make sure it is secure. If the belt is not long enough, see *Safety Belt Extender* on page 1-22.

Position the release button on the buckle so that the safety belt could be quickly unbuckled if necessary.

4. If equipped with a shoulder belt height adjuster, move it to the height that is right for you. See “Shoulder Belt Height Adjustment” later in this section for instructions on use and important safety information.
5. To make the lap part tight, pull up on the shoulder belt.



To unlatch the belt, push the button on the buckle. The belt should return to its stowed position. When the safety belt is not in use, slide the latch plate up the safety belt webbing.

Before a door is closed, be sure the safety belt is out of the way. If a door is slammed against a safety belt, damage can occur to both the safety belt and the vehicle.

Shoulder Belt Height Adjuster

The vehicle has a shoulder belt height adjuster for the driver and right front passenger seating position.

Adjust the height so that the shoulder portion of the belt is centered on the shoulder. The belt should be away from the face and neck, but not falling off the shoulder. Improper shoulder belt height adjustment could reduce the effectiveness of the safety belt in a crash.



To move it, squeeze the button on the front of the height adjuster to release the locking feature and move the height adjuster to the desired position.

After the adjuster is set to the desired position, try to move it down without squeezing the release button to make sure it has locked into position.

1-20 Seats and Restraints

Safety Belt Pretensioners

The vehicle has safety belt pretensioners for the front occupants. Although the pretensioners cannot be seen, they are part of the safety belt assembly. They can help tighten the safety belts during the early stages of a moderate to severe frontal or near frontal crash if the threshold conditions for pretensioner activation are met. And, if the vehicle has side impact airbags, safety belt pretensioners can help tighten the safety belts in a side crash.

Pretensioners work only once. If the pretensioners activate in a crash, they will need to be replaced, and probably other new parts for the vehicle's safety belt system. See *Replacing Safety Belt System Parts After a Crash* on page 1-23.

Rear Safety Belt Comfort Guides

Rear shoulder belt comfort guides may provide added safety belt comfort for older children who have outgrown booster seats and for some adults. When installed on a shoulder belt, the comfort guide positions the belt away from the neck and head.

There is one guide for each outboard passenger position in the rear seat. Here is how to install a comfort guide to the safety belt:

1. Pull the elastic cord out from the side of the seatback to remove the guide from its storage pocket.



2. Place the guide over the belt and insert the two edges of the belt into the slots of the guide.

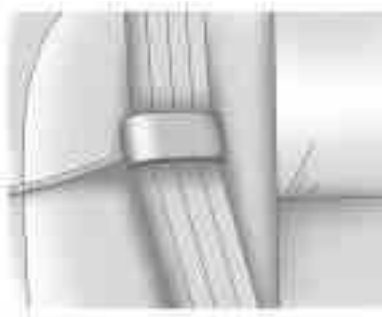

3. Be sure that the belt is not twisted and it lies flat. The elastic cord must be under the belt and the guide on top.

⚠ CAUTION

A safety belt that is not properly worn may not provide the protection needed in a crash. The person wearing the belt could be seriously injured. The shoulder

(Continued)

CAUTION (Continued)

belt should go over the shoulder and across the chest. These parts of the body are best able to take belt restraining forces.



4. Buckle, position, and release the safety belt as described previously in this section. Make sure that the shoulder belt crosses the shoulder.

To remove and store the comfort guide, squeeze the belt edges together so that the safety belt can be removed from the guide. Push the guide into the pocket on the side of seatback.

Properly secure the guide loop before folding the seatback. The comfort guide and vehicle can be damaged while closing a door if it is not properly secured in its storage location.

Safety Belt Use During Pregnancy

Safety belts work for everyone, including pregnant women. Like all occupants, they are more likely to be seriously injured if they do not wear safety belts.



A pregnant woman should wear a lap-shoulder belt, and the lap portion should be worn as low as possible, below the rounding, throughout the pregnancy.

The best way to protect the fetus is to protect the mother. When a safety belt is worn properly, it is more likely that the fetus will not be hurt in a crash. For pregnant women, as for anyone, the key to making safety belts effective is wearing them properly.

Safety Belt Extender

If the safety belt will fasten around you, you should use it.

But if a safety belt is not long enough, your dealer/retailer will order you an extender. When you go in to order it, take the heaviest coat you will wear, so the extender will be long enough for you. To help avoid personal injury, do not let someone else use it, and use it only for the seat it is made to fit. The extender has been designed for adults. Never use it for securing child seats. To wear it, attach it to the regular safety belt. For more information, see the instruction sheet that comes with the extender.

Safety Belt Check

Now and then, check that the safety belt reminder light, safety belts, buckles, latch plates, retractors and anchorages are working properly. Look for any other loose or damaged safety belt system parts that might keep a safety belt system from doing its job. See your dealer/retailer to have it repaired. Torn or frayed safety belts may not protect you in a crash. They can rip apart under impact forces. If a belt is torn or frayed, get a new one right away.

Make sure the safety belt reminder light is working. See *Safety Belt Reminders on page 4-13* for more information.

Keep safety belts clean and dry. See *Care of Safety Belts on page 1-23*.

Care of Safety Belts

Keep belts clean and dry.

 **CAUTION**

Do not bleach or dye safety belts. It may severely weaken them. In a crash, they might not be able to provide adequate protection. Clean safety belts only with mild soap and lukewarm water.

Replacing Safety Belt System Parts After a Crash

 **CAUTION**

A crash can damage the safety belt system in the vehicle. A damaged safety belt system may not properly protect the person using it, resulting in serious injury or even death in a crash. To help make sure the safety belt systems are working properly after a crash, have them inspected and any necessary replacements made as soon as possible.

After a minor crash, replacement of safety belts may not be necessary. But the safety belt assemblies that were used during any crash may have been stressed or damaged. See your dealer/retailer to have the safety belt assemblies inspected or replaced.

New parts and repairs may be necessary even if the safety belt system was not being used at the time of the crash.

Have the safety belt pretensioners checked if the vehicle has been in a crash, or if the airbag readiness light stays on after you start the vehicle or while you are driving. See *Airbag Readiness Light* on page 4-14.

Airbag System

Your vehicle has the following airbags:

- A frontal airbag for the driver.
- A frontal airbag for the right front passenger.
- A seat-mounted side impact airbag for the driver.
- A seat-mounted side impact airbag for the right front passenger.
- A roof-rail airbag for the driver and the passenger seated directly behind the driver.
- A roof-rail airbag for the right front passenger and the passenger seated directly behind the right front passenger.

All of the airbags in your vehicle will have the word AIRBAG embossed in the trim or on an attached label near the deployment opening.

For frontal airbags, the word AIRBAG will appear on the middle part of the steering wheel for the driver and on the instrument panel for the right front passenger.

With seat-mounted side impact airbags, the word AIRBAG will appear on the side of the seatback closest to the door.

With roof-rail airbags, the word AIRBAG will appear along the headliner or trim.

Airbags are designed to supplement the protection provided by safety belts. Even though today's airbags are also designed to help reduce the risk of injury from the force of an inflating bag, all airbags must inflate very quickly to do their job.

Here are the most important things to know about the airbag system:

CAUTION

You can be severely injured or killed in a crash if you are not wearing your safety belt — even if you have airbags. Airbags are designed to work with safety belts, but do not replace them. Also, airbags are not designed to deploy in every crash. In some crashes safety belts are your only restraint. See *When Should an Airbag Inflate?* on page 1-27.

Wearing your safety belt during a crash helps reduce your chance of hitting things inside the vehicle or being ejected from it. Airbags are “supplemental restraints” to the safety belts. Everyone in your vehicle should wear a safety belt properly — whether or not there is an airbag for that person.

 CAUTION

Airbags inflate with great force, faster than the blink of an eye. Anyone who is up against, or very close to, any airbag when it inflates can be seriously injured or killed. Do not sit unnecessarily close to the airbag, as you would be if you were sitting on the edge of your seat or leaning forward. Safety belts help keep you in position before and during a crash. Always wear your safety belt, even with airbags. The driver should sit as far back as possible while still maintaining control of the vehicle.

Occupants should not lean on or sleep against the door or side windows in seating positions with seat-mounted side impact airbags and/or roof-rail airbags.

 CAUTION

Children who are up against, or very close to, any airbag when it inflates can be seriously injured or killed. Airbags plus lap-shoulder belts offer protection for adults and older children, but not for young children and infants. Neither the vehicle's safety belt system nor its airbag system is designed for them. Young children and infants need the protection that a child restraint system can provide. Always secure children properly in your vehicle. To read how, see *Older Children on page 1-38* or *Infants and Young Children on page 1-40*.



There is an airbag readiness light on the instrument panel cluster, which shows the airbag symbol. The system checks the airbag electrical system for malfunctions. The light tells you if there is an electrical problem. See *Airbag Readiness Light on page 4-14* for more information.

Where Are the Airbags?

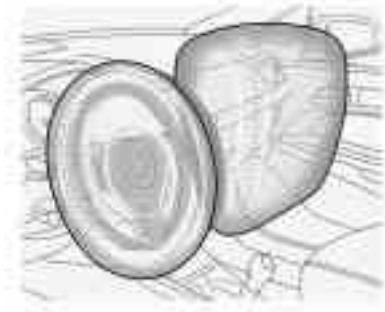

The driver frontal airbag is in the middle of the steering wheel.

The right front passenger frontal airbag is in the instrument panel on the passenger's side.

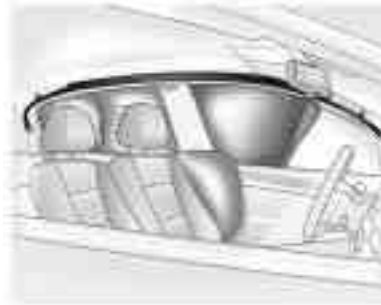

Driver Side shown, Passenger Side similar

The seat-mounted side impact airbags for the driver and right front passenger are in the side of the seatbacks closest to the door.

The roof-rail airbags for the driver, right front passenger, and second row outboard passengers are in the ceiling above the side windows.

CAUTION

If something is between an occupant and an airbag, the airbag might not inflate properly or it might force the object into that person causing severe injury or even death. The path of an inflating airbag must be kept clear. Do not put anything between an occupant and an airbag, and do not attach or put anything on the steering wheel hub or on or near any other airbag covering.

Do not use seat accessories that block the inflation path of a seat-mounted side impact airbag.

Never secure anything to the roof of a vehicle with roof-rail airbags by routing a rope or tie down through any door or window opening. If you do, the path of an inflating roof-rail airbag will be blocked.

When Should an Airbag Inflate?

Frontal airbags are designed to inflate in moderate to severe frontal or near-frontal crashes to help reduce the potential for severe injuries mainly to the driver's or right front passenger's head and chest. However, they are only designed to inflate if the impact exceeds a predetermined deployment threshold. Deployment thresholds are used to predict how severe a crash is likely to be in time for the airbags to inflate and help restrain the occupants.

Whether the frontal airbags will or should deploy is not based on how fast your vehicle is traveling. It depends largely on what you hit, the direction of the impact, and how quickly your vehicle slows down.

Frontal airbags may inflate at different crash speeds. For example:

- If the vehicle hits a stationary object, the airbags could inflate at a different crash speed than if the vehicle hits a moving object.
- If the vehicle hits an object that deforms, the airbags could inflate at a different crash speed than if the vehicle hits an object that does not deform.
- If the vehicle hits a narrow object (like a pole), the airbags could inflate at a different crash speed than if the vehicle hits a wide object (like a wall).
- If the vehicle goes into an object at an angle, the airbags could inflate at a different crash speed than if the vehicle goes straight into the object.

Thresholds can also vary with specific vehicle design.

Frontal airbags are not intended to inflate during vehicle rollovers, rear impacts, or in many side impacts.

In addition, the vehicle has dual-stage frontal airbags. Dual-stage airbags adjust the restraint according to crash severity. The vehicle has electronic frontal sensors, which help the sensing system distinguish between a moderate frontal impact and a more severe frontal impact. For moderate frontal impacts, dual-stage airbags inflate at a level less than full deployment. For more severe frontal impacts, full deployment occurs.

1-28 Seats and Restraints

The vehicle has seat-mounted side impact and roof-rail airbags. See *Airbag System on page 1-24*. Seat-mounted side impact and roof-rail airbags are intended to inflate in moderate to severe side crashes. Seat-mounted side impact and roof-rail airbags will inflate if the crash severity is above the system's designed threshold level. The threshold level can vary with specific vehicle design.

Seat-mounted side impact and roof-rail airbags are not intended to inflate in frontal impacts, near-frontal impacts, rollovers, or rear impacts. A seat-mounted side impact airbag is intended to deploy on the side of the vehicle that is struck. A roof-rail airbag is intended to deploy on the side of the vehicle that is struck.

In any particular crash, no one can say whether an airbag should have inflated simply because of the damage to a vehicle or because of what the repair costs were.

For frontal airbags, inflation is determined by what the vehicle hits, the angle of the impact, and how quickly the vehicle slows down. For seat-mounted side impact and roof-rail airbags, deployment is determined by the location and severity of the side impact.

What Makes an Airbag Inflate?

In a deployment event, the sensing system sends an electrical signal triggering a release of gas from the inflator. Gas from the inflator fills the airbag causing the bag to break out of the cover and deploy. The inflator, the airbag, and related hardware are all part of the airbag module.

Frontal airbag modules are located inside the steering wheel and instrument panel. For vehicles with seat-mounted side impact airbags, there are airbag modules in the side of the front seatbacks closest to

the door. For vehicles with roof-rail airbags, there are airbag modules in the ceiling of the vehicle, near the side windows that have occupant seating positions.

How Does an Airbag Restrain?

In moderate to severe frontal or near frontal collisions, even belted occupants can contact the steering wheel or the instrument panel. In moderate to severe side collisions, even belted occupants can contact the inside of the vehicle.

Airbags supplement the protection provided by safety belts. Frontal airbags distribute the force of the impact more evenly over the occupant's upper body, stopping the occupant more gradually. Seat-mounted side impact and roof-rail airbags distribute the force of the impact more evenly over the occupant's upper body.

But airbags would not help in many types of collisions, primarily because the occupant's motion is not toward those airbags. See *When Should an Airbag Inflate?* on page 1-27 for more information.

Airbags should never be regarded as anything more than a supplement to safety belts.

What Will You See After an Airbag Inflates?

After the frontal airbags and seat-mounted side impact airbags inflate, they quickly deflate, so quickly that some people may not even realize an airbag inflated. Roof-rail airbags may still be at least partially inflated for some time after they deploy. Some components of the airbag module may be hot for several minutes. For location of the airbag modules, see *What Makes an Airbag Inflate?* on page 1-28.

The parts of the airbag that come into contact with you may be warm, but not too hot to touch. There may be some smoke and dust coming from the vents in the deflated airbags. Airbag inflation does not prevent the driver from seeing out of the windshield or being able to steer the vehicle, nor does it prevent people from leaving the vehicle.

 **CAUTION**

When an airbag inflates, there may be dust in the air. This dust could cause breathing problems for people with a history of asthma or other breathing trouble.

(Continued)

CAUTION (Continued)

To avoid this, everyone in the vehicle should get out as soon as it is safe to do so. If you have breathing problems but cannot get out of the vehicle after an airbag inflates, then get fresh air by opening a window or a door. If you experience breathing problems following an airbag deployment, you should seek medical attention.

The vehicle has a feature that may automatically unlock the doors, turn the interior lamps on, and turn the hazard warning flashers on when the airbags inflate. You can lock the doors, turn the interior lamps off, and turn the hazard warning flashers off by using the controls for those features.

1-30 Seats and Restraints

In many crashes severe enough to inflate the airbag, windshields are broken by vehicle deformation. Additional windshield breakage may also occur from the right front passenger airbag.

- Airbags are designed to inflate only once. After an airbag inflates, you will need some new parts for the airbag system. If you do not get them, the airbag system will not be there to help protect you in another crash. A new system will include airbag modules and possibly other parts. The service manual for your vehicle covers the need to replace other parts.

- The vehicle has a crash sensing and diagnostic module which records information after a crash. See *Vehicle Data Recording and Privacy* on page 12-16 and *Event Data Recorders* on page 12-16.
- Let only qualified technicians work on the airbag systems. Improper service can mean that an airbag system will not work properly. See your dealer/retailer for service.

Passenger Sensing System

The vehicle has a passenger sensing system for the right front passenger position. The passenger airbag status indicator will be visible in the rearview mirror when the vehicle is started.



United States



Canada

The words ON and OFF, or the symbol for on and off, will be visible during the system check. When the system check is complete, either the word ON or OFF, or the symbol for on or off, will be visible. See *Passenger Airbag Status Indicator* on page 4-15.

The passenger sensing system will turn off the right front passenger frontal airbag and seat-mounted side impact airbag under certain conditions. The driver airbags are not affected by the passenger sensing system.

The passenger sensing system works with sensors that are part of the right front passenger's seat. The sensors are designed to detect the presence of a properly-seated occupant and determine if the right front passenger frontal airbag and seat-mounted side impact airbag should be enabled (may inflate) or not.

According to accident statistics, children are safer when properly secured in a rear seat in the correct child restraint for their weight and size.

We recommend that children be secured in a rear seat, including: an infant or a child riding in a rear-facing child restraint; a child riding in a forward-facing child seat; an older child riding in a booster seat; and children, who are large enough, using safety belts.

A label on the sun visor says, "Never put a rear-facing child seat in the front." This is because the risk to the rear-facing child is so great, if the airbag deploys.

 **CAUTION**

A child in a rear-facing child restraint can be seriously injured or killed if the right front passenger airbag inflates. This is because the back of the rear-facing child restraint would be very close to the inflating airbag. A child in a

(Continued)

CAUTION (Continued)

forward-facing child restraint can be seriously injured or killed if the right front passenger airbag inflates and the passenger seat is in a forward position.

Even if the passenger sensing system has turned off the right front passenger frontal airbag and seat-mounted side impact airbag (if equipped), no system is fail-safe. No one can guarantee that an airbag will not deploy under some unusual circumstance, even though the airbag(s) are off.

Secure rear-facing child restraints in a rear seat, even if the airbag(s) are off. If you secure a forward-facing child restraint in the right front seat, always move the front passenger seat as far back as it will go. It is better to secure the child restraint in a rear seat.

1-32 Seats and Restraints

The passenger sensing system is designed to turn off the right front passenger frontal airbag and seat-mounted side impact airbag if:

- The right front passenger seat is unoccupied.
- The system determines that an infant is present in a rear-facing infant seat.
- The system determines that a small child is present in a child restraint.
- The system determines that a small child is present in a booster seat.
- A right front passenger takes his/her weight off of the seat for a period of time.
- The right front passenger seat is occupied by a smaller person, such as a child who has outgrown child restraints.
- Or, if there is a critical problem with the airbag system or the passenger sensing system.

When the passenger sensing system has turned off the right front passenger frontal airbag and seat-mounted side impact airbag, the off indicator will light and stay lit to remind you that the airbags are off. See *Passenger Airbag Status Indicator on page 4-15*.

The passenger sensing system is designed to turn on (may inflate) the right front passenger frontal airbag and seat-mounted side impact airbag anytime the system senses that a person of adult size is sitting properly in the right front passenger seat. When the passenger sensing system has allowed the airbags to be enabled, the on indicator will light and stay lit to remind you that the airbags are active.

For some children who have outgrown child restraints and for very small adults, the passenger sensing system may or may not turn off the right front passenger frontal airbag

and seat-mounted side impact airbag, depending upon the person's seating posture and body build. Everyone in the vehicle who has outgrown child restraints should wear a safety belt properly — whether or not there is an airbag for that person.

CAUTION

If the airbag readiness light ever comes on and stays on, it means that something may be wrong with the airbag system. To help avoid injury to yourself or others, have the vehicle serviced right away. See *Airbag Readiness Light on page 4-14* for more information, including important safety information.

If the On Indicator is Lit for a Child Restraint

If a child restraint has been installed and the on indicator is lit:

1. Turn the vehicle off.
2. Remove the child restraint from the vehicle.
3. Remove any additional items from the seat such as blankets, cushions, seat covers, seat heaters, or seat massagers.
4. Reinstall the child restraint following the directions provided by the child restraint manufacturer and refer to *Securing Child Restraints (Rear Seat)* on page 1-51 or *Securing Child Restraints (Right Front Seat)* on page 1-53.

5. If, after reinstalling the child restraint and restarting the vehicle, the on indicator is still lit, turn the vehicle off. Then slightly recline the vehicle seatback and adjust the seat cushion, if adjustable, to make sure that the vehicle seatback is not pushing the child restraint into the seat cushion. Also make sure the child restraint is not trapped under the vehicle head restraint. If this happens, adjust the head restraint.
6. Restart the vehicle.

If the on indicator is still lit, secure the child in the child restraint in a rear seat position in the vehicle, and check with your dealer/retailer.

If the Off Indicator is Lit for an Adult-Size Occupant



If a person of adult-size is sitting in the right front passenger seat, but the off indicator is lit, it could be because that person is not sitting properly in the seat.

1-34 Seats and Restraints

If this happens, use the following steps to allow the system to detect that person and enable the right front passenger frontal airbag and seat-mounted side impact airbag:

1. Turn the vehicle off.
2. Remove any additional material from the seat, such as blankets, cushions, seat covers, seat heaters, or seat massagers.
3. Place the seatback in the fully upright position.
4. Have the person sit upright in the seat, centered on the seat cushion, with legs comfortably extended.
5. Restart the vehicle and have the person remain in this position for two to three minutes after the on indicator is lit.

Additional Factors Affecting System Operation

Safety belts help keep the passenger in position on the seat during vehicle maneuvers and braking, which helps the passenger sensing system maintain the passenger airbag status. See “Safety Belts” and “Child Restraints” in the Index for additional information about the importance of proper restraint use.

A thick layer of additional material, such as a blanket or cushion, or aftermarket equipment such as seat covers, seat heaters, and seat massagers can affect how well the passenger sensing system operates. We recommend that you not use seat covers or other aftermarket equipment except when approved by GM for your specific vehicle. See *Adding Equipment to Your Airbag-Equipped Vehicle* on page 1-36 for more information about modifications that can affect how the system operates.

A wet seat can affect the performance of the passenger sensing system. Here is how:

- The passenger sensing system may turn off the passenger airbag when liquid is soaked into the seat. If this happens, the off indicator will be lit, and the airbag readiness light on the instrument panel will also be lit.
- Liquid pooled on the seat that has not soaked in may make it more likely that the passenger sensing system will enable (turn on) the passenger airbag while a child restraint or child occupant is on the seat. If the passenger airbag is turned on, the on indicator will be lit.

If the passenger seat gets wet, dry the seat immediately. If the airbag readiness light is lit, do not install a child restraint or allow anyone to occupy the seat.

See *Airbag Readiness Light* on page 4-14 for important safety information.

The on indicator may be lit if an object, such as a briefcase, handbag, grocery bag, laptop or other electronic device, is put on an unoccupied seat. If this is not desired, remove the object from the seat.

 **CAUTION**

Stowing of articles under the passenger seat or between the passenger seat cushion and seatback may interfere with the proper operation of the passenger sensing system.

Servicing Your Airbag-Equipped Vehicle

Airbags affect how the vehicle should be serviced. There are parts of the airbag system in several places around the vehicle. Your dealer/retailer and the service manual have information about servicing the vehicle and the airbag system. To purchase a service manual, see *Service Publications Ordering Information* on page 12-15.

 **CAUTION**

For up to 10 seconds after the ignition is turned off and the battery is disconnected, an airbag can still inflate during improper service. You can be injured if you are close to an airbag when it inflates. Avoid yellow connectors. They are probably part of the airbag system. Be sure to follow proper service procedures, and make sure the person performing work for you is qualified to do so.

Adding Equipment to Your Airbag-Equipped Vehicle

Q: Is there anything I might add to or change about the vehicle that could keep the airbags from working properly?

A: Yes. If you add things that change the vehicle's frame, bumper system, height, front end or side sheet metal, they may keep the airbag system from working properly. Changing or moving any parts of the front seats, safety belts, the airbag sensing and diagnostic module, steering wheel, instrument panel, roof-rail airbag modules, ceiling headliner or pillar garnish trim, front sensors, or airbag wiring can affect the operation of the airbag system.

In addition, the vehicle has a passenger sensing system for the right front passenger position, which includes sensors that are part of the passenger's seat. The passenger sensing system may not operate properly if the original seat trim is replaced with non-GM covers, upholstery or trim, or with GM covers, upholstery or trim designed for a different vehicle. Any object, such as an aftermarket seat heater or a comfort enhancing pad or device, installed under or on top of the seat fabric, could also interfere with the operation of the passenger sensing system.

This could either prevent proper deployment of the passenger airbag(s) or prevent the passenger sensing system from properly turning off the passenger airbag(s). See *Passenger Sensing System on page 1-30*.

If you have any questions, call Customer Assistance. The phone numbers and addresses for Customer Assistance are in Step Two of the Customer Satisfaction Procedure in this manual. See *Customer Satisfaction Procedure on page 12-1*.

Q: Because I have a disability, I have to get my vehicle modified. How can I find out whether this will affect my airbag system?

A: If you have questions, call Customer Assistance. The phone numbers and addresses for Customer Assistance are in Step Two of the Customer Satisfaction Procedure in this manual. See *Customer Satisfaction Procedure on page 12-1*.

In addition, your dealer/retailer and the service manual have information about the location of the airbag sensors, sensing and diagnostic module and airbag wiring.

Airbag System Check

The airbag system does not need regularly scheduled maintenance or replacement. Make sure the airbag readiness light is working. See *Airbag Readiness Light on page 4-14* for more information.

Notice: If an airbag covering is damaged, opened, or broken, the airbag may not work properly. Do not open or break the airbag coverings. If there are any opened or broken airbag covers, have the airbag covering and/or airbag module replaced. For the location of the airbag modules, see *What Makes an Airbag Inflate? on page 1-28*. See your dealer/retailer for service.

Replacing Airbag System Parts After a Crash



A crash can damage the airbag systems in your vehicle. A damaged airbag system may not work properly and may not protect you and your passenger(s) in a crash, resulting in serious injury or even death. To help make sure your airbag systems are working properly after a crash, have them inspected and any necessary replacements made as soon as possible.

If an airbag inflates, you will need to replace airbag system parts. See your dealer/retailer for service. If the airbag readiness light stays on after the vehicle is started or comes on when you are driving, the airbag system may not work properly. Have the vehicle serviced right away. See *Airbag Readiness Light on page 4-14* for more information.

Child Restraints

Older Children



Older children who have outgrown booster seats should wear the vehicle's safety belts.

The manufacturer's instructions that come with the booster seat, state the weight and height limitations for that booster. Use a booster seat with a lap-shoulder belt until the child passes the below fit test:

- Sit all the way back on the seat. Do the knees bend at the seat edge? If yes, continue. If no, return to the booster seat.
- Buckle the lap-shoulder belt. Does the shoulder belt rest on the shoulder? If yes, continue. If no, try using the rear safety belt comfort guide. See "Rear Safety Belt Comfort Guides" under *Lap-Shoulder Belt* on page 1-18 for more information. If the shoulder belt still does not rest on the shoulder, then return to the booster seat.

- Does the lap belt fit low and snug on the hips, touching the thighs? If yes, continue. If no, return to the booster seat.
- Can proper safety belt fit be maintained for the length of the trip? If yes, continue. If no, return to the booster seat.

Q: What is the proper way to wear safety belts?

A: An older child should wear a lap-shoulder belt and get the additional restraint a shoulder belt can provide. The shoulder belt should not cross the face or neck. The lap belt should fit snugly below the hips, just touching the top of the thighs. This applies belt force to the child's pelvic bones in a crash. It should never be worn over the abdomen, which could cause severe or even fatal internal injuries in a crash.

Also see “Rear Safety Belt Comfort Guides” under *Lap-Shoulder Belt* on page 1-18.

According to accident statistics, children and infants are safer when properly restrained in a child restraint system or infant restraint system secured in a rear seating position.

In a crash, children who are not buckled up can strike other people who are buckled up, or can be thrown out of the vehicle. Older children need to use safety belts properly.

 **CAUTION**

Never do this.

Never allow two children to wear the same safety belt. The safety belt can not properly spread the impact forces. In a crash, the two children can be crushed together and seriously injured. A safety belt must be used by only one person at a time.



CAUTION

Never do this.

Never allow a child to wear the safety belt with the shoulder belt behind their back. A child can be seriously injured by not wearing the lap-shoulder belt properly. In a crash, the child would not be restrained by the shoulder belt. The child could move too far forward increasing the chance of head and neck injury. The child might also slide under the lap belt. The belt force would then be applied right on the abdomen. That could cause serious or fatal injuries. The shoulder belt should go over the shoulder and across the chest.



Infants and Young Children

Everyone in a vehicle needs protection! This includes infants and all other children. Neither the distance traveled nor the age and size of the traveler changes the need, for everyone, to use safety restraints. In fact, the law in every state in the United States and in every Canadian province says children up to some age must be restrained while in a vehicle.

CAUTION

Children can be seriously injured or strangled if a shoulder belt is wrapped around their neck and the safety belt continues to tighten. Never leave children unattended in a vehicle and never allow children to play with the safety belts.

Airbags plus lap-shoulder belts offer protection for adults and older children, but not for young children and infants. Neither the vehicle's safety belt system nor its airbag system is designed for them. Every time infants and young children ride in vehicles, they should have the protection provided by appropriate child restraints.

Children who are not restrained properly can strike other people, or can be thrown out of the vehicle.

⚠ CAUTION

Never do this.

Never hold an infant or a child while riding in a vehicle. Due to crash forces, an infant or a child will become so heavy it is not possible to hold it during a crash. For example, in a crash at only 25 mph (40 km/h), a 12 lb (5.5 kg) infant will suddenly become a 240 lb (110 kg) force on a person's arms. An infant should be secured in an appropriate restraint.



⚠ CAUTION

Never do this.

Children who are up against, or very close to, any airbag when it inflates can be seriously injured or killed. Never put a rear-facing child restraint in the right front seat. Secure a rear-facing child

(Continued)

CAUTION (Continued)

restraint in a rear seat. It is also better to secure a forward-facing child restraint in a rear seat. If you must secure a forward-facing child restraint in the right front seat, always move the front passenger seat as far back as it will go.



1-42 Seats and Restraints

Q: What are the different types of add-on child restraints?

A: Add-on child restraints, which are purchased by the vehicle's owner, are available in four basic types. Selection of a particular restraint should take into consideration not only the child's weight, height, and age but also whether or not the restraint will be compatible with the motor vehicle in which it will be used.

For most basic types of child restraints, there are many different models available. When purchasing a child restraint, be sure it is designed to be used in a motor vehicle. If it is, the restraint will have a label saying that it meets federal motor vehicle safety standards.

The restraint manufacturer's instructions that come with the restraint state the weight and height limitations for a particular child restraint. In addition, there are many kinds of restraints available for children with special needs.

CAUTION

To reduce the risk of neck and head injury during a crash, infants need complete support. This is because an infant's neck is not fully developed and its head weighs so much compared with the rest of its body. In a crash, an infant in a rear-facing child restraint settles into the restraint, so the crash forces can be distributed across the strongest part of an infant's body, the back and shoulders. Infants should always be secured in rear-facing child restraints.

CAUTION

A young child's hip bones are still so small that the vehicle's regular safety belt may not remain low on the hip bones, as it should. Instead, it may settle up around the child's abdomen. In a crash, the belt would apply force on a body area that is unprotected by any bony structure. This alone could cause serious or fatal injuries. To reduce the risk of serious or fatal injuries during a crash, young children should always be secured in appropriate child restraints.

Child Restraint Systems



(A) Rear-Facing Infant Seat

A rear-facing infant seat (A) provides restraint with the seating surface against the back of the infant.

The harness system holds the infant in place and, in a crash, acts to keep the infant positioned in the restraint.



(B) Forward-Facing Child Seat

A forward-facing child seat (B) provides restraint for the child's body with the harness.

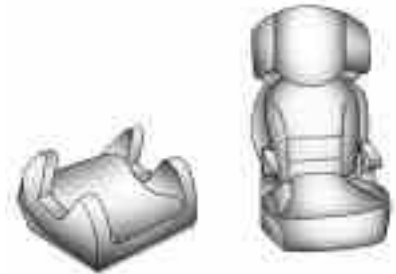

(C) Booster Seats

A booster seat (C) is a child restraint designed to improve the fit of the vehicle's safety belt system. A booster seat can also help a child to see out the window.

1-44 Seats and Restraints

Securing an Add-On Child Restraint in the Vehicle

CAUTION

A child can be seriously injured or killed in a crash if the child restraint is not properly secured in the vehicle. Secure the child restraint properly in the vehicle using the vehicle's safety belt or LATCH system, following the instructions that came with that child restraint and the instructions in this manual.

To help reduce the chance of injury, the child restraint must be secured in the vehicle. Child restraint systems must be secured in vehicle seats by lap belts or the lap belt portion of a lap-shoulder belt, or by the LATCH system. See *Lower*

Anchors and Tethers for Children (LATCH) on page 1-46 for more information. A child can be endangered in a crash if the child restraint is not properly secured in the vehicle.

When securing an add-on child restraint, refer to the instructions that come with the restraint which may be on the restraint itself or in a booklet, or both, and to this manual. The child restraint instructions are important, so if they are not available, obtain a replacement copy from the manufacturer.

Keep in mind that an unsecured child restraint can move around in a collision or sudden stop and injure people in the vehicle. Be sure to properly secure any child restraint in the vehicle — even when no child is in it.

Securing the Child Within the Child Restraint

CAUTION

A child can be seriously injured or killed in a crash if the child is not properly secured in the child restraint. Secure the child properly following the instructions that came with that child restraint.

Where to Put the Restraint

According to accident statistics, children and infants are safer when properly restrained in a child restraint system or infant restraint system secured in a rear seating position.

We recommend that children and child restraints be secured in a rear seat, including: an infant or a child riding in a rear-facing child restraint;

a child riding in a forward-facing child seat; an older child riding in a booster seat; and children, who are large enough, using safety belts.

A label on the sun visor says, "Never put a rear-facing child restraint in the front." This is because the risk to the rear-facing child is so great, if the airbag deploys.

 **CAUTION**

A child in a rear-facing child restraint can be seriously injured or killed if the right front passenger airbag inflates. This is because the back of the rear-facing child restraint would be very close to the inflating airbag. A child in a forward-facing child restraint can be seriously injured or killed if the right front passenger airbag inflates and the passenger seat is in a forward position.

(Continued)

CAUTION (Continued)

Even if the passenger sensing system has turned off the right front passenger frontal airbag, no system is fail-safe. No one can guarantee that an airbag will not deploy under some unusual circumstance, even though it is turned off.

Secure rear-facing child restraints in a rear seat, even if the airbag is off. If you secure a forward-facing child restraint in the right front seat, always move the front passenger seat as far back as it will go. It is better to secure the child restraint in a rear seat.

See *Passenger Sensing System* on page 1-30 for additional information.

When securing a child restraint in a rear seating position, study the instructions that came with the child restraint to make sure it is compatible with this vehicle.

Wherever a child restraint is installed, be sure to secure the child restraint properly.

Keep in mind that an unsecured child restraint can move around in a collision or sudden stop and injure people in the vehicle. Be sure to properly secure any child restraint in the vehicle — even when no child is in it.

Lower Anchors and Tethers for Children (LATCH)

The LATCH system holds a child restraint during driving or in a crash. This system is designed to make installation of a child restraint easier. The LATCH system uses anchors in the vehicle and attachments on the child restraint that are made for use with the LATCH system.

Make sure that a LATCH-compatible child restraint is properly installed using the anchors, or use the vehicle's safety belts to secure the restraint, following the instructions that came with that restraint, and also the instructions in this manual. When installing a child restraint with a top tether, you must also use either the lower anchors or the safety belts to properly secure the child restraint. A child restraint must never be installed using only the top tether and anchor.

In order to use the LATCH system in your vehicle, you need a child restraint that has LATCH attachments. The child restraint manufacturer will provide you with instructions on how to use the child restraint and its attachments. The following explains how to attach a child restraint with these attachments in your vehicle.

Not all vehicle seating positions or child restraints have lower anchors and attachments or top tether anchors and attachments.

Lower Anchors



Lower anchors (A) are metal bars built into the vehicle. There are two lower anchors for each LATCH seating position that will accommodate a child restraint with lower attachments (B).

Top Tether Anchor

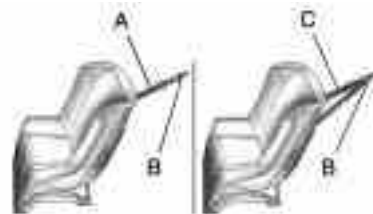

A top tether (A, C) anchors the top of the child restraint to the vehicle. A top tether anchor is built into the vehicle. The top tether attachment (B) on the child restraint connects to the top tether anchor in the vehicle in order to reduce the forward movement and rotation of the child restraint during driving or in a crash.

Your child restraint may have a single tether (A) or a dual tether (C). Either will have a single attachment (B) to secure the top tether to the anchor.

Some child restraints with top tethers are designed for use with or without the top tether being attached. Others require the top tether always to be attached. In Canada, the law requires that forward-facing child restraints have a top tether, and that the tether be attached. Be sure to read and follow the instructions for your child restraint.

If the child restraint does not have a top tether, one can be obtained, in kit form, for many child restraints. Ask the child restraint manufacturer whether or not a kit is available.

Lower Anchor and Top Tether Anchor Locations

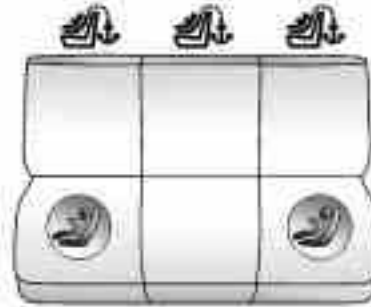

Rear Seat

 (Top Tether Anchor): Seating positions with top tether anchors.

 (Lower Anchor): Seating positions with two lower anchors.



To assist you in locating the lower anchors, each seating position with lower anchors has two labels, near the crease between the seatback and the seat cushion.



If the top tether anchors are covered, the top tether anchor symbol will be located on the cover to assist you in locating them.

1-48 Seats and Restraints

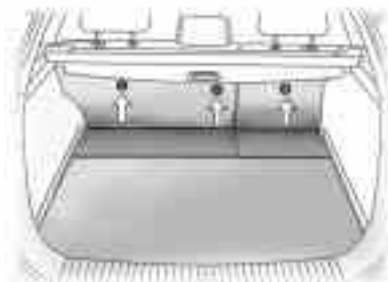

The top tether anchors are located on the seatback for each rear seating position. Be sure to use an anchor located on the same side of the vehicle as the seating position where the child restraint will be placed.

Do not secure a child restraint in a position without a top tether anchor if a national or local law requires that the top tether be attached, or if the instructions that come with the child restraint say that the top tether must be attached. There is no place to attach the top tether in this position.

Accident statistics show that children are safer if they are restrained in the rear rather than the front seat. See *Where to Put the Restraint* on page 1-44 for additional information.

Securing a Child Restraint Designed for the LATCH System

CAUTION

If a LATCH-type child restraint is not attached to anchors, the child restraint will not be able to protect the child correctly. In a crash, the child could be seriously injured or killed. Install a LATCH-type child restraint properly using the anchors, or use the vehicle's safety belts to secure the restraint, following the instructions that came with the child restraint and the instructions in this manual.

CAUTION

Do not attach more than one child restraint to a single anchor. Attaching more than one child restraint to a single anchor could cause the anchor or attachment to come loose or even break during a crash. A child or others could be injured. To reduce the risk of serious or fatal injuries during a crash, attach only one child restraint per anchor.

CAUTION

Children can be seriously injured or strangled if a shoulder belt is wrapped around their neck and the safety belt continues to

(Continued)

CAUTION (Continued)

tighten. Buckle any unused safety belts behind the child restraint so children cannot reach them. Pull the shoulder belt all the way out of the retractor to set the lock, if your vehicle has one, after the child restraint has been installed.

Notice: Do not let the LATCH attachments rub against the vehicle's safety belts. This may damage these parts. If necessary, move buckled safety belts to avoid rubbing the LATCH attachments.

Do not fold the empty rear seat with a safety belt buckled. This could damage the safety belt or the seat. Unbuckle and return the safety belt to its stowed position, before folding the seat.

1. Attach and tighten the lower attachments to the lower anchors. If the child restraint does not have lower attachments or the desired seating position does not have lower anchors, secure the child restraint with the top tether and the safety belts. Refer to your child restraint manufacturer instructions and the instructions in this manual.
 - 1.1. Find the lower anchors for the desired seating position.
 - 1.2. Put the child restraint on the seat.
 - 1.3. Attach and tighten the lower attachments on the child restraint to the lower anchors.

2. If the child restraint manufacturer recommends that the top tether be attached, attach and tighten the top tether to the top tether anchor, if equipped. Refer to the child restraint instructions and the following steps:
 - 2.1. Find the top tether anchor.
 - 2.2. If the anchor is covered, open the cover to expose the anchor.

1-50 Seats and Restraints

- 2.3. Route, attach, and tighten the top tether according to your child restraint instructions and the following instructions:



If the position you are using has an adjustable headrest or head restraint and you are using a dual tether, route the tether around the headrest or head restraint.



If the position you are using has an adjustable headrest or head restraint and you are using a single tether, raise the headrest or head restraint and route the tether under the headrest or head restraint and in between the headrest or head restraint posts.

3. Push and pull the child restraint in different directions to be sure it is secure.

Replacing LATCH System Parts After a Crash

CAUTION

A crash can damage the LATCH system in the vehicle. A damaged LATCH system may not properly secure the child restraint, resulting in serious injury or even death in a crash. To help make sure the LATCH system is working properly after a crash, see your dealer/retailer to have the system inspected and any necessary replacements made as soon as possible.

If the vehicle has the LATCH system and it was being used during a crash, new LATCH system parts may be needed.

New parts and repairs may be necessary even if the LATCH system was not being used at the time of the crash.

Securing Child Restraints (Rear Seat)

When securing a child restraint in a rear seating position, study the instructions that came with your child restraint to make sure it is compatible with this vehicle.

If the child restraint has the LATCH system, see *Lower Anchors and Tethers for Children (LATCH)* on page 1-46 for how and where to install your child restraint using LATCH. If a child restraint is secured in the vehicle using a safety belt and it uses a top tether, see *Lower Anchors and Tethers for Children (LATCH)* on page 1-46 for top tether anchor locations.

Do not secure a child restraint in a position without a top tether anchor if a national or local law requires that the top tether be anchored, or if the instructions that come with the child restraint say that the top strap must be anchored.

In Canada, the law requires that forward-facing child restraints have a top tether, and that the tether be attached.

If the child restraint does not have the LATCH system, you will be using the safety belt to secure the child restraint in this position. Be sure to follow the instructions that came with the child restraint. Secure the child in the child restraint when and as the instructions say.

If more than one child restraint needs to be installed in the rear seat, be sure to read *Where to Put the Restraint* on page 1-44.

1. Put the child restraint on the seat.
2. Pick up the latch plate, and run the lap and shoulder portions of the vehicle's safety belt through or around the restraint. The child restraint instructions will show you how.



3. Push the latch plate into the buckle until it clicks. Position the release button on the buckle so that the safety belt could be quickly unbuckled if necessary.

1-52 Seats and Restraints



4. Pull the rest of the shoulder belt all the way out of the retractor to set the lock.



5. To tighten the belt, push down on the child restraint, pull the shoulder portion of the belt to tighten the lap portion of the belt, and feed the shoulder belt back into the retractor. When installing a forward-facing child restraint, it may be helpful to use your knee to push down on the child restraint as you tighten the belt.

6. If your child restraint has a top tether, follow the child restraint manufacturer's instructions regarding the use of the top tether. See *Lower Anchors and Tethers for Children (LATCH)* on page 1-46 for more information.
7. Push and pull the child restraint in different directions to be sure it is secure.

To remove the child restraint, unbuckle the vehicle safety belt and let it return to the stowed position. If the top tether is attached to a top tether anchor, disconnect it.

Securing Child Restraints (Right Front Seat)

This vehicle has airbags. A rear seat is a safer place to secure a forward-facing child restraint. See *Where to Put the Restraint* on page 1-44.

In addition, the vehicle has a passenger sensing system which is designed to turn off the right front passenger frontal and seat-mounted side impact airbag under certain conditions. See *Passenger Sensing System* on page 1-30 and *Passenger Airbag Status Indicator* on page 4-15 for more information, including important safety information.

A label on the sun visor says, "Never put a rear-facing child seat in the front." This is because the risk to the rear-facing child is so great, if the airbag deploys.

CAUTION

A child in a rear-facing child restraint can be seriously injured or killed if the right front passenger airbag inflates. This is because the back of the rear-facing child restraint would be very close to the inflating airbag. A child in a forward-facing child restraint can be seriously injured or killed if the right front passenger airbag inflates and the passenger seat is in a forward position.

(Continued)

CAUTION (Continued)

Even if the passenger sensing system has turned off the right front passenger frontal airbag, no system is fail-safe. No one can guarantee that an airbag will not deploy under some unusual circumstance, even though it is turned off.

Secure rear-facing child restraints in a rear seat, even if the airbag is off. If you secure a forward-facing child restraint in the right front seat, always move the front passenger seat as far back as it will go. It is better to secure the child restraint in a rear seat.

See *Passenger Sensing System* on page 1-30 for additional information.

1-54 Seats and Restraints

If the child restraint has the LATCH system, see *Lower Anchors and Tethers for Children (LATCH)* on page 1-46 for how and where to install the child restraint using LATCH. If a child restraint is secured in the seating position using a safety belt and it uses a top tether, see *Lower Anchors and Tethers for Children (LATCH)* on page 1-46 for top tether anchor locations.

Do not secure a child seat in a position without a top tether anchor if a national or local law requires that the top tether be anchored, or if the instructions that come with the child restraint say that the top strap must be anchored.

In Canada, the law requires that forward-facing child restraints have a top tether, and that the tether be attached.

You will be using the lap-shoulder belt to secure the child restraint in this position. Follow the instructions that came with the child restraint.

1. Move the seat as far back as it will go before securing the forward-facing child restraint.

When the passenger sensing system has turned off the right front passenger frontal and seat-mounted side impact airbag, the off indicator on the passenger airbag status indicator should light and stay lit when you start the vehicle. See *Passenger Airbag Status Indicator* on page 4-15.

2. Put the child restraint on the seat.
3. Pick up the latch plate, and run the lap and shoulder portions of the vehicle's safety belt through or around the restraint. The child restraint instructions will show you how.



4. Push the latch plate into the buckle until it clicks.
Position the release button on the buckle so that the safety belt could be quickly unbuckled if necessary.



5. Pull the rest of the shoulder belt all the way out of the retractor to set the lock.



6. To tighten the belt, push down on the child restraint, pull the shoulder portion of the belt to tighten the lap portion of the belt and feed the shoulder belt back into the retractor. When installing a forward-facing child restraint, it may be helpful to use your knee to push down on the child restraint as you tighten the belt.

7. Push and pull the child restraint in different directions to be sure it is secure.

If the airbags are off, the off indicator in the passenger airbag status indicator will come on and stay on when the vehicle is started.

If a child restraint has been installed and the on indicator is lit, see "If the On Indicator is Lit for a Child Restraint" under *Passenger Sensing System on page 1-30* for more information.

To remove the child restraint, unbuckle the vehicle safety belt and let it return to the stowed position.

Keys, Doors and Windows

Keys

Keys	2-2
Remote Keyless Entry (RKE) System	2-3
Remote Keyless Entry (RKE) System Operation ...	2-4

Doors and Locks

Door Locks	2-5
Power Door Locks	2-6
Rear Door Security Locks	2-6
Liftgate	2-6

Theft-Deterrent Systems

Theft-Deterrent Systems	2-8
Immobilizer	2-8
Immobilizer Operation	2-8
Content Theft-Deterrent	2-9

Windows

Windows	2-10
Power Windows	2-10
Sun Visors	2-11

Mirrors

Manual Rearview Mirror ...	2-11
Outside Mirror(s)	2-11
Outside Power Mirror(s) ...	2-12

Sunroof

Sunroof	2-12
---------------	------

2-2 Keys, Doors and Windows

Keys

CAUTION

Leaving children in a vehicle with the ignition key is dangerous for many reasons, children or others could be badly injured or even killed. They could operate the power windows or other controls or even make the vehicle move. The windows will function with the keys in the ignition and children could be seriously injured or killed if caught in the path of a closing window. Do not leave the keys in a vehicle with children.



The key, located in the Remote Keyless Entry (RKE) transmitter, is used for the ignition and all locks.



Press the button on the RKE transmitter to extend the key. Press the button and the key blade to retract the key.

When a new vehicle is delivered, a key number is included in the vehicle documents.

Each key number tells your dealer/retailer or a qualified locksmith how to make extra keys. Keep this number in a safe place. If you lose your keys, you will be able to have one made easily using this number. If you need a new key, go to your dealer/retailer for the correct key code.

Notice: If you ever lock your keys in the vehicle, you may have to damage the vehicle to get in. Be sure you have spare keys.

If you are locked out of your vehicle, contact Roadside Assistance or OnStar. See *Roadside Assistance Program on page 12-6* or *OnStar® System on page 4-38*.

Remote Keyless Entry (RKE) System

The Remote Keyless Entry (RKE) system operates on a radio frequency subject to Federal Communications Commission (FCC) Rules and with Industry Canada.

This device complies with Part 15 of the FCC Rules. Operation is subject to the following two conditions:

1. This device may not cause interference.
2. This device must accept any interference received, including interference that may cause undesired operation of the device.

This device complies with RSS-210 of Industry Canada. Operation is subject to the following two conditions:

1. This device may not cause interference.
2. This device must accept any interference received, including interference that may cause undesired operation of the device.

Changes or modifications to this system by other than an authorized service facility could void authorization to use this equipment.

If there is a decrease in the RKE operating range, try this:

- Check the distance. The transmitter may be too far from the vehicle. Stand closer during rainy or snowy weather.
- Check the location. Other vehicles or objects may be blocking the signal. Take a few steps to the left or right, hold the transmitter higher, and try again.
- Check the transmitter's battery. See "Battery Replacement" later in this section.
- If the transmitter is still not working correctly, see your dealer/retailer or a qualified technician for service.

Remote Keyless Entry (RKE) System Operation



⊞ (Lock): Press to lock the doors, liftgate and fuel tank door.

If the driver door is open, the doors will not lock.

⊳ (Unlock): Press to unlock the doors, liftgate and fuel tank door.

Press and hold ⊳ to lower all the windows.

Programming Transmitters to the Vehicle

Only RKE transmitters programmed to this vehicle will work. If a transmitter is lost or stolen, a replacement can be purchased and programmed through your dealer/retailer. When the replacement transmitter is programmed to this vehicle, all remaining transmitters must also be reprogrammed.

Any lost or stolen transmitters will no longer work once the new transmitter is programmed. Each vehicle can have up to five transmitters programmed to it.

Battery Replacement

Replace the battery if the Remote Control Battery check message appears in the DIC. See “Remote Control Battery Check” under *DIC Warnings and Messages (Base and Uplevel Systems)* on page 4-36.

Notice: When replacing the battery, do not touch any of the circuitry on the transmitter. Static from your body could damage the transmitter.

To replace the battery:

1. Extend the key. See *Keys* on page 2-2 for additional information.



2. Open the RKE transmitter.
3. Remove the old battery. Do not use a metal object.
4. Insert the new battery, positive side facing up. Replace with a CR2032 or equivalent battery.
5. Close the RKE transmitter.

Synchronization

After changing the battery, turn the ignition to ON/RUN. This synchronizes the key.

Doors and Locks

Door Locks

⚠ CAUTION

Unlocked doors can be dangerous.

- Passengers, especially children, can easily open the doors and fall out of a moving vehicle. When a door is locked, the handle will not open it. You increase the chance of being thrown out of the vehicle in a crash if the doors are not locked. So, wear safety belts properly and lock the doors whenever you drive.

(Continued)

CAUTION (Continued)

- Young children who get into unlocked vehicles may be unable to get out. A child can be overcome by extreme heat and can suffer permanent injuries or even death from heat stroke. Always lock your vehicle whenever you leave it.
- Outsiders can easily enter through an unlocked door when you slow down or stop your vehicle. Locking your doors can help prevent this from happening.

To manually lock or unlock your vehicle, use the key in the driver's door from the outside to unlock it. When the driver door is opened the entire vehicle is unlocked. There are also window sill knobs that unlock each door from the inside.

2-6 Keys, Doors and Windows

Power Door Locks

The power door lock switch is located on the instrument panel.

 **(Door Lock):** Press to lock the doors, liftgate, and the fuel tank door. The button will illuminate when locked. Press again to unlock.

If the driver's door is not closed properly, the power door lock switch will not lock the doors.

When the vehicle has been unlocked, the key is not in the ignition, and no door is opened the vehicle will automatically lock itself again after one minute.

Rear Door Security Locks

Your vehicle has rear door security locks to prevent passengers from opening the rear doors from the inside.



Open the rear doors to access the security locks on the inside edge of each door.

To set the locks, insert a key into the slot and turn it to the horizontal position. The door can only be opened from the outside with the door unlocked. To return the door to normal operation, turn the slot to the vertical position.

Liftgate



Exhaust gases may enter the vehicle if it is driven with the liftgate, trunk/hatch open, or with any objects that pass through the seal between the body and the trunk/hatch or liftgate. Engine exhaust contains Carbon Monoxide (CO) which cannot be seen or smelled. It can cause unconsciousness and even death.

If the vehicle must be driven with the liftgate, or trunk/hatch open:

- Close all of the windows.
- Fully open the air outlets on or under the instrument panel.

(Continued)

CAUTION (Continued)

- Adjust the Climate Control system to a setting that brings in only outside air and set the fan speed to the highest setting. See Climate Control System in the Index.
- If the vehicle is equipped with a power liftgate, disable the power liftgate function.

For more information about carbon monoxide, see *Engine Exhaust* on page 8-14.

Notice: If you open the liftgate without checking for overhead obstructions such as a garage door, you could damage the liftgate or the liftgate glass. Always check to make sure the area above and behind the liftgate is clear before opening it.

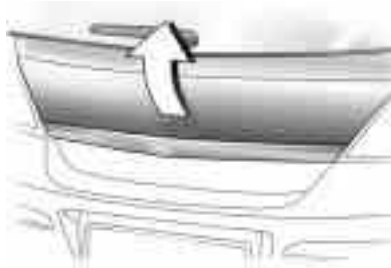

Press the touchpad located in the handle of the liftgate and lift up to open.



Use the inside pull handle to lower and close the liftgate.

Do not press the touchpad while closing the liftgate. This will cause the liftgate to be unlatched.

Always close the liftgate before driving.

Theft-Deterrent Systems

Vehicle theft is big business, especially in some cities. This vehicle has theft-deterrent features, however, they do not make it impossible to steal.

Immobilizer

This device complies with Part 15 of the FCC Rules. Operation is subject to the following two conditions:

1. This device may not cause interference.
2. This device must accept any interference received, including interference that may cause undesired operation.

This device complies with RSS-210 of Industry Canada. Operation is subject to the following two conditions:

1. This device may not cause interference.
2. This device must accept any interference received, including interference that may cause undesired operation of the device.

Changes or modifications to this system by other than an authorized service facility could void authorization to use this equipment.

Immobilizer Operation

This vehicle has a passive theft-deterrent system.

The system is automatically armed when the key is removed from the ignition.

The system is automatically disarmed when the key is turned to ON/RUN.

You do not have to manually arm or disarm the system.



The service vehicle soon light, located in the instrument panel cluster, comes on if there is a problem with arming or disarming the theft-deterrent system.

The key uses a transponder that matches an immobilizer control unit in the vehicle. Only the correct key starts the vehicle.

When starting the vehicle, the service vehicle soon light comes on briefly when the ignition is turned on.

If the engine does not start and the service vehicle soon light flashes there is a problem with the system. Turn the ignition off and try again.

If the engine still does not start and the service vehicle soon light continues to flash, try another key.

If the engine still does not start with the other key, the vehicle needs service. If the vehicle does start, the first key may be damaged. See your dealer/retailer who can service the theft-deterrent system and have a new key made.

In an emergency, contact Roadside Service. See *Roadside Assistance Program* on page 12-6.

Do not leave the key or device that disarms or deactivates the theft deterrent system in the vehicle.

Content Theft-Deterrent

This vehicle has a content theft-deterrent alarm system.



The security light is located on the instrument panel.

Do not use this system if there are people in the vehicle. The doors can not be unlocked from inside the vehicle.

Arming the System

To arm the system:

1. Close all doors, windows, hood and sunroof.
2. Press  on the Remote Keyless Entry (RKE) transmitter.

The security light flashes when the vehicle is armed.

Disarming the System

To disarm the system, do one of the following:

- Press  on the RKE transmitter.
- Turn the ignition on.

The security light stays on for approximately one second when the vehicle is disarming.

How the System Alarm is Activated

To activate the system if it is armed, open any door, the liftgate or hood. The horn will sound and the hazard warning flashers will flash.

How to Turn Off the System Alarm

To turn off the system alarm, do one of the following:

- Press the unlock button on the RKE transmitter.
- Insert the key in the ignition and turn it on.

The theft-deterrent system is disarmed when the alarm is turned off.

Windows

CAUTION

Leaving children, helpless adults, or pets in a vehicle with the windows closed is dangerous. They can be overcome by the extreme heat and suffer permanent injuries or even death from heat stroke. Never leave a child, a helpless adult, or a pet alone in a vehicle, especially with the windows closed in warm or hot weather.



Power Windows

CAUTION

Leaving children in a vehicle with the keys is dangerous for many reasons, children or others could be badly injured or even killed. They could operate the power windows or other controls or even make the vehicle move. The windows will function and they could be seriously injured or killed if caught in the path of a closing window. Do not leave keys in a vehicle with children.

When there are children in the rear seat use the window lockout button to prevent unintentional operation of the windows.



The window switches are located on each of the doors.

To lower a window, press the switch down. To raise a window, pull the switch up.

Express-Down Window

This feature is on all windows. It allows you to lower the window all the way without holding the switch down.

Press the front of the switch to the second position and release. If you want to stop the window as it is lowering, briefly pull up the switch.

Press and hold the unlock button on the Remote Keyless Entry (RKE) transmitter to lower all of the windows from outside the vehicle.

Window Lockout

 **(Window Lockout):** This button is located on the driver's door armrest. Slide the switch forward to turn the lockout feature on. The rear windows can only be opened or closed by the driver window switches. The light on the button indicates the feature is in use. Press again to turn off.

Sun Visors

Pull the visor toward you, or move it to the side to help reduce glare.

To use the lighted mirror, lift the cover.

Mirrors

Manual Rearview Mirror

Hold the mirror in the center to move it for a clearer view of behind your vehicle.

Headlamp Glare

To reduce headlamp glare from vehicles following from behind, pull the lever toward you. Push the lever forward after the vehicle glare is gone, to return the mirror back to the original position.

Vehicles with OnStar[®] have three additional control buttons located at the bottom of the mirror. See your dealer/retailer for more information on the system and how to subscribe to OnStar[®]. See *OnStar[®] System on page 4-38* for more information about the services OnStar provides.

Cleaning the Mirror

Do not spray glass cleaner directly on the mirror. Use a soft towel dampened with glass cleaner.

Outside Mirror(s)

To maximize the viewing area, adjust each mirror to see the side of your vehicle and the area beside and behind your vehicle.

Manually fold the mirrors inward to prevent damage when going through an automatic car wash. To fold, push the mirror toward the vehicle. Push the mirror outward, to return to its original position.

Outside Power Mirror(s)



 **(Power Mirrors):** Press to select the driver side or passenger side mirror. Press the arrows to move the selected mirror in the desired direction.

Outside Heated Mirrors

The vehicle may have outside heated mirrors which help clear the condensation, snow, and ice.

 **(Rear Window Defogger):** Press to heat the mirrors. See “Rear Window Defogger” under, *Climate Control System on page 7-1* for more information.

Sunroof



On vehicles with a sunroof, the switches are located in the overhead console. To operate the sunroof, the ignition must be turned on.

 **Vent/Open:** With the sunroof in the closed position, press to vent the sunroof. With the sunroof in the vent position, press to open the sunroof. The sunshade will open automatically with the sunroof.

 **Close:** Press to close the sunroof. Press and hold to close completely.

Sunshade

 **Sunshade Open:** Press to open the sunshade.

 **Sunshade Close:** Press to close the sunshade. Press and hold to close completely.

Storage

Storage

Glove Box	3-1
Cupholders	3-1
Sunglasses Storage Compartment	3-1
Cargo Cover	3-2
Cargo Tie Downs	3-2

Storage

Glove Box

Pull up on the handle to open the glovebox. There may be a shelf inside that can be removed by lifting up on the shelf and pulling it out.

Cupholders

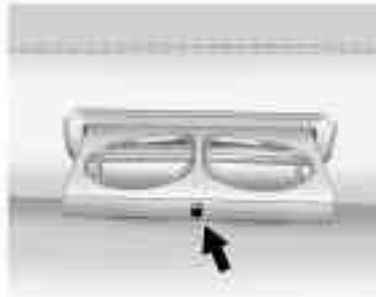

There is a cupholder on the front edge of the rear seat cushion. To open or close, press on the cupholder.

There is a cupholder on the rear center console.

Sunglasses Storage Compartment



The vehicle may have a sunglasses storage compartment located above the driver door. Pull the lid down to open the compartment.

3-2 Storage

Cargo Cover

Your vehicle may have a cargo cover.



To remove the cover, unhook the retaining straps from the liftgate and pull the cover from the side guides.

Cargo Tie Downs

Four cargo tie-downs are located in the rear compartment of the vehicle. The tie-downs can be used to secure small loads.

Instruments and Controls

Instrument Panel Overview

Instrument Panel Overview	4-2
Hazard Warning Flashers	4-4
Horn	4-4
Tilt Wheel	4-4
Turn Signal/Multifunction Lever	4-4
Cruise Control	4-5
Turn and Lane-Change Signals	4-8
Headlamp High/Low-Beam Changer	4-8
Flash-to-Pass	4-8
Windshield Wipers	4-8
Windshield Washer	4-9
Rear Window Wiper/Washer	4-9
Accessory Power Outlet(s)	4-10

Warning Lights, Gages, and Indicators

Warning Lights, Gages, and Indicators	4-11
Instrument Panel Cluster	4-12
Speedometer and Odometer	4-13
Trip Odometer(s)	4-13
Tachometer	4-13
Safety Belt Reminders	4-13
Airbag Readiness Light	4-14
Passenger Airbag Status Indicator	4-15
Charging System Light	4-16
Brake System Warning Light	4-16
Antilock Brake System (ABS) Warning Light	4-17
StabiliTrak [®] Indicator Light	4-17
Engine Coolant Temperature Warning Light	4-18
Tire Pressure Light	4-18
Malfunction Indicator Lamp	4-18
Oil Pressure Light	4-21
Low Oil Level Light	4-22

Winter Driving Mode Light	4-22
Fog Lamp Light	4-22
Exterior Lamps Off Reminder	4-23
Cruise Control Light	4-23
Highbeam On Light	4-23
Door Ajar Light	4-23
Service Vehicle Soon Light	4-23
Fuel Gage	4-24
Low Fuel Warning Light	4-24

Driver Information Center (DIC)

Driver Information Center (DIC)	4-25
DIC Operation and Displays (Uplevel DIC and Audio)	4-26
DIC Operation and Displays (Base Level DIC and Audio)	4-32
DIC Warnings and Messages (Base and Uplevel Systems)	4-36

OnStar[®] System

OnStar [®] System	4-38
----------------------------------	------

4-2 Instruments and Controls

Instrument Panel Overview

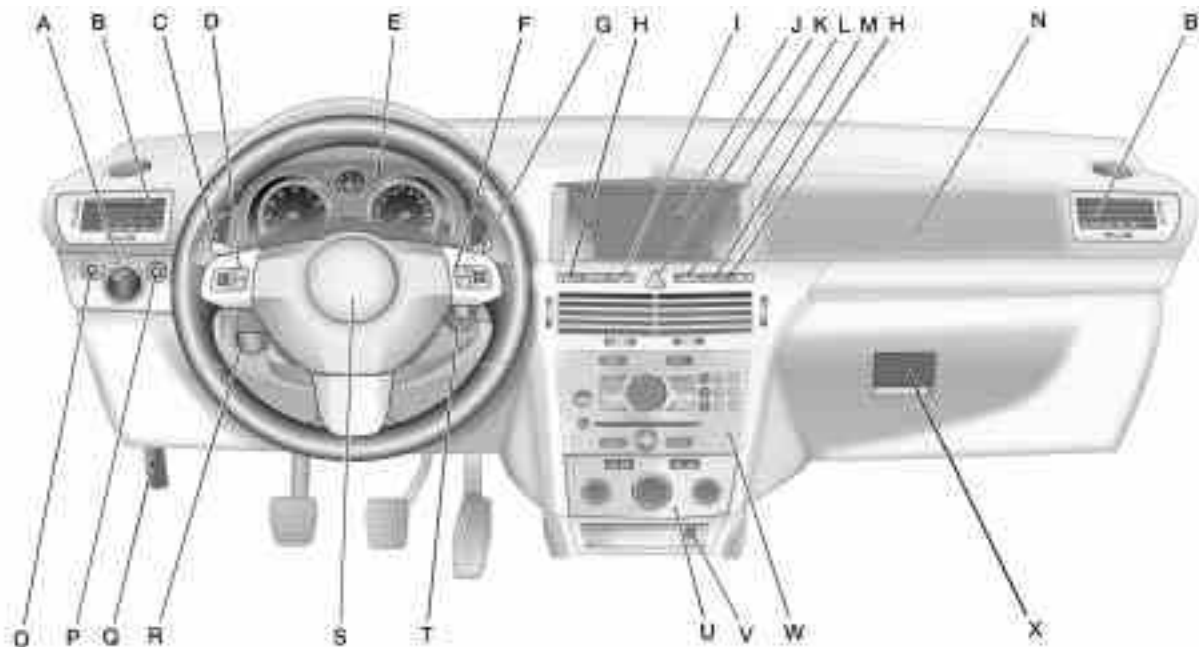

The main components of the instrument panel are the:

- A. *Exterior Lamps Controls on page 5-1.*
- B. *Outlets. Outlet Adjustment on page 7-4.*
- C. *Turn Signal/Multifunction Lever on page 4-4.*
- D. *DIC Operation and Displays (Uplevel DIC and Audio) on page 4-26 or DIC Operation and Displays (Base Level DIC and Audio) on page 4-32 and Audio Steering Wheel Controls on page 6-23. (If Equipped)*
- E. *Instrument Panel Cluster on page 4-12.*
- F. *Audio Steering Wheel Controls on page 6-23. (If Equipped)*
- G. *Windshield Wipers on page 4-8.*
- H. *Heated Seats on page 1-6. (If Equipped)*
- I. *StabiliTrak[®] System on page 8-19. (If Equipped)*
- J. *Driver Information Center (DIC) on page 4-25. (If Equipped)*
- K. *Hazard Warning Flashers on page 4-4.*
- L. *Power Door Locks on page 2-6.*
- M. *Passenger Safety Belt Reminder. Safety Belt Reminders on page 4-13.*
- N. *Front Passenger Airbag. Airbag System on page 1-24.*
- O. *Fog Lamps on page 5-2. (If Equipped)*
- P. *Instrument Panel Brightness on page 5-3.*
- Q. *Hood Release on page 9-5.*
- R. *Tilt Wheel on page 4-4.*
- S. *Horn on page 4-4.*
- T. *Ignition Positions on page 8-2.*
- U. *Climate Control System on page 7-1.*
- V. *Accessory Power Outlet(s) on page 4-10. (Covered)*
- W. *Audio System(s) on page 6-1.*
- X. *Glove Box on page 3-1.*

4-4 Instruments and Controls

Hazard Warning Flashers

 : Press this button located on the instrument panel, to make the front and rear turn signal lamps flash on and off. This warns others that you are having trouble. Press the button again to turn the flashers off.

While the hazard warning flashers are on, the turn signals do not work.

An indicator light on the hazard warning flasher button comes on whenever the ignition is turned on.

If the airbags are deployed, the hazard warning flashers turn on automatically. Press the button twice to turn them off.

Horn

Press the horn symbol in the middle of the steering wheel to sound the horn.

Tilt Wheel

A tilt and telescope wheel lets the steering wheel position be adjusted.



The adjustment lever is located on the left side of the steering column.

It allows the steering column to be moved up or down and in or out.

Do not adjust the steering wheel while driving.

Turn Signal/Multifunction Lever



The lever on the left side of the steering column includes the following:

 : Turn and Lane-Change Signals

 : Headlamp High/Low-Beam Changer

 : Cruise Control (If Equipped)

Flash-to-Pass Feature.

Information for these features is on the pages following.

Cruise Control

CAUTION

Cruise control can be dangerous where you cannot drive safely at a steady speed. So, do not use the cruise control on winding roads or in heavy traffic.

Cruise control can be dangerous on slippery roads. On such roads, fast changes in tire traction can cause excessive wheel slip, and you could lose control. Do not use cruise control on slippery roads.

With cruise control, a speed of about 25 mph (40 km/h) or more can be maintained without keeping your foot on the accelerator. Cruise control does not work at speeds below about 25 mph (40 km/h).



The cruise control buttons are located on the turn signal/multifunction lever on the left side of the steering wheel.

 **(On/Off):** Press and hold the button on the back end of the cruise control lever, to turn the cruise control system on or off. The CC on or CC off message will appear on the instrument panel cluster at the odometer display to show that the cruise control system is on or off.

 **(Set/Accelerate):** Press to set a speed and to accelerate the speed.

 **(Resume/Coast):** Press to resume a set speed and to decrease the speed.

4-6 Instruments and Controls

Setting Cruise Control

For safety reasons the cruise control cannot be turned on until the brake has been applied once.

With automatic transmission, only use cruise control in D (Drive).

Press the On/Off button to turn on the cruise control. A message briefly appears on the instrument panel cluster at the odometer display when the cruise control has been turned on.

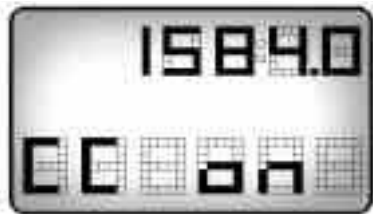

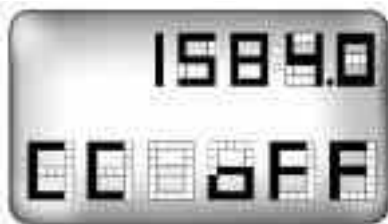

CC On Message



CC Off Message

CAUTION

If you leave your cruise control on when you are not using cruise, you might hit a button and go into cruise when you do not want to. You could be startled and even lose control. Keep the cruise control switch off until you want to use cruise control.

1. Press  and the current speed is stored and maintained.
2. Take your foot off the accelerator pedal. The  indicator light on the instrument panel cluster turns on after the cruise control has been set to the desired speed.

The cruise control automatically disengages under the following conditions:



- The vehicle speed drops below 25 mph (40 km/h).
- The brake is applied.
- The clutch pedal is applied (for manual transmission vehicles).
- The automatic transmission is in N (Neutral).
- The On/Off button is pressed.

Resuming a Set Speed

Once the vehicle speed reaches about 25 mph (40 km/h) or more and the cruise control is on, press . The vehicle returns to the previous speed selected before the cruise was disengaged.



The stored speed is deleted if the ignition is turned off.

Increasing Speed While Using Cruise Control

- Press and hold  until the desired speed is reached, then release it.
- To increase vehicle speed in small increments, briefly press  repeatedly. Each time this is done, the vehicle speed increase by about 1 mph (1.6 km/h) without using the accelerator pedal.

When the  button is released the current speed is stored and maintained.

Reducing Speed While Using Cruise Control

- Press and hold  until the desired lower speed is reached, then release it.
- To reduce vehicle speed in small increments, briefly press  repeatedly. Each time this is done, the vehicle speed decreases by about 1 mph (1.6 km/h).

When the  button is released the current speed is stored and maintained.

Passing Another Vehicle While Using Cruise Control

Use the accelerator pedal to increase the vehicle speed. When the accelerator pedal is released, the vehicle will return to the previously set cruise speed.

Using Cruise Control on Hills

How well the cruise control will work on hills depends upon the vehicle speed, load, and the steepness of the hills. While going up steep hills, you might have to step on the accelerator pedal to maintain the vehicle's speed. While going downhill, you might have to brake or shift to a lower gear to keep the vehicle's speed down. Of course, applying the brake turns off the cruise control.

Ending Cruise Control

There are several ways to end cruise control:

- Step lightly on the brake or clutch pedal.
- The automatic transmission is placed in N (Neutral).
- Press the  button.

Erasing Speed Memory

The cruise control set speed memory is erased when the cruise control or the ignition is turned off.

Turn and Lane-Change Signals



To signal a turn, move the lever all the way up or down, past the detent. The lever returns to its starting position when released.

An arrow on the instrument panel cluster flashes in the direction of the turn or lane change.

To signal a lane change, raise or lower the lever until the arrow starts to flash, and then release the lever. Do not move the lever past the detent. The turn signal will automatically flash three times and turn off.

To cancel it before turning, move the lever slightly in either direction. Do not past the detent.

If the turn signal is moved up or down and left engaged, the headlamps and taillamps will remain on and the battery could be drained.

Headlamp High/Low-Beam Changer



(Headlamp High/Low Beam Changer): To change the headlamps from low to high beam, push the multifunction lever towards the instrument panel. To return to low-beam headlamps, push the lever towards the instrument panel again or pull the lever toward you. Then release it.



This indicator light on the instrument panel cluster is on while the high beam headlamps are on.

Flash-to-Pass

Pull the turn signal/multifunction lever towards you to flash the high beams from low beam.

Windshield Wipers

Clear ice and snow from the wiper blades before using them. If the wiper blades are frozen to the windshield, gently loosen or thaw them. If the blades do become damaged, install new blades or blade inserts. See *Windshield Wiper Blade Replacement* on page 9-21.

Heavy snow or ice can overload the wiper motor. A circuit breaker will stop the motor until it cools down. Clear away snow or ice to prevent an overload.



The lever on the right side of the steering column operates the windshield wipers. Push up or pull down on the lever to place it in one of the following positions.

- ▬ (High):** For rapid wiping cycles.
- (Low):** For slow, steady wiping cycles.
- (Intermittent/RainSense™):** See RainSense™ wipers below.
- (Off):** Turns off the wipers.

For a single wipe pull the lever down from the off position. The lever will return to its original position. For more cycles, hold the lever down before releasing it.

RainSense™ Wipers

There is a moisture sensor mounted on the windshield next to the inside rearview mirror. When active, the sensor is able to detect moisture on the windshield and automatically control the frequency of the wipes according to the weather conditions.

To turn on the RainSense feature, the wipers must be set to the intermittent delay setting on the windshield wiper lever.

To turn off RainSense, move the lever downwards.

Notice: Going through an automatic car wash with the wipers on can damage them. Turn the wipers off when going through an automatic car wash.

Windshield Washer

⚠ CAUTION

In freezing weather, do not use your washer until the windshield is warmed. Otherwise the washer fluid can form ice on the windshield, blocking your vision.

Pull the windshield wiper lever toward you to spray washer fluid on the windshield. The wipers will run for a few cycles to clear the windshield. For more wash cycles, pull the lever forward and hold.

Rear Window Wiper/Washer

For vehicles with the rear wiper/washer feature, it is turned on by moving the windshield wiper lever.

To turn the rear wiper on or off, push the windshield wiper lever.

4-10 Instruments and Controls

To turn on the rear washer, hold the windshield wiper lever toward the front of the vehicle to spray the rear window.

The rear wiper turns on automatically when the windshield wiper is turned on and the shift lever is in R (Reverse).

The rear window washer uses the same fluid bottle as the windshield washer. However, the rear window washer will run out of fluid before the windshield washer. If washer fluid sprays onto the windshield but not the rear window, check the fluid level. See *Windshield Washer Fluid on page 9-20*.

For information on replacing the rear wiper blades, see *Windshield Wiper Blade Replacement on page 9-21*.

Accessory Power Outlet(s)

The 12-volt accessory power outlets can be used to connect electrical equipment, such as a cellular phone.

There may be a accessory power outlet located inside the console below the climate controls.

Notice: Leaving electrical equipment on for extended periods will drain the battery. Always turn off electrical equipment when not in use and do not plug in equipment that exceeds the maximum 20 ampere rating.

Certain electrical accessories may not be compatible with the accessory power outlet and could result in blown vehicle or adapter fuses. If there is a problem, see your dealer/retailer for additional information on the accessory power outlet.

Notice: Adding any electrical equipment to your vehicle may damage it or keep other components from working as they should. The repairs would not be covered by your warranty. Check with your dealer/retailer before adding electrical equipment.

When adding electrical equipment, be sure to follow the installation instructions included with the equipment.

Notice: Improper use of the power outlet can cause damage not covered by the warranty. Do not hang any type of accessory or accessory bracket from the plug because the power outlets are designed for accessory power plugs only.

Warning Lights, Gages, and Indicators

Warning lights and gages can signal that something is wrong before it becomes serious enough to cause an expensive repair or replacement. Paying attention to the warning lights and gages could prevent injury.

Warning lights come on when there may be or is a problem with one of the vehicle's functions. Some warning lights come on briefly when the engine is started to indicate they are working.

Gages can indicate when there may be or is a problem with one of the vehicle's functions. Often gages and warning lights work together to indicate a problem with the vehicle.

When one of the warning lights comes on and stays on while driving, or when one of the gages shows there may be a problem, check the section that explains what to do. Follow this manual's advice. Waiting to do repairs can be costly and even dangerous.

4-12 Instruments and Controls

Instrument Panel Cluster

The instrument cluster is designed to show at a glance how the vehicle is running. It shows how fast the vehicle is going, about how much fuel has been used, and many other things needed to drive safely and economically.



United States Base Automatic Transmission version shown, Canada, Manual Transmission and Uplevel similar

Speedometer and Odometer

The speedometer shows the vehicle's speed in both miles per hour (mph) or kilometers per hour (km/h).

The odometer shows how far the vehicle has been driven, in either miles or kilometers.

If a new odometer is installed, the new one is set to the mileage total of the old odometer. If it cannot, it will be set at zero and a label must be put on the driver's door to show the old mileage reading when the new odometer was installed. If the mileage is unknown, the label should then indicate "previous mileage unknown."

Trip Odometer(s)

The trip odometer, located at the center of the instrument panel cluster, tells how far the vehicle has been driven since the trip odometer was set to zero.

To reset the trip odometer, hold the reset stem, located to the right of the speedometer, for approximately one second while the trip odometer is displayed. The engine must be turned on.

Service Display

The vehicle may have a display above the odometer that shows when service is needed. The number that displays with "INSP" is the remaining distance that can be driven until service is required. See *Engine Oil Life System* on page 9-9 and the index of the Saturn Astra Limited Warranty, Maintenance and Owner Assistance Information Manual.

Tachometer

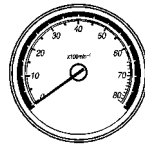

The tachometer displays the engine speed in revolutions per minute.

Safety Belt Reminders

Driver Safety Belt Reminder Light

There is a Driver Safety Belt Reminder Light on the instrument panel cluster.



When the engine is started this light and chime come on and stay on for several seconds to remind drivers to fasten their safety belts. The light also begins to flash.

This cycle repeats if the driver remains unbuckled and the vehicle is moving.

If the driver safety belt is already buckled, neither the light nor chime come on.

Passenger Safety Belt Reminder Light



For vehicles with this light, it operates the same as the Safety Belt Reminder Light except that it is meant for the front passenger.

If the passenger safety belt is buckled, neither the chime nor the light comes on.

The front passenger safety belt warning light and chime may turn on if an object is put on the seat such as a briefcase, handbag, grocery bag, laptop or other electronic device. To turn off the warning light and or chime, remove the object from the seat or buckle the safety belt

Airbag Readiness Light

This light shows if there is an electrical problem. The system check includes the airbag sensor, the pretensioners, the airbag modules, the wiring and the crash sensing and diagnostic module. For more information on the airbag system, see *Airbag System on page 1-24*.



This light will come on and stay on for several seconds when the vehicle is started. Then the light should go out.

If the airbag readiness light stays on after the vehicle has been started or comes on when while driving, the airbag system may not work properly. Have the vehicle serviced right away.

CAUTION

If the airbag readiness light stays on after the vehicle is started or comes on while driving, it means the airbag system might not be working properly. The airbags in the vehicle might not inflate in a crash, or they could even inflate without a crash. To help avoid injury, have the vehicle serviced right away.

Passenger Airbag Status Indicator

The vehicle has a passenger sensing system. See *Passenger Sensing System on page 1-30* for important safety information. The rearview mirror has a passenger airbag status indicator.



United States



Canada

When the vehicle is started, the passenger airbag status indicator will light ON and OFF, or the symbol for on and off, for several seconds

as a system check. Then, after several more seconds, the status indicator will light either ON or OFF, or either the on or off symbol to let you know the status of the right front passenger frontal and seat-mounted side impact airbags.

If the word ON or the on symbol is lit on the passenger airbag status indicator, it means that the right front passenger frontal airbag and seat-mounted side impact airbag are enabled (may inflate).

If the word OFF or the off symbol is lit on the passenger airbag status indicator, it means that the passenger sensing system has turned off the right front passenger frontal airbag and seat-mounted side impact airbag. See *Passenger Sensing System on page 1-30* for more on this, including important safety information.

If, after several seconds, both status indicator lights remain on, or if there are no lights at all, there may be a problem with the lights or the passenger sensing system. See your dealer/retailer for service.

CAUTION

If the airbag readiness light ever comes on and stays on, it means that something may be wrong with the airbag system. To help avoid injury to yourself or others, have the vehicle serviced right away. See *Airbag Readiness Light on page 4-14* for more information, including important safety information.

Charging System Light

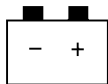

The charging system light comes on briefly when the ignition is turned on, but the engine is not running, as a check to show the light is working. It should go out when the engine is started.

If the light stays on, or comes on while driving, there could be a problem with the electrical charging system. Have it checked by your dealer/retailer. Driving while this light is on could drain the battery.

If a short distance must be driven with the light on, be sure to turn off all accessories, such as the radio and air conditioner.

Brake System Warning Light



BRAKE

United States



Canada

The brake indicator light should come on briefly as the engine is started. If it does not come on have the vehicle serviced by your dealer/retailer.

When the ignition is on, the brake system warning light comes on when the parking brake is set. The light stays on if the parking brake does not fully release. If it stays on after the parking brake is fully released, there is a brake problem. Have the brake system inspected immediately.

CAUTION

The brake system might not be working properly if the brake system warning light is on. Driving with the brake system warning light on can lead to a crash. If the light is still on after the vehicle has been pulled off the road and carefully stopped, have the vehicle towed for service.

If the light comes on while driving, a chime sounds. Pull off the road and stop. The pedal might be harder to push or go closer to the floor. It might also take longer to stop. If the light is still on, have the vehicle towed for service. See *Towing Your Vehicle on page 9-73*.

Antilock Brake System (ABS) Warning Light



The Antilock Brake System (ABS) light will come on briefly, as a check, when you start your vehicle.

If it does not, have your vehicle serviced so that the light works properly when it needs to.

If the light stays on longer than a few seconds after you start your engine, or comes on and stays on while you are driving, try resetting the system. To reset the system:

1. If you are driving, pull over when it is safe to do so. It may take longer to stop the vehicle.
2. Place the vehicle in P (Park).
3. Turn off the ignition.
4. Then restart the engine.

If the light remains on after resetting the system or comes on again while driving, your vehicle needs service. The antilock brakes are not working properly and there might be a problem stopping the vehicle. Pull off the road and stop. It may take longer to stop the vehicle. If the light is still on, have the vehicle towed for service. See *Towing Your Vehicle* on page 9-73 for more information.

CAUTION

Your brake system may not be working properly if the Antilock Brake System (ABS) light is on. Driving with the ABS light on can lead to an accident. If the light is still on after you have pulled off the road and stopped carefully, have the vehicle towed for service.

StabiliTrak[®] Indicator Light



For vehicles with this light, it should come on briefly when the ignition is turned on.

If the light does not come on, have it fixed so it will be ready to warn if there is a problem.

If the light stays on, or comes on while driving there may be a problem with the StabiliTrak system and your vehicle may need service. When this light is on, the StabiliTrak system does not assist in controlling the vehicle. Adjust your driving accordingly.

See *StabiliTrak[®] System* on page 8-19 for more information.

When the system is active, the light will flash while the system helps control the vehicle. You may also feel or hear the system working. This is normal.

Engine Coolant Temperature Warning Light

The engine coolant temperature light should come on briefly as the engine is started. If it does not come on have the vehicle serviced by your dealer/retailer.



Notice: Driving with the engine coolant temperature warning light on could cause the vehicle to overheat. See *Engine Overheating on page 9-18*. The vehicle's engine could be damaged, and it might not be covered by the vehicle warranty. Never drive with the engine coolant temperature warning light on.

If this light comes on and stays on, the engine has overheated. Pull over and see *Engine Overheating on page 9-18* for more information.

Tire Pressure Light



For vehicles with this light, it comes on briefly as a check when the ignition is turned on.

This light comes on and stays on when one or more of the vehicle's tires are significantly underinflated.

Stop and check the tires as soon as it is safe to do so. If underinflated, inflate to the proper pressure. See *Tires on page 9-40* for more information.

This light flashes for approximately one minute and then stays on when the system detects a malfunction. See *Tire Pressure Monitor System on page 9-49* for more information.

Malfunction Indicator Lamp

Check Engine Light

A computer system called OBD II (On-Board Diagnostics-Second Generation) monitors operation of the fuel, ignition, and emission control systems. It makes sure that emissions are at acceptable levels for the life of the vehicle, helping to produce a cleaner environment.



This light should come on when the ignition is on, but the engine is not running, as check to show it is working. If it does not, have the vehicle serviced by your dealer/retailer.

If the check engine light comes on and stays on, while the engine is running, this indicates that there is an OBD II problem and service is required.

Malfunctions often are indicated by the system before any problem is apparent. Heeding the light can prevent more serious damage to the vehicle. This system is also designed to assist the service technician in correctly diagnosing any malfunction.

Notice: If the vehicle is continually driven with this light on, after a while, the emission controls might not work as well, the vehicle's fuel economy might not be as good, and the engine might not run as smoothly. This could lead to costly repairs that might not be covered by the vehicle warranty.

Notice: Modifications made to the engine, transmission, exhaust, intake, or fuel system of the vehicle or the replacement of the original tires with other than those of the same Tire Performance Criteria (TPC) can affect the vehicle's emission controls and can cause this light to come on. Modifications to these systems could lead to costly repairs not covered by the vehicle warranty. This could also result in a failure to pass a required Emission Inspection/Maintenance test. See *Accessories and Modifications on page 9-3*.

This light comes on during a malfunction in one of two ways:

Light Flashing: A misfire condition has been detected. A misfire increases vehicle emissions and could damage the emission control system on the vehicle. Diagnosis and service might be required.

The following can prevent more serious damage to the vehicle:

- Reduce vehicle speed.
- Avoid hard accelerations.
- Avoid steep uphill grades.

If the light continues to flash, when it is safe to do so, stop the vehicle. Find a safe place to park the vehicle. Turn the key off, wait at least 10 seconds, and restart the engine. If the light is still flashing, follow the previous steps and see your dealer/retailer for service as soon as possible.

4-20 Instruments and Controls

Light On Steady: An emission control system malfunction has been detected on the vehicle. Diagnosis and service might be required.

An emission system malfunction might be corrected by doing the following:

- Make sure the fuel cap is fully installed. See *Filling the Tank on page 8-36*. The diagnostic system can determine if the fuel cap has been left off or improperly installed. A loose or missing fuel cap allows fuel to evaporate into the atmosphere. A few driving trips with the cap properly installed should turn the light off.
- If the vehicle has been driven through a deep puddle of water, the vehicle's electrical system might be wet. The condition is usually corrected when the electrical system dries out. A few driving trips should turn the light off.

- Make sure to fuel the vehicle with quality fuel. Poor fuel quality causes the engine not to run as efficiently as designed and may cause: stalling after start-up, stalling when the vehicle is changed into gear, misfiring, hesitation on acceleration, or stumbling on acceleration. These conditions might go away once the engine is warmed up.

If one or more of these conditions occurs, change the fuel brand used. It will require at least one full tank of the proper fuel to turn the light off.

See *Gasoline Octane on page 8-34*.

If none of the above have made the light turn off, have your dealer/retailer check the vehicle.

The dealer/retailer has the proper test equipment and diagnostic tools to fix any mechanical or electrical problems that might have developed.

Emissions Inspection and Maintenance Programs

Some state/provincial and local governments have or might begin programs to inspect the emission control equipment on your vehicle. Failure to pass this inspection could prevent getting a vehicle registration.

Here are some things to know to help the vehicle pass an inspection:

- The vehicle will not pass this inspection if the check engine light is on with the engine running, or if the key is in the ON/RUN and the light is not on.

- The vehicle will not pass this inspection if the OBD II (on-board diagnostic) system determines that critical emission control systems have not been completely diagnosed by the system. The vehicle would be considered not ready for inspection. This can happen if the battery has recently been replaced or if the battery has run down. The diagnostic system is designed to evaluate critical emission control systems during normal driving. This can take several days of routine driving. If this has been done and the vehicle still does not pass the inspection for lack of OBD II (system readiness, your dealer/retailer can prepare the vehicle for inspection.

Oil Pressure Light

CAUTION

Do not keep driving if the oil pressure is low. The engine can become so hot that it catches fire. Someone could be burned. Check the oil as soon as possible and have the vehicle serviced.

Notice: Lack of proper engine oil maintenance can damage the engine. The repairs would not be covered by the vehicle warranty. Always follow the maintenance schedule in this manual for changing engine oil.

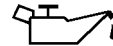

The oil pressure light should come on briefly as the engine is started. If it does not come on have the vehicle serviced by your dealer/retailer.

If the light comes on and stays on, it means that oil is not flowing through the engine properly. The vehicle could be low on oil and might have some other system problem.

Low Oil Level Light

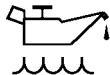

This light should come on briefly when the ignition is turned on as a check to let you know that the light is working.

If this light comes on and stays on while the engine is running, it means your engine is low on oil. You need to check the oil level as soon as possible. See *Engine Oil* on page 9-7 for further information.

Notice: Lack of proper engine oil maintenance can damage the engine. The repairs would not be covered by the vehicle warranty. Always follow the maintenance schedule in this manual for changing engine oil.

Winter Driving Mode Light



This light will come on when the winter driving mode feature is in use.

When you turn off the winter driving mode feature, the light will go out. If it stays on, your vehicle may need service. See your dealer/retailer. See “Winter Driving Mode” under *Automatic Transmission Operation* on page 8-6 for more information.

Fog Lamp Light



The fog lamp light comes on when the fog lamps are in use.

The light goes out when the fog lamps are turned off. See *Fog Lamps* on page 5-2 for more information.

Exterior Lamps Off Reminder



This light comes on whenever the exterior lights are off.

See *Exterior Lamps Controls* on page 5-1 for more information.

Cruise Control Light



This light comes on whenever you set the cruise control.

The light goes out when the cruise control is turned off or disengaged. See *Cruise Control* on page 4-5 for more information.

Highbeam On Light



This light comes on when the high-beam headlamps are in use.

See *Headlamp High/Low-Beam Changer* on page 4-8 for more information.

Door Ajar Light



This light comes on when a door or liftgate is open. Before driving, check that all doors are properly closed.

Service Vehicle Soon Light



This light should come on briefly when the ignition is turned on as a check to let you know that the light is working.

This light will come on if a condition exists that may require the vehicle to be taken in for service.

If the light comes on and stays on, see your dealer/retailer for service as soon as possible.

Fuel Gage

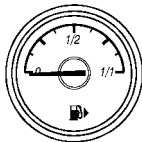

Your fuel gage tells you about how much fuel you have left, when the ignition is on.

When the indicator nears empty, the low fuel warning light will come on. You still have a little fuel left, but you should get more soon. See *Low Fuel Warning Light* on page 4-24 for more information.

The arrow on the fuel gage points to the side of the vehicle with the fuel door.

Here are five things that some owners ask about. These are normal and do not indicate a problem with your fuel gage:

- At the service station, the gas pump shuts off before the gage reads full.
- It takes a little more or less fuel to fill up than the gage indicated.
- The indicator moves a little when you turn a corner or speed up.
- The gage goes back to empty when you turn off the ignition.
- The vehicle is driven or parked on a grade.

Low Fuel Warning Light



This light, below the fuel gage, should come on briefly when the ignition is turned on as a check to let you know that the light is working.

This light also comes on when the fuel tank is low on fuel. When you add fuel the light should go off. If it does not, have your vehicle serviced.

Driver Information Center (DIC)

Vehicles with a Driver Information Center (DIC) can display:

- Time
- Outside temperature
- Date or audio system, if it is turned on
- Trip computer, on vehicles with this feature
- Warning messages

The type of information and how it is displayed depends on the equipment of the vehicle and the settings of the trip computer and audio system. See *DIC Operation and Displays (Uplevel DIC and Audio)* on page 4-26 or *DIC Operation and Displays (Base Level DIC and Audio)* on page 4-32 and *Audio System(s)* on page 6-1 for more information.

An F in the display indicates a fault. See your dealer/retailer for service.

Outside Air Temperature

The DIC shows the temperature outside of the vehicle in either degrees Fahrenheit or degrees Celsius. A fall in temperature is displayed immediately, while a rise in temperature is displayed after a short delay.

On vehicles with the base level DIC, ❄️ displays when the outside air temperature is cold enough to create icy road conditions.

On vehicles with the uplevel DIC, “Slippery road” displays.

The road surface may already be icy even though the DIC shows a few degrees above freezing. Adjust your driving accordingly.

DIC Operation and Displays (Uplevel DIC and Audio)



CDC 40

If the vehicle has the uplevel DIC, the following information explains how the system works.

Selecting Functions

Functions and settings of some equipment can be accessed through the DIC.

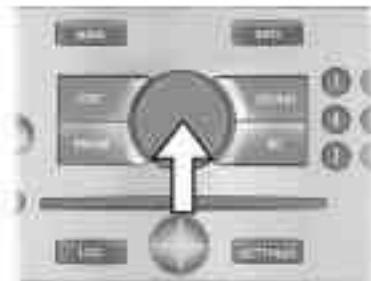

On some vehicles, menu options can be selected with the multifunction knob on the audio system:

1. Turn the multifunction knob until the desired menu item is highlighted.
2. Press the multifunction knob to select the menu item.

To exit a menu, turn the multifunction knob clockwise or counterclockwise to "Return" or "Main", then press the knob.



Menu options can be selected with the left thumbwheel on the steering wheel:

1. Turn the thumbwheel down to advance to the next menu item.
Turn the thumbwheel up to return to the previous menu item.
2. Press the thumbwheel to select the menu item.

On some vehicles, if a warning message appears, the display is blocked from other functions. See *DIC Warnings and Messages (Base and Uplevel Systems)* on page 4-36 for information on acknowledging the message.

For each functional area there is a main page (Main), which is selected at the top edge of the display:

- Audio
- Trip computer, if your vehicle has this feature
See “Trip Computer” later in this section for more information.

For Audio functions, see *Audio System(s)* on page 6-1 for more information.

System Settings

To enter the Settings menu, do one of the following:

- Press MAIN, if your vehicle has this feature, on the audio system.
- Press the SETTINGS button on the audio system.

The Settings menu will appear.

The functions are displayed in the following order:

1. Time, Date
2. Language
3. Units
4. Contrast
5. Day / Night
6. Ign. (Ignition) logic

4-28 Instruments and Controls

Setting Date and Time

To set the date and time:

1. Select Time, Date from the Settings menu.
The menu for Time, Date is displayed.
2. Select the menu items required.
3. Make the desired selection.

Language Selection

To select the display language for some functions:

1. Select Language from the Settings menu.
The available languages are displayed.
2. Make the desired selection.
When selected, a ► appears next to the item.

Setting Units of Measure

To select which units of measure are to be used:

1. Select Units from the Settings menu.
The available units are displayed.
2. Make the desired selection.
When selected, a ● appears next to the item.

Adjusting Contrast

The vehicle may have this feature. To adjust the contrast:

1. Select Contrast from the Settings menu.
The menu for Contrast is displayed.
2. Make the desired selection.

Day / Night

The vehicle may have this feature. The display can be adjusted to best match the lighting conditions. To adjust this setting:

1. Select Day / Night from the Settings menu.
The available options are displayed:
 - **Auto:** Adjusts the display automatically based on the lighting conditions.
 - **Day:** Black or colored text on a light background.
 - **Night:** White or colored text on a dark background.
2. Make the desired selection.

When selected, a ● appears next to the item.

Ignition Logic

If the vehicle has this feature, see *Audio System(s)* on page 6-1 for more information.

Trip Computer

The vehicle may have a trip computer. The trip computer provides information on driving data. This information is continually recorded and evaluated electronically. If power has been interrupted or if the battery voltage has dropped too low, the values stored in the trip computer will be lost.

The trip computer main page provides information on range and instantaneous consumption.

To access other trip computer vehicle data, do one of the following:

- Press the BC button on the audio system, if your vehicle has this feature.
- Press the left thumbwheel, if your vehicle has this feature, on the steering wheel.
- Select the trip computer menu front display.

The functions are displayed in the following order:

Range

This display shows the approximate number of remaining miles (mi) or kilometers (km) the vehicle can be driven without refueling.

The message “Range” displays if less than 31 miles (50 km) can be driven with the fuel remaining in the tank.

See *DIC Warnings and Messages (Base and Uplevel Systems)* on page 4-36 for information on acknowledging the message.

The fuel range estimate is based on an average of the vehicle’s fuel economy over recent driving history and the amount of fuel remaining in the fuel tank. This estimate will change if driving conditions change. For example, if driving in traffic and making frequent stops, this display may read one number, but if the vehicle is driven

on a freeway, the number may change even though the same amount of fuel is in the fuel tank. This is because different driving conditions produce different fuel economies. Generally, freeway driving produces better fuel economy than city driving. Fuel range cannot be reset.

Instantaneous Consumption

This display shows the current fuel economy at a particular moment and will change frequently as driving conditions change. This display shows the instantaneous fuel economy in miles per gallon (mpg) or liters per 100 kilometers (l/100 km).

The metric display changes depending on speed:

- Below 8 mph (13 km/h), displays in l/h.
- Above 8 mph (13 km/h), displays in l/100 km.

This screen cannot be reset.

4-30 Instruments and Controls

Distance Travelled

This display shows the current distance traveled in either miles (mi) or kilometers (km) since the last reset.

The measurement can be reset to zero at any time and restarted. See "Reset" later in this section.

Average Speed

This display shows the average speed of the vehicle in miles per hour (mph) or kilometers per hour (km/h). This average is calculated based on the various vehicle speeds recorded since the last reset of this value.

The measurement can be reset to zero at any time and restarted. See "Reset" later in this section.

Trip Consumption

This display shows the number of gallons (gal) or liters (l) of fuel used since the last reset.

The measurement can be reset to zero at any time and restarted. See "Reset" later in this section.

Average Consumption

This display shows the approximate average miles per gallon (mpg) or liters per 100 kilometers (l/100 km). This number is calculated based on the number of mpg (l/100 km) recorded since the last time this menu item was reset.

The measurement can be reset to zero at any time and restarted. See "Reset" later in this section.

Timer

This display can be used as a timer.

Select Timer from the menu. The Timer menu will display.

To start the timer, select Start.

To reset the timer, select Reset.

The desired stop watch displays can be selected from the Options menu, if your vehicle has this feature:

Driving Time excl. Stops: The time the vehicle is in motion is recorded. Stationary time is not included.

Driving Time incl. Stops: The time the vehicle is in motion is recorded along with the time the vehicle is stationary with the key in the ignition.

Travel Time: Measurement of the time from manual activation, by selecting Start, to manual deactivation, by selecting Reset.

Reset

The following trip computer information can be reset:

- Distance travelled
- Average speed
- Trip consumption
- Average consumption

To reset the value:

1. Select BC 1 or BC 2 from the trip computer menu.

The information of the two trip computers can be reset separately, making it possible to evaluate data from different time periods.

2. To reset, do one of the following:

- Select the desired trip computer information.
The value for the selected function will be reset and recalculated.
- To reset all information of a trip computer, select All values.

After resetting, dashes will display for the trip computer information selected. The recalculated values will display after a brief delay.

DIC Operation and Displays (Base Level DIC and Audio)



CD 30 with MP3 Player shown, without MP3 Player similar

If the vehicle has the base level DIC, the following information explains how the system works.

Selecting Functions

Functions and settings of some equipment can be accessed through the DIC. You can use the thumbwheel, if the vehicle has one, or the buttons on the audio system as described following.



On some vehicles, menu options can be selected with the left thumbwheel on the steering wheel:

1. Turn the thumbwheel down to advance to the next menu item.
Turn the thumbwheel up to return to the previous menu item.
2. Press the thumbwheel to select the menu item.

The available menu options are then shown in order on the display.

On some vehicles, if a warning message appears, the display is blocked from other functions. See *DIC Warnings and Messages (Base and Uplevel Systems)* on page 4-36 for information on acknowledging the message.

System Settings

To enter the Settings menu:

1. Press **SETTINGS** on the audio system.
Audio or System will appear.
2. Press the left arrow button on the audio system or use the thumbwheel on the steering wheel, if the vehicle has one, to reach menu item **System**.
After pressing the **OK** button, the first function of the **System** menu is shown.

The following functions are available:

- Time, setting hours
- Time, setting minutes
- Date, setting day
- Date, setting month
- Date, setting year
- Ignition Logic
- Language selection
- Setting units of measure

Setting Date and Time

To set the date and time:

1. Select time and date from the **Settings** menu.
2. Make the desired selections.
The setting is saved when the menu item is exited.

Ignition Logic

If the vehicle has this feature, see *Audio System(s)* on page 6-1 for more information.

Language Selection

To select the display language for some functions:

1. Select language from the **Settings** menu.
2. Make the desired selection.

Setting Units of Measure

To select which units of measure are to be used:

1. Select units from the **Settings** menu.
2. Make the desired selection.

4-34 Instruments and Controls

Trip Computer

The vehicle may have a trip computer. The trip computer provides information on driving data. This information is continually recorded and evaluated electronically. If power has been interrupted or if the battery voltage has dropped too low, the values stored in the trip computer will be lost.

To access trip computer vehicle data, do one of the following:

- Press the BC button on the audio system.
- Press the left thumbwheel, if your vehicle has this feature, on the steering wheel.

Once an audio function has been selected, the rows of the trip computer function are displayed.

The functions are displayed in the following order:

Instantaneous Consumption

This display shows the current fuel economy at a particular moment and will change frequently as driving conditions change. This display shows the instantaneous fuel economy in miles per gallon (mpg) or liters per 100 kilometers (l/100 km).

The metric display changes depending on speed:

- Below 8 mph (13 km/h), displays in l/h.
- Above 8 mph (13 km/h), displays in l/100 km.

This screen cannot be reset.

Average Consumption

This display shows the approximate average miles per gallon (mpg) or liters per 100 kilometers (l/100 km). This number is calculated based on the number of mpg (l/100 km) recorded since the last time this menu item was reset.

The measurement can be reset to zero at any time and restarted. See "Reset" later in this section.

Trip Consumption

This display shows the number of gallons (gal) or liters (l) of fuel used since the last reset.

The measurement can be reset to zero at any time and restarted. See "Reset" later in this section.

Average Speed

This display shows the average speed of the vehicle in miles per hour (mph) or kilometers per hour (km/h). This average is calculated based on the various vehicle speeds recorded since the last reset of this value.

The measurement can be reset to zero at any time and restarted. See "Reset" later in this section.

Distance Travelled

This display shows the current distance traveled in either miles (mi) or kilometers (km) since the last reset.

The measurement can be reset to zero at any time and restarted. See "Reset" later in this section.

Range

This display shows the approximate number of remaining miles (mi) or kilometers (km) the vehicle can be driven without refueling.

The message "Range" displays if less than 31 mi (50 km) can be driven with the fuel remaining in the tank. The message "Refuel!" displays when approximately 19 mi (30 km) can be driven with the fuel remaining in the tank.

With less than 19 mi (30 km) worth of fuel remaining the range display will show "- -" once the "Refuel!" message has been acknowledged.

See *DIC Warnings and Messages (Base and Uplevel Systems)* on page 4-36 for information on acknowledging the message.

The fuel range estimate is based on an average of the vehicle's fuel economy over recent driving history and the amount of fuel remaining in the fuel tank. This estimate will change if driving conditions change. For example, if driving in traffic and making frequent stops, this display may read one number, but if the vehicle is driven on a freeway, the number may change even though the same amount of fuel is in the fuel tank.

This is because different driving conditions produce different fuel economies. Generally, freeway driving produces better fuel economy than city driving. Fuel range cannot be reset.

Stop Watch

This display can be used as a timer.

To start or stop the timer, press the right arrow on the audio system.

To reset the timer, press the left arrow until the value returns to zero.

If your vehicle has the left thumbwheel on the steering wheel, you can start or stop the timer by pressing the thumbwheel.

Reset

The following trip computer information can be reset:

- Average consumption
- Trip consumption
- Average speed
- Distance travelled

To reset the value:

1. Select the desired trip computer information.
2. Press the OK button on the audio system, or press the left thumbwheel, if your vehicle has this feature, on the steering wheel:
 - To reset the current value, press and hold briefly.
 - To reset all values, press for six seconds.

DIC Warnings and Messages (Base and Uplevel Systems)

Messages are displayed on the DIC to notify the driver that the status of the vehicle has changed and that some action may be needed by the driver to correct the condition. Multiple messages may appear one after another.

The DIC monitors some fluid levels, battery of the Remote Keyless Entry (RKE) transmitter, the theft-deterrent system on vehicles with this feature, the brake light switch, and important exterior lights, including wiring and fuses.

Some messages may not require immediate action, but you can acknowledge that you received the messages and to clear them from the display by doing one of the following:

- Press the OK button on the base level audio system.
- Press the multifunction knob, if your vehicle has this feature, on the uplevel audio system.
- Press the left thumbwheel, if your vehicle has this feature, on the steering wheel.

If there are several warning messages, acknowledge them one at a time.

Some messages cannot be cleared from the DIC display because they are more urgent. These messages require action before they can be cleared. You should take any messages that appear on the display seriously and remember that clearing the messages will only make the messages disappear, not correct the problem.

Warning messages for the uplevel DIC follow. On the base level DIC, messages appear in an abbreviated form.

Brakelight check - - -

This message displays when there is a problem with the vehicle lighting. The source of the problem is displayed as text. For example, "Brakelight check right".

Brakelight switch check

This message displays when the brake lamp does not come on when the brake is applied. Have your vehicle serviced by your dealer/retailer immediately.

Coolant level check

This message displays when the engine coolant level is low. Have the cooling system serviced by your dealer/retailer as soon as possible. See *Engine Coolant on page 9-16*.

Remote Control Battery check

This message displays if the Remote Keyless Entry (RKE) transmitter battery is low. Replace the battery in the transmitter. See "Battery Replacement" under *Remote Keyless Entry (RKE) System Operation on page 2-4*.

Safeguard check

This message displays when there is a problem with the theft-deterrent system. Have the system serviced by your dealer/retailer immediately.

Washer Fluid Level (Base Level) or Washing Water Level (Uplevel)

This message displays when the vehicle's windshield washer fluid is low. When the washer fluid level is low, the rear window washer system is deactivated. Fill the windshield washer fluid reservoir to the proper level as soon as possible. See *Windshield Washer Fluid on page 9-20*.

OnStar[®] System



OnStar uses several innovative technologies and live advisors to provide a wide range of safety, security, information, and convenience services. If the airbags deploy, the system is designed to make an automatic call to OnStar Emergency advisors who can request emergency services be sent to your location. If the keys are locked in the vehicle, call OnStar at 1-888-4-ONSTAR to have a signal sent to unlock the doors. OnStar Hands-Free Calling, including 30 trial minutes good for 60 days, is available on most vehicles. OnStar Turn-by-Turn Navigation service, with one trial route, is available on most vehicles.

Press the OnStar button to have an OnStar advisor contact Roadside Service.

OnStar service is provided subject to the OnStar Terms and Conditions included in the OnStar Subscriber glove box literature.

Some services such as Remote Door Unlock or Stolen Vehicle Location Assistance may not be available until the owner of the vehicle registers with OnStar. After the first prepaid year, contact OnStar to select a monthly or annual subscription payment plan. If a payment plan is not selected, the OnStar system and all services, including airbag notification and emergency services, may be deactivated and no longer available. For more information visit onstar.com (U.S.) or onstar.ca (Canada), or press the OnStar button to speak with an advisor.

Not all OnStar services are available on all vehicles. To check if this vehicle is able to provide the services described below, or for a full description of OnStar services and system limitations, see the OnStar Owner's Guide in the glove box or visit onstar.com (U.S.) or onstar.ca (Canada), contact OnStar at 1-888-4-ONSTAR (1-888-466-7827) or TTY 1-877-248-2080, or press the OnStar button to speak with an OnStar advisor 24 hours a day, 7 days a week.

OnStar Services Available with the Safe & Sound Plan

- Automatic Notification of Airbag Deployment
- Link to Emergency Services
- Roadside Assistance
- Stolen Vehicle Location Assistance

- Remote Door Unlock/Vehicle Alert
- OnStar Vehicle Diagnostic Email
- GM Goodwrench On Demand Diagnostics (if equipped)
- OnStar Hands-Free Calling with 30 trial minutes
- OnStar Virtual Advisor (U.S. Only)

OnStar Services Included with Directions & Connections Plan

- All Safe and Sound Plan Services
- OnStar Turn-by-Turn Navigation (If equipped) or Driving Directions - Advisor delivered
- RideAssist
- Information and Convenience Services

OnStar Hands-Free Calling

OnStar Hands-Free Calling allows eligible OnStar subscribers to make and receive calls using voice commands. Hands-Free Calling is fully integrated into the vehicle, and can be used with OnStar Pre-Paid Minute Packages. Most vehicles include 30 trial minutes good for 60 days. Hands-Free Calling can also be linked to a Verizon Wireless service plan in the U.S. or a Bell Mobility service plan in Canada, depending on eligibility. To find out more, refer to the OnStar Owner's Guide in the vehicle's glove box, visit onstar.com or onstar.ca, or speak with an OnStar advisor by pressing the OnStar button or calling 1-888-4-ONSTAR (1-888-466-7827).

OnStar Turn-by-Turn Navigation

Vehicles with the OnStar Turn-by-Turn Navigation system can provide voice-guided driving directions. Press the OnStar button to have an OnStar advisor locate a business or address and download driving directions to the vehicle. Voice-guided directions to the desired destination will play through the audio system speakers. See the OnStar Owner's Guide for more information.

OnStar Virtual Advisor

OnStar Virtual Advisor is a feature of OnStar Hands-Free Calling that uses minutes to access location-based weather, local traffic reports, and stock quotes. Press the phone button and give a few simple voice commands to browse through the various topics. See the OnStar Owner's Guide for more information. This feature is only available in the continental U.S.

4-40 Instruments and Controls

How OnStar Service Works

The OnStar system can record and transmit vehicle information. This information is automatically sent to an OnStar Call Center when the OnStar button is pressed, the emergency button is pressed, or if the airbags deploy. This information usually includes the vehicle's GPS location and, in the event of a crash, additional information regarding the crash that the vehicle was involved in (e.g. the direction from which the vehicle was hit). When the Virtual Advisor feature of OnStar Hands-Free Calling is used, the vehicle also sends OnStar the vehicle's GPS location so they can provide services where it is located.

OnStar service cannot work unless the vehicle is in a place where OnStar has an agreement with a wireless service provider for service in that area. OnStar service also cannot work unless the vehicle is in a place where the wireless service

provider OnStar has hired for that area has coverage, network capacity and reception when the service is needed, and technology that is compatible with the OnStar service. Not all services are available everywhere, particularly in remote or enclosed areas, or at all times.

Location information about the vehicle is only available if the GPS satellite signals are unobstructed and available.

The vehicle must have a working electrical system, including adequate battery power, for the OnStar equipment to operate. There are other problems OnStar cannot control that may prevent OnStar from providing OnStar service at any particular time or place. Some examples are damage to important parts of the vehicle in a crash, hills, tall buildings, tunnels, weather or wireless phone network congestion.

Your Responsibility

Increase the volume of the radio if the OnStar advisor cannot be heard. If the light next to the OnStar buttons is red, the system may not be functioning properly. Press the OnStar button and request a vehicle diagnostic. If the light appears clear (no light is appearing), your OnStar subscription has expired and all services have been deactivated. Press the OnStar button to confirm that the OnStar equipment is active.

Lighting

Lighting

Exterior Lamps Controls	5-1
Daytime Running Lamps (DRL)	5-2
Delayed Headlamps	5-2
Fog Lamps	5-2
Instrument Panel Brightness	5-3
Dome Lamp(s)	5-3
Entry Lighting	5-3
Reading Lamps	5-3
Trunk Lamp	5-4
Battery Run-Down Protection	5-4

Lighting

Exterior Lamps Controls

The exterior lamp control is located on the instrument panel to the left of the steering wheel.



Turn the exterior lamp control to the following positions:

0 (Off): Turns off the exterior lamps.

AUTO (Automatic): Turns the exterior lamps on and off automatically, depending upon outside lighting.

 (Parking Lamps): Turns on the parking lamps together with the following:

- Taillamps
- Sidemarkers
- License Plate Lamps

 (Headlamps): Turns on the headlamps, together with the previously listed lamps.

After 15 minutes with the ignition switched off and the low-beam headlamps on, the parking lamps turn on.

5-2 Lighting

Daytime Running Lamps (DRL)

Daytime Running Lamps (DRL) can make it easier for others to see the front of your vehicle during the day. DRL can be helpful in many different driving conditions, but they can be especially helpful in the short periods after dawn and before sunset. Fully functional daytime running lamps are required on all vehicles first sold in Canada.

The DRL system makes the low-beam headlamps turn on at a reduced brightness when the following conditions are met:

- The engine is running.
- The light sensor determines it is night and the exterior lamps control is in the off position.
- The light sensor determines it is daytime.

The taillamps and other lamps will be off.

The DRL turns off when the engine is not running.

The regular headlamps or parking lamps should be used when needed.

Delayed Headlamps

Vehicles with headlamp exit delay, keep the headlamps and taillamps on for 30 seconds.

To activate:

1. Turn the ignition off and remove the key from the ignition.
2. Open the driver door.
3. Pull the multifunction lever toward the steering wheel.

To deactivate, do either of the following:

- Insert the key into the ignition.
- Pull the multifunction lever toward the steering wheel again while the driver door is open.

Fog Lamps

For vehicles with fog lamps, the button is located on the instrument panel, to the left of the steering wheel.

The ignition and headlamps or parking lamps must be on to use the fog lamps. The fog lamps will not turn on if the high beam headlamps or flash to pass are active.

 : Press to turn the fog lamps on or off. An indicator light on the instrument panel cluster comes on when the fog lamps are on.

Some localities have laws that require the headlamps to be on along with the fog lamps.

Instrument Panel Brightness

 **(Instrument Panel Brightness):** The knob with this symbol on it is located next to the exterior lamps control to the left of the steering wheel. Push the knob in all the way until it extends out and then turn the knob clockwise or counterclockwise to brighten or dim the lights. Push the knob back in when finished.

Dome Lamp(s)

There are two dome lamps. The rear dome lamp turns on automatically with the front dome lamp.

 **(On/Off):** Press to turn the front dome lamp on or off while the doors are closed.

Entry Lighting

With entry lighting, the interior of the vehicle is illuminated while entering the vehicle. The interior lamps turn on briefly when the door is unlocked using the key or the Remote Keyless Entry (RKE) transmitter and the ignition is in LOCK/OFF. After a few seconds have passed, the interior lamps will slowly fade out.

Reading Lamps

Front Reading Lamps



The front reading lamps, located on the headliner, can be controlled separately by the buttons located near each lamp.

 **(On/Off):** Press to turn the lamp on or off.

5-4 Lighting

Rear Reading Lamps

The rear seat reading lamps can be turned on while the ignition is on.

○ **(Off):** Press to turn the lamp off.

| **(On):** Press to turn the lamp on.

Trunk Lamp

The trunk lamp comes on when the trunk is opened and turns off when the trunk is closed.

Battery Run-Down Protection

This feature helps prevent the battery from being drained, if the courtesy lamps, reading lamps, sun visor, glovebox or rear compartment lamp are left on. If any of these lamps are left on, they automatically turn off after approximately 20 minutes, if the ignition is off.

Infotainment

Audio System(s)

Audio System(s)6-1
 Radio(s)6-2
 Theft-Deterrent Feature6-23
 Audio Steering Wheel
 Controls6-23
 Radio Reception6-24
 Fixed Mast Antenna6-24

Audio System(s)

Determine which radio the vehicle has and read the following pages to become familiar with its features.

 **CAUTION**

Taking your eyes off the road for extended periods could cause a crash resulting in injury or death to you or others. Do not give extended attention to entertainment tasks while driving.

This system provides access to many audio and non audio listings.

To minimize taking your eyes off the road while driving, do the following while the vehicle is parked:

- Become familiar with the operation and controls of the audio system.
- Set up the tone, speaker adjustments, and preset radio stations.

For more information, see *Defensive Driving* on page 8-16.

Notice: Contact your dealer/retailer before adding any equipment.

Adding audio or communication equipment could interfere with the operation of the vehicle's engine, radio, or other systems, and could damage them. Follow federal rules covering mobile radio and telephone equipment.

Radio(s)





CD 30 MP3 Shown, CD 30 Similar

System Operation

 (Volume/Power): Press to turn the system on or off. Turn to increase or decrease the volume.

BC (Board Computer): Press to use the Board Computer. See *DIC Operation and Displays (Uplevel DIC and Audio)* on page 4-26 or *DIC Operation and Displays (Base Level DIC and Audio)* on page 4-32.

OK: Press to confirm selections and go to the next page in the settings menu.

 or : Press to change menu options.



SOUND: Press to enter the sound settings menu and go to the next page in sound settings.

SETTINGS: Press to adjust system and sound settings.

Ignition Logic

When this feature is enabled it turns the audio system on or off when the ignition is turned on or off.

To turn the audio system on or off with Ignition Logic:

- Press  or insert a CD to turn the audio system on. Press  to turn the audio system off when the Ignition Logic system is disabled and the ignition is ON/RUN.

- For vehicles with OnStar[®], the audio system will only turn off if the ignition is OFF and OnStar is not in use when the Ignition Logic system is enabled.

The Ignition Logic is preset to turn off the audio system when the ignition is turned off. To enable or disable Ignition Logic:

1. Press SETTINGS until Audio displays.
2. Press ◀ until System displays.
3. Press OK until Ign. Logic ON or Ign. Logic OFF displays.
4. Press ◀ or ▶ to select the setting. The setting is saved automatically.
 - Press SETTINGS again to move back one level in the menu.
 - Press FM/AM, CD/MP3, or BC to turn on that feature.

Audio displays and the system starts to play if SETTINGS, FM/AM, CD/MP3, or BC is not pressed within five seconds after the setting is saved.

System Display

The following information shows on the system display:

- FM or AM, and the current station frequency if the radio is active.
- The station name displays if RDS is activated.
- AS displays if the AS level is activated.
- CD displays, and the CD title number or the CD title name if the CD player is active.
- MP3 displays if the CD is an MP3 CD.
- RDM displays if the CD is being played in random mode.

The most recent selected audio source plays when the audio system is turned on and the display is lit.

The outside temperature, time, and date display when the audio system is turned off and the ignition is ON/RUN, see *Driver Information Center (DIC) on page 4-25*.

Audio Settings

The audio settings can be set for each audio source and are stored separately for each radio station and the CD player.

Adjusting the Tone (Bass/Treble)

To adjust the Bass:

1. Press SOUND until Bass appears.
2. Press ◀ or ▶ to adjust the level from -12 through +12. The setting is saved automatically.
 - Press SETTINGS again to go back one level in the menu.
 - Press FM/AM, CD/MP3, or BC to display that function.

6-4 Infotainment

Audio displays and the audio system starts to play if SETTINGS, FM/AM, CD/MP3, or BC is not pressed within five seconds after the setting is saved.

To adjust the Treble:

1. Press SOUND until Treble appears.
2. Press ◀ or ▶ to adjust the level from -12 through +12. The setting is saved automatically.
 - Press SETTINGS again to go back one level in the menu.
 - Press FM/AM, CD/MP3, or BC to display that function.

Adjusting the Sound Settings

There are preset sound settings designed for different types of music

To adjust the sound settings using the SOUND button:

1. Press SOUND until Sound appears.
2. Press ◀ or ▶ to select between Rock, Disco, Classic, Jazz, Vocal, and Off. The setting is saved automatically.
 - Press SETTINGS again to go back one level in the menu.
 - Press FM/AM, CD/MP3, or BC to display that function.

To adjust the sound settings using the SETTINGS button:

1. Press SETTINGS until Audio appears.
2. Press OK until Sound appears.

3. Press ◀ or ▶ to select between Rock, Disco, Classic, Jazz, Vocal, and Off. The setting is saved automatically.
 - Press SETTINGS again to go back one level in the menu.
 - Press FM/AM, CD/MP3, or BC to display that function.

Adjusting the Speakers (Balance/Fade)

To adjust the Balance using the SOUND button:

1. Press SOUND until Balance appears.
2. Press ◀ or ▶ to adjust the level from -12 through +12. The setting is saved automatically.
 - Press SETTINGS again to go back one level in the menu.
 - Press FM/AM, CD/MP3, or BC to display that function.

To adjust the Balance using the SETTINGS button:

1. Press SETTINGS until Audio appears.
2. Press OK until Balance appears.
3. Press ◀ or ▶ to adjust the level from -12 through +12. The setting is saved automatically.
 - Press SETTINGS again to go back one level in the menu.
 - Press FM/AM, CD/MP3, or BC to display that function.

To adjust the Fade using the SOUND button:

1. Press SOUND until Fader appears.
2. Press ◀ or ▶ to adjust the level from -12 through +12. The setting is saved automatically.
 - Press SETTINGS again to go back one level in the menu.
 - Press FM/AM, CD/MP3, or BC to display that function.

To adjust the Fade using the SETTINGS button:

1. Press SETTINGS until Audio appears.
2. Press OK until Fader appears.
3. Press ◀ or ▶ to adjust the level from -12 through +12. The setting is saved automatically.
 - Press SETTINGS again to go back one level in the menu.
 - Press FM/AM, CD/MP3, or BC to display that function.

Speed-Dependant Volume Control (SDVC)

SDVC automatically adjusts the volume to compensate for road and wind noise as the vehicle increases or decreases speed while driving.

To adjust SDVC:

1. Press SETTINGS until Audio appears.
2. Press OK until SDVC appears.

3. Press ◀ or ▶ to adjust the level from 0 through 5. The setting is saved automatically.
 - Press SETTINGS again to go back one level in the menu.
 - Press FM/AM, CD/MP3, or BC to display that function.

OnStar® Volume

For vehicles with OnStar, the OnStar Volume is used to set the maximum initial volume level for the OnStar system when it is turned on.

To set OnStar Volume:

1. Press SETTINGS until Audio appears.
2. Press OK until OnStar Vol. appears.
3. Press ◀ or ▶ to adjust the level from -12 through 12. The setting is saved automatically.
 - Press SETTINGS again to go back one level in the menu.
 - Press FM/AM, CD/MP3, or BC to display that function.

6-6 Infotainment

On Volume

The On Volume is used to set the maximum initial volume level for the audio system when it is turned on.

The maximum initial volume level is used only if the volume level before turning the audio system off was higher than the maximum initial volume level set. This will work when the audio system has been off for at least five minutes and the ignition is OFF.

To set the On Volume level:

1. Press **SETTINGS** until Audio appears.
2. Press **OK** until On Volume appears.
3. Press **<** or **>** to adjust the level from -12 through 12. The setting is saved automatically.
 - Press **SETTINGS** again to go back one level in the menu.
 - Press **FM/AM**, **CD/MP3**, or **BC** to display that function.

Using the Radio

FM/AM: Press to select between FM, FM-AS, AM, and AM-AS, or to listen to the radio while a CD is playing.

RDS (Radio Data System): Press to identify stations by name instead of the radio frequency.

LOC (LOCAL/DX Function): Press to change between LOC ON or LOC OFF. When the LOC function is on, it searches for the strongest radio frequency. If none is found, it automatically search for a weaker radio frequency. If no frequency is found after the second search, the radio returns to the last active frequency. If a new station search is not started within one minute, the low sensitivity (LOCAL) is set when the next search is started. When LOC OFF is set, a search is carried out using the high sensitivity (DX).

Finding an FM/AM Station

1 - 9 (Station Preset Buttons):

Press to play stations that are programmed to the radio preset pushbuttons.

SCN (Station Preset Scan): Press to start station preset scan. The radio goes to the first preset station, plays for a few seconds, then goes to the next preset station. Press **SCN** again to stop scanning preset stations.

< or >: Press to find radio stations using the automatic station search or the manual station search.

Automatic Station Search: Use automatic station search when the radio frequency is unknown.

Press **<** or **>** for more than one second to have the radio search for the next station. Seek is shown on the display and the radio is muted until a station is found.

If the radio fails to locate a station, the last active frequency is then reset. When LOC is activated, a search for the next strong station is made. If it is not activated, it searches the next receivable station.

Manual Station Search: Use manual station search when the radio frequency is known.

To use manual station search:

- Press and hold ◀ or ▶ until the desired frequency is reached.
- Tap ◀ or ▶ until the desired frequency is reached.

Setting Preset Stations

The radio can store up to 36 stations using the station preset buttons:

- 9 FM
- 9 FM - AS (Autostore)
- 9 AM
- 9 AM - AS (Autostore)

Radio stations can be stored manually, and by using Autostore.

To manually store preset stations:

1. Select FM or AM and tune to the desired radio station.
2. Press and hold one of the nine station preset buttons, the radio briefly mutes and displays the previously stored station. The new station has been stored when the radio begins playing again.
3. Repeat the steps for each radio station to be stored.

AS (Autostore): Press to automatically store the nine strongest stations in the selected radio band.

To use Autostore:

1. Select FM or AM.
2. Press and hold AS until a beep is heard.
3. The radio begins storing the stations in the nine preset button locations.

Using the CD Player

Display Options

The display can be changed depending on what type of CD is in the CD player. The display options are:

Audio CD without CD text:

- Track number and playing time.

Audio CD with CD text:

- Track title
- Artist name
- Track number and playing time
- CD name

To change the display:

1. Press CD/MP3 twice, CD info appears on the display.
2. Press ◀ or ▶ to select the display type.
3. After about five seconds, the selected display type is saved.

6-8 Infotainment

Loading a CD

To load a CD, insert the CD label side up in the CD player. The CD player pulls the CD in automatically.

- The display shows Read CD, the CD symbol and the number of CD tracks.
- When the first track starts to play, the display shows track 1 and the playing time.

Playing a CD

CD/MP3: Press to play a CD or MP3 CD that is already loaded into the CD player while the radio is playing. See “Using an MP3” in the owner manual index.

◀ or ▶: Press to go to the next or previous track. Press and hold to fast forward or fast rewind within a track and the CD plays at a higher speed and a reduced volume.

△: Press to eject a CD, Eject CD is displayed and the radio begins playing.

Random: Press CD/MP3 three times to hear the tracks in random, rather than sequential order.

Press ◀ or ▶ to select between Random on and Random off. RDM shows on the display when random is in use.

Using an MP3 CD

The CD 30 MP3 is capable of playing MP3 CDs that have been recorded to a CD-R.

Supported File Structure

The CD 30 MP3 supports up to:

- 99 albums.
- 367 tracks.
- Bit rates up to 256 kbps.

File Naming

Files must be named .mp3 for the CD to work. ID3 tags are supported. The following information shows on the display when the CD MP3 is playing.

MP3 CDs recorded without ID3 tags display:

- File name
- Track number and playing time
- Album name

MP3 CDs recorded with ID3 tags display:

- Track title
- Artist name
- Track number and playing time
- Album name

To change the display:

1. Press CD/MP3 twice, CD info appears on the display.
2. Press ◀ or ▶ to select the display type.
3. After about five seconds, the selected display type is saved.

Playing an MP3

CD/MP3: Press to play an MP3 CD that is already loaded into the CD player while the radio is playing.

Selecting a Track

◀ or ▶: Press to go to the next or previous track. Press and hold to fast forward or fast rewind within a track. During fast forward, the CD plays at a higher speed and a reduced volume.

⏏: Press to eject a CD, Eject CD appears on the display and the radio begins playing.

Selecting an Album

To select a different album when the MP3 CD contains several albums:

1. Press CD/MP3.
2. Press ◀ or ▶ until the desired album displays.

Random Mode

MP3 CD can be played in the following random modes:

- Random album: Tracks from the selected album are played randomly.
- Random CD: All tracks from all albums are played randomly.
- Random Off: Turns off random play.

To use random:

1. Press CD/MP3 three times.
2. Press ◀ or ▶ to select between Random album, Random CD and Random Off.

RDM shows on the display when random is use.

Care of CD's and the CD Player

Care of CDs

Store CDs in their original cases or other protective cases and away from direct sunlight and dust.

The CD player scans the bottom of the disc. If the bottom of a CD is damaged it may not play properly or at all. Do not touch the bottom of a CD while handling it. Pick up CDs by grasping the outer edges or the edge of the hole and the outer edge.

If the surface of a CD is dirty, take a soft, lint free cloth or dampen a clean, soft cloth in a mild, neutral detergent solution mixed with water, and clean it. Make sure the wiping process starts from the center to the edge.

6-10 Infotainment

Care of the CD Player

Do not add labels to a CD, it could get caught in the CD player.

Use a marking pen to write on the top of the CD if a description is needed.

Do not use CD lens cleaners, they could damage the CD player.

Notice: If a label is added to a CD, or more than one CD is inserted into the slot at a time, or an attempt is made to play scratched or damaged CDs, the CD player could be damaged. While using the CD player, use only CDs in good condition without any label, load one CD at a time, and keep the CD player and the loading slot free of foreign materials, liquids, and debris.



CDC 40

System Operation

○| (Volume/Power): Press to turn the system on or off. Turn to increase or decrease the volume.

BC (Board Computer): Press to use the Board Computer, see *DIC Warnings and Messages (Base and Uplevel Systems)* on page 4-36.

⏏ (Multifunction Knob): Turn to select a menu item, press to enable or disable a menu item.

◀/▶/▲/▼ (Four-way Switch): Press to select menu options.



SOUND: Press to enter the sound settings menu and go to the next page in sound settings.

SETTINGS: Press to adjust system and sound settings.

Ignition Logic

When this feature is enabled it turns the audio system on or off when the ignition is turned on or off.

To turn the audio system on or off with the Ignition Logic:

- Press  or  to turn the audio system on. Press  to turn the audio system off when the Ignition Logic system is disabled and the ignition is ON/RUN.
- For vehicles with OnStar[®], the audio system will only turn off if the ignition is OFF and OnStar is not in use when the Ignition Logic system is enabled.

The Ignition Logic is preset to turn off the audio system when the ignition is turned off. To enable or disable Ignition Logic:





1. Press SETTINGS, System Settings displays.
2. Turn the multifunction knob to select Ign. Logic and press the multifunction knob to select or un-select the option.

System Display

The following information shows on the system display:

- FM or AM displays, and the current station frequency or station name if the radio is active.
- The station name displays when RDS stations are active.
- The station name displays if RDS is activated.
- AS displays if AS is activated.
- CD displays along with the CD number, CD track number, CD title, artists name or

album name plus track time and track name, if the CD player is active.

- CD in displays if more than one CD is inserted.
- MP3 displays if the CD is an MP3 CD.
- RDM displays if the CD is being played back in random mode.
- R  displays if Random CD is on.
- R  displays if Random Magazine is on.
-  displays if repeat track is on.
-  displays if Scan CD is on.

The most recent selected audio source plays when the audio system is turned on and the display is lit. The outside temperature, time, and date display when the audio system is turned off and the ignition is ON/RUN, see *Driver Information Center (DIC) on page 4-25.*

Menu System

The audio systems menu contains types of menu pages:

Selection pages

Selection pages have a selection menu on the left side of the screen showing a preview of the menu items. Selection pages lead to navigation or settings pages.

Feature pages

Feature pages are menu pages. Feature pages also contain menu items which can be selected and lead to other navigation or settings pages. The Tuner menu is an example of a feature page.

Settings pages

Setting pages are menu pages where the audio system settings can be changed.

Menus

The menus of the audio systems are structured in levels. The current menu level is indicated by vertical lines at the edge of the screen.

Selecting from a Menu

The items within a menu are selected by turning the multifunction knob to move the cursor. The cursor highlights the menu item being selected.

To select a menu item:

1. Turn the multifunction knob until the desired menu item is highlighted.
 2. Press the multifunction knob to select the function or to display another menu.
- Selected menu items display as or .
 - Un-selected menu items display as or .

To exit from a menu:

- Turn the multifunction knob to the left until Return is displayed and then press the knob.
- Press CDC, FM/AM, SETTINGS, SOUND, or MAIN at any time to exit from a menu and use that function.

Selecting the Audio Menu

The Audio menu allows access to FM, AM, CD, and Sound menus. To access the Audio menu from one of these menus:

Turn the multifunction knob to the left until Return displays and then press the knob.

Selecting from a List

Some menus are displayed in the form of lists.

- If the cursor is moved to the top or bottom area of the display, other list items appear. A scroll-bar on the right edge of the display indicates the current cursor position in the list.
- The last list item selected is marked with an arrow in some lists.
- The name of the list and the number of items in it are displayed above the list.

To select from a list:

1. Turn the multifunction knob until the desired item is highlighted.
2. Press the multifunction knob to select the item.

Overlay Menus

Additional notes and information on the audio system or other vehicle components may appear on the display as an overlay in some cases. The current menu is overlaid with the information box. Some settings have to be confirmed, others are automatically enabled after a short time.

Audio Settings

The audio settings can be set for each audio source and are stored separately for each radio station and the CD player.

Adjusting the Tone (Bass/Treble)

To adjust the Bass:

1. Press SOUND and select the Sound menu item.
2. Select Treble - Bass.

3. Select Bass from the menu and turn the multifunction knob to adjust the level.
4. Press the multifunction knob to save the setting.

Bass tones are automatically adjusted to the driving speed to compensate for rolling and ambient noise. The setting cannot be changed.

To adjust the Treble:

1. Press SOUND and select the Sound menu item.
2. Select Treble - Bass.
3. Select Treble from the menu and turn the multifunction knob to adjust the level.
4. Press the multifunction knob to save the setting.

6-14 Infotainment

Adjusting the Equalizer

The equalizer allows changes to be made to seven frequencies.

To adjust the equalizer:

1. Press SOUND and select the Sound menu item.
2. Select Equalizer.
3. Select the desired frequency and turn the multifunction knob to adjust the level.
4. Press the multifunction knob to save the setting.
5. Repeat these steps for each frequency.

After making changes to the equalizer, the user option in the Sound menu is enabled.

Adjusting the Sound Settings

There are preset sound settings designed for different types of music.

To adjust the sound settings:

1. Press SOUND and select the Sound menu item.
2. Select Sound.
3. Select: User, Jazz, Speech, Pop, Classical, and Rock.
4. Press the multifunction knob to save the setting.

Adjusting the Speakers (Balance/Fade)

To adjust the Balance:

1. Press SOUND and select the Sound menu item.
2. Select Fader - Balance.
3. Select Balance from the menu and turn the multifunction knob to adjust the level.
4. Press the multifunction knob to save the setting.

To adjust the Fade:

1. Press SOUND and select the Sound menu item.
2. Select Fader - Balance.
3. Select Fader from the menu and turn the multifunction knob to adjust the level.
4. Press the multifunction knob to save the setting.

Adjusting the Sound Position

The sound position for the audio system can be adjusted. The settings are:

Driver: Adjusts the sound position for the drivers seat.

Front: Adjusts the sound position for the front seats.

All Positions: The sound is adjusted for all seats.

To adjust the sound position:

1. Press SOUND and select the Sound menu item.
2. Select Position and then select the desired sound position.
3. Press the multifunction knob to save the setting.

Speed-Dependant Volume Control (SDVC)

SDVC automatically adjusts the volume for road and wind noise as the vehicle increases or decreases speed while driving.

To adjust SDVC:

1. Press SOUND, then SETTINGS and select Volume from the menu.
2. Select SDVC.
3. Turn the multifunction knob to adjust the level.
4. Press the multifunction knob to save the setting.

OnStar® Volume

For vehicles with OnStar, the OnStar Volume is used to set the maximum initial volume level for the OnStar system when it is turned on.

To set OnStar Volume:

1. Press SOUND, then SETTINGS and select Volume from the menu.
2. Select OnStar IN.
3. Turn the multifunction knob to adjust the level.
4. Press the multifunction knob to save the setting.

Start-up Volume

The Start-up Volume is used to set the maximum initial volume level for the audio system when it is turned on.

The maximum initial volume level is used when the volume level before turning the audio system off was higher than the maximum initial volume level set, or if the volume is below the maximum level.

To set the On Volume level:

1. Press SOUND, then SETTINGS and select Volume from the menu.
2. Select Start-up Volume.
3. Turn the multifunction knob to adjust the level.
4. Press the multifunction knob to save the setting.

Using the Radio

FM/AM: Press to select between FM, FM-AS, AM, and AM-AS, or to listen to the radio while a CD is playing. The Tuner Menu displays.

LOC (LOCAL/DX Function): Press to change between LOC ON or LOC OFF. When the LOC function is on, it searches for the strongest radio frequency. If none is found, it automatically searches for a weaker radio frequency. If no frequency is found after the second search, the radio returns to the last active frequency. If a new station search is not started within one minute, the low sensitivity (LOCAL) is set when the next search is started. When LOC OFF is set, a search is carried out using the high sensitivity (DX).

Finding an FM/AM Station

1 - 9 (Station Preset Buttons):

Press to play stations that are programmed to the radio preset pushbuttons.

Automatic Station Search: Use automatic station search when the radio frequency is unknown.

The radio is volume is muted while the radio searches for a station with strong reception. If the radio is unable to find a station, it automatically switches to a more sensitive search level. The radio returns to the last station playing if it fails to locate a station.

To use automatic station search, do one of the following:

- Press and hold ◀ or ▶ until seek displays.
- Select ◀ or ▶ from the radio menu with the multifunction knob.

Manual Station Search: Use manual station search when the radio frequency is known.

To use manual station search with the four-way switch:

- Press and hold Δ or ▽ until the desired frequency is reached.
- Press Δ or ▽ repeatedly until the desired frequency is reached.

To use manual station search with the multifunction knob:

1. Select Manual from the Tuner menu.
2. Turn the multifunction knob until the desired frequency is reached and press the knob.

Setting Preset Stations

The radio can store up to 36 stations using the station preset buttons:

- 9 FM
- 9 FM - AS (Autostore)
- 9 AM
- 9 AM - AS (Autostore)

Radio stations can be stored using the station preset buttons, the multifunction knob, and by using Autostore.

To manually store stations using the station preset buttons:

1. Select FM or AM and tune to the desired radio station.
2. Press and hold one of the 9 station preset buttons, the radio briefly mutes and displays the previously stored station. The new station is stored and the radio begins playing.
3. Repeat the steps for each radio station to be stored.

To manually store stations using the multifunction knob:

1. Select the desired radio station and select Store from the Tuner Menu, a list of all stored stations is displayed.
2. Turn the multifunction knob to choose the location for the station to be stored and press the multifunction knob.

To store stations using Autostore:

1. Select FM or AM and then select Autostore from the Tuner Menu.
2. The Autostore menu is displayed, and the automatic station storing is started.
3. The nine strongest stations in the selected band are stored to the preset buttons.



Using the CD Player

The CDC 40 is capable of playing CDs, MP3 CD-Rs, and mixed mode CD-Rs that have both audio and MP3 tracks on it.

The CD changer holds a maximum of 6 CDs, and can play smaller 3 inch (8 cm) single CDs with an adapter ring.

Loading a CD

To load CDs:

1. Press  (Eject), the CD-Changer menu displays.
2. Select an empty CD compartment using the multifunction knob, Please insert CD now displays.
3. Insert a CD into the slot, Reading CD displays and  appears next to the selected position.
4. Repeat Step 2 to load additional CDs.

Display Options

The display can be changed depending on what type of CD is in the CD player. The display options are:

- Disabled (): Track number, CD number, album number and playing time for an audio CD.
- Enabled (): CD name, track name, artist name, and album name for an audio CD with CD text.

To change the display:

1. Select Extras from the CD Menu.
2. Enable or disable the Display track box.

Playing a CD

CDC: Press to play a CD that is already loaded into the CD player while the radio is playing. The CD Menu displays.

Selecting a Track

Tracks can be selected using the four-way switch or the CD menu functions.

Selecting a track using the four-way switch:

◀ or ▶: Press to go to the next or previous track within a CD.

Selecting a track using the CD menu and the ◀ or ▶ function:

1. Turn the multifunction knob until Track is highlighted.
2. Press the multifunction knob until the desired track is displayed.

Selecting a track using the CD menu and the Track function:

1. Select Track from the CD menu.
2. Select the desired track from the menu.

Searching Within a Track

To search within a track using the four-way switch or the CD menu functions:

To search using the four-way switch:

1. Press and hold ◀ or ▶.
2. Release ◀ or ▶ when the desired point in the track is reached.

To search using the CD menu

1. Select ◀◀ or ▶▶.
2. Select ◀◀ or ▶▶ again when the desired point in the track is reached.

Selecting CD

CDs can be selected by:

- Pressing the appropriate station preset button.
- Pressing ▲ or ▼ on the four-way switch.
- Using the CD menu function.

To use the CD menu function:

1. Select CD from the CD menu.
2. Select the desired CD.

Random Mode

There are two modes for random:

- Random play CD.
- Random magazine.

Tracks on the current CD are played in random order for Random play CD:

To use Random play CD:

1. Select Extras from the CD menu.
2. Select Random CD, and R  displays.

To turn off random:

1. Select Extras from the CD menu.
2. Select Normal, and R  disappears.

4 tracks per CD are played before changing to the next CD for Random magazine:

To use random for all CDs:

1. Select Extras from the CD menu.
2. Select Random Magazine, and R  displays.





To turn off random:

1. Select Extras from the CD menu.
2. Select Normal, and R  disappears.

Repeat Track

The Repeat function repeats the current track. The function can be enabled and disabled by using the four-way switch or the CD menu.

To use repeat using the four-way switch:

1. Press and hold  until  appears on the display.
2. Press and hold  until  is no longer on the display to turn off repeat track.

To use repeat using the CD menu:

1. Select Extras from the CD menu.
2. Select Repeat Track,  appears on the display.

To turn off repeat using the CD menu:





1. Select Extras from the CD menu.
2. Select Normal,  disappears from the display.

Scan CD

The Scan CD function scans the first ten seconds of each track on the current CD. The function can be enabled and disabled by using the four-way switch or the CD menu.

6-20 Infotainment

To use Scan CD using the four-way switch:

1. Press and hold  until  appears on the display.
2. Press and hold  until  is no longer on the display to turn off repeat track.

To use Scan CD using the CD menu:

1. Select Extras from the CD menu.
2. Select Scan CD,  appears on the display.

To turn off Scan CD using the CD menu:

1. Select Extras from the CD menu.
2. Select Scan CD,  disappears from the display.

Ejecting a CD

To eject a CD:

1. Press .
2. Select the desired CD to eject by using the station preset buttons or the multifunction knob.

To eject all CDs:

1. Press and hold  until Eject all CDs displays.
2. Press the multifunction knob to confirm. The CDs are ejected.

Using an MP3 or Mixed Mode CD

Supported File Structure

The CDC 40 supports up to:

- 253 albums.
- 65,535 tracks.
- Bit rates up to 256 kbps.

File Naming

Files must be named .mp3 for the CD to work. ID3 tags are supported. The following information shows on the display when a CD MP3, or a mixed mode CD is playing.

- CD number
- Album name
- Track title and artist



Playing an MP3 or Mixed Mode CD

CDC: Press to play an MP3 CD that is already loaded into the CD player while the radio is playing. The CD Menu displays.

Selecting a Track

Tracks can be selected using the four-way switch or the CD menu functions.

Selecting a track using the four-way switch:

 or : Press to go to the next or previous track within an album.

Selecting a track using the CD menu and the ◀ or ▶ function:

1. Turn the multifunction knob until it is highlighted.
2. Press the multifunction knob until the desired track is displayed.

Selecting a track using the CD menu and the Track function:

1. Select Track from the CD menu.
2. Select the desired track from the menu.

Searching Within a Track

To search within a track using the four-way switch or the CD menu functions:

To search using the four-way switch:

1. Press and hold ◀ or ▷.
2. Release ◀ or ▷ when the desired point in the track is reached.

To search using the CD menu

1. Select ◀◀ or ▶▶.
2. Select ◀◀ or ▶▶ again when the desired point in the track is reached.

Selecting an MP3 or Mixed Mode Album

CDs can be selected by:

- Pressing the appropriate station preset button.
- Pressing ▲ or ▼ on the four-way switch.
- Using the CD menu function.

To use the CD menu function:

1. Select Album from the CD menu.
2. Select the desired Album.

Random Mode

MP3 CDs and Mixed Mode CDs can be played in random order. There are two modes for random:

- Random play CD.
- Random magazine.

To turn off random:

1. Select Extras from the CD menu.
2. Select Normal.

Tracks play in the following order for Random play CD:

- MP3 CD: If there are five or fewer albums on an MP3 CD, four tracks per album are played in random order. If there are more than five albums on the MP3 CD, one track is played per album. Tracks from the selected album are played randomly.
- Mixed Mode CD: On a Mixed Mode CD, the tracks from the audio part are played first in random order. Then the tracks from the MP3 part are played as described above.

To use Random play CD:

1. Select Extras from the CD menu.
2. Select Random CD, R  displays.

6-22 Infotainment

Tracks play in the following order for Random magazine:

- MP3 CD: If there are five or fewer albums on an MP3 CD, four tracks per album are played before changing to the next CD. If there are more than five albums, one track per album is played before changing to the next CD.
- Mixed Mode CD: On a Mixed Mode CD, the first of all four tracks from the audio part are played in random order and then the system changes to the next CD. The next time the system changes to the Mixed Mode CD, the tracks from the MP3 part are played as described above.

To use random for all CDs:

1. Select Extras from the CD menu.
2. Select Random Magazine, R  displays.

Care of CD's and the CD Player

Care of CDs

Store CDs in their original cases or other protective cases and away from direct sunlight and dust. The CD player scans the bottom of the disc. If the bottom of a CD is damaged it may not play properly or at all. Do not touch the bottom of a CD while handling it. Pick up CDs by grasping the outer edges or the edge of the hole and the outer edge.

If the surface of a CD is dirty, take a soft, lint free cloth or dampen a clean, soft cloth in a mild, neutral detergent solution mixed with water, and clean it. Make sure the wiping process starts from the center to the edge.

Care of the CD Player

Do not add labels to a CD, it could get caught in the CD player. Use a marking pen to write on the top of the CD if a description is needed.

Do not use CD lens cleaners, they could damage the CD player.

Notice: If a label is added to a CD, or more than one CD is inserted into the slot at a time, or an attempt is made to play scratched or damaged CDs, the CD player could be damaged. While using the CD player, use only CDs in good condition without any label, load one CD at a time, and keep the CD player and the loading slot free of foreign materials, liquids, and debris.

Theft-Deterrent Feature

The audio system is equipped with an electronic safety system to prevent theft, and only works in the vehicle.

Audio Steering Wheel Controls



Some audio controls can be adjusted at the steering wheel.

Several functions of the audio system can be operated with the audio remote control buttons and the rotary control located on both sides of the steering wheel.

Depending on the vehicle's features, see the following audio controls:

— (Rotary Control): Manually seek a station by turning to move the cursor either to the previous or next screen entry. Press to confirm the selection.

For the DIC (Driver Information Center), press the rotary control to call up the DIC menu. Press to reset the current value. Press and hold for two seconds to reset all of the values.

⏮): Press to go to the next preset station if playing the radio.

Press to go to the beginning of a currently playing CD or to the next album on an MP3.

⏮): Press to toggle between the radio and CD or MP3 as an active source for playback.

▽ / △: Press the arrows to go back or advance to the previous or next preset station if playing the radio. Press and hold to scroll through the preset stations.

Press to go back or advance one track at a time on a CD.

Press to quickly reverse or advance through the tracks within a CD.

◁ (volume): Turn the rotary control to adjust the volume. Press and hold to adjust the volume continuously.

Radio Reception

Frequency interference and static can occur during normal radio reception if items such as cell phone chargers, vehicle convenience accessories, and external electronic devices are plugged into the accessory power outlet. If there is interference or static, unplug the item from the accessory power outlet.

AM

The range for most AM stations is greater than for FM, especially at night. The longer range can cause station frequencies to interfere with each other. For better radio reception, most AM radio stations boost the power levels during the day, and then reduce these levels during the night. Static can also occur when things like storms and power lines interfere with radio reception. When this happens, try reducing the treble on your radio.

FM Stereo

FM stereo gives the best sound, but FM signals reach only about 10 to 40 miles (16 to 65 km). Tall buildings or hills can interfere with FM signals, causing the sound to fade in and out.

Cellular Phone Usage

Cellular phone usage may cause interference with the vehicle's radio. This interference may occur when making or receiving phone calls, charging the phone's battery, or simply having the phone on. This interference causes an increased level of static while listening to the radio. If static is received while listening to the radio, unplug the cellular phone and turn it off.

Fixed Mast Antenna

The fixed mast antenna can withstand most car washes without being damaged, or it can be removed. If the mast should ever become slightly bent, straighten it out by hand. If the mast is badly bent, replace it.

Check occasionally to make sure the mast is still tightened to the antenna base located on the roof of the vehicle.

Climate Controls

Climate Controls

- Climate Control System7-1
- Outlet Adjustment7-4

Climate Controls

Climate Control System

The heating, cooling, and ventilation for the vehicle can be controlled with this system.



- A. Air Conditioning
- B. Recirculation
- C. Rear Window Defogger

- D. Air Delivery Mode Control
- E. Temperature Control
- F. Fan Control

7-2 Climate Controls



Air Delivery Mode Control:



Turn the knob clockwise or counterclockwise to adjust the airflow direction inside the vehicle.

To change the current air delivery mode, select one of the following:

 **(Bi-Level):** Air is directed to the instrument panel and floor outlets. Cooler air is directed to the upper outlets and warmer air to the floor outlets.

 **(Vent):** Air is directed to the instrument panel outlets.

 **(Defog):** Air is directed to the windshield and front door windows. To reduce fogging, press  to turn on the air conditioner. The fan must also be on.

 **(Defog/Floor):** Air is directed to the windshield, front door windows, and floor outlets. To reduce fogging, press  to turn on the air conditioner. The fan must also be on.

 **(Floor):** Air is directed to the floor outlets.

Temperature Control: Turn the knob clockwise or counterclockwise to increase or decrease the temperature inside the vehicle.

Fan Control: Turn the knob clockwise or counterclockwise to increase or decrease the fan speed. The speed settings can be adjusted between 1 (Low) and 4 (High).

Turn the knob to  to turn the fan off. When the fan is off, the air conditioning compressor is also off. There will be some airflow from the outlets when driving, even with the fan in the off position.

Air Conditioning



For vehicles with air conditioning.

 **(Air Conditioning):** Press to turn the air conditioning system on or off. An indicator light comes on when the air conditioning is on. The air conditioning can only be operated if the engine is on and the fan is running.

When the air conditioning is on the air is cooled and dehumidified. If cooling or dehumidification is not desired, turn off the air conditioning to save fuel.

On hot days, open the windows briefly to let the hot inside air escape, then close them. This helps to reduce the time it takes for the vehicle to cool down.

For quicker cool down, do the following:

1. Press  to turn on the air conditioning.
2. Select  mode.
3. Set the temperature knob to the coldest temperature.
4. Set the fan knob to 4.
5. Open all vents.

Recirculation

 **(Recirculation):** Press to turn the recirculation mode on or off. An indicator light inside the button comes on when the recirculation mode is active. This mode recirculates air inside the passenger compartment and prevents outside air from entering the vehicle.

The quality of the passenger compartment air may decrease since the amount of outside air entering the vehicle is reduced.

When the recirculation mode is used without air conditioning, the air humidity increases, and the windows may fog. Avoid using the recirculation mode during high periods of humidity or cool outside temperatures since this may result in increased window fogging. If window fogging is experienced, select the defrost mode.

Rear Window Defogger

The rear window defogger uses a warming grid to remove fog from the rear window.

The rear window defogger will only work when the ignition is in ON/RUN.

(Rear Window Defogger):

Press to turn the rear window defogger on or off. An indicator light inside the button will be lit when in use.

If the vehicle has heated mirrors, they turn on when the rear window defogger button is pressed. Press the button again to turn them off. For more information, see *Outside Power Mirror(s) on page 2-12*.

The rear window defogger will stay on for approximately 15 minutes after the button is pressed, unless the ignition is turned off.

Notice: Do not use anything sharp on the inside of the rear window. If you do, you could cut or damage the warming grid, and the repairs would not be covered by the vehicle warranty. Do not attach a temporary vehicle license, tape, a decal or anything similar to the defogger grid.

Outlet Adjustment

Use the thumbwheel below the air outlets to change the direction of the air flow. Use the vertical thumbwheel next to the outlets to control the amount of air flow or to shut off the airflow completely.

Keep all outlets open whenever possible for best system performance.

Operation Tips

- Clear away any ice, snow, or leaves from the air inlets at the base of the windshield that can block the flow of air into the vehicle.
- Use of non-GM approved hood deflectors can adversely affect the performance of the system.
- Keep the path under all seats clear of objects to help circulate the air inside the vehicle more effectively.
- If fogging reoccurs while in vent or bi-level modes with mild temperature throughout the vehicle, turn on the air conditioner to reduce windshield fogging.

Driving and Operating

Starting and Operating Your Vehicle

New Vehicle Break-In	8-2
Ignition Positions	8-2
Retained Accessory Power (RAP)	8-3
Starting the Engine	8-3
Engine Heater	8-5
Automatic Transmission Operation	8-6
Manual Transmission Operation	8-9
Parking Brake	8-10
Shifting Into Park	8-11
Shifting Out of Park	8-12
Parking the Vehicle	8-13
Parking Over Things That Burn	8-13
Engine Exhaust	8-14
Running the Vehicle While Parked	8-14

Driving Your Vehicle

Driving for Better Fuel Economy	8-15
Defensive Driving	8-16
Drunk Driving	8-16
Control of a Vehicle	8-17
Braking	8-17
Antilock Brake System (ABS)	8-18
StabiliTrak® System	8-19
Steering	8-20
Off-Road Recovery	8-21
Passing	8-22
Loss of Control	8-22
Driving at Night	8-23
Driving in Rain and on Wet Roads	8-24
Before Leaving on a Long Trip	8-25
Highway Hypnosis	8-25
Hill and Mountain Roads	8-26
Winter Driving	8-27

If Your Vehicle is Stuck in Sand, Mud, Ice, or Snow	8-29
Rocking Your Vehicle to Get It Out	8-29
Loading the Vehicle	8-30

Fuel

Fuel	8-34
Gasoline Octane	8-34
Gasoline Specifications	8-34
California Fuel	8-34
Additives	8-34
Fuels in Foreign Countries	8-35
Filling the Tank	8-36
Filling a Portable Fuel Container	8-37

Starting and Operating Your Vehicle

New Vehicle Break-In

Notice: The vehicle does not need an elaborate break-in. But it will perform better in the long run if you follow these guidelines:

- Do not drive at any one constant speed, fast or slow, for the first 500 miles (805 km). Do not make full-throttle starts. Avoid downshifting to brake or slow the vehicle.
- Avoid making hard stops for the first 200 miles (322 km) or so. During this time the new brake linings are not yet broken in. Hard stops with new linings can mean premature wear and earlier replacement. Follow this breaking-in guideline every time you get new brake linings.

Following break-in, engine speed and load can be gradually increased.

Ignition Positions

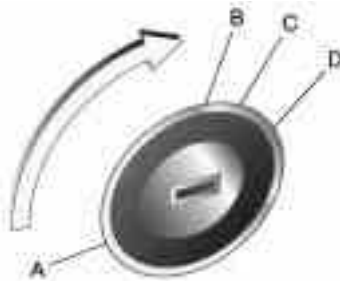

Use the key to turn the ignition switch to four different positions.

Notice: Using a tool to force the key to turn in the ignition could cause damage to the switch or break the key. Use the correct key, make sure it is all the way in, and turn it only with your hand. If the key cannot be turned by hand, see your dealer/retailer.

To shift out of P (Park), the ignition must be in the ON/RUN position and the regular brake pedal must be applied.

A (LOCK/OFF): This is the only position from which you can remove the key. This locks the steering wheel, ignition and automatic transmission.

On vehicles with an automatic transmission, the shift lever must be in P (Park) to turn the ignition switch to the LOCK/OFF position.

The ignition switch can bind in the LOCK/OFF position with your wheels turned off center. If this happens, move the steering wheel from right to left while turning the key to STEERING UNLOCK/IGNITION OFF. If this doesn't work, then the vehicle needs service.

B (STEERING UNLOCKED/IGNITION OFF): This position unlocks the steering wheel.

C (ON/RUN): The ignition switch stays in this position when the engine is running. This position can be used to operate the electrical accessories, as well as to display some warning and indicator lights.

The battery could be drained if you leave the key in the ON/RUN position with the engine off. You may not be able to start the vehicle if the battery is allowed to drain for an extended period of time.

D (START): This position starts the engine. When the engine starts, release the key. The ignition switch will return to ON/RUN for normal driving. A warning tone will sound when the driver door is opened and the key is in the ignition.

Retained Accessory Power (RAP)

The power windows and mirrors may be used for up to five minutes after the key is turned to LOCK/OFF.

The power windows and mirrors will not operate after any of the front doors are opened.

The radio may be used for up to sixty minutes after the key is turned to LOCK/OFF.

Starting the Engine

Automatic Transmission

Move the shift lever to P (Park) or N (Neutral). The engine will not start in any other position. To restart the engine when the vehicle is already moving, use N (Neutral) only.

Notice: Do not try to shift to P (Park) if the vehicle is moving. If you do, you could damage the transmission. Shift to P (Park) only when the vehicle is stopped.

Manual Transmission

The shift lever should be in N (Neutral) and the parking brake engaged. Hold the clutch pedal to the floor and start the engine. The vehicle will not start if the clutch pedal is not all the way down.

8-4 Driving and Operating

Starting Procedure

1. With your foot off the accelerator pedal, turn the ignition key to START. When the engine starts, let go of the key. The idle speed will go down as the engine gets warm. Do not race the engine immediately after starting it. Operate the engine and transmission gently to allow the oil to warm up and lubricate all moving parts.

The vehicle has a Computer-Controlled Cranking System. This feature assists in starting the engine and protects components. If the ignition key is turned to the START position, and then released when the engine begins cranking, the engine will continue cranking for a few seconds or until the vehicle starts. If the engine does not start and the key is held in START for many seconds, cranking will be stopped after 15 seconds to prevent cranking motor damage.

To prevent gear damage, this system also prevents cranking if the engine is already running. Engine cranking can be stopped by turning the ignition switch to STEERING UNLOCKED/IGNITION OFF or LOCK/OFF.

Notice: Cranking the engine for long periods of time, by returning the key to the START position immediately after cranking has ended, can overheat and damage the cranking motor, and drain the battery. Wait at least 15 seconds between each try, to let the cranking motor cool down.

2. If the engine does not start after 5-10 seconds, especially in very cold weather (below 0°F or -18°C), it could be flooded with too much gasoline. Try pushing the accelerator pedal all the way to the floor and holding it there as you hold the key in START for up to a maximum of 15 seconds.

Wait at least 15 seconds between each try, to let the cranking motor cool down. When the engine starts, let go of the key and accelerator. If the vehicle starts briefly but then stops again, do the same thing. This clears the extra gasoline from the engine. Do not race the engine immediately after starting it. Operate the engine and transmission gently until the oil warms up and lubricates all moving parts.

Notice: The engine is designed to work with the electronics in the vehicle. If you add electrical parts or accessories, you could change the way the engine operates. Before adding electrical equipment, check with your dealer/retailer. If you do not, the engine might not perform properly. Any resulting damage would not be covered by the vehicle warranty.

Engine Heater

The engine heater can provide easier starting and better fuel economy during engine warm-up in cold weather conditions at or below -4°F (-20°C). Vehicles with an engine heater should be plugged in at least four hours before starting.

To Use the Engine Heater

1. Turn off the engine.



2. The engine heater connector is located in the passenger side lower front grille. Open the cover and insert the 110-volt AC adapter delivered in the vehicles glove box.
3. Plug the other end of the adapter into a grounded 110-volt AC outlet.

CAUTION

Plugging the cord into an ungrounded outlet could cause an electrical shock. Also, the wrong kind of extension cord could overheat and cause a fire. You could be seriously injured. Plug the cord into a properly grounded three-prong 110-volt AC outlet. If the cord will not reach, use a heavy-duty three-prong extension cord rated for at least 15 amps.

4. Before starting the engine, be sure to unplug both ends of the adapter and store the adapter to prevent damage.

The length of time the heater should remain plugged in depends on several factors. Ask a dealer/retailer in the area where you will be parking the vehicle for the best advice on this.

Automatic Transmission Operation



If the vehicle has an automatic transmission, the shift lever is located on the console between the seats.

The vehicle may also have an electronic shift position indicator that displays the position of the shift lever. This indicator is located above the trip odometer on the instrument panel cluster.

P (Park): This position locks the front wheels. It is the best position to use when the engine is started because the vehicle cannot move easily.

CAUTION

It is dangerous to get out of the vehicle if the shift lever is not fully in P (Park) with the parking brake firmly set. The vehicle can roll.

Do not leave the vehicle when the engine is running unless you have to. If you have left the engine running, the vehicle can move suddenly. You or others could be injured. To be sure the vehicle will not move, even when you are on fairly level ground, always set the parking brake and move the shift lever to P (Park). See *Shifting Into Park* on page 8-11.

Make sure the shift lever is fully in P (Park) before starting the engine. The vehicle has an automatic transmission shift lock control system. The regular brakes must be applied before you can shift from P (Park) when the ignition key is in ON/RUN. If you cannot shift out of P (Park) while holding the brake pedal down, see *Shifting Out of Park* on page 8-12.

R (Reverse): Use this gear to back up.

Notice: **Shifting to R (Reverse) while the vehicle is moving forward could damage the transmission. The repairs would not be covered by the vehicle warranty. Shift to R (Reverse) only after the vehicle is stopped.**

To rock the vehicle back and forth to get out of snow, ice, or sand without damaging the transmission, see *Rocking Your Vehicle to Get It Out* on page 8-29.

N (Neutral): In this position, the engine does not connect with the wheels. To restart the engine when the vehicle is already moving, use N (Neutral) only. Also, use N (Neutral) when the vehicle is being towed.

 **CAUTION**

Shifting into a drive gear while the engine is running at high speed is dangerous. Unless your foot is firmly on the brake pedal, the vehicle could move very rapidly. You could lose control and hit people or objects. Do not shift into a drive gear while the engine is running at high speed.

Notice: Shifting out of P (Park) or N (Neutral) with the engine running at high speed may damage the transmission. The repairs would not be covered by the vehicle warranty. Be sure the engine is not running at high speed when shifting the vehicle.

D (Drive): This position is for normal driving.

Notice: If the vehicle seems to start up rather slowly or not shift gears when you go faster, and you continue to drive the vehicle that way, you could damage the transmission. Have the vehicle serviced right away.

3 (Third): This position is also used for normal driving, however, it offers more power and lower fuel economy than D (Drive). Here are some times you might choose 3 (Third) instead of D (Drive):

- When driving on hilly, winding roads.
- When going down a steep hill.

2 (Second): This position gives you more power but lower fuel economy. Use 2 (Second) on hills. It can help control the vehicles speed as you go down steep mountain roads, while using the brakes off and on.

Notice: Driving in 1 (First) for more than 25 miles (40 km) or at speeds over 55 mph (90 km/h) may damage the transmission. Also, shifting into 1 (First) at speeds above 65 mph (105 km/h) can cause damage. Drive in 3 (Third) or D (Drive) instead of 1 (First).

1 (First): This position gives you even more power but lower fuel economy than 2 (Second). Use it on very steep hills, or in deep snow or mud. If the shift lever is put in 1 (First), the transmission does not shift into first gear until the vehicle is going slowly enough.

Notice: Spinning the tires or holding the vehicle in one place on a hill using only the accelerator pedal may damage the transmission. The repair will not be covered by the vehicle warranty. If you are stuck, do not spin the tires. When stopping on a hill, use the brakes to hold the vehicle in place.

8-8 Driving and Operating

Winter Driving Mode

This feature helps you accelerate in slippery driving conditions by using 3 (Third) gear when you begin to accelerate from a stopped position.



The winter driving mode button is located on the center console.

Press once to turn on the winter driving mode feature. The vehicle will be in 3 (Third) gear when the vehicle begins to move. Once the vehicle is moving, the vehicle will upshift normally.

The Winter Driving Mode is turned off by one of the following:

- Pressing the winter driving mode button again.
- Manually shifting to 2 (Second) or 1 (First) gear.
- Turning off the ignition.



To protect the transmission, the winter program turns off automatically at high transmission oil temperatures.

Automatic Neutral Idle

The Automatic Neutral Idle shift function automatically sets the transmission to N (Neutral) to reduce fuel consumption when the vehicle is not moving.

Automatic neutral is activated when ALL of the following occurs:

- The selector lever is in D (Drive), 3 (Third), 2 (Second) or 1 (First) gear.
- The foot brake is pressed.
- The vehicle is stopped.
- The accelerator pedal is not pressed.
- The transmission fluid temperature is greater than 0° C (32° F).
- The road is not steeper than 15°.

When you release the brake with the transmission in gear, you may feel the transmission shift from N (Neutral) to D (Drive) automatically. You may also feel the transmission shift from D (Drive) to N (Neutral) when the brake is applied. This is normal operation of the automatic transmission.

Downhill Grade Assist

When traveling down steep grades the transmission may automatically downshift into a lower gear when the brake is applied. You may feel this downshift. This performance feature of the automatic transmission assists with engine braking to reduce wear on your brake system. This is normal operation of the automatic transmission.

Performance On Demand

This feature allows the driver to automatically force a downshift, when traveling at speeds less than approximately 70 mph (112 km/h), by fully pressing the accelerator pedal.

Manual Transmission Operation

Five-Speed

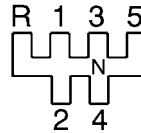

This is the shift pattern.

Here is how to operate the manual transmission:

1 (First): Press the clutch pedal and shift into 1 (First). Then, slowly let up on the clutch pedal as you press the accelerator pedal.

You can shift into 1 (First) when you are going less than 20 mph (32 km/h). If you have come to a complete stop and it is hard to shift into 1 (First), put the shift lever in N (Neutral) and let up on the clutch. Press the clutch pedal back down. Then shift into 1 (First).

2 (Second): Press the clutch pedal as you let up on the accelerator pedal and shift into 2 (Second). Then, slowly let up on the clutch pedal as you press the accelerator pedal.

3 (Third), 4 (Fourth) and 5 (Fifth): Shift into 3 (Third), 4 (Fourth) and 5 (Fifth), the same way you do for 2 (Second). Slowly let up on the clutch pedal as you press the accelerator pedal.

To stop, let up on the accelerator pedal and press the brake pedal. Just before the vehicle stops, press the clutch pedal and the brake pedal, and shift to N (Neutral).

N (Neutral): Use this position when you start or idle the engine.

8-10 Driving and Operating

R (Reverse):



With the vehicle stationary, wait three seconds after declutching and pull up on the button on the selector lever to engage R (Reverse) gear.

If R (Reverse) gear does not engage, set the selector lever in N (Neutral), and release the clutch pedal. Press the clutch pedal again and repeat the gear selection.

Notice: Shifting to R (Reverse) while the vehicle is moving forward could damage the transmission. The repairs would not be covered by the vehicle warranty. Shift to R (Reverse) only after the vehicle is stopped.

Also, use R (Reverse), along with the parking brake, to park the vehicle.

Shift Speeds

CAUTION

If you skip a gear when you downshift, you could lose control of the vehicle. You could injure yourself or others. Do not shift down more than one gear at a time when you downshift.

Parking Brake



The parking brake is located between the driver and passenger seats.

To set the parking brake, hold the brake pedal down and pull up on the parking brake lever.

To release the parking brake, hold the brake pedal down. Pull the parking brake lever up until you can press the release button. Hold the release button in as you move the brake lever all the way down.

A warning chime will sound and a brake warning light located on the instrument panel cluster will come on, if the parking brake is set, the ignition is on and the vehicle speed is greater than 5 mph (8 km/h).

Notice: Driving with the parking brake on can overheat the brake system and cause premature wear or damage to brake system parts. Make sure that the parking brake is fully released and the brake warning light is off before driving.

Shifting Into Park



It can be dangerous to get out of the vehicle if the shift lever is not fully in P (Park) with the parking brake firmly set. The vehicle can roll. If you have left the engine running, the vehicle can move suddenly. You or others could be injured. To be sure the vehicle will not move, even when you are on fairly level ground, use the steps that follow.

1. Hold the brake pedal down and set the parking brake. See *Parking Brake on page 8-10* for more information.

2. Move the shift lever into P (Park) by holding in the button on the shift lever and pushing the shift lever all the way toward the front of the vehicle.
3. Turn the ignition key to LOCK/OFF.
4. Remove the key and take it with you. If you can leave the vehicle with the ignition key in your hand, the vehicle is in P (Park).

8-12 Driving and Operating

Leaving the Vehicle with the Engine Running

CAUTION

It can be dangerous to leave the vehicle with the engine running. The vehicle could move suddenly if the shift lever is not fully in P (Park) with the parking brake firmly set. And, if you leave the vehicle with the engine running, it could overheat and even catch fire. You or others could be injured. Do not leave the vehicle with the engine running.

If you have to leave the vehicle with the engine running, be sure the vehicle is in P (Park) and the parking brake is firmly set before you leave it. After you have moved the shift lever into P (Park), hold the regular brake pedal down. Then, see if you can move the shift lever away from P (Park) without first pushing the button.

If you can, it means that the shift lever was not fully locked in P (Park).

Torque Lock

If you are parking on a hill and you do not shift the transmission into P (Park) properly, the weight of the vehicle may put too much force on the parking pawl in the transmission. You may find it difficult to pull the shift lever out of P (Park). This is called torque lock. To prevent torque lock, set the parking brake and then shift into P (Park) properly before you leave the driver seat. To find out how, see *Shifting Into Park* on page 8-11.

When you are ready to drive, move the shift lever out of P (Park) *before* you release the parking brake.

If torque lock does occur, you may need to have another vehicle push your vehicle a little uphill to take some of the pressure from the parking pawl in the transmission, so you can pull the shift lever out of P (Park).

Shifting Out of Park

This vehicle has an electronic shift lock release system. The shift lock release is designed to:

- Prevent ignition key removal unless the shift lever is in P (Park) with the shift lever button fully released.
- Prevent movement of the shift lever out of P (Park), unless the ignition is in the ON/RUN position and the regular brake pedal is applied.

The shift lock release is always functional except in the case of an uncharged or low voltage (less than 9 volt) battery.

If the vehicle has an uncharged battery or a battery with low voltage, try charging or jump starting the battery. See *Jump Starting on page 9-69* for more information.

To shift out of P (Park) use the following sequence:

1. Apply the brake pedal.
2. Press the shift lever button.
3. Move the shift lever to the desired position.

If you still are unable to shift out of P (Park):

1. Fully release the shift lever button.
2. While holding down the brake pedal, press the shift lever button again.
3. Move the shift lever to the desired position.

If you still cannot move the shift lever from P (Park), consult your dealer/retailer or a professional towing service.

Parking the Vehicle

Before you get out of the vehicle, move the shift lever into 1 (First) or R (Reverse) and firmly apply the parking brake. Once the shift lever has been placed into 1 (First) or R (Reverse) with the clutch pedal pressed in, you can turn the ignition off and release the clutch.

Parking Over Things That Burn



Things that can burn could touch hot exhaust parts under the vehicle and ignite. Do not park over papers, leaves, dry grass, or other things that can burn.

Engine Exhaust

CAUTION

Engine exhaust contains Carbon Monoxide (CO) which cannot be seen or smelled. Exposure to CO can cause unconsciousness and even death.

Exhaust may enter the vehicle if:

- The vehicle idles in areas with poor ventilation (parking garages, tunnels, deep snow that may block underbody airflow or tail pipes).
- The exhaust smells or sounds strange or different.
- The exhaust system leaks due to corrosion or damage.

(Continued)

CAUTION (Continued)

- The vehicle's exhaust system has been modified, damaged or improperly repaired.
- There are holes or openings in the vehicle body from damage or after-market modifications that are not completely sealed.

If unusual fumes are detected or if it is suspected that exhaust is coming into the vehicle:

- Drive it only with the windows completely down.
- Have the vehicle repaired immediately.

Never park the vehicle with the engine running in an enclosed area such as a garage or a building that has no fresh air ventilation.

Running the Vehicle While Parked

It is better not to park with the engine running. But if you ever have to, here are some things to know.

CAUTION

Idling a vehicle in an enclosed area with poor ventilation is dangerous. Engine exhaust may enter the vehicle. Engine exhaust contains Carbon Monoxide (CO) which cannot be seen or smelled. It can cause unconsciousness and even death. Never run the engine in an enclosed area that has no fresh air ventilation. For more information, see *Engine Exhaust on page 8-14*.

 **CAUTION**

It can be dangerous to get out of the vehicle if the automatic transmission shift lever is not fully in P (Park) with the parking brake firmly set. The vehicle can roll. Do not leave the vehicle when the engine is running unless you have to. If you have left the engine running, the vehicle can move suddenly. You or others could be injured. To be sure the vehicle will not move, even when you are on fairly level ground, always set the parking brake and move the shift lever to P (Park).

Follow the proper steps to be sure the vehicle will not move. See *Shifting Into Park on page 8-11*.

Driving Your Vehicle

Driving for Better Fuel Economy

Driving habits can affect fuel mileage. Here are some driving tips to get the best fuel economy possible.

- Avoid fast starts and accelerate smoothly.
- Brake gradually and avoid abrupt stops.
- Avoid idling the engine for long periods of time.
- When road and weather conditions are appropriate, use cruise control, if equipped.

- Always follow posted speed limits or drive more slowly when conditions require.
- Keep vehicle tires properly inflated.
- Combine several trips into a single trip.
- Replace the vehicle's tires with the same TPC Spec number molded into the tire's sidewall near the size.
- Follow recommended scheduled maintenance.

Defensive Driving

Defensive driving means “always expect the unexpected.” The first step in driving defensively is to wear your safety belt, see *Safety Belts on page 1-8*.

CAUTION

Assume that other road users (pedestrians, bicyclists, and other drivers) are going to be careless and make mistakes. Anticipate what they might do and be ready. In addition:

- Allow enough following distance between you and the driver in front of you.
- Focus on the task of driving.

Driver distraction can cause collisions resulting in injury or possible death. These simple defensive driving techniques could save your life.

Drunk Driving

CAUTION

Drinking and then driving is very dangerous. Your reflexes, perceptions, attentiveness, and judgment can be affected by even a small amount of alcohol. You can have a serious — or even fatal — collision if you drive after drinking. Do not drink and drive or ride with a driver who has been drinking. Ride home in a cab; or if you are with a group, designate a driver who will not drink.

Death and injury associated with drinking and driving is a global tragedy.

Alcohol affects four things that anyone needs to drive a vehicle: judgment, muscular coordination, vision, and attentiveness.

Police records show that almost 40 percent of all motor vehicle-related deaths involve alcohol. In most cases, these deaths are the result of someone who was drinking and driving. In recent years, more than 17,000 annual motor vehicle-related deaths have been associated with the use of alcohol, with about 250,000 people injured.

For persons under 21, it is against the law in every U.S. state to drink alcohol. There are good medical, psychological, and developmental reasons for these laws.

The obvious way to eliminate the leading highway safety problem is for people never to drink alcohol and then drive.

Medical research shows that alcohol in a person's system can make crash injuries worse, especially injuries to the brain, spinal cord, or heart. This means that when anyone who has been drinking — driver or passenger — is in a crash, that person's chance of being killed or permanently disabled is higher than if the person had not been drinking.

Control of a Vehicle

The following three systems help to control the vehicle while driving — brakes, steering, and accelerator. At times, as when driving on snow or ice, it is easy to ask more of those control systems than the tires and road can provide. Meaning, you can lose control of the vehicle.

Adding non-dealer/non-retailer accessories can affect vehicle performance. See *Accessories and Modifications on page 9-3*.

Braking

See *Brake System Warning Light on page 4-16*.

Braking action involves perception time and reaction time. Deciding to push the brake pedal is perception time. Actually doing it is reaction time.

Average reaction time is about three-fourths of a second. But that is only an average. It might be less with one driver and as long as two or three seconds or more with another. Age, physical condition, alertness, coordination, and eyesight all play a part. So do alcohol, drugs, and frustration. But even in three-fourths of a second, a vehicle moving at 60 mph (100 km/h) travels 66 feet (20 m). That could be a lot of distance in an emergency, so keeping enough space between the vehicle and others is important.

And, of course, actual stopping distances vary greatly with the surface of the road, whether it is pavement or gravel; the condition of the road, whether it is wet, dry, or icy; tire tread; the condition of the brakes; the weight of the vehicle; and the amount of brake force applied.

Avoid needless heavy braking. Some people drive in spurts — heavy acceleration followed by heavy braking — rather than keeping pace with traffic. This is a mistake. The brakes might not have time to cool between hard stops. The brakes will wear out much faster with a lot of heavy braking. Keeping pace with the traffic and allowing realistic following distances eliminates a lot of unnecessary braking. That means better braking and longer brake life.

If the engine ever stops while the vehicle is being driven, brake normally but do not pump the brakes. If the brakes are pumped, the pedal could get harder to push down.

8-18 Driving and Operating

If the engine stops, there will still be some power brake assist but it will be used when the brake is applied. Once the power assist is used up, it can take longer to stop and the brake pedal will be harder to push.

Adding non-dealer/non-retailer accessories can affect vehicle performance. See *Accessories and Modifications* on page 9-3.

Antilock Brake System (ABS)

This vehicle has the Antilock Brake System (ABS), an advanced electronic braking system that helps prevent a braking skid.

When the engine is started and the vehicle begins to drive away, ABS checks itself. A momentary motor or clicking noise might be heard while this test is going on, and it might even be noticed that the brake pedal moves a little. This is normal.



If there is a problem with ABS, this warning light stays on. See *Antilock Brake System (ABS) Warning Light* on page 4-17.

Let us say the road is wet and you are driving safely. Suddenly, an animal jumps out in front of you. You slam on the brakes and continue braking. Here is what happens with ABS:

A computer senses that the wheels are slowing down. If one of the wheels is about to stop rolling, the computer will separately work the brakes at each wheel.

ABS can change the brake pressure to each wheel, as required, faster than any driver could. This can help the driver steer around the obstacle while braking hard.

As the brakes are applied, the computer keeps receiving updates on wheel speed and controls braking pressure accordingly.

Remember: ABS does not change the time needed to get a foot up to the brake pedal or always decrease stopping distance. If you get too close to the vehicle in front of you, there will not be enough time to apply the brakes if that vehicle suddenly slows or stops. Always leave enough room up ahead to stop, even with ABS.

Using ABS

Do not pump the brakes. Just hold the brake pedal down firmly and let antilock work. The antilock pump or motor might be heard operating, and the brake pedal might be felt to pulsate, but this is normal.

Braking in Emergencies

ABS allows the driver to steer and brake at the same time. In many emergencies, steering can help more than even the very best braking.

StabiliTrak[®] System

The vehicle may have StabiliTrak which combines antilock brake, traction and stability control systems and helps the driver maintain directional control of the vehicle in most driving conditions.

When the vehicle is first started and driven away, the system performs several diagnostic checks to ensure there are no problems. The system may be heard or felt while it is working. This is normal and does not mean there is a problem with the vehicle. The system should initialize before the vehicle reaches 20 mph (32 km/h).

The system monitors vehicle movements, and helps the driver maintain control of the vehicle in most driving situations. When the vehicle's stability is affected the engine output is reduced, and the brakes are applied to individual wheels.



This light on the instrument panel cluster will come on briefly when the ignition is turned on.

StabiliTrak is automatically enabled whenever the vehicle is started. To assist the driver with vehicle directional control, especially in slippery road conditions, the system should always be left on. The system can be turned off if needed.

It is recommended to leave the system on for normal driving conditions, but it may be necessary to turn the system off if the vehicle is stuck in sand, mud, ice or snow, and you want to “rock” the vehicle to attempt to free it. It may also be necessary to turn off the system when driving in extreme off-road conditions where high wheel spin is required. See *If Your Vehicle is Stuck in Sand, Mud, Ice, or Snow* on page 8-29.

StabiliTrak may also turn off automatically if it determines that a problem exists with the system. The light on the instrument panel cluster will be on solid to warn the driver that StabiliTrak is disabled and requires service. If the problem does not clear after restarting the vehicle, see your dealer/retailer for service.



The  switch is located on the instrument panel below the Driver Information Center (DIC).

To turn off StabiliTrak, press and hold the  switch until the light in the switch illuminates.

To turn StabiliTrak on again, press the  switch again or restart the vehicle.

A light in the switch should come on briefly when the ignition key is turned to ON/RUN as a check that the light is working.

Adding non-dealer/non-retailer accessories can affect the vehicle's performance. See *Accessories and Modifications on page 9-3* for more information.

Steering

If the engine stalls while driving, the power steering assist system should continue to operate until you are able to stop the vehicle. If power steering assist is lost because the power steering system is not functioning, the vehicle can be steered but it will take more effort.

If you turn the steering wheel in either direction several times until it stops, or hold the steering wheel in the stopped position for an extended amount of time, you may notice a reduced amount of power steering assist. The normal amount of power steering assist should return shortly after a few normal steering movements.

The power steering system does not require regular maintenance. If you suspect steering system problems and/or the Service Vehicle Soon light comes on, contact your dealer/retailer for service repairs.

Steering Tips

It is important to take curves at a reasonable speed.

Traction in a curve depends on the condition of the tires and the road surface, the angle at which the curve is banked, and vehicle speed. While in a curve, speed is the one factor that can be controlled.

If there is a need to reduce speed, do it before entering the curve, while the front wheels are straight.

Try to adjust the speed so you can drive through the curve. Maintain a reasonable, steady speed. Wait to accelerate until out of the curve, and then accelerate gently into the straightaway.

Steering in Emergencies

There are times when steering can be more effective than braking. For example, you come over a hill and find a truck stopped in your lane, or a car suddenly pulls out from nowhere, or a child darts out from between parked cars and stops right in front of you. These problems can be avoided by braking — if you can stop in time. But sometimes you cannot stop in time because there is no room.

That is the time for evasive action — steering around the problem.

The vehicle can perform very well in emergencies like these. First apply the brakes. See *Braking on page 8-17*. It is better to remove as much speed as possible from a collision. Then steer around the problem, to the left or right depending on the space available.



An emergency like this requires close attention and a quick decision. If holding the steering wheel at the recommended 9 and 3 o'clock positions, it can be turned a full 180 degrees very quickly without removing either hand. But you have to act fast, steer quickly, and just as quickly straighten the wheel once you have avoided the object.

The fact that such emergency situations are always possible is a good reason to practice defensive driving at all times and wear safety belts properly.

Off-Road Recovery

The vehicle's right wheels can drop off the edge of a road onto the shoulder while driving.



If the level of the shoulder is only slightly below the pavement, recovery should be fairly easy. Ease off the accelerator and then, if there is nothing in the way, steer so that the vehicle straddles the edge of the pavement. Turn the steering wheel 3 to 5 inches, 8 to 13 cm, (about one-eighth turn) until the right front tire contacts the pavement edge. Then turn the steering wheel to go straight down the roadway.

Passing

Passing another vehicle on a two-lane road can be dangerous.

To reduce the risk of danger while passing:

- Look down the road, to the sides, and to crossroads for situations that might affect a successful pass. If in doubt, wait.
- Watch for traffic signs, pavement markings, and lines that could indicate a turn or an intersection. Never cross a solid or double-solid line on your side of the lane.
- Do not get too close to the vehicle you want to pass. Doing so can reduce your visibility.
- Wait your turn to pass a slow vehicle.
- When you are being passed, ease to the right.

Loss of Control

Let us review what driving experts say about what happens when the three control systems — brakes, steering, and acceleration — do not have enough friction where the tires meet the road to do what the driver has asked.

In any emergency, do not give up. Keep trying to steer and constantly seek an escape route or area of less danger.

Skidding

In a skid, a driver can lose control of the vehicle. Defensive drivers avoid most skids by taking reasonable care suited to existing conditions, and by not overdriving those conditions. But skids are always possible.

The three types of skids correspond to the vehicle's three control systems. In the braking skid, the wheels are not rolling. In the steering or cornering skid, too much speed or steering in a curve causes tires to slip and lose cornering force. And in the acceleration skid, too much throttle causes the driving wheels to spin.

If the vehicle starts to slide, ease your foot off the accelerator pedal and quickly steer the way you want the vehicle to go. If you start steering quickly enough, the vehicle may straighten out. Always be ready for a second skid if it occurs.

Of course, traction is reduced when water, snow, ice, gravel, or other material is on the road. For safety, slow down and adjust your driving to these conditions. It is important to slow down on slippery surfaces because stopping distance is longer and vehicle control more limited.

While driving on a surface with reduced traction, try your best to avoid sudden steering, acceleration, or braking, including reducing vehicle speed by shifting to a lower gear. Any sudden changes could cause the tires to slide. You might not realize the surface is slippery until the vehicle is skidding. Learn to recognize warning clues — such as enough water, ice, or packed snow on the road to make a mirrored surface — and slow down when you have any doubt.

Remember: Any Antilock Brake System (ABS) helps avoid only the braking skid.

Driving at Night

Night driving is more dangerous than day driving because some drivers are likely to be impaired — by alcohol or drugs, with night vision problems, or by fatigue.

Night driving tips include:

- Drive defensively.
- Do not drink and drive.
- Reduce headlamp glare by adjusting the inside rearview mirror.
- Slow down and keep more space between you and other vehicles because headlamps can only light up so much road ahead.

- Watch for animals.
- When tired, pull off the road.
- Do not wear sunglasses.
- Avoid staring directly into approaching headlamps.
- Keep the windshield and all glass on your vehicle clean — inside and out.
- Keep your eyes moving, especially during turns or curves.

No one can see as well at night as in the daytime. But, as we get older, these differences increase. A 50-year-old driver might need at least twice as much light to see the same thing at night as a 20-year-old.

Driving in Rain and on Wet Roads

Rain and wet roads can reduce vehicle traction and affect your ability to stop and accelerate. Always drive slower in these types of driving conditions and avoid driving through large puddles and deep-standing or flowing water.

CAUTION

Wet brakes can cause crashes. They might not work as well in a quick stop and could cause pulling to one side. You could lose control of the vehicle.

(Continued)

CAUTION (Continued)

After driving through a large puddle of water or a car/vehicle wash, lightly apply the brake pedal until the brakes work normally.

Flowing or rushing water creates strong forces. Driving through flowing water could cause your vehicle to be carried away. If this happens, you and other vehicle occupants could drown. Do not ignore police warnings and be very cautious about trying to drive through flowing water.

Hydroplaning

Hydroplaning is dangerous. Water can build up under your vehicle's tires so they actually ride on the water. This can happen if the road is wet enough and you are going fast enough. When your vehicle is hydroplaning, it has little or no contact with the road.

There is no hard and fast rule about hydroplaning. The best advice is to slow down when the road is wet.

Other Rainy Weather Tips

Besides slowing down, other wet weather driving tips include:

- Allow extra following distance.
- Pass with caution.
- Keep windshield wiping equipment in good shape.
- Keep the windshield washer fluid reservoir filled.
- Have good tires with proper tread depth. See *Tires on page 9-40*.
- Turn off cruise control.

Before Leaving on a Long Trip

To prepare your vehicle for a long trip, consider having it serviced by your dealer/retailer before departing.

Things to check on your own include:

- *Windshield Washer Fluid:* Reservoir full? Windows clean — inside and outside?
- *Wiper Blades:* In good shape?
- *Fuel, Engine Oil, Other Fluids:* All levels checked?
- *Lamps:* Do they all work and are lenses clean?
- *Tires:* Are treads good? Are tires inflated to recommended pressure?
- *Weather and Maps:* Safe to travel? Have up-to-date maps?

Highway Hypnosis

Always be alert and pay attention to your surroundings while driving. If you become tired or sleepy, find a safe place to park your vehicle and rest.

Other driving tips include:

- Keep the vehicle well ventilated.
- Keep interior temperature cool.
- Keep your eyes moving — scan the road ahead and to the sides.
- Check the rearview mirror and vehicle instruments often.

Hill and Mountain Roads

Driving on steep hills or through mountains is different than driving on flat or rolling terrain. Tips for driving in these conditions include:

- Keep the vehicle serviced and in good shape.
- Check all fluid levels and brakes, tires, cooling system, and transmission.
- Going down steep or long hills, shift to a lower gear.

CAUTION

If you do not shift down, the brakes could get so hot that they would not work well. You would then have poor braking or even none going down a hill. You could crash. Shift down to let the engine assist the brakes on a steep downhill slope.

CAUTION

Coasting downhill in N (Neutral) or with the ignition off is dangerous. The brakes will have to do all the work of slowing down

(Continued)

CAUTION (Continued)

and they could get so hot that they would not work well. You would then have poor braking or even none going down a hill. You could crash. Always have the engine running and the vehicle in gear when going downhill.

- Stay in your own lane. Do not swing wide or cut across the center of the road. Drive at speeds that let you stay in your own lane.

- Top of hills: Be alert — something could be in your lane (stalled car, accident).
- Pay attention to special road signs (falling rocks area, winding roads, long grades, passing or no-passing zones) and take appropriate action.

Winter Driving

Driving on Snow or Ice

Drive carefully when there is snow or ice between the tires and the road, creating less traction or grip. Wet ice can occur at about 32°F (0°C) when freezing rain begins to fall, resulting in even less traction. Avoid driving on wet ice or in freezing rain until roads can be treated with salt or sand.

Drive with caution, whatever the condition. Accelerate gently so traction is not lost. Accelerating too quickly causes the wheels to spin and makes the surface under the tires slick, so there is even less traction.

Try not to break the fragile traction. If you accelerate too fast, the drive wheels will spin and polish the surface under the tires even more.

The *Antilock Brake System (ABS)* on page 8-18 improves vehicle stability during hard stops on a slippery roads, but apply the brakes sooner than when on dry pavement.

Allow greater following distance on any slippery road and watch for slippery spots. Icy patches can occur on otherwise clear roads in shaded areas. The surface of a curve or an overpass can remain icy when the surrounding roads are clear. Avoid sudden steering maneuvers and braking while on ice.

Turn off cruise control, if equipped, on slippery surfaces.

Blizzard Conditions

Being stuck in snow can be in a serious situation. Stay with the vehicle unless there is help nearby. If possible, use the *Roadside Assistance Program on page 12-6*. To get help and keep everyone in the vehicle safe:

- Turn on the *Hazard Warning Flashers on page 4-4*.
- Tie a red cloth to an outside mirror.

CAUTION

Snow can trap engine exhaust under the vehicle. This may cause exhaust gases to get inside. Engine exhaust contains carbon monoxide (CO) which cannot be seen or smelled. It can cause unconsciousness and even death.

(Continued)

CAUTION (Continued)

If the vehicle is stuck in the snow:

- Clear away snow from around the base of your vehicle, especially any that is blocking the exhaust pipe.
- Check again from time to time to be sure snow does not collect there.
- Open a window about two inches (5 cm) on the side of the vehicle that is away from the wind to bring in fresh air.
- Fully open the air outlets on or under the instrument panel.
- Adjust the Climate Control system to a setting that circulates the air inside the vehicle and set the fan speed to the highest setting. See Climate Control System in the Index.

(Continued)

CAUTION (Continued)

For more information about carbon monoxide, see *Engine Exhaust on page 8-14*.

Snow can trap exhaust gases under your vehicle. This can cause deadly CO (carbon monoxide) gas to get inside. CO could overcome you and kill you. You cannot see it or smell it, so you might not know it is in your vehicle. Clear away snow from around the base of your vehicle, especially any that is blocking the exhaust.

Run the engine for short periods only as needed to keep warm, but be careful.

To save fuel, run the engine for only short periods as needed to warm the vehicle and then shut the engine off and close the window most of the way to save heat.

Repeat this until help arrives but only when you feel really uncomfortable from the cold. Moving about to keep warm also helps.

If it takes some time for help to arrive, now and then when you run the engine, push the accelerator pedal slightly so the engine runs faster than the idle speed. This keeps the battery charged to restart the vehicle and to signal for help with the headlamps. Do this as little as possible to save fuel.

If Your Vehicle is Stuck in Sand, Mud, Ice, or Snow

Slowly and cautiously spin the wheels to free the vehicle when stuck in sand, mud, ice, or snow. See *Rocking Your Vehicle to Get It Out* on page 8-29.

CAUTION

If you let your vehicle's tires spin at high speed, they can explode, and you or others could be injured. The vehicle can overheat, causing an engine compartment fire or other damage. Spin the wheels as little as possible and avoid going above 35 mph (55 km/h) as shown on the speedometer.

For information about using tire chains on the vehicle, see *Tire Chains* on page 9-60.

Rocking Your Vehicle to Get It Out

Turn the steering wheel left and right to clear the area around the front wheels. Turn off any stability system. Shift back and forth between R (Reverse) and a forward gear, or with a manual transmission, between 1 (First) or 2 (Second) and R (Reverse), spinning the wheels as little as possible. To prevent transmission wear, wait until the wheels stop spinning before shifting gears. Release the accelerator pedal while shifting, and press lightly on the accelerator pedal when the transmission is in gear. Slowly spinning the wheels in the forward and reverse directions causes a rocking motion that could free the vehicle. If that does not get the vehicle out after a few tries, it might need to be towed out. If the vehicle does need to be towed out, see *Towing Your Vehicle* on page 9-73.

Loading the Vehicle

It is very important to know how much weight your vehicle can carry. This weight is called the vehicle capacity weight and includes the weight of all occupants, cargo and all nonfactory-installed options. Two labels on your vehicle show how much weight it may properly carry, the Tire and Loading Information label and the Certification label.

CAUTION

Do not load the vehicle any heavier than the Gross Vehicle Weight Rating (GVWR), or either the maximum front or rear Gross Axle Weight Rating (GAWR). If you do, parts on the vehicle can break, and it can change the way your vehicle handles. These could cause you to lose control and crash. Also, overloading can shorten the life of the vehicle.

Tire and Loading Information Label

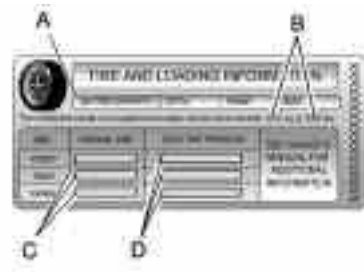

Label Example

A vehicle specific Tire and Loading Information label is attached to the vehicle's center pillar (B-pillar). With the driver's door open, you will find the label attached below the door lock post. The Tire and Loading Information label shows the number of occupant seating positions (A), and the maximum vehicle capacity weight (B) in kilograms and pounds.

The Tire and Loading Information label also shows the tire size of the original equipment tires (C) and the recommended cold tire inflation pressures (D). For more information on tires and inflation see *Tires on page 9-40* and *Inflation - Tire Pressure on page 9-47*.

There is also important loading information on the Certification label. It tells you the Gross Vehicle Weight Rating (GVWR) and the Gross Axle Weight Rating (GAWR) for the front and rear axle; see "Certification Label" later in this section.

Steps for Determining Correct Load Limit

1. Locate the statement "The combined weight of occupants and cargo should never exceed XXX kg or XXX lbs" on your vehicle placard.
2. Determine the combined weight of the driver and passengers that will be riding in your vehicle.
3. Subtract the combined weight of the driver and passengers from XXX kg or XXX lbs.
4. The resulting figure equals the available amount of cargo and luggage load capacity. For example, if the "XXX" amount equals 1400 lbs and there will be five 150 lb passengers in your vehicle, the amount of available cargo and luggage load capacity is 650 lbs (1400 – 750 (5 x 150) = 650 lbs).

5. Determine the combined weight of luggage and cargo being loaded on the vehicle. That weight may not safely exceed the available cargo and luggage load capacity calculated in Step 4.
6. If your vehicle will be towing a trailer, the load from your trailer will be transferred to your vehicle. Consult this manual to determine how this reduces the available cargo and luggage load capacity of your vehicle.

The vehicle is neither designed nor intended to tow a trailer.

8-32 Driving and Operating

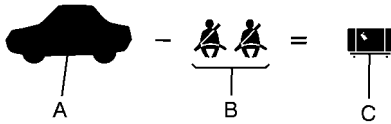

Example 1

- A. Vehicle Capacity Weight for Example 1 = 1,000 lbs (453 kg).
- B. Subtract Occupant Weight
 $150 \text{ lbs (68 kg)} \times 2 = 300 \text{ lbs (136 kg)}$.
- C. Available Occupant and Cargo Weight = 700 lbs (317 kg).

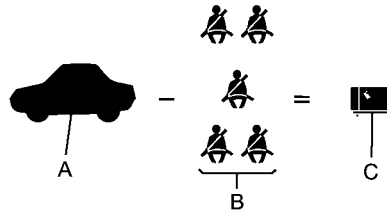

Example 2

- A. Vehicle Capacity Weight for Example 2 = 1,000 lbs (453 kg).
- B. Subtract Occupant Weight
 $150 \text{ lbs (68 kg)} \times 5 = 750 \text{ lbs (340 kg)}$.
- C. Available Cargo Weight = 250 lbs (113 kg).

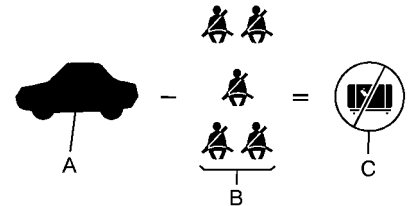

Example 3

- A. Vehicle Capacity Weight for Example 3 = 1,000 lbs (453 kg).
- B. Subtract Occupant Weight
 $200 \text{ lbs (91 kg)} \times 5 = 1,000 \text{ lbs (453 kg)}$.
- C. Available Cargo Weight = 0 lbs (0 kg).

Refer to the vehicle's Tire and Loading Information label for specific information about the vehicle's capacity weight and seating positions. The combined weight of the driver, passengers, and cargo should never exceed the vehicle's capacity weight.

Certification Label



Label Example

A vehicle specific Certification label, found on the rear edge of the driver's door, tells you the gross weight capacity of the vehicle, called the Gross Vehicle Weight Rating (GVWR). The GVWR includes the weight of the vehicle, all occupants, fuel, and cargo. Never exceed the GVWR for your vehicle, or the Gross Axle Weight Rating (GAWR) for either the front or rear axle.

And, if you do have a heavy load, you should spread it out. See “Steps for Determining Correct Load Limit” earlier in this section.

⚠ CAUTION

Do not load the vehicle any heavier than the Gross Vehicle Weight Rating (GVWR), or either the maximum front or rear Gross Axle Weight Rating (GAWR). If you do, parts on the vehicle can break, and it can change the way your vehicle handles. These could cause you to lose control and crash. Also, overloading can shorten the life of the vehicle.

If you put things inside your vehicle — like suitcases, tools, packages, or anything else — they will go as fast as the vehicle goes. If you have to stop or turn quickly, or if there is a crash, they will keep going.

⚠ CAUTION

Things you put inside the vehicle can strike and injure people in a sudden stop or turn, or in a crash.

- Put things in the trunk of your vehicle. In a trunk, put them as far forward as you can. Try to spread the weight evenly.
- Never stack heavier things, like suitcases, inside the vehicle so that some of them are above the tops of the seats.
- Do not leave an unsecured child restraint in the vehicle.
- When you carry something inside the vehicle, secure it whenever you can.
- Do not leave a seat folded down unless you need to.

Fuel

Use of the recommended fuel is an important part of the proper maintenance of this vehicle. To help keep the engine clean and maintain optimum vehicle performance, we recommend the use of gasoline advertised as TOP TIER Detergent Gasoline.

Gasoline Octane

Use regular unleaded gasoline with a posted octane rating of 87 or higher. If the octane rating is less than 87, you might notice an audible knocking noise when you drive, commonly referred to as spark knock. If this occurs, use a gasoline rated at 87 octane or higher as soon as possible. If you are using gasoline rated at 87 octane or higher and you hear heavy knocking, the engine needs service.

Gasoline Specifications

At a minimum, gasoline should meet ASTM specification D 4814 in the United States or CAN/CGSB-3.5 or 3.511 in Canada. Some gasolines contain an octane-enhancing additive called methylcyclopentadienyl manganese tricarbonyl (MMT). We recommend against the use of gasolines containing MMT. See *Additives on page 8-34* for additional information.

California Fuel

If the vehicle is certified to meet California Emissions Standards, it is designed to operate on fuels that meet California specifications. See the underhood emission control label. If this fuel is not available in states adopting California emissions standards, the vehicle will operate satisfactorily on fuels meeting federal specifications, but emission control system performance might be affected. The malfunction indicator lamp could turn on and the vehicle

might fail a smog-check test. See *Malfunction Indicator Lamp on page 4-18*. If this occurs, return to your authorized dealer/retailer for diagnosis. If it is determined that the condition is caused by the type of fuel used, repairs might not be covered by the vehicle warranty.

Additives

To provide cleaner air, all gasolines in the United States are now required to contain additives that help prevent engine and fuel system deposits from forming, allowing the emission control system to work properly. In most cases, you should not have to add anything to the fuel. However, some gasolines contain only the minimum amount of additive required to meet U.S. Environmental Protection Agency regulations. To help keep fuel injectors and intake valves clean, or if the vehicle experiences problems due to dirty injectors or valves, look for gasoline that is advertised as TOP TIER Detergent Gasoline.

For customers who do not use TOP TIER Detergent Gasoline regularly, one bottle of GM Fuel System Treatment PLUS, added to the fuel tank at every engine oil change, can help clean deposits from fuel injectors and intake valves. GM Fuel System Treatment PLUS is the only gasoline additive recommended by General Motors.

Also, your dealer/retailer has additives that will help correct and prevent most deposit-related problems.

Gasolines containing oxygenates, such as ethers and ethanol, and reformulated gasolines might be available in your area. We recommend that you use these gasolines, if they comply with the specifications described earlier. However, E85 (85% ethanol) and other fuels containing more than 10% ethanol must not be used in vehicles that were not designed for those fuels.

Notice: This vehicle was not designed for fuel that contains methanol. Do not use fuel containing methanol. It can corrode metal parts in the fuel system and also damage plastic and rubber parts. That damage would not be covered under the vehicle warranty.

Some gasolines that are not reformulated for low emissions can contain an octane-enhancing additive called methylcyclopentadienyl manganese tricarbonyl (MMT); ask the attendant where you buy gasoline whether the fuel contains MMT. We recommend against the use of such gasolines. Fuels containing MMT can reduce the life of spark plugs and the performance of the emission control system could be affected. The malfunction indicator lamp might turn on. If this occurs, return to your dealer/retailer for service.

Fuels in Foreign Countries

If you plan on driving in another country outside the United States or Canada, the proper fuel might be hard to find. Never use leaded gasoline or any other fuel not recommended in the previous text on fuel. Costly repairs caused by use of improper fuel would not be covered by the vehicle warranty.

To check the fuel availability, ask an auto club, or contact a major oil company that does business in the country where you will be driving.

Filling the Tank

CAUTION

Fuel vapor burns violently and a fuel fire can cause bad injuries. To help avoid injuries to you and others, read and follow all the instructions on the pump island. Turn off the engine when you are refueling. Do not smoke if you are near fuel or refueling the vehicle. Do not use cellular phones. Keep sparks, flames, and smoking materials away from fuel. Do not leave the fuel pump unattended when refueling the vehicle. This is against the law in some places. Do not re-enter the vehicle while pumping fuel. Keep children away from the fuel pump; never let children pump fuel.



The fuel cap is located behind a hinged fuel door on the passenger side of the vehicle.

To remove the fuel cap, turn it slowly counterclockwise.

The fuel cap has a spring in it, if the cap is released too soon it will spring back.

CAUTION

Fuel can spray out on you if you open the fuel cap too quickly. If you spill fuel and then something ignites it, you could be badly burned. This spray can happen if the tank is nearly full, and is more likely in hot weather. Open the fuel cap slowly and wait for any hiss noise to stop. Then unscrew the cap all the way.

Be careful not to spill fuel. Do not top off or overfill the tank and wait a few seconds after you have finished pumping before removing the nozzle. Clean fuel from painted surfaces as soon as possible. See *Exterior Cleaning on page 9-76*.

When replacing the fuel cap, turn it clockwise until it clicks. Make sure the cap is fully installed. The diagnostic system can determine if the fuel cap has been left off or improperly installed.

This would allow fuel to evaporate into the atmosphere. See *Malfunction Indicator Lamp on page 4-18*.

 **CAUTION**

If a fire starts while you are refueling, do not remove the nozzle. Shut off the flow of fuel by shutting off the pump or by notifying the station attendant. Leave the area immediately.

Notice: If you need a new fuel cap, be sure to get the right type. Your dealer/retailer can get one for you. If you get the wrong type, it may not fit properly. This may cause the malfunction indicator lamp to light and may damage the fuel tank and emissions system. See *Malfunction Indicator Lamp on page 4-18*.

Filling a Portable Fuel Container

 **CAUTION**

Never fill a portable fuel container while it is in the vehicle. Static electricity discharge from the container can ignite the fuel vapor. You can be badly burned and the vehicle damaged if this occurs. To help avoid injury to you and others:

- Dispense fuel only into approved containers.
- Do not fill a container while it is inside a vehicle, in a vehicle's trunk, pickup bed, or on any surface other than the ground.

(Continued)

CAUTION (Continued)

- Bring the fill nozzle in contact with the inside of the fill opening before operating the nozzle. Contact should be maintained until the filling is complete.
- Do not smoke while pumping fuel.
- Do not use a cellular phone while pumping fuel.

Vehicle Service and Care

Service

Service	9-2
Accessories and Modifications	9-3
California Proposition 65 Warning	9-3
California Perchlorate Materials Requirements	9-3
Doing Your Own Service Work	9-4
Adding Equipment to the Outside of the Vehicle	9-4

Owner Checks

Owner Checks	9-4
Hood Release	9-5
Engine Compartment Overview	9-6
Engine Oil	9-7
Engine Oil Life System	9-9
Engine Air Cleaner/Filter	9-11

Automatic Transmission Fluid	9-12
Manual Transmission Fluid	9-12
Hydraulic Clutch	9-12
Cooling System	9-12
Engine Coolant	9-16
Pressure Cap	9-18
Engine Overheating	9-18
Power Steering Fluid	9-20
Windshield Washer Fluid	9-20
Windshield Wiper Blade Replacement	9-21
Brakes	9-22
Battery	9-25

Headlamp Aiming

Headlamp Aiming	9-26
-----------------------	------

Bulb Replacement

Bulb Replacement	9-28
Halogen Bulbs	9-28
Front Turn Signal Lamps	9-28
Center High-Mounted Stoplamp (CHMSL)	9-29
Taillamps (Five-Door Hatchback)	9-30

Taillamps (Three-Door Hatchback)	9-32
License Plate Lamp	9-33
Replacement Bulbs	9-34

Electrical System

Add-On Electrical Equipment	9-34
Headlamp Wiring	9-34
Fuses	9-35
Engine Compartment Fuse Block	9-35
Rear Compartment Fuse Block	9-37

Tires

Tires	9-40
Winter Tires	9-41
Tire Sidewall Labeling	9-42
Tire Terminology and Definitions	9-44
Inflation - Tire Pressure	9-47
High-Speed Operation	9-48
Tire Pressure Monitor System	9-49
Tire Pressure Monitor Operation	9-51
Tire Inspection and Rotation	9-52

9-2 Vehicle Service and Care

When It Is Time for New Tires	9-54
Buying New Tires	9-54
Different Size Tires and Wheels	9-56
Uniform Tire Quality Grading	9-57
Wheel Alignment and Tire Balance	9-58
Wheel Replacement	9-59
Tire Chains	9-60

Tire Changing

If a Tire Goes Flat	9-60
Changing a Flat Tire	9-61
Removing the Spare Tire and Tools	9-62
Removing the Flat Tire and Installing the Spare Tire	9-63
Storing a Flat or Spare Tire and Tools	9-66
Compact Spare Tire	9-68

Jump Starting

Jump Starting	9-69
---------------------	------

Towing

Towing Your Vehicle	9-73
Recreational Vehicle Towing	9-73
Towing a Trailer	9-73

Appearance Care

Interior Cleaning	9-73
Exterior Cleaning	9-76
Sheet Metal Damage	9-79
Finish Damage	9-79
Underbody Maintenance	9-80
Chemical Paint Spotting	9-80

Service

For service and parts needs, visit your dealer/retailer. You will receive genuine Saturn parts and Saturn-trained and supported service people.

Genuine Saturn parts have one of these marks.

ACDelco[®]



SATURN[®]

Accessories and Modifications

When non-dealer/non-retailer accessories are added to the vehicle, they can affect vehicle performance and safety, including such things as airbags, braking, stability, ride and handling, emissions systems, aerodynamics, durability, and electronic systems like antilock brakes, traction control, and stability control. Some of these accessories could even cause malfunction or damage not covered by the vehicle warranty.

Damage to vehicle components resulting from the installation or use of non-GM certified parts, including control module modifications, are not covered under the terms of the vehicle warranty and may affect remaining warranty coverage for affected parts.

GM Accessories are designed to complement and function with other systems on the vehicle. Your GM dealer/retailer can accessorize the vehicle using genuine GM Accessories. When you go to your GM dealer/retailer and ask for GM Accessories, you will know that GM-trained and supported service technicians will perform the work using genuine GM Accessories.

Also, see *Adding Equipment to Your Airbag-Equipped Vehicle on page 1-36*.

California Proposition 65 Warning

Most motor vehicles, including this one, contain and/or emit chemicals known to the State of California to cause cancer and birth defects or other reproductive harm.

Engine exhaust, many parts and systems (including some inside the vehicle), many fluids, and some component wear by-products contain and/or emit these chemicals.

California Perchlorate Materials Requirements

Certain types of automotive applications, such as airbag initiators, seat belt pretensioners, and lithium batteries contained in remote keyless transmitters, may contain perchlorate materials. Special handling may be necessary. For additional information, see www.dtsc.ca.gov/hazardouswaste/perchlorate.

Doing Your Own Service Work

CAUTION

You can be injured and the vehicle could be damaged if you try to do service work on a vehicle without knowing enough about it.

- Be sure you have sufficient knowledge, experience, the proper replacement parts, and tools before attempting any vehicle maintenance task.
- Be sure to use the proper nuts, bolts, and other fasteners. English and metric fasteners can be easily confused. If the wrong fasteners are used, parts can later break or fall off. You could be hurt.

If doing some of your own service work, use the proper service manual. It tells you much more

about how to service the vehicle than this manual can. To order the proper service manual, see *Service Publications Ordering Information on page 12-15*.

This vehicle has an airbag system. Before attempting to do your own service work, see *Airbag System Check on page 1-37*.

Keep a record with all parts receipts and list the mileage and the date of any service work performed. See *Maintenance Record on page 11-16*.

Adding Equipment to the Outside of the Vehicle

Things added to the outside of the vehicle can affect the airflow around it. This can cause wind noise and can affect fuel economy and windshield washer performance. Check with your dealer/retailer before adding equipment to the outside of the vehicle.

Owner Checks

CAUTION

An electric fan under the hood can start up and injure you even when the engine is not running. Keep hands, clothing, and tools away from any underhood electric fan.

CAUTION

Things that burn can get on hot engine parts and start a fire. These include liquids like fuel, oil, coolant, brake fluid, windshield washer and other fluids, and plastic or rubber. You or others could be burned. Be careful not to drop or spill things that will burn onto a hot engine.

Hood Release

To open the hood:



1. Pull the handle that is located under the instrument panel.



2. Push the secondary hood release lever upward.
3. Lift the hood.

After the hood is slightly lifted, it will continue to open to the full position.

Before closing the hood, be sure all the filler caps are on properly. Then lift the hood to relieve pressure. Pull the hood down, close it firmly.

9-6 Vehicle Service and Care

Engine Compartment Overview

When you open the hood, this is what you will see:

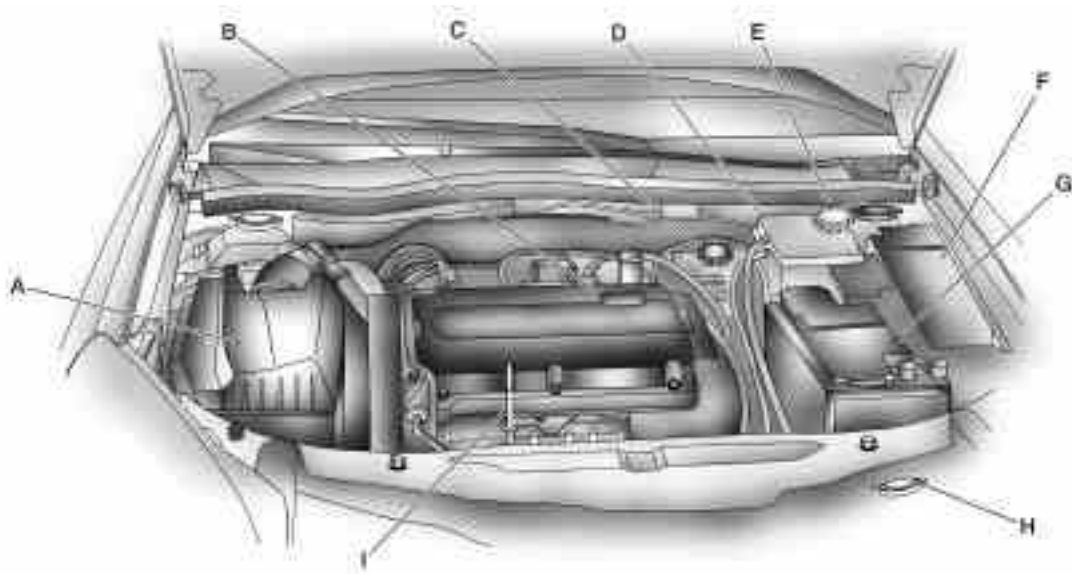

- A. *Engine Air Cleaner/Filter on page 9-11.*
- B. *Engine Oil Fill Cap. Engine Oil on page 9-7.*
- C. *Brake Fluid Reservoir. Brakes on page 9-22.*
- D. *Coolant Reservoir. Cooling System on page 9-12.*
- E. *Coolant Reservoir Pressure Cap. Pressure Cap on page 9-18.*
- F. *Engine Compartment Fuse Block on page 9-35.*
- G. *Battery on page 9-25.*
- H. *Windshield Washer Fluid on page 9-20.*
- I. *Engine Oil Dipstick. Engine Oil on page 9-7.*

Engine Oil

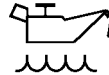

If the low oil level light appears on the instrument cluster, check the engine oil level right away. See *Low Oil Level Light on page 4-22*. Check the engine oil level regularly; this is just a reminder.

Checking Engine Oil

It is a good idea to check the engine oil level at each fuel fill. In order to get an accurate reading, the oil must be warm and the vehicle must be on level ground.

The engine oil dipstick handle is a yellow loop. See *Engine Compartment Overview on page 9-6* for the location of the engine oil dipstick.

1. Turn off the engine and give the oil several minutes to drain back into the oil pan. If this is not done, the oil dipstick might not show the actual level.
2. Pull the dipstick and clean it with a paper towel or cloth, then push it back in all the way. Remove it again, keeping the tip down and check the level.

9-8 Vehicle Service and Care

When to Add Engine Oil

If the oil is below the MIN (minimum) mark, add at least one quart/liter of the recommended oil. This section explains what kind of oil to use.

For engine oil crankcase capacity, see *Capacities and Specifications* on page 10-2.

Notice: Do not add too much oil. If the engine has so much oil that the oil level gets above the upper mark that shows the proper operating range, the engine could be damaged.



See *Engine Compartment Overview* on page 9-6 for the location of the engine oil fill cap.

Add enough oil to put the level somewhere in the proper operating range. Push the dipstick all the way back in when through.

What Kind of Engine Oil to Use

Look for three things:



- GM6094M
Use only an oil that meets GM Standard GM6094M.

- SAE 5W-30
SAE 5W-30 is best for the vehicle. These numbers on an oil container show its viscosity, or thickness. Do not use other viscosity oils such as SAE 20W-50.

- American Petroleum Institute (API) starburst symbol



Oils meeting these requirements should have the starburst symbol on the container. This symbol indicates that the oil has been certified by the American Petroleum Institute (API).

Notice: Use only engine oil identified as meeting GM Standard GM6094M and showing the American Petroleum Institute Certified For Gasoline Engines starburst symbol. Failure to use the recommended oil can result in engine damage not covered by the vehicle warranty.

Cold Temperature Operation

If in an area of extreme cold, where the temperature falls below -20°F (-29°C), use either an SAE 5W-30 synthetic oil or an SAE 0W-30 engine oil. Both provide easier cold starting for the engine at extremely low temperatures. Always use an oil that meets the required specification, GM6094M. See “What Kind of Engine Oil to Use” for more information.

Engine Oil Additives / Engine Oil Flushes

Do not add anything to the oil. The recommended oils with the starburst symbol that meet GM Standard GM6094M are all that is needed for good performance and engine protection.

Engine oil system flushes are not recommended and could cause engine damage not covered by the vehicle warranty.

Engine Oil Life System

When to Change Engine Oil

This vehicle has a computer system that indicates when to change the engine oil and filter. This is based on engine revolutions and engine temperature, and not on mileage. Based on driving conditions, the mileage at which an oil change is indicated can vary considerably. For the oil life system to work properly, the system must be reset every time the oil is changed.

When the system has calculated that oil life has been diminished, it indicates that an oil change is necessary. The letters InSP will appear in the odometer display. Change the oil as soon as possible within the mileage indicated on the display. If driving under the best conditions, the oil life system might indicate that an oil change is necessary once a year.

The engine oil and filter must be changed at least once a year and at this time the system must be reset. Your dealer/retailer has trained service people who will perform this work using genuine parts and reset the system. It is also important to check the oil regularly and keep it at the proper level.

If the system is ever reset accidentally, the oil must be changed at 3,000 miles (5 000 km) since the last oil change. Remember to reset the oil life system whenever the oil is changed.

9-10 Vehicle Service and Care

How to Reset the Engine Oil Life System

The Engine Oil Life System calculates when to change the engine oil and filter based on vehicle use. Whenever the oil is changed, reset the system so it can calculate when the next oil change is required. If a situation occurs where the oil is changed prior to the letters InSP appearing in the odometer display, reset the system.

After changing the engine oil, reset the system:

1. Turn the ignition key to LOCK/OFF.
2. Press the instrument panel cluster stem until the odometer is displayed, then release the stem.

3. Re-press and hold the cluster stem until the letters InSP are displayed.
4. Press and hold the brake pedal down, hold the cluster stem down, and turn the ignition key to ON/RUN.
5. The letters InSP in the instrument panel cluster display will flash.
6. Keep the cluster stem down for at least 10 seconds and release the stem and the brake pedal when the message “new remaining milage” is displayed.

What to Do with Used Oil

Used engine oil contains certain elements that can be unhealthy for your skin and could even cause cancer. Do not let used oil stay on your skin for very long. Clean your skin and nails with soap and water, or a good hand cleaner. Wash or properly dispose of clothing or rags containing used engine oil. See the manufacturer’s warnings about the use and disposal of oil products.

Used oil can be a threat to the environment. If you change your own oil, be sure to drain all the oil from the filter before disposal. Never dispose of oil by putting it in the trash, pouring it on the ground, into sewers, or into streams or bodies of water. Recycle it by taking it to a place that collects used oil.

Engine Air Cleaner/Filter

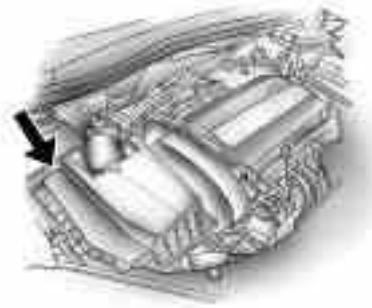

See *Engine Compartment Overview* on page 9-6 for the location of the engine air cleaner/filter.

When to Inspect the Engine Air Cleaner/Filter

Inspect the air cleaner/filter at the Maintenance II intervals and replace it at the first oil change after each 50,000 mile (83 000 km) interval. See “Schedule Maintenance” in Service and Maintenance for

more information. If you are driving in dusty/dirty conditions, inspect the filter at each engine oil change.

How to Inspect the Engine Air Cleaner/Filter

To inspect the air cleaner/filter, remove the filter from the vehicle and lightly shake the filter to release loose dust and dirt. If the filter remains caked with dirt, a new filter is required.

To inspect or replace the engine air cleaner/filter.

1. Remove the screws that hold the cover on.
2. Disconnect the electrical connector.
3. Lift off the cover.
4. Inspect or replace the engine air cleaner/filter.
5. Reverse Steps 1 through 3 to reinstall the cover and reconnect the electrical connector.

CAUTION

Operating the engine with the air cleaner/filter off can cause you or others to be burned. The air cleaner not only cleans the air; it helps to stop flames if the engine backfires. If it is not there and the engine backfires, you could be burned. Do not drive with it off, and be careful working on the engine with the air cleaner/filter off.

Notice: If the air cleaner/filter is off, a backfire can cause a damaging engine fire. And, dirt can easily get into the engine, which will damage it. Always have the air cleaner/filter in place when you are driving.

Automatic Transmission Fluid

It is not necessary to check the transmission fluid level. A transmission fluid leak is the only reason for fluid loss. If a leak occurs, take your vehicle to the dealer/retailer service department and have it repaired as soon as possible.

Change the fluid and filter at the intervals listed in the Maintenance Schedule. See “Additional Required Services” in Service and Maintenance. Be sure to use the transmission fluid listed in “Recommended Fluids and Lubricants” in Service and Maintenance.

Notice: Use of the incorrect automatic transmission fluid may damage your vehicle, and the damages may not be covered by your warranty.

See “Recommended Fluids and Lubricants” in the Limited Warranty, Maintenance and Owner Assistance Information manual.

Manual Transmission Fluid

It is not necessary to check the manual transmission fluid level. A transmission fluid leak is the only reason for fluid loss. If a leak occurs, take the vehicle to the dealer/retailer service department and have it repaired as soon as possible. You may also have your fluid level checked by your dealer/retailer when you have your oil changed. See “Part D: Recommended Fluids and Lubricants” in Service and Maintenance for the proper fluid to use.

Hydraulic Clutch

The hydraulic clutch linkage in your vehicle is self-adjusting. This system does not have its own reservoir. It receives fluid from the brake master cylinder reservoir. See *Brakes* on page 9-22 for more information.

Cooling System

When you decide it is safe to lift the hood, this is what you see:

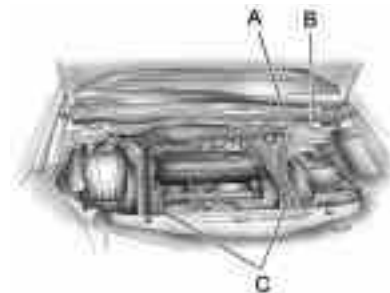

- A. Coolant Reservoir
- B. Coolant Reservoir Pressure Cap
- C. Engine Cooling Fans (Out of view)

 **CAUTION**

An electric engine cooling fan under the hood can start up even when the engine is not running and can cause injury. Keep hands, clothing, and tools away from any underhood electric fan.

If the coolant inside the coolant reservoir is boiling, do not do anything else until it cools down. The vehicle should be parked on a level surface.

The coolant level should be at or above the KALT/COLD mark on the coolant reservoir. If it is not, you may have a leak at the coolant reservoir pressure cap or in the radiator hoses, heater hoses, radiator, water pump, or somewhere else in the cooling system.

 **CAUTION**

Heater and radiator hoses, and other engine parts, can be very hot. Do not touch them. If you do, you can be burned.

Do not run the engine if there is a leak. If you run the engine, it could lose all coolant. That could cause an engine fire, and you could be burned. Get any leak fixed before you drive the vehicle.

If there seems to be no leak, with the engine on, check to see if the electric engine cooling fans are running. If the engine is overheating, both fans should be running. If they are not, your vehicle needs service.

Notice: Engine damage from running the engine without coolant is not covered by the warranty.

Notice: Using coolant other than DEX-COOL[®] can cause premature engine, heater core, or radiator corrosion. In addition, the engine coolant could require changing sooner, at 30,000 miles (50 000 km) or 24 months, whichever occurs first. Any repairs would not be covered by the vehicle warranty. Always use DEX-COOL[®] (silicate-free) coolant in the vehicle.

9-14 Vehicle Service and Care

How to Add Coolant to the Coolant Reservoir

Notice: This vehicle has a specific coolant fill procedure. Failure to follow this procedure could cause the engine to overheat and be severely damaged.

If you have not found a problem yet, check to see if coolant is visible in the coolant reservoir. If coolant is visible but the coolant level is not at or above the KALT/COLD mark, add a 50/50 mixture of clean, drinkable water and DEX-COOL[®] coolant at the coolant reservoir, but be sure the cooling system, including the coolant reservoir pressure cap, is cool before you do it. See *Engine Coolant* on page 9-16 for more information.

If no coolant is visible in the coolant reservoir, add coolant as follows:

CAUTION

Steam and scalding liquids from a hot cooling system can blow out and burn you badly. They are under pressure, and if you turn the coolant reservoir pressure cap — even a little — they can come out at high speed. Never turn the cap when the cooling system, including the coolant reservoir pressure cap, is hot. Wait for the cooling system and coolant reservoir pressure cap to cool if you ever have to turn the pressure cap.

CAUTION

Adding only plain water to the cooling system can be dangerous. Plain water, or some other liquid such as alcohol, can boil before the proper coolant mixture will. The vehicle's coolant warning system is set for the proper coolant mixture. With plain water or the wrong mixture, the engine could get too hot but you would not get the overheat warning. The engine could catch fire and you or others could be burned. Use a 50/50 mixture of clean, drinkable water and DEX-COOL[®] coolant.

Notice: In cold weather, water can freeze and crack the engine, radiator, heater core and other parts. Use the recommended coolant and the proper coolant mixture.

⚠ CAUTION

You can be burned if you spill coolant on hot engine parts. Coolant contains ethylene glycol and it will burn if the engine parts are hot enough. Do not spill coolant on a hot engine.

1. Remove the coolant reservoir pressure cap when the cooling system, including the coolant reservoir pressure cap and upper radiator hose, is no longer hot. Turn the coolant reservoir pressure cap slowly counterclockwise about two or two and one-half turns. If you hear a hiss, wait for that to stop. This will allow any pressure still left to be vented out the discharge hose.

**Coolant Reservoir Pressure Cap**

2. Keep turning the coolant reservoir pressure cap slowly, and remove it.
3. Fill the coolant reservoir with the proper mixture, to the KALT/COLD mark. Wait about five minutes, then check to see if the level is below the mark. If the level is below the KALT/COLD mark, add additional coolant to bring the level up to the mark. Repeat this procedure until the level remains constant at the KALT/COLD mark for at least five minutes.
4. With the coolant reservoir pressure cap off, start the engine and let it run until you can feel the upper radiator hose getting hot. Watch out for the engine cooling fans. By this time, the coolant level inside the coolant reservoir might be lower. If the level is lower than the KALT/COLD mark, add more of the proper mixture to the coolant reservoir until the level reaches the KALT/COLD mark.
5. Replace the coolant reservoir pressure cap. Be sure the pressure cap is hand-tight and fully seated.

Engine Coolant

The cooling system in your vehicle is filled with DEX-COOL[®] engine coolant. This coolant is designed to remain in your vehicle for five years or 150,000 miles (240 000 km), whichever occurs first, if you add only DEX-COOL[®] extended life coolant.

The following explains your cooling system and how to add coolant when it is low. If you have a problem with engine overheating, see *Engine Overheating on page 9-18*.

A 50/50 mixture of clean, drinkable water and DEX-COOL[®] coolant will:

- Give freezing protection down to -34°F (-37°C).
- Give boiling protection up to 265°F (129°C).

- Protect against rust and corrosion.
- Help keep the proper engine temperature.
- Let the warning lights and gages work as they should.

Notice: Using coolant other than DEX-COOL[®] can cause premature engine, heater core, or radiator corrosion. In addition, the engine coolant may require changing sooner, at the first maintenance service after each 30,000 miles (50 000 km) or 24 months, whichever occurs first. Any repairs would not be covered by the vehicle warranty. Always use DEX-COOL[®] (silicate-free) coolant in the vehicle.

What to Use

Use a mixture of one-half clean, drinkable water and one-half DEX-COOL[®] coolant which will not damage aluminum parts. If you use this coolant mixture, you do not need to add anything else.

CAUTION

Adding only plain water to the cooling system can be dangerous. Plain water, or some other liquid such as alcohol, can boil before the proper coolant mixture will. The vehicle's coolant warning system is set for the proper coolant mixture. With plain water or the wrong mixture, the engine could get too hot but would not get the overheat warning. The engine could catch fire and you or others could be burned. Use a 50/50 mixture of clean, drinkable water and DEX-COOL[®] coolant.

Notice: If an improper coolant mixture is used, the engine could overheat and be badly damaged. The repair cost would not be covered by the vehicle warranty. Too much water in the mixture can freeze and crack the engine, radiator, heater core, and other parts.

Notice: If you use extra inhibitors and/or additives in your vehicle's cooling system, you could damage your vehicle. Use only the proper mixture of the engine coolant listed in this manual for the cooling system. See **Recommended Fluids and Lubricants in the Maintenance and Limited Warranty and Owner Assistance Information manual.**

Checking Coolant



The coolant reservoir is located in the engine compartment on the driver's side of the vehicle. See *Engine Compartment Overview* on page 9-6 for more information on location.

CAUTION

Turning the coolant reservoir pressure cap when the engine and radiator are hot can allow steam and scalding liquids to blow out and burn you badly. Never turn the coolant reservoir pressure cap – even a little – when the engine and radiator are hot.

The vehicle must be on a level surface. When your engine is cold, the coolant level should be at the KALT/COLD line.

Do not overfill the coolant reservoir. Too much coolant can result in an overflow condition when the fluid is hot.

Adding Coolant

If you need more coolant, add the proper DEX-COOL® coolant mixture at the coolant reservoir, but only when the engine is cool. If the coolant reservoir is empty, a special fill procedure is necessary. See *Cooling System on page 9-12* for instructions on “How to Add Coolant to the Coolant Reservoir.”

CAUTION

You can be burned if you spill coolant on hot engine parts. Coolant contains ethylene glycol, and it will burn if the engine parts are hot enough. Do not spill coolant on a hot engine.

When replacing the pressure cap, make sure it is hand-tight and fully seated.

Pressure Cap

Notice: If the pressure cap is not tightly installed, coolant loss and possible engine damage may occur. Be sure the cap is properly and tightly secured.

See *Engine Compartment Overview on page 9-6* for more information on location.

Engine Overheating

There is an engine coolant temperature warning light on your vehicle's instrument panel. See *Engine Coolant Temperature Warning Light on page 4-18* for more information.

If Steam Is Coming From Your Engine

CAUTION

Steam from an overheated engine can burn you badly, even if you just open the hood. Stay away from the engine if you see or hear steam coming from it. Just turn it off and get everyone away from the vehicle until it cools down. Wait until there is no sign of steam or coolant before you open the hood.

If you keep driving when your engine is overheated, the liquids in it can catch fire. You or others could be badly burned. Stop your engine if it overheats, and get out of the vehicle until the engine is cool.

Notice: If the engine catches fire because of being driven with no coolant, your vehicle can be badly damaged. The costly repairs would not be covered by the vehicle warranty.

If No Steam Is Coming From Your Engine

An engine coolant temperature warning can indicate a serious problem. See *Engine Coolant Temperature Warning Light* on page 4-18.

If you get an engine coolant temperature warning, but see or hear no steam, the problem may not be too serious. Sometimes the engine can get a little too hot when you:

- Climb a long hill on a hot day.
- Stop after high-speed driving.
- Idle for long periods in traffic.

If you get the engine coolant temperature warning with no sign of steam, try this for a minute or so:

1. If your air conditioner is on, turn it off.
2. In heavy traffic, let the engine idle in N (Neutral) while stopped. If it is safe to do so, pull off the road, shift to P (Park) or N (Neutral) and let the engine idle.
3. Turn on your heater to full hot at the highest fan speed and open the windows as necessary.

If you no longer have the overheat warning, you can drive. Just to be safe, drive slower for about 10 minutes. If the warning does not come back on, you can drive normally.

If the warning continues and you have not stopped, pull over, stop, and park your vehicle right away.

If there is still no sign of steam, you can idle the engine for three minutes while you are parked. If you still have the warning, turn off the engine and get everyone out of the vehicle until it cools down.

You may decide not to lift the hood but to get service help right away.

Power Steering Fluid

When to Check Power Steering Fluid

It is not necessary to check the power steering fluid level. A power steering fluid leak is the only reason for fluid loss. If a leak occurs, take your vehicle to the dealer/retailer service department and have it repaired as soon as possible.

Windshield Washer Fluid

What to Use

When you need windshield washer fluid, be sure to read the manufacturer's instructions before use. If you will be operating your vehicle in an area where the temperature may fall below freezing, use a fluid that has sufficient protection against freezing.

Adding Washer Fluid



Open the cap with the washer symbol on it. Add washer fluid until the tank is full. See *Engine Compartment Overview* on page 9-6 for reservoir location.

Notice:

- When using concentrated washer fluid, follow the manufacturer's instructions for adding water.
- Do not mix water with ready-to-use washer fluid. Water can cause the solution to freeze and damage your washer fluid tank and other parts of the washer system. Also, water does not clean as well as washer fluid.
- Fill the washer fluid tank only three-quarters full when it is very cold. This allows for fluid expansion if freezing occurs, which could damage the tank if it is completely full.
- Do not use engine coolant (antifreeze) in your windshield washer. It can damage the vehicle's windshield washer system and paint.

Windshield Wiper Blade Replacement

Front Windshield Wiper

Windshield wiper blades should be inspected for wear or cracking.

See *Maintenance Replacement Parts* on page 11-14 for the proper type and length.

Raise the wiper arm, tilt the wiper blade at a 90° angle to the wiper arm, and remove to the side.

1. Turn the ignition off.
2. With the key in the ignition and key in the LOCK/OFF position, press the wiper lever down. Release the wiper lever when the wipers are in the vertical position.

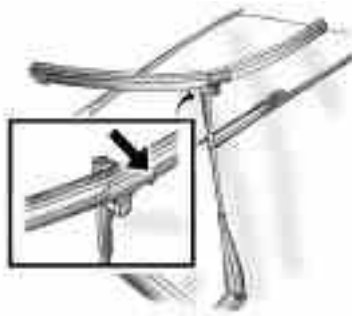

3. Raise the wiper arm away from the windshield.
4. Turn the wiper blade at a 90° angle to the wiper arm and remove the blade to the side.
5. Install the new wiper blade.
6. Lower the wiper arm on to the windshield.

Rear Windshield Wiper

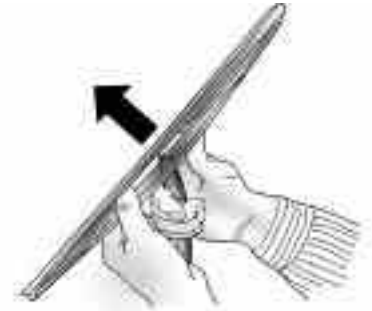

1. Lift the wiper arm straight up.
2. Push the wiper blade straight out of the wiper arm to remove.
3. Install the new wiper blade.

Brakes

Brake Fluid



The brake master cylinder and, on manual transmission vehicles, the clutch hydraulic system use the same reservoir. The reservoir is filled with DOT-4 brake fluid. See *Engine Compartment Overview on page 9-6* for the location of the reservoir.

There are only two reasons why the brake fluid level in the reservoir might go down:

- The brake fluid level goes down because of normal brake lining wear. When new linings are installed, the fluid level goes back up.

- A fluid leak in the brake and/or clutch hydraulic system can also cause a low fluid level. Have the brake and/or clutch hydraulic system fixed, since a leak means that sooner or later the brakes and/or clutch will not work well.

Do not top off the brake/clutch fluid. Adding fluid does not correct a leak. If fluid is added when the brake linings are worn, there will be too much fluid when new brake linings are installed. Add or remove fluid, as necessary, only when work is done on the brake/clutch hydraulic system.

CAUTION

If too much brake fluid is added, it can spill on the engine and burn, if the engine is hot enough. You or others could be burned,

(Continued)

CAUTION (Continued)

and the vehicle could be damaged. Add brake fluid only when work is done on the brake and/or clutch hydraulic system.

Refer to *Scheduled Maintenance on page 11-3* to determine when to check the brake fluid.

Checking Brake Fluid

The brake fluid can be checked without taking off the cap by looking at the brake fluid reservoir.

The fluid level should be above MIN. If it is not, have your brake hydraulic system checked to see if there is a leak. After work is done on the brake hydraulic system, make sure the level is above the MIN but not over the MAX mark.

What to Add

Use only new DOT-4 brake fluid from a sealed container. It is recommended that the brake hydraulic system be flushed and refilled with new DOT-4 fluid at a regular maintenance service every two years. See *Additional Required Services on page 11-6* and *Recommended Fluids and Lubricants on page 11-12*.

Always clean the brake fluid reservoir cap and the area around the cap before removing it. This helps keep dirt from entering the reservoir.

 **CAUTION**

With the wrong kind of fluid in the brake hydraulic system, the brakes might not work well. This could cause a crash. Always use the proper brake fluid.

Notice:

- **Using the wrong fluid can badly damage brake hydraulic system parts. For example, just a few drops of mineral-based oil, such as engine oil, in the brake hydraulic system can damage brake hydraulic system parts so badly that they will have to be replaced. Do not let someone put in the wrong kind of fluid.**
- **If brake fluid is spilled on the vehicle's painted surfaces, the paint finish can be damaged. Be careful not to spill brake fluid on the vehicle. If you do, wash it off immediately. See *Exterior Cleaning on page 9-76*.**

Brake Wear

This vehicle has disc brakes.

Notice: Continuing to drive with worn-out brake pads could result in costly brake repair.

Front disc brake pads have built-in brake pad wear indicators that make a high-pitched warning sound when the brake pads are worn and new pads are needed.

The sound can come and go or be heard all the time the vehicle is moving, except when applying the brake pedal firmly.

 **CAUTION**

The brake wear warning sound means that soon the brakes will not work well. That could lead to an accident. When the brake wear warning sound is heard, have the vehicle serviced.

9-24 Vehicle Service and Care

Rear disc brake pads do not have built-in brake pad wear indicators. Periodic visual inspection of the rear brake pads is required to determine when to replace the pads. Visually inspect the rear brake pads whenever the rear wheels are removed such as during tire rotation.

1. Set the parking brake and make sure that the brakes have been given enough time to cool.
2. Remove the rear wheels.
3. Visually inspect the rear brake inner pads (C) at each rear wheel through the inspection window in the brake caliper (A).

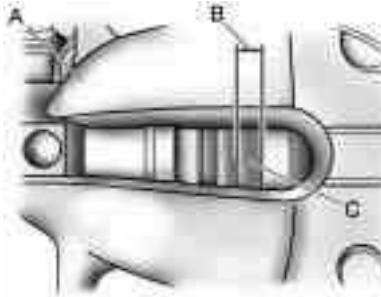

Brake pads should be replaced when the inner pad (C) is worn to $5/64$ in (2 mm) of pad thickness (B). New brake pads, with no wear, are $25/64$ of an inch (10 mm) thick.

4. After brake pad inspection or replacement, install the rear wheels.

Some driving conditions or climates can cause a brake squeal when the brakes are first applied or lightly applied. This does not mean something is wrong with the brakes.

Properly torqued wheel bolts are necessary to help prevent brake pulsation. When tires are rotated, inspect brake pads for wear and evenly tighten wheel bolts in the proper sequence to torque specifications in *Capacities and Specifications on page 10-2*.

Brake linings should always be replaced as complete axle sets.

Brake Pedal Travel

See your dealer/retailer if the brake pedal does not return to normal height, or if there is a rapid increase in pedal travel. This could be a sign that brake service might be required.

Brake Adjustment

Every brake stop, the disc brakes adjust for wear.

Replacing Brake System Parts

The braking system on a vehicle is complex. Its many parts have to be of top quality and work well together if the vehicle is to have really good braking. The vehicle was designed and tested with top-quality brake parts. When parts of the braking system are replaced — for example, when the brake linings wear down and new ones are installed — be sure to get new approved replacement parts. If this is not done, the brakes might not work properly. For example, if someone puts in brake linings that are wrong for the vehicle, the balance between the front and rear brakes can change — for the worse. The braking performance expected can change in many other ways if the wrong replacement brake parts are installed.

Battery

This vehicle has a maintenance free battery. When it is time for a new battery, see your dealer/retailer for one that has the replacement number shown on the original battery's label. See *Engine Compartment Overview on page 9-6* for battery location.

Warning: Battery posts, terminals, and related accessories contain lead and lead compounds, chemicals known to the State of California to cause cancer and reproductive harm. Wash hands after handling.

Vehicle Storage

CAUTION

Batteries have acid that can burn you and gas that can explode. You can be badly hurt if you are not careful. See *Jump Starting on page 9-69* for tips on working around a battery without getting hurt.

Infrequent Usage: If the vehicle is driven infrequently, remove the black, negative (–) cable from the battery. This helps keep the battery from running down.

Extended Storage: For extended storage of the vehicle, remove the black, negative (–) cable from the battery or use a battery trickle charger. This helps maintain the charge of the battery over an extended period of time.

Headlamp Aiming

The optical headlamp aiming system has been preset at the factory and should need no further adjustment.

However, If the vehicle is damaged in a crash, the headlamp aim may be affected and adjustment may be necessary.

If oncoming vehicles flash their high beams at you, this may also mean the vertical aim needs to be adjusted.

It is recommended that the vehicle is taken to your dealer/retailer for service if the headlamps need to be re-aimed. It is possible however, to re-aim the headlamps as described.

The vehicle should:

- Be placed so the headlamps are 25 ft. (7.6 m) from a light colored wall.
- Have all four tires on a perfectly level surface which is level all the way to the wall.
- Be placed so it is perpendicular to the wall.
- Not have any snow, ice, or mud on it.
- Be fully assembled and all other work stopped while headlamp aiming is being done.
- Have a full tank of fuel and one person or 160 lbs (75 kg) on the driver seat.
- Have all tires properly inflated.

Headlamp aiming is done with the vehicle's low-beam headlamps. The high-beam headlamps will be correctly aimed if the low-beam headlamps are aimed properly.

To adjust the vertical aim on the headlamps:

1. Open the hood. See *Hood Release* on page 9-5 for more information.

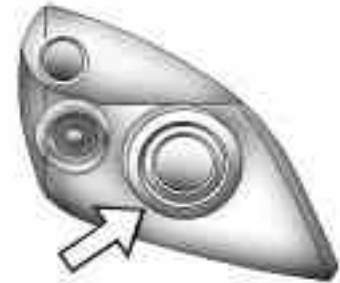

2. Locate the aim dot on the lens of the low-beam headlamp.
3. Record the distance from the ground to the aim dot on the low-beam headlamp.



4. At a wall, measure from the ground upward (A) to the recorded distance from Step 3 and mark it.
5. Draw or tape a horizontal line (B) on the wall the width of the vehicle at the height of the mark in Step 4.

Notice: Do not cover a headlamp to improve beam cut-off when aiming. Covering a headlamp may cause excessive heat build-up which may cause damage to the headlamp.

6. Turn on the low-beam headlamps and place a piece of cardboard or equivalent in front of the headlamp not being adjusted. Do not place it directly on the headlamp. This allows only the beam of light from the headlamp being adjusted to be seen on the flat surface.

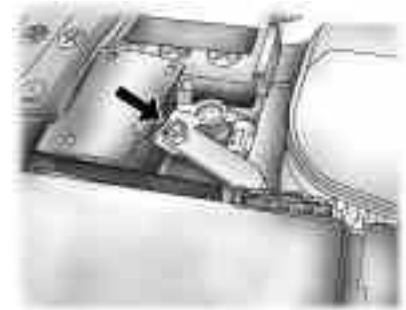

7. Locate the vertical headlamp aiming screws, which are under the hood near each headlamp assembly. The adjustment screw can be turned with a 6 mm socket wrench.
8. Turn the vertical aiming screw until the headlamp beam is aimed to the horizontal tape line. Turn it clockwise or counterclockwise to raise or lower the angle of the beam.



9. Make sure that the light from the headlamp is positioned at the bottom edge of the horizontal tape line. The lamp on the left (A) shows the correct headlamp aim. The lamp on the right (B) shows the incorrect headlamp aim.
10. Repeat Steps 7 through 9 for the opposite headlamp.

Bulb Replacement

For the proper type of replacement bulbs, see *Replacement Bulbs* on page 9-34.

For any bulb changing procedure not listed in this section, contact your dealer/retailer.

Halogen Bulbs

CAUTION

Halogen bulbs have pressurized gas inside and can burst if you drop or scratch the bulb. You or others could be injured. Be sure to read and follow the instructions on the bulb package.

Front Turn Signal Lamps



1. The bulbs of the turn signal lamp are replaced through openings in the front wheel wells. Turn the wheel to gain access to the push tabs and remove the cover.

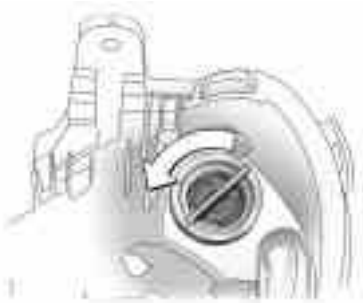

2. Turn the bulb socket counterclockwise and pull straight out.
3. Turn bulb counterclockwise and remove.
4. Install new bulb.
5. Reverse Steps 2 through 4 to reinstall.

Center High-Mounted Stoplamp (CHMSL)

1. Open the liftgate. See "Liftgate" for more information.

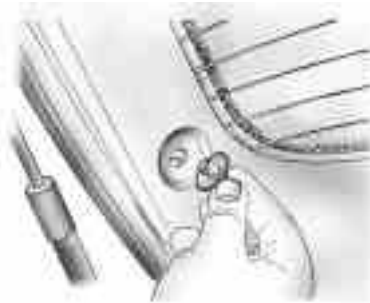

2. Remove the two pins in the tailgate trim.

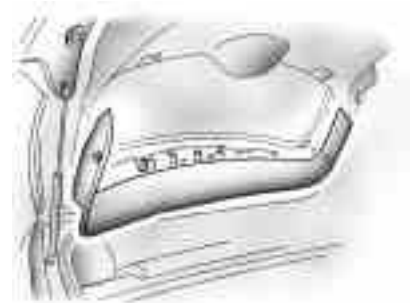

3. Remove the tailgate trim.



4. Unlock the six Center High-Mounted Stoplamp (CHMSL) clips.

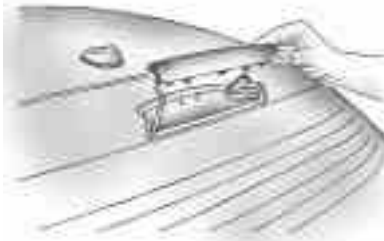

5. Remove the CHMSL from the top of the tailgate.
6. Reverse Steps 1 through 3 to reinstall the lamp assembly.

Taillamps (Five-Door Hatchback)

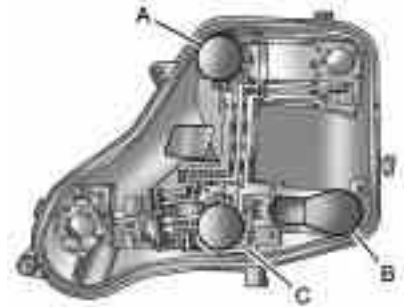

- A. Backup Lamp
- B. Taillamp
- C. Taillamp/Stoplamp/Turn Signal Lamp

To replace one of these bulbs:

1. Open the liftgate.
2. To replace the bulbs on the driver side, turn both locks and remove the cover.



To replace the bulbs on the passenger side, turn the lock clockwise and remove the cover.

3. Detach the plug connector from the bulb assembly.



4. Turn the nuts counterclockwise and hold the outside of taillamp assembly.
5. Pull the taillamp assembly straight out.
6. Remove the three nuts.
7. Press on the tabs on the outside of bulb assembly and remove the bulb assembly.
8. Remove the bulb from the bulb assembly.

9. Install a new bulb without touching the glass.
10. Reinstall the bulb assembly in taillamp assembly.



11. Make sure the seals are applied to the taillamp assembly and screws.
12. Insert the taillamp assembly into the body.
13. Reinstall the three nuts.
14. Attach the plug connector to the bulb assembly.

Taillamps (Three-Door Hatchback)

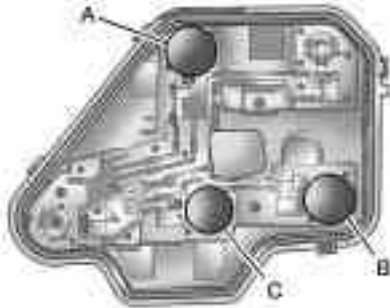

- A. Backup Lamp
- B. Taillamp
- C. Taillamp/Stoplamp/Turn Signal Lamp

To replace one of these bulbs:

1. Open the liftgate. See *Liftgate* on page 2-6 for more information.
2. Detach the plug connector from the bulb assembly.



3. Turn the nuts counterclockwise and hold the outside of taillamp assembly.
4. Pull the taillamp assembly straight out.



5. Remove the seal.
6. Press on the tabs on outside of bulb assembly and remove the bulb assembly.
7. Remove the bulb from the bulb assembly.
8. Install a new bulb without touching the glass.
9. Reinstall the bulb assembly in taillamp assembly.
10. Make sure the seals are applied to the taillamp assembly and screws.
11. Insert the taillamp assembly into the body.
12. Reinstall the three nuts.
13. Attach the plug connector to the bulb assembly.

License Plate Lamp

To replace one of these bulbs:



1. Push tab in and pull down on it to remove the license plate lamp.



2. Turn and pull the license plate lamp toward you through the opening.



3. Turn the bulb socket counterclockwise and pull the bulb straight out of the socket.
4. Install the new bulb.
5. Reverse Steps 1 through 3 to reinstall the license plate lamp.

Replacement Bulbs

Exterior Lamp	Bulb Number
Front Turn Signal Lamp	3157 NAK
License Plate Lamp	W5W
Parking Lamp	4157K
Taillamp	W21

For replacement bulbs not listed here, contact your dealer/retailer.

Electrical System

Add-On Electrical Equipment

Notice: Do not add anything electrical to the vehicle unless you check with your dealer/retailer first. Some electrical equipment can damage the vehicle and the damage would not be covered by the vehicle's warranty. Some add-on electrical equipment can keep other components from working as they should.

Add-on equipment can drain the vehicle battery, even if the vehicle is not operating.

The vehicle has an airbag system. Before attempting to add anything electrical to the vehicle, see *Servicing Your Airbag-Equipped Vehicle* on page 1-35.

Headlamp Wiring

The headlamp wiring is protected by fuses in the fuse block. An electrical overload will cause the lamps to turn off. If this happens, have the headlamp wiring checked right away.

Fuses

The wiring circuits in the vehicle are protected from short circuits by fuses. This greatly reduces the chance of damage caused by electrical problems.

Look at the silver-colored band inside the fuse. If the band is broken or melted, replace the fuse. Be sure to replace a bad fuse with a new one of the identical size and rating.

There are two fuse blocks in the vehicle: one in the engine compartment and one in the trunk.

There is a fuse puller located on the rear compartment fuse block. See *Rear Compartment Fuse Block on page 9-37*. It can be used to easily remove fuses from the fuse block.

Engine Compartment Fuse Block

The engine compartment fuse block is located in the front left side of the engine compartment. See *Engine Compartment Overview on page 9-6*.

To open the fuse block cover, insert a tool into the latch and turn. Pull up on the cover to remove.

Notice: Spilling liquid on any electrical components on the vehicle may damage it. Always keep the covers on any electrical component.

9-36 Vehicle Service and Care

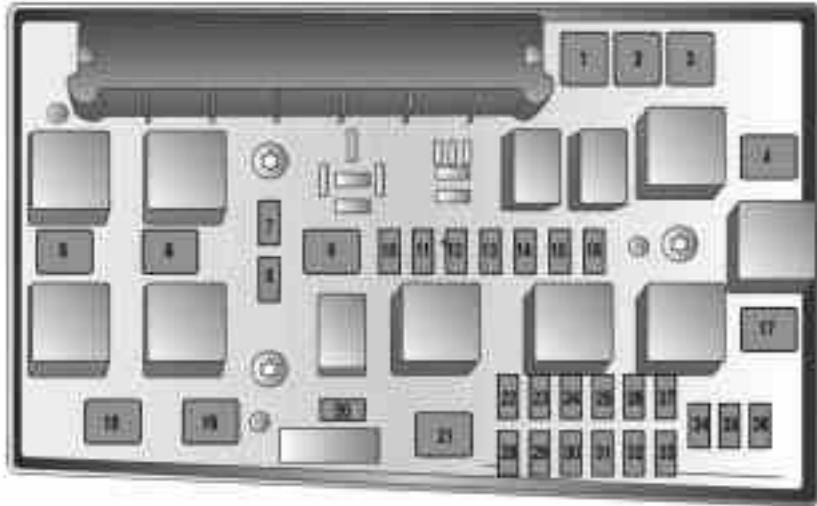

Fuses	Usage
1	Antilock Brake System (ABS) Valves
2	ABS Pump

Fuses	Usage
4	Climate Control System (Ignition)
5	Engine Cooling Fan (AT and AC only)

Fuses	Usage
6	Engine Cooling Fan
7	Windshield & Liftgate Glass Washer Motor

Fuses	Usage
8	Horn
10	Door Locks
13	Foglamps
14	Windshield Wipers (high speed)
15	Windshield Wipers (low speed)
16	Antilock Brake System, Brake Lamp Switch
17	Vacuum Pump
18	Starter
20	Air Conditioning Clutch
21	Engine Control Module (ECM) (Main Relay)
22	ECM (Battery)
24	Fuel Pump/Injectors
26	ECM (Sensor and Actuators)

Fuses	Usage
27	Power Steering
28	Automatic Transmission (Battery)
29	Automatic Transmission (Ignition)
30	ECM (Ignition)
32	Brake Switch
34	Steering Column Module
35	Radio
36	OnStar™ Module/ OnStar™ Interface Module/Display

Rear Compartment Fuse Block

To open the liftgate, See *Liftgate* on page 2-6.

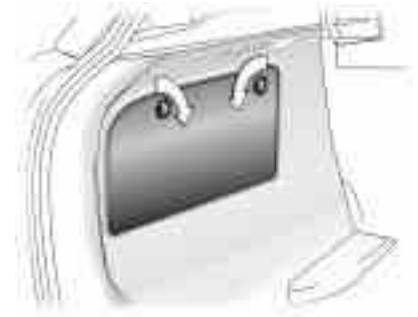

The rear compartment fuse block is located on the left side of the cargo area behind a cover.

Use the fuse puller, to remove and replace fuses.

9-38 Vehicle Service and Care

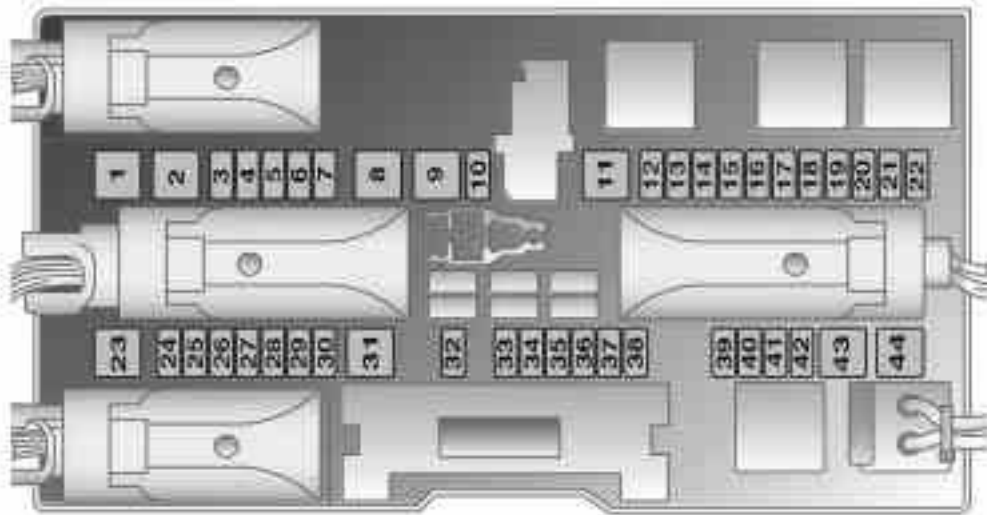

Fuses	Usage
1	Front Power Window
3	Cluster

Fuses	Usage
4	Climate Control System (Battery)
11	Rear Defogger

Fuses	Usage
12	Rear Windshield Wiper
14	Climate Control System (Ignition)

Fuses	Usage
16	Front Passenger Seat Detection Sensor
17	Tire Pressure Monitoring System (TPMS)/Rain Sensor/Inside Rearview Mirror
18	Interior Lights
21	Outside Mirror Heating
22	Sunroof
23	Rear Power Window
24	Diagnostic Link Connector
29	Accessory Power Outlet (APO)
34	Sunroof
38	Door Locks
39	Seat Heating Driver
40	Seat Heating Front Passenger

Tires

Your new vehicle comes with high-quality tires made by a leading tire manufacturer. If you ever have questions about the tire warranty and where to obtain service, see the “Limited Warranty, Maintenance and Owner Assistance Information” manual for details. For additional information refer to the tire manufacturer.

CAUTION

- Poorly maintained and improperly used tires are dangerous.
- Overloading your tires can cause overheating as a result of too much flexing. You could have an air-out and a serious accident. See *Loading the Vehicle on page 8-30*.
- Underinflated tires pose the same danger as overloaded tires. The resulting accident could cause serious injury. Check all tires frequently to maintain the recommended pressure. Tire pressure should be checked when your tires are cold. See *Inflation - Tire Pressure on page 9-47*.

(Continued)

CAUTION (Continued)

- Overinflated tires are more likely to be cut, punctured, or broken by a sudden impact — such as when you hit a pothole. Keep tires at the recommended pressure.
- Worn, old tires can cause accidents. If your tread is badly worn, or if your tires have been damaged, replace them.

See *High-Speed Operation on page 9-48* for inflation pressure adjustment for high speed driving.

Low-Profile Tires

If the vehicle has 225/40ZR18 or 215/45R18 size tires, they are classified as low-profile performance tires. These tires are designed for very responsive driving on wet or dry pavement. You may also notice more road noise with low-profile performance tires and that they tend to wear faster.

Notice: If the vehicle has low-profile tires, they are more susceptible to damage from road hazards or curb impact than standard profile tires. Tire and/or wheel assembly damage can occur when coming into contact with road hazards like, potholes, or sharp edged objects, or when sliding into a curb. The vehicle warranty does not cover this type of damage. Keep tires set to the correct inflation

pressure and, when possible avoid contact with curbs, potholes, and other road hazards.

Winter Tires

If the vehicle has 225/40ZR18 or 215/45R18 size tires, they are classified as low-profile performance tires. These tires are designed for very responsive driving on wet or dry pavement. If you expect to drive on snow or ice covered roads often, you may want to get winter tires for your vehicle. All season tires provide good overall performance on most surfaces but they may not offer the traction you would like or the same level of performance as winter tires on snow or ice covered roads.

Winter tires, in general, are designed for increased traction on snow and ice covered roads.

With winter tires, there may be decreased dry road traction, increased road noise, and shorter tire tread life. After switching to winter tires, be alert for changes in vehicle handling and braking.

See your dealer/retailer for details regarding winter tire availability and proper tire selection. Also, see *Buying New Tires on page 9-54*.

If you choose to use winter tires:

- Use tires of the same brand and tread type on all four wheel positions.
- Use only radial ply tires of the same size, load range, and speed rating as your original equipment tires.

Winter tires with the same speed rating as the original equipment tires may not be available for H, V, W, Y and ZR speed rated tires. If you choose winter tires with a lower speed rating, never exceed the tire's maximum speed capability.

Tire Sidewall Labeling

Useful information about a tire is molded into its sidewall.

The examples below show a typical passenger vehicle tire and a compact spare tire sidewall.

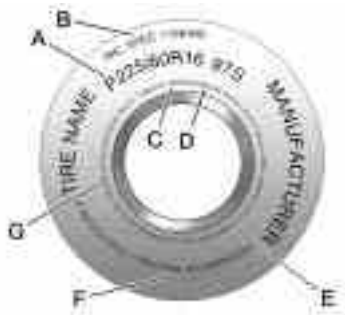

Passenger (P-Metric) Tire Example

(A) Tire Size: The tire size is a combination of letters and numbers used to define a particular tire's width, height, aspect ratio, construction type, and service description.

See the "Tire Size" illustration later in this section for more detail.

(B) TPC Spec (Tire Performance Criteria Specification):

Original equipment tires designed to GM's specific tire performance criteria have a TPC specification code molded onto the sidewall. GM's TPC specifications meet or exceed all federal safety guidelines.

(C) DOT (Department of Transportation):

The Department of Transportation (DOT) code indicates that the tire is in compliance with the U.S. Department of Transportation Motor Vehicle Safety Standards.

(D) Tire Identification Number (TIN):

The letters and numbers following DOT (Department of Transportation) code is the Tire Identification Number (TIN).

The TIN shows the manufacturer and plant code, tire size, and date the tire was manufactured. The TIN is molded onto both sides of the tire, although only one side may have the date of manufacture.

(E) Tire Ply Material: The type of cord and number of plies in the sidewall and under the tread.

(F) Uniform Tire Quality Grading (UTQG):

Tire manufacturers are required to grade tires based on three performance factors: treadwear, traction, and temperature resistance. For more information see *Uniform Tire Quality Grading on page 9-57*.

(G) Maximum Cold Inflation Load Limit:

Maximum load that can be carried and the maximum pressure needed to support that load.

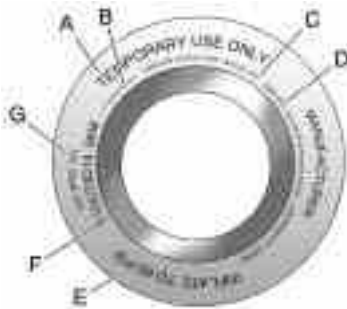

Compact Spare Tire Example

(A) Tire Ply Material: The type of cord and number of plies in the sidewall and under the tread.

(B) Temporary Use Only: The compact spare tire or temporary use tire has a tread life of approximately 3,000 miles (5 000 km) and should not be driven at speeds over 50 mph (80 km/h). The compact spare tire is for emergency use when a regular road tire has lost air and gone flat. If your vehicle has a compact spare tire.

See *Compact Spare Tire* on page 9-68 and *If a Tire Goes Flat* on page 9-60.

(C) Tire Identification Number (TIN): The letters and numbers following the DOT (Department of Transportation) code is the Tire Identification Number (TIN). The TIN shows the manufacturer and plant code, tire size, and date the tire was manufactured. The TIN is molded onto both sides of the tire, although only one side may have the date of manufacture.

(D) Maximum Cold Inflation Load Limit: Maximum load that can be carried and the maximum pressure needed to support that load.

(E) Tire Inflation: The temporary use tire or compact spare tire should be inflated to 60 psi (420 kPa). For more information on tire pressure and inflation see *Inflation - Tire Pressure* on page 9-47.

(F) Tire Size : A combination of letters and numbers define a tire's width, height, aspect ratio, construction type, and service description. The letter T as the first character in the tire size means the tire is for temporary use only.

(G) TPC Spec (Tire Performance Criteria Specification): Original equipment tires designed to GM's specific tire performance criteria have a TPC specification code molded onto the sidewall. GM's TPC specifications meet or exceed all federal safety guidelines.

Tire Size

The following illustration shows an example of a typical passenger vehicle tire size.

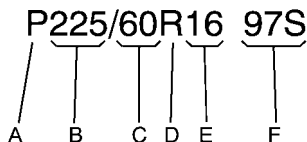

(A) Passenger (P-Metric) Tire:

The United States version of a metric tire sizing system. The letter P as the first character in the tire size means a passenger vehicle tire engineered to standards set by the U.S. Tire and Rim Association.

(B) Tire Width: The three-digit number indicates the tire section width in millimeters from sidewall to sidewall.

(C) Aspect Ratio: A two-digit number that indicates the tire height-to-width measurements.

For example, if the tire size aspect ratio is 60, as shown in item C of the illustration, it would mean that the tire's sidewall is 60 percent as high as it is wide.

(D) Construction Code: A letter code is used to indicate the type of ply construction in the tire. The letter R means radial ply construction; the letter D means diagonal or bias ply construction; and the letter B means belted-bias ply construction.

(E) Rim Diameter: Diameter of the wheel in inches.

(F) Service Description: These characters represent the load index and speed rating of the tire. The load index represents the load carry capacity a tire is certified to carry. The speed rating is the maximum speed a tire is certified to carry a load.

Tire Terminology and Definitions

Air Pressure: The amount of air inside the tire pressing outward on each square inch of the tire. Air pressure is expressed in pounds per square inch (psi) or kilopascal (kPa).

Accessory Weight: This means the combined weight of optional accessories. Some examples of optional accessories are, automatic transmission, power steering, power brakes, power windows, power seats, and air conditioning.

Aspect Ratio: The relationship of a tire's height to its width.

Belt: A rubber coated layer of cords that is located between the plies and the tread. Cords may be made from steel or other reinforcing materials.

Bead: The tire bead contains steel wires wrapped by steel cords that hold the tire onto the rim.

Bias Ply Tire: A pneumatic tire in which the plies are laid at alternate angles less than 90 degrees to the centerline of the tread.

Cold Tire Pressure: The amount of air pressure in a tire, measured in pounds per square inch (psi) or kilopascals (kPa) before a tire has built up heat from driving. See *Inflation - Tire Pressure* on page 9-47.

Curb Weight: The weight of a motor vehicle with standard and optional equipment including the maximum capacity of fuel, oil, and coolant, but without passengers and cargo.

DOT Markings: A code molded into the sidewall of a tire signifying that the tire is in compliance with the U.S. Department of Transportation (DOT) motor vehicle safety standards. The DOT code includes the Tire Identification Number (TIN), an alphanumeric designator which can also identify the tire manufacturer, production plant, brand, and date of production.

GVWR: Gross Vehicle Weight Rating. See *Loading the Vehicle* on page 8-30.

GAWR FRT: Gross Axle Weight Rating for the front axle. See *Loading the Vehicle* on page 8-30.

GAWR RR: Gross Axle Weight Rating for the rear axle. See *Loading the Vehicle* on page 8-30.

Intended Outboard Sidewall: The side of an asymmetrical tire, that must always face outward when mounted on a vehicle.

Kilopascal (kPa): The metric unit for air pressure.

Light Truck (LT-Metric) Tire: A tire used on light duty trucks and some multipurpose passenger vehicles.

Load Index: An assigned number ranging from 1 to 279 that corresponds to the load carrying capacity of a tire.

Maximum Inflation Pressure: The maximum air pressure to which a cold tire can be inflated. The maximum air pressure is molded onto the sidewall.

Maximum Load Rating: The load rating for a tire at the maximum permissible inflation pressure for that tire.

Maximum Loaded Vehicle

Weight: The sum of curb weight, accessory weight, vehicle capacity weight, and production options weight.

Normal Occupant Weight:

The number of occupants a vehicle is designed to seat multiplied by 150 lbs (68 kg). See *Loading the Vehicle on page 8-30*.

Occupant Distribution:

Designated seating positions.

Outward Facing Sidewall:

The side of an asymmetrical tire that has a particular side that faces outward when mounted on a vehicle. The side of the tire that contains a whitewall, bears white lettering, or bears manufacturer, brand, and/or model name molding that is higher or deeper than the same moldings on the other sidewall of the tire.

Passenger (P-Metric) Tire:

A tire used on passenger cars and some light duty trucks and multipurpose vehicles.

Recommended Inflation

Pressure: Vehicle manufacturer's recommended tire inflation pressure as shown on the tire placard. See *Inflation - Tire Pressure on page 9-47* and *Loading the Vehicle on page 8-30*.

Radial Ply Tire: A pneumatic tire in which the ply cords that extend to the beads are laid at 90 degrees to the centerline of the tread.

Rim: A metal support for a tire and upon which the tire beads are seated.

Sidewall: The portion of a tire between the tread and the bead.

Speed Rating: An alphanumeric code assigned to a tire indicating the maximum speed at which a tire can operate.

Traction: The friction between the tire and the road surface. The amount of grip provided.

Tread: The portion of a tire that comes into contact with the road.

Treadwear Indicators: Narrow bands, sometimes called wear bars, that show across the tread of a tire when only 1/16 inch (1.6 mm) of tread remains. See *When It Is Time for New Tires on page 9-54*.

UTQGS (Uniform Tire Quality Grading Standards):

A tire information system that provides consumers with ratings for a tire's traction, temperature, and treadwear. Ratings are determined by tire manufacturers using government testing procedures. The ratings are molded into the sidewall of the tire. See *Uniform Tire Quality Grading on page 9-57*.

Vehicle Capacity Weight:

The number of designated seating positions multiplied by 150 lbs (68 kg) plus the rated cargo load. See *Loading the Vehicle on page 8-30*.

Vehicle Maximum Load on the Tire: Load on an individual tire due to curb weight, accessory weight, occupant weight, and cargo weight.

Vehicle Placard: A label permanently attached to a vehicle showing the vehicle's capacity weight and the original equipment tire size and recommended inflation pressure. See "Tire and Loading Information Label" under *Loading the Vehicle on page 8-30*.

Inflation - Tire Pressure

Tires need the correct amount of air pressure to operate effectively.

Notice: Do not let anyone tell you that under-inflation or over-inflation is all right. It is not. If your tires do not have enough air (under-inflation), you can get the following:

- Too much flexing
- Too much heat
- Tire overloading
- Premature or irregular wear
- Poor handling
- Reduced fuel economy

If your tires have too much air (over-inflation), you can get the following:

- Unusual wear
- Poor handling
- Rough ride
- Needless damage from road hazards

A vehicle specific Tire and Loading Information label is attached to your vehicle. This label shows your vehicle's original equipment tires and the correct inflation pressures for your tires when they are cold. The recommended cold tire inflation pressure, shown on the label, is the minimum amount of air pressure needed to support your vehicle's maximum load carrying capacity.

For additional information regarding how much weight your vehicle can carry, and an example of the Tire and Loading Information label, see *Loading the Vehicle on page 8-30*. How you load your vehicle affects vehicle handling and ride comfort. Never load your vehicle with more weight than it was designed to carry.

When to Check

Check your tires once a month or more. Do not forget to check the compact spare tire, it should be at 60 psi (420 kPa). For additional information regarding the compact spare tire, see *Compact Spare Tire* on page 9-68.

How to Check

Use a good quality pocket-type gage to check tire pressure. You cannot tell if your tires are properly inflated simply by looking at them. Radial tires may look properly inflated even when they are under-inflated. Check the tire's inflation pressure when the tires are cold. Cold means your vehicle has been sitting for at least three hours or driven no more than 1 mile (1.6 km).

Remove the valve cap from the tire valve stem. Press the tire gage firmly onto the valve to get a pressure measurement. If the cold tire inflation pressure matches the recommended pressure on the Tire and Loading Information label, no further adjustment is necessary. If the inflation pressure is low, add air until you reach the recommended amount.

If you overfill the tire, release air by pushing on the metal stem in the center of the tire valve. Re-check the tire pressure with the tire gage.

Be sure to put the valve caps back on the valve stems. They help prevent leaks by keeping out dirt and moisture.

High-Speed Operation



Driving at high speeds, 100 mph (160 km/h) or higher, puts an additional strain on tires. Sustained high-speed driving causes excessive heat build up and can cause sudden tire failure. You could have a crash and you or others could be killed. Some high-speed rated tires require inflation pressure adjustment for high speed operation. When speed limits and road conditions are such that a vehicle can be driven at high speeds, make sure the tires are rated for high speed operation, in excellent condition, and set to the correct cold tire inflation pressure for the vehicle load.

If the vehicle has P205/55R16 size tires, additional air pressure is required when driving the vehicle at speeds of 99 mph (158 km/h) or higher. Set the cold tire inflation pressure to the maximum inflation pressure shown on the tire sidewall, or 32 psi (220 kPa), whichever is lower. See the example following.

Example:

The maximum load and inflation pressure is molded on the tire's sidewall, in small letters, near the rim flange. It reads something like this: Maximum load 710 kg (1565 lbs) 350 kPa (51 psi) Max. Press.

For this example, the cold tire inflation pressure for high-speed driving should be set at 32 psi (220 kPa).

When high-speed driving ends, return the tire pressure to the recommended cold inflation pressure shown on the Tire and Loading Information label.

See *Loading the Vehicle on page 8-30*. Tire pressure should be checked and correctly set when the tires are cold. See *Inflation - Tire Pressure on page 9-47*.

Tire Pressure Monitor System

The Tire Pressure Monitor System (TPMS) uses radio and sensor technology to check tire pressure levels. The TPMS sensors monitor the air pressure in your vehicle's tires and transmit tire pressure readings to a receiver located in the vehicle.

Each tire, including the spare (if provided), should be checked monthly when cold and inflated to the inflation pressure recommended by the vehicle manufacturer on the vehicle placard or tire inflation pressure label. (If your vehicle has tires of a different size than the size indicated on the vehicle placard or tire inflation pressure label, you should determine the proper tire inflation pressure for those tires.)

As an added safety feature, your vehicle has been equipped with a tire pressure monitoring system (TPMS) that illuminates a low tire pressure telltale when one or more of your tires is significantly under-inflated.

Accordingly, when the low tire pressure telltale illuminates, you should stop and check your tires as soon as possible, and inflate them to the proper pressure. Driving on a significantly under-inflated tire causes the tire to overheat and can lead to tire failure. Under-inflation also reduces fuel efficiency and tire tread life, and may affect the vehicle's handling and stopping ability.

Please note that the TPMS is not a substitute for proper tire maintenance, and it is the driver's responsibility to maintain correct tire pressure, even if under-inflation has not reached the level to trigger illumination of the TPMS low tire pressure telltale.

9-50 Vehicle Service and Care

Your vehicle has also been equipped with a TPMS malfunction indicator to indicate when the system is not operating properly. The TPMS malfunction indicator is combined with the low tire pressure telltale. When the system detects a malfunction, the telltale will flash for approximately one minute and then remain continuously illuminated. This sequence will continue upon subsequent vehicle start-ups as long as the malfunction exists.

When the malfunction indicator is illuminated, the system may not be able to detect or signal low tire pressure as intended. TPMS malfunctions may occur for a variety of reasons, including the installation of replacement or alternate tires or wheels on the vehicle that prevent the TPMS from functioning properly. Always check the TPMS malfunction telltale after replacing

one or more tires or wheels on your vehicle to ensure that the replacement or alternate tires and wheels allow the TPMS to continue to function properly.

See *Tire Pressure Monitor Operation on page 9-51* for additional information.

Federal Communications Commission (FCC) and Industry and Science Canada

The Tire Pressure Monitor System (TPMS) operates on a radio frequency and complies with Part 15 of the FCC Rules. Operation is subject to the following two conditions:

1. This device may not cause harmful interference.
2. This device must accept any interference received, including interference that may cause undesired operation.

The TPMS operates on a radio frequency and complies with RSS-210 of Industry and Science Canada. Operation is subject to the following two conditions:

1. This device may not cause interference.
2. This device must accept any interference received, including interference that may cause undesired operation of the device.

Changes or modifications to this system by other than an authorized service facility could void authorization to use this equipment.

Tire Pressure Monitor Operation

This vehicle may have a Tire Pressure Monitor System (TPMS). The TPMS is designed to warn the driver when a low tire pressure condition exists. TPMS sensors are mounted onto each tire and wheel assembly, excluding the spare tire. The TPMS sensors monitor the air pressure in the vehicle's tires and transmit tire pressure readings to a receiver located in the vehicle.



When a low tire pressure condition is detected, the TPMS illuminates the low tire pressure warning light located in the instrument panel cluster.

The low tire pressure warning light comes on at each ignition cycle until the tires are inflated to the correct inflation pressure.

The low tire pressure warning light may come on in cool weather when the vehicle is first started, and then turn off as you start to drive. This could be an early indicator that the air pressure in the tire(s) are getting low and need to be inflated to the proper pressure.

You must begin driving before the TPMS system is operational. TPMS sensors need to be installed onto the full-size tire and wheel assemblies, and the tires adjusted to the manufacturers' recommended tire pressure amount.

A Tire and Load Information label is attached to the vehicle, and shows the size of the vehicle's original equipment tires and the correct inflation pressure for the tires when they are cold. See *Loading the Vehicle on page 8-30*, for an example of the Tire and

Load Information label and its location on the vehicle. Also see *Inflation - Tire Pressure on page 9-47*.

The vehicle's TPMS can warn you about a low tire pressure condition but it does not replace normal tire maintenance. See *Tire Inspection and Rotation on page 9-52* and *Tires on page 9-40*.

Notice: Liquid tire sealants could damage the Tire Pressure Monitor System (TPMS) sensors. Sensor damage caused by using a tire sealant is not covered by your warranty. Do not use liquid tire sealants.

Each TPMS sensor has a unique identification code. Any time you replace one or more of the TPMS sensors or rotate the vehicle's tires, the identification codes are automatically learned by the TPMS. This occurs within a few moments of driving the vehicle over 19 mph (31 km/h).

TPMS Malfunction Light

The TPMS will not function properly if one or more of the TPMS sensors are missing or inoperable. When the system detects a malfunction, the low tire warning light flashes for about one minute and then stays on for the remainder of the ignition cycle. Some of the conditions that can cause the malfunction light to come on are:

- One of the road tires has been replaced with the spare tire. The spare tire does not have a TPMS sensor. The TPMS malfunction light and DIC message should go off once you re-install the road tire containing the TPMS sensor.
- One or more TPMS sensors are missing or damaged. The TPMS malfunction light should go off after the TPMS sensors are installed and the vehicle is driven for a few moments over 19 mph (31 km/h). See your dealer/retailer for service.

- Replacement tires or wheels do not match the vehicle's original equipment tires or wheels. Tires and wheels other than those recommended for the vehicle could prevent the TPMS from functioning properly. See *Buying New Tires on page 9-54*.
- Operating electronic devices or being near facilities using radio wave frequencies similar to the TPMS could cause the TPMS sensors to malfunction.

If the TPMS is not functioning it cannot detect or signal a low tire condition. See your dealer/retailer for service if the TPMS malfunction light comes on and stays on.

Tire Inspection and Rotation

Inspect tires regularly for signs of wear or damage. Also inspect the spare tire. For more information on tire inspection, see *When It Is Time for New Tires on page 9-54*.

Rotating vehicle tires helps them to wear evenly and keeps the vehicle performing like it did when tires were new.

Rotate the tires and check wheel alignment approximately every 5,000 to 8,000 miles (8 000 to 13 000 km) or when unusual tire wear is noted. See "Scheduled Maintenance" in the Index of the "Limited Warranty, Maintenance and Owner Assistance Information" manual for more information. Also check the wheels for damage, see *Wheel Replacement on page 9-59* for more information.

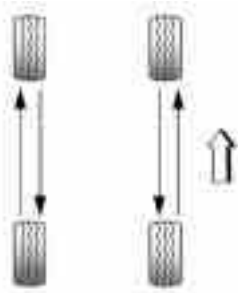

Use this pattern when rotating the vehicle tires. Do not include the compact spare tire in the tire rotation.

⚠ CAUTION

Rust or dirt on a wheel, or on the parts to which it is fastened, can make wheel bolts become loose after time.

(Continued)

CAUTION (Continued)

The wheel could come off and cause a crash. When you change a wheel, remove any rust or dirt from places where the wheel attaches to the vehicle using a scraper or wire brush.

Installing wheels with a good metal-to-metal contact at the mounting surfaces is necessary to prevent wheel bolts from becoming loose.

To prevent corrosion or rust build-up, lightly coat the wheel hub center and the cone-shaped surface of each wheel bolt with wheel bearing grease, after a wheel change.

See *Changing a Flat Tire* on page 9-61 for information on installing the tire and wheel assembly. Also see “Wheel Bolt Torque” under *Capacities and Specifications* on page 10-2.

Adjust the front and rear tires to the recommended cold tire inflation pressure shown on the Tire and Loading Information label. See *Inflation - Tire Pressure* on page 9-47 and *Loading the Vehicle* on page 8-30.

When It Is Time for New Tires

Various factors, such as maintenance, temperatures, driving speeds, vehicle loading, and road conditions influence when you need new tires.

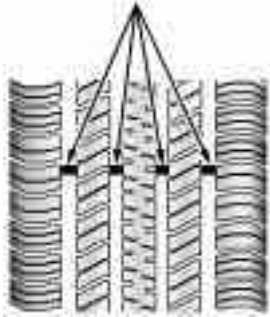

One way to tell when it is time for new tires is to check the treadwear indicators, which will appear when the tires have only 1/16 inch (1.6 mm) or less of tread remaining.

You need new tires if any of the following statements are true:

- You can see the indicators at three or more places around the tire.
- You can see cord or fabric showing through the tire's rubber.
- The tread or sidewall is cracked, cut, or snagged deep enough to show cord or fabric.
- The tire has a bump, bulge, or split.
- The tire has a puncture, cut, or other damage that cannot be repaired well because of the size or location of the damage.

The rubber in tires degrades over time, even if they are not being used. This is also true for the spare tire, if the vehicle has one. Multiple conditions affect how fast this aging takes place, including temperatures, loading conditions, and inflation pressure maintenance.

With proper care and maintenance tires typically wear out before they degrade due to age. If you are unsure about the need to replace the tires as they get older, consult the tire manufacturer for more information.

Buying New Tires

GM has developed and matched specific tires for your vehicle. The original equipment tires installed on your vehicle, when it was new, were designed to meet General Motors Tire Performance Criteria Specification (TPC Spec) system rating. If you need replacement tires, GM strongly recommends that you get tires with the same TPC Spec rating. This way, your vehicle will continue to have tires that are designed to give the same performance and vehicle safety, during normal use, as the original tires.

GM's exclusive TPC Spec system considers over a dozen critical specifications that impact the overall performance of your vehicle, including brake system performance, ride and handling, traction control, and tire pressure monitoring performance. GM's TPC Spec number is molded onto the tire's sidewall near the tire size. If the tires have an all-season tread design, the TPC Spec number will be followed by an MS for mud and snow. See *Tire Sidewall Labeling* on page 9-42 for additional information.

GM recommends replacing tires in sets of four. This is because uniform tread depth on all tires will help keep your vehicle performing most like it did when the tires were new. Replacing less than a full set of tires can affect the braking and handling performance of your vehicle. See *Tire Inspection and Rotation* on page 9-52 for information on proper tire rotation.

 **CAUTION**

Mixing tires could cause you to lose control while driving. If you mix tires of different sizes, brands, or types (radial and bias-belted tires), the vehicle may not handle properly, and you could have a crash. Using tires of different sizes, brands, or types may also cause damage to the vehicle. Be sure to use the correct size, brand, and type of tires on all wheels. It is all right to drive with the compact spare temporarily, as it was developed for use on the vehicle. See *Compact Spare Tire* on page 9-68.

 **CAUTION**

If you use bias-ply tires on the vehicle, the wheel rim flanges could develop cracks after many miles of driving. A tire and/or wheel could fail suddenly, causing a crash. Use only radial-ply tires with the wheels on the vehicle.

If you must replace your vehicle's tires with those that do not have a TPC Spec number, make sure they are the same size, load range, speed rating, and construction type (radial and bias-belted tires) as your vehicle's original tires.

Vehicles that have a tire pressure monitoring system could give an inaccurate low-pressure warning if non-TPC Spec rated tires are installed on your vehicle. Non-TPC Spec rated tires may give a low-pressure warning that is higher or lower than the proper warning level you would get with TPC Spec rated tires. See *Tire Pressure Monitor System on page 9-49*.

Your vehicle's original equipment tires are listed on the Tire and Loading Information Label. See *Loading the Vehicle on page 8-30*, for more information about the Tire and Loading Information Label and its location on your vehicle.

Different Size Tires and Wheels

If you add wheels or tires that are a different size than your original equipment wheels and tires, this may affect the way your vehicle performs, including its braking, ride and handling characteristics, stability, and resistance to rollover. Additionally, if your vehicle has electronic systems such as, anti-lock brakes, traction control, and stability control, the performance of these systems can be affected.



If you add different sized wheels, your vehicle may not provide an acceptable level of performance and safety if tires not recommended for those wheels are selected. You may increase the chance that you will crash and suffer serious injury. Only use Saturn specific wheel and tire systems developed for your vehicle, and have them properly installed by a Saturn certified technician.

See *Buying New Tires on page 9-54* and *Accessories and Modifications on page 9-3* for additional information.

Uniform Tire Quality Grading

Quality grades can be found where applicable on the tire sidewall between tread shoulder and maximum section width. For example:

Treadwear 200 Traction AA Temperature A

The following information relates to the system developed by the United States National Highway Traffic Safety Administration (NHTSA), which grades tires by treadwear, traction, and temperature performance. This applies only to vehicles sold in the United States. The grades are molded on the sidewalls of most passenger car tires. The Uniform Tire Quality Grading (UTQG) system does not apply to deep tread,

winter-type snow tires, space-saver, or temporary use spare tires, tires with nominal rim diameters of 10 to 12 inches (25 to 30 cm), or to some limited-production tires.

While the tires available on General Motors passenger cars and light trucks may vary with respect to these grades, they must also conform to federal safety requirements and additional General Motors Tire Performance Criteria (TPC) standards.

Treadwear

The treadwear grade is a comparative rating based on the wear rate of the tire when tested under controlled conditions on a specified government test course.

For example, a tire graded 150 would wear one and a half (1.5) times as well on the government course as a tire graded 100. The relative performance of tires depends upon the actual conditions of their use, however, and may depart significantly from the norm due to variations in driving habits, service practices, and differences in road characteristics and climate.

Traction – AA, A, B, C

The traction grades, from highest to lowest, are AA, A, B, and C. Those grades represent the tire's ability to stop on wet pavement as measured under controlled conditions on specified government test surfaces of asphalt and concrete. A tire marked C may have poor traction performance.

Temperature – A, B, C

The temperature grades are A (the highest), B, and C, representing the tire's resistance to the generation of heat and its ability to dissipate heat when tested under controlled conditions on a specified indoor laboratory test wheel. Sustained high temperature can cause the material of the tire to degenerate and reduce tire life, and excessive temperature can lead to sudden tire failure. The grade C corresponds to a level of performance which all passenger car tires must meet under the Federal Motor Vehicle Safety Standard No. 109. Grades B and A represent higher levels of performance on the laboratory test wheel than the minimum required by law. It should be

noted that the temperature grade for this tire is established for a tire that is properly inflated and not overloaded. Excessive speed, underinflation, or excessive loading, either separately or in combination, can cause heat buildup and possible tire failure.

WARNING

The temperature grade for this tire is established for a tire that is properly inflated and not overloaded. Excessive speed, underinflation, or excessive loading, either separately or in combination, can cause heat buildup and possible tire failure.

Wheel Alignment and Tire Balance

The tires and wheels on your vehicle were aligned and balanced carefully at the factory to give you the longest tire life and best overall performance. Adjustments to wheel alignment and tire balancing will not be necessary on a regular basis. However, if you notice unusual tire wear or your vehicle pulling to one side or the other, the alignment might need to be checked. If you notice your vehicle vibrating when driving on a smooth road, the tires and wheels might need to be rebalanced. See your dealer/retailer for proper diagnosis.

Wheel Replacement

Replace any wheel that is bent, cracked or badly rusted or corroded. If the wheel bolts keep coming loose, the wheel and wheel bolts should be replaced. If the wheel leaks air, replace it (except some aluminum wheels, which can sometimes be repaired). See your dealer/retailer if any of these conditions exist.

Your dealer/retailer will know the kind of wheel you need.

Each new wheel should have the same load-carrying capacity, diameter, width, offset and be mounted the same way as the one it replaces.

If you need to replace any of the wheels or wheel bolts, replace them only with new GM original equipment parts. This way, you will be sure to have the right wheel and wheel bolts for the vehicle.

CAUTION

Using the wrong replacement wheels or wheel bolts on your vehicle can be dangerous. It could affect the braking and handling of the vehicle, make the tires lose air and make you lose control of the vehicle. You could have a collision in which you or others could be injured. Always use the correct wheel and wheel bolts for replacement.

Notice: The wrong wheel can also cause problems with bearing life, brake cooling, speedometer or odometer calibration, headlamp aim, bumper height, vehicle ground clearance, and tire or tire chain clearance to the body and chassis.

See *Changing a Flat Tire* on page 9-61 for more information.

Used Replacement Wheels

CAUTION

Putting a used wheel on the vehicle is dangerous. You cannot know how it has been used or how far it has been driven. It could fail suddenly and cause a crash. If you have to replace a wheel, use a new GM original equipment wheel.

Tire Chains

CAUTION

Do not use tire chains. There is not enough clearance. Tire chains used on a vehicle without the proper amount of clearance can cause damage to the brakes, suspension or other vehicle parts. The area damaged by the tire chains could cause you to lose control of the vehicle and you or others may be injured in a crash.

Use another type of traction device only if its manufacturer recommends it for use on the vehicle and tire size combination and road conditions. Follow that manufacturer's instructions. To help avoid damage to the vehicle, drive slowly, readjust or remove the device if it is contacting the vehicle, and do not spin the vehicle's wheels. If you do find traction devices that will fit, install them on the front tires.

Tire Changing

If a Tire Goes Flat

It is unusual for a tire to blowout while you are driving, especially if you maintain your vehicle's tires properly. If air goes out of a tire, it is much more likely to leak out slowly. But if you should ever have a blowout, here are a few tips about what to expect and what to do:

If a front tire fails, the flat tire creates a drag that pulls the vehicle toward that side. Take your foot off the accelerator pedal and grip the steering wheel firmly. Steer to maintain lane position, and then gently brake to a stop well out of the traffic lane.

A rear blowout, particularly on a curve, acts much like a skid and may require the same correction you would use in a skid. In any rear blowout remove your foot from the accelerator pedal. Get the vehicle under control by steering the way you want the vehicle to go.

It may be very bumpy and noisy, but you can still steer. Gently brake to a stop, well off the road if possible.

CAUTION

Lifting a vehicle and getting under it to do maintenance or repairs is dangerous without the appropriate safety equipment and training. If a jack is provided with the vehicle, it is designed only for changing a flat tire. If it is used for anything else, you or others could be badly injured or killed if the vehicle slips off the jack. If a jack is provided with the vehicle, only use it for changing a flat tire.

If a tire goes flat, the next part shows how to use the jacking equipment to change a flat tire safely.

Changing a Flat Tire

If a tire goes flat, avoid further tire and wheel damage by driving slowly to a level place. Turn on the hazard warning flashers. See *Hazard Warning Flashers on page 4-4*.

CAUTION

Changing a tire can be dangerous. The vehicle can slip off the jack and roll over or fall on you or other people. You and they could be badly injured or even killed.

(Continued)

CAUTION (Continued)

Find a level place to change your tire. To help prevent the vehicle from moving:

1. Set the parking brake firmly.
2. Put an automatic transmission shift lever in P (Park), or shift a manual transmission to 1 (First) or R (Reverse).
3. Turn off the engine and do not restart while the vehicle is raised.
4. Do not allow passengers to remain in the vehicle.

To be certain the vehicle will not move, put blocks at the front and rear of the tire farthest away from the one being changed. That would be the tire on the other side, at the opposite end of the vehicle.

When the vehicle has a flat tire (B), use the following example as a guide to assist you in the placement of wheel blocks (A).



- A. Wheel Block
- B. Flat Tire

The following information explains how to use the jack and change a tire.

Removing the Spare Tire and Tools

The equipment you will need is located in the rear storage area.

1. Open the liftgate. See *Liftgate* on page 2-6.



2. Lift the floor cover to access the spare tire and tools.



3. Remove the foam pad. Turn the retainer counterclockwise to remove it.
4. Remove the spare tire by pulling it up and out of the trunk.

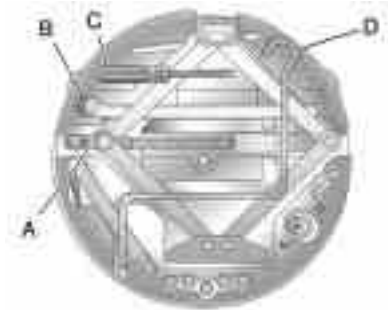

5. The jack and tools are stored below the spare tire.
6. The tools you will be using include the jack (A), wheel wrench (B), screwdriver (C), and jack handle (D).

Removing the Flat Tire and Installing the Spare Tire

1. If your vehicle has wheel covers, remove the cover.

Do not try to put a wheel cover on your compact spare tire. It will not fit. Store the wheel cover in the trunk until you have the flat tire repaired or replaced.

Notice: Wheel covers will not fit on your vehicle's compact spare. If you try to put a wheel cover on the compact spare, the cover or the spare could be damaged.

2. If your vehicle has wheel bolt caps, remove the caps. Store the caps with the wheel cover.



3. Use the wheel wrench to loosen all the wheel bolts. Do not remove them yet.

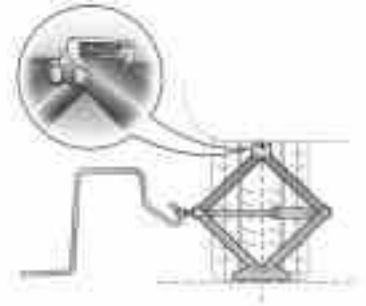

Notice: Make sure that the jack lift head is in the correct position or you may damage your vehicle. The repairs would not be covered by your warranty.

9-64 Vehicle Service and Care



4. Position the jack lift head at the jack location nearest the flat tire. The location is indicated by a mark on the bottom edge of the vehicle.
5. Put the compact spare tire near you.

CAUTION

Getting under a vehicle when it is jacked up is dangerous. If the vehicle slips off the jack, you could be badly injured or killed. Never get under a vehicle when it is supported only by a jack.

CAUTION

Raising your vehicle with the jack improperly positioned can damage the vehicle and even make the vehicle fall. To help avoid personal injury and vehicle damage, be sure to fit the jack lift head into the proper location before raising the vehicle.



6. Raise the vehicle by turning the jack handle clockwise. Raise the vehicle far enough off the ground so there is enough room for the compact spare tire to fit under the vehicle.
7. Remove all of the wheel bolts.

⚠ CAUTION

Rust or dirt on a wheel, or on the parts to which it is fastened, can make wheel bolts become loose after time. The wheel could come off and cause an accident. When you change a wheel, remove any rust or dirt from places where the wheel attaches to the vehicle. In an emergency, you can use a cloth or a paper towel to do this; but be sure to use a scraper or wire brush later, if needed, to get all the rust or dirt off. See *Changing a Flat Tire* on page 9-61.



8. Remove any rust or dirt from the wheel bolts, mounting surfaces and spare wheel.

Installing wheels with a good metal-to-metal contact at the mounting surface is necessary to prevent the wheel bolts from becoming loose.

To prevent corrosion or rust build-up, apply a light coat of wheel bearing grease to the wheel hub center and to the cone-shaped surface of each wheel bolt at every wheel change.

9. Place the compact spare tire on the wheel-mounting surface.



10. Reinstall the wheel bolts with the rounded end of the bolts toward the wheel. Tighten each bolt by hand until the wheel is held against the hub.
11. Lower the vehicle by turning the jack handle counterclockwise. Lower the jack completely.

9-66 Vehicle Service and Care

12. Tighten the wheel bolts firmly in a crisscross sequence, as shown.



CAUTION

Wheel nuts that are improperly or incorrectly tightened can cause the wheels to become loose or come off. The wheel nuts should be tightened with a torque wrench

(Continued)

CAUTION (Continued)

to the proper torque specification after replacing. Follow the torque specification supplied by the aftermarket manufacturer when using accessory locking wheel nuts. See *Capacities and Specifications on page 10-2* for original equipment wheel nut torque specifications.

Notice: Improperly tightened wheel nuts can lead to brake pulsation and rotor damage. To avoid expensive brake repairs, evenly tighten the wheel nuts in the proper sequence and to the proper torque specification. See *Capacities and Specifications on page 10-2* for the wheel nut torque specification.

Storing a Flat or Spare Tire and Tools

CAUTION

Storing a jack, a tire, or other equipment in the passenger compartment of the vehicle could cause injury. In a sudden stop or collision, loose equipment could strike someone. Store all these in the proper place.

To store a flat or spare tire and tools, do the following:

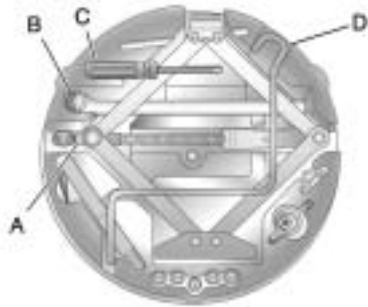

- A. Jack
- B. Wheel Wrench
- C. Screwdriver
- D. Jack Handle

1. Replace the jack and tools as shown.



- 2. Place the flat tire face down into the spare tire hub.
- 3. Turn spare tire hold-down bolt by turning clockwise. Return the foam pad to its original position.



4. Put the load floor back in place.

The compact spare tire is for temporary use only. Replace the compact spare with a full-size tire as soon as possible.

Compact Spare Tire

 **CAUTION**

Driving with more than one compact spare tire at a time could result in loss of braking and handling. This could lead to a crash and you or others could be injured. Use only one compact spare tire at a time.

Although the compact spare tire was fully inflated when the vehicle was new, it can lose air after a time. Check the inflation pressure regularly. It should be 60 psi (420 kPa).

After installing the compact spare on the vehicle, stop as soon as possible and make sure the spare tire is correctly inflated. The compact spare is made to perform well at speeds up to 65 mph (105 km/h) for distances up to 3,000 miles (5 000 km), so you can finish your trip and have the full-size tire repaired or replaced at your convenience. Of course, it is best to replace the spare with a full-size tire as soon as possible. The spare tire will last longer and be in good shape in case it is needed again.

Notice: When the compact spare is installed, do not take the vehicle through an automatic car wash with guide rails. The compact spare can get caught on the rails which can damage the tire, wheel and other parts of the vehicle.

Do not use the compact spare on other vehicles.

And do not mix the compact spare tire or wheel with other wheels or tires. They will not fit. Keep the spare tire and its wheel together.

Notice: Tire chains will not fit the compact spare. Using them can damage the vehicle and can damage the chains too. Do not use tire chains on the compact spare.

Jump Starting

If your battery has run down, try to use another vehicle and some jumper cables to start your vehicle. Be sure to use the following steps to do it safely.

CAUTION

Batteries can hurt you. They can be dangerous because:

- They contain acid that can burn you.
- They contain gas that can explode or ignite.
- They contain enough electricity to burn you.

If you do not follow these steps exactly, some or all of these things can hurt you.

Notice: Ignoring these steps could result in costly damage to the vehicle that would not be covered by the warranty.

Trying to start the vehicle by pushing or pulling it will not work, and it could damage the vehicle.

1. Check the other vehicle.
It must have a 12-volt battery with a negative ground system.

Notice: If the other vehicle's system is not a 12-volt system with a negative ground, both vehicles can be damaged. Only use vehicles with 12-volt systems with negative grounds to jump start your vehicle.

2. Get the vehicles close enough so the jumper cables can reach, but be sure the vehicles are not touching each other. If they are, it could cause a ground connection you do not want. You would not be able to start your vehicle, and the bad grounding could damage the electrical systems.

To avoid the possibility of the vehicles rolling, set the parking brake firmly on both vehicles involved in the jump start procedure. Put an automatic transmission in P (Park) or a manual transmission in N (Neutral) before setting the parking brake.

9-70 Vehicle Service and Care

Notice: If you leave the radio or other accessories on during the jump starting procedure, they could be damaged. The repairs would not be covered by the warranty. Always turn off the radio and other accessories when jump starting the vehicle.

3. Turn off the ignition on both vehicles. Unplug unnecessary accessories plugged into the cigarette lighter or the accessory power outlet. Turn off the radio and all lamps that are not needed. This will avoid sparks and help save both batteries. And it could save the radio!

4. Open the hoods and locate the batteries. Find the positive (+) and negative (-) terminal locations on each vehicle. Your vehicle's positive (+) terminal is identified by "+" sign on battery case or terminal. See *Engine Compartment Overview* on page 9-6.

CAUTION

An electric fan can start up even when the engine is not running and can injure you. Keep hands, clothing and tools away from any underhood electric fan.

CAUTION

Using a match near a battery can cause battery gas to explode. People have been hurt doing this, and some have been blinded. Use a flashlight if you need more light.

Be sure the battery has enough water. You do not need to add water to the battery installed in your new vehicle. But if a battery has filler caps, be sure the right amount of fluid is there. If it is low, add water to take care of that first. If you don't, explosive gas could be present.

Battery fluid contains acid that can burn you. Do not get it on you. If you accidentally get it in your eyes or on your skin, flush the place with water and get medical help immediately.

⚠ CAUTION

Fans or other moving engine parts can injure you badly. Keep your hands away from moving parts once the engine is running.

5. Check that the jumper cables do not have loose or missing insulation. If they do, you could get a shock. The vehicles could be damaged too.

Before you connect the cables, here are some things you to know. Positive (+) will go to positive (+) or to a remote positive (+) terminal if the vehicle has one. Negative (-) will go to the engine lift hook.

Do not connect positive (+) to negative (-) or you will get a short that would damage the battery and maybe other parts too. And do not connect the negative (-) cable to

the negative (-) terminal on the dead battery because this can cause sparks.

6. Connect the red positive (+) cable to the positive (+) terminal of the dead battery. Use a remote positive (+) terminal if the vehicle has one.
7. Do not let the other end touch metal. Connect it to the positive (+) terminal of the good battery. Use a remote positive (+) terminal if the vehicle has one.
8. Now connect the black negative (-) cable to the negative (-) terminal of the good battery. Use a remote negative (-) terminal if the vehicle has one.
Do not let the other end touch anything until the next step. The other end of the negative (-) cable *does not* go to the dead battery.



9. Connect the other end of the negative (-) cable at least 18 inches (45 cm) away from the dead battery, but not near engine parts that move. Connect it to the engine lift hook. You may need to scrape the surface with your jumper cable to obtain a proper ground. The electrical connection is just as good there, and the chance of sparks getting back to the battery is much less.

9-72 Vehicle Service and Care

10. Now start the vehicle with the good battery and run the engine for a while.
11. Try to start the vehicle that had the dead battery. If it will not start after a few tries, it probably needs service.

Notice: If the jumper cables are connected or removed in the wrong order, electrical shorting may occur and damage the vehicle. The repairs would not be covered by the vehicle warranty. Always connect and remove the jumper cables in the correct order, making sure that the cables do not touch each other or other metal.

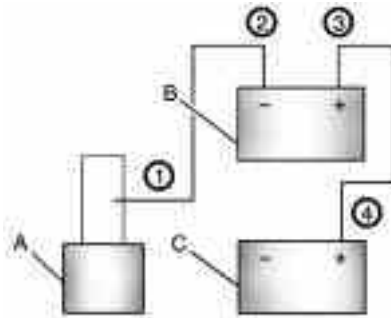

Jumper Cable Removal

- A. Heavy, Unpainted Metal Engine Part or Remote Negative (-) Terminal
- B. Good Battery or Remote Positive (+) and Remote Negative (-) Terminals
- C. Dead Battery or Remote Positive (+) Terminal

To disconnect the jumper cables from both vehicles, do the following:

1. Disconnect the black negative (-) cable from the vehicle that had the dead battery.
2. Disconnect the black negative (-) cable from the vehicle with the good battery.
3. Disconnect the red positive (+) cable from the vehicle with the good battery.
4. Disconnect the red positive (+) cable from the other vehicle.
5. Return the caps over the positive (+) and negative (-) terminals to their original positions.

Towing

Towing Your Vehicle

To avoid damage, the disabled vehicle should be towed with all four wheels off the ground. Consult your dealer/retailer or a professional towing service if the disabled vehicle must be towed. See *Roadside Assistance Program* on page 12-6.

Recreational Vehicle Towing

Notice: Dolly towing or dinghy towing the vehicle may cause damage because of reduced ground clearance. Always put the vehicle on a flatbed truck or trailer.

The vehicle was neither designed nor intended to be towed with any of its wheels on the ground.

Towing a Trailer

The vehicle is neither designed nor intended to tow a trailer.

Appearance Care

Interior Cleaning

Your vehicle's interior will continue to look its best if it is cleaned often. Although not always visible, dust and dirt can accumulate on your upholstery. Dirt can damage carpet, fabric, leather, and plastic surfaces. Regular vacuuming is recommended to remove particles from the upholstery. It is important to keep your upholstery from becoming and remaining heavily soiled. Soils should be removed as quickly as possible. Your vehicle's interior may experience extremes of heat that could cause stains to set rapidly.

Lighter colored interiors may require more frequent cleaning. Use care because newspapers and garments that transfer color to your home furnishings may also transfer color to your vehicle's interior.

9-74 Vehicle Service and Care

When cleaning your vehicle's interior, only use cleaners specifically designed for the surfaces being cleaned.

Permanent damage may result from using cleaners on surfaces for which they were not intended.

Use glass cleaner only on glass.

Remove any accidental over-spray from other surfaces immediately.

To prevent over-spray, apply cleaner directly to the cleaning cloth.

Notice: Using abrasive cleaners when cleaning glass surfaces on the vehicle, could scratch the glass and/or cause damage to the rear window defogger.

When cleaning the glass on the vehicle, use only a soft cloth and glass cleaner.

Many cleaners contain solvents that may become concentrated in your vehicle's breathing space.

Before using cleaners, read and adhere to all safety instructions on the label. While cleaning your vehicle's interior, maintain adequate ventilation by opening your vehicle's doors and windows.

Dust may be removed from small buttons and knobs using a small brush with soft bristles.

Your dealer/retailer has a product for cleaning your vehicle's glass. You can also obtain a product from your dealer/retailer to remove odors from your vehicle's upholstery.

Do not clean your vehicle using the following cleaners or techniques:

- Never use a knife or any other sharp object to remove a soil from any interior surface.
- Never use a stiff brush. It can cause damage to your vehicle's interior surfaces.

- Never apply heavy pressure or rub aggressively with a cleaning cloth. Use of heavy pressure can damage the interior and does not improve the effectiveness of soil removal.
- Use only mild, neutral-pH soaps. Avoid laundry detergents or dishwashing soaps with degreasers. Using too much soap will leave a residue that leaves streaks and attracts dirt. For liquid cleaners, about 20 drops per gallon (3.78 L) of water is a good guide.
- Do not heavily saturate the upholstery while cleaning.
- Damage to your vehicle's interior may result from the use of many organic solvents such as naphtha, alcohol, etc.

Fabric/Carpet

Use a vacuum cleaner with a soft brush attachment frequently to remove dust and loose dirt.

A canister vacuum with a beater bar in the nozzle may only be used on floor carpet and carpeted floor mats. For soils, always try to remove them first with plain water or club soda. Before cleaning, gently remove as much of the soil as possible using one of the following techniques:

- For liquids: gently blot the remaining soil with a paper towel. Allow the soil to absorb into the paper towel until no more can be removed.
- For solid dry soils: remove as much as possible and then vacuum.

To clean, use the following instructions:

1. Saturate a lint-free, clean white cloth with water or club soda.
2. Wring the cloth to remove excess moisture.
3. Start on the outside edge of the soil and gently rub toward the center. Continue cleaning, using a clean area of the cloth each time it becomes soiled.
4. Continue to gently rub the soiled area until the cleaning cloth remains clean.
5. If the soil is not completely removed, use a mild soap solution and repeat the cleaning process that was used with plain water.

If any of the soil remains, a commercial fabric cleaner or spot lifter may be necessary. When a commercial upholstery cleaner or spot lifter is to be used, test a small hidden area for colorfastness first. If the locally cleaned area gives any impression that a ring formation may result, clean the entire surface.

After the cleaning process has been completed, a paper towel can be used to blot excess moisture from the fabric or carpet.

Leather

A soft cloth dampened with water can be used to remove dust. If a more thorough cleaning is necessary, a soft cloth dampened with a mild soap solution can be used. Allow the leather to dry naturally. Do not use heat to dry. Never use steam to clean leather. Never use spot lifters or spot removers on leather. Many commercial leather cleaners and coatings that are sold to preserve and protect leather may permanently change the appearance and feel of your leather and are not recommended. Do not use silicone or wax-based products, or those containing organic solvents to clean your vehicle's interior because they can alter the appearance by increasing the gloss in a non-uniform manner. Never use shoe polish on leather.

Instrument Panel, Vinyl, and Other Plastic Surfaces

A soft cloth dampened with water may be used to remove dust. If a more thorough cleaning is necessary, a clean soft cloth dampened with a mild soap solution can be used to gently remove dust and dirt. Never use spot lifters or removers on plastic surfaces. Many commercial cleaners and coatings that are sold to preserve and protect soft plastic surfaces may permanently change the appearance and feel of your interior and are not recommended. Do not use silicone or wax-based products, or those containing organic solvents to clean your vehicle's interior because they can alter the appearance by increasing the gloss in a non-uniform manner.

Some commercial products may increase gloss on your instrument panel. The increase in gloss may cause annoying reflections in the windshield and even make it difficult to see through the windshield under certain conditions.

Exterior Cleaning

Cleaning Exterior Lamps/Lenses

Use only lukewarm or cold water, a soft cloth and a car washing soap to clean exterior lamps and lenses. Follow instructions under "Washing Your Vehicle" later in this section.

Finish Care

Occasional waxing or mild polishing of your vehicle by hand may be necessary to remove residue from the paint finish. You can get approved cleaning products from your dealer/retailer.

If your vehicle has a basecoat/clearcoat paint finish, the clearcoat gives more depth and gloss to the colored basecoat. Always use waxes and polishes that are non-abrasive and made for a basecoat/clearcoat paint finish.

Notice: Machine compounding or aggressive polishing on a basecoat/clearcoat paint finish may damage it. Use only non-abrasive waxes and polishes that are made for a basecoat/clearcoat paint finish on the vehicle.

Foreign materials such as calcium chloride and other salts, ice melting agents, road oil and tar, tree sap, bird droppings, chemicals from industrial chimneys, etc., can damage your vehicle's finish if they remain on painted surfaces. Wash the vehicle as soon as possible. If necessary, use non-abrasive cleaners that are marked safe for painted surfaces to remove foreign matter.

Exterior painted surfaces are subject to aging, weather and chemical fallout that can take their toll over a period of years. You can help to keep the paint finish looking new by keeping your vehicle garaged or covered whenever possible.

Protecting Exterior Bright Metal Parts

Bright metal parts should be cleaned regularly to keep their luster. Wash with water or use chrome polish on chrome or stainless steel trim, if necessary.

Use special care with aluminum trim. To avoid damaging protective trim, never use auto or chrome polish, steam or caustic soap to clean aluminum. A coating of wax, rubbed to high polish, is recommended for all bright metal parts.

Washing Your Vehicle

The best way to preserve your vehicle's finish is to keep it clean by washing it often.

Do not wash the vehicle in direct sunlight. Use a car washing soap.

Notice: Certain cleaners contain chemicals that can damage the emblems or nameplates on the vehicle. Check the cleaning product label. If it states that it should not be used on plastic parts, do not use it on the vehicle or damage may occur and it would not be covered by the warranty.

Do not use cleaning agents that are petroleum based or that contain acid or abrasives, as they can damage the paint, metal or plastic on your vehicle. Approved cleaning products can be obtained from your dealer/retailer. Follow all manufacturers' directions regarding correct product usage, necessary safety precautions and appropriate disposal of any vehicle care product.

Rinse the vehicle well, before washing and after to remove all cleaning agents completely. If they are allowed to dry on the surface, they could stain.

Dry the finish with a soft, clean chamois or an all-cotton towel to avoid surface scratches and water spotting.

High pressure car washes may cause water to enter the vehicle. Avoid using high pressure washes closer than 12 inches (30 cm) to the surface of the vehicle. Use of power washers exceeding 1,200 psi (8 274 kPa) can result in damage or removal of paint and decals.

Weatherstrips

Silicone grease on weatherstrips will make them last longer, seal better, and not stick or squeak. Apply silicone grease with a clean cloth. During very cold, damp weather frequent application may be required.

See “Fluids and Lubricants” in the Index of the “Maintenance and Warranty and Owner assistance Information” manual.

Wheels and Trim — Aluminum or Chrome

Your vehicle may have either aluminum or chrome-plated wheels.

Keep the wheels clean using a soft clean cloth with mild soap and water. Rinse with clean water. After rinsing thoroughly, dry with a soft clean towel. A wax may then be applied.

Notice: Chrome wheels and other chrome trim may be damaged if the vehicle is not washed after driving on roads that have been sprayed with magnesium, calcium or sodium chloride. These chlorides are used on roads for conditions such as ice and dust. Always wash the vehicle’s chrome with soap and water after exposure.

Notice: Using strong soaps, chemicals, abrasive polishes, cleaners, brushes, or cleaners that contain acid on aluminum or chrome-plated wheels, could damage the surface of the wheel(s). The repairs would not be covered by the warranty. Use only approved cleaners on aluminum or chrome-plated wheels.

The surface of these wheels is similar to the painted surface of your vehicle. Do not use strong soaps, chemicals, abrasive polishes, abrasive cleaners, cleaners with acid, or abrasive cleaning brushes on them because you could damage the surface. Do not use chrome polish on aluminum wheels.

Notice: Using chrome polish on aluminum wheels could damage the wheels. The repairs would not be covered by the warranty. Use chrome polish on chrome wheels only.

Use chrome polish only on chrome-plated wheels, but avoid any painted surface of the wheel, and buff off immediately after application.

Notice: Driving the vehicle through an automatic car wash that has silicone carbide tire cleaning brushes, could damage the aluminum or chrome-plated wheels. The repairs would not be covered by the warranty. Never drive a vehicle equipped with aluminum or chrome-plated wheels through an automatic car wash that uses silicone carbide tire cleaning brushes.

Windshield and Wiper Blades

Clean the outside of the windshield with glass cleaner.

Clean the rubber blades using a lint free cloth or paper towel soaked with windshield washer fluid or a mild detergent. Wash the windshield thoroughly when cleaning the blades.

Bugs, road grime, sap, and a buildup of vehicle wash/wax treatments may cause wiper streaking. Replace the wiper blades if they are worn or damaged.

Wipers can be damaged by:

- Extreme dusty conditions
- Sand and salt
- Heat and sun
- Snow and ice, without proper removal

Tires

To clean the tires, use a stiff brush with tire cleaner.

Notice: Using petroleum-based tire dressing products on the vehicle may damage the paint finish and/or tires. When applying a tire dressing, always wipe off any overspray from all painted surfaces on the vehicle.

Sheet Metal Damage

If the vehicle is damaged and requires sheet metal repair or replacement, make sure the body repair shop applies anti-corrosion material to parts repaired or replaced to restore corrosion protection.

Original manufacturer replacement parts will provide the corrosion protection while maintaining the vehicle warranty.

Finish Damage

Any stone chips, fractures or deep scratches in the finish should be repaired right away. Bare metal will corrode quickly and may develop into major repair expense.

Minor chips and scratches can be repaired with touch-up materials available from your dealer/retailer. Larger areas of finish damage can be corrected in your dealer's/retailer's body and paint shop.

Underbody Maintenance

Chemicals used for ice and snow removal and dust control can collect on the underbody. If these are not removed, corrosion and rust can develop on the underbody parts such as fuel lines, frame, floor pan, and exhaust system even though they have corrosion protection.

At least every spring, flush these materials from the underbody with plain water. Clean any areas where mud and debris can collect. Dirt packed in close areas of the frame should be loosened before being flushed. Your dealer/retailer or an underbody car washing system can do this.

Chemical Paint Spotting

Some weather and atmospheric conditions can create a chemical fallout. Airborne pollutants can fall upon and attack painted surfaces on the vehicle. This damage can take two forms: blotchy, ring-shaped discolorations, and small, irregular dark spots etched into the paint surface.

Although no defect in the paint job causes this, we will repair, at no charge to the owner, the surfaces of new vehicles damaged by this fallout condition within 12 months or 12,000 miles (20 000 km) of purchase, whichever occurs first.

Technical Data

Vehicle Identification

Vehicle Identification
 Number (VIN)10-1
 Service Parts
 Identification Label10-1

Capacities and Specifications

Capacities and
 Specifications10-2

Vehicle Identification

Vehicle Identification Number (VIN)



This is the legal identifier for the vehicle. It appears on a plate in the front corner of the instrument panel, on the driver side. It can be seen through the windshield from outside the vehicle. The VIN also appears on the Vehicle Certification and Service Parts labels and the certificates of title and registration.

Engine Identification

The eighth character in the VIN is the engine code. This code helps identify the vehicle's engine, specifications, and replacement parts. See "Engine Specifications" under *Capacities and Specifications on page 10-2* for the vehicle's engine code.

Service Parts Identification Label

This label is on the trunk floor. It is very helpful if parts need to be ordered. The label has the following information:

- Vehicle Identification Number (VIN)
- Model designation
- Paint information
- Production options and special equipment

Do not remove this label from the vehicle.

Capacities and Specifications

The following approximate capacities are given in English and metric conversions. See “Fluids and Lubricants” in the index of the “Limited Warranty, Maintenance and Owner Assistance Information” manual.

Application	Capacities	
	English	Metric
Air Conditioning Refrigerant	For the air conditioning system refrigerant charge amount, see the refrigerant caution label located under the hood. See your dealer/retailer for more information.	
Cooling System		
Automatic Transmission	6.2 qt	5.9 L
Manual Transmission	7.3 qt	6.9 L
Engine Oil with Filter	4.8 qt	4.5 L
Fuel Tank	11.9 gal	45.0 L

Application	Capacities	
	English	Metric
Transmission Fluid		
Automatic Transmission	4.2 qt	4.0 L
Manual Transmission	1.6 qt	1.5 L
Wheel Bolt Torque	81 lb ft	110 N•m
All capacities are approximate. When adding, be sure to fill to the approximate level, as recommended in this manual.		

Engine Specifications

Engine	VIN Code	Transmission	Spark Plug Gap
1.8L L4	1	Automatic Manual	0.035 in (0.90 mm)

Service and Maintenance

Service and Maintenance

Introduction	11-1
Maintenance Requirements	11-1
Your Vehicle and the Environment	11-2
Using the Maintenance Schedule	11-2
Scheduled Maintenance	11-3
Additional Required Services	11-6
Maintenance Footnotes	11-8
Owner Checks and Services	11-9
At Each Fuel Fill	11-9

At Least Once a Month	11-10
At Least Once a Year	11-10
Recommended Fluids and Lubricants	11-12
Maintenance Replacement Parts	11-14
Engine Drive Belt Routing	11-15
Maintenance Record	11-16

Service and Maintenance

Introduction

Important: Keep engine oil at the proper level and change as recommended.

Maintenance Requirements

Notice: Maintenance intervals, checks, inspections, replacement parts, and recommended fluids and lubricants as prescribed in this manual are necessary to keep this vehicle in good working condition. Any damage caused by failure to follow scheduled maintenance might not be covered by the vehicle warranty.

11-2 Service and Maintenance

Your Vehicle and the Environment

Proper vehicle maintenance not only helps to keep the vehicle in good working condition, but also helps the environment. All recommended maintenance is important. Improper vehicle maintenance can even affect the quality of the air we breathe. Improper fluid levels or the wrong tire inflation can increase the level of emissions from the vehicle. To help protect the environment, and to keep the vehicle in good condition, be sure to maintain the vehicle properly.

Using the Maintenance Schedule

We want to help keep this vehicle in good working condition. But we do not know exactly how you will drive it. You might drive very short distances only a few times a week. Or you might drive long distances all the time in very hot, dusty weather. You might use the vehicle in making deliveries. Or you might drive it to work, to do errands, or in many other ways.

Because of all the different ways people use their vehicles, maintenance needs vary. You might need more frequent checks and replacements. So please read the following and note how you drive. If you have any questions on how to keep the vehicle in good condition, see your dealer/retailer.

This schedule is for vehicles that:

- carry passengers and cargo within recommended limits on the Tire and Loading Information label. See *Loading the Vehicle* on page 8-30.
- are driven on reasonable road surfaces within legal driving limits.
- use the recommended fuel. See *Gasoline Octane* on page 8-34.

The services in *Scheduled Maintenance* on page 11-3 should be performed when indicated. See *Additional Required Services* on page 11-6 and *Maintenance Footnotes* on page 11-8 for further information.

 **CAUTION**

Performing maintenance work on a vehicle can be dangerous. In trying to do some jobs, you can be seriously injured. Do your own maintenance work only if you have the required know-how and the proper tools and equipment for the job. If you have any doubt, see your dealer/retailer to have a qualified technician do the work. See *Doing Your Own Service Work on page 9-4*.

Some maintenance services can be complex. So, unless you are technically qualified and have the necessary equipment, have your dealer/retailer do these jobs.

When you go to your dealer/retailer for service, trained and supported service technicians will perform the work using genuine parts.

To purchase service information, see *Service Publications Ordering Information on page 12-15*.

Owner Checks and Services on page 11-9 tells what should be checked, when to check it, and what can easily be done to help keep the vehicle in good condition.

The proper replacement parts, fluids, and lubricants to use are listed in *Recommended Fluids and Lubricants on page 11-12* and *Maintenance Replacement Parts on page 11-14*. When the vehicle is serviced, make sure these are used. All parts should be replaced and all necessary repairs done before you or anyone else drives the vehicle. We recommend the use of genuine parts from your dealer/retailer.

Scheduled Maintenance

When the letters InSP appear in the odometer display, service is required for the vehicle. Have the vehicle serviced as soon as possible within the mileage indicated on the display. The engine oil and filter must be changed at least once a year and at this time the system must be reset. Your dealer/retailer has trained service technicians who will perform this work using genuine parts and reset the system.

If the engine oil life system is ever reset accidentally, service the vehicle within 3,000 miles (5 000 km) since the last service. Remember to reset the oil life system whenever the oil is changed. See *Engine Oil Life System on page 9-9* for information on the oil life system and resetting the system.

11-4 Service and Maintenance

When InSP appears, certain services, checks, and inspections are required. Required services are described in the following for “Maintenance I” and “Maintenance II.” Generally, it is recommended that the first service be Maintenance I, the second service be Maintenance II, and then alternate Maintenance I and

Maintenance II thereafter. However, in some cases, Maintenance II might be required more often.

Maintenance I — Use Maintenance I if InSP displays within 10 months since the vehicle was purchased or Maintenance II was performed.

Maintenance II — Use Maintenance II if the previous service performed was Maintenance I. Always use Maintenance II whenever the letters InSP display 10 months or more since the last service or if InSP has not come on at all for one year.

Scheduled Maintenance

Service	Maintenance I	Maintenance II
Change engine oil and filter. See <i>Engine Oil on page 9-7</i> . Reset oil life system. See <i>Engine Oil Life System on page 9-9</i> . An <i>Emission Control Service</i> .	•	•
Visually check for any leaks or damage. See <i>footnote (a)</i> .	•	•
Inspect engine air cleaner filter. If necessary, replace filter. See <i>Engine Air Cleaner/Filter on page 9-11</i> . See <i>footnote (b)</i> .		•
Rotate tires and check inflation pressures and wear. See <i>Tire Inspection and Rotation on page 9-52</i> and “Tire Wear Inspection” in <i>At Least Once a Month on page 11-10</i> .	•	•

Scheduled Maintenance (cont'd)

Service	Maintenance I	Maintenance II
Inspect brake system. <i>See footnote (c).</i>	•	•
Check engine coolant and windshield washer fluid levels and add fluid as needed.	•	•
Perform any needed additional services. <i>See Additional Required Services on page 11-6.</i>	•	•
Inspect suspension and steering components. <i>See footnote (d).</i>		•
Inspect engine cooling system. <i>See footnote (e).</i>		•
Inspect wiper blades. <i>See footnote (f).</i>		•
Inspect restraint system components. <i>See footnote (g).</i>		•
Lubricate body components. <i>See footnote (h).</i>		•

11-6 Service and Maintenance

Additional Required Services

The following services should be performed at the first maintenance service (I or II) after the indicated miles (kilometers) shown for each item.

Additional Required Services

Service and Miles (Kilometers)	25,000 (40 000)	50,000 (80 000)	75,000 (120 000)	100,000 (160 000)	125,000 (200 000)	150,000 (240 000)
Inspect fuel system for damage or leaks.	•	•	•	•	•	•
Inspect exhaust system for loose or damaged components.	•	•	•	•	•	•
Replace engine air cleaner filter. <i>See Engine Air Cleaner/Filter on page 9-11.</i>		•		•		•
Replace passenger compartment air filter.	•	•	•	•	•	•
Change automatic transmission fluid (severe service). <i>See footnote (i).</i>		•		•		•
Change automatic transmission fluid (normal service).				•		
Replace spark plugs. <i>An Emission Control Service.</i> Not to exceed 35,000 miles (56 000 km).	•	•	•	•	•	•

Additional Required Services (cont'd)

Service and Miles (Kilometers)	25,000 (40 000)	50,000 (80 000)	75,000 (120 000)	100,000 (160 000)	125,000 (200 000)	150,000 (240 000)
Engine cooling system service (or every five years, whichever occurs first). <i>An Emission Control Service.</i> <i>See footnote (j).</i>						•
Solid lifter tappet adjustment (or every 10 years, whichever occurs first). <i>See footnote (m).</i> Not to exceed 90,000 miles (144 000 km).			•			•
Replace timing belt and tensioner (or every 10 years, whichever occurs first). <i>See footnote (m).</i> Not to exceed 100,000 miles (160 000 km).			•			•
Inspect engine accessory drive belt (or every two years, whichever occurs first). <i>An Emission Control Service.</i> <i>See footnote (k).</i> Not to exceed 36,000 miles (58 000 km).	•	•	•	•	•	•
Change brake and clutch hydraulic fluid at a regular maintenance service every two years. <i>See footnote (l).</i>						

Maintenance Footnotes

(a) *A fluid loss in any vehicle system could indicate a problem. Have the system inspected and repaired and the fluid level checked. Add fluid if needed.*

(b) *If driving regularly under dusty conditions or in high-polluted regions, replace the filter at each engine oil change.*

(c) *Inspect brake lines and hoses for proper hook-up, binding, leaks, cracks, chafing, etc. Inspect disc brake pads for wear and rotors for surface condition. Inspect other brake parts, including calipers, parking brake, etc.*

(d) *Inspect front and rear suspension and steering system for damaged, loose, or missing parts or signs of wear. Inspect power steering cables for proper hook-up, binding, cracks, chafing, etc. Inspect power steering hydraulic lines and hoses for proper hook-up, binding, leaks, cracks, chafing, etc.*

(e) *Inspect hoses and have them replaced if they are cracked, swollen, or deteriorated. Inspect all pipes, fittings and clamps; replace with genuine parts as needed. To help ensure proper operation, a pressure test of the cooling system and pressure cap and cleaning the outside of the radiator and air conditioning condenser is recommended at least once a year.*

(f) *Inspect wiper blades for wear, cracking, or contamination. Clean the windshield and wiper blades, if contaminated. Replace wiper blades that are worn or damaged. See Windshield Wiper Blade Replacement on page 9-21 and "Windshield and Wiper Blades" in Exterior Cleaning on page 9-76.*

(g) *Make sure the safety belt reminder light and safety belt assemblies are working properly. Look for any other loose or damaged safety belt system parts. If you see anything that might keep a safety belt system from doing*

its job, have it repaired. Have any torn or frayed safety belts replaced. Also see Airbag System Check on page 1-37.

(h) *Lubricate all key lock cylinders, door hinges and latches, hood hinges and latches, and trunk lid hinges and latches. More frequent lubrication may be required when exposed to a corrosive environment. Applying silicone grease on weatherstrips with a clean cloth will make them last longer, seal better, and not stick or squeak.*

(i) *Change automatic transmission fluid if the vehicle is mainly driven under one or more of these conditions:*

- *In heavy city traffic where the outside temperature regularly reaches 90°F (32°C) or higher.*
- *In hilly or mountainous terrain.*
- *When doing frequent trailer towing.*
- *Uses such as found in taxi, police, or delivery service.*

(j) *Drain, flush, and refill cooling system. This service can be complex; you should have your dealer/retailer perform this service. See Engine Coolant on page 9-16 for what to use. Inspect hoses. Clean radiator, condenser, pressure cap, and filler neck. Pressure test the cooling system and pressure cap.*

(k) *Inspect belt for fraying, excessive cracks, or obvious damage. Replace belt if necessary.*

(l) *Drain, flush, and refill brake/clutch hydraulic system at a regular service interval (I or II) every two years. This service can be complex; you should have your dealer/retailer perform this service. See Brakes on page 9-22.*

(m) *This service can be complex; you should have your dealer/retailer perform this service.*

Owner Checks and Services

These owner checks and services should be performed at the intervals specified to help ensure vehicle safety, dependability, and emission control performance. Your dealer/retailer can assist with these checks and services.

Be sure any necessary repairs are completed at once. Whenever any fluids or lubricants are added to the vehicle, make sure they are the proper ones, as shown in *Recommended Fluids and Lubricants on page 11-12.*

At Each Fuel Fill

It is important to perform these underhood checks at each fuel fill.

Engine Oil Level Check

Notice: It is important to check the engine oil regularly and keep it at the proper level. Failure to keep the engine oil at the proper level can cause damage to the engine not covered by the vehicle warranty.

Check the engine oil level and add the proper oil if necessary. See *Engine Oil on page 9-7.*

Engine Coolant Level Check

Check the engine coolant level and add DEX-COOL[®] coolant mixture if necessary. See *Engine Coolant on page 9-16.*

Windshield Washer Fluid Level Check

Check the windshield washer fluid level in the windshield washer fluid reservoir and add the proper fluid if necessary.

At Least Once a Month

Tire Inflation Check

Inspect the vehicle's tires and make sure they are inflated to the correct pressures. Do not forget to check the spare tire. See *Inflation - Tire Pressure on page 9-47*. Check to make sure the spare tire is stored securely. See *Changing a Flat Tire on page 9-61*.

Tire Wear Inspection

Tire rotation may be required for high mileage highway drivers prior to the Engine Oil Life System service notification. Check the tires for wear and, if necessary, rotate the tires. See *Tire Inspection and Rotation on page 9-52*.

At Least Once a Year

Starter Switch Check

CAUTION

When you are doing this inspection, the vehicle could move suddenly. If the vehicle moves, you or others could be injured.

1. Before starting this check, be sure there is enough room around the vehicle.
2. Firmly apply both the parking brake and the regular brake. See *Parking Brake on page 8-10*. Do not use the accelerator pedal, and be ready to turn off the engine immediately if it starts.
3. Try to start the engine in each gear. The vehicle should start only in P (Park) or N (Neutral). If the vehicle starts in any other position, contact your dealer/retailer for service.

Automatic Transmission Shift Lock Control System Check

CAUTION

When you are doing this inspection, the vehicle could move suddenly. If the vehicle moves, you or others could be injured.

1. Before starting this check, be sure there is enough room around the vehicle. It should be parked on a level surface.
2. Firmly apply the parking brake. See *Parking Brake on page 8-10*. Be ready to apply the regular brake immediately if the vehicle begins to move.
3. With the engine off, turn the ignition to ON/RUN, but do not start the engine. Without applying the regular brake, try to move the shift lever out of P (Park) with normal effort. If the shift lever moves out of P (Park), contact your dealer/retailer for service.

Ignition Transmission Lock Check

While parked, and with the parking brake set, try to turn the ignition to LOCK/OFF in each shift lever position.

- The ignition should turn to LOCK/OFF only when the shift lever is in P (Park).
- The ignition key should come out only in LOCK/OFF.

Contact your dealer/retailer if service is required.

Parking Brake and Automatic Transmission P (Park) Mechanism Check

 **CAUTION**

When you are doing this check, the vehicle could begin to move. You or others could be injured and property could be damaged.

(Continued)

CAUTION (Continued)

Make sure there is room in front of the vehicle in case it begins to roll. Be ready to apply the regular brake at once should the vehicle begin to move.

Park on a fairly steep hill, with the vehicle facing downhill. Keeping your foot on the regular brake, set the parking brake.

- To check the parking brake's holding ability: With the engine running and the transmission in N (Neutral), slowly remove foot pressure from the regular brake pedal. Do this until the vehicle is held by the parking brake only.
- To check the P (Park) mechanism's holding ability: With the engine running, shift to P (Park). Then release the parking brake followed by the regular brake.

Contact your dealer/retailer if service is required.

Underbody Flushing Service

At least every spring, use plain water to flush any corrosive materials from the underbody. Take care to clean thoroughly any areas where mud and other debris can collect.

11-12 Service and Maintenance

Recommended Fluids and Lubricants

Fluids and lubricants identified below by name, part number, or specification can be obtained from your dealer/retailer.

Usage	Fluid/Lubricant
Engine Oil	Engine oil which meets GM Standard GM6094M and displays the American Petroleum Institute Certified for Gasoline Engines starburst symbol. To determine the proper viscosity for your vehicle's engine, see <i>Engine Oil on page 9-7</i> .
Engine Coolant	50/50 mixture of clean, drinkable water and use only DEX-COOL [®] Coolant. See <i>Engine Coolant on page 9-16</i> .
Hydraulic Brake/Clutch System	Hydraulic Brake Fluid. Use only GM Part No. U.S. 88958860, in Canada 88901244, Super DOT-4 brake fluid.
Windshield Washer	Optikleen [®] Washer Solvent.
Power Steering System	GM Power Steering Fluid (GM Part No. U.S. 88901975, in Canada 88901976).
Automatic Transmission	Use only T-IV Automatic Transmission Fluid (GM Part No. U.S. 88900925, in Canada 22689186).

Usage	Fluid/Lubricant
Manual Transmission	Manual Transmission Fluid (GM Part No. U.S. 88862472, in Canada 88862473).
Key Lock Cylinders	Multi-Purpose Lubricant, Superlube (GM Part No. U.S. 12346241, in Canada 10953474).
Hood Latch Assembly, Secondary Latch, Pivots, Spring Anchor, and Release Pawl	Lubriplate Lubricant Aerosol (GM Part No. U.S. 12346293, in Canada 992723) or lubricant meeting requirements of NLGI #2, Category LB or GC-LB.
Hood and Door Hinges	Multi-Purpose Lubricant, Superlube (GM Part No. U.S. 12346241, in Canada 109435474).
Weatherstrip Conditioning	Weatherstrip Lubricant (GM Part No. U.S. 3634770, in Canada 10953518) or Dielectric Silicone Grease (GM Part No. U.S. 12345579, in Canada 992887).

11-14 Service and Maintenance

Maintenance Replacement Parts

Replacement parts identified below by name, part number, or specification can be obtained from your dealer/retailer.

Part	Part Numbers	ACDelco Part Numbers
Engine Air Cleaner/Filter	9117557	—
Engine Oil Filter	93185674	—
Passenger Compartment Air Filter Element		
Pollen Filter	13175553	—
Carbon Filter	13175554	—
Spark Plugs	93176801	—
Wiper Blades		
Front Wiper Kit	93187384	—
Rear Wiper	93189239	—

Engine Drive Belt Routing



Customer Information

Customer Information

- Customer Satisfaction Procedure12-1
- Online Owner Center12-4
- Customer Assistance for Text Telephone (TTY) Users12-5
- Customer Assistance Offices12-5
- GM Mobility Reimbursement Program12-6
- Roadside Assistance Program12-6
- Scheduling Service Appointments12-8
- Courtesy Transportation12-9
- Collision Damage Repair12-10

Reporting Safety Defects

- Reporting Safety Defects to the United States Government12-14
- Reporting Safety Defects to the Canadian Government ...12-14
- Reporting Safety Defects to Saturn12-14
- Service Publications Ordering Information12-15

Vehicle Data Recording and Privacy

- Vehicle Data Recording and Privacy12-16
- Event Data Recorders12-16
- OnStar®12-17
- Navigation System12-17
- Radio Frequency Identification (RFID)12-17

Customer Information

Customer Satisfaction Procedure

Your satisfaction and goodwill are important to your retailer and to Saturn. Together we are committed to providing our customers with unparalleled service, before, during, and after the purchase of a Saturn vehicle, for total customer satisfaction. We call this the Saturn Difference. Normally, any concerns with the sales transaction or the operation of the vehicle are resolved by the retailer's sales or service departments. If, for any reason, your ownership experience falls below your expectations, we suggest you take the following action:

STEP ONE: Contact the Retail Customer Assistance Liaison. Any member of the retail management team has the authority and the desire to resolve your concerns. Normally, concerns can be quickly resolved at this level.

12-2 Customer Information

STEP TWO: Should you need additional assistance, in the U.S., contact the Saturn Customer Assistance Center by calling 1-800-553-6000. In Canada, call the Saturn Customer Communication Centre at 1-800-263-1999. A Saturn Customer Assistance Center team member will handle your call and assist in providing product and warranty information, the nearest retailer location, roadside assistance, brochures, literature and discuss any concerns you may have.

We encourage you to call the toll-free number in order to give your inquiry prompt attention. Please have the following information available to give the Customer Assistance Representative:

- Vehicle Identification Number (VIN). This 17-digit number can be found on the vehicle registration or title, on the upper driver side corner of the instrument panel, or on your roadside assistance key card.

- The name of your selling and servicing retail facility.
- Vehicle delivery date and present mileage.
- Your daytime and evening phone numbers.

When contacting Saturn, please remember that your concern will likely be resolved at a retailer's facility. That is why we suggest you follow Step One first.

STEP THREE (U.S. Owners):

Both Saturn and its retailers are committed to making sure you are completely satisfied with your Saturn vehicle. However, if you continue to remain unsatisfied after following the procedure outlined in Steps One and Two, Saturn and its retailers offer the additional assistance of a neutral party through our voluntary participation in a mediation/ arbitration program called Better Business Bureau (BBB) Auto Line.

The BBB Auto Line Program is an out-of-court program administered by the Council of Better Business Bureaus to settle automotive disputes regarding vehicle repairs or the interpretation of the New Vehicle Limited Warranty. This program is available at no cost to you, our customer.

Although you may be required to resort to this informal dispute resolution program prior to filing a court action, use of the program is free of charge and your case is generally heard within 40 days. If you do not agree with the decision given in your case, you can reject it and proceed with any other venue for relief available to you.

Contact the BBB Auto Line Program by using the toll-free telephone number or by writing them at the following address:

BBB Auto Line Program
Council of Better Business
Bureaus, Inc.
4200 Wilson Boulevard
Suite 800
Arlington, VA 22203-1838

Telephone: 1-800-955-5100
dr.bbb.org/goauto

This program is available in all 50 states and the District of Columbia. Eligibility is limited by vehicle age, mileage and other factors. Saturn Corporation reserves the right to change eligibility limitations and/or discontinue its participation in this program.

STEP THREE (Canadian Owners):

General Motors Participation in the Mediation/Arbitration Program

In the event that you do not feel your concerns have been addressed after following the procedure outlined in Steps 1 and 2, General Motors of Canada Limited has committed to binding arbitration of owner disputes involving factory-related vehicle service claims. The program provides for the review of the facts involved by an impartial third party arbiter, and may include an informal hearing before the arbiter.

The program is designed so that the entire dispute settlement process, from the time you file your complaint to the final decision, should be completed in approximately 70 days. We believe our impartial program offers advantages over courts in most jurisdictions because it is informal, quick, and free of charge.

For further information concerning eligibility in the Canadian Motor Vehicle Arbitration Plan (CAMVAP), call toll-free 1-800-207-0685. Alternatively, you may call the Saturn Customer Communication Centre, 1-800-263-1999, or you may write to:

Mediation/Arbitration Program
c/o Customer Communication Centre
General Motors of Canada Limited
Mail Code: CA1-163-005
1908 Colonel Sam Drive
Oshawa, Ontario L1H 8P7
Telephone: 1-800-955-5100

Your inquiry should be accompanied by the Vehicle Identification Number (VIN).

12-4 Customer Information

Online Owner Center

Online Owner Center (U.S.) —
www.gmownercenter.com/saturn

Information and services customized for your specific vehicle — all in one convenient place.

- Digital owner manual, warranty information, and more
- Online service and maintenance records
- Find Saturn retailers for service nationwide
- Exclusive privileges and offers
- Recall notices for your specific vehicle
- OnStar® and GM Cardmember Services Earnings summaries

Other Helpful Links:

Saturn – www.saturn.com

Saturn Merchandise —
www.saturncollection.com

Help Center —
www.saturn.com/helpcenter

- FAQ
- Contact Us

My GM Canada (Canada) — **www.gm.ca**

My GM Canada is a password-protected section of www.gm.ca where you can save information on GM vehicles, get personalized offers, and use handy tools and forms with greater ease.

Here are a few of the valuable tools and services you will have access to:

- **My Showroom:** Find and save information on vehicles and current offers in your area.
- **My Dealers/Retailers:** Save details such as address and phone number for each of your preferred GM dealers/retailers.
- **My Driveway:** Access quick links to parts and service estimates, check trade-in values, or schedule a service appointment by adding the vehicles you own to your driveway profile.
- **My Preferences:** Manage your profile and use tools and forms with greater ease.

To sign up, visit the My GM Canada section within www.gm.ca.

Customer Assistance for Text Telephone (TTY) Users

To assist owners who have hearing difficulties, Saturn has installed special TDD (Telecommunication Devices for the Deaf) equipment in its Saturn Customer Assistance Center.

Any hearing or speech-impaired customer who has access to a TDD or to a conventional Text Telephone (TTY) can communicate with Saturn by dialing 1-800-TDD-6000. TTY users in Canada may dial 1-800-263-3830.

Customer Assistance Offices

Saturn encourages customers to call the toll-free number for assistance. If a customer wishes to write to Saturn, the letter should be addressed to:

Saturn Customer Assistance Center
P.O. Box 33173
Detroit, MI 48232-5173

1-800-553-6000
1-800-833-6000
(For Text Telephone devices (TTYs))
Roadside Assistance:
1-800-553-6000

In Canada, write to:

Saturn Customer Communication
Centre
General Motors of Canada Ltd.
CA1-163-005
1908 Colonel Sam Drive
Oshawa, Ontario L1H 8P7

GMcanada.com
1-800-263-1999
1-800-263-3830
(For Text Telephone devices (TTYs))
Roadside Assistance:
1-800-268-6800

GM Mobility Reimbursement Program



This program, available to qualified applicants, can reimburse you up to \$1,000 toward eligible aftermarket driver or passenger adaptive equipment you may require for your vehicle such as hand controls, wheelchair/scooter lifts, etc.

The offer is available for a limited period of time from the date of vehicle purchase/lease.

For more details, or to determine your vehicle's eligibility, visit your Saturn retailer or call the Saturn Customer Assistance Center at 1-800-553-6000. Text telephone (TTY) users, call 1-800-833-6000.

In Canada, customers may call the Saturn Customer Communication Centre at 1-800-263-1999. TTY users in Canada may call 1-800-263-3830.

Roadside Assistance Program

For U.S. purchased vehicles, call **1-800-553-6000**; (Text Telephone (TTY): **1-800-889-2438**).

For Canadian purchased vehicles, call **1-800-268-6800**.

Service is available 24 hours a day, 365 days a year.

Calling for Assistance

When calling Roadside Assistance, have the following information ready:

- Your name, home address, and home telephone number
- Telephone number of your location
- Location of the vehicle
- Model, year, color, and license plate number of the vehicle
- Odometer reading, Vehicle Identification Number (VIN), and delivery date of the vehicle
- Description of the problem

Coverage

Services are provided up to 5 years/100,000 miles (160 000 km), whichever comes first.

In the U.S., anyone driving the vehicle is covered. In Canada, a person driving the vehicle without permission from the owner is not covered.

Roadside Assistance is not a part of the New Vehicle Limited Warranty. Saturn and General Motors of Canada Limited reserve the right to make any changes or discontinue the Roadside Assistance program at any time without notification.

Saturn and General Motors of Canada Limited reserve the right to limit services or payment to an owner or driver if they decide the claims are made too often, or the same type of claim is made many times.

Services Provided

- **Emergency Fuel Delivery:** Delivery of enough fuel for the vehicle to get to the nearest service station.
- **Lock-Out Service:** Service is provided to unlock the vehicle if you are locked out. A remote unlock may be available if you have OnStar[®]. For security reasons, the driver must present identification before this service is given.
- **Emergency Tow From a Public Road or Highway:** Tow to the nearest Saturn retailer for warranty service, or if the vehicle was in a crash and cannot be driven. Assistance is also given when the vehicle is stuck in sand, mud, or snow.

- **Flat Tire Change:** Service is provided to change a flat tire with the spare tire. The spare tire, if equipped, must be in good condition and properly inflated. It is the owner's responsibility for the repair or replacement of the tire if it is not covered by the warranty.
- **Battery Jump Start:** Service is provided to jump start a dead battery.
- **Trip Interruption Benefits and Assistance:** If your trip is interrupted due to a warranty failure, incidental expenses may be reimbursed during the 5 years/100,000 miles (160 000 km) Powertrain warranty period. Items considered are hotel, meals, and rental car.

Services Not Included in Roadside Assistance

- Impound towing caused by violation of any laws.
- Legal fines.
- Mounting, dismounting or changing of snow tires, chains, or other traction devices.
- Towing or services for vehicles driven on a non-public road or highway.

12-8 Customer Information

Services Specific to Canadian Purchased Vehicles

- **Fuel delivery:** Reimbursement is approximately \$5 Canadian. Diesel fuel delivery may be restricted. Propane and other fuels are not provided through this service.
- **Lock-Out Service:** Vehicle registration is required.
- **Trip Routing Service:** Detailed maps of North America are provided when requested either with the most direct route or the most scenic route. There is a limit of six requests per year. Additional travel information is also available. Allow three weeks for delivery.
- **Trip Interruption Benefits and Assistance:** Must be over 250 kilometres from where your trip was started to qualify. General Motors of

Canada Limited requires pre-authorization, original detailed receipts, and a copy of the repair orders. Once authorization has been received, the Roadside Assistance advisor will help you make arrangements and explain how to receive payment.

- **Alternative Service:** If assistance cannot be provided right away, the Roadside Assistance advisor may give you permission to get local emergency road service. You will receive payment, up to \$100, after sending the original receipt to Roadside Assistance. Mechanical failures may be covered, however any cost for parts and labor for repairs not covered by the warranty are the owner responsibility.

Scheduling Service Appointments

When your vehicle requires warranty service, contact your dealer/retailer and request an appointment. By scheduling a service appointment and advising your service consultant of your transportation needs, your dealer/retailer can help minimize your inconvenience.

If your vehicle cannot be scheduled into the service department immediately, keep driving it until it can be scheduled for service, unless, of course, the problem is safety-related. If it is, please call your dealership/retailer, let them know this, and ask for instructions.

If the dealer/retailer requests you to bring the vehicle for service, you are urged to do so as early in the work day as possible to allow for the same day repair.

Courtesy Transportation

To enhance your ownership experience, we and our participating retailers are proud to offer Courtesy Transportation, a customer support program for vehicles with the Bumper to Bumper (Base Warranty Coverage period in Canada), extended powertrain, and hybrid specific warranties in both the U.S. and Canada.

Several courtesy transportation options are available to assist in reducing your inconvenience when warranty repairs are required.

Courtesy Transportation is not a part of the New Vehicle Limited Warranty. A separate booklet entitled "Warranty and Owner Assistance Information" furnished with each new vehicle provides detailed warranty coverage information.

Transportation Options

Warranty service can generally be completed while you wait. However, if you are unable to wait, Saturn helps to minimize your inconvenience by providing several transportation options. Depending on the circumstances, your retailer can offer you one of the following:

Shuttle Service

Shuttle service is the preferred means of offering Courtesy Transportation. Retailers may provide you with shuttle service to get you to your destination with minimal interruption of your daily schedule. This includes one-way or round trip shuttle service within reasonable time and distance parameters of the retailer's area.

Public Transportation or Fuel Reimbursement

If your vehicle requires overnight warranty repairs, and public transportation is used instead of the retailer's shuttle service, the expense must be supported by original receipts and can only be up to the maximum amount allowed by Saturn for shuttle service. In addition, for U.S. customers, should you arrange transportation through a friend or relative, limited reimbursement for reasonable fuel expenses may be available. Claim amounts should reflect actual costs and be supported by original receipts. See your retailer for information regarding the allowance amounts for reimbursement of fuel or other transportation costs.

12-10 Customer Information

Courtesy Rental Vehicle

Your retailer may arrange to provide you with a courtesy rental vehicle or reimburse you for a rental vehicle that you obtain if your vehicle is kept for an overnight warranty repair. Rental reimbursement will be limited and must be supported by original receipts. This requires that you sign and complete a rental agreement and meet state/provincial, local, and rental vehicle provider requirements. Requirements vary and may include minimum age requirements, insurance coverage, credit card, etc. You are responsible for fuel usage charges and may also be responsible for taxes, levies, usage fees, excessive mileage, or rental usage beyond the completion of the repair.

It may not be possible to provide a like-vehicle as a courtesy rental.

Additional Program Information

All program options, such as shuttle service, may not be available at every retailer. Please contact your retailer for specific information about availability. All Courtesy Transportation arrangements will be administered by appropriate retailer personnel.

Saturn reserves the right to unilaterally modify, change or discontinue Courtesy Transportation at any time and to resolve all questions of claim eligibility pursuant to the terms and conditions described herein at its sole discretion.

Collision Damage Repair

If your vehicle is involved in a collision and it is damaged, have the damage repaired by a qualified technician using the proper equipment and quality replacement parts. Poorly performed collision repairs diminish your vehicle's resale value, and safety performance can be compromised in subsequent collisions.

Collision Parts

Genuine GM Collision parts are new parts made with the same materials and construction methods as the parts with which your vehicle was originally built. Genuine GM Collision parts are your best choice to ensure that your vehicle's designed appearance, durability, and safety are preserved. The use of Genuine GM parts can help maintain your GM New Vehicle Warranty.

Recycled original equipment parts may also be used for repair. These parts are typically removed from vehicles that were total losses in prior crashes. In most cases, the parts being recycled are from undamaged sections of the vehicle. A recycled original equipment GM part, may be an acceptable choice to maintain your vehicle's originally designed appearance and safety performance, however, the history of these parts is not known. Such parts are not covered by your GM New Vehicle Limited Warranty, and any related failures are not covered by that warranty.

Aftermarket collision parts are also available. These are made by companies other than GM and may not have been tested for your vehicle. As a result, these parts may fit poorly, exhibit premature durability/corrosion problems, and may not perform properly in subsequent collisions.

Aftermarket parts are not covered by your GM New Vehicle Limited Warranty, and any vehicle failure related to such parts are not covered by that warranty.

Repair Facility

We recommend that you choose a collision repair facility that meets your needs before you ever need collision repairs. Your dealer/retailer may have a collision repair center with GM-trained technicians and state of the art equipment, or be able to recommend a collision repair center that has GM-trained technicians and comparable equipment.

Insuring Your Vehicle

Protect your investment in your GM vehicle with comprehensive and collision insurance coverage. There are significant differences in the quality of coverage afforded by various insurance policy terms.

Many insurance policies provide reduced protection to your GM vehicle by limiting compensation for damage repairs by using aftermarket collision parts. Some insurance companies will not specify aftermarket collision parts. When purchasing insurance, we recommend that you assure your vehicle will be repaired with GM original equipment collision parts. If such insurance coverage is not available from your current insurance carrier, consider switching to another insurance carrier.

If your vehicle is leased, the leasing company may require you to have insurance that assures repairs with Genuine GM Original Equipment Manufacturer (OEM) parts or Genuine Manufacturer replacement parts. Read your lease carefully, as you may be charged at the end of your lease for poor quality repairs.

12-12 Customer Information

If a Crash Occurs

Here is what to do if you are involved in a crash.

- Check to make sure that you are all right. If you are uninjured, make sure that no one else in your vehicle, or the other vehicle, is injured.
 - If there has been an injury, call emergency services for help. Do not leave the scene of a crash until all matters have been taken care of. Move your vehicle only if its position puts you in danger or you are instructed to move it by a police officer.
 - Give only the necessary and requested information to police and other parties involved in the crash. Do not discuss your personal condition, mental frame of mind, or anything unrelated to the crash. This will help guard against post-crash legal action.
- If you need roadside assistance, call GM Roadside Assistance. See *Roadside Assistance Program* on page 12-6 for more information.
 - If your vehicle cannot be driven, know where the towing service will be taking it. Get a card from the tow truck operator or write down the driver's name, the service's name, and the phone number.
 - Remove any valuables from your vehicle before it is towed away. Make sure this includes your insurance information and registration if you keep these items in your vehicle.
 - Gather the important information you will need from the other driver. Things like name, address, phone number, driver's

license number, vehicle license plate, vehicle make, model and model year, Vehicle Identification Number (VIN), insurance company and policy number, and a general description of the damage to the other vehicle.

- If possible, call your insurance company from the scene of the crash. They will walk you through the information they will need. If they ask for a police report, phone or go to the police department headquarters the next day and you can get a copy of the report for a nominal fee. In some states/provinces with "no fault" insurance laws, a report may not be necessary. This is especially true if there are no injuries and both vehicles are driveable.

- Choose a reputable collision repair facility for your vehicle. Whether you select a dealer/retailer or a private collision repair facility to fix the damage, make sure you are comfortable with them. Remember, you will have to feel comfortable with their work for a long time.
- Once you have an estimate, read it carefully and make sure you understand what work will be performed on your vehicle. If you have a question, ask for an explanation. Reputable shops welcome this opportunity.

Managing the Vehicle Damage Repair Process

In the event that your vehicle requires damage repairs, GM recommends that you take an active role in its repair. If you have a pre-determined repair facility of choice, take your vehicle there, or have it towed there. Specify to the facility that any required replacement collision parts be original equipment parts, either new Genuine GM parts or recycled original GM parts. Remember, recycled parts will not be covered by your GM vehicle warranty.

Insurance pays the bill for the repair, but you must live with the repair. Depending on your policy limits, your insurance company may initially value the repair using aftermarket parts. Discuss this with your repair professional, and insist on Genuine GM parts.

Remember if your vehicle is leased you may be obligated to have the vehicle repaired with Genuine GM parts, even if your insurance coverage does not pay the full cost.

If another party's insurance company is paying for the repairs, you are not obligated to accept a repair valuation based on that insurance company's collision policy repair limits, as you have no contractual limits with that company. In such cases, you can have control of the repair and parts choices as long as cost stays within reasonable limits.

Reporting Safety Defects

Reporting Safety Defects to the United States Government

If you believe that your vehicle has a defect which could cause a crash or could cause injury or death, you should immediately inform the National Highway Traffic Safety Administration (NHTSA), in addition to notifying Saturn Corporation.

If NHTSA receives similar complaints, it could open an investigation, and if it finds that a safety defect exists in a group of vehicles, it could order a recall and remedy campaign. However, NHTSA cannot become involved in individual problems between you, your retailer or Saturn Corporation.

To contact NHTSA, call the Vehicle Safety Hotline toll-free at 1-888-327-4236 (TTY: 1-800-424-9153); go to Safercar.gov; or write to:

Administrator, NHTSA
1200 New Jersey Avenue, S.E.
Washington D.C., 20590

You can also obtain other information about motor vehicle safety from Safercar.gov.

Reporting Safety Defects to the Canadian Government

If you live in Canada, and you believe that your vehicle has a safety defect, notify Transport Canada immediately, in addition to notifying General Motors of Canada Limited. Call them at 1-800-333-0510 or write to:

Transport Canada
Road Safety Branch
2780 Sheffield Road
Ottawa, Ontario K1B 3V9

Reporting Safety Defects to Saturn

In addition to notifying NHTSA (or Transport Canada) in a situation like this, please notify Saturn.

Call 1-800-553-6000, or write:

Saturn Corporation
100 Saturn Parkway
Mail Drop 371-999-S24
Spring Hill, TN 37174-1500

In Canada, call 1-800-263-1999, or write:

Saturn Customer Communication Centre
General Motors of Canada Limited
CA1-163-005
1908 Colonel Sam Drive
Oshawa, Ontario L1H 8P7

Service Publications Ordering Information

Service Manuals

A variety of publications are available to you. Saturn service manuals are written for trained technicians, and in some cases, specialized tools and equipment are necessary to complete certain repairs. However, the manuals are available to owners who either have the training, or wish to gain a greater understanding of the technical aspect of their Saturn.

For additional publications information or to order publications in the United States, call toll free 1-800-2-SATURN or visit Saturn-publications.com to order on-line.

In Canada, Saturn service manuals are available by calling toll free 1-800-551-4123.

Owner Publications

Information on how to obtain product bulletins and as described below is applicable only in the fifty U.S. states and the District of Columbia, and only for cars and light trucks with a Gross Vehicle Weight Rating (GVWR) less than 10,000 pounds (4 536 kg). Copies of individual bulletins are also at your participating Saturn retailer. You can ask to see them.

In Canada, information relating to product service bulletins can be obtained by contacting your Saturn retailer.

Service Bulletins

Saturn regularly sends its retailers useful service bulletins about Saturn products. Saturn monitors product performance in the field. We then prepare bulletins for servicing our products better. You can get these bulletins, too.

Bulletins cover various subjects. Some pertain to the proper use and care of your vehicle. Some describe costly repairs. Others describe inexpensive repairs which, if done on time with the latest parts, may avoid future costly repairs.

Some bulletins tell a technician how to repair a new or unexpected condition. Others describe a quicker way to fix your vehicle. They can help a technician service your vehicle better.

Most bulletins apply to conditions affecting a small number of vehicles. Your Saturn retailer or a qualified technician may have to determine if a specific bulletin applies to your vehicle. To order Saturn bulletins, call Saturn Publications at 1-800-2-SATURN or visit saturn-publications.com to order online.

Vehicle Data Recording and Privacy

Your Saturn vehicle has a number of sophisticated computers that record information about the vehicle's performance and how it is driven. For example, your vehicle uses computer modules to monitor and control engine and transmission performance, to monitor the conditions for airbag deployment and deploy airbags in a crash and, if so equipped, to provide antilock braking to help the driver control the vehicle. These modules may store data to help your dealer/retailer technician service your vehicle. Some modules may also store data about how you operate the vehicle, such as rate of fuel consumption or average speed. These modules may also retain the owner's personal preferences, such as radio pre-sets, seat positions, and temperature settings.

Event Data Recorders

This vehicle has an Event Data Recorder (EDR). The main purpose of an EDR is to record, in certain crash or near crash-like situations, such as an airbag deployment or hitting a road obstacle, data that will assist in understanding how a vehicle's systems performed. The EDR is designed to record data related to vehicle dynamics and safety systems for a short period of time, typically 30 seconds or less. The EDR in this vehicle is designed to record such data as:

- How various systems in your vehicle were operating
- Whether or not the driver and passenger safety belts were buckled/fastened
- How far, if at all, the driver was pressing the accelerator and/or brake pedal
- How fast the vehicle was traveling

This data can help provide a better understanding of the circumstances in which crashes and injuries occur.

Important: EDR data is recorded by your vehicle only if a non-trivial crash situation occurs; no data is recorded by the EDR under normal driving conditions and no personal data (e.g., name, gender, age, and crash location) is recorded. However, other parties, such as law enforcement, could combine the EDR data with the type of personally identifying data routinely acquired during a crash investigation.

To read data recorded by an EDR, special equipment is required, and access to the vehicle or the EDR is needed. In addition to the vehicle manufacturer, other parties, such as law enforcement, that have the special equipment, can read the information if they have access to the vehicle or the EDR.

Saturn will not access this data or share it with others except: with the consent of the vehicle owner or, if the vehicle is leased, with the consent of the lessee; in response to an official request of police or similar government office; as part of Saturn's defense of litigation through the discovery process; or, as required by law. Data that Saturn collects or receives may also be used for Saturn research needs or may be made available to others for research purposes, where a need is shown and the data is not tied to a specific vehicle or vehicle owner.

OnStar[®]

If your vehicle has OnStar and you subscribe to the OnStar services, please refer to the OnStar Terms and Conditions for information on data collection and use. See also *OnStar[®] System on page 4-38* in this manual for more information.

Navigation System

If your vehicle has a navigation system, use of the system may result in the storage of destinations, addresses, telephone numbers, and other trip information. Refer to the navigation system operating manual for information on stored data and for deletion instructions.

Radio Frequency Identification (RFID)

RFID technology is used in some vehicles for functions such as tire pressure monitoring and ignition system security, as well as in connection with conveniences such as key fobs for remote door locking/unlocking and starting, and in-vehicle transmitters for garage door openers. RFID technology in Saturn vehicles does not use or record personal information or link with any other Saturn system containing personal information.

A

Accessories and Modifications 9-3
 Accessory Power Outlets 4-10
 Adding Equipment to Your Airbag-Equipped Vehicle 1-36
 Additives, Fuel 8-34
 Add-On Electrical Equipment 9-34
 Air Cleaner/Filter, Engine 9-11
 Air Conditioning 7-1
 Airbag
 Passenger Status Indicator 4-15
 Readiness Light 4-14
 System, Replacing Parts After a Crash 1-37
 Airbag System 1-24
 Adding Equipment to Your Airbag-Equipped Vehicle 1-36
 Check 1-37
 How Does an Airbag Restrain? 1-28
 Passenger Sensing System 1-30

Airbag System (cont.)
 Servicing Your Airbag-Equipped Vehicle 1-35
 What Makes an Airbag Inflate? 1-28
 What Will You See After an Airbag Inflates? 1-29
 When Should an Airbag Inflate? 1-27
 Where Are the Airbags? 1-26
 Antenna, Fixed Mast 6-24
 Antilock Brake System (ABS) 8-18
 Antilock Brake, System Warning Light 4-17
 Appearance Care
 Chemical Paint Spotting 9-80
 Exterior Cleaning 9-76
 Finish Damage 9-79
 Interior Cleaning 9-73
 Sheet Metal Damage 9-79
 Underbody Maintenance 9-80
 Appointments, Scheduling Service 12-8

Audio System 6-1
 Audio Steering Wheel Controls 6-23
 Fixed Mast Antenna 6-24
 Radio Reception 6-24
 Theft-Deterrent Feature 6-23
 Audio System(s) 6-2
 Automatic Transmission
 Fluid 9-12
 Operation 8-6

B

Battery 9-25
 Run-Down Protection 5-4
 Brake Fluid 9-22
 Brakes 9-22
 System Warning Light 4-16
 Braking 8-17
 Break-In, New Vehicle 8-2
 Bulb Replacement
 Daytime Running Lamp 5-2
 Bulb Replacement
 Center High-Mounted Stoplamp (CHMSL) 9-29
 Fog Lamp 5-2
 Front Turn Signal Lamps ... 9-28

i-2 INDEX

Bulb Replacement (cont.)

- Halogen Bulbs 9-28
 - Headlamp Aiming 9-26
 - Headlamps 9-28
 - License Plate Lamps 9-33
 - Replacement Bulbs 9-34
 - Taillamps 9-30, 9-32
- Buying New Tires 9-54

C

- California Fuel 8-34
- California Perchlorate
Materials Requirements 9-3
- California Proposition 65
Warning 9-3
- Canadian Owners ii
- Capacities and
Specifications 10-2
- Carbon Monoxide 8-14, 8-27
- Care, Safety Belts 1-23
- Cargo Cover 3-2
- Cargo Tie Downs 3-2
- Cautions and Notices iii
- Center High-Mounted
Stoplamp (CHMSL) 9-29

- Chains, Tire 9-60
- Charging System Light 4-16
- Check
Engine Lamp 4-18
- Chemical Paint Spotting 9-80
- Child Restraints
Child Restraint Systems 1-43
Infants and Young
Children 1-40
Lower Anchors and
Tethers for Children 1-46
Older Children 1-38
Securing 1-51, 1-53
Where to Put the
Restraint 1-44
- Cleaning
Exterior 9-76
Interior 9-73
Underbody Maintenance 9-80
- Climate Control System 7-1
Outlet Adjustment 7-4
- Clutch, Hydraulic 9-12
- Collision Damage Repair 12-10
- Compact Spare Tire 9-68
- Content Theft-Deterrent 2-9
- Control of a Vehicle 8-17

Coolant

- Engine 9-16
- Engine Temperature
Warning Light 4-18
- Cooling System 9-12
- Courtesy
Transportation 12-5, 12-9
- Cruise Control 4-5
- Cruise Control Light 4-23
- Cupholders 3-1
- Customer Information
Courtesy
Transportation 12-5, 12-9
- Customer Assistance
Offices 12-5
- Customer Satisfaction
Procedure 12-1
- GM Mobility
Reimbursement
Program 12-6
- Online Owner Center 12-4
- Reporting Safety Defects
to Saturn 12-14
- Reporting Safety Defects
to the Canadian
Government 12-14

Customer Information (cont.)
 Reporting Safety Defects
 to the United States
 Government 12-14
 Roadside Assistance
 Program 12-6
 Service Publications
 Ordering Information 12-15

D

Defensive Driving 8-16
 Delayed Headlamps 5-2
 Doing Your Own
 Service Work 9-4
 Dome Lamps 5-3
 Door
 Ajar Light 4-23
 Locks 2-5
 Power Door Locks 2-6
 Rear Door Security Locks 2-6
 Driver Information
 Center (DIC) 4-25
 DIC Operation and
 Displays 4-26, 4-32
 DIC Warnings and
 Messages 4-36

Driving
 At Night 8-23
 Before a Long Trip 8-25
 Defensive 8-16
 Drunken 8-16
 Highway Hypnosis 8-25
 Hill and Mountain Roads 8-26
 In Rain and on Wet
 Roads 8-24
 Rocking Your Vehicle to
 Get it Out 8-29
 Winter 8-27
 Winter Mode Light 4-22
 Driving for Better Fuel
 Economy 8-15

E

EDR 12-16
 Electrical System
 Add-On Equipment 9-34
 Engine Compartment
 Fuse Block 9-35
 Fuses 9-35
 Headlamp Wiring 9-34
 Rear Compartment Fuse
 Block 9-37

Engine
 Air Cleaner/Filter 9-11
 Check and Service Engine
 Soon Lamp 4-18
 Coolant 9-16
 Coolant Temperature
 Warning Light 4-18
 Drive Belt Routing 11-15
 Engine Compartment
 Overview 9-6
 Exhaust 8-14
 Oil 9-7
 Oil Life System 9-9
 Overheating 9-18
 Starting 8-3
 Engine Heater 8-5
 Entry Lighting 5-3
 Event Data Recorders 12-16
 Extender, Safety Belt 1-22
 Exterior Lamps 5-1
 Exterior Lamps Off
 Reminder 4-23

F

Filter	
Engine Air Cleaner	9-11
Final Drive	
End Play Measurement	5-4
Finish Damage	9-79
Fixed Mast Antenna	6-24
Flashers, Hazard Warning	4-4
Flash-to-Pass	4-8
Flat Tire	9-60
Flat Tire, Changing	9-61
Flat Tire, Storing	9-66
Fluid	
Automatic Transmission	9-12
Power Steering	9-20
Windshield Washer	9-20
Fog Lamp	
Fog	5-2
Fog Lamp Light	4-22
Fuel	8-34
Additives	8-34
California Fuel	8-34
Driving for Better	
Economy	8-15
Filling a Portable Fuel	
Container	8-37

Fuel (cont.)

Filling the Tank	8-36
Fuels in Foreign	
Countries	8-35
Gage	4-24
Gasoline Octane	8-34
Gasoline Specifications	8-34
Low Warning Light	4-24
Fuses	9-35
Engine Compartment	
Fuse Block	9-35
Rear Compartment	
Fuse Block	9-37

G

Gage	
Fuel	4-24
Speedometer	4-13
Tachometer	4-13
Gasoline	
Octane	8-34
Specifications	8-34
Glove Box	3-1
GM Mobility Reimbursement	
Program	12-6

H

Hazard Warning Flashers	4-4
Head Restraints	1-5
Headlamp	
Aiming	9-26
Headlamp Wiring	9-34
Headlamps	
Bulb Replacement	9-28
Daytime Running Lamp	5-2
Delayed	5-2
Exterior Lamps	5-1
Flash-to-Pass	4-8
Front Turn Signal	
Lamps	9-28
Halogen Bulbs	9-28
High/Low Beam Changer	4-8
Heater	7-1
Engine	8-5
Height Adjuster, Seat	1-2
Highbeam On Light	4-23
High-Speed Operation,	
Tires	9-48
Highway Hypnosis	8-25
Hill and Mountain Roads	8-26
Hood	
Release	9-5

Horn 4-4
 How to Wear Safety Belts
 Properly 1-12
 Hydraulic Clutch 9-12

I

Ignition Positions 8-2
 Immobilizer 2-8
 Immobilizer Operation 2-8
 Infants and Young Children,
 Restraints 1-40
 Inflation - Tire Pressure 9-47
 Instrument Panel
 Brightness 5-3
 Cluster 4-12
 Overview 4-2

J

Jump Starting 9-69

K

Keyless Entry System 2-3
 Keys 2-2

L

Labeling, Tire Sidewall 9-42
 Lamp
 Malfunction Indicator 4-18
 Lamps
 Dome 5-3
 Exterior, Off Reminder 4-23
 Reading 5-3
 Lap-Shoulder Belt 1-18
 LATCH System
 Replacing Parts After a
 Crash 1-50
 LATCH System for Child
 Restraints 1-46
 License Plate Lamps 9-33
 Liftgate
 Carbon Monoxide 2-6
 Light
 Airbag Readiness 4-14
 Antilock Brake System
 (ABS) Warning 4-17
 Brake System Warning 4-16
 Charging System 4-16
 Cruise Control 4-23

Light (cont.)

 Door Ajar 4-23
 Engine Coolant
 Temperature Warning 4-18
 Fog Lamp 4-22
 Highbeam On 4-23
 Low Fuel Warning 4-24
 Low Oil Level 4-22
 Oil Pressure 4-21
 Passenger Airbag Status
 Indicator 4-15
 Safety Belt Reminders 4-13
 Service Vehicle Soon 4-23
 StabiliTrak® Indicator 4-17
 Tire Pressure 4-18
 Winter Driving Mode 4-22
 Lighting 5-3
 Entry 5-3
 Lights
 Exterior Lamps 5-1
 Flash-to-Pass 4-8
 High/Low Beam Changer 4-8
 Loading Your Vehicle 8-30

Locks	
Door	2-5
Power Door	2-6
Rear Door Security Locks	2-6
Loss of Control	8-22
Low Fuel Warning Light	4-24
Lower Anchors and Tethers	
for Children	1-46
Lumbar Seat Adjustment	1-3

M

Maintenance Replacement	
Parts	11-14
Maintenance Schedule	
Additional Required	
Services	11-6
At Each Fuel Fill	11-9
At Least Once a	
Month	11-10
At Least Once a Year	11-10
Introduction	11-1
Maintenance Footnotes	11-8
Maintenance Record	11-16
Maintenance Replacement	
Parts	11-14

Maintenance Schedule (cont.)	
Maintenance	
Requirements	11-1
Owner Checks and	
Services	11-9
Recommended Fluids	
and Lubricants	11-12
Scheduled Maintenance	11-3
Using	11-2
Your Vehicle and the	
Environment	11-2
Malfunction Indicator Lamp	4-18
Manual Seats	1-2
Manual Transmission	
Fluid	9-12
Operation	8-9
Message	
DIC Warnings and	
Messages	4-36
Mirrors	
Manual Rearview Mirror	2-11
Outside	2-11
Outside Power Mirrors	2-12
MyGMLink.com	12-4

N

Navigation System,	
Privacy	12-17
New Vehicle Break-In	8-2
Notices and Cautions	iii

O

Odometer	4-13
Odometers, Trip	4-13
Off-Road Recovery	8-21
Oil	
Engine	9-7
Low Oil Level Light	4-22
Pressure Light	4-21
Oil, Engine Oil Life System	9-9
Older Children, Restraints	1-38
OnStar, Privacy	12-17
OnStar [®] System, see	
OnStar [®] Manual	4-38
Outlet Adjustment	7-4
Outlets	
Accessory Power	4-10
Outside	
Mirrors	2-11
Power Mirrors	2-12

Owner Checks and Services 11-9
 Owner Checks, Service 9-4
 Owners, Canadian ii

P

Paint, Damage 9-79
 Park
 Shifting Into 8-11
 Shifting Out of 8-12
 Park Brake 8-10
 Parking
 Over Things That Burn 8-13
 Parking Your Vehicle 8-13
 Passenger Airbag Status Indicator 4-15
 Passenger Sensing System ... 1-30
 Passing 8-22
 Perchlorate Materials
 Requirements, California 9-3
 Power
 Door Locks 2-6
 Retained Accessory 8-3
 Steering Fluid 9-20
 Windows 2-10
 Pressure Cap 9-18

Privacy 12-16
 Event Data Recorders 12-16
 Navigation System 12-17
 OnStar 12-17
 Radio Frequency Identification 12-17

R

Radio Frequency Identification (RFID), Privacy 12-17
 Radio(s) 6-2
 Radios
 Reception 6-24
 Theft-Deterrent 6-23
 Reading Lamps 5-3
 Rear Door Security Locks 2-6
 Rear Heated Seats 1-6
 Rear Seat Operation 1-7
 Rear Windshield Washer/Wiper 4-9
 Rearview Mirrors 2-11
 Reclining Seatbacks 1-3
 Recommended Fluids and Lubricants 11-12
 Recreational Vehicle Towing ... 9-73
 Remote Keyless Entry (RKE) System 2-3

Remote Keyless Entry (RKE) System, Operation 2-4
 Removing the Flat Tire and Installing the Spare Tire 9-63
 Removing the Spare Tire and Tools 9-62
 Replacement Bulbs 9-34
 Replacing LATCH System Parts After a Crash 1-50
 Reporting Safety Defects
 Canadian Government 12-14
 Saturn 12-14
 United States Government 12-14
 Restraint System Check
 Replacing Airbag System Parts After a Crash 1-37
 Replacing Safety Belt System Parts After a Crash 1-23
 Retained Accessory Power 8-3
 Roadside Assistance Program 12-6
 Rocking Your Vehicle to Get it Out 8-29
 Routing, Engine Drive Belt ... 11-15
 Running the Vehicle While Parked 8-14

S

Safety Belt Reminders	4-13	Service	9-2	Spare Tire	
Safety Belts	1-8	Accessories and		Compact	9-68
Care of	1-23	Modifications	9-3	Installing	9-63
Check	1-22	Adding Equipment to the		Removing	9-62
How to Wear Safety		Outside of the Vehicle	9-4	Storing	9-66
Belts Properly	1-12	California Perchlorate		Specifications, Capacities	10-2
Lap-Shoulder Belt	1-18	Materials Requirements	9-3	Speedometer	4-13
Replacing Parts After a		California Proposition 65		StabiliTrak [®] Indicator Light	4-17
Crash	1-23	Warning	9-3	StabiliTrak [®] System	8-19
Safety Belt Extender	1-22	Doing Your Own Work	9-4	Starting the Engine	8-3
Safety Belt Use During		Engine Soon Lamp	4-18	Steering	8-20
Pregnancy	1-22	Owner Checks	9-4	Steering Wheel Controls,	
Scheduled Maintenance	11-3	Publications Ordering		Audio	6-23
Seats		Information	12-15	Steering Wheel, Tilt Wheel	4-4
Head Restraints	1-5	Vehicle Soon Light	4-23	Storage Areas	
Heated Seats - Rear	1-6	Service, Scheduling		Cupholders	3-1
Height Adjuster	1-2	Appointments	12-8	Glove Box	3-1
Lumbar Adjustment	1-3	Service, Your		Sunglasses Storage	
Rear Seat Operation	1-7	Airbag-Equipped Vehicle	1-35	Compartment	3-1
Reclining Seatbacks	1-3	Sheet Metal Damage	9-79	Stuck in Sand, Mud, Ice, or	
Securing Child		Shifting Into Park	8-11	Snow	8-29
Restraints	1-51, 1-53	Shifting Out of Park	8-12	Sun Visors	2-11
		Signals, Turn and		Sunroof	2-12
		Lane-Change	4-8		

T

Tachometer 4-13
 Taillamps 9-30, 9-32
 Theft-Deterrent, Radio 6-23
 Theft-Deterrent Systems 2-8
 Content Theft-Deterrent 2-9
 Immobilizer 2-8
 Immobilizer Operation 2-8
 Tilt Wheel 4-4
 Tire
 Pressure Light 4-18
 Tires 9-40
 Buying New Tires 9-54
 Chains 9-60
 Changing a Flat Tire 9-61
 Compact Spare Tire 9-68
 Different Size 9-56
 High-Speed Operation 9-48
 If a Tire Goes Flat 9-60
 Inflation - Tire Pressure 9-47
 Inspection and Rotation 9-52
 Installing the Spare Tire 9-63
 Pressure Monitor
 Operation 9-51
 Pressure Monitor
 System 9-49
 Removing the Flat Tire 9-63

Tires (cont.)

 Removing the Spare Tire
 and Tools 9-62
 Storing a Flat or Spare
 Tire and Tools 9-66
 Tire Sidewall Labeling 9-42
 Tire Terminology and
 Definitions 9-44
 Uniform Tire Quality
 Grading 9-57
 Wheel Alignment and
 Tire Balance 9-58
 Wheel Replacement 9-59
 When It Is Time for
 New Tires 9-54
 Winter Tires 9-41
 Towing
 Recreational Vehicle 9-73
 Towing a Trailer 9-73
 Your Vehicle 9-73
 Traction
 StabiliTrak® System 8-19
 Transmission
 Fluid, Automatic 9-12
 Fluid, Manual 9-12
 Transmission Operation,
 Automatic 8-6
 Transmission Operation,
 Manual 8-9

Trip Odometers 4-13
 Turn and Lane-Change
 Signals 4-8
 Turn Signal/Multifunction
 Lever 4-4

U

Uniform Tire Quality
 Grading 9-57

V

Vehicle
 Control 8-17
 Loading 8-30
 Parking Your 8-13
 Running While Parked 8-14
 Service Soon Light 4-23
 Symbols iii
 Vehicle Data Recording and
 Privacy 12-16
 Vehicle Identification
 Number (VIN) 10-1
 Service Parts Identification
 Label 10-1
 Ventilation Adjustment 7-4
 Visors 2-11

W

Warning Lights, Gages and Indicators 4-11

Warnings

- DIC Warnings and Messages 4-36
- Hazard Warning Flashers 4-4

Wheels

- Alignment and Tire Balance 9-58
- Different Size 9-56
- Replacement 9-59

Where to Put the Restraint 1-44

Windows 2-10

- Power 2-10

Windshield

- Washer 4-9
- Washer Fluid 9-20
- Wiper Blade Replacement 9-21
- Wipers 4-8

Windshield, Rear Washer/Wiper 4-9

- Wiper 4-9

Winter Driving 8-27

- Winter Driving Mode Light 4-22
- Winter Tires 9-41

Y

Your Vehicle and the Environment 11-2