

2005 Pontiac Vibe Owner Manual

Seats and Restraint Systems	1-1	Driving Your Vehicle	4-1
Front Seats	1-2	Your Driving, the Road, and Your Vehicle	4-2
Rear Seats	1-7	Towing	4-37
Safety Belts	1-8	Service and Appearance Care	5-1
Child Restraints	1-26	Service	5-3
Airbag System	1-46	Fuel	5-5
Restraint System Check	1-62	Checking Things Under the Hood	5-10
Features and Controls	2-1	All-Wheel Drive	5-48
Keys	2-2	Bulb Replacement	5-49
Doors and Locks	2-7	Windshield Wiper Blade Replacement	5-56
Windows	2-13	Tires	5-57
Theft-Deterrent Systems	2-15	Appearance Care	5-87
Starting and Operating Your Vehicle	2-17	Vehicle Identification	5-95
Mirrors	2-34	Electrical System	5-95
OnStar® System	2-35	Capacities and Specifications	5-100
Storage Areas	2-37	Normal Maintenance Replacement Parts	5-102
Sunroof	2-40	Maintenance Schedule	6-1
Instrument Panel	3-1	Maintenance Schedule	6-2
Instrument Panel Overview	3-4	Customer Assistance and Information	7-1
Climate Controls	3-20	Customer Assistance and Information	7-2
Warning Lights, Gages, and Indicators	3-25	Reporting Safety Defects	7-10
Audio System(s)	3-42	Index	1



GENERAL MOTORS, GM, the GM Emblem, PONTIAC, the PONTIAC Emblem and the name VIBE are registered trademarks of General Motors Corporation.

This manual includes the latest information at the time it was printed. We reserve the right to make changes after that time without further notice. For vehicles first sold in Canada, substitute the name "General Motors of Canada Limited" for Pontiac Division whenever it appears in this manual.

Keep this manual in the vehicle, so it will be there if it is needed when on the road. If the vehicle is sold, leave this manual in it so the new owner can use it.

Canadian Owners

A French language copy of this manual can be obtained from your dealer or from:

Helm, Incorporated
P.O. Box 07130
Detroit, MI 48207

How to Use This Manual

Many people read the owner manual from beginning to end when they first receive their new vehicle. If this is done, it can help you learn about the features and controls for the vehicle. Pictures and words work together in the owner manual to explain things.

Index

A good place to quickly locate information about the vehicle is the Index in the back of the manual. It is an alphabetical list of what is in the manual and the page number where it can be found.

Safety Warnings and Symbols

There are a number of safety cautions in this book. We use a box and the word CAUTION to tell about things that could hurt you if you were to ignore the warning.

 **CAUTION:**

These mean there is something that could hurt you or other people.

In the caution area, we tell you what the hazard is. Then we tell you what to do to help avoid or reduce the hazard. Please read these cautions. If you do not, you or others could be hurt.

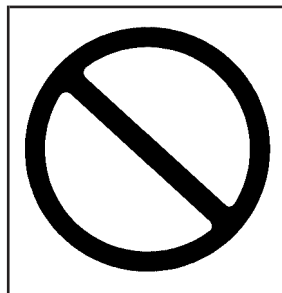

You will also find a circle with a slash through it in this book. This safety symbol means “Do Not,” “Do Not do this” or “Do Not let this happen.”

Vehicle Damage Warnings

Also, in this manual you will find these notices:

Notice: These mean there is something that could damage your vehicle.

A notice tells about something that can damage the vehicle. Many times, this damage would not be covered by your vehicle's warranty, and it could be costly. But the notice will tell what to do to help avoid the damage.

When you read other manuals, you might see CAUTION and NOTICE warnings in different colors or in different words.

There are also warning labels on the vehicle. They use the same words, CAUTION or NOTICE.

































Vehicle Symbols

The vehicle has components and labels that use symbols instead of text. Symbols are shown along with the text describing the operation or information relating to a specific component, control, message, gage, or indicator.

If you need help figuring out a specific name of a component, gage, or indicator, reference the following topics:

- Seats and Restraint Systems in Section 1
- Features and Controls in Section 2
- Instrument Panel Overview in Section 3
- Climate Controls in Section 3
- Warning Lights, Gages, and Indicators in Section 3
- Audio System(s) in Section 3
- Engine Compartment Overview in Section 5

These are some examples of symbols that may be found on the vehicle:

<p>CAUTION POSSIBLE INJURY </p>	<p>LATCH BOTH LAP AND SHOULDER BELTS TO PROTECT OCCUPANT DO NOT TWIST SAFETY BELT WHEN ATTACHING  </p>	<p>MASTER LIGHTING SWITCH </p>	<p>ENGINE COOLANT TEMP </p>	<p>FUSE BOX ACCESS </p>	
<p>PROTECT EYES BY SHIELDING </p>	<p>FASTEN SEAT BELTS </p>	<p>AIR BAG </p>	<p>TURN SIGNALS </p>	<p>BATTERY CHARGING SYSTEM </p>	<p>ENGINE COOLANT FAN </p>
<p>CAUSTIC BATTERY ACID COULD CAUSE BURNS </p>	<p>MOVE SEAT FULLY REARWARD SECURE CHILD SEAT </p>	<p>DO NOT INSTALL A REAR-FACING CHILD RESTRAINT IN THIS SEATING POSITION </p>	<p>PARKING LAMPS </p>	<p>BRAKE </p>	<p>FUEL </p>
<p>AVOID SPARKS OR FLAMES </p>	<p>PULL BELT OUT COMPLETELY THEN SECURE CHILD SEAT </p>	<p>DO NOT INSTALL A FORWARD-FACING CHILD RESTRAINT IN THIS SEATING POSITION </p>	<p>HAZARD WARNING FLASHER </p>	<p>COOLANT </p>	<p>OWNER'S MANUAL </p>
<p>SPARK OR FLAME COULD EXPLODE BATTERY </p>	<p>POWER WINDOW </p>	<p>DOOR LOCK UNLOCK </p>	<p>DAYTIME RUNNING LAMPS </p>	<p>ENGINE OIL PRESSURE </p>	<p>SERVICE MANUAL </p>
			<p>FOG LAMPS </p>	<p>ANTI-LOCK BRAKES </p>	

 **NOTES**

Section 1 Seats and Restraint Systems

Front Seats	1-2	Top Strap	1-35
Manual Seats	1-2	Top Strap Anchor Location	1-37
Driver Seat Height Adjuster	1-3	Lower Anchorages and Top Tethers for Children (LATCH System)	1-38
Reclining Seatbacks	1-3	Securing a Child Restraint Designed for the LATCH System	1-39
Head Restraints	1-5	Securing a Child Restraint in a Rear Seat Position	1-40
Passenger Folding Seatback	1-5	Securing a Child Restraint in the Right Front Seat Position	1-42
Rear Seats	1-7	Airbag System	1-46
Rear Seat Operation	1-7	Where Are the Airbags?	1-49
Safety Belts	1-8	When Should an Airbag Inflate?	1-51
Safety Belts: They Are for Everyone	1-8	What Makes an Airbag Inflate?	1-53
Questions and Answers About Safety Belts	1-13	How Does an Airbag Restrain?	1-53
How to Wear Safety Belts Properly	1-14	What Will You See After an Airbag Inflates?	1-54
Driver Position	1-14	Passenger Sensing System	1-56
Shoulder Belt Height Adjustment	1-20	Servicing Your Airbag-Equipped Vehicle	1-60
Safety Belt Use During Pregnancy	1-21	Adding Equipment to Your Airbag-Equipped Vehicle	1-61
Right Front Passenger Position	1-21	Restraint System Check	1-62
Rear Seat Passengers	1-21	Checking Your Restraint Systems	1-62
Safety Belt Pretensioners	1-24	Replacing Restraint System Parts After a Crash	1-63
Safety Belt Extender	1-25		
Child Restraints	1-26		
Older Children	1-26		
Infants and Young Children	1-28		
Child Restraint Systems	1-31		
Where to Put the Restraint	1-34		

Front Seats

Manual Seats

CAUTION:

You can lose control of the vehicle if you try to adjust a manual driver's seat while the vehicle is moving. The sudden movement could startle and confuse you, or make you push a pedal when you do not want to. Adjust the driver's seat only when the vehicle is not moving.



Lift the bar located under the front seat to unlock it. Slide the seat to where you want it and release the bar. Try to move the seat with your body, to make sure the seat is locked into place.

Don't put anything under the front seats. Items under the seats could keep the seats from locking into place properly.

Driver Seat Height Adjuster

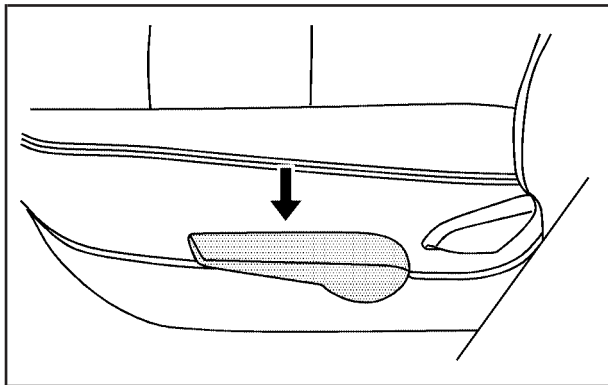

The manual driver seat height adjuster is located on the outboard side of the seat. To raise the seat, ratchet the lever upward until the seat is at the desired height. To lower the seat, ratchet the lever downward until the seat is at the desired height.

It is easier to use the adjuster when the seat is unoccupied. Make sure the vehicle is in PARK (P) before adjusting the seat.

Reclining Seatbacks

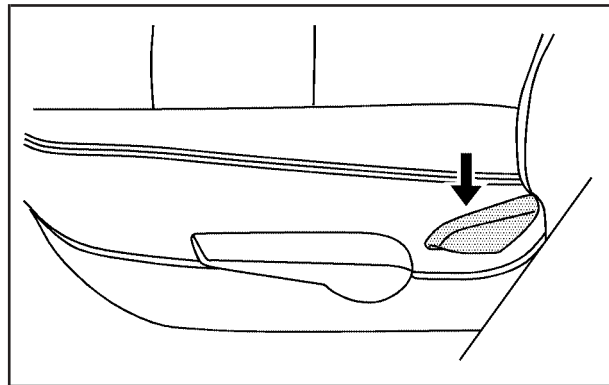

To adjust the seatback, lift the lever located on the outboard side of the seat. Release the lever to lock the seatback where you want it. Push on the seat to make sure it is locked into position. Pull up on the lever without pushing on the seatback, and the seat will go to its original upright position.



But do not have a seatback reclined if your vehicle is moving.

⚠ CAUTION:

Sitting in a reclined position when your vehicle is in motion can be dangerous. Even if you buckle up, your safety belts can not do their job when you are reclined like this.

The shoulder belt can not do its job because it will not be against your body. Instead, it will be in front of you. In a crash you could go into it, receiving neck or other injuries.

The lap belt can not do its job either. In a crash the belt could go up over your abdomen. The belt forces would be there, not at your pelvic bones. This could cause serious internal injuries.

For proper protection when the vehicle is in motion, have the seatback upright. Then sit well back in the seat and wear your safety belt properly.

Head Restraints



Adjust your head restraint so that the top of the restraint is closest to the top of your head. This position reduces the chance of a neck injury in a crash.

Press the release button near the base of the restraint to lower and raise the restraint to a comfortable position.

Passenger Folding Seatback

CAUTION:

If you fold the seatback forward to carry longer objects, such as skis, be sure any such cargo is not near an airbag. In a crash, an inflating airbag might force that object toward a person. This could cause severe injury or even death. Secure objects away from the area in which an airbag would inflate. For more information, see *Where Are the Airbags?* on page 1-49 and *Loading Your Vehicle* on page 4-32.

CAUTION:

Things you put on this seatback can strike and injure people in a sudden stop or turn, or in a crash. Remove or secure all items before driving.

You can fold the front passenger's seatback down to allow for more cargo space or as a temporary table while the vehicle is stopped.

To fold the seatback down, do the following:

1. Lower the head restraint to the lowest position and make sure the seatback is at the most upright position and locked.
2. Pull up on one of the levers located on either side of the back of the passenger's seatback.



3. Fold the seatback down.

To raise the seatback, do the following:

1. Pull the seatback up and push it back to lock it into place. Make sure the safety belt is not twisted or caught in the seatback.
2. Push and pull the top of the seatback to be sure it is locked into position.
3. Use the reclining front seatback lever to adjust the seatback to a comfortable position.

Rear Seats

Rear Seat Operation

You can fold either side of the seatback down for more cargo space. The rear right side seatback can also be used as a temporary table while the vehicle is stopped. Make sure the front seatback isn't reclined or in the rearward most position. If it is, the rear seatback won't fold down all the way.

CAUTION:

A rear seatback folded forward, or any other object contacting or pressing the front seatback may affect the proper functioning of the passenger sensing system. See *Passenger Sensing System* on page 1-56.

CAUTION:

If the seatback is not locked, it could move forward in a sudden stop or crash. That could cause injury to the person sitting there. Always press rearward on the seatback to be sure it is locked.

CAUTION:

A safety belt that is improperly routed, not properly attached, or twisted will not provide the protection needed in a crash. The person wearing the belt could be seriously injured. After raising the rear seatback, always check to be sure that the safety belts are properly routed and attached, and are not twisted.

To fold either seatback down, do the following:



1. Pull up on the lock release knob, located on the top of the seatbacks.

2. Fold the seatback down. Each seatback can be folded separately.

To raise the seatback, do the following:

1. Pull the seatback up and push it back to lock it into place. Make sure the safety belts are not twisted or caught in the seatback.
2. Push and pull the top of the seatback to be sure it is locked into position.

Safety Belts

Safety Belts: They Are for Everyone

This part of the manual tells you how to use safety belts properly. It also tells you some things you should not do with safety belts.

CAUTION:

Do not let anyone ride where he or she can not wear a safety belt properly. If you are in a crash and you are not wearing a safety belt, your injuries can be much worse. You can hit things inside the vehicle or be ejected from it. You can be seriously injured or killed. In the same crash, you might not be, if you are buckled up. Always fasten your safety belt, and check that your passengers' belts are fastened properly too.

⚠ CAUTION:

It is extremely dangerous to ride in a cargo area, inside or outside of a vehicle. In a collision, people riding in these areas are more likely to be seriously injured or killed. Do not allow people to ride in any area of your vehicle that is not equipped with seats and safety belts. Be sure everyone in your vehicle is in a seat and using a safety belt properly.



Your vehicle has a light that comes on as a reminder to buckle up. See *Safety Belt Reminder Light* on page 3-28.

In most states and in all Canadian provinces, the law says to wear safety belts. Here is why: *They work.*

You never know if you will be in a crash. If you do have a crash, you do not know if it will be a bad one.

A few crashes are mild, and some crashes can be so serious that even buckled up, a person would not survive. But most crashes are in between. In many of them, people who buckle up can survive and sometimes walk away. Without belts they could have been badly hurt or killed.

After more than 30 years of safety belts in vehicles, the facts are clear. In most crashes buckling up does matter... a lot!

Why Safety Belts Work

When you ride in or on anything, you go as fast as it goes.

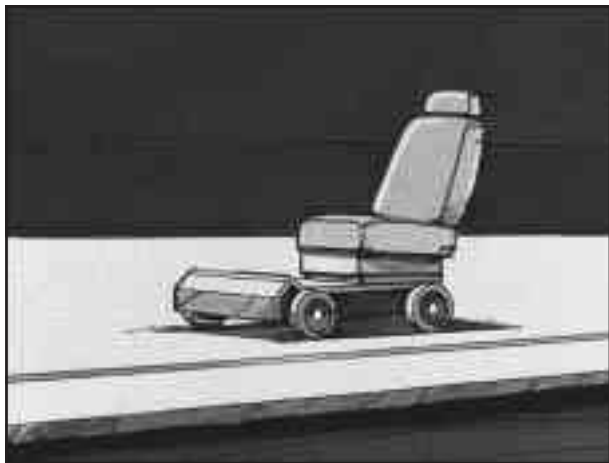

Take the simplest vehicle. Suppose it is just a seat on wheels.



Put someone on it.

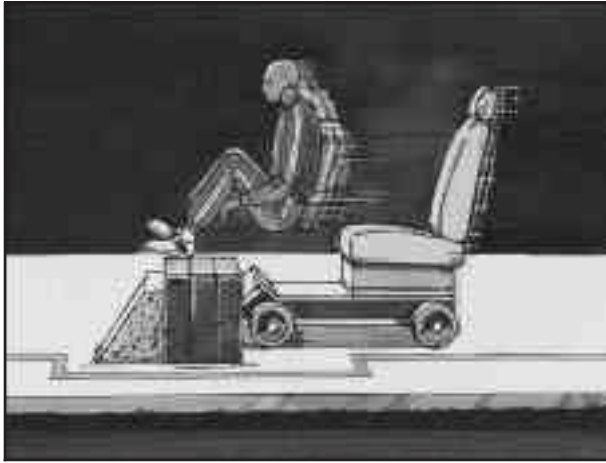

Get it up to speed. Then stop the vehicle. The rider does not stop.



The person keeps going until stopped by something. In a real vehicle, it could be the windshield...



or the instrument panel...



or the safety belts!

With safety belts, you slow down as the vehicle does. You get more time to stop. You stop over more distance, and your strongest bones take the forces. That is why safety belts make such good sense.

Questions and Answers About Safety Belts

Q: Will I be trapped in the vehicle after an accident if I am wearing a safety belt?

A: You *could* be — whether you are wearing a safety belt or not. But you can unbuckle a safety belt, even if you are upside down. And your chance of being conscious during and after an accident, so you *can* unbuckle and get out, is *much* greater if you are belted.

Q: If my vehicle has airbags, why should I have to wear safety belts?

A: Airbags are in many vehicles today and will be in most of them in the future. But they are supplemental systems only; so they work *with* safety belts — not instead of them. Every airbag system ever offered for sale has required the use of safety belts. Even if you are in a vehicle that has airbags, you still have to buckle up to get the most protection. That is true not only in frontal collisions, but especially in side and other collisions.

Q: If I am a good driver, and I never drive far from home, why should I wear safety belts?

A: You may be an excellent driver, but if you are in an accident — even one that is not your fault — you and your passengers can be hurt. Being a good driver does not protect you from things beyond your control, such as bad drivers.

Most accidents occur within 25 miles (40 km) of home. And the greatest number of serious injuries and deaths occur at speeds of less than 40 mph (65 km/h).

Safety belts are for everyone.

How to Wear Safety Belts Properly

This part is only for people of adult size.

Be aware that there are special things to know about safety belts and children. And there are different rules for smaller children and babies. If a child will be riding in your vehicle, see *Older Children on page 1-26* or *Infants and Young Children on page 1-28*. Follow those rules for everyone's protection.

First, you will want to know which restraint systems your vehicle has.

We will start with the driver position.

Driver Position

Lap-Shoulder Belt

The driver has a lap-shoulder belt. Here is how to wear it properly.

1. Close and lock the door.
2. Adjust the seat so you can sit up straight. To see how, see "Seats" in the Index.

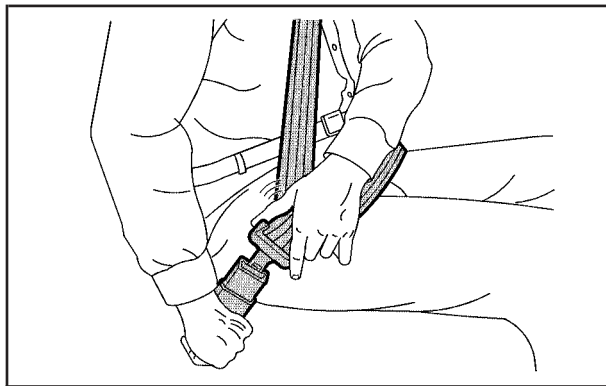

3. Pick up the latch plate and pull the belt across you. Do not let it get twisted.

The shoulder belt may lock if you pull the belt across you very quickly. If this happens, let the belt go back slightly to unlock it. Then pull the belt across you more slowly.

4. Push the latch plate into the buckle until it clicks. Pull up on the latch plate to make sure it is secure. If the belt is not long enough, see *Safety Belt Extender on page 1-25*.

Make sure the release button on the buckle is positioned so you would be able to unbuckle the safety belt quickly if you ever had to.

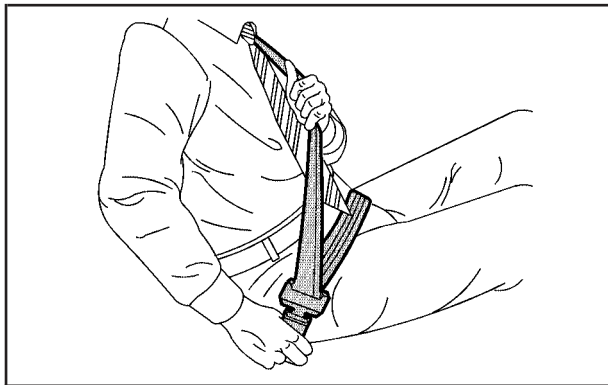

5. To make the lap part tight, pull down on the buckle end of the belt as you pull up on the shoulder belt.

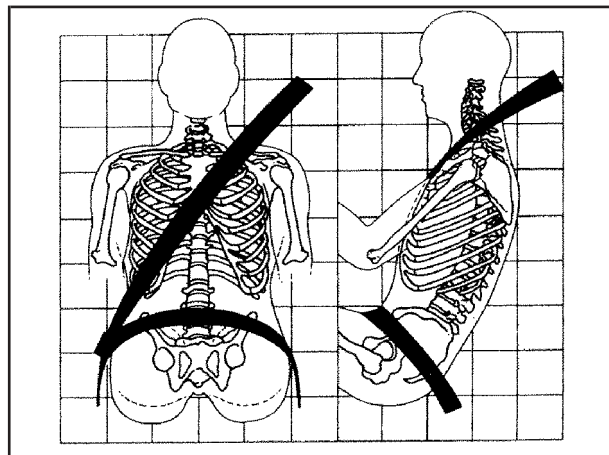

6. The lap part of the belt should be worn low and snug on the hips, just touching the thighs. In a crash, this applies force to the strong pelvic bones. And you would be less likely to slide under the lap belt. If you slid under it, the belt would apply force at your abdomen. This could cause serious or even fatal injuries. The shoulder belt should go over the shoulder and across the chest. These parts of the body are best able to take belt restraining forces. The safety belt locks if there is a sudden stop or crash, or if you pull the belt very quickly out of the retractor.

Q: What is wrong with this?

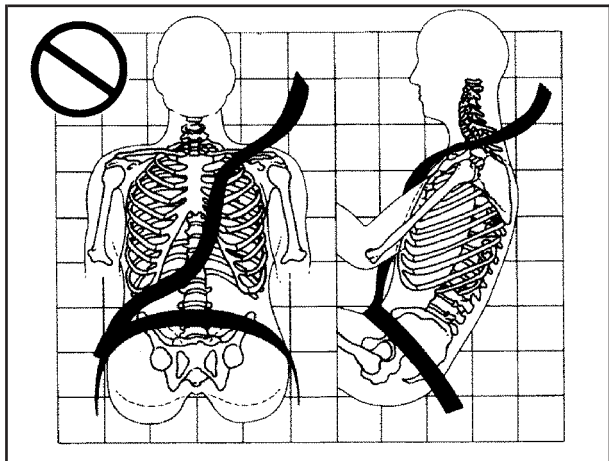

A: The shoulder belt is too loose. It will not give nearly as much protection this way.

⚠ CAUTION:

You can be seriously hurt if your shoulder belt is too loose. In a crash, you would move forward too much, which could increase injury. The shoulder belt should fit against your body.

Q: What is wrong with this?

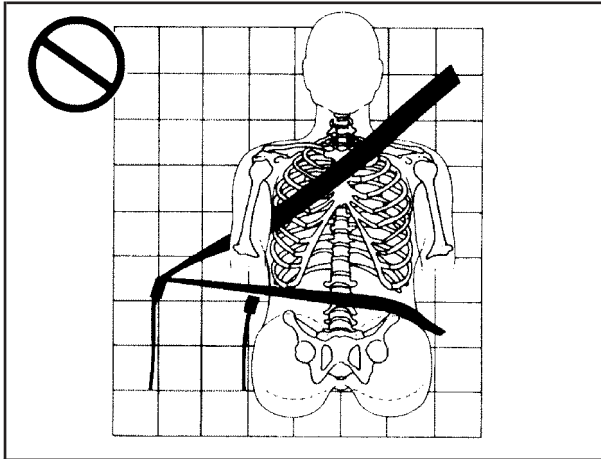

A: The belt is buckled in the wrong place.

⚠ CAUTION:

You can be seriously injured if your belt is buckled in the wrong place like this. In a crash, the belt would go up over your abdomen. The belt forces would be there, not at the pelvic bones. This could cause serious internal injuries. Always buckle your belt into the buckle nearest you.

Q: What is wrong with this?

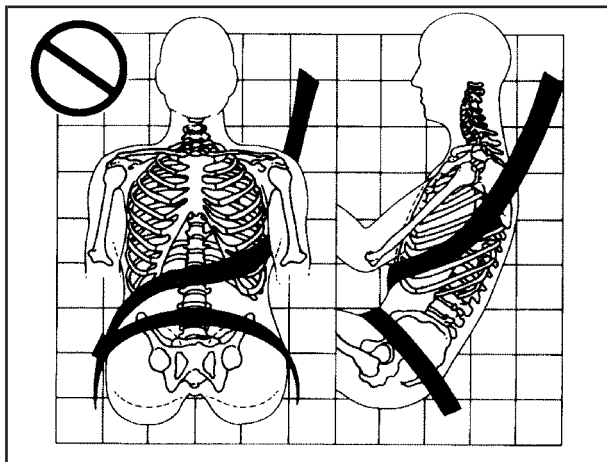

A: The shoulder belt is worn under the arm. It should be worn over the shoulder at all times.

⚠ CAUTION:

You can be seriously injured if you wear the shoulder belt under your arm. In a crash, your body would move too far forward, which would increase the chance of head and neck injury. Also, the belt would apply too much force to the ribs, which are not as strong as shoulder bones. You could also severely injure internal organs like your liver or spleen.

Q: What is wrong with this?

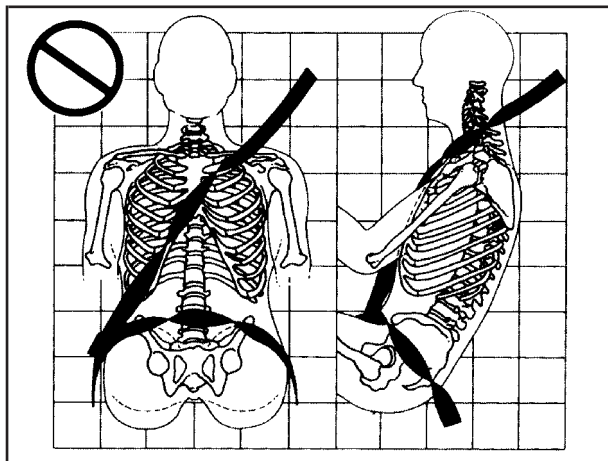

A: The belt is twisted across the body.

⚠ CAUTION:

You can be seriously injured by a twisted belt. In a crash, you would not have the full width of the belt to spread impact forces. If a belt is twisted, make it straight so it can work properly, or ask your dealer to fix it.

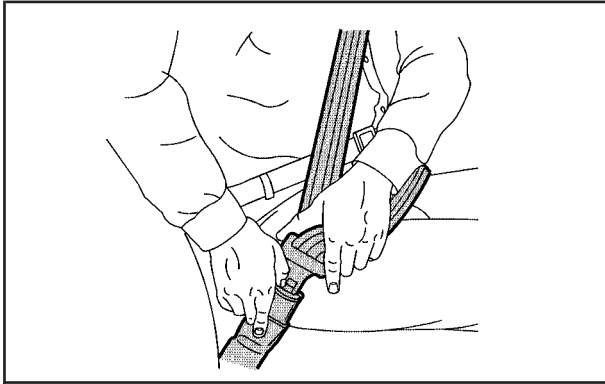

To unlatch the belt, just push the button on the buckle. The belt should go back out of the way.

Before you close the door, be sure the belt is out of the way. If you slam the door on it, you can damage both the belt and your vehicle.

Shoulder Belt Height Adjustment

Before you begin to drive, move the shoulder belt adjuster to the height that is right for you. Adjust the height so that the shoulder portion of the belt is centered on your shoulder. The belt should be away from your face and neck, but not falling off your shoulder.



To move it down, squeeze the button and move the height adjuster to the desired position. You can move the adjuster up just by pushing up on the shoulder belt guide.

After you move the adjuster to where you want it, try to move it down without squeezing the release button to make sure it has locked into position.

Safety Belt Use During Pregnancy

Safety belts work for everyone, including pregnant women. Like all occupants, they are more likely to be seriously injured if they do not wear safety belts.

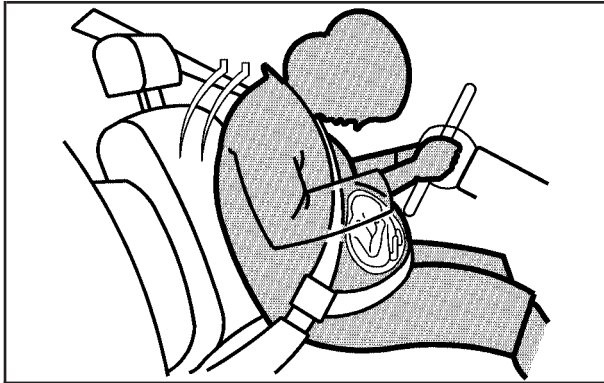

A pregnant woman should wear a lap-shoulder belt, and the lap portion should be worn as low as possible, below the rounding, throughout the pregnancy.

The best way to protect the fetus is to protect the mother. When a safety belt is worn properly, it is more likely that the fetus will not be hurt in a crash. For pregnant women, as for anyone, the key to making safety belts effective is wearing them properly.

Right Front Passenger Position

To learn how to wear the right front passenger's safety belt properly, see *Driver Position on page 1-14*.

The right front passenger's safety belt works the same way as the driver's safety belt – except for one thing. If you ever pull the shoulder portion of the belt out all the way, you will engage the child restraint locking feature. If this happens, just let the belt go back all the way and start again.

Rear Seat Passengers

It is very important for rear seat passengers to buckle up! Accident statistics show that unbelted people in the rear seat are hurt more often in crashes than those who are wearing safety belts.

Rear passengers who are not safety belted can be thrown out of the vehicle in a crash. And they can strike others in the vehicle who are wearing safety belts.

Lap-Shoulder Belt

All rear seating positions have lap-shoulder belts. Here is how to wear one properly.

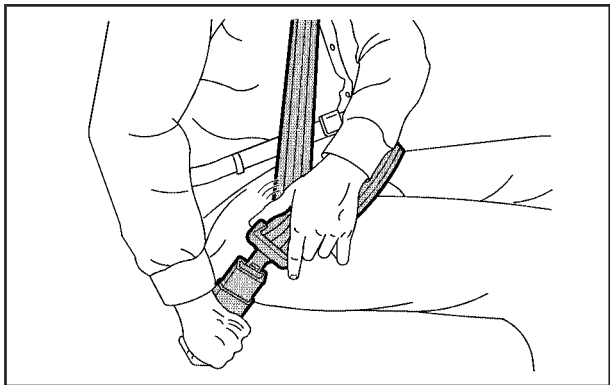

1. Pick up the latch plate and pull the belt across you. Do not let it get twisted.

The shoulder belt may lock if you pull the belt across you very quickly. If this happens, let the belt go back slightly to unlock it. Then pull the belt across you more slowly.

2. Push the latch plate into the buckle until it clicks. Pull up on the latch plate to make sure it is secure. If the buckle does not click, check to be sure that you are using the correct buckle. The buckle for the center rear passenger position has the word **CENTER** on it.

When the shoulder belt is pulled out all the way, it will lock. If it does, let it go back all the way and start again.

If the belt is not long enough, see *Safety Belt Extender* on page 1-25.

Make sure the release button on the buckle is positioned so you would be able to unbuckle the safety belt quickly if you ever had to.

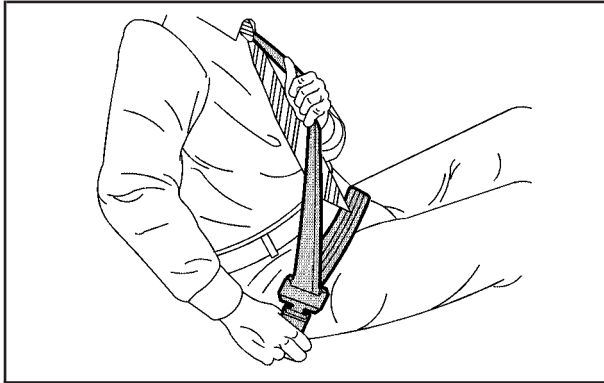

3. To make the lap part tight, pull down on the buckle end of the belt as you pull up on the shoulder belt.

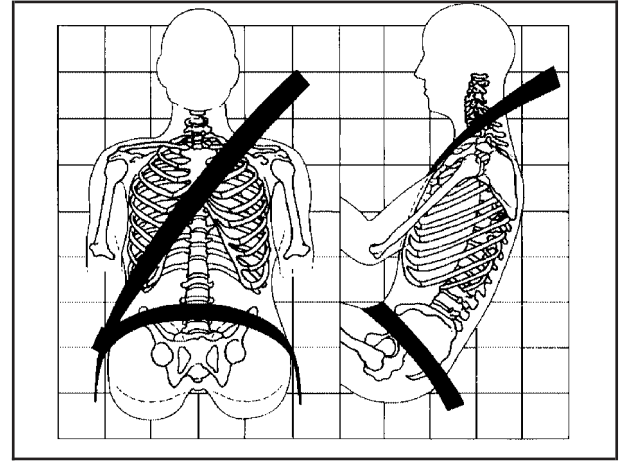

The lap part of the belt should be worn low and snug on the hips, just touching the thighs. In a crash, this applies force to the pelvic bones. And you would be less likely to slide under the lap belt. If you slid under it, the belt would apply force at your abdomen. This could cause serious or even fatal injuries. The shoulder belt should go over the shoulder and across the chest. These parts of the body are best able to take belt restraining forces.

The safety belt locks if there is a sudden stop or a crash, or if you pull the belt very quickly out of the retractor.

CAUTION:

You can be seriously hurt if your shoulder belt is too loose. In a crash, you would move forward too much, which could increase injury. The shoulder belt should fit against your body.

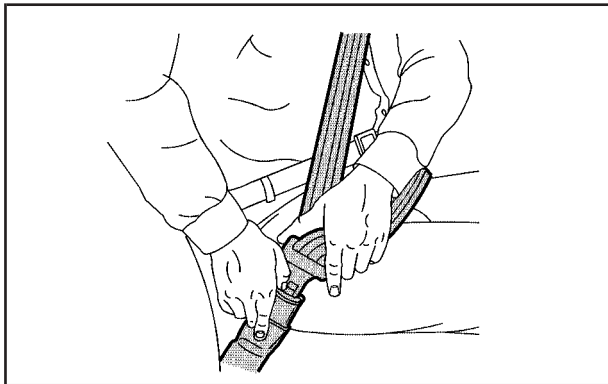

To unlatch the belt, just push the button on the buckle.

Safety Belt Pretensioners

Your vehicle has safety belt pretensioners. Although you cannot see them, they are located on the retractor part of the safety belts for the driver and right front passenger. They help the safety belts reduce a person's forward movement in a moderate to severe frontal or near frontal crash.

If the passenger sensing system detects that there is not a passenger in the right front passenger position, the safety belt pretensioner for that position will not activate. See *Passenger Sensing System* on page 1-56.

Pretensioners work only once. If they activate in a crash, you will need to get new ones, and probably other new parts for your safety belt system. See *Replacing Restraint System Parts After a Crash* on page 1-63.

Safety Belt Extender

If the vehicle's safety belt will fasten around you, you should use it.

But if a safety belt is not long enough, your dealer will order you an extender. It is free. When you go in to order it, take the heaviest coat you will wear, so the extender will be long enough for you. To help avoid personal injury, do not let someone else use it, and use it only for the seat it is made to fit. The extender has been designed for adults. Never use it for securing child seats. To wear it, just attach it to the regular safety belt. For more information see the instruction sheet that comes with the extender.

Always disconnect the extender from the safety belt after you use it so that the airbag will work properly the next time someone uses that seat.

When you use a safety belt extender in the right front passenger's seat, make sure the passenger airbag status indicator shows "ON". See *Passenger Airbag Status Indicator on page 3-30*. If the indicator shows "OFF", disconnect the extender's latch from the buckle then reconnect the safety belt. Make sure the indicator light shows "ON, then reconnect the safety belt extender. If you use the safety belt extender while the indicator light shows "OFF", the right front passenger's frontal and seat-mounted side impact airbags (if equipped) may not activate correctly. See *Airbag System on page 1-46* for important safety information about your airbags.

Child Restraints

Older Children

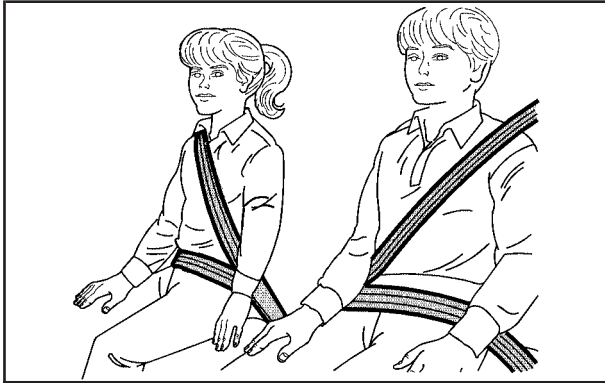

Older children who have outgrown booster seats should wear the vehicle's safety belts.

Q: What is the proper way to wear safety belts?

A: If possible, an older child should wear a lap-shoulder belt and get the additional restraint a shoulder belt can provide. The shoulder belt should not cross the face or neck. The lap belt should fit snugly below the hips, just touching the top of the thighs. It should never be worn over the abdomen, which could cause severe or even fatal internal injuries in a crash.

Accident statistics show that children are safer if they are restrained in the rear seat.

In a crash, children who are not buckled up can strike other people who are buckled up, or can be thrown out of the vehicle. Older children need to use safety belts properly.

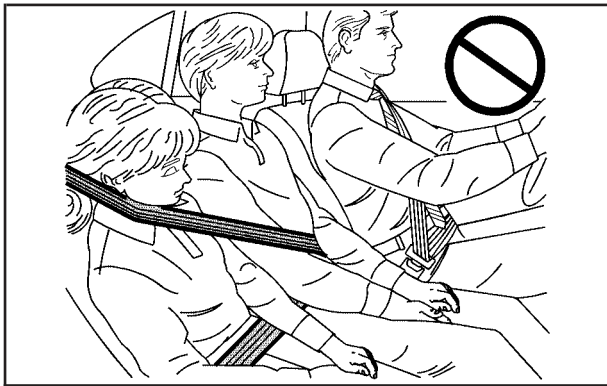

⚠ CAUTION:

Never do this.

Here two children are wearing the same belt. The belt can not properly spread the impact forces. In a crash, the two children can be crushed together and seriously injured. A belt must be used by only one person at a time.

Q: What if a child is wearing a lap-shoulder belt, but the child is so small that the shoulder belt is very close to the child's face or neck?

A: If the child is sitting in a seat next to a window, move the child toward the center of the vehicle. If the child is sitting in the center rear seat passenger position, move the child toward the safety belt buckle. In either case, be sure that the shoulder belt still is on the child's shoulder, so that in a crash the child's upper body would have the restraint that the belts provide.



The lap portion of the belt should be worn low and snug on the hips, just touching the child's thighs. This applies belt force to the child's pelvic bones in a crash.

Infants and Young Children

Everyone in a vehicle needs protection! This includes infants and all other children. Neither the distance traveled nor the age and size of the traveler changes the need, for everyone, to use safety restraints. In fact, the law in every state in the United States and in every Canadian province says children up to some age must be restrained while in a vehicle.

Every time infants and young children ride in vehicles, they should have the protection provided by the appropriate restraint. Young children should not use the vehicle's safety belts, unless there is no other choice.

CAUTION:

Never do this.

Here a child is sitting in a seat that has a lap-shoulder belt, but the shoulder part is behind the child. If the child wears the belt in this way, in a crash the child might slide under the belt. The belt's force would then be applied right on the child's abdomen. That could cause serious or fatal injuries.

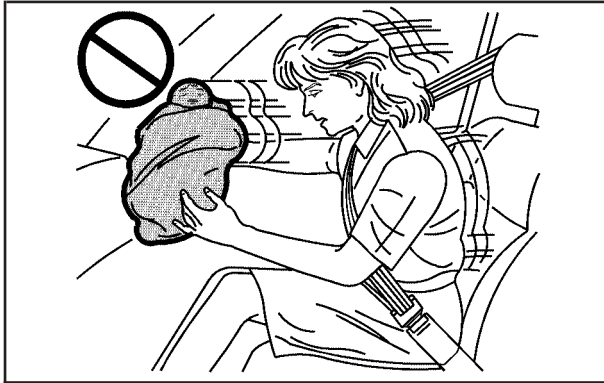

⚠ CAUTION:

People should never hold a baby in their arms while riding in a vehicle. A baby does not weigh much — until a crash. During a crash a baby will become so heavy it is not possible to hold it. For example, in a crash at only 25 mph (40 km/h), a 12-lb. (5.5 kg) baby will suddenly become a 240-lb. (110 kg) force on a person's arms. A baby should be secured in an appropriate restraint.

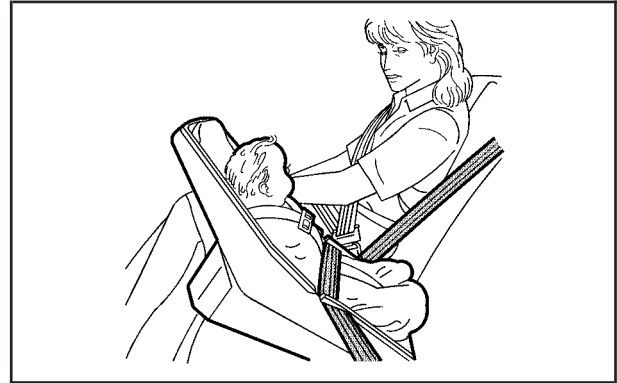

⚠ CAUTION:

Children who are up against, or very close to, any airbag when it inflates can be seriously injured or killed. Airbags plus lap-shoulder belts offer protection for adults and older children, but not for young children and infants. Neither the vehicle's safety belt system nor its airbag system is designed for them. Young children and infants need the protection that a child restraint system can provide.

Q: What are the different types of add-on child restraints?

A: Add-on child restraints, which are purchased by the vehicle's owner, are available in four basic types. Selection of a particular restraint should take into consideration not only the child's weight, height, and age but also whether or not the restraint will be compatible with the motor vehicle in which it will be used.

For most basic types of child restraints, there are many different models available. When purchasing a child restraint, be sure it is designed to be used in a motor vehicle. If it is, the restraint will have a label saying that it meets federal motor vehicle safety standards.

The restraint manufacturer's instructions that come with the restraint state the weight and height limitations for a particular child restraint. In addition, there are many kinds of restraints available for children with special needs.

 **CAUTION:**

Newborn infants need complete support, including support for the head and neck. This is necessary because a newborn infant's neck is weak and its head weighs so much compared with the rest of its body. In a crash, an infant in a rear-facing seat settles into the restraint, so the crash forces can be distributed across the strongest part of an infant's body, the back and shoulders. Infants always should be secured in appropriate infant restraints.

⚠ CAUTION:

The body structure of a young child is quite unlike that of an adult or older child, for whom the safety belts are designed. A young child's hip bones are still so small that the vehicle's regular safety belt may not remain low on the hip bones, as it should. Instead, it may settle up around the child's abdomen. In a crash, the belt would apply force on a body area that is unprotected by any bony structure. This alone could cause serious or fatal injuries. Young children always should be secured in appropriate child restraints.

Child Restraint Systems

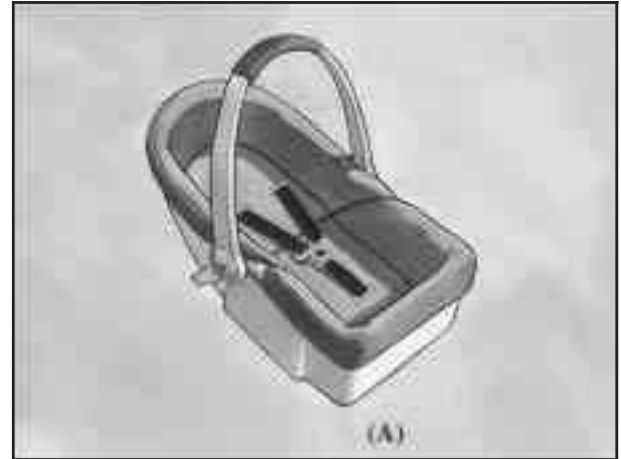

An infant car bed (A), a special bed made for use in a motor vehicle, is an infant restraint system designed to restrain or position a child on a continuous flat surface. Make sure that the infant's head rests toward the center of the vehicle.

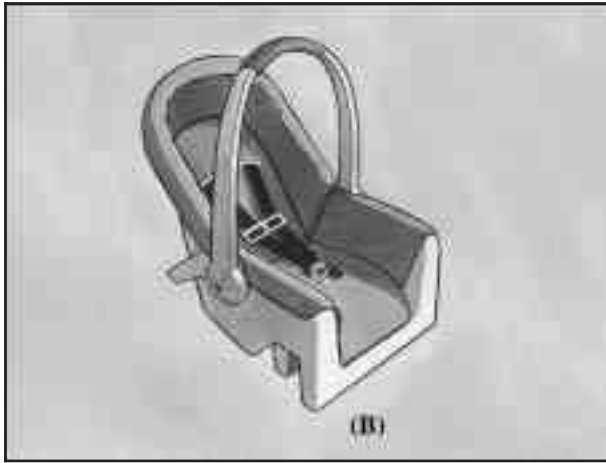

A rear-facing infant seat (B) provides restraint with the seating surface against the back of the infant. The harness system holds the infant in place and, in a crash, acts to keep the infant positioned in the restraint.

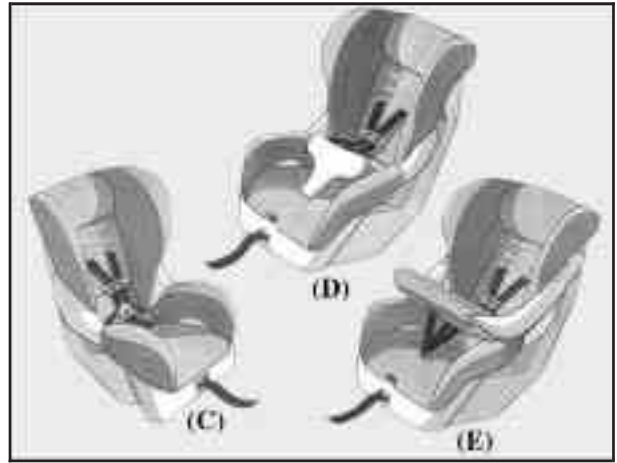

A forward-facing child seat (C-E) provides restraint for the child's body with the harness and also sometimes with surfaces such as T-shaped or shelf-like shields.

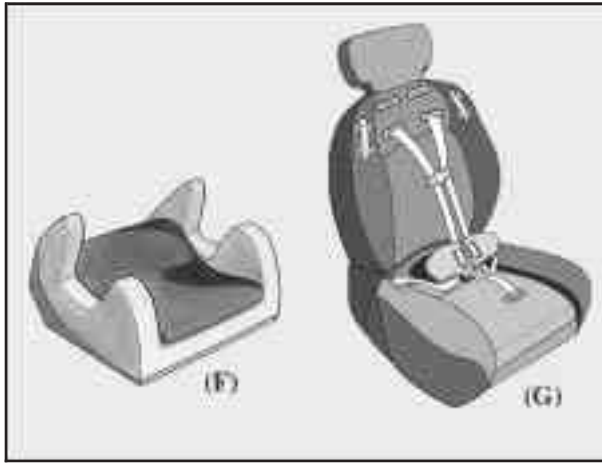

A booster seat (F-G) is a child restraint designed to improve the fit of the vehicle's safety belt system. Some booster seats have a shoulder belt positioner, and some high-back booster seats have a five-point harness. A booster seat can also help a child to see out the window.

Q: How do child restraints work?

A: A child restraint system is any device designed for use in a motor vehicle to restrain, seat, or position children. A built-in child restraint system is a permanent part of the motor vehicle. An add-on child restraint system is a portable one, which is purchased by the vehicle's owner.

For many years, add-on child restraints have used the adult belt system in the vehicle. To help reduce the chance of injury, the child also has to be secured within the restraint. The vehicle's belt system secures the add-on child restraint in the vehicle, and the add-on child restraint's harness system holds the child in place within the restraint.

One system, the three-point harness, has straps that come down over each of the infant's shoulders and buckle together at the crotch. The five-point harness system has two shoulder straps, two hip straps and a crotch strap. A shield may take the place of hip straps. A T-shaped shield has shoulder straps that are attached to a flat pad which rests low against the child's body. A shelf- or armrest-type shield has straps that are attached to a wide, shelf-like shield that swings up or to the side.

When choosing a child restraint, be sure the child restraint is designed to be used in a vehicle. If it is, it will have a label saying that it meets federal motor vehicle safety standards.

Then follow the instructions for the restraint. You may find these instructions on the restraint itself or in a booklet, or both. These restraints use the belt system or the LATCH system in your vehicle, but the child also has to be secured within the restraint to help reduce the chance of personal injury. When securing an add-on child restraint, refer to the instructions that come with the restraint which may be on the restraint itself or in a booklet, or both, and to this manual. The child restraint instructions are important, so if they are not available, obtain a replacement copy from the manufacturer.

Where to Put the Restraint

Accident statistics show that children are safer if they are restrained in the rear rather than the front seat. General Motors recommends that child restraints be secured in a rear seat, including an infant riding in a rear-facing infant seat, a child riding in a forward-facing child seat and an older child riding in a booster seat.

Your vehicle has a rear seat that will accommodate a rear-facing child restraint. A label on your sun visor says, "Never put a rear-facing child seat in the front." This is because the risk to the rear-facing child is so great, if the air bag deploys.

CAUTION:

A child in a rear-facing child restraint can be seriously injured or killed if the right front passenger's airbag inflates. This is because the back of the rear-facing child restraint would be very close to the inflating airbag.

Even though the passenger sensing system is designed to turn off the passenger's frontal airbag and seat-mounted side impact airbag (if equipped) under certain conditions, no system is fail-safe, and no one can guarantee that an airbag will not deploy under some unusual circumstance, even though it is turned off. General Motors recommends that rear-facing child restraints be secured in the rear seat, even if the airbag is off.

CAUTION: (Continued)

CAUTION: (Continued)

If you need to secure a forward-facing child restraint in the right front seat, always move the front passenger seat as far back as it will go. It is better to secure the child restraint in a rear seat.

Wherever you install it, be sure to secure the child restraint properly.

Keep in mind that an unsecured child restraint can move around in a collision or sudden stop and injure people in the vehicle. Be sure to properly secure any child restraint in your vehicle – even when no child is in it.

Top Strap

Some child restraints have a top strap, or “top tether.” It can help restrain the child restraint during a collision. For it to work, a top strap must be properly anchored to the vehicle. Some top strap-equipped child restraints are designed for use with or without the top strap being anchored. Others require the top strap always to be anchored. Be sure to read and follow the instructions for your child restraint. If yours requires that the top strap be anchored, do not use the restraint unless it is anchored properly.

If the child restraint does not have a top strap, one can be obtained, in kit form, for many child restraints. Ask the child restraint manufacturer whether or not a kit is available.

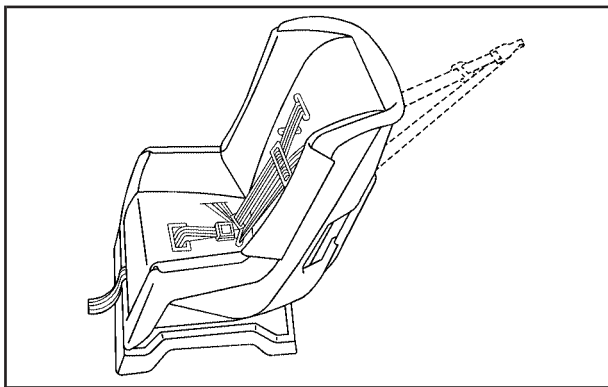

In Canada, the law requires that forward-facing child restraints have a top strap, and that the strap be anchored. In the United States, some child restraints also have a top strap. If your child restraint has a top strap, it should be anchored.

⚠ CAUTION:

Each top tether bracket is designed to anchor only one child restraint. Attaching more than one child restraint to a single bracket could cause the anchor to come loose or even break during a crash. A child or others could be injured if this happens. To help prevent injury to people and damage to your vehicle, attach only one child restraint per bracket.

Anchor the top strap to one of the following anchor points. Be sure to use an anchor point located on the same side of the vehicle as the seating position where the child restraint will be placed.

Raise the head restraint and route the top strap under it. See *Head Restraints* on page 1-5.

Once you have the top strap anchored, you will be ready to secure the child restraint itself. Tighten the top strap when and as the child restraint manufacturer's instructions say.

Top Strap Anchor Location

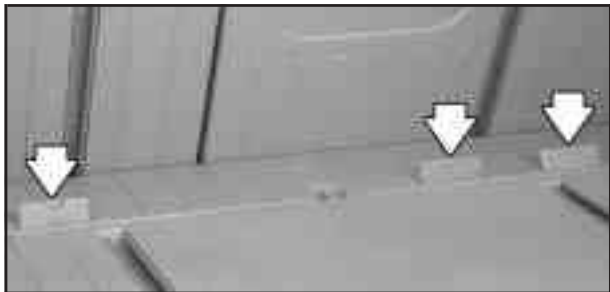

Anchor the top strap to one of the top strap anchors. Your vehicle has top strap anchors for the rear seating positions. You will find three top strap anchors in a covered compartment on the floor of the rear cargo area.

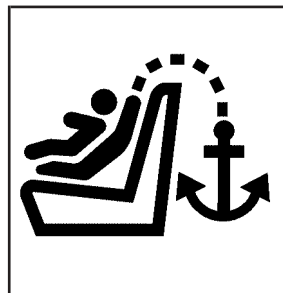

To access the anchors, open the compartment doors marked with the child restraint anchor symbol.

Do not secure a child restraint with a top strap in the right front passenger's position if a national or local law requires that the top strap be anchored, or if the instructions that come with the child restraint say that the top strap must be anchored. There is no place to anchor the top strap in this position.

Lower Anchorages and Top Tethers for Children (LATCH System)

Your vehicle has the LATCH system. You will find anchors for the outside rear seat positions.

This system, designed to make installation of child restraints easier, does not use the vehicle's safety belts. Instead, it uses vehicle anchors and child restraint attachments to secure the restraints. Some restraints also use another vehicle anchor to secure a top tether strap.

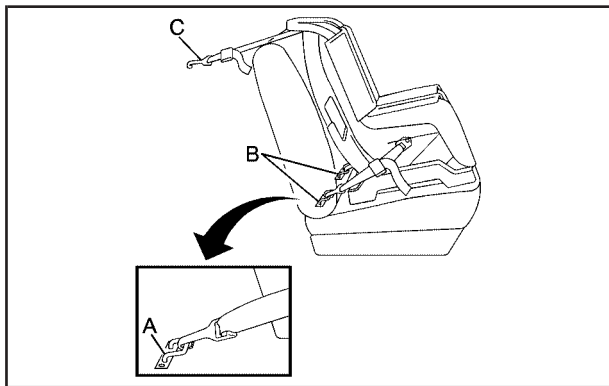

- A. Lower Anchorage
- B. Lower Anchorage
- C. Top Tether

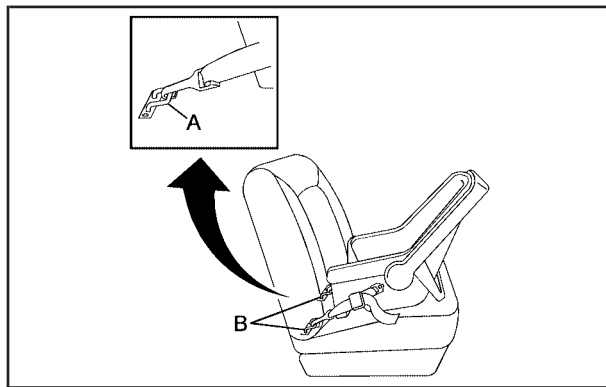

- A. Lower Anchorage
- B. Lower Anchorage

In order to use the LATCH system in your vehicle, you need a child restraint designed for that system.



To assist you in locating the lower anchors for this child restraint system, each seating position with the LATCH system has a label on the seatback at each lower anchor position.

To assist you in locating the anchors for this child restraint system, place your hand in a palm-up position and reach up between the seat cushion and the seatback, just under the label.

CAUTION:

If a LATCH-type child restraint is not attached to its anchorage points, the restraint will not be able to protect the child correctly. In a crash, the child could be seriously injured or killed. Make sure that a LATCH-type child restraint is properly installed using the anchorage points, or use the vehicle's safety belts to secure the restraint, following the instructions that came with that restraint, and also the instructions in this manual.

Securing a Child Restraint Designed for the LATCH System

1. Find the LATCH anchorages for the seating position you want to use, where the bottom of the seatback meets the back of the seat cushion. See *Lower Anchorages and Top Tethers for Children (LATCH System)* on page 1-38.
2. Put the child restraint on the seat.
3. Attach and tighten the LATCH attachments on the child restraint to the LATCH anchorages in the vehicle. The child restraint instructions will show you how.
4. If the child restraint is forward-facing, attach and tighten the top tether to the top tether anchorage. The child restraint instructions will show you how. Also see *Top Strap* on page 1-35.
5. Push and pull the child restraint in different directions to be sure it is secure.

To remove the child restraint, simply unhook the top tether from the top tether anchorage and then disconnect the LATCH attachments from the LATCH anchorages.

Securing a Child Restraint in a Rear Seat Position

If your child restraint is equipped with the LATCH system, see *Lower Anchorages and Top Tethers for Children (LATCH System)* on page 1-38. See *Top Strap* on page 1-35 if the child restraint has one.

If your child restraint does not have the LATCH system, you will be using the lap-shoulder belt to secure the child restraint in this position. Be sure to follow the instructions that came with the child restraint. Secure the child in the child restraint when and as the instructions say.

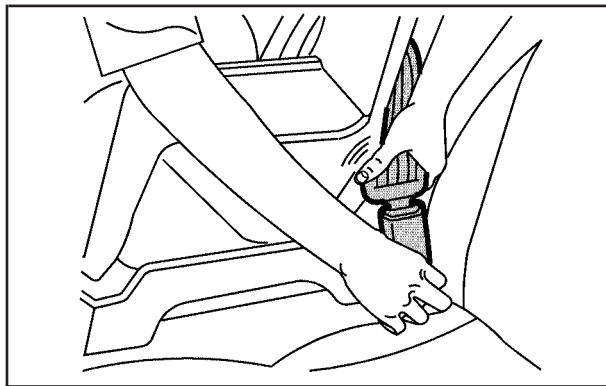

1. Put the child restraint on the seat.
2. Pick up the latch plate, and run the lap and shoulder portions of the vehicle's safety belt through or around the restraint. The child restraint instructions will show you how.

3. Buckle the belt. If the buckle does not click, check to be sure that you are using the correct buckle. The buckle for the center rear passenger position has the word CENTER on it.

Make sure the release button is positioned so you would be able to unbuckle the safety belt quickly if you ever had to.

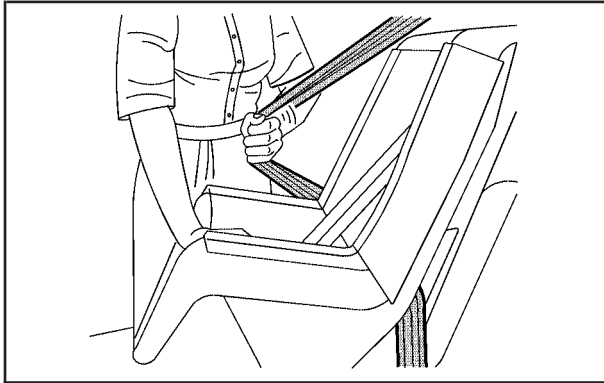

4. Pull the rest of the shoulder belt all the way out of the retractor to set the lock.

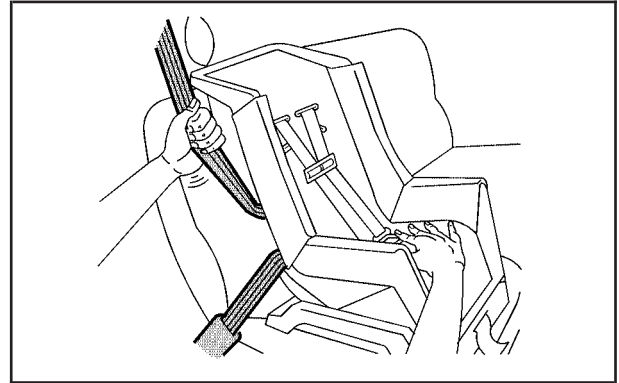

5. To tighten the belt, push down on the child restraint, pull the shoulder portion of the belt to tighten the lap portion of the belt and feed the shoulder belt back into the retractor. If you are using a forward-facing child restraint, you may find it helpful to use your knee to push down on the child restraint as you tighten the belt.
6. Push and pull the child restraint in different directions to be sure it is secure.

To remove the child restraint, just unbuckle the vehicle's safety belt and let it go back all the way. The safety belt will move freely again and be ready to work for an adult or larger child passenger.

Securing a Child Restraint in the Right Front Seat Position

Your vehicle has a right front passenger airbag. A rear seat is a safer place to secure a forward-facing child restraint. See *Where to Put the Restraint on page 1-34*.

In addition, your vehicle has the passenger sensing system. The passenger sensing system is designed to turn off the right front passenger's frontal airbag and seat-mounted side impact airbag (if equipped) when a child in a child restraint or booster seat is detected. See *Passenger Sensing System on page 1-56* and *Passenger Airbag Status Indicator on page 3-30* for more information about the conditions that could affect the passenger sensing system and other important safety information.

A label on your sun visor says, "Never put a rear-facing child seat in the front." This is because the risk to the rear-facing child is so great, if the airbag deploys.

CAUTION:

A child in a rear-facing child restraint can be seriously injured or killed if the right front passenger's airbag inflates. This is because the back of the rear-facing child restraint would be very close to the inflating airbag.

Even though the passenger sensing system is designed to turn off the passenger's frontal airbag and seat-mounted side impact airbag (if equipped) under certain conditions, no system is fail-safe, and no one can guarantee that an airbag will not deploy under some unusual circumstance, even though it is turned off. General Motors recommends that rear-facing child restraints be secured in the rear seat, even if the airbag is off.

If you need to secure a forward-facing child restraint in the right front seat position, move the seat as far back as it will go before securing the forward-facing child restraint. See *Manual Seats on page 1-2*.

If your child restraint is equipped with the LATCH system, see *Lower Anchorages and Top Tethers for Children (LATCH System) on page 1-38*.

There is no top strap anchor at the right front seating position. Do not secure a child seat in this position if a national or local law requires that the top strap be anchored or if the instructions that come with the child restraint say that the top strap must be anchored. See *Top Strap on page 1-35* if your child restraint has one.

You will be using the lap-shoulder belt to secure the child restraint in this position. Be sure to follow the instructions that came with the child restraint. Secure the child in the child restraint when and as the instructions say.

1. Your vehicle has airbags. See *Passenger Sensing System on page 1-56*. General Motors recommends that rear-facing child restraints be secured in a rear seat, even if the airbag is off. If your child restraint is forward-facing, move the seat as far back as it will go before securing the child restraint in this seat. See *Manual Seats on page 1-2*.

When the passenger sensing system has turned off the right front passenger's frontal airbag and seat-mounted side impact airbag (if equipped), the off indicator in the passenger airbag status indicator should light and stay lit when you turn the ignition to ON. See *Passenger Airbag Status Indicator on page 3-30*.

2. Put the child restraint on the seat.

3. Pick up the latch plate, and run the lap and shoulder portions of the vehicle's safety belt through or around the restraint. The child restraint instructions will show you how.

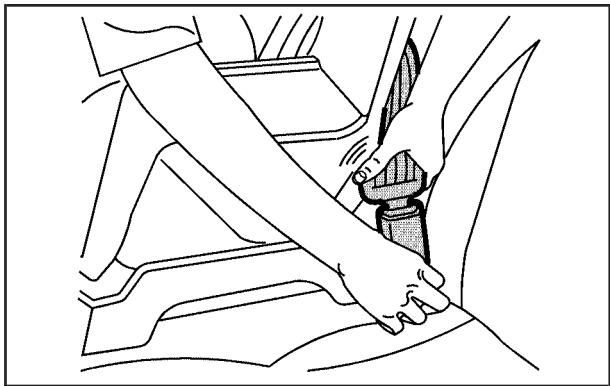

4. Buckle the belt. Make sure the release button is positioned so you would be able to unbuckle the safety belt quickly if you ever had to.

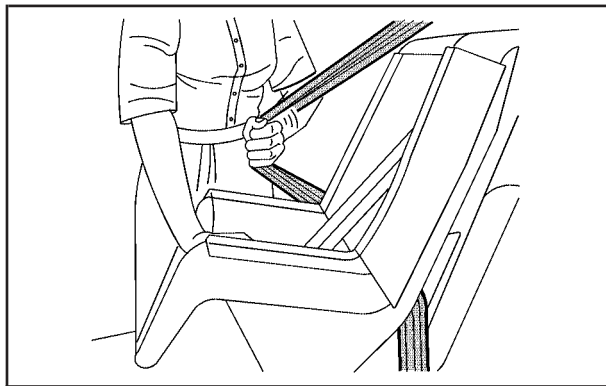

5. Pull the rest of the shoulder belt all the way out of the retractor to set the lock.

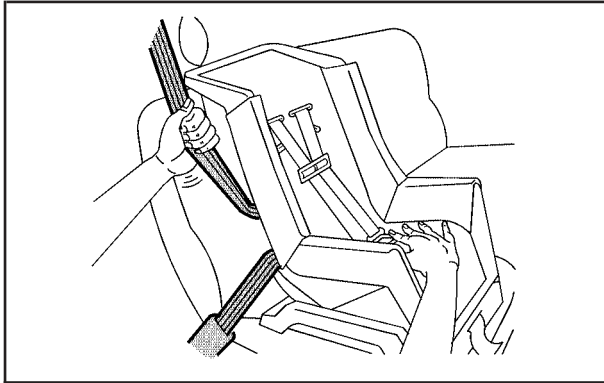

6. To tighten the belt, push down on the child restraint, pull the shoulder portion of the belt to tighten the lap portion of the belt and feed the shoulder belt back into the retractor. If you are using a forward-facing child restraint, you may find it helpful to use your knee to push down on the child restraint as you tighten the belt. You should not be able to pull more of the belt from the retractor once the lock has been set.

7. Push and pull the child restraint in different directions to be sure it is secure.
8. If the passenger sensing system has turned off the right front passenger's frontal airbag and seat-mounted side impact airbag (if equipped), the off indicator in the passenger airbag status indicator will be lit and stay lit when the key is turned to ON.

If a child restraint has been installed and the on indicator is lit, turn the vehicle off. Remove the child restraint from the vehicle and reinstall the child restraint with the ignition key in the ACC or LOCK position.

If after reinstalling the child restraint and restarting the vehicle, the on indicator is still lit, check to make sure that the vehicle's seatback is not pressing the child restraint into the seat cushion. If this happens, slightly recline the vehicle's seatback and adjust the seat cushion if possible. Also make sure the child restraint is not trapped under the vehicle head restraint. If this happens, adjust the head restraint.

If the on indicator is still lit, secure the child in the child restraint in a rear seat position in the vehicle and check with your dealer.

If the airbag readiness light and the OFF light in the passenger airbag status indicator come on together, it may mean there is a malfunction in the passenger sensing system. Secure the child in the child restraint in a rear seat position in the vehicle and check with your dealer.

To remove the child restraint, just unbuckle the vehicle's safety belt and let it go back all the way. The safety belt will move freely again and be ready to work for an adult or larger child passenger.

Airbag System

Your vehicle has a frontal airbag for the driver and a frontal airbag for the right front passenger. Your vehicle may also have seat-mounted side impact airbags for the driver and right front passenger. Your vehicle may also have roof-mounted side impact airbags for the driver and the passenger seated directly behind the driver and for the right front passenger and the passenger seated directly behind that passenger.

If your vehicle has side impact airbags, it will say SRS-SIDE AIR BAG on a label on the side of the driver's and right front passenger's seat closest to the door.

If your vehicle has roof-mounted side impact airbags, it will say SRS CURTAIN AIRBAG on the trim on the side of the windshield.

Frontal airbags are designed to help reduce the risk of injury from the force of an inflating frontal airbag. But these airbags must inflate very quickly to do their job and comply with federal regulations.

Here are the most important things to know about the airbag system:

 **CAUTION:**

You can be severely injured or killed in a crash if you are not wearing your safety belt — even if you have airbags. Wearing your safety belt during a crash helps reduce your chance of hitting things inside the vehicle or being ejected from it. Airbags are designed to work with safety belts but do not replace them.

Frontal airbags for the driver and right front passenger are designed to deploy only in moderate to severe frontal and near frontal crashes. They are not designed to inflate in rollover, rear or low-speed frontal crashes,

CAUTION: (Continued)

CAUTION: (Continued)

or in many side crashes. And, for some unrestrained occupants, frontal airbags may provide less protection in frontal crashes than more forceful airbags have provided in the past.

Side impact airbags are designed to inflate only in moderate to severe crashes where something hits the side of your vehicle. They are not designed to inflate in frontal, in rollover or in rear crashes.

Everyone in your vehicle should wear a safety belt properly — whether or not there is an airbag for that person.

 **CAUTION:**

Both frontal and side impact airbags inflate with great force, faster than the blink of an eye. If you are too close to an inflating airbag, as you would be if you were leaning forward, it could seriously injure you. Safety belts help keep you in position for airbag inflation before and during a crash. Always wear your safety belt, even with frontal airbags. The driver should sit as far back as possible while still maintaining control of the vehicle. Occupants should not lean on or sleep against the door.

 **CAUTION:**

Anyone who is up against, or very close to, any airbag when it inflates can be seriously injured or killed. Airbags plus lap-shoulder belts offer the best protection for adults, but not for young children and infants. Neither the vehicle's safety belt system nor its airbag system is designed for them. Young children and infants need the protection that a child restraint system can provide. Always secure children properly in your vehicle. To read how, see *Older Children on page 1-26* or *Infants and Young Children on page 1-28*.

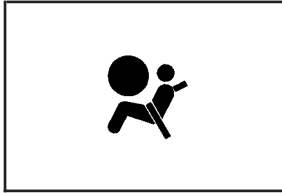

There is an airbag readiness light on the instrument panel, which shows the airbag symbol.

The system checks the airbag electrical system for malfunctions. The light tells you if there is an electrical problem. See *Airbag Readiness Light* on page 3-29 for more information.

Where Are the Airbags?



The driver's frontal airbag is in the middle of the steering wheel.



The right front passenger's frontal airbag is in the instrument panel on the passenger's side.

If your vehicle has a seat-mounted side impact airbag for the driver, it is in the side of the driver's seatback closest to the door.

If your vehicle has a seat-mounted side impact airbag for the right front passenger, it is in the side of the passenger's seatback closest to the door.

If your vehicle has a roof-mounted side impact airbag for the driver and the person seated directly behind the driver, it is in the ceiling above the side windows.

If your vehicle has a roof-mounted side impact airbag for the right front passenger and the person seated directly behind that passenger, it is in the ceiling above the side windows.

⚠ CAUTION:

If something is between an occupant and an airbag, the bag might not inflate properly or it might force the object into that person causing severe injury or even death. The path of an inflating airbag must be kept clear. Do not put anything between an occupant and an airbag, and do not attach or put anything on the steering wheel hub or on or near any other airbag covering. Do not let seat covers block the inflation path of a side impact airbag.

 **CAUTION:**

If something is between an occupant and an airbag, the bag might not inflate properly or it might force the object into that person causing severe injury or even death. The path of an inflating airbag must be kept clear. Do not put anything between an occupant and an airbag, and do not attach or put anything on the steering wheel hub or on or near any other airbag covering. And, if your vehicle has side impact airbags, never secure anything to the roof of your vehicle by routing the rope or tiedown through any door or window opening. If you do, the path of an inflating side impact airbag will be blocked. The path of an inflating airbag must be kept clear.

When Should an Airbag Inflate?

The driver's and right front passenger's frontal airbags are designed to inflate in moderate to severe frontal or near-frontal crashes. But they are designed to inflate only if the impact exceeds a predetermined deployment threshold. Deployment thresholds take into account a variety of desired deployment and non-deployment events and are used to predict how severe a crash is likely to be in time for the airbags to inflate and help restrain the occupants. Whether your frontal airbags will or should deploy is not based on how fast your vehicle is traveling. It depends largely on what you hit, the direction of the impact and how quickly your vehicle slows down.

In addition, your vehicle has “dual stage” frontal airbags, which adjust the restraint according to crash severity. Your vehicle is equipped with electronic frontal sensors, which help the sensing system distinguish between a moderate frontal impact and a more severe frontal impact. For moderate frontal impacts, these airbags inflate at a level less than full deployment. For more severe frontal impacts, full deployment occurs.

Airbags may inflate at different crash speeds. For example:

- If the vehicle hits a stationary object, the airbag could inflate at a different crash speed than if the object were moving.
- If the object deforms, the airbag could inflate at a different crash speed than if the object does not deform.
- If the vehicle hits a narrow object (like a pole) the airbag could inflate at a different crash speed than if the vehicle hits a wide object (like a wall).
- If the vehicle goes into an object at an angle the airbag could inflate at a different crash speed than if the vehicle goes straight into the object.

The frontal airbags for the driver and right front passenger may also deploy if a serious impact occurs to the underside of your vehicle such as hitting a curb, falling into a deep hole, or landing hard.

The frontal airbags (driver and right front passenger) are not intended to inflate during vehicle rollovers, rear impacts, or in many side impacts because inflation would not likely help the occupants.

The side impact airbags are designed to inflate in moderate to severe side crashes. A side impact airbag will inflate if the crash severity is above the system's designed "threshold level." The threshold level can vary with specific vehicle design. Side impact airbags are not designed to inflate in frontal or near-frontal impacts, rollovers or rear impacts, because inflation would not likely help the occupant. Your vehicle has sensors which detect side impacts. These sensors signal the appropriate side airbag to inflate. A side impact airbag will only deploy on the side of the vehicle that is struck.

It is possible that, in a crash involving the front of your vehicle, only one of the two frontal airbags in your vehicle will deploy. This is rare, but it can happen in a crash just severe enough to make a frontal airbag inflate.

In any particular crash, no one can say whether an airbag should have inflated simply because of the damage to a vehicle or because of what the repair costs were. For frontal airbags, inflation is determined by the angle of the impact and how quickly the vehicle slows down in frontal and near-frontal impacts. For side impact airbags, inflation is determined by the location and severity of the impact.

What Makes an Airbag Inflate?

In an impact of sufficient severity, the airbag sensing system detects that the vehicle is in a crash. For both frontal and side impact airbags, the sensing system triggers a release of gas from the inflator, which inflates the airbag. The inflator, the airbag and related hardware are all part of the airbag modules. Frontal airbag modules are located inside the steering wheel and instrument panel. For vehicles with seat-mounted side impact airbags, the airbag modules are located in the seatback closest to the driver's and/or right front passenger's door. For vehicles with roof-mounted side impact airbags, the airbag modules are located in the ceiling of the vehicle, near the side windows.

How Does an Airbag Restrain?

In moderate to severe frontal or near frontal collisions, even belted occupants can contact the steering wheel or the instrument panel. In moderate to severe side collisions, even belted occupants can contact the inside of the vehicle. Airbags supplement the protection provided by safety belts. Airbags distribute the force of the impact more evenly over the occupant's upper body, stopping the occupant more gradually. But a frontal airbag would not help you in many types of collisions, including rollovers, rear impacts, and many side impacts, primarily because an occupant's motion is not toward a frontal airbag. A side impact airbag would not help you in many types of collisions, including frontal or near frontal collisions, rollovers, and rear impacts, primarily because an occupant's motion is not toward a side airbag. Airbags should never be regarded as anything more than a supplement to safety belts, and then only in moderate to severe frontal or near-frontal collisions for frontal airbags, and only in moderate to severe side collisions for side impact airbags.

What Will You See After an Airbag Inflates?

After the airbag inflates, it quickly deflates, so quickly that some people may not even realize the airbag inflated. Some components of the airbag module – the steering wheel hub for the driver's airbag, the instrument panel for the right front passenger's bag, the side of the seatback closest to the front doors for the seat-mounted side impact airbags (if equipped), and the ceiling of your vehicle near the side windows for the roof-mounted side impact airbags (if equipped) – will be hot for a short time. The parts of the bag that come into contact with you may be warm, but not too hot to touch. There will be some smoke and dust coming from the vents in the deflated airbags. Airbag inflation does not prevent the driver from seeing or being able to steer the vehicle, nor does it stop people from leaving the vehicle.

CAUTION:

When an airbag inflates, there is dust in the air. This dust could cause breathing problems for people with a history of asthma or other breathing trouble. To avoid this, everyone in the vehicle should get out as soon as it is safe to do so. If you have breathing problems but can not get out of the vehicle after an airbag inflates, then get fresh air by opening a window or a door. If you experience breathing problems following an airbag deployment, you should seek medical attention.

In many crashes severe enough to inflate an airbag, windshields are broken by vehicle deformation. Additional windshield breakage may also occur from the right front passenger airbag.

- Airbags are designed to inflate only once. After an airbag inflates, you will need some new parts for your airbag system. If you do not get them, the airbag system will not be there to help protect you in another crash. A new system will include airbag modules and possibly other parts. The service manual for your vehicle covers the need to replace other parts.
- Your vehicle is equipped with a crash sensing and diagnostic module which records information after a crash. See *Vehicle Data Collection and Event Data Recorders* on page 7-9.
- Let only qualified technicians work on your airbag system. Improper service can mean that an airbag system will not work properly. See your dealer for service.

Notice: If you damage the covering for the frontal airbags, the airbag covering on the driver's and right front passenger's seatback or the airbag covering on the ceiling near the side windows, the airbags may not work properly. You may have to replace the airbag module in the steering wheel, both the airbag module and the instrument panel for the right front passenger's airbag, or the airbag modules, the seatback, and the ceiling covering for the side impact airbags (if equipped). Do not open or break the airbag coverings.

If your vehicle ever gets into a lot of water – such as water up to the carpeting or higher – or if water enters your vehicle and soaks the carpet, the airbag controller can be soaked and ruined. If this ever happens, and then you start your vehicle, the damage could make the frontal and side impact airbags inflate and safety belt pretensioners activate, even if there is no crash. You would have to replace the airbags, all the sensors and related parts, parts of the safety belt system and parts of the driver and right front passenger's seatbacks. If your vehicle is ever in a flood, or if it is exposed to water that soaks the carpet, you can avoid needless repair costs by turning off the vehicle immediately and disconnecting the battery cables. Do not let anyone start the vehicle under any circumstances. See your dealer for service.

Passenger Sensing System

Your vehicle has a passenger sensing system. A passenger airbag status indicator on the instrument panel will be visible when you turn your ignition key to ON. The words ON and OFF will be visible in the passenger airbag status indicator during the system check. When the system check is complete, either the word ON or the word OFF will be visible. See *Passenger Airbag Status Indicator* on page 3-30.

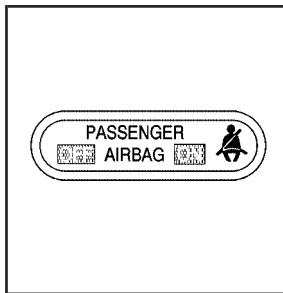

The passenger sensing system will turn off the right front passenger's frontal airbag and seat-mounted side impact airbag (if equipped) under certain conditions.

The passenger sensing system will also turn off the right front passenger's safety belt pretensioner if it detects that there is no occupant in that position. The driver's airbag and the roof-mounted side impact airbags are not part of the passenger sensing system.

The passenger sensing system works with sensors that are part of the right front passenger's seat assembly and safety belt assembly. The sensors are designed to detect the presence of a properly-seated occupant and determine if the passenger's frontal airbag and seat-mounted side impact airbag (if equipped) and safety belt pretensioner should be enabled (may inflate) or not.

Accident statistics show that children are safer if they are restrained in the rear rather than the front seat. General Motors recommends that child restraints be secured in a rear seat, including an infant riding in a rear-facing infant seat, a child riding in a forward-facing child seat and an older child riding in a booster seat.

Your vehicle has a rear seat that will accommodate a rear-facing child restraint. A label on your sun visor says, "Never put a rear-facing child seat in the front." This is because the risk to the rear-facing child is so great, if the airbag deploys.

 **CAUTION:**

A child in a rear-facing child restraint can be seriously injured or killed if the right front passenger's airbag inflates. This is because the back of the rear-facing child restraint would be very close to the inflating airbag.

Even though the passenger sensing system is designed to turn off the passenger's frontal airbag and seat-mounted side impact airbag (if equipped) under certain conditions, no system is fail-safe, and no one can guarantee that an airbag will not deploy under some unusual circumstance, even though it is turned off. General Motors recommends that rear-facing child restraints be secured in the rear seat, even if the airbag is off.

The passenger sensing system is designed to turn off the right front passenger's frontal airbag and seat-mounted side impact airbag (if equipped) if:

- the right front passenger seat is unoccupied
- the system determines that a small child is present in a child restraint
- the system determines that a small child is present in a booster seat
- a right front passenger takes his/her weight off of the seat for a period of time
- the right front passenger seat is occupied by a smaller person, such as a child who has outgrown child restraints
- or if there is a critical problem with the airbag system or the passenger sensing system.

When the passenger sensing system has turned off the passenger's frontal airbag and seat-mounted side impact airbag (if equipped), the off indicator will light and stay lit to remind you that the airbag is off.

If a child restraint has been installed and the on indicator is lit, turn the vehicle off. Remove the child restraint from the vehicle and reinstall the child restraint with the ignition key in the ACC or LOCK position, following the child restraint manufacturer's directions and refer to *Securing a Child Restraint in the Right Front Seat Position* on page 1-42.

If after reinstalling the child restraint and restarting the vehicle, the on indicator is still lit, check to make sure that the vehicle's seatback is not pressing the child restraint into the seat cushion. If this happens, slightly recline the vehicle's seatback and adjust the seat cushion if possible. Also make sure the child restraint is not trapped under the vehicle head restraint. If this happens, adjust the head restraint.

If the on indicator is still lit, secure the child in the child restraint in a rear seat position in the vehicle and check with your dealer.

An object, person or child in the rear seat contacting or pressing the right front passenger's seatback, or objects stowed under the right front passenger's seat, may affect the proper functioning of the passenger sensing system.

When you use a safety belt extender in the right front passenger's seat, make sure the passenger airbag status indicator shows "ON". If the indicator shows "OFF", disconnect the extender's latch from the buckle then reconnect the safety belt. Make sure the indicator light shows "ON", then reconnect the safety belt extender. If you use the safety belt extender while the indicator light shows "OFF", the right front passenger's

frontal airbag and seat-mounted side impact airbag (if equipped) may not activate correctly. See *Airbag System on page 1-46* for important safety information about your airbags.

The passenger sensing system is designed to enable (may inflate) the right front passenger's frontal airbag and seat-mounted side impact airbag (if equipped) and safety belt pretensioner anytime the system senses that a person of adult size is sitting properly in the right front passenger's seat. When the passenger sensing system has allowed the airbags and pretensioner to be enabled, the on indicator will light and stay lit to remind you that the airbags and pretensioners are active.

For some children who have outgrown child restraints and for very small adults, the passenger sensing system may or may not turn off the right front passenger's frontal airbag and seat-mounted side impact airbag (if equipped), depending upon the person's seating posture and body build. Everyone in your vehicle who has outgrown child restraints should wear a safety belt properly — whether or not there is an airbag for that person.

If a person of adult-size is sitting in the right front passenger's seat, but the off indicator is lit, it could be because that person is not sitting properly in the seat. If this happens, turn the vehicle off and ask the person to place the seatback in the fully upright position, then sit upright in the seat, centered on the seat cushion, with the person's legs comfortably extended. Restart the vehicle and have the person remain in this position for about two minutes. This will allow the system to detect that person and then enable the passenger's airbag.



If the airbag readiness light and the OFF light in the passenger airbag status indicator come on together, it may mean there is a malfunction in the passenger sensing system. Secure the child in the child restraint in a rear seat position in the vehicle and check with your dealer.

⚠ CAUTION:

If the airbag readiness light in the instrument panel cluster ever comes on and stays on, it means that something may be wrong with the airbag system. If this ever happens, have the vehicle serviced promptly, because an adult-size person sitting in the right front passenger's seat may not have the protection of the frontal airbag. See *Airbag Readiness Light* on page 3-29 for more on this, including important safety information.

Aftermarket equipment, such as seat covers or seat backpacks can affect how well the passenger sensing system operates. You may want to consider not using seat covers, seat backpacks or other aftermarket equipment if your vehicle has the passenger sensing system. See *Adding Equipment to Your Airbag-Equipped Vehicle* on page 1-61 for more information about modifications that can affect how the system operates.

 **CAUTION:**

Stowing of articles under the passenger's seat or between the passenger's seat cushion and seatback may interfere with the proper operation of the passenger sensing system.

Servicing Your Airbag-Equipped Vehicle

Airbags affect how your vehicle should be serviced. There are parts of the airbag system in several places around your vehicle. Your dealer and the service manual have information about servicing your vehicle and the airbag system. To purchase a service manual, see *Service Publications Ordering Information* on page 7-11.

 **CAUTION:**

For up to two minutes after the ignition key is turned off and the battery is disconnected, an airbag can still inflate during improper service. You can be injured if you are close to an airbag when it inflates. Avoid wires wrapped with yellow tape or yellow connectors. They are probably part of the airbag systems. Be sure to follow proper service procedures, and make sure the person performing work for you is qualified to do so.

The airbag system does not need regular maintenance.

Adding Equipment to Your Airbag-Equipped Vehicle

Q: Is there anything I might add to the vehicle that could keep the airbags from working properly?

A: Yes. If you add things that change your vehicle's frame, bumper system, front end or side sheet metal or height, they may keep the airbag system from working properly. Also, the airbag system may not work properly if you relocate any of the airbag sensors. If you have any questions about this, you should contact Customer Assistance before you modify your vehicle. The phone numbers and addresses for Customer Assistance are in Step Two of the Customer Satisfaction Procedure in this manual. See *Customer Satisfaction Procedure on page 7-2*.

Do not perform any of the following changes without consulting your dealer. Such changes can interfere with the proper operation of the airbag system, passenger sensing system and/or safety belt pretensioners.

- Repairs on or near the front seat belt retractor assemblies
- Modification of the suspension system
- Attachment of a grille guard (bull bar, kangaroo bar, etc), snowplow, winches or any other equipment to the front end
- Repairs made on or near the front fenders, front end structure or console
- Installation of electronic devices such as a mobile two-way radio, cassette tape player or compact disc player
- Modification of the suspension system
- Modification of the front end structure or the side structure of the passenger compartment
- Repairs made on or near the console of the front seat

Q: Because I have a disability, I have to get my vehicle modified. How can I find out whether this will affect my advanced airbag system?

A: Changing or moving any parts of the front seats, safety belts, the airbag sensing and diagnostic module (located under the driver's seat), or the instrument panel can affect the operation of the advanced airbag system. If you have questions, call Customer Assistance. The phone numbers and addresses for Customer Assistance are in Step Two of the Customer Satisfaction Procedure in this manual. See *Customer Satisfaction Procedure* on page 7-2.

Restraint System Check

Checking Your Restraint Systems

Now and then, make sure the safety belt reminder light and all your belts, buckles, latch plates, retractors and anchorages are working properly. Look for any other loose or damaged safety belt system parts. If you see anything that might keep a safety belt system from doing its job, have it repaired.

Torn or frayed safety belts may not protect you in a crash. They can rip apart under impact forces. If a belt is torn or frayed, get a new one right away.

Also look for any opened or broken airbag covers, and have them repaired or replaced. (The airbag system does not need regular maintenance.)

Replacing Restraint System Parts After a Crash

CAUTION:

A crash can damage the restraint systems in your vehicle. A damaged restraint system may not properly protect the person using it, resulting in serious injury or even death in a crash. To help make sure your restraint systems are working properly after a crash, have them inspected and any necessary replacements made as soon as possible.

If you have had a crash, do you need new belts or LATCH system parts?

After a very minor collision, nothing may be necessary. But if the belts were stretched, as they would be if worn during a more severe crash, then you need new parts.

If the LATCH system was being used during a more severe crash, you may need new LATCH system parts.

If belts are cut or damaged, replace them. Collision damage also may mean you will need to have LATCH system, safety belt or seat parts repaired or replaced. New parts and repairs may be necessary even if the belt or LATCH system was not being used at the time of the collision.

If the frontal airbags inflate, you will also need to replace the driver's and right front passenger's safety belt retractor assembly. Be sure to do so. Then the new retractor assembly will be there to help protect you in a collision.

After a crash you may need to replace the driver and front passenger's safety belt retractor assemblies, even if the frontal airbags have not deployed. The driver and front passenger's safety belt retractor assemblies contain the safety belt pretensioners. Have your safety belt pretensioners checked if your vehicle has been in a collision, or if your airbag readiness light stays on after you start your vehicle or while you are driving. See *Airbag Readiness Light on page 3-29*.

If an airbag inflates, you will need to replace airbag system parts. See the part on the airbag system earlier in this section.

 **NOTES**

Section 2 Features and Controls

Keys	2-2	Shifting Into Park (P) (Automatic Transaxle)	2-28
Remote Keyless Entry System	2-4	Shifting Out of Park (P) (Automatic Transaxle)	2-30
Remote Keyless Entry System Operation	2-5	Parking Your Vehicle (Manual Transaxle)	2-31
Doors and Locks	2-7	Parking Over Things That Burn	2-32
Door Locks	2-7	Engine Exhaust	2-32
Power Door Locks	2-8	Running Your Engine While You Are Parked	2-33
Programmable Automatic Door Locks	2-9	Mirrors	2-34
Rear Door Security Locks	2-10	Manual Rearview Mirror	2-34
Liftgate/Liftglass	2-11	Manual Rearview Mirror with OnStar®	2-34
Windows	2-13	Outside Remote Control Mirrors	2-34
Manual Windows	2-14	Outside Convex Mirror	2-35
Power Windows	2-14	OnStar® System	2-35
Sun Visors	2-14	Storage Areas	2-37
Theft-Deterrent Systems	2-15	Glove Box	2-37
Content Theft-Deterrent	2-15	Cupholder(s)	2-37
Starting and Operating Your Vehicle	2-17	Coinholder(s)	2-37
New Vehicle Break-In	2-17	Instrument Panel Storage Area	2-37
Ignition Positions	2-18	Center Console Storage Area	2-37
Starting Your Engine	2-19	Floor Mats	2-38
Engine Coolant Heater	2-21	Rear Storage Area	2-38
Automatic Transaxle Operation	2-22	Rear Cargo Accessory Track System	2-39
Overdrive Off	2-24	Cargo Cover	2-39
Manual Transaxle Operation	2-25	Cargo Tie Downs	2-40
Parking Brake	2-28	Sunroof	2-40

Keys

CAUTION:

Leaving children in a vehicle with the ignition key is dangerous for many reasons. They could operate the power windows or other controls or even make the vehicle move. The children or others could be badly injured or even killed. Do not leave the keys in a vehicle with children.





One key is used for the ignition, the doors and all other locks.

Each tag has a code on it that tells your dealer or a qualified locksmith how to make extra keys. Keep the tag in a safe place. If you lose your key, you'll be able to have a new one made easily using this code.

If you need a new key, contact your dealership to obtain the correct key code. See *Roadside Assistance Program* on page 7-6 for more information.

Notice: If you ever lock your keys in your vehicle, you may have to damage the vehicle to get in. Be sure you have spare keys.

When a new vehicle is delivered, the dealer removes the key tag from the key and gives it to the first owner.

Remote Keyless Entry System

If equipped, the keyless entry system operates on a radio frequency subject to Federal Communications Commission (FCC) Rules and with Industry Canada.

This device complies with Part 15 of the FCC Rules. Operation is subject to the following two conditions:

1. This device may not cause interference, and
2. This device must accept any interference received, including interference that may cause undesired operation of the device.

This device complies with RSS-210 of Industry Canada. Operation is subject to the following two conditions:

1. This device may not cause interference, and
2. This device must accept any interference received, including interference that may cause undesired operation of the device.

Changes or modifications to this system by other than an authorized service facility could void authorization to use this equipment.

At times you may notice a decrease in range. This is normal for any remote keyless entry system. If the transmitter does not work or if you have to stand closer to your vehicle for the transmitter to work, try this:

- Check the distance. You may be too far from your vehicle. You may need to stand closer during rainy or snowy weather.
- Check the location. Other vehicles or objects may be blocking the signal. Take a few steps to the left or right, hold the transmitter higher, and try again.
- Check to determine if battery replacement is necessary. See “Battery Replacement” under *Remote Keyless Entry System Operation on page 2-5*.
- If you are still having trouble, see your dealer or a qualified technician for service.

Remote Keyless Entry System Operation

If your vehicle has this feature, you can lock and unlock your doors from about 3 feet (1 m) up to 30 feet (9 m) away using the remote keyless entry transmitter supplied with your vehicle. The remote keyless entry transmitter will look different if your vehicle was purchased in Canada, however it will operate the same.

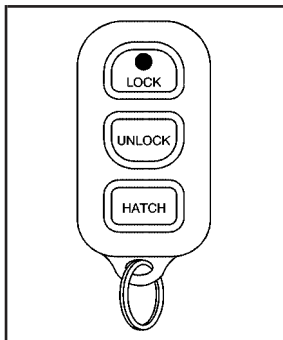

LOCK: Press this button to lock all of the doors.

The turn signal lights will flash once to confirm that the doors have locked. The remote keyless entry system will not operate while the doors are open, the key is in the ignition or if the liftglass or hatch are not completely closed and latched.

UNLOCK: Press this button once to unlock the driver's door. The turn signal lights will flash twice and the interior lamps will come on to confirm that the door has unlocked. If the UNLOCK button is pressed again within three seconds, all remaining doors will unlock. The interior lamps will stay on for 15 seconds or until the ignition is turned on. If the UNLOCK button is pressed and no door is opened, the doors will lock automatically after 30 seconds.

HATCH: Press this button to open the rear liftglass. If the ignition key is in the ON position, the liftglass cannot be opened by the HATCH button on the transmitter.

Matching Transmitter(s) to Your Vehicle

Each remote keyless entry transmitter is coded to prevent another transmitter from unlocking your vehicle. If a transmitter is lost or stolen, a replacement can be purchased through your dealer. Remember to bring any remaining transmitters with you when you go to your dealer. When the dealer matches the replacement transmitter to your vehicle, any remaining transmitters must also be matched. Once your dealer has coded the new transmitter, the lost transmitter will not unlock your vehicle. Each vehicle can have a maximum of four transmitters matched to it.

Battery Replacement

Under normal use, the battery in your remote keyless entry transmitter should last about three years.

You can tell the battery is weak if the transmitter won't work at the normal range in any location. If you have to get close to your vehicle before the transmitter works, it's probably time to change the battery.

Notice: When replacing the battery, use care not to touch any of the circuitry. Static from your body transferred to these surfaces may damage the transmitter.



To replace the battery, do the following:

1. Insert a small coin or similar object to separate the bottom half from the top half of the transmitter.
2. Remove the battery and replace it with the new one. Make sure the positive side of the battery faces upward. For battery replacement, use a three-volt battery, type CR2032, or equivalent.
3. Snap the transmitter back together tightly to be sure no moisture can enter.

Doors and Locks

Door Locks

CAUTION:

Unlocked doors can be dangerous.

- Passengers — especially children — can easily open the doors and fall out of a moving vehicle. When a door is locked, the handle will not open it. You increase the chance of being thrown out of the vehicle in a crash if the doors are not locked. So, wear safety belts properly and lock the doors whenever you drive.
- Young children who get into unlocked vehicles may be unable to get out. A child can be overcome by extreme heat and can suffer permanent injuries or even death from heat stroke. Always lock your vehicle whenever you leave it.

CAUTION: (Continued)

CAUTION: (Continued)

- Outsiders can easily enter through an unlocked door when you slow down or stop your vehicle. Locking your doors can help prevent this from happening.

There are several ways to lock and unlock your vehicle.

From the outside, use your key or the remote keyless entry transmitter, if equipped. See *Remote Keyless Entry System Operation on page 2-5* for more information.

If your vehicle has power door locks, open the driver's door by turning the key in the lock toward the rear of the vehicle. Turning the key back toward the center, then toward the rear again will unlock all of the doors. Using the key in the passenger's door will also unlock all of the doors.

Lock a door by turning the key toward the front of the vehicle. If you have power door locks, all the doors will lock.



To manually lock the door from the inside, press the knob on the door forward. To unlock the door, press the knob rearward. With manual locks, you must use the key to lock and unlock the liftgate.

Power Door Locks



If your vehicle has this feature, the power door lock switch is located on the armrest on the door.

 **(Power Door Lock):** Press the power door lock switch on the driver's or passenger's door to lock or unlock all the doors at once.

The automatic power door locks will lock all the doors and liftgate when the shift lever is moved out of PARK (P). The system will automatically unlock the doors and liftgate when the ignition key is turned to LOCK.

Programmable Automatic Door Locks

If you have an automatic transaxle, your vehicle is equipped with an auto door lock/unlock feature which enables you to program your power door locks.

Your vehicle left the factory programmed to Mode 4.

The following is a list of the available programming options:

Mode 1: All doors and liftgate lock when the shift lever is moved out of PARK (P) with the ignition on and all doors and liftgate closed. There is no automatic door unlocking.

Mode 2: No automatic door locking or unlocking.

Mode 3: All doors and liftgate lock when the shift lever is moved out of PARK (P) with the ignition on and all doors and liftgate closed. All doors and liftgate unlock when the shift lever is moved to PARK (P) with the ignition on.

Mode 4: All doors and liftgate lock when the shift lever is moved out of PARK (P) with the ignition on and all doors and liftgate closed. All doors and liftgate unlock when the ignition switch is turned from ON to ACC or to LOCK.

To change the mode you are in, do the following:

1. Set the interior lamp control dial to the door position. See *Interior Lamps Control on page 3-16*.
2. Move the shift lever into PARK (P) and close all doors and liftgate.
3. Turn the ignition to ON.
4. Within five seconds after the ignition is turned to ON, press and hold the power door lock switch in the lock position for about five seconds.
5. The interior lamp will flash to indicate that the mode has been changed. For example, if the lamp flashes once, the function has been changed to Mode 1.

If the battery is disconnected or run down, the mode is changed to the initial mode which is Mode 4.

Rear Door Security Locks

Your vehicle is equipped with rear door security locks that help prevent passengers from opening the rear doors on your vehicle from the inside.



The security locks are located on the inside of the rear door trim.

To use these locks, do the following:

1. Slide the lever down.
2. Close the door.
3. Do the same thing to the other rear door lock.

The rear doors on your vehicle cannot be opened from the inside when this feature is in use.

To open a rear door with the security lock, do the following:

1. Unlock the door from the inside.
2. Then open the door from the outside.

If you don't cancel the security lock feature, adults and older children who ride in the rear won't be able to open the rear door from the inside. You should let adults and older children know how these security locks work, and how to cancel the locks.

To cancel the rear door security lock, do the following:

1. Unlock the door from the inside and open the door from the outside.
2. Slide the lever up.
3. Do the same for the other rear door.

The rear door locks will now work normally.

Liftgate/Liftglass

CAUTION:

It can be dangerous to drive with the liftgate or liftglass open because carbon monoxide (CO) gas can come into your vehicle. You can not see or smell CO. It can cause unconsciousness and even death. If you must drive with the liftgate open or if electrical wiring or other cable connections must pass through the seal between the body and the liftgate or liftglass:

- **Make sure all other windows are shut.**
- **Turn the fan on your heating or cooling system to its highest speed and select the control setting that will force outside air into your vehicle. See Climate Control System in the Index.**
- **If you have air outlets on or under the instrument panel, open them all the way. See *Engine Exhaust* on page 2-32.**

Liftgate/Liftglass Release

To unlock and open the liftgate using the key, insert the key into the keyhole and turn counterclockwise to the second position. Use the handle in the center of the liftglass to help in lifting the glass.



When closing the liftgate, use the handle to pull it down.

To lock the liftgate, turn the key clockwise.

To open the liftglass using the key, insert the key into the keyhole and turn counterclockwise to the second position. Use the handle in the center of the liftglass to help in lifting the glass.

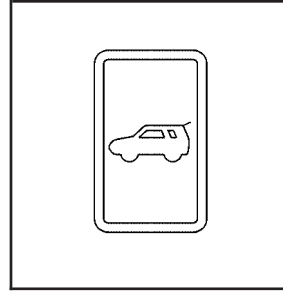

Your vehicle may have a liftglass release button which is located on the instrument panel to the left of the steering wheel. Press this button to release the liftglass.

Windows

CAUTION:

Leaving children, helpless adults, or pets in a vehicle with the windows closed is dangerous. They can be overcome by the extreme heat and suffer permanent injuries or even death from heat stroke. Never leave a child, a helpless adult, or a pet alone in a vehicle, especially with the windows closed in warm or hot weather.



Manual Windows

Use the window crank to open and close each window.

Power Windows



If your vehicle has this feature, the switches controlling the driver's and passenger's windows are located on the driver's door.

The power window switch on each passenger door controls that window only. These switches work while the ignition is ON or in ACC.

Press the front of a switch to lower a window and lift the front of the switch to raise a window.

AUTO (Express-Down): Press this switch all the way down and release it to lower the driver's window quickly.

 **(Lock-Out):** Press the window lock-out button, located near the driver's power door lock switches, to disable the passenger's power window switches. Press the button again to enable the window switches.

Only the driver's window will operate with the lock-out button pressed.

Sun Visors

To block out glare, you can swing down the visors. You can also swing them to the side.

The visors can also be extended for more coverage. Swing the visor down and to the side and then slide the visor out to extend it. Do not extend the visor when it is in the forward position, only when it is at the side of the vehicle.

Visor Vanity Mirror

Swing down the driver's sun visor and lift the cover to expose the vanity mirror. Swing down the passenger visor to expose the mirror.

Theft-Deterrent Systems

Vehicle theft is big business, especially in some cities. Although your vehicle has a number of theft-deterrent features, we know that nothing we put on it can make it impossible to steal.

Content Theft-Deterrent

If your vehicle has this feature, the theft-deterrent system is designed to activate an alarm if any of the side doors or the liftgate is forcibly unlocked or if the battery terminal is disconnected and then reconnected while the system is set.

The alarm will sound the horn intermittently and flash the headlamps, turn signal lamps and interior lights. If the driver's or front passenger's side doors are unlocked forcibly, the other side doors and the liftgate will be locked automatically.

Arming the System

To arm the system, do the following:

1. Turn the ignition key to the LOCK position and remove it.
2. Close and lock all doors and liftgate with the key or remote keyless entry transmitter.

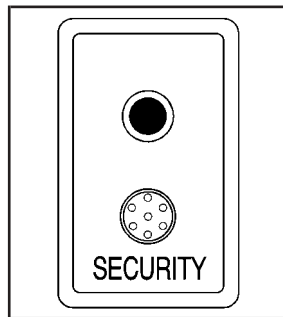

The indicator light located on the instrument panel to the left of the steering wheel will come on when all doors and liftgate are closed and locked.

The system will be automatically set after 30 seconds. When the system is set, the indicator light will start flashing.

3. After the indicator light starts flashing, you may leave the vehicle.

Do not leave anyone in the vehicle when you set the system, because unlocking the vehicle from the inside will activate the system.

Testing the Alarm

To test the alarm, do the following:

1. Open all the windows.
2. Set the system as described in the previous procedure. The doors and liftgate should be locked with the key or remote keyless entry transmitter. Be sure to wait until the indicator light starts flashing.
3. Unlock the driver's door from the inside. The system should activate the alarm.
4. Stop the alarm as described in the disarming procedure following.
5. Repeat this operation for the other doors. Also check that the system is activated when the battery terminal is disconnected and then reconnected.

If the system does not work properly, have it checked by your dealer.

How the System Alarm is Activated

The system will activate the alarm under the following conditions:

- If the driver's or front passenger's door is unlocked or if any of the other doors or the liftgate is forcibly opened without the key or remote keyless entry transmitter.
- If the battery terminal is disconnected and then reconnected.
- If the ignition is hot-wired.
- If the side window glass is broken or damaged.

The indicator light will come on when the system is activated.

If the driver's or front passenger's doors are unlocked without using the key or remote keyless entry transmitter, the other doors and the liftgate will be automatically locked again.

After one minute the alarm will automatically stop and the indicator light will start flashing again.

Reactivating the System

Once the system is set, it will automatically reset the alarm after the alarm stops. The alarm will activate again under the same conditions as described earlier.

Disarming the System

The alarm can be disarmed by doing one of the following:

- Turn the ignition key from LOCK to ON.
- Unlock any of the doors with the key or with the remote keyless entry transmitter.

If the liftgate or liftglass is opened with the key, the system will still be activated.

Starting and Operating Your Vehicle

New Vehicle Break-In

Notice: Your vehicle does not need an elaborate “break-in.” But it will perform better in the long run if you follow these guidelines:

- Do not drive at any one speed — fast or slow — for the first 500 miles (805 km). Do not make full-throttle starts.
- Avoid making hard stops for the first 200 miles (322 km) or so. During this time your new brake linings are not yet broken in. Hard stops with new linings can mean premature wear and earlier replacement. Follow this breaking-in guideline every time you get new brake linings.
- Do not tow a trailer during break-in. See *Towing a Trailer on page 4-40* for more information.

Ignition Positions

With the key in the ignition switch, you can turn it to four different positions.

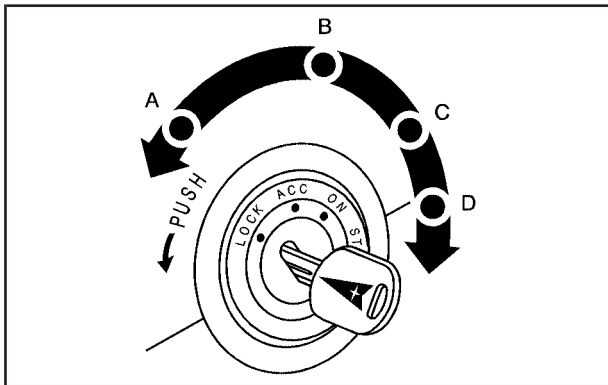

Notice: If your key seems stuck in LOCK and you can not turn it, be sure you are using the correct key; if so, is it all the way in? If it is, then turn the steering wheel left and right while you turn the key hard. Turn the key only with your hand. Using a tool to force it could break the key or the ignition switch. If none of these works, then your vehicle needs service.

(A) LOCK: This is the only position from which you can remove the key. This locks your steering wheel, ignition and automatic transaxle. Push in the ignition switch as you turn the key toward you.

If you have an automatic transaxle, the ignition switch cannot be turned to LOCK unless the shift lever is in PARK (P).

CAUTION:

On manual transaxle vehicles, turning the key to LOCK and removing it will lock the steering column and result in a loss of ability to steer the vehicle. This could cause a collision. If you need to turn the engine off while the vehicle is moving, turn the key only to ACC. Do not push the key in while the vehicle is moving.

(B) ACC (ACCESSORY): This position operates some of your electrical accessories, such as the radio, but not the ventilation fan. It unlocks the steering wheel and ignition. To move the key from ACC to LOCK, push in the key and then turn it to LOCK.

(C) ON: This is the position the switch returns to after you start your engine and release the switch. The switch stays in the ON position when the engine is running. But even when the ignition is not running, you can use ON to operate your electrical accessories, including the ventilation fan and 115 volt power outlet, and to display some warning and indicator lights.

(D) START: This position starts the engine. When the engine starts, release the key. The ignition switch will return to ON for normal driving.

When the engine is not running, ACC and ON allow you to operate some of your electrical accessories.

A warning tone will sound if you open the driver's door when the ignition is still in ACC or LOCK and the key is in the ignition.

Starting Your Engine

Automatic Transaxle

Move your shift lever to PARK (P) or NEUTRAL (N). Your engine will not start in any other position — that is a safety feature. To restart when you are already moving, use NEUTRAL (N) only.

Notice: Shifting into PARK (P) with the vehicle moving could damage the transaxle. Shift into PARK (P) only when your vehicle is stopped.

Manual Transaxle

The shift lever should be in NEUTRAL and the parking brake engaged. Hold the clutch pedal to the floor and start the engine. Your vehicle will not start if the clutch pedal is not all the way down — that is a safety feature.

Starting Your Engine

1. With your foot off the accelerator pedal, turn your ignition key to START. When the engine starts, let go of the key. The idle speed will go down as your engine gets warm.

Notice: Holding your key in START for longer than 15 seconds at a time will cause your battery to be drained much sooner. And the excessive heat can damage your starter motor. Wait about 15 seconds between each try to help avoid draining your battery or damaging your starter.

2. If it does not start, wait about 15 seconds and try again to start the engine by turning the ignition key to START. Wait about 15 seconds between each try.

When your engine has run about 10 seconds to warm up, your vehicle is ready to be driven. Do not run your engine at high speed when it is cold.

If the weather is below freezing (32°F or 0°C), let the engine run for a few minutes to warm up.

3. If your engine still will not start, or starts but then stops, it could be flooded with too much gasoline. Try pushing your accelerator pedal all the way to the floor and holding it there as you hold the key in START for about three seconds. If the vehicle starts briefly but then stops again, do the same thing, but this time keep the pedal down for five or six seconds. This clears the extra gasoline from the engine.

Notice: Your engine is designed to work with the electronics in your vehicle. If you add electrical parts or accessories, you could change the way the engine operates. Before adding electrical equipment, check with your dealer. If you do not, your engine might not perform properly.

Engine Coolant Heater

Your vehicle may have an engine coolant heater.

In very cold weather, 0°F (-18°C) or colder, the engine coolant heater can help. You will get easier starting and better fuel economy during engine warm-up.

Usually, the coolant heater should be plugged in a minimum of four hours prior to starting your vehicle.

At temperatures above 32°F (0°C), use of the coolant heater is not required.

To Use the Engine Coolant Heater

1. Turn off the engine.
2. Open the hood and unwrap the electrical cord.
The electrical cord is located on the driver's side of the engine compartment.
3. Plug it into a normal, grounded 110-volt AC outlet.

CAUTION:

Plugging the cord into an ungrounded outlet could cause an electrical shock. Also, the wrong kind of extension cord could overheat and cause a fire. You could be seriously injured. Plug the cord into a properly grounded three-prong 110-volt AC outlet. If the cord will not reach, use a heavy-duty three-prong extension cord rated for at least 15 amps.

4. Before starting the engine, be sure to unplug and store the cord as it was before to keep it away from moving engine parts. If you do not, it could be damaged.

How long should you keep the coolant heater plugged in? The answer depends on the outside temperature, the kind of oil you have, and some other things. Instead of trying to list everything here, we ask that you contact your dealer in the area where you will be parking your vehicle. The dealer can give you the best advice for that particular area.

Automatic Transaxle Operation

P
R
N
D
2
L

There are several different positions for your shift lever.

PARK (P): This position locks your front wheels. It is the best position to use when you start your engine because your vehicle cannot move easily.

CAUTION:

It is dangerous to get out of your vehicle if the shift lever is not fully in PARK (P) with the parking brake firmly set. Your vehicle can roll.

Do not leave your vehicle when the engine is running unless you have to. If you have left the engine running, the vehicle can move suddenly. You or others could be injured. To be sure your vehicle will not move, even when you are on fairly level ground, always set your parking brake and move the shift lever to PARK (P). See *Shifting Into Park (P) (Automatic Transaxle)* on page 2-28. If you are pulling a trailer, see *Towing a Trailer* on page 4-40.

Ensure that the shift lever is fully in PARK (P) before starting the engine. Your vehicle has an automatic transaxle shift lock control system. You have to fully apply your regular brakes before you can shift from PARK (P) when the ignition key is in ON.

If you cannot shift out of PARK (P), ease pressure on the shift lever, push the shift lever all the way into PARK (P) and release the shift lever button as you maintain brake application. Then press the shift lever button and move the shift lever into the gear you wish. See *Shifting Out of Park (P) (Automatic Transaxle)* on page 2-30.

REVERSE (R): Use this gear to back up.

Notice: Shifting to REVERSE (R) while your vehicle is moving forward could damage the transaxle. The repairs would not be covered by your warranty. Shift to REVERSE (R) only after your vehicle is stopped.

To rock your vehicle back and forth to get out of snow, ice or sand without damaging your transaxle, see *If You Are Stuck: In Sand, Mud, Ice or Snow* on page 4-30.

NEUTRAL (N): In this position, your engine does not connect with the wheels. To restart when you are already moving, use NEUTRAL (N) only.

 **CAUTION:**

Shifting into a drive gear while your engine is running at high speed is dangerous. Unless your foot is firmly on the brake pedal, your vehicle could move very rapidly. You could lose control and hit people or objects. Do not shift into a drive gear while your engine is running at high speed.

Notice: Shifting out of PARK (P) or NEUTRAL (N) with the engine racing may damage the transaxle. The repairs would not be covered by your warranty. Be sure the engine is not racing when shifting your vehicle.

DRIVE (D): This position is for normal driving. If you need more power for passing, and you are:

- Going less than about 27 mph (43 km/h), push your accelerator pedal about halfway down.
- Going about 29 mph (47 km/h) or more, push your accelerator pedal all the way down.

You will shift down to the next gear and have more power.

SECOND (2): This position gives you more power than DRIVE (D) but lower fuel economy. You can use SECOND (2) on hills. It can help control your speed as you go down steep mountain roads, but then you would also want to use your brakes off and on.

LOW (L): This position gives you even more power than SECOND (2) but lower fuel economy. You can use it on very steep hills, or in deep snow or mud. If the shift lever is put in LOW (L), the transaxle will not shift into low gear until the vehicle is going slow enough.

Notice: Spinning the tires or holding the vehicle in one place on a hill using only the accelerator pedal may damage the transaxle. If you are stuck, do not spin the tires. When stopping on a hill, use the brakes to hold the vehicle in place.

Overdrive Off



Your automatic transaxle has an O/D (overdrive off) button located on the left side of the shift lever.

Press the O/D button to turn off overdrive. A light on the instrument panel cluster will come on when this feature is used. Press the button again to turn overdrive back on. Then the light on the instrument panel cluster will go off. See *Overdrive Off Light on page 3-40*.

When you turn on your vehicle the overdrive will automatically be on until you turn it off.

Manual Transaxle Operation

Five-Speed Transaxle

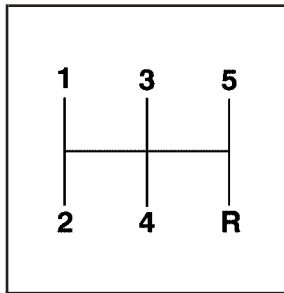

You can shift into FIRST (1) when you are going less than 20 mph (32 km/h). If you have come to a complete stop and it is hard to shift into FIRST (1), put the shift lever in NEUTRAL and let up on the clutch. Press the clutch pedal back down. Then shift into FIRST (1).

SECOND (2): Press the clutch pedal as you let up on the accelerator pedal and shift into SECOND (2). Then, slowly let up on the clutch pedal as you press the accelerator pedal.

FIRST (1): Press the clutch pedal and shift into FIRST (1). Then, slowly let up on the clutch pedal as you press the accelerator pedal.

THIRD (3), FOURTH (4), FIFTH (5): Shift into THIRD (3), FOURTH (4) and FIFTH (5) the same way you do for SECOND (2). Slowly let up on the clutch pedal as you press the accelerator pedal.

To stop, let up on the accelerator pedal and press the brake pedal. Just before the vehicle stops, press the clutch pedal and the brake pedal, and shift to NEUTRAL.

NEUTRAL: Use this position when you start or idle your engine.

REVERSE (R): To back up, press down on the clutch pedal and shift into REVERSE (R). Let up on the clutch pedal slowly while pressing the accelerator pedal.

Notice: Shifting to REVERSE (R) while your vehicle is moving forward could damage the transaxle. The repairs would not be covered by your warranty. Shift to REVERSE (R) only after your vehicle is stopped.

Also, use REVERSE (R) along with the parking brake for parking your vehicle.

Six-Speed Transaxle

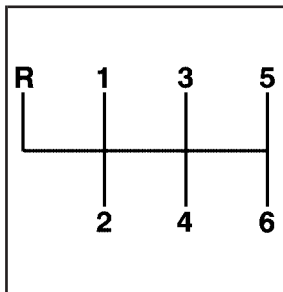

FIRST (1): Press the clutch pedal and shift into FIRST (1). Then, slowly let up on the clutch pedal as you press the accelerator pedal.

You can shift into FIRST (1) when you are going less than 20 mph (32 km/h). If you have come to a complete stop and it is hard to shift into FIRST (1), put the shift lever in NEUTRAL and let up on the clutch. Press the clutch pedal back down. Then shift into FIRST (1).

SECOND (2): Press the clutch pedal as you let up on the accelerator pedal and shift into SECOND (2). Then, slowly let up on the clutch pedal as you press the accelerator pedal. If you have come to a complete stop and it is hard to shift into SECOND (2), put the shift lever in NEUTRAL and let up on the clutch. Press the clutch pedal back down. Then shift into SECOND (2).

THIRD (3): Press the clutch pedal and upshift into THIRD (3). Then, slowly let up on the clutch pedal as you press the accelerator pedal.

FOURTH (4), FIFTH (5), SIXTH (6): Shift into FOURTH (4) and FIFTH (5) and SIXTH (6) the same way you do for THIRD (3). Slowly let up on the clutch pedal as you press the accelerator pedal.

To stop, let up on the accelerator pedal and press the brake pedal. Just before the vehicle stops, press the clutch pedal and the brake pedal, and shift to NEUTRAL.

NEUTRAL: Use this position when you start or idle your engine.

REVERSE (R): To back up, press down on the clutch pedal and shift into REVERSE (R). Let up on the clutch pedal slowly while pressing the accelerator pedal.

Notice: Shifting to REVERSE (R) while your vehicle is moving forward could damage the transaxle. The repairs would not be covered by your warranty. Shift to REVERSE (R) only after your vehicle is stopped.

Also, use REVERSE (R) along with the parking brake for parking your vehicle. There is an audible beep when the vehicle is in REVERSE (R) to ensure that FIRST (1) gear and REVERSE (R) are not confused.

Shift Speeds

CAUTION:

If you skip a gear when you downshift, you could lose control of your vehicle. You could injure yourself or others. Don't shift down more than one gear at a time when you downshift.

This chart shows when to shift to the next gear for the best fuel economy.

Manual Transmission Recommended Shift Speeds

Engine	1 to 2 or 2 to 1	2 to 3 or 3 to 2	3 to 4 or 4 to 3	4 to 5 or 5 to 4	5 to 6 or 6 to 5
1.8 L (Code 8)	15 mph 24 km/h	25 mph 40 km/h	40 mph 64 km/h	45 mph 72 km/h	—
1.8 L (Code L)	15 mph 24 km/h	25 mph 40 km/h	40 mph 64 km/h	45 mph 72 km/h	50 mph 80 km/h

If your speed drops below 20 mph (32 km/h), or if the engine is not running smoothly, you should downshift to the next lower gear. You may have to downshift two or more gears to keep the engine running smoothly or for good performance.

Parking Brake

To set the parking brake, hold the brake pedal down and pull up on the parking brake lever. If the ignition is on, the brake system warning light will come on.

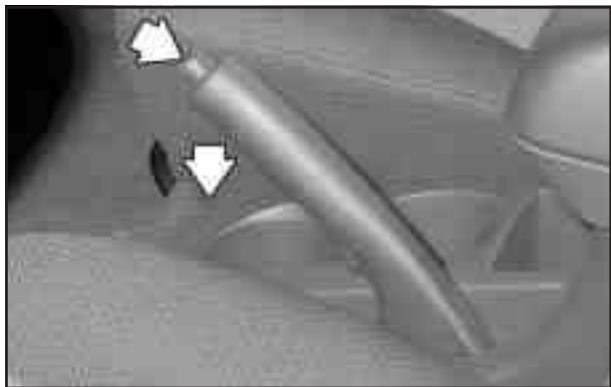

To release the parking brake, hold the brake pedal down. Pull the parking brake lever up until you can press the release button. Hold the release button in as you move the lever all the way down.

Notice: Driving with the parking brake on can overheat the brake system and cause premature wear or damage to brake system parts. Verify that the parking brake is fully released and the brake warning light is off before driving.

If you are towing a trailer, see *Towing a Trailer* on page 4-40.

Shifting Into Park (P) (Automatic Transaxle)

CAUTION:

It can be dangerous to get out of your vehicle if the shift lever is not fully in PARK (P) with the parking brake firmly set. Your vehicle can roll. If you have left the engine running, the vehicle can move suddenly. You or others could be injured. To be sure your vehicle will not move, even when you are on fairly level ground, use the steps that follow. If you are pulling a trailer, see *Towing a Trailer* on page 4-40.

To shift into PARK (P), do the following:

1. Hold the brake pedal down with your right foot and set the parking brake by pulling up on the parking brake lever.
2. Move the shift lever into PARK (P) by holding in the button on the shift lever and pushing the lever all the way toward the front of the vehicle.
3. Turn the ignition key to LOCK.
4. Remove the key and take it with you. If you can leave your vehicle with the key in your hand, your vehicle is in PARK (P).

Leaving Your Vehicle With the Engine Running (Automatic Transaxle)

CAUTION:

It can be dangerous to leave your vehicle with the engine running. Your vehicle could move suddenly if the shift lever is not fully in PARK (P) with the parking brake firmly set. And, if you leave the vehicle with the engine running, it could overheat and even catch fire. You or others could be injured. Do not leave your vehicle with the engine running.

If you have to leave your automatic transaxle vehicle with the engine running, be sure your vehicle is in PARK (P) and your parking brake is firmly set before you leave it. After you have moved the shift lever into PARK (P), hold the regular brake pedal down. Then, see if you can move the shift lever away from PARK (P) without first pulling it toward you. If you can, it means that the shift lever was not fully locked into PARK (P).

Torque Lock (Automatic Transaxle)

If you are parking on a hill and you do not shift into PARK (P) properly, the weight of the vehicle may put too much force on the parking pawl in the transaxle. You may find it difficult to pull the shift lever out of PARK (P). This is called “torque lock.” To prevent torque lock, set the parking brake and then shift into PARK (P) properly before you leave the driver’s seat. To find out how, see *Shifting Into Park (P) (Automatic Transaxle)* on page 2-28.

When you are ready to drive, move the shift lever out of PARK (P) before you release the parking brake.

If torque lock does occur, you may need to have another vehicle push yours a little uphill to take some of the pressure from the parking pawl in the transaxle, so you can pull the shift lever out of PARK (P).

Shifting Out of Park (P) (Automatic Transaxle)

Your vehicle has an automatic transaxle shift lock control system. You have to fully apply your regular brakes before you can shift from PARK (P) when the ignition is in ON. See *Automatic Transaxle Operation* on page 2-22.

If you cannot shift out of PARK (P), ease pressure on the shift lever – push the shift lever all the way into PARK (P) and release the shift lever button as you maintain brake application. Then press the shift lever button and move the shift lever into the gear you wish.

Shift Lock Release

If you ever hold the brake pedal down but still cannot shift out of PARK (P), try this:

1. Turn the ignition to LOCK. Make sure the parking brake is applied.



2. Carefully pry the cover from the shift lock override, located to the right of the shift lever.

3. Insert the end of a flat-tipped tool into the round slot and press down firmly.
4. While maintaining brake application, move the shift lever into the drive gear you want.
5. Have the vehicle fixed as soon as possible.

Parking Your Vehicle (Manual Transaxle)

Before you get out of your vehicle, move the shift lever into REVERSE (R), and firmly apply the parking brake. Once the shift lever has been placed into REVERSE (R) with the clutch pedal pressed in, you can turn the ignition key to OFF, remove the key and release the clutch.

If you are parking on a hill, or if your vehicle is pulling a trailer, see *Towing a Trailer on page 4-40*.

Parking Over Things That Burn

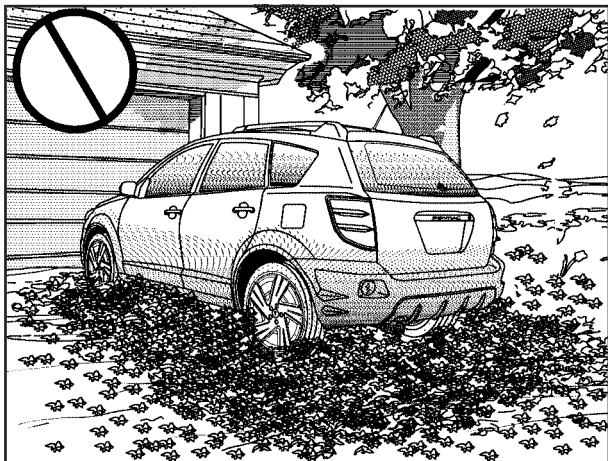

CAUTION:

Things that can burn could touch hot exhaust parts under your vehicle and ignite. Do not park over papers, leaves, dry grass or other things that can burn.

Engine Exhaust

CAUTION:

Engine exhaust can kill. It contains the gas carbon monoxide (CO), which you cannot see or smell. It can cause unconsciousness and death.

You might have exhaust coming in if:

- Your exhaust system sounds strange or different.
- Your vehicle gets rusty underneath.
- Your vehicle was damaged in a collision.
- Your vehicle was damaged when driving over high points on the road or over road debris.
- Repairs were not done correctly.
- Your vehicle or exhaust system had been modified improperly.

If you ever suspect exhaust is coming into your vehicle:

- Drive it only with all the windows down to blow out any CO; and
- Have your vehicle fixed immediately.

Running Your Engine While You Are Parked

It is better not to park with the engine running. But if you ever have to, here are some things to know.

CAUTION:

Idling the engine with the climate control system off could allow dangerous exhaust into your vehicle. See the earlier caution under *Engine Exhaust on page 2-32*.

Also, idling in a closed-in place can let deadly carbon monoxide (CO) into your vehicle even if the climate control fan is at the highest setting. One place this can happen is a garage. Exhaust — with CO — can come in easily. NEVER park in a garage with the engine running.

Another closed-in place can be a blizzard. See *Winter Driving on page 4-26*.

CAUTION:

It can be dangerous to get out of your vehicle if the shift lever is not fully in PARK (P) with the parking brake firmly set. Your vehicle can roll. Do not leave your vehicle when the engine is running unless you have to. If you have left the engine running, the vehicle can move suddenly. You or others could be injured. To be sure your vehicle will not move, even when you are on fairly level ground, always set your parking brake and move the shift lever to PARK (P).

Follow the proper steps to be sure your vehicle will not move. See *Shifting Into Park (P) (Automatic Transaxle) on page 2-28*.

If you are parking on a hill and if you are pulling a trailer, also see *Towing a Trailer on page 4-40*.

Mirrors

Manual Rearview Mirror

While sitting in a comfortable driving position, adjust the mirror so you can see clearly behind your vehicle. Grip the mirror in the center to move it up or down and side to side.

The control at the bottom of the mirror is the day/night feature that allows adjustment to the mirror so that the glare of headlamps from behind is reduced. Pull the control for night driving to reduce glare; push it to return to the day position.

The mirror may have map lights beneath the mirror. Push the lens to turn each light on or off.

Manual Rearview Mirror with OnStar®

The vehicle may have an inside rearview mirror with OnStar®. See your GM dealer for more information on the system and how to subscribe to OnStar®. See *OnStar® System on page 2-35* for information on the services OnStar® provides.

While sitting in a comfortable position, adjust the mirror so you can see clearly behind your vehicle. Grip the mirror in the center to move it up or down and side to side. The control at the bottom of the mirror is the day/night feature that allows adjustment to the mirror so that the glare of headlamps from behind is reduced. Move the control from left to right for day or night conditions.

Outside Remote Control Mirrors

The vehicle has outside power adjustable mirrors.



The controls are located to the left of the steering wheel on the instrument panel.

To adjust either mirror, push the button labeled L (left) or R (right). Use the arrows on the control pad to adjust the direction of the mirror.

Once both mirrors have been adjusted, move the selector switch back to the center. This prevents the mirrors from being moved once they have been adjusted.

Outside Convex Mirror

 **CAUTION:**

A convex mirror can make things (like other vehicles) look farther away than they really are. If you cut too sharply into the right lane, you could hit a vehicle on your right. Check your inside mirror or glance over your shoulder before changing lanes.

The passenger's side mirror is convex. A convex mirror's surface is curved so more can be seen from the driver's seat.

OnStar[®] System

OnStar[®] uses global positioning system (GPS) satellite technology, wireless communications, and call centers to provide you with a wide range of safety, security, information, and convenience services.

A complete OnStar[®] user's guide and the terms and conditions of the OnStar[®] Subscription Service Agreement are included in the vehicle's glove box literature. For more information, visit www.onstar.com or www.onstarcanada.com. Contact OnStar[®] at 1-888-4-ONSTAR (1-888-466-7827), or press the OnStar[®] button to speak to an OnStar[®] advisor 24 hours a day, 7 days a week.

Terms and conditions of the Subscription Service Agreement can be found at www.onstar.com or www.onstarcanada.com.

OnStar® Services

The Safe and Sound Plan is included on new vehicles for the first year for vehicles equipped with OnStar®. The plan can be extended or upgraded to the Directions and Connections Plan to meet your needs. For more information, press the OnStar® button to speak to an advisor.

Safe and Sound Plan

- Automatic Notification of Air Bag Deployment
- Emergency Services
- Roadside Assistance
- Stolen Vehicle Tracking
- AccidentAssist
- Remote Door Unlock/Vehicle Alert
- Remote Diagnostics
- Online Concierge

Directions and Connections Plan

- All Safe and Sound Plan Services
- Driving Directions
- RideAssist
- Information and Convenience Services

OnStar® Personal Calling

As an OnStar® subscriber, the Personal Calling capability is available if your hand-held cell phone is lost, forgotten, or has a low battery. It is a hands-free wireless phone that is integrated into the vehicle. Calls can be placed nationwide using simple voice commands with no additional contracts and no additional roaming charges. To find out more about OnStar® Personal Calling, refer to the OnStar® user's guide in the vehicle's glove box or visit www.onstar.com or www.onstarcanada.com; or speak with an OnStar advisor by pressing the OnStar® button or by calling 1-888-4-ONSTAR (1-888-466-7827).

OnStar® Virtual Advisor

Virtual Advisor is a feature of OnStar® Personal Calling that uses minutes to access up-to-date weather and traffic reports for your area, news and sports updates, stock quotes, entertainment and more. You are also able to listen and reply to your E-mail through your vehicle's audio system. Customize your information profile at www.myonstar.com. See the OnStar® user's guide for more information.

Storage Areas

Glove Box

Open the glove box by pulling the bottom of the handle upward. Close the glove box with a firm push.

Cupholder(s)

There are two fixed cupholders located in the console area between the two front seats. There are also two cupholders that fold out of the rear of the console storage unit.

Coinholder(s)

Your instrument panel has a coinholder located to the left of the steering wheel and on the center console near the parking brake.

Instrument Panel Storage Area

There are storage compartments located on the instrument panel in two places. They are below the interior/instrument panel brightness dial and below the shift lever. Pull the top of the door toward you to open it or for the compartment below the shift lever, push the button to open it.

Center Console Storage Area

A storage area is located in the console between the seats. There may also be an accessory power outlet located in the storage area.

To access the storage area, pull up the lock release lever while raising the lid.

Floor Mats

The driver's side floor mat is held in place by two locator hooks.

Be sure the driver's side floor mat is properly placed on the floor so that it does not block the movement of the accelerator pedal.

How to Remove and Replace the Floor Mat

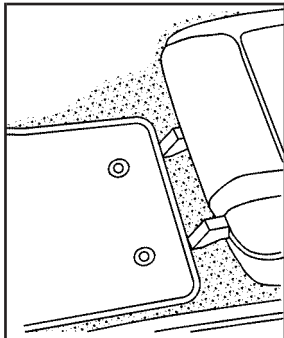

To remove the floor mat, pull up on the rear of the mat to disconnect it from the locator hooks.

To reinstall the floor mat, line up the openings in the floor mat over the locator hooks and push down into place.

Rear Storage Area

A storage area is located under the rear cargo area floor panel.



Turn the knobs on the floor panel to unlock the storage area access cover.

Be sure to lock the access cover to close it securely.

Rear Cargo Accessory Track System

Your vehicle has a track system located on the floor of the rear cargo area. This system can be used to carry accessories in your vehicle in many ways by using the tie-down anchors provided in your vehicle or accessory packages available from your GM dealer.

Make sure the cargo being carried in the rear cargo area is secure. See *Loading Your Vehicle on page 4-32*.



Cargo Cover

To use the cargo cover, attach the side hooks of the cargo cover to the upper tie down hooks located along both sides of the rear cargo area.

CAUTION:

An improperly stored cargo cover could be thrown about the vehicle during a collision or sudden maneuver. You or others could be injured. If you remove the cover, always store it in the proper storage location. When you put it back, always be sure that it is securely reattached.

Cargo Tie Downs



The tire tie-down straps are designed to secure a flat tire. You can also use the straps and hooks to secure your luggage.

There are eight tie-down hooks located in the rear of the vehicle. The straps are located under the cargo area floor panel. To use the straps, hook the ends to the lower tie-down hooks in a criss-cross pattern across the cargo. Pull on the straps at the buckle to tighten the straps as needed.

Sunroof

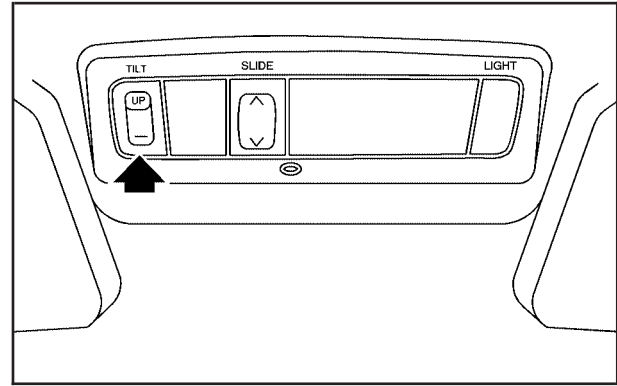

If the vehicle has a sunroof, it can be opened or put in a tilt position. To tilt the sunroof, slide the sunshade rearward, then press the switch marked UP. Press the other end of the switch to lower the sunroof. The ignition must be in the ON position for the switch to work.

To open or close the sunroof, press the switch marked SLIDE rearward or forward. The sunroof will close partially and stop. Once the sunroof stops, release the switch and press the button again to fully close it. The sunroof can be opened to any position. The sunshade will open when the sunroof is opened. The sunshade must be closed manually.

Section 3 Instrument Panel

Instrument Panel Overview	3-4	Climate Controls	3-20
Hazard Warning Flashers	3-6	Climate Control System	3-20
Other Warning Devices	3-6	Outlet Adjustment	3-22
Horn	3-6	Passenger Compartment Air Filter	3-23
Tilt Wheel	3-7	Warning Lights, Gages, and Indicators	3-25
Turn Signal/Multifunction Lever	3-7	Instrument Panel Cluster	3-26
Turn and Lane-Change Signals	3-8	Speedometer and Odometer	3-27
Headlamp High/Low-Beam Changer	3-8	Trip Odometers	3-27
Flash-to-Pass	3-8	Tachometer	3-27
Windshield Wipers	3-9	Safety Belt Reminder Light	3-28
Windshield Washer	3-10	Airbag Readiness Light	3-29
Cruise Control	3-10	Passenger Airbag Status Indicator	3-30
Exterior Lamps	3-13	Charging System Light	3-31
Headlamps on Reminder	3-13	Brake System Warning Light	3-32
Daytime Running Lamps	3-14	Anti-Lock Brake System Warning Light	3-33
Automatic Headlamp System	3-15	Low Tire Pressure Warning Light	3-33
Fog Lamps	3-15	Traction Control System (TCS) Warning Light	3-34
Instrument Panel Brightness	3-15	Stabilitrak [®] Indicator Light	3-34
Interior Lamps Control	3-16	Engine Coolant Temperature Gage	3-35
Entry Lighting	3-16	Malfunction Indicator Lamp	3-35
Reading Lamps	3-17	Oil Pressure Light	3-38
Accessory Power Outlets	3-18	Lights On Reminder	3-39
Power Outlet 115 Volt Alternating Current	3-18		
Ashtrays and Cigarette Lighter	3-19		

Section 3 Instrument Panel

Taillamp Indicator Light	3-39	Audio System(s)	3-42
Cruise Control Light	3-39	Setting the Time	3-42
Overdrive Off Light	3-40	Radio with CD	3-43
Highbeam On Light	3-40	Radio with Six-Disc CD	3-53
Low Washer Fluid Warning Light	3-40	Navigation/Radio System	3-64
Door Ajar Light	3-40	Radio Reception	3-64
Fuel Gage	3-41	Care of Your CDs	3-64
Low Fuel Warning Light	3-41	Care of Your CD Player	3-65
		Fixed Mast Antenna	3-65
		XM™ Satellite Radio Antenna System	3-65

Instrument Panel Overview

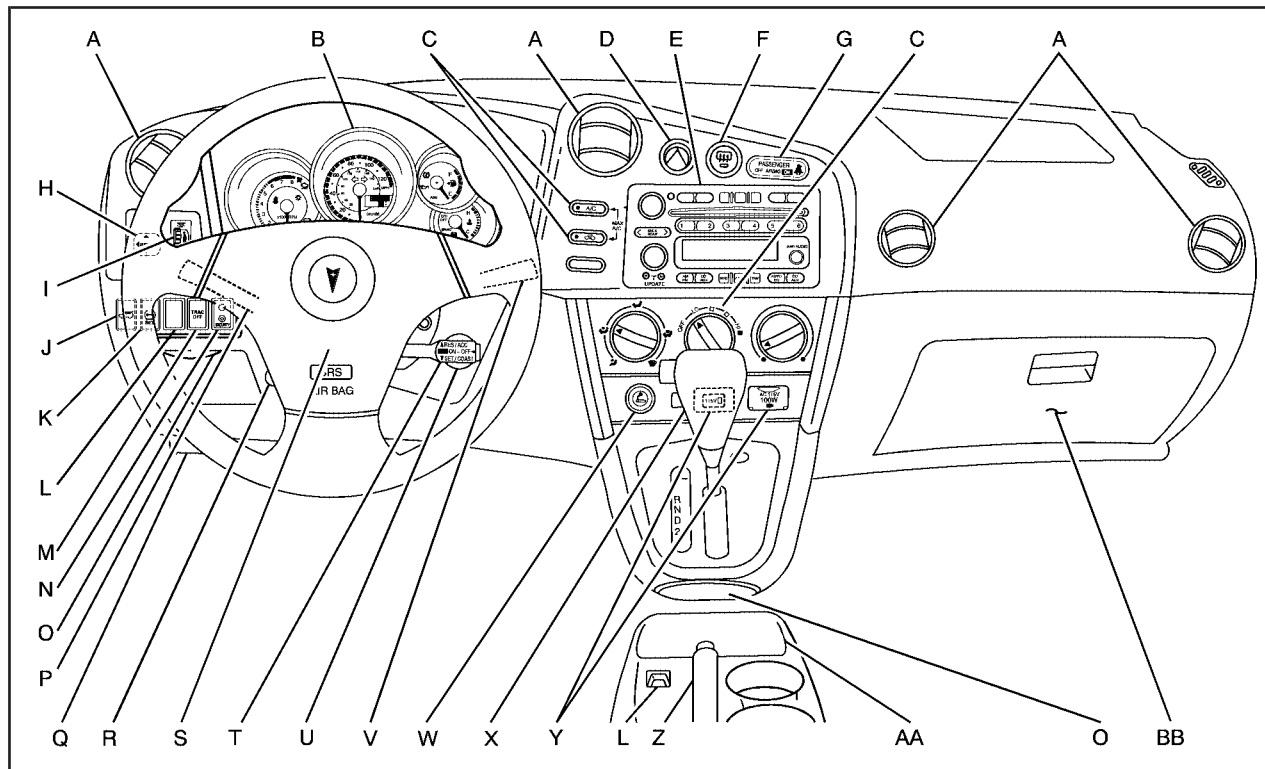

The main components of your instrument panel are the following:

- A. Air Outlets. See *Outlet Adjustment on page 3-22*.
- B. Instrument Panel Cluster. See *Instrument Panel Cluster on page 3-26*.
- C. Climate Control System. See *Climate Control System on page 3-20*.
- D. Hazard Warning Flasher Button. See *Hazard Warning Flashers on page 3-6*.
- E. Audio System. See *Audio System(s) on page 3-42*.
- F. Rear Window Defogger Button. See "Rear Window Defogger" under *Climate Control System on page 3-20*.
- G. Passenger Airbag Status Indicator. See *Passenger Airbag Status Indicator on page 3-30*. Front Passenger Safety Belt Reminder Light. See *Safety Belt Reminder Light on page 3-28*.
- H. Power Remote Control Mirror Button. See *Outside Remote Control Mirrors on page 2-34*.
- I. Instrument Panel Brightness Control. See *Instrument Panel Brightness on page 3-15*.
- J. Rear Liftglass Release Button. See *Liftgate/Liftglass on page 2-11*.
- K. Tire Pressure Monitor Reset Button. See *Tire Pressure Monitor System on page 5-65*.
- L. Coinholder. See *Coinholder(s) on page 2-37*.
- M. TRAC OFF Button. See *Traction Control System (TCS) on page 4-9*.
- N. Content Theft-Deterrent Security Light. See *Content Theft-Deterrent on page 2-15*.
- O. Storage Compartment. See *Instrument Panel Storage Area on page 2-37*.
- P. Turn Signal/Multifunction Lever and Exterior Lamp Stalk. See *Turn Signal/Multifunction Lever on page 3-7* and *Exterior Lamps on page 3-13*.
- Q. Hood Release. See *Hood Release on page 5-10*.
- R. Tilt Lever. See *Tilt Wheel on page 3-7*.
- S. Horn. See *Horn on page 3-6*.
- T. Cruise Control Lever (Option). See *Cruise Control on page 3-10*.
- U. Ignition Switch. See *Ignition Positions on page 2-18*.
- V. Windshield Wiper Lever. See *Windshield Wipers on page 3-9*.
- W. Cigarette Lighter or Accessory Power Outlet. See *Ashtrays and Cigarette Lighter on page 3-19* or *Accessory Power Outlets on page 3-18*.
- X. Shift Lever. See *Automatic Transaxle Operation on page 2-22*.

- Y. Power Outlet. See *Power Outlet 115 Volt Alternating Current* on page 3-18.
- Z. Parking Brake. See *Parking Brake* on page 2-28.
- AA. Center Console Storage Area. See *Center Console Storage Area* on page 2-37.
- AB. Glove Box. See *Glove Box* on page 2-37.

Hazard Warning Flashers

Your hazard warning flashers let you warn others. They also let police know you have a problem. Your front and rear turn signal lamps will flash on and off.

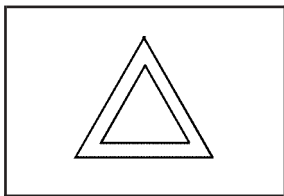

The hazard warning flasher button is located near the center of the instrument panel.

Your hazard warning flashers work no matter what position your key is in, and even if the key is not in.

Press the button to make the front and rear turn signal lamps flash on and off. Press the button again to turn the flashers off.

When the hazard warning flashers are on, your turn signals will not work.

Other Warning Devices

If you carry reflective triangles, you can set them up at the side of the road about 300 feet (100 m) behind your vehicle.

Horn

Press near or on the horn symbols on your steering wheel pad to sound the horn.

Tilt Wheel

A tilt steering column allows you to adjust the steering column before you drive. You can also raise it to the highest level to give your legs more room when you exit and enter the vehicle.



The tilt lever is located underneath, on the left side of the steering wheel column.

To tilt the column, move the lever downward. Adjust the steering wheel to a comfortable position, then move the lever upward to lock the column in place.

Turn Signal/Multifunction Lever



The turn signal/multifunction lever is located on the left side of the steering column.

This lever operates the following:

- Exterior Lamps. See *Exterior Lamps* on page 3-13.
- Turn and Lane-Change Signals. See *Turn and Lane-Change Signals* on page 3-8.
- Headlamp High/Low-Beam Changer. See *Headlamp High/Low-Beam Changer* on page 3-8.
- Flash-to-Pass. See *Flash-to-Pass* on page 3-8.
- Fog Lamps. See *Fog Lamps* on page 3-15.

Turn and Lane-Change Signals

The turn signal has an upward (for right) and a downward (for left) position. These positions allow you to signal a turn or a lane change.

To signal a turn, move the lever all the way up or down. When the turn is finished, the lever will return automatically.

To signal a lane change, raise or lower the lever until the arrow starts to flash. Hold it there until you complete your lane change. The lever will return by itself when you release it.

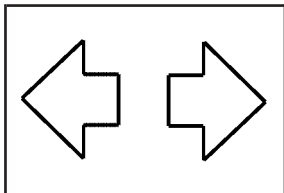

An arrow on the instrument panel cluster will flash in the direction of the turn or lane change.

If you signal a turn or a lane change and notice the arrow flashing rapidly, a signal bulb may be burned out and other drivers won't see your turn signal.

If a bulb is burned out, have it replaced to help avoid an accident. If the arrows don't go on at all when you signal a turn, check for burned-out bulbs and then check the fuse. See *Fuses and Circuit Breakers on page 5-96*.

Headlamp High/Low-Beam Changer

The headlamps must be on for this feature to work. For high beams, push the turn signal lever away from you.

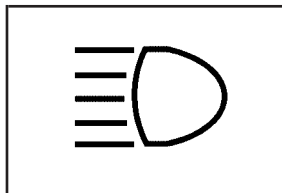

When the high beams are on, this light on the instrument panel cluster also will be on.

It will go off when you switch to the low beams. To switch back to low beams, pull the lever toward you.

Flash-to-Pass

With the lever in the low-beam position, pull the lever toward you to momentarily switch to high beams (to signal that you are going to pass). If you have the headlamps on when you release the lever, they will return to the low beams.

Windshield Wipers

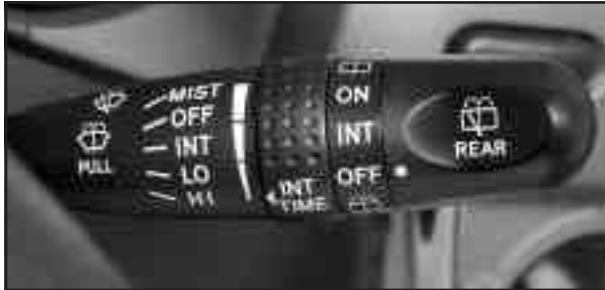

The lever on the right side of the steering column controls the windshield wipers and washer.

The available positions are the following:

MIST: For a single wiping cycle, move the lever to MIST. Hold it there until the wipers start, then let go. The wipers will stop after one wipe.

OFF: The wipers are off.

INT (Intermittent): Move the lever to INT to choose a delayed wiping cycle. In light rain or snow, you might want to use this position rather than continuous wiping. You can change the time between wipes by turning the INT TIME band. Turn the band forward or rearward for longer or shorter delay interval.

LO (Low): Move the lever to LO for steady wiping at low speed.

HI (High): Move the lever to HI for steady wiping at high speed.

REAR: To turn on the rear window wiper, twist the end of the lever upward to ON. For intermittent wiping, twist the end of the lever to INT. The wiper does not work with the rear liftglass open.

Be sure to clear ice and snow from the wiper blades before using them. If they're frozen to the windshield, carefully loosen or thaw them. If your blades do become damaged, get new blades or blade inserts.

Heavy snow or ice can overload your wipers. A circuit breaker will stop them until the motor cools. Clear away snow or ice to prevent an overload.

Windshield Washer

Pull the lever toward you to spray washer fluid on the windshield. The spray will continue until you release the lever. The wipers will run a few times. See *Windshield Washer Fluid* on page 5-38.

To squirt washer fluid on the rear window, twist the knob upward and downward as far as it will go. The knob automatically returns from these positions after you release it. You can twist the lever downward to create a large flow of water on the rear window, then twist the lever back up to wipe the window. This feature is helpful to quickly clear the rear liftglass when very dirty.

CAUTION:

In freezing weather, do not use your washer until the windshield is warmed. Otherwise the washer fluid can form ice on the windshield, blocking your vision.

Cruise Control



If your vehicle has cruise control, the lever is located on the right side of the steering wheel.

With cruise control, you can maintain a speed of 25 mph (40 km/h) or more without keeping your foot on the accelerator. This can really help on long trips. Cruise control does not work at speeds below 25 mph (40 km/h).

 **CAUTION:**

Cruise control can be dangerous where you cannot drive safely at a steady speed. So, do not use your cruise control on winding roads or in heavy traffic.

Cruise control can be dangerous on slippery roads. On such roads, fast changes in tire traction can cause needless wheel spinning, and you could lose control. Do not use cruise control on slippery roads.

Setting Cruise Control

 **CAUTION:**

If you leave your cruise control on when you are not using cruise, you might hit a button and go into cruise when you do not want to. You could be startled and even lose control. Keep the cruise control switch off until you want to use cruise control.

1. Press the ON-OFF button at the end of the cruise control lever. The CRUISE light on the instrument panel cluster will come on. See *Cruise Control Light on page 3-39* for more information.
2. Get up to the speed you want.
3. Move the lever down to SET/COAST and release it.
4. Take your foot off the accelerator pedal.

Resuming a Set Speed

Suppose the cruise control is set at a desired speed and then you apply the brake. This will shut off cruise control. But you won't need to reset it.

Unless you're going less than 25 mph (40 km/h) you can push the lever up to RES/ACC (Resume/Accelerate). You'll go right back up to your chosen speed and stay there.

The cruise control set speed is erased from memory if the vehicle speed goes below 25 mph (40 km/h). If your preset speed cancels out at speeds above 25 mph (40 km/h), there may be a problem with your vehicle's cruise control. See your dealer.

Increasing Speed While Using Cruise Control

There are two ways to go to a higher speed:

- Use the accelerator pedal to get to the higher speed. Move the lever down to SET/COAST. Release the lever and the accelerator pedal. You'll now cruise at the higher speed.
- Move the cruise lever up to RES/ACC. Hold it there until you get up to the speed you want, and then release the lever.
- To increase your speed in very small amounts, move the lever to RES/ACC briefly and then release it. Each time you do this, your vehicle will go about 1 mph (1.6 km/h) faster.

Reducing Speed While Using Cruise Control

There are two ways to reduce your speed while using cruise control:

- Push and hold the lever to SET/COAST until you reach the lower speed you want, then release it.
- To slow down in very small amounts, push the lever down briefly. Each time you do this, you'll go about 1 mph (1.6 km/h) slower.

Passing Another Vehicle While Using Cruise Control

Use the accelerator pedal to increase your speed. When you take your foot off the pedal, your vehicle will slow down to the cruise control speed you set earlier.

Using Cruise Control on Hills

How well your cruise control will work on hills depends upon your speed, load and the steepness of the hills.

When going up steep hills, you may have to step on the accelerator pedal to maintain your speed.

When going downhill, you may have to brake or shift to a lower gear to keep your speed down. Of course, applying the brake or downshifting to SECOND (2) or LOW (L) takes you out of cruise control. Many drivers find this to be too much trouble and don't use cruise control on steep hills.

Ending Cruise Control

There are several ways to turn off the cruise control:

- Step lightly on the brake pedal or push the clutch pedal, if you have a manual transaxle.
- Press the CRUISE ON-OFF button again.
- Pull the cruise control lever toward you.

Erasing Speed Memory

When you turn off the cruise control or the ignition, your cruise control set speed memory is erased. The set speed memory is also erased when the vehicle speed drops below 25 mph (40 km/h).

Exterior Lamps



The lever on the left side of the steering column operates the exterior lamps.

 **(Exterior Lamps):** Turn the outside part of the lever with the symbol on it, to operate the lamps. For vehicles sold in the U. S., this symbol will appear on the instrument panel cluster when your exterior lamps are on.

The exterior lamp switch has three positions:

OFF: Turning the switch to this position turns off all lamps, except the Daytime Running Lamps (DRL).

● **(Parking Lamps):** Turning the switch to this position turns on the parking lamps together with the following:

- Sidemarkers Lamps
- Taillamps
- License Plate Lamp
- Instrument Panel Lights

A symbol will appear on the instrument panel cluster when your parking lamps are on. See *Lights On Reminder* on page 3-39 and *Taillamp Indicator Light* on page 3-39 for additional information.

 **(Headlamps):** Turning the switch to this position turns on the headlamps, together with the previously listed lamps and lights.

Headlamps on Reminder

If you turn the ignition to LOCK or ACC and leave the lamps on, you'll hear a tone when you open the driver's door.

Daytime Running Lamps

Daytime Running Lamps (DRL) can make it easier for others to see the front of your vehicle during the day. DRL can be helpful in many different driving conditions, but they can be especially helpful in the short periods after dawn and before sunset. Fully functional daytime running lamps are required on all vehicles first sold in Canada.

The DRL system will make your headlamps come on at a reduced brightness when the following conditions are met:

- The ignition is on with the engine running.
- The exterior lamps switch is off.
- The parking brake is released.

When the DRL are on, only your headlamps will be on at a reduced brightness. The taillamps, sidemarker and other lamps won't be on. Your instrument panel won't be lit up either.

When you turn the exterior lamp switch to the headlamp position, your DRL will go off and your headlamps will come on. The other lamps that come on with your headlamps will also come on.

When it begins to get dark, the headlamps will automatically switch from DRL to the regular headlamps. See "Automatic Headlamp System" following.

When you turn the exterior lamp switch off, the regular lamps will go off and your headlamps will change to the reduced brightness of DRL provided it is not dark outside. DRL also comes on if only the parking lamps are being used.

To idle your vehicle with the DRL off, do the following:

1. Set the parking brake.
2. Turn the ignition off.
3. Turn the ignition back on.

The DRL will stay off until you release the parking brake.

As with any vehicle, you should turn on the regular headlamp system when you need it.

Automatic Headlamp System

Your vehicle is equipped with an automatic light sensor on the top left corner of the instrument panel, so be sure it is not covered or the headlamps will be on continuously.

When it is dark enough outside, your automatic headlamp system will turn on your low-beam headlamps at the normal brightness along with other lamps such as the taillamps, sidemarker, parking lamps and instrument panel lights. This is indicated by the headlamp symbol on your instrument panel cluster. See *Instrument Panel Cluster* on page 3-26.

If you are driving through a parking garage, overcast weather, or a tunnel, the automatic headlamp system may turn on your low-beam headlamps at a normal brightness along with the taillamps, sidemarker, parking lamps and the instrument panel lights. The radio lights will be dimmer, and the instrument panel cluster lights may dim. There will be a delay before the lights will turn on when starting the car at night.

Fog Lamps

⚡ (Fog Lamps): Turn the band on the turn signal/multifunction lever to the fog lamp symbol to turn the fog lamps on. They will come on only when the headlamps are on low beam.

Instrument Panel Brightness



The instrument panel brightness control is located to the left of the steering wheel on the instrument panel. Turn the wheel on the left of the control up or down to increase or decrease brightness.

The brightness of the instrument panel lights will decrease when the headlamps are on.

■ (Maximum Setting): It is recommended that the brightness level be kept at the maximum setting for all daytime driving to ensure proper visibility.

Interior Lamps Control

Turn the wheel on the right of the control to one of the following positions:

OFF: This position turns the light off.

ON: This position keeps the light on all the time.

 **(Door):** This position turns the light on when any door, the liftgate or the liftglass is opened. The light goes off when all the side doors, the liftgate and the liftglass are closed.

Entry Lighting

While the instrument panel brightness control is in the door position, the light will come on when any side door, the liftgate or the liftglass is opened. After all the doors, liftgate and liftglass are closed, and the key is out of the ignition, in LOCK or ACC, the light will remain on for about 15 seconds and then go out except under the following conditions:

- The ignition is turned to ACC or ON after all the doors, the liftgate and the liftglass are closed.
- All the doors and liftgate are locked when the liftglass is closed and the light is still on.

When any door is unlocked with the key or remote keyless entry system transmitter, the light comes on for 15 seconds, even if the door is not opened.

To prevent the battery from draining, the lamps will automatically turn off when the key is in the ACC or LOCK positions or if the key is removed for 20 minutes or more.

Reading Lamps

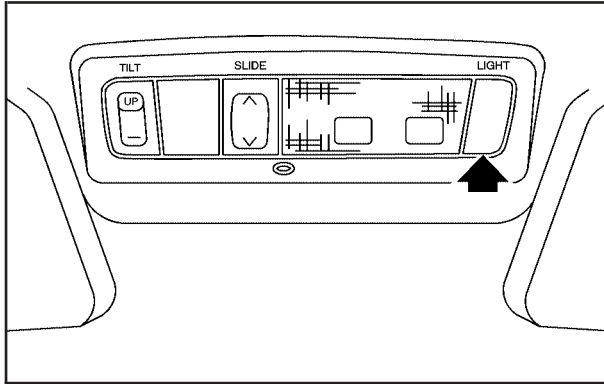

If you have a sunroof, you will have a reading lamp near the sunroof switch. Press the button to turn the lamp on and press it again to turn it off.



If you do not have a sunroof, your vehicle's inside rearview mirror may be equipped with reading lamps. If your vehicle is equipped with reading lamps, there are two buttons located on the bottom of the mirror. Press the buttons to turn the lamps on and press them again to turn the lamps off.

To prevent the battery from draining on vehicles with power door locks, the lamps will automatically turn off when the key is in the ACC or LOCK positions or if the key is removed for 20 minutes or more. The lights will come on when any of the doors are opened or if the key is turned to the ON position.

Accessory Power Outlets

With the accessory power outlet, you can plug in auxiliary electrical equipment.

The accessory power outlet is located in the center console storage area. Your vehicle may also have an additional outlet in place of the cigarette lighter.

To use the outlet, the ignition must be in ON or ACC. Pull down the small cover to access the outlet.

Notice: Leaving electrical equipment on for extended periods will drain the battery. Always turn off electrical equipment when not in use and do not plug in equipment that exceeds the maximum amperage rating.

These circuits are protected by a fuse and have maximum current levels.

Certain power accessory plugs may not be compatible to the power accessory outlet and could result in blown vehicle or adapter fuses. If you experience a problem see your dealer for additional information on the power accessory plugs.

Notice: Adding any electrical equipment to your vehicle may damage it or keep other components from working as they should. The repairs would not be covered by your warranty. Check with your dealer before adding electrical equipment.

When adding electrical equipment, be sure to follow the proper installation instructions included with the equipment.

Notice: Improper use of the power outlet can cause damage not covered by your warranty. Do not hang any type of accessory or accessory bracket from the plug because the power outlets are designed for accessory power plugs only.

Power Outlet 115 Volt Alternating Current

With this power outlet, you can plug in auxiliary electrical equipment with a maximum limit of 115 VAC. If you try to use equipment that requires more than the limit, a protection circuit will cut the power supply. The power will automatically restart when equipment that operates within the limit is plugged in.



The power outlet is located near the center of the instrument panel. Before using the outlet, turn on the ignition and press the button next to the outlet. An indicator light in the button will come on. After using the outlet, press the button again to turn it off.

The power outlet is not designed for the following electrical equipment and they may not work properly:

- Equipment with high initial peak wattage: cathode-ray tube type televisions, compressor-driven refrigerators, electric power tools.
- Other equipment requiring an extremely stable power supply: microcomputer-controlled electric blankets, touch sensor lamps, etc.

Ashtrays and Cigarette Lighter

Notice: If you put papers or other flammable items in the ashtray, hot cigarettes or other smoking materials could ignite them and possibly damage your vehicle. Never put flammable items in the ashtray.

To use the lighter, if your vehicle has one, push the lighter in all the way and let go. When it's ready, it will pop back out by itself. If the engine is not running, the key must be in ACC to use the lighter.

It is not recommended to use the cigarette lighter to plug in auxiliary electrical equipment. Use the accessory power outlet for phones and other electrical equipment. See *Accessory Power Outlets on page 3-18* or *Power Outlet 115 Volt Alternating Current on page 3-18*.

Notice: Holding a cigarette lighter in while it is heating will not allow the lighter to back away from the heating element when it is hot. Damage from overheating may occur to the lighter or heating element, or a fuse could be blown. Do not hold a cigarette lighter in while it is heating. Do not use anything other than the cigarette lighter in the heating element.

Your vehicle may have a removable ashtray that sits in your front cupholder in the center console storage area.

Climate Controls

Climate Control System

With this system you can control the heating, cooling and ventilation for your vehicle.

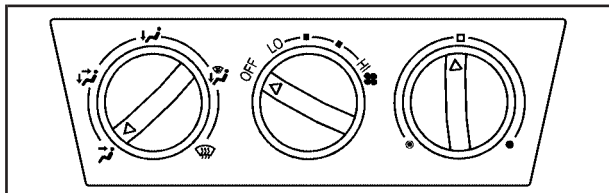

Operation

Fan: Turn the center knob away from OFF to turn the system on. Turn the knob toward HI to increase fan speed.

If the airflow seems low when the fan is at the highest setting, the passenger compartment air filter may need to be replaced. For more information, see *Passenger Compartment Air Filter* on page 3-23 and *Scheduled Maintenance* on page 6-4.

To change the current mode, select one of the following:

Vent: This mode directs air to the upper instrument panel outlets.

Bi-Level: This mode directs the air to the upper instrument panel outlets, and to the floor outlets.

Floor: This mode directs the air to the floor outlets and to the outboard outlets (for the side windows).

Recirculation: Press this button, located in the center of the instrument panel to the left of the audio system, to turn the recirculation mode on or off. This mode keeps outside air from coming in the vehicle. It can be used to prevent outside air and odors from entering your vehicle or to help heat or cool the air inside your vehicle more quickly. When the button is pressed, an indicator light in the button will come on. Press the button again to turn off recirculate and to circulate outside air through the system. The indicator light will go off. Recirculate is automatically turned off when the climate control system mode knob is turned to defog or defrost or is between modes.

Temperature Control: Turn the right knob clockwise or counterclockwise to increase or decrease the temperature inside your vehicle.

A/C (Air Conditioning): Press this button, located in the center of the instrument panel to the left of the audio system, to turn the air-conditioning system on or off. When A/C is pressed, an indicator light in the button will come on to let you know that the air conditioning is activated.

MAX A/C (Maximum Air Conditioning): Press the A/C and recirculation buttons at the same time to select MAX A/C.

On hot days, open the windows to let hot inside air escape; then close them. This helps to reduce the time it takes for your vehicle to cool down. It also helps the system to operate more efficiently.

The air-conditioning system removes moisture from the air, so you may sometimes notice a small amount of water dripping underneath your vehicle while idling or after turning off the engine. This is normal.

Defogging and Defrosting

Fog on the inside of windows is a result of high humidity (moisture) condensing on the cool window glass. This can be minimized if the climate control system is used properly. There are two modes to clear fog or frost from your windshield. Use the defog mode to clear the windows of fog or moisture and warm the passengers. Use the defrost mode to remove fog or frost from the windshield more quickly.

 **(Defog):** This mode directs the air between the windshield, side windows, instrument panel outlets and the floor outlets. The air-conditioning compressor will run automatically in this setting without pressing A/C, unless the outside temperature is at or below 32°F (0°C).

 **(Defrost):** This mode directs the air to the windshield, instrument panel outlets and the side windows. The air-conditioning compressor will run automatically in this setting without pressing A/C, unless the outside temperature is at or below 32°F (0°C).

Do not drive the vehicle until all the windows are clear.

Rear Window Defogger

The rear window defogger uses a warming grid to clear fog from the rear window.

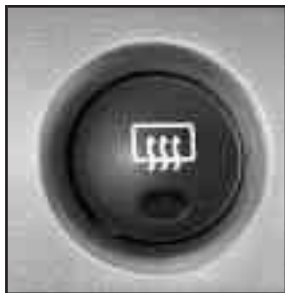

The rear window defogger button is located on the center of the instrument panel, above the audio system. The defogger does not operate with the rear liftglass opened.

The rear window defogger will only work when the ignition is in ON.

 **(Rear Defogger):** Press the defogger button to turn the rear window defogger on or off. An indicator light in the button will come on to let you know that the rear window defogger is activated. Be sure to clear as much snow from the rear window as possible.

The rear window defogger will turn off automatically approximately 15 minutes after the button is pressed. The defogger can also be turned off by pressing the button again or by turning off the engine.

Notice: Using a razor blade or sharp object to clear the inside rear window may damage the rear window defogger. Repairs would not be covered by your warranty. Do not clear the inside of the rear window with sharp objects.

Outlet Adjustment

Use the air outlets located in the center and outboard sides of the instrument panel, to change the direction of the air flowing through the vents.

Operation Tips

- Clear away any ice, snow or leaves from the air inlets at the base of the windshield that may block the flow of air into your vehicle.
- Use of non-GM approved hood deflectors may adversely affect the performance of the system.
- Keep the path under the front seats clear of objects to help circulate the air inside of your vehicle more effectively.
- If the airflow seems low when the fan is at the highest setting, the passenger compartment air filter may need to be replaced. For more information, see "Passenger Compartment Air Filter" following and *Scheduled Maintenance on page 6-4*.

Passenger Compartment Air Filter

Passenger compartment air, both outside and recirculated air, is routed through a passenger compartment air filter. The filter removes certain contaminants from the air, including pollen and dust particles. Reductions in airflow, which may occur more quickly in dusty areas, indicate that the filter needs to be replaced early. An air filter is available through your dealer. For how often to change the air filter, see *Scheduled Maintenance on page 6-4*.

The access panel for the air filter is behind the glove box. To replace the filter, follow these steps:

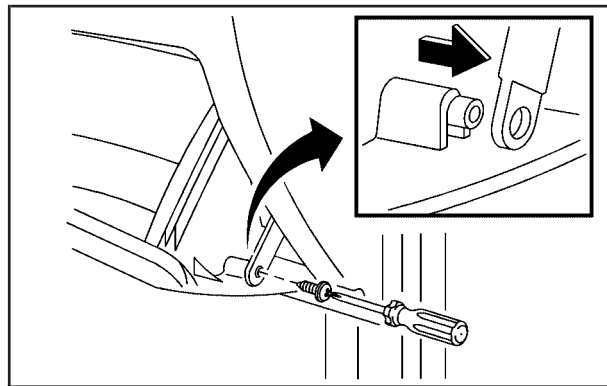

1. Lower the glove box door and remove the screw on the right side of the glovebox with a tool. Slide the arm of the glovebox off.
2. Push each side of the glovebox in and pull toward you.

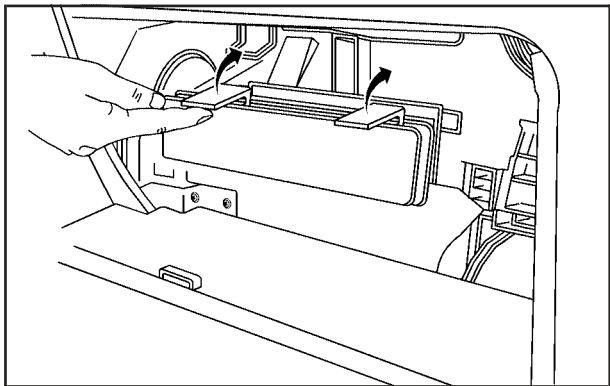

3. Lift the snaps on the filter cover to remove the cover.

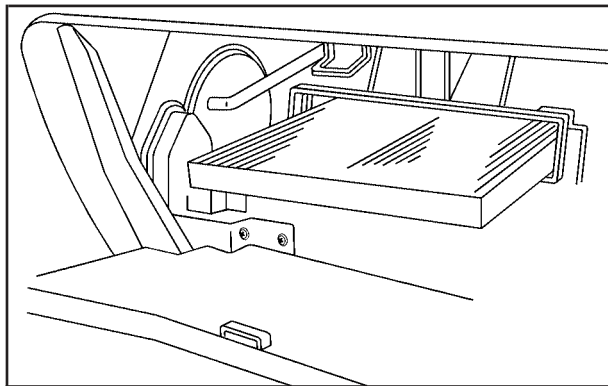

4. Remove the air filter.

5. Reverse the steps to install the new air filter.

It will not cause damage to your vehicle if you choose not to replace the air filter after removing it. However, the air coming into your vehicle will not be filtered.

Warning Lights, Gages, and Indicators

This part describes the warning lights and gages that may be on your vehicle. The pictures will help you locate them.

Warning lights and gages can signal that something is wrong before it becomes serious enough to cause an expensive repair or replacement. Paying attention to your warning lights and gages could also save you or others from injury.

Warning lights come on when there may be or is a problem with one of your vehicle's functions. As you will see in the details on the next few pages, some warning lights come on briefly when you start the engine just to let you know they're working. If you are familiar with this section, you should not be alarmed when this happens.

Gages can indicate when there may be or is a problem with one of your vehicle's functions. Often gages and warning lights work together to let you know when there's a problem with your vehicle.

When one of the warning lights comes on and stays on when you are driving, or when one of the gages shows there may be a problem, check the section that tells you what to do about it. Please follow this manual's advice. Waiting to do repairs can be costly- and even dangerous. So please get to know your warning lights and gages. They're a big help.

Instrument Panel Cluster

Your instrument panel is designed to let you know at a glance how your vehicle is running. You'll know how fast you're going, how much fuel is left in the tank and many other things you'll need to drive safely and economically.

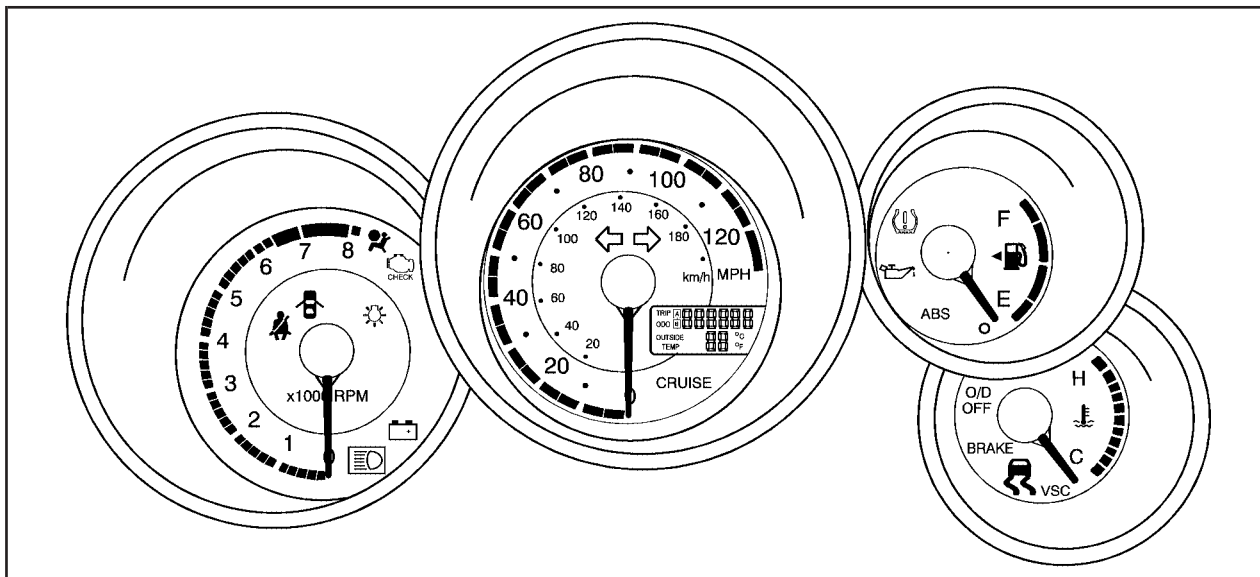

United States Cluster shown, Canada similar

Speedometer and Odometer

Your speedometer lets you see your speed in both miles per hour (mph) and kilometers per hour (km/h). Your odometer shows how far your vehicle has been driven, in miles.

You may wonder what happens if your vehicle needs a new odometer installed. If the new one can be set to the mileage total of the old odometer, then it must be. But if it cannot, then it is set at zero and a label must be put on the driver's door to show the old mileage reading when the new odometer was installed.

Trip Odometers

The trip odometers can tell you how far your vehicle has been driven since you last set the trip odometer to zero.

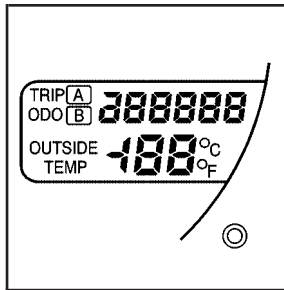

The button located on the right side of the instrument panel cluster allows you to switch between the odometer and the two trip odometers.

Press the button once to switch to TRIP A and again to switch to TRIP B. To return the display to the odometer reading, press the trip odometer button again.

To set the trip odometers to zero, press and hold the button.

Tachometer

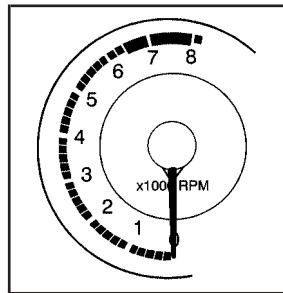

The tachometer shows engine speed in thousands of revolutions per minute (rpm).

Notice: If you operate the engine with the tachometer in the shaded warning area, your vehicle could be damaged, and the damages would not be covered by your warranty. Do not operate the engine with the tachometer in the shaded warning area.

Temperature Display

The outside air temperature is displayed on the center of the instrument panel, within the speedometer.

The display will show the outside air temperature in Fahrenheit with a range from -22°F to 122°F (-30°C to 50°C).

Safety Belt Reminder Light

When the key is turned to ON or START, a chime will come on for several seconds to remind people to fasten their safety belts, unless the driver's safety belt is already buckled.



The safety belt light will also flash until the driver's belt is buckled. If the driver's belt is already buckled, neither the chime nor the light will come on.

Your vehicle also has a safety belt reminder light for the right front passenger position.

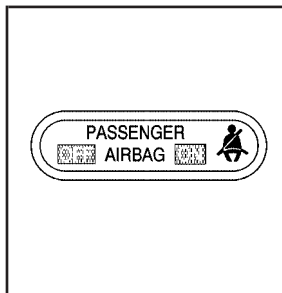

This light is located on the center of the instrument panel, above the audio system.

When the key is turned to ON or START, this light will come on as a reminder for the right front passenger to fasten the safety belt. The safety belt light will flash until the right front passenger's safety belt is buckled. The passenger's safety belt reminder light will not illuminate if the right front passenger's belt is already buckled or if a sensor does not detect the weight of a passenger in that seat.

If something is placed on the right front passenger's seat, the sensors in the seat may detect that object and cause the right front passenger's safety belt reminder light to come on. If this ever happens, move the object to the rear seat or place it in a rear storage area, if at all possible.

Airbag Readiness Light

There is an airbag readiness light on the instrument panel, which shows the airbag symbol. The system checks the airbag's electrical system for malfunctions. The light tells you if there is an electrical problem. The system check includes the airbag sensors, the airbag modules, the wiring and the diagnostic module. For more information on the airbag system, see *Airbag System* on page 1-46.



This light will come on for about seven seconds when you start your vehicle. Then the light should go out. This means the system is ready.

If the airbag readiness light stays on after you start the vehicle or comes on when you are driving, your airbag system may not work properly. Have your vehicle serviced right away.

CAUTION:

If the airbag readiness light stays on or keeps flashing after you start your vehicle, it means the airbag system and safety belt pretension system may not be working properly. The airbags in your vehicle may not inflate in a crash, or they could even inflate without a crash. To help avoid injury to yourself or others, have your vehicle serviced right away if the airbag readiness light stays on after you start your vehicle.

The airbag readiness light should come on for about seven seconds when you turn the ignition key to ON. If the light doesn't come on then, have it fixed so it will be ready to warn you if there is a problem.

Passenger Airbag Status Indicator

Your vehicle has a passenger airbag status indicator in the instrument panel.

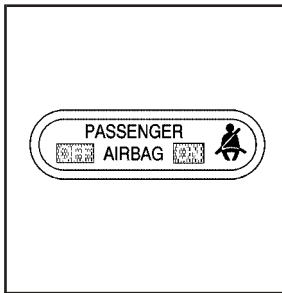

When the ignition key is turned to ON, the passenger airbag status indicator will light ON and OFF as a system check. Then, after several more seconds, the status indicator will light either ON or OFF to let you know the status of the right front passenger's frontal and seat-mounted side impact airbag (if equipped.)

If the word ON is lit on the passenger airbag status indicator, it means that the right front passenger's frontal and seat-mounted side impact airbag (if equipped) are enabled (may inflate).

CAUTION:

If the on indicator comes on when you have a rear-facing child restraint installed in the right front passenger's seat, it means that the passenger sensing system has not turned off the passenger's frontal airbag and seat-mounted side impact airbag (if equipped). A child in a rear-facing child restraint can be seriously injured or killed if the right front passenger's airbag inflates. This is because the back of the rear-facing child restraint would be very close to the inflating airbag. **Do not use a rear-facing child restraint in the right front passenger's seat.**

If the word OFF is lit on the passenger airbag status indicator, it means that the passenger sensing system has turned off the right front passenger's frontal airbag and seat-mounted side impact airbag (if equipped). See *Passenger Sensing System* on page 1-56 for information about the conditions that may affect the airbag system and also important safety information.

If, after several seconds, all status indicator lights remain on, or if there are no lights at all, there may be a problem with the lights or the passenger sensing system. See your dealer for service.

 **CAUTION:**

If the off indicator and the airbag readiness light ever come on together, it means that something may be wrong with the airbag system. If this ever happens, have the vehicle serviced promptly, because an adult-size person sitting in the right front passenger seat may not have the protection of the airbags. See *Airbag Readiness Light on page 3-29.*

Charging System Light

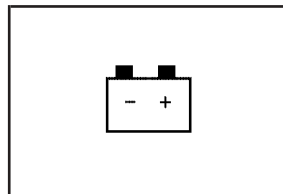

This light will come on briefly when you turn on the ignition, but the engine is not running, as a check to show you it is working. Then it should go out when the engine starts.

If it stays on, or comes on while you are driving, you may have a problem with the electrical charging system. It could indicate that you have a loose generator drive belt or another electrical problem. Have it checked right away. Driving while this light is on could drain your battery.

If you must drive a short distance with the charging system light on, be certain to turn off all your accessories, such as the radio and air conditioner.

Brake System Warning Light

Your vehicle's hydraulic brake system is divided into two parts. If one part isn't working, the other part can still work and stop you. For good braking, though, you need both parts working well.

If the warning light comes on, there is a brake problem. Have your brake system inspected right away.

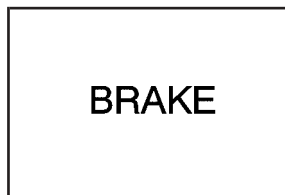

United States

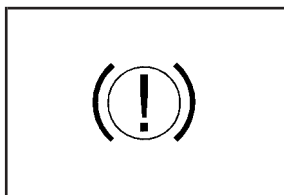

Canada

If your vehicle has anti-lock brakes, this light should come on when you turn the key to START. If it doesn't come on then, have it fixed so it will be ready to warn you if there's a problem.

When the ignition is on, the brake system warning light will also come on when you set your parking brake. The light will stay on if your parking brake doesn't release fully. If it stays on after your parking brake is fully released, it means you have a brake problem.

If the light comes on while you are driving, pull off the road and stop carefully. You may notice that the pedal is harder to push. Or, the pedal may go closer to the floor. It may take longer to stop. If the light is still on, have the vehicle towed for service. See *Anti-Lock Brake System Warning Light* on page 3-33 and *Towing Your Vehicle* on page 4-37.

CAUTION:

Your brake system may not be working properly if the brake system warning light is on. Driving with the brake system warning light on can lead to an accident. If the light is still on after you have pulled off the road and stopped carefully, have the vehicle towed for service.

Anti-Lock Brake System Warning Light

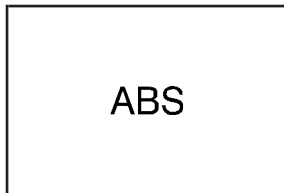

United States

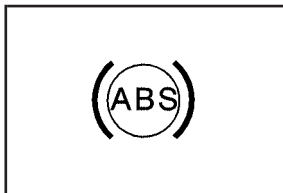

Canada

With the anti-lock brake system, the light will come on when your engine is started and may stay on for several seconds. That's normal.

If the light stays on, turn the ignition to LOCK. Or, if the light comes on when you're driving, stop as soon as possible and turn the ignition off. Then start the engine again to reset the system. If the light still stays on, or comes on again while you're driving, your vehicle needs service. If the regular brake system warning light isn't on, you still have brakes, but you don't have

anti-lock brakes. If the regular brake system warning light is also on, you don't have anti-lock brakes and there's a problem with your regular brakes. See *Brake System Warning Light* on page 3-32.

The anti-lock brake system warning light will come on briefly when you turn the ignition key to ON. This is normal. If the light doesn't come on then, have it fixed so it will be ready to warn you if there is a problem.

Low Tire Pressure Warning Light

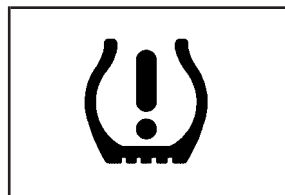

This light should come on briefly as you start the engine. It will then come on only when a low tire pressure condition exists.

See *Tire Pressure Monitor System* on page 5-65 for more information.

Traction Control System (TCS) Warning Light

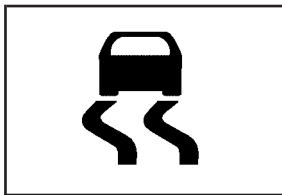

This light should come on briefly when you start the engine. If it stays on or comes on while you are driving, there is a problem with your traction control system.

The traction control system warning light comes on for a few seconds when the ignition is turned to ON. It will come on again when you press the TRAC OFF button to turn off the traction control system. See *Traction Control System (TCS)* on page 4-9 for more information.

In the following cases, contact your dealer:

- The indicator light does not come on when the ignition is turned to ON.
- The indicator light remains on after the ignition is turned ON.
- The indicator light comes on with the normal driving mode while driving.

StabiliTrak[®] Indicator Light

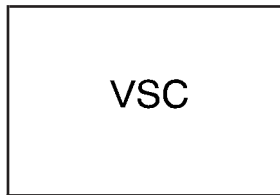

This light warns that there is a problem somewhere in the traction control system or the vehicle stability control (VSC) system.

The light will come on when the ignition is turned to ON and will go off after a few seconds.

If the light comes on while driving, the system does not work. However, as conventional braking operates when applied, there is no problem to continue driving.

In the following cases, contact your dealer:

- The warning light does not come on after the ignition is turned to ON.
- The warning light remains on after the ignition is turned to ON.
- The warning light comes on while driving.

The traction control system light will come on when the VSC warning light comes on, even if the TRAC OFF button is not pressed.

See *Traction Control System (TCS)* on page 4-9 for more information on Vehicle Stability Control System.

Engine Coolant Temperature Gage

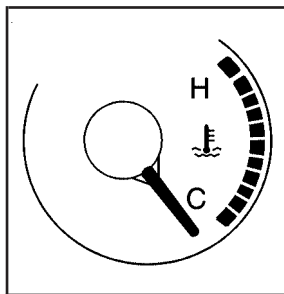

United States

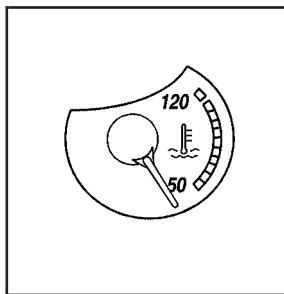

Canada

This gage shows the engine coolant temperature. If the gage pointer moves into the red area, your engine is too hot! It means that your engine has overheated. If you have been operating your vehicle under normal driving conditions, you should pull off the road, stop your vehicle and turn off the engine as soon as possible. See *Engine Overheating* on page 5-30.

Malfunction Indicator Lamp

Check Engine Light

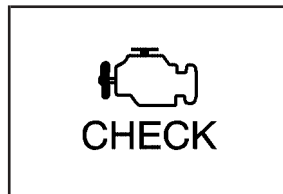

United States

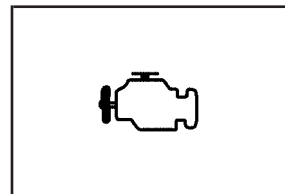

Canada

Your vehicle is equipped with a computer which monitors operation of the fuel, ignition, and emission control systems.

This system is called OBD II (On-Board Diagnostics-Second Generation) and is intended to assure that emissions are at acceptable levels for the life of the vehicle, helping to produce a cleaner environment. The CHECK ENGINE light comes on to indicate that there is a problem and service is required.

Malfunctions often will be indicated by the system before any problem is apparent. This may prevent more serious damage to your vehicle. This system is also designed to assist your service technician in correctly diagnosing any malfunction.

Notice: If you keep driving your vehicle with this light on, after awhile, your emission controls may not work as well, your fuel economy may not be as good, and your engine may not run as smoothly. This could lead to costly repairs that may not be covered by your warranty.

Notice: Modifications made to the engine, transaxle, exhaust, intake, or fuel system of your vehicle or replacement tires that do not match your vehicle's original tires can affect your vehicle's emission controls and may cause this light to come on. Modifications to these systems could lead to costly repairs not covered by your warranty. This may also result in a failure to pass a required Emission Inspection/Maintenance test.

This light should come on, as a check to show you it is working, when the ignition is on and the engine is not running. If the light does not come on, have it repaired. This light will also come on during a malfunction in one of two ways:

- **Light Flashing** — A misfire condition has been detected. A misfire increases vehicle emissions and may damage the emission control system on your vehicle. Diagnosis and service may be required.
- **Light On Steady** — An emission control system malfunction has been detected on your vehicle. Diagnosis and service may be required.

If the Light Is Flashing

The following may prevent more serious damage to your vehicle:

- Reducing vehicle speed
- Avoiding hard accelerations
- Avoiding steep uphill grades
- If you are towing a trailer, reduce the amount of cargo being hauled as soon as it is possible

If the light stops flashing and remains on steady, see "If the Light Is On Steady" following.

If the light continues to flash, when it is safe to do so, stop the vehicle. Find a safe place to park your vehicle. Turn the key off, wait at least 10 seconds and restart the engine. If the light remains on steady, see “If the Light Is On Steady” following. If the light is still flashing, follow the previous steps, and see your dealer for service as soon as possible.

If the Light Is On Steady

You also may be able to correct the emission system malfunction by considering the following:

Did you recently put fuel into your vehicle?

If so, reinstall the fuel cap, making sure to fully install the cap. See *Filling Your Tank on page 5-7*. The diagnostic system can determine if the fuel cap has been left off or improperly installed. A loose or missing fuel cap will allow fuel to evaporate into the atmosphere. A few driving trips with the cap properly installed should turn the light off.

Did you just drive through a deep puddle of water?

If so, your electrical system may be wet. The condition will usually be corrected when the electrical system dries out. A few driving trips should turn the light off.

Have you recently changed brands of fuel?

If so, be sure to fuel your vehicle with quality fuel. See *Gasoline Octane on page 5-5*. Poor fuel quality will cause your engine not to run as efficiently as designed. You may notice this as stalling after start-up, stalling when you put the vehicle into gear, misfiring, hesitation on acceleration, or stumbling on acceleration. (These conditions may go away once the engine is warmed up.) This will be detected by the system and cause the light to turn on.

If you experience one or more of these conditions, change the fuel brand you use. It will require at least one full tank of the proper fuel to turn the light off.

If none of the above steps have made the light turn off, your dealer can check the vehicle. Your dealer has the proper test equipment and diagnostic tools to fix any mechanical or electrical problems that may have developed.

Emissions Inspection and Maintenance Programs

Some state/provincial and local governments have or may begin programs to inspect the emission control equipment on your vehicle. Failure to pass this inspection could prevent you from getting a vehicle registration.

Here are some things you need to know to help your vehicle pass an inspection:

Your vehicle will not pass this inspection if the Check Engine light is on or not working properly.

Your vehicle will not pass this inspection if the OBD (on-board diagnostic) system determines that critical emission control systems have not been completely diagnosed by the system. The vehicle would be considered not ready for inspection. This can happen if you have recently replaced your battery or if your battery has run down. The diagnostic system is designed to evaluate critical emission control systems during normal driving. This may take several days of routine driving. If you have done this and your vehicle still does not pass the inspection for lack of OBD system readiness, your GM dealer can prepare the vehicle for inspection.

Oil Pressure Light

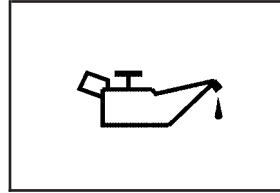

If you have a problem with your oil, this light may stay on after you start your engine or come on when you are driving.

This indicates that there is not enough oil pressure to keep your engine properly lubricated and cool.

The engine could be low on oil, or have some other oil related problem. Have it fixed right away.

The oil light could also come on in three other situations.

- When the ignition is on but the engine is not running, the light will come on as a test to show you it is working, but the light will go out when you turn the ignition to START. If it doesn't come on with the ignition on, you may have a problem with the fuse or bulb. Have it fixed right away.
- Sometimes when the engine is idling at a stop, the light may blink on and off. This is normal.
- If you make a hard stop, the light may come on for a moment. This is normal.

CAUTION:

Do not keep driving if the oil pressure is low. If you do, your engine can become so hot that it catches fire. You or others could be burned. Check your oil as soon as possible and have your vehicle serviced.

Notice: Lack of proper engine oil maintenance may damage the engine. The repairs would not be covered by your warranty. Always follow the maintenance schedule in this manual for changing engine oil.

Lights On Reminder

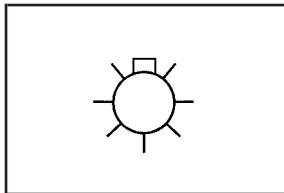

This light comes on whenever the parking lamps are on.

See *Headlamps on Reminder* on page 3-13 for more information.

Taillamp Indicator Light

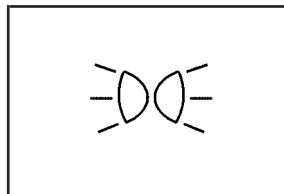

Canada Only

This light will come on when your taillamps are on.

See *Exterior Lamps* on page 3-13 for more information.

Cruise Control Light

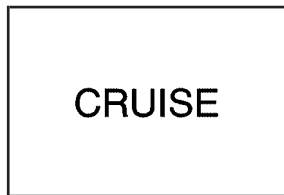

The CRUISE light appears whenever you use the ON-OFF button to set your cruise control. See *Cruise Control Light* on page 3-39 for more information.

Overdrive Off Light

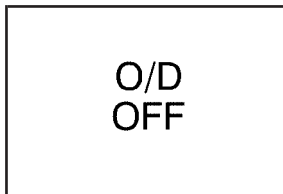

Your automatic transaxle has overdrive. The light will come on whenever you turn off the overdrive. See *Overdrive Off* on page 2-24 for more information.

Highbeam On Light

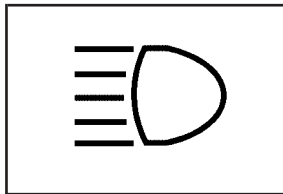

This light will illuminate when the headlamp high beams are in use.

See *Headlamp High/Low-Beam Changer* on page 3-8.

Low Washer Fluid Warning Light

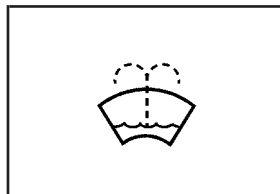

Canada Only

This light will come on when your windshield washer fluid is low.

See *Windshield Washer Fluid* on page 5-38 for more information.

Door Ajar Light

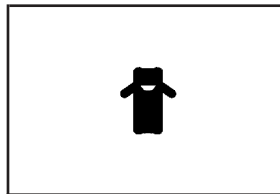

This light will come on if any door, the rear liftgate or the rear liftglass are not completely closed.

Fuel Gage

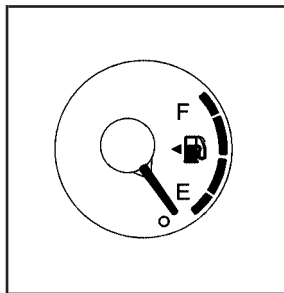

United States

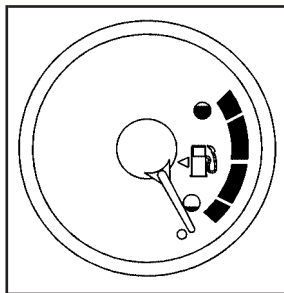

Canada

Your fuel gage shows about how much fuel is in your tank. There is an arrow on the fuel gage that indicates that the fuel filler door is on the driver's side of your vehicle. The fuel gage works only when the ignition switch is ON. When the gage first indicates E or empty, you still have a little fuel left, about 1 or 2 gallons (3.8 L or 7.6 L), but you need to get more right away. When your vehicle is low on fuel the low fuel warning light, located below the empty mark, will also come on to remind you to add fuel.

Here are five things some owners ask about. None of these show a problem with your fuel gage:

- At the gas station, the fuel pump shuts off before the gage reads F or full.
- It takes a little more or less fuel to fill up than the gage indicated. For example, the gage may have indicated the tank was half full, but it actually took more or less than half the tank's capacity to fill it.
- It takes the gage several minutes to read F or full after filling the vehicle with fuel.
- The gage moves a little when you turn, stop or speed up.
- The gage doesn't go back to E or empty when you turn off the ignition.

Low Fuel Warning Light

This light is located on the fuel gage and comes on when the fuel tank is low on fuel. To turn it off, add fuel to the fuel tank. See *Fuel* on page 5-5 for more information.

Audio System(s)

Notice: Before adding any sound equipment to your vehicle, like a tape player, CB radio, mobile telephone, or two-way radio, make sure that it can be added by checking with your dealer. Also, check federal rules covering mobile radio and telephone units. If sound equipment can be added, it is very important to do it properly. Added sound equipment may interfere with the operation of your vehicle's engine, radio, or other systems, and even damage them. Your vehicle's systems may interfere with the operation of sound equipment that has been added improperly.

Figure out which audio system is in your vehicle, find out what your audio system can do, and how to operate all of its controls.

Setting the Time

The radio may have a button marked with an H or HR to represent hours and an M or MIN to represent minutes.

Press and hold the hour button until the correct hour appears on the display. AM will appear for morning hours. Press and hold the minute button until the correct minute appears on the display. The time can be set with the ignition on or off.

To synchronize the time with an FM station broadcasting Radio Data System (RDS) information, press and hold the hour and minute buttons at the same time until UPDATED appears on the display. If the time is not available from the station, NO UPDATE will appear on the display.

RDS time is broadcast once a minute. After tuning to an RDS broadcast station, it may take a few minutes for the time to update.

Radio with CD



The radio has a blinking red light that is used as a theft-deterrent feature. The light will blink whenever the ignition is off.

Radio Data System (RDS)

The audio system has a Radio Data System (RDS). RDS features are available for use only on FM stations that broadcast RDS information.

With RDS, the radio can do the following:

- Seek to stations broadcasting the selected type of programming
- Receive announcements concerning local and national emergencies

- Display messages from radio stations
- Seek to stations with traffic announcements

This system relies upon receiving specific information from these stations and will only work when the information is available. In rare cases, a radio station may broadcast incorrect information that will cause the radio features to work improperly. If this happens, contact the radio station.

While the radio is tuned to an RDS station, the station name or call letters will appear on the display instead of the frequency. RDS stations may also provide the time of day, a program type (PTY) for current programming, and the name of the program being broadcast.

XM™ Satellite Radio Service

XM™ is a satellite radio service that is based in the 48 contiguous United States. XM™ offers 100 coast to coast channels including music, news, sports, talk, and children's programming. XM™ provides digital quality audio and text information that includes song title and artist name. A service fee is required in order to receive the XM™ service. For more information, contact XM™ at www.xmradio.com or call 1-800-852-XXXM (9696).

Playing the Radio

PWR (Power): Push this knob to turn the system on and off.

VOL (Volume): Turn this knob to increase or to decrease the volume.

RCL (Recall): Push this knob to switch the display between the radio station frequency and the time. Push this knob to display the time with the ignition off.

For RDS, push the RCL knob to change what appears on the display while using RDS. The display options are station, RDS station frequency, PTY, and the name of the program (if available).

For XM™ (if equipped), push the RCL knob while in XM™ mode to retrieve four different categories of information related to the current song or channel: Artist, Song Title, Category or PTY, Channel Number/Channel Name.

To change the default on the display, push the RCL knob until you see the display you want, then hold the knob until the display flashes. The selected display will now be the default.

SCV (Speed-Compensated Volume): This button is inoperable on this radio.

Finding a Station

BAND: Press this button to switch between FM1, FM2, AM, or XM1 or XM2 (if equipped). The display will show the selection.

TUNE: Turn this knob to select radio stations.

△ SEEK ▽: Press the up or the down arrow to go to the next or to the previous station and stay there.

The radio will only seek stations with a strong signal that are in the selected band.

△ SCAN ▽: Press and hold either SCAN arrow for two seconds until SCAN appears on the display and you hear a beep. The radio will go to a station, play for a few seconds, then go on to the next station. Press either SCAN arrow again to stop scanning.

To scan preset stations, press and hold either SCAN arrow for more than four seconds until PSCAN and the preset number appear on the display. You will hear a double beep. The radio will go to the first preset station stored on your pushbuttons, play for a few seconds, then go on to the next preset station. Press either SCAN arrow again to stop scanning presets.

The radio will only scan stations with a strong signal that are in the selected band.

Setting Preset Stations

Up to 30 stations (six FM1, six FM2, and six AM, six XM1 and six XM2 (if equipped)), can be programmed on the six numbered pushbuttons, by performing the following steps:

1. Turn the radio on.
2. Press BAND to select FM1, FM2, AM, or XM1 or XM2.
3. Tune in the desired station.
4. Press EQ to select the equalization.
5. Press and hold one of the six numbered pushbuttons until you hear a beep. Whenever that numbered pushbutton is pressed, the station that was set will return and the equalization that was selected will be stored for that pushbutton.
6. Repeat the steps for each pushbutton.

Setting the Tone (Bass/Treble)

TONE: Press and release this button until BASS, MID, or TREB appears on the display. The SELECT LED indicator will light to show that the tone control can be adjusted. Turn the SELECT knob to increase or to decrease. If a station is weak or noisy, decrease the treble.

To return all of the tone controls to the middle position press and hold the TONE button until FLAT appears on the display.

EQ (Equalizer): Press this button to select customized equalization settings.

Up to six customized equalization settings, can be programmed, by performing the following steps:

1. Turn the radio on.
2. Use the TONE button and the SELECT knob to create the equalization.
3. Press and hold the EQ button for two seconds. SELECT EQ # will appear on the display and the EQ symbol will flash.
4. Press EQ or turn the SELECT knob to select the EQ number.
5. Press and hold the EQ button or push the SELECT knob to store the equalization setting and the number. EQ SAVED will appear on the display and you will hear a beep.
6. Repeat the steps for the other EQ settings and numbers.

EQ 5 has been programmed at the factory for use with talk radio, but it can be set to a different tone.

Adjusting the Speakers (Balance/Fade)

BAL (Balance): To adjust the balance between the right and the left speakers, press and release this button until BAL appears on the display. The SELECT LED indicator will light to show that the speakers can be adjusted. Turn the SELECT knob to move the sound toward the right or the left speakers.

FADE: To adjust the fade between the front and the rear speakers, press and release this button until FADE appears on the display. The SELECT LED indicator will light to show that the speakers can be adjusted. Turn the SELECT knob to move the sound toward the front or the rear speakers.

To return all speaker settings to the middle position, press and hold the BAL FADE button for two seconds.

Finding a Program Type (PTY) Station (RDS and XM™)

To select and find a desired PTY perform the following:

1. Press PROG TYPE to activate program type select mode. The PTY symbol will appear on the display.
2. Turn the SELECT knob to select a PTY.

3. Once the desired PTY is displayed, press either SEEK arrow to select the PTY and take you to the PTY's first station.
4. To go to another station within that PTY and the PTY is displayed, press either SEEK arrow once. If the PTY is not displayed, press either SEEK arrow twice to display the PTY and then to go to another station.
5. Press PROG TYPE to exit program type select mode.
If PTY times out and is no longer on the display, go back to Step 1.

If both PTY and TRAF are on, the radio will search for stations with the selected PTY and traffic announcements.

SCAN: Scan the stations within a PTY by performing the following:

1. Press PROG TYPE to activate program type select mode. The PTY symbol will appear on the display.
2. Turn the SELECT knob to select a PTY.
3. Once the desired PTY is displayed, press and hold either SCAN arrow, and the radio will begin scanning the stations in the PTY.
4. Press either SCAN arrow to stop at a station.

If both PTY and TRAF are on, the radio will scan for stations with the selected PTY and traffic announcements.

BAND (Alternate Frequency): Alternate frequency allows the radio to switch to a stronger station with the same program type. To turn alternate frequency on, press and hold BAND for two seconds. AF ON will appear on the display. The radio may switch to stations with a stronger frequency.

To turn alternate frequency off, press and hold BAND again for two seconds. AF OFF will appear on the display. The radio will not switch to other stations.

This function does not apply for XM™ Satellite Radio Service.

Setting Preset PTYs (RDS Only)

These pushbuttons have factory PTY presets. Up to 12 PTYs (six FM1 and six FM2), can be programmed on the six numbered pushbuttons, by performing the following steps:

1. Press BAND to select FM1 or FM2.
2. Press PROG TYPE to activate program type select mode. The PTY symbol will appear on the display.
3. Turn the SELECT knob to select a PTY.
4. Press and hold one of the six numbered pushbuttons until you hear a beep. Whenever that numbered pushbutton is pressed, the PTY that was set will return, if program type select mode is on.
5. Repeat the steps for each pushbutton.

RDS Messages

ALERT!: Alert warns of local or national emergencies. When an alert announcement comes on the current radio station, ALERT! will appear on the display. You will hear the announcement, even if the volume is low or a CD is playing. If a CD is playing, play will stop during the announcement. Alert announcements cannot be turned off.

ALERT! will not be affected by tests of the emergency broadcast system. This feature is not supported by all RDS stations.

INFO (Information): If the current station has a message, INFO will appear on the display. Press this button to see the message. The message may display the artist, song title, call in phone numbers, etc.

If the entire message is not displayed, parts of the message will appear every three seconds. To scroll through the message, press and release the INFO button. A new group of words will appear on the display after every press of the button. Once the complete message has been displayed, INFO will disappear from the display until another new message is received. The last message can be displayed by pressing the INFO button. You can view the last message until a new message is received or a different station is tuned to.

TRAF (Traffic): If TRAF appears on the display, the tuned station broadcasts traffic announcements. Press this button to receive the traffic announcement from the station and brackets will be displayed around TRAF. When a traffic announcement comes on the tuned radio station you will hear it.

If the station does not broadcast traffic announcements, press the TRAF button and the radio will seek to a station that does. When a station that broadcasts traffic announcements is found, the radio will stop seeking and brackets will be displayed around TRAF. If no station is found that broadcasts traffic announcements, NO TRAFFIC will appear on the display.

If the brackets are on the display and TRAF is not, press the TRAF button to remove the brackets or use the TUNE knob or the SEEK arrows to go to a station that broadcasts traffic announcements. If no station is found that broadcasts traffic announcements, NO TRAFFIC will appear on the display.

The radio will play the traffic announcement if the volume is low. The radio will interrupt the play of a CD if the last tuned station broadcasts traffic announcements and the brackets are displayed.

This function does not apply to XM™ Satellite Radio Service.

Radio Messages

CALIBRATE: The audio system has been calibrated for your vehicle from the factory. If CALIBRATE appears on the display, it means that the radio has not been configured properly for the vehicle and must be returned to the dealer for service.

LOCKED: This message is displayed when the THEFTLOCK® system has locked up. Take the vehicle to the dealer for service.

If any error occurs repeatedly or if an error cannot be corrected, contact your dealer.

XM™ Radio Messages

Radio Display Message	Condition	Action Required
XL (Explicit Language Channels)	XL on the radio display, after the channel name, indicates content with explicit language.	These channels, or any others, can be blocked at a customer's request, by calling 1-800-852-XXMX (9696).
Updating	Updating encryption code	The encryption code in the receiver is being updated, and no action is required. This process should take no longer than 30 seconds.
No Signal	Loss of signal	The system is functioning correctly, but the vehicle is in a location that is blocking the XM signal. When you move into an open area, the signal should return.
Loading XM	Acquiring channel audio (after 4 second delay)	The audio system is acquiring and processing audio and text data. No action is needed. This message should disappear shortly.
CH Off Air	Channel not in service	This channel is not currently in service. Tune to another channel.
CH Unavail	Channel no longer available	This previously assigned channel is no longer assigned. Tune to another station. If this station was one of the presets, choose another station for that preset button.
No Info	Artist Name/Feature not available	No artist information is available at this time on this channel. The system is working properly.
No Info	Song/Program Title not available	No song title information is available at this time on this channel. The system is working properly.

XM™ Radio Messages (cont'd)

Radio Display Message	Condition	Action Required
No Info	Category Name not available	No category information is available at this time on this channel. The system is working properly.
No Info	No Text/Informational message available	No text or informational messages are available at this time on this channel. The system is working properly.
Not Found	No channel available for the chosen category	There are no channels available for the selected category. The system is working properly.
XM Locked	Theft lock active	The XM receiver in the vehicle may have previously been in another vehicle. For security purposes, XM receivers cannot be swapped between vehicles. If this message is received, after having your vehicle serviced, check with your dealer.
Radio ID	Radio ID label (channel 0)	If tuned to channel 0, this message will alternate with the XM Radio 8 digit radio ID label. This label is needed to activate the service.
Unknown	Radio ID not known (should only be if hardware failure)	If this message is received when tuned to channel 0, there may be a receiver fault. Consult with your dealer.
Chk XMRCvr	Hardware failure	If this message does not clear within a short period of time, the receiver may have a fault. Consult with your dealer.

Playing a CD

Insert a CD partway into the slot, label side up. The player will pull it in and the CD should begin playing. If you want to insert a CD when the ignition is off, first press the eject symbol or push the RCL knob. If you insert a CD with the radio off and the ignition on, it will start to play.

If the ignition or radio is turned off with a CD in the player, it will stay in the player. When the ignition or radio is turned on, the CD will start playing where it stopped, if it was the last selected audio source.

When the CD is inserted, the CD symbol will appear on the display. As each new track starts to play, the track number will appear on the display.

The CD player can play the smaller 3 inch (8 cm) single CDs with an adapter ring. Full-size CDs and the smaller CDs are loaded in the same manner.

If playing a CD-R the sound quality may be reduced due to CD-R quality, the method of recording, the quality of the music that has been recorded, and the way the CD-R has been handled. There may be an increase in skipping, difficulty in finding tracks, and/or difficulty in loading and ejecting. If these problems occur try a known good CD.

Do not add paper labels to CDs, they could get caught in the CD player.

If an error appears on the display, see "CD Messages" later in this section.

▶▶ 1 (Forward): Press and hold this pushbutton to advance quickly within a track. You will hear sound at a reduced volume. Release the pushbutton to play the passage. The elapsed time of the track will appear on the display.

RDM 3 (Random): Press this pushbutton to hear the tracks in random, rather than sequential, order. RDM and the track number will appear on the display. Press RDM again to turn off random play.

◀◀ (Reverse): Press and hold this pushbutton to reverse quickly within a track. You will hear sound at a reduced volume. Release the pushbutton to play the passage. The elapsed time of the track will appear on the display.

EQ (Equalizer): Press EQ to select an equalization setting while playing a CD. The equalization will be set whenever a CD is played. See "EQ" listed previously for more information. If you select an EQ setting for your CD, it will be activated each time you play a CD.

△ **SEEK** ▽ : Press the down arrow to go to the start of the current track if more than eight seconds have played. Press the up arrow to go to the next track. If either arrow is held or pressed more than once, the player will continue moving backward or forward through the CD.

△ **SCAN** ▽ : Press and hold either arrow for more than two seconds until SCAN and the track number appear on the display and you hear a beep. The CD will go to the next track, play for a few seconds, then go on to the next track. Press either arrow again to stop scanning.

RCL (Recall): Push this knob to see how long the current track has been playing. To change the default on the display, track and elapsed time, push the knob until you see the display you want, then hold the knob until the display flashes. The selected display will now be the default. While elapsed time is showing, CD TIME will appear on the display.

BAND: Press this button to listen to the radio when a CD is playing. The inactive CD will remain safely inside the radio for future listening.

CD AUX (Auxiliary): Press this button to play a CD when listening to the radio. The CD symbol will appear on the display when a CD is loaded.

△ (Eject): Press this button to eject a CD. Eject may be activated with either the ignition or radio off. CDs may be loaded with the ignition and radio off if this button is pressed first.

CD Messages

CHECK CD: If this message appears on the display and/or the CD comes out, it could be for one of the following reasons:

- It is very hot. When the temperature returns to normal, the CD should play.
- You are driving on a very rough road. When the road becomes smoother, the CD should play.
- The CD is dirty, scratched, wet, or upside down.
- The air is very humid. If so, wait about an hour and try again.
- There may have been a problem while burning the CD.
- The label may be caught in the CD player.

If the CD is not playing correctly, for any other reason, try a known good CD.

If any error occurs repeatedly or if an error cannot be corrected, contact your dealer. If the radio displays an error message, write it down and provide it to your dealer when reporting the problem.

Radio with Six-Disc CD



The radio has a blinking red light that is used as a theft-deterrent feature. The light will blink whenever the ignition is off.

Playing the Radio

PWR (Power): Push this knob to turn the system on and off.

VOLUME: Turn this knob to increase or to decrease the volume.

RCL (Recall): Press this knob to switch the display between the radio station frequency and the time. When the ignition is off, press this knob to display the time.

To change the default on the display, press the RCL knob until you see the display you want, then hold the knob until the display flashes. The selected display will now be the default.

AUTO VOL (Automatic Volume): The system has a feature called automatic volume. With this feature, the audio system adjusts automatically to make up for road and wind noise as you drive.

Set the volume at the desired level. Press this button to select MIN, MED, or MAX. Each higher setting will allow for more volume compensation at faster vehicle speeds. Then, as you drive, automatic volume increases the volume, as necessary, to overcome noise at any speed. The volume level should always sound the same to you as you drive. To turn automatic volume off, press this button until OFF appears on the display.

Finding a Station

BAND: Press this button to switch between FM1, FM2, or AM. The display will show the selection.

TUNE: Turn this knob to select radio stations.

< SEEK > : Press the right or the left arrow to go to the next or to the previous station and stay there.

The radio will only seek stations with a strong signal that are in the selected band.

< SCAN > : Press and hold either SCAN arrow for two seconds until SC appears on the display and you hear a beep. The radio will go to a station, play for a few seconds, then go on to the next station. Press either SCAN arrow again to stop scanning.

To scan preset stations, press and hold either SCAN arrow for more than four seconds. PRESET SCAN will appear on the display and you will hear a double beep. The radio will go to a preset station stored on the pushbuttons, play for a few seconds, then go on to the next preset station. Press either SCAN arrow again to stop scanning presets.

The radio will only scan stations with a strong signal that are in the selected band.

Setting Preset Stations

Up to 18 stations (six FM1, six FM2, and six AM), can be programmed on the six numbered pushbuttons, by performing the following steps:

1. Turn the radio on.
2. Press BAND to select FM1, FM2, or AM.
3. Tune in the desired station.
4. Press AUTO EQ to select the equalization.
5. Press and hold one of the six numbered pushbuttons until you hear a beep. Whenever that numbered pushbutton is pressed, the station that was set will return and the equalization that was selected will be stored for that pushbutton.
6. Repeat the steps for each pushbutton.

Setting the Tone (Bass/Treble)

AUDIO: Push and release the AUDIO knob until BASS, MID, or TREB appears on the display. Turn the knob to increase or to decrease. If a station is weak or noisy, decrease the treble.

To adjust bass, midrange, or treble to the middle position, select BASS, MID, or TREB and push and hold the AUDIO knob. The radio will produce one beep and adjust the display level to the middle position.

To adjust all tone and speaker controls to the middle position, push and hold the AUDIO knob when no tone or speaker controls are displayed. CENTERED will appear on the display and you will hear a beep.

AUTO EQ (Automatic Equalization): Press this button to select customized equalization settings designed for country, jazz, talk, pop, rock, and classical.

To return to the manual mode, press the AUTO EQ button until CUSTOM appears on the display. Then manually adjust the bass, midrange, and treble using the AUDIO knob.

Adjusting the Speakers (Balance/Fade)

AUDIO: To adjust the balance between the right and the left speakers, push and release the AUDIO knob until BAL appears on the display. Turn the knob to move the sound toward the right or the left speakers.

To adjust the fade between the front and rear speakers, push and release the AUDIO knob until FAD appears on the display. Turn the knob to move the sound toward the front or the rear speakers.

To adjust the balance and the fade to the middle position, select balance or fade and push and hold the AUDIO knob. The radio will beep once and adjust the display level to the middle position.

To adjust all tone and speaker controls to the middle position, push and hold the AUDIO knob when no tone or speaker controls are displayed. CENTERED will appear on the display and you will hear a beep.

Radio Data System (RDS)

The audio system has a Radio Data System (RDS). RDS features are available for use only on FM stations that broadcast RDS information.

With RDS, the radio can do the following:

- Seek to stations broadcasting the selected type of programming
- Receive announcements concerning local and national emergencies
- Display messages from radio stations
- Seek to stations with traffic announcements

This system relies upon receiving specific information from these stations and will only work when the information is available. In rare cases, a radio station may broadcast incorrect information that will cause the radio features to work improperly. If this happens, contact the radio station.

While the radio is tuned to an RDS station, the station name or call letters will appear on the display instead of the frequency. RDS stations may also provide the time of day, a program type (PTY) for current programming, and the name of the program being broadcast.

Finding a Program Type (PTY) Station

To select and find a desired PTY perform the following:

1. Press the P-TYPE button to activate program type select mode. P-TYPE and the last selected PTY will appear on the display.
2. Turn the P-TYPE knob to select a PTY.
3. Once the desired PTY is displayed, press either SEEK arrow to select and to take you to the PTY's first station.
4. To go to another station within that PTY and the PTY is displayed, press either SEEK arrow once. If the PTY is not displayed, press either SEEK arrow twice to display the PTY and then to go to another station.
5. Press the P-TYPE button to exit program type select mode.

If PTY times out and is no longer on the display, go back to Step 1.

If both PTY and TRAF are on, the radio will search for stations with the selected PTY and traffic announcements.

To use the PTY interrupt feature, press and hold the P-TYPE button until you hear a beep on the PTY you want to interrupt with. When selected, an asterisk will appear beside that PTY on the display. Select multiple interrupts if desired. When listening to a CD, the last selected RDS station will interrupt play if that selected program type format is broadcast.

SCAN: Scan the stations within a PTY by performing the following:

1. Press the P-TYPE button to activate program type select mode. P-TYPE and the last selected PTY will appear on the display.
2. Turn the P-TYPE knob to select a PTY.
3. Once the desired PTY is displayed, press and hold either SCAN arrow, and the radio will begin scanning the stations in the PTY.
4. Press either SCAN arrow to stop at a station.

If both PTY and TRAF are on, the radio will scan for stations with the selected PTY and traffic announcements.

BAND (Alternate Frequency): Alternate frequency allows the radio to switch to a stronger station with the same program type. To turn alternate frequency on, press and hold BAND for two seconds. AF ON will appear on the display. The radio may switch to stations with a stronger frequency.

To turn alternate frequency off, press and hold BAND again for two seconds. AF OFF will appear on the display. The radio will not switch to other stations.

Setting Preset PTYs

These pushbuttons have factory PTY presets. Up to 12 PTYs (six FM1 and six FM2), can be programmed on the six numbered pushbuttons, by performing the following steps:

1. Press BAND to select FM1 or FM2.
2. Press the P-TYPE button to activate program type select mode. P-TYPE and the last selected PTY will appear on the display.
3. Turn the P-TYPE knob to select a PTY.
4. Press and hold one of the six numbered pushbuttons until you hear a beep. Whenever that numbered pushbutton is pressed, the PTY that was set will return.
5. Repeat the steps for each pushbutton.

RDS Messages

ALERT!: Alert warns of local or national emergencies. When an alert announcement comes on the current radio station, ALERT! will appear on the display. You will hear the announcement, even if the volume is low or a CD is playing. If a CD is playing, play will stop during the announcement. Alert announcements cannot be turned off.

ALERT! will not be affected by tests of the emergency broadcast system. This feature is not supported by all RDS stations.

INFO (Information): If the current station has a message, INFO will appear on the display. Press this button to see the message. The message may display the artist, song title, call in phone numbers, etc.

If the entire message is not displayed, parts of the message will appear every three seconds. To scroll through the message, press and release the INFO button. A new group of words will appear on the display after every press of this button. Once the complete message has been displayed, INFO will disappear from the display until another new message is received. The last message can be displayed by pressing the INFO button. You can view the last message until a new message is received or a different station is tuned to.

TRAF (Traffic): If TRAF appears on the display, the tuned station broadcasts traffic announcements. To receive the traffic announcement from the tuned station, press this button. Brackets will be displayed around TRAF and when a traffic announcement comes on the tuned radio station you will hear it.

If the station does not broadcast traffic announcements, press the TRAF button and the radio will seek to a station that does. When a station that broadcasts traffic announcements is found, the radio will stop seeking and brackets will be displayed around TRAF. If no station is found that broadcast traffic announcements, NO TRAFFIC will appear on the display.

If the brackets are on the display and TRAF is not, press the TRAF button to remove the brackets or use the TUNE knob or the SEEK arrows to go to a station that supports traffic announcements. If no station is found that broadcasts traffic announcements, NO TRAFFIC will appear on the display.

The radio will play the traffic announcements if the volume is low. The radio will interrupt the play of a CD if the last tuned station broadcasts traffic announcements and the brackets are displayed.

Playing a CD

If the ignition or radio is turned off, with a CD in the player, it will stay in the player. When the ignition or radio is turned on, the CD will start playing where it stopped, if it was the last selected audio source.

When a CD is inserted, the CD symbol will appear on the CD. As each new track starts to play, the track number will appear on the display.

The CD player can play the smaller 3 inch (8 cm) single CDs with an adapter ring. Full-size CDs and the smaller CDs are loaded in the same manner.

If playing a CD-R the sound quality may be reduced due to CD-R quality, the method of recording, the quality of the music that has been recorded, and the way the CD-R has been handled. There may be an increase in skipping, difficulty in finding tracks, and/or difficulty in loading and ejecting. If these problems occur try a known good CD.

Do not add paper labels to CDs, they could get caught in the CD player.

If an error appears on the display, see “CD Messages” later in this section.

LOAD CD  : Press the LOAD side of this button to load CDs into the CD player. This CD player will hold up to six CDs.

To insert one CD, do the following:

1. Turn the ignition on.
2. Press and release the LOAD button.
3. Wait for the indicator light, located to the right of the slot, to turn green.
4. Load a CD. Insert the CD partway into the slot, label side up. The player will pull the CD in.

To insert multiple CDs, do the following:

1. Turn the ignition on.
2. Press and hold the LOAD button for two seconds. You will hear a beep and the indicator light, located to the right of the slot, will begin to flash.
3. Once the light stops flashing and turns green, load a CD. Insert the CD partway into the slot, label side up. The player will pull the CD in. Once the CD is loaded, the light will begin flashing again. Once the light stops flashing and turns green you can load another CD. The CD player takes up to six CDs. Do not try to load more than six.

To load more than one CD but less than six, complete Steps 1 through 3. When finished loading CDs, the radio will begin to play the last CD loaded.

If more than one CD has been loaded, a number for each CD will appear on the display.

Playing a Specific Loaded CD

For every CD loaded, a number will appear on the display. To play a specific CD, first press the CD AUX button, then press the numbered pushbutton that corresponds to the CD. A small bar will appear under the CD number that is playing and the track number will appear on the display.

If an error appears on the display, see “CD Messages” later in this section.

LOAD CD  (Eject): Press the CD eject side of this button to eject a CD(s). To eject the CD that is currently playing, press and release this button. To eject multiple CDs, press and hold this button for two seconds. You will hear a beep and the indicator light will flash to let you know when a CD is being ejected.

REMOVE CD will appear on the display. The CD can be removed. If the CD is not removed, after 25 seconds, the CD will be automatically pulled back into the player. If the CD is pushed back into the player, before the 25 second time period is complete, the player will sense an error and will try to eject the CD several times before stopping.

Do not repeatedly press the CD eject button to eject a CD after trying to push it in manually. The player’s 25-second eject timer will reset at each press of eject, causing the player to not eject the CD until the 25-second time period has elapsed.

Once the player stops and the CD is ejected, remove the CD. After removing the CD, push the PWR knob off and then on again, or wait for the system to reset. This will clear the CD-sensing feature and enable CDs to be loaded into the player again.

◀ REV (Reverse): Press and hold this button to reverse quickly within a track. You will hear sound at a reduced volume. Release this button to play the passage. The elapsed time of the track will appear on the display.

FWD ▶▶ (Forward): Press and hold this button to advance quickly within a track. You will hear sound at a reduced volume. Release this button to play the passage. The elapsed time of the track will appear on the display.

RPT (Repeat): With repeat, one track or an entire CD can be repeated.

To use repeat, do the following:

- To repeat the track you are listening to, press and release the RPT button. RPT will appear on the display. Press RPT again to turn off repeat play.
- To repeat the CD you are listening to, press and hold the RPT button for two seconds. RPT will appear on the display. Press RPT again to turn off repeat play.

RDM (Random): With random, you can listen to the tracks in random, rather than sequential, order, on one CD or on all of the CDs.

To use random, do one of the following:

- To play the tracks on the CD you are listening to in random order, press and release the RDM button. RANDOM ONE will appear on the display. Press RDM again to turn off random play.
- To play the tracks on all of the CDs that are loaded in random order, press and hold RDM for more than two seconds. You will hear a beep and RANDOM ALL will appear on the display. Press RDM again to turn off random play.

AUTO EQ (Automatic Equalization): Press AUTO EQ to select the equalization setting while playing a CD. The equalization will be stored whenever a CD is played. For more information on AUTO EQ, see "AUTO EQ" listed previously in this section.

< SEEK > : Press the left arrow to go to the start of the current track, if more than ten seconds have played. Press the right arrow to go to the next track. If either arrow is held or pressed more than once, the player will continue moving backward or forward through the CD.

< SCAN > : To scan one CD, press and hold either SCAN arrow for more than two seconds until SCAN appears on the display and you hear a beep. The radio will go to the next track, play for 10 seconds, then go on to the next track. Press either SCAN arrow again, to stop scanning.

To scan all loaded CDs, press and hold either SCAN arrow for more than four seconds until CD SCAN appears on the display and you hear a beep. Use this feature to listen to 10 seconds of the first track of each loaded CD. Press either SCAN arrow again, to stop scanning.

RCL (Recall): Press this knob to see how long the current track has been playing. To change the default on the display, track and elapsed time, press the knob until you see the display you want, then hold the knob until the display flashes. The selected display will now be the default.

BAND: Press this button to listen to the radio when a CD is playing. The inactive CD(s) will remain safely inside the radio for future listening.

CD AUX (Auxiliary): Press this button to play a CD when listening to the radio.

Using Song List Mode

The six-disc CD changer has a feature called song list. This feature is capable of saving 20 track selections.

To save tracks into the song list feature, perform the following steps:

1. Turn the CD player on and load it with at least one CD. See "LOAD CD" listed previously in this section for more information.
2. Check to see that the CD changer is not in song list mode. S-LIST should not appear in the display. If S-LIST is on the display, press the SONG LIST button to turn it off.

3. Select the desired CD by pressing the numbered pushbutton and then use the SEEK SCAN right arrow to locate the track to be saved. The track will begin to play.
4. Press and hold the SONG LIST button to save the track into memory. When SONG LIST is pressed, one beep will be heard immediately. After two seconds of continuously pressing the SONG LIST button, two beeps will be heard to confirm the track has been saved.
5. Repeat Steps 3 and 4 for saving other selections.

S-LIST FULL will appear on the display if you try to save more than 20 selections.

To play the song list, press the SONG LIST button. One beep will be heard and S-LIST will appear on the display. The recorded tracks will begin to play in the order they were saved.

Seek through the song list by using the SEEK SCAN arrows. Seeking past the last saved track will return to the first saved track.

To delete tracks from the song list, perform the following steps:

1. Turn the CD player on.
2. Press the SONG LIST button to turn song list on. S-LIST will appear on the display.
3. Press the SEEK SCAN arrows to select the desired track to be deleted.

4. Press and hold the SONG LIST button for two seconds. When SONG LIST is pressed, one beep will be heard immediately. After two seconds of continuously pressing the SONG LIST button, two beeps will be heard to confirm the track has been deleted.

After a track has been deleted, the remaining tracks are moved up the list. When another track is added to the song list, the track will be added to the end of the list.

To delete the entire song list, perform the following steps:

1. Turn the CD player on.
2. Press the SONG LIST button to turn song list on. S-LIST will appear on the display.
3. Press and hold the SONG LIST button for more than four seconds. One beep will be heard, followed by two beeps after two seconds, and a final beep will be heard after four seconds. S-LIST EMPTY will appear on the display indicating the song list has been deleted.

If a CD is ejected, and the song list contains saved tracks from that CD, those tracks are automatically deleted from the song list. Any tracks saved to the song list again are added to the bottom of the list.

To end song list mode, press the SONG LIST button. One beep will be heard and S-LIST will be removed from the display.

CD Messages

CHECK CD: If this message appears on the display and/or the CD comes out, it could be for one of the following reasons:

- It is very hot. When the temperature returns to normal, the CD should play.
- You are driving on a very rough road. When the road becomes smoother, the CD should play.
- The CD is dirty, scratched, wet, or upside down.
- The air is very humid. If so, wait about an hour and try again.
- There may have been a problem while burning the CD.
- The label may be caught in the CD player.

If the CD is not playing correctly, for any other reason, try a known good CD.

If any error occurs repeatedly or if an error cannot be corrected, contact your dealer. If the radio displays an error message, write it down and provide it to your dealer when reporting the problem.

Navigation/Radio System

Your vehicle may have a navigation radio system that includes a Radio Data System (RDS) with Program Type (PTY) selections that will seek out the kind of music you want to listen to. The radio can also communicate with the navigation system to broadcast announcements on traffic and emergency alert communications. For information on how to use this system, see the "Navigation System" manual.

Radio Reception

AM

The range for most AM stations is greater than for FM, especially at night. The longer range can cause station frequencies to interfere with each other. Static can occur on AM stations caused by things like storms and power lines. Try reducing the treble to reduce this noise.

FM Stereo

FM stereo will give the best sound, but FM signals will reach only about 10 to 40 miles (16 to 65 km). Tall buildings or hills can interfere with FM signals, causing the sound to fade in and out.

XM™ Satellite Radio Service

XM™ Satellite Radio Service gives digital radio reception from coast to coast. Just as with FM, tall buildings or hills can interfere with satellite radio signals, causing the sound to fade in and out. The radio may display NO SIGNAL to indicate interference.

Care of Your CDs

Handle CDs carefully. Store them in their original cases or other protective cases and away from direct sunlight and dust. If the surface of a CD is soiled, dampen a clean, soft cloth in a mild, neutral detergent solution and clean it, wiping from the center to the edge.

Be sure never to touch the side without writing when handling CDs. Pick up CDs by grasping the outer edges or the edge of the hole and the outer edge.

Care of Your CD Player

The use of CD lens cleaners for CD players is not advised, due to the risk of contaminating the lens of the CD optics with lubricants internal to the CD mechanism.

Fixed Mast Antenna

The fixed mast antenna can withstand most car washes without being damaged. If the mast should ever become slightly bent, straighten it out by hand. If the mast is badly bent, replace it.

Check occasionally to make sure the mast is still tightened to the antenna base located on the roof of the vehicle. If tightening is required, tighten by hand.

XM™ Satellite Radio Antenna System

The XM™ Satellite Radio antenna is located on the roof of your vehicle. Keep this antenna clear of snow and ice build up for clear radio reception.

The performance of the XM™ system may be affected if the sunroof is open.

Loading items onto the roof of your vehicle can interfere with the performance of the XM™ system. Make sure that the XM™ satellite antenna is not obstructed.

 **NOTES**

Section 4 Driving Your Vehicle

Your Driving, the Road, and Your Vehicle	4-2	Driving in Rain and on Wet Roads	4-18
Defensive Driving	4-2	City Driving	4-21
Drunken Driving	4-3	Freeway Driving	4-22
Control of a Vehicle	4-6	Before Leaving on a Long Trip	4-23
Braking	4-6	Highway Hypnosis	4-24
Anti-Lock Brake System (ABS)	4-7	Hill and Mountain Roads	4-24
Braking in Emergencies	4-9	Winter Driving	4-26
Traction Control System (TCS)	4-9	If You Are Stuck: In Sand, Mud, Ice or Snow	4-30
Stabilitrak [®] System	4-10	Rocking Your Vehicle to Get It Out	4-30
Panic Brake Assist	4-11	Recovery Hook	4-31
All-Wheel Drive (AWD) System	4-11	Loading Your Vehicle	4-32
Steering	4-11	Towing	4-37
Off-Road Recovery	4-14	Towing Your Vehicle	4-37
Passing	4-14	Recreational Vehicle Towing	4-37
Loss of Control	4-16	Towing a Trailer	4-40
Driving at Night	4-17		

Your Driving, the Road, and Your Vehicle

Defensive Driving

The best advice anyone can give about driving is: Drive defensively.

Please start with a very important safety device in your vehicle: Buckle up. See *Safety Belts: They Are for Everyone* on page 1-8.

Defensive driving really means “be ready for anything.” On city streets, rural roads, or freeways, it means “always expect the unexpected.”

Assume that pedestrians or other drivers are going to be careless and make mistakes. Anticipate what they might do. Be ready for their mistakes.

Rear-end collisions are about the most preventable of accidents. Yet they are common. Allow enough following distance. It is the best defensive driving maneuver, in both city and rural driving. You never know when the vehicle in front of you is going to brake or turn suddenly.

Defensive driving requires that a driver concentrate on the driving task. Anything that distracts from the driving task — such as concentrating on a cellular telephone call, reading, or reaching for something on the floor — makes proper defensive driving more difficult and can even cause a collision, with resulting injury. Ask a passenger to help do things like this, or pull off the road in a safe place to do them yourself. These simple defensive driving techniques could save your life.

Drunken Driving

Death and injury associated with drinking and driving is a national tragedy. It is the number one contributor to the highway death toll, claiming thousands of victims every year.

Alcohol affects four things that anyone needs to drive a vehicle:

- Judgment
- Muscular Coordination
- Vision
- Attentiveness

Police records show that almost half of all motor vehicle-related deaths involve alcohol. In most cases, these deaths are the result of someone who was drinking and driving. In recent years, more than 16,000 annual motor vehicle-related deaths have been associated with the use of alcohol, with more than 300,000 people injured.

Many adults — by some estimates, nearly half the adult population — choose never to drink alcohol, so they never drive after drinking. For persons under 21, it is against the law in every U.S. state to drink alcohol. There are good medical, psychological and developmental reasons for these laws.

The obvious way to eliminate the leading highway safety problem is for people never to drink alcohol and then drive. But what if people do? How much is “too much” if someone plans to drive? It is a lot less than many might think. Although it depends on each person and situation, here is some general information on the problem.

The Blood Alcohol Concentration (BAC) of someone who is drinking depends upon four things:

- The amount of alcohol consumed
- The drinker's body weight
- The amount of food that is consumed before and during drinking
- The length of time it has taken the drinker to consume the alcohol

According to the American Medical Association, a 180 lb (82 kg) person who drinks three 12 ounce (355 ml) bottles of beer in an hour will end up with a BAC of about 0.06 percent. The person would reach the same BAC by drinking three 4 ounce (120 ml) glasses of wine or three mixed drinks if each had 1-1/2 ounces (45 ml) of liquors like whiskey, gin, or vodka.



It is the amount of alcohol that counts. For example, if the same person drank three double martinis (3 ounces or 90 ml of liquor each) within an hour, the person's BAC would be close to 0.12 percent. A person who consumes food just before or during drinking will have a somewhat lower BAC level.

There is a gender difference, too. Women generally have a lower relative percentage of body water than men. Since alcohol is carried in body water, this means that a woman generally will reach a higher BAC level than a man of her same body weight will when each has the same number of drinks.

The law in most U.S. states, and throughout Canada, sets the legal limit at 0.08 percent. In some other countries, the limit is even lower. For example, it is 0.05 percent in both France and Germany. The BAC limit for all commercial drivers in the United States is 0.04 percent.

The BAC will be over 0.10 percent after three to six drinks (in one hour). Of course, as we have seen, it depends on how much alcohol is in the drinks, and how quickly the person drinks them.

But the ability to drive is affected well below a BAC of 0.10 percent. Research shows that the driving skills of many people are impaired at a BAC approaching 0.05 percent, and that the effects are worse at night. All drivers are impaired at BAC levels above 0.05 percent. Statistics show that the chance of being in a collision increases sharply for drivers who have a BAC of 0.05 percent or above. A driver with a BAC level of 0.06 percent has doubled his or her chance of having a collision. At a BAC level of 0.10 percent, the chance of this driver having a collision is 12 times greater; at a level of 0.15 percent, the chance is 25 times greater!

The body takes about an hour to rid itself of the alcohol in one drink. No amount of coffee or number of cold showers will speed that up. “I will be careful” is not the right answer. What if there is an emergency, a need to take sudden action, as when a child darts into the street? A person with even a moderate BAC might not be able to react quickly enough to avoid the collision.

There is something else about drinking and driving that many people do not know. Medical research shows that alcohol in a person’s system can make crash injuries worse, especially injuries to the brain, spinal cord, or heart. This means that when anyone who has been drinking — driver or passenger — is in a crash, that person’s chance of being killed or permanently disabled is higher than if the person had not been drinking.

 **CAUTION:**

Drinking and then driving is very dangerous. Your reflexes, perceptions, attentiveness, and judgment can be affected by even a small amount of alcohol. You can have a serious — or even fatal — collision if you drive after drinking. Please do not drink and drive or ride with a driver who has been drinking. Ride home in a cab; or if you are with a group, designate a driver who will not drink.

Control of a Vehicle

You have three systems that make your vehicle go where you want it to go. They are the brakes, the steering, and the accelerator. All three systems have to do their work at the places where the tires meet the road.

Sometimes, as when you are driving on snow or ice, it is easy to ask more of those control systems than the tires and road can provide. That means you can lose control of your vehicle.

Braking

Braking action involves perception time and reaction time.

First, you have to decide to push on the brake pedal. That is perception time. Then you have to bring up your foot and do it. That is reaction time.

Average reaction time is about three-fourths of a second. But that is only an average. It might be less with one driver and as long as two or three seconds or more with another. Age, physical condition, alertness, coordination and eyesight all play a part. So do alcohol, drugs and frustration. But even in three-fourths of a second, a vehicle moving at 60 mph (100 km/h) travels 66 feet (20 m). That could be a lot of distance in an emergency, so keeping enough space between your vehicle and others is important.

And, of course, actual stopping distances vary greatly with the surface of the road (whether it is pavement or gravel); the condition of the road (wet, dry, icy); tire tread; the condition of your brakes; the weight of the vehicle and the amount of brake force applied.

Avoid needless heavy braking. Some people drive in spurts — heavy acceleration followed by heavy braking — rather than keeping pace with traffic. This is a mistake. Your brakes may not have time to cool between hard stops. Your brakes will wear out much faster if you do a lot of heavy braking. If you keep pace with the traffic and allow realistic following distances, you will eliminate a lot of unnecessary braking. That means better braking and longer brake life.

If your engine ever stops while you are driving, brake normally but do not pump your brakes. If you do, the pedal may get harder to push down. If your engine stops, you will still have some power brake assist. But you will use it when you brake. Once the power assist is used up, it may take longer to stop and the brake pedal will be harder to push.

Anti-Lock Brake System (ABS)

Your vehicle may have anti-lock brakes. ABS is an advanced electronic braking system that will help prevent a braking skid.

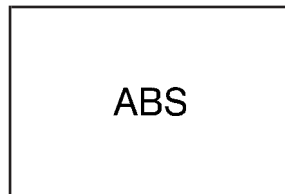

United States

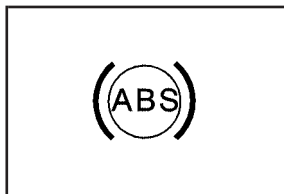

Canada

If your vehicle has anti-lock brakes, this warning light on the instrument panel will come on briefly when you start your vehicle.

When you start your engine, or when you begin to drive away, your anti-lock brake system will check itself. You may hear a momentary motor or clicking noise while this test is going on, and you may even notice that your brake pedal moves or pulses a little. This is normal.

If there is a problem with the anti-lock brake system, the anti-lock brake system warning light will stay on. See *Anti-Lock Brake System Warning Light* on page 3-33.



Let us say the road is wet and you are driving safely. Suddenly, an animal jumps out in front of you. You slam on the brakes and continue braking. Here is what happens with ABS:

A computer senses that wheels are slowing down. If one of the wheels is about to stop rolling, the computer will separately work the brakes at each front wheel and at both rear wheels.

The anti-lock system can change the brake pressure faster than any driver could. The computer is programmed to make the most of available tire and road conditions. This can help you steer around the obstacle while braking hard.



As you brake, your computer keeps receiving updates on wheel speed and controls braking pressure accordingly.

If your vehicle has the vehicle stability control system, it includes a brake assist system which provides more powerful braking during a sudden, hard brake application. See “Vehicle Stability Control System” under *Traction Control System (TCS)* on page 4-9.

Remember: Anti-lock does not change the time you need to get your foot up to the brake pedal or always decrease stopping distance. If you get too close to the vehicle in front of you, you will not have time to apply your brakes if that vehicle suddenly slows or stops. Always leave enough room up ahead to stop, even though you have anti-lock brakes.

Using Anti-Lock

Do not pump the brakes. Just hold the brake pedal down firmly and let anti-lock work for you. You may feel a slight brake pedal pulsation or notice some noise, but this is normal.

Braking in Emergencies

At some time, nearly every driver gets into a situation that requires hard braking.

If you have anti-lock, you can steer and brake at the same time. However, if you do not have anti-lock, your first reaction — to hit the brake pedal hard and hold it down — may be the wrong thing to do. Your wheels can stop rolling. Once they do, the vehicle cannot respond to your steering. Momentum will carry it in whatever direction it was headed when the wheels stopped rolling. That could be off the road, into the very thing you were trying to avoid, or into traffic.

If you do not have anti-lock, use a “squeeze” braking technique. This will give you maximum braking while maintaining steering control. You can do this by pushing on the brake pedal with steadily increasing pressure.

In an emergency, you will probably want to squeeze the brakes hard without locking the wheels. If you hear or feel the wheels sliding, ease off the brake pedal. This will help you retain steering control. If you *do* have anti-lock, it is different. See *Anti-Lock Brake System (ABS) on page 4-7*.

In many emergencies, steering can help you more than even the very best braking.

Traction Control System (TCS)

Your vehicle may have a traction control system that limits wheel spin. This is especially useful in slippery road conditions. The system operates only if it senses that one or both of the front wheels are spinning or beginning to lose traction. When this happens, the system works the front brakes and reduces engine power to limit wheel spin.

You may feel or hear the system working, but this is normal. Leave the system on during ordinary driving so that it can operate when needed. When the ignition is turned to ON, the system automatically turns on.

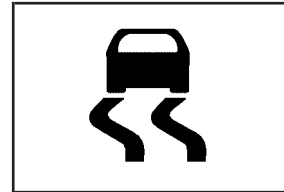

This light should come on briefly when you start the engine. If it stays on or comes on while you are driving, there is a problem with your traction control system.

A rectangular button with a black border and the text "TRAC OFF" centered inside in a bold, sans-serif font.

TRAC
OFF

The TRAC OFF button is located to the left of the steering wheel below the instrument panel cluster.

When getting the vehicle out of mud or newly fallen snow, turn off the traction control system. The system that controls engine performance interferes with the process of freeing the front wheels. To turn off traction control, press the TRAC OFF button. The traction control system warning light will come on. The vehicle stability control system (Stabilitrak[®]) is always activated, even when the traction control system is turned off. To turn the traction control system back on, press the TRAC OFF button again. The traction control system warning light will go off. See *Traction Control System (TCS) Warning Light* on page 3-34 for more information.

Stabilitrak[®] System

The Stabilitrak[®] system helps provide integrated control of the systems such as anti-lock brake system, traction control and engine control. This system automatically controls the brakes and engine to help prevent the vehicle from skidding when cornering on a slippery road surface or turning the steering wheel abruptly.

This system will activate when your vehicle speed reaches or exceeds 9 mph (15 km/h), and will deactivate when the vehicle speed reduces to below 9 mph (15 km/h).

You may hear a sound in the engine compartment for a few seconds when the engine is started or just after the vehicle begins to move. This means that the system is in the self-check mode, but does not indicate a malfunction.

If the vehicle is going to skid during driving, the traction control system warning light will blink and an alarm will sound intermittently. Adjust your driving accordingly.

A rectangular warning light with a black border and the text "VSC" centered inside in a bold, sans-serif font.

VSC

This light warns that there is a problem somewhere in the traction control system or Stabilitrak[®].

Panic Brake Assist

Your vehicle has a panic brake assist system that monitors the intention of the driver while braking. If the system senses that the driver has applied hard/fast pressure to the brake pedal, the system will generate additional pressure, making it easier for the driver to maintain brake application. When this happens the brake pedal will feel easier to push. Just hold the brake pedal down firmly and let the system work for you. You may feel the brakes vibrate, or you may notice some noise but this is normal. The brakes will return to normal operation after the brake pedal has been released.

The brake assist system becomes operational after the vehicle has accelerated to a speed in excess of approximately 6 mph (10 km/h). It stops operating when the vehicle decelerates to a speed below approximately 3 mph (5 km/h).

All-Wheel Drive (AWD) System

If your vehicle has all-wheel drive (AWD), the AWD system operates automatically without any action required by the driver. If the front drive wheels begin to slip, the rear wheels will automatically begin to drive the vehicle as required. There may be a slight engagement noise during hard use but this is normal.

Steering

Power Steering

If you lose power steering assist because the engine stops or the system is not functioning, you can steer but it will take much more effort.

Steering Tips

Driving on Curves

It is important to take curves at a reasonable speed.

A lot of the “driver lost control” accidents mentioned on the news happen on curves.

Here is why:

Experienced driver or beginner, each of us is subject to the same laws of physics when driving on curves.

The traction of the tires against the road surface makes it possible for the vehicle to change its path when you turn the front wheels. If there is no traction, inertia will keep the vehicle going in the same direction. If you have ever tried to steer a vehicle on wet ice, you will understand this.

The traction you can get in a curve depends on the condition of your tires and the road surface, the angle at which the curve is banked, and your speed.

While you are in a curve, speed is the one factor you can control.

Suppose you are steering through a sharp curve. Then you suddenly apply the brakes. Both control systems — steering and braking — have to do their work where the tires meet the road. Unless you

have four-wheel anti-lock brakes, adding the hard braking can demand too much of those places. You can lose control.

The same thing can happen if you are steering through a sharp curve and you suddenly accelerate. Those two control systems — steering and acceleration — can overwhelm those places where the tires meet the road and make you lose control.

What should you do if this ever happens? Ease up on the brake or accelerator pedal, steer the vehicle the way you want it to go, and slow down.

Speed limit signs near curves warn that you should adjust your speed. Of course, the posted speeds are based on good weather and road conditions. Under less favorable conditions you will want to go slower.

If you need to reduce your speed as you approach a curve, do it before you enter the curve, while your front wheels are straight ahead.

Try to adjust your speed so you can “drive” through the curve. Maintain a reasonable, steady speed. Wait to accelerate until you are out of the curve, and then accelerate gently into the straightaway.

Steering in Emergencies

There are times when steering can be more effective than braking. For example, you come over a hill and find a truck stopped in your lane, or a car suddenly pulls out from nowhere, or a child darts out from between parked cars and stops right in front of you. You can avoid these problems by braking — if you can stop in time. But sometimes you cannot; there is not room. That is the time for evasive action — steering around the problem.

Your vehicle can perform very well in emergencies like these. First apply your brakes — but, unless you have anti-lock, not enough to lock your wheels.

See *Braking on page 4-6*. It is better to remove as much speed as you can from a possible collision. Then steer around the problem, to the left or right depending on the space available.

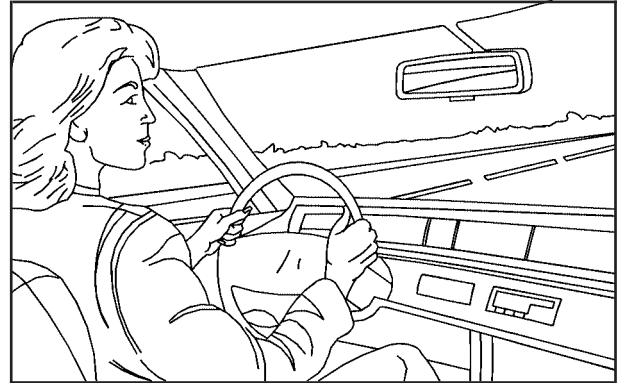

An emergency like this requires close attention and a quick decision. If you are holding the steering wheel at the recommended 9 and 3 o'clock positions, you can turn it a full 180 degrees very quickly without removing either hand. But you have to act fast, steer quickly, and just as quickly straighten the wheel once you have avoided the object.

The fact that such emergency situations are always possible is a good reason to practice defensive driving at all times and wear safety belts properly.

Off-Road Recovery

You may find that your right wheels have dropped off the edge of a road onto the shoulder while you're driving.

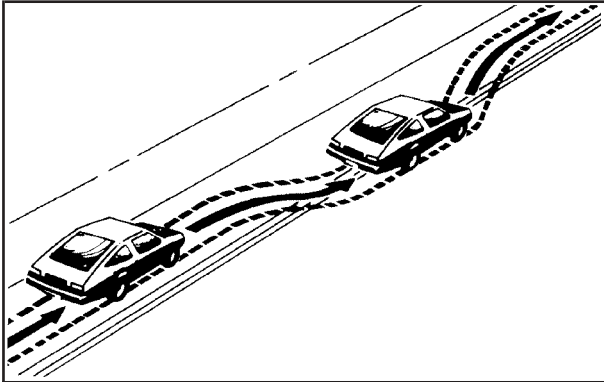

If the level of the shoulder is only slightly below the pavement, recovery should be fairly easy. Ease off the accelerator and then, if there is nothing in the way, steer so that your vehicle straddles the edge of the pavement. You can turn the steering wheel up to one-quarter turn until the right front tire contacts the pavement edge. Then turn your steering wheel to go straight down the roadway.

Passing

The driver of a vehicle about to pass another on a two-lane highway waits for just the right moment, accelerates, moves around the vehicle ahead, then goes back into the right lane again. A simple maneuver?

Not necessarily! Passing another vehicle on a two-lane highway is a potentially dangerous move, since the passing vehicle occupies the same lane as oncoming traffic for several seconds. A miscalculation, an error in judgment, or a brief surrender to frustration or anger can suddenly put the passing driver face to face with the worst of all traffic accidents — the head-on collision.

So here are some tips for passing:

- Drive ahead. Look down the road, to the sides and to crossroads for situations that might affect your passing patterns. If you have any doubt whatsoever about making a successful pass, wait for a better time.
- Watch for traffic signs, pavement markings and lines. If you can see a sign up ahead that might indicate a turn or an intersection, delay your pass. A broken center line usually indicates it is all right to pass, providing the road ahead is clear. Never cross a solid line on your side of the lane or a double solid line, even if the road seems empty of approaching traffic.

- Do not get too close to the vehicle you want to pass while you are awaiting an opportunity. For one thing, following too closely reduces your area of vision, especially if you are following a larger vehicle. Also, you will not have adequate space if the vehicle ahead suddenly slows or stops. Keep back a reasonable distance.
- When it looks like a chance to pass is coming up, start to accelerate but stay in the right lane and do not get too close. Time your move so you will be increasing speed as the time comes to move into the other lane. If the way is clear to pass, you will have a running start that more than makes up for the distance you would lose by dropping back. And if something happens to cause you to cancel your pass, you need only slow down and drop back again and wait for another opportunity.
- If other vehicles are lined up to pass a slow vehicle, wait your turn. But take care that someone is not trying to pass you as you pull out to pass the slow vehicle. Remember to glance over your shoulder and check the blind spot.
- Check your mirrors, glance over your shoulder, and start your left lane change signal before moving out of the right lane to pass. When you are far enough ahead of the passed vehicle to see its front in your inside mirror, activate your right lane change signal and move back into the right lane. Remember that your right outside mirror is convex. The vehicle you just passed may seem to be farther away from you than it really is.
- Try not to pass more than one vehicle at a time on two-lane roads. Reconsider before passing the next vehicle.
- Do not overtake a slowly moving vehicle too rapidly. Even though the brake lamps are not flashing, it may be slowing down or starting to turn.
- If you are being passed, make it easy for the following driver to get ahead of you. Perhaps you can ease a little to the right.

Loss of Control

Let us review what driving experts say about what happens when the three control systems — brakes, steering, and acceleration — do not have enough friction where the tires meet the road to do what the driver has asked.

In any emergency, do not give up. Keep trying to steer and constantly seek an escape route or area of less danger.

Skidding

In a skid, a driver can lose control of the vehicle. Defensive drivers avoid most skids by taking reasonable care suited to existing conditions, and by not overdriving those conditions. But skids are always possible.

The three types of skids correspond to your vehicle's three control systems. In the braking skid, your wheels are not rolling. In the steering or cornering skid, too much speed or steering in a curve causes tires to slip and lose cornering force. And in the acceleration skid, too much throttle causes the driving wheels to spin.

A cornering skid and an acceleration skid are best handled by easing your foot off the accelerator pedal.

If your vehicle starts to slide, ease your foot off the accelerator pedal and quickly steer the way you want the vehicle to go. If you start steering quickly enough, your vehicle may straighten out. Always be ready for a second skid if it occurs.

Of course, traction is reduced when water, snow, ice, gravel, or other material is on the road. For safety, you will want to slow down and adjust your driving to these conditions. It is important to slow down on slippery surfaces because stopping distance will be longer and vehicle control more limited.

While driving on a surface with reduced traction, try your best to avoid sudden steering, acceleration, or braking, including engine braking by shifting to a lower gear. Any sudden changes could cause the tires to slide. You may not realize the surface is slippery until your vehicle is skidding. Learn to recognize warning clues — such as enough water, ice, or packed snow on the road to make a mirrored surface — and slow down when you have any doubt.

If you have the anti-lock braking system, remember: It helps avoid only the braking skid. If you do not have anti-lock, then in a braking skid, where the wheels are no longer rolling, release enough pressure on the brakes to get the wheels rolling again. This restores steering control. Push the brake pedal down steadily when you have to stop suddenly. As long as the wheels are rolling, you will have steering control.

Driving at Night

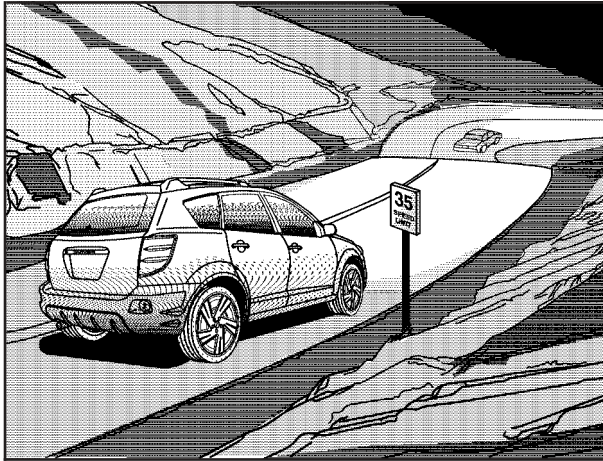

Night driving is more dangerous than day driving. One reason is that some drivers are likely to be impaired — by alcohol or drugs, with night vision problems, or by fatigue.

Here are some tips on night driving.

- Drive defensively.
- Do not drink and drive.
- Adjust your inside rearview mirror to reduce the glare from headlamps behind you.
- Since you cannot see as well, you may need to slow down and keep more space between you and other vehicles.
- Slow down, especially on higher speed roads. Your headlamps can light up only so much road ahead.
- In remote areas, watch for animals.
- If you are tired, pull off the road in a safe place and rest.

No one can see as well at night as in the daytime. But as we get older these differences increase. A 50-year-old driver may require at least twice as much light to see the same thing at night as a 20-year-old.

What you do in the daytime can also affect your night vision. For example, if you spend the day in bright sunshine you are wise to wear sunglasses. Your eyes will have less trouble adjusting to night. But if you are driving, do not wear sunglasses at night. They may cut down on glare from headlamps, but they also make a lot of things invisible.

Driving in Rain and on Wet Roads

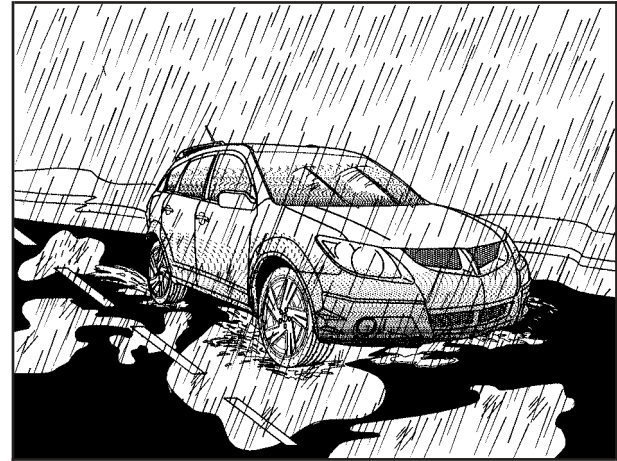

Rain and wet roads can mean driving trouble. On a wet road, you cannot stop, accelerate, or turn as well because your tire-to-road traction is not as good as on dry roads. And, if your tires do not have much tread left, you will get even less traction. It is always wise to go slower and be cautious if rain starts to fall while you are driving. The surface may get wet suddenly when your reflexes are tuned for driving on dry pavement.

You can be temporarily blinded by approaching headlamps. It can take a second or two, or even several seconds, for your eyes to re-adjust to the dark. When you are faced with severe glare, as from a driver who does not lower the high beams, or a vehicle with misaimed headlamps, slow down a little. Avoid staring directly into the approaching headlamps.

Keep your windshield and all the glass on your vehicle clean — inside and out. Glare at night is made much worse by dirt on the glass. Even the inside of the glass can build up a film caused by dust. Dirty glass makes lights dazzle and flash more than clean glass would, making the pupils of your eyes contract repeatedly.

Remember that your headlamps light up far less of a roadway when you are in a turn or curve. Keep your eyes moving; that way, it is easier to pick out dimly lighted objects. Just as your headlamps should be checked regularly for proper aim, so should your eyes be examined regularly. Some drivers suffer from night blindness — the inability to see in dim light — and are not even aware of it.

The heavier the rain, the harder it is to see. Even if your windshield wiper blades are in good shape, a heavy rain can make it harder to see road signs and traffic signals, pavement markings, the edge of the road, and even people walking.

It is wise to keep your windshield wiping equipment in good shape and keep your windshield washer tank filled with washer fluid. Replace your windshield wiper inserts when they show signs of streaking or missing areas on the windshield, or when strips of rubber start to separate from the inserts.

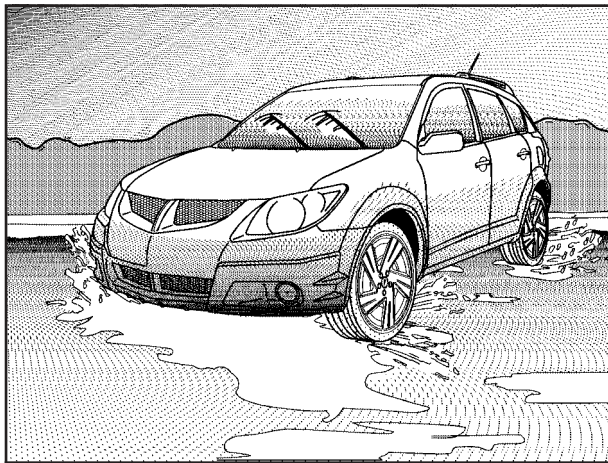

Driving too fast through large water puddles or even going through some car washes can cause problems, too. The water may affect your brakes. Try to avoid puddles. But if you cannot, try to slow down before you hit them.

⚠ CAUTION:

Wet brakes can cause accidents. They will not work as well in a quick stop and may cause pulling to one side. You could lose control of the vehicle.

After driving through a large puddle of water or a car wash, apply your brake pedal lightly until your brakes work normally.

Hydroplaning

Hydroplaning is dangerous. So much water can build up under your tires that they can actually ride on the water. This can happen if the road is wet enough and you are going fast enough. When your vehicle is hydroplaning, it has little or no contact with the road.

Hydroplaning does not happen often. But it can if your tires do not have much tread or if the pressure in one or more is low. It can happen if a lot of water is standing on the road. If you can see reflections from trees, telephone poles, or other vehicles, and raindrops dimple the water's surface, there could be hydroplaning.

Hydroplaning usually happens at higher speeds. There just is not a hard and fast rule about hydroplaning. The best advice is to slow down when it is raining.

Driving Through Deep Standing Water

Notice: If you drive too quickly through deep puddles or standing water, water can come in through your engine's air intake and badly damage your engine. Never drive through water that is slightly lower than the underbody of your vehicle. If you cannot avoid deep puddles or standing water, drive through them very slowly.

Driving Through Flowing Water

CAUTION:

Flowing or rushing water creates strong forces. If you try to drive through flowing water, as you might at a low water crossing, your vehicle can be carried away. As little as six inches of flowing water can carry away a smaller vehicle. If this happens, you and other vehicle occupants could drown. Do not ignore police warning signs, and otherwise be very cautious about trying to drive through flowing water.

Some Other Rainy Weather Tips

- Besides slowing down, allow some extra following distance. And be especially careful when you pass another vehicle. Allow yourself more clear room ahead, and be prepared to have your view restricted by road spray.
- Have good tires with proper tread depth. See *Tires* on page 5-57.

City Driving



One of the biggest problems with city streets is the amount of traffic on them. You will want to watch out for what the other drivers are doing and pay attention to traffic signals.

Here are ways to increase your safety in city driving:

- Know the best way to get to where you are going. Get a city map and plan your trip into an unknown part of the city just as you would for a cross-country trip.
- Try to use the freeways that rim and crisscross most large cities. You will save time and energy. See *Freeway Driving on page 4-22*.
- Treat a green light as a warning signal. A traffic light is there because the corner is busy enough to need it. When a light turns green, and just before you start to move, check both ways for vehicles that have not cleared the intersection or may be running the red light.

Freeway Driving

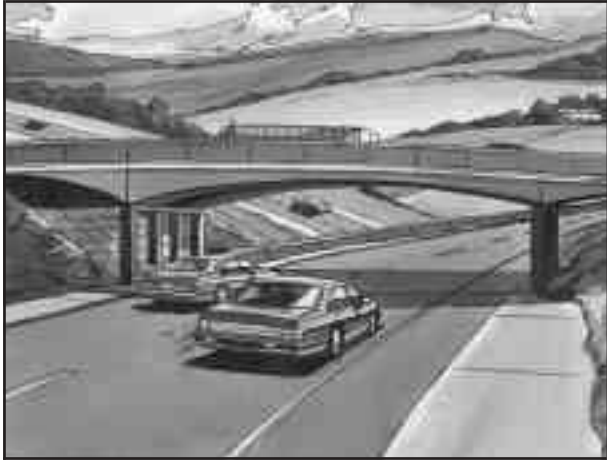

Mile for mile, freeways — also called thruways, parkways, expressways, turnpikes, or superhighways — are the safest of all roads. But they have their own special rules.

The most important advice on freeway driving is: Keep up with traffic and keep to the right. Drive at the same speed most of the other drivers are driving. Too-fast or too-slow driving breaks a smooth traffic flow. Treat the left lane on a freeway as a passing lane.

At the entrance, there is usually a ramp that leads to the freeway. If you have a clear view of the freeway as you drive along the entrance ramp, you should begin to check traffic. Try to determine where you expect to blend with the flow. Try to merge into the gap at close to the prevailing speed. Switch on your turn signal, check your mirrors, and glance over your shoulder as often as necessary. Try to blend smoothly with the traffic flow.

Once you are on the freeway, adjust your speed to the posted limit or to the prevailing rate if it is slower. Stay in the right lane unless you want to pass.

Before changing lanes, check your mirrors. Then use your turn signal.

Just before you leave the lane, glance quickly over your shoulder to make sure there is not another vehicle in your blind spot.

Once you are moving on the freeway, make certain you allow a reasonable following distance.

Expect to move slightly slower at night.

When you want to leave the freeway, move to the proper lane well in advance. If you miss your exit, do not, under any circumstances, stop and back up. Drive on to the next exit.

The exit ramp can be curved, sometimes quite sharply. The exit speed is usually posted. Reduce your speed according to your speedometer, not to your sense of motion. After driving for any distance at higher speeds, you may tend to think you are going slower than you actually are.

Before Leaving on a Long Trip

Make sure you are ready. Try to be well rested. If you must start when you are not fresh — such as after a day's work — do not plan to make too many miles that first part of the journey. Wear comfortable clothing and shoes you can easily drive in.

Is your vehicle ready for a long trip? If you keep it serviced and maintained, it is ready to go. If it needs service, have it done before starting out. Of course, you will find experienced and able service experts in GM dealerships all across North America. They will be ready and willing to help if you need it.

Here are some things you can check before a trip:

- *Windshield Washer Fluid:* Is the reservoir full? Are all windows clean inside and outside?
- *Wiper Blades:* Are they in good shape?
- *Fuel, Engine Oil, Other Fluids:* Have you checked all levels?
- *Lamps:* Are they all working? Are the lenses clean?
- *Tires:* They are vitally important to a safe, trouble-free trip. Is the tread good enough for long-distance driving? Are the tires all inflated to the recommended pressure?
- *Weather Forecasts:* What is the weather outlook along your route? Should you delay your trip a short time to avoid a major storm system?
- *Maps:* Do you have up-to-date maps?

Highway Hypnosis

Is there actually such a condition as highway hypnosis? Or is it just plain falling asleep at the wheel? Call it highway hypnosis, lack of awareness, or whatever.

There is something about an easy stretch of road with the same scenery, along with the hum of the tires on the road, the drone of the engine, and the rush of the wind against the vehicle that can make you sleepy. Do not let it happen to you! If it does, your vehicle can leave the road in less than a second, and you could crash and be injured.

What can you do about highway hypnosis? First, be aware that it can happen.

Then here are some tips:

- Make sure your vehicle is well ventilated, with a comfortably cool interior.
- Keep your eyes moving. Scan the road ahead and to the sides. Check your rearview mirrors and your instruments frequently.
- If you get sleepy, pull off the road into a rest, service, or parking area and take a nap, get some exercise, or both. For safety, treat drowsiness on the highway as an emergency.

Hill and Mountain Roads



Driving on steep hills or mountains is different from driving in flat or rolling terrain.

If you drive regularly in steep country, or if you are planning to visit there, here are some tips that can make your trips safer and more enjoyable.

- Keep your vehicle in good shape. Check all fluid levels and also the brakes, tires, cooling system, and transaxle. These parts can work hard on mountain roads.
- Know how to go down hills. The most important thing to know is this: let your engine do some of the slowing down. Shift to a lower gear when you go down a steep or long hill.

 **CAUTION:**

If you do not shift down, your brakes could get so hot that they would not work well. You would then have poor braking or even none going down a hill. You could crash. Shift down to let your engine assist your brakes on a steep downhill slope.

 **CAUTION:**

Coasting downhill in NEUTRAL (N) or with the ignition off is dangerous. Your brakes will have to do all the work of slowing down. They could get so hot that they would not work well. You would then have poor braking or even none going down a hill. You could crash. Always have your engine running and your vehicle in gear when you go downhill.

- Know how to go uphill. You may want to shift down to a lower gear. The lower gears help cool your engine and transaxle, and you can climb the hill better.
- Stay in your own lane when driving on two-lane roads in hills or mountains. Do not swing wide or cut across the center of the road. Drive at speeds that let you stay in your own lane.
- As you go over the top of a hill, be alert. There could be something in your lane, like a stalled car or an accident.
- You may see highway signs on mountains that warn of special problems. Examples are long grades, passing or no-passing zones, a falling rocks area, or winding roads. Be alert to these and take appropriate action.

Winter Driving



Here are some tips for winter driving:

- Have your vehicle in good shape for winter.
- You may want to put winter emergency supplies in your vehicle.

Also see *Tires* on page 5-57.

Include an ice scraper, a small brush or broom, a supply of windshield washer fluid, a rag, some winter outer clothing, a small shovel, a flashlight, a red cloth, and a couple of reflective warning triangles. And, if you will be driving under severe conditions, include a small bag of sand, a piece of old carpet or a couple of burlap bags to help provide traction. Be sure you properly secure these items in your vehicle.

Driving on Snow or Ice

Most of the time, those places where your tires meet the road probably have good traction.

However, if there is snow or ice between your tires and the road, you can have a very slippery situation. You will have a lot less traction, or grip, and will need to be very careful.

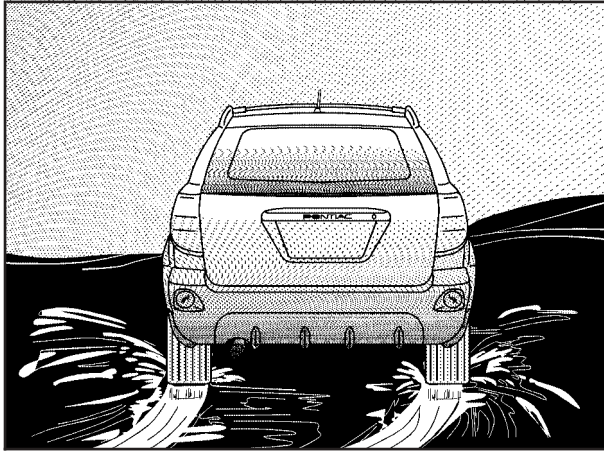

What is the worst time for this? Wet ice. Very cold snow or ice can be slick and hard to drive on. But wet ice can be even more trouble because it may offer the least traction of all. You can get wet ice when it is about freezing (32°F; 0°C) and freezing rain begins to fall. Try to avoid driving on wet ice until salt and sand crews can get there.

Whatever the condition — smooth ice, packed, blowing or loose snow — drive with caution.

Accelerate gently. Try not to break the fragile traction. If you accelerate too fast, the drive wheels will spin and polish the surface under the tires even more.

Unless you have the anti-lock braking system, you will want to brake very gently, too. If you do have anti-lock, see *Anti-Lock Brake System (ABS) on page 4-7*.

This system improves your vehicle's stability when you make a hard stop on a slippery road. Whether you have the anti-lock braking system or not, you will want to begin stopping sooner than you would on dry pavement. Without anti-lock brakes, if you feel your vehicle begin to slide, let up on the brakes a little. Push the brake pedal down steadily to get the most traction you can.

Remember, unless you have anti-lock, if you brake so hard that your wheels stop rolling, you will just slide. Brake so your wheels always keep rolling and you can still steer.

- Whatever your braking system, allow greater distance on any slippery road.
- Watch for slippery spots. The road might be fine until you hit a spot that is covered with ice. On an otherwise clear road, ice patches may appear in shaded areas where the sun cannot reach: around clumps of trees, behind buildings, or under bridges. Sometimes the surface of a curve or an overpass may remain icy when the surrounding roads are clear. If you see a patch of ice ahead of you, brake before you are on it. Try not to brake while you are actually on the ice, and avoid sudden steering maneuvers.

If You Are Caught in a Blizzard



If you are stopped by heavy snow, you could be in a serious situation. You should probably stay with your vehicle unless you know for sure that you are near help and you can hike through the snow. Here are some things to do to summon help and keep yourself and your passengers safe:

- Turn on your hazard flashers.
- Tie a red cloth to your vehicle to alert police that you have been stopped by the snow.

- Put on extra clothing or wrap a blanket around you. If you have no blankets or extra clothing, make body insulators from newspapers, burlap bags, rags, floor mats — anything you can wrap around yourself or tuck under your clothing to keep warm.

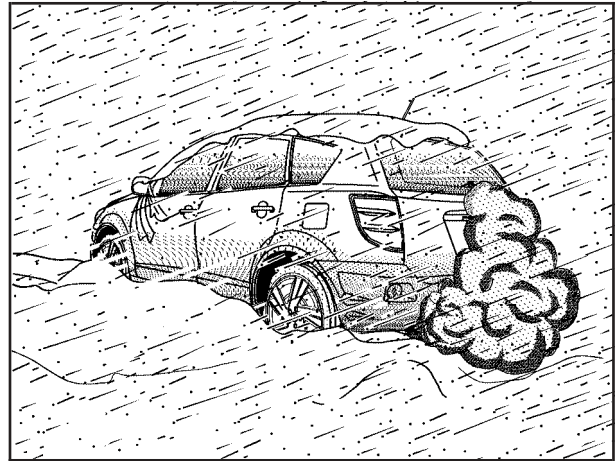

You can run the engine to keep warm, but be careful.

 **CAUTION:**

Snow can trap exhaust gases under your vehicle. This can cause deadly CO (carbon monoxide) gas to get inside. CO could overcome you and kill you. You cannot see it or smell it, so you might not know it is in your vehicle. Clear away snow from around the base of your vehicle, especially any that is blocking your exhaust pipe. And check around again from time to time to be sure snow does not collect there.

Open a window just a little on the side of the vehicle that is away from the wind. This will help keep CO out.

Run your engine only as long as you must. This saves fuel. When you run the engine, make it go a little faster than just idle. That is, push the accelerator slightly. This uses less fuel for the heat that you get and it keeps the battery charged. You will need a well-charged battery to restart the vehicle, and possibly for signaling later on with your headlamps. Let the heater run for a while.

Then, shut the engine off and close the window almost all the way to preserve the heat. Start the engine again and repeat this only when you feel really uncomfortable from the cold. But do it as little as possible. Preserve the fuel as long as you can. To help keep warm, you can get out of the vehicle and do some fairly vigorous exercises every half hour or so until help comes.

If You Are Stuck: In Sand, Mud, Ice or Snow

In order to free your vehicle when it is stuck, you will need to spin the wheels, but you do not want to spin your wheels too fast. The method known as rocking can help you get out when you are stuck, but you must use caution.

CAUTION:

If you let your tires spin at high speed, they can explode, and you or others could be injured. And, the transaxle or other parts of the vehicle can overheat. That could cause an engine compartment fire or other damage. When you are stuck, spin the wheels as little as possible. Do not spin the wheels above 35 mph (55 km/h) as shown on the speedometer.

Notice: Spinning your wheels can destroy parts of your vehicle as well as the tires. If you spin the wheels too fast while shifting your transaxle back and forth, you can destroy your transaxle. See ***Rocking Your Vehicle to Get It Out on page 4-30.***

For information about using tire chains on your vehicle, see *Tire Chains on page 5-73.*

Rocking Your Vehicle to Get It Out

First, turn your steering wheel left and right. That will clear the area around your front wheels. Then shift back and forth between REVERSE (R) and a forward gear (or with a manual transaxle, between FIRST (1) or SECOND (2) and REVERSE (R)), spinning the wheels as little as possible. Release the accelerator pedal while you shift, and press lightly on the accelerator pedal when the transaxle is in gear. By slowly spinning your wheels in the forward and reverse directions, you will cause a rocking motion that may free your vehicle. If that does not get you out after a few tries, you may need to be towed out. Or, you can use your recovery hook. If you do need to be towed out, see *Towing Your Vehicle on page 4-37.*

Recovery Hook

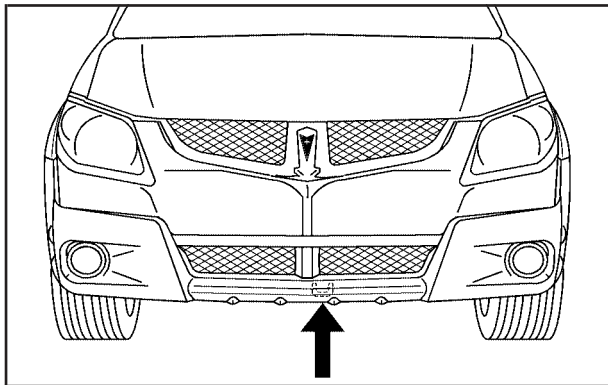

Your vehicle is equipped with a recovery hook. The recovery hook is provided at the front of your vehicle. It can only be used for pulling your vehicle out.

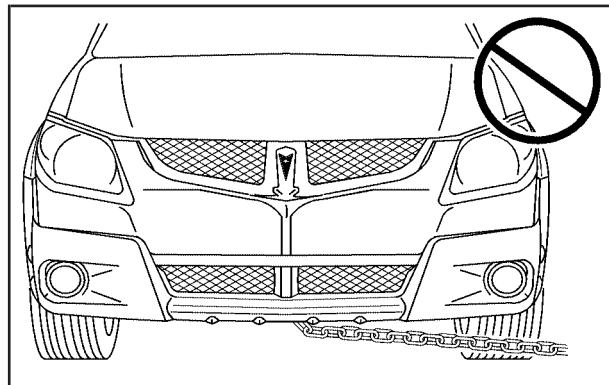

CAUTION:

The recovery hook, when used, is under a lot of force. Always pull the vehicle straight out. Never pull on the hook at a sideways angle. The hook could break off and you or others could be injured from the chain or cable snapping back.

Notice: Never use the recovery hook to tow the vehicle. Your vehicle could be damaged and it would not be covered by warranty.

Loading Your Vehicle

It is very important to know how much weight your vehicle can carry. Two labels on your vehicle show how much weight it may properly carry, the Tire and Loading Information label and the Certification label.

CAUTION:

Do not load your vehicle any heavier than the GVWR, or either the maximum front or rear GAWR. If you do, parts on your vehicle can break, and it can change the way your vehicle handles. These could cause you to lose control and crash. Also, overloading can shorten the life of your vehicle.

Tire and Loading Information Label

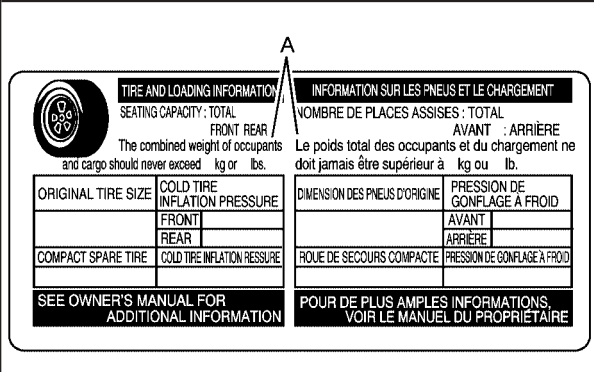

The image shows a sample of a Tire and Loading Information label. It is a rectangular label with a black border. At the top left is a tire icon. The label is divided into several sections. The top section is titled 'TIRE AND LOADING INFORMATION' and 'INFORMATION SUR LES PNEUS ET LE CHARGEMENT'. Below this, it lists 'SEATING CAPACITY: TOTAL' and 'VOMBRE DE PLACES ASSISES: TOTAL', with 'FRONT' and 'REAR' sub-sections. A note states: 'The combined weight of occupants and cargo should never exceed kg or lbs.' and 'Le poids total des occupants et du chargement ne doit jamais être supérieur à kg ou lb.'. An arrow labeled 'A' points to the top of the label. Below the seating capacity section are two tables: one for 'ORIGINAL TIRE SIZE' and 'COLD TIRE INFLATION PRESSURE' (with 'FRONT' and 'REAR' sub-sections), and another for 'DIMENSION DES PNEUS D'ORIGINE' and 'PRESSION DE GONFLAGE À FROID' (with 'AVANT' and 'ARRIÈRE' sub-sections). At the bottom, there are two boxes: 'SEE OWNER'S MANUAL FOR ADDITIONAL INFORMATION' and 'POUR DE PLUS AMPLES INFORMATIONS, VOIR LE MANUEL DU PROPRIÉTAIRE'.

TIRE AND LOADING INFORMATION		INFORMATION SUR LES PNEUS ET LE CHARGEMENT	
SEATING CAPACITY: TOTAL		VOMBRE DE PLACES ASSISES: TOTAL	
FRONT REAR		AVANT : ARRIÈRE	
The combined weight of occupants and cargo should never exceed kg or lbs.		Le poids total des occupants et du chargement ne doit jamais être supérieur à kg ou lb.	
ORIGINAL TIRE SIZE	COLD TIRE INFLATION PRESSURE	DIMENSION DES PNEUS D'ORIGINE	PRESSION DE GONFLAGE À FROID
	FRONT		AVANT
	REAR		ARRIÈRE
COMPACT SPARE TIRE	COLD TIRE INFLATION PRESSURE	ROUE DE SECOURS COMPACTE	PRESSION DE GONFLAGE À FROID
SEE OWNER'S MANUAL FOR ADDITIONAL INFORMATION		POUR DE PLUS AMPLES INFORMATIONS, VOIR LE MANUEL DU PROPRIÉTAIRE	

Tire and Loading Information Label Example

The Tire and Loading Information label shows the seating capacity and the vehicle capacity weight (A). This weight includes the weight of all occupants, cargo and all nonfactory-installed options. The Tire and Loading Information label is attached to the center pillar, below the driver's door lock post (striker).

The Tire and Loading Information label also gives you the size and recommended inflation pressures for the factory-installed, original equipment tires on your vehicle. For more information on tires and inflation see *Tires on page 5-57* and *Inflation - Tire Pressure on page 5-64*.

There is also important loading information on the Certification label. It tells you the Gross Vehicle Weight Rating (GVWR) and the Gross Axle Weight Rating (GAWR) for the front and rear axle; see "Certification Label" later in this section.

Steps for Determining Correct Load Limit

1. Locate the statement "The combined weight of occupants and cargo should never exceed XXX kg or XXX pounds" on your vehicle's placard.
2. Determine the combined weight of the driver and passengers that will be riding in your vehicle.
3. Subtract the combined weight of the driver and passengers from XXX kilograms or XXX pounds.

4. The resulting figure equals the available amount of cargo and luggage load capacity. For example, if the "XXX" amount equals 1400 lbs. and there will be five 150 lb. passengers in your vehicle, the amount of available cargo and luggage load capacity is 650 lbs. ($1400 - 750 (5 \times 150) = 650$ lbs.).
5. Determine the combined weight of luggage and cargo being loaded on the vehicle. That weight may not safely exceed the available cargo and luggage load capacity calculated in Step 4.
6. If your vehicle will be towing a trailer, the load from your trailer will be transferred to your vehicle. Consult this manual to determine how this reduces the available cargo and luggage load capacity of your vehicle.

If your vehicle can tow a trailer, see *Towing a Trailer on page 4-40* for important information on towing a trailer, towing safety rules and trailering tips.

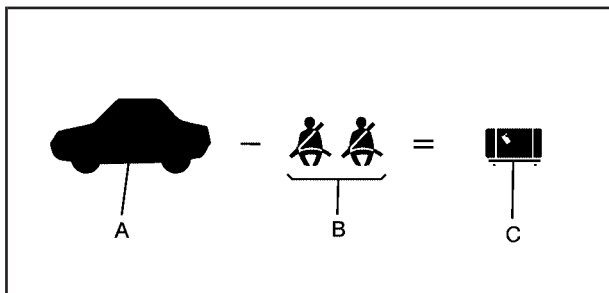

Example 1

Item	Description	Total
A	Vehicle Capacity Weight for Example 1 =	1,000 lbs (453 kg)
B	Subtract Occupant Weight 150 lbs (68 kg) x 2 =	300 lbs (136 kg)
C	Available Occupant and Cargo Weight =	700 lbs (317 kg)

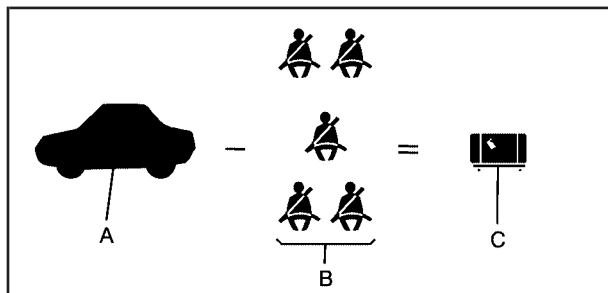

Example 2

Item	Description	Total
A	Vehicle Capacity Weight for Example 2 =	1,000 lbs (453 kg)
B	Subtract Occupant Weight 150 lbs (68 kg) x 5 =	750 lbs (340 kg)
C	Available Cargo Weight =	250 lbs (113 kg)

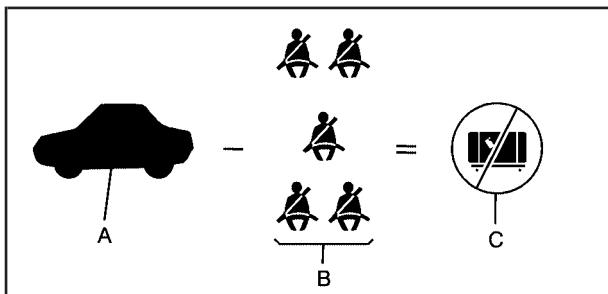

Example 3

Item	Description	Total
A	Vehicle Capacity Weight for Example 3 =	1,000 lbs (453 kg)
B	Subtract Occupant Weight 200 lbs (91 kg) x 5 =	1,000 lbs (453 kg)
C	Available Cargo Weight =	0 lbs (0 kg)

Refer to your vehicle's Tire and Loading Information label for specific information about your vehicle's capacity weight and seating positions. The combined weight of the driver, passengers and cargo should never exceed your vehicle's maximum vehicle capacity weight.

Certification Label



United States version shown, Canada Similar

The Certification label is also found on the center pillar, near the driver's door latch. It tells you the gross weight capacity of your vehicle, called the Gross Vehicle Weight Rating (GVWR). The GVWR includes the weight of the vehicle, all occupants, fuel and cargo.

Never exceed the GVWR for your vehicle, or the Gross Axle Weight Rating (GAWR) for either the front or rear axle.

And, if you do have a heavy load, you should spread it out.

 **CAUTION:**

Do not load your vehicle any heavier than the GVWR, or either the maximum front or rear GAWR. If you do, parts on your vehicle can break, and it can change the way your vehicle handles. These could cause you to lose control and crash. Also, overloading can shorten the life of your vehicle.

 **CAUTION:**

Things you put inside your vehicle can strike and injure people in a sudden stop or turn, or in a crash.

- **Put things in the rear area of your vehicle. Try to spread the weight evenly. If you have fold-down rear seats, you will find four anchors on the back wall of your trunk. You can use these anchors to tie down lighter loads. They are not strong enough for heavy things, however, so put them as far forward as you can in the trunk or rear area.**
- **Never stack heavier things, like suitcases, inside the vehicle so that some of them are above the tops of the seats.**
- **Do not leave an unsecured child restraint in your vehicle.**
- **When you carry something inside the vehicle, secure it whenever you can.**
- **Do not leave a seat folded down unless you need to.**

Towing

Towing Your Vehicle

Consult your dealer or a professional towing service if you need to have your disabled vehicle towed. See *Roadside Assistance Program on page 7-6*.

If you want to tow your vehicle behind another vehicle for recreational purposes (such as behind a motorhome), see “Recreational Vehicle Towing” following.

Recreational Vehicle Towing

Recreational vehicle towing means towing your vehicle behind another vehicle – such as behind a motorhome. The two most common types of recreational vehicle towing are known as “dinghy towing” (towing your vehicle with all four wheels on the ground) and “dolly towing” (towing your vehicle with two wheels on the ground and two wheels up on a device known as a “dolly”).

With the proper preparation and equipment, many vehicles can be towed in these ways. See “Dinghy Towing” and “Dolly Towing,” following.

Here are some important things to consider before you do recreational vehicle towing:

- What’s the towing capacity of the towing vehicle? Be sure you read the tow vehicle manufacturer’s recommendations.
- How far will you tow? Some vehicles have restrictions on how far and how long they can tow.
- Do you have the proper towing equipment? See your dealer or trailering professional for additional advice and equipment recommendations.
- Is your vehicle ready to be towed? Just as you would prepare your vehicle for a long trip, you’ll want to make sure your vehicle is prepared to be towed. See *Before Leaving on a Long Trip on page 4-23*.

Dinghy Towing

For front-wheel-drive vehicles with a manual transaxle, only do the following:

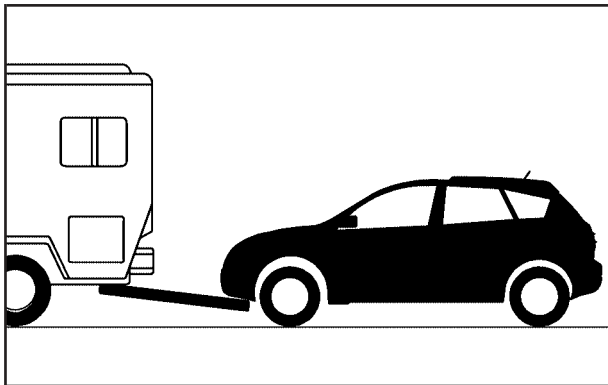

When dinghy towing, be sure to follow the posted legal speed limit.

1. Put the shift lever in NEUTRAL.
2. Turn the ignition to ACC to avoid locking the steering wheel. Make sure the audio system is turned off and that nothing is plugged into the power outlets.
3. Release the parking brake.

After dinghy towing, let the engine idle for more than three minutes before driving the vehicle.

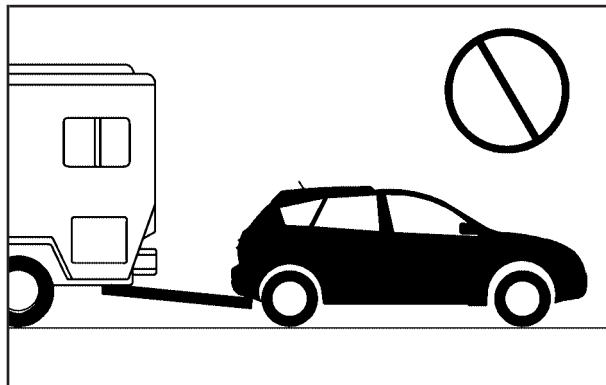

Do not tow your vehicle from the rear. Your vehicle could be badly damaged and the repairs would not be covered by your warranty.

Notice: Towing an all-wheel-drive vehicle with all four wheels on the ground, or even with only two of its wheels on the ground, will damage drivetrain components. Do not tow an all-wheel-drive vehicle if any of its wheels will be on the ground.

Dolly Towing

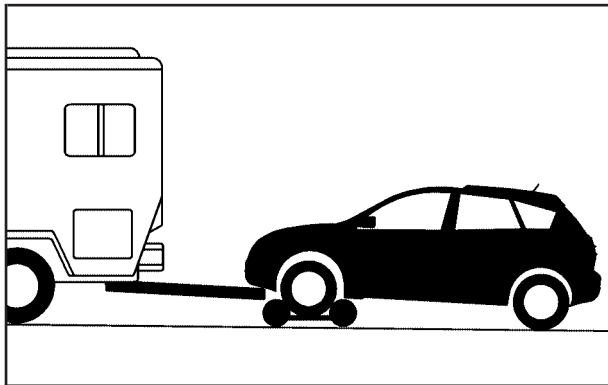

If your vehicle is a front-wheel drive vehicle it can be towed using a dolly. To tow your vehicle using a dolly, follow these steps:

1. Put the front wheels on a dolly.
2. Put the vehicle in PARK (P) for an automatic transaxle and in NEUTRAL for a manual transaxle.

3. Set the parking brake and then remove the key.
4. Clamp the steering wheel in a straight-ahead position with a clamping device designed for towing.
5. Release the parking brake.

Notice: Towing an all-wheel-drive vehicle with all four wheels on the ground, or even with only two of its wheels on the ground, will damage drivetrain components. Do not tow an all-wheel-drive vehicle if any of its wheels will be on the ground.

Towing a Trailer

CAUTION:

If you do not use the correct equipment and drive properly, you can lose control when you pull a trailer. For example, if the trailer is too heavy, the brakes may not work well — or even at all. You and your passengers could be seriously injured. You may also damage your vehicle; the resulting repairs would not be covered by your warranty. Pull a trailer only if you have followed all the steps in this section. Ask your dealer for advice and information about towing a trailer with your vehicle.

Your vehicle can tow a trailer if it is equipped with the proper trailer towing equipment. To identify what the vehicle trailering capacity is for your vehicle, you should read the information in “Weight of the Trailer” that appears later in this section. But trailering is different than just driving your vehicle by itself. Trailering means changes in handling, acceleration, braking, durability and fuel economy. Successful, safe trailering takes correct equipment, and it has to be used properly.

That’s the reason for this part. In it are many time-tested, important trailering tips and safety rules. Many of these are important for your safety and that of your passengers. So please read this section carefully before you pull a trailer.

Load-pulling components such as the engine, transaxle, wheel assemblies and tires are forced to work harder against the drag of the added weight. The engine is required to operate at relatively higher speeds and under greater loads, generating extra heat. What’s more, the trailer adds considerably to wind resistance, increasing the pulling requirements.

If You Do Decide To Pull A Trailer

If you do, here are some important points:

- There are many different laws, including speed limit restrictions, having to do with trailering. Make sure your rig will be legal, not only where you live but also where you'll be driving. A good source for this information can be state or provincial police.
- Consider using a sway control. You can ask a hitch dealer about sway controls.
- Don't tow a trailer at all during the first 1,000 miles (1 600 km) your new vehicle is driven. Your engine, axle or other parts could be damaged.
- Then, during the first 500 miles (800 km) that you tow a trailer, don't drive over 50 mph (80 km/h) and don't make starts at full throttle. This helps your engine and other parts of your vehicle wear in at the heavier loads.
- Obey speed limit restrictions when towing a trailer. Don't drive faster than the maximum posted speed for trailers, or no more than 55 mph (90 km/h), to save wear on your vehicle's parts.

Three important considerations have to do with weight:

- the weight of the trailer
- the weight of the trailer tongue
- and the total weight on your vehicle's tires

Weight of the Trailer

How heavy can a trailer safely be?

It should never weigh more than 1,500 lbs (680 kg). But even that can be too heavy.

It depends on how you plan to use your rig. For example, speed, altitude, road grades, outside temperature and how much your vehicle is used to pull a trailer are all important. And, it can also depend on any special equipment that you have on your vehicle.

You can ask your dealer for our trailering information or advice, or you can write us at:

Pontiac-GMC Customer Assistance Center
P.O. Box 33172
Detroit, MI 48232-5172

In Canada, write to:

General Motors of Canada Limited
Customer Communication Centre, 163-005
1908 Colonel Sam Drive
Oshawa, Ontario L1H 8P7

Weight of the Trailer Tongue

The tongue load (A) of any trailer is an important weight to measure because it affects the total or gross weight of your vehicle. The Gross Vehicle Weight (GVW) includes the curb weight of the vehicle, any cargo you may carry in it, and the people who will be riding in the vehicle. And if you tow a trailer, you must add the tongue load to the GVW because your vehicle will be carrying that weight, too. See *Loading Your Vehicle on page 4-32* for more information about your vehicle's maximum load capacity.

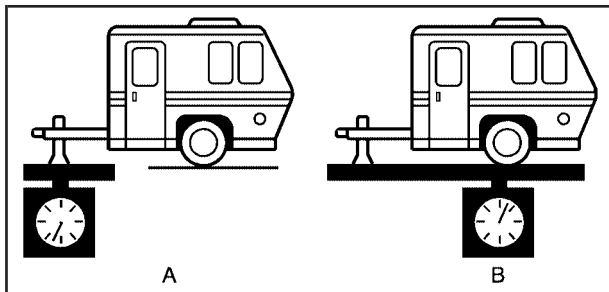

If you're using a weight-carrying hitch or a weight-distributing hitch, the trailer tongue (A) should weigh 10 to 15 percent of the total loaded trailer weight (B).

After you have loaded your trailer, weigh the trailer and then the tongue, separately, to see if the weights are proper. If they are not, you may be able to get them right simply by moving some items around in the trailer.

Total Weight on Your Vehicle's Tires

Be sure your vehicle's tires are inflated to the upper limit for cold tires. You'll find these numbers on the Tire-Loading Information label located in the glovebox. See *Loading Your Vehicle on page 4-32*. Then be sure you do not go over the GVW limit for your vehicle, including the weight of the trailer tongue.

Hitches

It's important to have the correct hitch equipment. Crosswinds, large trucks going by and rough roads are a few reasons why you'll need the right hitch. Here are some rules to follow:

- Don't let the steel in a hitch contact the aluminum on your bumper. If you do, the two will corrode. You can use something like paint or plastic tape to separate the steel and aluminum. The same steel to aluminum problem can happen with fasteners too.
- Will you have to make any holes in the body of your vehicle when you install a trailer hitch? If you do, then be sure to seal the holes later when you remove the hitch. If you don't seal them, deadly carbon monoxide (CO) from your exhaust can get into your vehicle. See *Engine Exhaust on page 2-32*. Dirt and water can too.

Safety Chains

You should always attach chains between your vehicle and your trailer. Cross the safety chains under the tongue of the trailer so that the tongue will not drop to the road if it becomes separated from the hitch. Instructions about safety chains may be provided by the hitch manufacturer or by the trailer manufacturer. Follow the manufacturer's recommendation for attaching safety chains and do not attach them to the bumper. Always leave just enough slack so you can turn with your rig. And, never allow safety chains to drag on the ground.

Trailer Brakes

Does your trailer have its own brakes?

Be sure to read and follow the instructions for the trailer brakes so you'll be able to install, adjust and maintain them properly. And, if you have anti-lock brakes, do not try to tap into your vehicle's brake system. If you do, both systems won't work well, or at all.

Driving with a Trailer

Towing a trailer requires a certain amount of experience. Before setting out for the open road, you'll want to get to know your rig. Acquaint yourself with the feel of handling and braking with the added weight of the trailer. And always keep in mind that the vehicle you are driving is now a good deal longer and not nearly as responsive as your vehicle is by itself.

Before you start, check the trailer hitch, platform and attachments, safety chains, electrical connector, lamps, tires and mirror adjustment. If the trailer has electric brakes, start your vehicle and trailer moving and then apply the trailer brake controller by hand to be sure the brakes are working. This lets you check your electrical connection at the same time.

During your trip, check occasionally to be sure that the load is secure, and that the lamps and any trailer brakes are still working.

Following Distance

Stay at least twice as far behind the vehicle ahead as you would when driving your vehicle without a trailer. This can help you avoid situations that require heavy braking and sudden turns.

Passing

You'll need more passing distance up ahead when you're towing a trailer. And, because you're a good deal longer, you'll need to go much farther beyond the passed vehicle before you can return to your lane.

Backing Up

Hold the bottom of the steering wheel with one hand. Then, to move the trailer to the left, just move that hand to the left. To move the trailer to the right, move your hand to the right. Always back up slowly and, if possible, have someone guide you.

Making Turns

Notice: Making very sharp turns while trailering could cause the trailer to come in contact with the vehicle. Your vehicle could be damaged. Avoid making very sharp turns while trailering.

When you're turning with a trailer, make wider turns than normal. Do this so your trailer won't strike soft shoulders, curbs, road signs, trees or other objects. Avoid jerky or sudden maneuvers. Signal well in advance.

Turn Signals When Towing a Trailer

When you tow a trailer, your vehicle may need a different turn signal flasher and/or extra wiring. Check with your dealer. The arrows on your instrument panel will flash whenever you signal a turn or lane change. Properly hooked up, the trailer lamps will also flash, telling other drivers you're about to turn, change lanes or stop.

When towing a trailer, the arrows on your instrument panel will flash for turns even if the bulbs on the trailer are burned out. Thus, you may think drivers behind you are seeing your signal when they are not. It's important to check occasionally to be sure the trailer bulbs are still working.

Driving On Grades

Reduce speed and shift to a lower gear *before* you start down a long or steep downgrade. If you don't shift down, you might have to use your brakes so much that they would get hot and no longer work well.

On a long uphill grade, shift down and reduce your speed to around 45 mph (70 km/h) to reduce the possibility of the engine and the transaxle overheating.

Parking on Hills

CAUTION:

You really should not park your vehicle, with a trailer attached, on a hill. If something goes wrong, your rig could start to move. People can be injured, and both your vehicle and the trailer can be damaged.

But if you ever have to park your rig on a hill, here's how to do it:

1. Apply your regular brakes, but don't shift into PARK (P) for an automatic transaxle or into gear for a manual transaxle, yet. When parking uphill, turn your wheels away from the curb. When parking downhill, turn your wheels into the curb.
2. Have someone place chocks under the trailer wheels.
3. When the chocks are in place, release the regular brakes until the chocks absorb the load.
4. Reapply the regular brakes. Then apply your parking brake and shift into PARK (P) for an automatic transaxle or REVERSE (R) for a manual transaxle.
5. Release the regular brakes.

When You Are Ready to Leave After Parking on a Hill

1. Apply your regular brakes and hold the pedal down while you:
 - start your engine
 - shift into a gear, and
 - release the parking brake
2. Let up on the brake pedal.
3. Drive slowly until the trailer is clear of the chocks.
4. Stop and have someone pick up and store the chocks.

Maintenance When Trailer Towing

Your vehicle will need service more often when you're pulling a trailer. See the Maintenance Schedule for more on this. Things that are especially important in trailer operation are automatic transaxle fluid (don't overfill), engine oil, drive belt, cooling system and brake system. Each of these is covered in this manual, and the Index will help you find them quickly. If you're trailering, it's a good idea to review this information before you start your trip.

Check periodically to see that all hitch nuts and bolts are tight.

Engine Cooling When Trailer Towing

Your cooling system may temporarily overheat during severe operating conditions. See *Engine Overheating on page 5-30*.

Section 5 Service and Appearance Care

Service	5-3	Power Steering Fluid	5-37
Doing Your Own Service Work	5-4	Windshield Washer Fluid	5-38
Adding Equipment to the Outside of Your Vehicle	5-5	Brakes	5-39
Fuel	5-5	Battery	5-42
Gasoline Octane	5-5	Jump Starting	5-43
Gasoline Specifications	5-6	All-Wheel Drive	5-48
California Fuel	5-6	Bulb Replacement	5-49
Additives	5-6	Halogen Bulbs	5-49
Fuels in Foreign Countries	5-7	Headlamps, Front Turn Signal, and Parking Lamps	5-49
Filling Your Tank	5-7	Center High-Mounted Stoplamp (CHMSL)	5-51
Filling a Portable Fuel Container	5-9	Taillamps, Turn Signal, and Stoplamps	5-53
Checking Things Under the Hood	5-10	Back-Up Lamps	5-54
Hood Release	5-10	Replacement Bulbs	5-55
Engine Compartment Overview	5-12	Windshield Wiper Blade Replacement	5-56
Engine Oil	5-16	Tires	5-57
Engine Air Cleaner/Filter	5-21	Tire Sidewall Labelling	5-58
Automatic Transaxle Fluid	5-23	Tire Terminology and Definitions	5-61
Manual Transaxle Fluid	5-26	Inflation - Tire Pressure	5-64
Hydraulic Clutch	5-27	Tire Pressure Monitor System	5-65
Engine Coolant	5-28	Tire Inspection and Rotation	5-68
Radiator Pressure Cap	5-30	When It Is Time for New Tires	5-69
Engine Overheating	5-30	Buying New Tires	5-70
Cooling System	5-32		

Section 5 Service and Appearance Care

Uniform Tire Quality Grading	5-70	Windshield, Backglass, and Wiper Blades	5-91
Wheel Alignment and Tire Balance	5-72	Aluminum Wheels	5-92
Wheel Replacement	5-72	Tires	5-92
Tire Chains	5-73	Sheet Metal Damage	5-93
If a Tire Goes Flat	5-74	Finish Damage	5-93
Changing a Flat Tire	5-75	Underbody Maintenance	5-93
Removing the Spare Tire and Tools	5-76	Chemical Paint Spotting	5-93
Removing the Flat Tire and Installing the Spare Tire	5-78	Vehicle Care/Appearance Materials	5-94
Storing a Flat or Spare Tire and Tools	5-84	Vehicle Identification	5-95
Compact Spare Tire	5-86	Vehicle Identification Number (VIN)	5-95
Appearance Care	5-87	Service Parts Identification Label	5-95
Fabric/Carpet	5-87	Electrical System	5-95
Vinyl	5-89	Add-On Electrical Equipment	5-95
Leather	5-89	Headlamp Wiring	5-96
Instrument Panel	5-89	Windshield Wiper Fuses	5-96
Interior Plastic Components	5-89	Power Windows and Other Power Options	5-96
Glass Surfaces	5-89	Fuses and Circuit Breakers	5-96
Care of Safety Belts	5-90	Instrument Panel Fuse Block	5-97
Weatherstrips	5-90	Engine Compartment Fuse Block	5-98
Washing Your Vehicle	5-90	Capacities and Specifications	5-100
Cleaning Exterior Lamps/Lenses	5-90	Normal Maintenance Replacement Parts	5-102
Finish Care	5-91		

Service

Your dealer knows your vehicle best and wants you to be happy with it. We hope you will go to your dealer for all your service needs. You will get genuine GM parts and GM-trained and supported service people.

We hope you will want to keep your GM vehicle all GM. Genuine GM parts have one of these marks:

ACDelco[®]

GM[®] **Parts**

GM[®]
Goodwrench

GM[®] **Accessories**

California Proposition 65 Warning

Most motor vehicles, including this one, contain and/or emit chemicals known to the State of California to cause cancer and birth defects or other reproductive harm. Engine exhaust, many parts and systems (including some inside the vehicle), many fluids, and some component wear by-products contain and/or emit these chemicals.

Doing Your Own Service Work

If you want to do some of your own service work, you will want to use the proper service manual. It tells you much more about how to service your vehicle than this manual can. To order the proper service manual, see *Service Publications Ordering Information* on page 7-11.

Your vehicle may have an airbag system. If it does, see *Servicing Your Airbag-Equipped Vehicle* on page 1-60 before attempting to do your own service work.

You should keep a record with all parts receipts and list the mileage and the date of any service work you perform. See *Part E: Maintenance Record* on page 6-21.

CAUTION:

You can be injured and your vehicle could be damaged if you try to do service work on a vehicle without knowing enough about it.

- **Be sure you have sufficient knowledge, experience, the proper replacement parts and tools before you attempt any vehicle maintenance task.**
- **Be sure to use the proper nuts, bolts and other fasteners. English and metric fasteners can be easily confused. If you use the wrong fasteners, parts can later break or fall off. You could be hurt.**

Adding Equipment to the Outside of Your Vehicle

Things you might add to the outside of your vehicle can affect the airflow around it. This may cause wind noise and affect windshield washer performance. Check with your dealer before adding equipment to the outside of your vehicle.

Fuel

The 8th digit of your vehicle identification number (VIN) shows the code letter or number that identifies your engine. You will find the VIN at the top left of the instrument panel. See *Vehicle Identification Number (VIN)* on page 5-95.

Gasoline Octane

If your vehicle has the 1.8L L4 (VIN Code 8) engine, use regular unleaded gasoline with a posted octane of 87 or higher. If the octane is less than 87, you may get a heavy knocking noise when you drive. If this occurs, use a gasoline rated at 87 octane or higher as soon as possible. Otherwise, you might damage your engine. A little pinging noise when you accelerate or drive uphill is considered normal. This does not indicate a problem exists or that a higher-octane fuel is necessary. If you are using 87 octane or higher-octane fuel and you hear heavy knocking, your engine needs service.

If your vehicle has the 1.8L L4 (VIN Code L) engine, use only premium unleaded gasoline with a posted octane of 91 or higher. In an emergency, you may be able to use a lower octane — as low as 87 — if heavy knocking does not occur. Refill your tank with premium fuel as soon as possible. Otherwise, you might damage your engine. If you are using 91 octane or higher-octane fuel and you hear heavy knocking, your engine needs service.

Gasoline Specifications

It is recommended that gasoline meet specifications which were developed by automobile manufacturers around the world and contained in the World-Wide Fuel Charter which is available from the Alliance of Automobile Manufacturers at www.autoalliance.org/fuel_charter.htm. Gasoline meeting these specifications could provide improved driveability and emission control system performance compared to other gasoline.

California Fuel

If your vehicle is certified to meet California Emission Standards (see the underhood emission control label), it is designed to operate on fuels that meet California specifications. If this fuel is not available in states adopting California emissions standards, your vehicle will operate satisfactorily on fuels meeting federal specifications, but emission control system performance may be affected. The malfunction indicator lamp may turn on and your vehicle may fail a smog-check test. See *Malfunction Indicator Lamp on page 3-35*. If this occurs, return to your authorized GM dealer for diagnosis. If it is determined that the condition is caused by the type of fuel used, repairs may not be covered by your warranty.

Additives

To provide cleaner air, all gasolines in the United States are now required to contain additives that will help prevent engine and fuel system deposits from forming, allowing your emission control system to work properly. You should not have to add anything to your fuel. However, some gasolines contain only the minimum amount of additive required to meet U.S. Environmental Protection Agency regulations. General Motors recommends that you buy gasolines that are advertised to help keep fuel injectors and intake valves clean. If your vehicle experiences problems due to dirty injectors or valves, try a different brand of gasoline.

Gasolines containing oxygenates, such as ethers and ethanol, and reformulated gasolines may be available in your area to contribute to clean air. General Motors recommends that you use these gasolines, particularly if they comply with the specifications described earlier.

Notice: Your vehicle was not designed for fuel that contains methanol. Do not use fuel containing methanol. It can corrode metal parts in your fuel system and also damage the plastic and rubber parts. That damage would not be covered under your warranty.

Some gasolines that are not reformulated for low emissions may contain an octane-enhancing additive called methylcyclopentadienyl manganese tricarbonyl (MMT); ask the attendant where you buy gasoline whether the fuel contains MMT. General Motors does not recommend the use of such gasolines. Fuels containing MMT can reduce the life of spark plugs and the performance of the emission control system may be affected. The malfunction indicator lamp may turn on. If this occurs, return to your authorized GM dealer for service.

Fuels in Foreign Countries

If you plan on driving in another country outside the United States or Canada, the proper fuel may be hard to find. Never use leaded gasoline or any other fuel not recommended in the previous text on fuel. Costly repairs caused by use of improper fuel would not be covered by your warranty.

To check the fuel availability, ask an auto club, or contact a major oil company that does business in the country where you will be driving.

Filling Your Tank

CAUTION:

Fuel vapor burns violently and a fuel fire can cause bad injuries. To help avoid injuries to you and others, read and follow all the instructions on the pump island. Turn off your engine when you are refueling. Do not smoke if you are near fuel or refueling your vehicle. Keep sparks, flames and smoking materials away from fuel. Do not leave the fuel pump unattended when refueling your vehicle — this is against the law in some places. Keep children away from the fuel pump; never let children pump fuel.



The tethered fuel cap is located behind a hinged fuel door on the driver's side of the vehicle.



The fuel door release lever is located near the floor under the driver's seat on the outboard side.

To remove the fuel cap, turn it slowly to the left (counterclockwise). On some vehicles you may have to push in while turning the cap.

While refueling, hang the fuel cap inside of the fuel door.

⚠ CAUTION:

If you spill fuel and then something ignites it, you could be badly burned. Fuel can spray out on you if you open the fuel cap too quickly. This spray can happen if your tank is nearly full, and is more likely in hot weather. Open the fuel cap slowly and wait for any hiss noise to stop. Then unscrew the cap all the way.

Be careful not to spill fuel. Do not top off or overfill the tank, and wait a few seconds after you have finished pumping before removing the nozzle. Clean fuel from painted surfaces as soon as possible. See *Washing Your Vehicle* on page 5-90.

When replacing the fuel cap, turn it to the right (clockwise) until it clicks. Make sure the cap is fully installed. The diagnostic system can determine if the fuel cap has been left off or improperly installed. This would allow fuel to evaporate into the atmosphere. See *Malfunction Indicator Lamp on page 3-35*.

 **CAUTION:**

If a fire starts while you are refueling, do not remove the nozzle. Shut off the flow of fuel by shutting off the pump or by notifying the station attendant. Leave the area immediately.

Notice: If you need a new fuel cap, be sure to get the right type. Your dealer can get one for you. If you get the wrong type, it may not fit properly. This may cause your malfunction indicator lamp to light and may damage your fuel tank and emissions system. See *Malfunction Indicator Lamp on page 3-35*.

Filling a Portable Fuel Container

 **CAUTION:**

Never fill a portable fuel container while it is in your vehicle. Static electricity discharge from the container can ignite the gasoline vapor. You can be badly burned and your vehicle damaged if this occurs. To help avoid injury to you and others:

- Dispense gasoline only into approved containers.
- Do not fill a container while it is inside a vehicle, in a vehicle's trunk, pickup bed or on any surface other than the ground.
- Bring the fill nozzle in contact with the inside of the fill opening before operating the nozzle. Contact should be maintained until the filling is complete.
- Do not smoke while pumping gasoline.

Checking Things Under the Hood

CAUTION:

An electric fan under the hood can start up and injure you even when the engine is not running. Keep hands, clothing and tools away from any underhood electric fan.

CAUTION:

Things that burn can get on hot engine parts and start a fire. These include liquids like fuel, oil, coolant, brake fluid, windshield washer and other fluids, and plastic or rubber. You or others could be burned. Be careful not to drop or spill things that will burn onto a hot engine.

Hood Release

To open the hood, do the following:



1. Pull the release handle inside the vehicle. It is located below the instrument panel to the left of the steering wheel.



2. Then go to the front of the vehicle and pull up on the secondary hood release. The lever is located near the middle of the hood.
3. Lift the hood.



4. Release the hood prop rod from its retainer and put it into the slot in the hood. To insert the hood prop rod into the slot, move it straight up. If it is moved to the side or toward the inside of the vehicle, it may become detached.

Before closing the hood, be sure all the filler caps are on properly. Make sure to return the hood prop rod carefully back to its retainer to avoid damaging the vehicle.

Engine Compartment Overview

When you open the hood of the 1.8L L4 (VIN Code 8) engine, you will see the following:

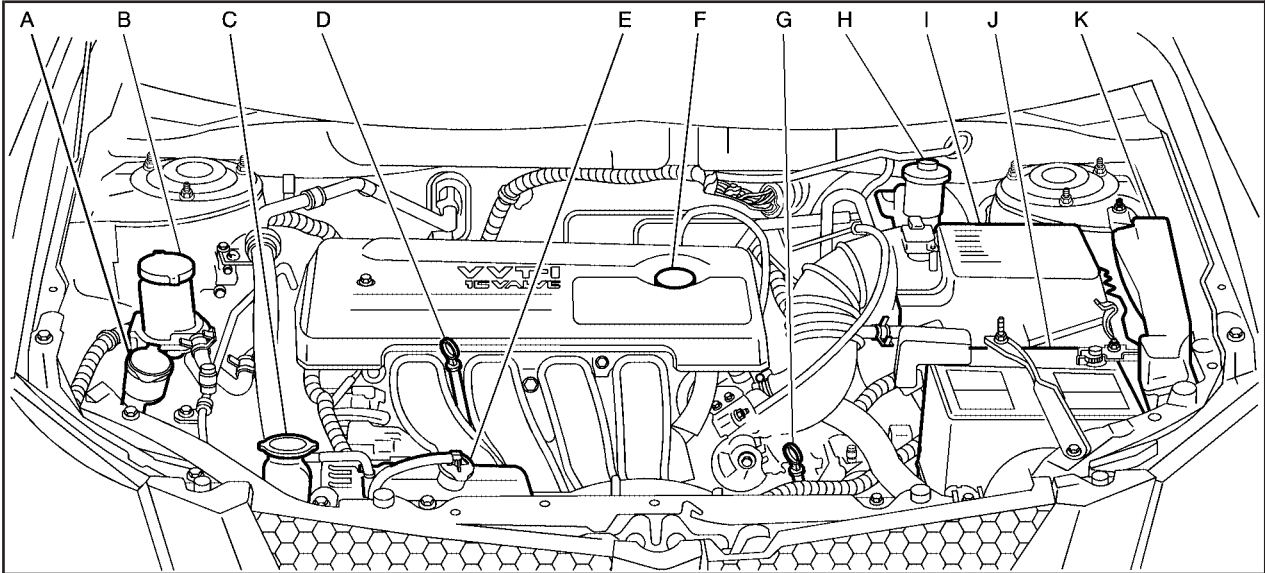

- A. Windshield Washer Fluid Reservoir. See “Adding Washer Fluid” under *Windshield Washer Fluid* on page 5-38.
- B. Power Steering Fluid Reservoir. See *Power Steering Fluid* on page 5-37.
- C. Radiator Pressure Cap. See *Radiator Pressure Cap* on page 5-30.
- D. Engine Oil Dipstick. See “Checking Engine Oil” under *Engine Oil* on page 5-16.
- E. Coolant Recovery Tank. See *Cooling System* on page 5-32.
- F. Engine Oil Fill Cap. See “When to Add Engine Oil” under *Engine Oil* on page 5-16.
- G. Automatic Transaxle Fluid Dipstick (If Equipped). See “Checking the Fluid Level” under *Automatic Transaxle Fluid* on page 5-23.
- H. Brake Master Cylinder Reservoir and Hydraulic Clutch (If Equipped). See “Brake Fluid” under *Brakes* on page 5-39 and *Hydraulic Clutch* on page 5-27.
- I. Engine Air Cleaner/Filter. See *Engine Air Cleaner/Filter* on page 5-21.
- J. Battery. See *Battery* on page 5-42.
- K. Engine Compartment Fuse Block. See *Engine Compartment Fuse Block* on page 5-98.

When you open the hood of the 1.8L L4 (VIN Code L) engine, you will see the following:

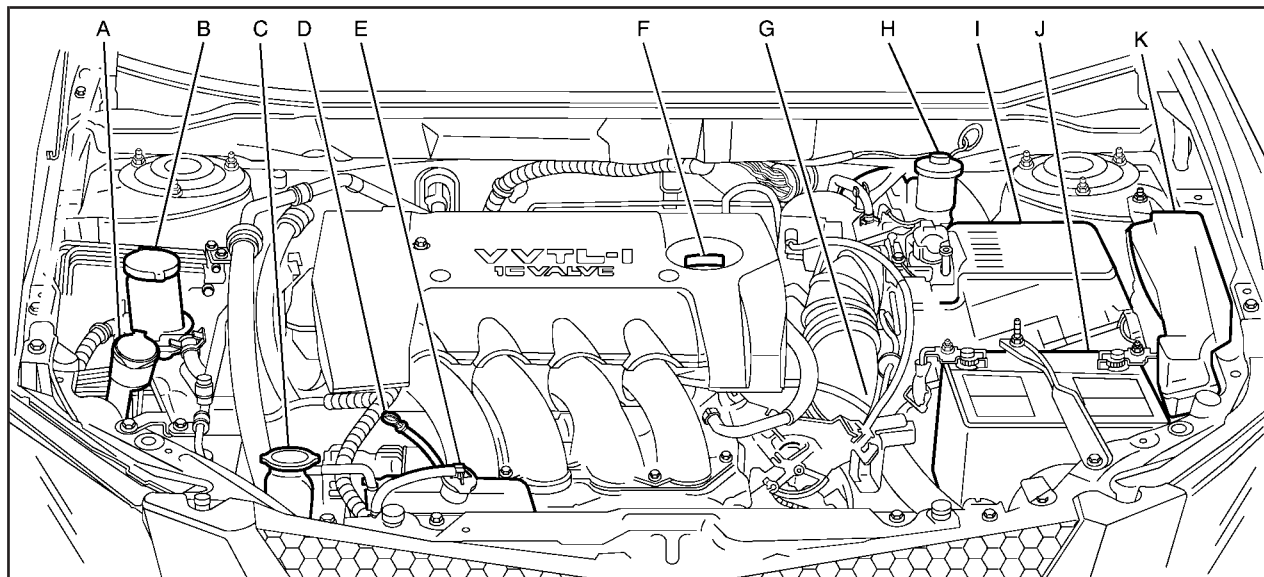

- A. Windshield Washer Fluid Reservoir. See “Adding Washer Fluid” under *Windshield Washer Fluid* on page 5-38.
- B. Power Steering Fluid Reservoir. See *Power Steering Fluid* on page 5-37.
- C. Radiator Pressure Cap. See *Radiator Pressure Cap* on page 5-30.
- D. Engine Oil Dipstick. See “Checking Engine Oil” under *Engine Oil* on page 5-16.
- E. Coolant Recovery Tank. See *Cooling System* on page 5-32.
- F. Engine Oil Fill Cap. See “When to Add Engine Oil” under *Engine Oil* on page 5-16.
- G. Automatic Transaxle Fluid Dipstick (If Equipped). See “Checking the Fluid Level” under *Automatic Transaxle Fluid* on page 5-23.
- H. Brake Master Cylinder Reservoir and Hydraulic Clutch (If Equipped). See “Brake Fluid” under *Brakes* on page 5-39 and *Hydraulic Clutch* on page 5-27.
- I. Engine Air Cleaner/Filter. See *Engine Air Cleaner/Filter* on page 5-21.
- J. Battery. See *Battery* on page 5-42.
- K. Engine Compartment Fuse Block. See *Engine Compartment Fuse Block* on page 5-98.

Engine Oil

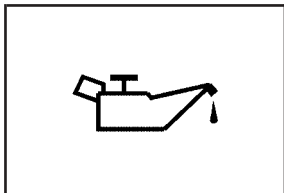

If the engine oil pressure light appears on the instrument cluster, it means you need to check your engine oil level right away.

For more information, see *Oil Pressure Light* on page 3-38.

You should check your engine oil level regularly; this is an added reminder.

Checking Engine Oil

It is a good idea to check your engine oil every time you get fuel. In order to get an accurate reading, the oil must be warm and the vehicle must be on level ground.

The engine oil dipstick handle is a yellow loop. See *Engine Compartment Overview* on page 5-12 for the location of the engine oil dipstick.

1. Turn off the engine and give the oil several minutes to drain back into the oil pan. If you do not do this, the oil dipstick might not show the actual level.
2. Pull out the dipstick and clean it with a paper towel or cloth, then push it back in all the way. Remove it again, keeping the tip down, and check the level.

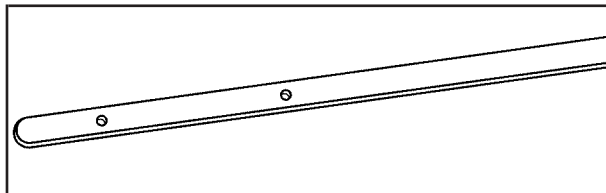

1.8L L4 (VIN Code 8) Engine

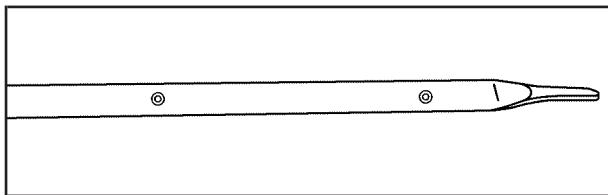

1.8L L4 (VIN Code L) Engine

When to Add Engine Oil

If the oil is at or below the hole at the tip of the dipstick, then you will need to add at least one quart of oil. But you must use the right kind. This section explains what kind of oil to use. For engine oil crankcase capacity, see *Capacities and Specifications on page 5-100*.

Notice: Do not add too much oil. If your engine has so much oil that the oil level gets above the upper hole, your engine could be damaged.

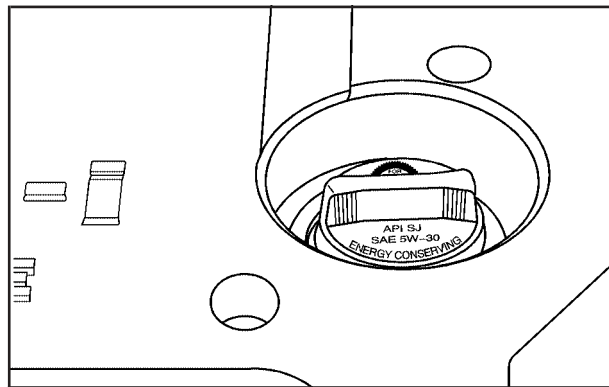

See *Engine Compartment Overview on page 5-12* for the location of the engine oil fill cap.

Be sure to add enough oil to put the level somewhere in the proper operating range. Push the dipstick all the way back in when you are through.

What Kind of Engine Oil to Use

Look for two things:

- GM6094M

Your vehicle's engine requires oil meeting GM Standard GM6094M. You should look for and use only an oil that meets GM Standard GM6094M.

RECOMMENDED SAE VISCOSITY GRADE ENGINE OILS

HOT WEATHER

COLD WEATHER

LOOK FOR THIS SYMBOL AND GM STANDARD GM 6094M

AMERICAN PETROLEUM INSTITUTE FOR GASOLINE ENGINES CERTIFIED

SAE 5W-30 RECOMMENDED

SAE 10W-30 ACCEPTABLE IF 5W-30 IS NOT AVAILABLE

DO NOT USE SAE 10W-40, SAE 20W-50 OR ANY OTHER VISCOSITY GRADE OIL NOT RECOMMENDED

- SAE 5W-30

As shown in the viscosity chart, SAE 5W-30 is best for your vehicle. However, if it is going to be 0°F (-18°C) or above and SAE 5W-30 is not available, you may use SAE 10W-30.

These numbers on an oil container show its viscosity, or thickness. Do not use other viscosity oils such as SAE 20W-50.



Oils meeting these requirements should also have the starburst symbol on the container. This symbol indicates that the oil has been certified by the American Petroleum Institute (API).

You should look for this information on the oil container, and use *only* those oils that are identified as meeting GM Standard GM6094M and have the starburst symbol on the front of the oil container.

Notice: Use only engine oil identified as meeting GM Standard GM6094M and showing the American Petroleum Institute Certified For Gasoline Engines starburst symbol. Failure to use the recommended oil can result in engine damage not covered by your warranty.

GM Goodwrench[®] oil meets all the requirements for your vehicle.

If you are in an area of extreme cold, where the temperature falls below -20°F (-29°C), it is recommended that you use either an SAE 5W-30 synthetic oil or an SAE 0W-30 oil. Both will provide easier cold starting and better protection for your engine at extremely low temperatures.

Engine Oil Additives

Do not add anything to your oil. The recommended oils with the starburst symbol that meet GM Standard GM6094M are all you will need for good performance and engine protection.

When to Change Engine Oil

If any one of these is true for you, use the short trip/city maintenance schedule:

- Most trips are less than 5 miles (8 km). This is particularly important when outside temperatures are below freezing.
- Most trips include extensive idling, such as frequent driving in stop-and-go traffic.
- You frequently tow a trailer or use a carrier on top of your vehicle.
- The vehicle is used for delivery service, police, taxi, or other commercial application.

Driving under these conditions causes engine oil to break down sooner. If any one of these is true for your vehicle, then you need to change your oil and filter every 3,000 miles (5 000 km) or 3 months — whichever occurs first.

If none of them are true, use the long trip/highway maintenance schedule. Change the oil and filter every 7,500 miles (12 500 km) or 12 months — whichever occurs first. Driving a vehicle with a fully warmed engine under highway conditions will cause engine oil to break down slower.

What to Do with Used Oil

Used engine oil contains certain elements that may be unhealthy for your skin and could even cause cancer. Do not let used oil stay on your skin for very long. Clean your skin and nails with soap and water, or a good hand cleaner. Wash or properly dispose of clothing or rags containing used engine oil. See the manufacturer's warnings about the use and disposal of oil products.

Used oil can be a threat to the environment. If you change your own oil, be sure to drain all the oil from the filter before disposal. Never dispose of oil by putting it in the trash, pouring it on the ground, into sewers, or into streams or bodies of water. Instead, recycle it by taking it to a place that collects used oil. If you have a problem properly disposing of your used oil, ask your dealer, a service station or a local recycling center for help.

Engine Air Cleaner/Filter



The engine air cleaner/filter is in the engine compartment on the driver's side of the vehicle. See *Engine Compartment Overview* on page 5-12 for more information on location.

When to Inspect the Engine Air Cleaner/Filter

If you are driving in dusty/dirty conditions, inspect the air cleaner/filter at each engine oil change. Replace the filter every 30,000 miles (48 000 km) or 24 months, whichever occurs first. See *Part A: Scheduled Maintenance Services* on page 6-4 for more information.

How to Inspect the Engine Air Cleaner/Filter

To inspect the air cleaner/filter remove the filter from the vehicle and lightly shake the filter to release loose dust and dirt. If the filter remains caked with dirt, a new filter is required.

To inspect or replace the engine air cleaner/filter, do the following:



1. Release the two clips that hold the cover down.
2. Lift the cover off.
3. Inspect or replace the engine air cleaner/filter.
4. Reinstall the cover.

⚠ CAUTION:

Operating the engine with the air cleaner/filter off can cause you or others to be burned. The air cleaner not only cleans the air; it helps to stop flame if the engine backfires. If it is not there and the engine backfires, you could be burned. Do not drive with it off, and be careful working on the engine with the air cleaner/filter off.

Notice: If the air cleaner/filter is off, a backfire can cause a damaging engine fire. And, dirt can easily get into your engine, which will damage it. Always have the air cleaner/filter in place when you are driving.

Automatic Transaxle Fluid

When to Check and Change

A good time to check your automatic transaxle fluid level is when the engine oil is changed.

Check the fluid in the transaxle and differential every 30,000 miles (48 000 km). Change the fluid every 60,000 miles (100 000 km) if the vehicle is mainly driven under one or more of these conditions:

- In heavy city traffic where the outside temperature regularly reaches 90°F (32°C) or higher.
- In hilly or mountainous terrain.
- When doing frequent trailer towing.
- Uses such as found in taxi, police or delivery service.

See *Part A: Scheduled Maintenance Services on page 6-4*.

How to Check

Because this operation can be a little difficult, you may choose to have this done at the dealership service department.

If you do it yourself, be sure to follow all the instructions here, or you could get a false reading on the dipstick.

Notice: Too much or too little fluid can damage the transaxle. Too much can mean that some of the fluid could come out and fall on hot engine or exhaust system parts, starting a fire. Too little fluid could cause the transaxle to overheat. Be sure to get an accurate reading if you check the transaxle fluid.

Wait at least 30 minutes before checking the transaxle fluid level if you have been driving:

- When outside temperatures are above 90°F (32°C).
- At high speed for quite a while.
- In heavy traffic — especially in hot weather.
- While pulling a trailer.

To get the right reading, the fluid should be at normal operating temperature, which is 158°F to 176°F (70°C to 80°C).

Get the vehicle warmed up by driving about 15 miles (24 km) when outside temperatures are above 50°F (10°C). If it is colder than 50°F (10°C), you may have to drive longer.

Checking the Fluid Level

Prepare your vehicle as follows:

- Park your vehicle on a level place. Keep the engine running.
- With the parking brake applied, place the shift lever in PARK (P).
- With your foot on the brake pedal, move the shift lever through each gear range, pausing for about three seconds in each range. Then, position the shift lever in PARK (P).
- Let the engine run at idle for three to five minutes.

Then, without shutting off the engine, follow these steps:



The automatic transaxle dipstick has an orange handle and is located near the front of the engine compartment. See *Engine Compartment Overview* on page 5-12 for more information on location.

1. Release the tab and pull out the dipstick and wipe it with a clean rag or paper towel.
2. Push it back in all the way, wait three seconds and then pull it back out again.



3. Check both sides of the dipstick, and read the lower level. The fluid level must be between the two dimples in the hot range.
4. If the fluid level is in the acceptable range, push the dipstick back in all the way; then press the tab down to lock the dipstick in place.

How to Add Fluid

Refer to the Maintenance Schedule to determine what kind of transaxle fluid to use. See *Part D: Recommended Fluids and Lubricants* on page 6-19.

If the fluid level is low, add only enough of the proper fluid to bring the level into the area between dimples on the dipstick.

1. Pull out the dipstick.
2. Using a long-neck funnel, add enough fluid at the dipstick hole to bring it to the proper level.

It does not take much fluid, generally less than one pint (0.5 L). *Do not overfill.*

Notice: Use of automatic transaxle fluid labeled other than T-IV Automatic Transaxle Fluid may damage your vehicle, and the damages may not be covered by your warranty. Always use T-IV labeled automatic transaxle fluid in your vehicle. See *Part D: Recommended Fluids and Lubricants* on page 6-19 for more information.

3. After adding fluid, recheck the fluid level as described under “How to Check,” earlier in this section.
4. When the correct fluid level is obtained, push the dipstick back in all the way; then press the tab down to lock the dipstick in place.

Manual Transaxle Fluid

When to Check

A good time to have your manual transaxle fluid level checked is when the engine oil is changed. However, the fluid in your manual transaxle does not require changing.

How to Check

Because this operation can be difficult, you may choose to have this done at your Pontiac dealership service department.

If you do it yourself, be sure to follow all the instructions here, or you could get a false reading.

Notice: Too much or too little fluid can damage the transaxle. Too much can mean that some of the fluid could come out and fall on hot engine or exhaust system parts, starting a fire. Too little fluid could cause the transaxle to overheat. Be sure to get an accurate reading if you check the transaxle fluid.

Check the fluid level only when your engine is off, the vehicle is parked on a level place and the transaxle is cool enough for you to rest your fingers on the transaxle case.

Then, follow these steps:

1. Remove the filler plug.
2. Check that the lubricant level is up to the bottom of the filler plug hole.
3. If the fluid level is good, install the plug and be sure it is fully seated. If the fluid level is low, add more fluid as described in the next steps.

How to Add Fluid

Here is how to add fluid. Refer to the Maintenance Schedule to determine what kind of fluid to use. See *Part D: Recommended Fluids and Lubricants on page 6-19*.

1. Remove the filler plug.
2. Add fluid at the filler plug hole. Add only enough fluid to bring the fluid level up to the bottom of the filler plug hole.
3. Install the filler plug. Be sure the plug is fully seated.

Hydraulic Clutch

The hydraulic clutch linkage in your vehicle is self-adjusting. The master cylinder reservoir is filled with DOT-3 brake fluid.

It is not necessary to regularly check the fluid unless you suspect there is a leak in the system. Adding fluid will not correct a leak.

The hydraulic clutch and brake master cylinder use the same reservoir.

A fluid loss in this system could indicate a problem. Have the system inspected and repaired.

When to Check and What to Use

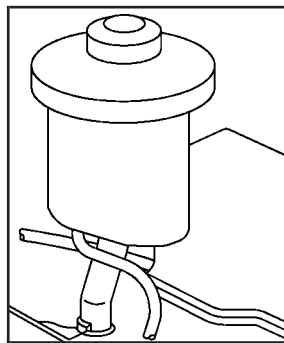

The reservoir is located at the back of the engine compartment, on the driver's side of the vehicle. See *Engine Compartment Overview* on page 5-12 for more information on location.

Refer to the Maintenance Schedule to determine how often you should check the fluid level in your master cylinder reservoir and for the proper fluid. See *Part B: Owner Checks and Services* on page 6-13 and *Part D: Recommended Fluids and Lubricants* on page 6-19.

How to Check and Add Fluid

Check to make sure that the fluid level is at or above the MIN mark. If the level is below the MIN mark, see the instructions on the reservoir cap.

Engine Coolant

Your vehicle was factory-filled with a coolant developed to last for 100,000 miles (160 000 km) or 5 years, whichever comes first. When coolant is added or changed, use DEX-COOL[®] coolant.

The following explains your cooling system and how to add coolant when it is low. If you have a problem with engine overheating, see *Engine Overheating* on page 5-30.

A 50/50 mixture of clean, drinkable water and DEX-COOL[®] coolant will:

- Give freezing protection down to -34°F (-37°C).
- Give boiling protection up to 265°F (129°C).
- Protect against rust and corrosion.
- Help keep the proper engine temperature.
- Let the warning lights and gages work as they should.

Notice: Using coolant other than DEX-COOL[®] may cause premature engine, heater core or radiator corrosion. In addition, the engine coolant may require changing sooner, at 30,000 miles (50 000 km) or 24 months, whichever occurs first. Any repairs would not be covered by your warranty. Always use DEX-COOL[®] (silicate-free) coolant in your vehicle.

What to Use

Use a mixture of one-half *clean, drinkable water* and one-half DEX-COOL[®] coolant which will not damage aluminum parts. If you use this coolant mixture, you do not need to add anything else.

CAUTION:

Adding only plain water to your cooling system can be dangerous. Plain water, or some other liquid such as alcohol, can boil before the proper coolant mixture will. Your vehicle's coolant warning system is set for the proper coolant mixture. With plain water or the wrong mixture, your engine could get too hot but you would not get the overheat warning. Your engine could catch fire and you or others could be burned. Use a 50/50 mixture of clean, drinkable water and DEX-COOL[®] coolant.

Notice: If you use an improper coolant mixture, your engine could overheat and be badly damaged. The repair cost would not be covered by your warranty. Too much water in the mixture can freeze and crack the engine, radiator, heater core and other parts.

If you have to add coolant more than four times a year, have your dealer check your cooling system.

Notice: If you use the proper coolant, you do not have to add extra inhibitors or additives which claim to improve the system. These can be harmful.

Checking Coolant

The vehicle must be on a level surface. When your engine is cold, the coolant level should be at LOW, or a little higher. When your engine is warm, the level should be up to FULL, or a little higher.

See *Engine Compartment Overview on page 5-12* for the location of the coolant recovery tank.

Adding Coolant

If you need more coolant, add the proper DEX-COOL[®] coolant mixture *at the coolant recovery tank*, but be careful not to spill it.

CAUTION:

Turning the radiator pressure cap when the engine and radiator are hot can allow steam and scalding liquids to blow out and burn you badly. With the coolant recovery tank, you will almost never have to add coolant at the radiator. Never turn the radiator pressure cap — even a little — when the engine and radiator are hot.

CAUTION:

You can be burned if you spill coolant on hot engine parts. Coolant contains ethylene glycol, and it will burn if the engine parts are hot enough. Do not spill coolant on a hot engine.

Occasionally check the coolant level in the radiator. For information on how to add coolant to the radiator, see *Cooling System on page 5-32*.

Radiator Pressure Cap

Notice: If the pressure cap is not tightly installed, coolant loss and possible engine damage may occur. Be sure the cap is properly and tightly secured.

See *Engine Compartment Overview* on page 5-12 for more information on location.

Engine Overheating

You will find a coolant temperature gage on your vehicle's instrument panel. See *Engine Coolant Temperature Gage* on page 3-35.

If Steam Is Coming From Your Engine

CAUTION:

Steam from an overheated engine can burn you badly, even if you just open the hood. Stay away from the engine if you see or hear steam coming from it. Just turn it off and get everyone away from the vehicle until it cools down. Wait until there is no sign of steam or coolant before you open the hood.

If you keep driving when your engine is overheated, the liquids in it can catch fire. You or others could be badly burned. Stop your engine if it overheats, and get out of the vehicle until the engine is cool.

Notice: If your engine catches fire because you keep driving with no coolant, your vehicle can be badly damaged. The costly repairs would not be covered by your warranty.

If No Steam Is Coming From Your Engine

If you get an engine overheat warning but see or hear no steam, the problem may not be too serious. Sometimes the engine can get a little too hot when you:

- Climb a long hill on a hot day.
- Stop after high-speed driving.
- Idle for long periods in traffic.
- Tow a trailer.

If you get the overheat warning with no sign of steam, try this for a minute or so:

1. In heavy traffic, let the engine idle in NEUTRAL (N) while stopped. If it is safe to do so, pull off the road, shift to PARK (P) or NEUTRAL (N) and let the engine idle.
2. Turn on your heater to full hot at the highest fan speed and open the windows as necessary.

If you no longer have the overheat warning, you can drive. Just to be safe, drive slower for about 10 minutes. If the warning does not come back on, you can drive normally.

If the warning continues and you have not stopped, pull over, stop, and park your vehicle right away.

If there is still no sign of steam, you can idle the engine for three minutes while you are parked. If you still have the warning, *turn off the engine and get everyone out of the vehicle* until it cools down.

You may decide not to lift the hood but to get service help right away.

Cooling System

When you decide it is safe to lift the hood, here is what you will see:

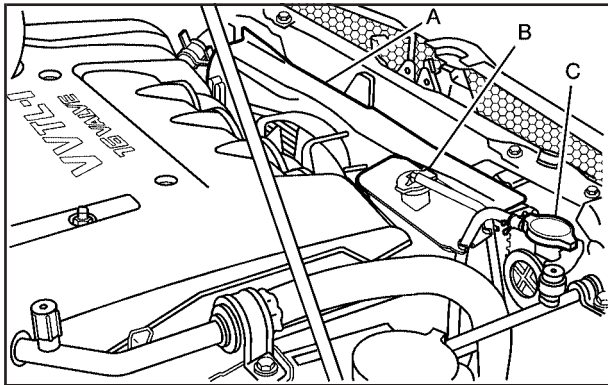

- A. Electric Engine Cooling Fan
- B. Engine Coolant Recovery Tank
- C. Radiator Pressure Cap

CAUTION:

An electric engine cooling fan under the hood can start up even when the engine is not running and can injure you. Keep hands, clothing and tools away from any underhood electric fan.

If the coolant inside the coolant recovery tank is boiling, do not do anything else until it cools down. The vehicle should be parked on a level surface.

The coolant level should be at or above the FULL mark. If it is not, you may have a leak at the pressure cap or in the radiator hoses, heater hoses, radiator, water pump or somewhere else in the cooling system.

 **CAUTION:**

Heater and radiator hoses, and other engine parts, can be very hot. Do not touch them. If you do, you can be burned.

Do not run the engine if there is a leak. If you run the engine, it could lose all coolant. That could cause an engine fire, and you could be burned. Get any leak fixed before you drive the vehicle.

If there seems to be no leak, with the engine on, check to see if the electric engine cooling fan is running. If the engine is overheating, the fan should be running. If it is not, your vehicle needs service.

Notice: Engine damage from running your engine without coolant is not covered by your warranty.

How to Add Coolant to the Coolant Recovery Tank

If you have not found a problem yet, but the coolant level is not at or above the FULL mark, add a 50/50 mixture of *clean, drinkable water* and DEX-COOL[®] coolant at the coolant recovery tank. See *Engine Coolant on page 5-28* for more information about the proper coolant mixture.

 **CAUTION:**

Adding only plain water to your cooling system can be dangerous. Plain water, or some other liquid such as alcohol, can boil before the proper coolant mixture will. Your vehicle's coolant warning system is set for the proper coolant mixture. With plain water or the wrong mixture, your engine could get too hot but you would not get the overheat warning. Your engine could catch fire and you or others could be burned. Use a 50/50 mixture of clean, drinkable water and a proper coolant.

Notice: In cold weather, water can freeze and crack the engine, radiator, heater core and other parts. Use the recommended coolant and the proper coolant mixture.

 **CAUTION:**

You can be burned if you spill coolant on hot engine parts. Coolant contains ethylene glycol and it will burn if the engine parts are hot enough. Do not spill coolant on a hot engine.

When the coolant in the coolant recovery tank is at the FULL mark, start your vehicle.

If the overheat warning continues, there is one more thing you can try. You can add the proper coolant mixture directly to the radiator but be sure the cooling system is cool before you do it.

 **CAUTION:**

Steam and scalding liquids from a hot cooling system can blow out and burn you badly. They are under pressure, and if you turn the radiator pressure cap — even a little — they can come out at high speed. Never turn the cap when the cooling system, including the radiator pressure cap, is hot. Wait for the cooling system and radiator pressure cap to cool if you ever have to turn the pressure cap.

How to Add Coolant to the Radiator

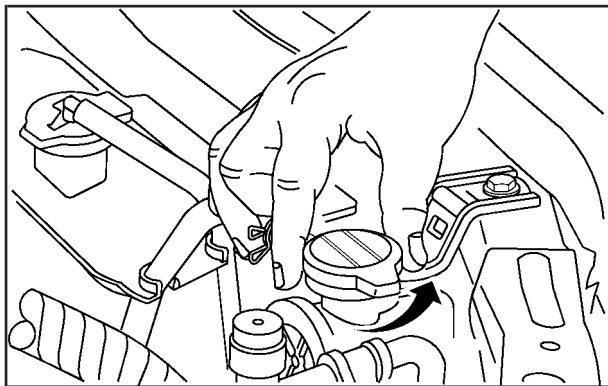

1. You can remove the radiator pressure cap when the cooling system, including the radiator pressure cap and upper radiator hose, is no longer hot. Turn the pressure cap slowly counterclockwise until it first stops. Do not press down while turning the pressure cap.

If you hear a hiss, wait for that to stop. A hiss means there is still some pressure left.

2. Then keep turning the pressure cap, but now push down as you turn it. Remove the pressure cap.

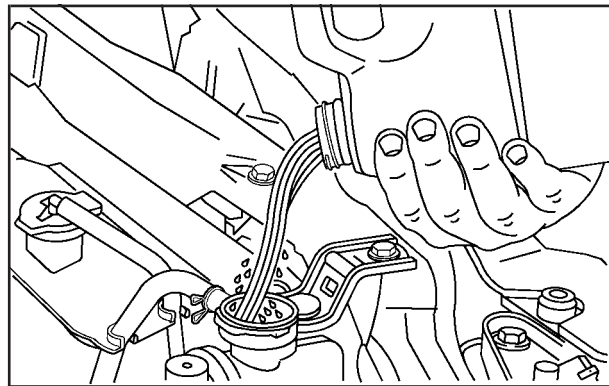

3. Fill the radiator with the proper coolant mixture, up to the base of the filler neck. See *Engine Coolant* on page 5-28 for more information about the proper coolant mixture.

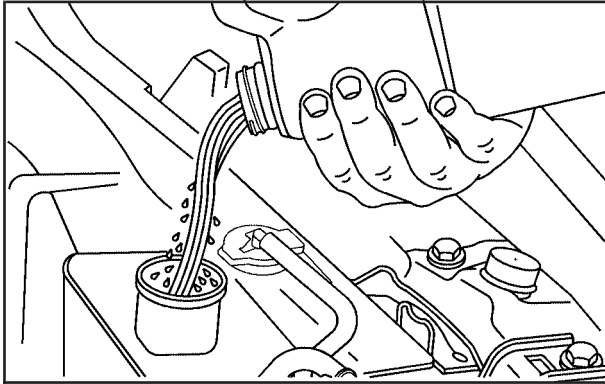

4. Then fill the coolant recovery tank to the FULL mark.
5. Put the cap back on the coolant recovery tank, but leave the radiator pressure cap off.

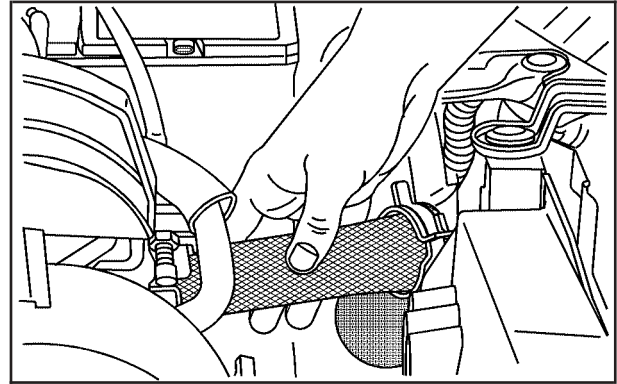

6. Start the engine and let it run until you can feel the upper radiator hose getting hot. Watch out for the engine cooling fan.
7. By this time, the coolant level inside the radiator filler neck may be lower. If the level is lower, add more of the proper coolant mixture through the filler neck until the level reaches the base of the filler neck.
8. Then replace the pressure cap. At any time during this procedure if coolant begins to flow out of the filler neck, reinstall the pressure cap. Be sure the ears on the pressure cap are in line with the vent tube.

Power Steering Fluid



The power steering fluid reservoir is located in the engine compartment on the passenger's side of the vehicle. See *Engine Compartment Overview* on page 5-12 for reservoir location.

When to Check Power Steering Fluid

It is not necessary to regularly check power steering fluid unless you suspect there is a leak in the system or you hear an unusual noise. A fluid loss in this system could indicate a problem. Have the system inspected and repaired.

How to Check Power Steering Fluid

You can check your fluid without taking the cap off. Just look at the reservoir.

- When the engine compartment is hot, the level should be between the HOT marks.
- When the engine compartment is cool, the level should be between the COLD marks.

What to Use

To determine what kind of fluid to use, see *Part D: Recommended Fluids and Lubricants* on page 6-19.

Notice: When adding power steering fluid or making a complete fluid change, always use the proper fluid. Failure to use the proper fluid can cause leaks and damage hoses and seals.

Windshield Washer Fluid

What to Use

When you need windshield washer fluid, be sure to read the manufacturer's instructions before use. If you will be operating your vehicle in an area where the temperature may fall below freezing, use a fluid that has sufficient protection against freezing.

Adding Washer Fluid

If your vehicle has the low windshield washer fluid level warning light, it will come on when the fluid level is too low. See *Low Washer Fluid Warning Light* on page 3-40.

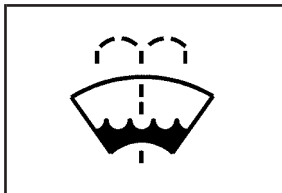

Open the cap with the washer symbol on it. Add washer fluid until the tank is full. See *Engine Compartment Overview* on page 5-12 for reservoir location.

Notice:

- When using concentrated washer fluid, follow the manufacturer's instructions for adding water.
- Do not mix water with ready-to-use washer fluid. Water can cause the solution to freeze and damage your washer fluid tank and other parts of the washer system. Also, water does not clean as well as washer fluid.
- Fill your washer fluid tank only three-quarters full when it is very cold. This allows for expansion if freezing occurs, which could damage the tank if it is completely full.
- Do not use engine coolant (antifreeze) in your windshield washer. It can damage your washer system and paint.

Brakes

Brake Fluid

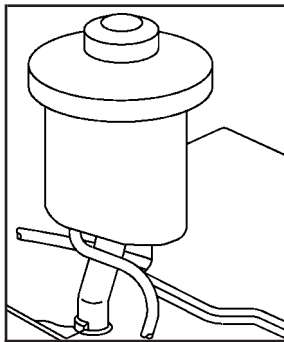

The hydraulic clutch and brake master cylinder use the same reservoir. It is filled with DOT-3 brake fluid. See *Engine Compartment Overview* on page 5-12 for the location of the reservoir.

There are only two reasons why the brake fluid level in the reservoir might go down. The first is that the brake fluid goes down to an acceptable level during normal brake lining wear. When new linings are put in, the fluid level goes back up. The other reason is that fluid is leaking out of the brake system or the hydraulic clutch system. If it is, you should have that system fixed, since a leak means that sooner or later your brakes will not work well, or will not work at all.

So, it is not a good idea to top off your brake fluid. Adding brake fluid will not correct a leak. If you add fluid when your linings are worn, then you will have too much fluid when you get new brake linings. You should add or remove brake fluid, as necessary, only when work is done on the brake hydraulic system.

CAUTION:

If you have too much brake fluid, it can spill on the engine. The fluid will burn if the engine is hot enough. You or others could be burned, and your vehicle could be damaged. Add brake fluid only when work is done on the brake hydraulic system.

When your brake fluid falls to a low level, your brake warning light will come on. See *Brake System Warning Light* on page 3-32.

What to Add

When you do need brake fluid, use only DOT-3 brake fluid. Use new brake fluid from a sealed container only. See *Part D: Recommended Fluids and Lubricants* on page 6-19.

Always clean the brake fluid reservoir cap and the area around the cap before removing it. This will help keep dirt from entering the reservoir.

CAUTION:

With the wrong kind of fluid in your brake system, your brakes may not work well, or they may not even work at all. This could cause a crash. Always use the proper brake fluid.

Notice:

- Using the wrong fluid can badly damage brake system parts. For example, just a few drops of mineral-based oil, such as engine oil, in your brake system can damage brake system parts so badly that they will have to be replaced. Do not let someone put in the wrong kind of fluid.
- If you spill brake fluid on your vehicle's painted surfaces, the paint finish can be damaged. Be careful not to spill brake fluid on your vehicle. If you do, wash it off immediately. See *Appearance Care* on page 5-87.

Brake Wear

The GT series has four-wheel disc brakes. All other models have front disc brakes and rear drum brakes.

Disc brake pads have built-in wear indicators that make a high-pitched warning sound when the brake pads are worn and new pads are needed. The sound may come and go or be heard all the time your vehicle is moving, except when you are pushing on the brake pedal firmly.

CAUTION:

The brake wear warning sound means that soon your brakes will not work well. That could lead to an accident. When you hear the brake wear warning sound, have your vehicle serviced.

Notice: Continuing to drive with worn-out brake pads could result in costly brake repair.

Some driving conditions or climates may cause a brake squeal when the brakes are first applied or lightly applied. This does not mean something is wrong with your brakes.

Properly torqued wheel nuts are necessary to help prevent brake pulsation. When tires are rotated, inspect brake pads for wear and evenly tighten wheel nuts in the proper sequence to GM torque specifications.

If you have rear drum brakes, they do not have wear indicators, but if you ever hear a rear brake rubbing noise, have the rear brake linings inspected immediately. Also, the rear brake drums should be removed and inspected each time the tires are removed for rotation or changing. When you have the front brake pads replaced, have the rear brakes inspected, too.

Brake linings should always be replaced as complete axle sets.

See *Brake System Inspection* on page 6-18.

Brake Pedal Travel

See your dealer if the brake pedal does not return to normal height, or if there is a rapid increase in pedal travel. This could be a sign of brake trouble.

Brake Adjustment

Every time you make a moderate brake stop, your disc brakes adjust for wear. If you rarely make a moderate or heavier stop, then your brakes might not adjust correctly. If you drive in that way, then — very carefully — make a few moderate brake stops about every 1,000 miles (1 600 km), so your brakes will adjust properly.

Replacing Brake System Parts

The braking system on a vehicle is complex. Its many parts have to be of top quality and work well together if the vehicle is to have really good braking. Your vehicle was designed and tested with top-quality GM brake parts. When you replace parts of your braking system — for example, when your brake linings wear down and you need new ones put in — be sure you get new approved

GM replacement parts. If you do not, your brakes may no longer work properly. For example, if someone puts in brake linings that are wrong for your vehicle, the balance between your front and rear brakes can change — for the worse. The braking performance you have come to expect can change in many other ways if someone puts in the wrong replacement brake parts.

Battery

Your vehicle has a maintenance free battery. When it is time for a new battery, get one that has the replacement number shown on the original battery's label. We recommend an ACDelco® replacement battery. See *Engine Compartment Overview on page 5-12* for battery location.

Warning: Battery posts, terminals and related accessories contain lead and lead compounds, chemicals known to the State of California to cause cancer and reproductive harm. Wash hands after handling.

Vehicle Storage

If you are not going to drive your vehicle for 25 days or more, remove the black, negative (-) cable from the battery. This will help keep your battery from running down.

CAUTION:

Batteries have acid that can burn you and gas that can explode. You can be badly hurt if you are not careful. See *Jump Starting on page 5-43* for tips on working around a battery without getting hurt.

Jump Starting

If your battery has run down, you may want to use another vehicle and some jumper cables to start your vehicle. Be sure to use the following steps to do it safely.

CAUTION:

Batteries can hurt you. They can be dangerous because:

- They contain acid that can burn you.
- They contain gas that can explode or ignite.
- They contain enough electricity to burn you.

If you do not follow these steps exactly, some or all of these things can hurt you.

Notice: Ignoring these steps could result in costly damage to your vehicle that would not be covered by your warranty.

Trying to start your vehicle by pushing or pulling it will not work, and it could damage your vehicle.

1. Check the other vehicle. It must have a 12-volt battery with a negative ground system.

Notice: If the other vehicle's system is not a 12-volt system with a negative ground, both vehicles can be damaged. Only use vehicles with 12-volt systems with negative grounds to jump start your vehicle.

2. Get the vehicles close enough so the jumper cables can reach, but be sure the vehicles are not touching each other. If they are, it could cause a ground connection you do not want. You would not be able to start your vehicle, and the bad grounding could damage the electrical systems.

To avoid the possibility of the vehicles rolling, set the parking brake firmly on both vehicles involved in the jump start procedure. Put an automatic transaxle in PARK (P) or a manual transaxle in NEUTRAL before setting the parking brake.

Notice: If you leave your radio or other accessories on during the jump starting procedure, they could be damaged. The repairs would not be covered by your warranty. Always turn off your radio and other accessories when jump starting your vehicle.

3. Turn off the ignition on both vehicles. Unplug unnecessary accessories plugged into the cigarette lighter. Turn off the radio and all lamps that are not needed. This will avoid sparks and help save both batteries. And it could save the radio!
4. Open the hoods and locate the batteries. Find the positive (+) and negative (-) terminal locations on each vehicle. See *Engine Compartment Overview on page 5-12* for more information on location.

 **CAUTION:**

An electric fan can start up even when the engine is not running and can injure you. Keep hands, clothing and tools away from any underhood electric fan.

 **CAUTION:**

Using a match near a battery can cause battery gas to explode. People have been hurt doing this, and some have been blinded. Use a flashlight if you need more light.

Be sure the battery has enough water. You do not need to add water to the battery installed in your new vehicle. But if a battery has filler caps, be sure the right amount of fluid is there. If it is low, add water to take care of that first. If you don't, explosive gas could be present.

Battery fluid contains acid that can burn you. Do not get it on you. If you accidentally get it in your eyes or on your skin, flush the place with water and get medical help immediately.

 **CAUTION:**

Fans or other moving engine parts can injure you badly. Keep your hands away from moving parts once the engine is running.

5. Check that the jumper cables do not have loose or missing insulation. If they do, you could get a shock. The vehicles could be damaged too.
Before you connect the cables, here are some basic things you should know. Positive (+) will go to positive (+) or to a remote positive (+) terminal if the vehicle has one. Negative (-) will go to a heavy, unpainted metal engine part or to a remote negative (-) terminal if the vehicle has one.
Do not connect positive (+) to negative (-) or you will get a short that would damage the battery and maybe other parts too. And do not connect the negative (-) cable to the negative (-) terminal on the dead battery because this can cause sparks.



6. Connect the red positive (+) cable to the positive (+) terminal of the dead battery. Use a remote positive (+) terminal if the vehicle has one.
7. Do not let the other end touch metal. Connect it to the positive (+) terminal of the good battery. Use a remote positive (+) terminal if the vehicle has one.

8. Now connect the black negative (-) cable to the negative terminal of the good battery. Use a remote negative (-) terminal if the vehicle has one.
Do not let the other end touch anything until the next step. The other end of the negative (-) cable *does not* go to the dead battery. It goes to a heavy, unpainted metal engine part or to a remote negative (-) terminal on the vehicle with the dead battery.
9. Connect the other end of the negative (-) cable at least 18 inches (45 cm) away from the dead battery, but not near engine parts that move. The electrical connection is just as good there, and the chance of sparks getting back to the battery is much less.
10. Now start the vehicle with the good battery and run the engine for a while.
11. Try to start the vehicle that had the dead battery. If it will not start after a few tries, it probably needs service.

Notice: If the jumper cables are removed in the wrong order, electrical shorting may occur and damage the vehicle. The repairs would not be covered by your warranty. Remove the jumper cables in the correct order, making sure that the cables do not touch each other or other metal.

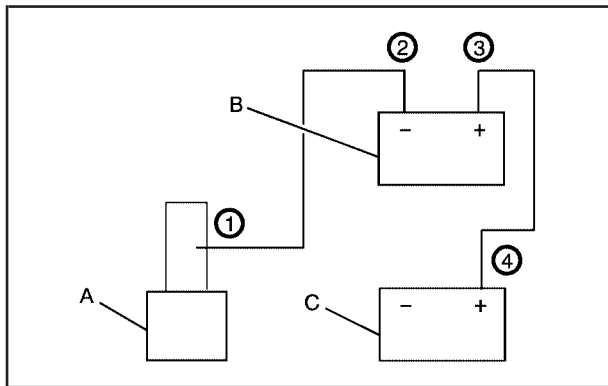

Jumper Cable Removal

- A. Heavy, Unpainted Metal Engine Part
- B. Good Battery
- C. Dead Battery

To disconnect the jumper cables from both vehicles, do the following:

1. Disconnect the black negative (-) cable from the vehicle that had the dead battery.
2. Disconnect the black negative (-) cable from the vehicle with the good battery.
3. Disconnect the red positive (+) cable from the vehicle with the good battery.
4. Disconnect the red positive (+) cable from the other vehicle.

All-Wheel Drive

If you have an all-wheel-drive vehicle, be sure to perform the lubricant checks described in this section.

Transfer Case (Power Transfer Unit)

When to Check Lubricant

Refer to the Maintenance Schedule to determine how often to check the lubricant. See *Part C: Periodic Maintenance Inspections on page 6-17*.

How to Check Lubricant

To get an accurate reading, the vehicle should be on a level surface.

If the level is below the bottom of the filler plug hole, you'll need to add some lubricant. Add enough lubricant to raise the level to the bottom of the filler plug hole.

What to Use

Refer to the Maintenance Schedule to determine what kind of lubricant to use. See *Part D: Recommended Fluids and Lubricants on page 6-19*.

Carrier Assembly-Differential (Rear Drive Module)

When to Check and Change Lubricant

Refer to the Maintenance Schedule to determine how often to check the lubricant and when to change it. See *Part A: Scheduled Maintenance Services on page 6-4*.

How to Check Lubricant

To get an accurate reading, the vehicle should be on a level surface.

If the level is below the bottom of the filler plug hole, you'll need to add some lubricant. Add enough lubricant to raise the level to the bottom of the filler plug hole. A fluid loss could indicate a problem; check and have it repaired, if needed.

What to Use

Refer to the Maintenance Schedule to determine what kind of lubricant to use. See *Part D: Recommended Fluids and Lubricants on page 6-19*.

Bulb Replacement

For the proper type of replacement bulbs, see *Replacement Bulbs* on page 5-55.

For any bulb changing procedure not listed in this section, contact your dealer.

Halogen Bulbs

CAUTION:

Halogen bulbs have pressurized gas inside and can burst if you drop or scratch the bulb. You or others could be injured. Be sure to read and follow the instructions on the bulb package.

Headlamps, Front Turn Signal, and Parking Lamps

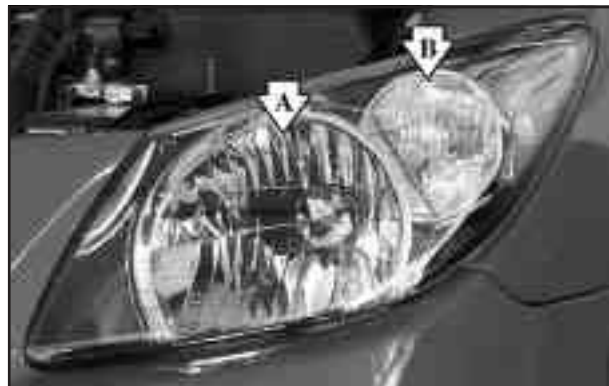

- A. Headlamp
- B. Turn Signal/Parking Lamp

To replace the headlamp, turn signal, or parking lamp bulb, do the following:



1. Open the hood and locate the lamp assembly.



2. Remove the rubber cover and socket from the headlamp or turn signal/parking lamp.



3. Release the retainer clip holding the bulb on the headlamp by pressing down and moving the metal retainer away from you.
Turn the turn signal/parking lamp bulb socket counterclockwise to remove.
4. Pull the bulb out of the fixture.
5. Reverse the steps to install a new bulb.

Center High-Mounted Stoplamp (CHMSL)

To replace the center high-mounted stoplamp bulb, do the following:

1. Locate the bulb which is on the inside of the liftgate/liftglass near the top.
2. Remove the two clips on both sides of the cover and remove it.

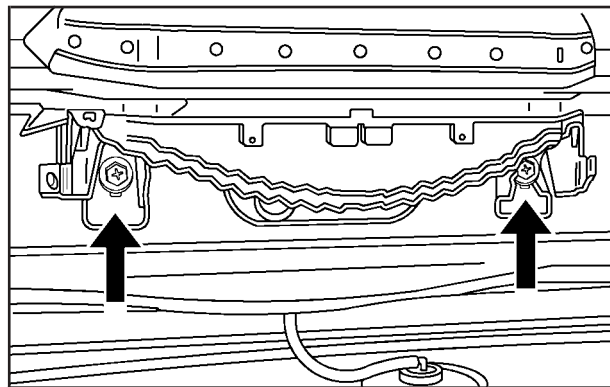

3. Remove the two screws from the CHMSL housing. Then remove the housing to expose the bulb.



4. Turn the bulb socket counterclockwise and pull it out of the lamp housing.



5. Pull the bulb straight out of the socket.
6. Reverse the previous steps to install a new bulb.

Taillamps, Turn Signal, and Stoplamps

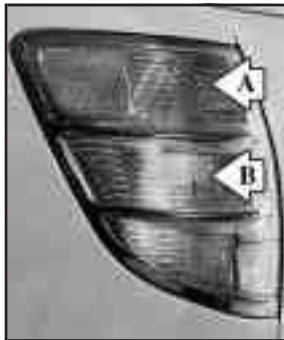

A. Stoplamp/Taillamp

B. Turn Signal Lamp

To replace the turn signal and/or stop/taillamp bulbs, do the following:



1. Remove the storage compartment cover in the rear cargo area of the vehicle to access the bulbs.



2. Turn the bulb socket counterclockwise and pull it out of the lamp housing.



3. Pull the bulb straight out of the socket.

Back-Up Lamps



The back-up lamp bulb is located in the bumper.

To replace the back-up lamp bulb, do the following:



1. Reach up under the rear fascia to locate the back-up lamp housing.

4. Reverse the previous steps to install a new bulb.
5. Reinstall the cover.



2. Turn the bulb socket counterclockwise and pull it out of the lamp housing.

3. Pull the bulb straight out of the socket.
4. Reverse the previous steps to install a new bulb.

Replacement Bulbs

Exterior Lamp	Bulb Number
Back-Up Lamp	7440
CHMSL	921
Front Turn Signal and Parking Lamp	1157NA
Headlamp High/Low-Beam	9003
Rear Turn Signal	7440
Stoplamp/Taillamp	7443

For replacement bulbs not listed here, please consult your dealer.

Windshield Wiper Blade Replacement

Windshield wiper blades should be inspected at least twice a year for wear or cracking. See “Wiper Blade Check” under *At Least Twice a Year on page 6-14* for more information.

Replacement blades come in different types and are removed in different ways. Here's how to remove the wiper blade:

1. Pull the windshield wiper arm away from the windshield.



2. Push the release lever and slide the wiper assembly toward the driver's side of the vehicle.
3. Install a new blade by reversing Steps 1 and 2.

Tires

Your new vehicle comes with high-quality tires made by a leading tire manufacturer. If you ever have questions about your tire warranty and where to obtain service, see your GM Warranty booklet for details. For additional information refer to the tire manufacturer's booklet included with your vehicle's Owner's Manual.

CAUTION:

Poorly maintained and improperly used tires are dangerous.

- **Overloading your tires can cause overheating as a result of too much friction. You could have an air-out and a serious accident. See *Loading Your Vehicle on page 4-32.***

CAUTION: (Continued)

CAUTION: (Continued)

- **Underinflated tires pose the same danger as overloaded tires. The resulting accident could cause serious injury. Check all tires frequently to maintain the recommended pressure. Tire pressure should be checked when your tires are cold. See *Inflation - Tire Pressure on page 5-64.***
- **Overinflated tires are more likely to be cut, punctured or broken by a sudden impact — such as when you hit a pothole. Keep tires at the recommended pressure.**
- **Worn, old tires can cause accidents. If your tread is badly worn, or if your tires have been damaged, replace them.**

Tire Sidewall Labelling

Useful information about a tire is molded into its sidewall. The examples below show a typical passenger car tire and a compact spare tire sidewall.

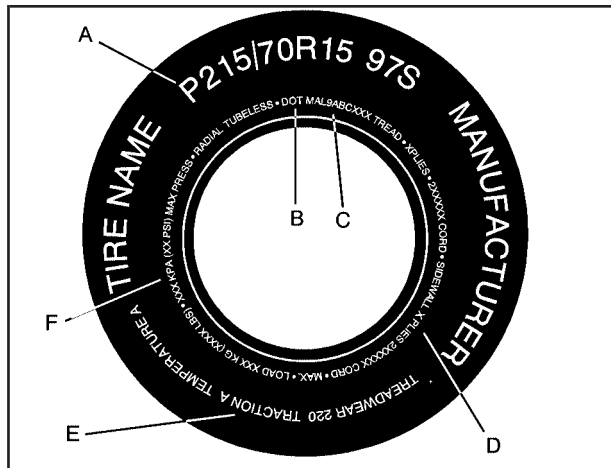

Passenger Car Tire Example

(A) Tire Size: The tire size is a combination of letters and numbers used to define a particular tire's width, height, aspect ratio, construction type and service description. See the "Tire Size" illustration later in this section for more detail.

(B) DOT (Department of Transportation): The Department of Transportation (DOT) code indicates that the tire is in compliance with the U.S. Department of Transportation Motor Vehicle Safety Standards.

(C) Tire Identification Number (TIN): The letters and numbers following DOT code are the Tire Identification Number (TIN). The TIN shows the manufacturer and plant code, tire size, and date the tire was manufactured. The TIN is molded onto both sides of the tire, although only one side may have the date of manufacture.

(D) Tire Ply Material: The type of cord and number of plies in the sidewall and under the tread.

(E) Uniform Tire Quality Grading (UTQG): Tire manufacturers are required to grade tires based on three performance factors: treadwear, traction and temperature resistance. For more information see *Uniform Tire Quality Grading* on page 5-70.

(F) Maximum Cold Inflation Load Limit: Maximum load that can be carried and the maximum pressure needed to support that load. For information on recommended tire pressure see *Inflation - Tire Pressure* on page 5-64 and *Loading Your Vehicle* on page 4-32.

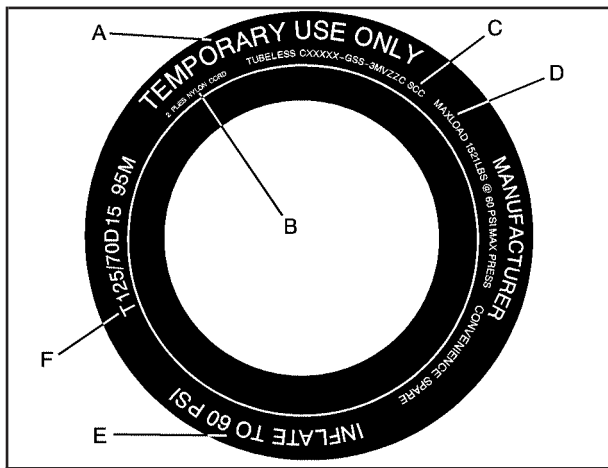

Compact Spare Tire Example

(A) Temporary Use Only: The compact spare tire or temporary use tire has a tread life of approximately 3,000 miles (5 000 km) and should not be driven at speeds over 65 mph (105 km/h). The compact spare tire is for emergency use when a regular road tire has lost air and gone flat. See *Compact Spare Tire* on page 5-86 and *If a Tire Goes Flat* on page 5-74.

(B) Tire Ply Material: The type of cord and number of plies in the sidewall and under the tread.

(C) Tire Identification Number (TIN): The Tire Identification Number (TIN). The TIN shows the manufacturer and plant code, tire size, and date the tire was manufactured. The TIN is molded onto both sides of the tire, although only one side may have the date of manufacture.

(D) Maximum Cold Inflation Load Limit: Maximum load that can be carried and the maximum pressure needed to support that load. See *Compact Spare Tire* on page 5-86 and *Loading Your Vehicle* on page 4-32.

(E) Tire Inflation: The temporary use tire or compact spare tire should be inflated to 60 psi (420 kPa). For more information on tire pressure and inflation see *Inflation - Tire Pressure* on page 5-64.

(F) Tire Size: A combination of letters and numbers define a tire's width, height, aspect ratio, construction type and service description. The letter T as the first character in the tire size means the tire is for temporary use only.

Tire Size

The following illustration shows an example of a typical passenger car tire size.

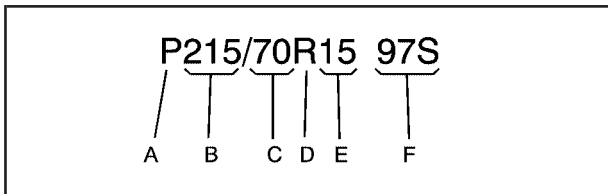

(A) Passenger (P-Metric) Tire: The United States version of a metric tire sizing system. The letter P as the first character in the tire size means a passenger vehicle tire engineered to standards set by the U. S. Tire and Rim Association.

(B) Tire Width: The three-digit number indicates the tire section width in millimeters from sidewall to sidewall.

(C) Aspect Ratio: A two-digit number that indicates the tire height-to-width measurements. For example, if the tire size aspect ratio is 70, as shown in item C of the illustration, it would mean that the tire's sidewall is 70% as high as it is wide.

(D) Construction Code: A letter code is used to indicate the type of ply construction in the tire. The letter R means radial ply construction; the letter D means diagonal or bias ply construction; and the letter B means belted-bias ply construction.

(E) Rim Diameter: Diameter of the wheel in inches.

(F) Service Description: These characters represent the load range and the speed rating of a tire. The load range represents the load carry capacity a tire is certified to carry. The speed rating is the maximum speed a tire is certified to carry a load. Speed ratings range from A to Z.

Tire Terminology and Definitions

Air Pressure: The amount of air inside the tire pressing outward on each square inch of the tire. Air pressure is expressed in pounds per square inch (psi) or kilopascal (kPa).

Accessory Weight: This means the combined weight of optional accessories. Some examples of optional accessories are, automatic transmission, power steering, power brakes, power windows, power seats, and air conditioning.

Aspect Ratio: The relationship of a tire's height to its width.

Belt: A rubber coated layer of cords that is located between the plies and the tread. Cords may be made from steel or other reinforcing materials.

Bead: The tire bead contains steel wires wrapped by steel cords that hold the tire onto the rim.

Bias Ply Tire: A pneumatic tire in which the plies are laid at alternate angles less than 90 degrees to the centerline of the tread.

Cold Inflation Pressure: The amount of air pressure in a tire, measured in pounds per square inch (psi) or kilopascals (kPa) before a tire has built up heat from driving. See *Inflation - Tire Pressure on page 5-64*.

Curb Weight: This means the weight of a motor vehicle with standard and optional equipment including the maximum capacity of fuel, oil and coolant, but without passengers and cargo.

DOT Markings: A code molded into the sidewall of a tire signifying that the tire is in compliance with the U.S. Department of Transportation (DOT) motor vehicle safety standards. The DOT code includes the Tire Identification Number (TIN), an alphanumeric designator which can also identify the tire manufacturer, production plant, brand and date of production.

GVWR: Gross Vehicle Weight Rating, see *Loading Your Vehicle on page 4-32*.

GAWR FRT: Gross Axle Weight Rating for the front axle, see *Loading Your Vehicle on page 4-32*.

GAWR RR: Gross Axle Weight Rating for the rear axle, see *Loading Your Vehicle* on page 4-32.

Intended Outboard Sidewall: The side of an asymmetrical tire, that must always face outward when mounted on a vehicle.

KiloPascal (kPa): The metric unit for air pressure.

Light Truck (LT-Metric) Tire: A tire used on light duty trucks and some multipurpose passenger vehicles.

Load Index: An assigned number ranging from 1 to 279 that corresponds to the load carrying capacity of a tire.

Maximum Inflation Pressure: The maximum air pressure to which a cold tire may be inflated. The maximum air pressure is molded onto the sidewall.

Maximum Load Rating: The load rating for a tire at the maximum permissible inflation pressure for that tire.

Maximum Loaded Vehicle Weight: The sum of curb weight; accessory weight; vehicle capacity weight; and production options weight.

Normal Occupant Weight: The number of occupants a vehicle is designed to seat multiplied by 150 lbs (68 kg). See *Loading Your Vehicle* on page 4-32.

Occupant Distribution: Designated seating positions.

Outward Facing Sidewall: The side of an asymmetrical tire that has a particular side that faces outward when mounted on a vehicle. The side of the tire that contains a whitewall, bears white lettering or bears manufacturer, brand, and/or model name molding that is higher or deeper than the same moldings on the other sidewall of the tire.

Passenger (P-Metric) Tire: A tire used on passenger cars and some light duty trucks and multipurpose vehicles.

Recommended Inflation Pressure: Vehicle manufacturer's recommended tire inflation pressure and shown on the tire placard. See *Inflation - Tire Pressure* on page 5-64 and *Loading Your Vehicle* on page 4-32.

Radial Ply Tire: A pneumatic tire in which the ply cords that extend to the beads are laid at 90 degrees to the centerline of the tread.

Rim: A metal support for a tire and upon which the tire beads are seated.

Sidewall: The portion of a tire between the tread and the bead.

Speed Rating: An alphanumeric code assigned to a tire indicating the maximum speed at which a tire can operate.

Traction: The friction between the tire and the road surface. The amount of grip provided.

Tread: The portion of a tire that comes into contact with the road.

Treadwear Indicators: Narrow bands, sometimes called “wear bars,” that show across the tread of a tire when only 1/16 inch (1.6 mm) of tread remains. See *When It Is Time for New Tires on page 5-69*.

UTQGS (Uniform Tire Quality Grading Standards):

A tire information system that provides consumers with ratings for a tire's traction, temperature, and treadwear. Ratings are determined by tire manufacturers using government testing procedures. The ratings are molded into the sidewall of the tire.

See *Uniform Tire Quality Grading on page 5-70*.

Vehicle Capacity Weight: The number of designated seating positions multiplied by 150 lbs (68 kg) plus the rated cargo load. See *Loading Your Vehicle on page 4-32*.

Vehicle Maximum Load on the Tire: Load on an individual tire due to curb weight, accessory weight, occupant weight, and cargo weight.

Vehicle Placard: A label permanently attached to a vehicle showing the original equipment tire size and recommended inflation pressure. See *Loading Your Vehicle on page 4-32*.

Inflation - Tire Pressure

Tires need the correct amount of air pressure to operate effectively.

Notice: Do not let anyone tell you that under-inflation or over-inflation is all right. It is not. If your tires do not have enough air (under-inflation), you can get the following:

- Too much flexing
- Too much heat
- Tire overloading
- Premature or irregular wear
- Poor handling
- Reduced fuel economy

If your tires have too much air (over-inflation), you can get the following:

- Unusual wear
- Poor handling
- Rough ride
- Needless damage from road hazards

A Tire and Loading Information label is attached to the vehicle's center pillar (B-pillar), below the driver's door latch. This label shows your vehicle's original equipment tires and the correct inflation pressures for your tires when they are cold. The recommended cold tire inflation pressure, shown on the label, is the minimum amount of air pressure needed to support your vehicle's maximum load carrying capacity.

For additional information regarding how much weight your vehicle can carry, and an example of the tire and loading information label, see *Loading Your Vehicle on page 4-32*. How you load your vehicle affects vehicle handling and ride comfort, never load your vehicle with more weight than it was designed to carry.

When to Check

Check your tires once a month or more. Do not forget to check the compact spare tire, it should be at 60 psi (420 kPa). For additional information regarding the compact spare tire, see *Compact Spare Tire on page 5-86*.

How to Check

Use a good quality pocket-type gage to check tire pressure. You cannot tell if your tires are properly inflated simply by looking at them. Radial tires may look properly inflated even when they are under-inflated. Check the tire's inflation pressure when the tires are cold. Cold means your vehicle has been sitting for at least three hours or driven no more than 1 mile (1.6 km).

Remove the valve cap from the tire valve stem. Press the tire gage firmly onto the valve to get a pressure measurement. If the cold tire inflation pressure matches the recommended pressure on the Tire and Loading Information label, no further adjustment is necessary. If the inflation pressure is low, add air until you reach the recommended amount.

If you overfill the tire, release air by pushing on the metal stem in the center of the tire valve. Re-check the tire pressure with the tire gage.

Be sure to put the valve caps back on the valve stems. They help prevent leaks by keeping out dirt and moisture.

Tire Pressure Monitor System

If your vehicle has this feature, it is designed to alert you when the system detects a large change in the pressure of one tire. The system cannot alert you before you drive that a tire is low or flat. You must begin driving before the system will work properly. The system works with the brake control system and is designed to detect differences in the tire rotation speeds that are caused by changes in tire pressure. The tire pressure monitoring system does not replace normal tire maintenance, see *Tires on page 5-57*, *Tire Inspection and Rotation on page 5-68* and *When It Is Time for New Tires on page 5-69*.

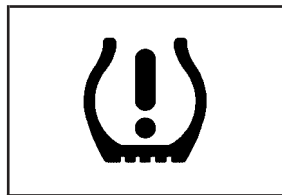

This light, on the instrument panel cluster, comes on when the tire pressure monitoring system detects a low-tire condition.

This light will also come on for a few seconds and then go off when you turn the ignition to ON. This indicates that the tire pressure monitoring system is functioning properly. If the low-tire pressure warning light comes on while driving your vehicle, the system may have detected a low-tire condition.

You need to stop as soon as possible and check your tires for damage. If a tire is flat, see *If a Tire Goes Flat* on page 5-74 and *Changing a Flat Tire* on page 5-75. Also check the tire pressure in all four tires, and set them to the specified level shown on the tire and loading label. See *Inflation - Tire Pressure* on page 5-64 for additional information.

Note: The tire pressure monitoring system on your vehicle will warn you when one of your tires is significantly under-inflated and when some combinations of your tires are significantly under-inflated. However, there are other combinations of significantly under-inflated tires for which your tire pressure monitoring system may not warn you. These other combinations are relatively common, accounting for approximately half the instances in which vehicles have significantly under-inflated tires. For example, your system may not warn you when both tires on the same side or on the same axle of your vehicle are significantly under-inflated. It is particularly important, therefore, for you to check the tire pressure in all of your tires regularly and maintain proper pressure.

In order for the tire pressure monitoring system to work properly you will need to reset (initialize) the tire pressure monitoring system. Any time you check and/or adjust a tire's pressure, repair or replace a tire or wheel or rotate the tires the tire pressure monitor system needs to be reset.

Do not reset (initialize) the system without first correcting the cause of the low-tire condition. If the system is reset when the tire pressures are incorrect, the system will not function properly and may not alert you when a tire is low.

To reset (initialize) the system:

1. Park the vehicle at a safe place and apply the parking brake. Turn the engine off.
2. Turn the ignition to ON with the engine off.

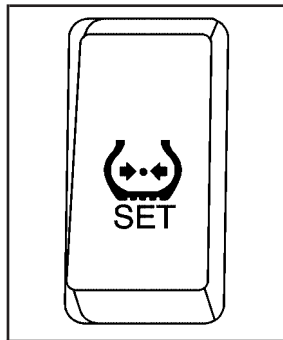

3. If the low-tire pressure warning light is on, push the SET (reset) button for a few seconds. The low-tire warning light should go off. The reset button is on the instrument panel to the left of the steering wheel.

4. Press and hold the SET (reset) button until the low-tire warning light comes on and flashes on/off three times. The tire pressure warning reset button starts the reset (initialization) process.

If the low-tire pressure warning light does not flash when you hold the reset button the system may be malfunctioning and needs service. See your GM dealer for service.

The system completes the reset (initialization) process after driving at vehicle speeds of at least 19 mph (30 km/h) to 62 mph (100 km/h) for more than one hour. Do not push the SET (reset) button while driving, if you do the initialization process will not be performed. The initialization process can take up to approximately one hour of driving under the following conditions:

- The vehicle speed is between 31 mph (50 km/h) and 62 mph (100 km/h).
- The roads are dry, smooth and straight.
- The number of passengers is one or two (including the driver).

The low-tire pressure warning light may not come on even if the tire inflation pressure is low, or it may come on when the tire inflation pressure is set correctly under the following circumstances:

- A compact spare tire, snow tires, or tire chains are installed on your vehicle.
- The tires are over-inflated, or the tire inflation pressure suddenly drops due to a tire bursting or other causes.
- The vehicle is driven on a slippery road surface such as rough or frozen roads.
- The vehicle speed is less than 19 mph (30 km/h), and the driving duration is less than five minutes.
- The tires are made by a different manufacturer or differ in tread pattern than the original equipment tires.
- Rapid acceleration/deceleration or multiple consecutive sharp turns.
- Towing a trailer.
- The vehicle is loaded over the limit or not balanced properly.
- The initialization (reset) procedure was not performed correctly after replacing or rotating tires or wheels.
- The outside temperature is below 32°F (0°C) or above 104°F (40°C).

Tire Inspection and Rotation

Tires should be rotated every 5,000 to 8,000 miles (8 000 to 13 000 km).

Any time you notice unusual wear, rotate your tires as soon as possible and check wheel alignment. Also check for damaged tires or wheels. See *When It Is Time for New Tires* on page 5-69 and *Wheel Replacement* on page 5-72 for more information.

The purpose of regular rotation is to achieve more uniform wear for all tires on the vehicle. The first rotation is the most important. See *Part A: Scheduled Maintenance Services* on page 6-4 for scheduled rotation intervals.

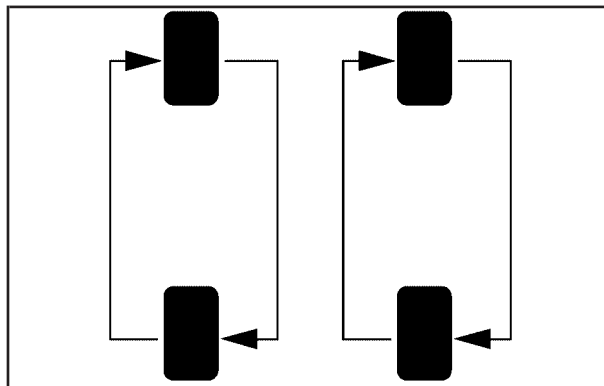

When rotating your tires, always use the correct rotation pattern shown here.

Tires should only be moved from front to rear and rear to front on the same side of the vehicle.

Do not include the compact spare tire in your tire rotation.

After the tires have been rotated, adjust the front and rear inflation pressures to the amounts shown on the Tire and Loading Information label. Make certain that all wheel nuts are properly tightened. See “Wheel Nut Torque” under *Capacities and Specifications* on page 5-100.

CAUTION:

Rust or dirt on a wheel, or on the parts to which it is fastened, can make wheel nuts become loose after a time. The wheel could come off and cause an accident. When you change a wheel, remove any rust or dirt from places where the wheel attaches to the vehicle. In an emergency, you can use a cloth or a paper towel to do this; but be sure to use a scraper or wire brush later, if you need to, to get all the rust or dirt off. See *Changing a Flat Tire* on page 5-75.

Vehicles equipped with a tire pressure monitoring system will need to reset (initialize) the system after each tire rotation. See *Tire Pressure Monitor System* on page 5-65.

When It Is Time for New Tires

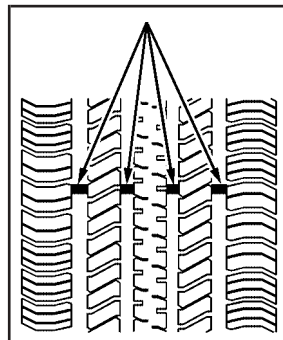

One way to tell when it's time for new tires is to check the treadwear indicators, which will appear when your tires have only 1/16 inch (1.6 mm) or less of tread remaining.

You need a new tire if any of the following statements are true:

- You can see the indicators at three or more places around the tire.
- You can see cord or fabric showing through the tire's rubber.
- The tread or sidewall is cracked, cut or snagged deep enough to show cord or fabric.
- The tire has a bump, bulge or split.
- The tire has a puncture, cut or other damage that can't be repaired well because of the size or location of the damage.

Buying New Tires

To find out what kind and size of tires you need, look at the Tire and Loading Information label. For more information about this label and where to find it, see *Loading Your Vehicle on page 4-32*.

Make sure the replacements are the same size, load capacity, speed rating and construction type (bias, bias-belted or radial) as your original tires.

CAUTION:

Mixing tires could cause you to lose control while driving. If you mix tires of different sizes or types (radial and bias-belted tires), the vehicle may not handle properly, and you could have a crash. Using tires of different sizes may also cause damage to your vehicle. Be sure to use the same size and type tires on all wheels. It's all right to drive with your compact spare temporarily, it was developed for use on your vehicle. See *Compact Spare Tire on page 5-86*.

CAUTION:

If you use bias-ply tires on your vehicle, the wheel rim flanges could develop cracks after many miles of driving. A tire and/or wheel could fail suddenly, causing a crash. Use only radial-ply tires with the wheels on your vehicle.

Uniform Tire Quality Grading

Quality grades can be found where applicable on the tire sidewall between tread shoulder and maximum selection width. For example:

Treadwear 200 Traction AA Temperature A

The following information relates to the system developed by the United States National Highway Traffic Safety Administration, which grades tires by treadwear, traction and temperature performance. (This applies only to vehicles sold in the United States.) The grades are molded on the sidewalls of most passenger car tires. The Uniform Tire Quality Grading system does not apply to deep tread, winter-type snow tires, space-saver or temporary use spare tires, tires with nominal rim diameters of 10 to 12 inches (25 to 30 cm), or to some limited-production tires.

While the tires available on General Motors passenger cars and light trucks may vary with respect to these grades, they must also conform to federal safety requirements.

Treadwear

The treadwear grade is a comparative rating based on the wear rate of the tire when tested under controlled conditions on a specified government test course. For example, a tire graded 150 would wear one and a half (1½) times as well on the government course as a tire graded 100. The relative performance of tires depends upon the actual conditions of their use, however, and may depart significantly from the norm due to variations in driving habits, service practices and differences in road characteristics and climate.

Traction — AA, A, B, C

The traction grades, from highest to lowest, are AA, A, B, and C. Those grades represent the tire's ability to stop on wet pavement as measured under controlled conditions on specified government test surfaces of asphalt and concrete. A tire marked C may have poor traction performance. Warning: The traction grade assigned to this tire is based on straight-ahead braking traction tests, and does not include acceleration, cornering, hydroplaning, or peak traction characteristics.

Temperature — A, B, C

The temperature grades are A (the highest), B, and C, representing the tire's resistance to the generation of heat and its ability to dissipate heat when tested under controlled conditions on a specified indoor laboratory test wheel. Sustained high temperature can cause the material of the tire to degenerate and reduce tire life, and excessive temperature can lead to sudden tire failure. The grade C corresponds to a level of performance which all passenger car tires must meet under the Federal Motor Vehicle Safety Standard No. 109. Grades B and A represent higher levels of performance on the laboratory test wheel than the minimum required by law.

Warning: The temperature grade for this tire is established for a tire that is properly inflated and not overloaded. Excessive speed, underinflation, or excessive loading, either separately or in combination, can cause heat buildup and possible tire failure.

Wheel Alignment and Tire Balance

The wheels on your vehicle were aligned and balanced carefully at the factory to give you the longest tire life and best overall performance.

If you notice unusual tire wear or your vehicle pulling one way or the other, the alignment may need to be reset. If you notice your vehicle vibrating when driving on a smooth road, your wheels may need to be rebalanced.

Wheel Replacement

Replace any wheel that is bent, cracked or badly rusted or corroded. If wheel nuts keep coming loose, the wheel, wheel bolts and wheel nuts should be replaced. If the wheel leaks air, replace it (except some aluminum wheels, which can sometimes be repaired). See your dealer if any of these conditions exist.

Your dealer will know the kind of wheel you need.

Each new wheel should have the same load-carrying capacity, diameter, width, offset and be mounted the same way as the one it replaces.

If you need to replace any of your wheels, wheel bolts or wheel nuts, replace them only with new GM original equipment parts. This way, you will be sure to have the right wheel, wheel bolts and wheel nuts for your vehicle.

CAUTION:

Using the wrong replacement wheels, wheel bolts or wheel nuts on your vehicle can be dangerous. It could affect the braking and handling of your vehicle, make your tires lose air and make you lose control. You could have a collision in which you or others could be injured. Always use the correct wheel, wheel bolts and wheel nuts for replacement.

Notice: The wrong wheel can also cause problems with bearing life, brake cooling, speedometer or odometer calibration, headlamp aim, bumper height, vehicle ground clearance and tire or tire chain clearance to the body and chassis.

See *Changing a Flat Tire* on page 5-75 for more information.

Used Replacement Wheels

CAUTION:

Putting a used wheel on your vehicle is dangerous. You can't know how it's been used or how far it's been driven. It could fail suddenly and cause a crash. If you have to replace a wheel, use a new GM original equipment wheel.

Tire Chains

Notice: Use tire chains only where legal and only when you must. Use only SAE Class "S" type chains that are the proper size for your tires. Install them on the front tires for front-wheel-drive vehicles. If your vehicle has all-wheel-drive, install the tire chains on the front or all four tires but never on the rear tires only. Tighten them as tightly as possible with the ends securely fastened. Drive slowly and follow the chain manufacturer's instructions. If you can hear the chains contacting your vehicle, stop and retighten them. If the contact continues, slow down until it stops. Driving too fast or spinning the wheels with chains on will damage your vehicle.

If a Tire Goes Flat

It's unusual for a tire to "blowout" while you're driving, especially if you maintain your tires properly. If air goes out of a tire, it's much more likely to leak out slowly. But if you should ever have a "blowout," here are a few tips about what to expect and what to do:

If a front tire fails, the flat tire will create a drag that pulls the vehicle toward that side. Take your foot off the accelerator pedal and grip the steering wheel firmly. Steer to maintain lane position, and then gently brake to a stop well out of the traffic lane.

A rear blowout, particularly on a curve, acts much like a skid and may require the same correction you'd use in a skid. In any rear blowout, remove your foot from the accelerator pedal. Get the vehicle under control by steering the way you want the vehicle to go. It may be very bumpy and noisy, but you can still steer. Gently brake to a stop, well off the road if possible.

CAUTION:

Lifting a vehicle and getting under it to do maintenance or repairs is dangerous without the appropriate safety equipment and training. The jack provided with your vehicle is designed only for changing a flat tire. If it is used for anything else, you or others could be badly injured or killed if the vehicle slips off the jack. Use the jack provided with your vehicle only for changing a flat tire.

If a tire goes flat, the next part shows how to use your jacking equipment to change a flat tire safely.

Changing a Flat Tire

If a tire goes flat, avoid further tire and wheel damage by driving slowly to a level place. Turn on your hazard warning flashers.

CAUTION:

Changing a tire can be dangerous. The vehicle can slip off the jack and roll over or fall on you or other people. You and they could be badly injured or even killed. Find a level place to change your tire. To help prevent the vehicle from moving:

1. Set the parking brake firmly.
2. Put an automatic transaxle shift lever in PARK (P), or shift a manual transaxle to FIRST (1) or REVERSE (R).
3. Turn off the engine and do not restart while the vehicle is raised.
4. Do not allow passengers to remain in the vehicle.

CAUTION: (Continued)

CAUTION: (Continued)

To be even more certain the vehicle will not move, you should put blocks at the front and rear of the tire farthest away from the one being changed. That would be the tire on the other side, at the opposite end of the vehicle.

When you have a flat tire, use the following example as a guide to assist you in the placement of wheel blocks.

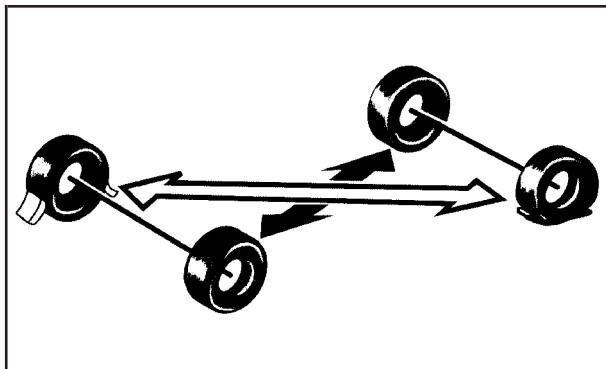

The following information will tell you how to use the jack and change a tire.

Removing the Spare Tire and Tools

The jack, wheel wrench, jack handle and spare tire are stowed in the rear of the vehicle, underneath the floor of the cargo area. To remove the spare tire and tools do the following:



1. Turn the two lock knobs on the floor of the cargo area to UNLOCK.



2. Lift up the cargo area floor panel, remove the hook attached to the bottom side of the panel and hook it over the weatherstripping.

Notice: If you do not put the hook in the proper location, you could damage your vehicle. Always put the hook in the proper location in order to avoid damaging the vehicle.

3. Remove the jack from the tray on the right side of the compartment and the jack handle and wheel wrench from the top side of the compartment.



4. Unscrew the center retaining nut and lift up the plastic tray to expose the compact spare tire.



5. Unscrew the center bolt from the compact spare tire and pull out the compact spare tire. See *Compact Spare Tire* on page 5-86



The tools you'll be using include the jack (A), jack handle (B) and wheel wrench (C).

Removing the Flat Tire and Installing the Spare Tire

1. Attach the jack handle to the jack.
2. Turn the jack handle clockwise to raise the lift head a little.

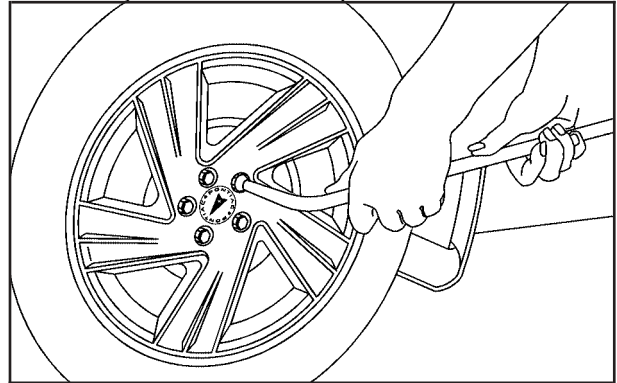

3. Using the wheel wrench, loosen all the wheel nuts. Don't remove them yet.

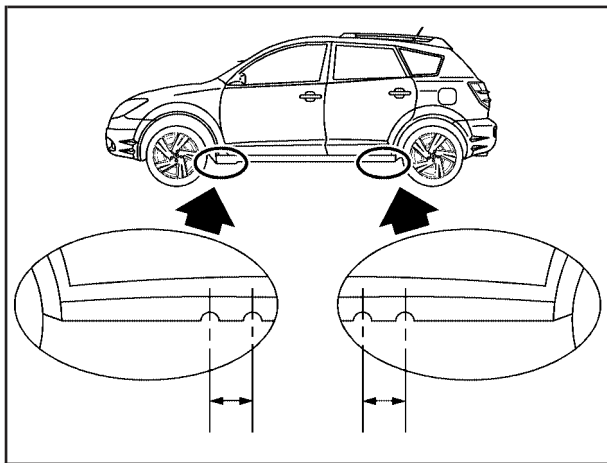

4. Position the jack and raise the jack lift head to fit over the car flange between the two notches.

⚠ CAUTION:

Getting under a vehicle when it is jacked up is dangerous. If the vehicle slips off the jack you could be badly injured or killed. Never get under a vehicle when it is supported only by a jack.

⚠ CAUTION:

Raising your vehicle with the jack improperly positioned can damage the vehicle and even make the vehicle fall. To help avoid personal injury and vehicle damage, be sure to fit the jack lift head into the proper location before raising the vehicle.



5. Raise the vehicle by turning the jack handle clockwise. Raise the vehicle far enough off the ground so there is enough room for the compact spare tire to fit underneath the wheel well.



7. Install the spare tire.

6. Remove all the wheel nuts and take off the flat tire.

⚠ CAUTION:

Rust or dirt on the wheel, or on the parts to which it is fastened, can make the wheel nuts become loose after a time. The wheel could come off and cause an accident. When you change a wheel, remove any rust or dirt from the places where the wheel attaches to the vehicle. In an emergency, you can use a cloth or a paper towel to do this; but be sure to use a scraper or wire brush later, if you need to, to get all the rust or dirt off.

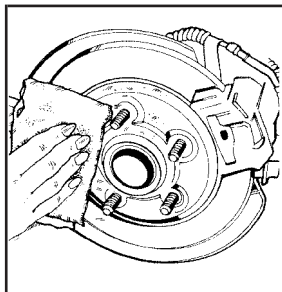

8. Remove any rust or dirt from the wheel bolts, mounting surfaces and spare wheel.

9. Place the compact spare tire on the wheel-mounting surface.

⚠ CAUTION:

Never use oil or grease on studs or nuts. If you do, the nuts might come loose. Your wheel could fall off, causing a serious accident.

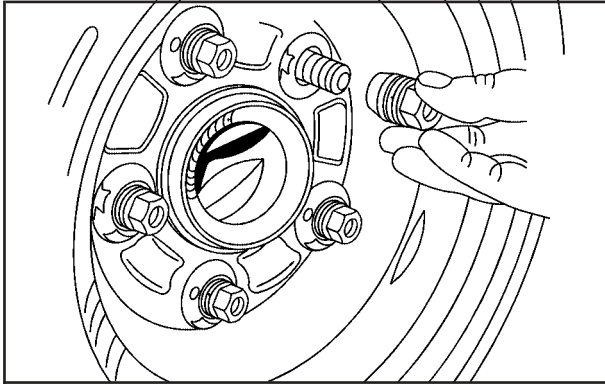

10. Reinstall the wheel nuts with the rounded end of the nuts toward the wheel. Tighten each nut by hand until the wheel is held against the hub.



11. Lower the vehicle by turning the jack handle counterclockwise. Lower the jack completely.

⚠ CAUTION:

Incorrect wheel nuts or improperly tightened wheel nuts can cause the wheel to come loose and even come off. This could lead to an accident. Be sure to use the correct wheel nuts. If you have to replace them, be sure to get new GM original equipment wheel nuts. Stop somewhere as soon as you can and have the nuts tightened with a torque wrench to the proper torque specification. See *Capacities and Specifications on page 5-100* for wheel nut torque specification.

Notice: Improperly tightened wheel nuts can lead to brake pulsation and rotor damage. To avoid expensive brake repairs, evenly tighten the wheel nuts in the proper sequence and to the proper torque specification. See *Capacities and Specifications on page 5-100* for the wheel nut torque specification.

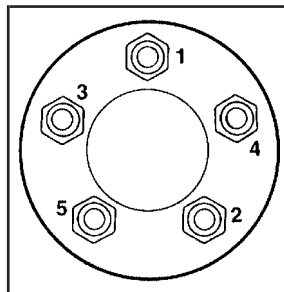

12. Tighten the wheel nuts firmly in a crisscross sequence as shown.

Storing a Flat or Spare Tire and Tools

⚠ CAUTION:

Storing a jack, a tire, or other equipment in the passenger compartment of the vehicle could cause injury. In a sudden stop or collision, loose equipment could strike someone. Store all these in the proper place.

The compact spare tire storage area is designed only for the compact spare tire, the standard tire cannot be stored there.

To store the flat tire, do the following:

1. Remove the center wheel cap before storing the flat tire, if your vehicle has aluminum wheels.
2. Place the flat tire on the rear cargo area floor panel with the outer side of the wheel facing up.
3. Use the tire tie-down straps located under the floor panel to secure the flat tire.

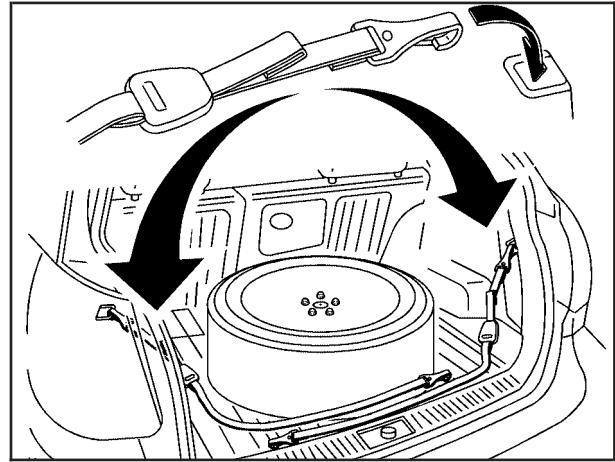

4. Hook the straps (end closest to the buckle) to the rear, upper tie-down hooks.

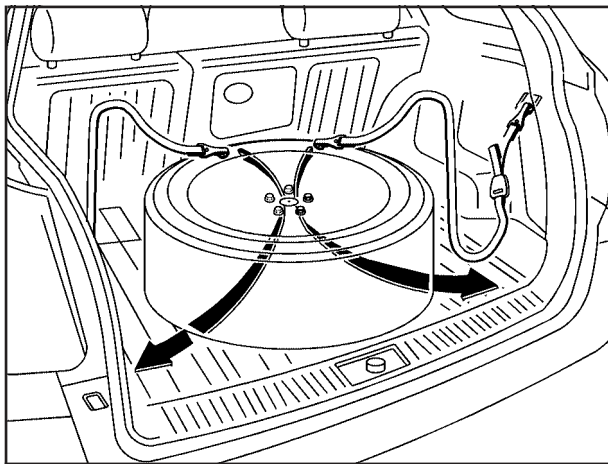

5. Pass the straps through the center hole of the wheel.
6. Attach the other end of the straps to the rear, lower tie-down hooks.

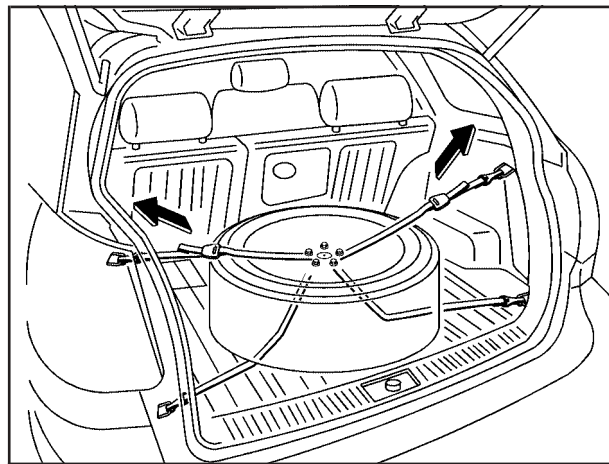

7. Position the tire edge against the rear center end of the floor panel. Pull the end of the straps to make sure the tire is secure.

Use the following diagram as a guide for storing the compact spare tire once you are done using it.

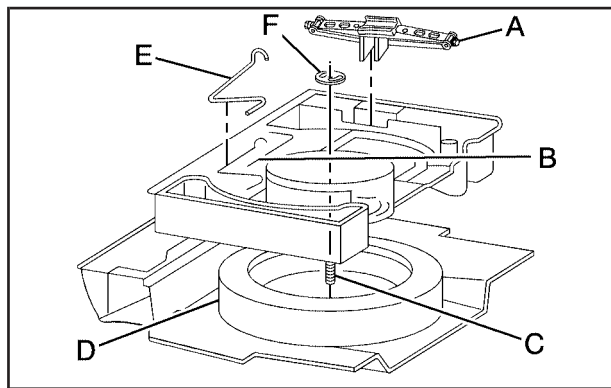

- | | |
|-----------------|----------------|
| A. Jack | D. Spare Tire |
| B. Wheel Wrench | E. Jack Handle |
| C. Bolt | F. Nut |

Return the jack, jack handle, wheel wrench and compact spare tire to the storage area. When storing the compact spare tire, put it in place with the inner side of the wheel facing up. The compact spare tire storage area is designed only for the compact spare tire, the standard tire cannot be stored there.

Compact Spare Tire

Although the compact spare tire was fully inflated when your vehicle was new, it can lose air after a time. Check the inflation pressure regularly. It should be 60 psi (420 kPa).

After installing the compact spare on your vehicle, you should stop as soon as possible and make sure your spare tire is correctly inflated. The compact spare is made to perform well at speeds up to 50 mph (80 km/h) for distances up to 3,000 miles (5 000 km), so you can finish your trip and have your full-size tire repaired or replaced where you want. Of course, it's best to replace your spare with a full-size tire as soon as you can. Your spare will last longer and be in good shape in case you need it again.

Notice: When the compact spare is installed, do not take your vehicle through an automatic car wash with guide rails. The compact spare can get caught on the rails. That can damage the tire and wheel, and maybe other parts of your vehicle.

Don't use your compact spare on other vehicles.

And don't mix your compact spare tire or wheel with other wheels or tires. They won't fit. Keep your spare tire and its wheel together.

Notice: Tire chains will not fit your compact spare. Using them can damage your vehicle and can damage the chains too. Do not use tire chains on your compact spare.

Appearance Care

Cleaning products can be hazardous. Some are toxic. Other cleaning products can burst into flames if a match is struck near them or if they get on a hot part of the vehicle. Some are dangerous if their fumes are inhaled in a closed space. When anything from a container is used to clean the vehicle, be sure to follow the manufacturer's warnings and instructions. Always open the doors or windows of the vehicle when cleaning the inside.

Never use these to clean the vehicle:

- Gasoline
- Benzene
- Naphtha
- Carbon Tetrachloride
- Acetone
- Paint Thinner
- Turpentine
- Lacquer Thinner
- Nail Polish Remover

They can all be hazardous — some more than others — and they can all damage the vehicle, too.

Do not use any of these products unless this manual says you can. In many uses, these will damage the vehicle:

- Alcohol
- Laundry Soap
- Bleach
- Reducing Agents

Fabric/Carpet

Use a vacuum cleaner often to get rid of dust and loose dirt. Wipe vinyl, leather, plastic, and painted surfaces with a clean, damp cloth.

GM-approved cleaning products can be obtained from your dealer.

Here are some cleaning tips:

- Always read the instructions on the cleaner label.
- Clean up stains as soon as you can before they set.
- Carefully scrape off any excess stain.
- Use a clean cloth or sponge, and change to a clean area often. A soft brush may be used if stains are stubborn.
- To avoid forming a ring on fabric after spot cleaning, clean the entire area immediately or it will set.

Most stains can be removed with club soda water. To clean, use the following instructions:

1. For liquids: blot with a clean, soft, white cloth. For solids: remove as much as possible and then vacuum or brush.
2. Apply club soda water to a clean, soft, white cloth. Do not over-saturate; the cloth should not drip water.
3. Clean the entire area. Avoid getting the fabric too wet.
4. Start cleaning from the seams into the stain to avoid a ring effect.
5. Continue cleaning, using a clean area of the cloth each time it becomes soiled.
6. When the stain is removed, blot the cleaned area with another dry, clean, soft, white cloth.

Using Cleaner on Fabric

1. First, try the cleaner in an inconspicuous area to make sure the cleaner does not affect the color of the fabric.
2. For liquids: blot with a clean, soft, white cloth. For solids: remove as much as possible and then vacuum or brush.
3. Spray a small amount of the cleaner onto a clean soft, white, cloth. Do not apply spray directly to the fabric.

4. Start cleaning from the seams into the stain to avoid a ring effect.
5. Continue cleaning, using a clean area of the cloth each time it becomes soiled.
6. When the stain is removed, blot the cleaned area with another dry, clean, soft, white cloth.
7. If the cleaner leaves a ring effect, follow up with the club soda water instructions given earlier in this section.

Special Fabric Cleaning Problems

Stains caused by such things as catsup, black coffee, egg, fruit, fruit juice, milk, soft drinks, vomit, urine, and blood can be removed using the club soda water instructions given earlier in this section. If an odor lingers after cleaning vomit or urine, treat the area with a water and baking soda solution: 1 teaspoon (5 ml) of baking soda to 1 cup (250 ml) of lukewarm water. Let dry.

Stains caused by oil and grease can be cleaned with an approved GM cleaner and a clean, white cloth.

1. Carefully scrape off excess stain.
2. Clean with cool water and allow to dry completely.
3. If a stain remains, follow the cleaner instructions described earlier.

Vinyl

Use warm water and a clean cloth.

- Rub with a clean, damp cloth to remove dirt. This may have to be done more than once.
- Things like tar, asphalt, and shoe polish will stain if they are not removed quickly. Use a clean cloth and vinyl cleaner. See your dealer for this product.

Leather

Use a soft cloth with lukewarm water and a mild soap or saddle soap and wipe dry with a soft cloth. Then, let the leather dry naturally. Do not use heat to dry.

- For stubborn stains, use a leather cleaner.
- Never use oils, varnishes, solvent-based or abrasive cleaners, furniture polish, or shoe polish on leather.
- Soiled or stained leather should be cleaned immediately. If dirt is allowed to work into the finish, it can harm the leather.

Instrument Panel

Use only mild soap and water to clean the top surfaces of the instrument panel. Sprays containing silicones or waxes may cause annoying reflections in the windshield and even make it difficult to see through the windshield under certain conditions.

Interior Plastic Components

Use only a mild soap and water solution on a soft cloth or sponge. Commercial cleaners may affect the surface finish.

Glass Surfaces

Glass should be cleaned often. GM Glass Cleaner or a liquid household glass cleaner will remove normal tobacco smoke and dust films on interior glass. See *Vehicle Care/Appearance Materials on page 5-94*.

Notice: If you use abrasive cleaners when cleaning glass surfaces on your vehicle, you could scratch the glass and/or cause damage to the rear window defogger and the integrated radio antenna. When cleaning the glass on your vehicle, use only a soft cloth and glass cleaner.

Care of Safety Belts

Keep belts clean and dry.

CAUTION:

Do not bleach or dye safety belts. If you do, it may severely weaken them. In a crash, they might not be able to provide adequate protection. Clean safety belts only with mild soap and lukewarm water.

Weatherstrips

Silicone grease on weatherstrips will make them last longer, seal better, and not stick or squeak. Apply silicone grease with a clean cloth. During very cold, damp weather frequent application may be required.

Washing Your Vehicle

The paint finish on the vehicle provides beauty, depth of color, gloss retention, and durability.

The best way to preserve the vehicle's finish is to keep it clean by washing it often with lukewarm or cold water.

Do not wash the vehicle in the direct rays of the sun. Use a car washing soap. Do not use strong soaps or chemical detergents. Be sure to rinse the vehicle well, removing all soap residue completely. GM-approved cleaning products can be obtained from your dealer. See *Vehicle Care/Appearance Materials* on page 5-94. Do not use cleaning agents that are petroleum based, or that contain acid or abrasives. All cleaning agents should be flushed promptly and not allowed to dry on the surface, or they could stain. Dry the finish with a soft, clean chamois or an all-cotton towel to avoid surface scratches and water spotting.

High pressure car washes may cause water to enter the vehicle.

Cleaning Exterior Lamps/Lenses

Use only lukewarm or cold water, a soft cloth and a car washing soap to clean exterior lamps and lenses. Follow instructions under *Washing Your Vehicle* on page 5-90.

Finish Care

Occasional waxing or mild polishing of the vehicle by hand may be necessary to remove residue from the paint finish. GM-approved cleaning products can be obtained from your dealer. See *Vehicle Care/Appearance Materials on page 5-94*.

The vehicle has a “basecoat/clearcoat” paint finish. The clearcoat gives more depth and gloss to the colored basecoat. Always use waxes and polishes that are non-abrasive and made for a basecoat/clearcoat paint finish.

Notice: Machine compounding or aggressive polishing on a basecoat/clearcoat paint finish may damage it. Use only non-abrasive waxes and polishes that are made for a basecoat/clearcoat paint finish on your vehicle.

Foreign materials such as calcium chloride and other salts, ice melting agents, road oil and tar, tree sap, bird droppings, chemicals from industrial chimneys, etc., can damage the vehicle’s finish if they remain on painted surfaces. Wash the vehicle as soon as possible. If necessary, use non-abrasive cleaners that are marked safe for painted surfaces to remove foreign matter.

Exterior painted surfaces are subject to aging, weather, and chemical fallout that can take their toll over a period of years. To help keep the paint finish looking new, keep the vehicle in a garage or covered whenever possible.

Windshield, Backglass, and Wiper Blades

If the windshield is not clear after using the windshield washer, or if the wiper blade chatters when running, wax, sap or other material may be on the blade or windshield.

Clean the outside of the windshield with a full-strength glass cleaning liquid. The windshield is clean if beads do not form when you rinse it with water.

Grime from the windshield will stick to the wiper blades and affect their performance. Clean the blade by wiping vigorously with a cloth soaked in full-strength windshield washer solvent. Then rinse the blade with water.

Check the wiper blades and clean them as necessary; replace blades that look worn.

Aluminum Wheels

Notice: If you use strong soaps, chemicals, abrasive polishes, cleaners, brushes, or cleaners that contain acid on aluminum or chrome-plated wheels, you could damage the surface of the wheel(s). The repairs would not be covered by your warranty. Use only GM-approved cleaners on aluminum or chrome-plated wheels.

Keep the wheels clean using a soft clean cloth with mild soap and water. Rinse with clean water. After rinsing thoroughly, dry with a soft clean towel. A wax may then be applied.

Notice: Using chrome polish on aluminum wheels could damage the wheels. The repairs would not be covered by your warranty. Use chrome polish on chrome wheels only.

The surface of these wheels is similar to the painted surface of the vehicle. Do not use strong soaps, chemicals, abrasive polishes, abrasive cleaners, cleaners with acid, or abrasive cleaning brushes on them because the surface could be damaged. Do not use chrome polish on aluminum wheels.

Notice: If you drive your vehicle through an automatic car wash that has silicone carbide tire cleaning brushes, you could damage the aluminum or chrome-plated wheels. The repairs would not be covered by your warranty. Never drive a vehicle equipped with aluminum or chrome-plated wheels through an automatic car wash that uses silicone carbide tire cleaning brushes.

Do not take the vehicle through an automatic car wash that has silicone carbide tire cleaning brushes. These brushes can also damage the surface of these wheels.

Tires

To clean the tires, use a stiff brush with tire cleaner.

Notice: Using petroleum-based tire dressing products on your vehicle may damage the paint finish and/or tires. When applying a tire dressing, always wipe off any overspray from all painted surfaces on your vehicle.

Sheet Metal Damage

If the vehicle is damaged and requires sheet metal repair or replacement, make sure the body repair shop applies anti-corrosion material to parts repaired or replaced to restore corrosion protection.

Original manufacturer replacement parts will provide the corrosion protection while maintaining the warranty.

Finish Damage

Any stone chips, fractures or deep scratches in the finish should be repaired right away. Bare metal will corrode quickly and may develop into major repair expense.

Minor chips and scratches can be repaired with touch-up materials available from your GM dealer. Larger areas of finish damage can be corrected in your GM dealer's body and paint shop.

Underbody Maintenance

Chemicals used for ice and snow removal and dust control can collect on the underbody. If these are not removed, corrosion and rust can develop on the underbody parts such as fuel lines, frame, floor pan, and exhaust system even though they have corrosion protection.

At least every spring, flush these materials from the underbody with plain water. Clean any areas where mud and debris can collect. Dirt packed in close areas of the frame should be loosened before being flushed. Your GM dealer or an underbody car washing system can do this for you.

Chemical Paint Spotting

Some weather and atmospheric conditions can create a chemical fallout. Airborne pollutants can fall upon and attack painted surfaces on the vehicle. This damage can take two forms: blotchy, ring-shaped discolorations, and small, irregular dark spots etched into the paint surface.

Although no defect in the paint job causes this, GM will repair, at no charge to the owner, the surfaces of new vehicles damaged by this fallout condition within 12 months or 12,000 miles (20 000 km) of purchase, whichever occurs first.

Vehicle Care/Appearance Materials

See your GM dealer for more information on purchasing the following products.

Description	Usage
Polishing Cloth Wax-Treated	Interior and exterior polishing cloth.
Tar and Road Oil Remover	Removes tar, road oil and asphalt.
Chrome Cleaner and Polish	Use on chrome or stainless steel.
White Sidewall Tire Cleaner	Removes soil and black marks from whitewalls.
Vinyl Cleaner	Cleans vinyl tops, upholstery and convertible tops.
Glass Cleaner	Removes dirt, grime, smoke and fingerprints.
Chrome and Wire Wheel Cleaner	Removes dirt and grime from chrome wheels and wire wheel covers.
Finish Enhancer	Removes dust, fingerprints, and surface contaminants. Spray on wipe off.

Description	Usage
Swirl Remover Polish	Removes swirl marks, fine scratches and other light surface contamination.
Cleaner Wax	Removes light scratches and protects finish.
Foaming Tire Shine Low Gloss	Cleans, shines and protects in one easy step, no wiping necessary.
Wash Wax Concentrate	Medium foaming shampoo. Cleans and lightly waxes. Biodegradable and phosphate free.
Spot Lifter	Quickly and easily removes spots and stains from carpets, vinyl and cloth upholstery.
Odor Eliminator	Odorless spray odor eliminator used on fabrics, vinyl, leather and carpet.
See your General Motors parts department for these products.	

Vehicle Identification

Vehicle Identification Number (VIN)



This is the legal identifier for your vehicle. It appears on a plate in the front corner of the instrument panel, on the driver's side. You can see it if you look through the windshield from outside your vehicle. The VIN also appears on the Vehicle Certification and Service Parts labels and the certificates of title and registration.

Engine Identification

The 8th character in your VIN is the engine code. This code will help you identify your engine, specifications and replacement parts.

Service Parts Identification Label

You will find this label on your spare tire cover. It is very helpful if you ever need to order parts. On this label, you will find the following:

- VIN
- Model designation
- Paint information
- Production options and special equipment

Be sure that this label is not removed from the vehicle.

Electrical System

Add-On Electrical Equipment

Notice: Don't add anything electrical to your vehicle unless you check with your dealer first. Some electrical equipment can damage your vehicle and the damage wouldn't be covered by your warranty. Some add-on electrical equipment can keep other components from working as they should.

Your vehicle has an airbag system. Before attempting to add anything electrical to your vehicle, see *Servicing Your Airbag-Equipped Vehicle* on page 1-60.

Headlamp Wiring

The headlamp wiring is protected by a circuit breaker. An electrical overload will cause the lamps to go on and off, or in some cases to remain off. If this happens, have your headlamp wiring checked right away.

Windshield Wiper Fuses

The windshield wiper motor is protected by a circuit breaker and a fuse. If the motor overheats due to heavy snow or ice, the wiper will stop until the motor cools. If the overload is caused by some electrical problem, and not snow or ice, be sure to get it fixed.

Power Windows and Other Power Options

Circuit breakers protect the power windows and other power accessories. When the current load is too heavy, the circuit breaker opens and closes, protecting the circuit until the problem is fixed or goes away.

Fuses and Circuit Breakers

The wiring circuits in your vehicle are protected from short circuits by fuses, circuit breakers and fusible thermal links in the wiring itself. This greatly reduces the chance of fires caused by electrical problems.

Look at the silver-colored band inside the fuse. If the band is broken or melted, replace the fuse. Be sure you replace a bad fuse with a new one of the correct size.

If you ever have a problem on the road and don't have a spare fuse, you can borrow one. Just pick some feature of your vehicle that you can get along without – like the radio or air conditioner – and use its fuse, if it is of the value you need. Replace it as soon as you can.

Before replacing a fuse, turn every electrical switch off.

Instrument Panel Fuse Block

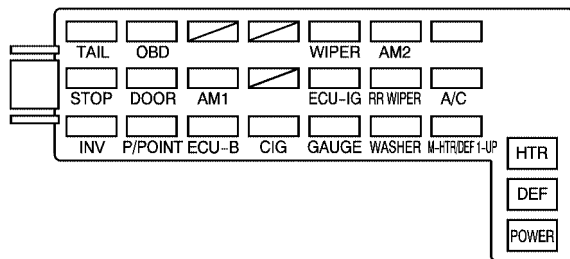

The instrument panel fuse block is located underneath the instrument panel on the driver's side of the vehicle.

Fuses	Usage
TAIL	Front Parking Lamps, Taillamps, License Plate Lamps, Instrument Panel Lights, Engine Control System
OBD	On-Board Diagnostic System
WIPER	Windshield Wipers

Fuses	Usage
AM2	Charging System, Air Bag System, Starter System, Engine Control
STOP	Stop Lamps, CHMSL, Engine Control System, Anti-lock Brakes, Cruise Control
DOOR	Power Door Locks, Liftglass Lock
AM1	Cigarette Lighter, Gauge, ECU-IG, Wiper, Rear Wiper, Washer Fuses
ECU-IG	Cruise Control, Anti-Lock Brakes, Theft Deterrent System, Automatic Transaxle Control System, Electric Cooling Fan
RR WIPER	Rear Window Wiper, Rear Window Defogger
A/C	Air Conditioning
INV	Power Outlets
P/POINT	Power Outlets
ECU-B	Daytime Running Lamps

Fuses	Usage
CIG	Cigarette Lighter, Power Rearview Mirrors, Power Outlets, Audio System, Automatic Transaxle Control System
GAUGE	Gauges and Meters, Back-Up Lamps, Charging System, Power Door Locks, Power Windows, Sunroof, Air Conditioning, Cruise Control
WASHER	Windshield Washers
M-HTR/ DEF 1-UP	Engine Control System
HTR	Air Conditioning System
DEF	Rear Window Defogger, M-HTR/DEF 1-UP Fuse
POWER	Power Windows, Electric Moon Roof

Engine Compartment Fuse Block

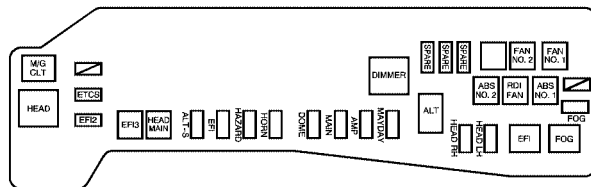

This engine compartment fuse block is located in the engine compartment on the driver's side of the vehicle near the air cleaner. See *Engine Compartment Overview* on page 5-12 for more information on location.

Fuses	Usage
SPARE	Spare Fuse
SPARE	Spare Fuse
SPARE	Spare Fuse
ETCS	Electronic Throttle Control System
ABS NO. 2	Anti-lock Brake System (Without Stability Control System)

Fuses	Usage
RDI FAN	Electric Cooling Fan
ABS NO. 1	Anti-lock Brake System (With Stability Control System)
FOG	Front Fog Lamps
EFI2	Multiport Fuel Injection System/ Sequential Multiport Fuel Injection System, Emission Control System
EFI3	Multiport Fuel Injection System/ Sequential Multiport Fuel Injection System, Emission Control System
HEAD MAIN	Right Headlamp, Left Headlamp Fuses
ALT-S	Charging System
EFI	Electronic Fuel Injection System
HAZARD	Turn Signal Lamps, Emergency Flasher
HORN	Horn
DOME	Interior Lights, Gauges and Meters, Audio System, Remote Keyless Entry System, Navigation System (If Equipped)

Fuses	Usage
MAIN	Starter System, AM2 Fuse
AMP	Audio System
MAYDAY	OnStar [®] System
ALT	ABS NO.1, ABS NO.2, RDI FAN, FOG, Heater, AM1, POWER, DOOR, ECU-B, TAIL, STOP, P/POINT, INV, OBD Fuses, Charging System
HEAD RH	Right-hand Headlamp, Headlamp High Beam Indicator Lamp
HEAD LH	Left-hand Headlamp

Relays	Usage
M/G	M/G
HEAD	Headlamps
DIMMER	Headlamp Dimmer
FAN NO. 2	Cooling Fan System
FAN NO. 1	Cooling Fan System
EFI	Electronic Fuel Injection System
FOG	Fog Lamps

Capacities and Specifications

The following approximate capacities are given in English and metric conversions.

Application	Capacities	
	English	Metric
Air Conditioning Refrigerant R134a	1.47 lbs	0.67 kg
Automatic Transaxle 1.8L (Code 8) 1.8L (Code 8) with AWD 1.8L (Code L)	3.2 quarts 3.1 quarts 4.3 quarts	3.0 L 2.9 L 4.1 L
Cooling System 1.8L (Code 8) 1.8L (Code L)	6.9 quarts 7.1 quarts	6.5 L 6.7 L
Engine Oil with Filter 1.8L (Code 8) 1.8L (Code L)	3.9 quarts 4.8 quarts	3.7 L 4.4 L
Fuel Tank With AWD Without AWD	11.9 gallons 13.2 gallons	45.0 L 50.0 L
Manual Transaxle Five-Speed Six-Speed	2.0 quarts 2.4 quarts	1.9 L 2.3 L

Application	Capacities	
	English	Metric
Rear Differential	0.5 quarts	0.5 L
Transfer Case	0.8 quarts	0.8 L
Wheel Nut Torque	76 ft lb	103 N•m

All capacities are approximate. When adding, be sure to fill to the approximate level, as recommended in this manual. See *Part D: Recommended Fluids and Lubricants on page 6-19*.

Engine Specifications

Engine	VIN Code	Transaxle	Spark Plug Gap
1.8L L4	8	Automatic and Manual	0.043 inches (1.1 mm)
1.8L L4 H.O. DOHC	L	Automatic and Manual	0.043 inches (1.1 mm)

Normal Maintenance Replacement Parts

Replacement parts identified below by name, part number, or specification can be obtained from your GM dealer.

Part	GM Part Numbers	Other Part Numbers
Battery	19001602	35-6YR
Engine Air Cleaner/Filter	88969107	—
Engine Oil Filter 1.8L (Code 8) 1.8L (Code L)	88971573 88969580	— —
Passenger Compartment Air Filter	88970273	—
PCV Valve 1.8L (Code 8) Base Model 1.8L (Code 8) AWD Model 1.8L (Code L)	94859406 94859404 88969512	— — —
Spark Plugs* 1.8L (Code 8) 1.8L (Code L)	94859448 88969637	SK16R11†, IFR5A11†† SK20R11†, IFR6A11††
*Your engine is fitted with iridium-tipped spark plugs. Use only iridium-tipped spark plugs for better engine performance. † DENSO †† NGK		

Section 6 Maintenance Schedule

Maintenance Schedule	6-2	At Least Once a Year	6-14
Introduction	6-2	Part C: Periodic Maintenance Inspections	6-17
Maintenance Requirements	6-2	Steering, Suspension and Front Drive Axle	
Your Vehicle and the Environment	6-2	Boot and Seal Inspection	6-17
How This Section is Organized	6-3	Exhaust System Inspection	6-17
Part A: Scheduled Maintenance Services	6-4	Fuel System Inspection	6-17
Using Your Maintenance Schedule	6-4	Engine Cooling System Inspection	6-18
Scheduled Maintenance	6-4	Throttle System Inspection	6-18
Part B: Owner Checks and Services	6-13	Brake System Inspection	6-18
At Each Fuel Fill	6-13	Part D: Recommended Fluids	
At Least Once a Month	6-13	and Lubricants	6-19
At Least Twice a Year	6-14	Part E: Maintenance Record	6-21

Maintenance Schedule

Introduction

Important: Keep engine oil at the proper level and change as recommended.



Have you purchased the GM Protection Plan? The Plan supplements your new vehicle warranties. See your Warranty and Owner Assistance booklet or your dealer for details.

Maintenance Requirements

Maintenance intervals, checks, inspections and recommended fluids and lubricants as prescribed in this manual are necessary to keep your vehicle in good working condition. Any damage caused by failure to follow scheduled maintenance may not be covered by warranty.

Your Vehicle and the Environment

Proper vehicle maintenance not only helps to keep your vehicle in good working condition, but also helps the environment. Improper vehicle maintenance can even affect the quality of the air we breathe. Improper fluid levels or the wrong tire inflation can increase the level of emissions from your vehicle. To help protect our environment, and to keep your vehicle in good condition, be sure to maintain your vehicle properly.

How This Section is Organized

This maintenance schedule is divided into five parts:

“Part A: Scheduled Maintenance Services” explains what to have done and how often. Some of these services can be complex, so unless you are technically qualified and have the necessary equipment, you should let your GM dealer’s service department do these jobs.

Your GM dealer has GM-trained and supported service people that will perform the work using genuine GM parts.

CAUTION:

Performing maintenance work on a vehicle can be dangerous. In trying to do some jobs, you can be seriously injured. Do your own maintenance work only if you have the required know-how and the proper tools and equipment for the job. If you have any doubt, have a qualified technician do the work.

If you want to get the service information, see *Service Publications Ordering Information* on page 7-11.

“Part B: Owner Checks and Services” tells you what should be checked and when. It also explains what you can easily do to help keep your vehicle in good condition.

“Part C: Periodic Maintenance Inspections” explains important inspections that your dealer’s service department can perform for you.

“Part D: Recommended Fluids and Lubricants” lists some recommended products necessary to help keep your vehicle properly maintained. These products, or their equivalents, should be used whether you do the work yourself or have it done.

“Part E: Maintenance Record” is a place for you to record and keep track of the maintenance performed on your vehicle. Keep your maintenance receipts. They may be needed to qualify your vehicle for warranty repairs.

Part A: Scheduled Maintenance Services

In this part are scheduled maintenance services which are to be performed at the mileage intervals specified.

Using Your Maintenance Schedule

We at General Motors want to keep your vehicle in good working condition. But we do not know exactly how you will drive it. You may drive short distances only a few times a week. Or you may drive long distances all the time in very hot, dusty weather. You may use your vehicle in making deliveries. Or you may drive it to work, to do errands or in many other ways.

Because of the different ways people use their vehicles, maintenance needs may vary. You may need more frequent checks and replacements. So please read the following and note how you drive. If you have questions on how to keep your vehicle in good condition, see your dealer.

This part tells you the maintenance services you should have done and when to schedule them.

When you go to your dealer for your service needs, you will know that GM-trained and supported service people will perform the work using genuine GM parts.

The proper fluids and lubricants to use are listed in Part D. Make sure whoever services your vehicle uses these. All parts should be replaced and all necessary repairs done before you or anyone else drives the vehicle.

This schedule is for vehicles that:

- carry passengers and cargo within recommended limits. You will find these on the tire and loading information label. See *Loading Your Vehicle on page 4-32*.
- are driven on reasonable road surfaces within legal driving limits.
- use the recommended fuel. See *Gasoline Octane on page 5-5*.

Scheduled Maintenance

The services shown in this schedule up to 120,000 miles (192 000 km) should be repeated after 120,000 miles (192 000 km) at the same intervals for the life of this vehicle.

See *Part B: Owner Checks and Services on page 6-13*, *Part C: Periodic Maintenance Inspections on page 6-17*, and *Part D: Recommended Fluids and Lubricants on page 6-19*.

Footnotes

† *The U.S. Environmental Protection Agency or the California Air Resources Board has determined that the failure to perform this maintenance item will not nullify the emissions warranty or limit recall liability prior to the completion of the vehicle's useful life. We, however, urge that all recommended maintenance services be performed at the indicated intervals and the maintenance be recorded.*

+ *A good time to check your brakes is during tire rotation. See Brake System Inspection on page 6-18.*

5,000 Miles (8 000 km)

- Change engine oil and filter (or every 3 months, whichever occurs first). *An Emission Control Service.*
- Rotate tires. See *Tire Inspection and Rotation on page 5-68* for proper rotation pattern and additional information. *(See footnote +.)*
- Inspect engine air cleaner filter if you are driving in dusty conditions. Replace filter if necessary. *An Emission Control Service. (See footnote †.)*

10,000 Miles (16 000 km)

- Change engine oil and filter (or every 3 months, whichever occurs first). *An Emission Control Service.*
- Rotate tires. See *Tire Inspection and Rotation on page 5-68* for proper rotation pattern and additional information. *(See footnote +.)*
- Inspect engine air cleaner filter if you are driving in dusty conditions. Replace filter if necessary. *An Emission Control Service. (See footnote †.)*

15,000 Miles (24 000 km)

- Change engine oil and filter (or every 3 months, whichever occurs first). *An Emission Control Service.*
- Rotate tires. See *Tire Inspection and Rotation on page 5-68* for proper rotation pattern and additional information. *(See footnote +.)*
- Inspect engine air cleaner filter if you are driving in dusty conditions. Replace filter if necessary. *An Emission Control Service. (See footnote †.)*
- Inspect passenger compartment air filter.
- Change transfer case fluid when doing frequent trailer towing.
- Change rear differential fluid when doing frequent trailer towing.

20,000 Miles (32 000 km)

- ❑ Change engine oil and filter (or every 3 months, whichever occurs first). *An Emission Control Service.*
- ❑ Rotate tires. See *Tire Inspection and Rotation on page 5-68* for proper rotation pattern and additional information. (See footnote +.)
- ❑ Inspect engine air cleaner filter if you are driving in dusty conditions. Replace filter if necessary. *An Emission Control Service.* (See footnote †.)

25,000 Miles (40 000 km)

- ❑ Change engine oil and filter (or every 3 months, whichever occurs first). *An Emission Control Service.*
- ❑ Rotate tires. See *Tire Inspection and Rotation on page 5-68* for proper rotation pattern and additional information. (See footnote +.)
- ❑ Inspect engine air cleaner filter if you are driving in dusty conditions. Replace filter if necessary. *An Emission Control Service.* (See footnote †.)

30,000 Miles (48 000 km)

- ❑ Change engine oil and filter (or every 3 months, whichever occurs first). *An Emission Control Service.*
- ❑ Rotate tires. See *Tire Inspection and Rotation on page 5-68* for proper rotation pattern and additional information. (See footnote +.)

- ❑ Replace engine air cleaner filter (or every 24 months, whichever occurs first). See *Engine Air Cleaner/Filter on page 5-21* for more information. *An Emission Control Service.*
- ❑ Replace passenger compartment air filter.
- ❑ Inspect fuel tank, cap, cap gasket and lines for damage or leaks (or every 24 months, whichever occurs first). Replace parts as needed. *An Emission Control Service.* (See footnote †.)
- ❑ Change manual transaxle fluid every 30,000 miles (48 000 km) only if your vehicle is used to tow a trailer.
- ❑ Change transfer case fluid when doing frequent trailer towing.
- ❑ Change rear differential fluid when doing frequent trailer towing.

35,000 Miles (56 000 km)

- ❑ Change engine oil and filter (or every 3 months, whichever occurs first). *An Emission Control Service.*
- ❑ Rotate tires. See *Tire Inspection and Rotation on page 5-68* for proper rotation pattern and additional information. (See footnote +.)
- ❑ Inspect engine air cleaner filter if you are driving in dusty conditions. Replace filter if necessary. *An Emission Control Service.* (See footnote †.)

40,000 Miles (64 000 km)

- Change engine oil and filter (or every 3 months, whichever occurs first). *An Emission Control Service.*
- Rotate tires. See *Tire Inspection and Rotation on page 5-68* for proper rotation pattern and additional information. (See footnote +.)
- Inspect engine air cleaner filter if you are driving in dusty conditions. Replace filter if necessary. *An Emission Control Service.* (See footnote †.)

45,000 Miles (72 000 km)

- Change engine oil and filter (or every 3 months, whichever occurs first). *An Emission Control Service.*
- Rotate tires. See *Tire Inspection and Rotation on page 5-68* for proper rotation pattern and additional information. (See footnote +.)
- Inspect engine air cleaner filter. If necessary, replace the filter. If vehicle is driven in dusty/dirty conditions, inspect filter at every engine oil change. See *Engine Air Cleaner/Filter on page 5-21* for more information. *An Emission Control Service.* (See footnote †.)
- Inspect passenger compartment air filter.
- Change transfer case fluid when doing frequent trailer towing.
- Change rear differential fluid when doing frequent trailer towing.

50,000 Miles (80 000 km)

- Change engine oil and filter (or every 3 months, whichever occurs first). *An Emission Control Service.*
- Rotate tires. See *Tire Inspection and Rotation on page 5-68* for proper rotation pattern and additional information. (See footnote +.)
- Inspect engine air cleaner filter. If necessary, replace the filter. If vehicle is driven in dusty/dirty conditions, inspect filter at every engine oil change. See *Engine Air Cleaner/Filter on page 5-21* for more information. *An Emission Control Service.* (See footnote †.)

55,000 Miles (88 000 km)

- Change engine oil and filter (or every 3 months, whichever occurs first). *An Emission Control Service.*
- Rotate tires. See *Tire Inspection and Rotation on page 5-68* for proper rotation pattern and additional information. (See footnote +.)
- Inspect engine air cleaner filter. If necessary, replace the filter. If vehicle is driven in dusty/dirty conditions, inspect filter at every engine oil change. See *Engine Air Cleaner/Filter on page 5-21* for more information. *An Emission Control Service.* (See footnote †.)

60,000 Miles (100 000 km)

- Change engine oil and filter (or every 3 months, whichever occurs first). *An Emission Control Service.*
- Rotate tires. See *Tire Inspection and Rotation on page 5-68* for proper rotation pattern and additional information. (See footnote +.)
- Replace engine air cleaner filter (or every 24 months, whichever occurs first). *An Emission Control Service.*
- Replace passenger compartment air filter.
- Inspect engine accessory drive belts (or every 48 months, whichever occurs first). *An Emission Control Service.*
- Inspect for tappet noise and engine vibration. Adjust valve clearance to factory specifications if necessary (or every 48 months, whichever occurs first). *An Emission Control Service.*
- Inspect fuel tank, cap, cap gasket and lines for damage or leaks (or every 24 months, whichever occurs first). Replace parts as needed. *An Emission Control Service.* (See footnote †.)
- Change transfer case fluid when doing frequent trailer towing.
- Change rear differential fluid when doing frequent trailer towing.
- Change manual transaxle fluid every 30,000 miles (48 000 km) only if your vehicle is used to tow a trailer.

- Change automatic transaxle fluid every 60,000 miles (96 000 km) if the vehicle is mainly driven under one or more of these conditions:
 - In heavy city traffic where the outside temperature regularly reaches 90°F (32°C) or higher.
 - In hilly or mountainous terrain.
 - When doing frequent trailer towing.
 - Uses such as found in taxi, police or delivery service.

If you do not use your vehicle under any of these condition, the fluid does not require changing. See Part D: Recommended Fluids and Lubricants on page 6-19 for the proper fluid to use.

65,000 Miles 104 000 km)

- Change engine oil and filter (or every 3 months, whichever occurs first). *An Emission Control Service.*
- Rotate tires. See *Tire Inspection and Rotation on page 5-68* for proper rotation pattern and additional information. (See footnote +.)
- Inspect engine air cleaner filter. If necessary, replace the filter. If vehicle is driven in dusty/dirty conditions, inspect filter at every engine oil change. See *Engine Air Cleaner/Filter on page 5-21* for more information. *An Emission Control Service.* (See footnote †.)

70,000 Miles (112 000 km)

- Change engine oil and filter (or every 3 months, whichever occurs first). *An Emission Control Service.*
- Rotate tires. See *Tire Inspection and Rotation on page 5-68* for proper rotation pattern and additional information. (See footnote +.)
- Inspect engine air cleaner filter. If necessary, replace the filter. If vehicle is driven in dusty/dirty conditions, inspect filter at every engine oil change. See *Engine Air Cleaner/Filter on page 5-21* for more information. *An Emission Control Service.* (See footnote †.)

75,000 Miles (120 000 km)

- Change engine oil and filter (or every 3 months, whichever occurs first). *An Emission Control Service.*
- Rotate tires. See *Tire Inspection and Rotation on page 5-68* for proper rotation pattern and additional information. (See footnote +.)
- Inspect engine air cleaner filter. If necessary, replace the filter. If vehicle is driven in dusty/dirty conditions, inspect filter at every engine oil change. See *Engine Air Cleaner/Filter on page 5-21* for more information. *An Emission Control Service.* (See footnote †.)

- Inspect passenger compartment air filter.
- Inspect engine accessory drive belts (or 12 months since last inspection). *An Emission Control Service.*
- Change transfer case fluid when doing frequent trailer towing.
- Change rear differential fluid when doing frequent trailer towing.

80,000 Miles (128 000 km)

- Change engine oil and filter (or every 3 months, whichever occurs first). *An Emission Control Service.*
- Rotate tires. See *Tire Inspection and Rotation on page 5-68* for proper rotation pattern and additional information. (See footnote +.)
- Inspect engine air cleaner filter. If necessary, replace the filter. If vehicle is driven in dusty/dirty conditions, inspect filter at every engine oil change. See *Engine Air Cleaner/Filter on page 5-21* for more information. *An Emission Control Service.* (See footnote †.)

85,000 Miles (136 000 km)

- ❑ Change engine oil and filter (or every 3 months, whichever occurs first). *An Emission Control Service.*
- ❑ Rotate tires. See *Tire Inspection and Rotation on page 5-68* for proper rotation pattern and additional information. (See footnote +.)
- ❑ Inspect engine air cleaner filter. If necessary, replace the filter. If vehicle is driven in dusty/dirty conditions, inspect filter at every engine oil change. See *Engine Air Cleaner/Filter on page 5-21* for more information. *An Emission Control Service.* (See footnote †.)

90,000 Miles (144 000 km)

- ❑ Change engine oil and filter (or every 3 months, whichever occurs first). *An Emission Control Service.*
- ❑ Rotate tires. See *Tire Inspection and Rotation on page 5-68* for proper rotation pattern and additional information. (See footnote +.)
- ❑ Replace engine air cleaner filter (or every 24 months, whichever occurs first). *An Emission Control Service.*
- ❑ Replace passenger compartment air filter.
- ❑ Inspect engine accessory drive belts (or 12 months since last inspection). *An Emission Control Service.*

- ❑ Inspect fuel tank, cap, cap gasket and lines for damage or leaks (or every 24 months, whichever occurs first). Replace parts as needed. *An Emission Control Service.* (See footnote †.)
- ❑ Change manual transaxle fluid every 30,000 miles (48 000 km) only if your vehicle is used to tow a trailer.
- ❑ Change transfer case fluid when doing frequent trailer towing.
- ❑ Change rear differential fluid when doing frequent trailer towing.

95,000 Miles (152 000 km)

- ❑ Change engine oil and filter (or every 3 months, whichever occurs first). *An Emission Control Service.*
- ❑ Rotate tires. See *Tire Inspection and Rotation on page 5-68* for proper rotation pattern and additional information. (See footnote +.)
- ❑ Inspect engine air cleaner filter. If necessary, replace the filter. If vehicle is driven in dusty/dirty conditions, inspect filter at every engine oil change. See *Engine Air Cleaner/Filter on page 5-21* for more information. *An Emission Control Service.* (See footnote †.)

100,000 Miles (160 000 km)

- ❑ Change engine oil and filter (or every 3 months, whichever occurs first). *An Emission Control Service.*
- ❑ Rotate tires. See *Tire Inspection and Rotation on page 5-68* for proper rotation pattern and additional information. (See footnote +.)
- ❑ Inspect engine air cleaner filter. If necessary, replace the filter. If vehicle is driven in dusty/dirty conditions, inspect filter at every engine oil change. See *Engine Air Cleaner/Filter on page 5-21* for more information. *An Emission Control Service.* (See footnote †.)
- ❑ Drain, flush and refill the cooling system (or every 5 years, whichever occurs first). See *Engine Coolant on page 5-28* for what to use. Inspect hoses. Clean radiator, condenser, pressure cap, and neck. Pressure test cooling system and pressure cap. *An Emission Control Service.*

105,000 Miles (168 000 km)

- ❑ Change engine oil and filter (or every 3 months, whichever occurs first). *An Emission Control Service.*
- ❑ Rotate tires. See *Tire Inspection and Rotation on page 5-68* for proper rotation pattern and additional information. (See footnote +.)

- ❑ Inspect engine air cleaner filter. If necessary, replace the filter. If vehicle is driven in dusty/dirty conditions, inspect filter at every engine oil change. See *Engine Air Cleaner/Filter on page 5-21* for more information. *An Emission Control Service.* (See footnote †.)
- ❑ Inspect passenger compartment air filter.
- ❑ Change transfer case fluid when doing frequent trailer towing.
- ❑ Change rear differential fluid when doing frequent trailer towing.

110,000 Miles (176 000 km)

- ❑ Change engine oil and filter (or every 3 months, whichever occurs first). *An Emission Control Service.*
- ❑ Rotate tires. See *Tire Inspection and Rotation on page 5-68* for proper rotation pattern and additional information. (See footnote +.)
- ❑ Inspect engine air cleaner filter. If necessary, replace the filter. If vehicle is driven in dusty/dirty conditions, inspect filter at every engine oil change. See *Engine Air Cleaner/Filter on page 5-21* for more information. *An Emission Control Service.* (See footnote †.)

115,000 Miles (184 000 km)

- ❑ Change engine oil and filter (or every 3 months, whichever occurs first). *An Emission Control Service.*
- ❑ Rotate tires. See *Tire Inspection and Rotation on page 5-68* for proper rotation pattern and additional information. (See footnote +.)
- ❑ Inspect engine air cleaner filter. If necessary, replace the filter. If vehicle is driven in dusty/dirty conditions, inspect filter at every engine oil change. See *Engine Air Cleaner/Filter on page 5-21* for more information. *An Emission Control Service.* (See footnote †.)

120,000 Miles (192 000 km)

- ❑ Change engine oil and filter (or every 3 months, whichever occurs first). *An Emission Control Service.*
- ❑ Rotate tires. See *Tire Inspection and Rotation on page 5-68* for proper rotation pattern and additional information. (See footnote +.)
- ❑ Replace engine air cleaner filter (or every 24 months, whichever occurs first). *An Emission Control Service.*
- ❑ Replace passenger compartment air filter.
- ❑ Inspect engine accessory drive belts (or every 48 months, whichever occurs first). *An Emission Control Service.*
- ❑ Replace spark plugs. *An Emission Control Service.*

- ❑ Inspect for tappet noise and engine vibration. Adjust valve clearance to factory specifications if necessary (or every 48 months, whichever occurs first). *An Emission Control Service.*
- ❑ Inspect fuel tank, cap, cap gasket and lines for damage or leaks (or every 24 months, whichever occurs first). Replace parts as needed. *An Emission Control Service.* (See footnote †.)
- ❑ Change transfer case fluid when doing frequent trailer towing.
- ❑ Change rear differential fluid when doing frequent trailer towing.
- ❑ Change manual transaxle fluid every 30,000 miles (48 000 km) only if your vehicle is used to tow a trailer.
- ❑ Change automatic transaxle fluid every 60,000 miles (96 000 km) if the vehicle is mainly driven under one or more of these conditions:
 - In heavy city traffic where the outside temperature regularly reaches 90°F (32°C) or higher.
 - In hilly or mountainous terrain.
 - When doing frequent trailer towing.
 - Uses such as found in taxi, police or delivery service.

If you do not use your vehicle under any of these conditions, the fluid does not require changing. See Part D: Recommended Fluids and Lubricants on page 6-19 for the proper fluid to use.

Part B: Owner Checks and Services

Listed in this part are owner checks and services which should be performed at the intervals specified to help ensure the safety, dependability and emission control performance of your vehicle.

Be sure any necessary repairs are completed at once. Whenever any fluids or lubricants are added to your vehicle, make sure they are the proper ones, as shown in Part D.

At Each Fuel Fill

It is important for you or a service station attendant to perform these underhood checks at each fuel fill.

Engine Oil Level Check

Check the engine oil level and add the proper oil if necessary. See *Engine Oil* on page 5-16 for further details.

Engine Coolant Level Check

Check the engine coolant level and add the proper coolant mixture if necessary. See *Engine Coolant* on page 5-28 for further details.

Windshield Washer Fluid Level Check

Check the windshield washer fluid level in the windshield washer tank and add the proper fluid if necessary. See *Windshield Washer Fluid* on page 5-38 for further details.

Hood Latch Operation Check

Pull the primary hood latch release handle inside the vehicle. The secondary latch should keep the hood from opening all the way when the primary latch is released. Make sure the hood closes firmly. See *Hood Release* on page 5-10 for further details.

At Least Once a Month

Tire Inflation Check

Visually inspect your tires and make sure tires are inflated to the correct pressures. Do not forget to check your spare tire. See *Tires* on page 5-57 for further details.

At Least Twice a Year

Restraint System Check

Make sure the safety belt reminder light and all your belts, buckles, latch plates, retractors and anchorages are working properly. Look for any other loose or damaged safety belt system parts. If you see anything that might keep a safety belt system from doing its job, have it repaired. Have any torn or frayed safety belts replaced.

Also look for any opened or broken air bag coverings, and have them repaired or replaced. (The air bag system does not need regular maintenance.)

Wiper Blade Check

Inspect wiper blades for wear or cracking. Replace blade inserts that appear worn or damaged or that streak or miss areas of the windshield. Also see *Windshield, Backglass, and Wiper Blades on page 5-91*.

Weatherstrip Lubrication

Silicone grease on weatherstrips will make them last longer, seal better, and not stick or squeak. Apply silicone grease with a clean cloth. During very cold, damp weather more frequent application may be required. See *Part D: Recommended Fluids and Lubricants on page 6-19*.

Fluid Level Check

Check the power steering pump and automatic or manual transaxle fluid levels and add as needed. See *Power Steering Fluid on page 5-37* and *Automatic Transaxle Fluid on page 5-23* or *Manual Transaxle Fluid on page 5-26*. Check for leaks. A fluid loss in these systems could indicate a problem. Have the system inspected and repaired at once.

At Least Once a Year

Key Lock Cylinders Service

Lubricate the key lock cylinders with the lubricant specified in Part D.

Seat Operation Check

Make sure the head restraints stay in position and all seat latches lock. Check that the recliner holds by pushing and pulling the seatback while it is reclined.

Body Lubrication Service

Lubricate all hood latch assembly, secondary latch, pivots, spring anchor, release pawl, hood and body door hinges, rear compartment and any folding seat hardware. Part D tells you what to use. More frequent lubrication may be required when exposed to a corrosive environment.

Starter Switch Check

CAUTION:

When you are doing this inspection, the vehicle could move suddenly. If the vehicle moves, you or others could be injured.

1. Before you start, be sure you have enough room around the vehicle.
2. Firmly apply both the parking brake and the regular brake. See *Parking Brake on page 2-28* if necessary.

Do not use the accelerator pedal, and be ready to turn off the engine immediately if it starts.

3. On automatic transaxle vehicles, try to start the engine in each gear. The starter should work only in PARK (P) or NEUTRAL (N). If the starter works in any other position, your vehicle needs service.

On manual transaxle vehicles, put the shift lever in NEUTRAL (N), push the clutch down halfway and try to start the engine. The starter should work only when the clutch is pushed down all the way to the floor. If the starter works when the clutch is not pushed all the way down, your vehicle needs service.

Automatic Transaxle Shift Lock Control System Check

CAUTION:

When you are doing this inspection, the vehicle could move suddenly. If the vehicle moves, you or others could be injured.

1. Before you start, be sure you have enough room around the vehicle. It should be parked on a level surface.
2. Firmly apply the parking brake. See *Parking Brake on page 2-28* if necessary.
Be ready to apply the regular brake immediately if the vehicle begins to move.
3. With the engine off, turn the ignition to ON, but do not start the engine. Without applying the regular brake, try to move the shift lever out of PARK (P) with normal effort. If the shift lever moves out of PARK (P), your vehicle needs service.

Ignition Transaxle Lock Check

While parked, and with the parking brake set, try to turn the ignition to LOCK in each shift lever position.

- With an automatic transaxle, the ignition should turn to LOCK only when the shift lever is in PARK (P).
- With a manual transaxle, the ignition should turn to LOCK only if you push the key in farther, while turning it toward LOCK.

Parking Brake and Automatic Transaxle Park (P) Mechanism Check

CAUTION:

When you are doing this check, your vehicle could begin to move. You or others could be injured and property could be damaged. Make sure there is room in front of your vehicle in case it begins to roll. Be ready to apply the regular brake at once should the vehicle begin to move.

Park on a fairly steep hill, with the vehicle facing downhill. Keeping your foot on the regular brake, set the parking brake.

- To check the parking brake's holding ability: With the engine running and transaxle in NEUTRAL (N), slowly remove foot pressure from the regular brake pedal. Do this until the vehicle is held by the parking brake only.
- To check the PARK (P) mechanism's holding ability: With the engine running, shift to PARK (P). Then release the parking brake followed by the regular brake.

Underbody Flushing Service

At least every spring, use plain water to flush any corrosive materials from the underbody. Take care to clean thoroughly any areas where mud and other debris can collect.

Part C: Periodic Maintenance Inspections

Listed in this part are inspections and services which should be performed at least twice a year (for instance, each spring and fall). *You should let your dealer's service department do these jobs. Make sure any necessary repairs are completed at once.*

Proper procedures to perform these services may be found in a service manual. See *Service Publications Ordering Information* on page 7-11.

Steering, Suspension and Front Drive Axle Boot and Seal Inspection

Inspect the front and rear suspension and steering system for damaged, loose or missing parts, signs of wear or lack of lubrication. Inspect the power steering lines and hoses for proper hook-up, binding, leaks, cracks, chafing, etc. Clean and then inspect the drive axle boot seals for damage, tears or leakage. Replace seals if necessary.

Exhaust System Inspection

Inspect the complete exhaust system. Inspect the body near the exhaust system. Look for broken, damaged, missing or out-of-position parts as well as open seams, holes, loose connections or other conditions which could cause a heat build-up in the floor pan or could let exhaust fumes into the vehicle. See *Engine Exhaust* on page 2-32.

Fuel System Inspection

Inspect the complete fuel system for damage or leaks.

Engine Cooling System Inspection

Inspect the hoses and have them replaced if they are cracked, swollen or deteriorated. Inspect all pipes, fittings and clamps; replace as needed. Clean the outside of the radiator and air conditioning condenser. To help ensure proper operation, a pressure test of the cooling system and pressure cap is recommended at least once a year.

Throttle System Inspection

Inspect the throttle system for interference or binding, and for damaged or missing parts. Replace parts as needed. Replace any components that have high effort or excessive wear. Do not lubricate accelerator and cruise control cables.

Brake System Inspection

Inspect the complete system. Inspect brake lines and hoses for proper hook-up, binding, leaks, cracks, chafing, etc. Inspect disc brake pads for wear and rotors for surface condition. Also inspect drum brake linings for wear and cracks. Inspect other brake parts, including drums, wheel cylinders, calipers, parking brake, etc. Check parking brake adjustment. You may need to have your brakes inspected more often if your driving habits or conditions result in frequent braking.

Part D: Recommended Fluids and Lubricants

Fluids and lubricants identified below by name, part number or specification may be obtained from your dealer.

Usage	Fluid/Lubricant
Engine Oil	Engine oil which meets GM Standard GM6094M and displays the American Petroleum Institute Certified for Gasoline Engines starburst symbol. GM Goodwrench oil meets all the requirements for your vehicle. To determine the proper viscosity for your vehicle's engine, see <i>Engine Oil on page 5-16</i> .
Engine Coolant	50/50 mixture of clean, drinkable water and use only DEX-COOL [®] Coolant. See <i>Engine Coolant on page 5-28</i> .
Hydraulic Brake/Clutch System	Delco Supreme 11 Brake Fluid or equivalent DOT-3 brake fluid.
Windshield Washer Solvent	GM Optikleen [®] Washer Solvent.

Usage	Fluid/Lubricant
Power Steering System	DEXRON [®] -III Automatic Transmission Fluid. Look for "Approved for the H-Specification" on the label.
Manual Transaxle	GM Goodwrench Synthetic Manual Transmission Fluid (GM Part No. U.S. 12346190, in Canada 10953477 — 1 quart) or SAE 75W-90 GL-5 gear oil.
Automatic Transaxle	Use only T-IV Automatic Transmission Fluid (GM Part No. U.S. 88900925, in Canada 22689186). See <i>Automatic Transaxle Fluid on page 5-23</i> .
Key Lock Cylinders	Multi-Purpose Lubricant, Superlube (GM Part No. U.S. 12346241, in Canada 10953474).
Manual Transaxle Shift Linkage	Chassis Lubricant (GM Part No. U.S. 12377985, in Canada 88901242) or lubricant meeting requirements of NLGI #2, Category LB or GC-LB.

Usage	Fluid/Lubricant
Clutch Linkage Pivot Points	Chassis Lubricant (GM Part No. U.S. 12377985, in Canada 88901242) or lubricant meeting requirements of NLGI #2, Category LB or GC-LB.
Floor Shift Linkage	Lubriplate Lubricant Aerosol (GM Part No. U.S. 12346293, in Canada 992723) or lubricant meeting requirements of NLGI #2 Category LB or GC-LB.
Chassis Lubrication	Chassis Lubricant (GM Part No. U.S. 12377985, in Canada 88901242) or lubricant meeting requirements of NLGI #2, Category LB or GC-LB.
Rear Axle (All-Wheel Drive)	Axle Lubricant (GM Part No. U.S. 12345977, in Canada 10953482) or SAE 80W-90 GL-5 gear lubricant.

Usage	Fluid/Lubricant
Transfer Case (All-Wheel Drive)	Axle Lubricant (GM Part No. U.S. 12345977, in Canada 10953482) or SAE 80W-90 GL-5 gear lubricant.
Hood Latch Assembly, Secondary Latch, Pivots, Spring Anchor and Release Pawl	Lubriplate Lubricant Aerosol (GM Part No. U.S. 12346293, in Canada 992723) or lubricant meeting requirements of NLGI #2, Category LB or GC-LB.
Hood and Door Hinges	Multi-Purpose Lubricant, Superlube (GM Part No. U.S. 12346241, in Canada 10953474).
Weatherstrip Conditioning	Dielectric Silicone Grease (GM Part No. U.S. 12345579, in Canada 992887).

Part E: Maintenance Record

After the scheduled services are performed, record the date, odometer reading and who performed the service and any additional information from "Owner Checks and Services" or "Periodic Maintenance" on the following record pages. Also, you should retain all maintenance receipts.

Maintenance Record

Date	Odometer Reading	Serviced By	Maintenance Record

Maintenance Record (cont'd)

Date	Odometer Reading	Serviced By	Maintenance Record

Maintenance Record (cont'd)

Date	Odometer Reading	Serviced By	Maintenance Record

Maintenance Record (cont'd)

Date	Odometer Reading	Serviced By	Maintenance Record

Section 7 Customer Assistance and Information

Customer Assistance and Information	7-2	Reporting Safety Defects	7-10
Customer Satisfaction Procedure	7-2	Reporting Safety Defects to the	
Online Owner Center	7-3	United States Government	7-10
Customer Assistance for Text Telephone		Reporting Safety Defects to the	
(TTY) Users	7-4	Canadian Government	7-11
Customer Assistance Offices	7-4	Reporting Safety Defects to	
GM Mobility Program for Persons		General Motors	7-11
with Disabilities	7-5	Service Publications Ordering Information	7-11
Roadside Assistance Program	7-6		
Courtesy Transportation	7-7		
Vehicle Data Collection and Event			
Data Recorders	7-9		

Customer Assistance and Information

Customer Satisfaction Procedure

Your satisfaction and goodwill are important to your dealer and to Pontiac. Normally, any concerns with the sales transaction or the operation of your vehicle will be resolved by your dealer's sales or service departments. Sometimes, however, despite the best intentions of all concerned, misunderstandings can occur. If your concern has not been resolved to your satisfaction, the following steps should be taken:

STEP ONE: Discuss your concern with a member of dealership management. Normally, concerns can be quickly resolved at that level. If the matter has already been reviewed with the sales, service or parts manager, contact the owner of the dealership or the general manager.

STEP TWO: If after contacting a member of dealership management, it appears your concern cannot be resolved by the dealership without further help, contact the Pontiac Customer Assistance Center by calling 1-800-762-2737. In Canada, contact GM of Canada Customer Communication Centre in Oshawa by calling 1-800-263-3777 (English) or 1-800-263-7854 (French).

We encourage you to call the toll-free number in order to give your inquiry prompt attention. Please have the following information available to give the Customer Assistance Representative:

- Vehicle Identification Number (VIN). This is available from the vehicle registration or title, or the plate at the top left of the instrument panel and visible through the windshield.
- Dealership name and location.
- Vehicle delivery date and present mileage.

When contacting Pontiac, please remember that your concern will likely be resolved at a dealer's facility. That is why we suggest you follow Step One first if you have a concern.

STEP THREE: Both General Motors and your dealer are committed to making sure you are completely satisfied with your new vehicle. However, if you continue to remain unsatisfied after following the procedure outlined in Steps One and Two, you should file with the BBB Auto Line Program to enforce any additional rights you may have. Canadian owners refer to your Warranty and Owner Assistance Information booklet for information on the Canadian Motor Vehicle Arbitration Plan (CAMVAP).

The BBB Auto Line Program is an out of court program administered by the Council of Better Business Bureaus to settle automotive disputes regarding vehicle repairs or the interpretation of the New Vehicle Limited Warranty. Although you may be required to resort to this informal dispute resolution program prior to filing a court action, use of the program is free of charge and your case will generally be heard within 40 days. If you do not agree with the decision given in your case, you may reject it and proceed with any other venue for relief available to you.

You may contact the BBB Auto Line Program using the toll-free telephone number or write them at the following address:

BBB Auto Line Program
Council of Better Business Bureaus, Inc.
4200 Wilson Boulevard
Suite 800
Arlington, VA 22203-1838
Telephone: 1-800-955-5100

This program is available in all 50 states and the District of Columbia. Eligibility is limited by vehicle age, mileage and other factors. General Motors reserves the right to change eligibility limitations and/or discontinue its participation in this program.

Online Owner Center

The Owner Center is a resource for your GM ownership needs. Specific vehicle information can be found in one place.

The Online Owner Center allows you to:

- Get e-mail service reminders.
- Access information about your specific vehicle, including tips and videos and an electronic version of this owner's manual. (United States only)
- Keep track of your vehicle's service history and maintenance schedule.
- Find GM dealers for service nationwide.
- Receive special promotions and privileges only available to members. (United States only)

Refer to the web for updated information.

To register your vehicle, visit www.MyGMLink.com. (United States) or My GM Canada within www.gmcanada.com (Canada).

Customer Assistance for Text Telephone (TTY) Users

To assist customers who are deaf, hard of hearing, or speech-impaired and who use Text Telephones (TTYs), Pontiac has TTY equipment available at its Customer Assistance Center. Any TTY user can communicate with Pontiac by dialing: 1-800-833-PONT (7668). (TTY users in Canada can dial 1-800-263-3830.)

Customer Assistance Offices

Pontiac encourages customers to call the toll-free number for assistance. If a U.S. customer wishes to write to Pontiac, the letter should be addressed to Pontiac's Customer Assistance Center.

United States — Customer Assistance

Pontiac Customer Assistance Center
P.O. Box 33172
Detroit, MI 48232-5172

1-800-762-2737 or
1-800-833-7668 (For Text Telephone devices (TTYs))
Roadside Assistance: 1-800-ROADSIDE (762-3743)
Fax Number: 313-381-0022

From Puerto Rico:
1-800-496-9992 (English)
1-800-496-9993 (Spanish)
Fax Number: 313-381-0022

From U.S. Virgin Islands:
1-800-496-9994
Fax Number: 313-381-0022

Canada — Customer Assistance

General Motors of Canada Limited
Customer Communication Centre, 163-005
1908 Colonel Sam Drive
Oshawa, Ontario L1H 8P7

1-800-263-3777 (English)
1-800-263-7854 (French)
1-800-263-3830 (For Text Telephone devices (TTYs))
Roadside Assistance: 1-800-268-6800

Overseas — Customer Assistance

Please contact the local General Motors Business Unit.

Mexico, Central America and Caribbean Islands/Countries (Except Puerto Rico and U.S. Virgin Islands) — Customer Assistance

General Motors de Mexico, S. de R.L. de C.V.
Customer Assistance Center
Paseo de la Reforma # 2740
Col. Lomas de Bezares
C.P. 11910, Mexico, D.F.
01-800-508-0000
Long Distance: 011-52-53 29 0 800

GM Mobility Program for Persons with Disabilities

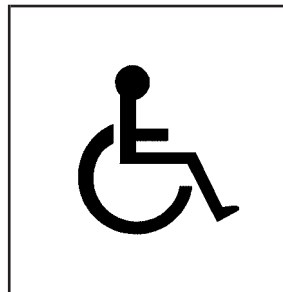

This program, available to qualified applicants, can reimburse you up to \$1,000 toward eligible aftermarket driver or passenger adaptive equipment that may be required for your vehicle, such as hand controls, wheelchair/scooter lifts, etc.

This program can also provide you with free resource information, such as area driver assessment centers and mobility equipment installers. The offer is available for a limited period of time from the date of vehicle purchase/lease. For more details, or to determine your vehicle's eligibility, see your GM dealer or call the GM Mobility Assistance Center at 1-800-323-9935. Text telephone (TTY) users, call 1-800-833-9935.

GM of Canada also has a Mobility Program. Call 1-800-GM-DRIVE (463-7483) for details. All TTY users call 1-800-263-3830.

Roadside Assistance Program

As the owner of a new Pontiac vehicle, you are automatically enrolled in the Pontiac Roadside Assistance program. This value-added service is intended to provide you with peace of mind as you drive in the city or travel the open road. Contact Pontiac's Roadside Assistance toll-free at 1-800-ROADSIDE (762-3743). Roadside Assistance Representatives are available 24 hours a day, 365 days a year.

We will provide the following services during the Bumper-to-Bumper warranty period, at no expense to you:

- **Fuel Delivery:** Delivery of enough fuel (\$5 maximum) for the customer to get to the nearest service station.
- **Lock-out Service (identification required):** Replacement keys or locksmith service will be covered at no charge if you are unable to gain entry into your vehicle. Delivery of the replacement key will be covered within 10 miles (16 km).
- **Emergency Tow:** Tow to the nearest dealership for warranty service or in the event of a vehicle-disabling accident. Assistance provided when the vehicle is mired in sand, mud, or snow.

- **Flat Tire Change:** Installation of a spare tire will be covered at no charge. The customer is responsible for the repair or replacement of the tire if not covered by a warrantable failure.
- **Jump Start:** No-start occurrences which require a battery jump start will be covered at no charge.
- **Dealer Locator Service**

In many instances, mechanical failures are covered under Pontiac's Bumper-to-Bumper warranty. However, when other services are utilized, our Roadside Assistance Representatives will explain any payment obligations you might incur.

For prompt and efficient assistance when calling, please provide the following to the Roadside Assistance Representative:

- Your name, home address, and home telephone number
- Telephone number of your location
- Location of the vehicle
- Model, year, color, and license plate number
- Mileage, Vehicle Identification Number (VIN), and delivery date of the vehicle
- Description of the problem

While we hope you never have the occasion to use our service, it is added security while traveling for you and your family. Remember, we are only a phone call away. Pontiac Roadside Assistance: 1-800-ROADSIDE (762-3743), text telephone (TTY) users, call 1-888-889-2438.

Pontiac reserves the right to limit services or reimbursement to an owner or driver when, in Pontiac's judgement, the claims become excessive in frequency or type of occurrence.

Roadside Assistance is not part of or included in the coverage provided by the New Vehicle Limited Warranty. Pontiac reserves the right to make any changes or discontinue the Roadside Assistance program at any time without notification.

Canadian Roadside Assistance

Vehicles purchased in Canada have an extensive roadside assistance program accessible from anywhere in Canada or the United States. Please refer to the Warranty and Owner Assistance Information book.

Courtesy Transportation

Pontiac has always exemplified quality and value in its offering of motor vehicles. To enhance your ownership experience, we and our participating dealers are proud to offer Courtesy Transportation, a customer support program for new vehicles.

The Courtesy Transportation program is offered to retail purchase/lease customers in conjunction with the Bumper-to-Bumper coverage provided by the New Vehicle Limited Warranty. Several transportation options are available when warranty repairs are required. This will reduce your inconvenience during warranty repairs.

Scheduling Service Appointments

When your vehicle requires warranty service, you should contact your dealer and request an appointment. By scheduling a service appointment and advising your service consultant of your transportation needs, your dealer can help minimize your inconvenience.

If your vehicle cannot be scheduled into the service department immediately, keep driving it until it can be scheduled for service, unless, of course, the problem is safety-related. If it is, please call your dealership, let them know this, and ask for instructions.

If the dealer requests that you simply drop the vehicle off for service, you are urged to do so as early in the work day as possible to allow for same day repair.

Transportation Options

Warranty service can generally be completed while you wait. However, if you are unable to wait Pontiac helps minimize your inconvenience by providing several transportation options. Depending on the circumstances, your dealer can offer you one of the following:

Shuttle Service

Participating dealers can provide you with shuttle service to get you to your destination with minimal interruption of your daily schedule. This includes a one way or round trip shuttle ride to a destination up to 10 miles (16 km) from the dealership.

Public Transportation or Fuel Reimbursement

If your vehicle requires overnight warranty repairs, reimbursement (five days maximum) may be available for the use of public transportation such as taxi or bus. In addition, should you arrange transportation through a friend or relative, reimbursement for reasonable fuel expenses (five day maximum) may be available. Claim amounts should reflect actual costs and be supported by original receipts.

Courtesy Rental Vehicle

Your dealer may arrange to provide you with a courtesy rental vehicle or reimburse you for a rental vehicle you obtained if your vehicle is kept for a warranty repair. Reimbursement will be limited to a maximum of \$30 a day and must be supported by receipts. This requires that you sign and complete a rental agreement and meet state, local and rental vehicle provider requirements. Requirements vary and may include minimum age requirements, insurance coverage, credit card, etc. You are responsible for fuel usage charges and may also be responsible for taxes, levies, usage fees, excessive mileage or rental usage beyond the completion of the repair.

Generally it is not possible to provide a like-vehicle as a courtesy rental.

Additional Program Information

Courtesy Transportation is available during the Bumper-to-Bumper warranty coverage period, but it *is not* part of the New Vehicle Limited Warranty. A separate booklet entitled *Warranty and Owner Assistance Information* furnished with each new vehicle provides detailed warranty coverage information.

Courtesy Transportation is available only at participating dealers and all program options, such as shuttle service, may not be available at every dealer. Please contact your dealer for specific information about availability. All Courtesy Transportation arrangements will be administered by appropriate dealer personnel.

Canadian Vehicles: For warranty repairs during the Complete Vehicle Coverage period of the General Motors of Canada New Vehicle Limited warranty, alternative transportation may be available under the Courtesy Transportation Program. Please consult your dealer for details.

General Motors reserves the right to unilaterally modify, change or discontinue Courtesy Transportation at any time and to resolve all questions of claim eligibility pursuant to terms and conditions described herein at its sole discretion.

Vehicle Data Collection and Event Data Recorders

Your vehicle, like other modern motor vehicles, has a number of sophisticated computer systems that monitor and control several aspects of the vehicle's performance. Your vehicle uses on-board vehicle computers to monitor emission control components to optimize fuel economy, to monitor conditions for air bag deployment and, if so equipped, to provide anti-lock braking and to help the driver control the vehicle in difficult driving situations. Some information may be stored during regular operations to facilitate repair of detected malfunctions; other information is stored only in a crash event by computer systems, such as those commonly called event data recorders (EDR).

In a crash event, computer systems, such as the Air Bag Sensing and Diagnostic Module (SDM) in your vehicle may record information about safety belt usage. If your vehicle is equipped with Stabilitrak[®], steering performance, including yaw rate, steering wheel angle, and lateral acceleration, is also recorded. Unlike the data recorders on many airplanes, these on-board systems do not record sounds, such as conversation of vehicle occupants.

To read this information, special equipment is needed and access to the vehicle or the device that stores the data is required. GM will not access information about a crash event or share it with others other than:

- with the consent of the vehicle owner or, if the vehicle is leased, with the consent of the lessee,
- in response to an official request of police or similar government office,
- as part of GM's defense of litigation through the discovery process, or
- as required by law.

In addition, once GM collects or receives data, GM may:

- use the data for GM research needs,
- make it available for research where appropriate confidentiality is to be maintained and need is shown, or
- share summary data which is not tied to a specific vehicle with non-GM organizations for research purposes.

Others, such as law enforcement, may have access to the special equipment that can read the information if they have access to the vehicle or the device that stores the data.

If your vehicle is equipped with OnStar[®], please check the OnStar[®] subscription service agreement or manual for information on its operations and data collection.

Reporting Safety Defects

Reporting Safety Defects to the United States Government

If you believe that your vehicle has a defect which could cause a crash or could cause injury or death, you should immediately inform the National Highway Traffic Safety Administration (NHTSA), in addition to notifying General Motors.

If NHTSA receives similar complaints, it may open an investigation, and if it finds that a safety defect exists in a group of vehicles, it may order a recall and remedy campaign. However, NHTSA cannot become involved in individual problems between you, your dealer, or General Motors.

To contact NHTSA, you may either call the Auto Safety Hotline toll-free at 1-800-424-9393 (or 366-0123 in the Washington, D.C. area) or write to:

NHTSA, U.S. Department of Transportation
Washington, D.C. 20590

You can also obtain other information about motor vehicle safety from the hotline.

Reporting Safety Defects to the Canadian Government

If you live in Canada, and you believe that your vehicle has a safety defect, you should immediately notify Transport Canada, in addition to notifying General Motors of Canada Limited. You may write to:

Transport Canada
330 Sparks Street
Tower C
Ottawa, Ontario K1A 0N5

Reporting Safety Defects to General Motors

In addition to notifying NHTSA (or Transport Canada) in a situation like this, we certainly hope you'll notify us. Please call us at 1-800-762-2737, or write:

Pontiac Customer Assistance Center
P.O. Box 33172
Detroit, MI 48232-5172

In Canada, please call us at 1-800-263-3777 (English) or 1-800-263-7854 (French). Or, write:

General Motors of Canada Limited
Customer Communication Centre, 163-005
1908 Colonel Sam Drive
Oshawa, Ontario L1H 8P7

Service Publications Ordering Information

Service Manuals

Service Manuals have the diagnosis and repair information on engines, transmission, axle, suspension, brakes, electrical, steering, body, etc.

RETAIL SELL PRICE: \$120.00

Transmission, Transaxle, Transfer Case Unit Repair Manual

This manual provides information on unit repair service procedures, adjustments, and specifications for GM transmissions, transaxles, and transfer cases.

RETAIL SELL PRICE: \$50.00

Service Bulletins

Service Bulletins give technical service information needed to knowledgeably service General Motors cars and trucks. Each bulletin contains instructions to assist in the diagnosis and service of your vehicle.

In Canada, information pertaining to Product Service Bulletins can be obtained by contacting your General Motors dealer or by calling 1-800-GM-DRIVE (1-800-463-7483).

Owner's Information

Owner publications are written specifically for owners and intended to provide basic operational information about the vehicle. The owner's manual will include the Maintenance Schedule for all models.

In-Portfolio: Includes a Portfolio, Owner's Manual, and Warranty Booklet.

RETAIL SELL PRICE: \$35.00

Without Portfolio: Owner's Manual only.

RETAIL SELL PRICE: \$25.00

Current and Past Model Order Forms

Service Publications are available for current and past model GM vehicles. To request an order form, please specify year and model name of the vehicle.

ORDER TOLL FREE: 1-800-551-4123 Monday-Friday 8:00 AM - 6:00 PM Eastern Time

For Credit Card Orders Only
(VISA-MasterCard-Discover), visit Helm, Inc. on the
World Wide Web at: www.helminc.com

Or you can write to:

Helm, Incorporated
P. O. Box 07130
Detroit, MI 48207

Prices are subject to change without notice and without incurring obligation. Allow ample time for delivery.

Note to Canadian Customers: All listed prices are quoted in U.S. funds. Canadian residents are to make checks payable in U.S. funds.

A

Accessory Power Outlets	3-18	Antenna, Fixed Mast	3-65
Adding Equipment to Your Airbag-Equipped Vehicle	1-61	Antenna, XM™ Satellite Radio Antenna System	3-65
Additives, Fuel	5-6	Anti-Lock Brake System (ABS)	4-7
Add-On Electrical Equipment	5-95	Anti-Lock Brake, System Warning Light	3-33
Air Cleaner/Filter, Engine	5-21	Appearance Care	5-87
Air Conditioning	3-20	Aluminum Wheels	5-92
Airbag Passenger Status Indicator	3-30	Care of Safety Belts	5-90
Readiness Light	3-29	Chemical Paint Spotting	5-93
Airbag Sensing and Diagnostic Module (SDM)	7-9	Cleaning Exterior Lamps/Lenses	5-90
Airbag System	1-46	Fabric/Carpet	5-87
Adding Equipment to Your Airbag-Equipped Vehicle	1-61	Finish Care	5-91
How Does an Airbag Restrain?	1-53	Finish Damage	5-93
Passenger Sensing System	1-56	Glass Surfaces	5-89
Servicing Your Airbag-Equipped Vehicle	1-60	Instrument Panel	5-89
What Makes an Airbag Inflate?	1-53	Interior Plastic Components	5-89
What Will You See After an Airbag Inflates?	1-54	Leather	5-89
When Should an Airbag Inflate?	1-51	Sheet Metal Damage	5-93
Where Are the Airbags?	1-49	Tires	5-92
All-Wheel Drive	5-48	Underbody Maintenance	5-93
All-Wheel-Drive (AWD) System	4-11	Vehicle Care/Appearance Materials	5-94
		Vinyl	5-89
		Washing Your Vehicle	5-90
		Weatherstrips	5-90
		Windshield, Backglass, and Wiper Blades	5-91
		Ashtrays	3-19

Audio System(s)	3-42
Care of Your CD Player	3-65
Care of Your CDs	3-64
Fixed Mast Antenna	3-65
Navigation/Radio System	3-64
Radio with CD	3-43
Radio with Six-Disc CD	3-53
Setting the Time	3-42
Understanding Radio Reception	3-64
XM™ Satellite Radio Antenna System	3-65
Automatic Headlamp System	3-15
Automatic Transaxle	
Fluid	5-23
Operation	2-22

B

Battery	5-42
Before Leaving on a Long Trip	4-23
Brake	
Anti-Lock Brake System (ABS)	4-7
Emergencies	4-9
Panic Assist	4-11
Parking	2-28
System Inspection	6-18
System Warning Light	3-32

Brakes	5-39
Braking	4-6
Braking in Emergencies	4-9
Break-In, New Vehicle	2-17
Bulb Replacement	5-49
Back-Up Lamps	5-54
Center High-Mounted Stoplamp (CHMSL)	5-51
Halogen Bulbs	5-49
Headlamps, Front Turn Signal, and Parking Lamps	5-49
Replacement Bulbs	5-55
Taillamps, Turn Signal, and Stoplamps	5-53
Buying New Tires	5-70

C

California Fuel	5-6
Canadian Owners	ii
Capacities and Specifications	5-100
Carbon Monoxide	2-11, 2-32, 4-26, 4-40
Care of	
Safety Belts	5-90
Your CD Player	3-65
Your CDs	3-64
Cargo Cover	2-39

Cargo Tie Downs	2-40	Cigarette Lighter	3-19
Center Console Storage Area	2-37	Cleaning	
Center High-Mounted Stoplamp (CHMSL)	5-51	Aluminum Wheels	5-92
Chains, Tire	5-73	Exterior Lamps/Lenses	5-90
Charging System Light	3-31	Fabric/Carpet	5-87
Check		Finish Care	5-91
Engine Light	3-35	Glass Surfaces	5-89
Checking Things Under the Hood	5-10	Instrument Panel	5-89
Chemical Paint Spotting	5-93	Interior Plastic Components	5-89
Child Restraints		Leather	5-89
Child Restraint Systems	1-31	Tires	5-92
Infants and Young Children	1-28	Underbody Maintenance	5-93
Lower Anchorages and Top Tethers for		Vinyl	5-89
Children (LATCH System)	1-38	Washing Your Vehicle	5-90
Older Children	1-26	Weatherstrips	5-90
Securing a Child Restraint Designed for		Windshield, Backglass, and Wiper Blades	5-91
the LATCH System	1-39	Climate Control System	3-20
Securing a Child Restraint in a		Air Filter, Passenger Compartment	3-23
Rear Seat Position	1-40	Outlet Adjustment	3-22
Securing a Child Restraint in the		Clutch, Hydraulic	5-27
Right Front Seat Position	1-42	Coinholder(s)	2-37
Top Strap	1-35	Compact Spare Tire	5-86
Top Strap Anchor Location	1-37	Content Theft-Deterrent	2-15
Where to Put the Restraint	1-34	Control of a Vehicle	4-6

Coolant	
Engine Temperature Gage	3-35
Heater, Engine	2-21
Cooling System	5-32
Cruise Control Lever	3-10
Cruise Control Light	3-39
Cupholder(s)	2-37
Customer Assistance Information	
Courtesy Transportation	7-7
Customer Assistance for Text Telephone (TTY) Users	7-4
Customer Assistance Offices	7-4
Customer Satisfaction Procedure	7-2
GM Mobility Program for Persons with Disabilities	7-5
Reporting Safety Defects to General Motors	7-11
Reporting Safety Defects to the Canadian Government	7-11
Reporting Safety Defects to the United States Government	7-10
Roadside Assistance Program	7-6
Service Publications Ordering Information	7-11

D

Daytime Running Lamps	3-14
Defensive Driving	4-2
Doing Your Own Service Work	5-4
Door	
Ajar Light	3-40
Locks	2-7
Power Door Locks	2-8
Programmable Automatic Door Locks	2-9
Rear Door Security Locks	2-10
Driver	
Position, Safety Belt	1-14
Seat Height Adjuster	1-3
Driving	
At Night	4-17
City	4-21
Defensive	4-2
Drunken	4-3
Freeway	4-22
Hill and Mountain Roads	4-24
In Rain and on Wet Roads	4-18
Recovery Hook	4-31
Rocking Your Vehicle to Get it Out	4-30
Winter	4-26

E

Electrical System	
Add-On Equipment	5-95
Engine Compartment Fuse Block	5-98
Fuses and Circuit Breakers	5-96
Headlamp Wiring	5-96
Instrument Panel Fuse Block	5-97
Power Windows and Other Power Options	5-96
Windshield Wiper Fuses	5-96
Engine	
Air Cleaner/Filter	5-21
Battery	5-42
Check and Service Engine Soon Light	3-35
Coolant	5-28
Coolant Heater	2-21
Coolant Temperature Gage	3-35
Cooling System Inspection	6-18
Engine Compartment Overview	5-12
Exhaust	2-32
Oil	5-16
Overheating	5-30
Starting	2-19
Entry Lighting	3-16
Event Data Recorders (EDR)	7-9
Extender, Safety Belt	1-25
Exterior Lamps	3-13

F

Filter	
Engine Air Cleaner	5-21
Finish Damage	5-93
Fixed Mast Antenna	3-65
Flash-to-Pass	3-8
Flat Tire	5-74
Flat Tire, Changing	5-75
Flat Tire, Storing	5-84
Floor Mats	2-38
Fluid	
Automatic Transaxle	5-23
Manual Transaxle	5-26
Power Steering	5-37
Windshield Washer	5-38
Fog Lamps	3-15
Folding Seatback, Passenger	1-5
Fuel	5-5
Additives	5-6
California Fuel	5-6
Filling a Portable Fuel Container	5-9
Filling Your Tank	5-7
Fuels in Foreign Countries	5-7
Gage	3-41
Gasoline Octane	5-5

Fuel (cont.)	
Gasoline Specifications	5-6
Low Warning Light	3-41
System Inspection	6-17
Fuses	
Engine Compartment Fuse Block	5-98
Fuses and Circuit Breakers	5-96
Instrument Panel Fuse Block	5-97
Windshield Wiper	5-96

G

Gage	
Engine Coolant Temperature	3-35
Fuel	3-41
Speedometer	3-27
Tachometer	3-27
Gasoline	
Octane	5-5
Specifications	5-6
Glove Box	2-37
GM Mobility Program for Persons with Disabilities	7-5

H

Hazard Warning Flashers	3-6
Head Restraints	1-5
Headlamp Wiring	5-96
Headlamps	
Automatic Headlamp System	3-15
Bulb Replacement	5-49
Daytime Running Lamps	3-14
Flash-to-Pass	3-8
Halogen Bulbs	5-49
Headlamps, Front Turn Signal, and Parking Lamps	5-49
High/Low Beam Changer	3-8
On Reminder	3-13
Heater	3-20
Height Adjuster, Driver Seat	1-3
Highbeam On Light	3-40
Highway Hypnosis	4-24
Hill and Mountain Roads	4-24
Hood	
Checking Things Under	5-10
Release	5-10
Horn	3-6
How to Use This Manual	ii
How to Wear Safety Belts Properly	1-14
Hydraulic Clutch	5-27

I

Ignition Positions	2-18
Infants and Young Children, Restraints	1-28
Inflation -- Tire Pressure	5-64
Inspection	
Brake System	6-18
Engine Cooling System	6-18
Exhaust System	6-17
Fuel System	6-17
Part C - Periodic Maintenance	6-17
Steering, Suspension and Front Drive Axle	
Boot and Seal	6-17
Throttle System	6-18
Instrument Panel	
Brightness	3-15
Cluster	3-26
Overview	3-4
Storage Area	2-37
Interior Lamps Control	3-16

J

Jump Starting	5-43
---------------------	------

K

Keyless Entry System	2-4
Keys	2-2

L

Labelling, Tire Sidewall	5-58
Lamps	
Exterior	3-13
Fog	3-15
Interior Control	3-16
Reading	3-17
LATCH System	
Child Restraints	1-38
Securing a Child Restraint Designed for the LATCH System	1-39
Liftgate/Liftglass	2-11
Liftglass/Liftgate	2-11
Light	
Airbag Readiness	3-29
Anti-Lock Brake System Warning	3-33
Brake System Warning	3-32
Charging System	3-31
Cruise Control	3-39
Door Ajar	3-40

Light (cont.)	
Highbeam On	3-40
Lights On Reminder	3-39
Low Fuel Warning	3-41
Low Tire Pressure Warning Light	3-33
Low Washer Fluid Warning	3-40
Malfunction Indicator	3-35
Oil Pressure	3-38
Overdrive Off	3-40
Passenger Airbag Status Indicator	3-30
Safety Belt Reminder	3-28
Stabilitrak [®] Indicator	3-34
Taillamp Indicator	3-39
TCS Warning Light	3-34
Traction Control System (TCS) Warning	3-34
Lighting	
Entry	3-16
Locks	
Door	2-7
Power Door	2-8
Programmable Automatic Door Locks	2-9
Rear Door Security Locks	2-10
Loss of Control	4-16
Low Fuel Warning Light	3-41
Low Washer Fluid Warning Light	3-40

M

Maintenance, Normal Replacement Parts	5-102
Maintenance Schedule	
At Each Fuel Fill	6-13
At Least Once a Month	6-13
At Least Once a Year	6-14
At Least Twice a Year	6-14
Brake System Inspection	6-18
Engine Cooling System Inspection	6-18
Exhaust System Inspection	6-17
Fuel System Inspection	6-17
How This Section is Organized	6-3
Introduction	6-2
Maintenance Requirements	6-2
Part A - Scheduled Maintenance Services	6-4
Part B - Owner Checks and Services	6-13
Part C - Periodic Maintenance Inspections	6-17
Part D - Recommended Fluids and Lubricants	6-19
Part E - Maintenance Record	6-21
Scheduled Maintenance	6-4
Steering, Suspension and Front Drive Axle	
Boot and Seal Inspection	6-17
Throttle System Inspection	6-18
Using Your	6-4
Your Vehicle and the Environment	6-2

Malfunction Indicator Light	3-35
Manual Seats	1-2
Manual Transaxle	
Fluid	5-26
Operation	2-25
Manual Windows	2-14
Mirrors	
Manual Rearview Mirror	2-34
Manual Rearview Mirror with OnStar®	2-34
Outside Convex Mirror	2-35
Outside Remote Control Mirrors	2-34
MyGMLink.com	7-3

N

Navigation/Radio System	3-64
New Vehicle Break-In	2-17
Normal Maintenance Replacement Parts	5-102

O

Odometer	3-27
Odometers, Trip	3-27
Off-Road Recovery	4-14

Oil	
Engine	5-16
Pressure Light	3-38
Older Children, Restraints	1-26
Online Owner Center	7-3
OnStar® System	2-35
Other Warning Devices	3-6
Outlet Adjustment	3-22
Outside	
Convex Mirror	2-35
Remote Controls Mirrors	2-34
Overdrive Off	2-24
Overdrive Off Light	3-40
Owners, Canadian	ii

P

Panic Brake Assist	4-11
Park (P)	
Shifting Into	2-28
Shifting Out of	2-30
Parking	
Brake	2-28
Over Things That Burn	2-32

Parking Your Vehicle	2-31
Part A - Scheduled Maintenance Services	6-4
Part B - Owner Checks and Services	6-13
Part C - Periodic Maintenance Inspections	6-17
Part D - Recommended Fluids and Lubricants	6-19
Part E - Maintenance Record	6-21
Passenger Airbag Status Indicator	3-30
Passenger Compartment Air Filter	3-23
Passenger Sensing System	1-56
Passing	4-14
Power	
Accessory Outlets	3-18
Door Locks	2-8
Electrical System	5-96
Outlet 115 Volt Alternating Current	3-18
Steering Fluid	5-37
Windows	2-14
Pretensioners, Safety Belt	1-24
Programmable Automatic Door Locks	2-9

Q

Questions and Answers About Safety Belts	1-13
--	------

R

Radiator Pressure Cap	5-30
Radios	3-42
Care of Your CD Player	3-65
Care of Your CDs	3-64
Navigation/Radio System	3-64
Radio with CD	3-43
Radio with Six-Disc CD	3-53
Setting the Time	3-42
Understanding Reception	3-64
Reading Lamps	3-17
Rear Cargo Accessory Track System	2-39
Rear Door Security Locks	2-10
Rear Seat Operation	1-7
Rear Seat Passengers, Safety Belts	1-21
Rear Storage Area	2-38
Rearview Mirror with OnStar®	2-34
Rearview Mirrors	2-34
Reclining Seatbacks	1-3
Recovery Hook	4-31
Recreational Vehicle Towing	4-37
Remote Keyless Entry System	2-4
Remote Keyless Entry System, Operation	2-5

Removing the Flat Tire and Installing the Spare Tire	5-78
Removing the Spare Tire and Tools	5-76
Replacement Bulbs	5-55
Reporting Safety Defects	
Canadian Government	7-11
General Motors	7-11
United States Government	7-10
Restraint System Check	
Checking Your Restraint Systems	1-62
Replacing Restraint System Parts After a Crash	1-63
Restraint Systems	
Checking	1-62
Replacing Parts	1-63
Right Front Passenger Position, Safety Belts	1-21
Roadside Assistance Program	7-6
Rocking Your Vehicle to Get it Out	4-30
Running Your Engine While You Are Parked	2-33

S

Safety Belt	
Pretensioners	1-24
Reminder Light	3-28

Safety Belts	
Care of	5-90
Driver Position	1-14
How to Wear Safety Belts Properly	1-14
Questions and Answers About Safety Belts	1-13
Rear Seat Passengers	1-21
Right Front Passenger Position	1-21
Safety Belt Extender	1-25
Safety Belt Use During Pregnancy	1-21
Safety Belts Are for Everyone	1-8
Shoulder Belt Height Adjuster	1-20
Safety Warnings and Symbols	iii
Scheduled Maintenance	6-4
Seatback, Folding Passenger	1-5
Seats	
Driver Seat Height Adjuster	1-3
Head Restraints	1-5
Manual	1-2
Passenger Folding Seatback	1-5
Rear Seat Operation	1-7
Reclining Seatbacks	1-3
Securing a Child Restraint	
Designed for the LATCH System	1-39
Rear Seat Position	1-40
Right Front Seat Position	1-42

Service	5-3
Adding Equipment to the Outside of Your Vehicle	5-5
Doing Your Own Work	5-4
Engine Soon Light	3-35
Publications Ordering Information	7-11
Servicing Your Airbag-Equipped Vehicle	1-60
Setting the Time	3-42
Sheet Metal Damage	5-93
Shifting Into Park (P)	2-28
Shifting Out of Park (P)	2-30
Shoulder Belt Height Adjuster	1-20
Signals, Turn and Lane-Change	3-8
Spare Tire	
Installing	5-78
Removing	5-76
Storing	5-84
Specifications, Capacities	5-100
Speedometer	3-27
Stabilitrak [®] System	4-10
Stabilitrak [®] Indicator Light	3-34
Starting Your Engine	2-19
Steering	4-11
Steering, Suspension and Front Drive	
Axle Boot and Seal Inspection	6-17

Steering Wheel, Tilt Wheel	3-7
Storage Areas	
Center Console Storage Area	2-37
Coinholder(s)	2-37
Cupholder(s)	2-37
Glove Box	2-37
Instrument Panel Storage Area	2-37
Rear Cargo Accessory Track System	2-39
Rear Storage Area	2-38
Stuck in Sand, Mud, Ice or Snow	4-30
Sun Visors	2-14
Sunroof	2-40

T

Tachometer	3-27
Taillamp Indicator Light	3-39
Taillamps	
Turn Signal, and Stoplamps	5-53
TCS Warning Light	3-34
Theft-Deterrent Systems	2-15
Content Theft-Deterrent	2-15
Throttle System Inspection	6-18
Tilt Wheel	3-7

Tires	5-57	Towing	
Aluminum Wheels, Cleaning	5-92	Recreational Vehicle	4-37
Buying New Tires	5-70	Towing a Trailer	4-40
Chains	5-73	Your Vehicle	4-37
Changing a Flat Tire	5-75	Traction	
Cleaning	5-92	Control System (TCS)	4-9
Compact Spare Tire	5-86	Control System Warning Light	3-34
If a Tire Goes Flat	5-74	Stabilitrak [®] System	4-10
Inflation -- Tire Pressure	5-64	Transaxle	
Inspection and Rotation	5-68	Fluid, Automatic	5-23
Installing the Spare Tire	5-78	Fluid, Manual	5-26
Pressure Monitor System	5-65	Transaxle Operation, Automatic	2-22
Removing the Flat Tire	5-78	Transaxle Operation, Manual	2-25
Removing the Spare Tire and Tools	5-76	Trip Odometers	3-27
Storing a Flat or Spare Tire and Tools	5-84	Turn and Lane-Change Signals	3-8
Tire Sidewall Labelling	5-58	Turn Signal/Multifunction Lever	3-7
Tire Terminology and Definitions	5-61		
Uniform Tire Quality Grading	5-70		
Wheel Alignment and Tire Balance	5-72		
Wheel Replacement	5-72		
When It Is Time for New Tires	5-69		
Top Strap	1-35		
Top Strap Anchor Location	1-37		

U

Understanding Radio Reception	3-64
Uniform Tire Quality Grading	5-70

V

Vehicle	
Control	4-6
Damage Warnings	iv
Parking Your	2-31
Symbols	iv
Vehicle Data Collection and Event	
Data Recorders	7-9
Vehicle Identification	
Number (VIN)	5-95
Service Parts Identification Label	5-95
Ventilation Adjustment	3-22
Visors	2-14

W

Warning Lights, Gages and Indicators	3-25
Warnings	
Hazard Warning Flashers	3-6
Other Warning Devices	3-6
Safety and Symbols	iii
Vehicle Damage	iv
Washer Fluid, Low Warning Light	3-40

Wheels	
Alignment and Tire Balance	5-72
Replacement	5-72
Where to Put the Restraint	1-34
Windows	2-13
Manual	2-14
Power	2-14
Windshield	
Backglass, and Wiper Blades, Cleaning	5-91
Windshield Washer	3-10
Fluid	5-38
Windshield Wiper	
Blade Replacement	5-56
Fuses	5-96
Windshield Wipers	3-9
Winter Driving	4-26

X

XM™ Satellite Radio Antenna System	3-65
--	------

Y

Your Vehicle and the Environment	6-2
--	-----